



HAL
open science

The emergence of low-carbon air mobility : dynamics, conflicts of use and energy justice

Jean-Baptiste Jarin

► **To cite this version:**

Jean-Baptiste Jarin. The emergence of low-carbon air mobility : dynamics, conflicts of use and energy justice. Economics and Finance. Université de Pau et des Pays de l'Adour, 2024. English. NNT : 2024PAUU2173 . tel-04906434

HAL Id: tel-04906434

<https://theses.hal.science/tel-04906434v1>

Submitted on 22 Jan 2025

HAL is a multi-disciplinary open access archive for the deposit and dissemination of scientific research documents, whether they are published or not. The documents may come from teaching and research institutions in France or abroad, or from public or private research centers.

L'archive ouverte pluridisciplinaire **HAL**, est destinée au dépôt et à la diffusion de documents scientifiques de niveau recherche, publiés ou non, émanant des établissements d'enseignement et de recherche français ou étrangers, des laboratoires publics ou privés.

THESE DE DOCTORAT

ED 481 - Sciences sociales et humanités

Présentée et soutenue le : 20/12/2024

Par : Jean-Baptiste JARIN

Thèse pour obtenir le grade de

Docteur de l'Université de Pau et des Pays de l'Adour

Science de la durabilité

The emergence of low-carbon air mobility: dynamics, conflicts of use and energy justice

JURY

Rapporteur, Président du Jury

- Erwin FRANQUET Professeur, Université Côte d'Azur

Rapporteur

- Oliver MASSOL Professeur, CentraleSupélec – Université Paris-Saclay

Examineur

- Iban LIZARRALDE Enseignant Chercheur, Ecole Supérieure des Technologies Industrielles Avancées

Directeurs de thèse

- Louis de FONTENELLE Maître de Conférences HDR, Université de Pau et des Pays de l'Adour
- Carole HARITCHABALET Professeur, Université de Pau et des Pays de l'Adour





FOREWORD

With this thesis, I would like to contribute to the debate on a subject that seems to me to be one of the major challenges of our time. Not only because I consider decarbonization and energy transition as important issues within our societies, but also because air mobility is an energy intensive tertiary need benefiting to the most affluent. As such the decarbonization of air mobility should be mandatory and exemplary. This need to set an example is all the greater given that decarbonizing air mobility largely involves decarbonizing its energy, which means that other parties are also involved. It is therefore important that energy justice be the cornerstone of the decarbonization roadmap for this hard-to-abate sector, energy justice being defined as an equitable access to energy, the fair distribution of costs and benefits, and the right to participate in choosing whether, and how, energy systems will change.

The research carried out aims to answer the question: How can we propose a decarbonization trajectory for air mobility that is commensurate with the stakes, credible, and socially acceptable? This required a holistic approach, adding new elements to the existing literature and knowledge in various disciplines, including energy, combustion, public policies, and energy justice. When producing the results, the aim was to make them as accessible as possible to all those interested in air mobility, energy, and climate issues, to facilitate the appropriation of the results by citizens and public policy players.

The research and views expressed in this thesis are my own and not those of the companies, institutes or individuals mentioned below. I have indeed had the immense good fortune to be able to study subjects that are close to my heart and of interest to me with great freedom.

Thanks

First, I would like to thank Louis de Fontenelle for accepting the challenge of a cross-disciplinary thesis and providing the guidance I needed. Thank you for reassuring me when necessary. Thank you for pushing me when necessary. My most sincere thanks go to my second thesis advisor, Carole Haritchabalet, who was available when I needed. This anxiety-inducing situation was quickly swept away by their benevolence and pedagogy, thank you both for the trust you have placed in me over the past three years.

I would also like to thank the entire E2S and EJ&SC Chairs who welcomed me during these three years, especially Louis de Fontenelle, but also Isabelle Montin, Laura de Resende, Elodie Annamayer, Halima Hussein, and Alice Moulene-Daubat. Thank you for your kindness and humanism. Thank you for your patience and your pragmatic advises.

I have had the chance to publish articles in very different reviews, from energy management to climate policies, and reaching a decent expertise in various disciplines was made possible thanks to the guidance and kindness of my publications co-authors. A special mention to two of them: Daniel Iracane from the French Académie des Technologies and Jean-Louis Champion from SafranTech, whose professionalism, experience, and kindness accompanied me all the way to improve my expertise.

During these three years I have had the opportunity to conduct researches, study, publish, but also teach. Learning and sharing is an endless endeavor and this approach brings me immense joy. My sincere thanks go to Iban Lizzaralde from ESTIA Institute of Technology, who trusted me to build and teach two major courses (climate, energy and economy within the energy transition, and low carbon aviation) for his 1st year students. His experience and empathy certainly shine within this thesis.

Starting a thesis is always a challenge, moreover after 25 years of working experience in the industry, and without the support of my wife and kids this journey would have not been the same. Thank you Lénaïg for your patience, support, and interest in my works, thank you Amélie & Léa for accepting your dad being a student (again).

I also had the opportunity to share and learn with various professionals, from interviews to working groups. Lots of side discussions took place during congresses and working groups and I would like to thank here Burkhard Schneider from ADAC, Jean-Philippe Evrard and Cyrille Weber from Airbus, Solene Regourd and Adrien Chabot from Amelia,

Seana Lanigan from Argus Media, Thomas Parsons from Bell, Professor Paul Peeters from Breda University, Christian Bachellerie and Pascal Clee from Daher, Michal Kubicki and Zlatko Kregar from European Commission, Freddy Duran Martinez and Benoit Decourt from Elyse Energy, Reetu Sallinen and Géraldine Pic-Paris from Neste, Bachir Lahsini and Pauline Gasquet from Rive Private Investment, Pascal Dauriac, Quentin Vincenzotto, Fabien Mercier-Calvairac, Olivier Pezeron and Stéphane Beddok from Safran, Angélique Chanal, Clarisse Doucet and Florent Picard from Total Energies, Edgar Steewinkel from Virent Inc.

Finally, many thanks to family, friends, and colleagues.

Abstract

From its birth a century ago to the present day, aviation and human societies have walked hand in hand, exchanging supranational entrepreneurial freedom for increased productivity for nations.

Today, this entrepreneurial freedom is coming up against energy and environmental constraints, and the sector is struggling to propose a credible decarbonization trajectory. But even more importantly for our societies, decarbonizing air mobility necessarily involves decarbonizing its energy, which will mobilize considerable quantities of biomass and electricity, resources that are already under pressure. This will have an impact on our societies as a whole, given that only 2% to 4% of the population travels internationally, and that even within the European Union, one of the richest regions in the world, it is the wealthiest 10% who account for 88% of all travel.

The concept of energy justice must therefore be considered when defining the roadmap for decarbonizing air mobility. The sector, which has just emerged from a cyclical crisis with Covid 19, could in the near future be faced with a triple structural crisis linked to climate change, energy transition and energy injustice, all of which would increase criticism of the sector. Today's "flyskam" can be explained solely by the continuing rise in eCO₂ emissions from air travel, against a backdrop of worsening climate change. Adding tensions over the energy transition and/or energy injustice for populations could only reinforce this mistrust of air transport.

Historically, the efficiency and optimization efforts of both manufacturers and airlines have not been aimed at lowering eCO₂ emissions, but at cutting costs in order to stimulate air traffic growth. The sector's key indicator, fuel consumption expressed in passenger-kilometers, shows a division by 5 when the reference point is the introduction of the first jet aircraft. This would be significantly less if the reference point had remained the propeller plane, which flew half as fast, but more importantly, this reduction translates into lower costs, which in turn generate an explosion in traffic, multiplied by 20 over the same period. This translates into a quadrupling of fuel consumption, and therefore eCO₂ emissions.

The need to reduce overall eCO₂ emissions has been identified since 1997. It was at this time that the Kyoto Protocol, in Article 2, mandated ICAO to prepare policy measures for the reduction of greenhouse gas (GHG) emissions from aviation. ICAO will take 19 years to reach resolution A39-3 (2016), which proposes a global market-based measure, CORSIA. It will take another 11 years, to 2027, for this measure to become mandatory. In those 30 years, eCO₂ emissions from air mobility will have doubled. And as the CORSIA measure aims to "stabilize net emissions at 2020 levels", while allowing the use of carbon offsets and aviation fuels still of fossil origin but with a lower eCO₂ content - just a few percent - it is therefore highly likely that the sector's emissions will continue to grow, as traffic is set to continue increasing by 3 to 4% / year.

As the decarbonization of air mobility is an imperative, it may seem a shame that it is a regulation external to ICAO, in this case the European Union's ReFuel EU Aviation, which is forcing the sector to take serious steps towards decarbonization, with the introduction of incorporation mandates and the precise definition of sustainable low-carbon fuels (SAF - Sustainable Aviation Fuel). From 2030, these mandates will oblige producers to produce, distributors to distribute and consumers to use an increasing proportion of SAF in their operations. 6% by 2030, and 70% by 2050.

Although ambitious, exemplary, and necessary, these regulations will only partially meet the need. However, this exemplary approach is starting to catch on, and several countries are beginning to draw inspiration from it, putting pressure on the ICAO, which still limits itself to proposing "carbon-neutral growth beyond 2020" and an "aspirational long-term goal of net zero by 2050". As these objectives are too vague and lack any real obligations, the 2009 target proposed by IATA will be used as a reference in this thesis. This target aims to achieve a 50% reduction in net eCO₂ emissions by 2050, compared with 2005 levels. This makes it possible to set a quantified target, in this case 325 Mt eCO₂. This figure may not seem very ambitious, but it should be compared with the sector's eCO₂ emissions of almost 1.4 Gt in 2019 (all air mobility, including upstream fuel emissions).

The roadmap established in this thesis to meet this objective concludes that six levers need to be mobilized, the two most important of which are speed reduction and, even more importantly, the massive deployment of low-carbon fuel (SAF for Sustainable Aviation Fuel). More than 90% of the decarbonization of air mobility depends on the decarbonization of its energy: without the total decarbonization of its energy, the target of 325 Mt eCO₂ is found to be unrealistic.

Ripping off and maintaining a heavier-than-air aircraft requires a significant amount of energy, and the options for air mobility will be further reduced for decades to come to molecules with the best energy density/volume density/mass density ratio, as the effects associated with carrier integration are considerable. The thesis defended here is that SAFs offer the best energy rate of return (ERoEI), which impacts on eCO₂ emissions and production costs, but also on the quantity of inputs (biomass, electricity) required. Compared with hydrogen or battery-electric options, SAFs happen to be the least inefficient energy carriers for air mobility. But while SAF combustion emissions are more environmentally friendly than those of fossil fuels, reducing not only CO₂ emissions but also emissions of pollutants such as soot or CO, SAF production involves concentrating energy that will be derived from biomass and/or electricity.

This is a major challenge, and one that goes far beyond air mobility alone, since it will require a new supply chain, and above all access to new raw materials: biomass and electricity. All energies have their externalities, and low-carbon energies even more so. While air mobility currently uses 8% of the world's oil, a primary energy largely dedicated to mobility and which meets a third of mankind's energy needs, it is clear that the replacement of this fossil energy by SAF will revolutionize our societies for three fundamental reasons. Firstly, the increased pressure on biomass and electricity needs could destabilize the supply-demand balance, with a shock to demand translating into higher prices. Secondly, these two inputs serve vital needs for the whole of humanity, which would magnify the effects of a demand shock and potentially increase the energy insecurity of the most fragile, who happen to be those who do not benefit from air mobility. Thirdly, as the price of a molecule of SAF is structurally 3 to 5 times higher than that of fossil fuels, it is highly likely that the sector will seek to minimize its costs, either directly through subsidies, or indirectly through energy taxation. The risks identified in both cases are not insignificant: energy injustice in developed countries, replication of the oil curse for developing countries.

The trajectory of decarbonization of air mobility is therefore on a crest, but the sharp rise in energy costs so feared by the sector could in fact be the key to changing the paradigm and thus reducing, or even annihilating, these side effects. Far from being a threat, the thesis defended here considers that this rise in energy costs presents a double opportunity, if we consider decarbonization as vital and energy justice as a prerequisite for maintaining harmony in our societies. It is an opportunity for the airline industry, as airlines have already proved in the past that they can increase their profitability when energy prices rise. At the same time, the development of ever more efficient and slower aircraft, based on turboprops and open rotors, will provide the industry with further food for thought. With an atypical ratio of eCO₂ emissions over the lifecycle, more than 90% of aviation emissions are due to jet fuel combustion, and just under 1% to aircraft construction and maintenance, the accelerated replacement of fleets presents numerous opportunities, both for the climate and for the economy. Secondly, higher prices would moderate traffic growth, the thesis considering that it could remain within a range of -0.5 to +1.6% / year, subject to lower flight speeds. This reduced growth in air traffic would in turn limit the pressure on biomass and low-carbon electricity, thus minimizing the knock-on effects for our societies. This loop, less vicious than the current one for both the environment and our societies, requires us to reverse our relationship with speed and price. The original paradigm of higher speeds and lower prices, with the corollary of ever-increasing pressure on energy resources and the climate, becomes one of lower speeds and higher prices, in order to minimize externalities.

However, even assuming that all the levers are fully deployed, conflicts over the use of biomass and electricity will be significant, and the stakes therefore go far beyond the air mobility sector alone. Energy is vital to our modern societies, and society at large, but even more so energy specialists and politicians need to understand that biomass and electrons are not only too precious to be wasted, but must also be viewed through the prism of energy justice. Air mobility cannot escape this, and should even be the driving force behind it, as long-distance mobility remains a tertiary, energy-intensive need that benefits only the most affluent populations.

Whether through the market, i.e. prices, or through a policy of resource allocation, inputs will be mobilized for the production of SAF, and the thesis proposes to consider a volume of between 150 and 300 Mt / year. This is 2 to 4 times less than the scenario envisaged by ICAO and IATA, which would mobilize 600 Mt of jet fuel by 2050. To illustrate, if this 600 Mt were to be SAF produced entirely from low-carbon electricity, this would mobilize around 20 000 TWh, equivalent to 80% of the world's electricity production in 2019. The ratio is therefore a long way from the current 8% with oil, which leads to two conclusions. Firstly, it is not the technology that is the problem, but scaling up. Secondly, unlike oil, which has been a primary energy source dedicated to mobility and chemicals since the oil crises, electricity, like biomass, is essentially used for basic human needs such as food, lighting, and heating. It is therefore essential that this commodity does not follow the same rules as those written over the decades for oil, and it is now time to establish the *quid pro quo*s to be associated with the earmarking of biomass and electricity resources.

The twofold quid pro quo proposed in this thesis is a cap on emissions combined with an overhaul of the energy tax system applied to air mobility, in strict compliance with climate objectives and the basic principles of energy justice. Indeed, while SAF will have a cost for the aviation sector, securing its inputs will have a cost for our societies as a whole, and this focus on biomass and electricity seems to me to justify the introduction of major compensatory measures. A strict emissions cap of 325 Mt eCO₂ would mean a de facto cap on jet fuel consumption. Indeed, the life cycle of SAF significantly reduces eCO₂ emissions when compared with fossil oil, but does not cancel them out. The average considered in the thesis being close to 20 g eCO₂ / MJ, this ceiling would therefore be 370 Mt of jet fuel, which is not very far from either the high range considered for the coming years in this thesis, close to 300 Mt, or the volume found to be consumed by the aviation sector in 2019, close to 330 Mt. In any case, this would be the annual volume not to be exceeded in the context of the coming transition.

Finally, in support of the energy transition and associated public policies, the proposed thesis develops and supports the concept of the pyramid of human energy needs as a foundation for energy justice. Based on Maslow's hierarchy, it proposes aligning the allocation of energy resources and their taxation with people's primary, secondary and tertiary energy needs. For instance energy injustice can be characterized, as identified in this thesis, by a final electricity price three times lower when it comes to long-distance mobility - a tertiary need affecting 2 to 4% of the world's population - than when it comes to meeting primary needs such as heating or food, which concern the whole of humanity.

This concept of decarbonizing air mobility through regulation and energy justice seems to me to be particularly well suited to the challenges associated with the decarbonization of the sector for at least two essential reasons: the credibility of the trajectory and its acceptance by public opinion.

Abstract - Français

Depuis sa naissance, il y a un siècle et jusqu'à aujourd'hui, l'aviation et les sociétés marchent main dans la main, échangeant une liberté d'entreprise supranationale contre une productivité accrue pour les nations.

Cette liberté d'entreprendre se heurte aujourd'hui aux contraintes énergétiques et environnementales, et le secteur peine à proposer une trajectoire de décarbonation crédible. Mais plus important encore pour nos sociétés, la décarbonation de la mobilité aérienne passe forcément par la décarbonation de son énergie, ce qui va mobiliser des quantités considérables de biomasse et d'électricité, des ressources qui sont déjà en tension. Cela ne sera donc pas sans impacts pour l'ensemble de nos sociétés, ce alors que seulement 2 à 4% de la population voyage à l'international et qu'au sein même de l'Union Européenne, l'une des zones les plus riches du monde, ce sont les 10% les plus aisés qui réalisent 88% des voyages.

Il est dès lors nécessaire que le concept de justice énergétique soit pris en compte lors de la définition de la feuille de route de décarbonation de la mobilité aérienne. Le secteur, qui vient de sortir d'une crise conjoncturelle avec le Covid 19, pourrait dans un avenir proche être confronté à une triple crise structurelle liée au changement climatique, à la transition énergétique, mais aussi à l'injustice énergétique, ce qui viendrait accroître les critiques envers le secteur. Le « flyskam » s'explique actuellement par la seule hausse continue des émissions eCO₂ de la mobilité aérienne dans un contexte de changement climatique, dont les effets vont en s'aggravant. Y ajouter des tensions sur la transition énergétique et / ou de l'injustice énergétique pour les populations ne pourraient que renforcer cette défiance envers le transport aérien.

Historiquement, les efforts d'efficacité et d'optimisation des constructeurs comme des compagnies aériennes ne visent pas à baisser les émissions eCO₂, mais à diminuer les coûts, afin de stimuler la croissance du trafic aérien. L'indicateur clef du secteur, la consommation de carburant exprimée en passagers-kilomètres, montre ainsi une division par 5 lorsque le point de référence est l'introduction du premier avion à réaction. Ce serait sensiblement moins si le point de référence était resté l'avion à hélice, qui volait deux fois moins vite, mais plus important encore, cette diminution se traduit par une baisse des coûts qui engendre une explosion du trafic, multiplié par 20 sur la même période. Cela se traduit par un quadruplement de la consommation de carburant, et donc des émissions d'eCO₂.

La nécessité de diminuer les émissions globales de eCO₂ est identifiée depuis 1997. C'est à cette date que le protocole de Kyoto, dans son article 2, charge l'OACI de préparer des mesures politiques pour la réduction des émissions de gaz à effet de serre (GES) de l'aviation. L'OACI mettra 19 ans pour parvenir à la résolution A39-3 (2016), qui propose une mesure globale basée sur le marché, CORSIA. Il faudra 11 ans de plus, 2027, pour que cette mesure devienne obligatoire. Au cours de ces 30 années, les émissions de eCO₂ de la mobilité aérienne auront doublé. Les mesures et objectifs proposés par le secteur ne semblent par ailleurs ne pas être à la hauteur des enjeux : « stabiliser les émissions nettes aux niveaux de 2020 » tout en autorisant l'utilisation de compensations carbone et de carburants aviation toujours d'origine fossile « à moindre teneur en eCO₂ » (quelques pourcents). Face à une croissance du trafic aérien estimée, et espérée par le secteur, de 3 à 4% / an, il est par conséquent très probable que les émissions du secteur continuent de croître dans les prochaines années.

La décarbonation de la mobilité aérienne étant un impératif, il peut sembler dommage que ce soit une réglementation externe à l'OACI, en l'occurrence celle de l'Union Européenne, ReFUel EU Aviation, qui force le secteur à prendre des mesures sérieuses avec la mise en place de mandats d'incorporation de carburants bas carbone et leurs définitions précises. Ces mandats vont obliger, à partir de 2030, producteurs à produire, distributeurs à distribuer, consommateurs à utiliser, une part croissante de SAF dans leurs opérations. 6% en 2030, et 70% en 2050.

Bien qu'ambitieuse, exemplaire et nécessaire, cette réglementation ne répondra que partiellement au besoin. Cette exemplarité commence toutefois à faire tache d'huile et plusieurs pays commencent à s'en inspirer, mettant sous pression l'OACI qui se limite encore à proposer une "croissance neutre en carbone au-delà de 2020" et à un "objectif aspirationnel à long terme de net zero d'ici 2050". Objectifs trop vagues et sans réelles obligations. Construire une trajectoire de décarbonation suppose un objectif, et cette thèse s'appuie sur celui proposé en 2009 par IATA « atteindre une réduction de 50 % des émissions nettes eCO₂ d'ici 2050 par rapport à 2005 ». Cela permet de fixer un objectif chiffré, en l'occurrence 325 Mt eCO₂, qui ne peut être contesté par le secteur. Si ce chiffre peut sembler peu ambitieux à l'heure où l'Union Européenne devrait tenir son objectif de -50% d'ici à 2030 vs 1990, la thèse démontre

qu'il représente déjà un défi de taille (les émissions eCO₂ de 2019 avoisinent 1,4 Gt, toute mobilité aérienne, y-inclus les émissions amont du carburant) et qu'il ne sera finalement qu'une étape dans la trajectoire de décarbonation du secteur.

La construction de la feuille de route établit dans cette thèse pour tenir cet objectif conclut à la nécessiter de mobiliser six leviers, les deux plus importants étant la réduction de la vitesse, mais plus encore le déploiement massif de carburant bas carbone (SAF pour Sustainable Aviation Fuel). Près de 99 % de la décarbonation de la mobilité aérienne repose sur la décarbonation de son énergie : sans la décarbonation totale de son énergie, l'objectif de 325 Mt eCO₂ n'est pas réaliste sauf à considérer d'autres leviers comme la compensation ou la séquestration du carbone. Le premier est largement critiqué, le second hypothétique. Ils ne sont pas considérés dans cette thèse, d'autant qu'ils devraient être réservés au socle de nos émissions incompressibles.

Arracher et maintenir un plus lourd que l'air à la gravité nécessite une quantité d'énergie importante, et les options pour la mobilité aérienne seront encore réduites pour les décennies à venir aux molécules ayant le meilleur rapport densité d'énergie / densité de volume / densité de masse car les effets associés à l'intégration au porteur sont considérables. La thèse défendue ici est que ce sont les SAF qui présentent le moins mauvais taux de retour énergétique (ERoEI), taux qui impacte les émissions eCO₂ et les coûts de production, mais aussi la quantité d'intrants (biomasse, électricité) nécessaires. Par rapport aux options hydrogène ou batterie électrique, il se trouve que les SAF sont les vecteurs énergétiques les moins inefficaces pour la mobilité aérienne. Mais si la thèse conclut que les émissions liées à la combustion des SAF s'avèrent plus respectueuses de l'environnement que celles des carburateurs fossiles qu'ils vont remplacer, réduisant non seulement les émissions de CO₂ mais aussi les émissions de polluants tels que la suie ou le CO, la production de SAF implique de concentrer l'énergie qui sera issue de la biomasse et / ou de l'électricité bas carbone, des ressources déjà en tension.

Il s'agit donc d'un défi de taille, qui dépasse largement les seuls enjeux de la mobilité aérienne car, in fine, cela revient à faire porter l'essentiel du poids de la transition à d'autres. Le développement et le déploiement de centaines de millions de tonne de SAF va nécessiter la mise en place d'une nouvelle chaîne d'approvisionnement, mais surtout un accès à la biomasse et à l'électricité. Toutes les énergies ont leurs externalités, et les énergies à faible teneur en carbone plus encore. Alors qu'actuellement la mobilité aérienne mobilise 8% du pétrole mondial (énergie primaire largement dédiée à la mobilité et qui vient répondre au tiers des besoins énergétiques de l'humanité), le constat est que le remplacement de cette énergie fossile par les SAF va bouleverser nos sociétés pour trois raisons fondamentales :

- Premièrement, la pression accrue sur les besoins en biomasse et en électricité peut déstabiliser l'équilibre offre-demande, un choc de la demande se traduisant par une hausse des prix. Le constat fait ici étant que le choc serait très significatif.
- Deuxièmement, ces deux intrants servent des besoins vitaux pour l'ensemble de l'humanité, ce qui viendrait magnifier les effets d'un choc de la demande et potentiellement accroître l'insécurité énergétique des plus fragiles.
- Troisièmement, le prix d'une molécule de SAF étant structurellement 3 à 5 fois supérieur à celle d'origine fossile, il est très probable que le secteur cherche à minimiser ses coûts de manière directe (par le biais de subventions), ou indirecte (par le biais de la fiscalité sur l'énergie). Les risques identifiés dans les deux cas ne sont pas anodins : injustice énergétique dans les pays développés, réplique de la malédiction du pétrole pour les pays en voie de développement.

La trajectoire de décarbonation de la mobilité aérienne s'inscrit donc sur une ligne de crête, mais cette hausse peut représenter une double opportunité dès lors que nous considérons la décarbonation comme vitale et la justice énergétique comme prérequis pour maintenir l'harmonie dans nos sociétés.

Aussi, la thèse défend l'idée que la hausse très sensible du coût de l'énergie pour la mobilité aérienne ne devrait pas être tant redoutée par le secteur. Au contraire, elle pourrait en réalité être une opportunité : la clef pour changer de paradigme et ainsi minimiser ces bouleversements pour l'ensemble de nos sociétés.

C'est une opportunité pour le secteur de l'aérien car les compagnies aériennes ont déjà prouvé par le passé qu'elles pouvaient accroître leur rentabilité lorsque le prix de l'énergie augmente. Dans le même temps, le développement d'aéronefs toujours plus efficaces et moins rapides, à base de turbopropulseurs et d'open rotor, viendrait nourrir les industriels. Avec un ratio atypique des émissions eCO₂ sur le cycle de vie, 99% des émissions de l'aérien reposent sur la combustion du jet fuel, pour un peu moins de 1% pour la construction et la maintenance des aéronefs, le remplacement accéléré des flottes présente en ce sens de nombreuses opportunités, pour le climat comme pour l'économie de l'aérien.

Deuxièmement, la hausse des prix viendrait modérer la croissance du trafic, qui peut, toujours sous réserve de baisser la vitesse des vols, demeurer dans une fourchette de -0.5 à +1.6% / an. Cette moindre croissance du trafic aérien limiterait en retour la pression sur la biomasse et l'électricité bas carbone, minimisant ainsi les effets de bords pour nos sociétés. Cette boucle, moins vicieuse que l'actuelle pour l'environnement comme pour nos sociétés, impose d'inverser notre rapport à la vitesse et au prix. Le paradigme originel, hausse de la vitesse et baisse des prix, avec comme corollaire une pression toujours plus accrue sur les ressources énergétiques et le climat, devient baisse de la vitesse et hausse des prix afin d'en minimiser les externalités.

Toutefois, et même en considérant que l'ensemble des leviers soient pleinement déployés, les conflits sur l'utilisation de la biomasse et de l'électricité seront sensibles, et l'enjeu dépasse donc largement le seul secteur de la mobilité aérienne. L'énergie est vitale pour nos sociétés modernes, et la société au sens large. Dès à présent, nos politiques publiques doivent considérer que biomasse et électricité sont, non seulement trop précieuses pour être gaspillées, mais qu'elles doivent aussi être considérées sous le prisme de la justice énergétique. La mobilité aérienne ne peut y échapper. Mieux, elle devrait en être le moteur car la mobilité longue distance reste un besoin tertiaire, à forte intensité énergétique, qui ne bénéficie qu'aux populations les plus aisées.

Que ce soit par le marché, donc les prix, ou par une politique d'allocation des ressources, des intrants seront mobilisés pour la production de SAF. La thèse propose de considérer un volume qui s'établirait entre 150 et 300 Mt / an afin de tenir compte des enjeux sociétaux associés au fléchage de ces intrants. C'est 2 à 4 fois moins que le scénario envisagé par ICAO et IATA, qui mobiliserait plus de 600 Mt de carburéacteur en 2050, mais il semble difficilement concevable d'atteindre de tels volumes. Pour illustrer le propos, si ce volume de 600 Mt devait être du SAF produit en totalité à partir d'électricité bas carbone, cela mobiliserait environ 20 000 TWh, l'équivalent de 80% de la production mondiale d'électricité de 2019. Le ratio est donc très éloigné des 8% actuel sur le pétrole, ce qui amène à deux conclusions :

- Premièrement, ce n'est pas la technologie qui est problématique, mais le passage à l'échelle.
- Deuxièmement, contrairement au pétrole qui est une énergie primaire dédiée à la mobilité et à la chimie depuis les chocs pétroliers, l'électricité et la biomasse servent pour l'essentiel les besoins de base de l'humanité, tel que se nourrir, s'éclairer, se chauffer.

Il est donc nécessaire que ces commodités ne suivent pas les mêmes règles que celles écrites au fil des décennies pour le pétrole. Aussi, il convient dès à présent d'établir les contreparties à associer au fléchage de ces deux ressources.

La thèse propose une triple contrepartie qui s'inscrit dans une logique de justice énergétique et climatique. Strict plafonnement des émissions globales, orientation des intrants disponibles avec la mise en place d'un ordre de mérite pour la biomasse et l'électricité, refonte de la fiscalité énergétique appliquée à la mobilité aérienne. Afin de soutenir cette approche, le concept de pyramide des besoins énergétiques de l'humain comme socle à la justice énergétique vient conclure cette thèse. Basée sur la hiérarchie de Maslow, elle propose d'aligner l'allocation des ressources énergétiques et de leurs fiscalités sur les besoins énergétiques primaires, secondaires et tertiaires de l'humain. Seule cette approche me semble être de nature à éviter l'injustice énergétique, comme par exemple un prix final de l'électricité qui serait trois fois moins élevé lorsque dédié à l'aérien que lorsque appelé pour répondre à des besoins primaires comme se chauffer. De manière générale, le concept de justice énergétique doit être vu comme une opportunité pour la construction d'une trajectoire de décarbonation de la mobilité aérienne qui soit à la fois crédible, juste et efficace.

TABLE OF CONTENTS

Foreword	3
Thanks	3
Abstract.....	5
Abstract - Français.....	8
Table of contents	11
List of abbreviations	16
Definitions: SAF & Scope of air mobility eCO ₂ emissions	18
List of FIGURES	20
List of TABLES	27
Introduction	31
1. Climate Change and energy.....	31
1.1. eCO ₂ emissions.....	31
1.2. Climate Change, Energy and GDP	34
1.3. Climate change and energy transition.....	37
1.4. Beyond GHG.....	39
2. The role of energy in our mobility.....	42
2.1. Energy and GHG emissions in our mobilities	42
2.2. Which energy for which mobility	44
2.3. Electricity, the energy at the heart of tomorrow's sustainable mobility.....	45
2.4. Which low-carbon energy carriers for which sustainable mobility?.....	46
3. Objectives and methodology.....	49
3.1. Problematic	49
3.2. Theorizing energy justice within air mobility.....	50
3.3. Part I Understanding the Decarbonizing Air Mobility	51
3.4. Part II From decarbonizing the energy for mobility to conflicts over resource use.....	52
3.5. Part III The role of Energy Justice within the air mobility decarbonization roadmap	52
Part I. Understanding the decarbonization of air mobility	53
I.I eCO₂ emissions	55
I.I.1. Air mobility past and current eCO ₂ emissions	55
I.I.1.1. Defining the scope and comparing data	55
I.I.1.2. Air mobility fuel burn within air mobility total emissions	60
I.I.1.3. Fuel burn carbon intensity.....	62
I.I.1.4. Fuel consumption	64

I.I.1.5. Air Mobility global eCO ₂ emissions.....	67
I.I.1.6. Understanding the gap between different eCO ₂ emissions reports.....	69
I.I.2. A proposed methodology for the calculation of air mobility eCO ₂ emissions.....	73
I.I.2.1. Calculating eCO ₂ emissions: Existing regulations & methodologies.....	74
I.I.2.2. Methodology applied to Helicopter.....	75
I.I.2.3. Fuel Carbon Intensity.....	77
I.I.2.4. Fuel burn.....	79
I.I.2.5. Mission duration.....	80
I.I.2.6. Motorization.....	81
I.I.2.7. Mission profile.....	82
I.I.2.8. Combinatorial.....	85
I.II. Air Mobility.....	89
I.II.1. Context.....	89
I.II.1.1. 1960-1980: Jet Age & Jet Set.....	90
I.II.1.2. 1980-2000: Deregulation, expanding the market sphere.....	93
I.II.1.3. 2000-2019 Cost & Leisure, boosting the traffic growth.....	96
I.II.2. Regulations.....	101
I.II.2.1. ICAO and CORSIA.....	102
I.II.2.2. IATA.....	106
I.II.2.3. CORSIA and the new leading role of the European Union.....	108
I.III. Air Mobility GHG future scenarios.....	115
I.III.1. Role of technologies.....	115
I.III.1.1. Propulsion systems and aircraft efficiency.....	115
I.III.1.2. Operational efficiency.....	119
I.III.1.3. Potential of technologies and way forward.....	121
I.III.1.4. SAF.....	125
I.III.2. Role of sobriety in use.....	131
I.III.2.1. Cost Index.....	132
I.III.2.2. The role of speed in eCO ₂ emissions.....	133
I.III.2.3. Modal shift.....	138
I.III.3. Proposed scenarios for the decarbonization of Air Mobility.....	141
I.III.3.1. ICAO and IATA scenarios.....	141
I.III.3.2. NGOs scenarios.....	143
I.III.3.3 Proposed scenarios.....	144
I.IV. Part I conclusions.....	151
Part II. From decarbonizing the energy for air mobility to conflicts over resources use.....	153

II.I Which energies for decarbonizing air mobility.....	155
II.I.1. Comparing energy efficiency	155
II.I.1.1. Introduction.....	155
II.I.1.2. Design of VTOL considering energy carrier integration effects.....	159
II.I.1.3. Energy Carriers and Life Cycle Assessment (LCA).....	162
II.I.1.4. Results.....	163
II.I.1.5. Conclusions.....	169
II.I.2. Jet Fuel properties, from fossil to SAF.....	171
II.I.2.1. Jet fuel properties and norms.....	171
II.I.2.2. SAF properties and norms.....	173
II.I.2.3. SAF Production pathways and feedstocks.....	174
II.II. Sustainable Aviation Fuels emissions	181
II.II.1. Emissions of Non-Drop In SAF, measured at exhaust.....	182
II.II.1.1. Introduction	182
II.II.1.2. Methodology	183
II.II.1.3. Results	187
II.II.1.3. Conclusions	191
II.II.2. Emissions of Drop In SAF, measured at exhaust.....	193
II.II.2.1. Introduction	193
II.II.2.2. Methodology	194
II.II.2.3. Results	197
II.II.2.4. Conclusions	206
II.III. Sustainable Aviation Fuels Techno-Economic	207
II.III.1. Costs of SAF.....	208
II.III.1.1. CAPEX.....	208
II.III.1.2. OPEX.....	211
II.III.1.3. Projections	215
II.III.2. SAF volumes and impacts on conflicts of use.....	222
II.III.2.1. Biofuels.....	222
II.III.2.2. Efuels.....	226
II.III.2.3. Merit of order and conflict of use	229
II.III.2.4. SAF volumes in a constrained world	232
II.III.3. SAF impacts on air mobility economics	234
II.III.3.1. Impact for airlines, the Norge scenario.....	234
II.III.3.2. Impact for airlines, the EU scenarios	236
II.III.3.3. Higher prices should impact air mobility demand.....	239

II.III.3.4. Impact on airlines profit margin.....	242
II.IV. Part II conclusions.....	245
Part III. the role of energy justice within the air mobility decarbonization roadmap.....	249
III.I. SAF impacts within our societies	251
III.I.1. The impacts of offer and demand.....	251
III.I.1.1. Impacts of biofuel demand on feedstocks prices.....	251
III.I.1.2. Impacts of demand in future oil prices	255
III.I.2. A National & Regional assessment.....	261
III.I.2.1. National assessment: France.....	261
III.I.2.2. Regional assessment: Nouvelle Aquitaine	265
III.I.2.3. Impact on Jobs.....	266
III.II. Limits associated with importation and the role of energy justice.....	269
III.II.1. Exporting from the Global South.....	269
III.II.1.1. Procedural justice	270
III.II.1.2. Future Proofing	270
III.II.1.3. Review of Green Hydrogen Policy and Energy Scenarios for the selected countries.....	272
III.II.1.4. Green Hydrogen Policies	273
III.II.1.5. Improving Procedural Justice for Green Hydrogen.....	275
III.II.2. Avoiding replicating the oil curse	277
III.II.2.1. Oil curse.....	278
III.II.2.2. Review of the European regulations	280
III.II.2.3. Selected countries	281
III.II.2.4. Decent living and energy justice	284
III.II.2.5. Conclusions.....	285
III.III Introducing energy justice within our public policies	287
III.III.1. Understanding the role of electricity in societies and the influence of tax and policies	287
III.III.1.1. Electricity in our societies.....	287
III.III.1.2. Review of current and future use of electricity and evaluation of electricity volumes for eSAF.....	289
III.III.1.3. Review of the taxation policies	291
III.III.1.4. Review of electricity consumptions	294
III.III.2. Energy justice within tax policies.....	298
III.III.2.1. Air mobility and energy justice.....	298
III.III.2.2. Effects of current tax schemes and final electricity prices	300
III.III.2.3. Distributive justice	304
III.III.3 Proposals.....	307

III.III.3.1. Adapting the Pyramid of Needs to energy justice	307
III.III.3.2. Comparing Tax Policies with the Pyramid of Energy Needs and the impacts for air mobility.....	309
III.III.3.3. Elements for public policies	314
III.IV. Part III and General conclusions.....	319
III.IV.1. Part III conclusions	319
III.IV.2. General conclusions	321
III.IV.3. Research perspectives.....	323
III.IV.4. List of publications.....	325

List of abbreviations

2DS	2 Degree °C Scenario
ACARE	Advisory Council for Aeronautics Research in Europe
APU	Auxiliary Power Unit
ASK	Available Seat Kilometer
ATA	Air Transport Association of America (now Airlines for America)
ATAG	Air Transport Action Group
ATJ	Alcohol To Jet
BECCS	Bio Energy with Carbon Capture and Sequestration
Biofuel	Liquid fuel issued from the biomass
BioSAF	Share of biofuel dedicated to Sustainable Aviation Fuel
CAPEX	Capital Expenditure
CH ₄	Methane (Natural Gas)
CO	Carbon Monoxide
CO ₂	Carbon Dioxide
COP	Conference Of the Parties
CORSIA	Carbon Offsetting and Reduction Scheme for International Aviation
CCU	Carbon Capture and Use
CCS	Carbon Capture and Sequestration
efuel	Liquid fuel issued from low carbon electricity
eSAF	Share of efuel dedicated to Sustainable Aviation Fuel
FRL	Fuel Readiness Level
FT	Fischer-Tropsch
GHG	Greenhouse Gases
HHV	Higher Heating Value
H ₂	Dihydrogen, commonly referred as hydrogen
HEFA	Hydro processed Esters and Fatty Acids
IATA	International Air Transport Association
ICAO	International Civil Aviation Organization
IEA	International Energy Agency
ILUC	Indirect Land Use Change
IPCC	International Panel on Climate Change

kWh / MWh / TWh	Kilo Watt Hour / Mega / Tera
LHV	Lower Heating Value
LUC	Land Use Change
NO _x	Nitrogen Oxides
OPEX	Operational Expenditure
ppm	parties per million
PtG	Power to Gas
PtL	Power to Liquid (or efuel, electro-fuel)
RF	Radiative Forcing
RLCF	Renewable & Low Carbon Fuels
UCO	Used Cooking Oil

Definitions: SAF & Scope of air mobility eCO₂ emissions

GHG emissions include seven types of greenhouse gases which are covered by the UNFCCC / Kyoto Protocol and the Paris agreement: CO₂, CH₄, N₂O, HFCs, PFCs, SF₆ and NF₃. Since Air Mobility is concerned by CO₂, CH₄ and N₂O, the carbon dioxide equivalent or eCO₂ abbreviated is the metric measure which is used to compare the emissions which includes these three gases. While there is a significant concern regarding the Global Warming Potential (GWP) of aviation due to contrails formation and the associated radiative forcing as significant amount of H₂O are released in the high atmosphere, this thesis only focuses on eCO₂. Readers interested in the GWP associated with contrails formation can have access to the works of David Lee ¹ from the Manchester University, which describe why the aviation GWP goes well beyond its CO₂ emissions. The scientific consensus is evolving, but could currently be estimated between a factor 1.5 to 3. In France, the French agency for the development and energy efficiency, ADEME, applies a factor of 1.8 ².

eCO₂ emissions from air mobility includes all flights, from IFR (instrument flight rules) accounted to commercial aviation, to business jets and general aviation (private flights), missions of social value (medical and humanitarian flights, almost all helicopter flights) and military operations. These last 3 categories account for around 10% of global aviation emissions. In addition, emissions are classified into two main categories: domestic (a flight that takes off and lands in the same country) and international (a flight that takes off from one country and lands in another).

SAF: Sustainable Aviation Fuel includes all renewables (not always sustainable) but also low carbon synthetic fuels. The acronym LCAF (for Lower Carbon Aviation Fuel) has been proposed by the OACI (International Civil Aviation Organization) during the third OACI conference on alternative fuels (CAAF/3) held in Dubai in November 2023 ³. These LCAF are not considered in this study as issued from fossil fuels they do not provide significant CO₂ reductions but rather a transfer of CO₂ emissions (chapter I.2 Regulations).

Fuel: For the French readers, "Fuel" in English, and used in French as synonym of "carburant", designates either a fuel (containing no carbon: dihydrogen, for example) or a motor fuel. In French, fuel is equivalent to "carburant", which implicates the presence of Carbon and therefore excludes H₂.

Drop In: Liquid fuel that can be used without any modification (neither to the aircraft, the engine or any kind of infrastructure such as airport hydrants).

Non-Drop In: Liquid fuel that cannot be used without modifications to the aircraft, engine or ground infrastructure. These are typically SAF which do not contain aromatics molecules.

Alternative Fuels: Fuel (liquid or gaseous) such as H₂, NH₃ or CH₄, which requires major modifications (specific aircraft, adapted engines, new ground infrastructures).

Jet Fuel = Jet A1 = Jet A = Kerosene. This is the fuel currently used in air transport. It can be made up of Conventional Aviation Fuel (fossil) or SAF, or a mixture of the two. By default Jet Fuel means fossil jet fuel.

CAF (Conventional Aviation Fuel): Jet Fuel of 100% fossil petroleum origin. In 2022 this represents 99.99% of the Jet Fuel consumed.

SAF (Sustainable Aviation Fuel): Sustainable Aviation Fuel, i.e. low-carbon, non-fossil fuel. They can be made from biomass (biofuel or bioSAF) or electricity (efuel, also known as eSAF, PtL, Power to Liquid, or ekerosene) or from a combination of both (ebioSAF, ebiofuel).

¹ D.S. Lee et al, The contribution of global aviation to anthropogenic climate forcing for 2000 to 2018, Atmospheric Environment, Volume 244, 2021, 117834, ISSN 1352-2310, <https://doi.org/10.1016/j.atmosenv.2020.117834>

² <https://impactco2.fr/outils/transport> accessed August 13, 2024

³ <https://www.icao.int/Newsroom/Pages/ICAO-Conference-delivers-strong-global-framework-to-implement-a-clean-energy-transition-for-international-aviation.aspx> accessed August 13, 2024

RLCF (Renewable and Low Carbon Fuels) is also an acronym used by the European Commission in order to group together low-carbon fuels, whether derived from biomass (renewable) or electricity (low-carbon) with associated sustainability criteria.

In this study biofuels and efuels refer to the production of renewable fuels which can be used by different sectors while bioSAF means a biofuel which is dedicated for aviation. The same applies for efuel and eSAF.

Energy units are often an issue when addressing energy, even more when addressing air mobility. Some data are provided in toe (ton equivalent), others in Joules (J) and sometimes in watts (W). To complexify this situation, maybe on purpose, the aviation fuel consumption is sometime expressed in metric ton (or kg), in liters, in US gallons, in toe or even in barrel of oil. A barrel of oil is a standard international measurement of volume primarily associated with the oil industry and equaling 42 US gallons, or very close to 159 liters of oil. Barrel is also shortened to bbl. While the jet fuel density ranges from 0.775 to 0.840, the density of jet fuel in this thesis is set at 0.8: 0.8 kilograms of jet fuel = 1 liter.

While UNStats⁴ proposes 1 metric ton of Kerosene-type jet fuel (or Jet A1) being equivalent to 1235 litre or 326 US Gallon or 272 Imperial Gallon or 7.77 Barrel or 0.02129 Barrel per day or 1.235 cubic meter, in this study metric ton is equivalent to US ton, so 1.25 cubic meter (density of 0.8) and the conversions are, when needed, using the aviation benefits tools for SAF⁵.

For the reader's convenience, energy is converted to Wh (watt hour) whenever possible, and to Whe (watt hour of electricity) when electricity is concerned.

Order of magnitude and scalability is of great importance when addressing energy. As mentioned above, energy will be converted whenever possible in Wh:

- k: kilo, 10^3 (1.000 Wh), kWh, scale generally used for household consumption.
- M: mega, 10^6 (1.000.000 Wh), MWh, scale generally used for industrial production.
- G: giga, 10^9 (1.000.000.000), GWh, scale generally used for industrial production.
- T: tera, 10^{12} (1.000.000.000.000.000 Wh), TWh, scale generally used on a national or global scale.

E, or exa (10^{18} or 1.000.000.000.000.000.000) will be used when addressing biomass. Biomass energy content is often expressed in joules (J), with 3600 J being equivalent to 1 Wh. When the higher heating value is at stake J will be preferred while W et Wh will be preferred when considering lower heating value.

HHV and LHV: The lower heating value also known as net calorific value or neat heat of combustion of a fuel is defined as the amount of heat released by combusting a specified quantity (initially at 25°C) and returning the temperature of the combustion products to 150°C, which assumes the latent heat of vaporization of water in the reaction products is not recovered. The higher heating value (also known gross calorific value or gross energy) of a fuel is defined as the amount of heat released by a specified quantity (initially at 25°C) once it is combusted and the products have returned to a temperature of 25°C, which considers the latent heat of vaporization of water in the combustion products. Since recovering the heat produced during the combustion is not in sight within air mobility applications as the added weight by such a system is prohibitive, the LHV is systematically used.

⁴ <https://unstats.un.org/unsd/energystats/pubs/yearbook/documents/2019eyb.pdf> page 44 - xliii, accessed August 13, 2024

⁵ <https://aviationbenefits.org/environmental-efficiency/climate-action/sustainable-aviation-fuel/conversions-for-saf/> accessed August 13, 2024

List of FIGURES

FIGURE 1 GLOBAL CO ₂ CONCENTRATION IN PPM (Y-AXIS). COMPARING TWO SCIENTIFIC STUDIES PUBLISHED IN 1980 (ROTTY AND MARLAND), IN 1990 (ANASTASI ET AL) WITH REAL MEASUREMENTS FROM NOAA IN FEB 1978, FEB 1990, FEB 2024, DATA EXTRAPOLATED FOR 2030 (440 PPM), SOURCE JEAN-BAPTISTE JARIN	32
FIGURE 2 WORLD LAND AND OCEAN TEMPERATURE ANOMALIES FOR THE SELECTED PERIOD, HERE 1850 TO 2024, SOURCE NOAA	33
FIGURE 3 TREND OF GLOBAL NATURAL CATASTROPHE LOSSES AS % OF GLOBAL GDP (Y-AXIS) FROM 1994 TO 2023, SOURCE SWISS RE.....	34
FIGURE 4 GHG EMISSION REDUCTIONS SCENARIOS, SOURCE IPCC	34
FIGURE 5 COMPARING WORLD GDP GROWTH AND WORLD FOSSIL FUELS (OIL, COAL, GAS) CONSUMPTION FROM YEAR 0 TO 2012, GDP IS BASE 100 IN YEAR 0 AND WORLD FOSSIL FUELS ARE IN TWH (Y-AXIS), SOURCE JEAN-BAPTISTE JARIN WITH DATA FROM PIKETTY AND OWID.....	35
FIGURE 6 CONSTANT GDP (IN BUS\$, X-AXIS) VS ENERGY (IN TWH, Y-AXIS), SOURCE JEAN-BAPTISTE JARIN WITH DATA FROM SMIL FOR THE WORLD GLOBAL PRIMARY ENERGY AND WORLD BANK FOR GDP.....	36
FIGURE 7 YEARLY OIL EXPLORATION EXPENSE (BUS\$) S VS YEARLY DISCOVERIES (BBOE) WITH THE BARREL OIL PRICE AS A REFERENCE FROM 2000 TO 2016 IN Y-AXIS. SOURCE JEAN-BAPTISTE JARIN, WITH DATA FROM WOOD MACKENZIE AND RYSTAD. ONE CAN NOTICE THAT THE EXPLORATION EXPENSES ARE NOT CORRELATED WITH THE DISCOVERIES BUT WITH THE OIL BARREL PRICE, CASH BEING AVAILABLE FOR THE OIL AND GAS INDUSTRY TO SPEND IN EXPLORATION AND PRODUCTION	38
FIGURE 8 ENERGY PER CAPITA FROM 1965 TO 2015, ALL ENERGIES CONVERTED IN TON OIL EQUIVALENT (TOE, Y-AXIS), SOURCE JEAN-BAPTISTE JARIN WITH DATA FROM WORLD BANK, UN AND BP STATISTICAL REVIEW	38
FIGURE 9 THE EVOLUTION OF PLANET BOUNDARIES – STOCKHOLM RESILIENCE CENTRE – STOCKHOLM UNIVERSITY	41
FIGURE 10 AIR MOBILITY WITHIN MOBILITIES IN FRANCE, SHARE OF KILOMETERS TRAVELED, TRAVEL TIMES AND NUMBER OF TRIPS. WITH DATA FROM BIGO	43
FIGURE 11 THE 6 LEVERS IDENTIFIED TO SUPPORT THE DECARBONIZATION OF AIR MOBILITY ALONG WITH THE ASSOCIATED MAIN PARAMETERS. IN DARK AND LIGHT BROWN, THE RESPECTIVELY MAIN AND SECONDARY TOPICS WHICH ARE ADDRESSED IN THE DIFFERENT PARTS OF THE THESIS, SOURCE JEAN-BAPTISTE JARIN	50
FIGURE 12 ENERGY RELATED eCO ₂ EMISSIONS IN BILLION TON FOR THE WORLD AND EUROPE (EU28) FROM 1950 TO 2019, SOURCE JEAN-BAPTISTE JARIN WITH DATA FROM ROBBIE ET AL	59
FIGURE 13 PARETO DIAGRAM OF AIRCRAFT GHG EMISSIONS (LCA), SOURCE JEAN-BAPTISTE JARIN WITH DATA FROM CHESTER	61
FIGURE 14 AIRCRAFT GHG EMISSIONS BY AIRCRAFT TYPE AND CATEGORY, IN %, SOURCE JEAN-BAPTISTE JARIN WITH DATA FROM CHESTER	61
FIGURE 15 ICAO-CORSIA METHODOLOGY FOR CALCULATING ACTUAL LIFE CYCLE EMISSIONS VALUES, SOURCE ICAO	63
FIGURE 16 EXTRACT FROM ICAO CARBON EMISSIONS CALCULATOR METHODOLOGY V9, PAGE 3 SOURCE ICAO.....	66
FIGURE 17 (LEFT) AND FIGURE 18 (RIGHT), RESPECTIVELY EXTRACT FROM THE IFP PRESENTATION TO THE DAST IN 2005, PAGE 30 AND EXTRACT FROM THE AIRCRAFT EMISSIONS: CURRENT INVENTORIES AND FUTURE SCENARIOS PUBLISHED IN 1999. SOURCES SÉNAT AND BAUGHUM ET AL.....	67
FIGURE 19 AIR MOBILITY eCO ₂ EMISSIONS IN MT FROM 1950 TO 2019 (SCOPE 1-2-3), SOURCE JEAN-BAPTISTE JARIN WITH DATA FROM GROTE ET AL AND UN ENERGY STATISTICS.....	68
FIGURE 20 ICAO CALCULATION PROCEDURE, PAGE 4 OF THE ICAO CARBON EMISSIONS CALCULATOR METHODOLOGY, V9, SOURCE ICAO.....	69
FIGURE 21 BOEING 777-300 OF EMIRATES AIRLINES, 3 CABIN CLASS, PROPORTIONS ARE RESPECTED, FIRST (LEFT), BUSINESS (CENTER), ECONOMY (RIGHT), SOURCE EMIRATES AIRLINES	71
FIGURE 22 METHODOLOGY 1 ST LEVEL ARCHITECTURE.....	76
FIGURE 23 METHODOLOGY FUEL CARBON INTENSITY, 2 ND LEVEL ARCHITECTURE, SOURCE JEAN-BAPTISTE JARIN	78
FIGURE 24 COMPARING JET FUEL EMISSIONS. DEFAULT VALUES USED FOR CAF, SAF AND ALTERNATIVE FUELS, FROM CHAPTER I.III.1.4 FIGURE 54 COMPARING JET FUELS EMISSIONS, IN g eCO ₂ /MJ (Y-AXIS). IN RED THE CAF REFERENCE WITHIN EU REGULATION (94 g eCO ₂ /MJ), IN GREEN THE SAF WHICH ARE ACCEPTED WITHIN THE EU REGULATION AND CORSIA, IN BLUE THE SAF OR CAF FROM FOSSILS ALLOWED AS LOWER CARBON FUEL OR SUSTAINABLE AVIATION FUELS ACCEPTED WITHIN CORSIA BUT CONSIDERED AS NON-SUSTAINABLE WITHIN EU REGULATION. SOURCE JEAN-BAPTISTE JARIN. NOTA: HEFA PALM OIL, IN BLACK, IS ACCEPTED WITHIN CORSIA, SEE TABLE 19 ABOVE	79

FIGURE 25 EMS CALCULATED ENGINE TIME FOR 47 CONSECUTIVE MISSIONS, IN MINUTES (Y-AXIS), SOURCE JEAN-BAPTISTE JARIN.....	80
FIGURE 26 OFFSHORE CALCULATED ENGINE TIME FOR 18 CONSECUTIVE MISSIONS, IN MINUTES (Y-AXIS), SOURCE JEAN-BAPTISTE JARIN	81
FIGURE 27 FLIGHT PROFILE ANALYSIS FOR A SELECTED EMS MISSION, WITH TIME IN SECONDS (X-AXIS) AND FUEL BURN IN LITER / HOUR / ENGINE (Y-AXIS), SOURCE JEAN-BAPTISTE JARIN	82
FIGURE 28 COMBINATORIAL, ARCHITECTURE LEVEL 2, SOURCE JEAN-BAPTISTE JARIN	83
FIGURE 29 FLIGHT PROFILE ANALYSIS FOR A SELECTED UTILITY MISSION, WITH TIME IN SECONDS (X-AXIS) AND FUEL BURN IN LITER / HOUR / ENGINE (Y-AXIS), SOURCE JEAN-BAPTISTE JARIN	84
FIGURE 30 FLIGHT PROFILE ANALYSIS FOR A SELECTED OFFSHORE MISSION, WITH TIME IN SECONDS (X-AXIS) AND FUEL BURN IN LITER / HOUR / ENGINE (Y-AXIS), SOURCE JEAN-BAPTISTE JARIN	85
FIGURE 31 FLIGHT PROFILE ANALYSIS FOR A SELECTED EMS MISSION, WITH TIME IN SECONDS (X-AXIS) AND FUEL BURN IN LITER / HOUR / ENGINE (Y-AXIS), SOURCE JEAN-BAPTISTE JARIN	85
FIGURE 32 WORLD TRAFFIC (IN PSK) AND WORLD GDP GROWTH FROM 1961 TO 2019, IN YEARLY % INCREASE, SOURCE JEAN-BAPTISTE JARIN WITH DATA FROM WORLD BANK, ICAO AND OWID	90
FIGURE 33 AIRCRAFT ENERGY INTENSITIES IN MJ PER AVAILABLE SEAT / KM, RANGES SHOW THE IMPACT OF CABIN CONFIGURATION. FIGURE IS ISSUED FROM “FUEL EFFICIENCY OF COMMERCIAL AIRCRAFT, AN OVERVIEW OF HISTORICAL AND FUTURE TRENDS”, ORIGINALLY FIGURE 5 PAGE 17, WITH THE KIND AUTHORIZATION OF FIRST AUTHOR, PROFESSOR PAUL PEETERS.....	91
FIGURE 34 1980 ATA REPORT, PAGE 3, DETAILING OPERATING EXPENSES AND FUEL COSTS DATA, SOURCE ATA.....	92
FIGURE 35 JET FUEL PRODUCER PRICE INDEX (BASE 100 IN 1982) FOR SELECTED YEAR 1960-1980. SOURCE ST-LOUIS FEDERAL BANK	93
FIGURE 36 JET FUEL PRODUCER PRICE INDEX (BASE 100 IN 1982) FOR SELECTED YEARS 1980-2000. SOURCE ST-LOUIS FEDERAL BANK	94
FIGURE 37 PASSENGER TRAFFIC IN ASK AND RPK (OR PSK), SOURCE OWID	95
FIGURE 38 JET FUEL PRODUCER PRICE INDEX (BASE 100 IN 1982) FOR SELECTED YEARS 2000-2019. SOURCE ST-LOUIS FEDERAL BANK	97
FIGURE 39 2005-2050 CO2 EMISSIONS REDUCTION ROADMAP. IATA 2010 ANNUAL REPORT, PAGE 26, SOURCE IATA	98
FIGURE 40 ECO ₂ EMISSIONS FROM AIR MOBILITY ACCORDING TO THE INCOME CLASS WITHIN THE EU POPULATION, SOURCE JEAN-BAPTISTE JARIN WITH DATA PROVIDED BY IVANOVA & WOOD “THE UNEQUAL DISTRIBUTION OF HOUSEHOLD CARBON FOOTPRINTS IN EUROPE AND ITS LINK TO SUSTAINABILITY” WITH COURTESY OF FIRST AUTHOR.....	100
FIGURE 41 AVIATION (INTERNATIONAL) CO ₂ E EMISSIONS: OBJECTIVE OF CARBON NEUTRAL GROWTH FROM ICAO, SOURCE ICAO 2016 ENVIRONMENTAL REPORT.....	105
FIGURE 42 50 YEARS OF ENGINE FUEL CONSUMPTION SAVINGS IN AVIATION (GREEN DOTS AND CURVE), WAYPOINT 2050, PAGE 12, SOURCE ATAG	116
FIGURE 43 ENGINE SFC FROM 1955 TO 1995, NRC 1992, PAGE 50, SOURCE NRC	117
FIGURE 44 LOWER AIRCRAFT WEIGHT WITH THE USE OF COMPOSITES, ATAG EFFICIENCY GUIDE, 2010, PAGE 9, SOURCE ATAG	118
FIGURE 45 ASK AND PSK EVOLUTION FROM 1929 TO 2019, SOURCE OWID	119
FIGURE 46 PASSENGER LOAD FACTOR FROM 1950 TO 2019, SOURCE OWID	120
FIGURE 47 EUROPEAN SINGLE SKY / DIRECT FLIGHT PATH EXAMPLE, ATAG, EFFICIENCY GUIDE PAGE 17, SOURCE ATAG ...	121
FIGURE 48 JET FUEL PRICE FROM SELECTED PERIOD 1968 AND 1979, IN PRODUCER PRICE INDEX BASE 100 IN 1982, SOURCE U.S BUREAU OF LABOR STATISTICS	122
FIGURE 49 AIRCRAFT FUEL EFFICIENCY EXPRESSED IN ENERGY INTENSITY MJ/ASK. ORIGINALLY FIGURE 2 FROM ARE TECHNOLOGY MYTHS STALLING AVIATION CLIMATE POLICY, WITH KIND AUTHORIZATION OF THE FIRST AUTHOR, PROF PAUL PEETERS.....	123
FIGURE 50 AVERAGE FUEL BURN OF NEW COMMERCIAL JET AIRCRAFT, BASE 100 IN 1968. AIRCRAFT FE TRENDS, PAGE 11, SOURCE ICCT	124
FIGURE 51 AVERAGE FUEL BURN OF NEW COMMERCIAL JET AIRCRAFT FROM 1960 (COMET) AND EXTRAPOLATED TO 2050, BASE 100 IN 1960, SOURCE JEAN-BAPTISTE JARIN	125
FIGURE 52 COMPARING THE CARBON INTENSITY OF ALTERNATIVE FUELS WITH FOSSIL JET FUEL BASE 1, SOURCE JEAN-BAPTISTE JARIN WITH DATA FROM DAGGET ET AL	126
FIGURE 53 DIAGRAM OF THE VARIOUS STAGES IN THE ETHANOL PRODUCTION CHAIN, FROM THE CORNFIELD TO THE GAS STATION, AND THE ENERGY COSTS ASSOCIATED WITH EACH STAGE. AVERAGE DATA IN 2001 FOR THE FARM (EXCLUDING	

IRRIGATION), IN 2005 FOR THE PLANT FLEET. ORIGINALLY FIGURE 1 OF ENERGY YIELD FOR THE PRODUCTION OF ETHANOL FROM CORN, REPRODUCED HERE WITH THE KIND AUTHORIZATION OF FIRST AUTHOR, JP FRANGI.....	128
FIGURE 54 COMPARING JET FUELS EMISSIONS, IN G eCO ₂ /MJ (Y-AXIS). IN RED THE CAF REFERENCE WITHIN EU REGULATION (94 G eCO ₂ /MJ), IN GREEN THE SAF WHICH ARE ACCEPTED WITHIN THE EU REGULATION AND CORSIA, IN BLUE THE SAF OR CAF FROM FOSSILS ALLOWED AS LOWER CARBON FUEL OR SUSTAINABLE AVIATION FUELS ACCEPTED WITHIN CORSIA BUT CONSIDERED AS NON-SUSTAINABLE WITHIN EU REGULATION. SOURCE JEAN-BAPTISTE JARIN. NOTA: HEFA PALM OIL, IN BLACK, IS ACCEPTED WITHIN CORSIA, SEE TABLE 19 ABOVE.....	130
FIGURE 55 IMPACT OF A DIFFERENT COST INDEX ON ANNUAL COST SAVINGS, BOEING AERO MAGAZINE 2007, SOURCE BOEING	132
FIGURE 56 TYPICAL PROPULSIVE EFFICIENCIES FOR THE MOST COMMON AIRCRAFT ENGINE TYPES, ORIGINALLY FIGURE 3 OF AIRCRAFT PROPELLERS – IS THERE A FUTURE, SOURCE ALVES, SILVESTRE, GAMBOA, AIRCRAFT PROPELLERS – IS THERE A FUTURE ? WITH COURTESY OF AUTHORS AND MDPI	134
FIGURE 57 COMPARING JETS VS TURBOPROP BLOCK TIME AND BLOCK FUEL FOR SIMILAR DISTANCE / PAYLOAD, THE GAP IS 16 MINUTES IN FAVOR OF THE JET, BUT WITH AN EXTRA FUEL BURN OF 300 KG, OR +37%, SOURCE JEAN-BAPTISTE JARIN ...	136
FIGURE 58 SHARE OF FUEL BURN AND ASSOCIATED eCO ₂ EMISSIONS PER AIRCRAFT CATEGORY AS % OF TOTAL, SOURCE JEAN-BAPTISTE JARIN WITH DATA FROM ATAG.....	138
FIGURE 59 ATAG 2012 SUMMIT DECLARATION, TOWARD SUSTAINABLE AVIATION (LEFT).....	141
FIGURE 60 IATA ANNUAL REPORT, PAGE 27, SOURCES ATAG AND IATA (RIGHT).....	141
FIGURE 61 IATA 2023 VISION FOR 2050, SAF IS THE MAIN LEVER FOR DECARBONIZATION, IATA NET 0 ROADMAP, PAGE 6, SOURCE IATA.....	142
FIGURE 62 COMPARING THE EFFECT OF TRAFFIC GROWTH INCREASE ON GLOBAL FUEL CONSUMPTION IN MT (Y-AXIS) FROM 1950 TO 2050 WITH DIFFERENT CAGR: 2%, 3.1% (IATA SCENARIO) AND 4.57% (PAST DECADE CAGR GROWTH), SOURCE JEAN-BAPTISTE JARIN.....	143
FIGURE 63 FUEL BURN AND ASSOCIATED eCO ₂ EMISSIONS OF AIR MOBILITY (SCOPE 1-2-3) IN MT, IN A BUSINESS-AS-USUAL SCENARIO: FOSSIL JET FUEL, TRAFFIC GROWTH 3.1% CAGR AND EFFICIENCY 0.85% CARR, SOURCE JEAN-BAPTISTE JARIN	146
FIGURE 64 FUEL BURN AND ASSOCIATED eCO ₂ EMISSIONS IN A BUSINESS-AS-USUAL SCENARIO (TRAFFIC GROWTH 3.1% CAGR AND EFFICIENCY 0.85% CARR), COMPARING FOSSIL AND SAF (AVERAGE 18.85 G eCO ₂ / MJ), SAF RATIO ARE 20% IN 2030, 50% IN 2040 AND 100% IN 2050, SOURCE JEAN-BAPTISTE JARIN	147
FIGURE 65 FUEL BURN (MT) PER FLIGHT CATEGORY WITH DATA FROM IATA-ATAG WAYPOINT 2050 FOR THE DISTRIBUTION, BEFORE INTRODUCTION OF SPEED CONSTRAINT, SOURCE JEAN-BAPTISTE JARIN	148
FIGURE 66 FUEL BURN (MT) PER FLIGHT CATEGORY WITH DATA FROM IATA-ATAG WAYPOINT 2050 FOR THE DISTRIBUTION, AFTER INTRODUCTION OF SPEED CONSTRAINT, SAME SCALE AS FIGURE 65 TO ALLOW COMPARISON, SOURCE JEAN-BAPTISTE JARIN	149
FIGURE 67 SHARE OF FUEL BURN AND eCO ₂ EMISSIONS PER FLIGHT CATEGORY IN 2050, SOURCE JEAN-BAPTISTE JARIN.....	149
FIGURE 68 SIMPLIFIED VIEW OF ENERGY CARRIERS BASED ON ELECTRICITY APPLIED TO VTOL WITH THE ASSOCIATED PROPULSIVE ARCHITECTURE, SOURCE JEAN-BAPTISTE JARIN AND STEPHANE BEDDOK.....	157
FIGURE 69 MISSION PROFILE, SOURCE JEAN-BAPTISTE JARIN AND STEPHANE BEDDOK.....	158
FIGURE 70 DESIGN STEPS FOR CALCULATION, SOURCE JEAN-BAPTISTE JARIN AND STEPHANE BEDDOK	161
FIGURE 71 eCO ₂ EMISSIONS CALCULATED FOR EACH ENERGY CARRIER WITH AN ELECTRICITY CI FROM 5 TO 340 G eCO ₂ /KWH, SOURCE JEAN-BAPTISTE JARIN AND CAROLE HARITCHABALET	166
FIGURE 72 eCO ₂ EMISSIONS CALCULATED FOR EACH ENERGY VECTOR WITH AN ELECTRICITY CI FROM 5 TO 50 G eCO ₂ /KWH, SOURCE JEAN-BAPTISTE JARIN AND CAROLE HARITCHABALET	167
FIGURE 73 ENERGY MISSION COST IN USD, SOURCE JEAN-BAPTISTE JARIN AND CAROLE HARITCHABALET	168
FIGURE 74 DIRECT ENERGY COST FOR EACH ENERGY CARRIER IN 3 EUROPEAN COUNTRIES, IN EUR/MISSION. FOSSIL JET FUEL AND BIOFUEL (HEFA-UCO) ARE INTRODUCED FOR COMPARISON ONLY, SOURCE JEAN-BAPTISTE JARIN AND CAROLE HARITCHABALET	170
FIGURE 75 SYNTHESIS OF SAF AND ALTERNATIVE FUELS, WITH PRO AND CONS, SOURCE JEAN-BAPTISTE JARIN	174
FIGURE 76 FUELS APPROVAL PROCESS VIA ASTM D4054. APPROVED FUELS ARE ANNEXED UNDER D7566 AND CONSIDERED SYNTHETIC BLEND COMPONENTS (SBC). CURRENT ANNEXES REQUIRE THAT SBCs BE BLENDED WITH CONVENTIONAL JET FUEL. ONCE BLENDED, THE FUEL MEETS ASTM D1655 CRITERIA FOR AVIATION TURBINE FUEL, SOURCE FAA.....	174
FIGURE 77 SCHEMATIC OVERVIEW OF THE DIFFERENT FUELS CONSIDERED FOR AVIATION, EFUELS ARE INTRODUCED THROUGH THE H ₂ PATHWAY, SEE CHAPTER II.I.1 ABOVE. NH ₃ IS BEING DISREGARDED NOT BECAUSE OF ITS EFFICIENCY BUT BECAUSE OF SAFETY, SOURCE JEAN-BAPTISTE JARIN	175

FIGURE 78 GENERIC SCHEME OF EFUEL PRODUCTION, SOURCE LBST	176
FIGURE 79 LIST OF SAF APPROVED ACCORDING TO ASTM D7566 AS OF 2023. MAX BLENDING RATIO IS INDICATED AND SPECIFIC ANNEX CAN BE FOUND IN FIGURE 76. ORIGINALLY FIGURE 7, WITH COURTESY OF CABRERA AND MELO DE SOUSA	176
FIGURE 80 eCO ₂ LCA OF THE SAF TESTED IN ACCORDANCE WITH EU REQUIREMENTS (EU) 2018/2001, ANNEX V, SEE TABLE 10, HERE 8.69 g eCO ₂ /MJ, SOURCE TOTAL ENERGIES.....	182
FIGURE 81 NORMALIZED CONCENTRATION MEASUREMENTS FOR VERTICAL AND HORIZONTAL SAMPLING ARRANGEMENT, SOURCE JEAN-BAPTISTE JARIN AND JEAN-LOUIS CHAMPION	184
FIGURE 82 FIGURE 83 FIGURE 84 FIGURE 85 FIGURE 86: NON-DIMENSIONAL CO ₂ , CO, NO _x , NO AND O ₂ CONCENTRATION VERSUS REDUCED ENGINE ROTATION SPEED IN %. COMPARISON BETWEEN BEARCAT (2021, IN BLUE) AND MAKILA SERIAL ENGINE (2018, IN ORANGE) RESULTS, SOURCE JEAN-BAPTISTE JARIN AND JEAN-LOUIS CHAMPION.	185
FIGURE 87 AND FIGURE 88 NON-DIMENSIONAL CO ₂ CONCENTRATIONS VS FUEL MASS FLOW RATE FOR SAF (RED) AND CAF (BLUE), SOURCE JEAN-BAPTISTE JARIN AND JEAN-LOUIS CHAMPION	187
FIGURE 89 FIGURE 90 NON-DIMENSIONAL CO CONCENTRATIONS VS FUEL MASS FLOW RATE FOR SAF (RED) AND CAF (YELLOW), SOURCE JEAN-BAPTISTE JARIN AND JEAN-LOUIS CHAMPION.....	188
FIGURE 91 ENGINE POWER VS FUEL MASS FLOW RATE FOR SAF (RED) AND CAF (BLUE), SOURCE JEAN-BAPTISTE JARIN AND JEAN-LOUIS CHAMPION	188
FIGURE 92 FIGURE 93 NON-DIMENSIONAL NO _x CONCENTRATIONS VS FUEL MASS FLOW RATE FOR SAF (RED) AND CAF (GREEN), SOURCE JEAN-BAPTISTE JARIN AND JEAN-LOUIS CHAMPION.....	188
FIGURE 94 FIGURE 95 NON-DIMENSIONAL NO CONCENTRATIONS VS FUEL MASS FLOW RATE FOR SAF (RED) AND CAF (GREEN), SOURCE JEAN-BAPTISTE JARIN AND JEAN-LOUIS CHAMPION.....	189
FIGURE 96 FIGURE 97 NON DIMENSIONAL O ₂ CONCENTRATIONS VS FUEL MASS FLOW RATE FOR SAF (RED) AND CAF (BLUE), SOURCE JEAN-BAPTISTE JARIN AND JEAN-LOUIS CHAMPION	189
FIGURE 98 FIGURE 99 NON-DIMENSIONAL SMOKE NUMBER (SN) VS FUEL MASS FLOW RATE FOR SAF (RED) AND CAF (BLUE), SOURCE JEAN-BAPTISTE JARIN AND JEAN-LOUIS CHAMPION	190
FIGURE 100 FIGURE 101 EI OF CO VS FUEL MASS FLOW RATE (LEFT) AND POWER (RIGHT) FOR SAF (RED) AND CAF (YELLOW), SOURCE JEAN-BAPTISTE JARIN AND JEAN-LOUIS CHAMPION.....	190
FIGURE 102 FIGURE 103 EMISSION INDEX OF NO _x AND NO VS FUEL MASS FLOW RATE (LEFT) AND POWER (RIGHT) FOR SAF (RED-YELLOW) AND CAF (GREEN), SOURCE JEAN-BAPTISTE JARIN AND JEAN-LOUIS CHAMPION	190
FIGURE 104 COMBUSTION EFFICIENCY VS ENGINE POWER FOR SAF (RED) AND CAF (BLUE), SOURCE JEAN-BAPTISTE JARIN AND JEAN-LOUIS CHAMPION	191
FIGURE 105 PHOTOS OF SN PAPER FILTERS, CAF (LEFT) ET SAF (RIGHT), SOURCE JEAN-BAPTISTE JARIN AND JEAN-LOUIS CHAMPION	192
FIGURE 106 ASTM SAF STANDARDIZATION STATUS AS OF JUNE 2023, SOURCE CAAFI	193
FIGURE 107 CROSS SECTIONAL VIEW OF THE MAKILA TURBOSHAFT, SOURCE SAFRAN	195
FIGURE 108 LOCATION OF GAZES ANALYSIS PROBE	195
FIGURE 109 TEST CYCLES, SOURCE JEAN-BAPTISTE JARIN AND JEAN-LOUIS CHAMPION.....	196
FIGURE 110 CO ₂ CONCENTRATION IN % VERSUS FUEL MASS FLOW RATE FOR SAF-SPK/A AND CAF, SOURCE JEAN-BAPTISTE JARIN AND JEAN-LOUIS CHAMPION	197
FIGURE 111 CO CONCENTRATION VERSUS FUEL MASS FLOW RATE FOR SAF-SPK/A AND CAF, SOURCE JEAN-BAPTISTE JARIN AND JEAN-LOUIS CHAMPION	198
FIGURE 112 CO EMISSION INDEX VERSUS FUEL MASS FLOW RATE FOR SAF-SPK/A AND CAF, SOURCE JEAN-BAPTISTE JARIN AND JEAN-LOUIS CHAMPION	199
FIGURE 113 CO EMISSION INDEX NORMALIZED BY THE LHV OR THE HC RATIO VERSUS FUEL MASS FLOW RATE FOR SAF-SPK/A AND CAF, SOURCE JEAN-BAPTISTE JARIN AND JEAN-LOUIS CHAMPION	199
FIGURE 114 CO/CO ₂ RATIO ACCORDING TO FUEL MASS FLOW RATE (CO/CO ₂ *1000) FOR SAF-SPK/A AND CAF, SOURCE JEAN-BAPTISTE JARIN AND JEAN-LOUIS CHAMPION	200
FIGURE 115 NO _x CONCENTRATION VERSUS FUEL MASS FLOW RATE, SOURCE JEAN-BAPTISTE JARIN AND JEAN-LOUIS CHAMPION	201
FIGURE 116 NO _x EMISSION INDEX VERSUS FUEL MASS FLOW RATE, SOURCE JEAN-BAPTISTE JARIN AND JEAN-LOUIS CHAMPION	201
FIGURE 117 NO _x EMISSION INDEX REALIZED WITH LHV AND H/C RATIO VERSUS FUEL MASS FLOW RATE, SOURCE JEAN-BAPTISTE JARIN AND JEAN-LOUIS CHAMPION	202
FIGURE 118 NO EMISSION CONCENTRATION VERSUS FUEL MASS FLOW RATE, SOURCE JEAN-BAPTISTE JARIN AND JEAN-LOUIS CHAMPION	202

FIGURE 119 NO EMISSION INDEX VERSUS FUEL MASS FLOW RATE, SOURCE JEAN-BAPTISTE JARIN AND JEAN-LOUIS CHAMPION	203
FIGURE 120 NO EMISSION INDEX REALIZED WITH LHV AND H/C RATIO VERSUS FUEL MASS FLOW RATE, SOURCE JEAN-BAPTISTE JARIN AND JEAN-LOUIS CHAMPION	203
FIGURE 121 O ₂ CONCENTRATION VERSUS FUEL MASS FLOW RATE, SOURCE JEAN-BAPTISTE JARIN AND JEAN-LOUIS CHAMPION	204
FIGURE 122 SMOKE NUMBER CONCENTRATION VERSUS FUEL MASS FLOW RATE FOR SAF-SPK/A, CAF AND DROP IN SAF (SPK), SOURCE JEAN-BAPTISTE JARIN AND JEAN-LOUIS CHAMPION	205
FIGURE 123 OVERVIEW OF THE TECHNO-ECONOMIC PROPERTIES OF SAF, SOURCE JEAN-BAPTISTE JARIN	207
FIGURE 124 OVERVIEW OF THE PROCESS CONVERSION YIELD FOR THE TOTAL ENERGIES PRODUCTION SITE OF GRANDPUITS, FRANCE, SOURCE JEAN-BAPTISTE JARIN WITH DATA FROM TOTAL ENERGIES AND UOP. THE YIELD IS HERE OF 0.85 AND SHALL REACH 0.9 IN THE COMING YEARS WITH FURTHER REFINING IMPROVEMENTS	210
FIGURE 125 OVERVIEW OF AN EFUEL PRODUCTION UNIT WITH NUMBERS. IT IS FOUND HERE THAT THE MAJOR PART OF THE COST OF PRODUCING AN EFUEL IS ELECTRICITY, HERE EXPRESSED IN € / MWh, SOURCE ACADEMIE DES TECHNOLOGIES, WITH COURTESY OF DANIEL IRACANE	211
FIGURE 126 INITIAL COST MODEL FOR SAF CONSIDERING LCOP OF EACH PROCESS / FEEDSTOCK AND VOLUME CONSTRAINTS FOR EACH FEEDSTOCK WHILE INCREASING THE BLEND RATIO OVER TIME, SOURCE JEAN-BAPTISTE JARIN	215
FIGURE 127 COST OF UCO FEEDSTOCK COMPLIANT WITH EU (RED) AND DELIVERED IN EUROPE ARA (ANTWERPEN – ROTTERDAM – AMSTERDAM) FROM FEBRUARY 2022 TO JULY 2024, IN USD/TON, SOURCE JEAN-BAPTISTE JARIN WITH DATA FROM ARGUS MEDIA	216
FIGURE 128 COST OF UCO FROM 2017 TO 2022, IN €/TON, SOURCE GREENEA	217
FIGURE 129 COMPARING UCOME DELIVERED IN EUROPE (ANTWERPEN – ROTTERDAM – AMSTERDAM) FROM FEBRUARY 2022 TO JULY 2024, IN US\$/TON, SOURCE JEAN-BAPTISTE JARIN WITH DATA FROM ARGUS MEDIA	218
FIGURE 130 COST OF FEEDSTOCK AND SAF PRICE RELATIONSHIP, IN US\$/TON, SOURCE JEAN-BAPTISTE JARIN WITH DATA FROM ARGUS MEDIA	218
FIGURE 131 COMPARING FOSSIL JET FUEL, SAF (HEFA-UCO) AND UCO FEEDSTOCK FROM 2020 TO 2024, IN US\$/TON, SOURCE JEAN-BAPTISTE JARIN WITH DATA FROM ARGUS MEDIA	219
FIGURE 132 Mc KINSEY SAF PRICE FORECAST, 2019, IN US\$/TON, SOURCE Mc KINSEY	220
FIGURE 133 COMPARING SAF LEVELIZED COST OF PRODUCTION (LCOP), M(F)SP (MINIMUM (FUEL) SELLING PRICE) FOR THE MAIN PATHWAYS AND FEEDSTOCKS AND PROPOSING AN AVERAGE MFSP, SOURCE JEAN-BAPTISTE JARIN WITH DATA FROM TABLE 41 COMPARING LCOP OR MINIMUM SELLING PRICE (MSP), SOURCE JEAN-BAPTISTE JARIN WITH DATA FROM IRENA, ICCT, ISAE, BRAUN ET AL, WATSON ET AL	221
FIGURE 134 GLOBAL TECHNICAL PRIMARY BIOMASS POTENTIAL FOR BIOENERGY BY MAIN RESOURCE CATEGORY FOR THE YEAR 2050. THE FIGURE SHOWS THE RANGES IN THE ESTIMATES BY MAJOR RESOURCE CATEGORY OF THE GLOBAL TECHNICAL PRIMARY BIOMASS POTENTIAL FOR BIOENERGY. THE COLOR GRADING IS INTENDED TO SHOW QUALITATIVELY THE DEGREE OF AGREEMENT IN THE ESTIMATES, FROM BLUE (ALL RESEARCHERS AGREE THAT THIS LEVEL CAN BE ATTAINED) TO PURPLE (MEDIUM AGREEMENT) TO RED (FEW RESEARCHERS AGREE THAT THIS LEVEL CAN BE ATTAINED). IN ADDITION, REDUCING TRADITIONAL BIOMASS DEMAND BY INCREASING ITS USE EFFICIENCY COULD RELEASE THE SAVED BIOMASS FOR OTHER ENERGY PURPOSES WITH LARGE BENEFITS FROM A SUSTAINABLE DEVELOPMENT PERSPECTIVE. SOURCE: CREUTZIG ET AL, WITH COURTESY OF FIRST AUTHOR AND WILEY	225
FIGURE 135 LAND AREA REQUIREMENTS FOR DIFFERENT BIOFUELS TO REPLACE US DOMESTIC CAF IN 2050. SOURCE: ICAO, U.S. FUEL TRENDS ANALYSIS AND COMPARISON TO GIACC/4-IP/1, MAY 2009, PAGE 76	226
FIGURE 136 HYDROGEN VALUE CHAIN IN 2020. SOURCE IEA HYDROGEN REPORT 2019	227
FIGURE 137 GLOBAL ELECTRICITY GENERATION BY SOURCE FROM 2010 TO 2050, ANNOUNCED PLEDGES SCENARIO, SOURCE JEAN-BAPTISTE JARIN WITH DATA FROM IEA WEO 2021	228
FIGURE 138 SHARE OF JET FUEL WITHIN THE GLOBAL PRIMARY ENERGY (IN EJ) IN 2020. JET FUEL REPRESENTS 7% (IEA) TO 8% (EI) OF OIL, WHICH REPRESENTS ITSELF 31% OF THE GLOBAL PRIMARY ENERGY, SOURCE JEAN-BAPTISTE JARIN WITH DATA FROM EI AND IEA WEO 2021	229
FIGURE 139 OVERVIEW OF THE DIFFERENT CONFLICTS OF USE FROM UPSTREAM TO DOWNSTREAM FOR THE MAIN FEEDSTOCKS CONSIDERED FOR THE PRODUCTION OF SAF, SOURCE JEAN-BAPTISTE JARIN	230
FIGURE 140 OVERVIEW OF THE PROPOSED MERIT OF ORDER FOR ELECTRICITY. WHILE MARITIME AND AVIATION ARE AHEAD OF HEATING AND ROAD TRANSPORTATION FOR THE BIOMASS, THIS IS THE OPPOSITE FOR LOW CARBON ELECTRICITY. SOURCE UK CCC	231
FIGURE 141 JET FUEL PRICES IN \$/GALLON, SPOT, SOURCE US ENERGY INFORMATION ADMINISTRATION	235

FIGURE 142 WORST CASE SCENARIO FOR JET FUEL COST BY 2030, WITH MAIN HYPOTHESES BEING ALIGNED WITH NORWAY SCENARIO, I.E. 30% SAF BY 2030 WITH A CARBON TAX AT 2000 NOK / TON OF eCO ₂ , CAF AND SAF PRICES IN 2030 ARE 720 AND 4425 \$/TON RESPECTIVELY, SOURCE JEAN-BAPTISTE JARIN	235
FIGURE 143 DETAILING AVIATION EXEMPTION FOR CARBON TAX, SOURCE JEAN-BAPTISTE JARIN	236
FIGURE 144 OPT ReFUEL EU SCENARIO FOR AIRLINES. PRICE OF SAF AND CAF IN 2030 ARE RESPECTIVELY 2200 AND 1000 \$/TON, SOURCE JEAN-BAPTISTE JARIN	237
FIGURE 145 PESS ReFUEL EU SCENARIO FOR AIRLINES. PRICE OF SAF AND CAF ARE RESPECTIVELY 3200 AND 1160 \$/TON IN 2030, REACHING 4000 AND 2000 \$/TON IN 2050, SOURCE JEAN-BAPTISTE JARIN	237
FIGURE 146 COMPARING JET FUEL COST TILL 2050, WITH 2023 AVERAGE FOR BOTH OPT AND PESS SCENARIOS, IN \$/T, SOURCE JEAN-BAPTISTE JARIN.....	239
FIGURE 147 COMPARING THE COST OF ENERGY BETWEEN CAF AND SAF (100% SAF, PESS VALUE OF 4000 \$/TON), FOR SHORT, MEDIUM AND TWO LONG HAUL DESTINATIONS, RETURN TRIP, SOURCE JEAN-BAPTISTE JARIN	242
FIGURE 148 AIRLINES NET PROFIT MARGIN (%) IN THE USA, FUNCTION OF JET FUEL PRICE (US\$). COMPARING JET FUEL PRICE IN X-AXIS, AND AIRLINES NET PROFIT MARGIN IN Y-AXIS FOR THE PERIOD 2000-2010, SOURCE JEAN-BAPTISTE JARIN WITH DATA FROM VARIOUS ATA REPORTS.....	244
FIGURE 149 AIR MOBILITY GLOBAL FUEL BURN AND ASSOCIATED eCO ₂ EMISSIONS IN 2050 WITH DIFFERENT CAGR, ASSUMING ALL LEVERS ARE DEPLOYED: 100% SAF, LOWER SPEED, MODAL SHIFT. THE SAF VOLUMES MEAN SCENARIO SUPPOSES A CAGR OF -0.5%, THE HIGH SCENARIO 1.6%, SOURCE JEAN-BAPTISTE JARIN	247
FIGURE 150 GLOBAL BIOFUELS PRODUCTION AND CONSUMPTION IN 2019, HERE IN THOUSANDS OF BOEPD (Y-AXIS), SOURCE JEAN-BAPTISTE JARIN WITH DATA FROM BP STATISTICAL REVIEW 2022	252
FIGURE 151 OBSERVED VS BUSINESS AS USUAL CROP PRICES FOR CORN (A), SOYBEANS (B) AND WHEAT (C) IN THE USA. SOURCE LARK ET AL, ORIGINALLY FIGURE 1 IN ENVIRONMENTAL OUTCOMES OF THE US RENEWABLE FUEL STANDARD. IT IS FOUND THAT THE DEVELOPMENT OF BIOFUELS POLICIES FOR TRANSPORTATION INCREASED CORN PRICES OF 31%, WHEAT AND SOYBEANS OF 20 AND 19% RESPECTIVELY	253
FIGURE 152 USED COOKING OIL STOCK PRICES FROM 2017 TO 2022, IN €/TON, SOURCE GREENEA ⁵¹⁹	254
FIGURE 153 GLOBAL OIL PRODUCTION FROM 2011 TO 2019, IN THOUSANDS BOEPD, DETAILING THE SHARE OF CRUDE AND CONDENSATE (INCLUDING SHALE OIL AND TAR SANDS), NATURAL GAS TO LIQUIDS, AND BIOFUELS, SOURCE JEAN-BAPTISTE JARIN WITH DATA FROM BP STATISTICAL REVIEW OF WORLD ENERGY	255
FIGURE 154 INTRODUCING 3 CHANNELS TO ISOLATE OIL PRICE VOLATILITY, SOURCE JEAN-BAPTISTE JARIN WITH DATA FROM BP STATISTICAL REVIEW OF WORLD ENERGY FOR THE CRUDE OIL PRICES FROM 1861 TO 2021 (YEARLY AVERAGE IN US\$ 2021 DEFLATED WITH US CPI).....	258
FIGURE 155 JET FUEL CONSUMPTION IN FRANCE FROM 2010 TO 2019 IN MT WITH 3 DIFFERENT SCENARIOS FOR 2050: BUSINESS AS USUAL, MEAN AND OPTIMISTIC SAF AVAILABILITY, SOURCE JEAN-BAPTISTE JARIN	262
FIGURE 156 SAF DEMAND CURVES FOR SAF IN FRANCE FUNCTION OF THE BIOMASS AVAILABILITY. WHEN BIOENERGY IS SUFFICIENT, THE SAF DEMAND IS MET BY EBIO SAF PROCESSES, MOBILIZING 10 MWH PER TON OF SAF. WHEN THIS IS NO LONGER THE CASE, THE RESIDUAL NEED IS MET BY EFUEL PROCESSES, MOBILIZING 35 MWH PER TON OF SAF TO REFLECT A 60% SELECTIVITY. GRAPHIC ADAPTED WITH THE COURTESY OF THE ORIGINAL AUTHOR, DR DANIEL IRACANE.....	263
FIGURE 157 TOTAL ELECTRICITY PRODUCTION IN FRANCE IN 2050 ACCORDING TO RTE N03 REFERENCE SCENARIO, IN TWH, SOURCE RTE	264
FIGURE 158 EVALUATION OF JOBS ASSOCIATED TO THE EFUEL PRODUCTION, WITH BREAKDOWN BY CATEGORY. 12 000 DIRECT JOBS PER MT PRODUCTION UNIT WHEN INCLUDING LOW CARBON ELECTRICITY PRODUCTION AND DISTRIBUTION, SOURCE JEAN-BAPTISTE JARIN.....	268
FIGURE 159 VALUE CHAIN AND JOBS OVERVIEW FOR BIOFUEL AND EFUEL PRODUCTION, SOURCE JEAN-BAPTISTE JARIN.....	268
FIGURE 160 ELECTRICITY CONSUMPTION IN FRANCE IN 2050, SHARE OF ELECTRICITY IN %, H ₂ INCLUDES EFUEL FOR AVIATION AMONG OTHER USAGES, DATA FROM RTE.....	289
FIGURE 161 eSAF ELECTRICITY REQUIREMENTS IN FRANCE, MIN / MAX HYPOTHESIS WITH 2050 RTE REFERENCE SCENARIO, SOURCE JEAN-BAPTISTE JARIN WITH DATA FROM RTE AND IATA	291
FIGURE 162 SHARE OF ELECTRICITY CONSUMPTION IN kWh PER PERSON (YEARLY CONSUMPTION FOR HEATING, COOKING, HOT WATER, LIGHTING, HOME APPLIANCES AND ELECTRIC CAR, SINGLE RETURN TRIP FOR AIR MOBILITY), SOURCE JEAN-BAPTISTE JARIN.....	295
FIGURE 163 ELECTRICITY PRICES IN FRANCE IN S1 2021 FOR HOUSEHOLD (RED), INDUSTRIES (FROM 500 TO 2000 MWH PER YEAR, IN ORANGE) AND eSAF PRODUCTION (BLUE), IN € / MWH, SOURCE JEAN-BAPTISTE JARIN	297

FIGURE 164 AVERAGE CARBON FOOTPRINT DISTRIBUTION (IN TON eCO ₂) BY CONSUMPTION CATEGORY IN THE EUROPEAN UNION. ORIGINALLY FIGURE 3A OF THE UNEQUAL DISTRIBUTION OF HOUSEHOLD CARBON FOOTPRINTS IN EUROPE AND ITS LINK TO SUSTAINABILITY, IVANOVA AND WOOD. WITH COURTESY OF FIRST AUTHOR	299
FIGURE 165 eCO ₂ EMISSIONS FROM AIR MOBILITY ACCORDING TO THE INCOME WITHIN THE EU POPULATION, SOURCE JEAN-BAPTISTE JARIN WITH DATA PROVIDED BY IVANOVA & WOOD “THE UNEQUAL DISTRIBUTION OF HOUSEHOLD CARBON FOOTPRINTS IN EUROPE AND ITS LINK TO SUSTAINABILITY”, WITH KIND AUTHORIZATION OF FIRST AUTHOR DR IVANOVA	300
FIGURE 166 ELECTRICITY PRICE FOR THE HOUSEHOLD IN FRANCE IN 2021 EXPRESSED IN € / MWh DETAILING THE SHARE OF PRODUCTION, T&D AND TAXES, SOURCE JEAN-BAPTISTE JARIN	301
FIGURE 167 ELECTRICITY PRICES IN FRANCE IN S1 2021 FOR HOUSEHOLD (PRIMARY, SECONDARY, TERTIARY NEEDS) AND eSAF FOR AIR MOBILITY (TERTIARY NEED) IN € / MWh, SOURCE JEAN-BAPTISTE JARIN	303
FIGURE 168 COMPARING CAPITA / YEAR ELECTRICITY CONSUMPTION IN GLOBAL SOUTH COUNTRIES CONSIDERED FOR H ₂ / eSAF PRODUCTION AND ELECTRICITY CONSUMPTION FOR A RETURN TRIP (1 PAX) PARIS TO NEW-YORK WITH eSAF, DATA FROM TABLE 56 SOCIO-ENERGETIC OVERVIEW OF THE SELECTED COUNTRIES, SOURCE JEAN-BAPTISTE JARIN	305
FIGURE 169 MASLOW’S PYRAMID OF NEEDS, ADAPTED FROM MASLOW	308
FIGURE 170 PROPOSED PYRAMID OF HUMAN ENERGY NEEDS (PHEN) WITH PRIMARY NEEDS IN GREEN, SECONDARY NEEDS IN BLUE AND TERTIARY NEEDS IN ORANGE, SOURCE JEAN-BAPTISTE JARIN	309
FIGURE 171 COMPARING THE PYRAMID OF HUMAN ENERGY NEEDS (PHEN) WITH THE CURRENT TAX SCHEMES INCLUDING TRANSPORT & DISTRIBUTION (T&D), EXCISE TAX, TRANSMISSION TARIFF CONTRIBUTION (CTA) AND VAT, SOURCE JEAN-BAPTISTE JARIN. THE % OF THE POPULATION CONCERNED BY EACH STAGE OF THE PHEN IN FRANCE IS 100% FOR BASIC NEEDS, ABOVE 90% FOR THE SECONDARY NEEDS WITH INTERNET ACCESS AS REFERENCE AND BELOW 10% FOR AIR MOBILITY WHEN ASSUMING A LONG-DISTANCE TRIP PER YEAR (FIGURE 165 eCO ₂ EMISSIONS FROM AIR MOBILITY ACCORDING TO THE INCOME WITHIN THE EU POPULATION, SOURCE JEAN-BAPTISTE JARIN WITH DATA PROVIDED BY IVANOVA & WOOD “THE UNEQUAL DISTRIBUTION OF HOUSEHOLD CARBON FOOTPRINTS IN EUROPE AND ITS LINK TO SUSTAINABILITY”, WITH KIND AUTHORIZATION OF FIRST AUTHOR DR IVANOVA).....	310
FIGURE 172 COMPARING, FOR VARIOUS DESTINATIONS (RETURN TRIP), THE IMPACT OF THE ENERGY PRICES WITH CURRENT TAX SCHEME FOR eSAF (NO TAXES NOR CONTRIBUTIONS, 0.0543 € / kWh) AND PROPOSED TAX SCHEME BASED ON PHEN (SAME ELECTRICITY PRICES FOR TERTIARY NEEDS THAN FOR PRIMARY AND SECONDARY NEEDS, 0.194 € / kWh), SOURCE JEAN-BAPTISTE JARIN.....	311
FIGURE 173 COMPLETING FIGURE 172 WITH ULTRA LONG-HAUL FLIGHTS, HERE THE WORLD LONGEST FLIGHT WHICH IS OPERATED IN 2024 BY SINGAPORE AIRLINES WITH AN AIRBUS A350-900 ULR, SOURCE JEAN-BAPTISTE JARIN WITH DATA FROM (161.000 LITERS FOR 161 SEATS, HYPOTHESIS OF 95% LOAD FACTOR BEING EQUIVALENT TO 44 800 kWh PER PASSENGER FOR A RETURN TRIP).....	312

List of TABLES

TABLE 1 COMPARING WORLD GDP & WORLD POPULATION FROM 0 TO 2012, SOURCE JEAN-BAPTISTE JARIN WITH DATA FROM PIKETTY	35
TABLE 2 COMPARING GDG, FOSSILS FUELS AND GHG EMISSIONS FROM 0 TO 2012, SOURCE JEAN-BAPTISTE JARIN WITH DATA FROM PIKETTY , SMIL – ENERGY INSTITUTE ²² , JONES ET AL , RITCHIE ET AL	36
TABLE 3 CORSIA CO ₂ EMISSIONS EXCEL TOOL, SOURCE ICAO	56
TABLE 4 AVIATION CO ₂ EMISSIONS IN MT IN 2019 ACCORDING TO SEVERAL SOURCES · JEAN-BAPTISTE JARIN.....	57
TABLE 5 eCO ₂ EMISSIONS IN BILLION TON FOR THE WORLD, EUROPE (EU28) AND FRANCE FROM 1950 TO 2019, SOURCE JEAN-BAPTISTE JARIN	58
TABLE 6 COMPARING RESULTS OF 4 INDEPENDENT STUDIES ADDRESSING AIRCRAFT GHG EMISSIONS USING LIFE CYCLE ANALYSIS METHODOLOGY. SOURCE JEAN-BAPTISTE JARIN WITH DATA FROM CHESTER, LOPEZ, HOWE AND JAKOVLJEVIC, * MEANS DATA WAS DEDUCTED BY THE AUTHOR	62
TABLE 7 COMPARING THE JET FUEL QUANTITIES USED BY AVIATION IN 2019, SOURCE JEAN-BAPTISTE JARIN WITH DATA FROM UN, STATISTA, BP, IATA, AND COPERNICUS FOR QUADROS AND GAIA	65
TABLE 8 DATA CONSIDERED FOR JET FUEL PRODUCTION FROM 1950 TO 2019, JEAN-BAPTISTE JARIN WITH DATA FROM GROTE ET AL AND UN ENERGY STATISTICS	67
TABLE 9 eCO ₂ EMISSIONS CALCULATED FOR THE SAME SINGLE FLIGHT WITH DIFFERENT eCO ₂ CALCULATORS, SOURCE JEAN-BAPTISTE JARIN	70
TABLE 10 METHODOLOGY FOR SAF CARBON INTENSITY CALCULATION, FROM EU DIRECTIVE (EU) 2018/2001, ANNEX V.....	78
TABLE 11 DETAILING FUEL BURN FOR A SPECIFIC COMBINATORIAL, FLIGHT TIME PER PHASE IN % AND ASSOCIATED FUEL BURN IN LITER PER HOUR PER ENGINE, SOURCE JEAN-BAPTISTE JARIN.....	86
TABLE 12 DETAILING FUEL BURN FOR A SPECIFIC COMBINATORIAL, TOTAL PER FLIGHT PHASE, SOURCE JEAN-BAPTISTE JARIN .	86
TABLE 13 RESULTS FOR SEVERAL FUEL BURN MODELS TESTED, SOURCE JEAN-BAPTISTE JARIN	87
TABLE 14 COMPOUND AVERAGE GROWTH RATE OF AVIATION AVAILABLE SEATS KILOMETER WITH DATA FROM OWID.....	89
TABLE 15 COMPARING EUROPEAN UNION GLOBAL eCO ₂ EMISSIONS REDUCTION OBJECTIVES WITH ICAO OBJECTIVES FOR AVIATION, SOURCE JEAN-BAPTISTE JARIN WITH DATA FROM ICAO AND EU	106
TABLE 16 COMPARING EUROPEAN UNION GLOBAL eCO ₂ EMISSIONS REDUCTION OBJECTIVES WITH IATA OBJECTIVES FOR AVIATION, SOURCE JEAN-BAPTISTE JARIN WITH DATA FROM IATA AND EU	108
TABLE 17 ReFUEL EU MANDATORY SHARES OF SUSTAINABLE AVIATION FUELS (SAFs), DATA FROM EU.....	110
TABLE 18 SAMPLE CALCULATION OF PENALTIES FOR FUEL PRODUCERS AND AIRLINES IN 2035 (20% BLEND RATIO), SOURCE JEAN-BAPTISTE JARIN WITH HYPOTHESIS OF CAF FROM JET-A1-FUEL AND SAF FROM ARGUS	111
TABLE 19 COMPARING eCO ₂ EMISSIONS OF CONVENTIONAL JET FUELS, ALTERNATIVE JET FUELS FROM FOSSIL, MOST STUDIED BIOFUELS AND EFUELS CONSIDERED FOR AVIATION, SOURCE JEAN-BAPTISTE JARIN WITH DATA STRATTON ET AL, SEBER ET AL, DE JONG ET AL, ICCT, IPCC AND EEA	129
TABLE 20 COMPARING THE SHARE OF FUEL IN AIRLINES EXPENSES, VALUES ARE GIVEN AS A PERCENTAGE OF THE TOTAL EXPENSES, AVERAGE OF THE INDUSTRY. SOURCE JEAN-BAPTISTE JARIN WITH DATA FROM ATA ANNUAL REPORTS FOR 1959 AND 1979 , AIRBUS FOR 1998 AND IATA FOR 2019	131
TABLE 21 COMPARING JETS VS TURBOPROP, SOURCE JEAN-BAPTISTE JARIN WITH TECHNICAL DATA OF ERJ135-145 AND ATR42-500	135
TABLE 22 COMPARING JETS VS TURBOPROP BLOCK TIME AND BLOCK FUEL FOR SIMILAR DISTANCE / PAYLOAD, SOURCE JEAN-BAPTISTE JARIN WITH DATA FROM AMELIA	135
TABLE 23 COMPARING JETS VS TURBOPROP SPEEDS AND BLOCK, SOURCE JEAN-BAPTISTE JARIN WITH DATA FROM FLIGHT RADAR (30 RANDOM FLIGHTS IN SUMMER 2024).....	137
TABLE 24 COMPARING JETS VS TURBOPROP SPEED DIFFERENCE AND ASSOCIATED IMPACT ON TOTAL TRAVEL TIME, SOURCE JEAN-BAPTISTE JARIN.....	137
TABLE 25 COMPARING GLOBAL FUEL BURN IN 2030-2050 IN BUSINESS AS USUAL AND SPEED CONSTRAINT SCENARIOS, SOURCE JEAN-BAPTISTE JARIN.....	148
TABLE 26 COMPARING 2050 GLOBAL FUEL BURN IN VARIOUS SCENARIOS, WITH HYPOTHESIS OF 0.85% EFFICIENCY CARR AND 18.8 g eCO ₂ /MJ SAF CARBON INTENSITY. IN BOLD THE PROPOSED SCENARIO WHEN CONSIDERING NO INPUTS LIMITS (BIOMASS, ELECTRICITY, SEE PART III) AND HIGHER , SOURCE JEAN-BAPTISTE JARIN	152

TABLE 27 MAIN PROPERTIES OF JET FUEL AND LH ₂ CONSIDERED IN THIS STUDY, SOURCE JEAN-BAPTISTE JARIN AND STEPHANE BEDDOK.....	160
TABLE 28 MAIN HYPOTHESES USED FOR PROPULSIVE SYSTEM DESIGN, SOURCE JEAN-BAPTISTE JARIN AND STEPHANE BEDDOK	161
TABLE 29 MAX TOW AND ASSOCIATED ENERGY REQUIREMENTS ACCORDING TO EACH VTOL ENERGY CARRIER/PROPULSIVE SYSTEM, SOURCE JEAN-BAPTISTE JARIN AND STEPHANE BEDDOK.....	164
TABLE 30 TOTAL ELECTRICITY REQUIRED FROM THE GRID FOR EACH ENERGY CARRIER, WELL TO ROTOR, IN kWh, SOURCE JEAN-BAPTISTE JARIN AND STEPHANE BEDDOK.....	165
TABLE 31 EXAMPLES OF PHYSICO-CHEMICAL PROPERTIES MEASURED IN THE JET A1 STANDARD WITH DATA FROM ASTM D1655.....	172
TABLE 32 EXAMPLES OF PHYSICO-CHEMICAL PROPERTIES, SOURCE UOP.....	179
TABLE 33 MAIN CHARACTERISTICS OF CAF AND SAF, SOURCE JEAN-BAPTISTE JARIN AND JEAN-LOUIS CHAMPION	183
TABLE 34 MAIN CHARACTERISTICS OF THE FUELS TESTED, SOURCE JEAN-BAPTISTE JARIN AND JEAN-LOUIS CHAMPION.....	194
TABLE 35 MAIN CHARACTERISTICS OF THE FUEL TESTED, SOURCE JEAN-BAPTISTE JARIN AND JEAN-LOUIS CHAMPION.....	205
TABLE 36 CAPEX VALUES, IN M€, FOR A TYPICAL PRODUCTION UNIT OF 180 KT / YEAR FOR THE 3 PATHWAYS CONSIDERED, HEFA, ATJ AND FT, SOURCE JEAN-BAPTISTE JARIN WITH DATA FROM IRENA AND ICCT	208
TABLE 37 PROCESS YIELDS TO CONVERSION FROM THE BIOMASS, SOURCE JEAN-BAPTISTE JARIN WITH DATA FROM ICCT AND TOTALENERGIES.....	209
TABLE 38 ENERGY RETURN ON ENERGY INVESTED FOR DIFFERENT PATHWAYS AND FEEDSTOCKS, SOURCE JEAN-BAPTISTE JARIN WITH DATA FROM HALL ET AL ¹³⁸ , USINE NOUVELLE AND RESTUCCIA ET AL . FOR EFUEL THE EROEI IS CALCULATED USING THE LHV OF EFUEL, 12 kWh/kg, WHICH REQUIRES 22 TO 28 kWh TO BE PRODUCED.....	209
TABLE 39 SYNTHESIS OF HYDROGEN PRODUCTION COSTS, SOURCE JEAN-BAPTISTE JARIN WITH DATA FROM DIFFERENT SOURCES ⁴¹⁹	214
TABLE 40 ESTIMATED OPEX SHARE OF FEEDSTOCK FOR THE TWO MAIN PATHWAYS, HEFA AND FT, WITH SUSTAINABLE FEEDSTOCKS (USED COOKING OIL AND FORESTRY RESIDUES), SOURCE JEAN-BAPTISTE JARIN WITH DATA FROM ARGUS MEDIA, ICCT AND MARSAC ET AL	214
TABLE 41 COMPARING LCOP OR MINIMUM SELLING PRICE (MSP), SOURCE JEAN-BAPTISTE JARIN WITH DATA FROM IRENA, ICCT, ISAE, BRAUN ET AL, WATSON ET AL	215
TABLE 42 OVERVIEW OF THE PROPOSED MERIT OF ORDER FOR THE BIOMASS, SOURCE JEAN-BAPTISTE JARIN.....	230
TABLE 43 PROPOSED SCENARIO FOR SAF PRODUCTION IN 2050, IN MT. SOURCE JEAN-BAPTISTE JARIN WITH DATA FROM CREUTZIG ET AL ⁶⁷ , SEARLE AND MALINS ⁵³⁹ , IEEP , TOTALENERGIES , IEA , ARGUS MEDIA	233
TABLE 44 REVIEW OF STUDIES ON PRICE ELASTICITIES FOR AIR DEMAND, SOURCE JEAN-BAPTISTE JARIN WITH DATA FROM VARIOUS STUDIES ^{558 559 560 561 562 563 564 565}	241
TABLE 45 REVIEW OF AIRLINES (USA) NET PROFIT MARGINS AND RELATED INPUTS FROM 2000 TO 2010, SOURCE JEAN-BAPTISTE JARIN WITH DATA FROM VARIOUS REPORTS OF ATA.....	243
TABLE 46 OIL DEMAND ELASTICITY IN THE USA, SOURCE ASKIN AND KRAFT IN ECONOMETRIC DIMENSIONS OF ENERGY DEMAND AND SUPPLY, 1976	257
TABLE 47 NUMBER OF JOBS AND BREAK DOWN PER ACTIVITY FOR 18 UNITS PRODUCING 0.1 MT OF EFUEL EACH IN 2050, HERE ACCORDING TO THE MEAN SAF SCENARIO, SOURCE JEAN-BAPTISTE JARIN	267
TABLE 48 OVERVIEW OF THE SELECTED COUNTRIES, SOURCE JEAN-BAPTISTE JARIN AND HALIMA HUSSEIN.....	273
TABLE 49 WORLD LCH ₂ DEMAND IN MT, SOURCE JEAN-BAPTISTE JARIN WITH DATA FROM IEA, BP, DELOITTE, MCKINSEY..	278
TABLE 50 LCH ₂ PROJECTS BEING CURRENTLY EVALUATED IN MAURITANIA, SOURCE JEAN-BAPTISTE JARIN WITH DATA FROM IEA.....	282
TABLE 51 LCH ₂ PROJECTS BEING CURRENTLY EVALUATED IN MOROCCO, SOURCE JEAN-BAPTISTE JARIN WITH DATA FROM IEA	282
TABLE 52 LCH ₂ PROJECTS BEING CURRENTLY EVALUATED IN NAMIBIA, SOURCE JEAN-BAPTISTE JARIN WITH DATA FROM IEA	282
TABLE 53 LCH ₂ PROJECTS BEING CURRENTLY EVALUATED IN THE UAE, SOURCE JEAN-BAPTISTE JARIN WITH DATA FROM IEA	283
TABLE 54 LCH ₂ PROJECTS BEING CURRENTLY EVALUATED IN CHILE, SOURCE JEAN-BAPTISTE JARIN WITH DATA FROM IEA....	283
TABLE 55 GLOBAL SOUTH COUNTRIES CONSIDERED, ENERGY KEY CRITERIA, WITH FRANCE FOR COMPARISON, SOURCE JEAN-BAPTISTE JARIN	284
TABLE 56 SOCIO-ENERGETIC OVERVIEW OF THE SELECTED COUNTRIES, SOURCE JEAN-BAPTISTE JARIN.....	286

TABLE 57 AVERAGE ELECTRICITY CONSUMPTION PER APPLICATION AND PER PERSON / YEAR, SOURCE JEAN-BAPTISTE JARIN WITH DATA FROM ENGIE, EV-DATABASE, STATISTA AND AVIATION CIVILE (DGAC).....	295
TABLE 58 ELECTRICITY PRICES IN FRANCE IN S1 2021 FOR HOUSEHOLD (PRIMARY, SECONDARY, TERTIARY NEEDS) AND eSAF FOR AIR MOBILITY (TERTIARY NEED) IN € / MWH, SOURCE JEAN-BAPTISTE JARIN	303
TABLE 59 YEARLY BUDGET PER PERSON FOR VITAL NEEDS AND GROUND MOBILITY, SOURCE JEAN-BAPTISTE JARIN	304
TABLE 60 COMPARING THE COST OF ENERGY FOR SHORT, MEDIUM, LONG, AND ULTRA LONG-HAUL FLIGHTS, WITH AUGUST 2024 TICKET PRICE, SOURCE JEAN-BAPTISTE JARIN.....	313
TABLE 61 TICKET PRICE SIMULATION FOR SHORT, MEDIUM, LONG, AND ULTRA-LONG-HAUL FLIGHTS (RETURN, 1 PAX), CONSIDERING PRICE OF ELECTRICITY OF HOUSEHOLDS FOR SAF PRODUCTION AND CONSIDERING THE SHARE OF FUEL BEING 25% IN 2024 AIRLINES TOTAL OPERATION COSTS, SOURCE JEAN-BAPTISTE JARIN	314



INTRODUCTION

The thesis seeks to establish the link between decarbonized air mobility and decarbonized energy before analyzing the associated effects on societies with the prism of energy justice. This sheds light on the trajectories of use and efficiencies of low-carbon energy production, allowing to characterize the resource use conflicts associated with the decarbonization of energy for air mobility while avoiding fueling energy injustice within societies. Within this work, while engineering sciences, mostly energy management, and energy justice are the core, it required to address other disciplines such as sociology, law, economic, combustion and public policies. This holistic approach is deemed necessary to assess realistic low-carbon trajectories from a technical and societal point of view, enabling us to understand the role of energy justice which will be on the lookout for the avoidance of any form of energetic injustice.

We can only regulate, legislate and, most importantly, propose decarbonization scenarios that benefit society if we have all the relevant technical, societal, and economic data. So, before explaining the issues and the concept of energy justice, we need to look at the climate and energy context, as well as that of our mobility.

1. Climate Change and energy

Climate change, and to a lesser extent peak energy, are the main reasons why nations and companies are committed to decarbonizing their activities and this is true for air mobility.

The work of the IPCC (International Panel on Climate Change) has confirmed mankind's role in global warming “human activities, principally through emissions of greenhouse gases, have unequivocally caused global warming, with global surface temperature reaching 1.1°C above 1850–1900 in 2011–2020”. Until now, global greenhouse gas emissions have continued to increase, “with unequal historical and ongoing contributions arising from unsustainable energy use, land use and land-use change”⁶.

1.1. eCO₂ emissions

These eCO₂ emissions are directly related to land use change and fossil fuel use⁷. But while land use change eCO₂ emissions remain within a channel of 2.5 to 7.5 billion tons since 1850, 4.60 billion tons in 2019, fossil fuels emissions keep rising, reaching 37.04 billion tons in 2019, an impressive 18.798% increase compared to the 0.196 billion tons in 1850.

These effects have been studied for more than 100 years. In 1824, French physicist and mathematician Jean-Baptiste Joseph Fourier published “remarques générales sur les températures du globe terrestre et des espaces planétaires”⁸, in which he explains that the temperature of the earth is increased by the role of the atmosphere. In 1838, Claude Pouillet, another French physicist, experimentally established a law of dependence of incident solar flux as a function of atmospheric thickness⁹ which he attributed to the natural greenhouse effect to water vapor and carbon dioxide. Pouillet asserted that any variation in the quantity of water vapor or CO₂ must result in a change in climate. Finally in 1896, Swedish chemist Svante Arrhenius (Nobel Prize 1903) predicts that the intensive use of fossil fuels will lead to global warming. He gives an order of magnitude: 4°C more for a doubling of CO₂ in the air.

⁶ https://www.ipcc.ch/report/ar6/syr/downloads/report/IPCC_AR6_SYR_FullVolume.pdf, page 4, accessed August 13, 2024

⁷ Jones, M.W., Peters, G.P., Gasser, T. *et al.* National contributions to climate change due to historical emissions of carbon dioxide, methane, and nitrous oxide since 1850. *Sci Data* 10, 155 (2023). <https://doi.org/10.1038/s41597-023-02041-1>

⁸ Jean-Louis Dufresne, Jean-Baptiste Joseph Fourier et la découverte de l'effet de serre. *La Météorologie*, 2006, 53, pp.42-46. <https://hal.science/hal-00113200> accessed August 13, 2024

⁹ La détermination de la constante solaire par Claude Pouillet, JeanLouis Dufresne, Laboratoire de Météorologie Dynamique (LMD), Institut Pierre Simon Laplace (IPSL), CNRS. <https://hal.science/hal-00423480/document> accessed August 13, 2024

Since the 1st industrial revolution and the massive combustion of fossil fuels, growth has been uninterrupted and brutal, reaching 424 ppm in February 2024 ¹⁰, whereas the concentration was 283 ppm in 1800 ¹¹. Some may point out that we are rapidly approaching doubling atmospheric CO₂ despite the warning of the scientific community.

In FIGURE 1 are introduced the projections of two scientific studies published in 1978 ¹² and 1990 ¹³, comparing their results with real data measured by the National Oceanic and Atmospheric Administration (NOAA).

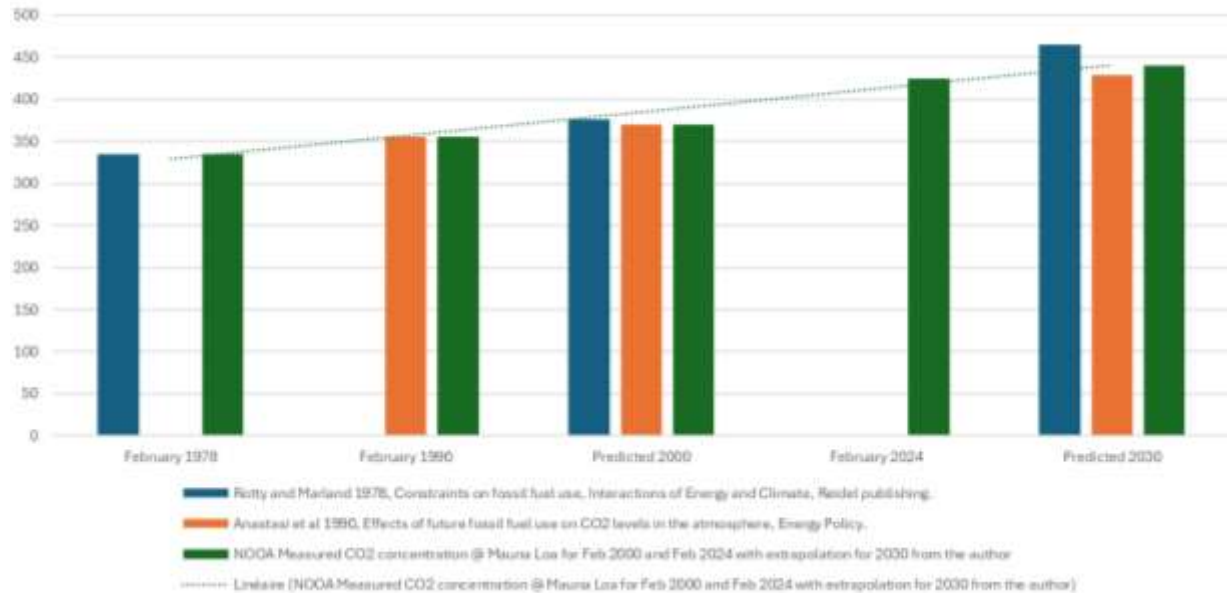

FIGURE 1 Global CO₂ concentration in ppm (y-axis). Comparing two scientific studies published in 1980 (Rotty and Marland), in 1990 (Anastasi et al) with real measurements from NOAA in Feb 1978, Feb 1990, Feb 2024, data extrapolated for 2030 (440 ppm), source Jean-Baptiste Jarin

One can see that the projections are quite accurate, with a 2% margin of error in 2000 for Rotty et al. compared to their 1978 estimate, and most likely a 2 to 6% margin of error for 2030, assuming that the CO₂ concentration in 2030 will continue to rise at the same rate as in recent years, to reach 440 ppm.

28 years passed between the 1st COP (Conference Of the Parties) in 1995 and the consensus reached by the States at the Paris Accords during COP 21 in 2015 ¹⁴, which stipulates that it is vital for humanity not to exceed +2°C vs. pre-industrial temperatures, because beyond a situation that will already be complicated to manage at this threshold (rising sea levels, repeated droughts, significant drop in agricultural yields, modification of the water cycle and rainfall, migrations of several hundred million people...) the feedback effects would be such (melting of permafrost with massive releases of methane, a powerful GHG, accelerated melting of glaciers, etc.) that a runaway effect is feared, which would lead the planet towards +5 to +8°C and would in fact make the climate difficult to bear for humanity.

¹⁰ <https://gml.noaa.gov/ccgg/trends/graph.html> accessed August 13, 2024

¹¹ [https://www.eea.europa.eu/data-and-maps/daviz/atmospheric-concentration-of-carbon-dioxide-5#tab-chart_5_filters=%7B%22rowFilters%22%3A%7B%7D%3B%22columnFilters%22%3A%7B%22pre_config_pollutant%22%3A%5B%22CO2%20\(ppm\)%22%5D%7D%7D](https://www.eea.europa.eu/data-and-maps/daviz/atmospheric-concentration-of-carbon-dioxide-5#tab-chart_5_filters=%7B%22rowFilters%22%3A%7B%7D%3B%22columnFilters%22%3A%7B%22pre_config_pollutant%22%3A%5B%22CO2%20(ppm)%22%5D%7D%7D) accessed August 13, 2024

¹² Ralph M. Rotty, Atmospheric carbon dioxide: Possible consequences of future fossil fuel use, Resources and Energy, Volume 1, Issue 3, 1978, Pages 231-249, ISSN 0165-0572, [https://doi.org/10.1016/0165-0572\(78\)90006-3](https://doi.org/10.1016/0165-0572(78)90006-3)

¹³ C. Anastasi, R. Hudson, V.J. Simpson, Effects of future fossil fuel use on CO₂ levels in the atmosphere, Energy Policy, Volume 18, Issue 10, 1990, Pages 936-944, ISSN 0301-4215, [https://doi.org/10.1016/0301-4215\(90\)90128-Q](https://doi.org/10.1016/0301-4215(90)90128-Q)

¹⁴ https://unfccc.int/files/essential_background/convention/application/pdf/english_paris_agreement.pdf accessed August 13, 2024

In FIGURE 2 are plotted the global and hemispheric anomalies in temperatures for the selected period, 1901-2000 average, using the NOAA Global Time Series ¹⁵ from 1850 to 2024.



FIGURE 2 World land and ocean temperature anomalies for the selected period, here 1850 to 2024, source NOAA

Already, climate change has reduced agricultural productivity, caused hundreds of billions of dollars in weather related disasters with an increasing trend in global GDP losses (FIGURE 3, source Swiss RE Institute ¹⁶).

A significant rise in temperatures would affect air mobility, but not only that. Crop yields could be significantly reduced worldwide ¹⁷, including in our territories ¹⁸, while a significant part of humanity would be directly at risk of deadly heat since the rise in temperatures would be accompanied with extreme humidity ¹⁹.

Part of the IPCC's work focuses on modeling climate change, and thus future temperatures, based on anthropogenic CO₂ emissions. Based on past and future emissions, it is possible to determine the amount of CO₂ that must not be exceeded in the atmosphere, while also determining the amount that would be emitted as a result of human activities. Although the names of the IPCC scenarios have recently changed, the fundamentals remain the same, and depending on the path chosen by humanity (constant, increasing or decreasing emissions), the impact on the climate will be more or less pronounced. The current trend, 9 years after the Paris Agreements, is for a further increase in GHG emissions, particularly CO₂ and CH₄, which could mean an increase of +3.5°C by the end of the century.

The goal of deep emissions cuts is to slow the world's progress toward a dangerous temperature threshold, beyond which climate impacts are likely to become more severe and widespread. In the 2015 Paris Climate Agreement, nearly 200 nations pledged to keep the average temperature this century well below 2°C and to "pursue efforts to limit the temperature increase to 1.5°C above pre-industrial levels, recognizing that this would significantly reduce the risks and impacts of climate change." This is translated in National Determined Contributions (NDCs). It is therefore possible to compare these NDCs with the implemented policies and the emissions path to 1.5°C and 2°C as shown in FIGURE 4 issued from IPCC 6th assessment report (AR6), page 25, published in 2023 ²⁰.

¹⁵ https://www.ncei.noaa.gov/access/monitoring/climate-at-a-glance/global/time-series/globe/land_ocean/12/1/1850-2023?trend=true&trend_base=10&begtrendyear=1850&endtrendyear=2024 accessed August 13, 2024

¹⁶ <https://www.swissre.com/dam/jcr:3a23765e-8aab-460a-a975-fb8bc1f30f9b/2024-03-sr-sigma-1-facts-sheet.pdf> page 2, accessed August 13, 2024

¹⁷ Kornhuber, K., Lesk, C., Schleussner, C.F. *et al.* Risks of synchronized low yields are underestimated in climate and crop model projections. *Nat Commun* 14, 3528 (2023). <https://doi.org/10.1038/s41467-023-38906-7>

¹⁸ Acclima Terra, Le Treut, H (Dir.) (2018). Anticiper les changements climatiques en Nouvelle-Aquitaine. Pour agir dans les territoires. Éditions Région Nouvelle-Aquitaine. <https://archimer.ifremer.fr/doc/00444/55569/>

¹⁹ Mora, C., Dousset, B., Caldwell, I. *et al.* Global risk of deadly heat. *Nature Clim Change* 7, 501–506 (2017). <https://doi.org/10.1038/nclimate3322>

²⁰ https://report.ipcc.ch/ar6syrr/pdf/IPCC_AR6_SYR_LongerReport.pdf accessed August 13, 2024

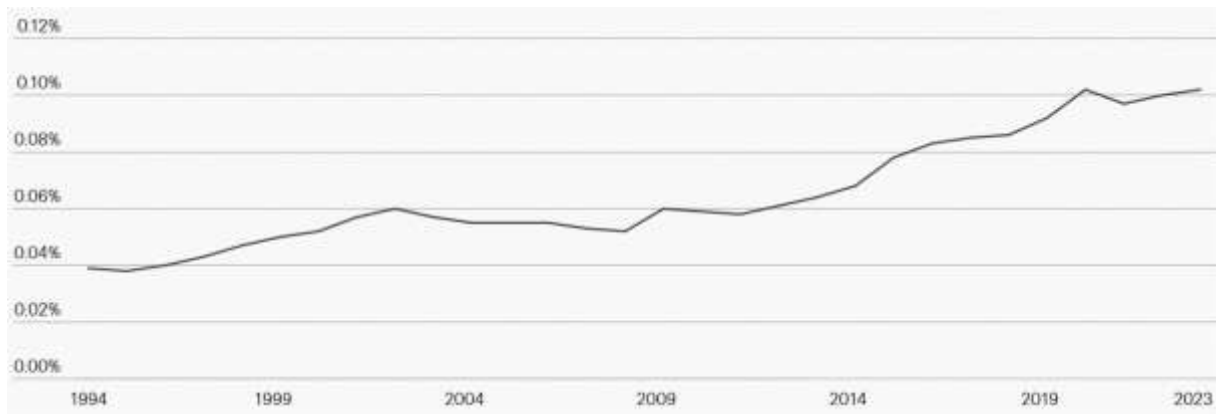

FIGURE 3 Trend of global natural catastrophe losses as % of global GDP (y-axis) from 1994 to 2023, source Swiss Re

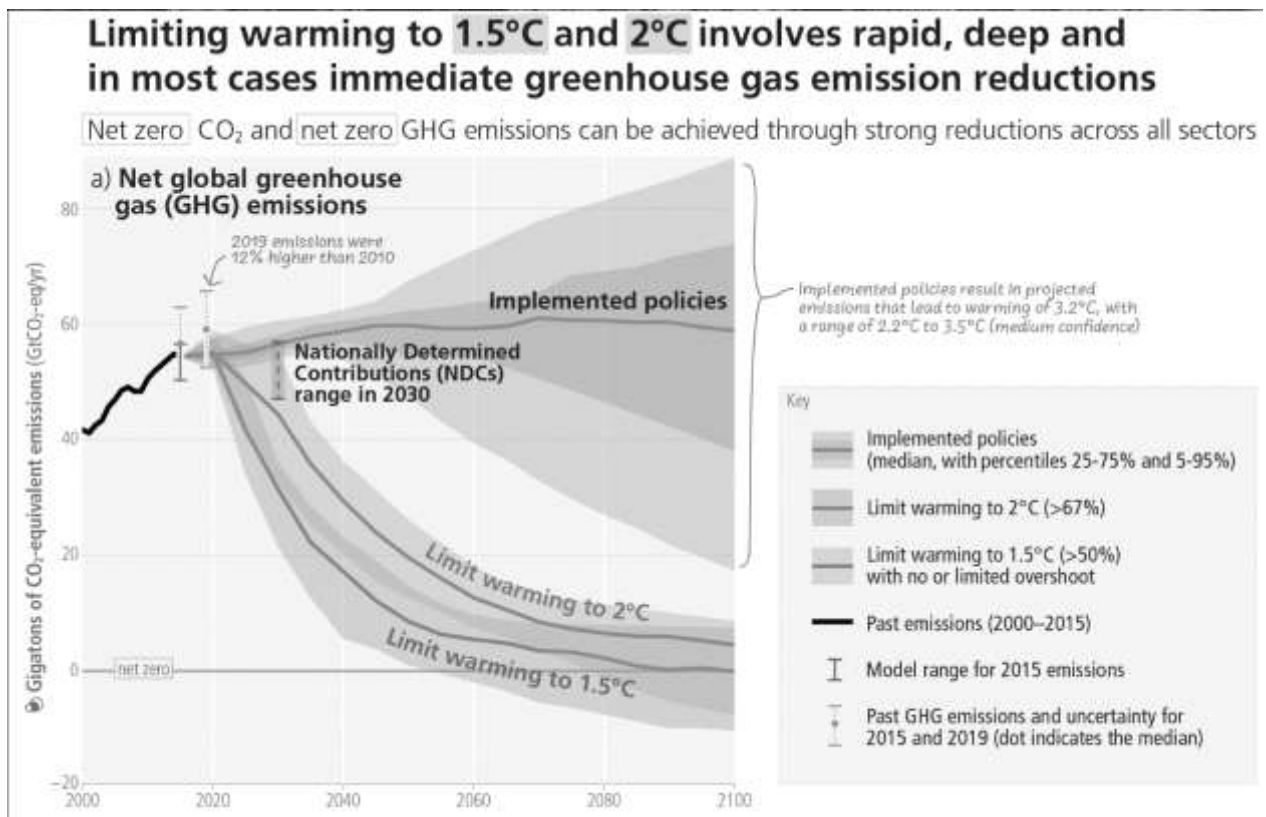

FIGURE 4 GHG emission reductions scenarios, source IPCC

Until very recently, the talk was of rising temperatures in 2100: a distant and necessarily hypothetical scenario, which spoke little to our senses. As the problems will not arrive suddenly in 2100, but rather gradually (though probably exponentially), two milestones - 2030, but above all 2050 - are now shared by the international community, and the main objectives are linked to them. These milestones will be used as reference in the coming chapters.

1.2. Climate Change, Energy and GDP

But one must understand that CO₂, therefore global warming, is not a goal, but one of the prices to pay for economic growth. As shown in FIGURE 5, fossils fuels have been the bedrock of our Gross Domestic Product (GDP) growth and therefore the production of goods and services.

In FIGURE 6, data are from Thomas Piketty “le capital au 21ème siècle”, page 127 for the world production of goods and services ²¹ and from the Energy Institute based on the works of Smil for the fossil fuels consumption ²². The data of Thomas Piketty are focused on the world GDP growth since year 0 and expressed in average annual growth rate (%). His works allow one to understand the role of the population growth in the GDP but it also possible to visualize the role of fossil fuels when these data are introduced.

Until 1820, the GDP average annual growth rate follows the growth rate of the population. Using the data of Piketty, these growth rates are of 0.1% and 0.1% from 0 to 1700 and 0.5% and 0.4% from 1700 to 1820, respectively for the GDP and the population, TABLE 1.

Data from Piketty, le capital au 21ème siècle, page 127

Period	Average Annual Growth Rate in %	
	World GDP	World Population
0 - 1700	0,1%	0,1%
1700 - 1820	0,5%	0,4%
1820 - 1913	1,5%	0,6%
1913 - 2012	3,0%	1,4%

TABLE 1 Comparing World GDP & World Population from 0 to 2012, source Jean-Baptiste Jarin with data from Piketty

It is only with the 1st industrial revolution, characterized by the use of coal, that the GDP growth truly disconnect from the population growth. The use of coal increases significantly since 1820, while oil and gas are slowly introduced at the end of the 19th century, before a significant increase after the middle of the 20th century. To make the graph readable, it is converted with Piketty's data with a base 100 for the year 0, then it is applied the proposed growth rate for each period. In this way, it is possible to visualize GDP growth over the period while comparing it to fossil fuel consumption. Data are available in TABLE 2 Comparing GDG, Fossils Fuels and GHG emissions from 0 to 2012, source Jean-Baptiste Jarin with data from Piketty , Smil – Energy Institute ²², Jones et al , Ritchie et al .

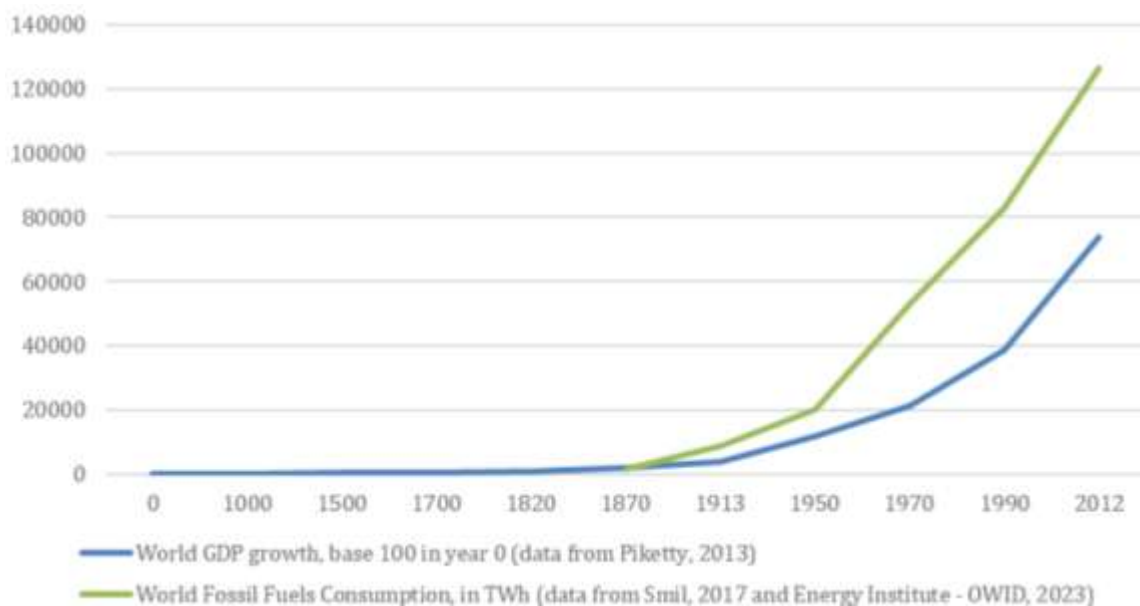

FIGURE 5 Comparing World GDP growth and World fossil fuels (oil, coal, gas) consumption from year 0 to 2012, GDP is base 100 in year 0 and World Fossil Fuels are in TWh (y-axis), source Jean-Baptiste Jarin with data from Piketty and OWID

²¹ <http://piketty.pse.ens.fr/fr/capital21c> accessed August 13, 2024

²² <https://ourworldindata.org/grapher/global-fossil-fuel-consumption> accessed August 13, 2024

Comparing GDP, Fossil Fuels and GHG	0	1000	1500	1700	1820	1870	1913	1950	1970	1990	2012
World GDP growth, base 100 in year 0 (data from Piketty, 2013)	100	271	448	546	993	2070	3965	11836	21377	38610	73982
World Fossil Fuels Consumption, in TWh (data from Smil, 2017 and Energy Institute - OWID, 2023)						1642	9000	20139	53193	83064	126339
World annual GHG emissions, including land use change, in Mt (data from Jones et al, OWID, 2023)						4680	10370	16130	27600	37860	52390
World annual CO2 emissions from fossil fuels, in Mt (data from Ritchie et al, OWID, 2020)					51	530	3290	5930	14900	22750	34940

TABLE 2 Comparing GDG, Fossils Fuels and GHG emissions from 0 to 2012, source Jean-Baptiste Jarin with data from Piketty²³, Smil – Energy Institute²², Jones et al²⁴, Ritchie et al²⁵

Since the use of fossil fuels significantly increase in the recent decades, it was found necessary to gather more accurate data from the World Bank for the GDP²⁶. In FIGURE 6, each dot represents a year from 1960 to 2020. The dot reflects the yearly world GDP in billion US\$ in the x-axis while the y-axis reflects the world primary energy consumption in TWh, once again from Smil – Energy Institute 2017.

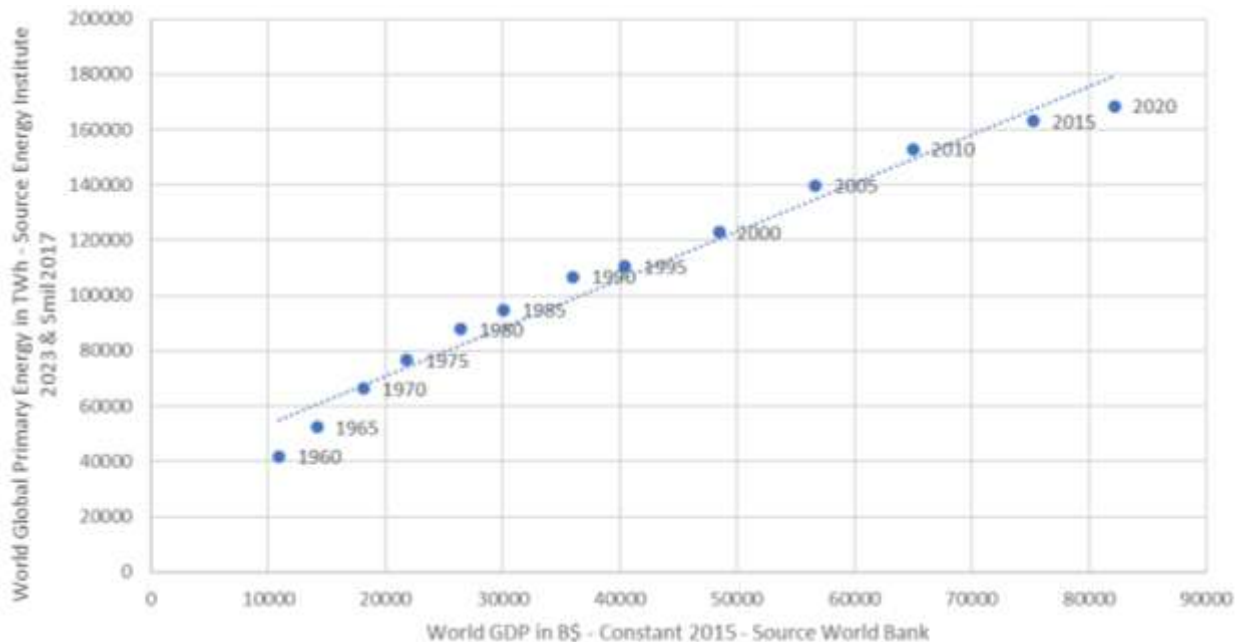

FIGURE 6 Constant GDP (in BUS\$, x-axis) vs Energy (in TWh, y-axis), source Jean-Baptiste Jarin with data from Smil for the world global primary energy and World Bank for GDP

It is important to remember that when comparing GDP to energy for different years, it is fundamental to know whether the economy is producing more, or whether we are simply charging more for the same thing. In other words, are we comparing constant values (the economy is earning more) or current values (we are charging more for the same thing).

Since we have an almost straight line, FIGURE 6 Constant GDP (in BUS\$, x-axis) vs Energy (in TWh, y-axis), source Jean-Baptiste Jarin with data from Smil for the world global primary energy and World Bank for GDP, we could conclude that Energy = GDP, or GDP = Energy. While there are still debates regarding the correlation, and causality, between energy and GDP, the conclusions of Victor Court²⁷, while demonstration the need

²³ <http://piketty.pse.ens.fr/fr/capital21c> accessed August 13, 2024

²⁴ <https://ourworldindata.org/grapher/ghg-emissions-by-gas> accessed August 13, 2024

²⁵ <https://ourworldindata.org/emissions-by-fuel#article-citation> accessed August 13, 2024

²⁶ <https://data.worldbank.org/indicator/NY.GDP.MKTP.KD.ZG?locations=1W> accessed August 13, 2024

²⁷ <https://theses.fr/203999967> accessed August 13, 2024

to consider exergy instead of energy, confirm the strong correlation between exergy, and GDP. These conclusions will feed the reflections of this thesis:

- Fossil fuels are the main reason for climate change.
- Fossil fuels are the main reason for the decoupling of economic growth / population growth, which means that our modern societies are accountable to fossil fuels, which implies that decarbonization could have a cost.
- Last but not least, energy characterizes the change of state of a medium. Applied to the Earth System, this can mean that we are changing our environment increasingly rapidly.

1.3. Climate change and energy transition

Understanding that the climate change effects could be accompanied by an energy peak, as the quantity of fossil fuels (coal, gas, but above all oil) is not infinite in a finite world, is therefore important for aviation.

IEA (International Energy Agency) and several oil majors estimate that peak production of conventional oil, in simple terms oil of good quality and cheap to extract was reached between 2005 and 2008, and that peak all-oil production could be reached by 2025²⁸. Figures provided by the oil industry FIGURE 7 below confirm that, although the amounts invested in exploration and production are higher than ever, new oilfield discoveries remain at an all-time low, with annual volumes discovered close to ten days' consumption since the start of the 21st century. Such a situation indeed confirms the conclusion of Hacquard et al *"Is the oil industry able to support a world that consumes 105 million barrels of oil per day"*.

While climate change calls for a lower carbon intensity of the fuels used, peak energy will at the same time push towards replacing, and at the very least supplementing, 100% fossil fuels with energy carriers based on low carbon biomass and / or electricity.

A complementary angle of view concerns available energy per capita, as air transport is the sector that uses the most energy per passenger (or kg of freight) transported, since to be moved it must first be removed from the earth's gravity.

An analysis of available energy per capita (all energies and uses combined) reveals a levelling off at global level, and even a decline in all developed countries. Only China, and to a lesser extent India, which are starting from a very low base and are trying to catch up with the industrialized countries at breakneck speed, are progressing, FIGURE 8. A glance at the graph confirming IATA's traffic growth forecasts: low in Europe and North America, very high in Asia-Pacific. Their upper classes now have more energy than the middle classes of developed countries (China has now overtaken Italy), and they concentrate more inhabitants (4.5 billion vs. around 1.2 billion for Europe and North America) over a larger territory, which is therefore favorable to air travel.

²⁸ Is the oil industry able to support a world that consumes 105 million barrels of oil per day in 2025? Pierre Hacquard, Marine Simoën and Emmanuel Hache, Oil Gas Sci. Technol. – Rev. IFP Energies nouvelles, 74 (2019) 88 ,DOI: <https://doi.org/10.2516/ogst/2019061>

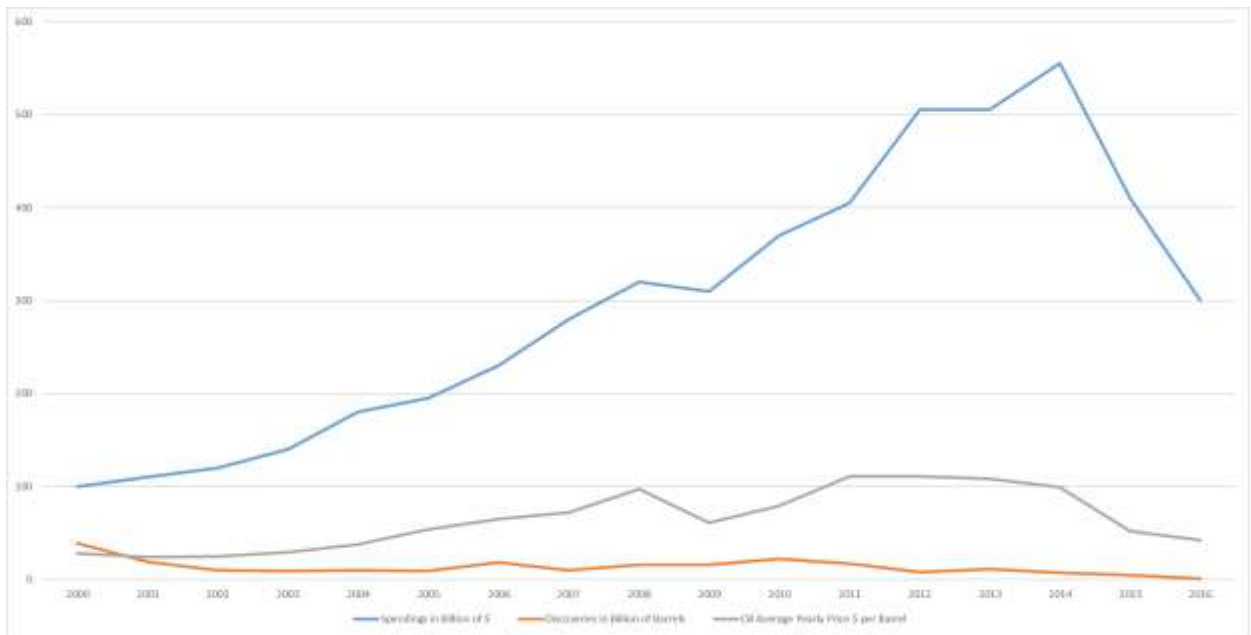

FIGURE 7 Yearly oil exploration expense (BUS\$) vs yearly discoveries (Bboe) with the barrel oil price as a reference from 2000 to 2016 in y-axis. Source Jean-Baptiste Jarin, with data from Wood Mackenzie and Rystad. One can notice that the exploration expenses are not correlated with the discoveries but with the oil barrel price, cash being available for the oil and gas industry to spend in Exploration and Production

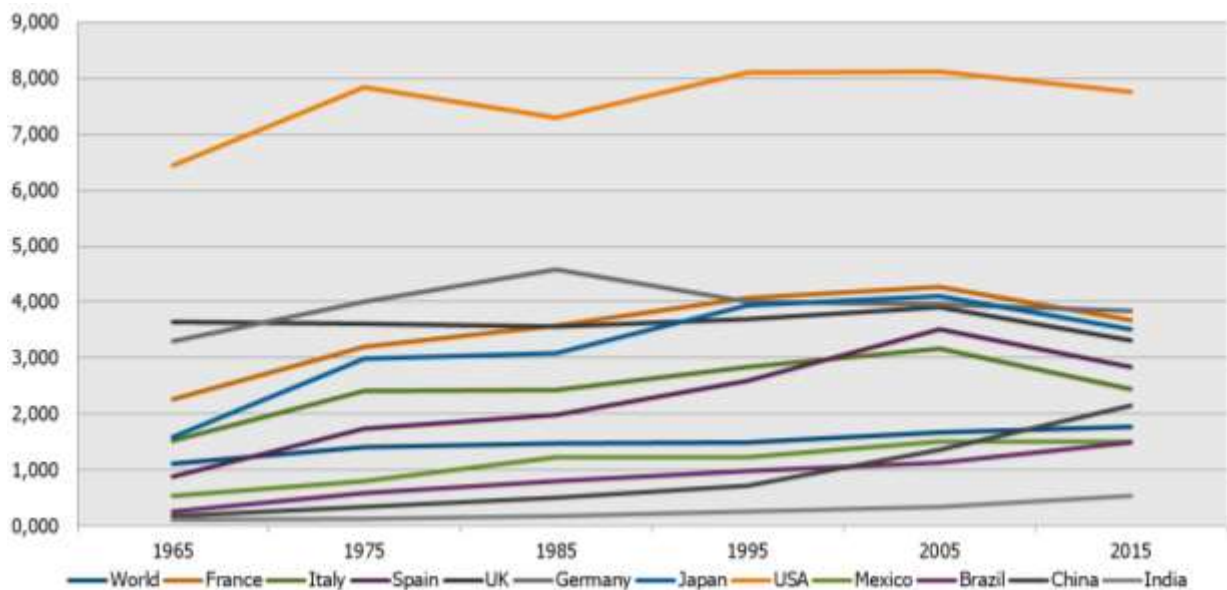

FIGURE 8 Energy per capita from 1965 to 2015, all energies converted in ton oil equivalent (toe, y-axis), source Jean-Baptiste Jarin with data from World Bank, UN and BP Statistical Review

As such there is a need to understand the cross effects as well as the need to choose the least inefficient energy for each purpose²⁹. These cross effects on feedstocks are further detailed in part II.

At a time when the European Union is beginning to embrace the notion of just transition, and when energy justice is likely to become a dominant theme in the years ahead, it is becoming essential for the law to understand and master the physical, economic, and societal issues that accompany energy. And since that “*which cannot be measured does not exist*” to cite Niels Bohr, Nobel Prize in Physics 1922, tackling the choice of energy requires a multi-disciplinary

²⁹ <https://boutique.lexisnexis.fr/12623-le-droit-des-mobilites/> Jarin, JB, Partie 4 pages 361 to 370, accessed August 13, 2024

approach, which alone will enable us to provide the best possible input for the decisions that will have to be made in our standards, our laws, and even more so in our planning instruments such as the national low-carbon strategy (SNBC) and the multi-annual energy program (PPE, articles L. 141-1 to L. 141-4 of the Energy Code).

Mobility requires electrical and/or mechanical energy. The Watt-hour (Wh), a unit of energy measurement that corresponds to the quantity produced or consumed in one hour by a one-watt machine, is particularly well-suited. The units expressed in this chapter will therefore most often be the kWh (thousand watts hour) on a machine and/or individual scale, and the TWh (thousand billion Wh or 1 billion kWh) on a national or global scale. For greater precision when discussing and comparing energy choices in relation to mobility, the measure will be kWh/km/kg (quantity of energy used in kWh per kilometer traveled for one kilogram transported). This measure can then be compared with the orders of magnitude of energy on the production side, shedding light on the societal, environmental, and economic issues involved, and feeding into our legal considerations.

1.4. Beyond GHG

Sustainability goes beyond CO₂, and this is even more true with energy since the associated impacts go far beyond eCO₂, i.e. land use change with the production of biomass to produce bioSAF. This is demonstrated by the work of the Stockholm Resilience Center, Stockholm University, and humanity has recently crossed 6 planetary boundaries as shown in FIGURE 9³⁰. Not only CO₂, but also biosphere integrity, freshwater change, or land system change.

The risk to reach several tipping points is well documented in the chapter 3 of the Sixth Assessment Report (AR6) of IPCC³¹, “avoiding Regional Tipping Points by Achieving More Ambitious Global Temperature Goals”. Tipping points refers to a “critical thresholds in a system that, when exceeded, can lead to a significant change in the state of the system, often with an understanding that the change is irreversible.” There are several tipping points addressed in this report, such as, but not limited to, the ice sheet melting, the release of CH₄ (methane) from the arctic tundra or the weakening of the AMOC (Atlantic Meridional Overturning Circulation). The Global Tipping Points Reports 2023 published in 2023³² highlights in its conclusions that “Harmful tipping points in the natural world pose some of the gravest threats faced by humanity.”

While ice sheet melting is not occurring at the same pace all over the globe³³, the weakening of the AMOC and the increasing emissions of methane from Arctic tundra are well documented. Rößger et al conclude in 2022 that “increase in early summer methane emissions shows that atmospheric warming has begun to considerably affect the methane flux dynamics of permafrost-affected ecosystems in the Arctic”³⁴ while Rhamstorf from the Postdam Institute considers that the weakening of the AMOC is taking place now and there could be a significant drop in temperatures over Europe in the coming decades³⁵. A colder Europe in a warming world is not an opportunity since the formation of storms and floods are based on the confrontation of warm and cold air masses. Excessively cold air masses over Europe meeting excessively warm air masses on the periphery could thus compromise the habitability of the European continent and prevent any aviation movements.

In the recent years, along the “flygskam” which will be further discussed in the next chapters, the effects of climate change are already affecting, still at a low scale, air mobility operations. These effects are of different natures, such as

³⁰ <https://www.stockholmresilience.org/research/planetary-boundaries.html> accessed August 13, 2024

³¹ <https://www.ipcc.ch/sr15/chapter/chapter-3/> accessed August 13, 2024

³² Lenton, T.M., D.I. Armstrong McKay, S. Loriani, J.F. Abrams, S.J. Lade, J.F. Donges, M. Milkoreit, T. Powell, S.R. Smith, and others, eds. 2023. The Global Tipping Points Report 2023. University of Exeter, Exeter, UK, 479 pp <https://pure.iiasa.ac.at/id/eprint/19228/> accessed August 13, 2024

³³ <https://www.univ-grenoble-alpes.fr/news/headlines/west-antarctic-ice-sheet-has-not-reached-its-tipping-point-towards-irreversible-collapse-yet-new-research-finds-1305955.kjsp?RH=1581082035011> accessed August 13, 2024

³⁴ Rößger, N., Sachs, T., Wille, C. *et al.* Seasonal increase of methane emissions linked to warming in Siberian tundra. *Nat. Clim. Chang.* 12, 1031–1036 (2022). <https://doi.org/10.1038/s41558-022-01512-4>

³⁵ <https://tos.org/oceanography/assets/docs/37-rahmstorf.pdf> accessed August 13, 2024

less lift associated with higher humidity^{36 37} since the proportion of water vapor contained in the air is not constant, but ranges from 0.1 to 5 percent. This proportion is strongly affected by the air temperature and +1°C air temperature translates in +7% humidity content in the air, leading to a higher fuel consumption and / or a lighter payload³⁸. Another perceptible impact is related to airport closures due to weather, such as extreme storms or flooding, in Nice in 2017³⁹, Osaka in 2018⁴⁰ or Porto Alegre in May 2024⁴¹ or during hot spells when the airports are located in high altitude, in Phoenix in 2017, London in 2018⁴². There are possibilities to avoid these conditions, such as longer runways and / or less payload, but this requires more energy and therefore would only increase the climate change effects as concluded by Gratton & al⁴³.

But the factor that is likely to have the greatest impact is turbulence. This phenomenon has been observed and analyzed for many years, and the conclusions point to a marked increase in turbulence, both in number and intensity as concluded by Kim et al⁴⁴ and Williams et al⁴⁵. The painful experience of crews and passengers during recent flights, such as the SIA, Qatar, Emirates or Air Europa^{46 47 48 49} flights in May and June 2024 could occur more frequently according to the most recent studies.

³⁶ <https://www.meteoswiss.admin.ch/weather/weather-and-climate-from-a-to-z/humidity.html>

³⁷ Balicki, Włodzimierz & Głowacki, Paweł & Szczeciński, Stefan & Chachurski, Ryszard & Szczeciński, Jerzy. (2014). Effect of the Atmosphere on the Performances of Aviation Turbine Engines. *Acta Mechanica et Automatica*. 8. 70-73. 10.2478/ama-2014-0012. <http://dx.doi.org/10.2478/ama-2014-0012>

³⁸ <https://simpleflying.com/humidity-impact-on-aircraft-performance-guide/> accessed August 13, 2024

³⁹ <https://monacolife.net/flights-cancelled-at-nice-airport-roads-closed-flood-warnings-in-effect/> accessed August 13, 2024

⁴⁰ <https://www.weforum.org/agenda/2018/10/japan-s-flooded-airport-demonstrates-the-threat-from-rising-seas/> accessed August 13, 2024

⁴¹ <https://www.flightglobal.com/air-transport/brazils-porto-alegre-airport-remains-crippled-after-storm-flooding/158199.article> accessed August 13, 2024

⁴² <https://edition.cnn.com/travel/article/climate-change-airplane-takeoff-scen/index.html> accessed August 13, 2024

⁴³ Gratton, G., Padhra, A., Rapsomanikis, S. *et al.* The impacts of climate change on Greek airports. *Climatic Change* 160, 219–231 (2020). <https://doi.org/10.1007/s10584-019-02634-z>

⁴⁴ Kim, SH., Kim, JH., Chun, HY. *et al.* Global response of upper-level aviation turbulence from various sources to climate change. *npj Clim Atmos Sci* 6, 92 (2023). <https://doi.org/10.1038/s41612-023-00421-3>

⁴⁵ Williams, P., Joshi, M. Intensification of winter transatlantic aviation turbulence in response to climate change. *Nature Clim Change* 3, 644–648 (2013). <https://doi.org/10.1038/nclimate1866>

⁴⁶ <https://apnews.com/article/singapore-airline-flight-turbulence-c8a890fc3596bc69b766ab9a6e5987bb> accessed August 13, 2024

⁴⁷ <https://www.bloomberg.com/news/articles/2024-05-30/emirates-adds-turbulence-detection-tools-after-recent-incidents> accessed August 13, 2024

⁴⁸ <https://fr.euronews.com/2024/05/26/un-nouvel-cas-de-turbulence-six-blesses-sur-un-vol-entre-qatar-et-dublin> accessed August 13, 2024

⁴⁹ <https://www.reuters.com/world/americas/passengers-diverted-air-europa-flight-recount-turbulence-ordeal-2024-07-02/> accessed August 13, 2024

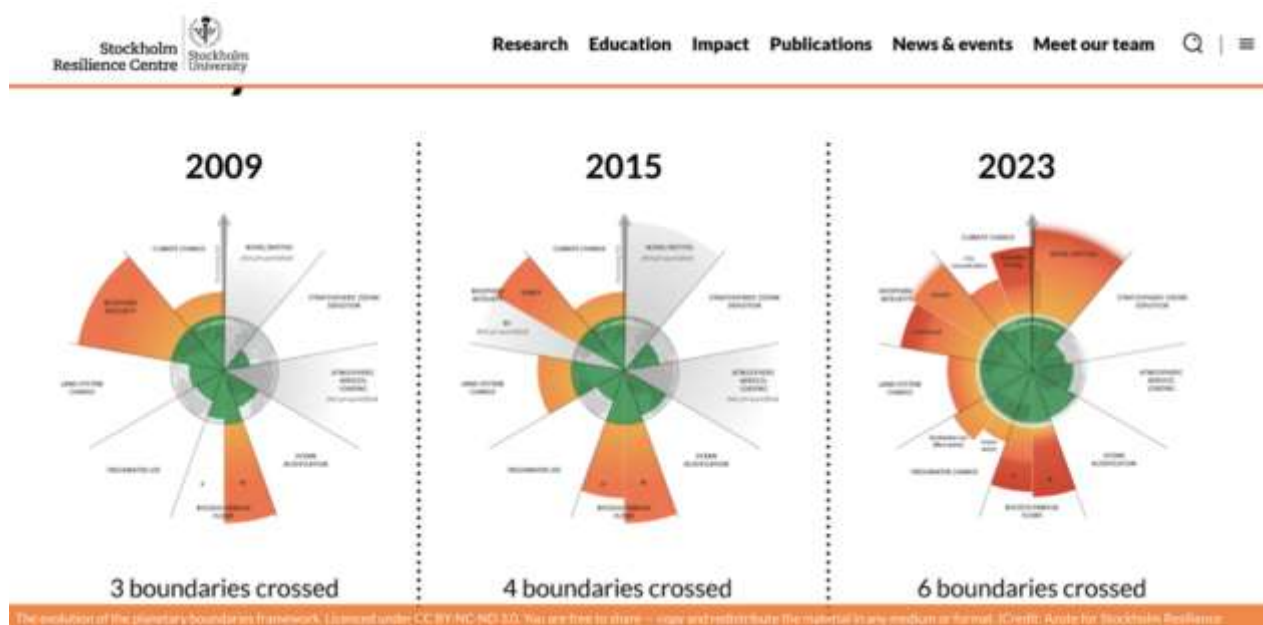

FIGURE 9 The evolution of planet boundaries – Stockholm Resilience Centre – Stockholm University

Beyond GHG also means that land use change shall be considered especially when addressing biofuels, a solution often cited as the most promising solution for decarbonizing air mobility. Indeed “The International Air Transport Association (IATA) considers it a key element in reducing the environmental impact of aviation”⁵⁰. But as developed in chapter IV of part II, biomass availability is far from being granted. For instance, in 2021, food and feed crop-based biofuels and biogas account for only 4% of the energy mix within the EU transports⁵¹ while mobilizing more than 5 million of hectares of land⁵², or 3.5% of the current agricultural surface⁵³. And since “Natural resources are scarce and their preservation is a prerequisite for ensuring prosperity in the long-term. This basic fact applies even to land – it is a finite resource that cannot be imported or reproduced”⁵⁴, the impacts of land use change (LUC) and indirect land use change (ILUC) must be considered as limiting the analysis to the climate change and associated CO₂ emissions would lead to falling from the frying pan into the oven since those two boundaries are already crossed since 2023 as shown in FIGURE 9.

The pace of these changes has significantly increased since the second half of the 20th century, which is in line with the increasing use of energy in our societies. More energy means a greater possibility to impact the environment, not only in GHG emissions but also in various pollutions and other side effects which are defined and tracked by the Stockholm Resilience Centre since 2009⁵⁵.

Beyond GHG: While this thesis will remain focus on decarbonization, understanding the impacts of a higher energy consumption in our environment must be acknowledged to characterize the impact on human societies, chapter II part I and chapter III part III. Moreover, when addressing the next chapter (past and current GHG emissions of Air Mobility) and chapter III (future scenarios), not only the reference will be the year 1990 which is the Kyoto Protocol base year for emissions for the CO₂ emissions, but also for the energy at stake for air mobility so the global impacts on the environment can be introduced.

⁵⁰ <https://www.iata.org/en/iata-repository/pressroom/fact-sheets/fact-sheet---alternative-fuels/> accessed August 13, 2024

⁵¹ <https://www.eca.europa.eu/en/publications?ref=sr-2023-29> accessed August 13, 2024

⁵² <https://www.transportenvironment.org/articles/biofuels-an-obstacle-to-real-climate-solutions> accessed August 13, 2024

⁵³ https://ec.europa.eu/eurostat/statistics-explained/index.php?title=Farms_and_farmland_in_the_European_Union_-_statistics accessed August 13, 2024

⁵⁴ <https://www.fao.org/family-farming/detail/fr/c/357469/> accessed August 13, 2024

⁵⁵ <https://www.stockholmresilience.org/research/planetary-boundaries.html> accessed August 13, 2024

2. The role of energy in our mobility

As introduced above, energy is vital for air mobility, but also for our global economies.

Weighing 6.5 to 13% of the world Gross Domestic Product (GDP) in the recent years⁵⁶, or 12%⁵⁷ to 29%⁵⁸ of airlines expenses, energy is often seen by airlines as a commodity weighing too much in their costs, and by policy makers as nothing more than an important share of the GDP.

But in reality, energy in air mobility is as vital as in GDP, perhaps even more so, since historically the heavier than air has only been able to lift a significant payload by combining the internal combustion engine with dense, liquid energy: fossil jet fuel. Historically the lighter than air, balloons, was short-lived as no real applications, except some sightseeing in a limited space, occurred. In 1869, Samuel Pierpont Langley was the first to launch an unmanned heavier than air aircraft on a sustained flight successfully. Langley was later funded by the US government to create a crewed version of his aircraft for purposes of spying on the enemy. However, his design was not successful.

It is recognized that the Wright brothers solved the issue of controlled, powered flight. On December 17th, 1903, the two brothers successfully built and launched the first crewed flight. This is also the universally recognized date that launched modern aviation. Just a century ago when maritime (750 BCE earliest identified use of mast ships) and road transportation (2000 BCE chariots were used for transportation) have accompanied civilizations for millenniums.

Indeed, air mobility was only able to see the light of day a century ago, when technology encountered an energy that was sufficiently dense, both in mass and volume, and easily storable and mobilizable (because liquid).

Once this energy density lock was lifted, progress was rapid. In 1906, Alberto Santos-Dumont set the world record by flying his aircraft 220 meters over Paris. In 1914, Roland Garros attached a machine gun to his aircraft and France produced more than 60 000 aircrafts during World War I. Initially for military use, the airplane quickly became a useful means of transport for mankind, if only to connect the whole of the globe, which had only just been conquered.

In 1940 more than 10.000 civil aircrafts are operated in the USA only⁵⁹ and by 1959, “the first full year of the jet age”, some 80 million civil passengers were recorded⁶⁰.

In 2019, according to ICAO 4.5 billion passengers were carried on scheduled services⁶¹. While detailed in the next chapters it is highlighted here that 4.5 billion passengers does not mean that 4.5 billion of citizens flew in 2019. Indeed, only a fraction of the population flies, with less than 10% of the population counting for 90% of the flights.

2.1. Energy and GHG emissions in our mobilities

The transport sector's relative share of greenhouse gas (GHG) emissions is 24%, 31% and 43% respectively for the world, Europe, and France⁶². This high share of GHG emissions is due to the dominance of oil in this sector, whose eCO₂ equivalent content per unit of energy is exceeded only by coal. As of today, 65% of the oil production goes to transport and FIGURE 10 details this energy use by mode of transport: share of kilometers traveled, travel times and number of trips for France. As intuited by many, air mobility is dedicated to long distance and this particularity has an impact not only on GHG emissions, but also on its role within our societies as well as the form of energy required.

⁵⁶ <https://www.bloomberg.com/news/articles/2022-03-16/energy-costs-set-to-reach-record-13-of-global-gdp-this-year> accessed August 13, 2024

⁵⁷ ATA 1960 Annual Report, page 6 <https://airlines.org/wp-content/uploads/2014/08/1960.pdf> accessed August 13, 2024

⁵⁸ ATA 1980 Annual Report, page 3 <https://airlines.org/wp-content/uploads/2014/08/1980.pdf> accessed August 13, 2024

⁵⁹ ATA 1940 Annual Report page 6 <https://airlines.org/wp-content/uploads/2014/08/1940.pdf> accessed August 13, 2024

⁶⁰ ATA 1959 Annual Report page 4 <https://airlines.org/wp-content/uploads/2014/08/1960.pdf> accessed August 13, 2024

⁶¹ <https://www.icao.int/annual-report-2019/Pages/the-world-of-air-transport-in-2019.aspx> accessed August 13, 2024

⁶² <https://www.i4ce.org/publication/datalab-chiffres-cles-climat-2022-france-europe-monde-climat/> page 38, accessed August 13, 2024

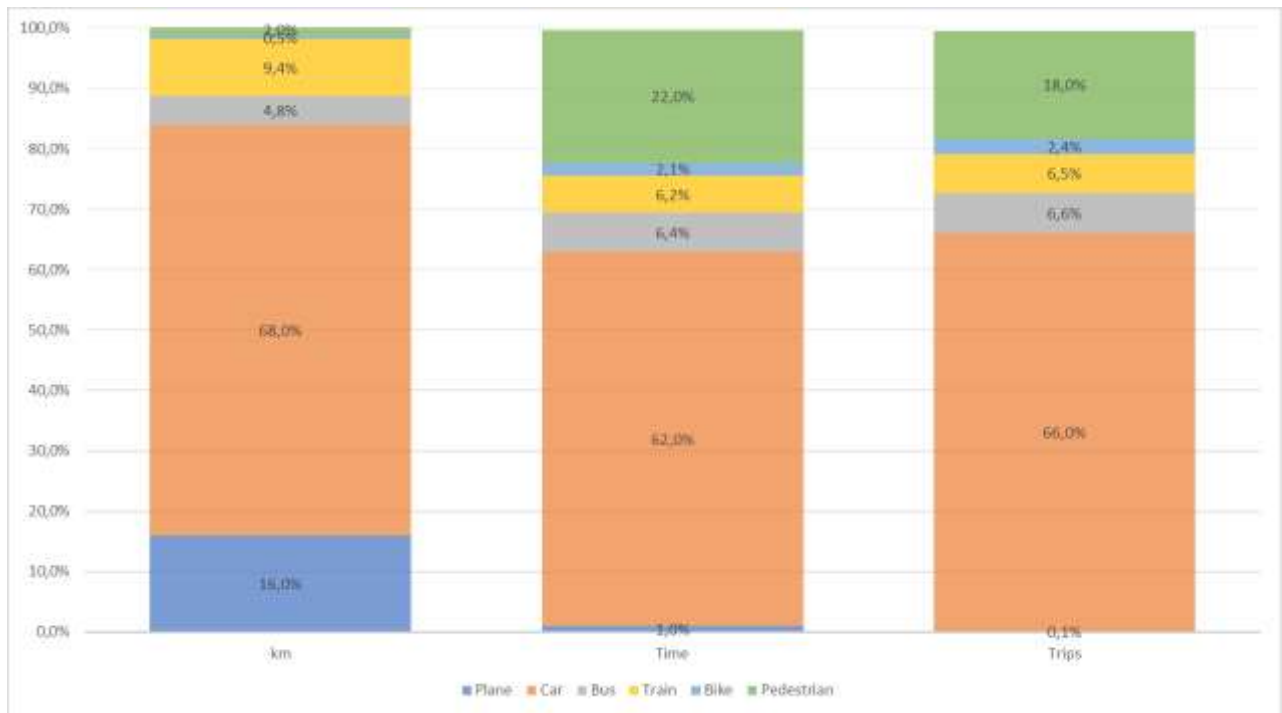

FIGURE 10 Air Mobility within mobilities in France, share of kilometers traveled, travel times and number of trips. With data from Bigo⁶³

Sustainable mobility means doing without fossil oil and gas. However, all energies, even renewable ones, emit CO₂, if only during the manufacturing stages. In our country, on an individual basis, mobility accounts for 2.9 tons of GHG emissions out of a total of 10.8 tons⁶⁴. Respecting the Paris agreements implies dividing our GHG emissions by five, and when we detail potential actions, the share dedicated to mobility should be close to 300 kg of GHG per year and per inhabitant.

But how can we decarbonize mobility? Lifecycle analysis is a tool that enables us to detail the cradle-to-grave emissions of our products and their uses. While the proportions vary, for each type of mobility, energy remains the main contributor to GHG emissions, with a maximum of 95% for air transport, which can be explained by the extraordinary mileage an aircraft will have covered before being retired - up to 80 million kilometers⁶⁵. If mobility is at the heart of environmental issues, energy is at the heart of our mobility.

Oil is the energy at the heart of today's mobility

Largely dedicated to mobility, oil is the world's leading energy source⁶⁶. This dominance in our energy mix sometimes leads experts to refer to oil as the mother of all energies, and energy companies regularly convert other forms of energy into ton of oil equivalent (toe). Easy access to this exceptionally energy dense resource, both in terms of mass and volume, explains our society's infatuation with this molecule, which has rapidly become an integral part of all our forms of mobility, whether by land, air, or sea. Historically, it was the internal combustion engine/oil pairing that enabled globalization, enabling our societies to go ever faster and ever further (and for much less money). Thus, until

⁶³ Aurélien Bigo. Les transports face au défi de la transition énergétique. Explorations entre passé et avenir, technologie et sobriété, accélération et ralentissement.. Economies et finances. Institut Polytechnique de Paris, 2020. Français <https://theses.fr/2020IPPAX068>

⁶⁴ Carbone 4, faire sa part (<https://www.carbone4.com/publication-faire-sa-part>) accessed August 13, 2024

⁶⁵ https://www.sccer-mobility.ch/export/sites/sccer-mobility/capacity-areas/dwn_capacity_areas/Jemiolo_Thesis_Final.pdf, page 57, accessed August 13, 2024

⁶⁶ <https://www.bp.com/content/dam/bp/business-sites/en/global/corporate/pdfs/energy-economics/statistical-review/bp-stats-review-2022-full-report.pdf>, page 9, accessed August 13, 2024

very recently, only the railways, thanks to the direct electrification provided by catenary power supply, were able to develop using energy other than oil.

Complying with the Paris agreements therefore means replacing oil with other forms of energy whose GHG emissions will be considerably reduced, and whose measure, as seen in the introduction, will be the percentage reduction in GHG emissions per kilogram transported per kilometer. This measure is vital: for example, it would be counterproductive to electrify a vehicle whose energy consumption and/or the CO₂ content of the energy used would be so high that the gains in upstream energy decarbonization would be cancelled out by the vehicle's final consumption.

This example alone explains why a limited number of energy options are available to the transport sector when we decide to move towards sustainable mobility. We are moving away from free primary energy, as nobody ever paid a euro for oil, which is concentrated and easy to mobilize, to energy carriers with multiple conversion stages. As it happens, converting induces efficiency losses, and these efficiency losses translate into economic costs and increased pressure on resources.

2.2. Which energy for which mobility

Opinions still sometimes differ as to which energy vector is best suited to sustainable mobility, but it is already clear that the answer will not be the same depending on the mode of transport chosen. But whether it is hydrogen, in reality dihydrogen as there are two hydrogen molecules in H₂, biofuels, efuels, biogas or battery electrification, these energy carriers all rely on two coveted raw materials: biomass and/or electricity. While discussions are already focusing on the best technologies to implement for each type of mobility, best technology is sadly often approached through the prism of industrial interests, or at best sovereignty. While this is obviously necessary, it must not obscure the essential issue of access to the two raw materials concerned, biomass and electricity. To forget this aspect of the problem would be to accept and amplify future conflicts of use that will go beyond our mobility issues: biomass is sometimes a carbon sink, sometimes a food resource, sometimes an energy resource, and always accompanied by biodiversity issues. Electricity, which is still be largely carbon-intensive⁶⁷, is also already under pressure, and it is used for a multitude of purposes, including heating, cooking, the cold chain, and lighting. Access to biomass is now well documented, and the various scientific publications converge around an availability of 100 exajoules (EJ), part of which could be mobilized for bio energies⁶⁸. Relative to our current oil consumption, this would represent at best, after conversion efficiencies, a few percent. Moreover, the resulting conflicts of use such as with cooking, heating, land use change, are numerous. This explains the recent position of the European Commission, which, after two decades of incentives, has just amended its regulations on renewable energies (RED 2), strictly regulating the raw materials intended to produce renewable energies.

So, logically, we are now turning our attention to the other raw material that could power tomorrow's sustainable mobility: electricity. Over the past few decades, technology has made it possible to convert uranium, water, wind, and sunlight into low-carbon electricity with emissions ranging from 12 to 48 g eCO₂/kWh, compared with 490 and 820 for gas and coal respectively⁶⁹. We already use this electricity for most of our purposes: heating, cooking, lighting, food preservation, household appliances, industrial production... and as highlighted by the International Energy Agency, ADEME, and RTE in France, this electrification of our uses will continue to grow. However, recent events remind us that access to electricity is neither guaranteed nor free. In the winter of 2022-2023, a slight rise in the price of gas, the

⁶⁷ <https://www.bp.com/content/dam/bp/business-sites/en/global/corporate/pdfs/energy-economics/statistical-review/bp-stats-review-2022-full-report.pdf> page 51, accessed August 13, 2024

⁶⁸ Creutzig, F., Ravindranath, N.H., Berndes, G., Bolwig, S., Bright, R., Cherubini, F., Chum, H., Corbera, E., Delucchi, M., Faaij, A., Fargione, J., Haberl, H., Heath, G., Lucon, O., Plevin, R., Popp, A., Robledo-Abad, C., Rose, S., Smith, P., Stromman, A., Suh, S. and Maserà, O. (2015), Bioenergy and climate change mitigation: an assessment. *GCB Bioenergy*, 7: 916-944. <https://doi.org/10.1111/gcbb.12205>

⁶⁹ IPCC, Annex 3, p. 1335 https://www.ipcc.ch/site/assets/uploads/2018/02/ipcc_wg3_ar5_annex-iii.pdf accessed August 13, 2024

primary energy source that accounts for only 20% of Europe's electricity production ⁷⁰, resulted in a five-fold increase in electricity prices. It is also worth pointing out here that almost two-thirds of the 28 466 TWh, one terawatt-hour corresponds to 1 billion kWh, for reference according to Engie the average household in France consumes 4 679 kWh/year, of electricity produced worldwide in 2021 is currently highly carbon-intensive, i.e. from thermal power plants fueled by coal (36%), gas (23%) or oil (2.5%) ⁶⁷. Readers could legitimately ask whether limiting global warming might not mean prioritizing the decarbonization of this electricity before electrifying new uses, but this is not the subject of this chapter.

Driven once again by advances in technology, mobility can now use these TWh of electricity to replace oil. We know how to charge batteries, convert electricity by electrolysis of water into H₂, a molecule which is then converted back into electricity to power H₂ vehicles via a fuel cell. We can even produce efuels by recombining H₂ with CO₂ via the Fischer-Tropsch process, process named after the German chemists who invented it in 1923. This process consists of a chemical reaction that allows the catalysis of hydrocarbons from carbon monoxide and hydrogen. Today's internal combustion engine/oil combination could therefore be replaced by an internal combustion engine powered by H₂ or efuel, or by an electric motor powered either by a fuel cell that converts H₂ into electricity in the vehicle, or directly by batteries.

2.3. Electricity, the energy at the heart of tomorrow's sustainable mobility

This means that kWh on an individual scale (TWh on a national scale) will be systematically mobilized to manufacture the energy vectors that will ensure our future mobility. Increasingly, our focus will shift from the price of a barrel of oil and the price expressed in liters at the pump to the price of electricity and the price expressed in kWh at service stations. In France, domestic consumption of petroleum products in 2021 will amount to 67.2 million tons, including 41.3 million tons for land transport ⁷¹. At the same time, our electricity production will amount to 522.9 TWh, down to 445.2 TWh in 2022 due to lower availability of nuclear power and hydroelectricity because of drought, a physical constraint associated to climate change ⁷².

These orders of magnitude should give us food for thought, because it is not technology that will be the limiting factor tomorrow, but the physical and, to a lesser extent, economic limits. So, if we take the example of Porsche, which advocates retaining the internal combustion engine for road transport by replacing oil with efuels ⁷³, we would need to mobilize for the French rolling stock, on the basis of a highly optimized efficiency of 37 kWh/kg of efuel, including 60% selectivity ⁷⁴, some 1,500 TWh, or almost three times our country's current electricity production. As it happens, the order of magnitude would be the same for engines powered directly by H₂, as dihydrogen is the main ingredient in electrofuels.

The RTE reference scenario for 2050 is 645 TWh, while the high scenario peaks at 754 TWh ⁷⁵. Lastly, in RTE's N03 balanced scenario ⁷⁶, meeting the reference scenario means increasing photovoltaic electricity production sevenfold, increasing onshore wind power by almost threefold, installing several thousand offshore wind turbines, building

⁷⁰ Ember, p.14, <https://www.connaissancedesenergies.org/sites/default/files/pdf-pt-vue/Report-European-Power-Sector-in-2020.pdf> accessed August 13, 2024

⁷¹ INSEE <https://www.insee.fr/fr/statistiques/2119673> accessed August 13, 2024

⁷² RTE <https://www.rte-france.com/actualites/bilan-electrique-2022> accessed August 13, 2024

⁷³ <https://newsroom.porsche.com/en/2022/company/porsche-highly-innovative-fuels-hif-opening-efuels-pilot-plant-haru-oni-chile-synthetic-fuels-30732.html> accessed August 13, 2024

⁷⁴ Rapport de l'Académie des Technologies, 2023, p. 52 (<https://www.academie-technologies.fr/wp-content/uploads/2023/03/Rapport-decarbonation-secteur-aerien-production-carburants-durables-AT-Mars-2023.pdf>) accessed August 13, 2024

⁷⁵ Futurs-Energetiques-2050-principaux-resultats.pdf, rte-france.com page 16 <https://assets.rte-france.com/prod/public/2021-12/Futurs-Energetiques-2050-principaux-resultats.pdf> accessed August 13, 2024

⁷⁶ Futurs-Energetiques-2050-principaux-resultats.pdf, rte-france.com page 43 <https://assets.rte-france.com/prod/public/2021-12/Futurs-Energetiques-2050-principaux-resultats.pdf> accessed August 13, 2024

several new nuclear power plants, and extending the life of existing plants. We also need to transport this electricity, and our high- and medium-voltage transmission network will also have to be significantly expanded.

All in all, we will need to mobilize the energy sector in a major way over the coming decades. Decarbonizing our mobility therefore represents a considerable challenge. If we are to control our destiny as effectively as possible, we need to put in place a systemic vision of the future, from upstream, i.e. power generation, to downstream, i.e. the entire life cycle of each propulsion system. This approach would ensure real effects on our energy consumption and real gains on our GHG emissions, from well to wheel for land and rail, from well to propeller for marine, and from well to rotor or thrust for air mobility.

This is the best way for our society to deal with the conflicts of use that are already arising, and which will increase as each sector attempts to decarbonize, whether to proactively combat global warming or to comply with the various regulations being put in place to enforce the Paris agreements.

Having established this, it might seem logical to integrate the best technological choice into our planning, i.e., the best energy efficiency per kilogram transported per kilometer for each type of mobility. In return, it would be put in place a plan for the allocation of shared resources such as biomass and electricity.

The notion of time, and therefore speed, could also be taken into account, because as Ivan Illich ⁷⁷ has argued, speed has a price, but above all a cost for society. In economic terms, as taken up by the concept of "generalized speed", but even more so in societal terms, since tomorrow it is the common good of electricity, which meets many basic needs (housing, heating, food) that will be put in competition. If we take as an example one of the recent proposals of the Citizens' Climate Convention ⁷⁸, reducing freeway speed by 20 km/h is equivalent to saving around 20% in energy. This is a subject of discussion with oil, since we are comparing saving time against money, without considering the effects on an energy that is not yet too constrained. With electricity, it will be an economic and societal issue tomorrow, as it will affect our entire energy infrastructure, from generation plants to distribution networks, as well as all our uses. Recent tensions over the price of electricity should alert us to the effects of future competition between uses, and it is disturbing to note that future hydrogen or efuel production projects dedicated to mobility are calling for a price per kWh of less than 5 cents, and even 1 cent across the Atlantic ⁷⁹ when the French household is billed 22 euro cents (regulated tariff, before the 10% increase in August 2023), and the "tariff shield" for businesses is 28 euro cents.

2.4. Which low-carbon energy carriers for which sustainable mobility?

While discussions should also focus on the issues of speed (driving, sailing, or flying at lower speeds) and sobriety of use (limiting motorized travel), we can already conclude here that it is essential to agree on the best energy vector, i.e. the one that is the most efficient when expressed in kWh, and therefore the most sober in terms of GHG emissions, for each type of mobility.

This approach is all the more useful as breaking down mobility in terms of greater energy efficiency should also benefit the consumer, since the cost of travel becomes systematically proportional to the price per kWh of electricity multiplied by the quantity mobilized. This would also mean less pressure on the French (and European) electricity system, and therefore less tension on electricity prices, as illustrated above, as demand would be better controlled.

The logic adopted here is therefore to focus on the energy efficiency of propulsion systems, and then to try to apply them to each mode of transport, taking into account their intrinsic limitations, such as the mass of the batteries for an aircraft, for example.

When we compare propulsion systems powered directly or indirectly by electricity, the most efficient is logically direct electrification: few conversions and therefore few losses. Efficiency is around 95% (for every 100 kWh taken from the

⁷⁷ Y. Crozet, *Économie de la vitesse: Ivan Illich revisited*; *Les révolutions de la mobilité: L'Économie politique* 2017, no. 76, pp. 24-37 <https://shs.hal.science/halshs-01685277/document> accessed August 13, 2024

⁷⁸ PT3.1 proposition de réduire la vitesse sur autoroute à 110 km/h maximum <https://propositions.conventioncitoyennepourleclimat.fr/> accessed August 13, 2024

⁷⁹ Hydrogen shot, Department of Energy <https://www.energy.gov/eere/fuelcells/hydrogen-shot> accessed August 13, 2024

power grid, 95 kWh is useful energy). In fact, the French rail network is our biggest consumer of electricity, but it is also the most efficient when measured in terms of useful kg (passengers or goods) transported per km. Direct electrification is therefore to be preferred, but although it has been tested on a few stretches of freeway, it will most probably remain reserved for the train - metro - tramway trio, i.e. collective mobility with heavy infrastructures (presence of rails and catenaries).

It is obviously not accessible to airplanes, boats, or individual vehicles, but it has almost all the qualities of sustainable mobility, provided that the electricity produced is low-carbon (hydro, wind, solar, nuclear).

Next comes battery electrification (chemical conversion of electricity to concentrate it) with an efficiency of around 80 to 85%.

This option is reserved for light mobility - 2-wheelers, cars, and vans - as the mass of the battery must not prevent take-off, for example. This is the case for aircraft, where 180 tons of batteries would theoretically be needed to get an Airbus A320 or Boeing 737 off the ground, compared with their 30-tons payload⁸⁰. To give an idea of the volume of electricity needed, the total electrification of the passenger car fleet in France seems achievable, with an estimated requirement of 76 TWh, i.e. 10% to 15% of the target production for 2050 according to RTE (assumption of 38.7 million passenger cars in France, with an average annual mileage of 13 100 km and an average consumption of 15 kWh/100 km for an electric vehicle).

For heavy-duty mobility - trucks, boats, and aircraft - the options are less obvious, given the many externalities involved. An H₂ propulsion system with a fuel cell has an efficiency close to 35%, which drops to 20% for efuel⁸¹. Favoring biomass energy for these heavy mobilities seems obvious, but volumes will not be sufficient, and electricity will also have to be mobilized, as discussed above.

For trucks, studies are continuing, the choice is between batteries and H₂ with fuel cells. Energy efficiency is clearly in favor of the batteries approach, but externalities such as access to raw materials and recycling of batteries, charging time for haulers... need to be considered. At this stage, the most efficient approach seems to be Switzerland's piggyback approach (trucks on trains), which deserves to be studied more seriously.

For ships, the H₂ + fuel cell option is not available, as the power required is not compatible. Commonality with other forms of bioenergy also militates in favor of electrofuels since once integration effects have been taken into account, their energy balance is comparable or better to that of dihydrogen.

The same choice of electrofuels should be made for air mobility in the future, because while light air mobility should be able to be electrified with a few constraints, the weight of the batteries remains incompatible with an aircraft that must carry several dozen passengers over hundreds or thousands of kilometers. The same applies to dihydrogen: the integration effects on the carrier are such that the final yield is once again in favor of electrofuels. With annual consumption in France standing at 8 Mt, this route will give rise to many debates and choices for society, since a "100% efuel" route would require almost 200 TWh of electricity for French needs alone (compared with 76 TWh for the electrification of all the country's private cars).

These last two means of transport, sea and air, have many similarities: similar oil consumption and GHG emissions, growing and largely globalized sectors and, as we have seen, the same appetite for biofuels and electrofuels. Indeed, the European Commission has recently asked these two sectors to work together on sustainable mobility within the Renewable & Low Carbon Fuel Alliance⁸².

⁸⁰ Safran Bourget 2019 press kit, The electrical future of aeronautics, p. 30, https://www.lepoint.fr/economie/salon-du-bourget-il-y-a-de-l-electricite-dans-l-air-16-06-2019-2319215_28.php#11 accessed August 13, 2024

⁸¹ <https://www.transportenvironment.org/wp-content/uploads/2022/02/TE-Briefing-Rewarding-renewable-efficiency.docx.pdf> accessed August 13, 2024

⁸² https://transport.ec.europa.eu/transport-themes/clean-transport/alternative-fuels-sustainable-mobility-europe/renewable-and-low-carbon-fuels-value-chain-industrial-alliance_en accessed August 13, 2024

However, with an estimated consumption of 500 million toe in 2050 for both sea and air transport, this would represent around 20 000 TWh in a 100% efuel scenario. Remembering that 20 000 TWh is equivalent to 80% of current world electricity production, and that by 2050, according to the IEA trajectory, this would be equivalent to all renewable electricity production⁸³. Here too, there will be plenty of debate about the conflicting uses of our future low-carbon electrons.

Recent experience shows that it is not certain that the law of supply and demand alone can contribute to collective well-being, whereas in at the same time the pressure on inputs such as biomass and electricity is growing.

Addressing the choice of energy in sustainable mobility therefore means optimizing our resources as much as possible, but also imagining a new approach between the allocation of these resources and the uses to which they will be put: this approach must inform our standards, laws, and planning tools.

The choice of energy for sustainable mobility calls for a cross disciplinary approach, as the impact on energy systems, and therefore on society, is massive. Our society needs to get to grips with the subject right away, because the decisions we make today can condition the inequalities of tomorrow.

⁸³ eia.gov <https://www.eia.gov/todayinenergy/detail.php?id=42555> accessed August 13, 2024

3. Objectives and methodology

The construction of this thesis required the construction of a complex jigsaw puzzle, since beyond the cross-disciplinary aspect it is necessary to understand and combine the inputs as well as the links and collateral effects of each brick. This sometimes meant introducing elements of one brick into another chapter, such as the eCO₂ balance of SAFs in the first part to assess different decarbonization scenarios, whereas they are only detailed in the second part on their overall balance of emissions, supply-chain, costs, and impact on inputs. References to previous and / or subsequent chapters are then indicated to facilitate the reading that sometimes requires this back-and-forth.

Also, for a first reading that helps to grasp the main elements developed in the thesis, it is possible to refer to the conclusions of each part (3). 173 FIGURES and 61 TABLES also allow a quick reading of the main points highlighted. Finally, the table of contents helps the reader to grasp the elements developed in each chapter. Given the impossibility of fully mastering all the disciplines involved in this thesis (energy management, combustion, law, political and social sciences, economics, climate, and natural sciences), the research work is based on numerous publications and reports, as well as interviews and participation in various working groups. Over 800 references are cited in this thesis, and for ease of access these are listed at the bottom of each page so that the full title is easily accessible.

The thesis is divided into 3 parts, which can be read separately, but the construction of the thesis and the role of energy justice with the decarbonization of air mobility, developed in Part 3, presuppose a good command of all the chapters of Part I and II, or at least their conclusions.

Since several disciplines are at stake, the thesis must be heavily sourced. In this thesis, articles mean peer reviewed scientific articles published in Q1 journals, or exceptionally equivalent proceedings for recognized congress. Reports are from consulting firms, NGOs, industries, which are generally not peer reviewed. This includes data from organizations such as IEA, ATA, IATA, or ICAO. Data are always compared, and peer reviewed conclusions are always preferred. When different results still exist, the rationale for using a set of data rather than other is provided.

Within the 840 references cited in this thesis:

- 40% are from peer reviewed articles.
- 29% are from bills and regulations, or renowned organisms, such as IPCC, UN Stats, NOAA, OWID, INSEE, Académie des Technologies...
- 31% are from the press, industries, consulting firms, NGOs, such as T&E, IATA, ATA, McKinsey, Airbus, Reuters, Ember, RTE...

3.1. Problematic

Understanding the decarbonization of air mobility therefore requires an understanding of energy carriers and energy systems with their respective infrastructure, the circular economy, the access to resources and the associated externalities such as land use change effects, and the economic and social sciences that will allow us to rethink an economic model that remains focused on growth and tends to forget its externalities. At stake, therefore, are energy management and energy justice, but the thesis required to draw on other disciplines such as combustion, economics, social sciences, resource management, law and public policies. While not fully cross-disciplinary, the thesis to require the application of multiple disciplines, Knapp et al ⁸⁴ “*cross-disciplinary collaborations have become an increasingly important part of science. They are seen as key if we are to find solutions to pressing, global-scale societal challenges, including green technologies (...). Regulators and policy-makers have realized the power of such collaborations*”. This even more true when addressing energy and decarbonization, Mallaband et al ⁸⁵. According to the United Nations

⁸⁴ Knapp B, Bardenet R, Bernabeu MO, Bordas R, Bruna M, Calderhead B, et al. (2015) Ten Simple Rules for a Successful Cross-Disciplinary Collaboration. PLoS Comput Biol 11(4): e1004214. <https://doi.org/10.1371/journal.pcbi.1004214>

⁸⁵ B. Mallaband, G. Wood, K. Buchanan, S. Staddon, N.M. Mogles, E. Gabe-Thomas, The reality of cross-disciplinary energy research in the United Kingdom: A social science perspective, Energy Research & Social Science, Volume 25, 2017, Pages 9-18, ISSN 2214-6296, <https://doi.org/10.1016/j.erss.2016.11.001>

climate dictionary, “Decarbonization means reducing the amount of greenhouse gas emissions that a society produces, as well as increasing the amount that is being absorbed. It entails changing many, if not all, aspects of the economy, from how energy is generated, to how goods and services are produced and delivered, to how buildings are built and how lands are managed (...) Meaningful decarbonization requires substantial investments in low-carbon infrastructure and transportation, renewable energy sources, circular economy and resource efficiency, and land and soil restoration. It also requires a rethinking of current economic models that are focused on growth at all costs”⁸⁶: addressing decarbonization is in its very nature a cross-disciplinary exercise.

As the air transport system relies on massive energy use, 8.1% of world oil production is dedicated to air mobility in 2019⁸⁷, and since this consumption is influenced by numerous parameters, 6 main levers are identified, directly concerned with the Avoid – Shift – Improve concept⁸⁸. FIGURE 11 below summarizes the main parameters at stake with these levers. In bold are indicated the levers and parameters which are addressed in this thesis while the main (dark brown) and secondary (light brown) subjects dealt with in the various parts of the thesis are indicated.

Role of Public Policies	Regulation	Taxes	Regulation	Subsidies	Subsidies	Taxes / Subsidies	Regulation, Subsidies, Taxes	Taxes	
Inputs	Population, Economy, Purchase Power, Travel Price	Infrastructures, Public Policies, Values	Public Policies, Technologies, Time Value	Technology (yield)	Technology (engines, drag, weight)	Technology (ERoEI)	Biomass, Electricity		
TOPIC	Demand x	Modal Shift x	Speed x	Load Factor x	Energy Efficiency	=	Fuel Burn x	Fuel Carbon Intensity =	eCO₂ emissions
	AVOID	SHIFT	IMPROVE	IMPROVE			IMPROVE		
Side Effects for societies	Lower GDP, lower subsidies	Investments (infrastructures)	Time	Lower ticket price	Lower ticket price	Price of energy	Prices of commodities (food, electricity, oil)	Climate Change	
Air Mobility Impacts	Traffic growth (CAGR)	Traffic growth (CAGR)	Traffic growth (CAGR)	Lower operation Costs	Lower operation Costs	Price of energy	Higher Costs	Higher Costs	
Disciplines involved	Economy, Energy Justice	Economy, Energy management, Energy Justice	Energy management, Economy	Energy Management, Economy	Energy management	Energy Management, Combustion	Energy Management, Energy Justice	Energy Justice, Public policies	
Part I									
Part II									
Part III									

FIGURE 11 The 6 levers identified to support the decarbonization of air mobility along with the associated main parameters. In dark and light brown, the respectively main and secondary topics which are addressed in the different Parts of the thesis, source Jean-Baptiste Jarin

3.2. Theorizing energy justice within air mobility

Energy is the cornerstone of our modern world, serving needs such as heating or eating. It is seen as a lifeline in all countries, with sometimes free basic allotments provided to the citizens. Still, energy is evenly undistributed, globally⁸⁹, but also locally due to income inequalities⁹⁰. On the opposite, air mobility is a more exclusive application which is highly energy intensive, potentially leading to conflicts of use and supply-demand imbalance when requiring low carbon fuels produced from electricity and / or biomass. Since renewable and low carbon fuels, often cited as SAF (Sustainable Aviation Fuel) will soon be mandatory - 2030 within the EU - energy policies dedicated to SAF are very

⁸⁶ https://climatepromise.undp.org/sites/default/files/research_report_document/the_climate_dictionary_0.pdf, page 32, accessed August 13, 2024

⁸⁷ <https://www.energyinst.org/statistical-review> page 29, accessed August 13, 2024

⁸⁸ <https://projects2014-2020.interregeurope.eu/innotrans/news/news-article/6151/sustainable-transport-avoid-shift-improve/> accessed August 13, 2024

⁸⁹ Brian Min, Zachary P. O’Keeffe, Babatunde Abidoye, Kwawu Mensan Gaba, Trevor Monroe, Benjamin P. Stewart, Kimberly Baugh, Bruno Sánchez-Andrade Nuño, Lost in the dark: A survey of energy poverty from space, Joule, Volume 8, Issue 7, 2024, Pages 1982-1998, ISSN 2542-4351, <https://doi.org/10.1016/j.joule.2024.05.001>

⁹⁰ Ivanova D, Wood R (2020), the unequal distribution of household carbon footprints in Europe and its link to sustainability. Global Sustainability 3, e18,1-12. <https://doi.org/10.1017/sus.2020.12>

much still in the formative stage and energy justice is the perfect theory to identify energy injustices before they occur, ensuring a more fair, equal, equitable and inclusive transition.

Energy justice means the consideration of human rights in the energy life cycle, it therefore starts with extraction and production of energy carriers, i.e. biomass and electricity⁹¹. Among the five forms of energy justice, distributive justice is appropriate when addressing air mobility as it is concerned with the fair distribution of the burdens and benefits of social cooperation among diverse persons with competing needs and claims⁹². In this thesis, public policies are seen as necessary to drive not only the production but also the consumption within a distributive justice perspective. This is a prerequisite not only to avoid energy injustice but also because public acceptability is crucial for society and for decision making⁹³.

As such, with the perspective of future low carbon energy carriers based on biomass, and moreover when based on electricity, public policies such as taxation scheme have a central place to avoid any future inequalities. Public policies that will be translated into laws must balance economic, environmental and energy security issues to offer the best solutions, at least the best compromise, to the populations⁹⁴. Indeed, energy production and consumption must come with fair taxation, taxation being the cornerstone of equality⁹⁵.

In this thesis, fair and explicit public policies, while not in contradiction with incentivizing the development of new technologies such as SAF production, are preferred to distributional policies which generally involved complex mechanisms which can become inexplicit, leading to lower efficiency than market conditioning⁹⁵. And since EU explicitly aims to enable a just transition towards a low-carbon energy system⁹⁶, it is therefore the prism of distributive justice, through tax policies, which should ensure that rates applied to SAF are not disadvantageous to purposes that may be vital for all compared to more exclusive applications such as air mobility.

While the thesis does not specifically address what a fair level of wealth or a fair level of growth might be, the notion of a minimum energy requirement to ensure a decent standard of living is addressed in Part III and it was found that globally the implementation of transformational policies and strategies aimed at achieving low carbon emissions should not interfere with energy justice.

3.3. Part I Understanding the Decarbonizing Air Mobility

This first part addresses air mobility global eCO₂ emissions, past, current and future. The main levers for decarbonizing air mobility are identified, the context and the objectives are set, challenging the common belief. The role of low carbon fuels, but also speed, modal shift, and air traffic growth / degrowth are reviewed, allowing to evaluate the amount of low carbon energies required to support a credible decarbonization of air mobility.

This involved several disciplines such as economy, climate sciences as well as law to capture the essence of the different regulations. It was found necessary to understand why we need to decarbonize air mobility, but also its role in our societies and the regulation that accompanies this sector. Understanding and building a decarbonization scenario typically involve several disciplines, such as energetic and economy. While engineering skills were needed to understand the role of technologies, social and legal skills where needed to address the role of air mobility and its

⁹¹ Energy justice in a nutshell means the consideration of human rights in the energy life cycle, from extraction all the way to waste management. See RJ Heffron 'The challenge for energy justice: Correcting human rights abuses', Palgrave Macmillan, 2021, <http://dx.doi.org/10.1007/978-3-030-80097-0>

⁹² A. Kaufman, Distributive Justice, Theories of, Editor(s): Ruth Chadwick, Encyclopedia of Applied Ethics (Second Edition), Academic Press, 2012, Pages 842-850, ISBN 9780123739322, <https://doi.org/10.1016/B978-0-12-373932-2.00227-1>

⁹³ Stuart N. Soroka, Christopher Wlezién, Degrees of Democracy, Public Preferences and Policy in Comparative Perspective, https://www.nuff.ox.ac.uk/Politics/papers/2003/Soroka_Wlezién_Degrees_2004.pdf

⁹⁴ R. J. Heffron, The Just Framework, https://doi.org/10.1007/978-3-030-89460-3_3

⁹⁵ Gribnau, Hans and Vording, Henk, The Birth of Tax as a Legal Discipline (February 1, 2017). <http://dx.doi.org/10.2139/ssrn.2919003>

⁹⁵ Nathan J. Kelly, American Journal of Political Science, Vol. 49, No. 4, October 2005, Pp. 865–880, <https://nathanjkelly.utk.edu/wp-content/uploads/2017/10/Kelly-2005.pdf>

⁹⁶ https://commission.europa.eu/strategy-and-policy/priorities-2019-2024/european-green-deal/finance-and-green-deal/just-transition-mechanism_en

associated regulations. Confronting the different points of view, such as those of scientists and manufacturers, required going through numerous reports produced by consulting firms or industrial groups, as well as hundreds of scientific publications. Combined with several interviews it allowed to develop a holistic vision of the context and the issues involved.

3.4. Part II From decarbonizing the energy for mobility to conflicts over resource use

Once the quantities of low carbon energies defined, it was found necessary to compare the different options proposed by the energy carriers from well to wake. Since it is found that Sustainable Aviation Fuels (SAF) produced from the biomass and / or electricity are the least inefficient carrier for air mobility, several tests were conducted to understand the associated pollutant emissions along with the eCO₂ footprint. The focus on SAF allows an evaluation of their detailed characteristics, from cost to eCO₂ emissions, thus allowing to address the potential economic impact on the air mobility sector. This approach allows to address the collateral effects such as conflicts over use of resources, which makes it clear that the necessary decarbonization of energy has a cost not only for the sector, but more broadly for human societies.

This second part required mostly energy management and combustion skills since it deals with the decarbonization of the energy and the efficiency of propulsive systems. Significant fuel emissions measurements were realized in engine test cells with the collaboration of an engine manufacturer thanks to the BEARCAT test cell of SafranTech⁹⁷. Several tests comparing SAF with fossil jet fuel have been realized with the support of SAF producers during this thesis to confirm not only the benefits but also ensure that no collateral damages, such as an increase in local air pollutant, would occur when using SAF.

3.5. Part III The role of Energy Justice within the air mobility decarbonization roadmap

The impacts of offer and demand on feedstocks required by the production of SAF are addressed, along with the opportunities, such as jobs creation, but also the risks, such as replicating the oil curse and energy injustice. The role of public policies and energy justice are evaluated and proposals are drafted.

This part could not exist without the expertise and knowledge gained in part I and II, involving mostly energy justice, economic and public policies sciences. This part addresses the impacts of conflicts over use of resources and the role of tax and public policies before proposing guidelines. The collateral effects are addressed, from energy sovereignty and jobs opportunities to the risk of replicating the oil curse.

Along with researches, the discussions with the industry as well as with the NGOs regarding the E-CHO project, a SAF plant which should be in operation by 2029 in Nouvelle Aquitaine, France, helped to characterize a scenario at the regional but also national scale. In this way, it is possible to compare global scenarios on the basis of scientific data, the inputs issued from reports, along with the reality on the ground at a regional level. This approach is therefore cross-disciplinary and multi-spatial, while at the same time underpinning the literature data with industrial realities.

⁹⁷ Champion-Réaud, J, Bidan, G, Breining, J, Lambert, P, Mendes, C, & Zouloumian, N. "BEARCAT: The SAFRAN Brand New Test Engine Heavily Instrumented for Accurate Comparison With CFD Calculations." *Proceedings of the ASME Turbo Expo 2020: Turbomachinery Technical Conference and Exposition. Volume 2D: Turbomachinery*. Virtual, Online. September 21–25, 2020. V02DT38A004. ASME. <https://doi.org/10.1115/GT2020-14295>

PART I.

UNDERSTANDING THE DECARBONIZATION OF AIR MOBILITY



I.I eCO₂ emissions

I.I.1. Air mobility past and current eCO₂ emissions

While the focus is the GHG emissions or air mobility, this chapter includes overall GHG emissions with a focus on mobility emissions to better understand the context and to propose a point of comparison. And since air mobility has no borders, it was found necessary that GHG emissions are compared not only for France, but also for Europe, and World.

For air mobility, as discussed in the previous chapter, GHG includes CO₂, CH₄ and NO₂ emissions. Therefore, eCO₂ will be the metric which will go through the thesis as from now. Also, to avoid data distortion due to the Covid Crisis which affected world economies from 2020 to 2022 and significantly impacted the aviation sector, the latest year of reference in this thesis is 2019.

Finally, it is reminded here that the life cycle analysis considered in this study does not fully apply the ISO 14040 referential, as it only considers eCO₂ emissions.

I.I.1.1. Defining the scope and comparing data

The 2DS trajectory (trajectory to stay below a temperature increase of 2 Degrees °C compared to the pre-industrial era) entered into force on November 4th 2016 following the Paris Agreement in 2015 (COP 21) and has since been implemented by the European Union (EU) and individual countries, including France. It is a legally binding international treaty on climate change. Its overarching goal is to hold “the increase in the global average temperature to well below 2°C above pre-industrial levels”.

For France, the National Low Carbon Strategy (SNBC) of March 2020⁹⁸ represents the country's roadmap to combat climate change. Introduced by the French Energy Transition Law for Green Growth, it reflects the transposition of European directives into our laws and regulations. It provides guidelines for implementing the transition to a low-carbon, circular and sustainable economy in all sectors of activity, with a greenhouse gas emission reduction trajectory by 2050. First adopted in 2015, the SNBC was revised in 2019 with the aim of achieving carbon neutrality by 2050 (an increased ambition compared to the first SNBC, which aimed for Factor 4, i.e. a 75% reduction in GHG emissions by 2050 compared to 1990).

Within the EU, the fit for 55 package is the backbone of this trajectory. In June 2019 EU leaders called for a climate-neutral, green, fair and social Europe and accordingly the European Council adopted a new strategic agenda for 2019-2024, the European Green Deal which appears in the European Council conclusions in December 2019⁹⁹: “All relevant EU legislation and policies need to be consistent with, and contribute to, the fulfilment of the climate neutrality objective while respecting a level playing field”. In December 2020 the European Council endorsed a binding EU target of a net domestic reduction of greenhouse gas emissions by at least 55% by 2030, compared to 1990 levels. It called on Council and Parliament to reflect this new target in the European climate law proposal and in May 2021 EU ambassadors approved the final compromise text for the EU climate law. The text includes the 55% net emission target for 2030, now known as “fit for 55” and add a EU-wide climate neutrality target for 2050. Within the fit for 55 package, ReFuelEU Aviation is discussed later that year and while the EU objective for transport emissions is -90%, the ReFuelEU Aviation adopts another approach¹⁰⁰, based on the incorporation of sustainable aviation fuels (SAF), which includes

⁹⁸ [Stratégie Nationale Bas-Carbone \(SNBC\) | Ministère de la Transition écologique \(ecologie.gouv.fr\)](#) accessed August 13, 2024

⁹⁹ <https://www.consilium.europa.eu/en/meetings/european-council/2019/12/12-13/> accessed August 13, 2024

¹⁰⁰ <https://www.consilium.europa.eu/en/press/press-releases/2022/06/02/fit-for-55-package-council-adopts-its-position-on-three-texts-relating-to-the-transport-sector/> accessed August 13, 2024

synthetic aviation fuels. The new legislation is adopted in October 2023¹⁰¹, aiming to put air transport on the trajectory of the EU’s climate targets for 2030 and 2050 by increasing both demand for and supply of sustainable aviation fuels. Another directive concerning aviation was agreed in December 2022 when the Council and the European Parliament reached a provisional political agreement on the revision of the EU emissions trading system (EU ETS) rules applying to the aviation sector¹⁰². The agreement ensures that aviation contributes to the EU's emission reduction objectives under the Paris Agreement. According to the agreement, the EU ETS will apply for intra-European flights, while CORSIA will apply to for extra-European flights to and from third countries participating in CORSIA.

CORSIA, Carbon Offsetting and Reduction Scheme for International Aviation, was agreed on by the ICAO in 2016¹⁰³ with the aim of limiting greenhouse gas emissions from international aviation at their 2020 levels. It complements a broader set of measures, including aircraft technology improvements, operational improvements, and sustainable aviation fuels. As explained above, the reference year in this thesis is 2019 instead of 2020 to avoid the Covid crisis impact. The CORSIA obligations have already started. The monitoring, reporting and verification (MRV) requirements relating to CO₂ emissions from international flights apply as of 1 January 2019. These obligations have been implemented in EU law by means of secondary legislation as discussed above. The CORSIA emissions report is based on the aggregation of airlines CO₂ Emissions based on their fuel consumption as shown in TABLE 3 below.

Table of all State pairs									
Aeroplane Operator	State of departure		CO ₂ emissions estimated with CERT?	Total No. of flights	Fuel type ⁽¹⁾	Total mass of fuel (in tonnes)	Fuel conversion factors	Total CO ₂ emissions (in tonnes)	Subject to offsetting requirements?
	ICAO airport code	State							

Table of all aerodrome pairs											
Aeroplane Operator	Departure		Arrival		CO ₂ emissions estimated with CERT?	Total No. of flights	Fuel type ⁽¹⁾	Total amount of fuel used (in tonnes)	Fuel conversion factors	CO ₂ emissions (in tonnes)	Subject to offsetting requirements?
	ICAO airport code	State	ICAO airport code	State							

TABLE 3 CORSIA CO₂ emissions excel tool, source ICAO¹⁰⁴

Air mobility is both domestic and international and accounting the associated eCO₂ emissions is not easy. Adding uncertainties on the numerator, eCO₂ emissions of aviation perimeter, and the denominator, eCO₂ or overall GHG including land use change or solely energy emissions explain why aviation figures are not consistent. To cite only a few sources, CO₂ emissions for 2019 goes from 905 Mt to 1030 Mt, TABLE 4. For ATAG the global aviation industry produces around 2.1% of all human-induced CO₂ emissions¹⁰⁵, but this figure goes up to 3.1% of total global CO₂ emissions from fossil fuel combustion for Bergero et al, citing IEA¹⁰⁶, while some other sources would even add the non-CO₂ emissions (radiative forcing due to contrails formation) as discussed above. This thesis only considers eCO₂ emissions.

¹⁰¹ <https://www.consilium.europa.eu/en/infographics/fit-for-55-refueu-and-fueu/> accessed August 13, 2024

¹⁰² <https://www.consilium.europa.eu/en/press/press-releases/2022/12/07/ets-aviation-council-and-parliament-strike-provisional-deal-to-reduce-flight-emissions/> accessed August 13, 2024

¹⁰³ <https://www.icao.int/environmental-protection/CORSIA/Pages/default.aspx> accessed August 13, 2024

¹⁰⁴ [https://www.icao.int/environmental-protection/CORSIA/Pages/Aggregation of CO₂ emissions.aspx](https://www.icao.int/environmental-protection/CORSIA/Pages/Aggregation%20of%20CO2%20emissions.aspx) accessed August 13, 2024

¹⁰⁵ <https://atag.org/facts-figures> accessed August 13, 2024

¹⁰⁶ Bergero, C., Gosnell, G., Gielen, D. *et al.* Pathways to net-zero emissions from aviation. *Nat Sustain* 6, 404–414 (2023). <https://doi.org/10.1038/s41893-022-01046-9>

Organisation	Source	2019 CO ₂ emissions in Mt
ICCT	https://theicct.org/publication/co2-emissions-from-commercial-aviation-2013-2018-and-2019/	920
IEA	Bergero, C., Gosnell, G., Gielen, D. et al. Pathways to net-zero emissions from aviation. <i>Nat Sustain</i> 6, 404-414 (2023). https://doi.org/10.1038/s41893-022-01046-9	1030
Statista	https://www.statista.com/statistics/1186820/co2-emissions-commercial-aviation-worldwide/	905
IATA	https://www.iata.org/contentassets/d13875e9ed784f75bac90f000760e998/fact_sheet_on_climate_change.pdf	915
ATAG	https://atag.org/facts-figures	914

TABLE 4 Aviation CO₂ emissions in Mt in 2019 according to several sources ^{106 107 108 109 110}, Source Jean-Baptiste Jarin

With this context, the methodology applied to evaluate past, current but also future (chapter III below) GHG emissions will be based on the fuel emissions for air mobility, excluding non-CO₂ effects such as contrails, and compared to the fossil fuels emissions, thus excluding land use change emissions. These data will cover World, the EU 28 and France for the year 1950, 1990, the year of reference for the European Union and France, 2005, the year of reference for IATA, and 2019.

Once this perimeter defined it was still found complicated to agree on the exact figures

Data for energy related eCO₂ emissions are scrutinized for decades but still are not always consistent. As highlighted by Marland et al back in 1999 “ostensibly similar efforts to estimate emissions using ostensibly similar energy statistics have produced results that differ significantly for many countries” ¹¹¹. The most recent data from IEA (International Energy Agency), BP Statistical Review, Climate Watch, WRI (World Resource Institute) and GCP (Global Carbon Project) were therefore compared. Even with the most modern tools, results are not always consistent. Data from the United Nations data portal were also considered but since there are significant limitations (area) they are not reproduced here ¹¹².

For the year 2019:

- IEA: 33,3 Gt ¹¹³
- BP: 34.04 Gt ¹¹⁴
- Climate Watch: 36.95 ¹¹⁵

¹⁰⁷ <https://theicct.org/publication/co2-emissions-from-commercial-aviation-2013-2018-and-2019/> accessed August 13, 2024

¹⁰⁸ <https://www.statista.com/statistics/1186820/co2-emissions-commercial-aviation-worldwide/> accessed August 13, 2024

¹⁰⁹ https://www.iata.org/contentassets/d13875e9ed784f75bac90f000760e998/fact_sheet_on_climate_change.pdf accessed August 13, 2024

¹¹⁰ <https://atag.org/facts-figures> accessed August 13, 2024

¹¹¹ Gregg Marland, Antoinette Brenkert, Jos Olivier, CO₂ from fossil fuel burning: a comparison of ORNL and EDGAR estimates of national emissions, *Environmental Science & Policy*, Volume 2, Issue 3, 1999, Pages 265-273, ISSN 1462-9011, [https://doi.org/10.1016/S1462-9011\(99\)00018-0](https://doi.org/10.1016/S1462-9011(99)00018-0)

¹¹² <http://data.un.org/Data.aspx?q=CO2&d=GHG&f=seriesID%3aGH2> accessed August 13, 2024

¹¹³ <https://www.iea.org/articles/global-co2-emissions-in-2019> accessed August 13, 2024

¹¹⁴ <https://www.bp.com/content/dam/bp/business-sites/en/global/corporate/pdfs/energy-economics/statistical-review/bp-stats-review-2021-full-report.pdf> page 15, accessed August 13, 2024

¹¹⁵ https://www.climatewatchdata.org/ghg-emissions?breakBy=regions&end_year=2020&gases=co2®ions=WORLD&source=Climate%20Watch&start_year=1990 accessed August 13, 2024

- WRI: 37.1 (for 2018 ¹¹⁶, last data available with source being GCP so the 2019 should be equivalent for both agencies, this similitude is confirmed when comparing data from 1900 to 2004 ¹¹⁷)
- GCP: 37.04 ¹¹⁸

Since land use change related emissions are not considered in any of the above date, these differences could be explained by different definitions.

For the UN Data portal, GHGs include all gazes covered by the Kyoto protocol (carbon dioxide (CO₂), methane (CH₄), nitrous oxide (N₂O), hydrofluorocarbons (HFCs), perfluorocarbons (PFCs), unspecified mix of HFCs and PFCs, sulfur hexafluoride (SF₆) and nitrogen trifluoride (NF₃)).

BP considers that carbon emissions reflect only those through consumption of oil, gas and coal for combustion related activities and natural gas flaring, based on default CO₂ emissions factors for combustion listed by the IPCC. This excludes methane flaring, which is considered by WRI and GCP.

This could be surprising as methane (CH₄) is a primary component of natural gas, BP's core activity, is responsible for about a third of the planetary warming, and its emissions are still rising. But this could maybe be explained since fossil fuels operations "release large amounts CH₄, either by accident or design" according to the IEA ¹¹⁹.

Since methane flaring is becoming a significant issue ¹²⁰, since CH₄ is considered within aviation eCO₂ measures and since data from WRI, GCP and Climate Watch all consider CH₄, the figures which are considered for global GHG in this thesis are the ones of Robbie et al, Global Carbon Project, providing a single base of comparison.

Moreover, data for global emissions issued from Robbie et al for the Global Carbon Project's fossil CO₂ emissions dataset ¹¹⁸ allow to have access to significant temporal and spatial distribution. They are summarized in TABLE 5 below and land use change is for information only.

The visual representation, FIGURE 12, highlights the significant growth of energy related eCO₂ emissions since 1950 as well as the efforts of the EU28 to decrease its emissions.

eCO ₂ emissions in Bt	1950		1990		2005		2019	
	Fossil Fuels	Land Use Change	Fossil Fuels	Land Use Change	Fossil Fuels	Land Use Change	Fossil Fuels	Land Use Change
World	5,93	6,07	22,75	5,17	29,59	4,89	37,04	4,6
EU 28	1,78	0,141	4,47	-0,151	4,31	-0,152	3,27	-0,155
France	0,202	-0,046	0,393	-0,014	0,416	-0,024	0,315	-0,018

TABLE 5 eCO₂ emissions in Billion ton for the world, Europe (EU28) and France from 1950 to 2019, with data from Robbie et al

¹¹⁶ <https://www.wri.org/insights/new-global-co2-emissions-numbers-are-theyre-not-good> accessed August 13, 2024

¹¹⁷ <https://www.wri.org/data/global-emissions-co2-fossil-fuels-1900-2004> accessed August 13, 2024

¹¹⁸ Andrew, R. M., & Peters, G. P. (2023). The Global Carbon Project's fossil CO₂ emissions dataset (2023v36) [Data set]. Zenodo. <https://doi.org/10.5281/zenodo.10177738>

¹¹⁹ <https://www.iea.org/energy-system/fossil-fuels/methane-abatement> accessed August 13, 2024

¹²⁰ <https://news.un.org/en/story/2023/12/1144282> accessed August 13, 2024

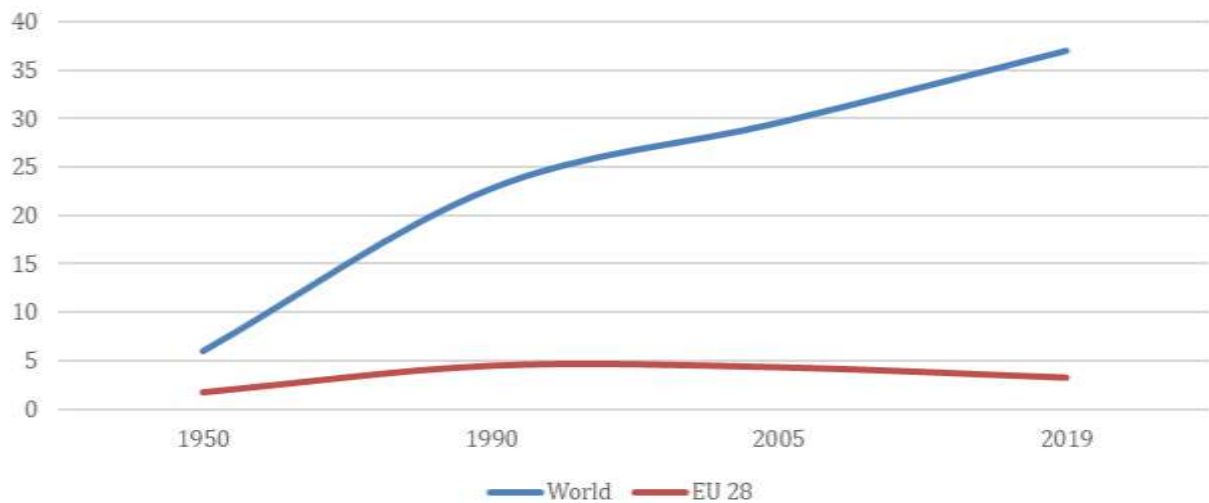

FIGURE 12 Energy related eCO₂ emissions in Billion ton for the World and Europe (EU28) from 1950 to 2019, source Jean-Baptiste Jarin with data from Robbie et al

Data for CO₂ emissions of air mobility are even more complicated to access

Air mobility is both domestic and international while its related eCO₂ emissions should cover Scope 1 to Scope 3. The Greenhouse Gas Protocol ¹²¹ provides the most widely recognized accounting standards for greenhouse gas emissions categorizes GHG emissions into three scopes and when detailed for a multinational company as provided by El Geneidy et al ¹²², one should realize that most of the emissions are indirect emissions considered in scope 3. Scopes are detailed below:

- Scope 1 covers direct emissions from owned or controlled sources such as company vehicles. This includes fugitive emissions, reinforcing the need to include methane emissions as discussed above.
- Scope 2 covers indirect emissions from the purchase and use of electricity, steam, heating, and cooling. By using the energy, an organization is indirectly responsible for the release of these GHG emissions.
- Scope 3 includes all other indirect emissions that occur in the upstream and downstream activities of an organization, such as but not limited to business travels, purchase of goods and services, but more important for aviation: the use of sold products.

While there are still some discussions regarding which emitter should be considered for which emissions when detailing the respective activities, there are no such considerations when considering a sector as a whole and all scopes must be included when addressing air mobility. This goes from the well such as the extraction of the oil to the combustion of the fuel, from the mining of metals to the construction of the planes, from the construction of the airport to the heating of passenger terminals.

Such a wide scope, even in a cross-disciplinary thesis, would represent a significant amount of work and understanding the classification of the cause and effect is therefore quite important.

¹²¹ https://ghgprotocol.org/sites/default/files/standards_supporting/FAQ.pdf accessed August 13, 2024

¹²² Sami El Geneidy, Stefan Baumeister, Valentino Marini Govigli, Timokleia Orfanidou, Venla Wallius, The carbon footprint of a knowledge organization and emission scenarios for a post-COVID-19 world, Environmental Impact Assessment Review, Volume 91, 2021, 106645, ISSN 0195-9255, <https://doi.org/10.1016/j.eiar.2021.106645> accessed August 13, 2024

I.I.1.2. Air mobility fuel burn within air mobility total emissions

Applying the Pareto Principle also referred to as the 80/20 Rule is often a good practice. This rule states that approximately 80% of all effects come from roughly 20% of the causes. Applied originally to total quality management, this could also apply to the scope of this thesis: effort aimed at the right 20% could solve 80% of the problems when addressing decarbonization of air mobility.

Several articles and thesis addressing energy and / or GHG emissions in air mobility have been reviewed. Some articles are focused on overall aviation emissions^{123 124 125} and it is interesting to underline that the ongoing discussions regarding the non-CO₂ impact of aviation to global warming was already addressed in 1999. It is then estimated that the net impact of aviation on radiative forcing is larger than just the impact of CO₂ by a factor of 2.5. Within these reviews of existing articles and publications, the approach proposed by Mikhail Chester in Life-cycle Environmental Inventory of Passenger Transportation in the United States in 2008 was particularly enlightening¹²⁶. His PhD research in the early 2000's focused on the energy use and emission (GHG) factors for every passenger transportation mode such as cars, buses, trains, and aircrafts. Although not dedicated to emissions from air mobility, he proposed a life-cycle inventory for each mode to appropriately address the transportation sector's energy and emissions which was then followed by other researchers and numerous studies have since confirmed and refined these results (TABLE 6). Data are provided from pages 165 to 183, detailing infrastructures, maintenance, construction, and tailpipe emissions but also introducing the fuel emissions own life cycle assessment when applied to air mobility. Fuel GHG emissions associated to its productions are addressed, while the fuel use is detailed for the aircraft operations such as taxiing, take-off or cruise. With these data it is then possible, FIGURE 13 below, to confirm that the Pareto principles can be applied to eCO₂ emissions in air mobility. The share of fuel being close to 90% of the overall emissions. The remaining 10% being issued from ground infrastructures (airport) and aircraft construction and maintenance.

Data also address the disparities of aircrafts, detailing regional (Embraer ERJ145 aircraft), short-medium haul (Boeing B737 aircraft) and long haul (Boeing B747 aircraft) as described in FIGURE 14 below, once again illustrating that whatever the aircraft category, GHG emissions associated to the fuel represent the most significant share, from 87 to 91%. While the study of Chester was published in 2008, these aircrafts are found to be representative of the aircrafts world fleet, as of 2022. Moreover, since the share of fuel is by far the most important, and since the Top 2 aircrafts operated in Europe¹²⁷ are the Boeing 737, followed by the Airbus 320, both equipped with similar engines (CFM56 / LEAP), there is a high confidence that the conclusions of Chester still apply today.

¹²³ Xander Olsthoorn, Carbon dioxide emissions from international aviation: 1950–2050, *Journal of Air Transport Management*, Volume 7, Issue 2, 2001, Pages 87-93, ISSN 0969-6997, [https://doi.org/10.1016/S0969-6997\(00\)00031-4](https://doi.org/10.1016/S0969-6997(00)00031-4)

¹²⁴ Baughcum, S. L., Begin, J. J., Franco, F., Greene, D. L., Lee, D. S., McLaren, M., Mortlock, A. K., Newton, P. J., Schmitt, A., Sutkus, D. J., Vedantham, A., & Wuebbles, D. J. (1999). Aircraft Emissions: Current Inventories and Future Scenarios. Retrieved from http://repository.upenn.edu/library_papers/59

¹²⁵ Anu Vedantham, Michael Oppenheimer, Long-term scenarios for aviation: Demand and emissions of CO₂ and NO_x, *Energy Policy*, Volume 26, Issue 8, 1998, Pages 625-641, ISSN 0301-4215, [https://doi.org/10.1016/S0301-4215\(98\)00021-4](https://doi.org/10.1016/S0301-4215(98)00021-4)

¹²⁶ Chester, M. V. (2008). Life-cycle Environmental Inventory of Passenger Transportation in the United States. *UC Berkeley: Institute of Transportation Studies UC Berkeley* <https://escholarship.org/content/qt7n29n303/qt7n29n303.pdf?t=krnoyq>

¹²⁷ https://ansperformance.eu/economics/cba/standard-inputs/chapters/fleet_size.html accessed August 13, 2024

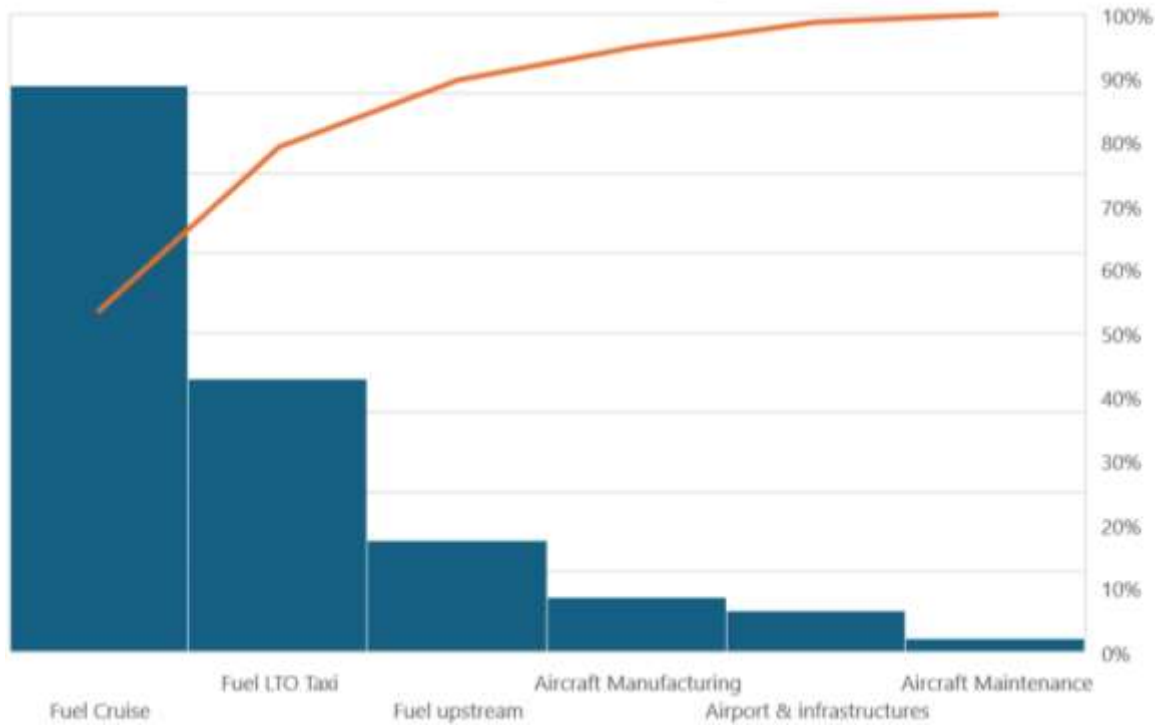

FIGURE 13 Pareto Diagram of aircraft GHG emissions, source Jean-Baptiste Jarin with data from Chester

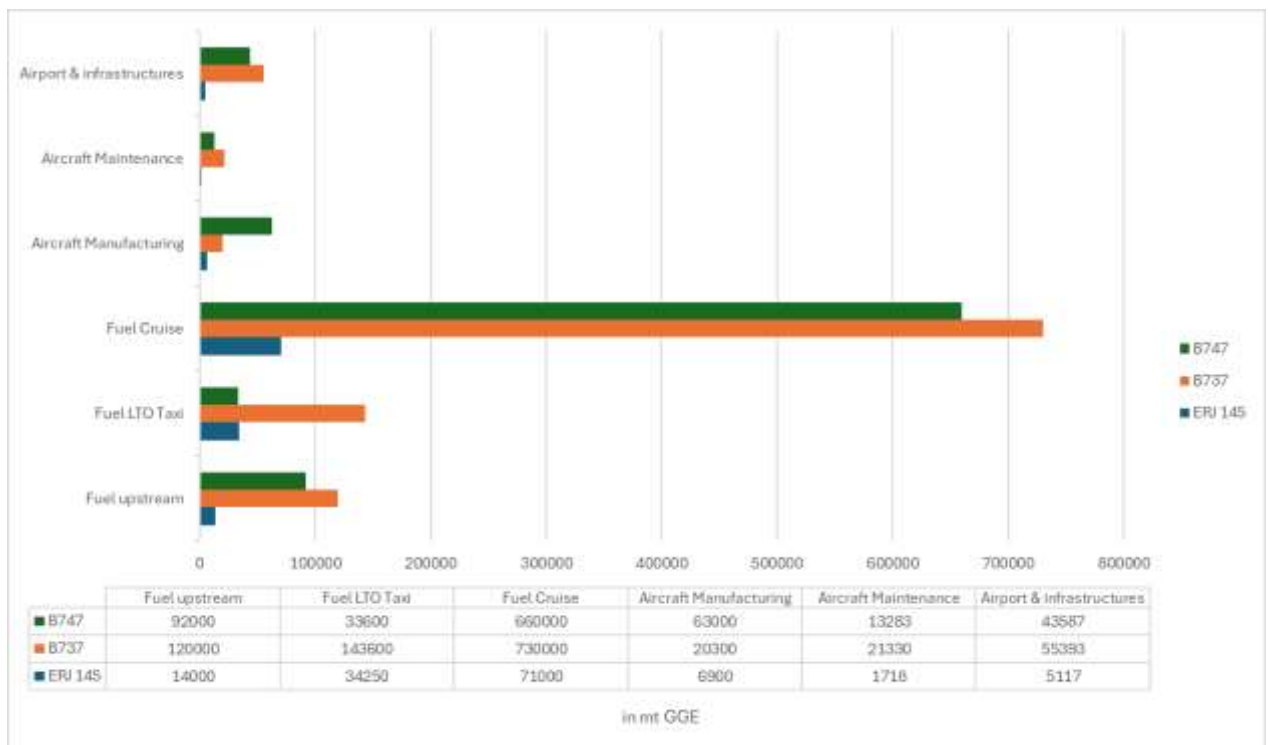

FIGURE 14 Aircraft GHG emissions, in mt GGE (Grams GHG Equivalent), by aircraft type and category, source Jean-Baptiste Jarin with data from Chester

In TABLE 6 below are compared the results of 4 independent studies: Chester in 2008, detailed above, Lopez in 2010¹²⁸, Howe in 2013¹²⁹ and Jakovljevic in 2018¹³⁰. All studies confirm that the share of fuel is above 90%, and even above 99% for the latest studies.

Share of Energy and / or Emissions over the lifetime of an aircraft				
Author	Chester	Lopez	Howe	Jakovljevic
Year	2008	2010	2013	2018
Source	https://escholarship.org/uc/item/7n29n303	https://www.semanticscholar.org/paper/Life-Cycle-Assessment-of-the-Airbus-A330-200-Lopes/b635c37428c28a1d5f9cb302aad54c2cf0336b3d	https://doi.org/10.1016/j.trd.2012.12.004	https://doi.org/10.1016/j.energy.2018.02.022
Methodology	LCA applied to mobilities	LCA / ReCiPe of A320	LCA of Airbus A320 according to ISO 14040/44	LCA of Airbus A320 and B737
Share of Operations (fuel burn) % , Regional	89%	N/A	N/A	N/A
Share of Operations (fuel burn) % , short-medium haul	91%	99%	99%	99%
Share of Operations (fuel burn) % , log haul	86%	N/A	N/A	N/A
CO ₂ / Fuel ratio	3,47	3,66	3,16 *	3,16
Remarks	Data are for ERJ145, B373 and B747. 10% GHG added to the fuel for upstream	Detailed LCA of A320. Maintenance and infrastructures considered	Airport infrastructure excluded, aircraft lifetime 20 years. Only emissions from combustion considered, * assuming ICAO value of 3.16	Focus on aircraft performance degradation causing higher fuel consumption. Airport infrastructure excluded

TABLE 6 Comparing results of 4 independent studies addressing aircraft GHG emissions using Life Cycle Analysis methodology. Source Jean-Baptiste Jarin with data from Chester, Lopez, Howe and Jakovljevic, * means data was deducted by the author

The slight differences are found to be related to the perimeters considered but also, and mostly, to the carbon intensity (CI) of the fuel considered, the CO₂ / Fuel ratio.

I.I.1.3. Fuel burn carbon intensity

Concluding that 99% of air mobility eCO₂ emissions comes from the fuel is a significant conclusion, but it requires to agree on the definition of fuel CO₂ emissions. Currently, emissions of aviation are calculated using mass of fuel with a factor of conversion. The conversion factor which is currently used with the aviation sector is the one provided by ICAO¹³¹ : “CO₂ emissions (kg) per kg carried = 3.16”.

This conversion factor should be based on the jet fuel lower heating value, which by norm is “greater than or equal to 42.8 MJ/kg”¹³² and the supposed carbon intensity (CI) of the fuel: 89 grams eCO_{2e} / MJ, which is based on an evaluation of the global petroleum jet fuel production from well to wake¹³³. This includes crude oil recovery, transportation and refining, jet fuel transportation, and jet fuel combustion.

¹²⁸ Lopez, Life Cycle Assessment of the Airbus A330-200 Aircraft, University of Lisbon, 2010, <https://www.semanticscholar.org/paper/Life-Cycle-Assessment-of-the-Airbus-A330-200-Lopes/b635c37428c28a1d5f9cb302aad54c2cf0336b3d>

¹²⁹ S. Howe, A.J. Kolios, F.P. Brennan, Environmental life cycle assessment of commercial passenger jet airliners, Transportation Research Part D: Transport and Environment, Volume 19, 2013, Pages 34-41, ISSN 1361-9209, <https://doi.org/10.1016/j.trd.2012.12.004>

¹³⁰ Ivan Jakovljević, Radomir Mijailović, Petar Mirosavljević, Carbon dioxide emission during the life cycle of turboprop aircraft, Energy, Volume 148, 2018, Pages 866-875, ISSN 0360-5442, <https://doi.org/10.1016/j.energy.2018.02.022>

¹³¹ [https://applications.icao.int/icec/Freighter Methodology 1.0.pdf](https://applications.icao.int/icec/Freighter%20Methodology%201.0.pdf) page 3, accessed August 13, 2024

¹³² Randall C. Boehm, Zhibin Yang, David C. Bell, John Feldhausen, Joshua S. Heyne, Lower heating value of jet fuel from hydrocarbon class concentration data and thermo-chemical reference data: An uncertainty quantification, Fuel, Volume 311, 2022, 122542, ISSN 0016-2361, <https://doi.org/10.1016/j.fuel.2021.122542>

¹³³ Prussi et al, CORSIA: The first internationally adopted approach to calculate life-cycle GHG emissions for aviation fuels, Renewable and Sustainable Energy Reviews, Volume 150, 2021, 111398, ISSN 1364-0321, <https://doi.org/10.1016/j.rser.2021.111398>

CO₂ / Fuel ratio = 42.8 MJ/kg * 89 grams eCO₂e / MJ = 3.809

It is found however that this is not the value which is currently proposed by the aviation sector to calculate its own CO₂e emissions, as only the value of combustion, 74 gCO₂e/MJ, is currently considered. This is detailed by the ICAO – CORSIA methodology for calculating actual life cycle emissions values ¹³⁴, page 32:

CO₂ / Fuel ratio = 42.8 MJ/kg * 74 grams eCO₂e / MJ = 3.167 (rounded to 3.16 by ICAO).

This factor of conversion needs to be redefined for at least two reasons, and the equation proposed by ICAO-CORSIA ¹³⁴ itself, page 22 in FIGURE 15 below, should apply.

$$CO = CI_{crude\ oil} + CI_{crude\ trans} + CI_{refinery} + CI_{jet\ trans} + CI_{combustion}$$

where:

<i>CI_{crude oil}</i>	= emissions (carbon intensity, CI) associated with the recovery and processing of the crude mix used by an LCAF producer (gCO ₂ e/MJ crude), life cycle stages 2-3
<i>CI_{crude trans}</i>	= emissions from crude oil transportation (gCO ₂ e/MJ crude), life cycle stage 4
<i>CI_{refinery}</i>	= refinery emissions allocated to jet fuels (gCO ₂ e/MJ jet), life cycle stage 5
<i>CI_{jet trans}</i>	= emissions from jet fuel transportation (gCO ₂ e/MJ jet), life cycle stage 6
<i>CI_{combustion}</i>	= jet fuel combustion emissions (74 gCO ₂ e/MJ jet), life cycle stage 7

FIGURE 15 ICAO-CORSIA methodology for calculating actual life cycle emissions values, source ICAO

As illustrated above, the current ratio omits the upstream emissions of the fuel such as extraction, transport to refineries, refining and upgrading, transport to tank. Meanwhile the introduction of Sustainable Aviation Fuels has minimal effects on the combustion (part II) but offers significant upstream emissions reductions, i.e thanks to the use of a biomass which absorbs CO₂ during its growth. This methodology should therefore include the upstream emissions in the near future not only to reflect the real emissions of air mobility but also benefit from the reduced emissions procured by SAF.

The proposed value for the jet fuel lower heating value (LHV) is 44 MJ/kg as this value is consistent with:

- The current ASTM D1655 norm, which addresses Jet Fuel LHV and requires a “greater than or equal to 42.8 MJ/kg”.
- The EU Directive 2018/2001 ¹³⁵, which in its annex III specifies the energy content of fuels by origin, from 43 to 44 MJ/kg (L328/143 and L/328/144).
- The value supported by ADEME in France ¹³⁶, 44 MJ/kg.
- Results obtained from specific jet fuel emissions tests realized during this thesis ¹³⁷, 43.7 MJ/kg for fossil jet fuel and 44.4 MJ/kg for a 100% Sustainable Aviation Fuel.

¹³⁴ https://www.icao.int/environmental-protection/CORSIA/Documents/CORSIA_Eligible_Fuels/ICAO%20document%2007%20-%20Methodology%20for%20Actual%20Life%20Cycle%20Emissions%20-%20June%202022.pdf page 32, accessed August 13, 2024

¹³⁵ <https://eur-lex.europa.eu/legal-content/EN/TXT/PDF/?uri=CELEX:32018L2001> accessed August 13, 2024

¹³⁶ https://prod-basecarbonesolo.ademe-dri.fr/documentation/UPLOAD_DOC_FR/index.htm?new_liquides.htm accessed August 13, 2024

¹³⁷ Jarin, J, Champion-Réaud, J, Lambert, P, Mendes, C, Jeuland, N, May-Carle, J, Doucet, C, & Picard, F. "Gas Concentration Maps Within a Turbomachine Combustor Fueled With Jet-A1 or Sustainable Aviation Fuel (SAF)." *Proceedings of the ASME Turbo Expo 2023: Turbomachinery Technical Conference and Exposition. Volume 3A: Combustion, Fuels, and Emissions.* Boston, Massachusetts, USA. June 26–30, 2023. V03AT04A024. ASME. <https://doi.org/10.1115/GT2023-101375>

- The average of the 17 Jet Fuel samples tested, 43.45 gCO₂e/MJ, within the LHV determination method proposed by Boehm et al in 2022 ¹³².

As described above, the upstream emissions of Jet Fuel need to be added to the combustion value of 74 gCO₂e/MJ. The proposed value proposed by ICAO value of 89 gCO₂e/MJ in the CORSIA methodology, page 2 ¹³⁸ means a 15 gCO₂e/MJ which certainly does not reflect neither the variety of fossil oil nor the reality of the oil industry, which is constantly having to bring ever more complex oil fields on stream, leading to a significant reduction in EROEI ^{139 140}. A decrease in EROEI should translate into a higher carbon intensity, and for instance the fossil oil issued from the tar sands have been found to significantly increase the GHG emissions for gasoline and diesel in U.S. refineries, in the range of 99–117 gCO₂e/MJ ¹⁴¹. While jet fuel issued from tar sand is still not quite noticeable, its share can only increase in the future. These variations are confirmed in a recent article, “well-to-wake carbon intensity calculated for jet fuel by each refinery has a much more noticeable variation, 77.3 to 112 gCO₂e/MJ” ¹⁴², an average of 94.95 gCO₂e/MJ.

The proposed value for the jet combustion emissions with fossil jet fuel is therefore 94 gCO₂e/MJ. This value is not only consistent with the methodology described above, but also with the value specified by the European directive 2018/2001, page 74, “the fossil fuel comparator shall be 94 gCO₂e/MJ” ¹³⁵.

In conclusion, the CO₂ / Fuel ratio which is proposed, and which will be used in this thesis, is:

$$\text{CO}_2 / \text{Fuel ratio} = 44 \text{ MJ/kg} * 94 \text{ grams eCO}_2\text{e} / \text{MJ} = 4.136$$

It is highlighted here, that introducing the upstream emissions of the Jet Fuel, is quite necessary when addressing Sustainable Aviation Fuels (SAF). As detailed in part II, SAF combustion emissions are very similar to the fossil jet fuel ones ¹³⁷, and it is only the upstream emissions (i.e. the carbon capture of the biomass during its growth) which can significantly reduce the fuel CO₂ emissions.

I.I.1.4. Fuel consumption

To calculate the past and current GHG of air mobility it is now required to retrieve the jet fuel production and / or consumption and several sources have been studied and compared as shown in TABLE 7 below. As aviation is both domestic and international, data are not always consistent as Jet Fuel is not accounted for in the same way.

¹³⁸ https://www.icao.int/environmental-protection/CORSIA/Documents/CORSIA_Eligible_Fuels/ICAO%20document%2007%20-%20Methodology%20for%20Actual%20Life%20Cycle%20Emissions%20-%20June%202022.pdf page 2, accessed August 13, 2024

¹³⁹ Gagnon et al, A Preliminary Investigation of Energy Return on Energy Investment for Global Oil and Gas Production. *Energies* 2009, 2, 490-503. <https://doi.org/10.3390/en20300490>

¹⁴⁰ Charles A.S. Hall, Jessica G. Lambert, Stephen B. Balogh, EROI of different fuels and the implications for society, *Energy Policy*, Volume 64, 2014, Pages 141-152, ISSN 0301-4215, <https://doi.org/10.1016/j.enpol.2013.05.049>

¹⁴¹ Cai et al, well-to-wheels greenhouse gas emissions of Canadian oil sand products, *Environmental Science & Technology* 2015, <https://doi.org/10.1021/acs.est.5b01255>

¹⁴² Jing, El-Houjeiri,, Monfort *et al.* Understanding variability in petroleum jet fuel life cycle greenhouse gas emissions to inform aviation decarbonization. *Nat Commun* 13, 7853 (2022). [lower c](#)

Comparing 2019 Jet Fuel quantities from different sources			
Author	Source	Result in Mt	Remark
GAIA	https://acp.copernicus.org/articles/24/725/2024/acp-24-725-2024-supplement.pdf	283	Copernicus.org
Quadros et al		297	
IATA	https://www.iata.org/en/iata-repository/pressroom/fact-sheets/industry-statistics	290,7	Data supplied in billion gallons (96) converted in Mt using ref 5
BP Stat Review	https://www.bp.com/content/dam/bp/business-sites/en/global/corporate/pdfs/energy-economics/statistical-review/bp-stats-review-2021-	369,3	BP Stat Review 2021 page 27. Data supplied in thousands barrels daily (7953) and converted using ref 5
Statista	https://www.statista.com/statistics/655057/fuel-consumption-of-airlines-worldwide/	287,7	Data supplied in billion gallons (95) converted in Mt using ref 5
United Nation Energy Statistics	https://unstats.un.org/unsd/energystats/pubs/yearbook/documents/2019eyb.pdf	337,7	Data available in Table 20, page 250

TABLE 7 Comparing the Jet Fuel quantities used by aviation in 2019, source Jean-Baptiste Jarin with data from UN, Statista, BP, IATA, and Copernicus for Quadros and Gaia ^{143 144 145 146 147}

One can notice a noticeable variation in the results, from 283 Mt (GAIA) to 369.3 Mt (BP Statistical Energy Review). This wide gap could be explained by the perimeters and methodology used by the different authors, BP and the United Nations (UN) Energy statistics using production data while Statista, GAIA, Quadros and IATA are using the ICAO model ¹⁴⁸ shown in FIGURE 16 below. While detailed in the following chapters it is highlighted here that IATA numbers only consider commercial aviation, excluding military but also general aviation. It is also highly probable that IATA numbers also consider IATA's own perimeter ¹⁴⁹. Currently there are 120 countries and 330 airlines affiliated to IATA while in comparison ICAO includes 193 countries ¹⁵⁰. Another reason is that BP and UN consider with jet fuel both gasoline type jet fuel and kerosene-type jet fuel. While there are different types of jet fuels, they can be classified in two categories: Gasoline type jet fuels which are generally used by general aviation and piston propeller engines and kerosene type jet fuels which are used by jets and turbo propeller engines. It is therefore assumed that since IATA only considers a share of commercial aviation, it does not include all types of fuel used in air mobility.

The data which will be used are the one provided by the United Nation Energy statistics when available for two main reasons: decarbonization of aviation should include all type of aircrafts and usages: commercial (passengers and fret), business aviation, general aviation. UN Energy statistics could be considered as the most neutral and extensive source, extensively covering the above usages, while the gap with the BP Stat review could be explained by the fuel consumed by military applications, approximately 8 to 9% ^{151 152}, which are not considered in this study.

¹⁴³ <https://acp.copernicus.org/articles/24/725/2024/acp-24-725-2024-supplement.pdf> accessed August 13, 2024

¹⁴⁴ <https://www.iata.org/en/iata-repository/pressroom/fact-sheets/industry-statistics> accessed August 13, 2024

¹⁴⁵ <https://www.bp.com/content/dam/bp/business-sites/en/global/corporate/pdfs/energy-economics/statistical-review/bp-stats-review-2021-full-report.pdf> accessed August 13, 2024

¹⁴⁶ <https://www.statista.com/statistics/655057/fuel-consumption-of-airlines-worldwide/> accessed August 13, 2024

¹⁴⁷ <https://unstats.un.org/unsd/energystats/pubs/yearbook/documents/2019eyb.pdf> accessed August 13, 2024

¹⁴⁸ https://www.icao.int/environmental-protection/CarbonOffset/Documents/Methodology_ICAO_Carbon-Calculator_v9_2016.pdf accessed August 13, 2024

¹⁴⁹ <https://www.iata.org/en/youandiata/airlines/> accessed August, 13, 2024

¹⁵⁰ <https://www.icao.int/about-icao/Pages/default.aspx> accessed August 13, 2024

¹⁵¹ Stefan Gössling, Andreas Humpe, The global scale, distribution and growth of aviation: Implications for climate change, Global Environmental Change, Volume 65, 2020, 102194, ISSN 0959-3780,

<https://doi.org/10.1016/j.gloenvcha.2020.102194>

¹⁵²

<https://watson.brown.edu/costsofwar/files/cow/imce/papers/Pentagon%20Fuel%20Use%2C%20Climate%20Change%20and%20the%20Costs%20of%20War%20Revised%20November%202019%20Crawford.pdf> accessed August 13, 2024

2.1 General Description of the Methodology

The ICAO Carbon Emission Calculator requires that the user input the airports of origin and destination for a direct through flight (i.e. a flight which does not have a change of the flight number). This is then compared with the published scheduled flights to obtain the aircraft types used to serve the two airports concerned and the number of departures per aircraft. Each aircraft is then mapped into one of the 312 equivalent aircraft types in order to calculate the fuel consumption for the trip based on the great circle distance between the airports involved in the journey. The passenger load factors, and passenger to cargo ratios, obtained from traffic and operational data collected by ICAO, are then applied to obtain the proportion of total fuel used which can be attributed to the passengers carried. The system then calculates the average fuel consumption for the journey weighted by the frequency of departure of each equivalent aircraft type. This is then divided by the total number of economy class equivalent passengers, giving an average fuel burn per economy class passenger. The result is then multiplied by 3.16 in

FIGURE 16 Extract from ICAO Carbon Emissions Calculator Methodology v9, page 3 source ICAO

Moreover, when addressing the period 1990-2019, UN Energy statistics provides historical data which are consistent with data collected from the French “Institut Français du Pétrole” (IFP) which was audited by the “direction des affaires stratégiques” in 2005 ¹⁵³, as well as with the result for 1990 proposed by Baughcum et al in Aviation and the Global Atmosphere, Intergovernmental Panel on Climate Change, pages 290-331, in 1999 ¹²⁴ as shown in FIGURE 17 and 18 below.

- Expressed in thousands of barrels daily, the 1990 result for IFP is equivalent to 176 Mt.
- Expressed in Mt /year, the 1990 result for Baughcum et al is close to 180 Mt.
- Expressed in Mt / year, the 1990 result for Grote et al is close to 180 Mt ¹⁵⁴.
- Expressed in thousands of barrels daily, the 1990 result for Index Mundi ¹⁵⁵ is 183 Mt. With data from 1980 to 2012 this set of data confirms the IFP graph which shows a 6% variation from 1990 to 1992.

Expressed in Mt of Jet Fuel while the figure proposed by the UN Energy Statistics for the same year is calculated to be close to 179 Mt, data collected from the 2003 report, page 264 ¹⁵⁶ which indicates for 1992 a value of 169 Mt, extrapolated with the above value of +6% for 1990.

¹⁵³ <https://www.ecologie.gouv.fr/sites/default/files/Energie%20total.pdf> page 30, accessed August 13, 2024

¹⁵⁴ Matt Grote, Ian Williams, John Preston, Direct carbon dioxide emissions from civil aircraft, Atmospheric Environment, Volume 95, 2014, Pages 214-224, ISSN 1352-2310, <https://doi.org/10.1016/j.atmosenv.2014.06.042>

¹⁵⁵ <https://www.indexmundi.com/energy/?product=jet-fuel&graph=production> accessed August 13, 2024

¹⁵⁶ https://unstats.un.org/unsd/energystats/pubs/yearbook/documents/EYB_2003.pdf accessed August 13, 2024

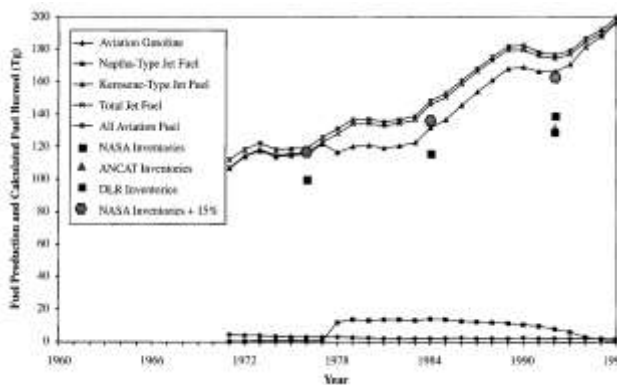

FIGURE 17 (left) and FIGURE 18 (right), respectively extract from the IFP presentation to the DAST in 2005, page 30 and extract from the Aircraft Emissions: Current Inventories and Future Scenarios published in 1999. Sources Sénat and Baughcum et al

As described above, it was found complicated to find accurate data for 1990, 2005 and 2019. It is even more complicated to evaluate the quantity of fuel used by the aviation sector in 1950, even when understanding that it was then mostly gasoline type fuel as the jet age only started in the late fifties.

Data from Grote et al allow to evaluate the fuel quantity used by the aviation sector in 1950 at 20 Mt. This approximation can be confirmed when comparing the data provided by OWID based on the works of Lee et al, Bergero et al and GCP for the aviation share of global emissions. The value proposed for 1950 is 0.58% of global CO_{2e} emissions including land use change of 12 Gt, or 69.6 Mt of CO_{2e}. Using the ICAO ratio of 3.16 which applies in such situation, this translates into an equivalent of 22 Mt of Jet Fuel.

In TABLE 8 below are summarized the data available for the period 1950-2019. Data from Grote et al are considered for 1950 and 1980 while data from UN Energy Statistics are considered from 1990 to 2019.

Data from UN Energy Statistics with the hypothesis that production is equal to consumption					
	1950	1980	1990	2005	2019
UNES			179	225,9	337,7
			https://unstats.un.org/unsd/energystats/pubs/yearbook/documents/2005e_yb.pdf		https://unstats.un.org/unsd/energystats/pubs/yearbook/documents/2019_eyb.pdf
			Table 21 page 294	Table 21 page 295	Table 20 page 250
Grote et al	20	140	180	230	N/A
			https://doi.org/10.1016/j.atmosenv.2014.06.042		

TABLE 8 Data considered for Jet Fuel Production from 1950 to 2019, Jean-Baptiste Jarin with data from Grote et al and UN Energy Statistics

I.I.1.5. Air Mobility global eCO₂ emissions

With the above numbers it is now possible to build the air mobility eCO₂ emissions since 1950 to 2019 including SCOPE 1-2-3, therefore using the 4.136 kg fuel to kg CO₂ ratio. For each considered year, the annual jet fuel production is multiplied by 4.136.

FIGURE 19 allows one to visualize the Air Mobility eCO₂ emissions from 1950 to 2019.

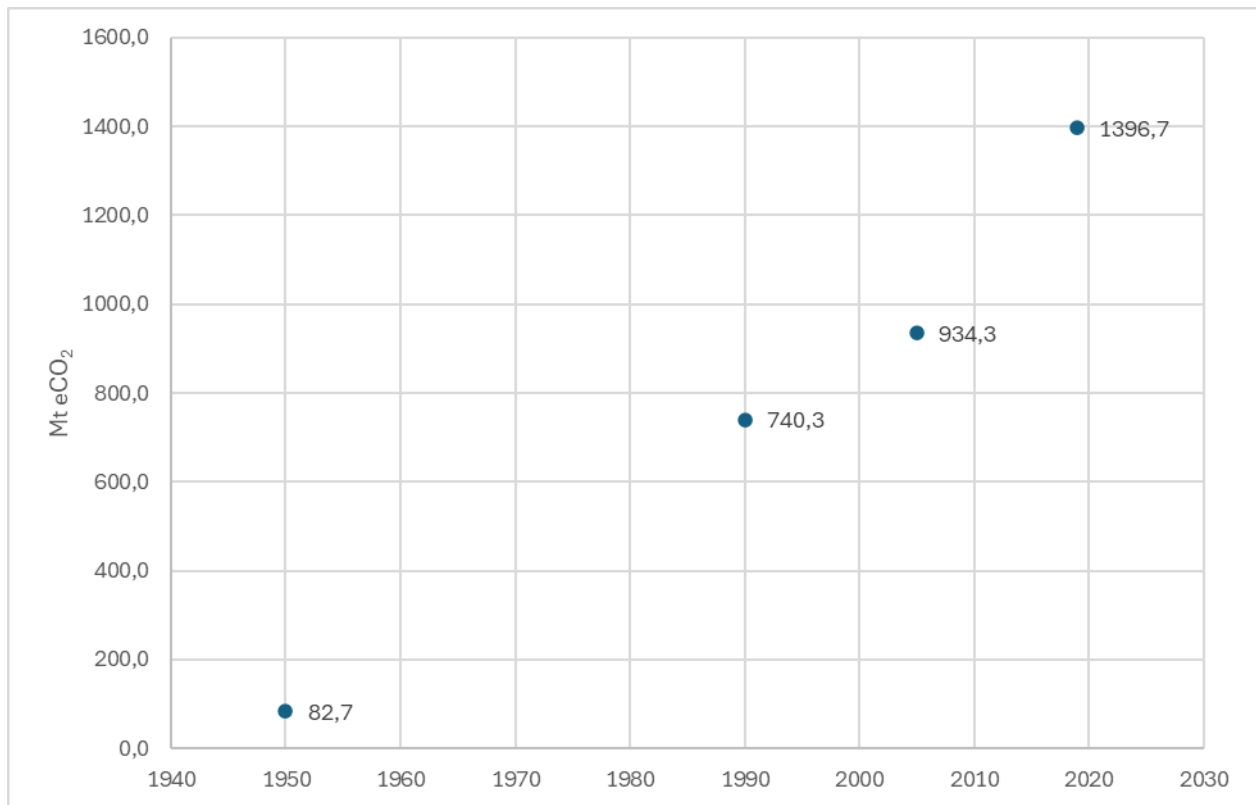

FIGURE 19 Air Mobility eCO₂ emissions in Mt from 1950 to 2019 (Scope 1-2-3), source Jean-Baptiste Jarin with data from Grote et al and UN Energy Statistics.

Compared to the world eCO₂ emissions, the share of aviation within world eCO₂ emissions, excluding land use change and non-CO₂ effects such as contrails, were in 1.39% in 1950, 3.25% in 1990, 3.16% in 2005, which means that from 1990 to 2005 aviation emissions grew less than overall emissions before a significant rebound with 3.77% in 2019.

The above numbers highlight that air mobility emissions growth is not aligned with the overall world GHG emissions. This is mostly explained by the curve of the traffic growth combined with technology over the considered period. For instance, the replacement of piston airliners by jets in the early sixties was immediately accompanied by a doubling of jet fuel consumption, but then followed by a significant reduction in aircraft consumption over the following decades thanks to significant progress, mostly in turbine specific fuel consumption. This will be further detailed in chapter III part I.

As detailed in the definition section, while there is a significant concern regarding the Global Warming Potential (GWP) of aviation due to contrails formation and the associated radiative forcing as significant amount of H₂O are released in the high atmosphere, this thesis only focuses on CO₂ emissions. Readers interested in the GWP associated with contrails formation can have access to the works of David Lee ¹ from the Manchester University, which describes why the aviation GWP goes well beyond its CO₂ emissions. The scientific consensus is evolving, but could currently be estimated between a factor 1.5 to 3. In France, the French agency for the development and energy efficiency, ADEME, applies a factor of 1.8 ¹⁵⁷. Such factor would boost aviation eCO₂ emissions to 2500 Gt in 2019, or 6.7% of the world eCO₂ emissions.

Finally, this methodology based on fuel production and SCOPE 1-2-3 fuel emissions seems more robust than the current methodology applied by IATA which is detailed above. It shows a significant gap with the widely spread information regarding aviation emissions, which are more generally close to 2.5% for most organizations such as WEF

¹⁵⁷ <https://impactco2.fr/outils/transport> accessed August 13, 2024

¹⁵⁸, OWID ¹⁵⁹, Carbone 4 ¹⁶⁰, or even lower, 2.1% for ATAG ¹⁶¹. It is found that the closer the organization to the airline industry, the lower the figure.

These gaps can be explained in 3 steps, for the year 2019:

- Introduction of land use change to the global GHG emissions, 41.64 Gt compared to 37.04 Gt (ATAG)
- Fuel emissions factor: 3.16 instead of 4.136 (all)
- Fuel quantities: 289 Mt instead of 337 Mt (all)

I.I.1.6. Understanding the gap between different eCO₂ emissions reports

Measuring the air mobility eCO₂ emissions is a difficult but necessary task. As concluded above, 99% of aviation eCO₂ emissions are related to Jet Fuel emissions. Still, the global volume of jet fuel as well as the carbon intensity of the jet fuel needed to be refined. The existing consensus being that aviation emissions figures proposed by IATA's embraces all emissions from air travel are included is unfounded, while piling on approximations can only add to incomprehension.

As discussed above, it was found that the main gaps identified within the ICAO methodology are the volume of fuels considered and the CO₂ content of the fuel. The general approach of ICAO is based on assumptions and estimations as described in FIGURE 20 ¹⁶², which are added and therefore lead to approximations which can misguide societies, not only in a global reporting, but also at individual scale since more inputs, still using approximations, are introduced.

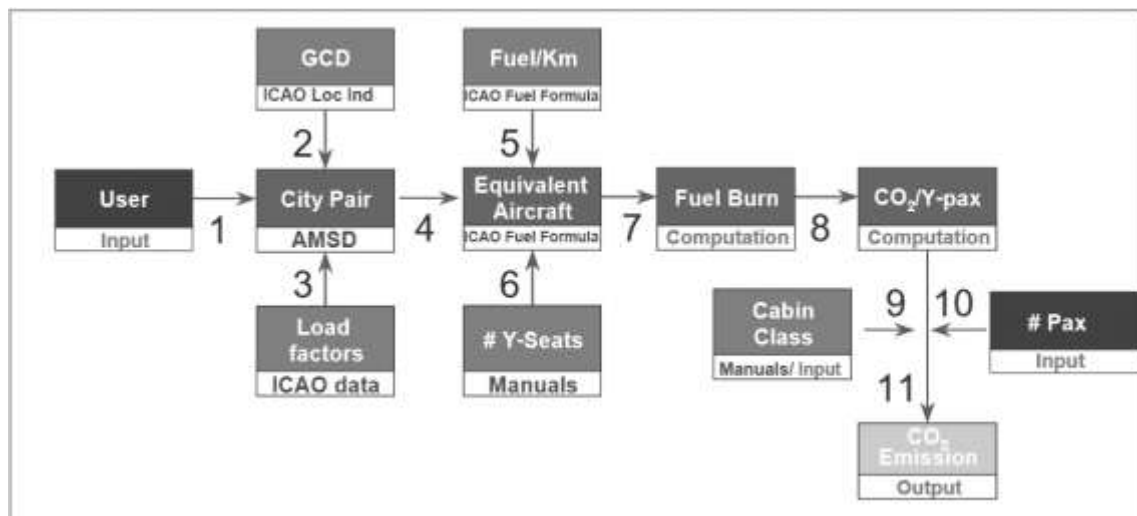

FIGURE 20 ICAO calculation procedure, page 4 of the ICAO Carbon Emissions Calculator Methodology, v9, source ICAO

To calculate the overall CO₂ emissions and the Pax (passenger) CO₂ emissions, it is not the real data of each flight which are considered, but the estimation of:

- The distance between 2 airports, the city pair, corrected by a fixed Great Circle Distance number

¹⁵⁸ <https://www.weforum.org/agenda/2022/12/aviation-net-zero-emissions/> accessed August 13, 2024

¹⁵⁹ <https://ourworldindata.org/grapher/aviation-share-co2?time=1950..2019> accessed August 13, 2024

¹⁶⁰ <https://www.carbone4.com/en/analysis-faq-aviation-climate> accessed August 13, 2024

¹⁶¹ https://aviationbenefits.org/media/167159/fact-sheet_2_aviation-and-climate-change.pdf accessed August 13, 2024

¹⁶² https://www.icao.int/environmental-protection/CarbonOffset/Documents/Methodology_ICAO_Carbon_Calculator_v9_2016.pdf page 4, accessed August 13, 2024

- The load factor of the aircraft is based on the yearly average in the considered region
- The aircraft fuel burn is based on the estimation for each aircraft type
- The ICAO fuel formula does not include the upstream emissions of the fuel
- To calculate the CO₂ per passenger, the number of seats as well as the cabin class are also estimated, with a fixed ratio of 1.2

These approximations can lead to very significant differences in the results. For instance, when using the CO₂ calculator of 5 different entities: ADEME, DGAC, SAS, ICAO, Good Planet, the difference is up to 350%.

Data are summarized in TABLE 9 below.

- ADEME ¹⁶³ is the French agency for energy development and management. This agency is part of the French Ministry of the Economy
- DGAC ¹⁶⁴ is the French civil aviation authority
- ICAO ¹⁶⁵ is the International Civil Aviation Organization
- SAS ¹⁶⁶ is the leading Scandinavian Airline
- Good Planet ¹⁶⁷ is a French Public Utility Foundation

Single Trip Paris to Los Angeles, or 9103 km, data are calculated in 04/2024

eCO₂ emissions in kg per passenger

Good Planet	1640	https://www.goodplanet.org/fr/calculateurs-carbone/particulier/?calculator=1&action=calcul&type=voyage&step=calc_avion&calcul=success
ADEME	1383	https://agirpourlatransition.ademe.fr/particuliers/bureau/deplacements/calculer-emissions-carbone-trajets
DGAC	758	https://eco-calculateur.aviation-civile.gouv.fr/
SAS	542	https://www.flysas.com/en/sustainability/emission-calculator/
ICAO	463	https://www.icao.int/environmental-protection/Carbonoffset/Pages/default.aspx

TABLE 9 eCO₂ emissions calculated for the same single flight with different eCO₂ calculators, source Jean-Baptiste Jarin

Surprisingly, there is also a significant difference between ICAO (463 kg eCO₂), airline (542 kg) and the French Civil Aviation Authority (758 kg eCO₂) while they are supposed to apply the same calculation procedure with the same inputs.

¹⁶³ <https://agirpourlatransition.ademe.fr/particuliers/bureau/deplacements/calculer-emissions-carbone-trajets> accessed August 13, 2024

¹⁶⁴ <https://eco-calculateur.aviation-civile.gouv.fr/comment-ca-marche> accessed August 13, 2024

¹⁶⁵ <https://www.icao.int/environmental-protection/Carbonoffset/Pages/default.aspx> accessed August 13, 2024

¹⁶⁶ <https://www.flysas.com/en/sustainability/emission-calculator/> accessed August 13, 2024

¹⁶⁷ https://www.goodplanet.org/fr/calculateurs-carbone/particulier/?calculator=1&action=calcul&type=voyage&step=calc_avion accessed August 13, 2024

While we can assume that the eCO₂ to fuel ratio could explain a 30% difference and that it will be corrected in the coming years thanks to the introduction of SAF as discussed in the previous chapter, there are still some significant inputs which should be improved.

- Fuel Consumption: the exact fuel burn per flight of per airline should be made available. If these data are not available, the inputs from flight radar for airlines, and the helicopter logbooks for the VTOL industry, should provide a more accurate data. As of today, ICAO Carbon Emissions Calculator is using the bird-eye distance corrected by a Great Circle Distance (GCD), as detailed page 8, of +50 km for distance below 550 km, +125 km for flights above 5500 km and +100 km for distance in between. The fuel burn is then estimated using the distance * aircraft type fuel consumption based on manufacturer certification data (ICAO appendix C).
- Load factors should also be made available for all flights, or at least by city pair. The current methodology applies an average load factor per region (ICAO appendix A), i.e. the same load factor for all domestic flights in Europe. As it will be detailed in the next chapter, III.2 part I, load factors are significantly different for each flight and one should admit that the load factor of a low-cost airline is extremely different than the load factor of a regional airline acting as public service delegation.
- Cabin class factor: as detailed by ICAO, methodology ICAO carbon calculator, page 9, “The ICAO Carbon Emissions calculator does not use a specific aircraft configuration; instead, it uses the equivalent aircraft approach that represents the actual equipment in use. Due to the general nature of this methodology, it was decided to use a simplified approach, restricting the cabin classes to two: one representing the economy class, and the other representing the premium classes (premium-economy, business, and first). The ratio is 1.2 for flights below 3 000 km and 2 for flights above 3 000 km. As shown, this ratio for long haul flights seems quite underestimated. Not only there are often more than 2 cabin class, mostly 3 but up to 4, typically economy, premium economy, business and first, but the ratio between economy and first is closer to 6 rather than 2 as shown in FIGURE 21: for the same volume, 50 seats are offered in economy class while 8 are proposed in first class and 21 in business class.



FIGURE 21 Boeing 777-300 of Emirates Airlines, 3 cabin class, proportions are respected, first (left), business (center), economy (right), source Emirates Airlines ¹⁶⁸

While approximative, the ICAO methodology is applied by airlines. However, it is interesting to note that in Europe Air France has recently decided to introduce more accurate data in its own report such as the flying distance instead of the bird eye distance proposed by ICAO, appendix page 6 of the 2022 report ¹⁶⁹. The ratio between first and economy class is also closer to reality (ratio of 6 instead of 2 as proposed by ICAO), appendix page 7 of the same report. Such a move is important as the data accuracy will be key to meet the CSRD requirements and the introduction of this new regulation has probably guided the airline’s decision to improve the accuracy of its reported emissions.

While it was found that piling approximations could lead to imprecision, it appeared that not all air mobility emissions were embraced, and while a novel methodology could be proposed, a specific methodology for helicopter operations

¹⁶⁸ <https://www.emirates.com/fr/french/experience/seating-charts/?aircraft=b777-300-three-class-long-range> accessed August 13, 2024

¹⁶⁹ https://afcprod.prod.acquia-sites.com/sites/default/files/media-pdf/23%2006%2020_AF-Report%20CO2%20calculatorMethodology_signed%20%28002%29.pdf accessed August 13, 2024

is required since none exist today as reported by the European Environmental Agency (EEA) and its EMEP air pollutant emission inventory guidebook (Category 3, page 10) ¹⁷⁰.

¹⁷⁰ <https://www.eea.europa.eu/publications/emep-eea-guidebook-2023/part-b-sectoral-guidance-chapters/1-energy/1-a-combustion/1-a-3-a-aviation-2023/view> accessed August 13, 2024

I.1.2. A proposed methodology for the calculation of air mobility eCO₂ emissions

It is found in the previous chapter that the aviation eCO₂ emissions are underestimated and that this is mostly due to the methodology with inputs adding up approximations as for the fuel carbon intensity which would need to integrate the well-to-wake in a life cycle analysis approach, which adds +30%.

This underestimation shall most probably disappear with the incorporation of SAF but also under pressure from latest regulatory requirements.

For instance, within the European Union, the SFDR¹⁷¹ (Sustainable Finance Disclosure Regulation) and the CSRD¹⁷² (Corporate Sustainability Reporting Directive) and the European Sustainability Reporting Standards (ESRS) will apply progressively from January 1, 2024.

This tightening of corporate sustainability reporting requirements is a key element of the Green Pact for Europe. The main aim of the Corporate Sustainability Reporting Directive (CSRD) is to harmonize corporate sustainability reporting and improve the availability and quality of published ESG (environmental, social and governance) data. These changes will make it possible, for example, to meet the information needs of financial players, who are themselves subject to ESG reporting obligations.

The CSRD amends four existing European texts: the Accounting Directive, the Transparency Directive, the Audit Directive, and the Audit Regulation.

The main changes introduced in comparison with the 2014 Non-financial Reporting Directive (NFRD) on the publication of non-financial information are:

- A broader scope of application: a significantly larger number of companies will be subject to reporting obligations.
- Reinforcement and standardization of reporting obligations: based on harmonized European standards. A greater number of companies will be required to publish detailed information on their risks, opportunities, and material impacts in relation to social, environmental and governance issues.
- A single location: sustainability reporting must be published in a dedicated section of the management report.
- Mandatory digital format: the annual report must be published in a single European electronic format. Tags will be inserted in the sustainability report, and will be defined in a new digital taxonomy to be defined by delegated act.

The provisions of the CSRD have been transposed into French law by the Ordinance of December 6, 2023¹⁷³ and Decree no. 2023-1394 of December 30, 2023¹⁷⁴.

These new obligations mean that more and more airlines and helicopter operators will have to calculate and report their eCO₂ emissions and this reporting needs to be accurate. It was also found that not only the current methodology underestimates the eCO₂ emissions of air mobility, but also that the ICAO methodology is not applicable for helicopter operations. For instance, the first input of the ICAO methodology is City Pair, which means a departing airport and an arrival airport. The distance is then estimated using bird eye distance with the association of Great Circle Distance (GCD). While the helicopter population is not far from the commercial aircraft population, 34 667 in 2016, helicopters

¹⁷¹ https://finance.ec.europa.eu/sustainable-finance/disclosures/sustainability-related-disclosure-financial-services-sector_en accessed August 13, 2024

¹⁷² https://finance.ec.europa.eu/capital-markets-union-and-financial-markets/company-reporting-and-auditing/company-reporting/corporate-sustainability-reporting_en accessed August 13, 2024

¹⁷³ <https://www.legifrance.gouv.fr/download/pdf?id=fOTM7ilGbxcYwc159WYE-xxp0eSIBFgHonwOt6OlVQA=> accessed August 13, 2024

¹⁷⁴ <https://www.legifrance.gouv.fr/jorf/id/JORFTEXT000048735301> accessed August 13, 2024

fly less and burn more fuel per mission, accounting for 1% of the global fuel burn¹⁷⁵. More important, the diversity of helicopter missions means that using City Pair is inadequate. For instance, the projects conducted with HBG, BTA, RIVE and ADAC showed very different utilization profiles while it was found that helicopters mostly operate from one single base (same departing and arrival heliport). HBG operates its helicopters for passenger transport, aerial work, flight school, mountain rescue, and emergency medical services (EMS) in France¹⁷⁶. ADAC in Germany operates mostly EMS flights¹⁷⁷ and BTA is a flight school¹⁷⁸. RIVE¹⁷⁹ is a lessor and as such leases its helicopters to various operators, the main missions being offshore transportation, EMS, firefighting, windfarm maintenance, utility and search and rescue (SAR). While a significant share of helicopter missions is military, these are not reported here due to the sensitivity of the information. Some data shared below are presented with the kind authorization of RIVE.

I.I.2.1. Calculating eCO₂ emissions: Existing regulations & methodologies

The European CSRD (Corporate Sustainability Reporting Directive) and the European Sustainability Reporting Standards (ESRS) have been phased in since January 1, 2024.

This strengthening of corporate sustainability reporting requirements is a key element of the Green Pact for Europe. The main aim of the Corporate Sustainability Reporting Directive (CSRD) is to harmonize corporate sustainability reporting and improve the availability and quality of published ESG (environmental, social and governance) data. These changes will make it possible, for example, to meet the information needs of financial players, who are themselves subject to ESG reporting obligations.

The CSRD amends four existing European texts: the Accounting Directive, the Transparency Directive, the Audit Directive, and the Audit Regulation.

The provisions of the CSRD were transposed into French law by the Ordinance of December 6, 2023 and Decree no. 2023-1394 of December 30, 2023¹⁸⁰.

These new obligations mean that more and more airlines and helicopter operators will have to calculate and report their eCO₂ emissions. This declaration must be as accurate as possible, with a tolerance accepted for the first few years to allow time for this reporting to become more reliable.

Carbon dioxide equivalent (CO₂ equivalent or eCO₂) is the metric measure used in this report to compare the emissions of various greenhouse gases on the basis of their global warming potential (GWP). This definition is that of the IPCC and the EU¹⁸¹, the principle being to convert the quantities of the various gases emitted into the equivalent quantity of carbon dioxide with the same global warming potential. The main pollutants generated by aviation activities are carbon dioxide (CO₂) and nitrogen oxides (NO_x), but also carbon monoxide (CO), hydrocarbons (HC) and sulfur oxides (SO_x). Effects other than CO₂ (condensation trails) are not dealt with here for two reasons: the scientific evidence has yet to be validated, and helicopter operations are not concerned, as they fly lower than the altitude generally considered to be conducive to the formation of condensation trails (8,000 meters).

The European Environment Agency (EEA) proposes a methodology for calculating emissions¹⁸². As it happens, calculating eCO₂ emissions for helicopters is complex, as confirmed by the same agency in its EMEP (European Monitoring and Evaluation Program) guide to pollutant emissions, which points out that no methodology is currently

¹⁷⁵ Tjandra et al, GHG reduction study for the rotorcraft industry. *76th Annual Forum & Technology Display Vertical Flight Society*, Oct 2020, Montreal (virtual), Canada. (hal-03225084)

¹⁷⁶ <https://www.hbg-helicopteres.aero/?lang=en> accessed August 13, 2024

¹⁷⁷ <https://luftrettung.adac.de/> accessed August 13, 2024

¹⁷⁸ <https://fr.bellflight.com/support/training/united-states-academy> accessed August 13, 2024

¹⁷⁹ <https://www.rive-investment.com/sustainable-infrastructure/> accessed August 13, 2024

¹⁸⁰ <https://www.legifrance.gouv.fr/jorf/id/JORFTEXT000048735301> accessed August 13, 2024

¹⁸¹ https://ec.europa.eu/eurostat/statistics-explained/index.php?title=Glossary:Carbon_dioxide_equivalent/fr accessed August 13, 2024

¹⁸² <https://www.eea.europa.eu/publications/emep-eea-guidebook-2023> accessed August 13, 2024

in place for helicopter operations, whose flights are difficult to capture (cat.3, page 10) ¹⁷⁰. Approximate methodologies are those of ICAO ¹⁸³ and the Tier 1, Tier 2, Tier 3 models of the EEA in its EMEP guide ¹⁷⁰.

Helicopter missions are highly demanding, and each flight is unique, or almost. Operating at low altitude, often under VFR (visual flight rules), carrying a wide variety of loads on disparate flight profiles, fuel consumption is consequently difficult to model. Unlike aircraft, including military aircraft, no database is available for the above-mentioned methodologies. What is more, the ground/flight phase approach (LTO - CCD) appears difficult to apply, if only because the proposed ratio for the ground phase is over 30 minutes, which is often close to, and sometimes longer than, the total duration of a helicopter mission.

The 2 graphs above underline the difficulty of modeling a typical mission based on the LTO - CCD model (Landing - Take-Off and Climb - Cruise - Descent phases) proposed by ICAO and EEA. The same helicopter, on 47 consecutive missions and here for the same type of operation (medical evacuation), carries out flights of very disparate durations. Moreover, within the same mission, it is sometimes difficult to distinguish between LTO and CCD phases.

The exact fuel consumption of a helicopter mission also remains difficult to assess in the absence of data captured and transmitted automatically during flights. To date, the amount of fuel is generally entered manually by the pilot in the log book. This can lead to errors, especially as helicopters often refuel away from airbases, sometimes directly from drums. In addition, some missions are subject to unforeseen circumstances, such as lifting operations where the pilot may have to partially empty the fuel tank.

There are a number of similarities between airplanes and helicopters:

- Use of the same fuel according to ASTM1655 (Jet-A1).
- The eCO₂ emissions pareto, which for over 90% (~99% found in studies) is based on fuel combustion when the life cycle is analyzed.

These two points in common mean that, as with aircraft models, the methodology and data used must meet:

$$eCO_2 = m_{fuel} * fuel_{Cl}$$

m_{fuel} represents the mass of fuel consumed whereas $fuel_{Cl}$ represents the carbon intensity in eCO₂ of the fuel used.

This approach is essential, since more than 90% of the eCO₂ emissions of a helicopter or airplane over its lifecycle are associated with fuel ^{128 129 130 184}.

Any major inaccuracy in the calculation of fuel consumption and/or carbon intensity would reduce the confidence level of the reporting. It is however important to remind here that any model is by definition imprecise. ICAO and EMEP methodologies, for example, tolerate a margin of error of up to 45% for certain parameters (since several parameters can be added together, further degrading the final result).

Depending on the model used, the final margin of error proposed by the methodology proposed, named HeloCarbTM, ranges from 10% to 40%.

I.I.2.2. Methodology applied to Helicopter

1^{er} level architecture is shown below, FIGURE 22:

¹⁸³ https://www.icao.int/environmental-protection/CarbonOffset/Documents/Methodology%20ICAO%20Carbon%20Calculator_v10-2017.pdf accessed August 13, 2024

¹⁸⁴ <https://www.airbus.com/en/sustainability/respecting-the-planet/decarbonisation/decarbonising-helicopters>

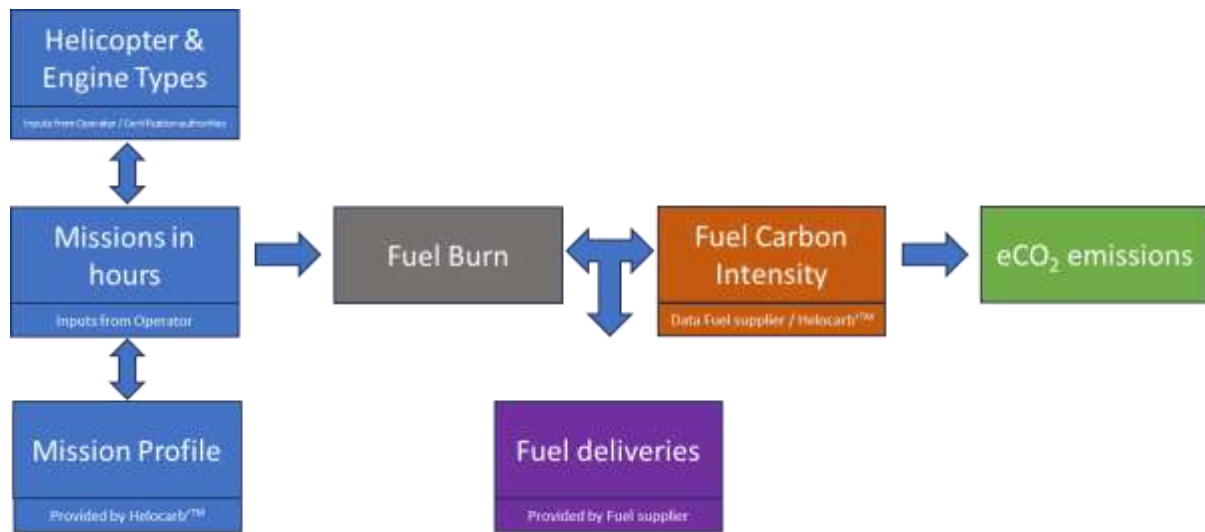

FIGURE 22 Methodology 1st level architecture

The main differences with the EMEP and ICAO methodologies concern the calculation of fuel burn and fuel carbon intensity.

The innovation and main differentiating factor are the combination of engine (a helicopter can sometimes use different engines) and the mission profile constructed to establish fuel consumption. The module for calculating fuel carbon intensity innovates by directly integrating upstream emissions at a level that distinguishes between the contribution of sustainable fuels (SAF: Sustainable Aviation Fuels) and the impact of non-conventional oils on eCO₂ emissions.

As mentioned above, helicopter missions are too disparate to be captured in a single LTO-CCD (Landing, Taxi and Take-Off - Climb, Cruise and Descent) model, as proposed by the ICAO and EMEP methodologies. A versatile machine, a helicopter's cabin layout is nevertheless specialized for a particular type of mission. For example, EMS (Emergency Medical Services) missions require a cabin capable of accommodating a patient, often in critical condition, and medical personnel. While it is always possible to modify the aircraft's cabin to use the machine for other tasks, this involves a visit to the maintenance center and the immobilization of the aircraft for several months, in which case it is possible to identify this transformation and integrate this new data into the following reporting.

After analysis of several thousand flights, the main factors influencing fuel consumption are identified: mission duration, engine, flight profile. Integrating these influential factors is essential, and the methodology distinguishes between several mission profiles. This approach is made possible by adapting a helicopter to the missions it has to carry out, since a helicopter will be operated under very specific conditions. These conditions, which mean that the fuel consumption of the same helicopter can vary by several tens of percent, are captured in the "flight profile" section, which then takes account of mission duration. The engine characteristics are finally integrated to create a combinatorial system.

A methodology depends on the quality of its architecture and data. To meet this dual requirement:

- The construction of combinatorial between mission profile and engine type, with the construction of several models which are compared to reinforce the reliability of the results.
- The quality of the data, collected directly from operators, manufacturers, energy suppliers and certification authorities. This is complemented by analyses of various regulations and scientific articles, notably on the carbon intensity of fuel.
- A recourse system that systematically favors the most accurate model/data, and failing that the most demanding, so as not to underestimate eCO₂.

- Implementation of a validation loop between fuel quantities delivered and estimated fuel consumed.
- Transparency on reporting accuracy, with 4 confidence classes that integrate the accuracy levels of the main parameters. This approach makes it possible to determine a confidence level specific to each combinatorial (class A for accurate data $\geq 90\%$, class B $\geq 80\%$, class C $\geq 65\%$, class D below).

I.I.2.3. Fuel Carbon Intensity

The ratio used differs from the ICAO and EEA methodologies, by integrating all SCOPE 1-2-3. As discussed in previous chapter, considering all eCO₂ emissions over the lifecycle (extraction, refining, transport-distribution, combustion) seems necessary not only to assess emissions accurately, but also to correctly anticipate the future incorporation of sustainable aviation fuel (SAF) in flight operations. The rising carbon intensity of fossil fuels, driven by a noticeable increase in unconventional oils in recent years, is also considered, as this trend is set to continue. Emissions associated with the combustion of SAF are very similar to those of fossil fuel jets¹³⁷, and it is essentially the upstream phase that explains the significant reduction in eCO₂ emissions over the life cycle between SAF and fossil fuel jets (with, for example, the capture of CO₂ by the biomass during its growth, a quantity of CO₂ that will then be released during combustion).

The carbon intensity (CI) of jet fuel is calculated by multiplying its Lower Heating Value (LHV) by its carbon intensity. These two values can fluctuate, and the method used requires data to be collected for each delivery of jet fuel to airbases. By default, the most demanding value is used.

- LHV: the minimum value required by the standard is 42.8 MJ/kg. When not declared, the value used is 44 MJ/kg. This value is consistent with ADEME data¹⁸⁵, EU directive 2018/2001¹³⁵, and test results.
- CI: there is no regulatory value. Some authorities assume 72 to 74 g eCO₂ /MJ for combustion, or 87 to 89 g eCO₂ /MJ for the whole life cycle (SCOPE 1-2-3). Recent studies indicate that this value can exceed 100 g eCO₂ /MJ when the jet fuel is derived from unconventional oil^{142 186}. The average value used in the latest scientific publications is 94.95 g eCO₂ /MJ, and the value used by the EU in its directive 2018/2001 is 94 g eCO₂ /MJ¹³⁵.

When not declared, the value used is 94 g eCO₂ /MJ for 2023 and 2024, and the references used mean that this value has a high level of certainty (+/- 1%).

The ratio retained for the years 2023 and 2024 is :

$$\text{eCO}_2 / \text{Fuel ratio} = 44 \text{ MJ/kg} * 94 \text{ g eCO}_2 / \text{MJ} = 4.136$$

This ratio is 30% higher than the ratio currently used by ICAO for commercial aviation.

¹⁸⁵ https://prod-basecarbonesolo.ademe-dri.fr/documentation/UPLOAD_DOC_FR/index.htm?new_liquides.htm accessed August 13, 2024

¹⁸⁶ Cai et al, well-to-wheels greenhouse gas emissions of Canadian oil sand products, Environmental Science & Technology 2015, <https://doi.org/10.1021/acs.est.5b01255>

This ratio will decline with the incorporation of SAF, but the very likely increase in the carbon intensity of fossil fuels, driven by a mix incorporating more non-conventional fuels, must also be taken into account. In 2023 and 2024, there will be no significant operations with SAF (0.2 and 0.5% respectively¹⁸⁷), but its introduction is mandatory from 2025 (2% in France), and more significantly in 2030 (6%, European regulations). To achieve this is included a module for calculating the carbon intensity of jet fuel, based on data from regulations and scientific publications, as well as data collected from energy suppliers and operators. For each batch of jet fuel delivered, the SAF percentage must be specified, and its origin must comply with Directive (EU) 2018/2001 on the promotion of the use of energy from renewable sources. The total value of eCO₂ includes waste, and the most important values for calculating CI (Carbon Intensity) are Ep + Etd, where Ep are the emissions linked to processing and Etd the emissions linked to transport and distribution, from directive (EU) 2018/2001, Annex V, TABLE 10 below.

FIGURE 23 Methodology Fuel Carbon Intensity, 2nd level architecture, source Jean-Baptiste Jarin

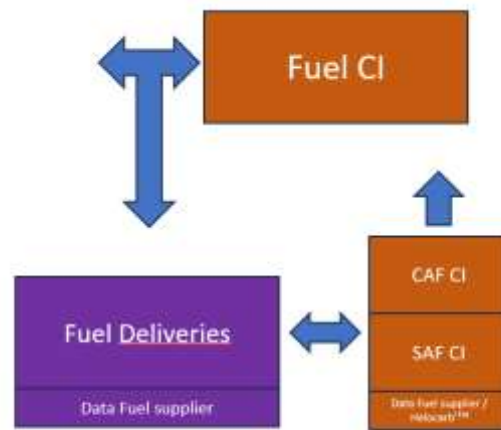

$$E = e_{ec} + e_l + e_p + e_{td} + e_u - e_{sa} - e_{cs} - e_{cr}$$

where

E	=	total emissions from the use of the fuel;
e _{ec}	=	emissions from the extraction or cultivation of raw materials;
e _l	=	annualised emissions from carbon stock changes caused by land-use change;
e _p	=	emissions from processing;
e _{td}	=	emissions from transport and distribution;
e _u	=	emissions from the fuel in use;
e _{sa}	=	emission savings from soil carbon accumulation via improved agricultural management;
e _{cs}	=	emission savings from CO ₂ capture and geological storage; and
e _{cr}	=	emission savings from CO ₂ capture and replacement.

TABLE 10 Methodology for SAF carbon intensity calculation, from EU directive (EU) 2018/2001, Annex V

These values are normally supplied with the delivery of each batch of jet fuel and integrated into the CI calculation module, however in the absence of data, default values are in place in the database using the scientific literatures and the EU regulations, as shown in FIGURE 24 below (see chapter III below for more details on SAF emissions). For the CSRD declaration, the minimal values are those of Directive (EU) 2018/2001.

In addition, a specific module can be used to forecast future emissions and energy costs using a proprietary algorithm based on the ratio of accessible volume to production cost for each SAF family (there are several SAF families, each with a specific accessible volume and production cost).

¹⁸⁷ <https://www.iata.org/en/pressroom/2023-releases/2023-12-06-02/> accessed August 13, 2024

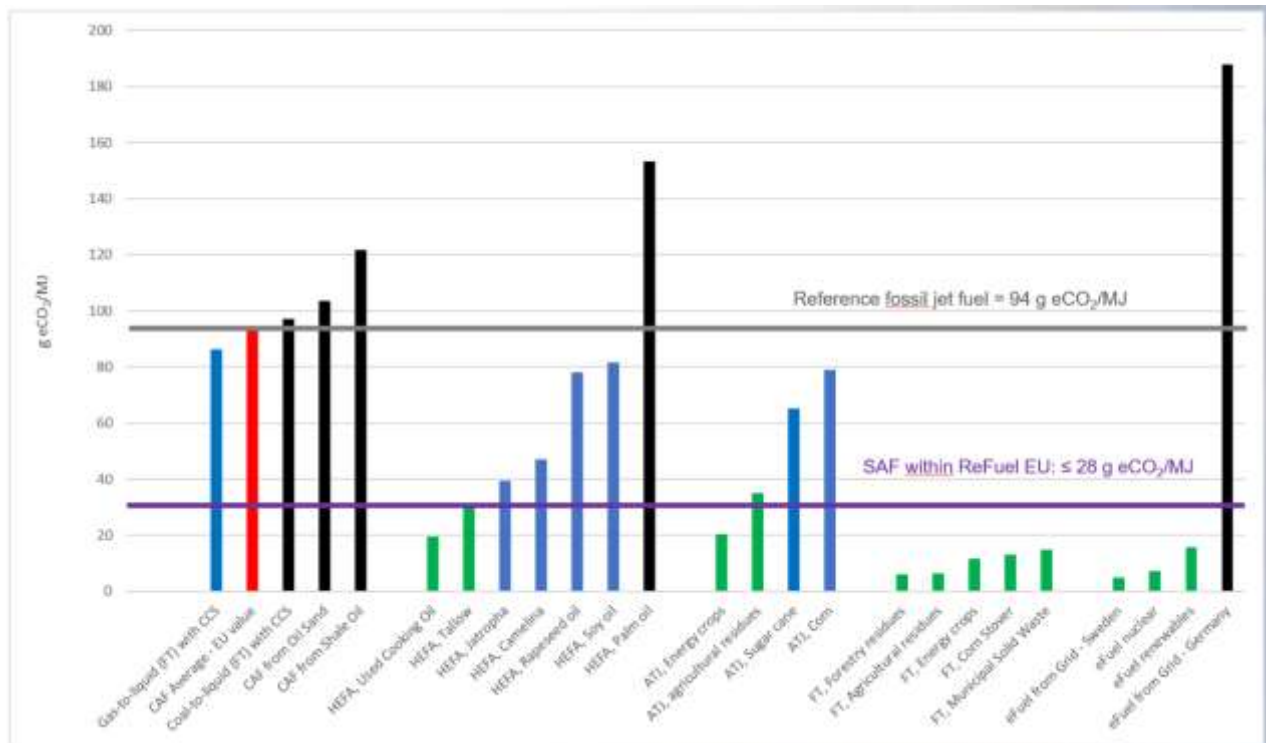

FIGURE 24 Comparing jet fuel emissions. Default values used for CAF, SAF and Alternative Fuels, from Chapter I.III.1.4 FIGURE 54 Comparing jet fuels emissions, in g eCO₂/MJ. In red the CAF reference within EU regulation (94 g eCO₂/MJ), in green the SAF which are accepted within the EU regulation and CORSIA, in blue the SAF or CAF from fossils allowed as lower carbon fuel or sustainable aviation fuels accepted within CORSIA but considered as non-sustainable within EU regulation. Source Jean-Baptiste Jarin. Nota: HEFA Palm Oil, in black, is accepted within CORSIA, see TABLE 19 above

I.I.2.4. Fuel burn

As mentioned in the introduction, the methodology innovates with the implementation of combinatorial that consider the 3 main influencing factors:

- Actual engine operating hours
- The motorization used
- Mission profile

In the absence of a precise fuel consumption value reported by the machine and the operator, it appears necessary to combine these 3 parameters, the core of the methodology. This requires a detailed analysis of each combination, in order to develop and compare several consumption models and select the one closest to the actual values recorded by sampling.

To achieve this, it analyzes and cross-references various data sets from operators (helicopter user, maintenance center), manufacturers (engine manufacturers), certification authorities (EASA¹⁸⁸), the FOCA ed.2 database¹⁸⁹ and various scientific publications.

¹⁸⁸ EASA

<https://www.google.com/url?sa=t&source=web&rct=j&opi=89978449&url=https://www.easa.europa.eu/en&ved=2ahUK Ewim9duf0YeGAxWYTKQEHSkgBVYQFnoECAYQAQ&usq=AOvVaw3i9flhvnmlTLAIKYy351Q> accessed August 13, 2024

¹⁸⁹ <https://www.bazl.admin.ch/bazl/fr/home/flugbetrieb/cat/helicoptere.html> accessed August 13, 2024

The other parameters (on-board weight, environment, takeoff/landing procedure, altitude, and weather) are of lesser importance, and are captured in the averages derived from the analysis of data covering several dozen to several hundred missions, depending on the combinatorics.

I.I.2.5. Mission duration

The data collected comes directly from the operator, as the regulatory monitoring of each machine normally records the number of operating hours and the number of engine cycles completed. On a sample basis, these values can be compared with data from the engine control unit (ECU), where available. At this stage, the type of motorization is not exclusive, but it is still necessary to cross-check these data, since taken in isolation, they do not give a sufficiently precise idea of the actual duration of missions. The graphs opposite illustrate this difficulty, detailing the duration in minutes of several successive missions performed by the same aircraft in two distinct mission profiles (EMS, Offshore). The averages observed fluctuate considerably: from 10 to 50 minutes for EMS missions, and from 50 minutes to over 3 hours for Offshore missions as shown in FIGURE 25 and FIGURE 26 below.

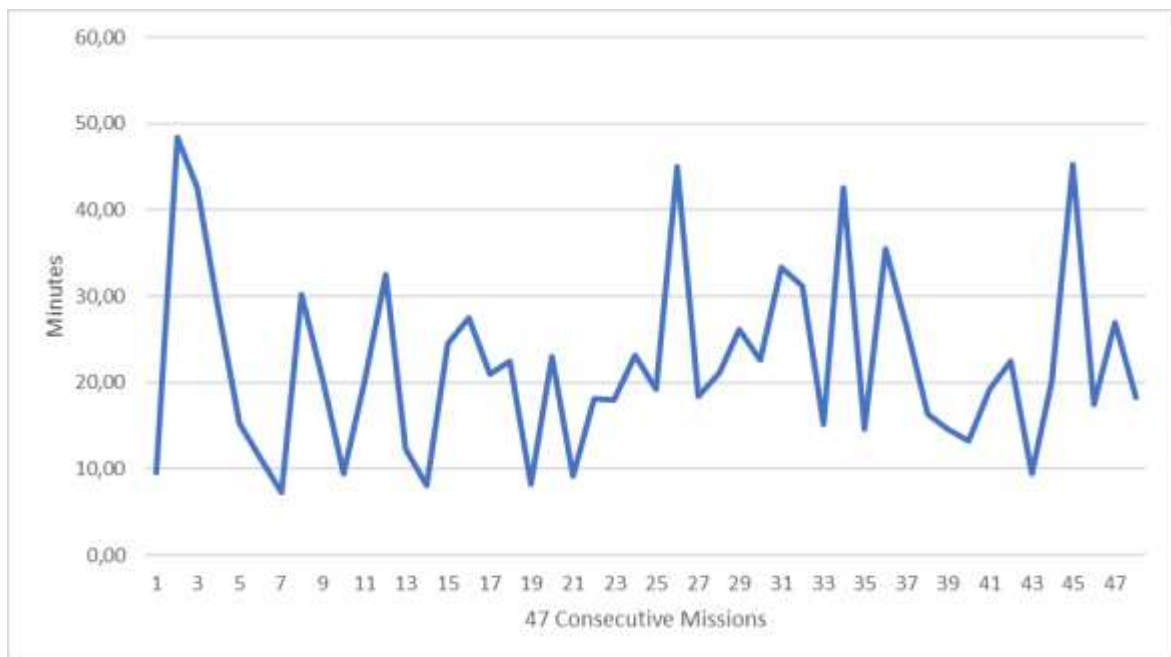

FIGURE 25 EMS calculated engine time for 47 consecutive missions, in minutes (y-axis), source Jean-Baptiste Jarin

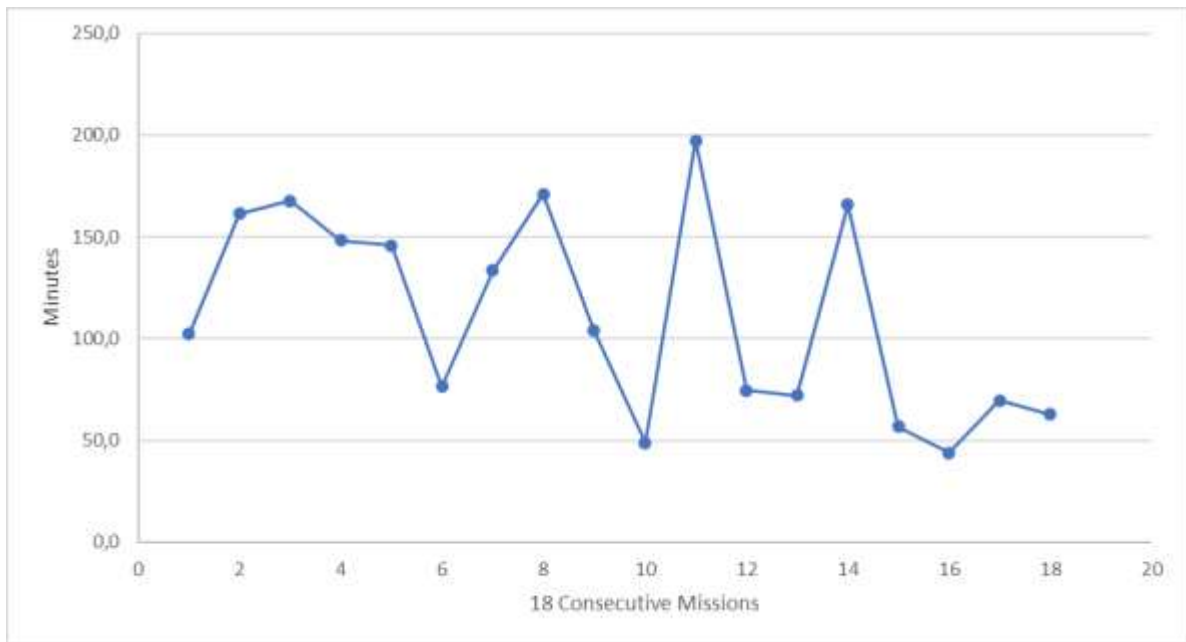

FIGURE 26 Offshore calculated engine time for 18 consecutive missions, in minutes (y-axis), source Jean-Baptiste Jarin

This peculiarity means that we need to capture and integrate this data into the mission profiles we draw up.

This average duration is broken down into several flight phases, as fuel consumption can fluctuate by a factor of 4 between ground idle and climb, for example. The methodology used considers 5 distinct phases:

- Ground start/idle (Start, Idle)
- TO - Climb
- Cruise including intermediate TO-Climb and Approach-Landing when necessary
- Approach - Landing
- Ground idle / stop (Idle - Stop)

This approach enables us to propose a flight profile adapted to each type of mission: the proportion of each phase fluctuates significantly according to the type of mission. The acronym used when the "cruise - resources" section is extracted is STOCAS for -Start - idle, Take-Off - climb, Cruise - resources, Approach, idle - Stop-).

This data is then used to establish the power demand, and therefore consumption, according to mission profile and motorization, making each combinatorial unique.

Recourse in the absence of data: once an assignment profile has been established, it is still possible to propose a combinatorial model for the same type of assignment, even if not all the data are available. In this case, the model used can be based on the hours worked over a different period, and as a last resort on the average hours worked by other operators for identical assignments. As a result, the level of precision will be significantly degraded.

I.1.2.6. Motorization

Engine size is a key factor in calculating fuel consumption.

Some helicopters may use different engines, so it is the engine that is considered when establishing the combinatorial (manufacturer = engine manufacturer). There are two reasons for this:

- The fuel consumption of a given helicopter model can vary considerably according to its engine type

- Data collection can display different levels of precision depending on the parameters that each manufacturer agrees to communicate.

Whenever possible, the data collected from operators is compared with data from manufacturers and certification authorities. This enables to obtain a precise consumption figure for each flight made by the helicopter as shown in FIGURE 27, here with operator and engine data collected and combined. The degree of confidence is therefore very high, and these data are directly integrated into a combinatorial system, - Flight Profile - model below.

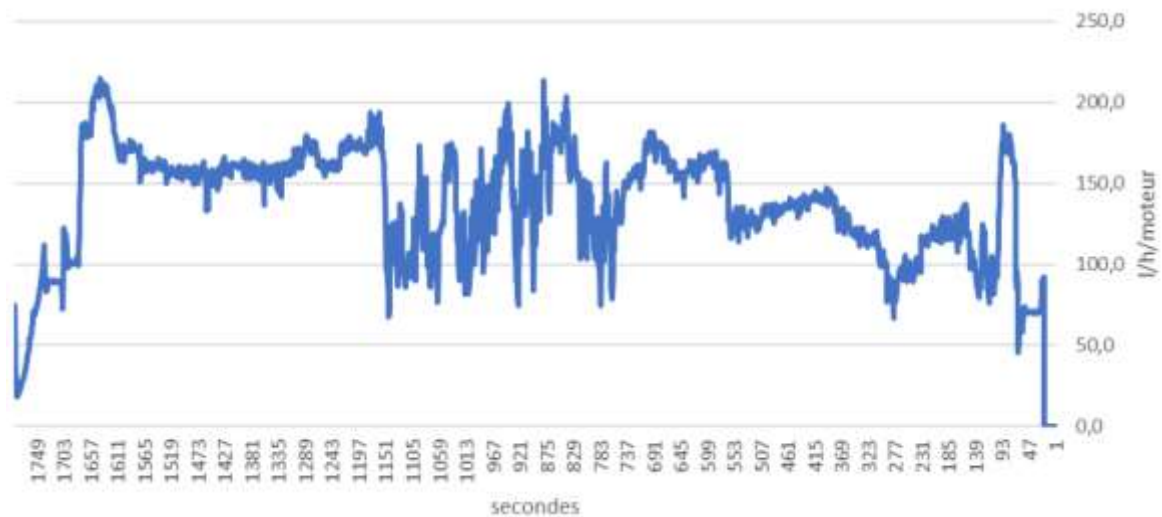

FIGURE 27 Flight Profile analysis for a selected EMS mission, source Jean-Baptiste Jarin

In the absence of data, the turbine consumption reference frame from the FOCA ed.2 database is used. The reference system is based on fuel flow as a function of power demand. This reference system can be used to calculate approximate fuel consumption by machine type, by evaluating the associated power level. This reference system, which is not very precise, can sometimes be supplemented with manufacturer data (engine consumption profile, for example). It is also possible to cross-check the results obtained from this reference system with another combination within the same job profile. In this case, the calculated value becomes fairly accurate, and the degree of confidence can be considered good ("MCP+" model).

In the total absence of data, it is possible to extrapolate from the engine power given by the certification authorities (EASA) using the TCDS (Type Certificate Data Sheet), such as for the Arrius 2B2¹⁹⁰. The approximate average value of 65% of the MCP is generally used: "MCP Mean" model. The level of precision will therefore be low.

1.1.2.7. Mission profile

A detailed analysis of the missions reveals significantly different fuel consumption figures for identical engines and flight durations. Fuel consumption differs according to a number of parameters, but the flight profile is the main influencing factor. A versatile machine par excellence, the helicopter can nevertheless be prepared for specific missions. This is obviously the case for military operations (weapons systems), but also for certain civil applications. A helicopter dedicated to medical evacuation, for example, will have a very specific cabin layout, and will be operated under very specific conditions.

The methodology employed has set 8 mission profiles and builds, completes, and updates databases detailing these. The duration of missions is directly integrated to calculate the distribution of flight phases and associated power

¹⁹⁰ Arrius 2B2

https://www.google.com/url?sa=t&source=web&rct=j&opi=89978449&url=https://www.easa.europa.eu/en/downloads/7745/en&ved=2ahUKEwji-TMzICGAXITaQEHRASB88QFnoECBYQAQ&usg=AOvVaw08vVPvvlz6dXyHEFJ_pOrb accessed August 13, 2024

requirements (flight profile). Each mission profile thus has its own power demand characteristics, expressed in terms of both time and fuel consumption. When associated with the motorization, the combinatorial can be built as shown in FIGURE 28 below.

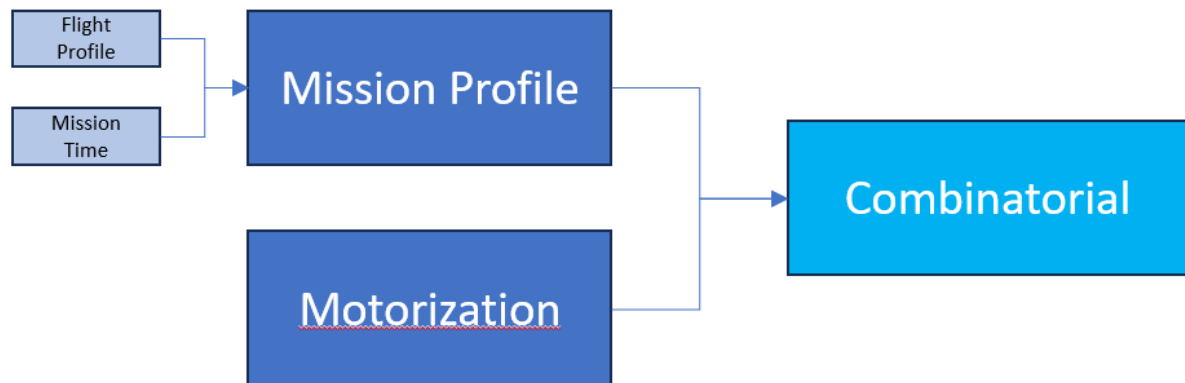

FIGURE 28 Combinatorial, architecture level 2, source Jean-Baptiste Jarin

8 distinct mission profiles are defined to build the combinatorial:

- EMS: Emergency Medical Services. Half of all missions involve patients, often requiring a landing with or without engine shutdown before returning to base.
- SAR: Search And Rescue, mainly in difficult environments such as seas and mountains. Civil security falls into this category. These are very demanding missions, involving numerous hovering flights, which significantly increase fuel consumption.
- Firefighting: collecting and dropping water and/or retardants to fight fires, mainly forest fires.
- Offshore: Transporting personnel on oil and gas platforms (a mission that most closely resembles an aircraft-type flight profile).
- Training: Training courses, flight schools.
- Utility: Aerial work, from filming events to transporting equipment in the mountains.
- Surveillance : police, gendarmerie, surveillance of sensitive infrastructures
- Wind Farm: Construction and maintenance of wind farms.

Both the assignment of a helicopter to a mission profile and the analysis of these missions are based on operator and/or manufacturer data. Sometimes confidential, they contain from a few parameters (at least operator base, engine type, engine cycles and operating hours) to several dozen parameters for each second of flight. Each mission profile thus has its own accuracy class, depending on the volume of data available and analyzed (the sample size):

Sample size: number of machines * number of jobs

Continuously enriched, the database built makes it possible to establish in 2024:

- EMS: very high precision (dozens of machines, dozens of missions)
- SAR: under construction, data cumulated with "EMS" which is very close, high precision

- Firefighting: little data, cumulative data with "Utility", average accuracy
- Offshore: very high precision (dozens of machines, several dozen missions)
- Training: under construction, low precision
- Utility: high precision (a few machines, several dozen missions)
- Monitoring: under construction, low accuracy
- Wind Farm: little data, use of "Utility" profile, average accuracy

A high level of precision requires a large amount of data, which is the case for Utility, EMS and Offshore. These 3 mission profiles are based on a database of several hundred flights (around 50 parameters for several hundred thousand lines), comparing operator data (hours and engine cycles) with manufacturer data. An example of a distribution key is shown in the TABLE 11, and representative flight profiles for EMS, Utility and Offshore are shown in the graphs below (1 point = 1 second). FIGURE 29, FIGURE 30 and FIGURE 31 below are explicit and one can understand that the fuel consumption would be different.

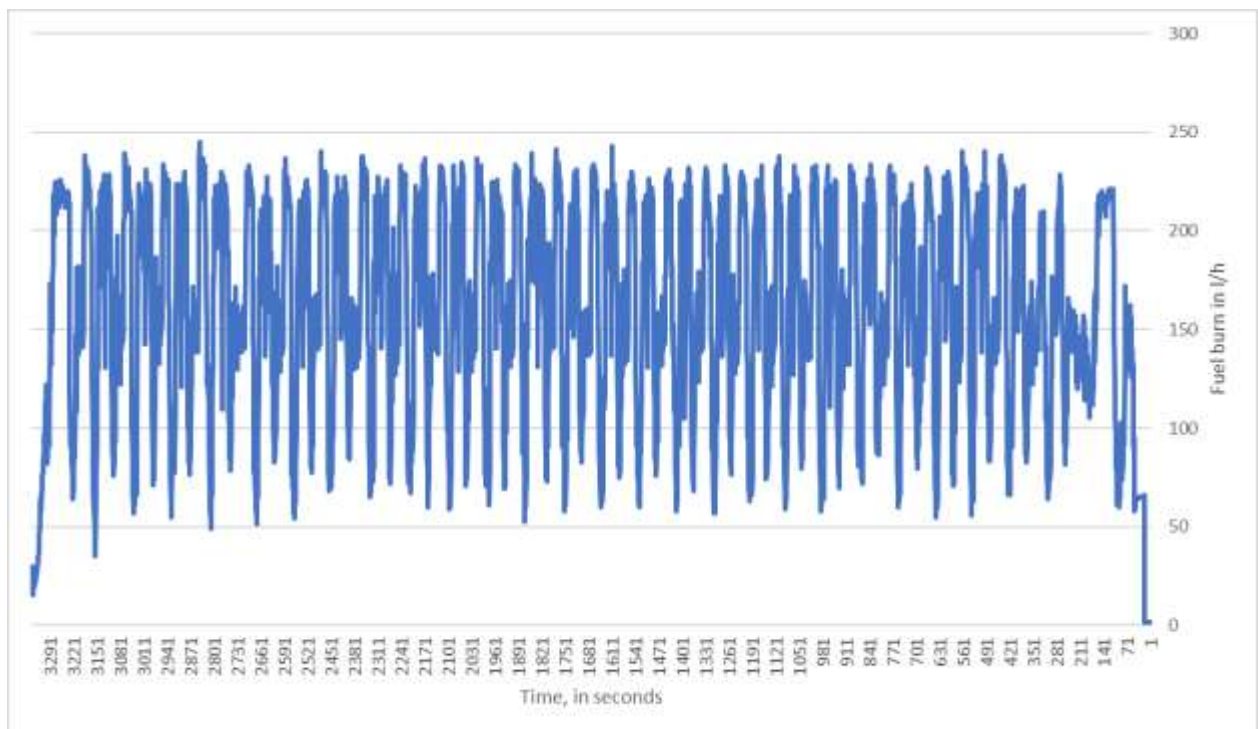

FIGURE 29 Flight Profile analysis for a selected Utility mission, source Jean-Baptiste Jarin

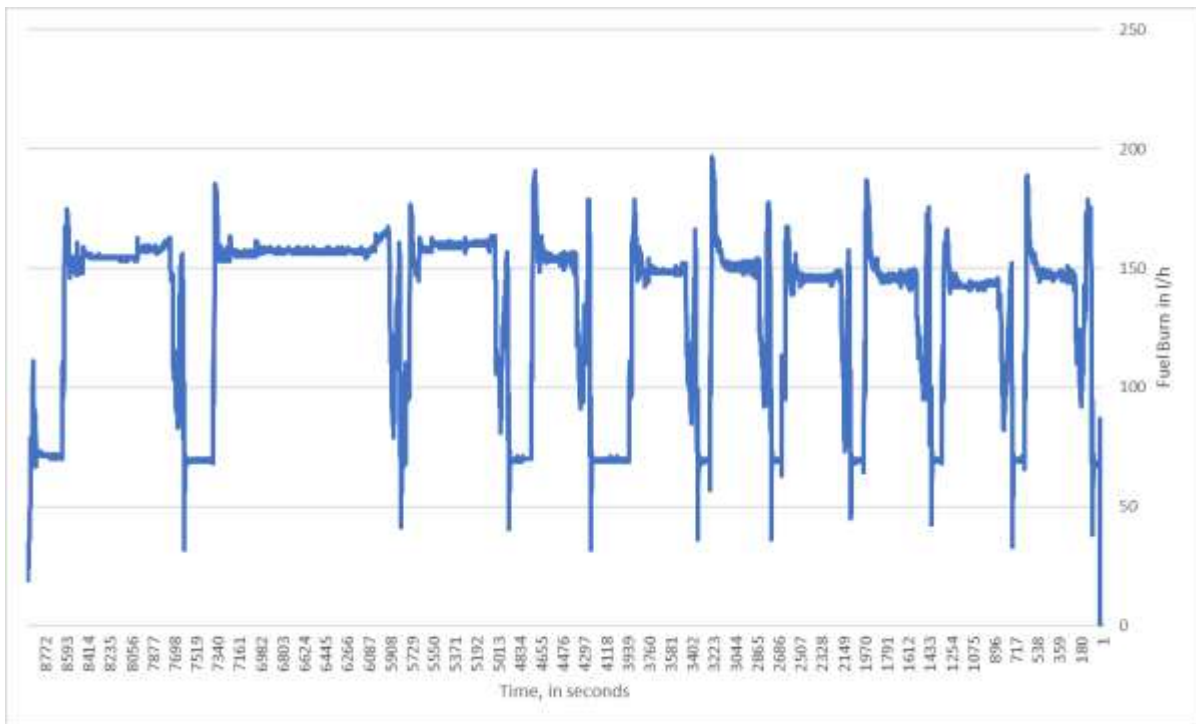

FIGURE 30 Flight Profile analysis for a selected Offshore mission, source Jean-Baptiste Jarin

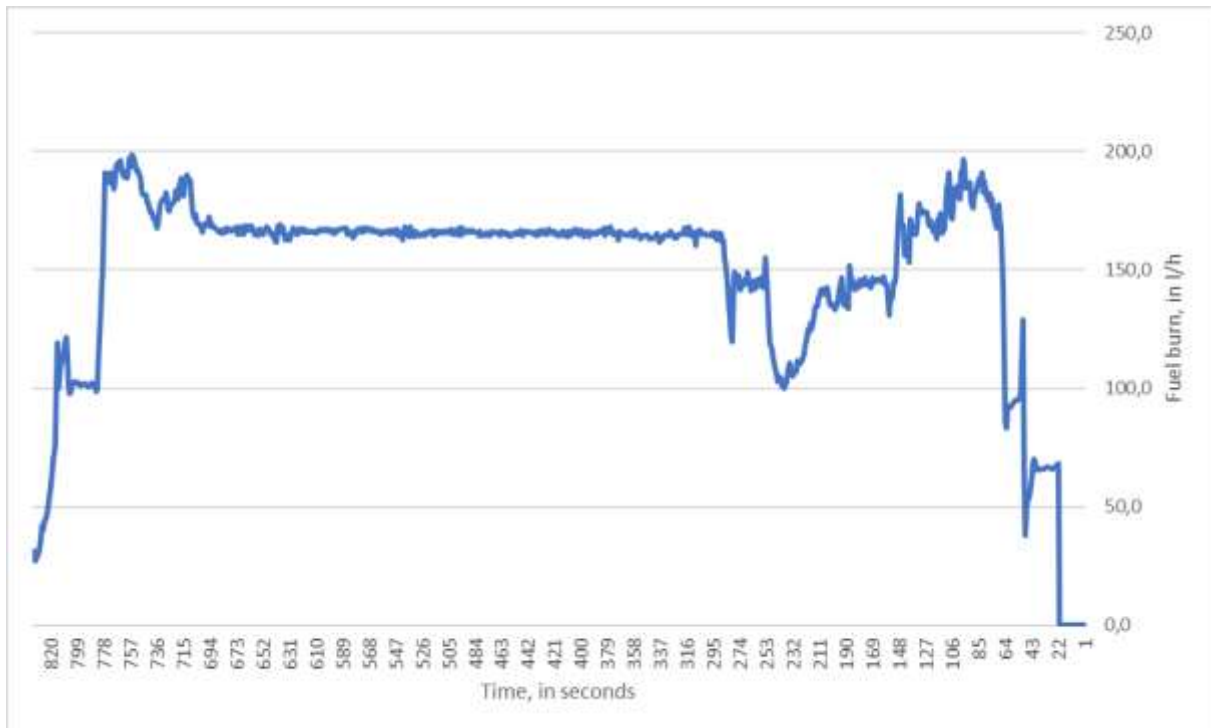

FIGURE 31 Flight Profile analysis for a selected EMS mission, source Jean-Baptiste Jarin

I.1.2.8. Combinatorial

Once this data has been collected and analyzed, combinatorics can be established. A combination combines Mission Profile and type of engine used. Depending on the fleets analyzed, there may be several dozen combinatorial, i.e. for the fleet managed by RIVE analyzed for the 2023 fiscal year, 17 combinatorial have been identified.

A combinatorial system systematically distinguishes between flight phases, the associated distribution key and the relationship between power demand and fuel consumption as shown in TABLE 11 and TABLE 12 below.

	Phases de vol en %	Conso Associée (l/h/mot)
Start - Idle	6,37%	74,9
TO - Climb	3,48%	176,8
Cruise - Mission	75,30%	154,1
Approach	12,12%	120,4
Idle - Stop	2,73%	65,3

TABLE 11 Detailing fuel burn for a specific combinatorial, flight time per phase in % and associated fuel burn in liter per hour per engine, source Jean-Baptiste Jarin

Cruise = time * 68,9 g/s	kg	kg		
Start - Idle	2,814	16,118	84 secondes	326 secondes (5mn26s)
TO - Climb	3,637		46 secondes	
Approach	8,615		160 secondes	
Idle - Stop	1,051		36 secondes	

TABLE 12 Detailing fuel burn for a specific combinatorial, total per flight phase, source Jean-Baptiste Jarin

As mentioned in the Motorization section, several models are established and compared in order to obtain the best possible level of precision.

TABLE 13 below summarizes the results for a given combinatorial model. Since here all data are available, it is possible to compare not only the reliability of a model, but also to determine the level of accuracy of remedies when certain data are not available. It is therefore possible to compare the accuracy of different models.

The actual consumption value (ref) is shown in the last line of the table. 4 missions (1-3-5-7) are detailed, representing typical missions for the mission profile considered in duration, here from 528 to 2343 seconds (8 mn 48 s to 39 mn 03 s). The cruise portion is shown after deduction of the value calculated for the other phases of flight, in this case 326 seconds. The cruise phase and its particularities (power calls, landings without engine stops, etc.) are calculated to establish an average, here expressed in g/s. Cruise flight time is therefore expressed in seconds * 68.9 g/s of fuel.

- When manufacturer data are available, an analysis of average consumption over several missions using two samples of different classes is carried out. This approach generally gives good results, although it may tend to underestimate actual consumption and therefore final eCO₂ emissions. Unsurprisingly, the larger the sample, the greater the accuracy, generally between 80 and 95%. Systematically calculated for model verification, this averaging approach can give good results on certain mission profiles.
- An approach based on % of average engine power (% of MCP value) is also systematically applied, using the "MCP Mean" model. Generally ranging from 60 to 90%, depending on engine and mission profile, an average MCP value of 65% is used in the absence of other data. The level of accuracy varies greatly according to mission profile, and its degree of confidence may therefore fluctuate.
- The "MCP+" model is used when part of the manufacturer's data is available, and a "Flight Profile" model of similar combinatorics is available. These data can be used to refine the % MCP derived from the "MCP Mean" model. The resulting accuracy level is significantly improved, in the range of 90-95%. The confidence level may fluctuate, but is generally 90%.

- With all the data available (Operator and Manufacturer), it is possible to establish a precise flight profile and achieve a very high level of accuracy, beyond 95% and up to 99%. For this model, "Flight Profile", a confidence level of 95% is reached.

Mission #	secondes	#1	#3	#5	#7	Moyenne
<i>Modèle HeloCarb'</i>	g/s	528	2343	813	1730	1318
Av.FB - Sample 26	62,9	33,211	147,375	51,138	108,817	82,9022
Av. FB - Sample 8	61	32,208	142,923	49,593	105,530	80,398
	68,9	202	2017	487	1404	992
<i>Flight Profile</i>		30,035	155,089	49,672	112,853	84,466
<i>ICAO</i>		non applicable				
<i>MCP Mean</i>	66	34,848	154,638	53,658	114,180	86,988
<i>MCP+</i>	65	34,320	152,295	52,845	112,450	85,670
Conso réelle		28,87	151,10	53,74	110,05	84,6

TABLE 13 Results for several fuel burn models tested, source Jean-Baptiste Jarin

The same methodology is used to establish each mission profile, and the graphs opposite show the level of accuracy of each model for Offshore and Utility.

This approach is decisive in calculating fuel consumption, as it has been found that for the same machine, engine and flight time, fuel consumption can vary by more than 50%.

Once the mass of fuel consumed and the eCO₂ carbon intensity of the fuel used have been determined, it is possible to provide the eCO₂ emissions for a given machine, mission, or fleet:

$$eCO_2 = m_{fuel} * fuel_{CI}$$

Confidence level: each combinatorial is based on averages which, although built on several thousand pieces of data, cannot claim 100% accuracy. And as it is necessary to stack several blocks (duration, flight profile, etc.), the methodology proposes a confidence level based on the level of precision achieved for each average, while a degree of appreciation is left to the analysis in compliance with the classification proposed opposite.



I.II. Air Mobility

I.II.1. Context

Mobility in our modern societies is now often seen as the freedom to travel ¹⁹¹ when initially the Universal Declaration of Human Rights, proclaimed by the United Nations General Assembly in Paris on 10 December 1948 ¹⁹² as a common standard of achievements for all peoples and all nations, approaches the right to mobility from the strict angle of the right to come and go, article 13 ¹⁹³:

1. "Everyone has the right to freedom of movement and residence within the borders of each State".

2. "Everyone has the right to leave any country, including his own, and to return to his country".

This approach was subsequently enhanced in law, as in France, where the right to mobility is now extended to the possibility of accessing a means of transport, as underlined in article L1111-1 ¹⁹⁴: «...mobility...must satisfy the needs of users and make effective the right of every person... to travel and the freedom to choose the means of doing so». Article L1111-2 ¹⁹⁵ goes even further, highlighting that « the progressive implementation of the right to mobility enables users to travel under reasonable conditions of access, quality, price and cost to the community, in particular by using a means of transport open to the public».

Air mobility in developed countries is now often seen as a right, and the recent survey in Europe conducted by 40 dB. / Nuances d’Avenir in 2024 ¹⁹⁶ highlights that people now associate positive emotions with flying. When asked about the potential impact of not being able to fly, the two most cited impacts are the inability to visit dream destinations and discover other cultures. Despite its environmental impact, air travel remains synonymous with escape, enjoying a positive image and strong emotional attachment. Even those who do not fly often associate air travel with escape and vacations, and almost half of French people say they would fly more if money and time were no object.

This perception in 2024 is far from the one perceived in the sixties, when the “Jet Set” and businessmen were the only fraction of the population which could afford to travel ¹⁹⁷. To better understand the evolution of the social contract, 3 different periods have been considered, each period having its CAGR (Compound Average Growth Rate) and social characteristics:

- 1960 to 1980: Jet Age / Jet Set
- 1980 to 2000: Deregulation and market expansion
- 2000 to 2019: Cost efficiency

	Jet Set		Deregulation		Low Cost	
	1960	1980	2000	2019		
ASK in B km	184	1720	4500	10520		
CAGR	11,82%		4,93%		4,57%	

TABLE 14 Compound Average Growth Rate of aviation Available Seats Kilometer with data from OWID

¹⁹¹ The role of well-being in transport policy, Alexa Delbosc <https://pdf.sciencedirectassets.com/271794/1-s2.0-S0967070X12X00040/1-s2.0-S0967070X12000893/dx.doi.org/10.1016/j.tranpol.2012.06.005>

¹⁹² (General Assembly resolution 217 A) accessed August 13, 2024

¹⁹³ https://www.ohchr.org/sites/default/files/UDHR/Documents/UDHR_Translations/frn.pdf accessed August 13, 2024

¹⁹⁴ https://www.legifrance.gouv.fr/codes/section_lc/LEGITEXT000023086525/LEGISCTA000023068943/ accessed August 13, 2024

¹⁹⁵ https://www.legifrance.gouv.fr/codes/section_lc/LEGITEXT000023086525/LEGISCTA000023068943/ accessed August 13, 2024

¹⁹⁶ https://partage.univ-pau.fr/service/home/~/?auth=co&loc=fr_FR&id=19832&part=2 accessed August 13, 2024

¹⁹⁷ Patrice Ballester, La Jet Set, épisode II.5 <https://hal.science/hal-04101110/>

When compared to the GDP annual growth, FIGURE 32 below, one can notice that the aviation traffic growth is always higher than the GDP growth, even during the oil shocks, with the exceptions of two economic downturns which directly impact air mobility: the Gulf War and September 11th.

For the first two periods the data are mostly issued from ATA (Air Transport Association of America). This is explained by the leading role of North America during that period, with almost half of the traffic until 2000, and still 25% in 2019. For the third period data are issued from ATA and IATA.

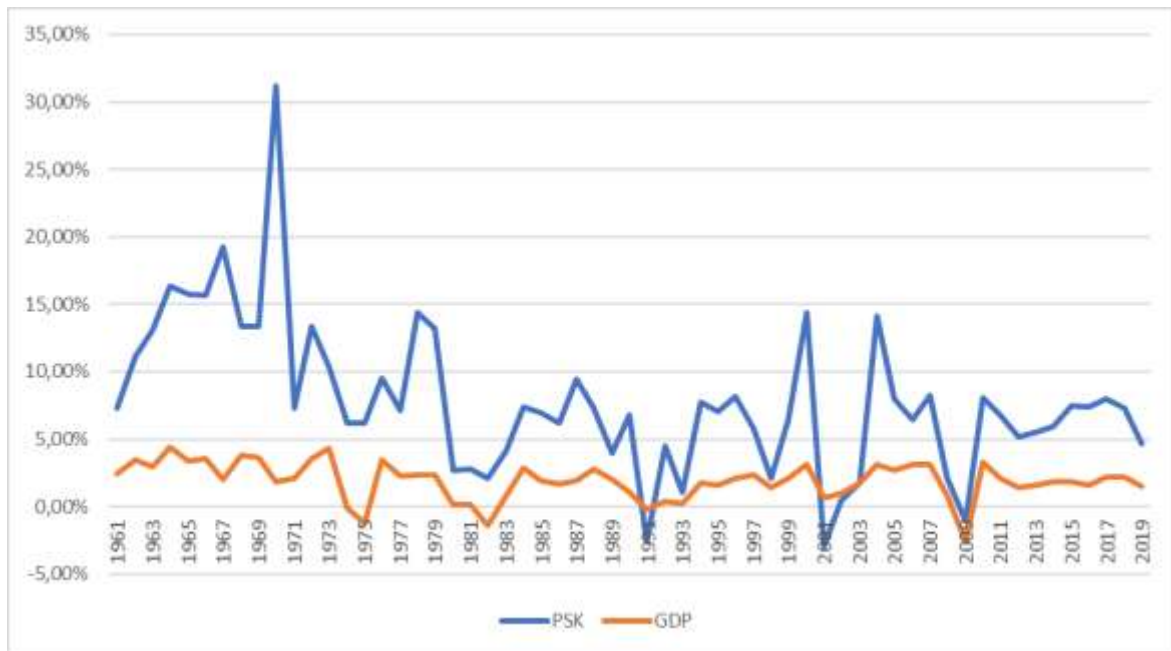

FIGURE 32 World Traffic (in PSK) and World GDP growth from 1961 to 2019, in yearly % increase, source Jean-Baptiste Jarin with data from World Bank, ICAO and OWID

I.II.1.1. 1960-1980: Jet Age & Jet Set

Flying further, higher, faster, safer, and more, to boost the economy. Environmental issues are limited to noise and black smoke due to local air quality.

The first full year of the jet age is considered to 1959 by ATA ¹⁹⁸, page 4 of the 1960 report.

During this period, until the oil shocks, the key performance indicators tracked are the number of airlines, the number of cities served, number of aircraft in service, number of seats available, the number of people employed and payroll, the number of passengers carried, and speed. In 1949, the cruising speed of fastest transport is 315 mph (507 km/h), ten years later, in 1959 it has almost doubled at 615 mph (990 km/h). In less than 5 years the percentage of passengers / miles in turbine powered aircrafts rose from 10 to 80% ¹⁹⁹.

The benefits of air travel for the economy are promoted, in workforce but also investments, as well as the services to the nation, from mail to military transport. Comparison with other means of long-distance transportation is introduced (train and coaches) as well the profits for airlines.

¹⁹⁸ Air Transport Facts and Figures, 1960, page 4 <https://airlines.org/wp-content/uploads/2014/08/1960.pdf> accessed August 13, 2024

¹⁹⁹ Air Transport Facts and Figures, 1965, page 7 <https://airlines.org/wp-content/uploads/2014/08/1965.pdf> accessed August 13, 2024

Fuel burn and CO₂ emissions are not considered until the oil shocks, and the introduction of supersonic planes is expected in the late 70's. Fuel is often mentioned only once in the yearly ATA report, in the expenses section along with taxes, amortization and depreciation, passengers food or employees payroll.

The replacement of piston aircraft by jet aircrafts, FIGURE 33 illustrate this as aircraft energy intensities was multiplied immediately by a factor of almost 3, which means three times more fuel and three times more CO₂ emissions for the same purpose²⁰⁰.

The Lockheed Constellation (L-1049) and Starliner (L-1649) as well as Douglas DC-7 piston-engine aircrafts are then replaced by jet aircrafts such as the Boeing 707, de Havilland Comet or Sud Aviation, which later became Airbus, Caravelle. The speed is almost doubled, from 480 km/h to 900 km/h, the fuel burn, therefore the eCO₂ emissions, is almost tripled. This swap from propellers to jet occurred fast: in 1959 in the United States only 84 aircrafts out of 1827 fixed wings were jets. Ten years later, in 1969, 1973 jets are operated out of 2403 fixed wings²⁰¹.

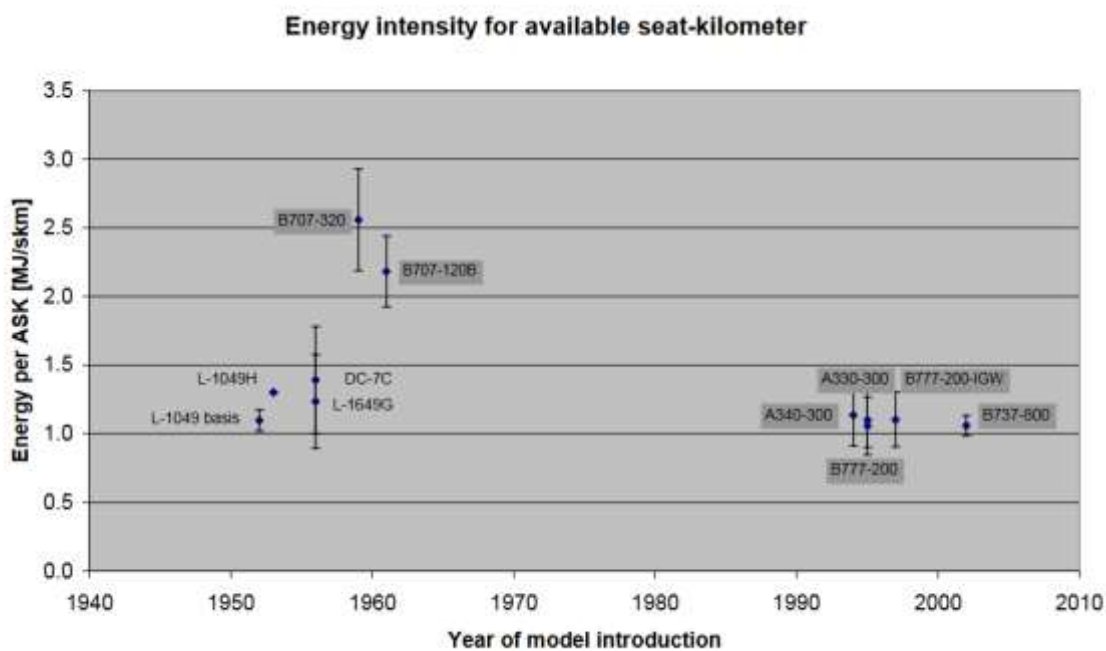

FIGURE 33 Aircraft energy intensities in MJ per available seat / km, ranges show the impact of cabin configuration. Figure is issued from "Fuel efficiency of commercial aircraft, an overview of historical and future trends", originally figure 5 page 17, with the kind authorization of first author, Professor Paul Peeters.

Flying faster could not be better illustrated than with the Concorde, which flies at Mach 2.02 or 2182 km/h. But speed has a price, namely fuel consumption, and breaking the sound barrier requires significant quantities of fuel, approximately 30 tons for this process²⁰². The fuel burn per passenger is then at its highest, with approximately 25600 liters of fuel burn per hour for carrying 100 passengers according to British Airways²⁰³, the only airline which operated Concorde along with Air France. The Concorde technical sheet of British Airways highlights that carrying 100 passengers (approximately 10 tons with luggage) required almost 100 tons of jet fuel from London to New-York, or 5570 km, for a maximum take-off weight of 185 tons. This means the return trip was equivalent to 8 tons of eCO₂ per

²⁰⁰ Peeters, P.M., Middel, J. and Hoolhorst, A. (2005) Fuel Efficiency of Commercial Aircraft: An Overview of Historical and Future Trends. NLR-CR-2005-669. <https://temis.documentation.developpement-durable.gouv.fr/docs/Temis/0058/Temis-0058759/16695.pdf> accessed August 13, 2024

²⁰¹ Air Transport Facts and Figures, 1970, page 46 <https://airlines.org/wp-content/uploads/2014/08/1970.pdf> accessed August 13, 2024

²⁰² https://aircrafttechnic.com/aircraft_mechanic/how-was-concordes-fuel-consumption/, accessed August 13, 2024

²⁰³ <https://www.britishairways.com/content/information/about-ba/history-and-heritage/celebrating-concorde>, accessed August 13, 2024

passenger. The fuel burn when expressed in ASK (available seat kilometer) is 7.9 MJ / seat – km, almost 8 times higher than the most efficient piston engine aircraft (Concorde is not represented in FIGURE 33 above).

Safety is also significantly improved and carefully monitored as soon as 1960, with growing investments in safety ²⁰⁴, with the massive introduction of flight simulators and the first collision avoidance system in the following years. The number of airliner accidents decreased from 75 in 1960 to 48 in 1980 while the ASK grew from 184 to 1720 billion km ²⁰⁵, a significant improvement.

While the number of jobs associated to air mobility is mentioned as soon as 1959, fuel cost is disregarded until the first oil shock (1973) while environmental issues are limited to local pollution: noise and smoke.

This era of jet age / jet set which disregard energetic issues cannot be better summarized than by S.G. Tipton, chairman of the board of Air Transport Association of America, who declared in 1974 while acknowledging that energy conservation will have to become a way of life for the American people due to the oil shock that “One thing is clear – the fuel needs of air transportation must continue to be met. Air transportation is a solution to the energy problem rather than a cause...energy efficiency must be based not only upon its ability to move people and goods but must include a recognition that speed requirements must be met also” ²⁰⁶.

In 1980, after the second oil shock, fuel cost becomes a significant issue as shown in FIGURE 34 below, and the detailed airlines operating expenses shows that fuel is close to 1/3 of the total, just behind labor costs: from approximately 12% at the beginning of the period, Jet Fuel is now considered as a major issue, second line of expenses behind labor ²⁰⁷. Fuel costs per gallons rose 10 folds during this era.

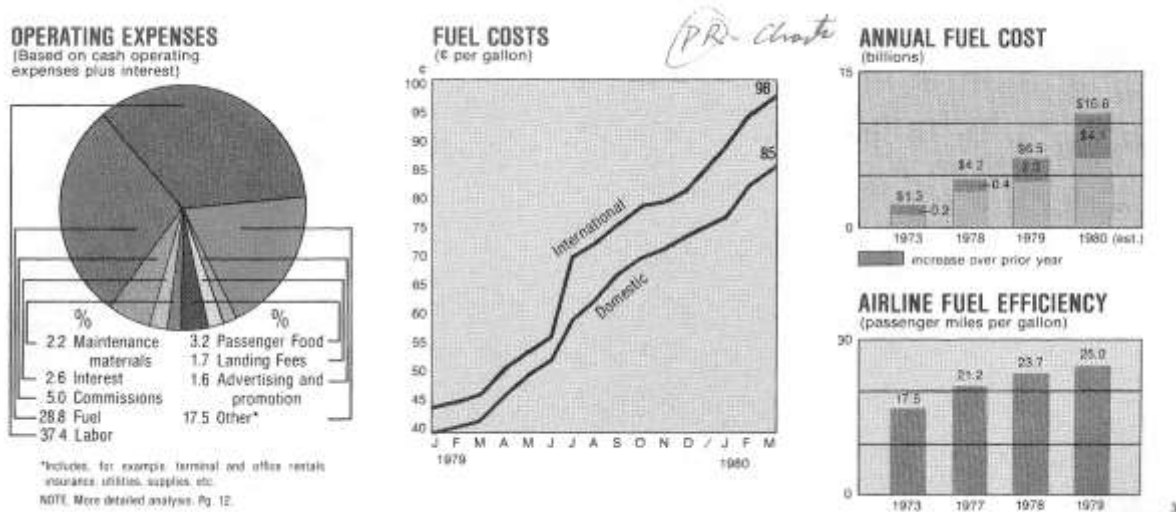

FIGURE 34 1980 ATA report, page 3, detailing operating expenses and fuel costs data, source ATA

The CAGR of aviation traffic during this period was remarkable, close to 12%. The association of the technology and an unlimited supply of cheap energy (until 1979) most certainly explain this remarkable result. FIGURE 35 below supports this hypothesis: the cost of jet fuel was remarkably low and stable until the first oil shock (1973), before climbing significantly at the end of the period, with the second oil shock (1979).

²⁰⁴ Air Transport Facts and Figures, 1963, page 12 <https://airlines.org/wp-content/uploads/2014/08/1963.pdf> accessed August 13, 2024

²⁰⁵ <https://asn.flightsafety.org/statistics/period/stats.php?cat=A1> , accessed August 13, 2024

²⁰⁶ Air Transport Facts and Figures, 1974, page 4 <https://airlines.org/wp-content/uploads/2014/08/1974.pdf> accessed August 13, 2024

²⁰⁷ Air Transport Facts and Figures, 1980, page 3 <https://airlines.org/wp-content/uploads/2014/08/1980.pdf> accessed August 13, 2024

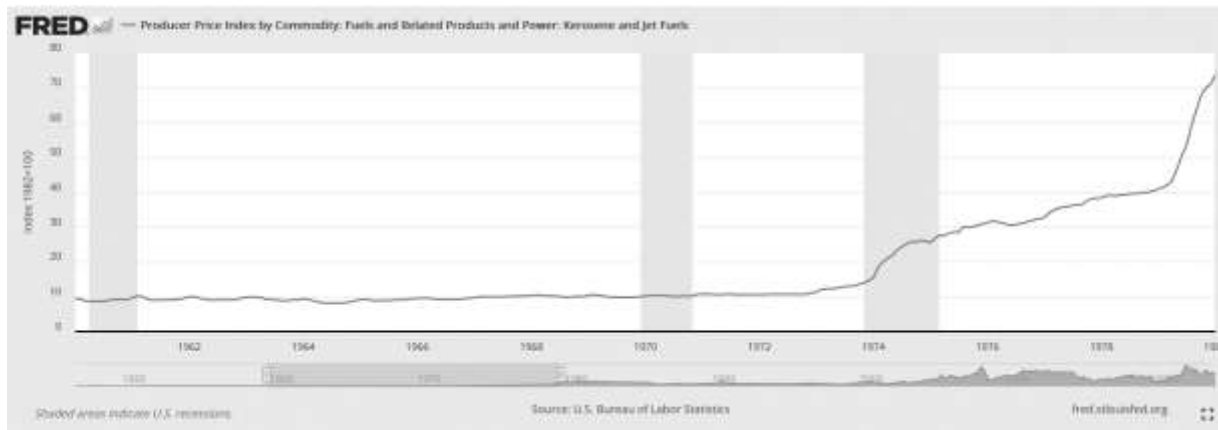

FIGURE 35 Jet Fuel producer price index (base 100 in 1982) for selected year 1960-1980. Source St-Louis Federal Bank ²⁰⁸

During this period, it can be summarized as the promises to develop the economy not only with jobs, but also with faster information deliveries (delivering mails next day is often cited). Energy becomes an issue only during the last years of this period and the aviation industry is associated with technical progress. Subsidies are barely mentioned and air mobility is expected to become a significant mean of transportation for the people in the following decade. Environmental issues are only related to noise and black smoke, and these are tackled by the end of the era.

I.II.1.2. 1980-2000: Deregulation, expanding the market sphere

As concluded above, the oil shocks in the 70's changed this paradigm, and fuel costs which were non-significant in airlines operation costs starts to be considered: the gallon of jet fuel has been multiplied by 5 in 10 years, from 11.2 cents in 1969 to 57.5 cents in 1979 (yearly average).

Is the energy crisis and the rising cost of fuel a reason for deregulation? While the WEF considers that low-cost airlines have democratized air mobility since the 2000's ²⁰⁹, Nick Calio, the CEO of Airlines for America considers that it started in 1978, when President Carter signed the bipartisan Airline Deregulation Act into law ²¹⁰.

This deregulation act comes with others as highlighted by Mondou et al in Assessing the impacts of aviation liberalization on tourism ²¹¹ "Amongst neoliberal policies, privatizing firms and liberalizing markets make it possible to expand the market sphere" and this period sees the development of leisure flights which will soon significantly expand the market.

Expanding the market sphere comes with productivity and efficiency and aviation liberalization come with competition to force airlines to lower their airfares.

This period sees the introduction of high bypass ratio turbofans such as the CFM56 in the early 80's, allowing a significant reduction in fuel burn, -20% ²¹².

With more efficient aircrafts "when an airline replaces a B727-200 with a B757-200 it gains 39 seats per aircraft while fuel consumption decreases by 19.0 percent" ²¹³ and a declining cost of jet fuel over the period (FIGURE 36 below)

²⁰⁸ <https://fred.stlouisfed.org/series/WPU0572> accessed August 13, 2024

²⁰⁹ <https://www.weforum.org/agenda/2017/04/low-cost-airlines-have-democratized-travel-it-s-time-airports-did-their-part/> accessed August 13, 2024

²¹⁰ <https://www.airlines.org/nick-calio-the-democratization-of-air-travel/> accessed August 13, 2024

²¹¹ Frédéric Dobruszkes, Véronique Mondou, Aymen Ghedira, Assessing the impacts of aviation liberalisation on tourism: Some methodological considerations derived from the Moroccan and Tunisian cases, Journal of Transport Geography, Volume 50, 2016, Pages 115-127, ISSN 0966-6923, <https://doi.org/10.1016/j.jtrangeo.2015.06.022>

²¹² Saga du CFM56, public presentation by Alesi and Joyez, Arts&Métiers (s.d.), page 26 https://am.arts-et-metiers.asso.fr/manifestation_cr/cr_3728.pdf accessed August 13, 2024

²¹³ Air Transport Facts and Figures, 1997, page 6 <https://airlines.org/wp-content/uploads/2014/08/1997.pdf> accessed August 13, 2024

the sector can lower its fares and expand its market: almost non existing in the 60s, the share of pleasure / personal trips reaches 63% in 1992 (37% business trips) ²¹⁴.

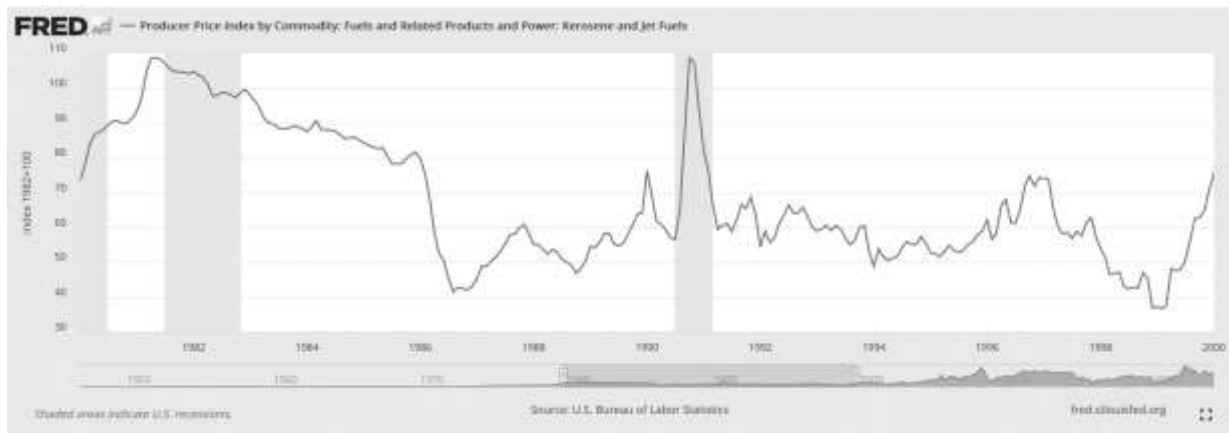

FIGURE 36 Jet Fuel producer price index (base 100 in 1982) for selected years 1980-2000. Source St-Louis Federal Bank ²¹⁵

With a lower fuel consumption (in ASK) and a lower cost of fuel, closer to 40-60 cents per gallon compared to more than 100 after the oil shocks, the ATA reports during this period do not focus anymore on the impact of fuel cost (fuel cost is no longer detailed in the operating expenses). Productivity is the focus, with detailed statistics on wages, cost of labor, passenger yields, load factor.

When looking at the numbers, FIGURE 37, both WEF and Calio are rights but one must acknowledged that expanding the market:

- Could take place when the price of fuel stabilized, and even decreased, while being counter balanced with more efficient engines and more efficient aircrafts as shown in FIGURE 33.
- Mass transportation does not mean a higher CAGR as shown in TABLE 14.

Indeed, this period sees a swift in the typology of passengers, leisure trips are now dominating, but the CAGR declines sharply, from 11.82% during the previous era to 4.93% (TABLE 14).

²¹⁴ Air Transport Facts and Figures, 1995, page 11 <https://airlines.org/wp-content/uploads/2014/08/1995.pdf>

²¹⁵ <https://fred.stlouisfed.org/series/WPU0572> accessed August 13, 2024

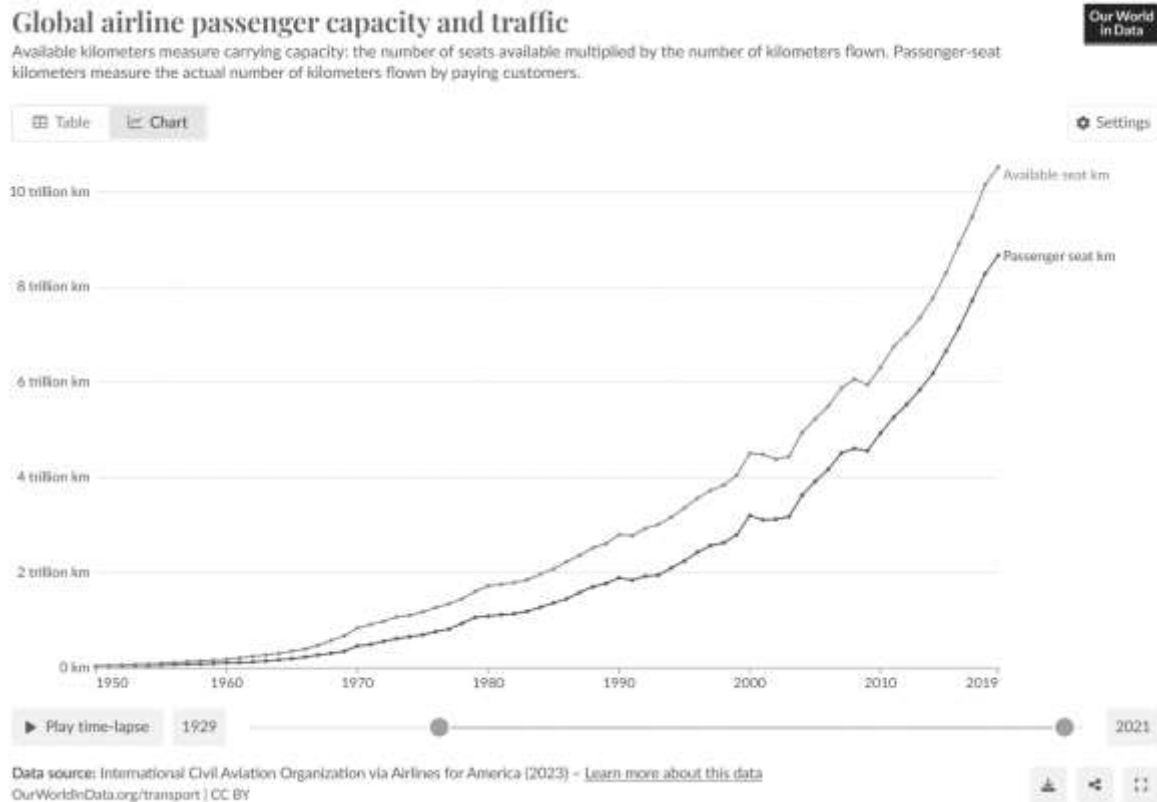

FIGURE 37 Passenger traffic in ASK and RPK (or PSK), source OWID²¹⁶

The “democratization” of air travel therefore relied on more efficient and larger aircrafts to reduce the fuel consumption along with an increase load factor and will be further detailed in chapter III.

Surprisingly the liberalization comes with less communications, and the ATA report shrinks to a dozen of pages (it was 48 pages in 1970), with less details. For instance, the fuel cost is not mentioned anymore, merged with labor and probably other costs in “flying operations”²¹⁷.

Even more surprisingly the economic downturn in the early 90’s sees the aviation industry calling for tax and regulatory relief²¹⁸. This phenomenon occurred, to a lesser extent, during the COVID crisis and one must understand that what is indeed required are direct subsidies, the tax and regulation being a trade-off.

The key indicators evolved, speed is now granted and not mentioned anymore, and focus an economic performance with ASK (in miles), Load factors, revenue per passenger mile, rate of return on investment...While a fraction of the total revenues, mail revenues are still indicated. The number of jobs, and associated compensations, are still mentioned. The airline price ticket is compared vs consumer prices and highlights the immense work realized by the aviation industry, from aircrafts manufacturers and their supply chains to airlines, airports, and traffic control. For the decade 1989-1999 while the consumer prices index increased by 35%, the airline price ticket remained almost stable (less than +5%)²¹⁹.

It is only at the end of this period, 1997, that communication improved, in a move to defy potential regulations. The ATA 1997 reports stated, front page, that aviation industry is “seeking to prevent legislative and regulatory actions

²¹⁶ <https://ourworldindata.org/grapher/airline-capacity-and-traffic?time=1960..latest> accessed August 13, 2024

²¹⁷ Air Transport Facts and Figures, 1984, page 9 <https://airlines.org/wp-content/uploads/2014/08/1984.pdf> accessed August 13, 2024

²¹⁸ Air Transport Facts and Figures, 1993, page 2 <https://airlines.org/wp-content/uploads/2014/08/1993.pdf> accessed August 13, 2024

²¹⁹ Air Transport Facts and Figures, 2000, page 5 <https://airlines.org/wp-content/uploads/2014/08/2000.pdf> accessed August 13, 2024

that would penalize airlines and their customers” or “endeavoring to reduce disproportionate share of taxes and fees paid by airlines and their passengers”²²⁰.

Environmental issues are barely mentioned, as jet fuel consumption and even cost. No mention was found until 1997 since the decline of jet fuel prices in the early 80’s. The share of fuel in airline expenses is not mentioned, but an Airbus presentation in 1998 shows a figure of 11.3%²²¹, a very close figure to the average of the previous period and most probably a relief for the industry after the 28.8% recorded in 1979 after the oil shocks. This result of 11.3% can be explained by the improvements in aircraft fuel consumption and load factors.

During this period, it appears that in exchange for entrepreneurial freedom, but above all an absence of taxes and overly restrictive regulations, air transport offers a significant economic impact via the conduct of business and consequently a productive nation as mass tourism is not yet mentioned during this period. The sector is placing itself above national considerations, successfully proposing its own objectives and regulations, notably concerning flight safety - a prerequisite for any growth in traffic.

I.II.1.3. 2000-2019 Cost & Leisure, boosting the traffic growth

The IATA (International Air Transport Association) was founded in 1945 and is the backbone of civil aviation. For this third period, the IATA annual reports, which are available from 2005, are introduced in the analysis.

From 4 500 to 10 500 billion ASK (FIGURE 37 above) means a robust CAGR of 4.57% (TABLE 14) and the pursuit of market expansion initiated in the previous period.

Lowering the airline price ticket is therefore even more important to expand the market toward leisure and personal trips, and this goes along with social acceptance.

The cost of fuel is now carefully followed by all actors, and the 2001 IATA report reflects this, highlighting that “Each one-cent increase in the price of jet fuel adds \$200 million to airline industry costs”²²². Compared to 1999 the price of Jet Fuel, average for the full year, increased to 80.6 cents per gallon compared to 53.1 cents the previous year. The IATA 2005 reports share the same conclusions, considering aviation being now a “low cost industry”²²³.

As shown in FIGURE 38 below, this price increase in jet fuel is just a start, and this period is marked not only by market expansion but also the increasing cost of energy. Environmental issues are now considered, even if social acceptance becomes an issue only at the end of the period.

²²⁰ Air Transport Facts and Figures, 1997, page 2 <https://airlines.org/wp-content/uploads/2014/08/1997.pdf> accessed August 13, 2024

²²¹ Airbus Cost Index, 1998, page 8 <https://ansperformance.eu/library/airbus-cost-index.pdf> accessed August 13, 2024

²²² Air Transport Facts and Figures, 2001, page 12 <https://airlines.org/wp-content/uploads/2014/08/2001.pdf> accessed August 13, 2024

²²³ IATA Annual Report, 2005, page 9 <https://www.iata.org/contentassets/c81222d96c9a4e0bb4ff6ced0126f0bb/annual-report-2005.pdf> accessed August 13, 2024

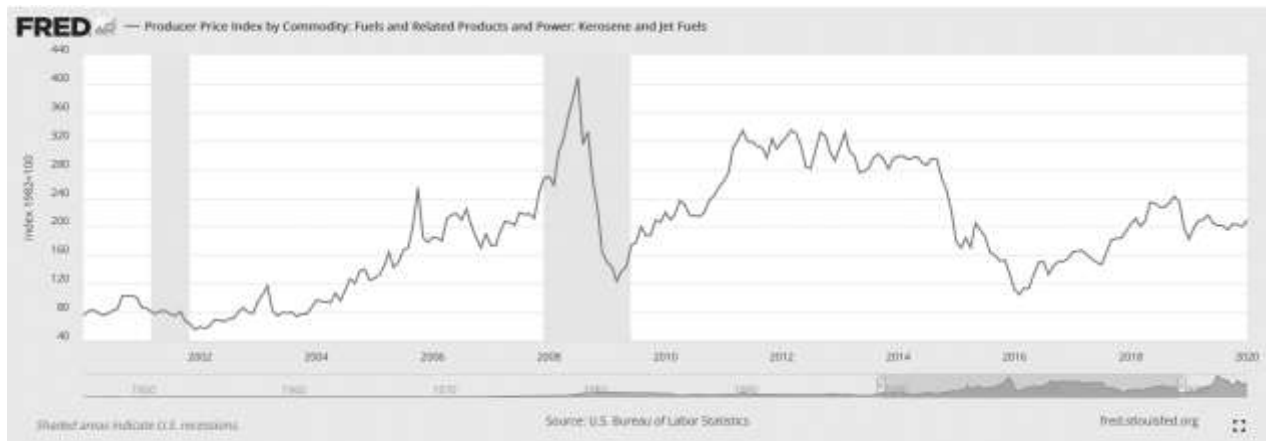

FIGURE 38 Jet Fuel producer price index (base 100 in 1982) for selected years 2000-2019. Source St-Louis Federal Bank ²²⁴

Surprisingly the communications of the aviation industry at the beginning of this period remained focus on tax and regulations despite the significant price increase of jet fuel (the ATA 2005 report that the price gallon is \$1.15 in 2004 ²²⁵). “Every day, the airline industry propels the economic takeoff of our nation” and “This situation raises the subject of those costs that are beyond airline control—specifically, aviation excise taxes and other government-imposed fees”, “Globally, airlines are responsible for US\$1.4 trillion of economic activity, including US\$0.4 trillion in direct and US\$1 trillion in indirect transactions. Yet rather than support the growth of the air transport industry as a strategic part of the economy, governments worldwide continue to saddle it with complex, costly and often unnecessary regulations” remained the main axis of communication of the aviation industry in 2005 ^{226 227} even if one could understand that the rapid increase of jet fuel cost would probably be the main reason for these losses.

For the first time GHG emissions are mentioned, but with no details and no figures, and through fuel efficiency. The environment section in the 2005 report is 1/3 of a page, mainly focusing on NOx, Noise and de-icing fluids associated water pollutions ²²⁸.

Fuel costs are getting more and more attention, with the front page in the ATA 2009 report “From \$99.64 to \$87.16 – and then from \$145.29 to \$33.87 – what a wild ride the price of a barrel of crude oil took through the course of 2008. On the way up, in just 103 days of trading on the New York Mercantile Exchange (NYMEX), the price of crude soared 67 percent (more than \$58 per barrel) to its July 3 peak, followed immediately by a precipitous 77 percent decline (more than \$111) in just 118 days of trading. That remarkable, unprecedented volatility carried through to jet fuel prices, whose daily average incredibly spanned \$2.96 per gallon, ranging from a low of \$1.26 to a high of \$4.26. The industry’s already largest cost center also became its most volatile with a 235 percent fluctuation in the span of a year” ²²⁹.

Even during the 70’s oil shocks such an introduction to oil and jet fuel costs did not occur.

The structure of the communications evolves in the late 00’s, the report being now over 30 pages. 1 full page is dedicated to fuel, 1 page to environment and 2 pages on taxes: still the aviation industry focuses on fuel burn, not GHG “Given that fuel burn, which is the source of GHG emissions, is our largest cost center – accounting for 30 to 40

²²⁴ <https://fred.stlouisfed.org/series/WPU0572> accessed August 13, 2024

²²⁵ Air Transport Facts and Figures, 2005, page 13 <https://airlines.org/wp-content/uploads/2014/08/2005.pdf> accessed August 13, 2024

²²⁶ Air Transport Facts and Figures, 2005, page 5 <https://airlines.org/wp-content/uploads/2014/08/2005.pdf> accessed August 13, 2024

²²⁷ IATA Annual Report, 2005, page 26 <https://www.iata.org/contentassets/c81222d96c9a4e0bb4ff6ced0126f0bb/annual-report-2005.pdf> accessed August 13, 2024

²²⁸ Air Transport Facts and Figures, 2005, page 10 <https://airlines.org/wp-content/uploads/2014/08/2005.pdf> accessed August 13, 2024

²²⁹ Air Transport Facts and Figures, 2008, page 5 <https://airlines.org/wp-content/uploads/2014/08/2008.pdf> accessed August 13, 2024

percent of our costs – our environmental and economic interests are perfectly aligned”²³⁰. There is nothing more wrong as fuel efficiencies are counter balanced with the market expansion as discussed in the previous chapter, as recognized indirectly within the 2005 IATA annual report “Thanks to constant improvements in fuel efficiency, of around 1.3% per year, CO₂ emissions from aviation grow at a slower rate than air traffic”²³¹.

Alternative Fuels are mentioned since 2007, with the Commercial Aviation Alternative Fuels Initiative (CAAFI), but all alternative fuels are not always sustainable. Energy security is considered, and coal to liquids and gas to liquids are part of the initiative²³². The 2007 IATA report mentions the “2020 vision”, with a commitment to an industry-wide strategy to address climate change. It focuses on fuel efficiency (technology and infrastructure enhancements), with a strong opposition to fuel taxes and a preference for emissions trading instead of taxes²³³. A significant commitment is taken: IATA has set a target for 10% of fuel to come from synthetic or biofuel sources within 10 years (2017).

With growing concerns regarding climate change, the 2010 IATA report introduces the objective of 50% less CO₂ emissions by 2050 compared to 2005. A detailed roadmap is proposed, and is summarized in FIGURE 39 below. Surprisingly, while showing higher CO₂ emissions than fossil jet fuel, gas-to-liquid are mentioned along with biofuels.

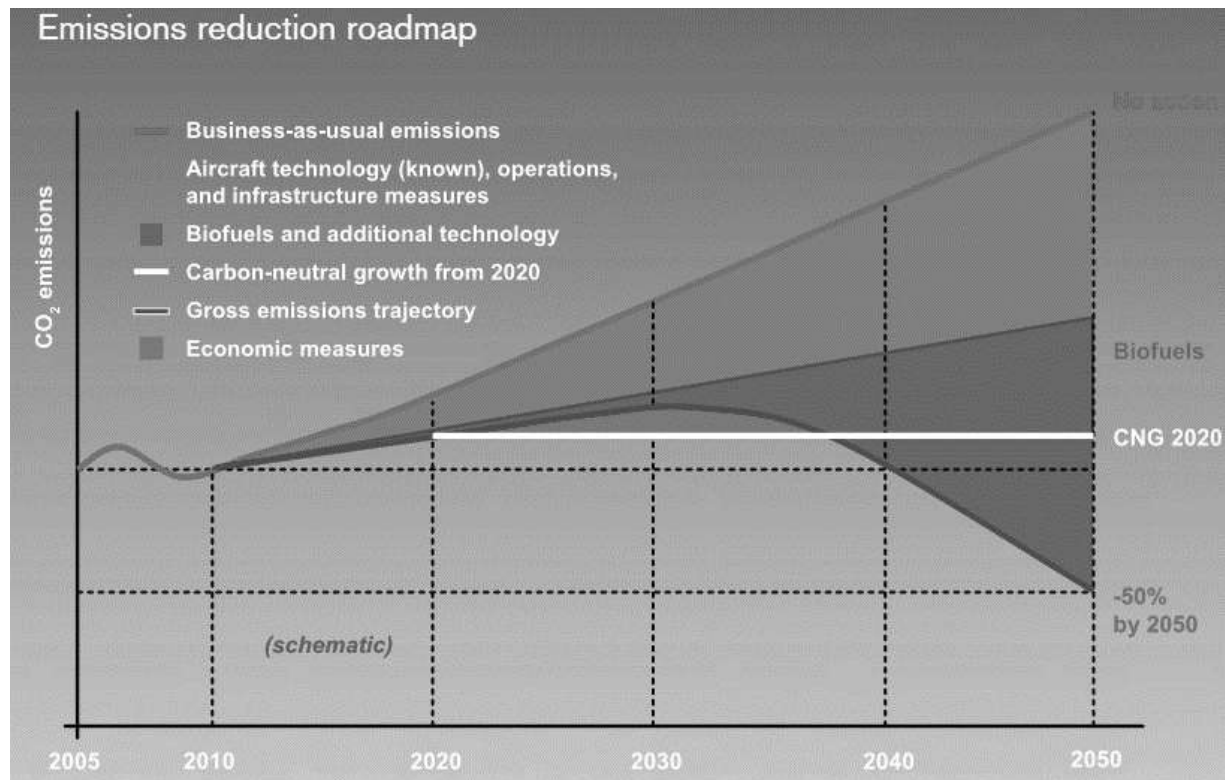

FIGURE 39 2005-2050 CO₂ Emissions reduction roadmap. IATA 2010 annual report, page 26, source IATA²³⁴

²³⁰ Air Transport Facts and Figures, 2009, page 16 <https://airlines.org/wp-content/uploads/2014/08/2009.pdf> accessed August 13, 2024

²³¹ IATA Annual Report, 2005, page 31 <https://www.iata.org/contentassets/c81222d96c9a4e0bb4ff6ced0126f0bb/annual-report-2005.pdf> accessed August 13, 2024

²³² https://www.caafi.org/focus_areas/feedstocks.html accessed August 13, 2024

²³³ IATA Annual Report, 2007, page 35 <https://www.iata.org/contentassets/c81222d96c9a4e0bb4ff6ced0126f0bb/ar2007.pdf> accessed August 13, 2024

²³⁴ IATA Annual Report, 2010, page 26 <https://www.iata.org/contentassets/c81222d96c9a4e0bb4ff6ced0126f0bb/iataannualreport2010.pdf> accessed August 13, 2024

This commitment is reinforced in the IATA 2012 report ²³⁵:

- Improve fuel efficiency an average of 1.5% annually to 2020
- Cap net carbon emissions with carbon-neutral growth from 2020
- Achieve a 50% reduction in net carbon emissions by 2050 compared with 2005

These commitments will be used as the backbone of Chapter I.III, Air Mobility GHG future scenarios.

Aside these new environmental concerns, the communication remained focus on:

- Efficiency, including jet fuel cost, counting for 23.7% of airlines operating expenses in 2019 ²³⁶
- Fighting taxes and regulations
- Promoting the economic impact of aviation, but while initially at destination of politics, it now also seeks social acceptance

The market expansion becomes a reality during this period, as the share of leisure and personal travels significantly dominates business travels which is now 12% of travelers (Fortune, Sept 15th 2023) ²³⁷.

During this period, sustainability and democratization of air travel are placed back to back, in exchange for “the business of freedom” ²³⁸, which includes the absence of taxes and overly restrictive regulations, air transport keeps offering significant economic impact via the conduct of business, the democratization of air travel, the development of international tourism, and a commitment to carbon neutral growth from 2020 accompanied with a 50% reduction in net carbon emissions by 2050 compared with 2005.

While the economic impact of aviation is not in question and the environmental commitments will be further studied in the next chapters, the democratization of air mobility must be understood.

4.5 billion passengers in 2019 ²³⁹: this figure is often evoked to suggest the democratization of air transport. However, 4.5 billion passengers should not be confused with 4.5 billion citizens who fly, and citizens can be divided into two categories: those who fly regularly, and those who never, or rarely, fly. The expectations and demands of the two groups are often orthogonal, along with the “flygskam” on the one hand, and the benefits of air transport (in terms of technological progress, bringing territories closer together or employment) on the other.

In 2019, half of the sector's global emissions comes from the main OECD countries, notably European and American travelers according to IATA (the 1st zone is Asia Pacific, which is growing, while Europe and North America are stable at around half of global air traffic). The segmentation can be further refined within each country, with travelers coming mainly from the upper classes.

In Boarding classes, Measuring the massification of air travel in France (1974-2008) ²⁴⁰, Demoli and Subtil concluded that “air travel is currently going through a quantitative democratization” (an equal increase of the chances to utilize air transport for every category) along “with a polarization among air travelers” (a multiplication of air travels rather than a multiplication of air travelers).

²³⁵ IATA Annual Report, 2012, page 32

<https://www.iata.org/contentassets/c81222d96c9a4e0bb4ff6ced0126f0bb/annual-review-2012.pdf> accessed August 13, 2024

²³⁶ <https://www.iata.org/contentassets/25e5377cf53c4e48bbaa49d252f3ab03/fact-sheet-fuel.pdf> accessed August 13, 2024

²³⁷ <https://fortune.com/2023/09/15/airline-industry-business-travel-revenues-flights-emissions-climate-change/> accessed August 13, 2024

²³⁸ IATA Annual Report 2018, page 8 <https://www.iata.org/contentassets/c81222d96c9a4e0bb4ff6ced0126f0bb/iata-annual-review-2018.pdf> accessed August 13, 2024

²³⁹ <https://www.icao.int/annual-report-2019/Pages/the-world-of-air-transport-in-2019.aspx> accessed August 13, 2024

²⁴⁰ Demoli, Y. & Subtil, J. (2019). *Boarding Classes*. Mesurer la démocratisation du transport aérien en France (1974-2008). *Sociologie*, 10, 131-151. <https://doi.org/10.3917/socio.102.0131>

It seems therefore necessary to better characterize the polarization among air travelers and the detailed quantification proposed by Ivanova & Wood in *The unequal distribution of household carbon footprints in Europe and its link to sustainability*⁹⁰ has been used here with data provided with the courtesy of the author Dr Diana Ivanova. This will be further detailed in Part III, but it is noted here, as shown in FIGURE 40 which details the eCO₂ emissions per capita within the European Union (EU) in 2018 that most of the aviation emissions are issued from the wealthiest part of the population. As one can notice the air travel emissions reported confirms the polarization among air travelers, and the conclusion below has been shared and validated by the author of the study.

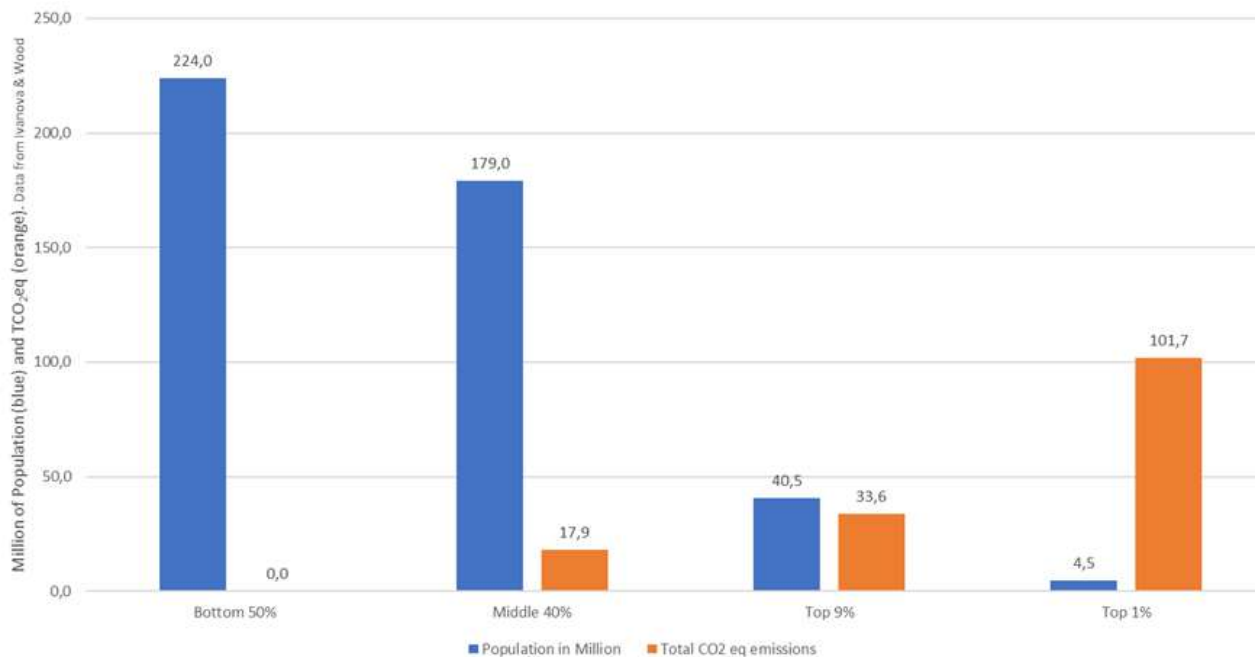

FIGURE 40 eCO₂ emissions from air mobility according to the income class within the EU population, source Jean-Baptiste Jarin with data provided by Ivanova & Wood "The unequal distribution of household carbon footprints in Europe and its link to sustainability" with courtesy of first author

Within the EU, one of the wealthiest world areas, in 2018, the top 1% of the population is responsible of 66% of the eCO₂ emissions, and the top 10% of 88%.

This conclusion is in direct contradiction with the notion democratization of air travel, and it should fuel our reflections when considering the role of energy justice within the decarbonization roadmap of air mobility (Part III).

I.II.2. Regulations

When discussing the regulations of air mobility and decarbonization, it is important to understand the special role of aviation within our societies. Since its birth aviation is seen as a “*special problem requiring special treatment*” in time of peace as of in time of war, F.D. Roosevelt, 1939²⁴¹. In the same statement, the President of the USA underlines the necessity of an economically and technically sound air transportation system. The Chicago convention, founding act of civil aviation, is built on these foundations and this can explain the role and interactions of the different stakeholders, and in particular:

- The role of ICAO and IATA whose roles are to promote and regulate air mobility in the international playing field
- The role of the governments, and particularly the European Commission, which leads the recent environmental regulations
- The role of the other stakeholders which can influence climate policies

Stakeholders can be divided into 6 main categories but air transport organizations and governments are the ones dealing with regulations:

- Air Transport organizations: ICAO, IATA, Airlines for America (formerly ATA)
- Aviation Industry: mostly airlines, but also aircraft – engine – equipment & parts manufacturers
- Governments, including the EU bodies (European Commission, European Parliament, European Council)
- Energy producers (Jet Fuel and equivalent)
- Academics (universities)
- Non-Governmental Organizations (NGOs)

The regulatory framework that set decarbonization objectives is still established by governments, but it will draw on the interactions between these stakeholders, the European Regulations being the most advanced.

On both sides of the spectrum, academics display a scientific neutrality that is nonetheless often regarded as critical by the air transport organizations and industry, as it is widely echoed by NGOs, while the industry stands united to justify the relevance of its business model for society in general, and the economy in particular (see previous chapter).

The UN SDGs provide a non-binding framework for tackling climate change (goal no. 13²⁴²). These Sustainable Development Goals give us a roadmap for achieving a better, more sustainable future for all. They respond to the global challenges we face, notably those linked to poverty, inequality, climate, environmental degradation, prosperity, peace, and justice. Very generic and ill-suited to our problems, they are nevertheless a reminder, as UN Secretary-General Antonio Guterres emphasized on November 12, 2020, as he celebrated the 5th anniversary of the Paris agreements: “The decisions we make now will determine the course of the next 30 years and beyond: emissions must fall by half by 2030 and reach net-zero emissions no later than 2050 to reach the 1.5 °C goal. Science is clear: if we fail to meet these goals, the disruption to economies, societies and people caused by COVID-19 will pale in comparison to what the climate crisis holds in store”²⁴³.

This perspective is important and should guide the decarbonization trajectories of all sectors of the economy, but particularly that of air transport. For example, the impact of Covid 19 on air traffic is far greater than on the rest of

²⁴¹ Little known facts vol.2, ATA, 1940, page 2 <https://www.airlines.org/wp-content/uploads/2014/08/1940.pdf> accessed August 13, 2024

²⁴² <https://sdgs.un.org/goals/goal13> accessed August 13, 2024

²⁴³ <https://webtv.un.org/en/asset/k18/k18ackbgsu> accessed August 13, 2024

the economy, with a drop of -85% in April 2020²⁴⁴. The negative externalities associated with climate change represent a real and serious threat to the future of air traffic. The first effects can be felt when airports are flooded, or when outside temperatures are too high for aircraft to operate, as air density decreases with altitude and rising temperature. The latter situation is becoming increasingly frequent, particularly for airports located at altitude (see chapter Part I, I.1). As populations and other industries, aviation entered a new circle and will have to minimize and adapt. Beyond objectives and good intentions, institutional bodies can set the regulatory framework within which air transport evolves.

The airline industry presents the paradox of being both highly regulated in many respects (flight safety, routes, airport zones, aircraft and engine certification, jet fuel norms.) and, in other respects, often by default, able to exempt itself or set its own rules, such as fuel taxes, VAT or CO₂ emissions. This particularity is explained by the dual nature of air transport: both national and international, which explains the important role played by ICAO, IATA and even ATA (now A4A).

As such, neither the Paris Agreement in 2015²⁴⁵ nor the Kyoto Protocol in 1997²⁴⁶ do explicitly provide provisions for the limitation of aviation eCO₂ emissions. However, the Kyoto Protocol in its article 2 tasked ICAO to prepare policy measures for the reduction of greenhouse gas emissions (GHG) from aviation. It took almost 20 years for ICAO to reach Assembly Resolution A39-3²⁴⁷ on global market-based measure, CORSIA, in 2016, and 11 more years, 2027, for this measure to enter into force.

I.II.2.1. ICAO and CORSIA

The International Civil Aviation Organization (ICAO), is the specialized agency of the United Nations responsible for coordinating and regulating international air transport. Its objectives are to develop the principles and techniques of international air navigation and to foster the planning and development of international air transport. Safety and economic development are since then the pillars of the organization, ICAO, Guiding International Civil Aviation into the 21st century, 1997, page 5²⁴⁸. The environmental issues were not within the objectives of the organization, at least regarding climate change until 2007. The 2004 ICAO annual report states, page 3, “...*determined to continue striving for optimum safety and security; the continued progressive, worldwide liberalization of air transport; a globally interoperable, harmonized and seamless air traffic management system; maximum compatibility between the safe and orderly development of civil aviation and the quality of the environment; and the further development of a unified, global legal framework*”²⁴⁹.

No specific mention of GHG emissions is mentioned in the report and one must access to the Annex 16, the dedicated ICAO annual report for emissions to understand that CO₂e emissions are yet not covered.

It is during the 36th Session of the ICAO Assembly in 2007, that contracting States adopted Assembly Resolution A36-22: Summary of ICAO's standing policy and practice in the field of environmental protection. This resolution provided for the establishment of a process leading to the development and recommendation to the Council of a program of action on International Aviation and Climate Change, and a common strategy to limit or reduce greenhouse gas emissions from international civil aviation. This resolution will lead to a 3rd volume, dedicated to eCO₂ emissions, within Annex 16.

²⁴⁴ ICAO, Effects of Novel Coronavirus (COVID-19) on Civil Aviation: Economic Impact Analysis, April 8th 2020, page 10, <https://www.icao.int/sustainability/Documents/COVID-19/ICAO%20Coronavirus%202020%2004%2008%20Econ%20Impact.pdf> accessed August 13, 2024

²⁴⁵ <https://unfccc.int/resource/docs/2015/cop21/eng/l09r01.pdf> accessed August 13, 2024

²⁴⁶ <https://unfccc.int/resource/docs/convkp/kpeng.pdf> accessed August 13, 2024

²⁴⁷ https://www.icao.int/environmental-protection/documents/resolution_a39_3.pdf accessed August 13, 2024

²⁴⁸ https://www.icao.int/Documents/strategic-objectives/sap1997_en.pdf accessed August 13, 2024

²⁴⁹ https://www.icao.int/Documents/annual-reports/rp04_en.pdf accessed August 13, 2024

Since all documents are not available on the ICAO web portal ²⁵⁰, the Swiss Federal Council web portal was used to obtain the necessary report ²⁵¹

- 1st volume is dedicated to noise, aircraft noise, 8th edition in July 2017, 260 pages ²⁵²
- 2nd volume is dedicated to aircraft engine emissions local air quality (smoke, CO, NOx, Nvp...), 4th edition in July 2017 counts 174 pages ²⁵³
- 3rd volume is dedicated to aircraft eCO₂ emissions, 1st edition in July 2017, 40 pages ²⁵⁴

This 3rd volume is seconded by CORSIA (Carbon Offsetting and Reduction Scheme for International Aviation), a global market-based measure offering an harmonized way to reduce emissions from international aviation via offsetting the emissions, resolution A41-42 ²⁵⁵. CORSIA complements the other elements of the basket of measures by offsetting the amount of CO₂ emissions that cannot be reduced using technological improvements, operational improvements, and sustainable aviation fuels with emissions units from the carbon market.

It is noted here that ICAO while clearly acknowledging the climate change effects, adaptation is seen as more important as eCO₂ emissions reduction as detailed in Annex I, pages I-64-67 ²⁵⁶, A41-21: Consolidated statement of continuing ICAO policies and practices related to environmental protection – Climate change, and A41-22: Consolidated statement of continuing ICAO policies and practices related to environmental protection – Carbon Offsetting and Reduction Scheme for International Aviation (CORSIA):

- *limit or reduce the impact of aviation greenhouse gas emissions on the global climate; and*
- *ensure future resilience of air transport by adapting its infrastructure and operations to the consequences of climate change*

while *“Urging States to refrain from environmental measures that would adversely affect the orderly and sustainable development of international civil aviation.”*

While the primacy of States in regulating transport is affirmed (article 1), what is mostly known today as the “Convention of Chicago” (since it was done in Chicago, USA, on December 7th 1944), established the basis for international cooperation and operations. As a preamble: *“Whereas the future development of international civil aviation can greatly help to create and preserve friendship and understanding among the nations and peoples of the world, yet its abuse can become a threat to the general security; and whereas it is desirable to avoid friction and to promote that cooperation between nations and peoples upon which the peace of the world depends; therefore the undersigned governments having agreed on certain principles and arrangements in order that international civil aviation may be developed in a safe and orderly manner and that international air transport services may be established on the basis of equality of opportunity and operated soundly and economically”* ²⁵⁷.

This convention, originally signed by 52 countries (Germany and Japan are logically absent), now encompasses 193 countries and establishes the principles of cooperation with defined objectives, such as flight safety (article 44),

²⁵⁰ <https://www.icao.int/environmental-protection/Pages/default.aspx> accessed August 13, 2024

²⁵¹ <https://www.bazl.admin.ch/bazl/fr/home/themen/bases-legales/annexes-a-la-convention-de-l-organisation-internationale-de-l-av.html> accessed August 13, 2024

²⁵² https://www.bazl.admin.ch/dam/bazl/fr/dokumente/Fachleute/Regulationen_und_Grundlagen/icao-annex/icao_annex_16_environmentalprotectionvolumei-aircraftnoise.pdf.download.pdf/icao_annex_16_environmentalprotectionvolumei-aircraftnoise.pdf accessed August 13, 2024

²⁵³ <https://ffac.ch/wp-content/uploads/2020/10/ICAO-Annex-16-Environmental-protection-Vol-II-Aircraft-Engine-Emissions.pdf> accessed August 13, 2024

^{254,254} https://www.bazl.admin.ch/dam/bazl/fr/dokumente/Fachleute/Regulationen_und_Grundlagen/icao-annex/icao_annex_16_environmentalprotectionvolumeiii_co2.pdf.download.pdf/icao_annex_16_environmentalprotectionvolumeiii_co2.pdf accessed August 13, 2024

²⁵⁵ https://www.icao.int/environmental-protection/CORSIA/Documents/Resolution_A41-22_CORSIA.pdf accessed August 13, 2024

²⁵⁶ https://www.icao.int/Meetings/a41/Documents/Resolutions/10184_en.pdf accessed August 13, 2024

²⁵⁷ ICAO Convention on International Civil Aviation, page 1, https://www.icao.int/publications/Documents/7300_orig.pdf accessed August 13, 2024

standardization of procedures and systems (articles 28 and 37), airworthiness (articles 31 and 41) or accident investigation management (article 26). Sometimes, there is even a degree of anticipation: pilotless aircraft (article 8) or pandemic management (article 14) are mentioned.

But the most famous article when considering decarbonization of aviation, aside the preamble which states “yet its abuse can become a threat to the general security,” is article 24²⁵⁸. This article is still often discussed by NGOs and government regarding the absence of taxes on jet fuels (excise tax nor VAT).

Article 24 is specifically about jet fuel, but about customs duties, which stipulates that fuel (among other liquids and parts) contained in an aircraft on arrival in a country shall be exempt of from custom duty, inspection fees or similar local or national duties and charges. While it is clear that the jet fuel which is still present in the aircraft after landing cannot be taxed, filling the tanks of an aircraft which then has to take off is not part of this agreement, and jet fuel could therefore be taxed.

This situation has subsequently led to numerous bilateral agreements, which ultimately result in the absence of any taxation of kerosene (apart from purely national flights, which remain the domain of the States, but few countries apply such a tax). ICAO policies on jet fuel directing countries not to impose taxes on uplift for international flights²⁵⁹ is therefore an interpretation of article 24.

The same applies to VAT, which cannot be applied (again, outside purely domestic flights: France, for example, applies a VAT rate of 10% to its domestic flights).

This situation, which can create a distortion of competition (with road transport, for example, where fuel is taxed, excise tax + VAT), is justified by the desire of nations, at the end of the Second World War, to promote international trade to ensure peace for decades to come.

The European Union, for example, has wanted to introduce a tax on aviation kerosene for several years, but has come up against lobbying from manufacturers and certain countries, mostly led by IATA (see below). In France, members of parliament who sought to bring emissions from the sector under stricter control with Bill N°3164²⁶⁰ source, aimed at introducing an individual carbon quota to limit the use of airplanes, came up against not only the economic stakes involved, but also the very applicability of the law at international level.

The same applies to CO₂ emissions. The Paris agreements (COP 21) and the regulations of the States, like those of the European Union, do not apply to emissions from air transport, which has proposed and ratified its own targets. This explains the difference in treatment between the commitments made by Europe and its member countries, and those made by the air transport industry, whether flights are domestic, within the EU, or international (TABLE 15 below).

FIGURE 41 below is from the ICAO 2016 environmental report. While the Carbon Neutral Growth from 2020 is made clear, the goal of -50% in 2050 compared to 2005 is not mentioned, see FIGURE 41 from IATA above.

²⁵⁸ ICAO Convention on International Civil Aviation, page 12, https://www.icao.int/publications/Documents/7300_orig.pdf accessed August 13, 2024

²⁵⁹ IATA annual report 2013, page 27 <https://www.iata.org/contentassets/c81222d96c9a4e0bb4ff6ced0126f0bb/iata-annual-review-2013-en.pdf> accessed August 13, 2024

²⁶⁰ [Proposition de loi n° 3164 visant à instaurer un quota carbone individuel pour limiter l'usage de l'avion \(assemblee-nationale.fr\)](https://www.assemblee-nationale.fr) accessed August 13, 2024

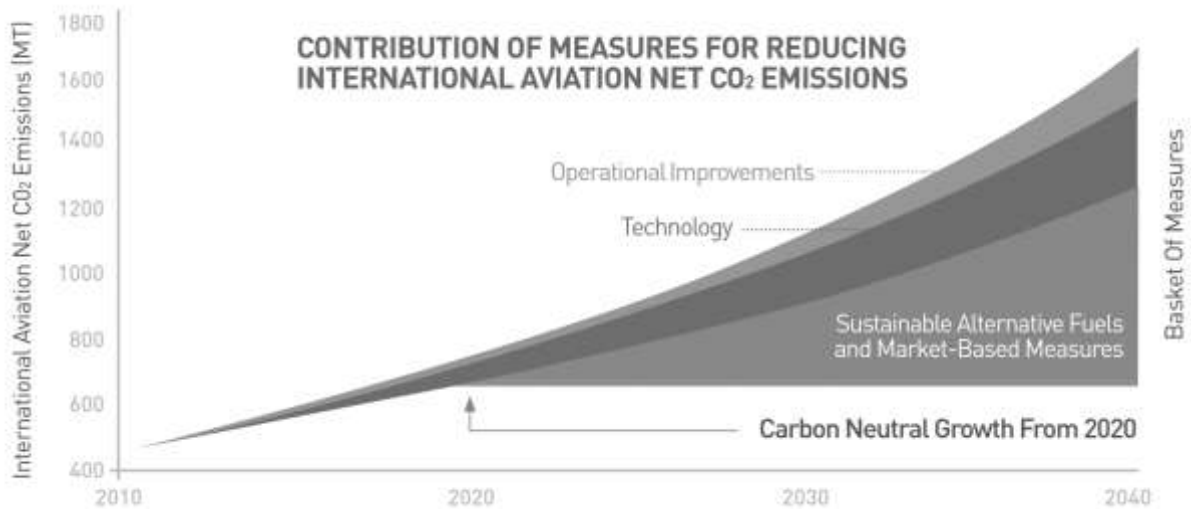

FIGURE 41 Aviation (international) CO₂e emissions: objective of Carbon Neutral Growth from ICAO, source ICAO 2016 environmental report

The details being important, only international emissions are considered (approximately 2/3 of aviation emissions).

While the EU is leading by example with objectives for 2020, 2030 and 2050 in line with the COP21 objectives, the ICAO strives to propose not only objectives which are compliant with the COP21 objectives and the UN SDGs, but still fails to propose a credible path. In adopting a new ICAO global framework for sustainable aviation fuels (SAF), lower carbon fuels (LCAF) and other cleaner energies for aviation on November 24th 2023, ICAO and its Member States claim to “have agreed to strive towards an ambitious global and collective vision for the reduction of CO₂ emissions in international aviation by 5% by 2030, compared to zero use of cleaner energy”²⁶¹. This assertion is highly questionable, as not only is the reference vague "compared to zero use of cleaner energy", but it also directly contradicts the previous commitment to peak CO₂ emissions by 2020, as shown in FIGURE 41 above, 2016 ICAO Environmental Report page 2²⁶².

This will be further analyzed in chapter III.3, but the latest assertion dated November 24th 2023 could mean that the aviation CO₂e emissions will keep rising along with traffic growth since in 2024 passengers air traffic already surpasses 2019 level²⁶³. ICAO commitments related to international aviation eCO₂ emissions objectives for 2050 are far from the NDC's of most countries. When compared with the European Union objectives, the gap is significant as shown in TABLE 15 below.

- The EU objective for 2020 were set out in the climate and energy package adopted in 2008 with a 20% cut in GHG emissions compared to 1990. It is estimated that EU emissions in 2020 were 31% lower than in 1990²⁶⁴. For 2030 the objective is -55% compared to 1990 while the goal being carbon neutral by 2050²⁶⁵. These objectives are passed into the law.

²⁶¹ <https://www.icao.int/Newsroom/Pages/ICAO-Conference-delivers-strong-global-framework-to-implement-a-clean-energy-transition-for-international-aviation.aspx> accessed August 13, 2024

²⁶² https://www.icao.int/environmental-protection/Documents/ICAOEnvironmental_Brochure-1UP_Final.pdf accessed August 13, 2024

²⁶³ <https://www.icao.int/Newsroom/Pages/Passenger-air-traffic-surpasses-pre-pandemic-levels.aspx> accessed August 13, 2024

²⁶⁴ <https://www.eumonitor.eu/9353000/1/j9vvik7m1c3gyxp/vkpxmuhpwlvh?ctx=vhurdyxqxfmg> accessed August 13, 2024

²⁶⁵ https://climate.ec.europa.eu/eu-action/european-climate-law_en accessed August 13, 2024

- ICAO objectives are Carbon Neutral Growth after 2020, -5% in 2030 compared to zero use of cleaner energy, net 0 by 2050 ²⁶⁶. These objectives are “long term aspirational goal” and only concern international aviation. Carbon dioxide emissions from domestic air operations are covered under States’ Paris Agreement commitments (NDC).

	European Union	ICAO
2020	Compared to 1990: -20%	None
2030	Compared to 1990: -55%	Carbon Neutral Growth starting 2020
2050	Carbon Neutral	Net 0

TABLE 15 Comparing European Union global eCO₂ emissions reduction objectives with ICAO objectives for aviation, source Jean-Baptiste Jarin with data from ICAO and EU

Since ICAO considers only international aviation which represents 65% of total aviation eCO₂ emissions, one can assume that the 1990 level was 65% of 740.3 Mt eCO₂, FIGURE 19, or 481 Mt.

In 2019 the total aviation eCO₂ emissions reached 1396 Mt (FIGURE 19). With the hypothesis that the share of international aviation vs domestic remained 65%, this leads to 907 Mt eCO₂, or +88%.

I.II.2.2. IATA

The International Air Transport Association (IATA) is major stakeholder even if not a regulatory body. Its mission is to represent, lead and serve the airline industry ²⁶⁷. Founded in 1945, a year later than ICAO, IATA is active in 124 countries (193 for ICAO). Not all countries, and not all airlines, belong to IATA.

As an association representing an industry (airlines), the core mission of IATA is advocacy and it has a significant voice during regulations discussions.

The position of IATA regarding aviation eCO₂ emissions is made clear in 2004 ²⁶⁸ and has not evolved since:

- Aviation is delivering results long before the Kyoto protocol, reducing emissions per passenger kilometer 70% (as detailed in the next chapters this is in contradiction with the overall emissions)
- We must support ICAO's mission to study and report on economic measures related to the environment, including emissions trading
- Governments, in turn, must not levy additional taxes and charges that limit our ability to invest in new environment-related technology.

These positions are fiercely defended:

²⁶⁶ <https://www.icao.int/Newsroom/Pages/States-adopts-netzero-2050-aspirational-goal-for-international-flight-operations.aspx> accessed August 13, 2024

²⁶⁷ <https://www.iata.org/en/iata-repository/pressroom/fact-sheets/fact-sheet---iata/> accessed August 13, 2024

²⁶⁸ IATA 2004 annual report, page 28, <https://www.iata.org/contentassets/c81222d96c9a4e0bb4ff6ced0126f0bb/annual-report-2005.pdf> accessed August 13, 2024

- *“Airlines are often plagued by (governmental) regulation that is not necessary, is poorly conceived, and is badly executed. Governments must be held accountable by both the industry and its consumers”* ²⁶⁹ .
- *“IATA secured tax savings for the industry of \$1.4 billion, in 2008”* ²⁷⁰
- *“Governments underestimate, overtax, and misregulate aviation”* ²⁷¹
- *“Where existing or new taxes threaten this mutually beneficial balance, the industry looks to convince governments to change course”* ²⁷²

Still, IATA has committed in December 2006 to an industry-wide strategy to address climate change. This 4-point strategy focuses on technology, infrastructure enhancements, opposition to fuel taxes, and a preference for emissions trading instead of taxes. Alternative fuels (SAF but also synthetic fuels from gas-to-liquid are later cited) are considered within the technology pillar, and IATA has set a target for 10% of fuel to come from synthetic or biofuel sources by 2017.

In June 2009, IATA underlined this commitment by adopting three sequential goals ²⁷³:

- Further improve fuel efficiency an average of 1.5% annually by 2020
- Cap net carbon emissions with carbon-neutral growth from 2020
- Achieve a 50% reduction in net CO₂ emissions by 2050 compared with 2005

In 2012 biofuels (SAF issued from the biomass) are seen as the main lever for reaching the 2050 objective of a 50% reduction in net CO₂ emissions by 2050 compared with 2005 ²⁷⁴. This same year IATA is reinforcing its communication in aviation’s role in the environmental debate in supporting the Air Transport Action Group (ATAG), a pan-industry body for promoting aviation’s role in sustainable development.

Still, claiming that *“No other industry has agreed to such ambitious global goals”* ²⁷⁵ seems inappropriate when the European Union global GHG emissions objective for 2030 is -55% compared to 1990, TABLE 16 below.

²⁶⁹ IATA 2007 annual report, page 30 <https://www.iata.org/contentassets/c81222d96c9a4e0bb4ff6ced0126f0bb/ar2007.pdf> accessed August 13, 2024

²⁷⁰ IATA 2009 annual report, page 31 <https://www.iata.org/contentassets/c81222d96c9a4e0bb4ff6ced0126f0bb/iataannualreport2009.pdf> accessed August 13, 2024

²⁷¹ IATA 2011 annual report, page 24 <https://www.iata.org/contentassets/c81222d96c9a4e0bb4ff6ced0126f0bb/annual-report-2011.pdf> accessed August 13, 2024

²⁷² IATA 2016 annual report, page 29 <https://www.iata.org/contentassets/c81222d96c9a4e0bb4ff6ced0126f0bb/iata-annual-review-2016.pdf> accessed August 13, 2024

²⁷³ IATA 2010 annual report, page 26 <https://www.iata.org/contentassets/c81222d96c9a4e0bb4ff6ced0126f0bb/iataannualreport2010.pdf> accessed August 13, 2024

²⁷⁴ IATA 2012 annual report, page 33 <https://www.iata.org/contentassets/c81222d96c9a4e0bb4ff6ced0126f0bb/annual-review-2012.pdf> accessed August 13, 2024

²⁷⁵ IATA 2013 annual report, page 34 <https://www.iata.org/contentassets/c81222d96c9a4e0bb4ff6ced0126f0bb/iata-annual-review-2013-en.pdf> accessed August 13, 2024

	Objectives	
	European Union	IATA
2020	Compared to 1990: -20%	None
2030	Compared to 1990: -55%	Carbon Neutral Growth starting 2020
2050	Carbon Neutral	Compared to 2005: -50%

TABLE 16 Comparing European Union global eCO₂ emissions reduction objectives with IATA objectives for aviation, source Jean-Baptiste Jarin with data from IATA and EU

The 2018 IATA annual report page 42-43 ²⁷⁶, is key for two reasons:

- IATA acknowledge, and regret, the decision of some countries to go beyond CORSIA, “Support for CORSIA is unfortunately undermined by the decisions of some governments to use carbon pricing to justify levies on air transport”
- IATA indirectly acknowledge that it significantly missed its first objective in reducing eCO₂ emissions. In 2007 IATA committed to 10% of SAF by 2017 ²⁷⁷. In the 2018 annual report page 43 it highlights that the SAF production was 12 million liters, or 9 600 tons. Since the total jet fuel production in 2017 is 315.2 million tons ²⁷⁸, the result is very far from the objective: 0.003% vs 10%.

While these 2 events are most probably not directly connected, the growing aviation CO₂ emissions since the Kyoto Protocol (1997) which tasked ICAO to prepare policy measures for reducing these emissions and the realization that aviation was far from succeeding in introducing SAF to the extent of its own commitments most probably prompted the EU to pursue its own regulations for aviation beyond the EU-ETS.

I.II.2.3. CORSIA and the new leading role of the European Union

As highlighted in TABLE 15 and TABLE 16 above, the EU is committed to deliver, by law, in reducing its eCO₂ emissions. With significant results achieved by 2022 (-32.5% vs an objective of -20% compared to 1990) ²⁷⁹ the gap with aviation is wide and keeps widening. It took 19 years (1997-2016) for ICAO with the support of IATA to propose objectives which are either not met (10% SAF in aviation by 2017), will most probably not be met in the near future (Carbon Neutral Growth by 2020) and are long term aspirational goal in the long term.

²⁷⁶ IATA 2018 annual report, page 42 and 43

<https://www.iata.org/contentassets/c81222d96c9a4e0bb4ff6ced0126f0bb/iata-annual-review-2018.pdf> accessed August 13, 2024

²⁷⁷ IATA 2007 annual report, page 3

<https://www.iata.org/contentassets/c81222d96c9a4e0bb4ff6ced0126f0bb/ar2007.pdf> accessed August 13, 2024

²⁷⁸ UN Energy Statistics Yearbook 2018, page 250

<https://unstats.un.org/unsd/energystats/pubs/yearbook/documents/2018eyb.pdf> accessed August 13, 2024

²⁷⁹ https://climate.ec.europa.eu/eu-action/climate-strategies-targets/progress-climate-action_en accessed August 13, 2024

Reacting to the slow progress at ICAO and IATA levels, the EU introduced the EU ETS for aviation, a market-based measure regulating CO₂ emissions, in 2012²⁸⁰. The initial legal frameworks for the EU ETS for aviation is the EU Directives 2008/101/EC²⁸¹, therefore well before the implementation of CORSIA by ICAO as detailed above (2016). Not only the timing of CORSIA is found not adequate with the emergency of tackling change, its objectives are found not sufficient. The IATA 2019 annual report, page 39, highlights that the implementation of CORSIA “will mitigate around 2.5 bn metric tons of CO₂” for the period 2021-2035 and “generate over 40 bn in climate finance”²⁸². These assumptions are in line with the CORSIA guidelines (offsetting international CO₂ emissions which are above the 2019 level for voluntary airlines only until 2027) but these figures must be set against the sector's emissions (1.4 bn metric tons of eCO₂ in 2019), i.e. between 1 and 2% of annual emissions, and against the cost of offset, which over a 15-year period with 4% inflation would come to €12 per ton CE 2021. Over the period 2022-2025 the EU-ETS is close to 84 € / ton²⁸³, a seven-fold difference.

The difference between EU-ETS and CORSIA is also based on their purpose: EU-ETS is a carbon tax, whereas CORSIA proposes an offset principle. The very principle of offsets, whether transfers to other sectors easier to decarbonize, or the financing of carbon sinks, is often called into question by academics as highlighted by Becken and Mackey in *What role for offsetting aviation greenhouse gas emissions in a deep-cut carbon world? “Current growth and uncertainty around offsets make absolute reductions necessary”*²⁸⁴ and NGOs such as T&E's which disclosed as soon as 2019 “*why ICAO and CORSIA cannot deliver on climate*”²⁸⁵.

Part of the Fit-for-55 package there are 14 legislative instruments to reduce the GHG by 55% in 2030 compared to 1990 and reach climate neutrality by 2050. EU-ETS is one of the regulations adopted by the EU, and it includes aviation to ensure the sector will reduce its eCO₂ emissions. While the Energy Taxation Directive is not yet finalized (it could include jet fuel), the EU adopted the Renewable Energy Directive (RED) and more recently the ReFuel EU Aviation. Those two regulations work hand in hand, ReFuel EU aviation setting the pace of SAF incorporation through mandates in % (see below) and RED defining emissions and setting the rules of the eligible inputs.

While other regulations indirectly concern aviation, such as CBAM, these two regulations set the pace of the decarbonization within the European Union but not only as several other areas are currently evaluating the adoption of similar regulations such as UK²⁸⁶, China²⁸⁷ or Singapore²⁸⁸.

SAF being tested for 2 decades but still non adopted by aviation in 2022 (less than 0.1% in 2022 according to the latest figure published by IATA²⁸⁹: 300 million liters produced in 2022 being equivalent to 240.000 metric tons), it was found that the chicken and egg dilemma could only be tackled by regulation, namely SAF incorporation mandate, since for years airlines were arguing that the cost of SAF proposed by producers is too high for being massively implemented and the energy producers responding that SAF are indeed expensive and that the lack of volume was not in favor of decreasing the cost of SAF. This dilemma being fueled by consulting firms such as McKinsey which stated that SAF

²⁸⁰ Holly Preston, David S. Lee, Paul D. Hooper, The inclusion of the aviation sector within the European Union's Emissions Trading Scheme: What are the prospects for a more sustainable aviation industry?, *Environmental Development*, Volume 2, 2012, Pages 48-56, ISSN 2211-4645, <https://doi.org/10.1016/j.envdev.2012.03.008>

²⁸¹ <https://eur-lex.europa.eu/legal-content/FR/TXT/?uri=CELEX%3A32008L0101> accessed August 13, 2024

²⁸² IATA 2019 annual report, page 39 <https://www.iata.org/contentassets/c81222d96c9a4e0bb4ff6ced0126f0bb/iata-annual-review-2019.pdf> accessed August 13, 2024

²⁸³ <https://www.statista.com/statistics/1334906/average-carbon-price-projections-worldwide-by-region/> accessed August 13, 2024

²⁸⁴ Susanne Becken, Brendan Mackey, What role for offsetting aviation greenhouse gas emissions in a deep-cut carbon world?, *Journal of Air Transport Management*, Volume 63, 2017, Pages 71-83, ISSN 0969-6997, <https://doi.org/10.1016/j.jairtraman.2017.05.009>

²⁸⁵ [Why ICAO and Corsia cannot deliver on climate | Transport & Environment](#) accessed August 13, 2024

²⁸⁶ <https://www.gov.uk/government/news/aviation-fuel-plan-supports-growth-of-british-aviation-sector> accessed August 13, 2024

²⁸⁷ <https://www.reuters.com/sustainability/climate-energy/chinese-firms-invest-green-jet-fuel-anticipating-blending-rule-2024-05-16/> accessed August 13, 2024

²⁸⁸ <https://www.reuters.com/sustainability/singapore-require-departing-flights-use-sustainable-fuel-2026-2024-02-19/> accessed August 13, 2024

²⁸⁹ <https://www.iata.org/en/iata-repository/pressroom/fact-sheets/fact-sheet---alternative-fuels/> accessed August 13, 2024

prices would drop significantly by 2025 and reach parity with CAF (Conventional Aviation Fuel: fossil jet fuel) by 2035²⁹⁰. This will be detailed in Part II, but by its very nature (manufacturing an energy carrier is energy intensive) SAF are and most probably will remain significantly more expensive than CAF.

ReFuel EU Aviation: introducing the SAF mandate of incorporation to tackle the chicken & egg dilemma.

Promulgated in October 2023, regulation 2023/2405²⁹¹ is the latest tool in the EU's implementation of its renewable energy and decarbonization policy. This regulation completes the RED (see below), which established general rules on renewable energy for the transport sector, but no aviation specific measures. In 2021, the EU's Fit-for-55 package foreshadowed the ReFuel EU Aviation initiative, which would require aviation fuel suppliers to blend increasing levels of SAF into the conventional jet fuel used on board aircraft at EU airports, % are detailed in TABLE 17 below. The regulation, which is the result of this initiative, applies to aircraft operators, EU airports and aviation fuel suppliers. All parties (fuel suppliers, airports, airlines) are therefore now subject to the regulation's declaration regime, and to the associated penalties if objectives are not met.

	2025	2030	2032	2035	2040	2045	2050
SAF	2%	6%		20%	34%	42%	70%
of which eFuels		1,2%*	2%*	5%	10%	15%	35%
* average share of 1.2% for the period 2030-2031 and 2% for the period 2032-2034							

TABLE 17 ReFuel EU mandatory shares of sustainable aviation fuels (SAFs), data from EU

SAF include synthetic aviation fuels, aviation biofuels which include advanced biofuels and recycled carbon-based aviation fuels. Essentially, all types of SAF must meet the lifecycle emission reduction criteria set out in RED III (see below).

From 2025, aviation fuel suppliers must ensure that all fuel made available to aircraft operators at EU airports contains a minimum share of SAF and a minimum sub-share of synthetic aviation fuels from 2030, increasing over time. The rationale behind the minimum share of synthetic aviation fuels is that minimum thresholds will facilitate their scale-up and could ultimately reduce production costs. In addition, certain biofuels produced from feedstocks in competition with other industries cannot contribute more than 3% to meeting the minimum SAF shares, and there is a five-year transition period during which aviation fuel suppliers can provide the minimum SAF share as an average over all the aviation fuel they have supplied to EU airports during this reporting period. A book and claim is therefore possible during this period.

Aircraft operators must ensure that the annual quantity of aviation fuel, taken on board at a given EU airport, corresponds to at least 90% of their annual aviation fuel requirements. This provision is important as it is designed to avoid tankering, a common practice for airlines as highlighted in Eurocontrol ThinkPaper#1 in June 2019²⁹², and prevent them from refueling at airports with cheaper fuel (which means carrying unnecessary extra fuel, leading higher fuel consumption and therefore eCO₂ emissions). Airlines use software to calculate the differential of kerosene they can take on board over and above what is strictly necessary for the flight to be completed, to avoid having to refuel at the destination airport if the price of Jet Fuel were higher there. The principle is based on the Jet Fuel price differential that can exist between 2 airports, particularly for short and medium-haul aircraft whose fuel tanks are often far too large for the mission in hand. The software precisely calculates the profitability of the additional fuel that can be taken on board while remaining profitable (since each kg taken on board has an energy cost, and therefore a price). Financially attractive, it is a practice that runs directly counter to a reduction in eCO₂ emissions, and does a disservice to the image of air transport. According to the Eurocontrol study cited above, the practice remains

²⁹⁰ Mc Kinsey, How airlines can chart a path to zero-carbon flying, exhibit 3 page 8

<https://www.mckinsey.com/~media/McKinsey/Industries/Travel%20Transport%20and%20Logistics/Our%20Insights/How%20airlines%20can%20chart%20a%20path%20to%20zero%20carbon%20flying/How-airlines-can-chart-a-path-to-zero-carbon-flying.pdf> accessed August 13, 2024

²⁹¹ <https://eur-lex.europa.eu/eli/reg/2023/2405/oj> accessed August 13, 2024

²⁹² <https://www.eurocontrol.int/publication/fuel-tankering-european-skies-economic-benefits-and-environmental-impact> accessed August 13, 2024

widespread and it recommended a significant increase in the price per ton of eCO₂. With ReFuel EU and EU-ETS in place, this practice shall soon disappear.

Aircraft operators are not entitled to declare the use of SAF under more than one greenhouse scheme. However, aircraft operators are incentivized to use SAF under the EU ETS, as all quantities of SAF used that are certified as compliant with the RED will be assigned zero emissions under the EU scheme. This also allows aircraft operators to retain their emission allowances when using SAF instead of fossil fuels, although the phase-out of free emission allowances for the aviation sector is due to come into force in 2026.

EU member states have drawn up rules on penalties for aircraft operators and aviation fuel suppliers in the event of failure to meet their obligations under the regulation. Fines for EU airport is still to be defined and structured by EU member states. Fines must be proportionate and dissuasive, and must not be less than twice the price difference between conventional fuel and the applicable type of aviation fuel, multiplied by the missing quantity. As such the minimum fines for fuel suppliers is twice the difference between SAF and CAF prices multiplied by the quantity of aviation fuel not complying with the quota. For the airlines the minimum fine is twice the yearly average price of aviation fuel per ton multiplied by the yearly non tanked quantity. Penalties sample calculation is provided in TABLE 18 below.

	Fuel Suppliers	Airlines
Hypothesis CAF & SAF prices in € / ton as of Jan 2023	€ / ton	
CAF Price https://jet-a1-fuel.com/average/2023	1100	
SAF Price https://www.argusmedia.com/en/news-and-insights/latest-market-news/2413894-sustainable-aviation-fuel-premium-holds-steady	3000	
Average Price of aviation fuel (here calculated with 2035 blend ratio of 20% SAF and 80% CAF)		1480
Minimum Fine	3800	2960

TABLE 18 Sample calculation of penalties for fuel producers and airlines in 2035 (20% blend ratio), source Jean-Baptiste Jarin with hypothesis of CAF from jet-a1-fuel ²⁹³ and SAF from Argus ²⁹⁴

RED: not only aviation is looking after renewable and low carbon fuels (RLCF) and the introduction of SAF into the world of air transport must be accompanied by a new regulatory framework. This regulatory framework shall go far beyond the issues at stake in the sector, especially as alternative sustainable fuels are already regulated in many countries, often following the introduction of biofuels into land transport some twenty years ago.

²⁹³ <https://jet-a1-fuel.com/average/2023> accessed August 13, 2024

²⁹⁴ <https://www.argusmedia.com/en/news-and-insights/latest-market-news/2413894-sustainable-aviation-fuel-premium-holds-steady> accessed August 13, 2024

This is the case of the European Union, which established a regulatory framework as early as 2009, with its RED (Renewable Energy Directive) ²⁹⁵ on renewable energies, particularly in road transport.

In December 2018, the revised renewable energy directive 2018/2001/EU entered into force ²⁹⁶ and the third revision on November 20th 2023 ²⁹⁷.

This directive contains a large number of provisions - definitions, objectives, procedural rules - which it is essential to understand when considering SAF even if renewable fuels are only a part of this directive. Some of the main cross-cutting provisions of this important new directive include the modification and creation of numerous definitions such as innovative renewable energy technology or renewable fuels, the increase of the share of renewable energies in the EU's gross final consumption of electricity, the creation of a target for the share of innovative technologies, the encouragement of the use of renewable energy purchase agreements. While not directly connected to SAF, these latter modifications are important when considering the production of efuels which will be further discussed in parts II & III with the creation of a legal incentive framework for the production and consumption of renewable fuels.

RED III directive amends the directive (EU) 2018/2001 of December 11, 2018 on the promotion of the use of energy from renewable sources the regulation (EU) 2018/1999 of the European Parliament and of the Council of December 11, 2018 on the governance of the energy union and climate action, the directive 98/70/EC of the European Parliament and of the Council of 13 October 1998 relating to the quality of petrol and diesel fuels.

This directive strengthened the sustainability and GHG emission reduction requirements for alternative fuels, following feedback that has not always been positive, particularly for 1st-generation biomass SAF. In particular, options concerning land use (direct and indirect) and the percentage improvement (65% when issued from the biomass and 70% when issued from electricity) to be achieved in comparison with CAF eCO₂ emissions is now specified. There is here once again a significant gap with CORSIA, the system proposed by the air transport industry, which is limited to a 10% improvement in eCO₂ emissions.

Strict sustainability criteria are also set: monitoring soil quality, preserving biodiversity-rich land, land with a high carbon stock or peat bogs, sustainable forest management. These important criteria (see chapter I, Beyond GHG) will have a direct impact on the quantity of biomass available for SAF (further discussed in part II), with the first effect being the scheduled end of 1st generation biofuels which competed directly with food, as well as on biomass prices. This will have an impact on operating costs (OPEX) of SAF production (further discussed in part III).

On GHG reduction: emission reduction levels defined according to plant commissioning dates, calculated on a lifecycle basis and in relation to a reference fossil fuel (CAF); non-biological renewable transport fuels (typically efuels) are also subject to GHG reduction requirements, -70% compared to CAF; energy efficiency requirements for biomass power generation plants are also introduced. This has a direct impact on production costs, particularly capital expenditure (CAPEX) and will be further discussed in part II.

Finally, another framework is now being imposed as within the EU, the corporate sustainability reporting directive (CSRD) requires large companies to publish regular reports on the social and environmental risks they face, and on how their activities impact people and the environment (see chapter I.3 above). This includes most airlines but also aerospace companies, to disclose the environmental consequences of their activities and decisions. This could expose companies whose CO₂ emissions remain stable or increase to legal action. More and more class action suits are being brought, both against industrial sectors and governments (as in the case of the "affaire du siècle" in France), and such a situation cannot be ruled out in the years to come. This must be factored into risk analyses, especially as the courts seem to be more sensitive to the obligation to achieve results than to the obligation of means as concluded by the

²⁹⁵ [Directive 2009/28/EC of the European Parliament and of the Council of 23 April 2009 on the promotion of the use of energy from renewable sources and amending and subsequently repealing Directives 2001/77/EC and 2003/30/EC \(europa.eu\)](#) accessed August 13, 2024

²⁹⁶ https://eur-lex.europa.eu/legal-content/EN/TXT/?uri=uriserv:OJ.L_.2018.328.01.0082.01.ENG&toc=OJ:L:2018:328:TOC accessed August 13, 2024

²⁹⁷ <https://eur-lex.europa.eu/legal-content/EN/TXT/?uri=CELEX%3A32023L2413&qid=1699364355105> accessed August 13, 2024

district court of The Hague, Netherlands, in *Milieudefensie et al versus Royal Dutch Shell plc* ²⁹⁸. Filed in 2019, the environmental group Milieudefensie and co-plaintiffs are asking Shell to reduce its CO₂ emissions by 45% by 2030 compared to 2010 levels and to zero by 2050, in line with the Paris Climate Agreement. On May 26th 2021 the Court concluded that Royal Dutch Shell must reduce its Scope 1, 2, and 3 emissions, across its entire energy portfolio, by 45% by 2030, relative to 2019 emission levels. Royal Dutch Shell appealed the decision, arguing that *"a civilian judge simply is not equipped to make rulings in a civil case which has national and political implications"* and *"if this judgement is upheld, it will have far-reaching consequences for Dutch business, employment and the Dutch investment climate"* ²⁹⁹. This last argument is indeed very similar to the ones promoted by ATA and IATA when considering regulation, taxes and penalties (chapter II.1 above).

With emissions on the rise in a world seeking to reduce them, it is hardly surprising that NGOs and a number of consultancies specializing in energy transition are keeping a close eye on the air transport sector. Their studies are often based on scientific publications from the academic world. Most NGOs share the same vision: technology will not be sufficient to decrease the CO₂ emissions. This is also one the conclusion of this thesis.

²⁹⁸ <https://climatecasechart.com/non-us-case/milieudefensie-et-al-v-royal-dutch-shell-plc/> accessed August 13, 2024

²⁹⁹ <https://www.france24.com/en/europe/20240402-shell-appeals-against-dutch-court-s-landmark-climate-ruling> accessed August 13, 2024



I.III. Air Mobility GHG future scenarios

Until now, the figures associated with eCO₂ emissions from air transport have been presented in very different ways by different stakeholders. The differences in total emissions are significant (chapters I.I.1 and I.I.2 above), but above all, while NGOs and to some extent governments only account for and communicate total eCO₂ emissions, the air transport industry systematically highlights emissions per passenger, most often expressed in eCO₂/rpk (fuel consumption per passenger kilometer).

This difference in approach can probably be explained by the choice to minimize the sector's emissions and highlight the progress made in reducing fuel consumption which, as discussed in previous chapters, is by far the sector's 1st contributor to eCO₂ emissions.

As we saw earlier, fuel consumption was not an issue for the aviation sector until the oil shocks, as demonstrated by the decision to switch from propeller engines to jet engines, which increased speed but led to a 3-fold increase in fuel consumption. With the rise in jet fuel prices, fuel consumption has become a matter of concern for the aviation industry, but the subject remains, until today, purely economic for airlines and technological for aircraft and engine manufacturers. Since the birth of aviation, and except during major crisis, customer demand increased faster than fuel efficiency.

Therefore, potential levers are identified first and foremost by the industry itself. These are exclusively technological levers: aircraft efficiency, operational efficiency, and more recently a lower carbonized energy with the introduction of SAF and hydrogen or electric aircrafts. This will be addressed in the role of technologies Chapter in which SAF will have a dedicated section before being further detailed in Part II.

The other levers can be considered as sobriety of use. This includes reducing air traffic, whether through prices and/or taxes, or an individual quota, but also modal shift and reducing speed as flying slower mobilizes less energy, thus consuming less jet fuel, thus emitting less eCO₂ while avoiding contrails issues. This will be addressed in the sobriety of use Chapter.

Once these levers have been learned, it is possible to evaluate and propose different eCO₂ emission scenarios, which is addressed in sub-chapter III.3, proposed scenarios.

This approach is considered as necessary since aviation is dominated by a customer demand which increases faster than fuel efficiency since its early development.

I.III.1. Role of technologies

Technologies embraces various fields such as propulsion system efficiency to reduce engines specific fuel combustion, by far the main lever, aircraft efficiency to reduce weight and drag, load factor to decrease empty seats on board or air traffic management to reduce ground and flight times to cite the most important ones. More recently the decarbonization of energy with the use of Sustainable Aviation Fuels (SAF) have been introduced. The role and effects of these technologies are detailed below in 3 sections, Propulsion systems and aircraft efficiency, operational efficiency and a proposed synthesis and way forward as it is important to quantify the gains and limits of these technologies before introducing the role SAF in the future.

I.III.1.1. Propulsion systems and aircraft efficiency

This has been the driving force behind air transport, with a marked reduction in aircraft fuel consumption since the jet age. Engine manufacturers have been competing for decades, with SFC (Specific Fuel Consumption: fuel consumption per unit of thrust) at the heart of the battle since the oil shocks. It is hardly surprising, then, that the

reduction in aircraft fuel consumption is largely due to the efficiency of gas turbines as shown in FIGURE 42 below. Associated to lighter and aerodynamically improved aircrafts and other levers such as load factor, this is the aircraft fuel burn per seat (next Chapter).

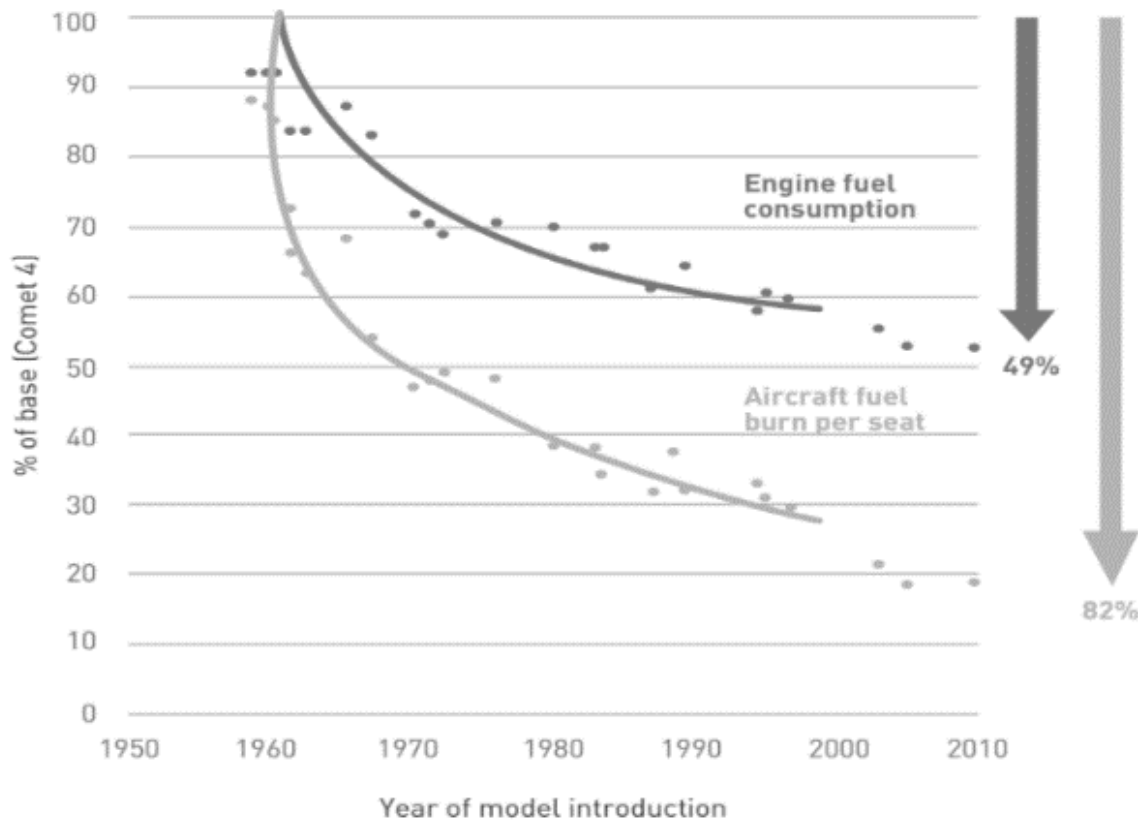

FIGURE 42 50 years of engine fuel consumption savings in aviation (green dots and curve), Waypoint 2050, page 12, source ATAG ³⁰⁰

Lee et al (2001) in Historical and future trends in aircraft performance, cost and emissions ³⁰¹, introduced the term energy intensity (EI), the energy consumption per available seat kilometer (MJ/ASK), as a measure of the performance of an aircraft. This EI depends on various aircraft's parameters, the most significant technological parameters being engine SFC, aerodynamic efficiency and aircraft weight, measured using the ratio between aircraft empty weight and maximum take-off weight. Other parameters such as cabin layout and load factor are discussed in the next section, efficiency of operations.

Engines: It should be noted that most of the reduction occurred in the 60s and 70s, while the rest of the improvement occurred progressively after 1980, as shown in FIGURE 43 below issued from the USA National Research Council, Aeronautical Technologies for the Twenty-First Century, 1992.

³⁰⁰ https://aviationbenefits.org/media/167187/w2050_full.pdf page 12, accessed August 13, 2024

³⁰¹ Lee, Lukachko, Waitz, Schafer, Historical and future trends in aircraft performance, cost and emissions, annual review of environment and resources, Vol. 26:167-200, November 2001, <https://doi.org/10.1146/annurev.energy.26.1.167>

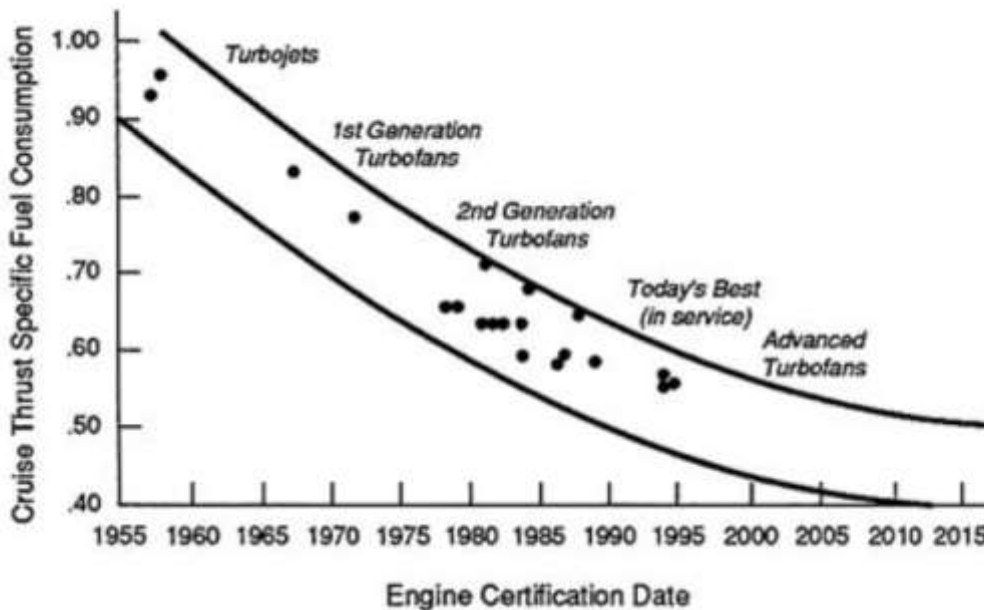

FIGURE 43 Engine SFC from 1955 to 1995, NRC 1992, page 50, source NRC ³⁰²

Since the Sixties, turbofan efficiency has evolved considerably, firstly through improvements in core efficiency, and then through continuous increases in bypass ratio, which achieve greater propulsion efficiency by sending more air around the engine core. The core efficiency strategy, which relies heavily on improving the engine's thermodynamic properties in using higher overall pressure ratios and turbine inlet temperatures, has made a decisive contribution to improving the engine's thermodynamic efficiency. This path, which has required significant design solutions such as engine air bleed for cooling turbine blades, coating, blade alloys and casting or forging processes for high-temperature engine components, has already achieved superior performance, in which any further improvement will be residual as we are getting closer to the physical limits of most materials and processes. Future improvements in engine efficiency, even if limited, must therefore rely on other technological strategies. The introduction in the 60s and the continuous increase of the engine bypass ratio, with its emphasis on reducing exhaust airflow velocity and increasing airflow mass, has further improved propulsion efficiency, thus contributing to improvements in overall engine efficiency. From a ratio of 1:1 in the 70s ³⁰³, it evolved to 4:1 in the 80s, 8:1 in the late 90s and, finally, up to 11:1 ³⁰⁴ during the last decade. However, as the bypass ratio increased, the engine diameter also becomes larger, resulting in increased engine weight and aerodynamic drag. A balance between aerodynamism, weight and SFC must therefore be found, limiting the potential progress in the future.

Alesi and Joyez ³⁰⁵ reaches the same conclusion, as it is the introduction of new generation of engines which provides significant fuel savings. According to the authors, the introduction of the CFM56 in the 1980s led to a 20% reduction in fuel consumption compared with the previous generation. Between the 1st version of the CFM56, the -3, and the latest, the -7, progress continued, with a further reduction of around 6% in 20 years. A new breakthrough came in 2016 with the introduction of the LEAP, the next generation and successor to the CFM56, which saw a further 15% reduction in fuel consumption. For the authors, from 1980 till 2015, and with over 3 generations of turbines, the reduction is therefore close to 1.2 % per year on average. Engine manufacturers are already working on the next generation, based on concepts such as Geared Ultra High Bypass Ratio Turbofan, above 13:1, which would enable a

³⁰² <https://dokumen.pub/qdownload/aeronautical-technologies-for-the-twenty-first-century-1nbsped-9780309584548-9780309047326.html> page 50, accessed August 13, 2024

³⁰³ <https://www.prattwhitney.com/en/products/commercial-engines/jt8d> accessed August 13, 2024

³⁰⁴ https://www.cfmaeroengines.com/wp-content/uploads/2017/09/Brochure_LEAPfiches_2017.pdf page 18, accessed August 13, 2024

³⁰⁵ Alesi and Joyez, Saga du CFM56, Arts&Métiers (s.d.), page 26 https://am.arts-et-metiers.asso.fr/manifestation_cr/cr_3728.pdf accessed August 13, 2024

further reduction in fuel consumption of around 10%, or the counter rotation propfans, which by design is the most efficient as described by the Nasa in *The Promise and Challenges of Ultra High Bypass Ratio Engine*, page 5³⁰⁶. This technology is currently being developed by CFM with the objective to further reduce the fuel consumption by 15 to 20%, with an entry into service by 2035³⁰⁷. Considering that an aircraft generation last 20 to 30 years, a further reduction of 15% in SFC is the value used in this study.

Aerodynamic and weight: as for engine efficiency, the lift to drag ratio improved significantly. Rivets, tiny grooves cut in the direction of airflow to reduce turbulence and drag on the fuselage, have been shown to reduce friction drag by 4-8%³⁰⁸. The introduction of winglets reduced the induced drag by approximately 20 percent, improving the overall aircraft lift-drag ratio by 6 to 9 percent, leading to a minus 4 to minus 6% fuel burn reduction³⁰⁹. In the longer term, a promising aerodynamic technology for effectively reducing drag is laminar flow control. By incorporating these technologies, Airbus predicts up to 50% reduction of wing friction and up to 5% lower fuel burn³¹⁰. If laminar flow over the entire chord can be achieved, NRC estimates a further improvement of 10% is possible³¹¹. Reducing weight means reducing fuel and aircraft manufacturers, as shown in FIGURE 44 below, have been using composite materials to lighten aircraft since the 1980s, with a marked acceleration over the last ten years or so with the introduction of new-generation aircraft such as the Airbus A350, Bombardier C Series now Airbus A220, and Boeing 787.

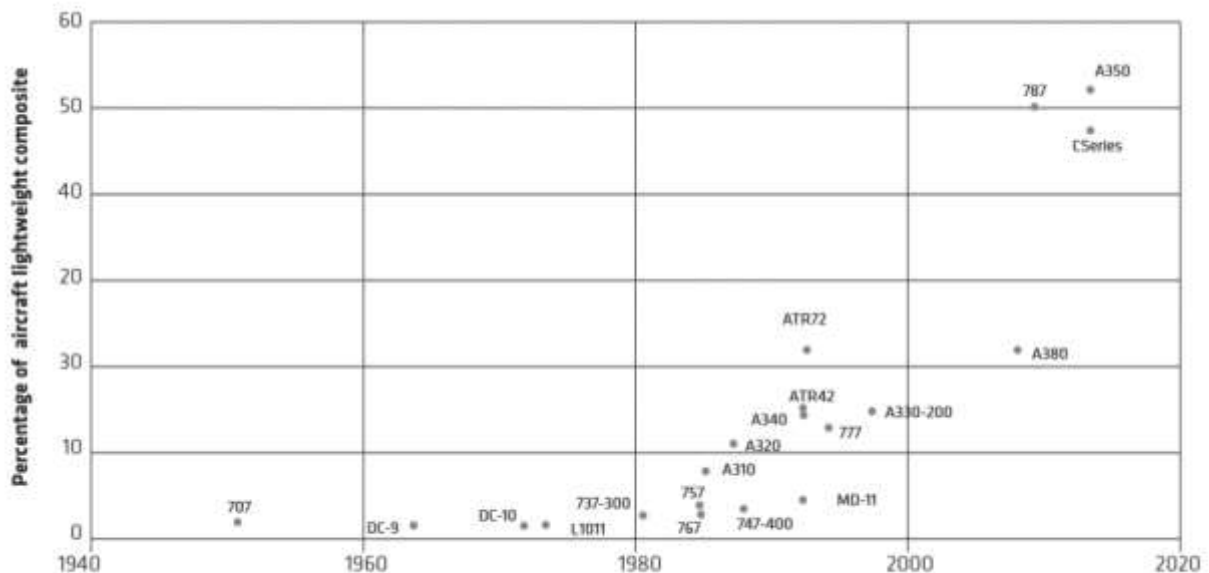

FIGURE 44 Lower aircraft weight with the use of composites, ATAG efficiency guide, 2010, page 9, source ATAG³¹²

³⁰⁶ <https://ntrs.nasa.gov/api/citations/20110011737/downloads/20110011737.pdf> page 5, accessed August 13, 2024

³⁰⁷ https://www.cfmaeroengines.com/wp-content/uploads/2021/07/CFM_RISE_Whitepaper_Media.pdf page 5, accessed August 13, 2024

³⁰⁸ Greene D.L., Energy efficiency improvement potential of commercial aircraft, annual review of environment and resources, Vol.17:537-573, November 1992 <https://doi.org/10.1146/annurev.eg.17.110192.002541>

³⁰⁹ https://spinoff.nasa.gov/Spinoff2010/t_5.html accessed August 13, 2024

³¹⁰ <https://www.airbus.com/en/newsroom/press-releases/2017-09-airbus-blade-laminar-flow-wing-demonstrator-makes-first-flight> accessed August 13, 2024

³¹¹ <https://dokumen.pub/qdownload/aeronautical-technologies-for-the-twenty-first-century-1nbsped-9780309584548-9780309047326.html> page 51, accessed August 13, 2024

³¹² https://atag.org/media/zetphs4m/atag_efficiencyguide_reprint_web.pdf page 9, accessed August 13, 2024

I.III.1.2. Operational efficiency

Operational efficiency is essentially based on two levers: the aircraft load factor, by far the most important lever, and optimizing the time the engines are on: ground operations and flight paths.

Load Factor, or share of airline seats filled by passengers, is a very important metric for airlines as empty seats still burn fuel, and emit eCO₂, but without revenues. There is therefore a significant difference between available seat kilometer (ASK) and passenger seat kilometer (PSK). FIGURE 45³¹³, source OWID, below shows the difference between those two metrics.

The difference between ASK and PSK is the passenger load factor, and since the metric used by the aviation industry is the fuel burn per passenger kilometer, this difference has a direct impact on global revenues for the airlines. Regarding global fuel burn and emissions, this is less true, ASK being more adequate.

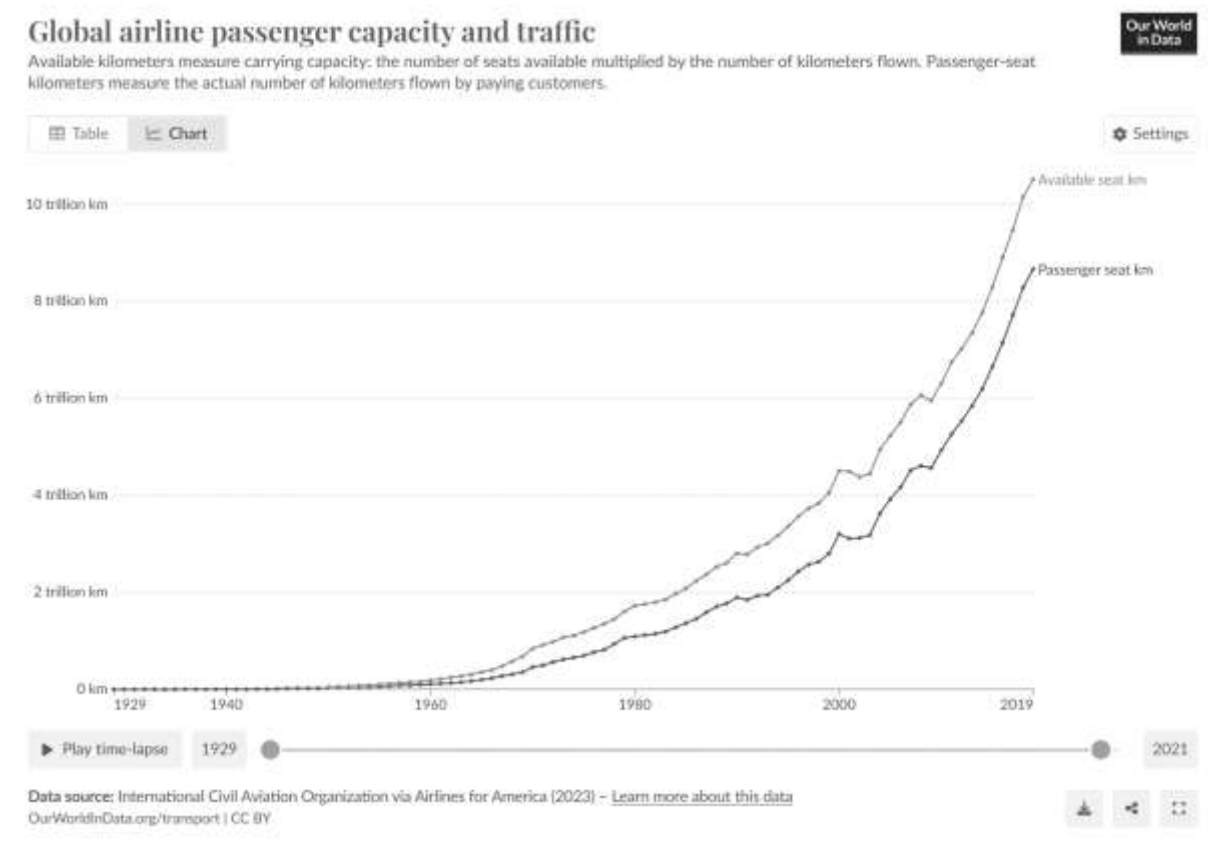

FIGURE 45 ASK and PSK evolution from 1929 to 2019, source OWID

FIGURE 46³¹⁴ below, source OWID, show the variation of this load factor from 1950 to 2019. The optimization of route management, hubs, use of code-share, or yield management significantly improved this ratio with a world average of 82% in 2019. However, this ratio varies according to the different areas and routes served. In IATA's v9 repository³¹⁵, the 2014 data show a significant standard deviation, with a worldwide average of 80%, a min. of 64% (North Asia Domestic) and a max. of 85% (Europe-South America).

³¹³ <https://ourworldindata.org/grapher/airline-capacity-and-traffic?time=earliest..2019> accessed August 13, 2024

³¹⁴ <https://ourworldindata.org/grapher/airline-passenger-load-factor?time=earliest..2019> accessed August 13, 2024

³¹⁵ https://www.icao.int/environmental-protection/CarbonOffset/Documents/Methodology_ICAO_Carbon_Calculator_v9_2016.pdf, pages 12-13, accessed August 13, 2024

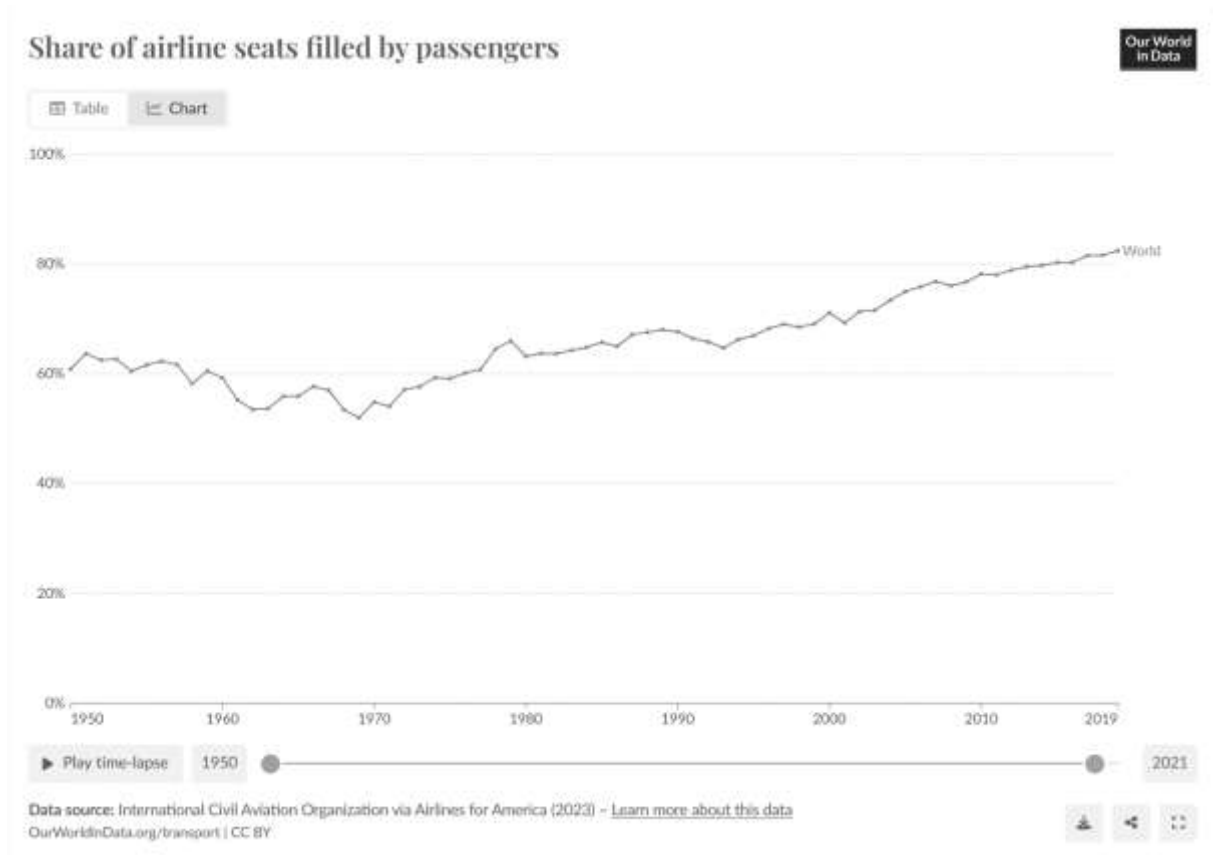

FIGURE 46 Passenger load factor from 1950 to 2019, source OWID

This coefficient rose significantly between 2000 and 2020, from an average load factor of 70% to 80%. For the period 2020-2050, the aim is to achieve a 90% load factor and this is probably a maximum as load factors above a certain level “reduce the service experience, create delays, make reservations difficult, and lead to passengers bumped from flights...resulting in lower reliability as airlines operations have less slack to react to external shocks such as bad weather”³¹⁶.

Ground operations: regarding flight times, the ICAO benchmark indicates the minutes devoted to non-cruise operations, which makes it possible to distinguish between progress made in ground and flight operations. The ground operations include gate and taxiing before take-off and after landing, but also the climb and the approach. The standard proposed by ICAO is 26 minutes on ground, and a total of 6.9 minutes for take-off, climb and approach. Easier access to flight level and continuous descent in approach are now widely adopted. Operations on ground are benefitting from the installation of direct electrical supplies to aircraft to reduce the use of the aircraft auxiliary power unit. The single engine taxiing is also becoming a standard, and the use of electric airport tugs is increasing. While economically efficient, these improvements remain marginal as the most significant share of the fuel is burnt during flight. According to Airbus, 4 minutes holding with an A320, burns 100 kg of jet fuel³¹⁷. This is a worst case since both engines are running. Using the standard ICAO model with 26 minutes of ground operations, the worst fuel consumption would be 0.65 ton when the fuel on board is close 20 tons³¹⁸. While significant, as 650 kg of fuel is equal to filling the tanks of approximately 20 cars, this represents only a fraction, 3.25%, of the total fuel burn for a short to medium range mission.

³¹⁶ IATA Vision 2050, 2011, page 50 <https://www.iata.org/contentassets/bccae1c5a24e43759607a5fd8f44770b/vision-2050.pdf> accessed August 13, 2024

³¹⁷ <https://www.airbus.com/sites/g/files/jlcbta136/files/2021-11/Backgrounder-EN-Most-Efficient-Flight.pdf> page 3, accessed August 13, 2024

³¹⁸ <https://safetyfirst.airbus.com/fuel-monitoring-on-a320-family-aircraft/> accessed August 13, 2024

Air Traffic Management (ATM) such as direct flight paths could also help improving the reduction of jet fuel. The European Union is currently working on adopting a single sky through the SESAR project (Single European Sky ATM Research) ³¹⁹. FIGURE 47 illustrates the current zig zag which could be replaced in the future with direct flight paths.

Example of flying to avoid military airspace and national borders

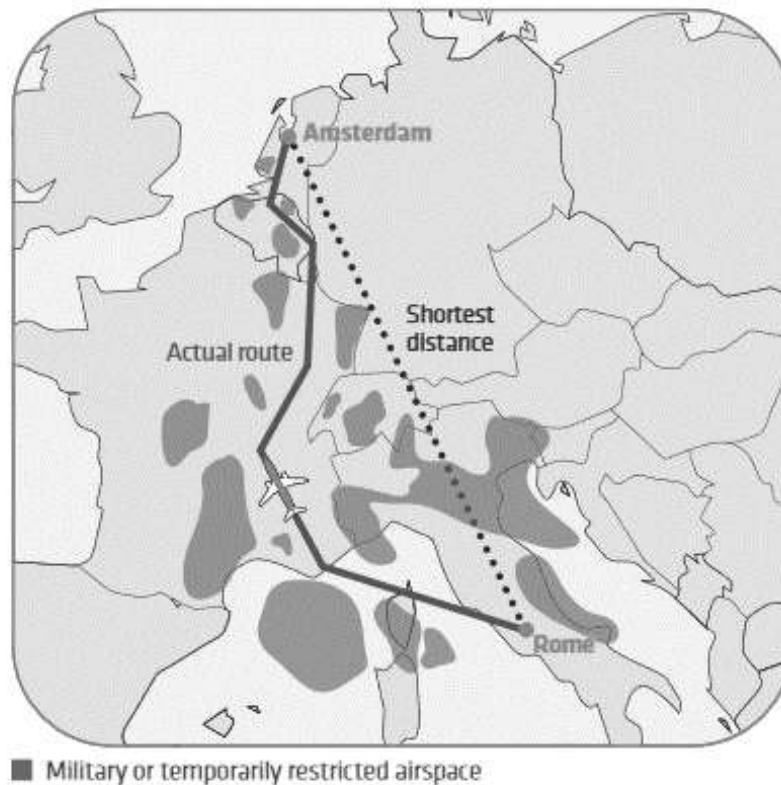

FIGURE 47 European Single Sky / Direct flight path example, ATAG, efficiency guide page 17, source ATAG ³²⁰

While all these efforts are indeed necessary to reduce aviation fuel burn and eCO₂ impact, they are not the ones that will contribute most to long-term CO₂ reduction. The ATAG Waypoint 2050 report considers a contribution between 0 to 6% in eCO₂ emissions by 2050, or a compounded annual reduction rate (CAGR) from 0 to 0.2% ³²¹. This should be considered as a maximum since opposite forces are also at stake. For instance, the Russian invasion of Ukraine led to the closure of the Russian sky to most airlines, which considerably lengthens the distance of flights from Europe to Asia for most airlines ³²², increasing fuel burn and therefore eCO₂ emissions.

I.III.1.3. Potential of technologies and way forward

Many studies present technological trends in terms of constant annual percentage efficiency gains, as observed historically. Lee et al ³⁰¹ for example state that this ratio will be between 1.2% and 2.2%. ATAG, the Air Transport Action Group supported by IATA, proposes an average of 1.3% in the 2020 report Waypoint 2050 ³²³ as shown in

³¹⁹ https://transport.ec.europa.eu/transport-modes/air/single-european-sky_en accessed August 13, 2024

³²⁰ https://atag.org/media/zetphs4m/atag_efficiencyguide_reprint_web.pdf accessed August 13, 2024

³²¹ https://aviationbenefits.org/media/167187/w2050_full.pdf page 54, accessed August 13, 2024

³²² <https://www.euronews.com/travel/2024/07/30/heres-how-restrictions-on-flying-over-russia-are-making-flights-longer-and-more-expensive> accessed August 13, 2024

³²³ https://aviationbenefits.org/media/167187/w2050_full.pdf accessed August 13, 2024

FIGURE 42 above which shows a 49% fuel burn improvement in 50 years, the starting point being the De Havilland Comet 4³²⁴, one of the very first civil jet aircraft.

This compounded annual reduction rate of 1.2 to 1.3% is also the conclusion of the ICCT report, Fuel efficiency trends for new commercial jet aircraft from 1960 to 2014, issued in 2015³²⁵. The authors, page 9, concluding that “the average fuel burn of new aircraft fell approximately 45% from 1968 to 2014, or a compounded annual reduction rate of 1.3%”. They also noted, and this is also a conclusion of Alesi & Joyez, that the rate of reduction can vary significantly in time. However, it is not easy to pinpoint a single determining factor, including the evolution of jet fuel prices, and this fluctuation seems to be rather multifactorial, based on the entry into service of new technologies that often take more than a decade to develop, and once developed and proposed to the market taking another decade for being massively adopted.

The figures and data proposed by Alesi & Joyez support this conclusion³²⁶: the first drawings are dated 1968 and the first engine to test occurred in 1974 but not customers were interested until 1979 despite a significant SFC improvement and the program was about to stop. Interestingly the first order came with the second oil shock as shown in FIGURE 48 which describes the price of jet fuel from 1968, the start of the CFM56 program, to 1979, the date of the 1st order. The introduction of the CFM56 in the early 80’s offered immediately -20% in SFC compared to the previous generation of engines. With a significant increase in jet fuel price the CFM56 was then seen as a game changer and was massively adopted during the 80’s. The continuous improvements during the following years offering a limited reduction of a further -6%. The next generation engine proposed by CFM, the LEAP, entered into service in 2016, offering a -15% SFC reduction.

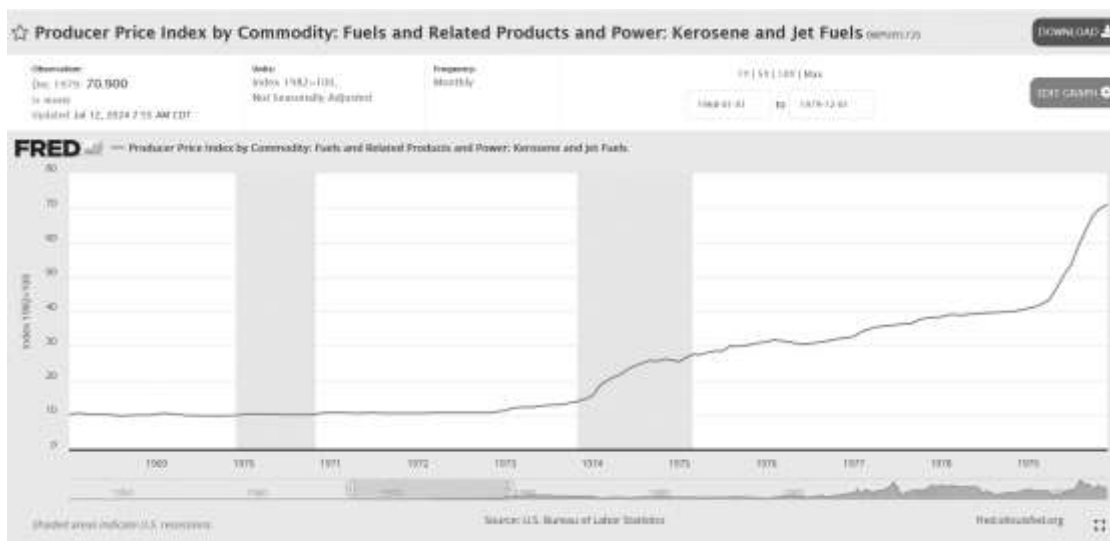

FIGURE 48 Jet Fuel Price from selected period 1968 and 1979, in producer price index base 100 in 1982, source U.S Bureau of Labor Statistics³²⁷

The sharp increase in jet fuel price was certainly the trigger which led to the massive adoption of the CFM56, meanwhile it most probably killed the Concorde program which, due to its speed, was tripling the SFC compared to the subsonic jets.

³²⁴ <https://www.baesystems.com/en/heritage/de-havilland-comet-3---4> accessed August 13, 2024

³²⁵ https://theicct.org/sites/default/files/publications/ICCT_Aircraft-FE-Trends_20150902.pdf accessed August 13, 2024

³²⁶ Alesi and Joyez, Saga du CFM56, Arts&Métiers (s.d.) , page 3, 11, 14-17, 26 https://am.arts-et-metiers.asso.fr/manifestation_cr/cr_3728.pdf accessed August 13, 2024

³²⁷ <https://fred.stlouisfed.org/series/WPU0572> accessed August 13, 2024

This decline in compounded annual reduction rate is further detailed by Peeters et al in Are technology myths stalling aviation climate policy³²⁸. The authors demonstrate that the reduction percentage itself is not a constant, but reduces with time.

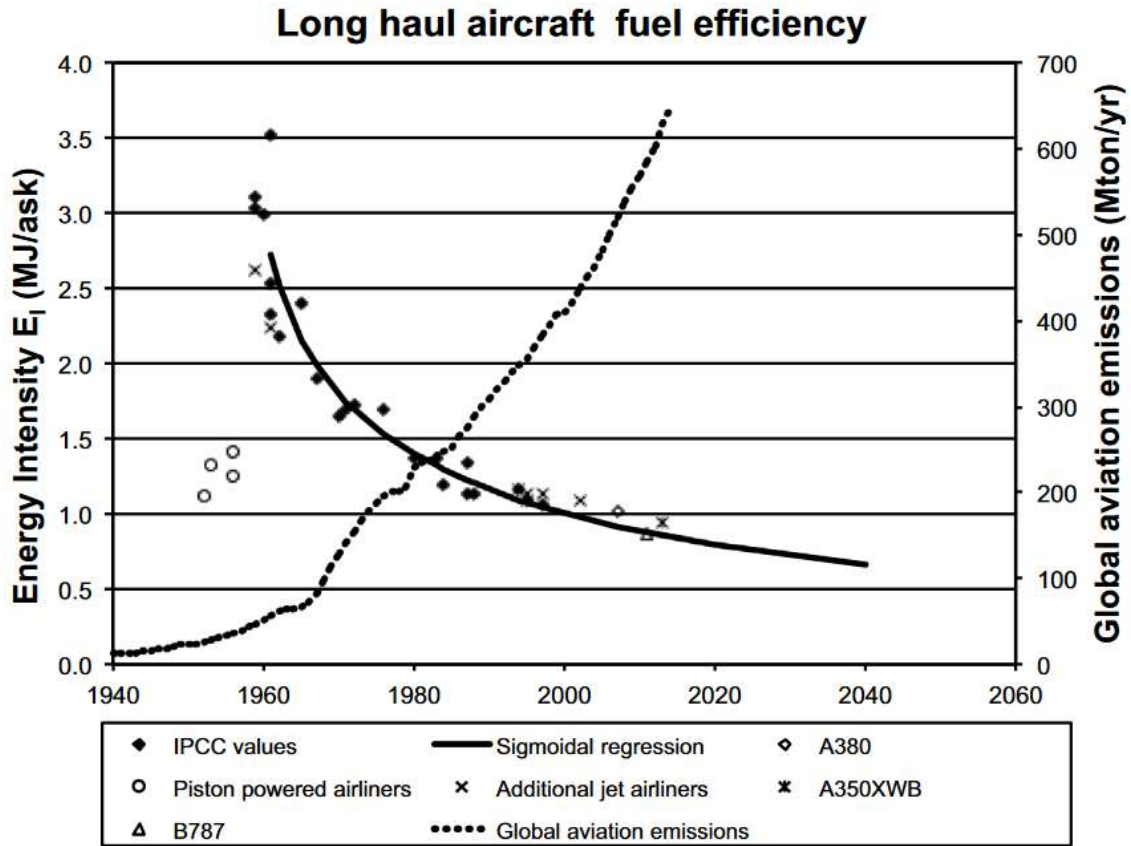

FIGURE 49 Aircraft fuel efficiency expressed in energy intensity MJ/ask. Originally Figure 2 from Are technology myths stalling aviation climate policy, with kind authorization of the first author, Prof Paul Peeters

This is made particularly clear in FIGURE 49 above since the tendency curve is presented from 1960 to 2040. As a result, the percentage fuel reductions observed in the past cannot be directly used for future fuel reduction assumptions. It is noted here that these data are limited to long haul aircraft, which are the most efficient.

With the above conclusions, the past rate of a 1.3% / year reduction in aircraft fuel burn will most probably keep declining. The introduction of the next generation of engines and aircrafts is not expected before 2035, with a potential which is probably close to -20% when combining engine, such as open rotor, with aerodynamic and weight breakthroughs such as laminar flow control and the increasing adoption of composite materials and additive manufacturing processes. Meanwhile improvements in operations and infrastructures have proven to be limited and would most probably provide a limited further reduction of 0.1% (average CARR, mid scenario ATAG).

Using the above conclusions, the approach proposed by Peeters et al in FIGURE 49 and historical data from Kharina & Rutherford in Fuel efficiency trends for new commercial jet aircraft: 1960 to 2014³²⁹, it is possible to propose hypothesis which will be used in the next chapter.

³²⁸ Peeters, Higham, Kutzner, Cohen, Gössling, Are technology myths stalling aviation climate policy?, Transportation Research Part D: Transport and Environment, Volume 44, 2016, Pages 30-42, ISSN 1361-9209 <https://doi.org/10.1016/j.trd.2016.02.004>

³²⁹ https://theicct.org/sites/default/files/publications/ICCT_Aircraft-FE-Trends_20150902.pdf pages 10-11, accessed August 13, 2024

FIGURE 51 below proposes a simple model to evaluate the aviation consumption evolution from 2019 to 2020 using the historical data and tendency curves proposed by Peeters et al, Alesi & Joyez, ATAG and Kharina & Rutherford, discussed above. Base 100 is 1960 and 2010 is used as a reference year to validate the model before extrapolation to 2050.

While the CARR from 1960 to 2010 is 1.38% (ATAG: base 100 in 1960 and 51 in 2010; Kharina & Rutherford 49 gfuel/passenger-km in 1968 and 28 in 2008), it is found necessary to adopt the learning curve (or sigmoidal regression curve) proposed by Peeters et al. to improve model accuracy. The hypothesis is that, as historically proven by Kharina and Rutherford, the rate is decreasing but also not constant in time, FIGURE 50.

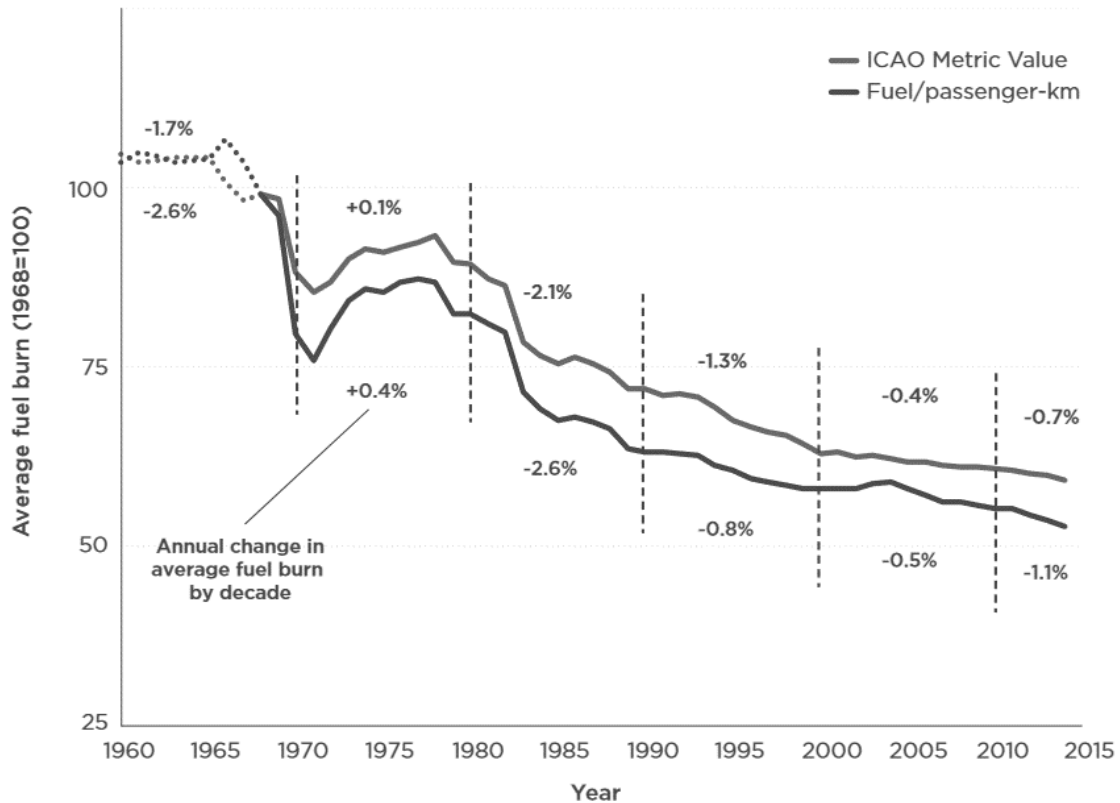

FIGURE 50 Average fuel burn of new commercial jet aircraft, base 100 in 1968. Aircraft FE Trends, page 11, source ICCT

The model therefore is built on CARR per decade, adapting the data of Kharina and Rutherford from 1970 up to 2020, and considering the constant introduction of the latest generation of aircrafts – engines until 2030 (CARR 1.1%) followed by a slower CARR (0.4%) until 2040. Future technologies such as open rotor are considered for the period 2040-2050, with a CARR of 1.2%, a slightly higher value than the previous “next gen” as more disruptive technologies are expected. The hypothesis here being that the 3rd generation of aircraft were limited to the engine performance: the difference between the A320 and the A320 Neo being mostly its engines (-15% SFC). For the 4th generation expected in 2035-2040 the open rotor configuration will impose significant aerodynamic changes to the aircraft designers which in return will have the opportunity to introduce more disruptive technologies, increasing the opportunity of fuel burn reduction. Also, with the constraint of jet fuel cost and SAF costs (see Part II), no increases are introduced in the model unlike the historical trend in the 70’s.

Considering that the model is built for fleet average fuel burn in operation, the 10%, or 8-years difference (53.9 vs 49) with the ATAG model, which compares the most efficient aircraft for the period and the average, is found acceptable. The difference with Kharina & Rutherford is less than 5% (26.7 gfuel/passenger-km vs 28).

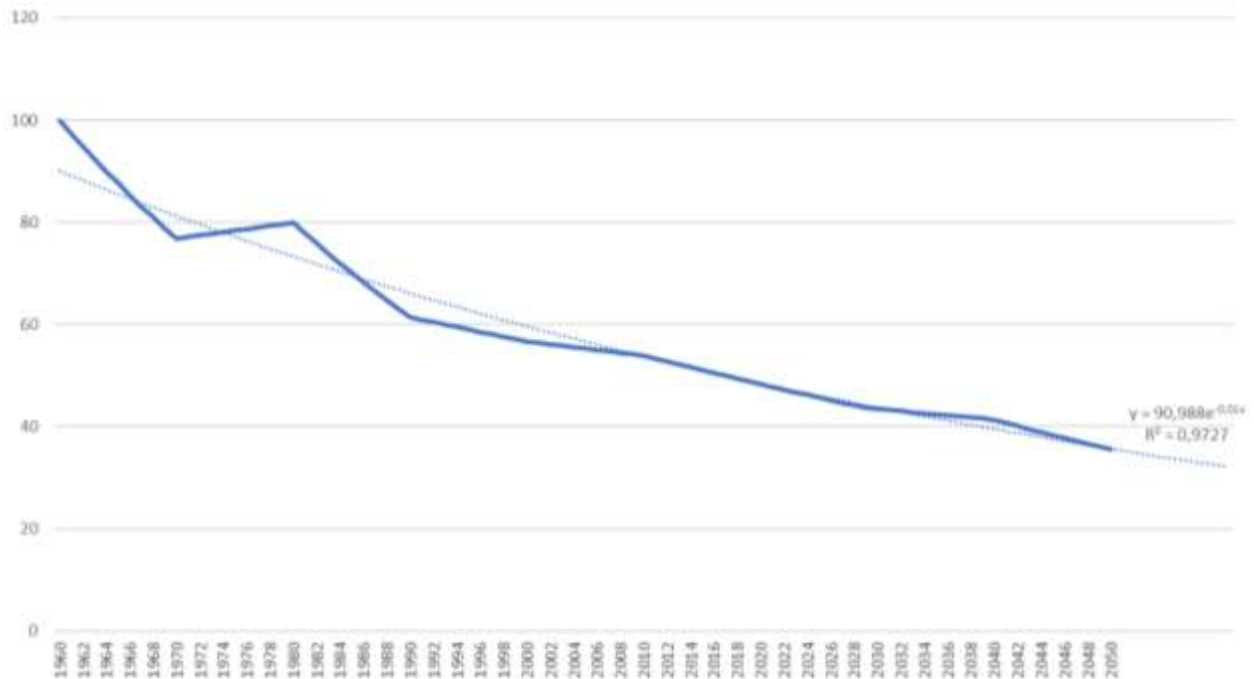

FIGURE 51 Average fuel burn of new commercial jet aircraft from 1960 (Comet) and extrapolated to 2050, base 100 in 1960, source Jean-Baptiste Jarin

For the readers convenience, the final result can be expressed in fuel burn PSK or liters per passenger for 100 km, i.e 2.3 liters per passenger for 100 km in 2050, a remarkable figure.

A compounded annual reduction rate of 0.85% for the period 2020-2050 is therefore the hypothesis adopted for the rest of this study. This is well below the claimed objectives of the sector, but as highlighted by Kharina & Rutherford “the industry is already lagging behind both the 2020 and 2030 ICAO goals by approximately 12 years”³³⁰. The gap is even wider when considering the ACARE (Advisory Council for Aviation Research and innovation in Europe) 2020 objective, which in its Strategic Research Agenda, asked for a 50% reduction in fuel burn and eCO₂ emissions compared to 2000³³¹.

I.III.1.4. SAF

Sustainable Aviation Fuels will be detailed in Part II, however it was found necessary to introduce the eCO₂ reduction opportunity brought by the SAF before proposing GHG future scenarios in the next sub-chapter. As detailed in the next chapters, hypothesis in this study is that nor hydrogen powered planes neither electric aircraft will play a significant role by 2050, as such the decarbonization of the energy for aviation relies on Sustainable Aviation Fuels, therefore their carbon content, which will then be multiplied for the volume used (see sub-chapter I.3 of Part I above).

$$eCO_2 = m_{fuel} * fuel_{CI}$$

m_{fuel} represents the mass of fuel consumed.

$fuel_{CI}$ represents the carbon intensity in eCO₂ of the fuel used.

The fuel carbon intensity for the CAF (Conventional Aviation Fuel issued from fossil fuel) goes from 77.3 to 112 gCO₂e/MJ as detailed in sub-chapter Part I I.2, the average being 94 g eCO₂/MJ.

³³⁰ https://theicct.org/sites/default/files/publications/ICCT_Aircraft-FE-Trends_20150902.pdf pages 16, accessed August 13, 2024

³³¹ Dron S., Proceedings for ICAS 2008, https://www.icas.org/ICAS_ARCHIVE/ICAS2008/PAPERS/595.PDF accessed August 13, 2024

Alternative jet fuels CO₂ emissions depending on the process used have been known for many years and some, such as coal to liquid, largely produced. FIGURE 52 below summarizes the carbon intensity of alternative jet fuels compared to CAF with data from Daggett et al in Alternative fuels for use in commercial aircraft³³². The values are supplemented by the value of 25g CO₂e/MJ for efuels produced from low carbon H₂ calculated by the author and further detailed in part II, to provide an efuel comparison starting point. One can notice that within alternative fuels only those produced from the biomass and low carbon electricity can provide a reduction in carbon intensity. Interestingly, the authors of this article raised peak energy to justify the development of alternative fuels, thus including coal-to-liquid and gas-to-liquid, the carbon intensity being not the primary reason.

The values for biofuels should be further refined, because while the central value of 40 g eCO₂/MJ seems credible, each process/feedstock pair will in reality have its own carbon footprint.

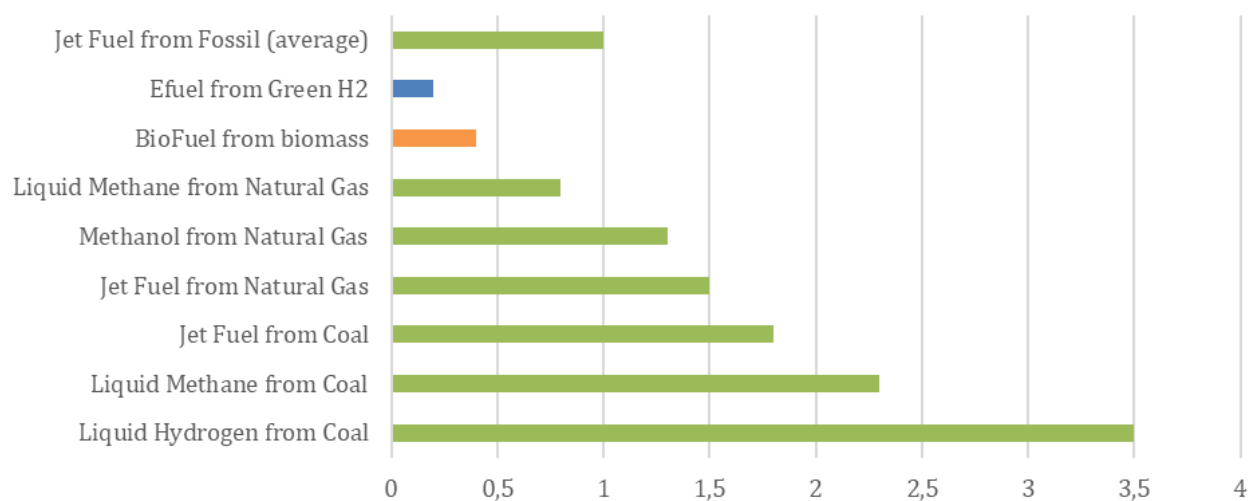

FIGURE 52 Comparing the carbon intensity of alternative fuels with fossil jet fuel as base 1, source Jean-Baptiste Jarin with data from Daggett et al

Efuels: produced with the combination of low carbon H₂ with CO₂ and H₂O, efuel potential could be useful as if the volumes of biofuels alone do not meet the volumes required for the decarbonization of air mobility. However, one shall understand that no energy is totally decarbonized, and that CO₂ emissions per kWh need to be considered depending on the primary energy source chosen. According to Reiter & Lindorfer in Evaluating CO₂ sources for power-to-gas applications - A case study for Austria³³³, electricity with a carbon footprint of less than 190 g eCO₂ / kWh would be needed for hydrogen produced by water electrolysis to be more virtuous than grey hydrogen (141 g eCO₂/MJ) which is produced from gas steam reforming. European electricity production in 2022 emits 258 g eCO₂ / kWh, according to the European Environment Agency³³⁴. Low-carbon production methods will therefore have to be used exclusively to meet the value of 36.4 g eCO₂/MJ (LHV, or 4.36 kg eCO₂ per kg of H₂) set by CertifHy in IRENA's in Green Hydrogen - a guide to policy making³³⁵, for hydrogen to qualify as low carbon. The production of 1kg of liquid H₂ requiring 65 kWh of electricity for water electrolysis, this means that the electricity CI (carbon intensity) must be below

³³² Daggett et al, 2008, Alternate Fuels for Use in Commercial Aircraft, <https://api.semanticscholar.org/CorpusID:56412666>

³³³ Gerda Reiter, Johannes Lindorfer, Evaluating CO₂ sources for power-to-gas applications – A case study for Austria, Journal of CO₂ Utilization, Volume 10, 2015, Pages 40-49, ISSN 2212-9820, <https://doi.org/10.1016/j.jcou.2015.03.003>

³³⁴ https://www.eea.europa.eu/data-and-maps/daviz/co2-emission-intensity-15#tab-chart_7 accessed August 13, 2024

³³⁵ https://www.irena.org/-/media/Files/IRENA/Agency/Publication/2020/Nov/IRENA_Green_hydrogen_policy_2020.pdf?rev=c0cf115d8c724e4381343cc93e03e9e0 page 29, accessed August 13, 2024

67 g eCO₂ / kWh without any consideration of eCO₂ emissions for the other stages such as stack manufacturing and replacement, or transport and distribution.

This challenging value can however be met, as highlighted by Hacatoglu et al in Comparative life cycle assessment of hydrogen and other selected fuels ³³⁶.

Using the values proposed by IPCC in its Annex III, 2018 report ³³⁷, electricity generated by wind, solar, hydro or nuclear would qualify and the values have been summarized in FIGURE 54.

Biofuels: The carbon footprint of jet fuel has become an important piece of information since climate change issues were considered, although it obviously does not overshadow that of price, as will be discussed in part II. The value of 40 g eCO₂/MJ presented above is an average value, since the carbon content of a biofuel will in fact depend on the manufacturing process/biomass used, which life-cycle analysis studies make it possible to detail. Numerous scientific publications address the subject, and in 2019 ICAO published its CORSIA Eligible Fuel (CEF) ³³⁸ that are certified or could be in the future.

However, discrepancies are sometimes significant, particularly for 1st Generation biofuels which often compete with food. In this respect, the European RED (sub-chapter II.2 above) demonstrates the progress made in understanding the life-cycle impact of biofuels and taking associated externalities into account. Unlike with CAF or even efuels, the surface area required to produce biofuels represents a significant proportion of the carbon balance, and direct effects such as land-use change can sometimes transform a positive CO₂ balance into a negative one, i.e. one that is more emissive than fossil fuel. These direct and indirect land-use changes, known as LUC (Land Use Change) and ILUC (Indirect Land Use Change), are now systematically taken into account and have a major impact on the final value expressed in g eCO₂/MJ as shown in TABLE 19 below.

A common example of ILUC is the replacement of a primary forest, which captures a huge amount of carbon each year, by an oil palm plantation. Not only do oil palms capture much less carbon than a primary forest, but clearing the land will release a huge amount of CO₂ that was buried and sequestered in the soil. The notion of LUC can be illustrated by a case where European rapeseed diverted to biofuel production mechanically drives up oilseed prices, leading to an increase in soybean cultivation in Brazil which will be exported to Europe. This new production requires land, which is taken from the Amazon rainforest, reproducing the same pattern as for palm oil. The production of 1st generation biomass raises other issues such as food competition (Part III), costs (Part II) and energy return on energy invested (ERoEI).

The notion of ERoEI have been discussed in sub-chapter above, and this key notion is crucial to understand the economics of man made fuels. For 1st generation biofuel, using FIGURE 53 proposed by Chavanne and Frangi in Energy yield for the production of ethanol from corn ³³⁹, the yield calculated by the authors, i.e. the volume of energy produced by the biofuel minus the fossil energy required to produce it, does not exceed 19% in the best case, or an ERoEI between 1.1 and 1.2. For comparison, the ERoEI for fossil fuels are generally close to 100 in the middle-east, 30 for offshore, and between 5 and 10 for the shale and tar sands oils.

³³⁶ Kevork Hacatoglu, Marc A. Rosen, Ibrahim Dincer, Comparative life cycle assessment of hydrogen and other selected fuels, International Journal of Hydrogen Energy, Volume 37, Issue 13, 2012, Pages 9933-9940, ISSN 0360-3199, <https://doi.org/10.1016/j.ijhydene.2012.04.020>

³³⁷ https://www.ipcc.ch/site/assets/uploads/2018/02/ipcc_wg3_ar5_annex-iii.pdf page 1335, accessed August 13, 2024

³³⁸ https://www.icao.int/environmental-protection/CORSIA/Documents/ICAO%20Environmental%20Report%202019_Chapter%206.pdf page 228, accessed August 13, 2024

³³⁹ Xavier Chavanne, Jean-Pierre Frangi, Le rendement énergétique de la production d'éthanol à partir de maïs, Comptes Rendus Geoscience, Volume 340, Issue 5, 2008, Pages 263-287, ISSN 1631-0713, <https://doi.org/10.1016/j.crte.2008.01.006>

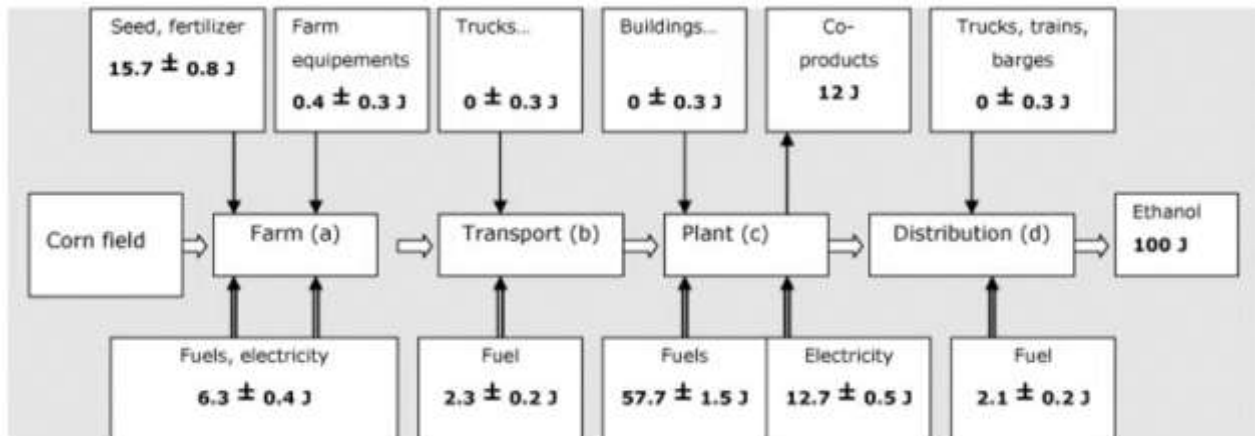

FIGURE 53 Diagram of the various stages in the ethanol production chain, from the cornfield to the gas station, and the energy costs associated with each stage. Average data in 2001 for the farm (excluding irrigation), in 2005 for the plant fleet. Originally Figure 1 of Energy yield for the production of ethanol from corn, reproduced here with the kind authorization of first author, JP Frangi

The economic performance of the industry also raises questions, but this is not the subject of this study.

It was therefore found necessary to conduct an extensive review of the articles and reports on alternative fuels emissions. A synthesis is proposed in TABLE 19 below in which data from peer reviewed articles are synthesized, the baseline being data from Stratton, Hileman et al ^{340 341} who proposed an extensive review of jet fuels produced from fossils (oil, coal, gas) and fatty acids. This detailed review allows one to understand the associated emissions which come with the production of man-made fuels, such as energy inputs or land use change, but the also the opportunity to valorize by-products. As for all studies reviewed, not all feedstocks and processed are considered and these data are completed for the other feedstocks with articles from Seber et al ³⁴², de Jong et al ³⁴³ and when need the report of ICCT ³⁴⁴.

Values from the ICAO CORSIA report also introduced for comparison ³⁴⁵, the values presented here being the L_{CEF} (Lifecycle emissions for a CORSIA Eligible Fuel), using the USA value when more than one value is available. While other processes than the one listed in TABLE 19 below exist, such as ETJ, HTL or SIP, the yields and final eCO_2 value are worse than with other pathways and therefore not considered here. Detailed pathways are available in sub-chapter I.1 of part II while non- CO_2 emissions associated with combustion are detailed in sub-chapters I.2 and I.3 of part II.

For efuels (power to liquid) the values are calculated using the electricity carbon intensity proposed by IPCC for means of production, and EEA ³⁴⁶ for grid production. This is a very simple calculation using the 26.48 kWh of electricity required to produce 1 kg of efuel. This value is calculated within the research conducted for the Observatoire Français

³⁴⁰ J.I. Hileman, R.W. Stratton, Alternative jet fuel feasibility, Transport Policy, Volume 34, 2014, Pages 52-62, ISSN 0967-070X, <https://doi.org/10.1016/j.tranpol.2014.02.018>

³⁴¹ Stratton, Wong, Hileman, Lifecycle GHG emissions from alternative jet fuels, Partner Project 28 report, 2010, MIT, <http://web.mit.edu/aeroastro/partner/reports/proj28/partner-proj28-2010-001.pdf>

³⁴² Gonca Seber, Robert Malina, Matthew N. Pearlson, Hakan Olcay, James I. Hileman, Steven R.H. Barrett, Environmental and economic assessment of producing hydroprocessed jet and diesel fuel from waste oils and tallow, Biomass and Bioenergy, Volume 67, 2014, Pages 108-118, ISSN 0961-9534, <https://doi.org/10.1016/j.biombioe.2014.04.024>

³⁴³ de Jong, S., Antonissen, K., Hoefnagels, R. et al. Life-cycle analysis of greenhouse gas emissions from renewable jet fuel production. *Biotechnol Biofuels* 10, 64 (2017). <https://doi.org/10.1186/s13068-017-0739-7>

³⁴⁴ https://theicct.org/wp-content/uploads/2021/06/Alternative_jet_fuels_cost_EU_2020_06_v3.pdf page 9, accessed August 13, 2024

³⁴⁵ https://www.icao.int/environmental-protection/CORSIA/Documents/CORSIA_Eligible_Fuels/ICAO%20document%2006%20-%20Default%20Life%20Cycle%20Emissions%20-%20March%202024.pdf pages 2-6, accessed August 13, 2024

³⁴⁶ <https://www.eea.europa.eu/en/analysis/indicators/greenhouse-gas-emission-intensity-of-1> accessed August 13, 2024

des efuels ³⁴⁷. It is consistent with most articles as well as with the Académie des Technologies report which assume from 22.8 to 28 kWh/kg. It is assumed here that the lifecycle analysis is not fully calculated as emissions issued from construction, overhaul and maintenance are not covered and these values should be considered as a minimum.

To facilitate the comprehension of the table, the values in bold are the value considered as the most accurate values and are the ones considered in this study. The compatibility with the European Union regulations (ReFuel EU and RED, see chapter II.2 above) is also introduced. To match with the EU requirements the feedstock needs to be listed in Annex IX and offer a -65% reduction for biofuels or -70% reduction for efuels compared to the fossil reference of 94 g eCO₂ / MJ. For instance, PFAD are authorized by ICAO but are not listed in Annex IX of the EU, while corn grain is not authorized within the EU due to its eCO₂ footprint: 79 g eCO₂/MJ vs 32.9 g eCO₂/MJ (65% of 94 g eCO₂/MJ).

Comparing eCO ₂ emissions of Jet Fuels, all values expressed in g eCO ₂ /MJ (value in bold is the final value considered in this study)		Published articles				OACI (CORSIA)		Compatible with EU regulations	
		Direct	Min with LUC - ILUC	Max with LUC - ILUC	Low / High (w/o LUC - ILUC)	Source	Direct		Final with LUC-ILUC
CAF	Conventional Oil, low sulfur, low	89,1			84,6 / 111,2	Stratton et al			na
	Oil sands (Canada)	103,4		na	97,9 / 139	Stratton et al			
	Oil shale (USA)	121,6			84,1 / 141	Stratton et al			
Alternative Jet Fuel from fossil	Gas-to-liquid (FT)	101			100,1 / 102,4	Stratton et al			NO
	Gas-to-liquid (FT) with CCS	86,2		na		Stratton et al			
	Coal-to-liquid (FT)	194,9			174 / 208	Stratton et al			
	Coal-to-liquid (FT) with CCS	97,2			84,9 / 112,6	Stratton et al			
HEFA	Soy oil (grassland - rainforest), HEFA	37	81,7	774,7	27,3 / 59,2	Stratton et al	40,4	64,9	NO
	Palm oil (rainforest - peatland), HEFA	30,1	153,2	801,2	22,5 / 38,1	Stratton et al	37,4	76,5	NO
	PFAD (Palm Fatty Acid Distillate)							20,7	NO
	Rapeseed oil (set aside land), HEFA	54,9	78,2	128,5	39,8 / 75,9	Stratton et al		71,5	NO
	Jatropha, HEFA	39,4			31,8 / 45,1	Stratton et al	46,8	-1,3	NO
	Algae, HEFA	50,7			14,1 / 193,2	Stratton et al			NO
	Salicornia, HEFA	47,7			30,5 / 66,1	Stratton et al			NO
	Used Cooking Oil, HEFA	19,4			16,8 / 21,4	Seber et al		13,9	YES
	Tallow (waste, no methane), HEFA	29,8			25,7 / 37,5	Seber et al		22,5	YES
	Camelina, HEFA	47				de Jong et al	42	28,6	NO
ATJ	Corn	65	79			ICCT - GREET	55,8	77,9	NO
	Corn stover, agricultural residues	35				de Jong et al	29,3		YES
	Sugar cane	48,1	65,1			ICCT - Staples	24	31,3	NO
	Energy crops	20,3				ICCT - GREET			YES
FT	Switchgrass (w/o soil sequestration)	17,7			11,9 / 26	Stratton et al	10,4	6,6	YES
	Poplar	10				de Jong et al	12,2	7	YES
	Corn Stover	13				de Jong et al			YES
	Forestry residues	6				de Jong et al	8,3	8,3	YES
	Agricultural residues	6,3				ICCT - GREET	7,7	7,7	YES
	Municipal Solid Waste	14,8				ICCT - GREET	5,2	5,2	YES
	Energy crop other than switchgrass (such as Miscanthus)	11,7				ICCT - GREET	10,4	-22,5	YES
Power to Liquids, assuming 26,48 kWh / kg	eFuel from Wind & Solar (50/50)	15,6	26			IPCC 2018			YES
	eFuel from Nuclear and / or hydro	7,2	12			IPCC 2018			YES
	eFuel from Grid - Europe	136,6	227			EEA - 2020			NO
	eFuel from Grid - Sweden	4,8	8			EEA - 2020			YES
	eFuel from Grid - Germany	187,8	312			EEA - 2020			NO

TABLE 19 Comparing eCO₂ emissions of conventional jet fuels, alternative jet fuels from fossil, most studied biofuels and efuels considered for aviation, source Jean-Baptiste Jarin with data Stratton et al, Seber et al, de Jong et al, ICCT, IPCC and EEA

In FIGURE 54 are presented the results in g eCO₂ / MJ for the most considered SAF, but also lower carbon aviation fuels since CORSIA considers lower carbon aviation fuels as eligible, using the data from peer reviewed published articles presented in TABLE 19 above.

Since CORSIA values can be different, one should understand that some fuels considered as sustainable by CORSIA, such as Palm Oil HEFA, are not further considered in this study since not only the deviation with scientific literature is important but also the EU regulation does not authorize such feedstocks in its directive 2018/2001 Annex IX ³⁴⁸, amended 2024/1405 ³⁴⁹.

³⁴⁷ <https://www.sia-partners.com/fr/publications/publications-de-nos-experts/observatoire-francais-des-e-fuels> page 50, accessed August 13, 2024

³⁴⁸ <https://eur-lex.europa.eu/eli/dir/2018/2001/oj> page 123 or L328/204, accessed August 13, 2024

³⁴⁹ <https://eur-lex.europa.eu/legal-content/EN/TXT/PDF/?uri=OJ:L.202401405> page 3, accessed August 13, 2024

FIGURE 54 demonstrates the importance of having a strict SAF definition, and the next chapters will only consider the feedstocks and processes which do not offer only the best yields and eCO₂ emissions reduction, but more importantly which meet the European Union definitions and reduction objectives. Indeed, producing efuel from the grid in Germany would be quite counter-productive, as importing palm oil from Asia, or displacing corn production to produce fuels instead of food (which results in importing soy meal to feed European livestock and poultry).

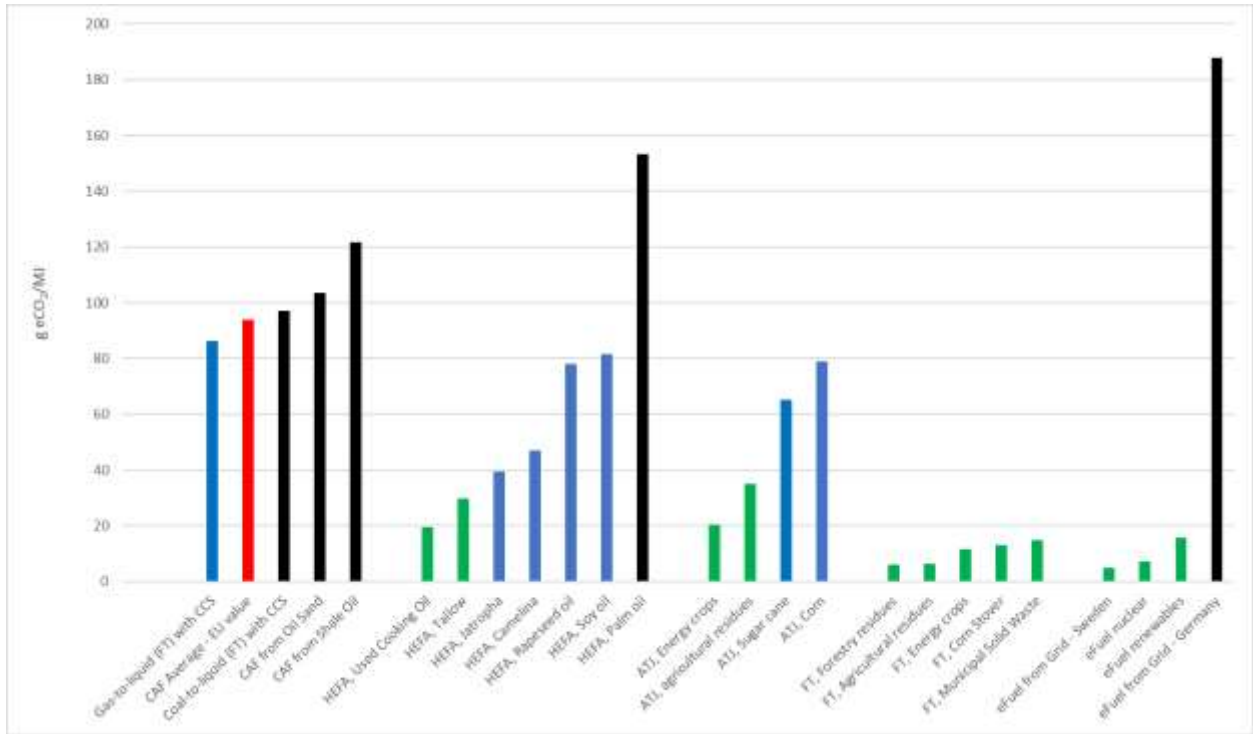

FIGURE 54 Comparing jet fuels emissions, in g eCO₂/MJ. In red the CAF reference within EU regulation (94 g eCO₂/MJ), in green the SAF which are accepted within the EU regulation and CORSIA, in blue the SAF or CAF from fossils allowed as lower carbon fuel or sustainable aviation fuels accepted within CORSIA but considered as non-sustainable within EU regulation. Source Jean-Baptiste Jarin. Nota: HEFA Palm Oil, in black, is accepted within CORSIA, see TABLE 19 above

Chapter I.III.3 below will therefore consider that a 100% SAF would save 80% eCO₂ compared to fossil jet fuel, an average value of 18.8 g eCO₂ / MJ. It is noted here that the CAF or SAF accepted within CORSIA, in blue, are not only considered as non-sustainable by the EU regulation, but moreover their carbon intensity are too high to significantly reduce the aviation emissions.

I.III.2. Role of sobriety in use

While technology will keep progressing, although at a lower pace than in the past, and SAF are called to play a major role in the decarbonization of air mobility, history have proved that more efficient aircrafts gains were largely offset by speed and traffic increase. The role of sobriety of use is therefore mandatory to decrease the sector’s emission (chapter I.III.3).

Efficiency and sobriety have different meanings. As discussed above, more efficient airplanes came along with increased eCO₂ emissions, the efficiency, -80% in 50 years in fuel burn per passenger (PSK), allowing lower costs thus lower airfares. This situation translated into very significant increase in air traffic, which is multiplied by 20 during the same period. The paradox of Jevon, as concluded by Alcott in Jevons’ paradox³⁵⁰, can be fully applied to aviation, as an increased fuel efficiency, here by a factor of almost 5, led to increase 4 folds of the same resource, therefore quadrupling the eCO₂ emissions of the sector during the same period. The author concludes that “*even taxes on fuel or CO₂ would be compensated by efficiency increases*” and that “*business as usual but also policy induced efficiency gains are partial causes of the environmental stress*” enhancing “*the attractiveness of directly lowering impact through rationing and quotas, whether resources or emissions*”. This approach will therefore be considered when building possible future scenarios for aviation, which will be discussed in the next sub-chapter.

This is well illustrated with the current strategies deployed in aviation economics. As discussed above, the replacement of propeller-driven aircraft by jets immediately increased fuel consumption by a factor of 3 in the late '50s, however flying faster brought significant economic advantages and jets were immediately massively adopted by the air transport industry, in less than 5 years. The introduction of more efficient turbines kept pace only with rising oil prices, as demonstrated by the saga of the CFM56 in the late 70s.

While modal shift or reducing speed should be embraced by aviation as it would significantly cut fuel consumption and therefore eCO₂ emissions, this will be discussed below, the economic efficiency prevails, and it is not always in favor of reducing the fuel burn as time can a more decisive factor for airlines despite fuel being a significant share in airlines expenses as shown in TABLE 20.

Share of Fuel in Airlines expenses as % of total from 1979 to 2019		Source
1959	12,7	ATA
1979	28,8	ATA
1998	11,3	Airbus - IATA
2019	23,7	IATA

TABLE 20 Comparing the share of fuel in airlines expenses, values are given as a percentage of the total expenses, average of the industry. Source Jean-Baptiste Jarin with data from ATA Annual Reports for 1959³⁵¹ and 1979³⁵², Airbus for 1998³⁵³ and IATA for 2019³⁵⁴.

³⁵⁰ Blake Alcott, Jevons' paradox, Ecological Economics, Volume 54, Issue 1, 2005, Pages 9-21, ISSN 0921-8009, <https://doi.org/10.1016/j.ecolecon.2005.03.020>

³⁵¹ <https://airlines.org/wp-content/uploads/2014/08/1960.pdf> page 6, accessed August 13, 2024

³⁵² <https://airlines.org/wp-content/uploads/2014/08/1979.pdf> page 3, accessed August 13, 2024

³⁵³ <https://ansperformance.eu/library/airbus-cost-index.pdf> page 8, accessed August 13, 2024

³⁵⁴ <https://www.iata.org/en/iata-repository/publications/economic-reports/airline-industry-economic-performance---november-2020---data-tables/> page 1, accessed August 13, 2024

I.III.2.1. Cost Index

Time is money, and this expression has probably never been truer than with aviation. As detailed by both Airbus³⁵⁵ and Boeing³⁵⁶ as early as 1998, the Cost Index reflects the ratio between the time-based cost of operating an aircraft and the cost of fuel. The value of Cost Index reflects the relative effects of fuel cost on the overall cost of the trip compared with the direct time-based operating cost. In short burning more fuel can be found more economical for an airline.

The basic equation being $Cost\ Index = \frac{Time\ Cost\ (\frac{\$}{hour})}{Fuel\ Cost\ (\frac{\$}{ton})}$ the rationale being that the Cost Index is to achieve minimum trip cost by means of a trade-off between operating costs per hour and incremental fuel burn. For Boeing it is calculated in \$/hour for the time and \$/100 pounds for the fuel. For Airbus, it is in \$/minute and \$/kg. The scale varies depending of the aircraft but the principles and results are the same.

While the cost of fuel can be captured globally³⁵⁷ or within each airline, it can be complicated to precisely determine as fuel tankering and fuel hedging are common practice within airlines

The cost of time is even more complex and it will vary across airlines, but it basically considers aircraft model, route, aircraft hourly maintenance costs, crew costs, leasing costs and aircraft depreciation.

For the extreme, a minimum value for the Cost Index results in minimum trip fuel, the opposite resulting in maximum flight envelope speeds, thus ignoring the higher fuel consumption.

Once determined by the airlines the Cost Index value is directly entered by the crew into the aircraft flight management computer, which will then propose the most appropriate climb, cruise, and descent speeds.

FLEET	CURRENT COST INDEX	OPTIMUM COST INDEX	TIME IMPACT MINUTES	ANNUAL COST SAVINGS (\$000's)
737-400	30	12	+1	US\$754 – \$771
737-700	45	12	+3	US\$1,790 – \$1,971
MD-80	40	22	+2	US\$319 – \$431

FIGURE 55 Impact of a different Cost Index on annual cost savings, Boeing aero magazine 2007, source Boeing

According to Boeing in its 2nd quarter 2007 Aero Magazine, FIGURE 55 above, the difference for airlines can be calculated in million dollars per year understanding that the associated impact in time per flight goes from only 1 to 3 minutes.

³⁵⁵ <https://ansperformance.eu/library/airbus-cost-index.pdf> page 7, accessed August 13, 2024

³⁵⁶ http://www.boeing.ch/commercial/aeromagazine/articles/qtr_2_07/AERO_Q207.pdf page 26, accessed August 13, 2024

³⁵⁷ <https://www.iata.org/en/publications/economics/fuel-monitor/> accessed August 13, 2024

It is noted here that a similar approach is available for fuel tankering, the software calculating the best extra fuel to carry once data regarding the fuel price difference between the departure and arrival airport, the MTOW and the distance are gathered ³⁵⁸.

This Cost Index approach demonstrates that economic intensity is preferred to eCO₂ intensity in aviation and it can explain the decision of some airlines to replace more efficient turboprops by less efficient jets those past years, such as Hop which now only operates jets when historically turboprops were half of its fleet ³⁵⁹³⁶⁰.

But with the increasing cost of jet fuel, which will soon be driven by the cost of SAF which are significantly more expensive than CAF (sub-chapter III.1 of Part II), reducing speed might soon become a reality.

I.III.2.2. The role of speed in eCO₂ emissions

Jets have recently reduced their speeds, the cruise Mach number becoming more important than the max Mach number. Supersonic flight is not seriously considered by the industry and even the latest subsonic aircrafts such as the Boeing 787 or Airbus A350 have reduced their cruising speed, Mach 0.85 ³⁶¹, when the promised of the Boeing Sonic Cruiser in the late 90's was Mach 0.98 ³⁶² a time where jet fuel cost was much lower than today.

With increasing fuel costs, the Cost Index might now tend to reduce fuel burn versus time, as highlighted by the study of Alves et al in Aircraft Propellers - is there a future ³⁶³, the Mach cruise speed for a total of 80 flights from various airlines in Europe with Boeing 737-800 and Airbus A320neo jets have been reduced, showing an average of Mach 0.769.

For Torenbeek the future of aviation will be closer to Mach 0.75. In Advanced Aircraft Design ³⁶⁴, the author concludes that the "future long-range airliners optimized for environmentally friendly operation may cruise at no more than Mach 0.75 (800 km/h).

Reducing speed shall change the way aircrafts are designed and developed. Propfan seems to be the most promising design for the future medium to long range aircraft, as proposed by CFM ³⁶⁵ with the RISE program ³⁶⁶, which aims for a service entry within 10 to 15 years.

For short and medium range aircrafts, as shown in FIGURE 56 below, jets might, or should if tackling climate change is the goal, be replaced by Turboprops. While not the core of this thesis, it is reminded here that as turboprops fly lower than jets, they are not concerned with contrails.

³⁵⁸ <https://support.universalweather.com/hc/en-us/articles/10606700597275-Performing-Fuel-Tankering-Calculations-in-Flight-Planning> accessed August 13, 2024

³⁵⁹ <https://www.airfleets.fr/flottecie/Hop!.htm> accessed August 13, 2024

³⁶⁰ <https://www.hop.fr/notre-flotte/> accessed August 13, 2024

³⁶¹ <https://simpleflying.com/boeing-787-vs-the-airbus-a350/> accessed August 13, 2024

³⁶² <https://secure.boeingimages.com/archive/Sonic-Cruiser-with-Angled-Canards-in-Flight-2F3XC5HT3ES.html> accessed August 13, 2024

³⁶³ Alves, P.; Silvestre, M.; Gamboa, P. Aircraft Propellers—Is There a Future? *Energies* 2020, 13, 4157.

<https://doi.org/10.3390/en13164157>

³⁶⁴ Torenbeek, E. *Advanced Aircraft Design: Conceptual Design, Analysis and Optimization of Subsonic Civil Airplanes*; John Wiley & Sons: Delft, The Netherlands, 2013; ISBN 978-1-118-56811-8,

https://books.google.com/books?hl=fr&lr=&id=C0gUyoYewhoC&oi=fnd&pg=PT7&ots=pscSaKJs1V&sig=f9PCvpf_Ex7LERX_GQKXR31W-CjA chapter 2.1.2

³⁶⁵ <https://newatlas.com/aircraft/ge-cfm-rise-open-fan/> accessed August 13, 2024

³⁶⁶ https://www.cfmaeroengines.com/wp-content/uploads/2021/07/CFM_RISE_Whitepaper_Media.pdf accessed August 13, 2024

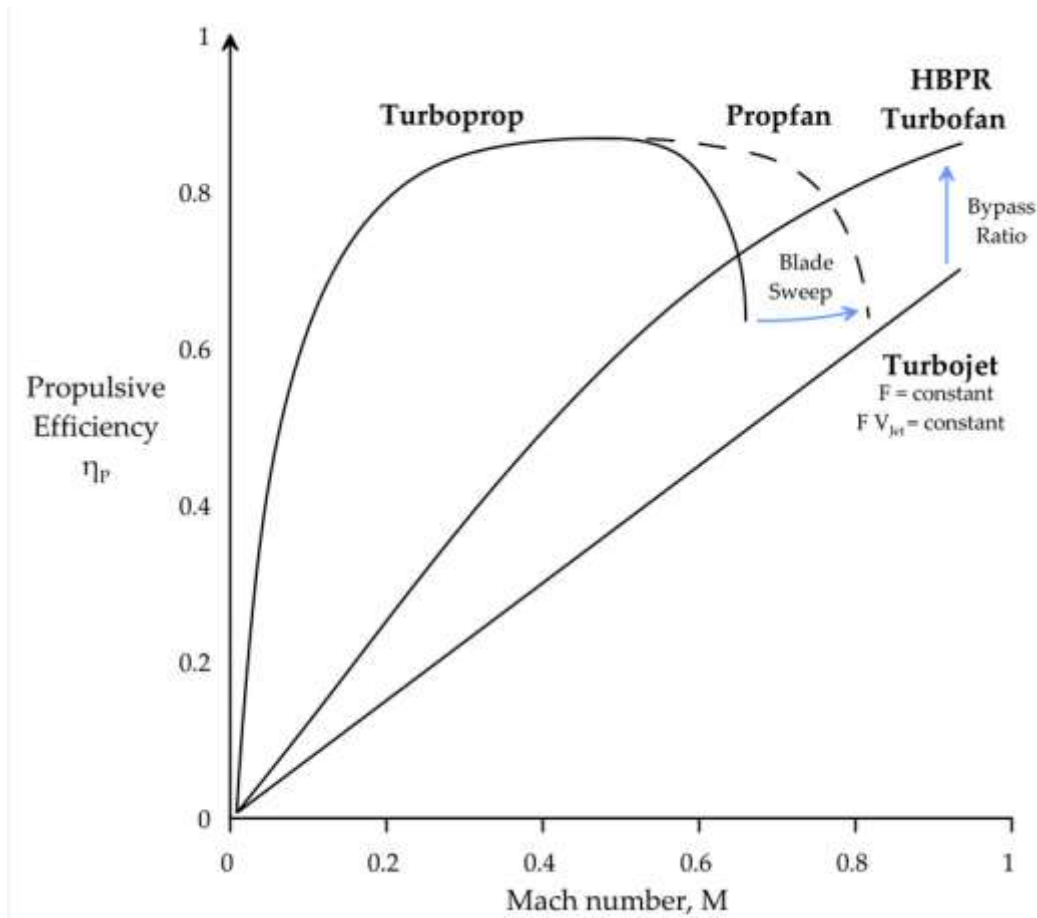

FIGURE 56 Typical propulsive efficiencies for the most common aircraft engine types, originally figure 3 of Aircraft propellers – is there a future, source Alves, Silvestre, Gamboa, Aircraft Propellers – Is there a future ? with courtesy of authors and MDPI

The shorter the route the more efficient is a Turboprop as Jets need to gain as much altitude as possible, typically above 10 000 meters, to get the most out of their engines while Turboprop will operate at approximately 6000 meters as propellers can maintain high efficiency in the denser air found at lower altitudes. Operating at lower altitude also means that there no issues with contrails as they generally form above 8000 meters ³⁶⁷. Turboprops are also more efficient than jets in hot & high conditions, which are becoming more frequent with climate change (chapter I.1 above).

In order to compare the two technologies, and with the courtesy of the management of Amelia ³⁶⁸, data performed with Jets and Turboprops of similar range and payloads have been collected and analyzed.

The data covers more than 6000 flights operated by the airline Amelia over a 12 months period for the aircrafts considered. Return trips have been preferred for the analysis to minimize wind and other weather-related effects. The aircrafts considered for the study are the Embraer ERJ135-145 and ATR42-500.

The ERJ135-145 are regional jets, seating 30 to 50 passengers, and ATR42 is a TurboProp seating 48.

Both aircrafts were developed in the 80s, but the first variant of the ATR42 entered into service in 1985 while the first variant of the ERJ45 entered into service in 1996. The ATR42-500 entered into service in 1995 and both aircrafts can be defined as belonging to the same generation. Key technical data are listed in TABLE 21 below and for this study were compared the 50 seats configuration of both aircrafts operated by Amelia Airline (ERJ145 and ATR42-500).

³⁶⁷ <https://elib.dlr.de/58314/1/i1520-0469-66-2-227.pdf> page 235, Table 1, accessed August 13, 2024

³⁶⁸ <https://flyamelia.com/> accessed August 13, 2024

	ERJ135	ERJ145	ATR42-500
Max Cruise Speed	M.78 (963 km/h)		M 0.45 (556 km/h)
MTOW	19000	20990	18600
Max Payload	4198	5153	5500
Max Fuel	4132		4500
Time to climb	20 minutes to FL350		12.7 minutes to FL170
Service Ceiling	37000 ft (FL370, 11300 meters)		17000 ft (FL170, 5200 meters)
Range (km)	2400	2200	1300
Seats	37	50	48

TABLE 21 Comparing Jets vs TurboProp, source Jean-Baptiste Jarin with technical data of ERJ135-145³⁶⁹ and ATR42-500³⁷⁰

In TABLE 22 and FIGURE 57 below are presented the results of the fuel burn (block fuel) and time (block time) comparison between an ERJ145 and an ATR42-500, block meaning from the departure gate to the arrival gate. Both aircrafts have similar seatings and payload. The city pairs are Paris Orly to Brive for the ERJ135, a distance (Great Circle Distance) of 415 km, and Paris Orly to Aurillac for the ATR42-500, a distance (GCD) of 425 km. Both cities are located south of Paris Orly airport and offer similar runways and airport facilities.

Artefacts were removed from the analysis, such as significant diversion due to weather or typo, resulting in 661 flights covered for the ATR42-500 and 725 flights for the ERJ145 over a 12 months period. Since the flights are two ways there are no tailwind effects to be considered. The average load factor was also similar, with 20 pax on average for the ATR42-500 and 21 pax for the ERJ145.

Aircraft	City Pair	n° of flights over a 12 months period	Distance (GCD)	Block Time	Block Fuel
			km	minutes	kg
ERJ145	Paris-Orly to Brive	611	415	59	1111
ATR42-500	Paris-Orly to Aurillac	725	425	75	811

TABLE 22 Comparing Jets vs TurboProp block time and block fuel for similar distance / payload, source Jean-Baptiste Jarin with data from Amelia

³⁶⁹ <https://www.embraercommercialaviation.com/commercial-jets/eri145/> accessed August 13, 2024

³⁷⁰ <http://www.atr-aircraft.com/wp-content/uploads/2020/07/42-500.pdf> accessed August 13, 2024

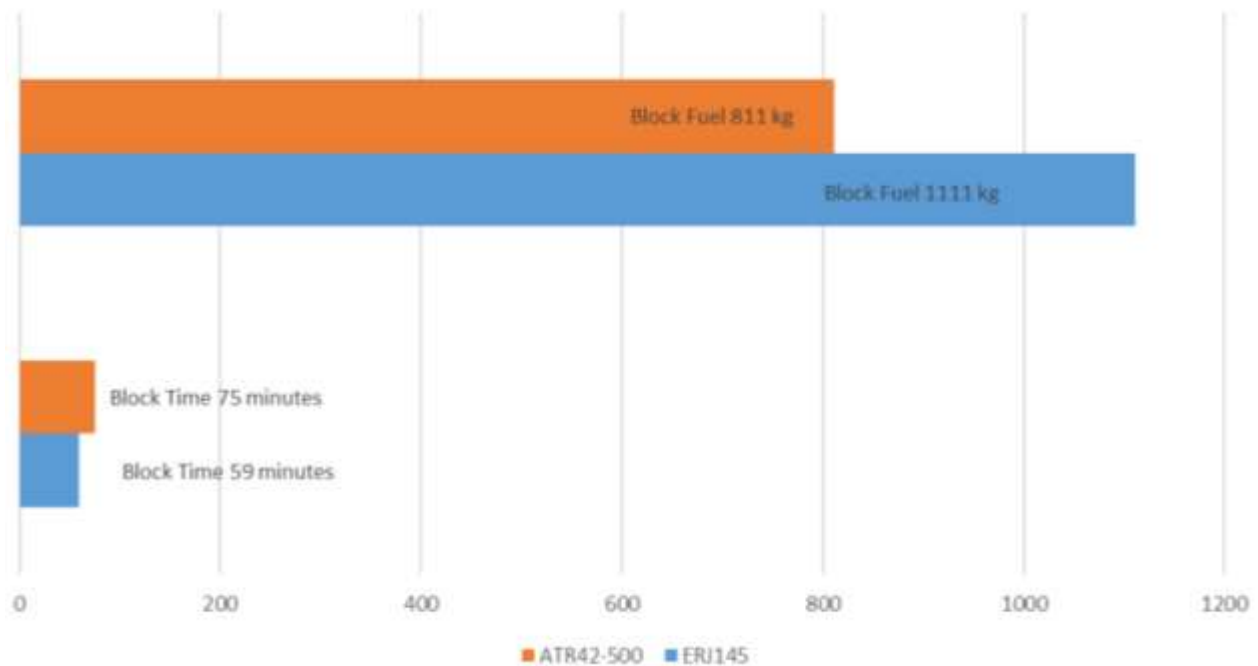

FIGURE 57 Comparing Jets vs TurboProp block time and block fuel for similar distance / payload, 1316 flights over a 12 months period. The gap is 16 minutes in favor of the jet, but with an extra fuel burn of 300 kg, or +37%, source Jean-Baptiste Jarin

The detailed analysis confirms that TurboProp are significantly more fuel efficient than Jets, the difference being -37% for the same distance and same payload. The price to pay in time difference is 16 minutes, which means a noticeable +25%.

The difference in speed between the 2 aircrafts being 75%, this limited time difference confirms that Jets are already being used well below the cruise speed design point to save fuel.

The simple calculation of speed being $V = d/t$, the average block time, which takes into consideration taxiing in and out, is 422 km/h for the ERJ145 and 340 km/h for the ATR42-500. The difference with their max cruise speed being 62% for the ATR and 230% for the ERJ145. These differences clearly demonstrate that the Jet is under optimized for such short distance and that, despite flying slower flying below its cruise design speed, the Jet fuel burn remains significantly higher than TurboProp.

This difference in speed has been confirmed using Flight Radar database with a limited random sample of 30 flights, 15 ERJ145 and 15 ATR42, during summer 2024.

Data are presented in TABLE 23 below: The ERJ145 average speed is 763 km/h vs a max cruise speed of 963 km/h, a 20.7% difference, while the ATR42 average speed is 523 km/h vs a max cruise speed of 556 km/h, the difference being limited to 5.8%.

More important, when considering speed as a passenger service, the average speed block time, which considers ground operations as per ICAO and EEA/EMEP methodology for a total of 26 minutes³⁷¹ (taxi, ground idle), increases significantly and narrows the difference between the two aircrafts to less than 10% will the fuel burn difference would remain unchanged, ie -37%.

³⁷¹ <https://www.eea.europa.eu/publications/emep-eea-guidebook-2023/part-b-sectoral-guidance-chapters/1-energy/1-a-combustion/1-a-3-a-aviation-2023/view> page 12, accessed August 13, 2024

	ERJ145	ATR42
Max Cruise Speed	963	556
Average Cruise Speed, FR	763,64	523,87
% difference real cruise vs max	20,70%	5,78%
Average Distance FR	789,07	408,13
Average Block Time FR	1,8	0,98
Average Speed Block Time	446,4	416,0

TABLE 23 Comparing Jets vs TurboProp speed (converted in km/h) and time (hour), source Jean-Baptiste Jarin with data from Flight Radar (30 random flights in summer 2024)

When considering a flight trip there are additional parameters to consider such as travelling to and from the airport, check-in, luggage, security check. The time associated can fluctuate and in TABLE 24 below an average of 2 hours have been considered for commuter, regional, short, and medium haul flights. These categories are the ones proposed par IATA – ATAG in Waypoint 2050 ³⁷². With an average distance considered from 380 to 1 520 km, it embraces most of the European network, and 70% of the global aviation fuel burn, or eCO₂ emissions as shown in FIGURE 58 below with data from IATA-ATAG Waypoint 2050, page 54.

TIME FACTOR Jet vs Turboprop	Jet - Average Flight Speed 760 km/h						TP - Average Flight Speed 410 km/h			
	Typical Flight Time, minutes	Average flight time considered, minutes	Considered distance as function of flight speed and flight time	Return trips to and from airports, Security, Boarding, Disembarkation, Luggage	Taxi, Ground Idle	Jet, Total average time	Flight Time Impact, ratio	Flight Time Impact, minutes	TP, Total average time	Time Impact if TP instead of Jet, %
Commuter	Below 60	30	380	120	26	176	0,54	16,2	192,2	9,20%
Regional	30-90	60	760			206	0,54	32,4	238,4	15,73%
Short haul	45 - 120	90	1140			236	0,54	48,6	284,6	20,59%
Medium haul	60 - 150	120	1520			266	0,54	64,8	330,8	24,36%

TABLE 24 Comparing Jets vs TurboProp speed difference and associated impact on total travel time, source Jean-Baptiste Jarin

The notion of time elasticity of demand, which is detailed by Beloba, Odini and Barnhart ³⁷³ can be introduced here. Time elasticity is the percentage change in demand that occurs with a 1% increase in total time, as defined previously. Time elasticity is negative, an increase in total time will cause a demand decrease, but only if all else being equal, i.e. no change in prices. While business air travel demand is assumed to be more time elastic ($E_t < -1.0$), business passengers have proved to travel more frequently if total trip time is reduced as comfort and efficiency are improved, leisure demand is assumed to be time inelastic ($0 > E_t > -1.0$) since tourists are more willing to endure longer total trip times to secure a lower fare.

Understanding that the difference in fuel burn would remain 37% in favor of Turboprop, the impact on time for flights up to 1500 km, 24%, seems reasonable and could be accepted by most of the passengers, leisure representing now ¾ of the trips.

It is however probable that the Cost Index will prevail within the aviation industry and that only a significant increase in fuel prices could encourage airlines to seriously consider a return to the Turboprop.

³⁷² https://aviationbenefits.org/media/167417/w2050_v2021_27sept_full.pdf page 54, accessed August 13, 2024

³⁷³ <http://komaristiy.ru/stud/the.global.airline.industry.pdf#page=68> page 62, accessed August 13, 2024

Since the development of an aircraft takes around 10 years, the successors to the regional jets, as well as the successors of Airbus and Boeing's short-haul aircraft (A320 and B737), should be considered. This should be addressed within our public policies and as from in France and Europe within the Advisory Council for Aeronautics Research in Europe (ACARE), since public subsidies are at stake.

To feed the next sub-chapter, Proposed scenarios, reflecting this gap in fuel burn between Turboprop and Jets as in conjunction with the distribution of aircraft emissions by category as shown in FIGURE 58 below, a proposal would be that the next generation of aircrafts which will enter into service by 2035-2040 should be Turboprops up to the medium haul segment.

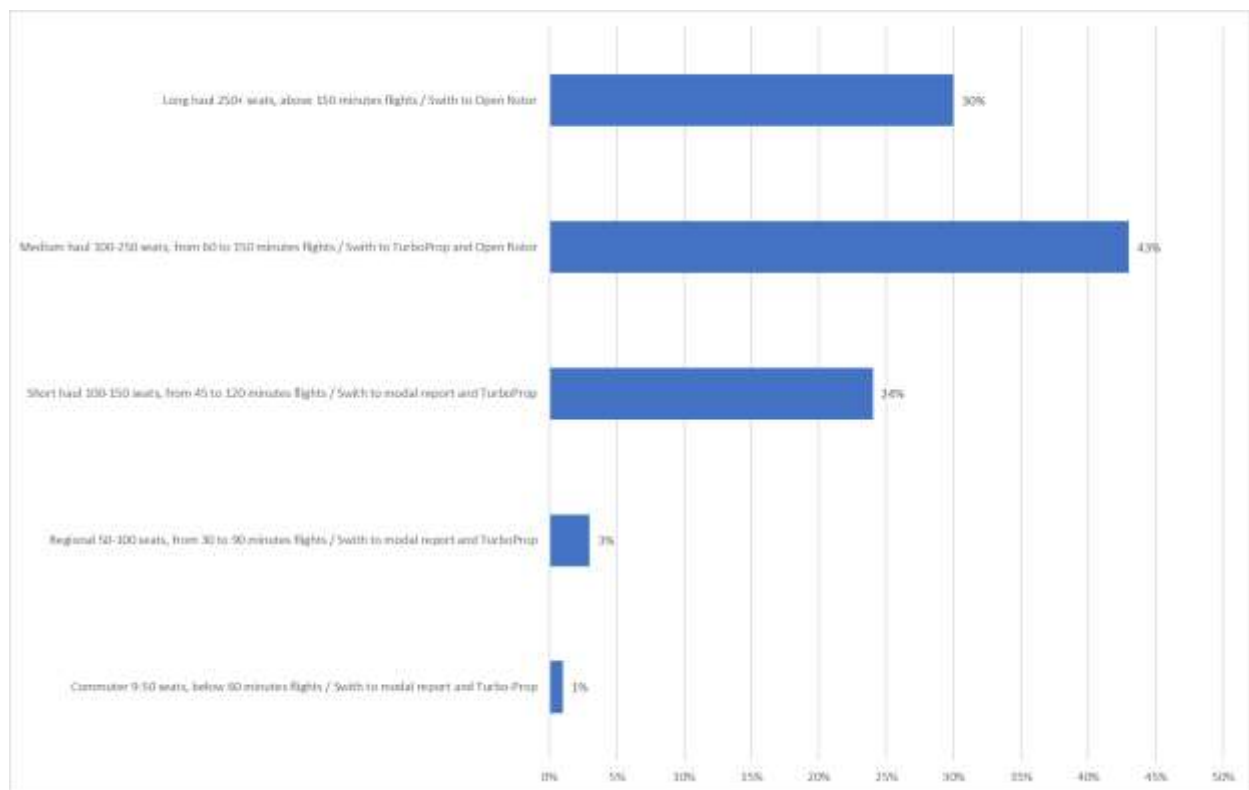

FIGURE 58 Share of fuel burn and associated eCO₂ emissions per aircraft category as % of total, source Jean-Baptiste Jarin with data from ATAG. TurboProp (Mach 0.45), Open Rotor (Mach 0.75)

I.III.2.3. Modal shift

Some modal shift articles between aviation and train are available in the literature. In Europe Prussi et al compared the emissions between some European major cities ³⁷⁴, in Scandinavia Morfeldt et al evaluated the emissions when comparing night train vs aviation ³⁷⁵, in Australia Robertson studied the city pair Sydney-Melbourne ³⁷⁶ or China, which

³⁷⁴ Prussi & Lonza, Passenger Aviation and High Speed Rail: A Comparison of Emissions Profiles on Selected European Routes, Journal of Advanced Transportation, Volume 2018, Article ID 6205714, 10 pages, <https://doi.org/10.1155/2018/6205714>

³⁷⁵ Morfeldt et al, Carbon footprint effects of shifting from flights to night trains for Swedish tourism, Journal of Cleaner Production, Volume 420, 2023, 138321, ISSN 0959-6526, <https://doi.org/10.1016/j.jclepro.2023.138321>

³⁷⁶ Robertson, The potential mitigation of CO₂ emissions via modal substitution of high-speed rail for short-haul air travel from a life cycle perspective – An Australian case study, Transportation Research Part D: Transport and Environment, Volume 46, 2016, Pages 365-380, ISSN 1361-9209, <https://doi.org/10.1016/j.trd.2016.04.015>

has already an extensive high-speed rail (HSR) network³⁷⁷. All concluded that the modal shift would reduce CO₂ emissions, even when more train tracks and infrastructure are required, the highest gain being for highly populated city pair. The conclusions of the aviation industry differ³⁷⁸ with the report of the consulting firm Oxera ordered by the aviation industry³⁷⁹ and concludes that there is the need for a case-by-case assessment.

Overall, as concluded by Bartoli and Féraille “*HSR can decarbonize mobility*”, along with other modal shift such as coach or car-pooling³⁸⁰.

This modal shift is supported by the European Union. In December 2020, European Union EVP Timmermans, responsible for the European Green Deal, underlined that “*We need to limit short-haul journeys by aviation and make sure that under 500 km within Europe travel becomes carbon neutral... Meaning less flights, more trains and cleaner public transport*”³⁸¹. The objectives are to tackle the climate crisis, improve local air quality but also to offer a resilient transport system to cope with the risks associated to climate change (I.I.1).

Public policies are therefore evolving, with more support to high-speed rails, especially in Europe and China.

Several countries are implementing measures to initiate this modal shift such as France, Austria, Spain, or Germany. Some measures are based on prices, such as Belgium which introduced a €10 tax on short-haul flights that less than 500km from Brussels Airport, or Austria, which implemented a minimum price, 40 euros, for all airline tickets to avoid dumping and which could support train rather plane for short distance. But the most significant measure comes from France and Spain.

In both country, 2023 in France³⁸², 2024 in Spain³⁸³, domestic short-haul flights were a train journey alternative below 2H30 exist are banned to discourage flying and encourage train travel. The restriction includes an exception for connections with hub airports that link with international routes, which significantly limit the measure, but this is a significant change compared to less than ten years ago, when the French airline decided to launch a commercial sales offensive to compete with the French train operator for domestic travels³⁸⁴.

Spain is following France, which journey to flight ban started in 2021 with the conclusions of the citizens' climate convention and the enactment of the Climate and Resilience Law in August 2021. Following approval by the European Commission and the French Council of State in December 2022, the decree relating to this cancellation came into force in May 2023³⁸⁵. As a result, three air routes are now banned in France: Paris Orly - Nantes, Paris Orly - Lyon and Paris Orly - Bordeaux.

This seems to go into the right direction, but this decree is far for the initial proposal, which proposed to ban all flights when a train journey alternative below 4H00 exist, including hub airports that link with international routes³⁸⁶. When 8 routes with over 35 000 domestic flights per year would have been concerned with the initial proposal, the final

³⁷⁷ Yu et al, Effects of railway speed on aviation demand and CO₂ emissions in China, Transportation Research Part D: Transport and Environment, Volume 94, 2021, 102772, ISSN 1361-9209,
<https://doi.org/10.1016/j.trd.2021.102772>

^{378,379} <https://aviationweek.com/air-transport/airports-networks/modal-shift-study-points-complications-moving-air-rail> accessed August 13, 2024

³⁷⁹ https://www.oxera.com/insights/agenda/articles/grounded-the-environmental-implications-of-modal-shift-from-air-to-rail/#_ftn11 accessed August 13, 2024

³⁸⁰ Bortoli, Féraille, Banning short-haul flights and investing in high-speed railways for a sustainable future?, Transportation Research Part D: Transport and Environment, Volume 128, 2024, 103987, ISSN 1361-9209,
<https://doi.org/10.1016/j.trd.2023.103987>

³⁸¹ https://ec.europa.eu/commission/presscorner/detail/en/SPEECH_20_2370 accessed August 13, 2024

³⁸² <https://www.bbc.com/news/world-europe-65687665> accessed August 13, 2024

³⁸³ <https://www.eraa.org/proposed-ban-short-haul-flights-spain> accessed August 13, 2024

³⁸⁴ <https://www.connaissancedesenergies.org/tribune-actualite-energies/le-co2-aerien-francais-ecrase-la-cop21> accessed August 13, 2024

³⁸⁵ <https://www.publicsenat.fr/actualites/environnement/interdiction-des-vols-interieurs-courts-un-engagement-a-minima> accessed August 13, 2024

³⁸⁶ https://www.lemonde.fr/les-decodeurs/article/2023/05/24/l-interdiction-des-vols-interieurs-courts-en-france-une-mesure-vidée-de-sa-substance_6174641_4355770.html accessed August 13, 2024

decree is finally limited to 5000 flights / year for the 3 city pairs mentioned above. This measure is therefore to be seen as a pioneering one.

As concluded Txapartegi et al in Short-haul flights ban in France: Relevant potential but yet modest effects of GHG emissions reduction ³⁸⁷ *“results are showing that the implementation is still having a quite limited quantitative effect... introducing a city-by-city basis...reduced emissions of CO₂ can be multiplied by >3 times”*.

Finally, one must acknowledge that such a ban has negative economic effects on the airline industry, and its entire value chain, which is more consistent than with rail, and that the expected effects can go beyond the short-haul, the traveler being engaged to think about its final destination. It is probably this last reason that justifies IATA's tough stance on this measure ³⁸⁸.

Modal shift could have a major role in reducing air mobility eCO₂ emissions and it is a variable to be considered in the next sub-chapter. While not being investigated here, it is noted here that the role of urban air mobility (UAM) is the reverse proposal from the sector: allowing some to leave public transportation, or cars or taxis, for UAM to potentially improve speed. Using the technical datasheet of one of the most advanced industrial, which aims to propose some demonstration flight during summer 2024 in Paris, it was found when using one of the UAM technical data sheet ³⁸⁹ that carrying one passenger over 20 kilometers, the distance between Paris to its main airport, would require approximately 50 kWh of electricity, which is enough to carry 3 passengers in an electric taxi in comfort for almost 300 kilometers. In any case this means a 45 folds increase in energy consumption and therefore eCO₂ emissions. This situation should give us food for thought about the uses we make of technology. Science without conscience is but the ruin of the soul.

³⁸⁷ Txapartegi, Cazcarro, Galarraga, Short-haul flights ban in France: Relevant potential but yet modest effects of GHG emissions reduction, Ecological Economics, Volume 224, 2024, 108289, ISSN 0921-8009, <https://doi.org/10.1016/j.ecolecon.2024.108289>

³⁸⁸ <https://www.iata.org/en/iata-repository/publications/economic-reports/french-domestic-flight-bans-and-carbon-emissions-reductions/> accessed August 13, 2024

³⁸⁹ <https://www.ovans.es/wp-content/uploads/2017/08/Volocopter-2X-design-specifications-ovans.pdf> accessed August 13, 2024

I.III.3. Proposed scenarios for the decarbonization of Air Mobility

While ICAO (International Civil Aviation Organization) belongs to the United Nations (UN) and can cite some objectives with the implementation of CORSIA, there are not yet any firm commitment equivalent to the nation's determined contribution (NDCs) but a "Long Term Aspirational Goal" (LTAG) ³⁹⁰. It also has been found in I.II.2 that the first engagement to lower eCO₂ emissions will be limited to offset for emissions above the 2019 level, this engagement being mandatory starting 2027, therefore 30 years after the Kyoto Protocol which asked aviation to propose a roadmap to lower its carbon footprint. The aviation eCO₂ emissions in 1997 were approximately 820 Mt while reaching 1396 Mt in 2019, and most probably a figure close to 1500 Mt by 2027. In 30 years, instead of being reduced, eCO₂ emissions have been multiplied by almost 2.

I.III.3.1. ICAO and IATA scenarios

As such, the official proposed scenario for aviation considered in this study is limited to the objectives set by the IATA, ATAG and other industry leaders, including aircraft and engine manufacturers, in 2012 as shown in FIGURE 59, which stipulates "...demonstrate environmental leadership by delivering on our goal to cap net aircraft carbon emissions from 2020 and work to achieve our ambitious goal of a 50% reduction in net carbon emissions by 2050 compared to 2005 levels" ³⁹¹.

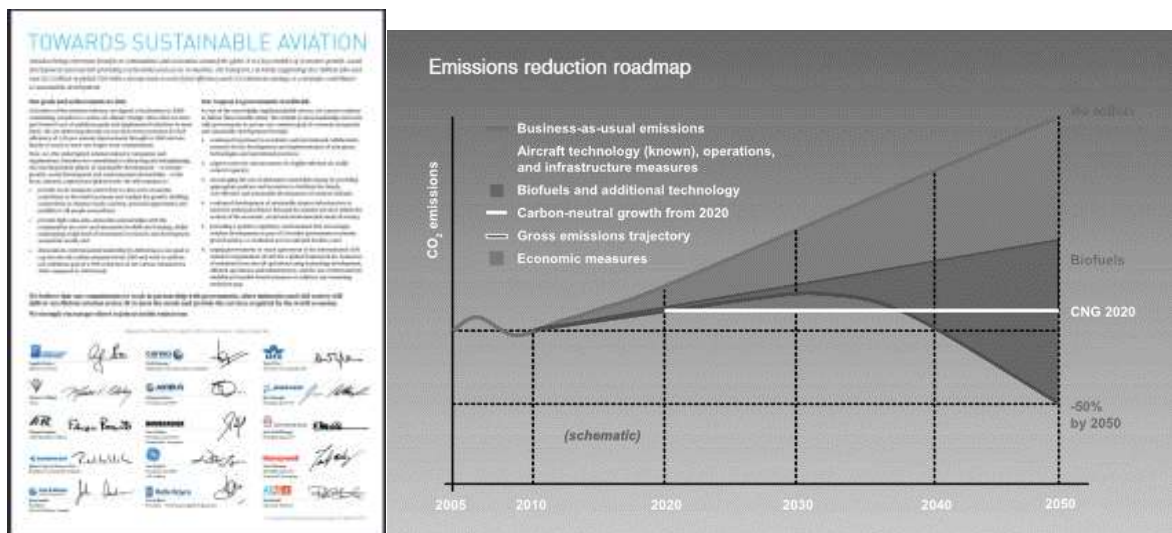

FIGURE 59 ATAG 2012 summit declaration, toward sustainable aviation (left)

FIGURE 60 IATA Annual report, page 27, sources ATAG and IATA (right)

This statement is made in March 2012 and reinforce the objectives of IATA proposed in 2010, FIGURE 60 above. In 2021, during its 77th annual general meeting, IATA proposed to go beyond these objectives in a Resolution on the industry's commitment to reach net 0 carbon emissions by 2050 ³⁹², which led to the endorsement of LTAG by ICAO in October 2022. During this meeting, IATA compared the results achieved since the 2010 agreed goals to address aviation's CO₂ emissions "namely: an average improvement in fuel efficiency of 1.5% per year between n 2010 and 2020; a cap on net aviation CO₂ emissions from 2020; and a reduction in net aviation CO₂ emissions of 50% by 2050

³⁹⁰ <https://www.icao.int/Newsroom/Pages/States-adopts-netzero-2050-aspirational-goal-for-international-flight-operations.aspx> accessed August 13, 2024

³⁹¹ https://atag.org/media/3etlk22z/2012-summit-declaration_web-res-3-1.pdf accessed August 13, 2024

³⁹² <https://www.iata.org/contentassets/d13875e9ed784f75bac90f000760e998/iata-agm-resolution-on-net-zero-carbon-emissions.pdf> accessed August 13, 2024

relative to 2005 levels”, considering that since then “a lot of progress has been made” despite a net increase in eCO₂ emissions of +50%, or 3% CAGR as shown in FIGURE 19 during the same period.

Moreover, the IATA 2021 statement stipulates that “the industry’s action is supported by a coherent and coordinated policy framework which drives innovation and initiative”, which could mean public subsidies, “does not rely on cost-ineffective instruments with little or no environmental benefits such as ticket and carbon taxes” and requires “fuel-producing companies providing large scale, cost-competitive sustainable aviation fuels to the market”, “governments and air navigation service providers eliminating inefficiencies in air traffic management and airspace infrastructure”, “aircraft and engine manufacturers producing radically more efficient airframe and propulsion technologies”, “airport operators providing the needed infrastructure to supply SAF, at cost, and in a cost-effective manner”. When detailing climate targets since 1997 which were often missed, such as those for SAF, these requirements could be interpreted as conditions for success despite the climate change emergency. This interpretation being reinforced by the recent statement of a major airline “CEO of Qatar airways has described the airline industry’s emissions goals as Public Relation exercise, saying aviation is on track to miss its...2030...and 2050 targets”³⁹³.

However The IATA Net 0 roadmap was released in 2023³⁹⁴, FIGURE 61 below, detailing the main levers envisaged by the organization in which SAF would play a major role. This is even more true if we consider that hydrogen technology will not be available in the near future and that SAF would prevail instead (sub-chapter I.III.2 above and Part II.I.2).

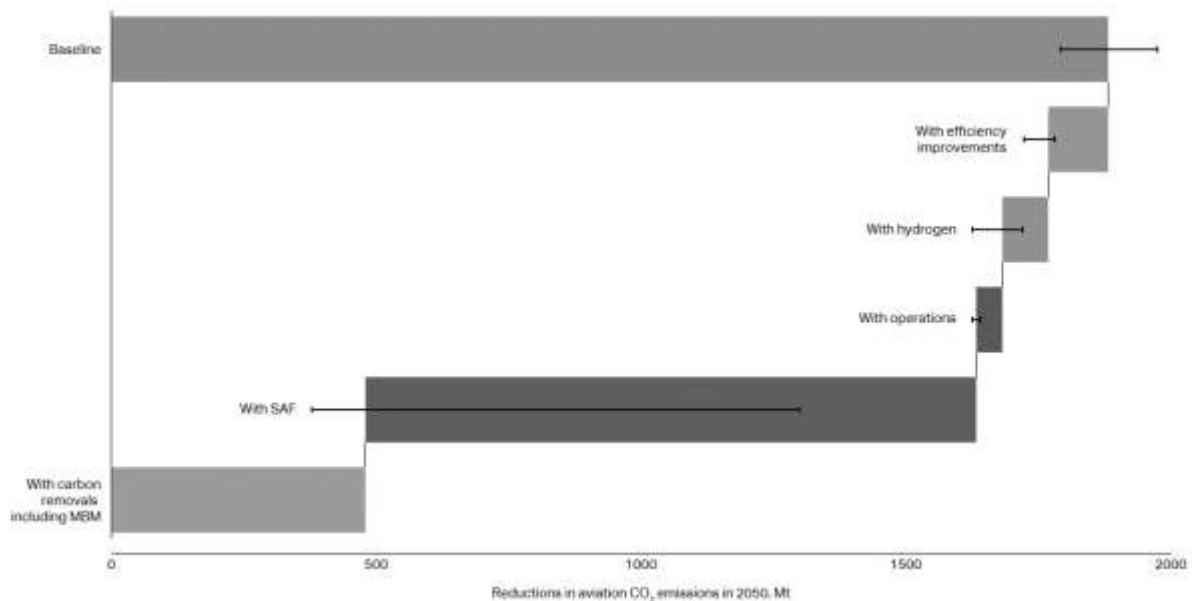

Source: IATA Sustainability and Economics, ICAO LTAG SAF availability scenarios

FIGURE 61 IATA 2023 vision for 2050, SAF is the main lever for decarbonization, IATA Net 0 roadmap, page 6, source IATA

Since it has been demonstrated above that eCO₂ emissions of aviation are directly correlated to the fuel burn (with a ratio of 4.136), the main focus is determining the aviation fuel consumption from 2019 to 2050. Before building any scenario, FIGURE 62 below shows the annual jet fuel consumption of aviation by 2050 as a function of the CAGR of passenger traffic. 2 assumptions have been made at this stage: an average CAGR of 3.1%, as proposed in the central IATA-ATAG scenario, and an average CAGR of 4.57%, which reflects the trend of the last two decades (TABLE 14). The hypothesis in efficiency as concluded above being 0.85% CARR.

³⁹³ <https://edition.cnn.com/2023/06/05/business/qatar-airways-net-zero-aviation/index.html> accessed August 13, 2024

³⁹⁴ <https://www.iata.org/contentassets/8d19e716636a47c184e7221c77563c93/executive-summary---net-zero-roadmaps.pdf> accessed August 13, 2024

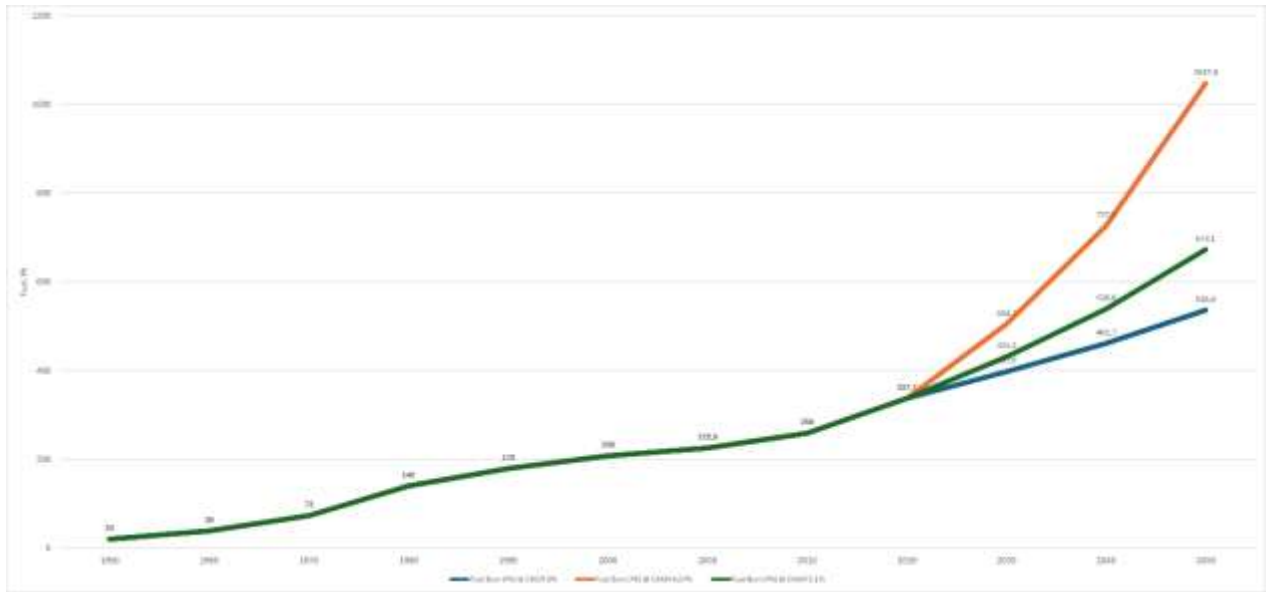

FIGURE 62 Comparing the effect of traffic growth increase on global fuel consumption in Mt from 1950 to 2050 with different CAGR: 2%, 3.1% (IATA scenario) and 4.57% (past decade CAGR growth), source Jean-Baptiste Jarin

These projections can explain why, as discussed in Chapter II above, academics are less optimistic than IATA since efficiency will remain lagging behind traffic growth. Even when introducing a 5% SAF by 2030, an optimistic assumption since the IATA recent objective from 2030 is 5% of SAF and Lower Carbon Aviation Fuel, see I.II.2 and Definition section, the eCO₂ emissions of aviation in 2030 would reach in the central scenario 1711 Mt, or 215 Mt above 2019 level.

I.III.3.2. NGOs scenarios

To complete this introduction, 3 reports have been reviewed and detailed, which confirms that along with academics, NGOs are also very cautious regarding the ability of aviation to truly lower its eCO₂ emissions.

According to B&L, whose report ³⁹⁵ covers domestic and international civil aviation from and to France, the aviation sector accounts for 7.3% of the country's emissions. This is three times higher than the world average, but in line with the level measured in developed countries. Above all, they point out that for France, even in the best-case scenarios (priority allocation of biomass to aircraft, technological progress...), GHG emissions from civil aviation will approach the country's entire carbon budget by 2050, according to the SNBC. In their view, technological progress in the sector will not be enough, and a significant reduction in traffic must be envisaged now. One of their proposals, the study was issued July 2020, found a particular echo in February 2021, when the cancellation of the Terminal 4 project at Roissy Charles de Gaulle airport was confirmed by the political authorities. From a societal point of view, B&L believe that air transport is desirable, particularly for the economic world and for the younger generations who need to build their lives and for whom social interaction is key. They argue that air traffic should be limited to essential business trips which is approximately 25% of current air traffic, and that flights for tourism should only concern young people, up to a limit of 2 trips. This approach is very similar to the « Proposition de loi n°3164, to introduce an individual carbon quota to limit the use of airplanes » ³⁹⁶ which will be further developed below. Finally, the analysis highlights the possibility of modal shift to reduce short-haul air traffic, which is in line with the above conclusions, sub-chapter I.III.2.

T&E in its final paper Roadmap to decarbonizing European aviation ³⁹⁷ identifies the same levers as those proposed by IATA such as improved aircraft fuel efficiency and massive introduction of SAF, but sets itself apart by proposing a reduction in demand via the rapid and gradual introduction of a carbon tax with a target of €150 per ton of CO₂.

³⁹⁵ <https://www.bl-evolution.com/publication/climat-pouvons-nous-encore-prendre-lavion/> accessed August 13, 2024

³⁹⁶ https://www.assemblee-nationale.fr/dyn/15/textes/l15b3164_proposition-loi# accessed August 13, 2024

³⁹⁷ https://www.transportenvironnement.org/uploads/files/2018_10_Aviation_decarbonisation_paper_final.pdf accessed August 13, 2024

According to the NGO, this amount would also facilitate the incorporation of SAFs, which are significantly more expensive than fossil Jet Fuel. While the report does not go into detail on the issues surrounding non-CO₂ emissions such as the Global Warming Potential due to contrails, it does emphasize the need for the European Union to address the subject rapidly, especially since, in the NGO's view, air transport is not in a position to meet its own commitments, which ultimately fall short of the climate challenge. Regarding the principle of carbon offsetting (CORSIA), the opinion is also highly critical according to an interview with Laura Buffet, in charge of aviation within the NGO: *"ICAO and CORSIA cannot deliver on Climate and T&E even considers that it runs counter to the Paris Agreements, and therefore to the 2DS trajectory"*.

The third report is the one produced by SupAero Decarbo and The Shift Project ³⁹⁸, which estimates the aviation sector's contribution to global warming at around 6% (including contrails). This report draws on two interviews with Auriane Joudiou and Marie Rebière from the ISAE-SUPAERO whose work also enriches the NGO's analysis. The report underlines the sector's continuing marked growth, with traffic doubling over the last ten years, and while it highlights technological progress, with consumption reduced to 3 liters / 100 km per passenger in a modern aircraft, the analysts remind us that flying means going far, and relate fuel consumption to flight time per passenger: 25 liters per hour in an aircraft flying at over 800 km / hour, compared with 4 liters for two people in a car travelling at 130 km / hour. As with the B&L, however, the report considers that technological advances will be less marked in the future, and that the progress made over the last few decades has mainly favored lower costs and a considerable rebound effect on traffic trends, and therefore ultimately on the evolution of CO₂ emissions from air transport. This is in line with the conclusions I.III.1 above. SAF are discussed, but the report considers that they will have a limited impact: while the cost aspect is not addressed in their study, the issue of volumes is, and it is assumed that around 10% of Jet Fuel could be supplied by SAF by 2050.

I.III.3.3 Proposed scenarios

Proposing adequate scenarios in line with the above IATA requirements would lead to another report, and therefore the choice has been made to propose here scenarios by absurdity, in this case dictating the maximum annual CO₂ budget that aviation must not exceed in order to meet its own commitments based on few variables.

This approach has two major merits:

- Since the decarbonization of air mobility means decarbonization of its energy, this would define the minimum yearly quantities of SAF but also the associated volume of air traffic, therefore supporting the reflexional regarding SAF availability
- Establishing a CO₂ budget sets a clear path and allow one to build different scenarios by adjusting the different variables

The variables are the ones illustrated above, namely fuel burn efficiencies brought by technology, speed, modal shift and SAF. As discussed in I.III.1 and II.I.2, hydrogen aircrafts are not considered as efuel (SAF from H₂ + CO₂) is found to be less inefficient. Electric aircrafts are not considered either as their entry into service would be too late to have a significant impact. Moreover, electric aircraft would be only possible for commuter and regional flights, which cumulated represent less than 5% of aviation global fuel burn. It is noted here that urban air mobility, which is often quoted in the press, is not considered either, mostly because it would only add and not remove emissions since their potential is limited to new applications. The other inputs, such as societal aspects or flights quota per capita will be addressed in part III, the objective here being to determine the amount of fuel burn and associated eCO₂ emissions, thus the quantities of SAF and the potential impacts on traffic growth.

Several budgets for 2050 can be proposed, the hypothesis was initially to propose 2 budgets which are matching the different IATA commitments, "Reducing 2050 emissions of 50% compared to 2005" and "Net zero by 2050". While the latter would make sense when considering the emergency of climate change, it was found that when comparing these

³⁹⁸ https://theshiftproject.org/wp-content/uploads/2021/12/TSP_AVIATION_RAPPORT_211116.pdf accessed August 13, 2024

2 objectives there are no major differences. Indeed, the Net zero commitment introduces not only carbon offset, which are still hypothetical and often found not efficient and without enough quality criteria ³⁹⁹ but also carbon removal up to 500 Mt of CO₂ / year. Therefore, instead of focusing on the definition of Net zero, and since the real impacts of offsets is limited and should be reserved for offsetting the incompressible part of our emissions as part of a global strategic Avoid / Shift / Improve ⁴⁰⁰, the hypothesis in this thesis is to meet the objective of reducing 2050 emissions of 50% compared to 2005, which means according to IATA's data 325 Mt of eCO₂ per year in 2050 ⁴⁰¹. This could be seen by some as an unambitious goal, but it remains challenging for the aviation industry, even more so when we consider no MBM and that the 2019 emissions were close to 1400 Mt in 2019 (sub-chapter I.I.2) with a projection to 1700 Mt in 2030. While the exact number could be further discussed among policy makers, the range of 325 Mt eCO₂ seems reasonable and it is one of the main hypotheses of this thesis.

In FIGURE 63 below is shown the projection of eCO₂ emission with a business-as-usual scenario:

- Efficiency CARR is 0.85% year which includes technology and operation gains as concluded in chapter I.III.1
- Traffic growth CAGR is 3.1 % as proposed in the IATA-ATAG scenario ⁴⁰². It is noted here that this growth of 3.1% is significantly below the past decade average (4.57%) and any variation, over a 25 years period, could lead to significant differences

³⁹⁹ Elena Huber, Vanessa Bach, Matthias Finkbeiner, A qualitative meta-analysis of carbon offset quality criteria, *Journal of Environmental Management*, Volume 352, 2024, 119983, ISSN 0301-4797, <https://doi.org/10.1016/j.jenvman.2023.119983>

⁴⁰⁰ Alain Karsenty, Cirad, 2021, Planter des arbres, une solution réaliste pour compenser nos émissions https://www.connaissancedesenergies.org/tribune-actualite-energies/planter-des-arbres-une-solution-realiste-pour-compenser-nos-emissions?utm_source=newsletter&utm_medium=mardi-energie&utm_campaign=/newsletter/cest-mardi-un-peu-denergie-16-mars-2021 accessed August 13, 2024

⁴⁰¹ https://www.iata.org/contentassets/d13875e9ed784f75bac90f000760e998/fact_sheet_on_climate_change.pdf accessed August 13, 2024

⁴⁰² https://aviationbenefits.org/media/167417/w2050_v2021_27sept_full.pdf page 31, accessed August 13, 2024

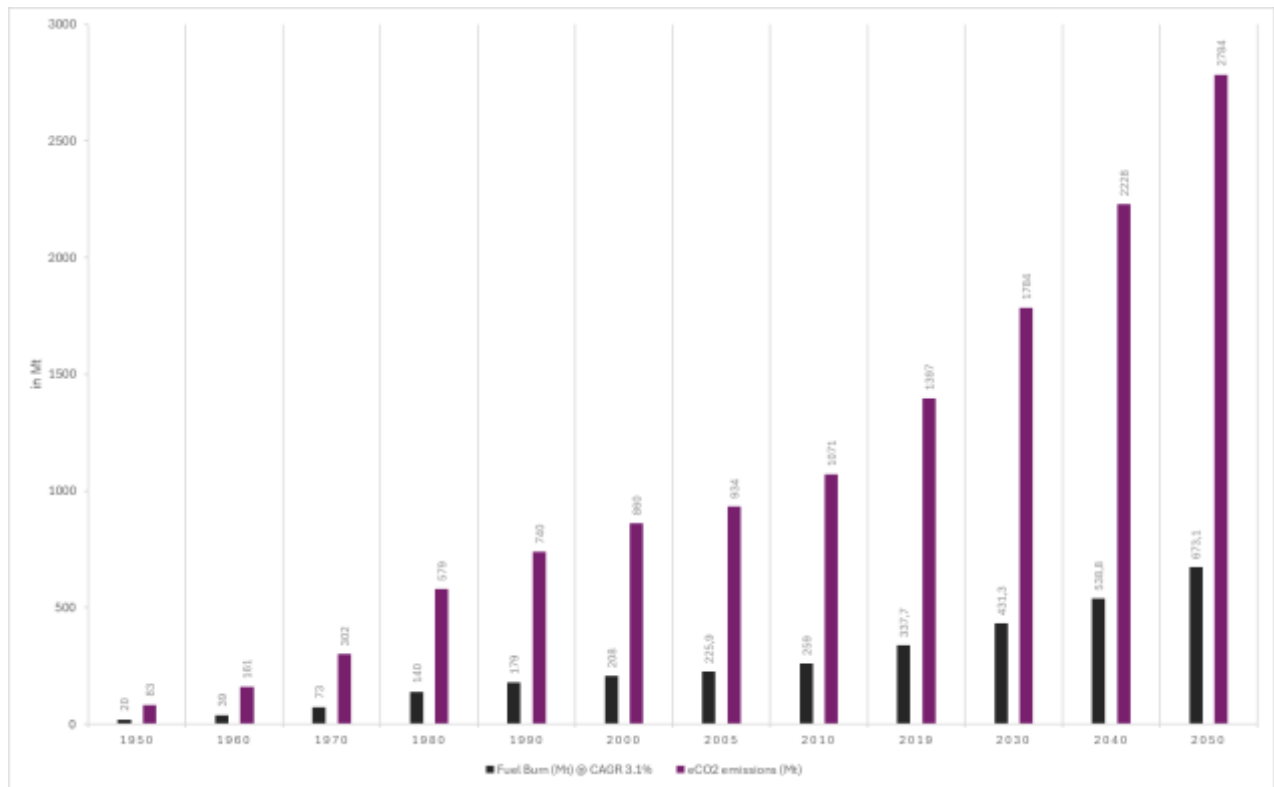

FIGURE 63 Fuel Burn and associated eCO₂ emissions of air mobility (scope 1-2-3) in Mt, in a Business-as-Usual scenario: fossil jet fuel, traffic growth 3.1% CAGR and efficiency 0.85% CARR, source Jean-Baptiste Jarin

One can notice that efficiency gains being significantly below the traffic growth rate, the pace of global fuel burn and associated eCO₂ emissions increase quite significantly, almost doubling in 30 years, at 673 Mt of jet fuel burn per year. This means almost 2800 Mt of associated eCO₂ emissions. It is noted here that if the traffic CAGR remains at the level of the previous 2 decades, i.e. 4.57%, it is 1048 Mt of jet fuel which would be required, or above 4300 Mt of eCO₂ emissions. Einstein is quoted as saying that “the power of compound interest is the greatest force in the universe”⁴⁰³, and this quote is found to be quite powerful here, for better or worse.

When introducing SAF among the levers to reduce aviation eCO₂ emissions, with the hypothesis of -80% compared to fossil fuels as concluded in chapter I.III.1 above, the global fuel burn does not change, reaching 673 Mt per year in 2050, but the eCO₂ emissions decline significantly due to the low carbon intensity of the SAF (here 18.8 g eCO₂ / MJ vs 94 g eCO₂ / MJ), confirming SAF are by far the main lever in decarbonizing aviation.

FIGURE 64 shows the noticeable impact of SAF on the overall eCO₂ emissions. The hypothesis being an aggressive ramp up in the introduction of SAF with air mobility operations: 20% blend by 2030, 50% by 2040 and 100% by 2050. This is well above the most demanding regulation (the EU ReFuel EU) and it shows the aggressive pathway aviation must follow to meet its own objectives.

⁴⁰³ <https://www.cbsnews.com/news/compound-interest-the-most-powerful-force-in-the-universe/> accessed August 13, 2024

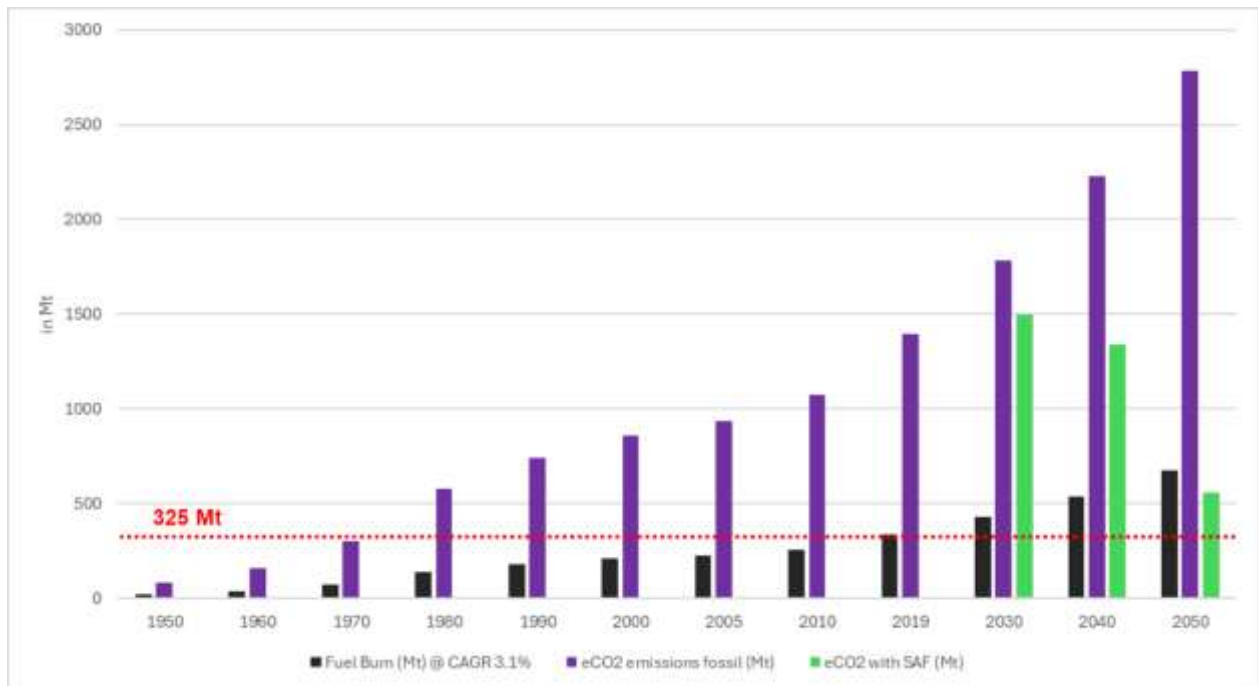

FIGURE 64 Fuel Burn and associated eCO₂ emissions in a Business-as-Usual scenario (traffic growth 3.1% CAGR and efficiency 0.85% CARR), comparing fossil and SAF (average 18.85 g eCO₂ / MJ), SAF ratio are 20% in 2030, 50% in 2040 and 100% in 2050, source Jean-Baptiste Jarin

While the volume of fuel burn remains at 673 Mt per year in 2050, the associated eCO₂ emissions would drop from 2784 Mt to 557 Mt.

While being a significant reduction, this is still 232 Mt above the objective of 325 Mt, while raising some other issues such as, but not limited to, can the volume of SAF be as high as 673 Mt per year, or can the aviation industry cope with the cost of 100% SAF and what would be the impact on demand, which will be addressed in part II and III.

The gap being 232 Mt, the levers addressed above must be considered. This includes reducing speed and modal shift. If these levers were not sufficient, a direct reduction in air traffic would be necessary.

As discussed above there is the opportunity for the aviation industry to significantly reduce speed, in replacing jets by turboprop and / or introducing propfan optimized for an optimal cruise speed, Mach 0.75. While the technology is already in place for commuters and regional, therefore allowing a direct replacement of the jet aircrafts by turboprops, the short haul and medium markets have no turboprop proposals yet. While proven to be less efficient than SAF (namely efuel, see Part II), the hydrogen aircraft pathway envisaged by Airbus with its ZEROe program may paradoxically pave the way for the introduction of short- and medium-haul turboprop aircraft by 2035-2040⁴⁰⁴ with the propeller design.

While not considered by ICAO or IATA as this would probably decrease the attractiveness of air mobility, introducing the obligation to reduce speed in order to significantly reduce consumption could enable the aviation industry to meet its commitments, while at the same time controlling the rise in ticket prices a little better, which will be constrained by the cost of SAF. Any gain, however small, in consumption is all the more precious when energy is expensive.

FIGURE 65 details the global fuel burn per flight category. The share of commuter (1%), regional (3%), short haul (24%) and medium haul (43%) is issued from the IATA-ATAG report Waypoint 2050⁴⁰⁵.

⁴⁰⁴ <https://www.airbus.com/en/newsroom/stories/2020-09-these-new-airbus-concept-aircraft-have-one-thing-in-common> accessed August 13, 2024

⁴⁰⁵ https://aviationbenefits.org/media/167417/w2050_v2021_27sept_full.pdf page 54, accessed August 13, 2024

The hypothesis presented in FIGURE 66 below is therefore a replacement of regional jets and commuters by 2030, short haul and medium haul by 2040. The associated gain in fuel burn being 37% as concluded above. Another important hypothesis is the optimization of the future long haul with propfan technologies, designed for a Mach 0.75 cruise speed as proposed by Torenbeek ³⁶⁴, the hypothesis here being that such a constraint could reduce long haul fuel burn by approximately 10% with an entry into service by 2040. The pace of efficiency is then maintained (-0.85% CARR). While the model needs to be further refined to address the pace of aircraft introduction into the airline fleets, the proposed result is too optimistic but sufficiently substantiated to be considered.

When introducing such speed limitations, the global fuel burn decreases significantly as shown in TABLE 25, almost minus 200 Mt per year by 2050.

in Mt	2030	2040	2050
Global Fuel Burn, Business as Usual	431,3	538,8	673,1
Global Fuel Burn with speed constraint	424,9	381,6	476,8

TABLE 25 Comparing global fuel burn in 2030-2050 in business as usual and speed constraint scenarios, source Jean-Baptiste Jarin

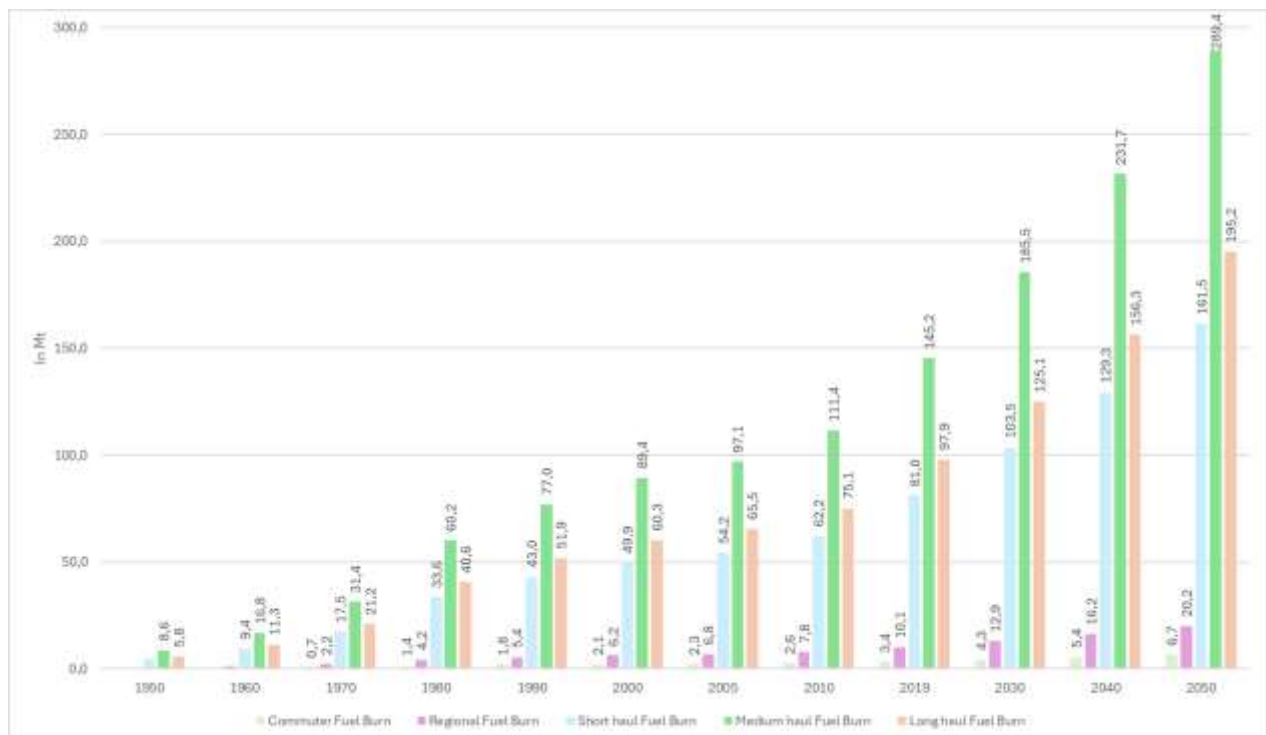

FIGURE 65 Fuel Burn (Mt) per flight category with data from IATA-ATAG Waypoint 2050 for the distribution, before introduction of speed constraint, source Jean-Baptiste Jarin

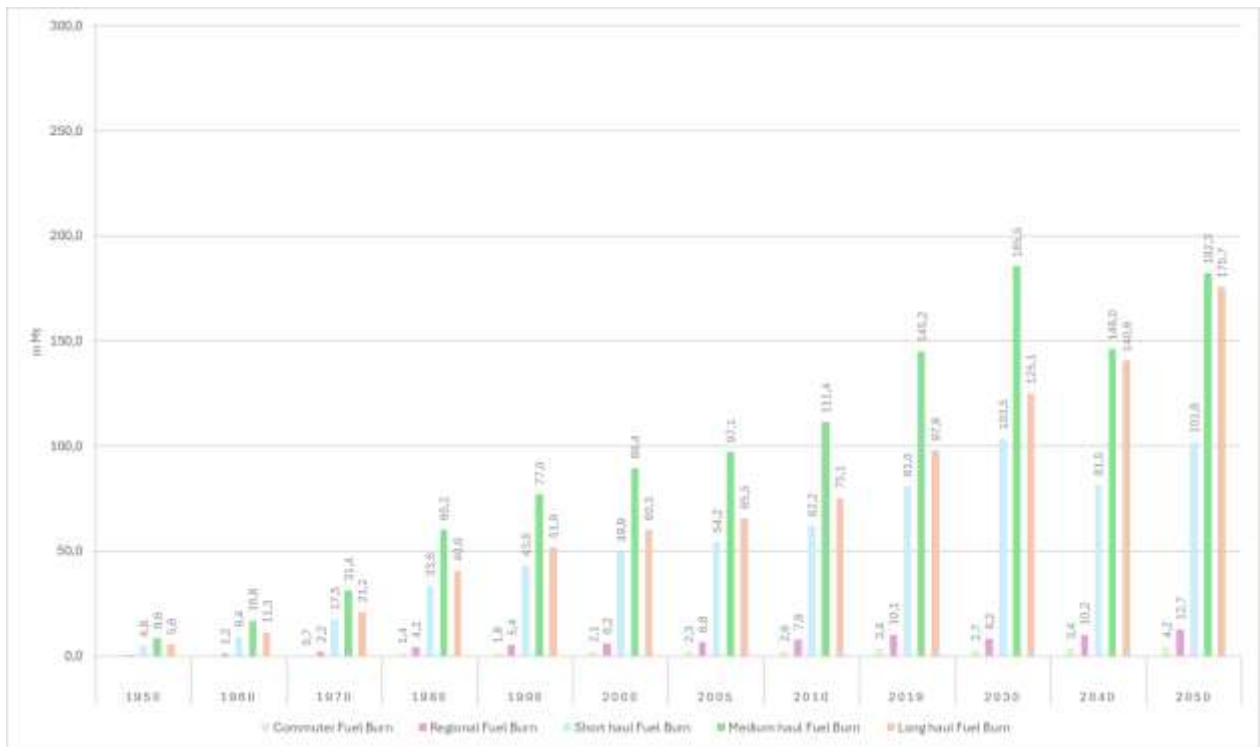

FIGURE 66 Fuel Burn (Mt) per flight category with data from IATA-ATAG Waypoint 2050 for the distribution, after introduction of speed constraint, same scale as FIGURE 65 to allow comparison, source Jean-Baptiste Jarin

Once the speed constraint adopted, the share of fuel and emission changes, reaching 37% for the long haul, FIGURE 67, while the global fuel burns is reduced to 477 Mt.

With the eCO₂ emissions of SAF and for a 100% SAF projection in 2050, these 477 Mt of SAF would emit 395 Mt.

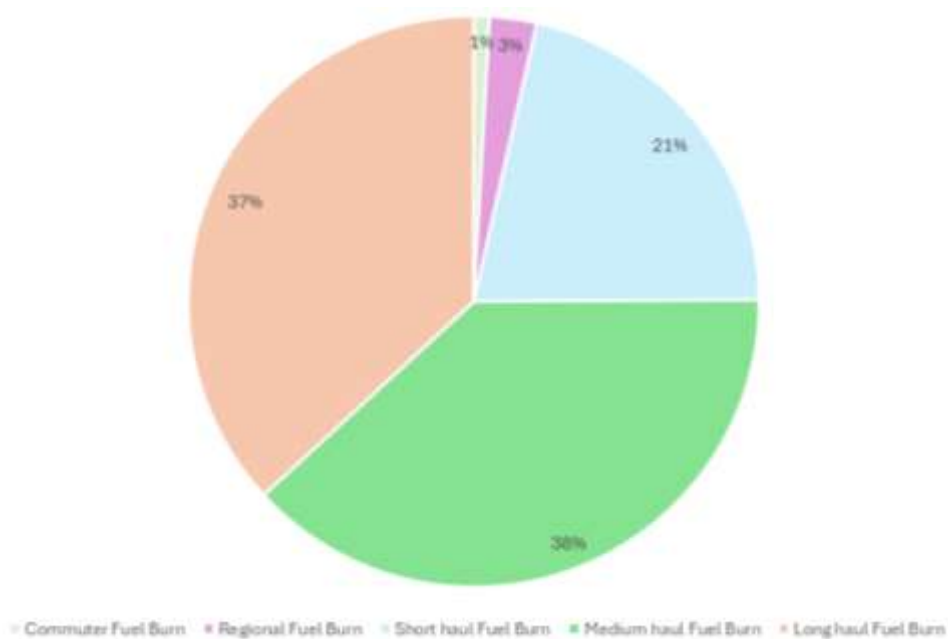

FIGURE 67 Share of fuel burn and eCO₂ emissions per flight category in 2050, source Jean-Baptiste Jarin

Introducing SAF and speed constraint brings significant results, especially when remembering that these figures are supposing a 3.1% CAGR from 2019 to 2050. However, there is still a 70 Mt gap in eCO₂ emissions would the volume of SAF being available.

Finally, speed reduction is perhaps the most equitable measure for our societies, but also for air transport: airlines are on an equal footing, while the price of a plane ticket will be a little less affected by the cost of SAF thanks to this significant reduction in consumption.

Modal shift could thus be activated on high-potential routes, typically city pairs with high population density. This could be achieved by introducing a different CAGR for short haul flights, the logic being that commuter and regional flights serve regions poorly served by rail. Short haul, for example, is widely used on high-density routes such as Lyon-Marseille in France (300 km, HSR in place), where the distance is very short, or Melbourne-Sydney in Australia (900 km, no HSR). The rationale behind this choice is not to deny access to air travel to a part of the population that does not live in major cities, in the name of fairness.

Introducing a significant modal shift for short haul, i.e. in considering a CAGR of 0%, would save approximately another 37 Mt of fuel or 30 Mt of eCO₂ emissions with 100% SAF, which would further reduce emissions down to 365 Mt.

The need to review the CAGR seems therefore necessary and the main lever identified for achieving a significant reduction in CAGR is the rise in the price of airline tickets, which will be mechanical with the introduction of SAF, whose cost is significantly higher than that of fossil jet fuel, this aspect will be detailed in Part III.

With the current knowledge, it is a given that if aviation does not move towards a massive introduction of SAF and a significant reduction in speed in the coming 5 years, typically 20% SAF by 2030 with a path to 100% by 2050 and Mach 0.75 for long haul, Mach 0.45 for other categories, eCO₂ emissions will only increase, turning the ICAO Long Term Aspirational Goal as purely aspirational, putting aviation at risk of public rejection as the climate change and energy transition effects will most probably gradually impact populations.

I.IV. Part I conclusions

Decarbonizing air mobility means decarbonizing its energy while other measures are found to be necessary such as speed limit, modal shift and most probably traffic limitations.

Climate change effects are worsening and aviation will not be spared, it is therefore time for aviation to really decarbonize. This is even more true in a period of energy transition, energy being the heart of aviation.

Emissions from the combustion of jet fuel have been found directly proportional to jet fuel consumption, close to 99%: decarbonizing aviation means decarbonizing its energy. Since the aircrafts which will fly in 2050 are currently in service and in production, jet fuel must be decarbonized.

Jet fuel carbon intensity ratio currently proposed by ICAO and IATA only considers combustion emissions, leaving aside the emissions associated to the extraction, transport, refining and distribution, and there is a need to introduce the well-to-tank scope. This will hopefully change soon thanks to the introduction of SAF since the lower emissions of SAF are precisely associated to the well-to-tank scope, the combustion CO₂ emissions being in the same ball park as for fossil fuels (Part II). The carbon intensity ratio which should be considered for fossil jet fuel is 4.136 instead of 3.16. A new calculation method for eCO₂ emissions is proposed, and while being specifically adapted for helicopters, which currently have no tools to measure their eCO₂ emissions, it could be deployed to the entire air mobility industry.

Air mobility is generally a blessing for humanity, but as is written into its genesis, *“yet its abuse can become a threat to the general security”*. The historical relationship between the air mobility sector and societies – business, safety, and economic growth versus supranational autonomy and absence of taxes such as VAT or fuel excise tax - cannot withstand climate change.

With a traffic CAGR since the jet age being significantly above the world GDP CAGR but also above the efficiency gains, the emissions since 1960 have been multiplied by 4, reaching almost 1400 Mt in 2019, and about to reach 1700 Mt by 2030. Meanwhile it was found that the democratization of aviation remains a chimera, since 2/3 of the emissions, therefore use of aviation, are made by the top 1% wealthiest. This ratio being 88% of total emissions for the top 10% wealthiest.

Regulations are tangled, with aviation being both domestic and international. This duality enables aviation to build its own standards, successfully as in the case of safety, but with a significant latency as regards to the environment. Generally speaking, anything that can hinder business is combated by the sector, and the environment is no exception. For instance, it took 30 years for commercial aviation to implement an imperfect mechanism, CORSIA, which will enter fully into force in 2027: the Kyoto protocol tasked ICAO, in its article 2, to prepare policy measures for the reduction of aviation greenhouse gas emissions (GHG) in 1997.

This might change in the coming years thanks to the European regulations which are particularly well thought-out, with an approach based on renewable and low carbon fuels incorporation mandates and a precise definition of what is sustainable, whereas CORSIA is much more permissive, promoting offsets and other market based measures.

To place aviation in the right direction, the two top key performances indicators (KPI) of the sector, Cost Index, a ratio between mostly time vs fuel costs, and fuel burn - emissions per PKM (passenger kilometer) must change in aviation along with the fuel carbon intensity ratio since. History have proven that the Jevons paradox applies particularly well to aviation: since 1960, dividing fuel burn / PKM by 5 came along with a traffic multiplied by 20, therefore the global fuel burn, and eCO₂ emissions quadrupled.

Global fuel burn shall become the KPI, and while the Cost Index should remain, it shall switch its ratio as saving fuel should become more important than saving time. Indeed, it was found a significant gap in fuel consumption when time constraints are relaxed, -37% between jets and turboprops for the same purpose. We therefore should give priority in the coming years and decades to lowering speed and for most routes replacing jets by turboprops (Mach 0.45). Open rotor should become a priority for long haul, and some medium haul, aircrafts (Mach 0.75).

Finally, it was found that the objectives and scenarios proposed by the aviation sector, ICAO, IATA, ATA, ATAG, are neither ambitious nor credible. This is a fact previously underlined by numerous academic studies and NGO reports. As a whole what only counts to measure the sector's capacity, but also its possibility, to decarbonize, is indeed global jet fuel consumption and the carbon intensity from well to wake (or well to prop). A cap in volume and / or a significant price increase should therefore be planned, and since the trajectory taken by aviation keeps leading to a significant continuation of jet fuel consumption and therefore emissions in the coming years, it is proposed to commit firmly to a double constraint:

- Massive introduction of SAF along with significant price increase. This means 100% SAF in all operations to reach less than 20 g eCO₂ / MJ, instead of 94 g eCO₂ / MJ for fossil fuels. The current carbon intensity ratio would drop from 4.136 to 0.88
- Speed reduction, which would minimize jet fuel needs while lowering the price increase due to higher energy costs

This double constraint is a necessity, because if one variable fails, the not so ambitious objective of limiting emissions to 325 Mt of eCO₂ by 2050, i.e. -50% vs. 2005 when the EU, for example, will reach -50% by 2030 vs. 1990, will not be achieved.

2050 Fuel Burn & eCO ₂ Emissions, in Mt	Global Fuel Burn	Global eCO ₂ emissions CAF	Global eCO ₂ emissions 100% SAF
CAGR 3.1%	673	2784	558
CAGR 4.57%	1048	4335	869
CAGR 3.1% with Speed Constraint	477	1973	395
CAGR 3.1% with Speed Constraint and modal shift	440	1820	365

TABLE 26 Comparing 2050 global fuel burn in various scenarios, with hypothesis of 0.85% efficiency CARR and 18.8 g eCO₂/MJ SAF carbon intensity. In bold the proposed scenario when considering no inputs limits (biomass, electricity, see part III), source Jean-Baptiste Jarin

Applying this double constraint would limit the need for SAF to 477 Mt per year by 2050 instead of 673 Mt, which might be already a challenge by itself and it is therefore proposed to introduce modal shift to further reduce the global fuel burn to 440 Mt. These values suppose a traffic CAGR of 3.1% as proposed by the aviation industry, an efficiency CARR of 0.85% and a SAF carbon intensity of 18.85 g eCO₂ / MJ as calculated in the above chapters as summarized in TABLE 26. One can notice that the related global eCO₂ emissions is still above the objective, which means the traffic CAGR must be below 3.1% (part II).

Ending Part I leaves some questions to be answered:

- Are SAF efficient compared to other energy carriers and better than fossil jet fuel in overall emissions, not only CO₂?
- Is there enough feedstocks, namely biomass and electrons, to support the aviation thirst for SAF, 440 Mt?
- What would be the impact on aviation economics?
- What would be the impact within our societies?
- How to develop the relationship between air mobility and societies?

The first 3 questions are answered in Part II while part III will address the last two remaining questions

PART II. FROM DECARBONIZING THE ENERGY FOR AIR MOBILITY TO CONFLICTS OVER RESOURCES USE



II.I Which energies for decarbonizing air mobility

II.I.1. Comparing energy efficiency

As concluded in part I, the decarbonization of air mobility means decarbonizing its energy. Several molecules are at stake, SAF and H₂ being the most often mentioned. But since the volumes considered are extremely important, this would require both sobriety of use, and energy efficiency. While some companies, or advocacies, may ask for a technological neutrality, the numbers should be made clear. Indeed, as concluded by Ríos, technological neutrality is often “tagged from various interest groups, often only seek a favorable scenario for their business interests”⁴⁰⁶ and one need to be cautious when hearing *technological neutrality*.

Comparing the energy efficiency from well to rotor, for helicopter and turboprop, or well to wake for jets, becomes mandatory when understanding that the resources at stakes are costly, and limited, probably leading to conflicts of use. Defining the most efficient carriers are key for several reasons, mostly cost, volume access, and GHG emissions. For instance, H₂ has been mentioned, by some, as the silver bullet for aviation, with several companies aiming at demonstrating this assertion, but the conclusions reached in this study significantly differ.

This approach of comparing energy efficiency is therefore a cornerstone of this thesis, and results have been published⁴⁰⁷. While applied to VTOL (Vertical Take-Off and Landing), the methodology can easily be translated to aircrafts, the results in first approximation being very similar.

II.I.1.1. Introduction

As for the entirety of air transportation, vertical take-off, and landing (VTOL) aircraft, which currently account for 1% of the total jet fuel consumption and CO₂ emissions¹⁷⁵, will significantly rely on sustainable aviation fuels (SAFs) to lower their carbon footprint⁴⁰⁸. SAFs are sustainable if they are produced from renewable sources such as biomass (biofuels) and low-carbon-intensity electricity, such as efuels. Since each energy carrier has its own conversion steps and losses, and since each energy carrier has also a specific impact on an aircraft’s propulsive system and, therefore, its energy consumption, defining the cleanest and most affordable energy carrier might require a novel approach.

Air mobility is recognized as a hard to abate sector and several technologies are currently being considered in attempting to lower its CO₂ emissions. While biofuels will play an important role in the short- and long-term, low-carbon electricity is now considered, using either direct electrification with rechargeable batteries (BE) or energy vectors such as hydrogen (H₂) or efuel. Efuel can be produced with the Fischer–Tropsch process (H₂ + CO₂ + H₂O). It requires electricity for water electrolysis, CO₂ to CO reduction and CO₂ capture, but requires no modification to the carrier. H₂ is also electro-intensive, requiring electricity for the water electrolysis, before further steps such as liquefaction. It can be combined either with a fuel cell + battery hybrid system (FCH₂) or a gas turbine (GTH₂), in both cases requiring significant modifications to the carrier. Similarly, direct battery electrification (BE) requires major modifications to the aircraft. For BE, FCH₂ and GTH₂, this means a significant weight gain for the aircraft. Other pathways such as NH₃ (ammonia) and CH₄ (methane) are also sometimes cited⁴⁰⁹; however, these pathways are not considered here.

⁴⁰⁶ Ríos, Mauro, Technological Neutrality and Conceptual Singularity (January 10, 2013). Available at SSRN: <https://ssrn.com/abstract=2198887> or <http://dx.doi.org/10.2139/ssrn.2198887>

⁴⁰⁷ Jarin, J.-B.; Beddok, S.; Haritchabalet, C. Techno-Economic Comparison of Low-Carbon Energy Carriers Based on Electricity for Air Mobility. *Energies* 2024, 17, 1151. <https://doi.org/10.3390/en17051151>

⁴⁰⁸ ATAG Waypoint 2050 Report. 2021, Page 6. Available online: https://aviationbenefits.org/media/167418/w2050_v2021_27sept_summary.pdf accessed August 13, 2024

⁴⁰⁹ Dahal, K.; Brynolf, S.; Xisto, C.; Hansson, J.; Grahn, M.; Grönstedt, T.; Lehtveer, M. Techo-economic review of alternative fuels and propulsion systems for the aviation sector. *Renew. Sustain. Energy Rev.* 2021, 151, 111564. <https://doi.org/10.1016/j.rser.2021.111564>

The mission profile and the means of transportation could have an impact on the results and this study focuses on vertical take-off and landing (VTOL) aircraft as they are the most demanding in terms of energy when expressed in terms of payload–distance. VTOL aircraft are also often considered in studies analyzing the opportunity to switch from fossil jet fuel to more disruptive energy vectors, such as BE and/or H₂ as mentioned by Dahal et al, Kusmierek et al⁴¹⁰ or Brejle and Martins⁴¹¹. Since the focus is on VTOL, the conclusions might not apply to large aircraft⁴¹² but in first approximation, when comparing the UA project for retrofitting an existing ATR with a propulsive system based on LCH₂⁴¹³, results were found to be close⁴¹⁴. In this study, H₂ is considered liquified and not compressed due to its too low volumetric density.

Since the path to low-carbon energy for air mobility induces low-yield energy vectors, and since the limited resources already reveal some tension regarding biomass supplies for biofuels⁴¹⁵⁴¹⁶, this study reviews a combination of the most cited energy vectors based on electricity with the most studied propulsive energy concept for VTOL.

The energy required to fulfill the considered mission is first expressed in the units of the energy carrier before being translated into kWh at the well, the electricity grid, and its carbon intensity (CI), being the central focus of our analysis. Electricity is used either for direct charging, for liquified hydrogen (LH₂) production through water electrolysis or for efuel conversion using the Fischer–Tropsch process, which requires hydrogen and carbon dioxide. The results are then finally converted to CO₂ emissions and direct energy cost to fulfill the mission.

A significant number of articles cover alternative aviation fuels and propulsion systems. Grahn et al., in 2022, reviewed the cost of efuel and its environmental impact⁴¹⁷, with no clear conclusions regarding the CO₂ impact. The Académie des Technologies report on the role of SAFs in air transport in 2023⁴¹⁸, highlighted the needs and limits of the deployment of low-carbon electricity to reach a viable production volume of efuel. In Europe, the recent ReFuel EU regulation will require 70% of aviation fuel to be sustainable by 2050, of which half would be efuel⁴¹⁹. Rojas-Michaga et al.⁴²⁰ reviewed the SAF production through power to liquid (efuel) and concluded that the dominant factor in efuel's CO₂ emissions is the electricity carbon intensity (CI).

Dahal et al. established a techno-economic review of alternative fuels and propulsion systems for the aviation sector⁴⁰⁹. Using the available literature, the model is based on top-level aircraft requirements, applied to Airbus A321 and A350 models using the Pacelab APD design tool. Their conclusions are then expressed in USD per passenger/kilometers to allow for a fair comparison between the different fuels evaluated. Biofuel appears to be the most competitive while H₂ and efuel share very close figures. Compared to fossil jet fuel, the cost range is 15 to 500% higher.

⁴¹⁰ Kuśmierek, A.; Galiński, C.; Stalewski, W. Review of the hybrid gas - electric aircraft propulsion systems versus alternative systems. *Prog. Aerosp. Sci.* 2023, 141, 100925. <https://doi.org/10.1016/j.paerosci.2023.100925>

⁴¹¹ Brejle and Martins, Electric, hybrid, and turboelectric fixed-wing aircraft: A review of concepts, models, and design approaches. *Prog. Aerosp. Sci.* 2019, 104, 1–19. <https://doi.org/10.1016/j.paerosci.2018.06.004>

⁴¹² Adler and Martins, Hydrogen-powered aircraft: Fundamental concepts, key technologies, and environmental impacts. *Prog. Aerosp. Sci.* 2023, 141, 100922. <https://doi.org/10.1016/j.paerosci.2023.100922>

⁴¹³ <https://www.lesechos.fr/pme-regions/occitanie/a-toulouse-universal-hydrogen-convertit-les-avions-atr-a-lhydrogene-1782344> accessed August 13, 2024

⁴¹⁴ Working group with Amelia, September – December 2023

⁴¹⁵ Lark, T.J.; Hendricks, N.P.; Smith, A.; Pates, N.; Spawn-Lee, S.A.; Bougie, M.; Booth, E.G.; Kucharik, C.J.; Gibbs, H.K. Environmental Outcomes of the US Renewable Fuel Standard. *Proc. Natl. Acad. Sci. USA* 2022, 119, e2101084119. Available online: <https://www.pnas.org/doi/full/10.1073/pnas.2101084119> accessed August 13, 2024

⁴¹⁶ Becken, S.; Mackey, B.; Lee, D.S. Implications of preferential access to land and clean energy for Sustainable Aviation Fuels. *Sci. Total. Environ.* 2023, 886, 163883. <https://doi.org/10.1016/j.scitotenv.2023.163883>

⁴¹⁷ Grahn, M.; Malmgren, E.; Korberg, A.D.; Taljegard, M.; Anderson, J.E.; Brynolf, S.; Hansson, J.; Skov, I.R.; Wallington, T.J. Review of electrofuels feasibility. *Prog. Energy* 2022, 4, 032010. <https://doi.org/10.1088/2516-1083/ac7937>

⁴¹⁸ Rapport de l'Académie des Technologies. La Décarbonation du Secteur Aérien par la Production de Carburants Durables. 2023, pp. 54–58. Available online: <https://www.academie-technologies.fr/wp-content/uploads/2023/03/Rapport-decarbonation-secteur-aerien-production-carburants-durables-AT-Mars-2023.pdf> accessed August 13, 2024

⁴¹⁹ European Parliament, September. 2023. Available online: <https://www.europarl.europa.eu/news/en/press-room/20230911PR04913/70-of-jet-fuels-at-eu-airports-will-have-to-be-green-by-2050> accessed August 13, 2024

⁴²⁰ Rojas-Michaga, M.F.; Michailos, S.; Cardozo, E.; Akram, M.; Hughes, K.J.; Ingham, D.; Pourkashanian, M. Sustainable aviation fuel production through power-to-liquid: A combined techno-economic and life cycle assessment. *Energy Convers. Manag.* 2023, 292, 117427. <https://doi.org/10.1016/j.enconman.2023.117427>

The same approach as Dahal et al is adapted to a VTOL aircraft with design principles based on the Froude–Rankine theory and the statistical design method for VTOL. As concluded in the previous chapter, it is found necessary to introduce the electricity input from the well to the tank to allow for a direct comparison in cost and eCO₂ emissions.

Electricity, expressed here in kWh, is the common and main feedstock for all energy carriers considered: battery electrification (BE), liquified H₂ with fuel cells (FCH₂), liquified H₂ with gas turbine (GTH₂) and efuels. Fossil jet fuel and sustainable aviation fuels (SAF) issued from the biomass will only be considered in the conclusion and discussion section to compare the results.

The electricity requirements to produce H₂ and / or efuels are significant^{418 420 421 422 423 424} and these energy carriers based on electricity offer negative ERoEI, between 0.4 and 0.6. Therefore, the impacts associated with the production of these energy carriers shall be considered, namely cost and CO₂.

To compare the different energy vectors reviewing the efficiency of each energy carrier from the electricity grid to the tank (“well to tank”) is found necessary before introducing its associated propulsive system and the integration effects on the aircraft’s weight to determine the final energy requirements, the “tank to rotor” efficiency. This is described in the simplified view, FIGURE 68, below:

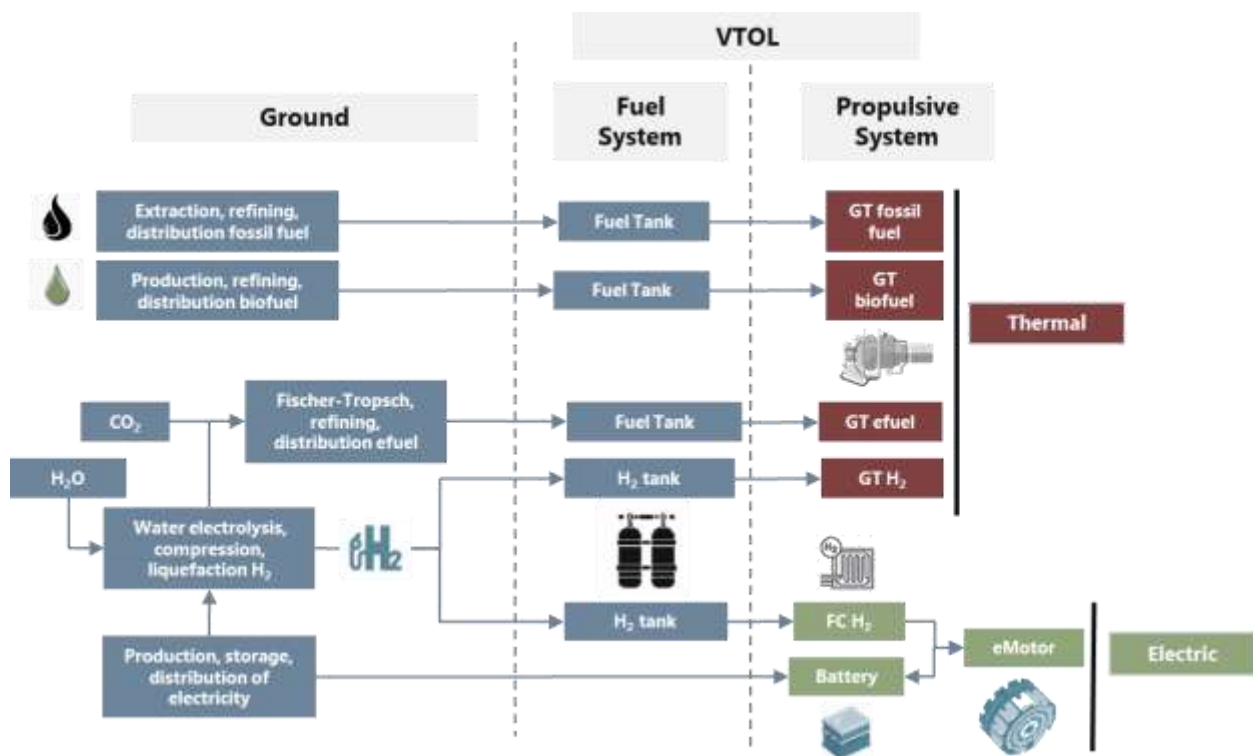

FIGURE 68 Simplified view of energy carriers based on electricity applied to VTOL with the associated propulsive architecture, source Jean-Baptiste Jarin and Stephane Beddok

⁴²¹ Schmidt, P.; Batteiger, V.; Roth, A.; Weindorf, W.; Raksha, T. Power to Liquids as renewable fuel option for aviation. *Chem. Ing. Tech.* 2018, 90, 127–140. <https://doi.org/10.1002/cite.201700129>

⁴²² Younas, M.; Shafique, S.; Hafeez, A.; Javed, F.; Rehman, F. An Overview of Hydrogen Production: Current Status, Potential, and Challenges. *Fuel* 2022, 316, 123317. <https://doi.org/10.1016/j.fuel.2022.123317>

⁴²³ Galimova, T.; Fasihi, M.; Bogdanov, D.; Breyer, C. Impact of international transportation chains on cost of green e-hydrogen: Global cost of hydrogen and consequences for Germany and Finland. *Appl. Energy* 2023, 347, 121369. <https://doi.org/10.1016/j.apenergy.2023.121369>

⁴²⁴ Peters, R.; Wegener, N.; Samsun, R.C.; Schorn, F.; Riese, J.; Grünewald, M.; Stolten, D. A techno-economic assessment of Fischer-Tropsch fuels based on syngas from co-electrolysis. *Processes* 2022, 10, 699. <https://doi.org/10.3390/pr10040699>

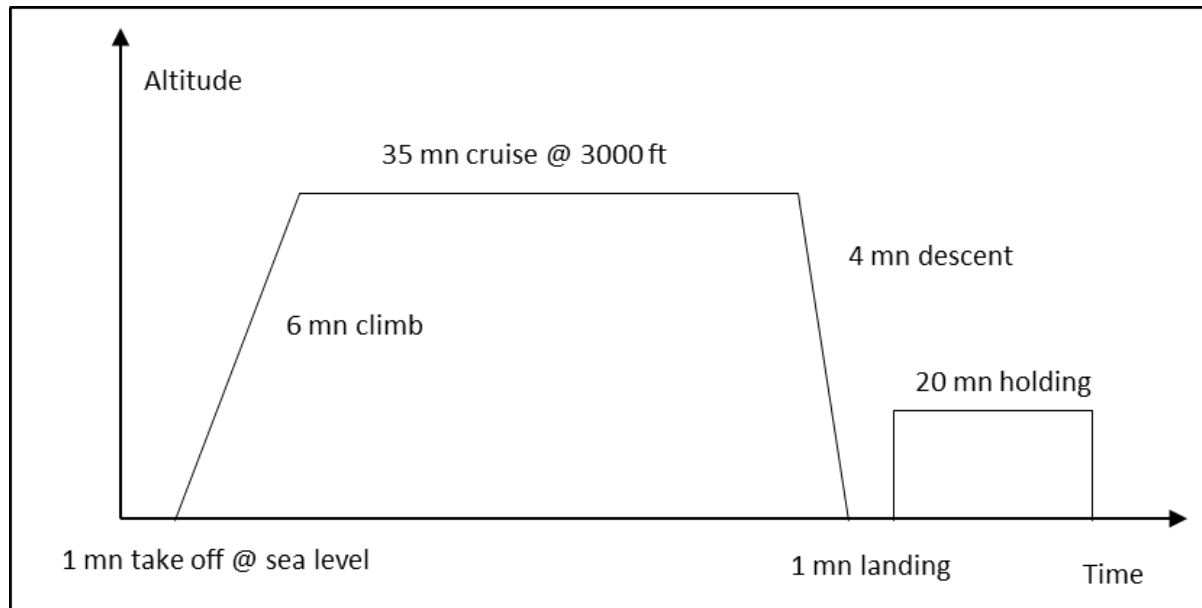

FIGURE 69 Mission profile, source Jean-Baptiste Jarin and Stephane Beddok

These calculations are applied to a standard VTOL mission, which is to carry 4 passengers, or an equivalent of 400 kg of payload, over 80 nautical miles (nm) with a reserve of 20 nm to ensure safety. The mission profile is described below in FIGURE 69 above.

Although the range of VTOL aircraft is often in excess of 300 nm, and typical missions often exceed this range between refueling, the 80 nm limit was set to take into account the possibility of introducing BE (Battery Electric), as some potential air taxi missions are envisaged in the future with BE as studied by Liberacki et al ⁴²⁵. The crew is limited to one pilot, and the altitude is up to 4000 feet. A typical mission before refueling is around 45 minutes of flight time, as shown in FIGURE 69 above. However efficient it may be, a VTOL aircraft must continually fight gravity and will always consume more energy than a fixed-wing aircraft with a similar payload and range.

Abbreviations specifically used in this chapter

a_{DW}	Downwash coefficient (-)
a_{TR}	Tail rotor coefficient (-)
BAT	Battery
η_{PGB}	Gearbox efficiency (%)
m	Advance ratio (-)
ρ_{air}	Air density (kg/m ³)
b_{MR}	Number of blade of the main rotor (-)
C_{MR}	Main rotor chord (m)
D_{MR}	Main rotor diameter (m)
FC	Fuel Cell

⁴²⁵ Liberacki, A.; Trincone, B.; Duca, G.; Aldieri, L.; Vinci, C.P.; Carlucci, F. The Environmental Life Cycle Costs of Urban Air Mobility as an input for sustainable urban mobility. *J. Clean. Prod.* 2023, 389, 136009. <https://doi.org/10.1016/j.jclepro.2023.136009>

GT	Gas Turbine
PW_{BLD}	Blade profile power (kW)
PW_{FUS}	Fuselage power (kW)
PW_{IND}	Induced power (kW)
S_{MR}	Main rotor surface (m ²)
SC_x	Helicopter drag (m ²)
T	Rotor vertical thrust (N)
U_{MR}	End tip blade velocity (m/s)
V_i	Induced velocity (m/s)
V_{i0}	Induced velocity in hover (m/s)
V_x	Aircraft horizontal speed (m/s)
V_z	Aircraft vertical speed (m/s)
W_{CR}	Crew Weight (kg)
W_{EP}	Empty Weight (kg)

II.1.1.2. Design of VTOL considering energy carrier integration effects

The properties of the energy carrier are extremely important when designing an aircraft. An excellent gravimetric energy density can be penalized by a volumetric energy density that is too low. This will lead to larger tanks, penalizing the drag and empty weight of the aircraft, leading to structural reinforcement and thus more weight. A heavier aircraft will require higher power requirements and ultimately increased energy consumption. Payload and range also have significant contributory effects as highlighted by Liberacki et al. In this study the limited range and payload limit these effects, enabling a comparison with battery electrification (BE).

In our approach, we need to determine the power required at the main gearbox input to calculate the aircraft performance and ability to perform the mission. No modifications are assumed on the aircraft and a standard configuration comprising a large main rotor and a tail rotor to counteract the main rotor torque is used. The modelling is based on two well-known principles: the Froude–Rankine theory and the statistical design method for VTOL, here in the range of 1500 to 3000 kg, as proposed by A.Tremolet in “Numerical models and methods for conceptual studies of rotary-wing aircraft”⁴²⁶. The performance equations are described below.

⁴²⁶ Tremolet, Modèles et Méthodes Numériques les Études Conceptuelles D’aéronefs à Voilure Tournante within “the Concepts of Rotorcraft Enhanced Assessment through Integrated Optimization Network Project”. 2014. Available online: <https://theses.hal.science/tel-00952559> ,accessed August 13, 2024

Power required

$$PW_{req} = (PW_{ind} + PW_{bld} + PW_{fus}) \cdot (1 + \alpha_{TR}) / \eta_{PGB}$$

$$PW_{ind} = T \cdot (V_z + V_i)$$

$$T = W_{TO} \cdot g \cdot (1 + \alpha_{dw})$$

$$\left(\frac{V_{i0}}{V_i}\right)^2 = \left(\frac{V_x}{V_{i0}}\right)^2 + \left(\frac{V_z + V_i}{V_{i0}}\right)^2$$

$$V_{i0}^2 = \frac{T}{2 \cdot \rho_{air} \cdot S_{MR}}$$

$$PW_{bld} = \frac{\rho_{air} \cdot b_{MR} \cdot C_{MR} \cdot D_{MR} \cdot C_{xp} \cdot U_{MR}^2}{16} \cdot (1 + 5\mu^2)$$

$$D_{MR} = W_{TO}^{0,3}$$

$$PW_{fus} = \frac{\rho_{air} \cdot S \cdot C_x \cdot V_x^3}{2}$$

EQUATION 1 Performance equations, adapted from A.Tremolet, numerical models and methods for conceptual studies of rotary-wing aircraft ⁴²⁶

Each propulsion system is designed to meet the power and energy requirements which are issued from the aircraft modeling.

Weight breakdown is described in Equation 2 below :

$$W_{TO} = W_{EP} + W_{PS} + W_{CR} + W_{PL} + W_{FL} \text{ when } W_{EP} = \alpha_{EW} \cdot W_{TO}$$

EQUATION 2 Weight equation

The take-off weight of a VTOL aircraft for a given mission is then calculated for each energy carrier / propulsive system combination. The assumptions made in this study are detailed in

TABLE 27 and TABLE 28 while the design stages are described in FIGURE 70 below.

Property	Jet Fuel	LH ₂
Specific energy (MJ/kg)	43.2	120
Energy density (MJ/L)	34.9	8.5
Storage temperature (K)	Ambient	21 °K
Storage pressure (bar)	Ambient	2
Tank gravimetric efficiency (%)	100%	30%

TABLE 27 Main properties of jet fuel and LH₂ considered in this study, source Jean-Baptiste Jarin and Stephane Beddok

H ₂ and Fuel Cell	Batteries	Power Distribution
H ₂ LHV: 33 kWh/kg	Max C Rate: 6	Distribution efficiency: 99%
LH ₂ density @ 21 °K 1 atm: 71 kg/m ³	Depth of discharge: 90%	eMotor efficiency: 95%
LH ₂ max usable fuel in tank: 80%	Cell energy density @ 2C: 600 Whkg ⁻¹	eMotor power density: 8 kW/kg
LH ₂ gravimetric index: 30%	Integration factor: 1.35	
Fuel Cell efficiency: 50%		
Fuel Cell power density: 1.5 kW/kg		

TABLE 28 Main hypotheses used for propulsive system design, source Jean-Baptiste Jarin and Stephane Beddok

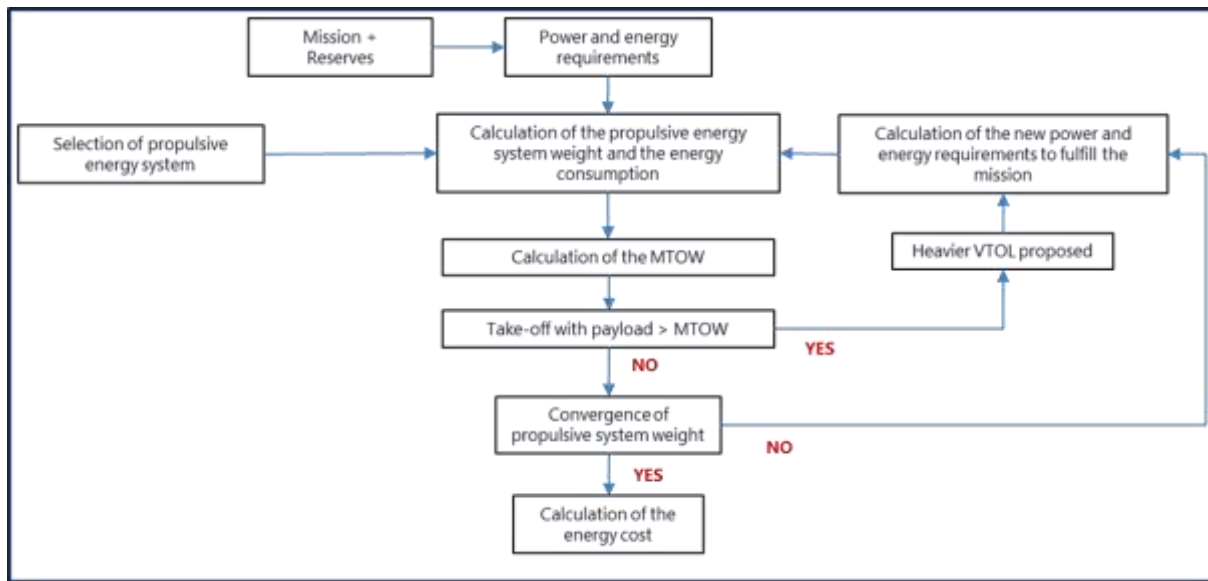

FIGURE 70 Design steps for calculation, source Jean-Baptiste Jarin and Stephane Beddok

In our model, the LH₂ gravimetric index, the full cell efficiency and the battery cell energy density have a significant impact in the VTOL design. Hypothesis are detailed below.

LH₂ gravimetric index: The tanks required to store H₂ as cryogenic liquid result in added weight which will be carried during the entire mission. This means a more robust airframe such as a more robust, i.e., thus heavier, landing system (in an aircraft, the max landing weight is below the TOW to benefit from the fuel burned during the mission which makes the aircraft lighter). An important performance measure for assessing tank storage efficiency is gravimetric efficiency, presented in Equation 2 below, where W_{H₂} is the weight of hydrogen the tank can hold and W_{tank} represents the weight of the empty tank. Gravimetric efficiency is the fraction of the storage system's weight absorbed by the fuel when it is full. While this tank metric does not represent the volumetric efficiency, it quantifies the weight penalty incurred by using a given hydrogen storage solution. Evolutionary improvements are predicted to be 25–40%⁴¹² and we have used a 30% value in our design model. For comparison, the gravimetric efficiency of kerosene tanks is limited in a VTOL aircraft to ~ 20 kg.

$$n_{\text{tank}} = \frac{W_{\text{H}_2}}{W_{\text{H}_2} + W_{\text{tank}}}$$

Fuel cell efficiency: This has a direct impact on the quantity of LH₂ onboard the VTOL aircraft and, thus, the size and weight of the LH₂ tanks and, thus, the power requirements and, thus, the energy consumption. In our model, a proton exchange membrane (PEM) is preferred to solid-oxide fuel cells (SOFC) as a PEM can operate at low temperatures. Lower temperatures allow quick response times while SOFC, which operate at higher temperatures (600 to 1000 °C), require some time to start up and shut down: “at least 10 min, and maybe an hour or more” as highlighted by Adler and Martins and, therefore, are inappropriate with most VTOL operations such as emergency medical services or

search and rescue. The same article from Adler and Martins mentions 50% efficiency for the fuel cell, which is the value used in this study.

Battery cell energy density: Electricity is electrochemically stored. Li-ion batteries are currently the main technology used in electric vehicles and are still progressing. “Li-ions and electrons travel between cathode and anode during charge-discharge cycles repeatedly and the process goes on throughout the life cycle”⁴²⁷. While the current cell energy density is close to 300 Whkg⁻¹, the target for 2030 is 500 Wh⁻¹/kg by 2030⁴²⁸ and we have assumed a further improvement to 600 Wh⁻¹/kg when associated with an integration factor of 1.35.

II.I.1.3. Energy Carriers and Life Cycle Assessment (LCA)

This study focuses on energy carriers based on electricity. However, sustainable aviation fuels issued from biomass (biofuel) will play a significant role in the decarbonization of aviation and, therefore, are used as a reference for comparing the CO₂ emissions and affordability of the energy for air mobility in the Discussion and Conclusions section. Since biofuels can have different costs and CO₂ emissions^{429 430}, we compare the different energy carriers with the most readily available SAF in 2023, which is HEFA-UCO (hydro-esterification of fatty acids, made from used cooking oil). This biofuel is certified according to the ASTM standard and already in operation in the air transport industry in blend proportions up to 50% with fossil jet fuel.

Fossil jet fuel: used as a reference with CO₂ emissions of 94 gCO₂/MJ⁴³¹ with a LHV of 44.1 GJ/t¹³².

Biofuel: HEFA-UCO used as a reference with CO₂ emissions of 20 gCO₂/MJ, same reference as above, with a LHV of 44.1 GJ/t, same reference as above.

Electricity: used for battery electrification (BE), the production of liquid H₂ and efuels. Electricity is considered as the raw material for all energy carrier/propulsive system combinations studied here as described in FIGURE 68. We assume that electricity is supplied by the grid with no consideration of load factor: electricity is always available either for charging a BE VTOL or to produce LH₂ or efuel. The carbon intensity is expressed in gCO₂/kWh and costs in €/kWh.

- Electricity for BE: 10% charging losses are added to the energy required to fulfill the mission, a figure slightly above the best mean efficiency of 87% found by Reick et al. in 2021⁴³² to reflect a 2030 state of the art.
- Electricity for liquid H₂: LH₂ produced from water electrolysis will be either used in a gas turbine or in a fuel cell. Our assumptions is that LH₂ will be directly manufactured on site to avoid any long-distance transportation as carrying hydrogen significantly impacts the cost and CO₂ emissions⁴²³. The value for electrolysis is 20 g/kWh or 50 kWh per kg of H₂ as proposed by Younas et al. in “An Overview of Hydrogen Production: Current Status, Potential, and Challenges”⁴²² while the energy cost for liquefaction adds 15 kWh per kg of H₂ as highlighted by Al Ghafri et al. in “Hydrogen liquefaction: a review of the fundamental physics,

⁴²⁷ Tian, W.; Liu, L.; Zhang, X.; Shao, J.; Ge, J. A coordinated optimization method of energy management and trajectory optimization for hybrid electric UAVs with PV/Fuel Cell/Battery. *Int. J. Hydrogen Energy* 2024, 50, 1110–1121. <https://doi.org/10.1016/j.ijhydene.2023.11.030>

⁴²⁸ Khan, F.M.N.U.; Rasul, M.G.; Sayem, A.; Mandal, N.K. Design and optimization of lithium-ion battery as an efficient energy storage device for electric vehicles: A comprehensive review. *J. Energy Storage* 2023, 71, 108033. <https://doi.org/10.1016/j.est.2023.108033>

⁴²⁹ Seber, G.; Escobar, N.; Valin, H.; Malina, R. Uncertainty in life cycle greenhouse gas emissions of sustainable aviation fuels from vegetable oils. *Renew. Sustain. Energy Rev.* 2022, 170, 112945. <https://doi.org/10.1016/j.rser.2022.112945>

⁴³⁰ Shahriar, M.F.; Khanal, A. The current techno-economic, environmental, policy status and perspectives of sustainable aviation fuel (SAF). *Fuel* 2022, 325, 124905. <https://doi.org/10.1016/j.fuel.2022.124905>

⁴³¹ Commission Delegated Regulation, EC Europa. 2023; p. 2. Available online: https://energy.ec.europa.eu/system/files/2023-02/C_2023_1086_1_EN_annexe_acte_autonome_part1_v4.pdf accessed August 13, 2024

⁴³² Reick, B.; Konzept, A.; Kaufmann, A.; Stetter, R.; Engelmann, D. Influence of Charging Losses on Energy Consumption and CO₂ Emissions of Battery-Electric Vehicles. *Vehicles* 2021, 3, 736–748. <https://doi.org/10.3390/vehicles3040043>

engineering practice and future opportunities”⁴³³. A total of 65 kWh of electricity per kg of LH₂ is, therefore, considered in this study.

- Electricity for efuel: as for LH₂, electricity is the dominant factor when producing efuel and efuel will require an optimized unit of production as proposed in using either direct air capture or biogenic CO₂^{418 424 434}. As for LH₂, H₂ is produced using water electrolysis but collocated with Fischer–Tropsch and direct air capture (DAC) units to optimize the efficiency of efuel production. This significantly improves the efficiency as described by Peters et al. in “a techno-economic assessment of Fischer-Tropsch fuels based on syngas from co-electrolysis”²⁵⁴. The efficiency ranges from 46 to 67% and we used the value refined by the Académie des Technologies in 2023 of 22.2 kWh per kg of efuel, an efficiency of 55%²⁵³. This figure considers a selectivity of 60%, which means 40% of co-products such as diesel or naphtha.

The energy used in operation represents more than 99% of the emissions of the aircraft and the impacts associated with the manufacturing are negligible^{129 130}. We, therefore, consider all VTOL architectures to be equal and do not take into consideration the environmental impact, nor the CAPEX, associated with the various aircraft configurations with the exception of the battery pack as battery manufacturing has a significant impact on the lifetime costs and CO₂ emissions of a vehicle⁴³⁵. The hypothesis for battery manufacturing is a GHG of 72.9 kg CO₂ per kWh of battery, cell and battery management system included⁴³⁶. With frequent high-speed charging, our assumption for battery replacement is 1350 cycles⁴³⁷, equivalent to 200.000 km, while the battery cost hypothesis is 75 USD/kWh as proposed by Lutsey and Nicholas in “update on electric vehicle costs through 2030”⁴³⁸.

For FCH₂ configuration (fuel cell with LH₂), a battery pack of 100 kWh is required to accommodate the transient and voltage stabilization^{427 439}, the above numbers being proportional to the battery pack size.

The LCA of water electrolysis units and efuels units are directly proportional to the carbon intensity (CI) of electricity as highlighted by Liu et al. in “a life cycle assessment of greenhouse gas emissions from direct air capture and Fischer–Tropsch fuel”⁴⁴⁰: “the synthetic fuel CI is dictated by the electricity emission factor; the lower the electricity CI, the lower is the GHG impact of the fuel produced”. This is in accordance with the conclusions of Peters et al and Académie des Technologies previously cited, and the CO₂ emissions of LH₂ and efuel are calculated with $Q_{kWh} \cdot CI_{kWh}$ whereas Q is the quantity of electricity required (65 kWh/kg of LH₂ and 22.2 kWh/kg of efuel) and CI is the carbon intensity of the electricity used to produce the above molecules.

II.1.1.4. Results

VTOL Energy Requirements per Energy Carrier

⁴³³ Al Ghafri, S.Z.; Munro, S.; Cardella, U.; Funke, T.; Notardonato, W.; Trusler, J.P.M.; Leachman, J.; Span, R.; Kamiya, S.; Pearce, G.; et al. Hydrogen liquefaction: A review of the fundamental physics, engineering practice and future opportunities. *Energy Environ. Sci.* 2022, 15, 2690–2731. <https://doi.org/10.1039/D2EE00099G>

⁴³⁴ Pio, D.; Vilas-Boas, A.; Araújo, V.; Rodrigues, N.; Mendes, A. Decarbonizing the aviation sector with Electro Sustainable Aviation Fuel (eSAF) from biogenic CO₂ captured at pulp mills. *Chem. Eng. J.* 2023, 463, 142317. <https://doi.org/10.1016/j.cej.2023.142317>

⁴³⁵ Ellingsen, L.A.-W.; Thorne, R.J.; Wind, J.; Figenbaum, E.; Romare, M.; Nordelöf, A. Life cycle assessment of battery electric buses. *Transp. Environ.* 2022, 112, 103498. <https://doi.org/10.1016/j.trd.2022.103498>

⁴³⁶ Dai, Q.; Kelly, J.C.; Gaines, L.; Wang, M. Life Cycle Analysis of Lithium-Ion Batteries for Automotive Applications. *Batteries* 2019, 5, 48. <https://doi.org/10.3390/batteries5020048>

⁴³⁷ Su-Ungkavatin, P.; Tiruta-Barna, L.; Hamelin, L. Biofuels, electrofuels, electric or hydrogen: A review of current and emerging sustainable aviation systems. *Prog. Energy Combust. Sci.* 2023, 96, 101073. <https://doi.org/10.1016/j.pecs.2023.101073>

⁴³⁸ Lutsey, N.; Nicholas, M. Update on electric vehicle costs through 2030. In Proceedings of the ICCT, 2019. <https://doi.org/10.13140/RG.2.2.25390.56646>

⁴³⁹ Graf, T.; Fonk, R.; Paessler, S.; Bauer, C.; Kallo, J.; Willich, C. Low pressure influence on a direct fuel cell battery hybrid system for aviation. *Int. J. Hydrogen Energy* 2023, 50, 672–681. <https://doi.org/10.1016/j.ijhydene.2023.09.003>

⁴⁴⁰ Liu et al, A life cycle assessment of greenhouse gas emissions from direct air capture and Fischer–Tropsch fuel production, *Sustainable Energy Fuels*, 2020,4, 3129-3142, The Royal Society of Chemistry, <http://dx.doi.org/10.1039/C9SE00479C>

The analysis was carried out for each propulsion system, leading to different VTOL sizes for carrying out the same mission. The results are presented in TABLE 29 below, with the weight distribution of each propulsion system and the associated energy consumption to complete the mission.

The choice of energy carrier has a significant impact on take-off weight and, therefore, on the energy required when applying integration effects.

Propulsive System	Component Weight in kg					Propulsive System Weight	VTOL TOW	Energy Required to Perform the Mission
	Turbine/ Fuel Cell	Tank	Battery	Electric Motor	Others			
Gas Turbine with eFuel	120	20			N/A	190	1400	63 kg of eFuel
Gas Turbine with LH ₂	160	210			670	1040	2500	36 kg of LH ₂
Fuel Cell with LH ₂	800	220	160	80	40	1300	2900	41 kg of LH ₂
Battery Electrification			870	80	100	1050	2700	360 kWh of electricity

TABLE 29 Max TOW and associated energy requirements according to each VTOL energy carrier/propulsive system, source Jean-Baptiste Jarin and Stephane Beddok

The lowest TOW, which is rounded at 1400 kg, is associated with the liquid fuel/gas turbine combination at ambient temperature. This is valid for efuel, but also biofuel and the current Jet-A1 (fossil) fuel. This would require 63 kg of efuel. The TOW and the energy required, which are calculated using the methodology described in Section 2.2 (design of VTOL), are consistent with the current VTOL in operation¹⁷⁵, which brings credibility to the model used for this study.

When using LH₂, the need to accommodate wider and more robust tanks (Section 2.2) leads to a heavier VTOL. TOW is almost doubled compared to GT with efuel, reaching 2500 kg (rounded value) for GTH₂ and 2900 kg (rounded value) for FCH₂. This added weight can be explained as follows:

The propulsive system based on fuel cells is penalized by the fuel cell weight and the associated balance of the plant⁴¹², the need to dissipate the heat generated and the integration of a 100-kWh battery pack to cope with the transient and voltage stabilization⁴⁴¹.

The gas turbine, while lighter, must accommodate a complex fuel system to allow the stored LH₂ @ 21 °K to reach the combustion chamber without safety issues, leading to heavier pipes and additional monitoring and safety components⁴⁴².

A heavier TOW requires a greater amount of energy: 36 and 41 kg of LH₂ for GTH₂ and FCH₂, respectively.

To calculate the BE VTOL TOW, the battery pack size is calculated with the above hypotheses. Since the energy required to fulfill the mission reaches 360 kWh of electricity, the battery pack must grow to 625 kWh. This is explained by the integration of the safety reserve, 90 kWh for 20 nm, the minimum 10% state of charge before charging⁴⁴³, and the aging of the battery before replacement with the assumption of 80% before reaching the battery's knee-point⁴⁴⁴.

Energy Requirements "Well to Rotor" in kWh

To calculate the total electricity consumption, we apply the methodology detailed in Section 2.3 (energy carriers):

⁴⁴¹ Graf, T.; Fonk, R.; Paessler, S.; Bauer, C.; Kallo, J.; Willich, C. Low pressure influence on a direct fuel cell battery hybrid system for aviation. *Int. J. Hydrogen Energy* 2023, 50, 672–681. <https://doi.org/10.1016/j.ijhydene.2023.09.003>

⁴⁴² Manigandan, S.; Praveenkumar, T.; Ryu, J.I.; Verma, T.N.; Pugazhendhi, A. Role of hydrogen on aviation sector: A review on hydrogen storage, fuel flexibility, flame stability, and emissions reduction on gas turbines engines. *Fuel* 2023, 352, 129064. <https://doi.org/10.1016/j.fuel.2023.129064>

⁴⁴³ Park, S.-W.; Son, S.-Y. Techno-economic analysis for the electric vehicle battery aging management of charge point operator. *Energy* 2023, 280, 128095. <https://doi.org/10.1016/j.energy.2023.128095>

⁴⁴⁴ You, H.; Zhu, J.; Wang, X.; Jiang, B.; Wei, X.; Dai, H. Nonlinear aging knee-point prediction for lithium-ion batteries faced with different application scenarios. *eTransportation* 2023, 18, 100270. <https://doi.org/10.1016/j.etrans.2023.100270>

Battery electrification: charging losses are added, so 10% of 360 kWh: 400 kWh of electricity will be used from the grid.

Efuel: the electricity required for the Fischer–Tropsch process ($H_2 + CO_2 + H_2O$) is 22.2 kWh per kg of efuel. Since 63 kg of efuel is required to fulfill the mission, this leads to 1399 kWh of electricity used from the grid.

LH₂: 65 kWh of electricity is required to produce 1 kg of LH₂:

- GTH₂: 36 kg of LH₂ is required to fulfill the mission, so 2340 kWh of electricity will be used from the grid.
- FCH₂: 41 kg of LH₂ is required to fulfill the mission, so 2665 kWh of electricity will be used from the grid.

The results are synthetized in TABLE 30.

Mission: 4 pax, 80 NM	VTOL Energy Carrier Requirement	Electricity Required to Produce the Energy Vector	Total Electricity Consumption, kWh
eFuel	63 kg	22.2 kWh/kg	1399
H2 Gas Turbine	36 kg	65 kWh/kg	2340
H2 Fuel Cell	41 kg	65 kWh/kg	2665
Battery Electrification	360 kWh	10% charging losses	400

TABLE 30 Total electricity required from the grid for each energy carrier, well to rotor, in kWh, source Jean-Baptiste Jarin and Stephane Beddok

One can notice that when expressed in kWh at the well, the electricity grid in our model, the consumptions are extremely different, which will significantly impact not only the affordability of the mission but also the associated CO₂ emissions: using clean energy shall come with efficiency.

eCO₂ Emissions

The CO₂ emissions are proportional to the carbon intensity of the electricity in g eCO₂/kWh multiplied by the quantity of electricity required to perform the mission: $Q_{kWh} \cdot Cl_{kWh}$.

Q_{kWh} being the quantity of kWh required and Cl_{kWh} being the carbon intensity of the electricity in gCO₂ equivalent.

This is true for all energy carriers except for BE and FCH₂ as battery manufacturing comes with significant CO₂ emissions as described in Section 2.4 (LCA). The CI of the battery manufacturing shall, therefore, be added to the result of $Q_{kWh} \cdot Cl_{kWh}$.

For battery electrification, the hypothesis for battery manufacturing is a GHG of 72.9 kg eCO₂/kWh⁴⁴⁵, which means 45.56 kg of e for the 625-kWh battery pack calculated in Section 3.1. The battery pack will be replaced every 200.000 km as detailed in Section 2.4 (LCA); therefore, 0.228 kg of eCO₂ should be added per km or 33.7 kg of eCO₂ per mission (80 nm being equivalent to 148 km: $0.228 \cdot 148 = 33.7$).

For FCH₂, the 100-kWh battery pack, using the same approach, would add 5.4 kg of CO₂ per mission.

For BE and FCH₂, the equation is $Bat_{CO_2} + Q_{kWh} \cdot Cl_{kWh}$, Bat_{CO_2} being the fixed CO₂ emissions associated to battery pack manufacturing.

⁴⁴⁵ Dai, Q.; Kelly, J.C.; Gaines, L.; Wang, M. Life Cycle Analysis of Lithium-Ion Batteries for Automotive Applications. *Batteries* 2019, 5, 48. <https://doi.org/10.3390/batteries5020048>

Since the eCO₂ emissions are proportional to the CI of the electricity and while this could be infinite, we used the European Union carbon intensity of electricity which decreased from 641 g eCO₂/kWh in 1990 to 334 g eCO₂/kWh in 2019⁴⁴⁶ to draw the first results as shown in FIGURE 71.

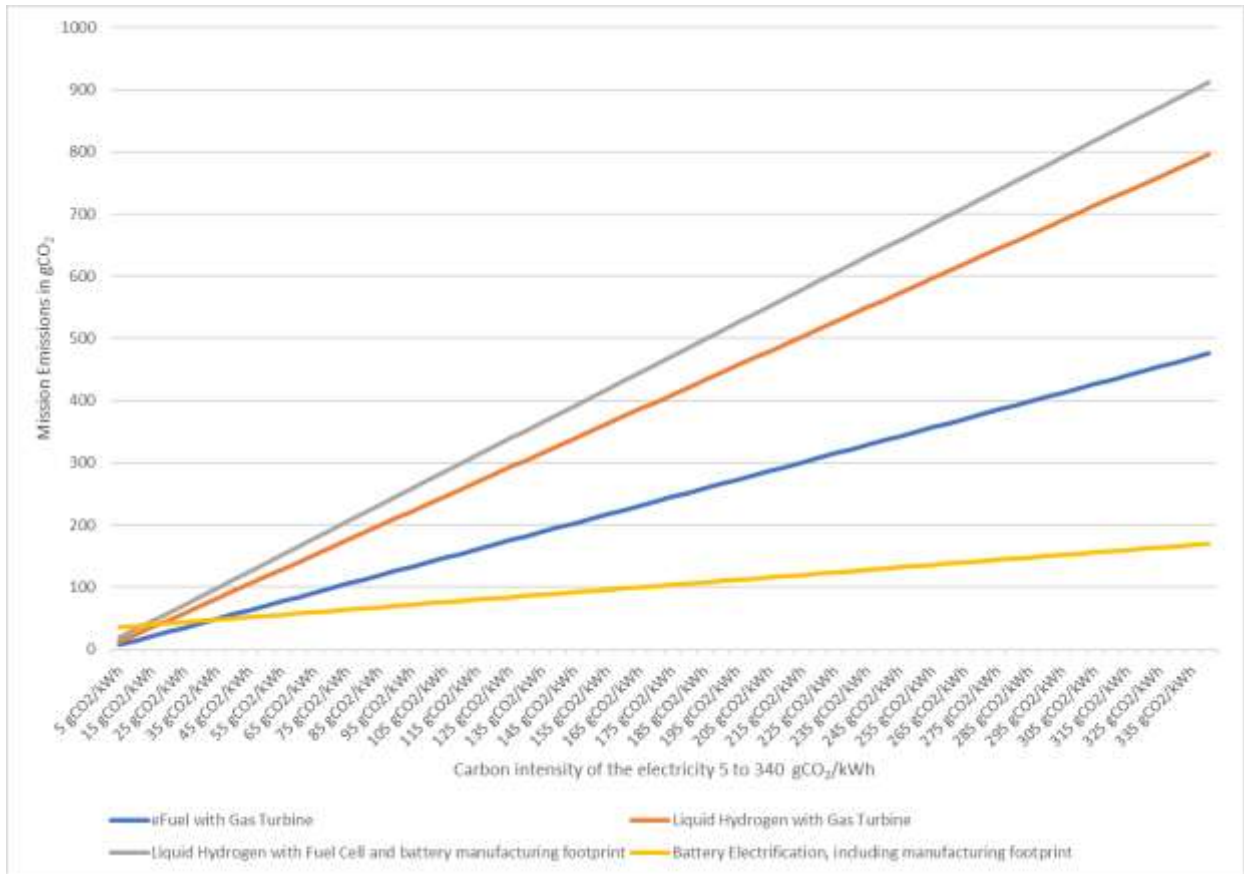

FIGURE 71 eCO₂ emissions calculated for each energy carrier with an electricity CI from 5 to 340 g eCO₂/kWh, source Jean-Baptiste Jarin and Carole Haritchabalet

Calculations are based on $Q_{kWh} \cdot CI_{kWh}$ for eFuel with Gas Turbine and Liquid Hydrogen with Gas Turbine (GTH₂) and $Bat_{CO_2} + Q_{kWh} \cdot CI_{kWh}$ for Liquid Hydrogen with Fuel Cell (FCH₂) and Battery Electrification (BE).

Carbon Intensity in FIGURE 71 goes from 5 to 340 g eCO₂/kWh (x axis) and the result for the mission is expressed in g eCO₂ in the y axis.

One can notice that, either combined with a Fuel Cell or a Gas Turbine, LH₂ has higher eCO₂ emissions than eFuel whatever the carbon intensity of the electricity, the gap widening with the CI of electricity. This can be explained by the overall efficiency of the energy carrier when applied to air mobility as described in TABLE 30, with 1399 kWh for eFuel, 2340 kWh for GTH₂ and 2665 kWh for FCH₂.

Battery electrification has the lowest CO₂ emissions except when the carbon intensity is very low, which could be explained by the impact of battery manufacturing.

While the results are clear when the CI of electricity is above 50 g eCO₂/kWh, this is not the case when the CI of electricity is below 50 g eCO₂/kWh.

⁴⁴⁶ Scarlat, N.; Prussi, M.; Padella, M. Quantification of the carbon intensity of electricity produced and used in Europe. *Appl. Energy* 2021, 305, 117901. <https://doi.org/10.1016/j.apenergy.2021.117901>

These results should also be put in perspective of the recent pledges for low-carbon energies in the transport sector. For instance, the European Union recently implemented dedicated regulations such as the European Regulation for Renewable and Low Carbon Fuels. This regulation defines what can be considered as a low-carbon fuel, and the minimum reduction for RFNBOs compared to the fossil fuel reference shall be -70%, a potential definition of clean energy.

With a CI of 94 g eCO₂/MJ and a LHV of 44.1 GJ/t, i.e., 4.15 kg of eCO₂ per kg of fossil fuel, efuel CI shall remain below 1.25 kg of eCO₂ per kg. Since the CI of efuel is directly proportional to $Q_{kWh} \cdot CI_{kWh}$, and with Q being 22.2 kWh, the maximum CI of electricity is 56 gCO₂/kWh for efuel to be considered as a clean energy.

In FIGURE 72 we therefore focus on carbon intensity of the electricity from 5 to 50 g eCO₂/kWh. One can notice that when the carbon intensity of the electricity is very low, the choice of energy carrier is less obvious.

When electricity CI is below 35 g eCO₂/kWh, efuel shows lower emissions than any other pathway, including battery electrification. This can be explained by the impact of battery pack manufacturing eCO₂ emissions. However, it is difficult to conclude as battery recycling is expected to grow in the coming years, lowering the carbon footprint of battery packs.

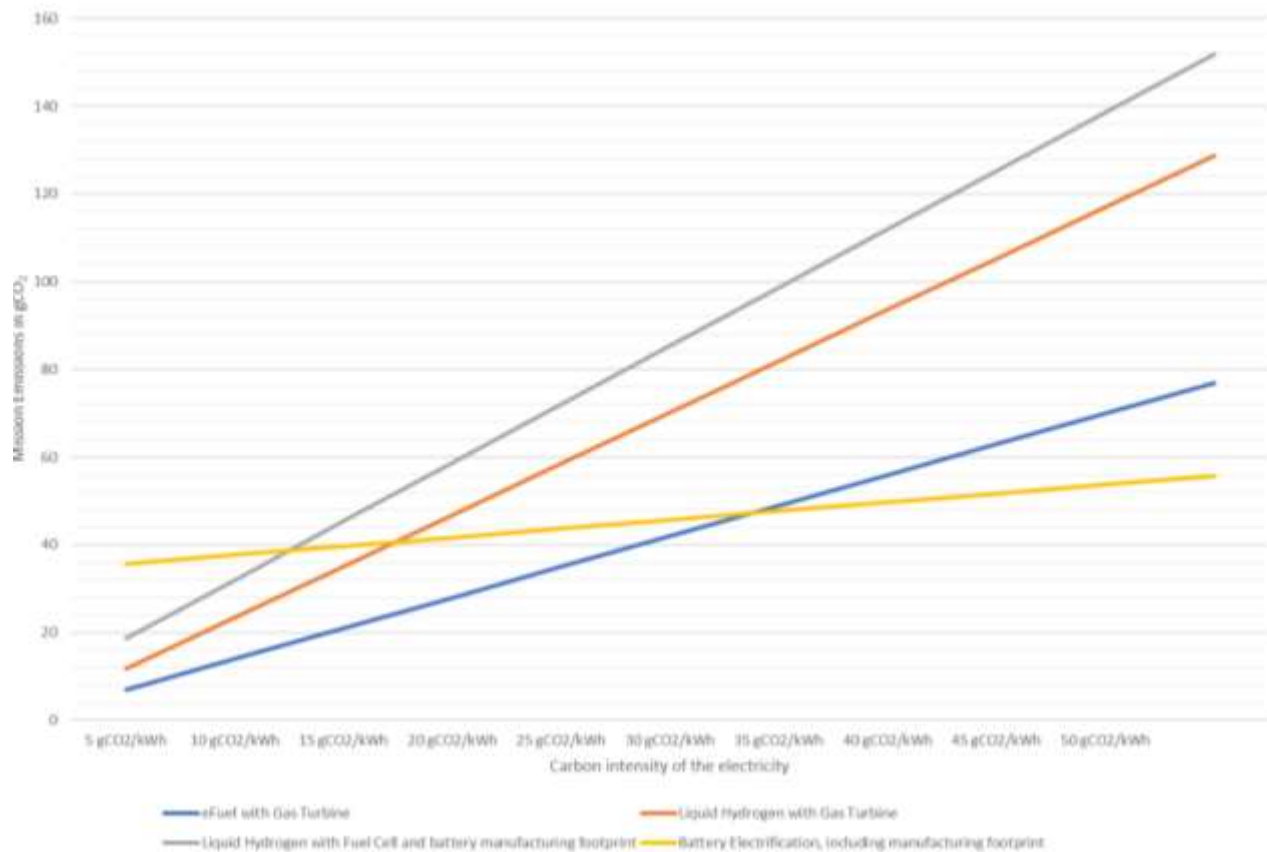

FIGURE 72 eCO₂ emissions calculated for each energy vector with an electricity CI from 5 to 50 g eCO₂/kWh, source Jean-Baptiste Jarin and Carole Haritchabalet

For LH₂ and efuel energy carriers, FIGURE 72 confirms that whatever the carbon intensity of the electricity, efuel has lower eCO₂ emissions than any propulsive systems using LH₂ (FCH₂ and GTH₂). This is mainly explained by the VTOL TOW, which is significantly heavier for FCH₂ and GTH₂, thus requiring more energy and, thus, more electricity from the grid.

Cost of Electricity for the Mission

The costs calculated here apply to the cost of the electricity required to perform the mission plus the cost of the battery pack when applicable. The share of CAPEX is considered as second order, the focus being on GHG and final price of electricity, but this will be the subject of further research.

The cost of the mission is, therefore, proportional to the electricity required for the mission (M_{kWh}) and the electricity price expressed in USD/kWh: $M_{kWh} \cdot \$_{kWh}$

This is true for all energy carriers except for BE and FCH₂ as battery manufacturing implicates significant costs as described in Section 2.4 (LCA).

For battery electrification, the hypothesis for the battery manufacturing is a cost of 75 USD/kWh, which means USD 46.87 for the 625-kWh battery pack which will be replaced every 1350 cycles or an equivalent of 200.000 km. This means USD 0.23 is to be added per km, or USD 34.7 for the mission, 80 nm being equivalent to 148 km ($0.234 \cdot 148$).

For FCH₂, the 100-kWh battery pack, using the same formula, would add USD 5.5.

Since, in our model, the costs are proportional to the price of electricity, and while this could be infinite, we used the levelized full system costs of electricity applied to low-carbon electricity plants with a load factor greater than 95%, so between 90 and 192 USD/MWh as proposed by Idel in Levelized Full System Costs Of Electricity (LFSCOE)⁴⁴⁷.

Results are shown in FIGURE 73 below, the cost of the mission is expressed in USD in the y axis while the LFSCOE is in the x axis.

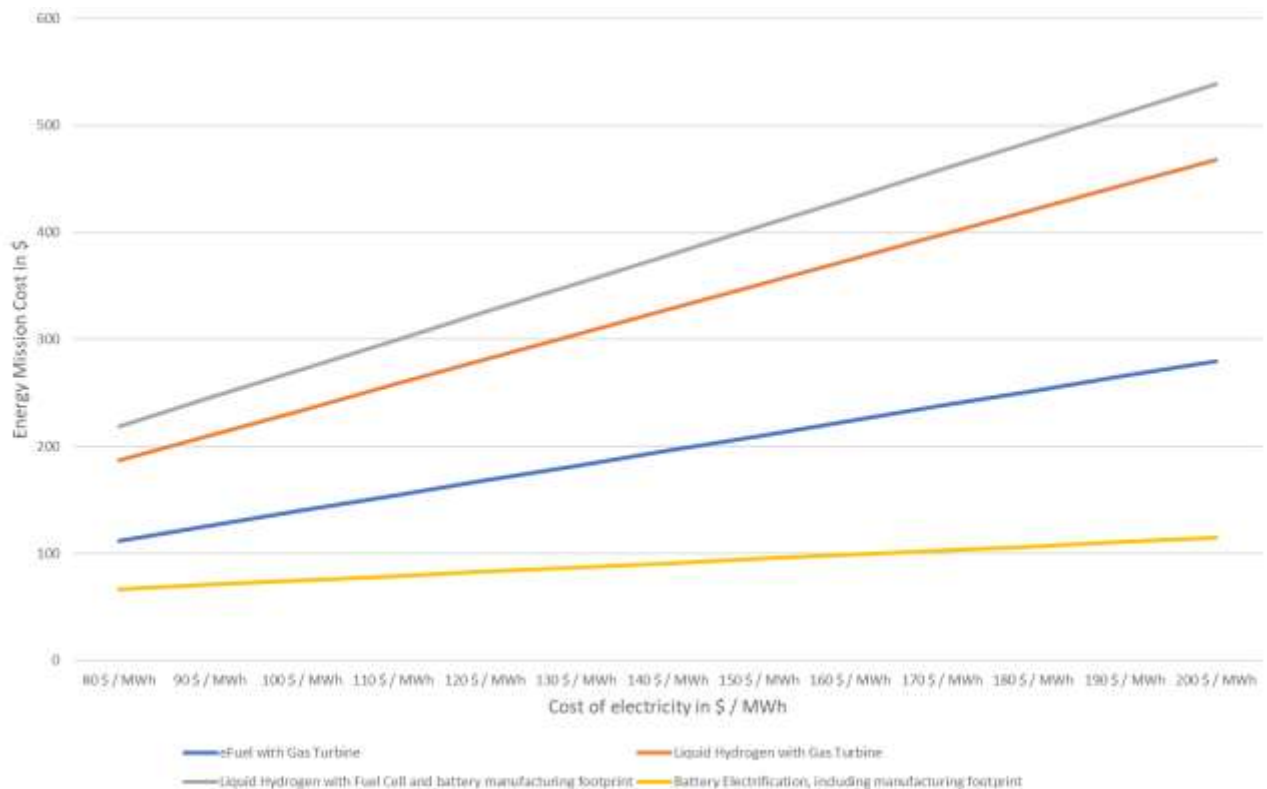

FIGURE 73 Energy Mission cost in USD, source Jean-Baptiste Jarin and Carole Haritchabalet

Whatever the price of electricity, battery electrification is always the cheapest option while a VTOL aircraft using LH₂ either with a gas turbine or a fuel cell is always the most expensive option.

⁴⁴⁷ Idel, R. Levelized Full System Costs of Electricity. *Energy* 2022, 259, 124905. <https://doi.org/10.1016/j.energy.2022.124905>

II.1.1.5. Conclusions

While there are various solutions when considering the transition to low-carbon energy⁴⁴⁸, flying requires much more energy than floating or rolling. Therefore, the integration effects when considering new energy carriers such as efuel, battery electrification or H₂, either coupled with a gas turbine or with fuel cells, shall be considered.

We found that energy carriers using electricity as a raw material can be directly compared, either to evaluate eCO₂ emissions or the cost of energy when applied to a given mission.

Battery electrification should be the preferred option, if the take-off weight is compatible with the payload and the range, which is in line with the conclusions of Zhang et al.⁴⁴⁹. However, battery electrification means heavier platforms and the opportunity of such a technology could remain limited to short distances and/or limited payloads and, thus, in competition with public transportation and/or electric cars which are far more efficient⁴²⁵. The impact on battery material could also be an issue as aircraft can travel more than 2 million kilometers per year, therefore consuming almost one battery pack per month since the average lifetime of a battery pack is 1350 cycles or 200.000 km⁴⁵⁰.

In all scenarios, efuel shows less eCO₂ emissions and lower costs than LH₂-based propulsive systems. We can conclude that carrying the most efficient molecule in an aircraft pays the extra energy cost spent on the ground for its production, namely the Fischer–Tropsch process which combines H₂ + CO₂ + H₂O. This will be further investigated in future works since VTOL requirements, such as hovering, are extremely energy demanding, thus probably magnifying the results.

A limitation of this study is that the boil-off rate of LH₂ is not considered as the model does not consider turnaround time nor the time between two flights. This would further penalize the LH₂ option. Another limitation of this study concerns the impacts of NO_x, contrails and noise which are not considered here. Future works should be conducted to refine the FCH₂ potential for small, fixed-wing aircrafts which could perhaps accommodate a fuel cell more efficiently than a VTOL aircraft^{411 412}.

As the aviation industry intends to decarbonize its energy, one shall consider that the LH₂ option requires not only more electricity from the grid compared to efuel but also that it comes with the need to be produced at the point of use as it does not travel efficiently⁴²³. LH₂ should be produced locally, which could significantly harm the cost for airlines in countries where electricity prices are high as shown in FIGURE 74 below.

In FIGURE 74 we apply the price of electricity (EUR/kWh) of three European countries, using data from Statista⁴⁵¹ for the second semester of 2022: EUR 150, 260 and 440 per MWh in France, Germany and Denmark, respectively. We introduced the cost of fossil fuel and the cost of the most common biofuel (HEFA-UCO)⁴⁰⁹ for comparison.

⁴⁴⁸ Connolly, D.; Mathiesen, B.; Ridjan, I. A comparison between renewable transport fuels that can supplement or replace biofuels in a 100% renewable energy system. *Energy* 2014, 73, 110–125. <https://doi.org/10.1016/j.energy.2014.05.104>

⁴⁴⁹ Zhang, J.; Roumeliotis, I.; Zhang, X.; Zolotas, A. Techno-economic-environmental evaluation of aircraft propulsion electrification: Surrogate-based multi-mission optimal design approach. *Renew. Sustain. Energy Rev.* 2023, 175, 113168. <https://doi.org/10.1016/j.rser.2023.113168>

⁴⁵⁰ Su-Ungkavatin, P.; Tiruta-Barna, L.; Hamelin, L. Biofuels, electrofuels, electric or hydrogen: A review of current and emerging sustainable aviation systems. *Prog. Energy Combust. Sci.* 2023, 96, 101073. <https://doi.org/10.1016/j.pecs.2023.101073>

⁴⁵¹ Statista. The Price of Electricity in Most European Countries. Available online:

<https://fr.statista.com/infographie/30253/comparaison-prix-electricite-pour-les-industriels-entreprises-par-pays-en-europe/>, accessed August 13, 2024

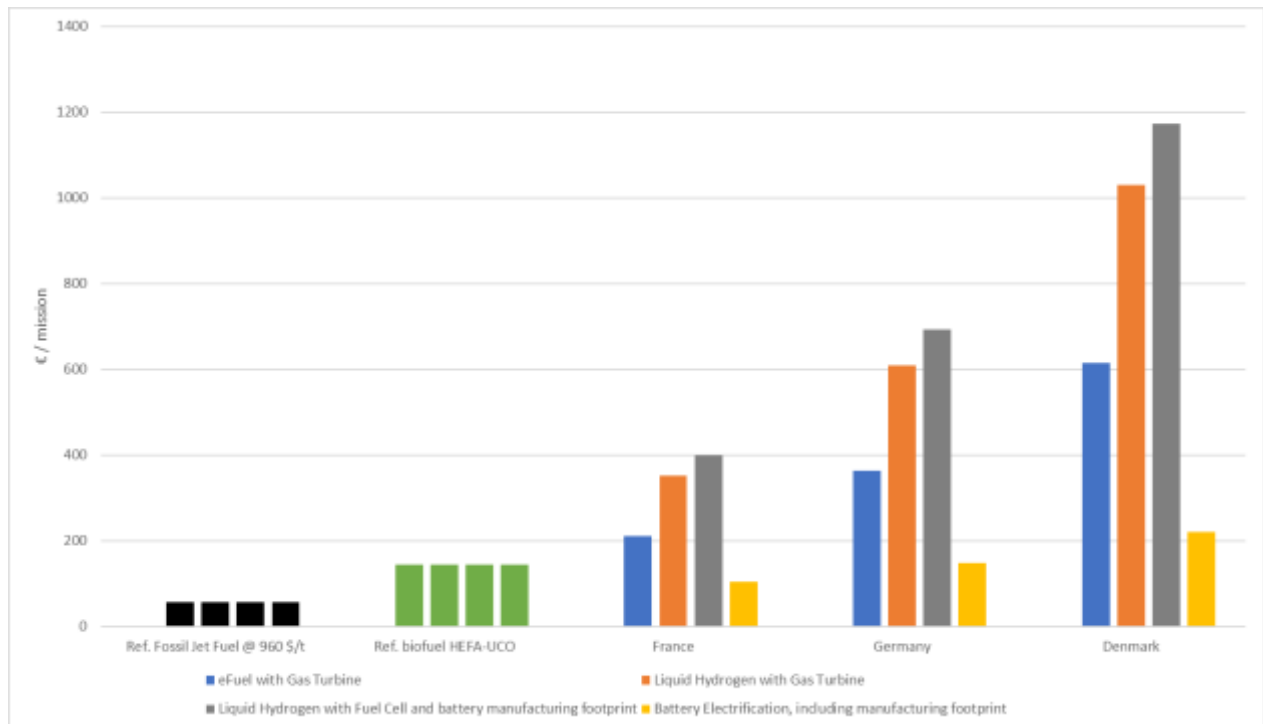

FIGURE 74 Direct energy cost for each energy carrier in 3 European countries, in EUR/mission. Fossil jet fuel and biofuel (HEFA-UCO) are introduced for comparison only, source Jean-Baptiste Jarin and Carole Haritchabalet

In FIGURE 74, one can notice that fossil fuel remains the cheapest option but also that biofuel (HEFA-UCO) could almost compete with battery electrification. More interestingly, a country with high electricity prices, such as Denmark, might consider importing efuel from France, where electricity is much cheaper, rather than charging a BE VTOL aircraft domestically. While this is probably not an option, it does highlight the disparities between future producers of low-carbon energy carriers: electricity not only needs to be low-carbon but also affordable.

Finally, we note that the impacts on electricity production could be significant. Consequently, the impact on electricity production must be considered at a national and/or continental level. In Europe, the European Union (EU) recently set a target of 35% RFNBO in its ReFuel EU regulation for 2050⁴⁵², and this study concludes that it would most likely be efuel. If the EU needs 50 Mt of jet fuel by 2050, this would mean 17.5 Mt of efuel. With 60% selectivity, meaning 60% efuel and 40% co-products as proposed by the French Académie des Technologies cited above, 37 TWh of electricity would be needed per Mt of efuel. This equals 650 TWh (17.5 Mt · 37 TWh/Mt) in an optimized scenario. In 2022, the European Union produced 2641 TWh, of which 23.5% was of wind and solar, or 607 TWh⁴⁵³. Large-scale efuel production would, therefore, require a significant amount of low-carbon electricity, which could lead to conflicts of use in the future. These findings are in line with those of Becken et al. in "Implications of preferential access to land and clean energy for Sustainable Aviation Fuels"⁴¹⁶, and this aspect of energy decarbonization for air mobility is explored in the next chapters.

⁴⁵² European Parliament, September. 2023. Available online: <https://www.europarl.europa.eu/news/en/press-room/20230911IPR04913/70-of-jet-fuels-at-eu-airports-will-have-to-be-green-by-2050> ,accessed August 13, 2024

⁴⁵³ European Council. How Is Electricity Produced and Sold. Available online: <https://www.consilium.europa.eu/en/infographics/how-is-eu-electricity-produced-and-sold/> ,accessed August 13, 2024

II.1.2. Jet Fuel properties, from fossil to SAF

As discussed above, aviation could only emerge when the technology, piston engine then turbines, met the fossil fuel and its unique properties, which over years would become jet fuel for aviation.

Before introducing the characteristics of SAF, now that it has been concluded that SAF will be the most widely used energy molecules in aviation by 2050, and probably the only low carbon ones, it is important to understand the challenges and properties of Jet Fuel. The focus here is on Jet-A and JET-A1, the most used jet fuels in aviation. Other grades, mostly for military, will be shortly introduced while Aviation Gasoline (Avgas) which is a specific grade for general aviation and some light helicopters, is not covered here while associated are considered similar.

II.1.2.1. Jet fuel properties and norms

While the chemical composition of Jet Fuel may vary depending on the origin of the crude oil or the refining processes used, the final product must meet strict requirements. Composed essentially of molecules with between 9 and 16 carbon atoms. The predominant components of jet fuels are branched and linear paraffins and naphthene (cycloalkanes) which usually account for over 70% of the components by volume. Aromatic hydrocarbons such as alkylbenzenes and naphthalenes do not exceed 25% of the total. Olefins represent an insignificant fraction of the total composition. The aromatic hydrocarbons content will be specifically address in the SAF characteristics section since while having important properties, such as for lubrication, it is a major precursor of soot and its final share in the total content is being investigated (see II.II.1, 2 and 3).

Ever since oil first appeared in our society, producers have been optimizing refining processes and the various cuts to optimize the different uses of crude oil. Jet fuel lies between gasoline and diesel in the distillation column, followed by heavy fuel oil at the bottom, mainly for shipping, and naphtha at the top, mainly for the chemical industry.

Jet fuel represents a small fraction of the final refined products, approximately 7% (see Part II Chapter IV) but its many properties make it the benchmark fuel for aviation, such as but not limited to liquid over a wide temperature range with a freezing point at -47°C and a decent gravimetric density (44 MJ/kg) combined with an excellent volumetric density (35 MJ/L).

Jet fuels must serve different purpose, combustion, but jet fuel is also being used as a heat transfer fluid, as a lubricant and as a hydraulic fluid. Jet fuel must also be available, with the same properties, in every airports of the world. To achieve this, the fuels used must comply with the international ASTM D1655 which is the Standard Specification for Aviation Turbine Fuels ⁴⁵⁴.

The most common names are Jet Fuel, kerosene, Jet A1 or Jet A. The notion of CAF (Conventional Aviation Fuel for 100% fossil Jet Fuel) is increasingly used with the arrival of SAF.

ASTM is the American Society for Testing Material, a standards organization that writes and produces technical standards for materials and products. It is this world-renowned organization that evaluates and qualifies aeronautical fuels, whether of fossil or non-fossil origin, as we shall see below. In the case of Jet Fuel, the standard specifies the physical requirements it must meet in order to be used: its composition, volatility, fluidity, combustion, corrosion, thermal stability, additives...

There are 19 criteria, divided into 3 main categories of properties and the most important properties are list in TABLE 31 below:

- Combustion mode properties: the target here is to facilitate air-fuel mixture preparation, reduce flame radiation, reduce carbon deposit formation, and ensure energy efficiency. In terms of volatility, a compromise must be found

⁴⁵⁴ <https://www.astm.org/d1655-22a.html> accessed August 13, 2024

between the best spray quality and the risk of evaporation. Viscosity must be ensured so lubrication is guaranteed. Aromatics must be present in sufficient quantity to ensure engine seal compatibility while limiting soot emissions.

- Properties related to high-altitude use: the fuel must be able to withstand temperatures down to -50°C and pressures of 0.3 bar in all its operating stages. This implies demanding characteristics in terms of crystal disappearance point, high thermal stability, and high calorific value. The viscosity at low temperature must also be ensured.

- Properties linked to ground storage and distribution operations: need to avoid spontaneous ignition, storage degradation or corrosion of materials. A safe handling requires for example a high flash point and sufficient conductivity to dissipate static energy.

These requirements, which are specific to the aeronautical sector, severely limit the various possibilities for alternative fuels. Road biofuels, for example, are not applicable, not least because their cold behavior will make them unsuitable for use at -47°C, a temperature frequently encountered at altitude by long-haul flights.

ASTM D1655 test Standard Limit; Jet A-1	
aromatics, % vol (D1319)	25
total sulfur, % mass (D4294)	0,003
total acid number, mg KOH/g max (D3242)	0,1
initial boiling point, °C (D86)	report
10% evaporated (v/v), °C (D86) max	205
50% evaporated (v/v), °C (D86)	report
90% evaporated (v/v), °C (D86)	report
final boiling point, °C (D86) max	300
freezing point, °C (D5972) max.	-47
existent gum, mg/100mL (D381) max	7
viscosity @ -20°C, mm ² /s (D445) max.8.0 4.10 3.73 3.38	8
viscosity @ 40°C, mm ² /s (D445)	report
density @ 20°C, kg/m ³ (D1298)	771-836
density @ 15°C, kg/m ³ (D1298)	775-840
smoke point, mm (D1322) min	25
flash point, °C (D93) min	38
specific energy (LHV), MJ/kg (D3338) min	42,8

TABLE 31 Examples of physico-chemical properties measured in the Jet A1 standard with data from ASTM D1655

Having always been accustomed to constantly improving the performance of gas turbines, engine manufacturers have also been focusing on the downstream, i.e. emissions, under regulatory pressure. Not only SFC, but also combustion emissions are now taken into account since the early stage of the turbine design. For instance black smoke have long been a thing of the past, thanks to technical advances in both the management of pollutant emissions and the reduction of turbine power consumption. The emissions associated with the combustion are detailed in chapter II.II, the main products being after air-fuel mixture combustion (jet fuel: $C_xH_yS_z$ and air: 78% N_2 , 22% O_2) CO_2 , H_2O , N_2 , O_2 , SO_x , unburned hydrocarbons, CO , soot, NO_x . This is slightly different than theoretical emissions (CO_2 , H_2O , N_2 , O_2 , SO_2).

It is a commonplace in the aviation industry to hear that the last drop of oil will be burned in an aircraft engine, yet the sector has only taken an interest in energy issues on some occasions: during the first two oil shocks in the 70's, during the 3rd oil shock in 2007, and more recently with the need to decarbonize and the associated regulations, introducing the SAF into the spectrum.

II.1.2.2. SAF properties and norms

Energy, and in this case oil, is at the heart of air transport, but until now the two sectors have crossed paths without really cooperating, apart from the standards and certification of aviation fuels. The challenges posed by global warming, but mostly the more stringent regulations, are now forcing the air transport industry to look upstream in particular at the carbon dioxide content of the fuel to be used. This situation will force the sector to cooperate with the energy industry and to display CO₂ emissions almost continuously over the entire life cycle (see I.1.2).

But as mentioned above, safety is never a compromise in aviation and all the above requirements are being maintained and even reinforced with SAF, understanding that today only blend SAF is authorized and that work is ongoing to extend to 100%.

The notion of blend needs here to be further detailed. As introduced in part I SAF is the main lever in reducing aviation emissions and blend % were proposed 3 (20% in 2030, 50% in 2040 before reaching 100% in 2050). This could have been interpreted as a share of aircrafts fly with fossil jet fuel and the other share with SAF, but in reality, the SAF is, and most probably will remain blended with fossil jet fuel in the coming years. This reality is sometimes difficult to apprehend as press releases often mention the use of SAF but without detailing which SAF and more important in which proportion. FIGURE 75 below details the various definitions of SAF, introducing the blend but also the Drop In / Non-Drop In as well as alternative fuels. The pro and cons are detailed, the focus of this study being on the most credible solutions: Blend SAF, which are already authorized up to 50%, and 100% Drop In SAF.

While being not the focus on this study, Drop In and Non-Drop In SAF were both tested, see II.II, it is important to understand that there are no eCO₂ emissions differences between Drop In and Non-Drop In, the major difference between the two being the absence of aromatics in the Non-Drop In. This absence of aromatics explains by itself the term Non-Drop In: with a lack of lubrication failure of major components could occur, and therefore the vast majority of the current fleet in operation would not be compatible. You cannot simply drop this type of fuel in the existing fleet, nor in the existing infrastructures such as airport hydrants. The main collateral benefit expected with the Non-Drop In are reduced emissions of soot, which have a role in contrails formation. This role remains however limited, the latest study published concluding to a -26% effect on contrail formation with a 100% Non Drop in SAF⁴⁵⁵ compared to fossil jet fuel. More studies, including 100% SAF Drop In are still to be realized. Flying at lower altitudes or adapting the route upon the weather conditions are other options currently studied. Another collateral would be the increased pace in the replacement of aircrafts, but only the aircraft manufacturers and some of their supply chain could see a positive outcome in this situation while the engine manufacturers and airlines would mostly suffer from such a move.

As with CAF (Conventional Aviation Fuel, of fossil origin), the SAF certification process is based on a rigorous assessment, starting with a request from an energy supplier for a raw material/process pairing, and then being evaluated by engine and aircraft manufacturers. Partial tests are then carried out, and if they are conclusive, the manufacturers approve the proposed fuel. It then must be approved by the authorities, before ASTM finalizes the process by including the ASTM D7566 specification in an appendix. In particular, this appendix will specify the maximum percentage of SAF to be blended with fossil fuels. FIGURE 76 details this process along with the on-going tests as of March 2022, source FAA from Update to FAA REDAC E&E Subcommittee, March 2022, page 7⁴⁵⁶. Among the several on-going testing mentioned is noted the Virent SAK bio-aromatic which has been tested in 2023 within this study.

⁴⁵⁵ <https://www.airbus.com/en/newsroom/press-releases/2024-06-worlds-first-in-flight-study-of-commercial-aircraft-using-100> accessed August 13, 2024

⁴⁵⁶ <https://www.faa.gov/media/74261> accessed August 13, 2024

SAF	PRINCIPE	+	-
SAF DROP IN BLEND UP TO 50%	BLEND OF SAF & CAF (CONVENTIONAL AVIATION FUEL = FOSSIL JET A1) ASTM7566 ⇒ ASTM1655	7 PATHWAYS VALIDATED DROP IN POSITIVE EFFECTS ON BLACK TAIL BEING STUDIED	« UP TO »: MAX % OF SAF HAS A CAP IN REAL LIFE (1655). NOTE: M/MU NOW UPDATED
100% SAF DROP IN	ADAPTED SAF: SAK SYNTHETIC KEROSENE WITH AROMATICS & ADDITIVES	EASY TO GO (2023 OR 2024 FOR THE 1ST APPLICATION) DROP IN (NO RETROFIT) SAFETY PRESERVED WITH UPDATED ASTM SPEC	BEYOND CO ₂ OVER LCA, COLLATERAL BENEFITS ON EMISSIONS TO BE ASSESSED COMPARED TO NON DROP IN
100% SAF NON DROP IN (WAS NEAR DROP IN)	ADAPTED ENGINE: « PURE » SAF	COLLATERAL BENEFITS ON EMISSIONS SUCH AS SOOT (MAYBE CONTRAILS, TBC)	JET-X: TO BE ASSESSED (VOLCAN, R&T WITH TE) BUT CHANGE OF SOME MATERIALS IS EXPECTED (SUCH AS NITRILE). RETROFIT ? 2 HYDRANTS ?
ALTERNATIVE FUELS (WAS NON DROP IN)	H ₂ , CH ₄ , NH ₃	NO EMISSIONS AT EXHAUST EXCEPT H ₂ O	VERY LOW YIELD FROM WELL TO ROTOR. NO GAIN VS eFUEL

FIGURE 75 Synthesis of SAF and Alternative Fuels, with pro and cons, source Jean-Baptiste Jarin

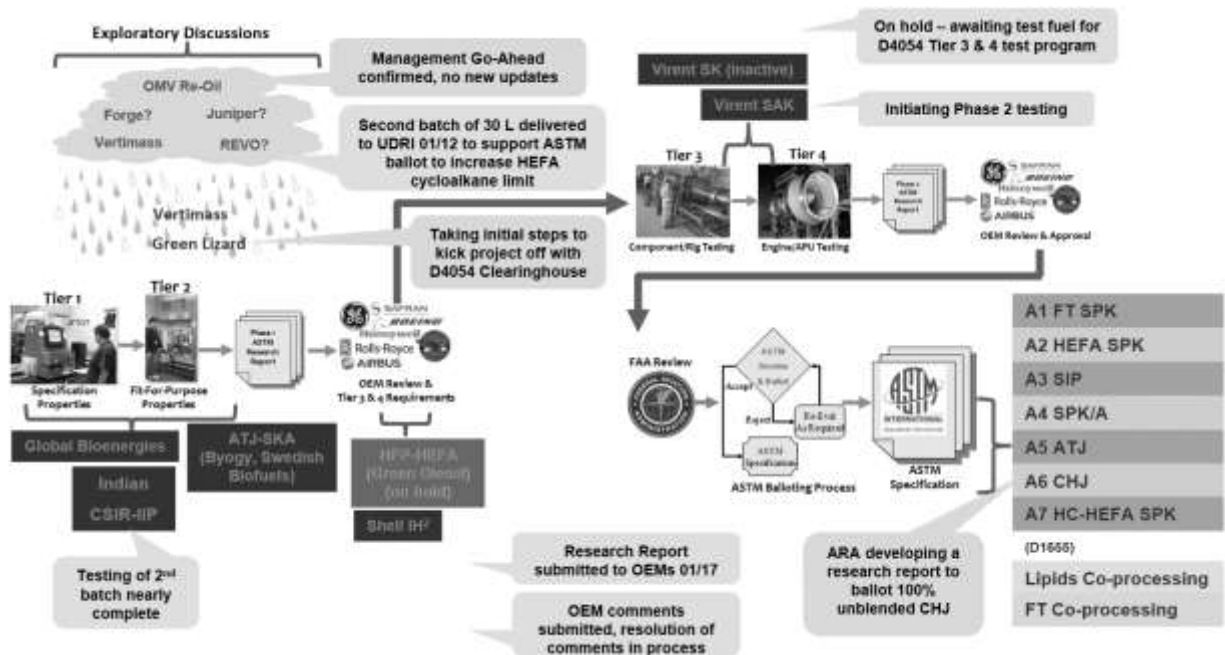

FIGURE 76 Fuels approval process via ASTM D4054. Approved fuels are annexed under D7566 and considered synthetic blend components (SBC). Current annexes require that SBCs be blended with conventional jet fuel. Once blended, the fuel meets ASTM D1655 criteria for aviation turbine fuel, Source FAA

II.I.2.3. SAF Production pathways and feedstocks

SAF can be manufactured through different processes and various feedstocks. A schematic of the main routes is proposed in FIGURE 77 while a synthetic overview of the currently approved pathway is proposed by Cabrera and

Sousa ⁴⁵⁷ in FIGURE 79 with courtesy of the authors. Biofuels and efuels are both accepted once they have demonstrated to be low carbon as discussed in part I. A more detailed overview can be found in ⁴⁰⁹, figure 3, which allows one to understand to different conversion steps at stake when manufacturing a SAF. The more conversion steps the higher the cost, and often the eCO₂ emissions, and a brief description of the most important pathways is proposed below (HEFA, FT, ATJ and PtL). For the reader interested in the other pathways, including co-processing, the EASA page provides detailed information ⁴⁵⁸.

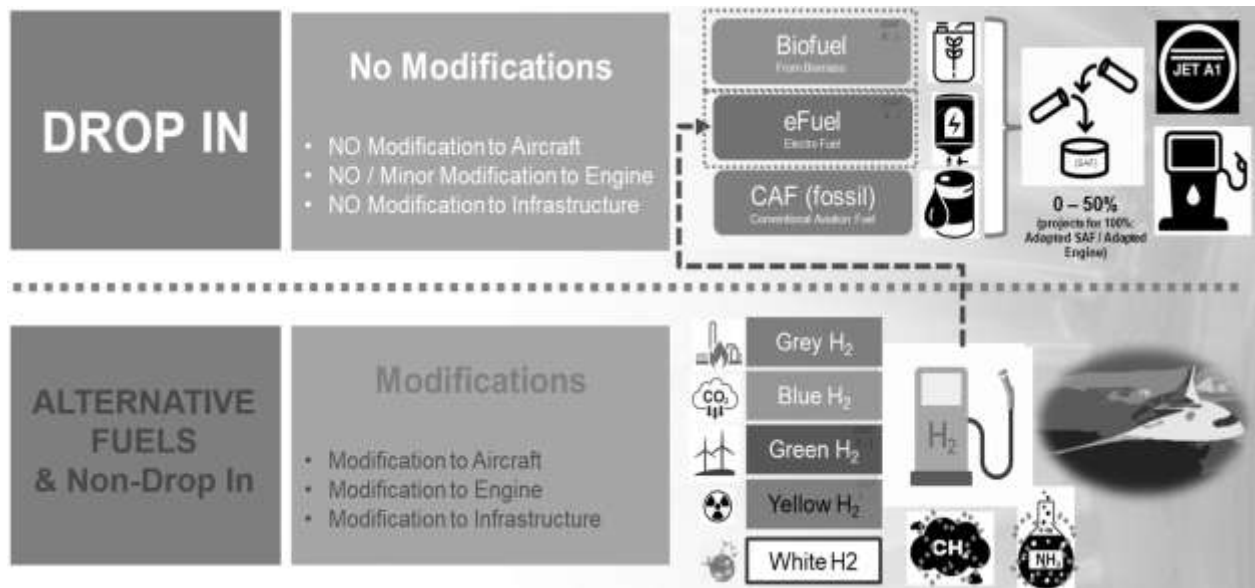

FIGURE 77 Schematic overview of the different fuels considered for aviation, efuels are introduced through the H₂ pathway, see Chapter II.1.1 above. NH₃ is being disregarded not because of its efficiency but because of safety, source Jean-Baptiste Jarin

H₂ and efuels: It's worth remembering that H₂ is only an energy carrier, and must therefore be manufactured. The 2 main processes for obtaining hydrogen are:

- Steam reforming of fossil fuels: grey and blue hydrogen. More expensive than oil in terms of available energy, it is also highly emissive, in the order of 10 to 24 kg of CO₂ per kg of H₂. Described as grey hydrogen, it is possible to reduce its CO₂ emissions using CCS (Carbon Capture & Storage) process to make blue hydrogen, but this entails an additional cost that few manufacturers will tolerate. 97% of the hydrogen produced in the world today is grey hydrogen, which is mostly used on site as a reagent for fertilizers and refining.

- Water electrolysis: hydrogen produced by water electrolysis is often called green hydrogen. It then requires low carbon electricity from renewables. It can be yellow hydrogen when its coming from nuclear and therefore remain low carbon, it shall be authorized within the EU regulation, discussions are on going. The only CO₂ emitted is that linked to the raw materials needed for electrolysis (pure water and electricity).

The final CO₂ balance will therefore depend on the source of electricity and, to a lesser extent, the water supply. More virtuous in terms of emissions, hydrogen produced from low-carbon electrical sources is currently 4 to 5 times more expensive to produce than grey hydrogen, which is itself 3 times more expensive than jet fuel when compared to the cost per MJ available.

⁴⁵⁷ E. Cabrera and J. M. Melo de Sousa, "Use of Sustainable Fuels in Aviation - A Review", *Energies* 2022, 15 (7) 2440, <https://doi.org/10.3390/en15072440>

⁴⁵⁸ <https://www.easa.europa.eu/eco/eaer/topics/sustainable-aviation-fuels/what-are-sustainable-aviation-fuels> accessed August 13, 2024

PTL: efuels via the Power To Liquid pathway do not require biomass but water and electricity, which are used in an electrolyser to produce hydrogen, which is subsequently synthesized with CO₂ into syngas. A generic scheme is proposed in FIGURE 78. The resulting syngas is then further processed into fuel by the Fischer-Tropsch reactor or alternatively by methanol synthesis. The CO₂ needed for the PtL process can be sourced from industrial waste gases, biomass or captured directly from the atmosphere (Direct Air Capture). The production of the electricity and the sourcing of CO₂ are the determining factors in the sustainability as well as the overall costs of PtL.

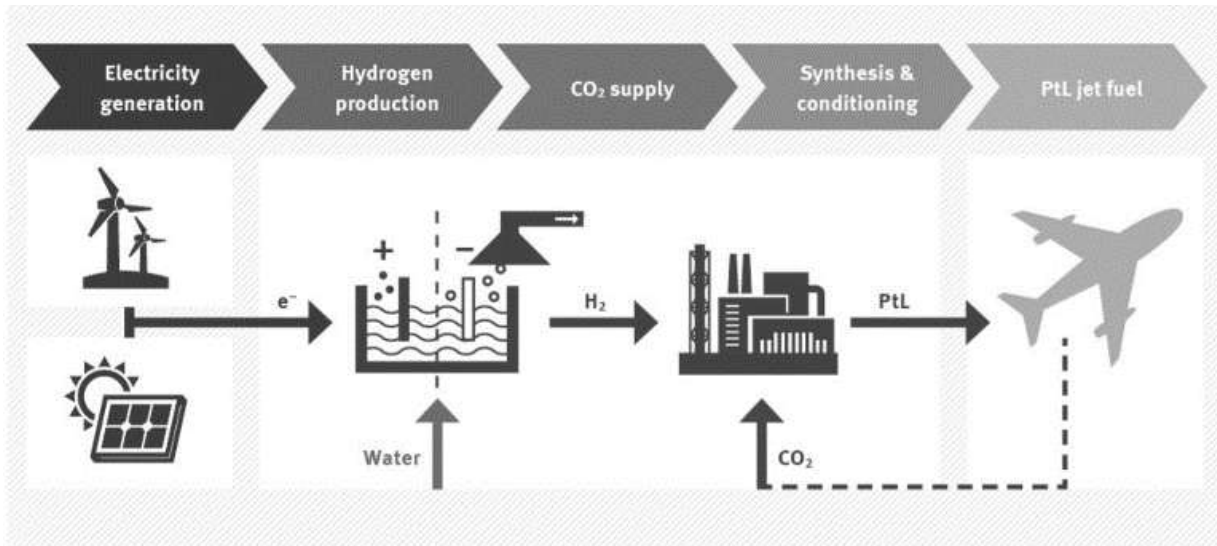

FIGURE 78 Generic scheme of e-fuel production, source LBST⁴⁵⁹

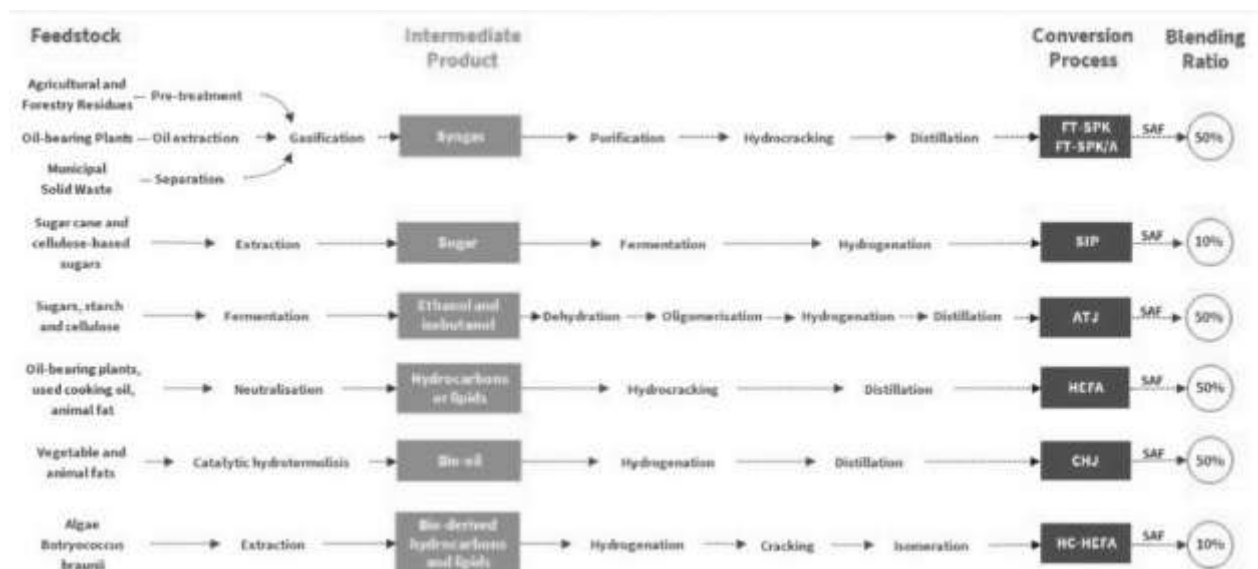

FIGURE 79 List of SAF approved according to ASTM D7566 as of 2023. Max blending ratio is indicated and specific annex can be found in FIGURE 76. Originally figure 7, with courtesy of Cabrera and Melo de Sousa

HEFA: this pathway produces also biodiesel for the automotive sector for decades and is quite mature. Many players are currently involved in commercializing these technologies on a larger scale and diversifying the raw materials used. While refineries converting vegetable oils, only Used Cooking Oil is authorized for SAF within the EU, into biofuels are

459

https://www.umweltbundesamt.de/sites/default/files/medien/377/publikationen/161005_uba_hintergrund_ptl_barrierefrei.pdf accessed August 13, 2024

already established, new prototype plants to synthesize these biofuels from tallows (animal fats, category 1 and 2 being authorized within the EU) are under development. Among the world's largest biofuel producers is the Finnish company Neste. A batch of 100% HEFA from UCO supplied by Neste have been experimentally tested, see II.II.3, while several batches of blend SAF were used in demo flights in the USA, UK and Singapore during this study^{460 461}. With a limited feedstocks of UCO and tallows (chapter II.III.2) algae is seen as a potential resource by some industrials (HC-HEFA), but no significant progress have been made during the past 20 years and this feedstock could, if it ever exist, be worse than fossil fuel for the environment⁴⁶². As of today HEFA from UCO remains the cheapest SAF available (see chapter II.III.1 below). Requiring minor adaptations of the existing refineries, the fossil jet fuel producers are investing in this technology along with Neste are Shell, BP or TotalEnergies. Recently 2 majors projects from BP⁴⁶³ and Shell⁴⁶⁴ have been put on hold, the main reason envisaged in this study being the lack of demand as volumes produced would have been higher than that requested by the regulation until 2030.

FT: Technologies for manufacturing biofuels using the Fischer-Tropsch process are currently certified, with the commercialization phase lagging behind. While commercially available from coal or gas, the main obstacle to the development of FT fuel production plants from the biomass is the reliability of feedstock gasification equipment. Indeed, as they are used, the biomass ashes that are formed significantly deteriorate the performance of these tools. This phenomenon, although not significant at first sight, nevertheless limits the commercialization of large-scale technologies until it is resolved. Similarly, as well as making progress in production, raw material supply chains also need to be adapted. The FT pathway requires new infrastructures need to be put in place, and while being smaller in size and therefore more versatile and adapted to feedstock locations (100 kt / year vs 10 Mt or more per year for the existing refineries). Several new players are investing in this pathway such but these new comers must secure the technology, the feedstock, and the offtake. But with production costs higher than HEFA the volumes remain very limited today and most actors, such as Fulcrum⁴⁶⁵, Velocys⁴⁶⁶ or Red Rock⁴⁶⁷, are struggling. This situation reinforces the conclusion of part I (leave no choice to airlines to use SAF as soon as possible) and, along with the recent news with HEFA, contradict the IATA statement that *"Demand is not the issue: Every drop of SAF produced has been bought and used"*⁴⁶⁸. This will be developed in chapter III below.

ATJ : There is a wide range of technologies that produce fuel from biomass, using different alcohols as intermediates. In general the same feedstock can be used using the Fischer-Tropsch pathway. The technical processes used in the ATJ family are considered mature, being widely used in commercial petrochemical applications. In Europe Lanzajet⁴⁶⁹ is among the world pioneer at the industrial scale but the production cost being more expensive than those of HEFA, the volumes remain limited. As for the other pathways considered here the choice of feedstock is important and while SAF produced by the ATJ pathway will be produced only from residues, the current production mostly comes from crops competing with food, such as corn, sugar beets or sugar cane. The reason is in the production costs, and research is underway to exploit more cellulosic feedstocks with a focus on improving pre-treatment methods that break down the cellulose, making the sugar available for fermentation. As for HEFA there is the possibility to adapt existing

⁴⁶⁰ <https://www.neste.com/news/southeast-asia-s-first-helicopter-flight-using-sustainable-aviation-fuel-takes-off-from-seletar-airport-in-singapore> accessed August 13, 2024

⁴⁶¹ <https://news.bellflight.com/en-US/223284-bell-505-becomes-world-s-first-single-engine-helicopter-to-fly-using-100-sustainable-aviation-fuel> accessed August 13, 2024

⁴⁶² <https://www.techniques-ingenieur.fr/actualite/articles/algocarburants-bilan-agrocarburants-53532/> accessed August 13, 2024

⁴⁶³ <https://www.energyintel.com/00000190-39e6-df74-a79f-7bff23090000> accessed August 13, 2024

⁴⁶⁴ <https://renewablesnow.com/news/shell-puts-work-on-dutch-biofuels-project-on-hold-862236/> accessed August 13, 2024

⁴⁶⁵ <https://www.wastedive.com/news/fulcrum-bioenergy-sierra-biofuels-forbearance-reno-nevada-gary-indiana/698991/> accessed August 13, 2024

⁴⁶⁶ <https://www.uktech.news/climate-tech/velocys-rescue-consortium-20240212> accessed August 13, 2024

⁴⁶⁷

<https://www.google.com/url?sa=t&source=web&rct=j&opi=89978449&url=https://www.oregonlive.com/business/2023/01/never-opened-300-million-plus-biofuels-refinery-facing-foreclosure-in-southern-oregon.html&ved=2ahUKewiQ5eTV38SHAxVaVaQEHOAyL8YQFn0ECBkQAQ&usq=AOvVaw10mtl7mPMqGfv9a6Qp-6Zq> accessed August 13, 2024

⁴⁶⁸ <https://www.iata.org/en/pressroom/2023-releases/2023-12-06-02/> accessed August 13, 2024

⁴⁶⁹ <https://www.lanzajet.com/> accessed August 13, 2024

refineries to cope with ATJ (or MTJ, Methanol to Jet) intermediate product, it is therefore carefully investigated by the majors such as TotalEnergies since the existing refineries can be adapted. New comers would generally prefer FT.

With many processes and feedstocks at stake, the final composition and physical and chemical properties can vary. Behind the CO₂e/MJ values which are different for each type of SAF (FIGURE 54), the differences in the chemical and physical characteristics which could lead to operational issues explain the Drop In approach proposed by the ASTM SAF working group as regulated by ASTM D7566 above the ASTM D1655, see chapter II.II.3.

As discussed above, and without detailing the synthetic fuels which are produced from coal or gas since almost a century, and sometimes used in aviation such as in South Africa during the apartheid, SAF are being seriously investigated for two decades. For instance, the FT-SPK pathway was approved by ASTM for incorporation into ASTM D7566 as soon as September 2009 while the HEFA pathway, the most common SAF today, was approved in June 2011⁴⁷⁰. While efuels can be considered as novel molecules, the water electrolysis process to split H₂O in H₂ and O₂ is well known, as well as the Fischer-Tropsch process to combine H₂ and CO₂. Since efuels can be produced either from the Fischer-Tropsch or the methanol pathways. FIGURE 78 describes the generic efuel process, discussions are already initiated with ASTM and the approval of the first efuel produced via the methanol pathway as an annex to ASTM D7566 should occur in the coming years, well before being mandatory in aviation (see chapter I.II.2 regulation), while the FT pathway is already approved.

SAF can be produced either from biomass and / or electricity. And / or because a recent pathway, which we called ebiofuel in the Académie des Technologies report, could increase the conversion yields. At its early stage it is not detailed here.

All SAF issued from the biomass can be considered as biofuels, which have been around since the invention of the combustion engine, Rudolf Diesel ran his engines on peanut oil. At that time, it was the cheapness and abundance of oil that made biofuels disappeared from the global energy scene, since only economic - and sometimes strategic - interest counted. As such the first SAFs were developed to help ensure the security of energy supplies, not because of environmental concerns, and the S of SAF was to be understood as Synthetic rather than Sustainable. The first projects were CTL (Coal To Liquid) and GTL (Gas To Liquid), with much higher CO₂ emissions than fossil oil, following the example of SASOL in South Africa⁴⁷¹ Qatar proposed and operated GTL as soon as 2009 in revenue flights⁴⁷².

SAF are now seen as contributing to the fight against climate change, which is not compatible with CTL or GTL projects. Only SAFs with a better CO₂ balance than CAF are considered, with a target balance of 65% lower for SAF issued from the biomass and 70% when being renewable fuels from non-biological origin, such as efuels, see chapter I.II.2.

Since then, most stakeholders led by ICAO and supported by governments, have been stepping up their research and development efforts in biofuels for over a decade such as the European Clean Sky programs since 2008, conclusions for 2020 can be found in⁴⁷³, or SWAFEA in 2009⁴⁷⁴ which delivered its conclusions in 2011, highlighting that, already, cost and feedstocks are the main issues with SAF.

In the USA, as soon as 2009, Boeing and UOP presented the characteristics of the first potential biofuels, based on a 50% blend of seaweed, camelina and jatropha. The technical conclusions are synthesized in TABLE 32 below and confirm that there are no major technical hurdles in deploying SAF in aviation, while none of the tested feedstocks have been developed since. However, the difference in viscosity, and therefore lubricity, is significant, which explains the 2 routes currently being evaluated: Non Drop In (pure SAF) and Drop In (SAF with added aromatics).

⁴⁷⁰ <https://www.iata.org/contentassets/d13875e9ed784f75bac90f000760e998/saf-technical-certifications.pdf> accessed August 13, 2024

⁴⁷¹ <https://www.sasol.com/media-centre/media-releases/sasol-produces-15-billion-barrels-synthetic-fuel-coal-fifty-years> accessed August 13, 2024

⁴⁷² <https://www.airwaysmag.com/legacy-posts/worlds-first-revenue-gtl-fuel-flight> accessed August 13, 2024

⁴⁷³ https://clean-aviation.eu/sites/default/files/2021-08/Highlights-2020_en.pdf accessed August 13, 2024

⁴⁷⁴ <https://www.icao.int/environmental-protection/GFAAF/Pages/Project.aspx?ProjectID=8> accessed August 13, 2024

Properties		Jet A1 (fossil)	Jatropha	Camelina	Jatropha / Algae	Jatropha / Algae / Camelina
Freeze Point °C	Max	-47	-57	-63	-54	-63
Flash Point °C	Min	38	46	42	41	ND
Thermal Stability °C	Min	260	340	340	340	300
Viscosity 20 °C, mm ² /s	Max	8.0	3.663	3.336	3.510	3.535
LHV MJ/kg	Min	42,8	44,4	44,0	44,2	44,2

TABLE 32 Examples of physico-chemical properties, source UOP

While there are still some progresses to be made for some pathways, most are already reaching a FRL (Fuel Readiness Level) above 7⁴⁷⁵ as concluded by Dahal et al in⁴⁰⁹ (originally table 3), which means they are commercially available or certified and ready for commercialization.

In the next chapter are addressed the emissions of combustion, since any regression would be a major drawback for aviation, before introducing the key challenges of SAF: cost and feedstocks. Those two last challenges being largely in the hands of energy companies, a cooperation between the aviation and the energy sectors will have to intensify, since it is the energy companies that will have to invest in future SAF production units, and to do so they need to know the real prospects offered by air transport in terms of volume and price. As of today, it is regulation which offers this prospect. This cooperation will have to take place in a world that is also set to evolve, after having remained static for a long time (the oil sector has been remarkably stable and resilient for a century): new energy providers are appearing, driven by the deployment of alternative fuels, and more broadly, the entire energy sector is undergoing change under the dual pressure of climate change and oil shocks. This is encouraging the emergence of start-ups and new production units where the race for size is no longer necessarily the best economic response.

⁴⁷⁵ https://www.caafi.org/tools/Fuel_Readiness_Level.html accessed August 13, 2024



II.II. Sustainable Aviation Fuels emissions

As discussed above, there are various type of SAF, and emissions need to be carefully reviewed to validate that no collateral damages would accompany the development and deployment of SAF, i.e. a net gain in eCO₂ emissions shall not be harmed by increased CO, NO_x or Soot emissions for example.

As seen in the previous chapters, SAF can be Drop-In, but also Non-Drop In. While there are still ongoing discussions regarding the pro and cons of each pathway, FIGURE 75, it is found necessary to better understand the emissions associated to each pathway.

During this thesis, we have conducted several tests, using the BEARCAT test cell (picture below). Two major test campaigns took place, the first in 2021, testing a 100% Non Drop In SAF (HEFA). Results were presented during TSAS 2022. For proprietary reasons the results shown have been scaled. The second test campaign occurred in 2023, testing a 100% Drop In SAF (HEFA + bio aromatics). Results were peer reviewed, and presented during ASME Turbo Expo 2024.

Using a unique test cell, with the same test protocol, ensures a high level of repeatability and reproducibility. Details of BEARCAT (picture below) can be found in chapter II.II.2.2. and in ⁹⁷.

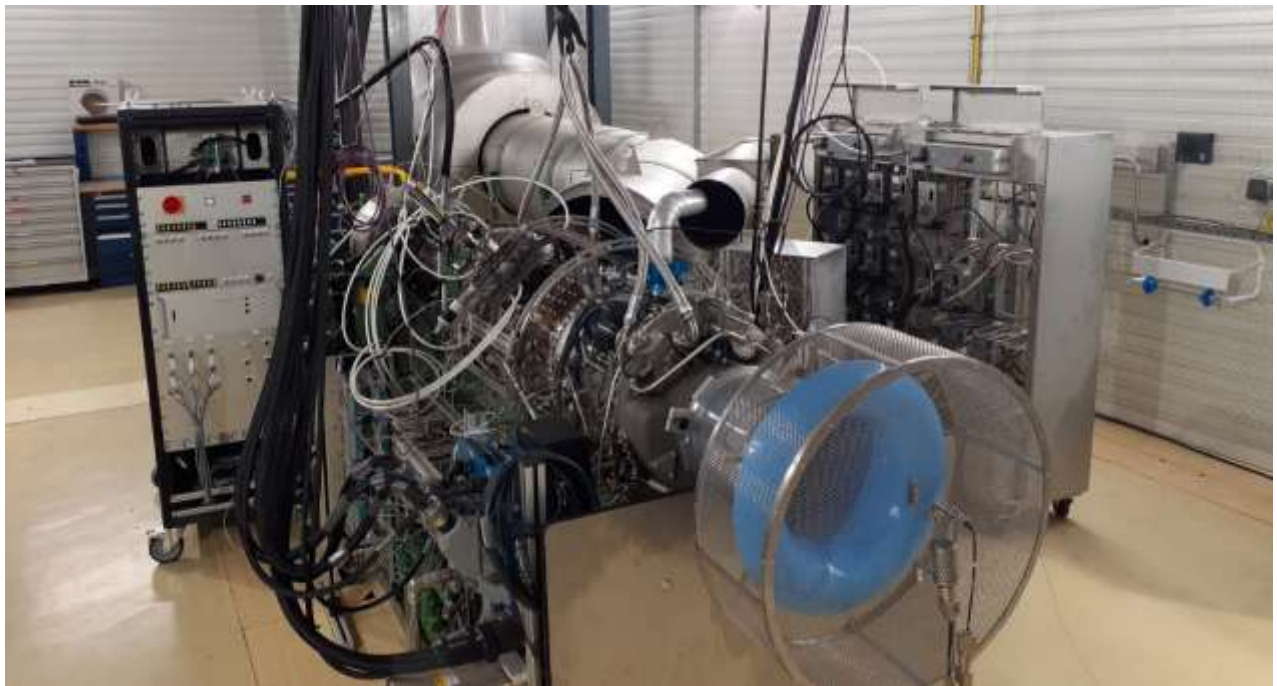

The next two chapters present these results for both Drop in and Non-Drop In SAF. The Non-Drop In SAF emissions were measured both at exhaust, and within the combustion chamber. While allowing a greater understanding of the gases formation and evolution, the results within the combustion chambers are in line with those at exhaust, and are not detailed here but the results, peer reviewed, were presented during ASME Turbo Expo 2023 ⁴⁷⁶.

⁴⁷⁶ Jarin, J, Champion-Réaud, J, Lambert, P, Mendes, C, Jeuland, N, May-Carle, J, Doucet, C, & Picard, F. "Gas Concentration Maps Within a Turbomachine Combustor Fueled With Jet-A1 or Sustainable Aviation Fuel (SAF)." *Proceedings of the ASME Turbo Expo 2023: Turbomachinery Technical Conference and Exposition. Volume 3A: Combustion, Fuels, and Emissions*. Boston, Massachusetts, USA. June 26–30, 2023. V03AT04A024. ASME. <https://doi.org/10.1115/GT2023-101375>

These results concluded that SAF emissions were always better, or equal, to CAF emissions, confirming that SAF are technically feasible and environmentally desirable.

II.II.1. Emissions of Non-Drop In SAF, measured at exhaust

II.II.1.1. Introduction

SAF can be manufactured through different processes and various feedstocks. Therefore, the composition and physical & chemical properties can vary. Behind the eCO_2/MJ values which are different for each type of SAF, the differences in the chemical and physical characteristics explain the Drop In approach proposed by the ASTM SAF working group as regulated by ASTM D7566 above the ASTM D1655. However, neat SAF (Non-Drop In) is the SAF currently available in blend and there could be a possibility to use neat SAF in the future. It is therefore necessary to measure and understand the impacts on fuel systems and associated emissions beyond CO_2 to evaluate the risks and benefits associated.

As discussed above, according to the the ReFuel EU and RED regulations ⁴⁷⁷, in order to qualify biofuels as renewable energy sources, biofuels have to achieve a 65 % greater reduction in emissions against a fossil fuel baseline of 94 gCO_2e/MJ . Using the same LCA the 100% SAF HEFA-SPK specially manufactured by TotalEnergies for this study and used during the test campaign is set at 8.69 $g CO_2e/MJ$, confirming that for some SAF a 90 % saving on eCO_2 LCA is achievable, FIGURE 80.

Address of dispatch/shipping point of the sustainable material: TotalEnergies Fluides, Route du Canal de Tancarville, 76430 Oudalle FR
 Same as address of supplier

Address of receipt/receiving point of the sustainable material: SAFRAN HELICOPTER ENGINES, AVENUE JOSEPH SZYDLOWSKI, 64511 BORDES
 Same as address of recipient

Date of dispatch of the sustainable material: 17/08/2021

1. General information

Type of Product: HEFA
 Type of Raw Material: Used cooking oil (UCO)
 Additional Information (voluntary): Name of product: Fluid HEFA
 Country of Origin (of the raw material): CN/China
 Quantity: 5,980 mt m³ metric tons
 Energy content (MJ): #N/A MJ

3. Greenhouse Gas (GHG) emission information

Total default value according to RED II applied Yes No

$E = E_{ec} + E_i + E_p + E_{td} + E_u^3 - E_{sc} - E_{cc} - E_{cr} = 8,69 \text{ gCO}_2\text{eq/MJ}$

FIGURE 80 eCO_2 LCA of the SAF tested in accordance with EU requirements (EU) 2018/2001, Annex V, see TABLE 10, here 8.69 $g CO_2/MJ$, source TotalEnergies

⁴⁷⁷ https://eur-lex.europa.eu/legal-content/EN/TXT/?uri=uriserv:OJ.L_.2018.328.01.0082.01.ENG&toc=OJ:L:2018:328:TOC accessed August 13, 2024

The SAF used during this test campaign, HEFA-SPK from UCO, is quite representative of the SAF used in blend today, up to 50%, by the aviation industry. With a mature process and feedstock availability in the range of 20 Mt / year, it is believed to be, and to remain, the most competitive SAF for the coming decades.

The 100% SAF HEFA-SPK properties can be compared to the CAF and the major difference lies in the lack of aromatics and lower sulfur content. In a roadmap to 100% SAF, it is important to understand the phenomena at stake during the combustion phase in order to characterize the impact of SAF on not only CO₂, but also on CO, NO, NO_x, SN (Smoke Number) and O₂ emissions.

II.II.1.2. Methodology

Main fuel characteristics are similar, except for the lack of aromatics of the SAF and its low sulfur content. This leads to a higher H/C ratio and a higher LHV, TABLE 33.

SAF HEFA-SPK : $C_{12}H_{26}$ $H(y)/C(x) = 2,162$ $LHV = 44,4 \text{ MJ/kg}$ $M_{fuel} = 165,6 \text{ g/mole}$	CAF: $C_{11}H_{22}$ $H(y)/C(x) = 1,897$ $LHV = 43,7 \text{ MJ/kg}$ $M_{fuel} = 161,5 \text{ g/mole}$
--	--

TABLE 33 Main characteristics of CAF and SAF, source Jean-Baptiste Jarin and Jean-Louis Champion

The SAF density is also lower than the CAF with a density at 15°C of 754 kg/m³ according ASTM D1298. As mentioned by Burnes et al.⁴⁷⁸, the H/C ratio is a distinctive attribute of fuel. As the H/C ratio increases, the fuel becomes lighter and specific energy is increasing. Tests have been carried out with BEARCAT ("Banc d'Essai Avancé pour la Recherche en Combustion et Aérothermique des Turbomachines"). A description of BEARCAT can be found in⁹⁷. It is a heavily instrumented engine developed by SafranTech on a MAKILA 2B turboshaft (2200 SHP). The first objective of this test campaign was the delivery of a Flight Clearance Note (FCN) to Airbus Helicopters in order to allow the realization of a flight on a H225 Helicopter with one engine fed with 100% SAF⁴⁷⁹. This has been done with success in November 2021, while Airbus Helicopter performed a 2nd flight in May 2022 with both MAKILA engines fed with 100% SAF. In this framework, and in parallel to the FCN's dedicated tests, we performed experiments in order to quantify some global behavior of SAF combustion. "Global" means at the engine exhaust, despite the possibility to investigate the SAF combustion inside the combustion chamber of BEARCAT thanks to the thorough modifications allowing the flow investigations inside the machine.

Back-to-back tests with MAKILA engine

First of all, it was found necessary to verify that the thorough modifications implemented on BEARCAT do not change drastically the results, leading impossible any comparison with serial MAKILAs powering helicopters. Therefore, we started our SAF campaign by feeding BEARCAT with CAF (Conventional Aviation Fuel: fossil Jet-A1). We performed gas sampling 4 meters downstream of the engine exhaust nozzle. This corresponds to 6 times the inner diameter of the exhaust tube. Gas sampling is performed along a diameter of the exhaust tube by means of a stainless tube being 10 mm in diameter and regularly fitted with small sampling holes. Gas sample is analyzed by a device developed by the ENVA Company. It allows the determination of the volume concentration of the following species: CO, CO₂, O₂, NO and NO_x. The accuracy of gas concentration is given by the analyzer manufacturer at less than 0.2 % full scale⁹⁷. Gas concentration measurements are carried out in stabilized conditions (10 minutes of stabilization delay), both in

⁴⁷⁸ Burnes, D., and Camou, A. (July 31, 2019). "Impact of Fuel Composition on Gas Turbine Engine Performance." ASME. *J. Eng. Gas Turbines Power*. October 2019; 141(10): 101006. <https://doi.org/10.1115/1.4044238>

⁴⁷⁹ <https://www.google.com/url?sa=t&source=web&rct=j&opi=89978449&url=https://www.airbus.com/en/newsroom/press-releases/2021-11-first-airbus-helicopter-flight-with-100-sustainable-aviation-fuel&ved=2ahUKewi2tdnkt7CGAxXOUaQEHRZdDFcQFnoECDMQAAQ&usq=A0vVaw0YvStA4JK05K6gQf1tt41> accessed August 13, 2024

increasing and decreasing the engine power. For that purpose, the serial exhaust nozzle is replaced by a specific one, which avoid ingestion of air, thanks to the Venturi effect caused by the burned gases jet exhausting from the engine nozzle.

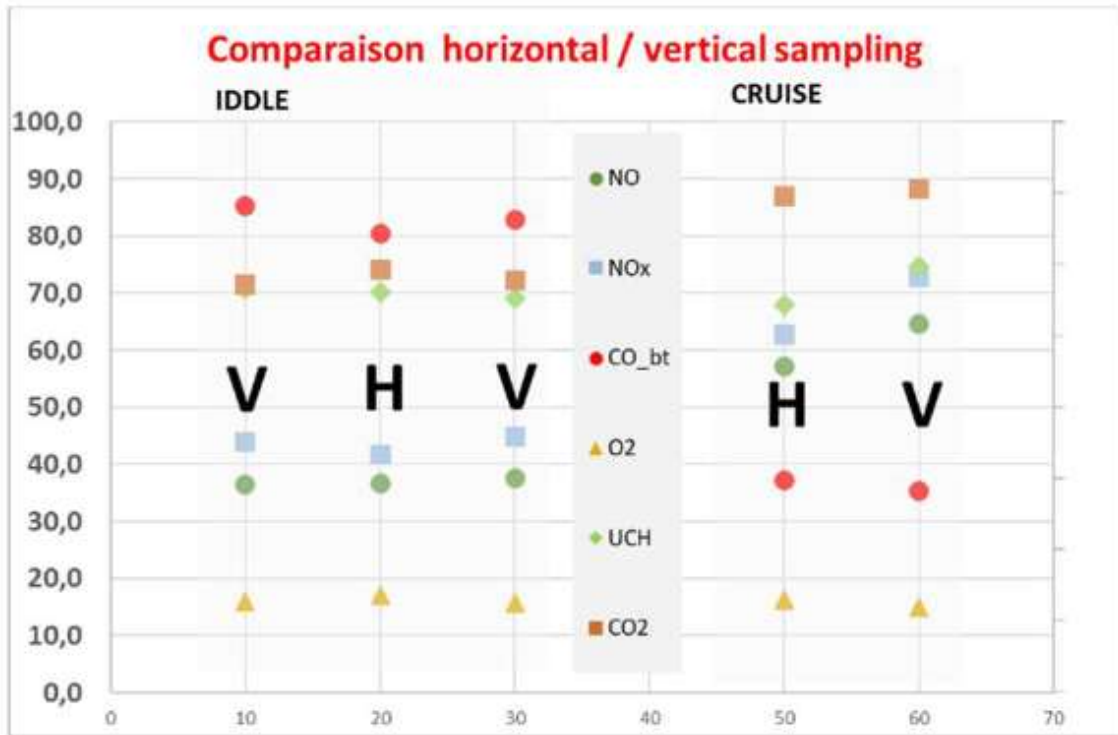
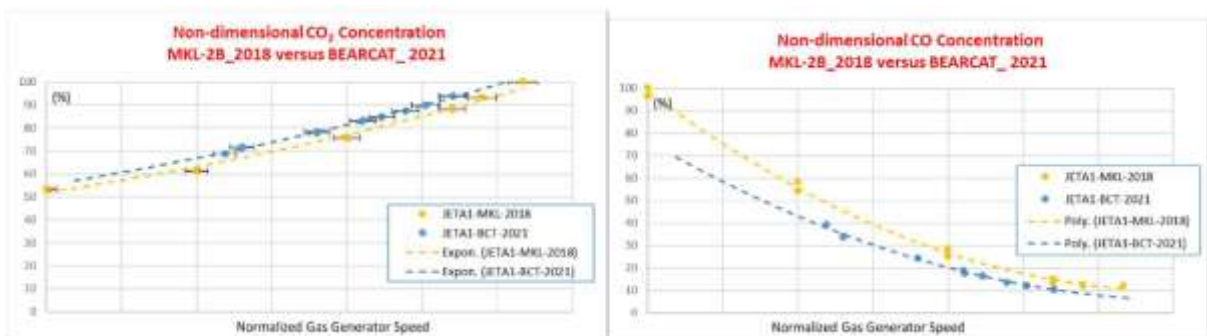

FIGURE 81 Normalized concentration measurements for vertical and horizontal sampling arrangement, source Jean-Baptiste Jarin and Jean-Louis Champion

The BEARCAT's exhaust nozzle, as MAKILA's one, is highly 3D. Therefore, it appears necessary to verify that measurements do not depend in the way the sampling is done. For that purpose, we carried out experiments with on horizontal, as well as a vertical arrangement of the sampling tube. FIGURE 81 above shows that, whatever the sampling arrangement considered, concentration measurements are very similar. This confirms that the mixing at the level of the sampling plane (4 meters downstream of the engine exhaust nozzle) lead to a homogeneity sufficient for our purpose. Gas concentration measured on BEARCAT are compared with measurements performed on a MAKILA engine in 2018, both fed with fossil Jet-A1. In FIGURE 82 to 86 we plotted the normalized gas concentration versus the normalized gas generator speed (in %). The uncertainty in measuring the rotation speed is lower than 1%. In order to enhance the graph visibility, we decided to plot bar errors only on the first graph. For each species, the concentration is normalized by the maximum value recorded. Therefore, the uncertainty on the normalized concentration is no greater than 0.5 %. That means that corresponding error bars are not visible on the graph, because they are smaller than dots.



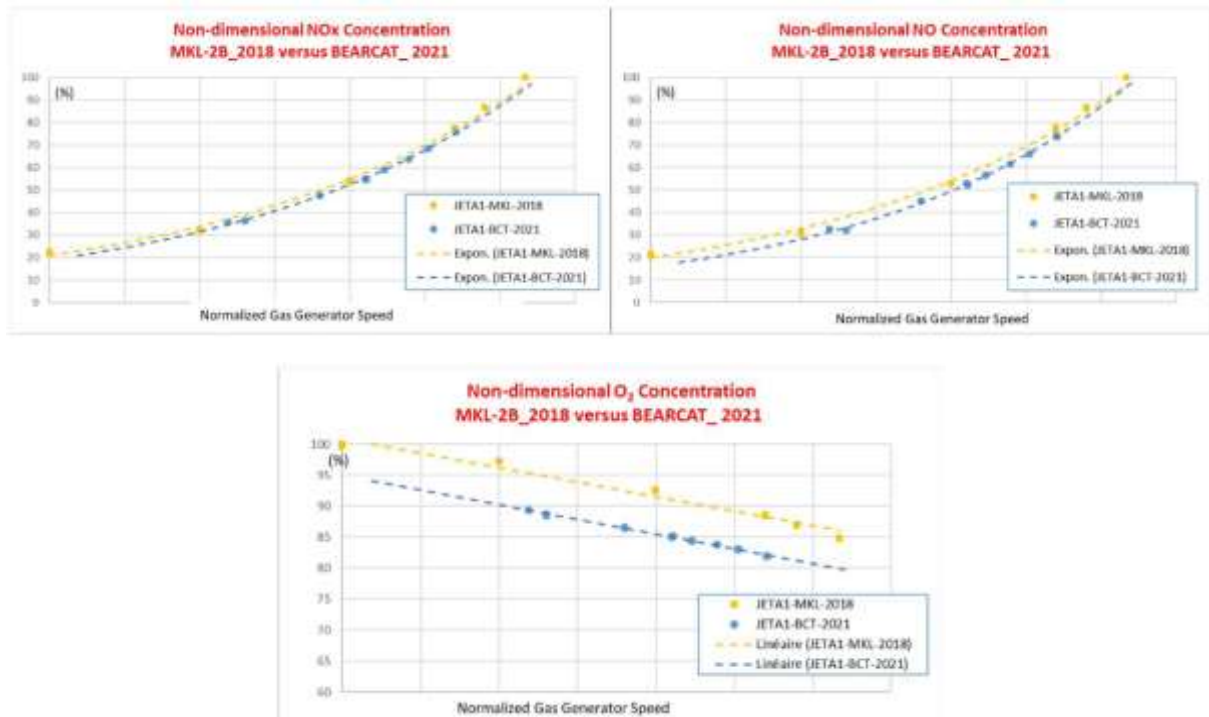

FIGURE 82 FIGURE 83 FIGURE 84 FIGURE 85 FIGURE 86: non-dimensional CO₂, CO, NO_x, NO and O₂ concentration versus reduced engine rotation speed in %. Comparison between BEARCAT (2021, in blue) and Makila serial engine (2018, in orange) results, source Jean-Baptiste Jarin and Jean-Louis Champion

As expected, the variation of CO₂ concentration with the Fuel mass flow rate can be considered as a linear function of the fuel mass flow rate. Both results follow the same trend. Even if results are very close for both tests, CO₂ concentration measured on BEARCAT are slightly higher (5%) than the one measured on MAKILA. The CO concentration measured on BEARCAT is also higher than the one measured on MAKILA. The difference reaches 15% for low regimes, and tends to be negligible at high regimes.

NO_x and NO concentrations measured on BEARCAT and on MAKILA are very close. The difference is less than 3 %.

The O₂ concentration measured on MAKILA is greater than the one measured on BEARCAT. The difference is constant and close to 7%. This feature could be a consequence of modifications implemented on BEARCAT, which could impact the Secondary Air System flow rate devoted to engine cooling.

These features clearly show that BEARCAT's and MAKILA's results are very similar. This confirms that, despite the differences between BEARCAT and a standard MAKILA serial production engine, results observed on BEARCAT, with SAF, can be transposed to Standard MAKILA Engine with a high level of confidence. This result is of importance considering the Flight Clearance Note delivery, but also in generalizing BEARCAT's results to the serial MAKILA fleet.

NOx Emission Index (ei_NOx) deduced from ARP-1533 standard measurements performed on BEARCAT are compared with correlations from literature (Lipfert ⁴⁸⁰, Mongia ⁴⁸¹, Mulder ⁴⁸², Daggett ⁴⁸³). We only compare with classical “P3T3” correlations (i.e. ei_NOx is assumed to be a function of the T3 temperature and/or the P3 Pressure of the engine). It is found that no correlations proposed provide a good match with experimental data (except Lipfert at low regime). It could be due to the fact that these correlations are not built on small turboshafts.

Carbon Monoxide correlations can be found in Filippone ⁴⁸⁴ and Rizk ⁴⁸⁵ for Jet A1. CO emissions measured on BEARCAT are compared with correlations from literature. A good agreement is found with an adapted version of the correlation proposed by Rizk & Mongia which is also cited by Gaspar & Souza ⁴⁸⁶.

Numerous recent papers deal with SAF experiments on Gas Turbine. Sundararaj et al ⁴⁸⁷ reported combustion and emission characteristics from biojet fuel blends. Depending on the biofuel they tested (Camelina or Jatropha based fuels), the trend in terms of CO and NOx can be drastically different. They attribute this difference to spray characteristics induced by the fuel viscosity. Gawron et al. ⁴⁸⁸ performed emissions measurement on a miniature turbojet engine (GTM-140) fueled with HEFA blends from different feedstock (Camelina und UCO), as well as Jet-A1. They found CO emissions lower with HEFA blends than with Jet-A1. They did not evidence significant variations in CO₂ emissions, but significant differences for NOx emissions, which were higher for both biofuels tested. Przysowa et al. compared gas emissions from the GTM-140 micro-turbine to a DGEN-380, a high by-pass ratio turbofan (255 daN of thrust), fed with different HEFA blends ⁴⁸⁹. They found that increasing the content of biofuel leads to an increase of the CO and NOx emissions.

This is in contradiction with the conclusions of Gawron et al, and they conclude that the use of micro-turbine for emissions testing is debatable. In the framework of the ECLIF2 (Emission and Climate Impact of Alternative Fuels) program, Schripp et al. ⁴⁹⁰ studied two fossil fuels and three different blends of biofuels (HEFA-SPK type) on an A320

⁴⁸⁰ Lipfert, FW. "Correlation of Gas Turbine Emissions Data. Proceedings of the ASME 1972 International Gas Turbine and Fluids Engineering Conference and Products Show. ASME 1972 International Gas Turbine and Fluids Engineering Conference and Products Show. San Francisco, California, USA. March 26–30, 1972. V001T01A059. ASME. <https://doi.org/10.1115/72-GT-60>

⁴⁸¹ Mongia, H., and Dodds, W., "Low Emissions Propulsion Engine Combustor Technology Evolution Past, Present and Future," 24th Congress of the International Council of the Aeronautical Sciences, International Council of the Aeronautical Sciences Paper 2004-6.9.2, Yokohama, Japan, 29 Aug.–3 Sept. 2004. http://www.icas.org/ICAS_ARCHIVE/ICAS2004/ABSTRACTS/609.HTM

⁴⁸² Mulder, T. J., and Ruijgrok, G. J. J., "On the Reduction of NOx Emission Levels by Performing Low NOx Flights," 26th Congress of the International Council of the Aeronautical Sciences Including the Eighth AIAA Aviation Technology, Integration, and Operations Conference, International Council of the Aeronautical Sciences Paper ICAS2008-4.7 ST2, Anchorage, AK, 14–19 Sept. 2008. http://www.icas.org/ICAS_ARCHIVE/ICAS2008/PAPERS/532.PDF

⁴⁸³ Daggett, D. L., "Water Misting and Injection of Commercial Aircraft Engines to Reduce Airport NOx", NASA CR-2004-212957, 2004 https://www.researchgate.net/publication/287645497_Revisiting_Water_Injection_for_Commercial_Aircraft

⁴⁸⁴ Antonio Filippone, Nicholas Bojdo, Statistical model for gas turbine engines exhaust emissions, Transportation Research Part D: Transport and Environment, Volume 59, 2018, Pages 451-463, ISSN 1361-9209, <https://doi.org/10.1016/j.trd.2018.01.019>

⁴⁸⁵ Rizk, N. K., and Mongia, H. C. (July 1, 1993). "Semianalytical Correlations for NO_x, CO, and UHC Emissions." ASME. *J. Eng. Gas Turbines Power*. July 1993; 115(3): 612–619. <https://doi.org/10.1115/1.2906750>

⁴⁸⁶ R.M.P. Gaspar, J.M.M. Sousa, Impact of alternative fuels on the operational and environmental performance of a small turbofan engine, Energy Conversion and Management, Volume 130, 2016, Pages 81-90, ISSN 0196-8904, <https://doi.org/10.1016/j.enconman.2016.10.042>

⁴⁸⁷ Sundararaj, Ramraj & Roshan, Dinesh & Raut, Anoop & T., Chandra & Pandey, Vivek & Kushari, Abhijit & Puri, S.K. (2019). Combustion and Emission Characteristics from Biojet Fuel Blends in a Gas Turbine Combustor. Energy. DOI:[10.1016/j.energy.2019.06.060](https://doi.org/10.1016/j.energy.2019.06.060)

⁴⁸⁸ Gawron, B.; Białecki, T.; Janicka, A.; Suchocki, T. Combustion and Emissions Characteristics of the Turbine Engine Fueled with HEFA Blends from Different Feedstocks. *Energies* 2020, *13*, 1277. <https://doi.org/10.3390/en13051277>

⁴⁸⁹ R. Przysowa et al., "Performance and Emissions of a Microturbine and Turbofan Powered by Alternative Fuels", 2021, Aerospace, 8, 25. <https://doi.org/10.3390/aerospace8020025>

⁴⁹⁰ Tobias Schripp, Bruce E. Anderson, Uwe Bauder, Bastian Rauch, Joel C. Corbin, Greg J. Smallwood, Prem Lobo, Ewan C. Crosbie, Michael A. Shook, Richard C. Miale-Lye, Zhenhong Yu, Andrew Freedman, Philip D. Whitefield, Claire E. Robinson, Steven L. Achterberg, Markus Köhler, Patrick Oßwald, Tobias Grein, Daniel Sauer, Christiane Voigt, Hans Schlager, Patrick LeClercq, Aircraft engine particulate matter emissions from sustainable aviation fuels: Results from ground-based measurements during the NASA/DLR campaign ECLIF2/ND-MAX, Fuel, Volume 325, 2022, 124764, ISSN 0016-2361,

aircraft powered by a V2527-A5 engine (ground tests). They investigated the aromatic content and the corresponding Fuel / Hydrogen content on the non-volatile particles, and NO_x emissions. They observed a reduction of 70% of the non-volatile particles with SAF compared to Jet-A1, even if the trend tends to decrease with the power. They did not find significant effects on the NO_x emissions with biofuels.

II.II.1.3. Results

BEARCAT is fed with 100% SAF and the same experiments are reproduced. In FIGURE 87 to 95 we plotted the normalized gas concentrations (CO₂, CO, NO_x, NO and O₂, respectively) measured for SAF and CAF, as a function of the fuel mass flow rate, in order to take into account the density difference between both fuels. Therefore, a direct comparison between CAF and SAF is made easy. In parallel, we also plotted gas concentrations versus the engine power. These two representations give two different points of view. The first one is the chemist point of view, by comparing the amount of pollutant emitted directly to the amount of fuel injected. The second point of view is the one of the engine operator, by comparing the amount of pollutant with the engine power.

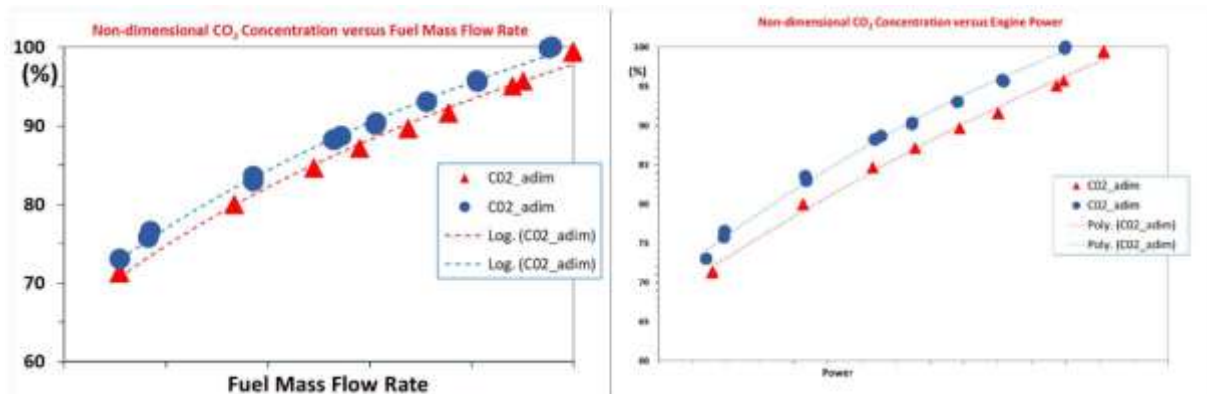
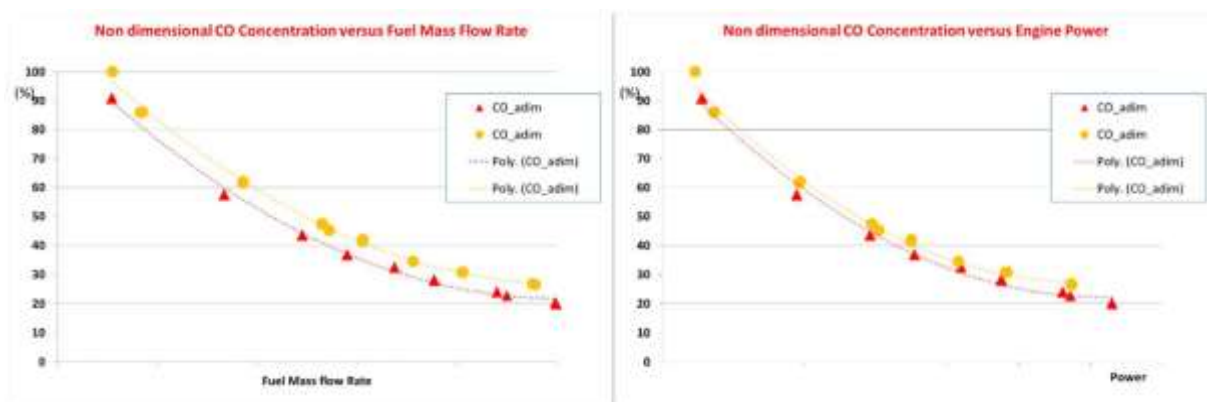

FIGURE 87 and FIGURE 88 non-dimensional CO₂ concentrations vs fuel mass flow rate for SAF (Red) and CAF (blue), source Jean-Baptiste Jarin and Jean-Louis Champion

The first interesting result is given by a reduction of 5% of the amount of CO₂ emitted, whatever the point of view considered. With SAF, the CO concentration exhibits a reduction of 5.0%, versus the fuel mass flow rate. The reduction is less (3.0%) if the results are plotted versus the engine power. Note that this difference is greater than the uncertainty in determining the normalized CO₂ concentration, which is estimated lower than $\pm 0.5\%$ (not visible on graphs). This clearly shows the importance of the results presentation.



<https://doi.org/10.1016/j.fuel.2022.124764>

FIGURE 89 FIGURE 90 non-dimensional CO concentrations vs fuel mass flow rate for SAF (Red) and CAF (yellow), source Jean-Baptiste Jarin and Jean-Louis Champion

These reductions (CO and CO₂) are a direct consequence of the SAF chemical formula, which exhibits a H/C ratio greater than CAF, typically lower than 2 (TABLE 33). It is interesting to note that CO and CO₂ concentration reduction occur even when the fuel mass flow rate at a given engine power is higher with SAF, as shown in FIGURE 91 below. A direct consequence of the H/C ration is that the amount of water in SAF burned gases should be greater than for CAF and cannot be ignored. Indeed, this shall be taken into account when considering the contrails formation and their potential impact on the global climate change.

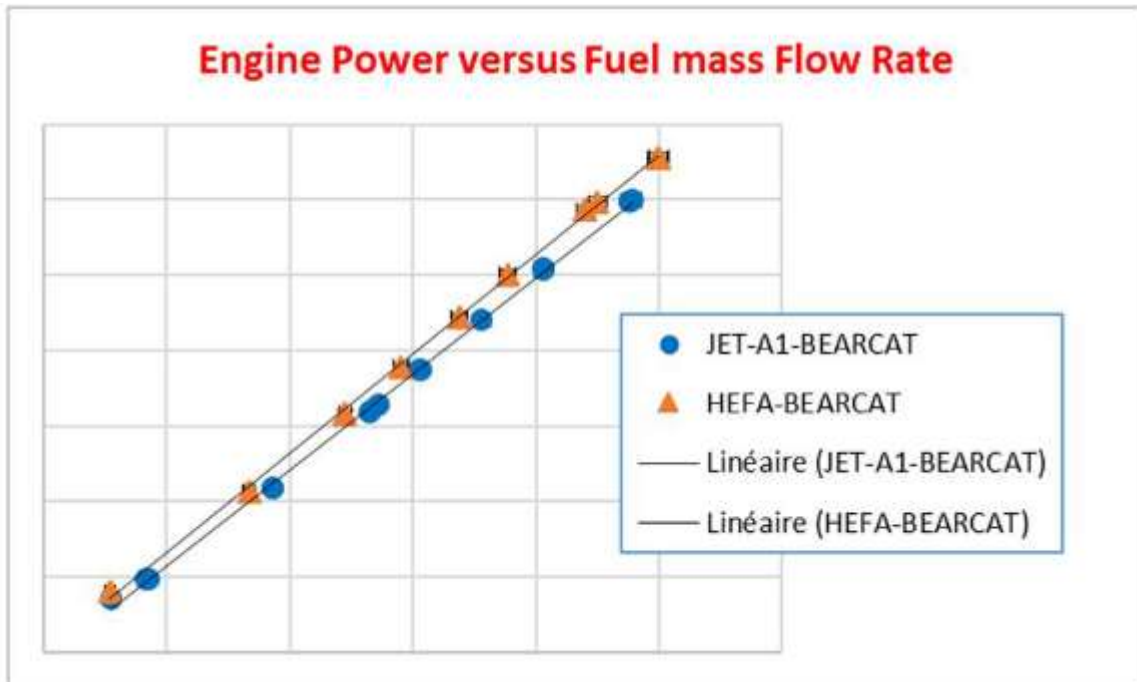

FIGURE 91 engine power vs fuel mass flow rate for SAF (Red) and CAF (blue), source Jean-Baptiste Jarin and Jean-Louis Champion

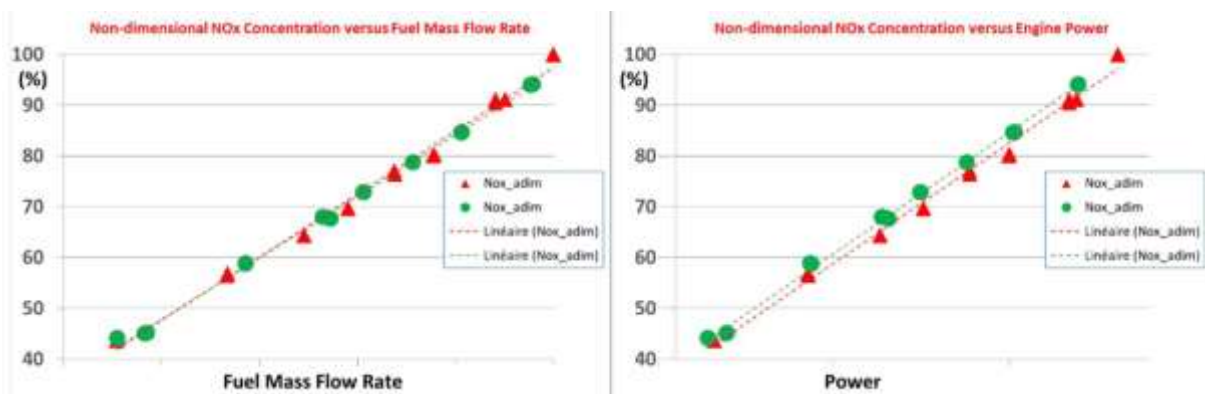

FIGURE 92 FIGURE 93 non-dimensional NOx concentrations vs fuel mass flow rate for SAF (Red) and CAF (green), source Jean-Baptiste Jarin and Jean-Louis Champion

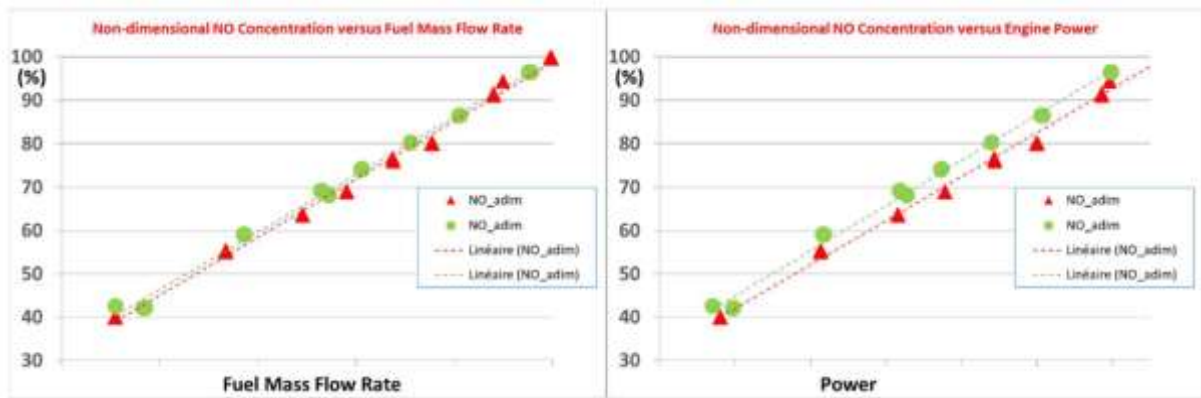
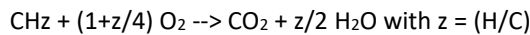

FIGURE 94 FIGURE 95 non-dimensional NO concentrations vs fuel mass flow rate for SAF (Red) and CAF (green), source Jean-Baptiste Jarin and Jean-Louis Champion

Comparisons of NOx and NO emissions for both fuels are given in FIGURE 92 to 95. Despite a greater LHV for SAF, no significant differences are observed between CAF and SAF on NO and NOx emissions versus the fuel mass flow rate. More surprisingly, when plotted versus the Engine Power, it appears that NOx and NO emissions are lower than the one with encountered with CAF, the difference being lower than 5 % for both species. The uncertainty in determining the normalized NOx and NO concentrations is estimated lower than ± 0.5 % (not visible on graphs).

FIGURE 96 and 97 below show that the O₂ concentration in burned gases is lower (approximately 1 %) for SAF than for CAF, for both representations. This value is greater than the uncertainty in determining the normalized O₂ concentration, which is estimated lower than ± 0.5 % (not visible on the graph). This is also a direct consequence of the higher H/C ratio of SAF. This is shown by the equation for complete hydrocarbon combustion below:



If the H/C ratio increases, then the amount of remaining O₂ is decreasing and consequently the amount of water is increasing in burned gases.

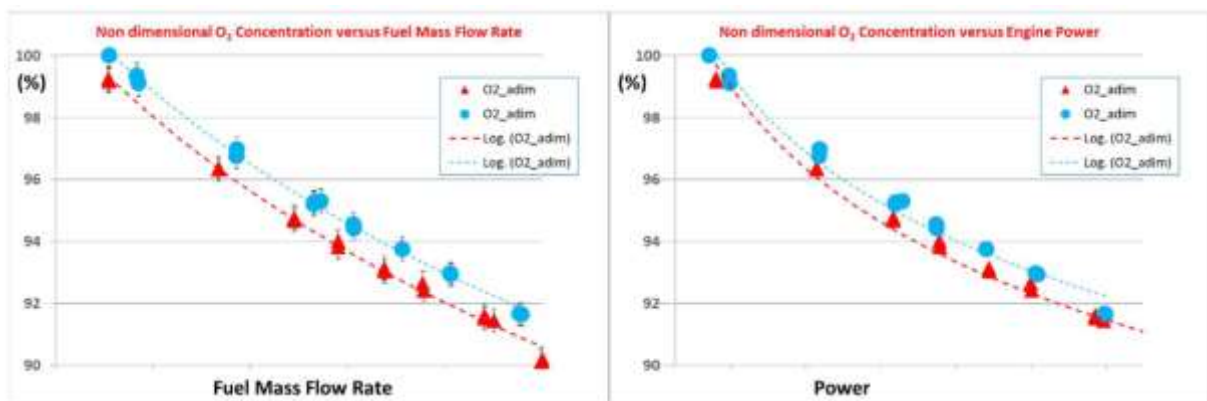

FIGURE 96 FIGURE 97 Non dimensional O₂ concentrations vs fuel mass flow rate for SAF (Red) and CAF (blue), source Jean-Baptiste Jarin and Jean-Louis Champion

However, the most impressive result is observed on the Smoke Number (SN), FIGURE 98 and 99, which exhibits a decrease of at least 50% with SAF (60 % at low regime) compared with CAF. This is mainly because the SAF we tested did not contain any aromatic compounds, considered as precursors of smoke. Schripp et al. reported a similar result on a V2527-A5 engine⁴⁹⁰. Note that the uncertainty on the Smoke Number is estimated to 5 %.

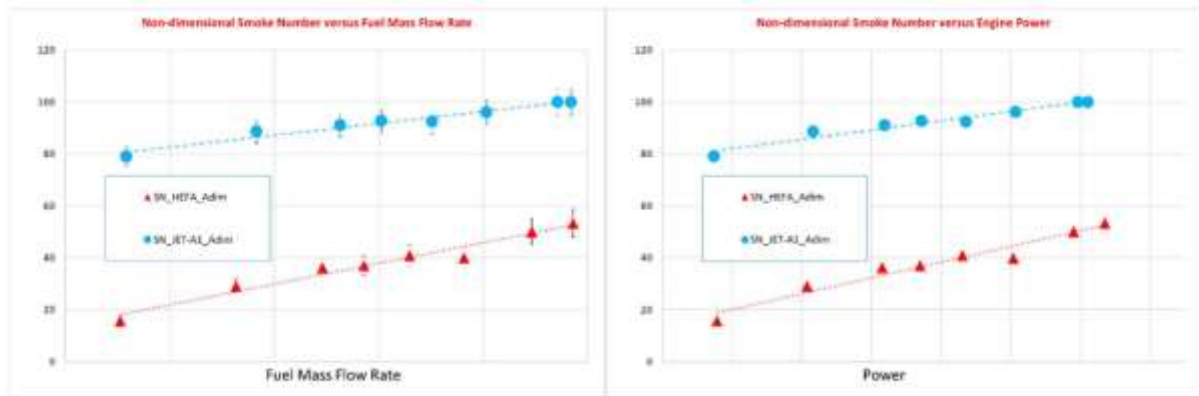

FIGURE 98 FIGURE 99 non-dimensional Smoke Number (SN) vs fuel mass flow rate for SAF (Red) and CAF (blue), source Jean-Baptiste Jarin and Jean-Louis Champion

Based on the concentration measurements, we calculated through the ARP1533 standard the emission index of NO, NOx and CO. These results are plotted versus the mass flow rate or versus the Engine Power in FIGURE 100 and 101 for ei_CO and ei_NOx, respectively.

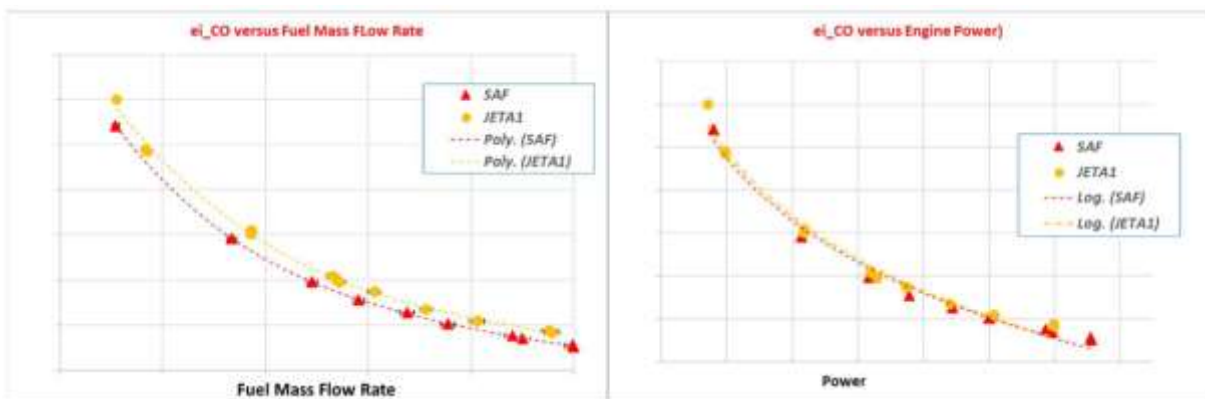

FIGURE 100 FIGURE 101 ei of CO vs fuel mass flow rate (left) and power (right) for SAF (Red) and CAF (yellow), source Jean-Baptiste Jarin and Jean-Louis Champion

As expected for both fuels, the ei_CO is decreasing as the mass flow rate is increasing. Emission Index (ei) CO is slightly lower for SAF. Note that this trend is not visible if ei_CO is plotted versus the engine power. Note that the uncertainty in ei-NOx and ei_NO values is better than 0,5% (Not visible on the graph). We also indicated the uncertainty on the fuel mass rate, estimated to $\pm 1\%$ of the measured value.

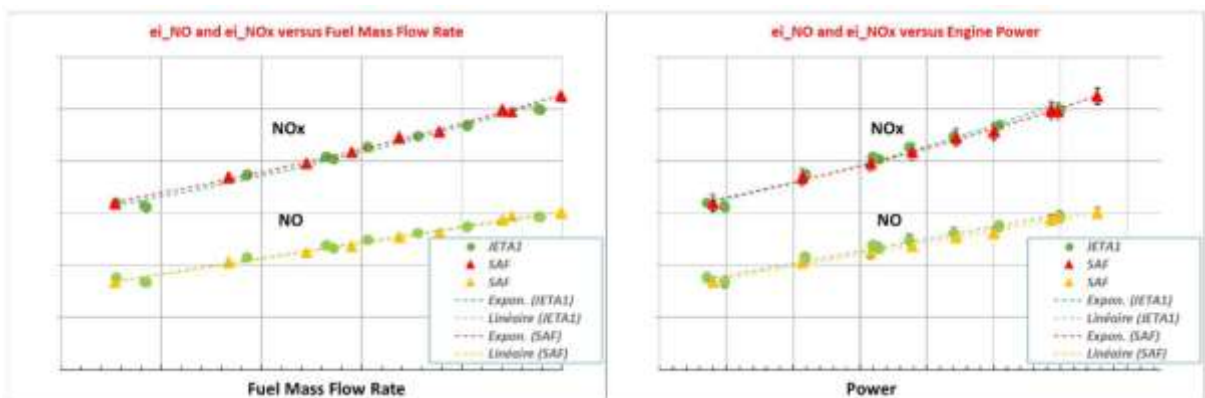

FIGURE 102 FIGURE 103 Emission Index of NOx and NO vs fuel mass flow rate (left) and power (right) for SAF (Red-Yellow) and CAF (green), source Jean-Baptiste Jarin and Jean-Louis Champion

As shown in FIGURE 102 and 103 above, both ei_{NO} and ei_{NOx} are increasing with the fuel mass flow rate and thus versus the engine power. Whatever the representation chosen, ei_{NOx} and ei_{NO} for CAF and SAF are the same. Note that the uncertainty in ei_{NOx} and ei_{NO} values is better than 0,5% (Not visible on the graph).



FIGURE 104 combustion efficiency vs engine power for SAF (red) and CAF (blue), source Jean-Baptiste Jarin and Jean-Louis Champion

By means of the ARP-1533 analysis, we determined the combustion efficiency, which is plotted for both fuels versus the engine power in FIGURE 104 above. The combustion efficiency is found to be increasing with the engine power. The error in determining the combustion efficiency is found to be $\pm 0,01$ %. We also found that the combustion efficiency is slightly higher for SAF than for CAF, with a constant gap close to $2.0 \cdot 10^{-4}$.

II.II.1.3. Conclusions

While the performances of the 100% SAF are similar to the CAF, the impacts on emissions are significant.

The results obtained on SN must be further characterized as the impact on water vapor while an equal or lower concentration of CO, NO and NOx compared to CAF have been recorded.

The significant decrease of the SN (above 50%) is most probably due to the lower aromatic contents and testing Drop In SAF with different aromatics content and formula should be supported. The results are however impressive as shown in FIGURE 105.

The CO₂ emissions have been drastically reduced due to the upstream phase of the life cycle analysis (considered as waste, the default value of UCO is 0 g CO₂/MJ), and combustion effect while marginal (2 g CO₂/MJ) can help to further reduce the carbon footprint of the aviation industry.

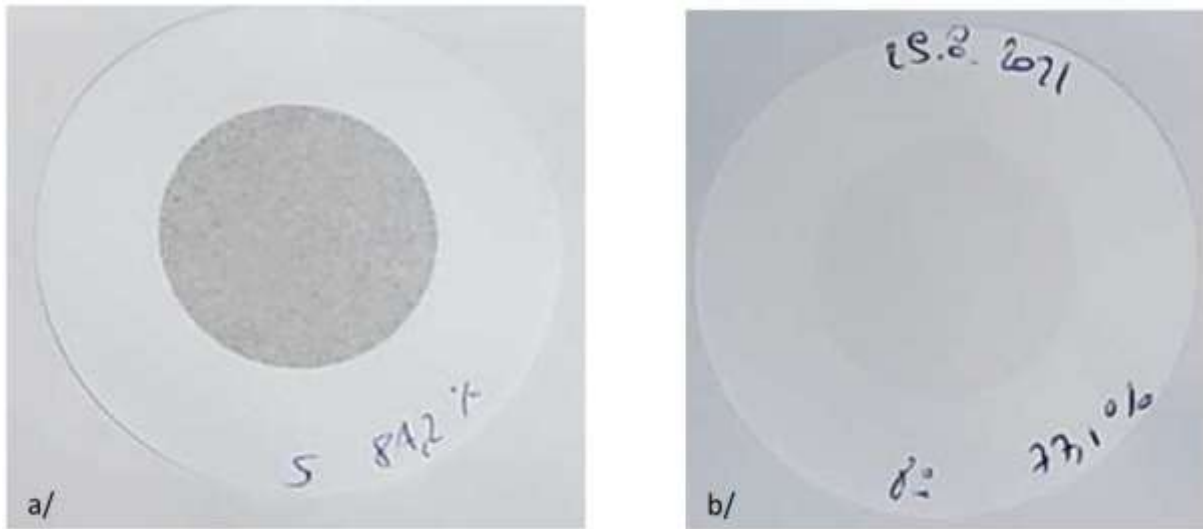

FIGURE 105 photos of SN paper filters, CAF (left) et SAF (right), source Jean-Baptiste Jarin and Jean-Louis Champion

II.II.2. Emissions of Drop In SAF, measured at exhaust

As discussed above, since the gap in viscosity and lubricity could be an issue with neat SAF, the path to 100% SAF would most probably be Drop-In. Drop In combines neat SAF with a percentage of bio-aromatics, so that the chemical and physical properties of the 100% SAF would be like the ASTM D1655 norm. The result being that this 100% SAF could be dropped, as is, within aircrafts and helicopters tanks, without requiring any kind of modifications.



It was therefore found necessary to test a 100% Drop In SAF, and this was done in 2023. The detailed results, peer reviewed, were published and presented during ASME Turbo Expo 2024 ⁴⁹¹.

II.II.2.1. Introduction

The definitions and on-going development of Drop In and Non-Drop In are presented in FIGURE 106 below, issued from the SATF.

100% SATF Standardization Status

Drop-in: not just compatible with particular engine and/or aircraft, but fleet-wide and infrastructure-wide compatible

100% SAF	Drop-in   	non-Drop-in
Composition:	Fully formulated Jet A/A-1	Subset of Jet A/A-1
Applicability:	Fleet Wide drop-in	Designated aircraft/engines only
Example pathways:	CHJ (D7566 Annex A6), FT-SKA (D7566 Annex A4), future: ATJ-SKA, HEFA-SKA, blending of blend components	FT-SPK (D7566 Annex A1) HEFA-SPK (D7566 Annex A2) ATJ-SPK (D7566 Annex A5) <i>certain types</i>
Specification:	ASTM D7566	New standard needed
Regulatory Cert/Substantiation:	No change	Required for each intended aircraft/engine model
Infrastructure:	No impact	Separate supply chain/handling/storage required



ASTM Task Force est. Apr '21
Chair: G. Andac (GE), Vice-Chair: M. Rumizen (FAA)
Approval of use of conforming 100% SAF as Jet A/A-1

ASTM Task Force est. Apr '22
Chair D. Parmenter (Airbus), Vice-Chair: A. Hobday (Rolls-Royce)
NOT approval of use as Jet A/A-1 or as a new fuel; to be used for testing and certification

FIGURE 106 ASTM SATF standardization status as of June 2023, source CAAFI ⁴⁹²

An important feature of commercially available SAF is the absence of aromatics. While being not an issue today as the maximum blend is limited to 50%, it is an issue when understanding the necessity to reach 100% SAF in the coming years. The absence or low content of aromatics would require certain modifications to aircraft and logistic infrastructures to maintain the safety levels required in the aviation. For example, the swelling of certain elastomers

⁴⁹¹ Jarin, J, Champion-Réaud, J, Sallinen, R, & Steenwinkel, E. "Emissions Comparison of 100% SAF With Bio-Aromatics and Conventional (Fossil) Jet Fuel." *Proceedings of the ASME Turbo Expo 2024: Turbomachinery Technical Conference and Exposition. Volume 2: Ceramics and Ceramic Composites; Coal, Biomass, Hydrogen, and Alternative Fuels*. London, United Kingdom. June 24–28, 2024. V002T03A012. ASME. <https://doi.org/10.1115/GT2024-124002>

⁴⁹² https://www.caafi.org/resources/pdf/SAF_Virtual_Conf_June2023_Session_14_Mark_Rumizen_and_Gurhan_Andac.pdf page 10, accessed August 13, 2024

has been shown to be significantly lower and this could lead to fuel leaks, as concluded by de Witt et al⁴⁹³ or Corporan et al⁴⁹⁴.

Drop In means adding bio-aromatics to SAF to allow 100% SAF without having to modify aircrafts nor infrastructures, see FIGURE 106 above.

With the necessity to reach 100% SAF within two decades, it is important to characterize and understand the various combustion emissions, not only CO₂, but also CO, SN, NO and NO_x as any increase in those pollutants could discredit the use of SAF.

The results shown below are based on a dedicated study comparing SN, CO₂, CO, NO, NO_x and O₂ emissions between Drop In SAF (SPK/A), a 100% SAF with 9% bio-aromatics, and the current fossil jet fuel available (CAF). Since the test protocol is similar to the one above with Non-Drop In, data for SN are also compared.

II.II.2.2. Methodology

The CAF used in the test is a 100% fossil jet fuel, compliant with ASTM D1655. The fuel is supplied to the test cell via the existing hydrant network and its main characteristics are the same as for the Non-Drop in test detailed above.

The SAF-SPK/A tested here is experimental and was manufactured on purpose for 91% by Neste using the HEFA process with UCO and for 9% by Virent Inc. using Hydro De Oxygenated Synthetized Aromatic Kerosene (HDO-SAK) process with sugar as feedstock. Once combined those two fractions was delivered to the test cell and supplied to the engine fuel pump with a dedicated tank and fuel line to avoid external pollution.

Main characteristics of both fuels are within the ASTM D1655 criteria but show some differences such as their aromatic content as shown in TABLE 34 below. Density of SAF-SPK/A is slightly lower than CAF, which the H/C ratio is 5% higher. As mentioned by Burnes and Camou⁴⁷⁸, “the H/C ratio is a distinctive attribute of fuel, as the H/C ratio increases, the fuel becomes lighted and LHV is increasing”. This distinctive attribute will be used when resizing the Emission Index (EI).

Property	Test method	Unit	CAF	SAF-SPK/A
Density at 15C	ASTM D4052	kg/m ³	800	778.5
Aromatics, volume percent	ASTM D6379	% (v/v)	15.0	9.1
Net heat of combustion (LHV)	ASTM D3338	MJ/kg	43.7	43.9
Hydrogen/Carbon	H _(y) / C _(x)		1.90	1.99

TABLE 34 Main characteristics of the fuels tested, source Jean-Baptiste Jarin and Jean-Louis Champion

⁴⁹³ DeWitt et al, Effects of Aromatic Type and Concentration in Fischer–Tropsch Fuel on Emissions Production and Material Compatibility, Energy & Fuels 2008 22 (4), 2411-2418, <https://pubs.acs.org/doi/10.1021/ef8001179>

⁴⁹⁴ Corporan et al, Chemical, Thermal Stability, Seal Swell, and Emissions Studies of Alternative Jet Fuels Energy & Fuels 2011 25 (3), 955-966, <https://pubs.acs.org/doi/10.1021/ef101520v>

Numerous papers deal with SAF experiments. Burnes and Camou studied the impact of fuel composition on gas turbine engine performance. They highlighted the benefits of using fuels with higher hydrogen to carbon ratios, which includes higher power, higher efficiency, and lower carbon emissions. Sundaraj et al.⁴⁸⁷ reported combustion and emissions characteristics from bio-based jet fuel blends and found that depending on the biofuel tested, for instance camelina or jatropha based fuels, the trend in terms of CO and NOx can be quite different. The authors attributed this difference to spray characteristics induced by the fuel viscosity. In the framework of the ECLIF program (Emission and Climate Impact of Alternative Fuels) program, Schripp et al.⁴⁹⁰ studied two fossil fuels and three different blends of biofuels produced with the HEFA process with various blend ratio on a V2527-A5 engine on ground. They observed a decrease in particle emission with increasing fuel hydrogen content. They also noted that the fuel naphthalene content had significant impact on the particle number emission.

The same test cell and protocol are used from the Non-Drop In and Drop In tests. The test campaign is realized with the BEARCAT (Banc d'Essai Avancé pour la Recherche en Combustion et Aérothermique des Turbomachines) test cell of SafranTech. It is a heavily instrumented engine based on a Makila 2B turboshaft, rated 2200 shp, see cross section in FIGURE 107 below.

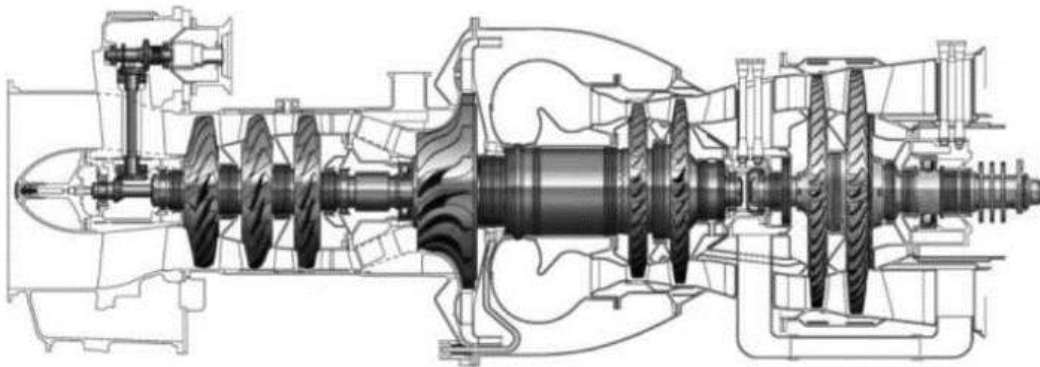

FIGURE 107 Cross sectional view of the Makila turboshaft, source Safran

SN, CO₂, CO, NO, NO_x and O₂ concentration measurements are performed inside the engine test cell exhaust muffler as shown in FIGURE 108. The location of the gas analysis probe is approximately 4 meters from the engine exhaust. This position allows a near perfect mixture of the gases. Gas sampling is performed along the diameter of the exhaust tube by means of a 10mm diameter stainless tube with regularly positioned small sampling holes. The gas samples are analyzed by an instrument developed by the ENVA Company, details are available in⁹⁷.

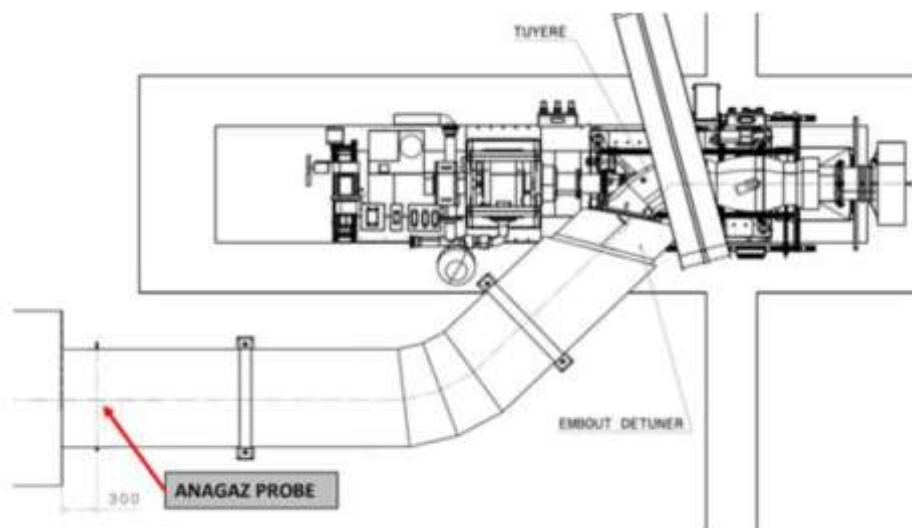

FIGURE 108 Location of gases analysis probe

It analyses the volume concentration of the following species: CO, CO₂, O₂, NO and NOX. The accuracy of gas concentration is given by the analyzer manufacturer at less than 2% full scale. During the analysis the serial exhaust nozzle is replaced by a specific one, which avoids the ingestion of air, due to the venturi effect caused by the burned gases jet exhausted from the jet engine nozzles.

Since Smoke Number (SN) is an old method of quantifying the exhaust plume from an engine, it was found relevant for turbofans, but not turboprops and turboshaft⁴⁹⁵ (Makila is a turboshaft) to replace this method by nvPM (nonvolatile particle matters) measurements in terms of mass and number⁴⁹⁶. However, at this stage the measurements had to be made at the exhaust and a correlation between smoke number, measured with Whatmann grade 4 paper, see above chapter FIGURE 105 and soot mass concentration is realized as proposed by Stettler et al⁴⁹⁷ as the authors found that for the same particle concentration, a lower smoke number is observed for smaller soot particles. They attributed this behavior to several parameters which include penetration of the soot particle into the filter, its mass collection efficiency, and the structure of the deposit.

Stability and repeatability tests are identical to the one illustrated in the above chapter for the Non-Drop In test, the typical test cycle consist of 8 stages, with the engine rotating speed ranging from 77.1% to 93.2% so a fuel mass flow ranging from 175 to 415 kg per hour to match with the experimentation cycles as shown in FIGURE 109 below.

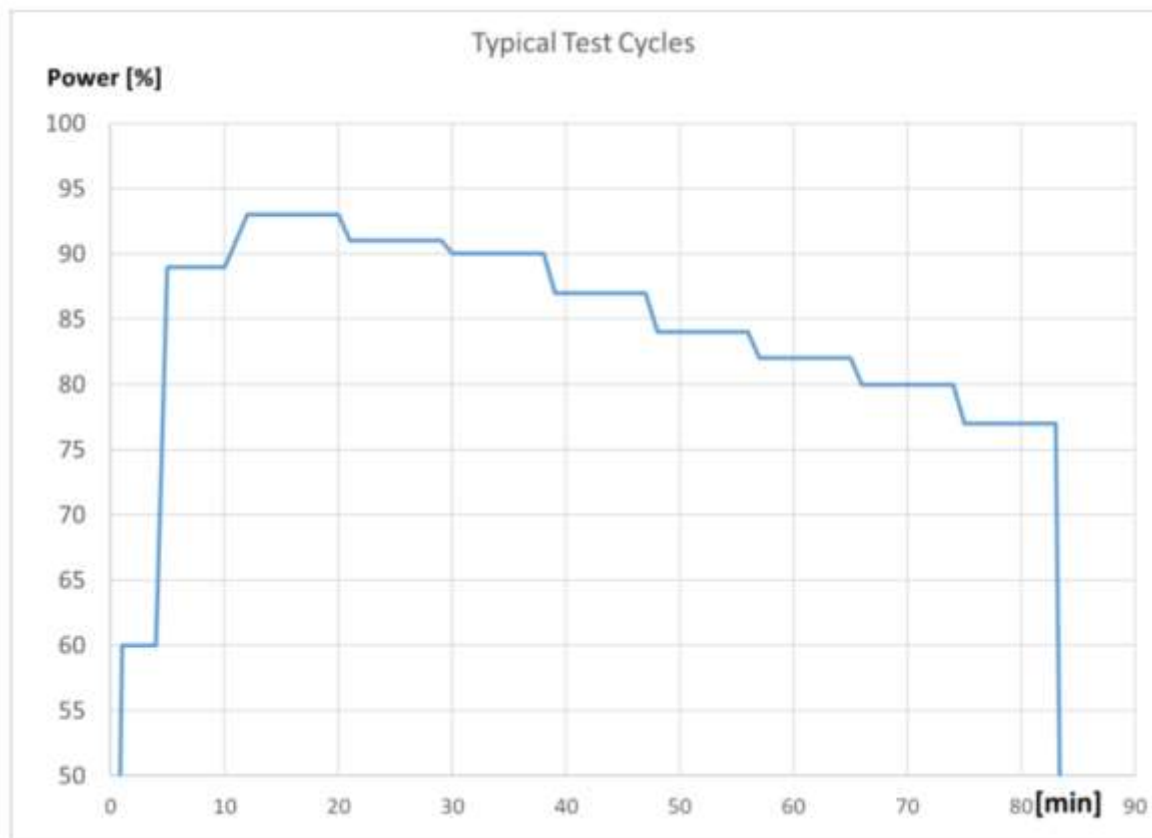

FIGURE 109 Test cycles, source Jean-Baptiste Jarin and Jean-Louis Champion

⁴⁹⁵ https://www.icao.int/publications/Documents/9889_cons_en.pdf accessed August 13, 2024

⁴⁹⁶ https://www.icao.int/environmental-protection/Documents/EnvironmentalReports/2022/ENVReport2022_Art17.pdf accessed August 13, 2024

⁴⁹⁷ Stettler, M. E. J., Swanson, J. J., Barrett, S. R. H., & Boies, A. M. (2013). Updated Correlation Between Aircraft Smoke Number and Black Carbon Concentration. *Aerosol Science and Technology*, 47(11), 1205–1214. <https://doi.org/10.1080/02786826.2013.829908>

II.II.2.3. Results

During the experiments the BEARCAT test rig is fed with both fuels. The figures below present the normalized gas concentrations measured for SAF-SPK/A and CAF as function of the fuel mass flow rate, thereby compensating for the density difference between both fuels.

In FIGURE 110 are plotted CO₂ concentration versus fuel mass flow rate for both fuels. At each point are indicated the level of accuracy, here +/- % or twice the value given by the analyzer manufacturer for the concentration, y axis, and +/-1% for the fuel mass flow rate, x axis.

The first interesting result is a reduction of almost 3% of CO₂ with SAF-SPK/A compared to CAF. This could be attributed to the higher H/C ratio, +5%, as shown in TABLE 34 above. Since a higher H/C ratio could also mean an increase in the amount of water vapor, this should be taken into consideration when studying the contrails formation and their potential impact on the radiative forcing.

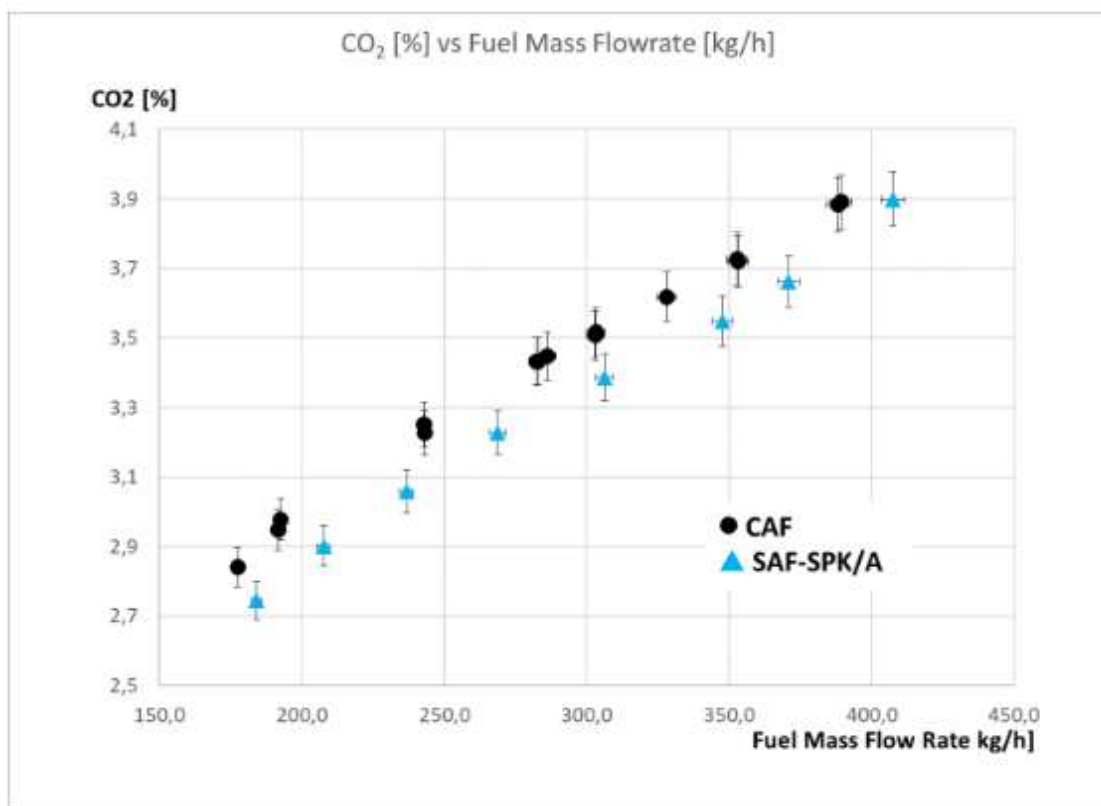

FIGURE 110 CO₂ concentration in % versus fuel mass flow rate for SAF-SPK/A and CAF, source Jean-Baptiste Jarin and Jean-Louis Champion

This reduction in CO₂ should be further studied and considered when calculating the overall CO₂ reduction of SAF when compared with CAF since the current methodology only considers the upstream missions, 72 gCO₂e/MJ is the reference value for combustion whatever the fuel characteristics. It is noted here that all SAF tested since 2021 have shown a higher LHV but a lower density when compared with CAF. This distinctive attribute of the SAF could be further investigated.

In FIGURE 111 are compared the CO emissions. There is a significant reduction correlated to the fuel mass flow rate. The higher the fuel mass flow rate, the greater the reduction in CO, up to -50% at max power. This could be attributed to the lower aromatic content and / or the composition of the aromatic part since SAK used in this experimental test does not contain polynuclear aromatics (PNA). But this could also be attributed to the H/C ratio and or LHV of each fuel. Three different emissions index (EI) have therefore been introduced: raw EI in FIGURE 112 and EI normalized either by LHV or the H/C ratio in FIGURE 113. As shown, since the reduction of CO between SAF-SPK/A and CAF is not

explained by the LHV nor the H/C ratio, the hypothesis is that it could be attributed to the lower aromatic content and / or the composition of these aromatics.

In FIGURE 114 below are shown the CO/CO₂ ratio, highlighting a cleaner combustion irrespective of the engine regime, characterized here with the fuel mass flow rate. While low regimes results show a marginal gain, the gap increases with the fuel mass flow rate, therefore the engine power, and can reach almost -50% at max power.

This hypothesis should be further characterized in future tests.

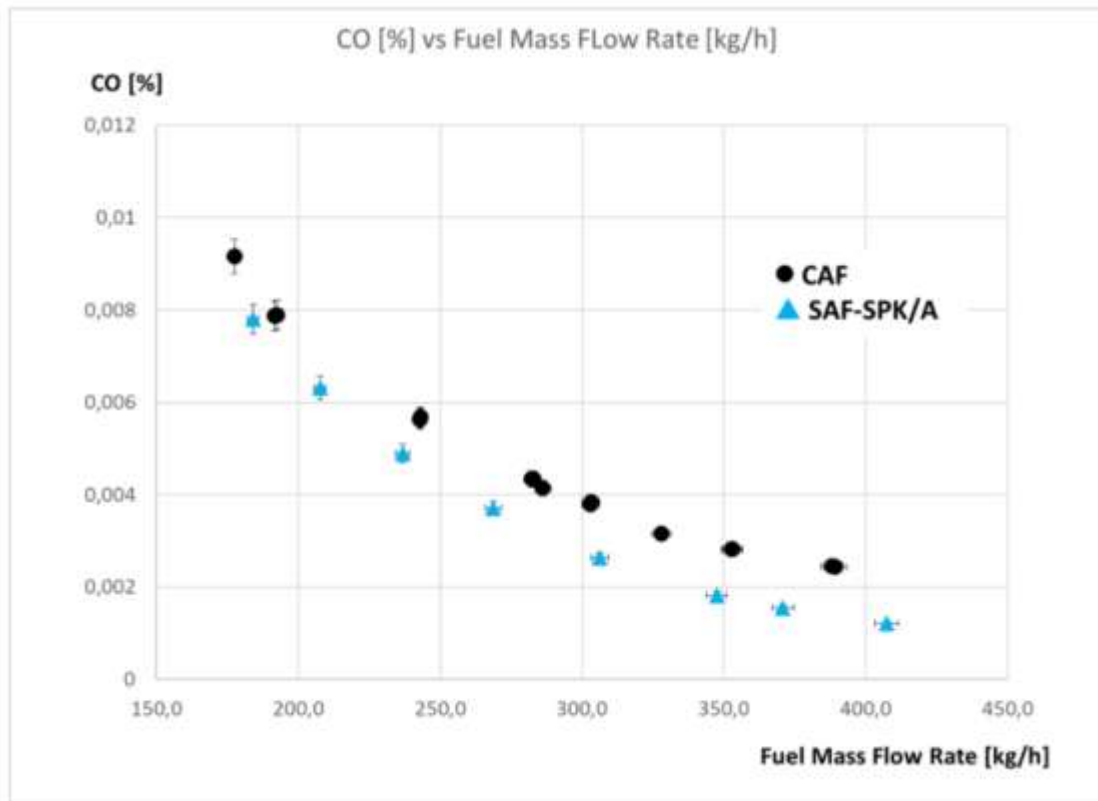

FIGURE 111 CO concentration versus fuel mass flow rate for SAF-SPK/A and CAF, source Jean-Baptiste Jarin and Jean-Louis Champion

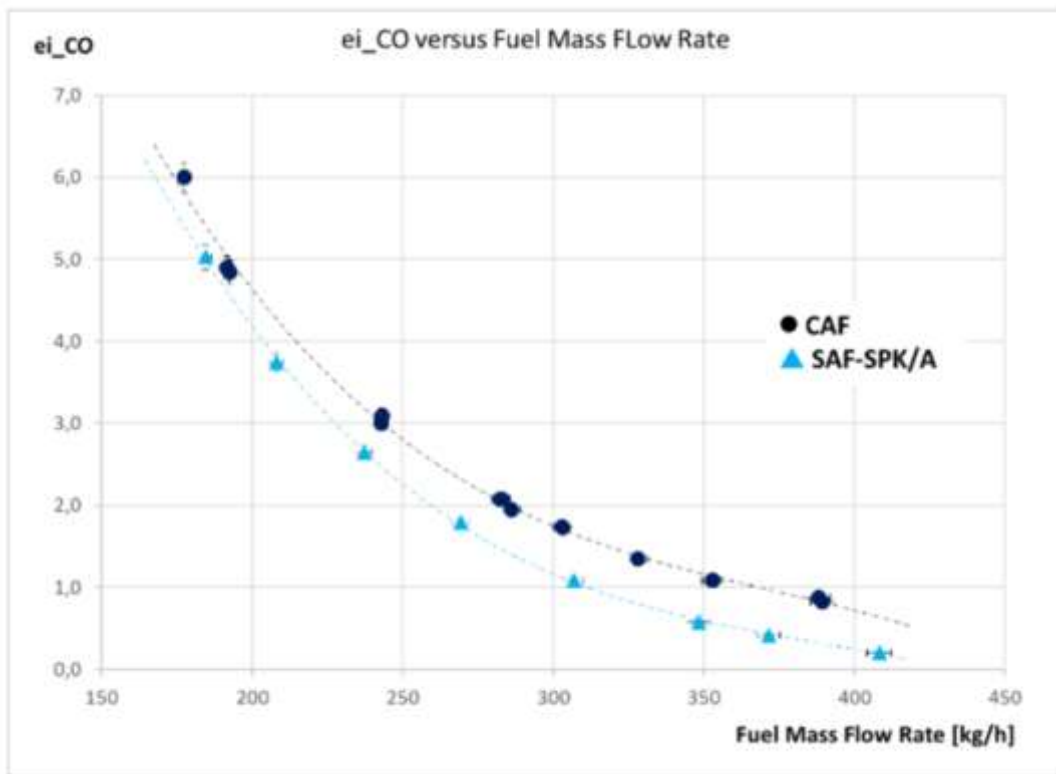

FIGURE 112 CO Emission Index versus fuel mass flow rate for SAF-SPK/A and CAF, source Jean-Baptiste Jarin and Jean-Louis Champion

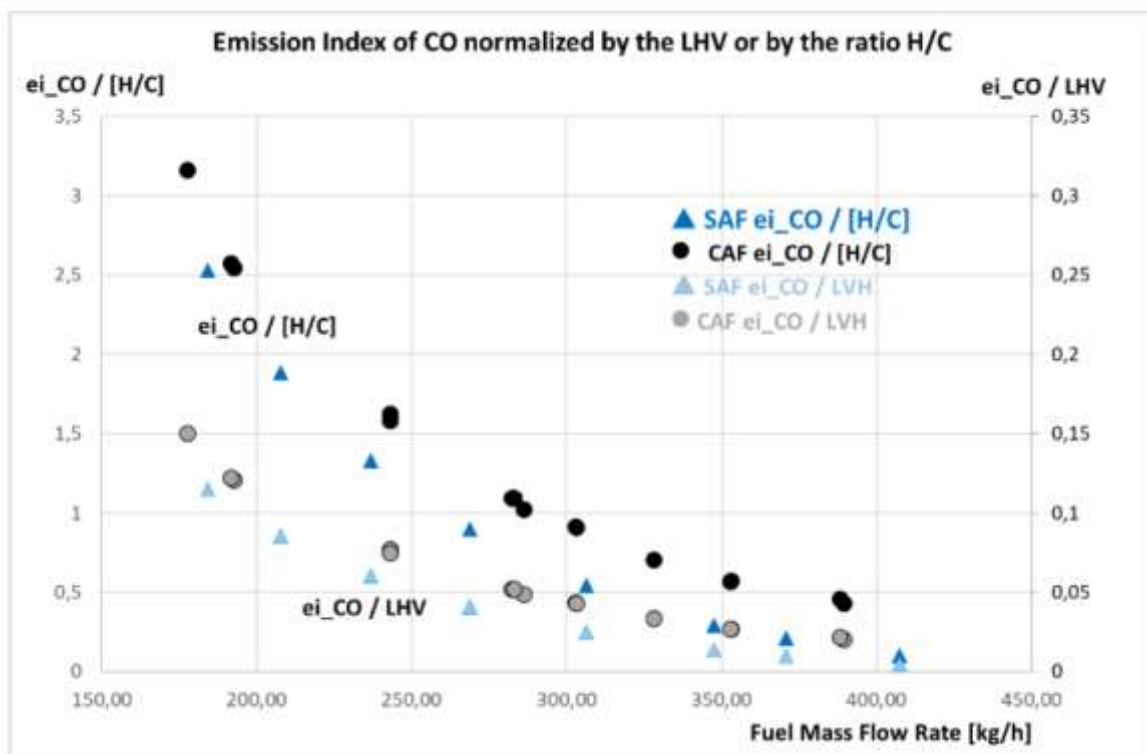

FIGURE 113 CO Emission Index normalized by the LHV or the HC ratio versus fuel mass flow rate for SAF-SPK/A and CAF, source Jean-Baptiste Jarin and Jean-Louis Champion

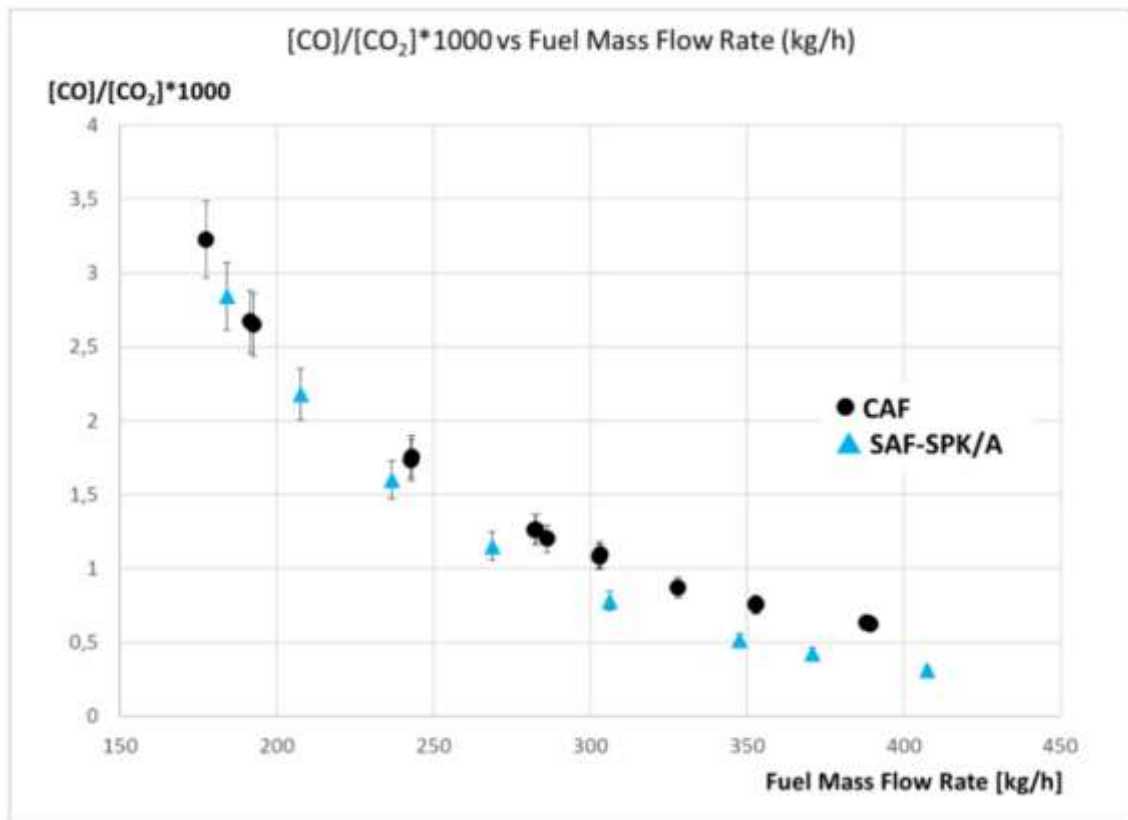

FIGURE 114 CO/CO₂ ratio according to fuel mass flow rate (CO/CO₂*1000) for SAF-SPK/A and CAF, source Jean-Baptiste Jarin and Jean-Louis Champion

The comparison of NO_x and NO emissions for both fuels follow the same logic as for CO: Raw, EI and EI normalized with LHV and H/C ratio. Results are given in FIGURE 115, FIGURE 116, FIGURE 117 for NO_x, and FIGURE 118, FIGURE 119, FIGURE 120, for NO.

No significant differences are observed between the two fuels on raw NO and NO_x emissions while EI show more NO_x and NO for SAF-SPK/A compared to CAF. Since these phenomena could be attributed to the distinctive characteristics of the fuels tested, as for CO, the EI normalized is considered and one can notice that unlike with CO there is strong correlation meaning that NO_x and NO emissions are indeed very similar for both fuels.

This means that the EI when comparing two different fuels should be considered normalized either by the LHV or the H/C. Khandelwal et al ⁴⁹⁸ found similar results when measuring the effect of alternative fuels (SPK, 0.1% aromatic) on emission performance but in an Auxiliary Power Unit: a decrease in CO and a significant decrease in SN was observed in relation to a lower aromatic content, while NO and NO_x remained almost unchanged.

⁴⁹⁸ Khandelwal, B. et al. (2019) 'The effect of alternative fuels on gaseous and particulate matter (PM) emission performance in an auxiliary power unit (APU)', *The Aeronautical Journal*, 123(1263), pp. 617–634. <http://dx.doi.org/10.1017/aer.2019.16>

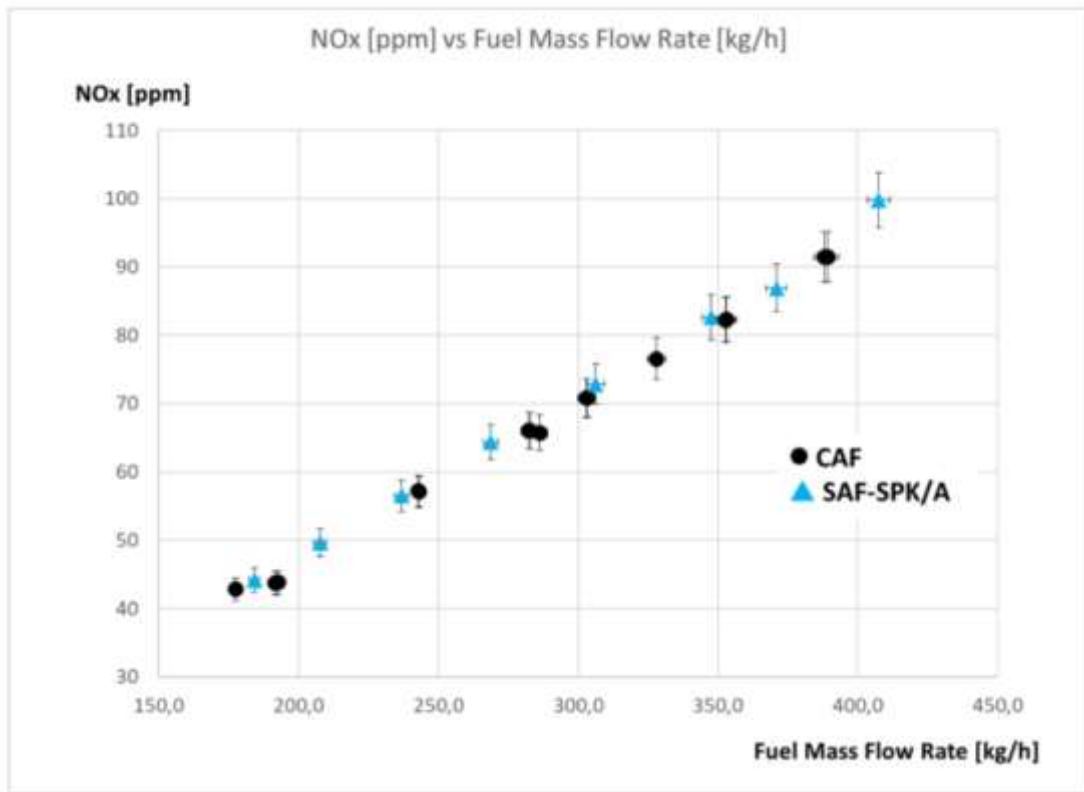

FIGURE 115 NO_x concentration versus fuel mass flow rate, source Jean-Baptiste Jarin and Jean-Louis Champion

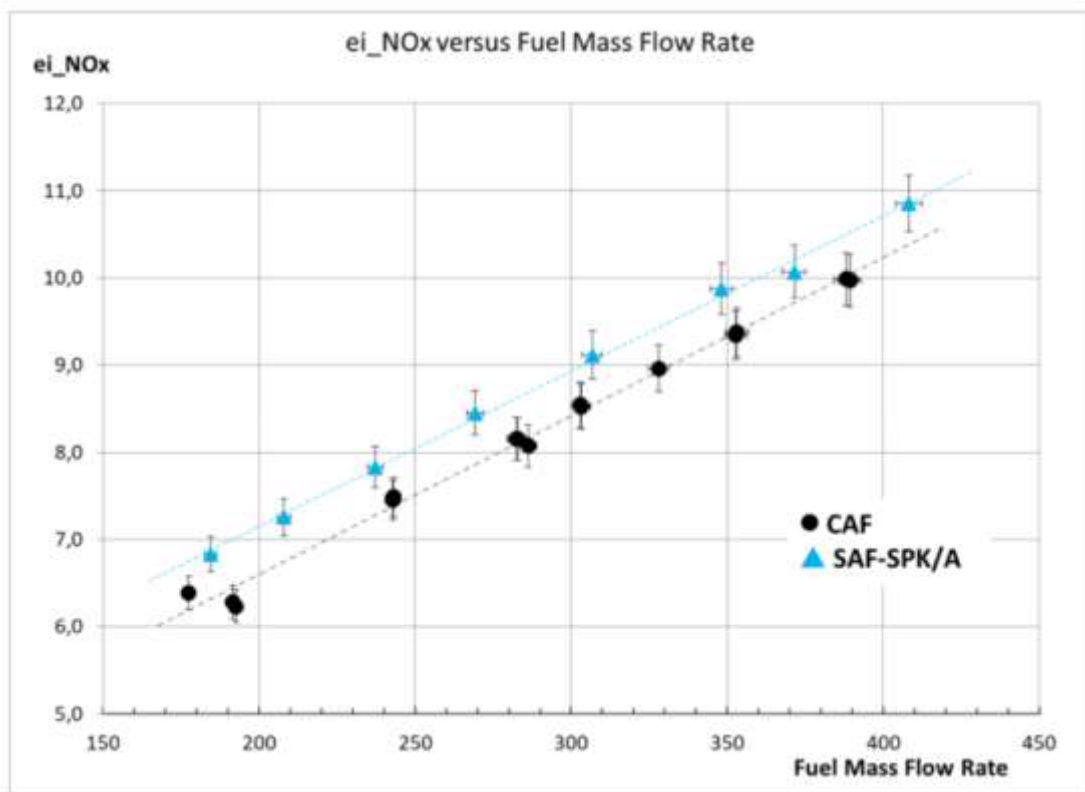

FIGURE 116 NO_x Emission Index versus fuel mass flow rate, source Jean-Baptiste Jarin and Jean-Louis Champion

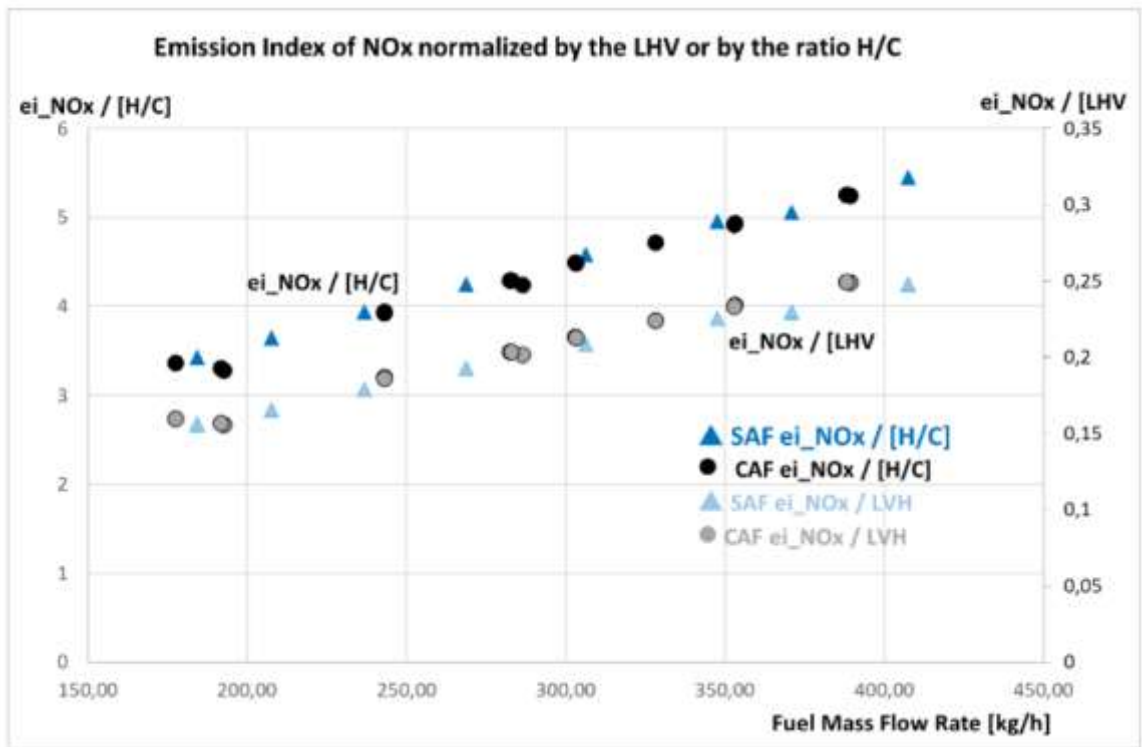

FIGURE 117 NO_x Emission Index realized with LHV and H/C ratio versus fuel mass flow rate, source Jean-Baptiste Jarin and Jean-Louis Champion

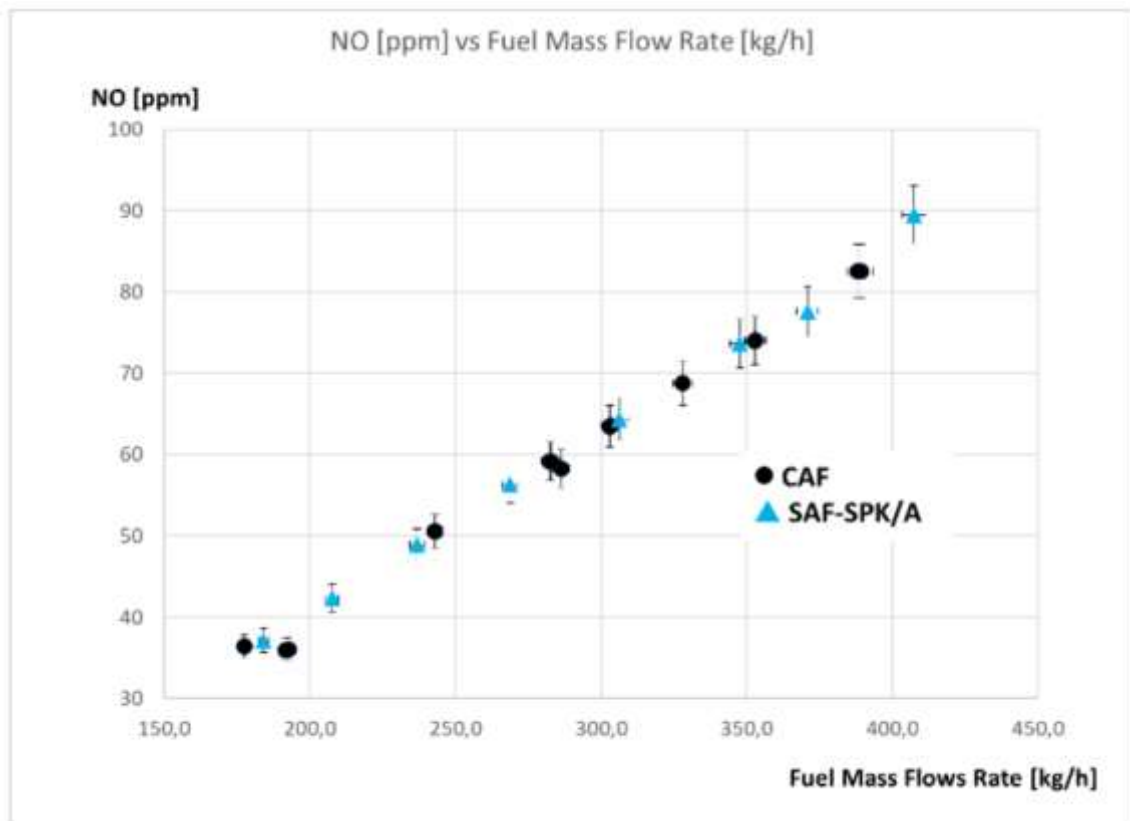

FIGURE 118 NO Emission concentration versus fuel mass flow rate, source Jean-Baptiste Jarin and Jean-Louis Champion

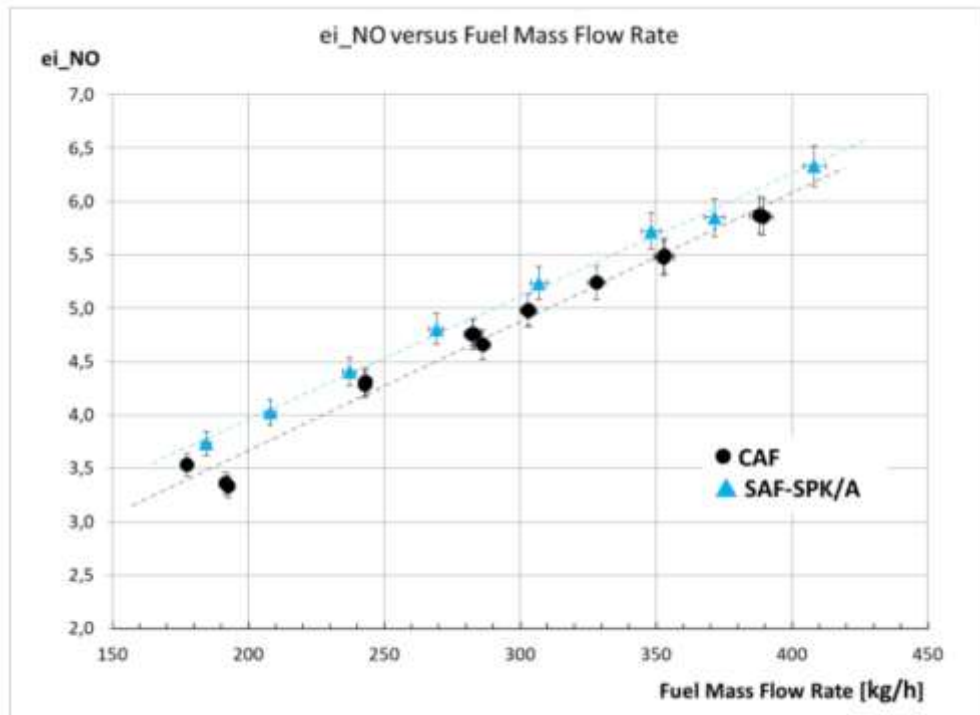

FIGURE 119 NO Emission Index versus fuel mass flow rate, source Jean-Baptiste Jarin and Jean-Louis Champion

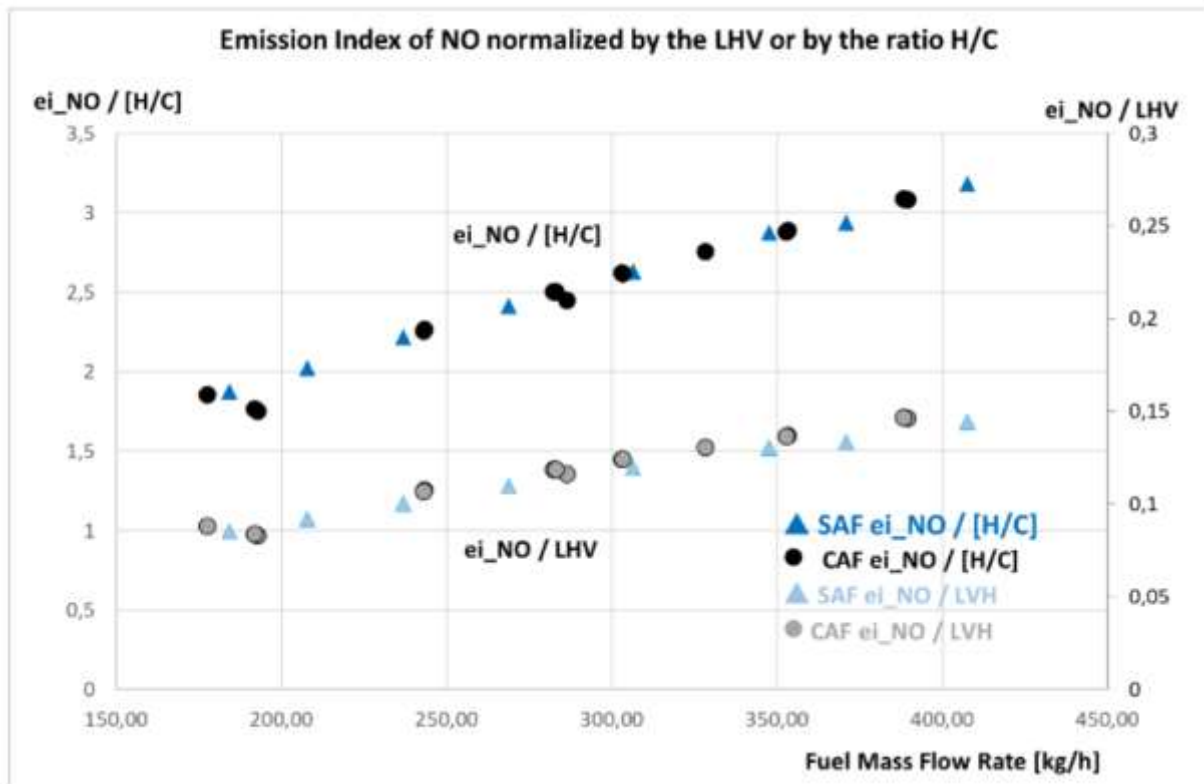

FIGURE 120 NO Emission Index realized with LHV and H/C ratio versus fuel mass flow rate, source Jean-Baptiste Jarin and Jean-Louis Champion

O₂ emissions are presented in FIGURE 121 below. The O₂ concentration in burned gases is lower for the SAF-SPK/A than for CAF. This could be explained by the higher H/C ratio and confirmed by the complete hydrocarbon combustion equation with $z = H/C$: $CH_z + (1+z/4) O_2 \rightarrow CO_2 + z/2 H_2O$

If the H/C ratio increases then the amount of water should increase in burned gases.

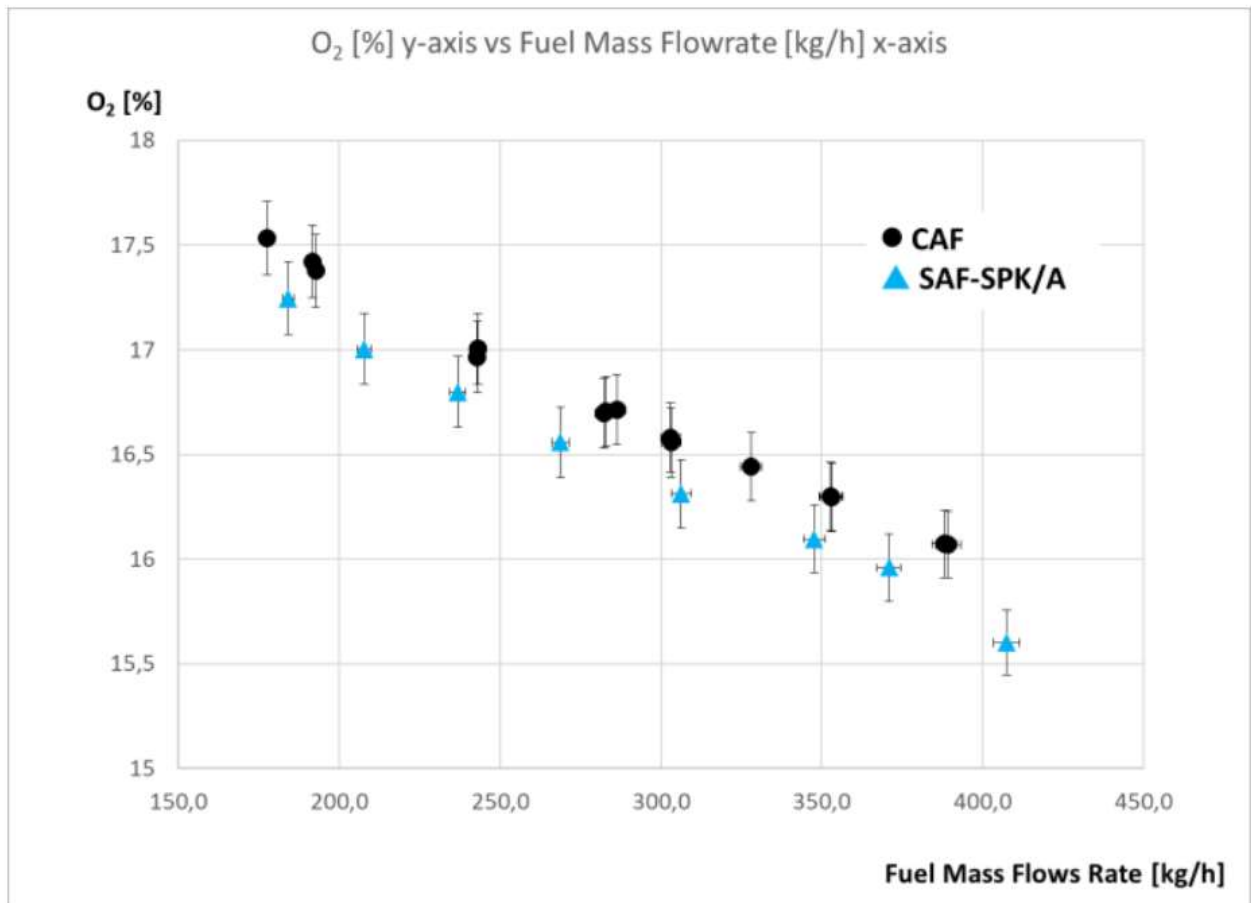

FIGURE 121 O₂ concentration versus fuel mass flow rate, source Jean-Baptiste Jarin and Jean-Louis Champion

Another significant result is observed on the Smoke Number (SN). As shown in FIGURE 122 below there is a decrease of 20 to 50% with the SAF-SPK/A compared to CAF. Smoke Number is the fractional reduction in reflectance by a smoke filter due to the blackening of its surface by soot (see chapter above). Soot is supposed to decrease local air quality and increase contrail formation, therefore having a potential role in non-CO₂ effects. Khandelwal et al found similar results when measuring the effect of alternative fuels: the lower the aromatic content, the lower the SN.

For comparison in FIGURE 122 the SN value measured with the Drop In (see chapter above) SAF is introduced and the main characteristics of the fuels tested are presented in TABLE 35.

One can notice that the SN is significantly lower with the SAF-SPK, up to -80% at low regime when compared to CAF. The result is still important with SAF-SPK/A which contains 9% of SAK, -40% at low regime.

We therefore suppose that a lower SN could be explained by a lower aromatic content and / or by the absence of PNAs in SAK. This needs to be further characterized in the future.

Property	Test method	Unit	CAF	SAF-SPK/A	SAF HEFA-SPK
Density at 15C	ASTM D4052	kg/m3	800	778.5	754.2
Aromatics, volume percent	ASTM D6379	% (v/v)	15.0	9.1	0
Net heat of combustion (LHV)	ASTM D3338	MJ/kg	43.7	43.9	44.4
Hydrogen/Carbon	$H_{(y)} / C_{(x)}$		1.90	1.99	2.16

TABLE 35 Main characteristics of the fuel tested, source Jean-Baptiste Jarin and Jean-Louis Champion

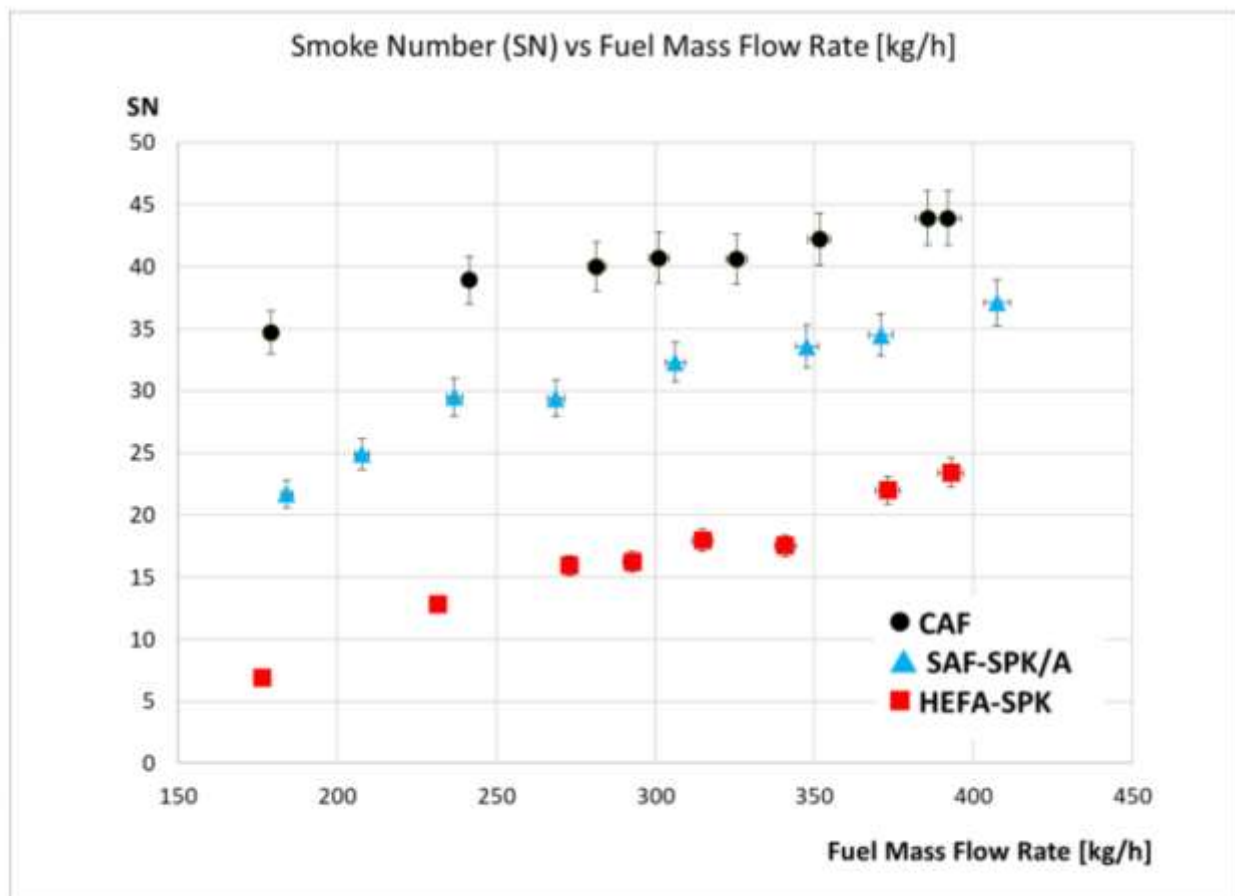

FIGURE 122 Smoke Number concentration versus fuel mass flow rate for SAF-SPK/A, CAF and Drop In SAF (SPK), source Jean-Baptiste Jarin and Jean-Louis Champion

II.II.2.4. Conclusions

While the performance of the 100% SAF-SPK/A were measured as like CAF, the positive impacts on emissions are significant.

Most dominantly a significant decrease of the SN, -20 to -40% depending on the engine fuel mass flow rate, is measured. A lower aromatic content and the absence of PNA could explain this result. The CO concentration is also significantly reduced, within almost the same proportion as the SN and still depending on the engine fuel mass flow rate while the CO/CO₂ ratio highlights a cleaner combustion. These conclusions need to be validated in future tests.

Lower concentration of CO₂ and O₂ were also recorded, and while relatively marginal, approximately 2 gCO₂/MJ, the reduction in CO₂ emissions can support the aviation pathway to decarbonization while the lower O₂ concentration could mean a higher H₂O contain, which could affect contrails formation.

The only significant gaps between Drop and Non-Drop in SAF being the nVPM / Smoke Number, the root cause being the nature and % content of aromatics and the potential effect being a decrease on contrails, this raises two major issues, one being technical, the other being societal:

- Is there an opportunity to reach an optimum % of aromatic content and / or nature of the aromatic fraction (PNA)? The future tests planned with BEARCAT aim at better characterizing these effects to propose such an optimum.
- Since the vast majority of the aircraft fleet which will be operated in 2050 will not be compliant with Non Drop in SAF, there should be a clear signal that any delays in the implementation of 100% SAF would harm the decarbonization objectives. As such the Drop In should be the priority of the different aviation stakeholders.

II.III. Sustainable Aviation Fuels Techno-Economic

While the different categories of SAF have been reviewed in Part I and the expected volumes drafted, it was found necessary to characterize their techno-economic properties. What is the cost means what are the costs of these molecules since are there many pathways (process) and feedstocks at stake. And since a cost is not a price, mainly due to offer and demand law, the notion of minimum jet selling price is introduced.

It is common to hear that SAF are expensive, but that the costs will decline soon. This is not the conclusion of this thesis, which concludes that not only SAF will remain expensive, but that the average price of SAF may well increase in the next decade.

Finally, since prices of SAF could affect the demand of air mobility, simulation of costs evolution for operators are introduced along with the notion of price elasticity on the final demand.

To introduce this chapter, it is important to understand the rationale behind the production of SAF. For almost a century air mobility, as other mean of transportation, used fossil oil, a free primary energy with unique properties. It is therefore technically complicated (chapter above) but as found in this chapter also economically difficult to replace it. Mother nature worked for free during million years so that human added value has been limited to explore, dig and refine. It is getting a bit more complicated since a decade with the non-conventional oil (see TABLE 38) but it will even be more complicated with SAF as we now intend to collect, carry, concentrate different feedstocks to turn them into SAF. In FIGURE 123 below are detailed the key parameters at stake with the production of SAF. These parameters are keys to understand the techno-economic properties of SAF, optionality meaning competition, but also conflict of use in a more constrained world.



FIGURE 123 Overview of the techno-economic properties of SAF, source Jean-Baptiste Jarin

II.III.1. Costs of SAF

The cost structure for SAF breaks down into two main categories: capital expenditure (CAPEX) and operating costs (OPEX), with feedstock being the main component. The cost of feedstock is found to be always high, either directly, such as for UCO or tallows, or indirectly, such as for lignocellulosic waste, due to the cost of collecting the residues. Numerous studies and reports are available, the general trend being that reports from consulting firms propose lower costs, and prices, than those proposed in scientific articles. The focus, as discussed above, being on the most important pathways: HEFA, ATJ and FT while, when necessary, the parity hypothesis between euro and US dollar is 1.

Of the many scientific publications available, the synthesis proposed here mainly relies on:

- The latest review published, Sustainable aviation fuel technologies, costs, emissions, policies, and markets: A critical review by Watson et al ⁴⁹⁹
- The ICCT report, advocacy for clean transportation, which often uses scientific peer reviewed articles as main source ⁵⁰⁰
- IRENA, which is the advocacy of the renewable industries ⁵⁰¹
- Mc Kinsey, a consulting firm ⁵⁰²

The reports from ICCT and IRENA, while citing the sources, which are often peer reviewed articles, allow to draw a comparison of the different CAPEX and OPEX required to produce SAF.

II.III.1.1. CAPEX

Even if the main rules for calculating the value of investments are very similar from one study to the next (20-year lifespan, WACC 7 to 8%, inflation 1 to 2%), CAPEX is the most difficult to understand, as manufacturers communicate little, and the differences are very significant, even within the same study. It is noted here that since most data were gathered by the authors before 2021, the inflation rate hypothesis of 1 to 2% per year seems rather optimistic, since the inflation rates in 2022, 2023 and forecast for 2024 are respectively 9.32%, 6.28% and 2.74% according to Statista ⁵⁰³. For SAF produced from the biomass, TABLE 36 below details the minimum and maximum amount of CAPEX required for an average production of 180 000 tons per year. Scalability being a major issue with SAF, approximately 2650 units would be required by 2050 to meet the nominal SAF volume scenario of 477 Mt.

CAPEX (M€ 2013) for a 180 kt / year production unit for the main considered pathways		IRENA		ICCT	
Process	FRL	Min.	Max.	Min.	Max.
FT-SPK	7	327	1186	585	
HEFA	9	200	644	137	
ATJ	7	283	498	345	548

TABLE 36 CAPEX values, in M€, for a typical production unit of 180 kt / year for the 3 pathways considered, HEFA, ATJ and FT, source Jean-Baptiste Jarin with data from Irena and ICCT

⁴⁹⁹ M.J. Watson, P.G. Machado, A.V. da Silva, Y. Saltar, C.O. Ribeiro, C.A.O. Nascimento, A.W. Dowling, Sustainable aviation fuel technologies, costs, emissions, policies, and markets: A critical review, Journal of Cleaner Production, Volume 449, 2024, 141472, ISSN 0959-6526, <https://doi.org/10.1016/j.jclepro.2024.141472>

⁵⁰⁰ https://theicct.org/wp-content/uploads/2021/06/Alternative_jet_fuels_cost_EU_2020_06_v3.pdf accessed August 13, 2024

⁵⁰¹ <https://www.irena.org/publications/2017/Feb/Biofuels-for-aviation-Technology-brief> accessed August 13, 2024

⁵⁰² <https://www.mckinsey.com/industries/travel-logistics-and-infrastructure/our-insights/how-airlines-can-chart-a-path-to-zero-carbon-flying> accessed August 13, 2024

⁵⁰³ <https://www.statista.com/statistics/267908/inflation-rate-in-eu-and-euro-area/> accessed August 13, 2024

Given the capacities of the production units, which are a few hundred thousand tons/year (typically 100 kt for a FT and unit, 300 to 1 000 kt for a HEFA unit), the CAPEX impact will represent a significant proportion of the cost in terms of price per ton (\$/toe).

The share of the CAPEX in the final cost, and therefore the final selling price, will be significantly impacted by the conversion yields, therefore the feedstock. A summary of the process yields to conversion from the biomass is proposed in TABLE 37 while a synthesis of Energy Return on Energy Invested (ERoEI) is proposed in TABLE 38, which includes the efuel pathway. The yield conversion gives the output from the feedstock after conversion, i.e. 1 liter of used cooking oil would provide 0.9 liter of SAF, while the ERoEI describes the output energy obtained with 1 unit as input, it is generally expressed in Joule.

Pathway	Feedstock	Typical yield	References
HEFA	UCO	0,9	Greet 2018, TotalEnergies 2023
ATJ	Cellulosic	0,26	ICCT
ATJ	Sugar	0,47	Greet 2018, TotalEnergies 2023
FT	Residues	0,12	ICCT

TABLE 37 Process yields to conversion from the biomass, source Jean-Baptiste Jarin with data from ICCT and TotalEnergies

ERoEI	
Oil - Onshore	30 - 100
Oil - Offshore	20 - 30
Oil - Ultra Deep	8 - 15
Oil - Shale	5 - 10
Oil - Tar sands	3 - 5
Biofuel 1G - Crops	0,8 - 1,2
Biofuel 2G - Crops	0,9 - 1,5
Biofuel 2G - Residues	1,5 - 2,5
eFuel	0,4 - 0,6

TABLE 38 Energy Return on Energy Invested for different pathways and feedstocks, source Jean-Baptiste Jarin with data from Hall et al ⁵⁰⁴, Usine Nouvelle ⁵⁰⁴ and Restuccia et al ⁵⁰⁵. For efuel the ERoEI is calculated using the LHV of efuel, 12 kWh/kg, which requires 22 to 28 kWh to be produced

One can notice that the ERoEI is not only declining but also getting closer to 1, and for efuel below 1. This means that we are using more energy to produce the molecule than its energy content.

This is described with FIGURE 124 below, which describes the input and output of a HEFA production site, operated by TotalEnergies and located in Grandpuits, France ⁵⁰⁶.

⁵⁰⁴ L'usine nouvelle, n°3407122, Janvier 2015, pages 25-28

⁵⁰⁵ Restuccia, A., Failla, S., Longo, D., Caruso, L., Mallia, I. and Schillaci, G. (2013) "Assessment of energy return on energy investment (EROEI) of oil bearing crops for renewable fuel production", *Journal of Agricultural Engineering*, 44(s2). <https://doi.org/10.4081/jae.2013.349>

⁵⁰⁶ <https://bioenergyinternational.com/total-selects-honeywell-uop-ecofining-for-grandpuits-zero-crude-project/> accessed August 13, 2024

For efuels, investments should take electricity generation units into account. Indeed, the latter need to be dedicated to avoid efuel production coming into direct competition with electricity production, which has its own decarbonization trajectory and must meet other uses. Dedicated power generation facilities would also ensure that the electricity produced is truly low-carbon, as discussed above. However, all studies found only consider the FT or the MTJ processes. The other investments concern the electrolyser, the CO₂ capture system (Direct Air Capture, DAC) and the fuel synthesis system.

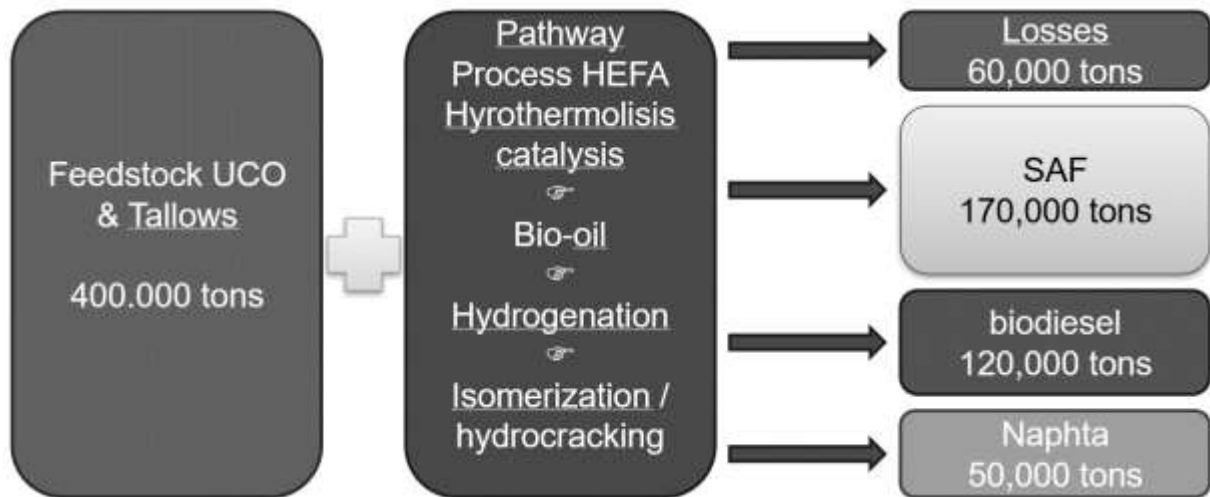

FIGURE 124 Overview of the process conversion yield for the TotalEnergies production site of Grandpuits, France, source Jean-Baptiste Jarin with data from TotalEnergies and UOP. The yield is here of 0.85 and shall reach 0.9 in the coming years with further refining improvements

Interviews with several energy producers reveals that the CAPEX to be considered for the FT pathway, including DAC for CO₂ and excluding electricity production investments, which will therefore be part of the OPEX, are close to 1B€ for a 70 kt / year production unit, and 10 B€ for a 1 Mt / year production unit. An overview of the considered production unit is proposed in FIGURE 125 below with courtesy of Daniel Iracane from the Académie des Technologies. With an average production price of electricity of 70 € / year which the current price for electro-intensive units, and excluding any forms of taxes or grid contribution, the yearly production of 1 Mt of efuel would cost almost 2 B€ / year, or 1/5 of the CAPEX.

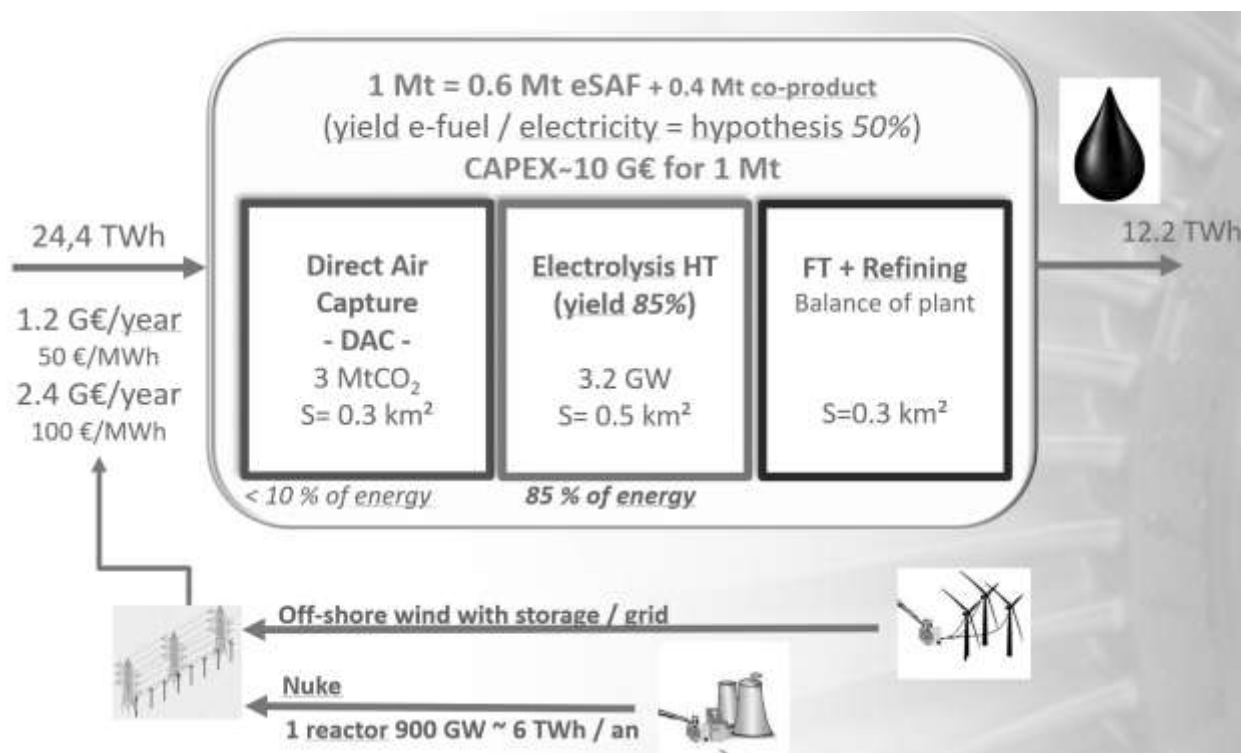

FIGURE 125 Overview of an efuel production unit with numbers. It is found here that the major part of the cost of producing an efuel is electricity, here expressed in € / MWh, source Académie des Technologies, with courtesy of Daniel Iracane

II.III.1.2. OPEX

As with conventional oil, the main component of SAF is feedstock, and it is this that needs to be considered.

Fuels: With the requirement to start with low carbon hydrogen, therefore water electrolysis using low carbon electricity, the main feedstock for efuels is electricity. Production costs will therefore derive largely from the price of electricity, which is consumed essentially in the electrolysis of water to create hydrogen; and to a lesser extent in the CO₂ capture process (DAC).

For Brynholf et al, the share of electricity alone approaches €1500 / ton based on a kWh price of 5 cents⁵⁰⁷. This number is close to the one found in the Académie des Technologies report when assuming a 25 to 30 kWh / kg process conversion yield. Along with the electricity price, it is necessary to understand that electricity shall be low carbon, available with high yields and in sufficient quantities. FIGURE 125 above exhibit a number of 6 TWh per year to produce 600kt of SAF, this is the equivalent of one nuclear plant. The notion of high yield is also very important, as for technical and economical reasons, the electrolyzers required to produce H₂ should run constantly, with a yield factor above 80%. Below this number the impact on the CAPEX would not only be significant, but the technical feasibility would be at risk since electrolyzers are sensitive to variations in load factors⁵⁰⁸.

It is noted here that these conclusions are in direct contradiction with most consulting firm and advocacy reports, which assume that solar and / or wind electricity could be produced as low as 20 € / MWh without major issues regarding their micro and macro yields variations. While, as for other studies, taxes and grid costs are not included, these assumptions seem rather optimistic and driven by the current buzz around the hydrogen molecule, which is by

⁵⁰⁷ Brynholf, Maria Taljegard, Maria Grahn, Julia Hansson, Electrofuels for the transport sector: A review of production costs, Renewable and Sustainable Energy Reviews, Volume 81, Part 2, 2018, Pages 1887-1905, ISSN 1364-0321, <https://doi.org/10.1016/j.rser.2017.05.288>

⁵⁰⁸ Emma Nguyen, Pierre Olivier, Marie-Cécile Pera, Elodie Pahon, Robin Roche, Impacts of intermittency on low-temperature electrolysis technologies: A comprehensive review, International Journal of Hydrogen Energy, Volume 70, 2024, Pages 474-492, ISSN 0360-3199, <https://doi.org/10.1016/j.ijhydene.2024.05.217>

far the main ingredient in efuels. For comparison, TABLE 39 below compares hydrogen production costs according to different sources. The discrepancy between consulting and advocacy reports with scientific articles speaks for itself. The production costs presented here do not include transportation costs, which are estimated to be close to 3 \$/kg⁵⁰⁹. While the production of efuel is meant to be located next to the electrolyzers, thus avoiding the cost of transport, the cost the hydrogen molecule would most probably be in the upper range proposed in TABLE 39, which would lead to a cost of eSAF production between 3000 to 5000 \$/ton.

⁵⁰⁹ Tory Borsboom-Hanson, Shashank Reddy Patlolla, Omar E. Herrera, Walter Mérida, Point-to-point transportation: The economics of hydrogen export, *International Journal of Hydrogen Energy*, Volume 47, Issue 74, 2022, Pages 31541-31550, ISSN 0360-3199, <https://doi.org/10.1016/j.ijhydene.2022.07.093>

Source	Classification	Reference	Cost in \$/kg by 2030
US Dept of Energy	Governmental report	https://www.energy.gov/eere/fuelcells/hydrogen-shot	1
ReThink	Consulting firm	https://www.rethinkresearch.biz/articles/market-dynamics-to-drag-green-hydrogen-to-1-50-kg-by-2030/	1,5
Mc Kinsey	Consulting firm	https://www.mckinsey.com/industries/oil-and-gas/our-insights/global-energy-perspective-2023-hydrogen-outlook	1,5 to 2
IEA	International agency	https://www.iea.org/data-and-statistics/charts/hydrogen-production-costs-and-potential-supply-from-dedicated-hybrid-solar-pv-and-onshore-wind-in-africa-within-200-km-of-a-serviceable-coast-2030	2
IRENA	International agency	https://www.irena.org/-/media/Files/IRENA/Agency/Publication/2020/Nov/IRENA_Green_Hydrogen_breakthrough_2021.pdf	2
International Journal of Hydrogen Energy	Peer reviewed article	Zixuan Shanguan, Hao Li, Bowen Yang, Zhongkai Zhao, Tiantian Wang, Liming Jin, Cunman Zhang, Optimization of alkaline electrolyzer operation in renewable energy power systems: A universal modeling approach for enhanced hydrogen production efficiency and cost-effectiveness, International Journal of Hydrogen Energy, Volume 49, Part C, 2024, Pages 943-954, ISSN 0360-3199, https://doi.org/10.1016/j.ijhydene.2023.10.057	4,6 to 5,3
International Journal of Hydrogen Energy	Peer reviewed article	Mostafa Rezaei, Alexandr Akimov, Evan MacA. Gray, Economics of solar-based hydrogen production: Sensitivity to financial and technical factors, International Journal of Hydrogen Energy, Volume 47, Issue 65, 2022, Pages 27930-27943, ISSN 0360-3199, https://doi.org/10.1016/j.ijhydene.2022.06.116	5,3
Applied Energy	Peer reviewed article	JoungHo Park, Kyung Hwan Ryu, Chang-Hee Kim, Won Chul Cho, MinJoong Kim, Jae Hun Lee, Hyun-Seok Cho, Jay H. Lee, Green hydrogen to tackle the power curtailment: Meteorological data-based capacity factor and techno-economic analysis, Applied Energy, Volume 340, 2023, 121016, ISSN 0306-2619, https://doi.org/10.1016/j.apenergy.2023.121016	5,9
Fuel	Peer reviewed article	Muhammad Younas, Sumeer Shafique, Ainy Hafeez, Fahad Javed, Fahad Rehman, An Overview of Hydrogen Production: Current Status, Potential, and Challenges, Fuel, Volume 316, 2022, 123317, ISSN 0016-2361, https://doi.org/10.1016/j.fuel.2022.123317	6,3 to 10,3
California Energy Commission	Data from field	https://h2fcp.org/content/cost-refill	16,1 (2019)

TABLE 39 Synthesis of hydrogen production costs, source Jean-Baptiste Jarin with data from different sources^{422 510 511 512 513 514 515 516 517 518}

For biofuels the main feedstock for biofuels is the feedstock itself, which can take a variety of forms and comes with unique sustainability, collectability and optionality characteristics as shown in FIGURE 123 above.

3 main families can be identified: wastes which can be residues or municipal solid waste, used cooking oil and tallows, and food crops.

While costs are found not related to the volumes available nor their CO₂ emissions (chapter III of part I), they offer a wide range as detailed in TABLE 40 below using data from Argus Media, ICCT and Marsac et al⁵¹⁹ for the collecting costs, which have been actualized here using an average inflation rate of 3%. The process conversion yields are applied to reflect the real final cost of the feedstock.

OPEX Feedstock for Biofuels, in \$/ton, 2024		Feedstock \$ / ton	Process Conversion yield	Estimated cost of collect in \$/ton	Estimated OPEX Feedstock \$/t
HEFA	UCO	1380	0,9	non applicable (ARA)	1533
FT	Residues	109	0,12	135	1043

TABLE 40 Estimated OPEX share of feedstock for the two main pathways, HEFA and FT, with sustainable feedstocks (Used Cooking Oil and forestry residues), source Jean-Baptiste Jarin with data from Argus Media, ICCT and Marsac et al.

⁵¹⁰ Zixuan Shangguan, Hao Li, Bowen Yang, Zhongkai Zhao, Tiantian Wang, Liming Jin, Cunman Zhang, Optimization of alkaline electrolyzer operation in renewable energy power systems: A universal modeling approach for enhanced hydrogen production efficiency and cost-effectiveness, International Journal of Hydrogen Energy, Volume 49, Part C, 2024, Pages 943-954, ISSN 0360-3199, <https://doi.org/10.1016/j.ijhydene.2023.10.057>

⁵¹¹ Mostafa Rezaei, Alexandr Akimov, Evan MacA. Gray, Economics of solar-based hydrogen production: Sensitivity to financial and technical factors, International Journal of Hydrogen Energy, Volume 47, Issue 65, 2022, Pages 27930-27943, ISSN 0360-3199, <https://doi.org/10.1016/j.ijhydene.2022.06.116>

⁵¹² Joungho Park, Kyung Hwan Ryu, Chang-Hee Kim, Won Chul Cho, MinJoong Kim, Jae Hun Lee, Hyun-Seok Cho, Jay H. Lee, Green hydrogen to tackle the power curtailment: Meteorological data-based capacity factor and techno-economic analysis, Applied Energy, Volume 340, 2023, 121016, ISSN 0306-2619, <https://doi.org/10.1016/j.apenergy.2023.121016>

⁵¹³ https://www.irena.org/-/media/Files/IRENA/Agency/Publication/2020/Nov/IRENA_Green_Hydrogen_breakthrough_2021.pdf accessed August 13, 2024

⁵¹⁴ <https://h2fcp.org/content/cost-refill> accessed August 13, 2024

⁵¹⁵ <https://www.iea.org/data-and-statistics/charts/hydrogen-production-costs-and-potential-supply-from-dedicated-hybrid-solar-pv-and-onshore-wind-in-africa-within-200-km-of-a-serviceable-coast-2030> accessed August 13, 2024

⁵¹⁶ <https://www.mckinsey.com/industries/oil-and-gas/our-insights/global-energy-perspective-2023-hydrogen-outlook> accessed August 13, 2024

⁵¹⁷ <https://www.rethinkresearch.biz/articles/market-dynamics-to-drag-green-hydrogen-to-1-50-kg-by-2030/> accessed August 13, 2024

⁵¹⁸ <https://www.energy.gov/eere/fuelcells/hydrogen-shot> accessed August 13, 2024

⁵¹⁹ Marsac, Sylvain & Labalette, Françoise & Savoure, Marie-Laure & Costes, Jean-Louis & Berthelot, Alain & François, Damien & Pittochi, Sophie & Gomes, Céline & Vivancos, Caroline. (2012). Energy crops and woody biomass production cost comparison https://www.researchgate.net/publication/269100391_Energy_crops_and_woody_biomass_production_cost_comparison accessed August 13, 2024

II.III.1.3. Projections

Using the above data a synthesis of levelized cost of production of SAF is proposed (OPEX + CAPEX model), introducing data from the ISAE report, The role of alternative fuels in the decarbonization of the aviation sector, issued in 2020, ICCT ⁵²⁰, Watson et al ⁴⁹⁹ and Braun et al ⁵²¹, TABLE 41.

Comparing LCOP, in \$/ton	OPEX + CAPEX	IRENA	ICCT	ISAE	Braun et al (mean MSP)	Watson et al (mean MSP)
HEFA - UCO	1709	1518	1019	1229	1942	1400
FT - Residues	2188	2024	2097	2154	2233	2600
FT - MSW	1787		1514	1655		
ATJ Residues	3026	2700	2796	2844	2116	2112
ATJ Crops (sugar beets, sugar cane)	1882		1922	1901		
eFuel	3240		3087	3060	3216	

TABLE 41 Comparing LCOP or Minimum Selling Price (MSP), source Jean-Baptiste Jarin with data from Irena, ICCT, ISAE, Braun et al, Watson et al

Based on the above assumptions, a simple model considering the limits in volume for each feedstock was built in 2022, FIGURE 126.

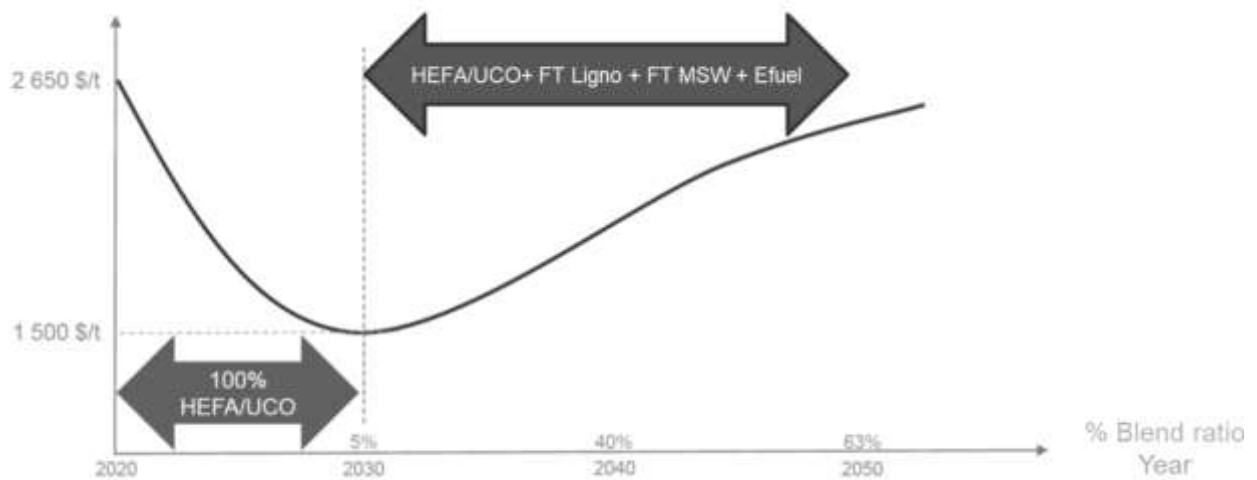

FIGURE 126 Initial cost model for SAF considering LCOP of each Process / Feedstock and volume constraints for each feedstock while increasing the blend ratio over time, source Jean-Baptiste Jarin

While the model can be upgraded, this initial version was found imperfect, as the feedstock price fluctuation was not introduced. It initially worked as an engineering model, considering the LCOP of each SAF in association with their inherent volumes access. In example, for the HEFA-UCO, the maximum production being approximately 20 Mt (see next chapter), the model considers that until 2030 these volumes are enough to meet the aviation demand based on the ReFuel EU regulation. From 2020 to 2030, it was then anticipated that the cost of HEFA-UCO would decline to

⁵²⁰ <https://theicct.org/publication/the-cost-of-supporting-alternative-jet-fuels-in-the-european-union/>, 2019, accessed August 13, 2024

⁵²¹ Matthias Braun, Wolfgang Grimme, Katrin Oesingmann, Pathway to net zero: Reviewing sustainable aviation fuels, environmental impacts and pricing, Journal of Air Transport Management, Volume 117, 2024, 102580, ISSN 0969-6997, <https://doi.org/10.1016/j.jairtraman.2024.102580>

1500 \$ / ton to reflect increased competition and approach the average values listed in TABLE 41 above. After 2030, the average cost of SAF would start to increase as more expensive SAF such as FT – Residues or efuel would be necessary to meet the regulation and increase the volumes of SAF on the market.

This approach was therefore found inappropriate when considering the price fluctuation of the feedstock. As shown in FIGURE 127, these costs can also fluctuate significantly. During the considered period here, February 2022 – July 2024, the listed price of the feedstock, here UCO, shows a wide range, from 1000 à 2500 \$/ton. Historically the gap is even wider, as shown in FIGURE 128, showing a 3-fold increase from the low 600 \$/ton, in spring 2018, to the high 2000 \$/ton, in spring 2022. Most of the studies reviewed did not consider the feedstock price variation, and this can mislead the industry, as well as policies. This also has repercussions on current usages, highlighting the forthcoming conflicts of use, and this will be addressed in a dedicated chapter. However, it should be noted here that when UCO is priced at \$1,000/ton, this is above the price of food oil for most of the world population. While these variations affect the SAF final price, it also has an impact on commodity prices serving basic needs, while encouraging fraud. In 2019, while the price of UCO was close to 900 \$/ton, it was estimated that 1/3 of the UCO in Europe is fraudulent ⁵²². Basically, palm oil is labeled as UCO, or worse, virgin oil is heated to be labeled d as UCO.

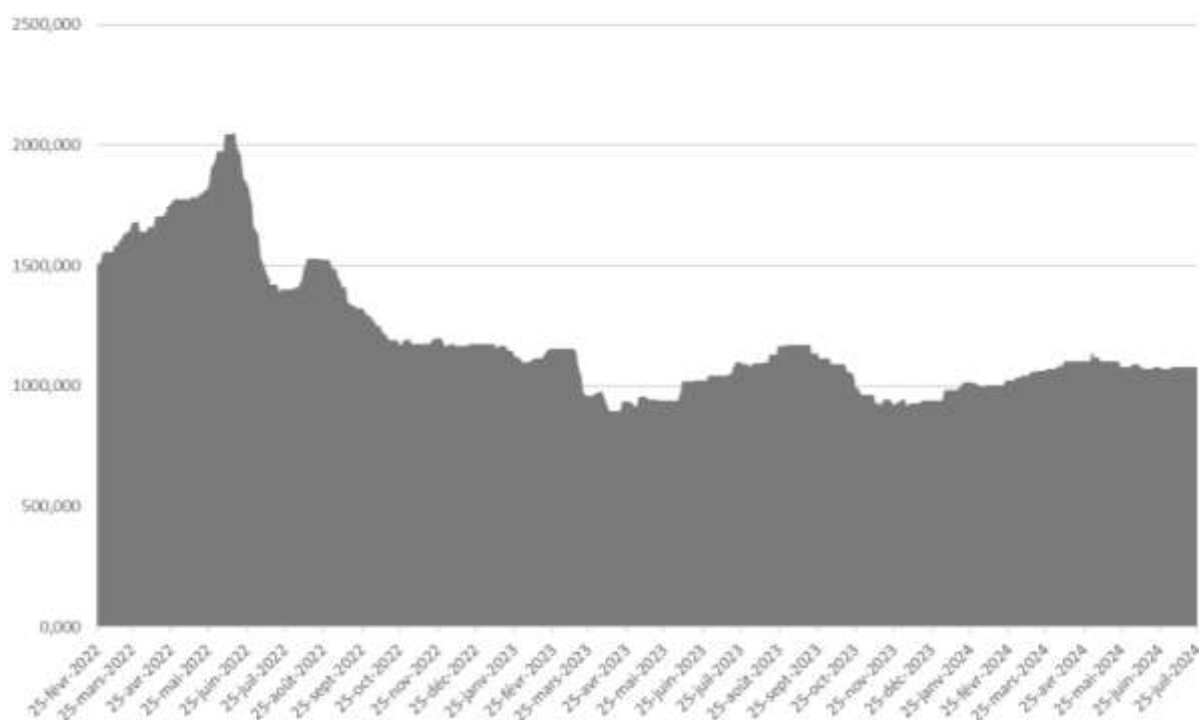

FIGURE 127 Cost of UCO feedstock compliant with EU (RED) and delivered in Europe ARA (Antwerpen – Rotterdam – Amsterdam) from February 2022 to July 2024, in USD/ton, source Jean-Baptiste Jarin with data from Argus Media

⁵²² <https://www.euractiv.com/section/agrifuels/news/industry-source-one-third-of-used-cooking-oil-in-europe-is-fraudulent/> accessed August 13, 2024



FIGURE 128 Cost of UCO from 2017 to 2022, in €/ton, source Greenea ⁵²³

These data demonstrate that building a rationale purely on cost is not adequate, since the law of demand and offer seems inevitable in an unregulated market, leading to higher prices since the offer is limited ⁵²⁴ ⁵²⁵. Moreover, the impact on feedstocks and intermediate products, goes well beyond the aviation sector, as indicated by FIGURE 129 below, which is for UCOME, the biodiesel used in cars. This is an introduction to the forthcoming conflict of use, which will be addressed in the next chapter, and an imperative to improve the existing model proposed above.

⁵²³ <https://www.greenea.com/analyses-marche/> accessed August 13, 2024

⁵²⁴ Johnson, S. (2021, October 21). Supply imbalances bring higher inflation and lower global economic growth. *S&P Global*. <https://www.spglobal.com/market-intelligence/en/news-insights/research/supply-imbalances-bring-higher-inflation-lower-global-growth> accessed August 13, 2024

⁵²⁵ Eicke, A., Ruhnau, O., & Hirth, L. (2021). Electricity balancing as a market equilibrium: An instrument-based estimation of supply and demand for imbalance energy. *Energy Economics*, 102, 105455. <https://doi.org/10.1016/j.eneco.2021.105455>

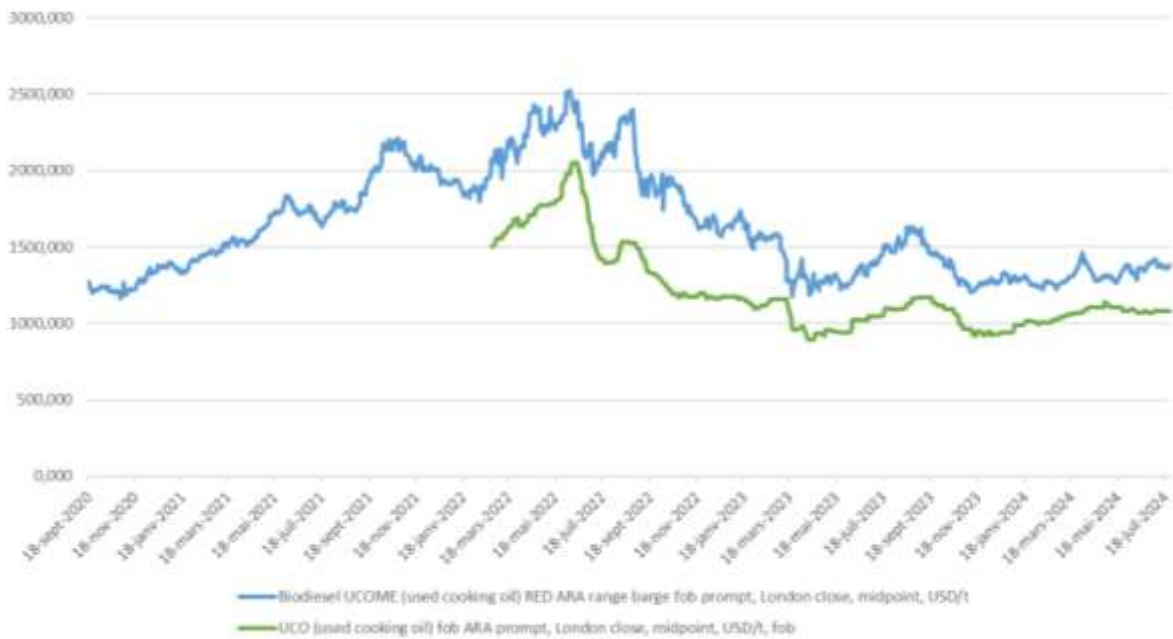

FIGURE 129 Comparing UCOME delivered in Europe (Antwerpen – Rotterdam – Amsterdam) from February 2022 to July 2024, in US\$/ton, source Jean-Baptiste Jarin with data from Argus Media

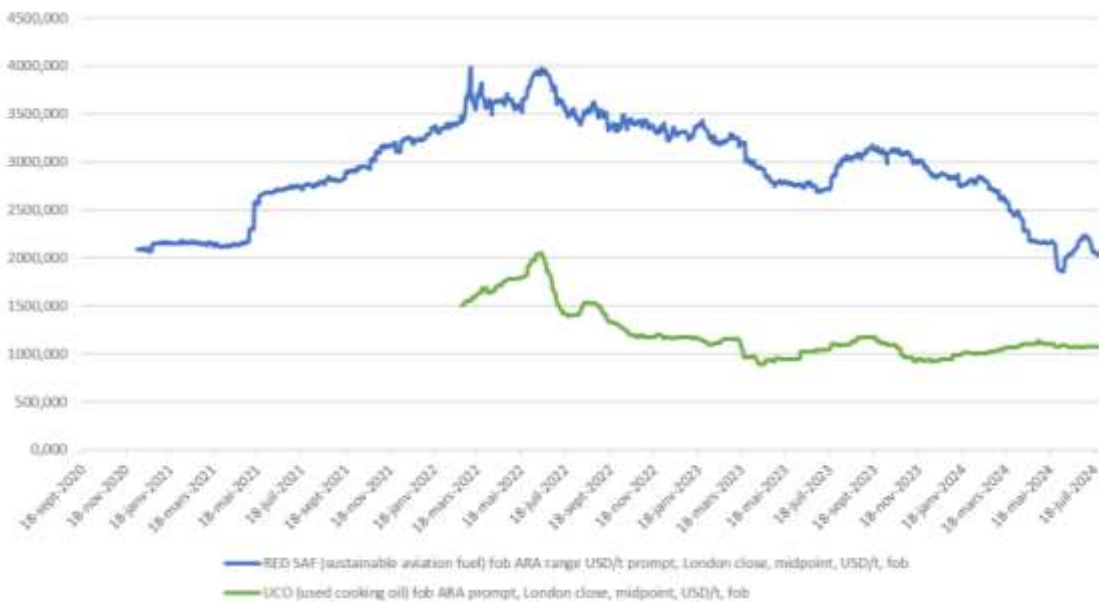

FIGURE 130 Cost of feedstock and SAF price relationship, in US\$/ton, source Jean-Baptiste Jarin with data from Argus Media

In FIGURE 130, the correlation between the SAF (RED SAF, HEFA-UCO) and the feedstock (UCO) prices, although visible on the graph, is not demonstrated. The data are not stationary, and when transformed into stationary data, the R is less than 0.5. Moreover, correlation is not causation, and a Granger test reveals feedback between the two series.

The introduction of fossil jet fuel in the graph, FIGURE 131 above, can also allow one to understand that, while the price of the cheapest SAF to produce, HEFA-UCO, ranges from 2000 to 4000 \$/ton, the cost of the feedstock itself, UCO, never went below the price of jet fuel. Since the volumes produced in 2023 are still very low, close to 1 Mt, the impact on the demand is yet to come, driven by the obligation to incorporate SAF at significant level in the coming years. This could significantly impact the price of UCO. Still, the same results are also found for the data shown in FIGURE 131 (no correlation, no causality). This will indeed require further analysis.

However, as demonstrated by Lark et al in *Environmental outcomes of the US Renewable Fuel Standard*⁵²⁶, the supply and demand imbalance, created by the development and deployment of biofuels, exists, and is at the origin of the significant price increase of the feedstocks considered (corn, soybean, wheat). It is therefore important to limit the supply and demand imbalance, which means limiting the volumes, while the decarbonization of air mobility would, at the same time, require significant volumes of SAF, significantly impacting the demand of biomass.



FIGURE 131 Comparing fossil jet fuel, SAF (HEFA-UCO) and UCO feedstock from 2020 to 2024, in US\$/ton, source Jean-Baptiste Jarin with data from Argus Media

SAF manufactured from UCO is supposed to be the cheapest SAF, TABLE 41. Still, and while the cost learning curve is mostly beyond us, its price is between 2000 to 4000 US\$/ton during the past four years, when before 2020, the channel was between 600 and 900 US\$/ton, FIGURE 128.

These conclusions are in direct contradiction with most reports issued from consulting firms, such as Mc Kinsey⁵²⁷, FIGURE 132, which concluded that SAF (synthetic jet fuel in the report) will become cost competitive with fossil jet fuel within 10 years, reaching a cost close to 1000 \$/ton between 2030 (aggressive case) and 2035 (reference case). Since the methodology used by consulting firms, such as Mc Kinsey, is not provided, and since these results significantly differ with peer reviewed studies, as well as with the conclusions of this thesis, the conclusion proposed by Mc Kinsey should be considered here for information only, while the objective behind such a publication could deserve to be investigated in future researches.

⁵²⁶ Tyler J. Lark, Nathan P. Hendricks, Aaron Smith, Nicholas Pates, Seth A. Spawn-Lee, Matthew Bougie, Eric G. Booth, Christopher J. Kucharik, Holly K. Gibbs, *Environmental outcomes of the US Renewable Fuel Standard*, Journal Article, 2022, Proceedings of the National Academy of Sciences, <https://www.pnas.org/doi/full/10.1073/pnas.2101084119>

⁵²⁷ <https://www.mckinsey.com/~media/McKinsey/Industries/Travel%20Transport%20and%20Logistics/Our%20Insights/How%20airlines%20can%20chart%20a%20path%20to%20zero%20carbon%20flying/How-airlines-can-chart-a-path-to-zero-carbon-flying.pdf> page 8, accessed August 13, 2024

With low renewable costs or regulation, synthetic jet fuel could become cost competitive with fossil jet fuel.

Cost of synthetic-jet-fuel production, \$/metric ton, 2019¹

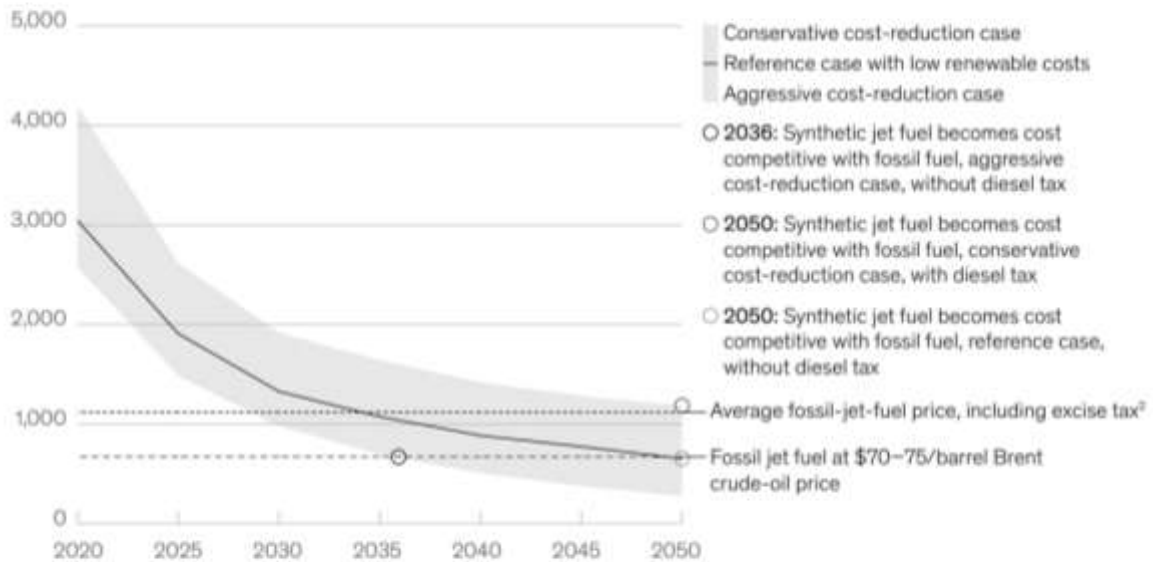

¹ Costs of synthetic fuel produced in a facility built in the corresponding year. 1 metric ton = 2,205 pounds.
² Assumed similar to EU diesel tax for road use (\$0.50/liter).
 Source: Energy Insights by McKinsey

FIGURE 132 Mc Kinsey SAF price forecast, 2019, in US\$/ton, source Mc Kinsey

Reports from IEA (International Energy Agency) is less optimistic. In its Renewables 2020⁵²⁸, the agency concluded that air transport will face rising fuel prices with the introduction of SAF. It should be noted that the agency considers that the sector should be more ambitious regarding the timeline for the introduction of SAF and/or the introduction of a carbon tax, particularly following the massive injection of public aid with the Covid effect, which the IEA evaluates at a minimum of \$76 billion. For IEA, SAF prices will be between 2 and 7 times more expensive than jet fuel produced from CAF, these ratios being equivalent to the ones proposed in TABLE 41, and in line with the ratio expected by TotalEnergies⁵²⁹. Those will be used in the next chapters, while upgrading the cost model accordingly.

⁵²⁸ <https://www.iea.org/reports/renewables-2020> accessed August 13, 2024

⁵²⁹ TotalEnergies, Symposium Aerospace Valley, Biarritz, 2023

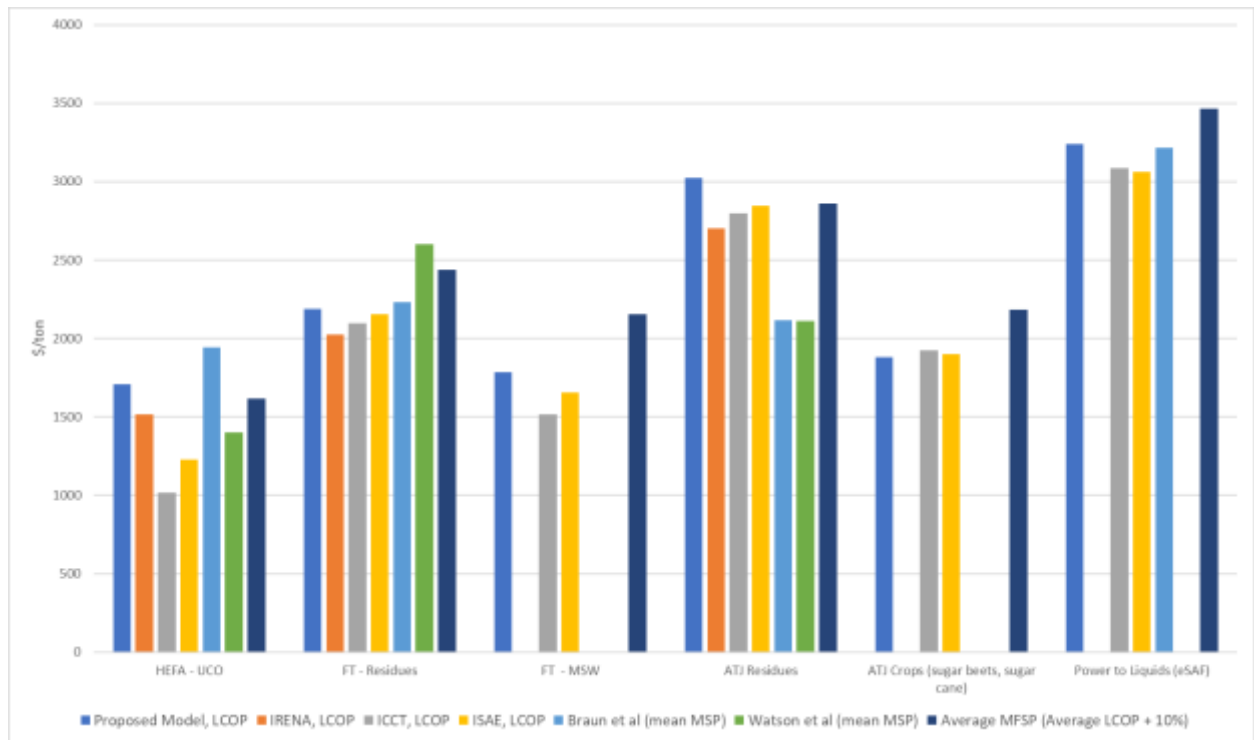

FIGURE 133 Comparing SAF Levelized Cost of Production (LCOP), M(F)SP (Minimum (Fuel) Selling Price) for the main pathways and feedstocks and proposing an average MFSP, source Jean-Baptiste Jarin with data from TABLE 41 Comparing LCOP or Minimum Selling Price (MSP), source Jean-Baptiste Jarin with data from Irena, ICCT, ISAE, Braun et al, Watson et al

FIGURE 133 above proposes a synthesis of the production cost (LCOP) for the main SAF process and feedstocks considered. One can notice that values for the FT, ATJ and PtL (eSAF) are within the same ballpark. Values for HEFA differs significantly (ICCT 1019 \$/ton, Braun 1942 \$/ton) and this is explained by the variation of the Used Cooking Oil prices as discussed above, the article of Braun et al being published in 2024 while the ICCT was published in 2019, therefore before understanding the significant price variation of the Used Cooking Oil, because of the offer and demand law.

As a conclusion, it appears that the model initially proposed, FIGURE 126, it not valid, and that most probably the price of SAF will be aligned, as for the price of fossil fuel, on the cost of the last ton produced.

The situation will be very complex, however, since only European regulation is currently imposing a share of eSAF (from 2030), while CORSIA's requirements, as well as those of North America's IRA, fall far short of EU requirements. The global SAF market could therefore see the emergence of two market prices from 2030 onwards, one European based on the price of eSAF, and the other global, based on the price of the highest SAF.

Studies converge to indicate that the supply of HEFA-UCO, the cheapest SAF, will be reached around 20 Mt, i.e. around 2030. As it happens, the requirement to incorporate eSAF in the European Union is concomitant, and it is therefore from this date onwards that there could be a divergence. However, as each feedstock has its own volume limits, the market could converge again before 2050.

II.III.2. SAF volumes and impacts on conflicts of use

While the economic consensus being that the accessibility and therefore volumes would be driven by offer and demand, the physical limits associated with the biomass (biofuels), and to some extent to electricity (efuels) are a heavy burden.

The short term is currently driven by the offer and demand, the demand being driven by regulations, and while there are currently no shortages, some frauds have already appeared due to the high margin SAF can procure⁵³⁰. As seen in previous chapter, it is often more economical to produce SAF from energy crops such as palm oil or sugar beets than with residues. Boosted by regulations, mostly in Europe and Asia, or incentives, mostly in North America, the production in 2025 should reach 5 Mt⁵³¹, of which almost half produced in the USA⁵³².

This situation where offer meeting driven by regulation demand should last until the feedstocks are sufficient to meet the demand. Conflicts of use, already pregnant, will then become major, and it is likely that biomass and electricity will have to be earmarked. The sections below address both biofuels and efuels feedstocks availability while considering conflicts of use and proposing the introduction of merit of order.

II.III.2.1. Biofuels

Whereas the development of efuels is essentially based on one resource: electricity, the development of biofuels will be based on different types of feedstocks.

With SAF, which will mobilize waste, but also agricultural land and/or forests, we are entering a new era, in which, after having replaced land use and human labor with underground fossil fuels, we are going to do the opposite: saving fossil fuels, under the energy-climate constraint, by mobilizing land and human labor. Historically, it was the emergence of fossil fuels that first saved forests, particularly in Europe.

A strong constraint that will be addressed concerns the available land surface and the effects of land use change and 4 major feedstock categories need to be detailed, as they do not have the same characteristics.

On the one hand, there are the three feedstocks that have no impact on crops and whose use would have potential collateral benefits for society: Municipal Solid Waste (MSW), Used oils and category 1 animal fats⁵³³ (UCO and Tallow), forestry and agricultural waste (cellulosic and ligno-cellulosic, residues).

On the other hand, a feedstock based on crops such as corn, palm oil, soybeans or sugar cane which may raise the question of land use and competition with food, in a context of global warming that is beginning to impact crop yields, and energy crops such as miscanthus, camelina or jatropha.

While the energy crops are not directly competing with alimentation, they have a lower ERoEi and are also affected by the climate change effects as concluded by Osborne and Wheeler in Evidence for a climate signal in trends of global crop yield variability over the past 50 years⁵³⁴. On a regional scale these conclusions are shared by Hervé Le Treut, IPCC, in the 2013 report on the impacts of climate change in Aquitaine⁵³⁵.

⁵³⁰ <https://www.euractiv.com/section/agrifuels/news/industry-source-one-third-of-used-cooking-oil-in-europe-is-fraudulent/> accessed August 13, 2024

⁵³¹ <https://view.argusmedia.com/rs/584-BUW-606/images/Brochure%20-%20Spotlight%20on%20European%20SAF%20Market%20-%20Countdown%20to%202025.pdf?version=0+> accessed August 13, 2024

⁵³² <https://www.eia.gov/todayinenergy/detail.php?id=62504> accessed August 13, 2024

⁵³³ https://food.ec.europa.eu/safety/animal-products_en?prefLang=fr accessed August 13, 2024

⁵³⁴ T M Osborne and T R Wheeler, Evidence for climate signal in trends of global crop yield variability over the past 50 years, 2013 Environ. Res. Lett. 8 024001 <https://dx.doi.org/10.1088/1748-9326/8/2/024001>

⁵³⁵ <http://www.acclimaterra.fr/uploads/2015/10/LES-IMPACTS-DU-CHANGEMENT-CLIMATIQUE-EN-AQUITAINE-110Mo.pdf> pages 109-125, accessed August 13, 2024

An alternative that seems more virtuous for this feedstock would be based on waste from crops and forestry operations, which induces fewer negative externalities: little competition for land use, less impact on biodiversity. This segmentation can be reflected in the distinction between 1st Generation (1G) and 2nd Generation (2G) of biofuels, the first category being banned within the EU for the use in SAF while a cap on biofuels for road transportation has been acted ⁵³⁶, but being almost immediately sued by crops and ethanol producers ⁵³⁷.

Crop-based feedstock: These are the 1G, generally referring to high-sugar and high-starch energy crops and oilseeds. These represent the bulk of feedstocks used in biofuels today, the vast majority of which are destined for road transport. Rapeseed, corn, and palm oil are the main crops used. These are crops that come into direct conflict with food uses, but as they are also the least expensive thanks in particular to their high energy content, this explains why it is this feedstock that has been favored in recent years. After more than a decade of development, notably in the USA, where 40% of corn production is dedicated to biofuels, and in Europe, governments, fueled by scientists and NGOs, have realized the collateral damage induced by the development of this first generation of biofuels, particularly on the issue of indirect land use change (ILUC). EU Directive 2015/1513 ⁵³⁸ recognizes for the first time not only the emissions associated with ILUCs, but also that their scale is likely to cancel out, in part or in full, the GHG emission reductions achieved by biofuels. After encouraging their development, the European Union is now going to seriously limit them. The European Commission's delegated regulation EU 2019/807 ⁵³⁹ will limit the maximum contribution of biofuels to final energy consumption in the transport sector to 7%. These new guidelines are correlated with the carbon footprint of biofuels produced from crops (palm, soya, corn) which, when the main externalities, ILUC in particular, are considered, show values very close to those of fossil fuels (see Part I chapter III). Generally speaking, biofuel production from food crops seems hardly viable despite being promoted by producers, mostly in Brazil (sugar cane) and USA (corn and soy). It is already no longer encouraged in most developed countries and should therefore not be considered in the production potential of SAF. Energy crops, such as miscanthus, camelina or jatropha show a better potential since they do not compete with land use change. These are mostly perennial crops, or crops grown on degraded lands, specifically cultivated to produce energy through direct combustion or gasification of the crops, such as ethanol which can then be upgraded to SAF.

Waste-based feedstock: These can be classified as 2G. They do not compete with food crops, but their production is more costly due to a lower energy content, and requires other externalities to be taken into account, such as increased transport requirements or limited volumes. For example, agricultural waste is already widely valorized by farmers, who mobilize between 50 and 60% of it to cover and nourish the soil. Used Cooking Oil and tallows fall within this category and show an interesting potential with a high energy content and a very good carbon balance.

Generally speaking, biomass resources are numerous and renewable, but limited in terms of quantity, whether for agricultural biomass or forest biomass. For the latter, the situation is particularly constraining, as forest biomass is first and foremost a carbon sink, a sink that is beginning to show several signs of weakness, both globally⁵⁴⁰ and on the scale of a territory like France, where the CO₂ storage capacity of forest ecosystems has been halved in ten years ⁵⁴¹.

Moreover, bioenergy production rises ethical concerns as it competes with other forms of land use. This may generate ethical problems mainly for two reasons. First, bioenergy production may compete, directly or indirectly, with food production; and as consequence the food security of poor people may be adversely affected. Secondly, the production of bioenergy may directly or indirectly lead to deforestation and other changes of land use that have a negative effect on biodiversity and greenhouse gas emissions. This poses a significant problem even in the European Union, as soy

⁵³⁶ <https://www.euronews.com/green/2024/03/19/commission-backs-use-of-farmland-for-aviation-fuel-production> accessed August 13, 2024

⁵³⁷ <https://www.argusmedia.com/en/news-and-insights/latest-market-news/2564987-us-biofuel-groups-challenge-eu-saf-regulation> accessed August 13, 2024

⁵³⁸ <https://eur-lex.europa.eu/legal-content/FR/TXT/?uri=celex%3A32015L1513> accessed August 13, 2024

⁵³⁹ https://eur-lex.europa.eu/eli/reg_del/2019/807/oj accessed August 13, 2024

⁵⁴⁰ <https://www.reuters.com/business/environment/worlds-forests-failed-curb-2023-climate-emissions-study-finds-2024-07-29/> accessed August 13, 2024

⁵⁴¹ https://www.lemonde.fr/planete/article/2023/06/06/la-foret-francaise-un-puits-de-carbone-en-peril_6176474_3244.html accessed August 13, 2024

and palm oil which are used as biofuel feedstocks directly or indirectly are concerned⁵⁴². This situation led the EU to implement rules to guarantee that the products EU citizens consume do not contribute to deforestation or forest degradation worldwide⁵⁴³. The introduction of land use change (LUC) and indirect land use change (ILUC) with the eCO₂ life cycle assessment calculation have allowed to characterize these two concerns. Moreover, regarding the production of SAF, considering the ILUC emissions is a must both in ReFuel EU / RED and the less demanding CORSIA. As such the eCO₂ emissions of crops being well above the required value, only energy crops are considered in this section.

While the potential of bioenergy can therefore differ with the perimeter considered, it is found that it also differs function of the source of the study as it has been found a wide range, from a few EJ to over 1000 EJ per year (1 Exajoule = 10¹⁸ Joules). The International Energy Agency addressed the issue of potentially available volumes as early as 2006, and the range proposed in its report was 250 to 500 EJ per year⁵⁴⁴. Since then, several articles have addressed the subject in order to characterize more precisely this issue of available bioenergy volume, as interest in bioenergy is growing. While most scientific publications prior to 2011 showed an average of 500 EJ / year, the most recent publications are more in the region of 100 EJ / year, particularly when considering the evolution of the world's population on a warming planet as concluded in the IPCC 2019 special report Climate Change, Desertification, Land Degradation, Sustainable Land Management, Food Security and GHG fluxes in Terrestrial Ecosystems⁵⁴⁵. The report links the issues of GHGs, agricultural yields, land use, carbon sinks and biodiversity, which resonates with the first chapter of Part One, beyond GHG. While of the 130 Mkm² of ice-free land, only 16% remains intact, plus 12% for arid, barren, and rocky land, the report stresses that the development of bioenergy from food crops would put access to food under strain for several hundred million people.

One of the most significant articles considered here is the one of Creutzig et al in Bioenergy and climate change mitigation: an assessment⁶⁸. The authors have reviewed a few hundred peer reviewed articles but also reports from organizations such as IEA. They concluded that the sustainable technical potential of global bioenergy is up to 100 EJ / year before conversion, with high agreement, FIGURE 134. A larger scale deployment, above 200 EJ / year could only realize high GHG emissions savings if technological and governance preconditions are met, but such a high deployment of land-intensive bioenergy feedstocks is considered to also lead to detrimental climate effects, negatively impact ecosystems, biodiversity and livelihoods, underlining the need to think beyond GHG (Part I Chapter I). Since biomass is already used, mostly in developing countries, this maximum of 100 EJ per year should be reduced to 80 EJ when considering a reduced demand in traditional biomass.

These conclusions are in line with those of Searle and Malins⁵⁴⁶, who concluded that the maximum plausible limit to sustainable bioenergy, combining dedicated crops, wastes, forestry and crop residues, is 60–120 EJ / year in primary energy, therefore before conversion, the mean value being 80 EJ, similar to the one proposed by Creutzig et al. In agreement with the researches conducted in this thesis, the authors concluded that after accounting for current trends in bioenergy allocation and conversion losses, there is an estimated maximum potentials of 10–20 EJ / year of biofuel, or 230 to 460 Mt.

These values are found to be similar to the ones proposed in the 2020 Energy Outlook, which indicates 10 to 20 EJ of biofuels, of which 5 EJ could serve air mobility⁵⁴⁷, since other sectors, such as maritime or road transportation, are at stake.

⁵⁴² <https://www.euractiv.com/section/energy-environment/news/the-eus-imported-deforestation-problem-a-closer-look/> accessed August 13, 2024

⁵⁴³ https://environment.ec.europa.eu/topics/forests/deforestation/regulation-deforestation-free-products_en accessed August 13, 2024

⁵⁴⁴ <https://www.ieabioenergy.com/blog/publications/iea-bioenergy-strategic-plan-2003-2006/> accessed August 13, 2024

⁵⁴⁵ <https://www.ipcc.ch/srccl/> accessed August 13, 2024

⁵⁴⁶ Searle, S. and Malins, C. (2015), A reassessment of global bioenergy potential in 2050. *GCB Bioenergy*, 7: 328-336. <https://doi.org/10.1111/gcbb.12141>

⁵⁴⁷ <https://www.bp.com/content/dam/bp/business-sites/en/global/corporate/pdfs/energy-economics/energy-outlook/bp-energy-outlook-2020.pdf> pages 42 and 48, accessed August 13, 2024

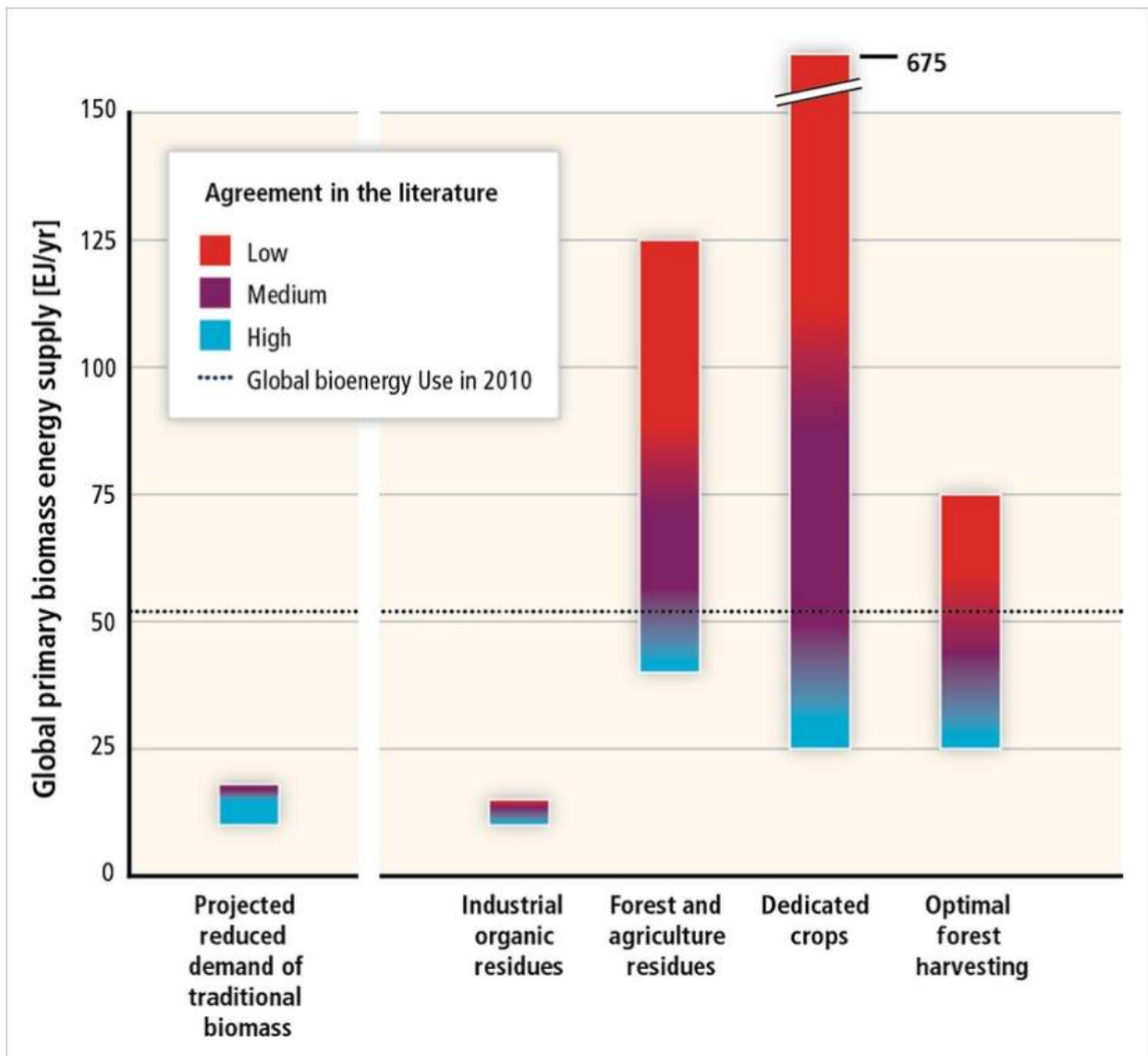
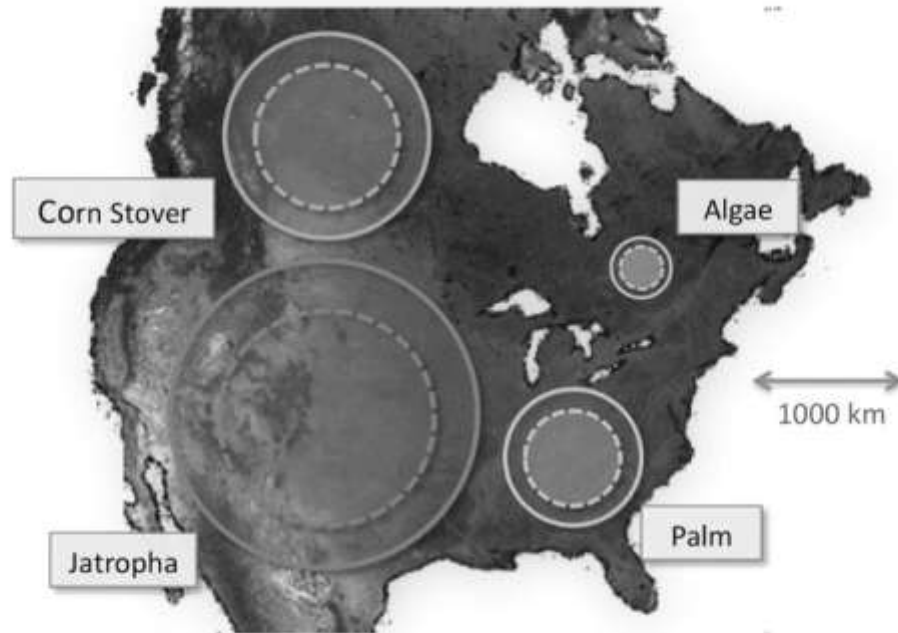

FIGURE 134 Global Technical Primary Biomass Potential for Bioenergy by Main Resource Category for the year 2050. The figure shows the ranges in the estimates by major resource category of the global technical primary biomass potential for bioenergy. The color grading is intended to show qualitatively the degree of agreement in the estimates, from blue (all researchers agree that this level can be attained) to purple (medium agreement) to red (few researchers agree that this level can be attained). In addition, reducing traditional biomass demand by increasing its use efficiency could release the saved biomass for other energy purposes with large benefits from a sustainable development perspective. Source: Creutzig et al, with courtesy of first author and Wiley

These limits in biomass are explicit when placed on a map. In FIGURE 135 below are placed different circles which illustrate the land area required to fill the domestic (not international) flights in the United States of America with 100% SAF in 2050, solid circles.

US Alternative Fuel Land Requirements in 2050 Compared to the United States



Note: Dashed circles correspond to replacement of conventional jet fuel with 50/50 (vol%) blend of the respective biofuel with conventional jet fuel; solid circles correspond to replacement of conventional jet fuel with 100% mix of the respective biofuel

FIGURE 135 Land area requirements for different biofuels to replace US domestic CAF in 2050. Source: ICAO, *U.S. fuel trends analysis and comparison to GIACC/4-IP/1*, May 2009, page 76⁵⁴⁸

These limits in biomass are being more and more considered as countries are engaged to fulfill their NDC (Nationally Determined Contribution). Setting targets for mitigating GHG and defining plans to reach these targets implicate the need for ecological planning in the energy sector, including biomass looping. In the case of France, the June 2023 working paper from the General Secretariat for Ecological Planning, which reports to the Prime Minister, concluded "a tense situation for biomass looping as early as 2030"⁵⁴⁹.

80 EJ / year of bioenergy is therefore seen as maximum when considering biomass for biofuels before considering competition / conflict of use. As discussed above, 10 to 20 EJ / year could be biofuels. Assuming that sectors which can be directly electrified, such as road transportation, are electrified by 2050, this would leave biofuels for hard to abate sectors, such as aviation and maritime.

II.III.2.2. Efuels

After the 1G and 2G biofuels, efuels are considered as a 3rd generation. There are in theory no limit as the main feedstock is low carbon electricity. The development of efuels relies therefore on the massive development of the energy vector represented by hydrogen, necessarily renewable as discussed above, to transform it into efuel with a carbon footprint compatible with the decarbonization trajectory of air transport. To get an idea of the starting point, FIGURE 136 shows the hydrogen value chain as it exists today, with around 70 Mt H₂ produced worldwide in 2019. The current production being above 99% fossil-based, the sector's yearly emissions are significant, 830 MtCO₂ and producing an efuel with this high carbon intensity hydrogen would mean higher eCO₂ emissions than with fossil fuel.

⁵⁴⁸ <http://web.mit.edu/aeroastro/partner/reports/proj28/fueltrend-analy.pdf> page 76, accessed August 13, 2024

⁵⁴⁹ <https://www.info.gouv.fr/upload/media/content/0001/06/3a74943433702a0247ca9f7190177a37710a9678.pdf> page 13, accessed August 13, 2024

This situation also means that the number-one priority for the hydrogen sector is to become self-decarbonizing, and renewable hydrogens will probably be given priority to meet this objective.

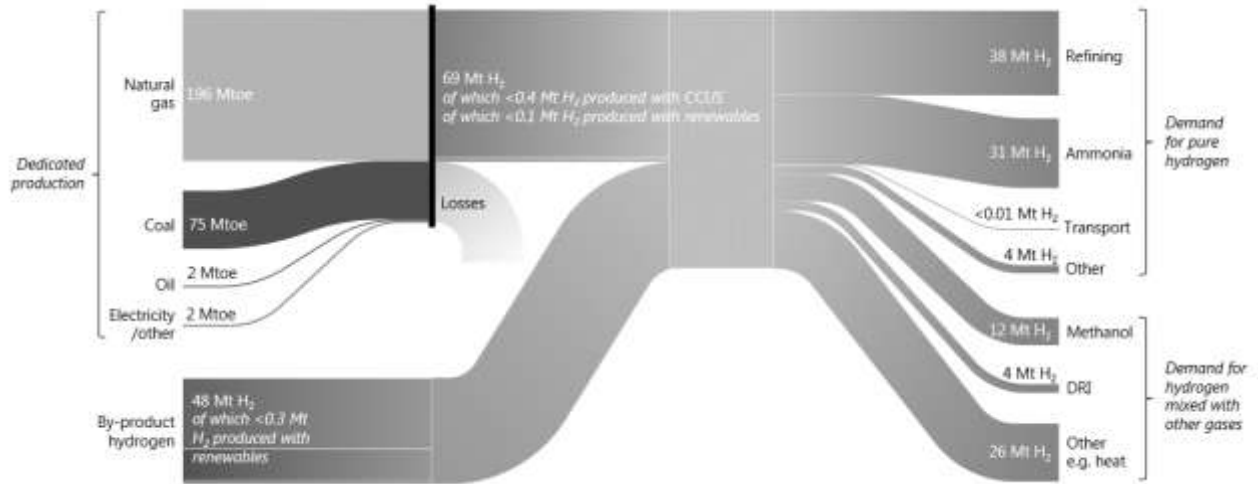

FIGURE 136 Hydrogen value chain in 2020. Source IEA hydrogen report 2019⁵⁵⁰

With a projected production of 8 Mt/year of renewable hydrogen, there is still a long way to go before the hydrogen industry can meet demand from other sectors, since this would represent just over 10% of current needs.

As for the biomass, there are already competitors for the use of hydrogen, first in refineries and fertilizers, and more to come, such as in steel production. The first unit using this technology started up in Sweden in 2020.

Renewable electricity production is also counting heavily on the potential represented by the hydrogen vector. Of the 7600 GWh produced worldwide in 2019, only a small proportion is storable, mainly by storage and pumping stations, which have limited potentials (170 GWh). Hydrogen is therefore seen as the answer to the main drawback of wind and solar energies which are not controllable: storage is therefore a key element in accelerating their development. This is the choice made by Germany in its low-carbon strategy and hydrogen plan.

Before reaching aircraft fuel tanks as efuel, current hydrogen production will have to switch from high carbon intensity when produced via steam methane reforming from gas or coal to low carbon intensity when produced via water electrolysis with low carbon electricity (see chapter I.III). This would already mobilize around 3600 TWh of electricity. 3600 TWh represents the total production of the European Union in 2019, which should mobilize a large part of the resources of energy companies in the years to come since producing low carbon hydrogen does not only unit electrolyzers but also solar, wind, hydro or nuclear electricity production, along with grids for transport and distribution.

Proposing a projection for efuel production by 2050 therefore implies considering global electricity production, which must be abundant and low-carbon. FIGURE 137 is based on IEA data on global electricity production between 2010 and 2050. The first observation is that, although this figure is rising sharply to over 50 000 TWh in 2050, it does not take into account the needs of efuels. The production of 1 million tons of efuel requires around 25 TWh of low-carbon electricity, so a demand of 400 Mt would be equivalent to almost a quarter of global production, which seems hardly conceivable (see chapter I.III). Secondly, just over a third of production is still significantly carbon-based, which means that the carbon intensity of electricity produced in 2050 is close to 130 g eCO₂/kWh, well above the 53 g required to qualify efuel as SAF according to the European Regulation. A significant proportion of the world's low-carbon electricity

⁵⁵⁰ https://iea.blob.core.windows.net/assets/9e3a3493-b9a6-4b7d-b499-7ca48e357561/The_Future_of_Hydrogen.pdf page 32, accessed August 13, 2024

production would therefore have to be directed towards aviation, to the detriment of other sectors. This singularity calls for the establishment of an order of merit, before being addressed in greater detail in Part III.

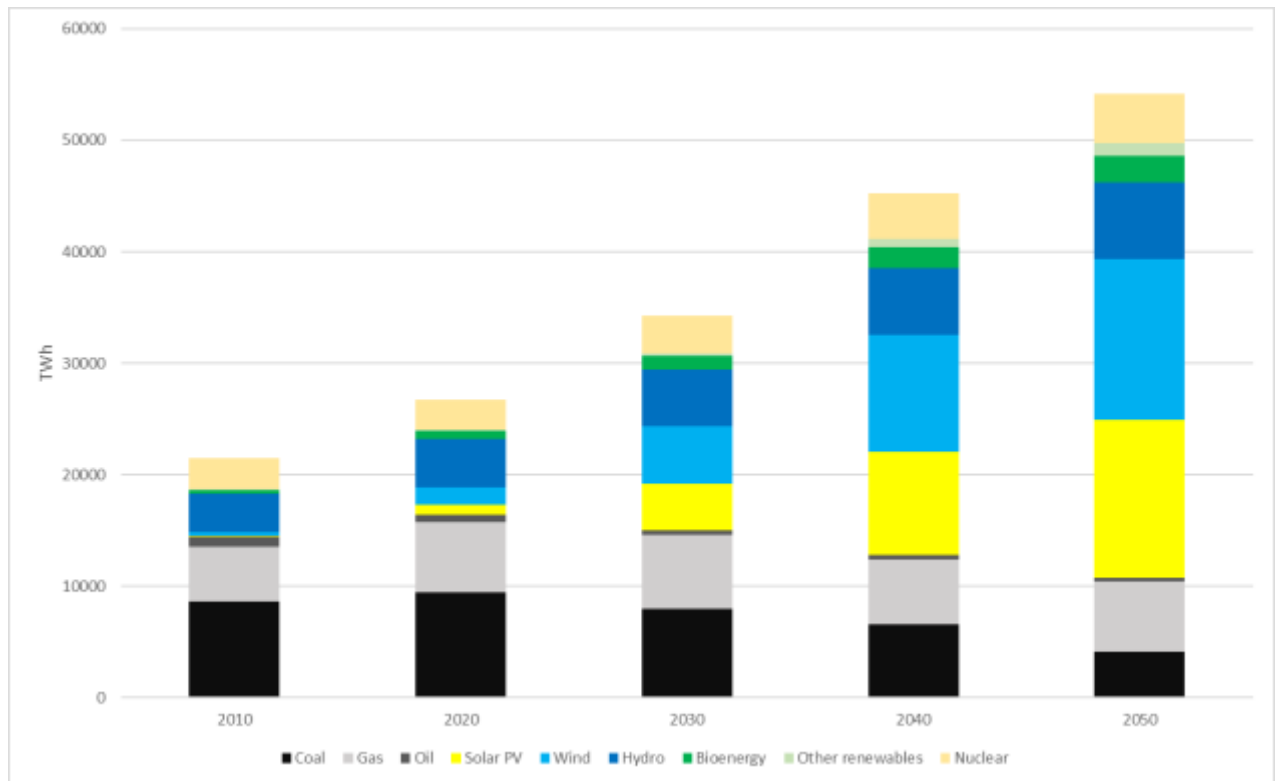

FIGURE 137 Global electricity generation by source from 2010 to 2050, announced pledges scenario, source Jean-Baptiste Jarin with data from IEA WEO 2021⁵⁵¹

In FIGURE 138 is indicated the current share of jet fuel in global primary energy with data from the IEA world outlook 2021⁵⁵¹. While oil represents 31% of our global primary energy in 2020, air mobility captures 7 to 8%, or 2.1% of the total. This number is found to be equivalent with equivalent to maritime. But this number could increase significantly in a projection where aviation would require 200 to 500 Mt of efuels. With 22 to 28 kWh / kg to produce efuel (Chapter I.III), this would require 4400 to 14 000 TWh. The higher figure represents half of the total electricity production of 2020, which is heavily carbonized, and still one third of the total forecasted low carbon electricity in 2050. If maritime where to follow a similar path, those numbers would have to be multiplied by almost 2.

Moreover, 7 to 8% of oil, which is a commodity almost entirely dedicated to transportation and chemicals, cannot be found equivalent to 20 to 50% of electricity, a commodity which serves basic needs. In an unregulated market, the impact of the demand on a limited offer would certainly lead to a strong price increase, harming basic needs such as heating, cooking, cooling and lighting and this is addressed in part III.

⁵⁵¹ <https://www.iea.org/reports/world-energy-outlook-2021> accessed August 13, 2024

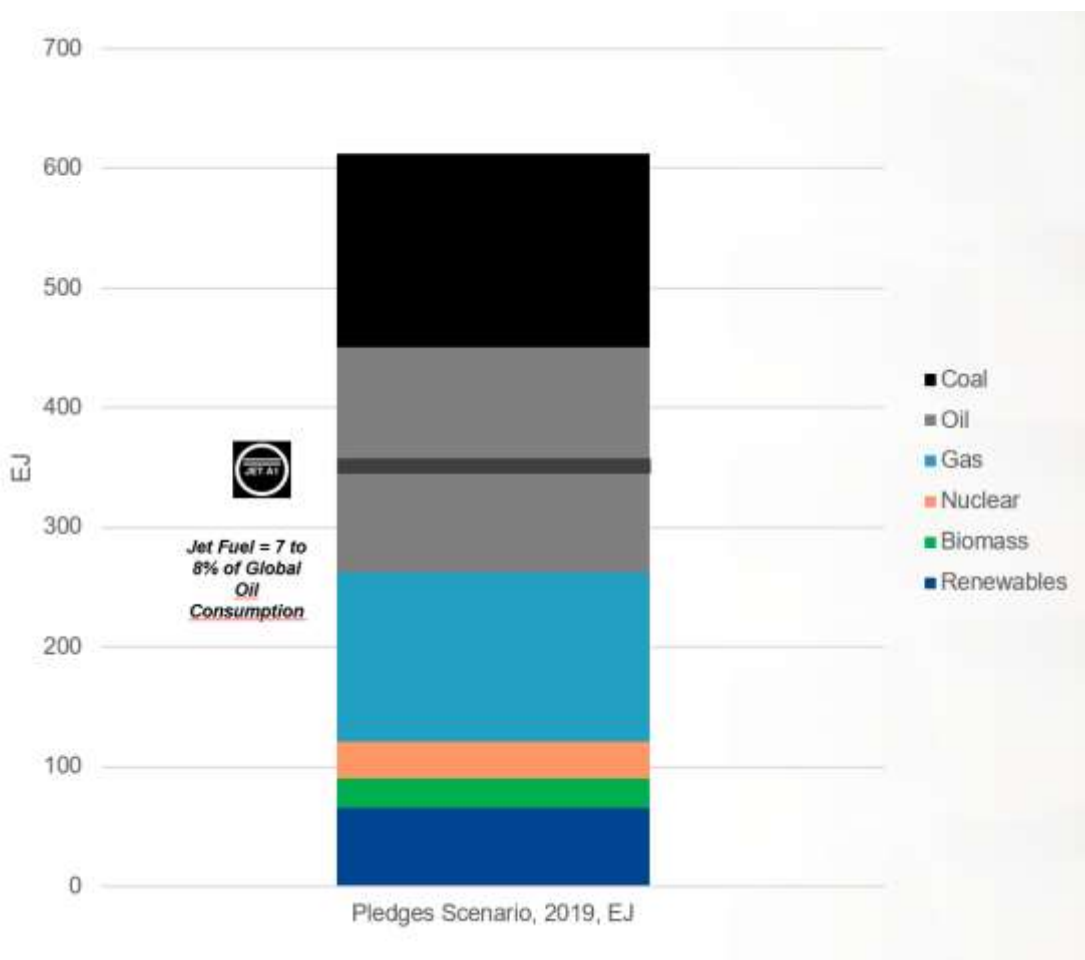

FIGURE 138 Share of jet fuel within the global primary energy (in EJ) in 2020. Jet fuel represents 7% (IEA) to 8% (EI) of oil, which represents itself 31% of the global primary energy, source Jean-Baptiste Jarin with data from EI and IEA WEO 2021

It is therefore unlikely that efuels will account for a significant share of air transport, even despite the regulation. For instance, the 2020 BP Energy Outlook simply did not consider hydrogen nor efuel for use in air mobility⁵⁵².

Consequently, efuels, which are also the most expensive of the SAF, will most probably complement biofuels rather than dominating the SAF production.

II.III.2.3. Merit of order and conflict of use

Among the main challenges facing SAF (Sustainable Aviation Fuel), access to the resource is probably the most important. Whether derived from biomass, biofuels, electricity, efuels, or a combination of the two, SAF is an energy carrier based on a process / raw material combination.

Whatever raw material is mobilized, it is either already used by one or more other economic sectors, or is in the process of becoming so. The fraction available for SAF must therefore be measured according to two approaches: physical and social. Physical, to determine the initial volume available and the needs of the various sectors. Physical availability is a systemic issue for biomass, and refers to energy policy for electrons. Social in order to prioritize uses.

⁵⁵² <https://www.bp.com/content/dam/bp/business-sites/en/global/corporate/pdfs/energy-economics/energy-outlook/bp-energy-outlook-2020.pdf> page 48, accessed August 13, 2024

FIGURE 139 below gives an overview of the various conflicts of use for the main considered feedstocks for SAF from upstream to downstream, highlighting that conflict of use are present all over the value chain. Since feedstocks are in growing tensions, introducing the merit of order to public policies seems desirable.

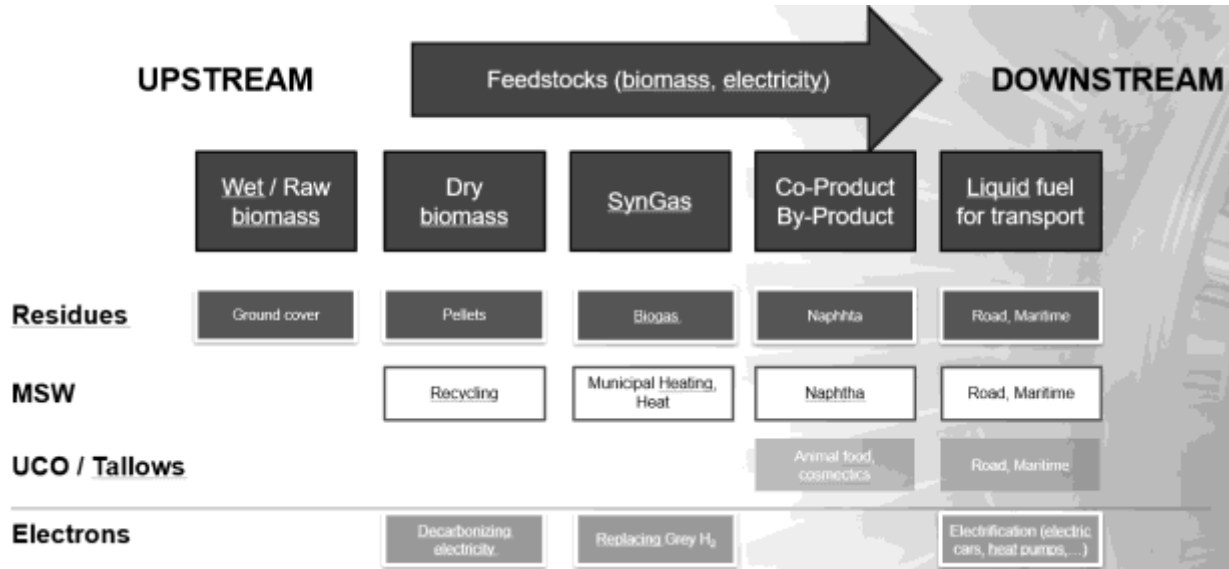

FIGURE 139 Overview of the different conflicts of use from upstream to downstream for the main feedstocks considered for the production of SAF, source Jean-Baptiste Jarin

The decarbonization of energy, as envisaged by air mobility, must therefore be the subject to the objectivization of priorities, which requires first and foremost criteria to be clearly defined.

For the biomass, the proposed merit of order is detailed in TABLE 42 below. The basic needs are a priority, such as food, heat, but also serving the industry to produce goods. Air mobility and maritime arrive before road transportation or building heating, which can rely on other solutions to decarbonize. However, if building heating can replace gas, ideally biogas, by direct electrification, or that road transportation can replace liquid fuels, ideally biofuels, by direct electrification, it would mean that these two hard to abate sectors should be prioritized, when addressing low carbon electricity needs.

	BIOMASS	Objective	Crops	Energy Crops	MSW	Residues
1	Human food	Basic needs	x	x		
2	Animal food	Basic needs (proteins)	x			
3	Ground cover	Yields				x
4	Energy for agriculture	Producing low carbon food	x	x		x
5	Carbon sink	Climate Change Mitigation - NDC	x	x		x
6	Industry	Biogaz	x	x	x	x
7	Maritime	Hard to abate sector	x	x	x	x
7	Air Mobility	Hard to abate sector	x	x	x	x
-	Road Transportation	Direct Electrification				
-	Electricity	Restricted to Solar, Wind, Nuclear, Hydro				
-	Building heat	Switch from gas to heat pump				

TABLE 42 Overview of the proposed merit of order for the biomass, source Jean-Baptiste Jarin

For electricity, while the merit of order could follow the same approach, serving basic needs as cooling, heating, cooking, or lighting, since these needs are mostly served already, especially in developed countries, it is proposed to classify the use by the ton of eCO₂ saved when using low carbon electricity replacing high carbonized electricity. This approach is proposed by the UK CCC (Committee on Climate Change) and FIGURE 140 below is issued from the 6th Carbon Budget ⁵⁵³.

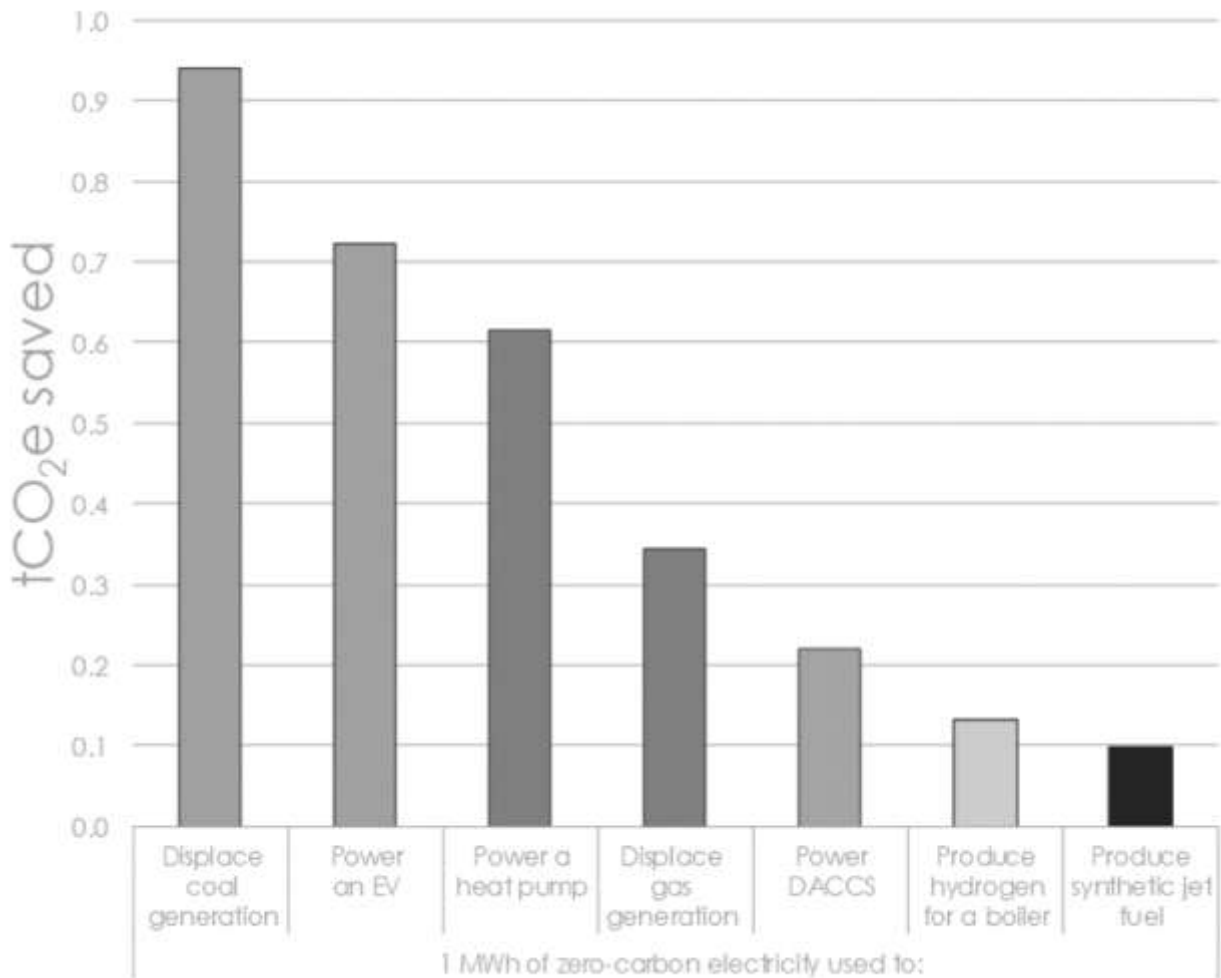

FIGURE 140 Overview of the proposed merit of order for electricity. While maritime and aviation are ahead of heating and road transportation for the biomass, this is the opposite for low carbon electricity. Source UK CCC

The committee highlights that given potential limits to the pace of deployment of low-carbon capacity, it will be important to focus on sectors which have the most efficient use of low-carbon electricity. Displacing coal generation shall be the first priority all over the world, and, since coal is still a major source of electricity production in 2050, FIGURE 137 above, this raises the legitimate question of whether low-carbon electrons should be channeled into less CO₂-friendly applications. This will be addressed in part III.

⁵⁵³ <https://www.theccc.org.uk/wp-content/uploads/2020/12/Sector-summary-Electricity-generation.pdf> page 11, accessed August 13, 2024

II.III.2.4. SAF volumes in a constrained world

There is therefore a theoretical potential of around 25 EJ for 1G bioenergy (from crops). However, the carbon footprint when transformed into biofuel and the competition for use (food), not to mention the climatic impacts and loss of biodiversity, make this resource unacceptable.

The potential of 2G bioenergy is greater, on the order of 80 EJ, and it generally has an attractive carbon balance: it therefore seems appropriate to integrate biofuels from 2G bioenergy into the production of SAF for air transport.

However, global energy needs and the ability to meet them with increasingly low-carbon energy must be taken into account if the 2DS trajectory is to be met. We also need to take into account existing competition for energy use, i.e. 50 EJ are consumed each year for heating and cooking, mainly in emerging countries, or future competition, such as the use of municipal waste in district heating or construction.

A balance of 20 EJ from solid and liquid bio energies seems to be the most plausible scenario, part of which could be used to produce SAF.

According to Searle and Malins⁵⁴⁶, the potential is 10 to 20 EJ for biofuels, which would mean 5 to 10 EJ for SAF once co and by-products are taken into account, such as naphtha for the chemical industry and low carbon fuels for maritime, which are other hard to abate sectors. 5 to 10 EJ for SAF would mean 115 to 230 Mt per year.

In its 2020 Energy Outlook report, BP anticipates air transport fuel demand to be either stable at 14 EJ (2DS), or growing slightly towards 20 EJ (+ 1.1% CAGR between 2018 and 2050), with the potential for SAF estimated at between 4 and 7 EJ, or between 92 and 161 Mt, to meet this demand. The balance being CAF. These values are very close to those proposed by the most recent scientific publications. Based on the values proposed in the various articles mentioned in the previous section, a scenario by feedstock family is proposed. An optimistic hypothesis, which would see a priority allocation of resources to SAF, either through supply and demand policy, or through a resource allocation policy, is indicated, as shown in TABLE 43 below.

While attractive if produced for low carbon electricity, the situation for efuels which in theory seems highly desirable, is contrasted due to the strong conflict of use and the low merit of order. The hypotheses at this stage is that as long as the electricity is not low carbon, below 53 g eCO₂ / kWh, the introduction of significant volumes of efuel (and / or H₂) would penalize the decarbonization roadmap of most countries. This is further detailed in page and the rationale here is that since jet fuel represents 7 to 8 % of the global oil volume, or 2 to 3% of the global primary energy volume, it is the order of magnitude to consider when evaluating the potential of efuel production. As discussed above, it is not the technology but the scalability which is the main issue. With a global electricity production expected above 50 000 TWh / year by 2050, of which 2/3 could be low carbon, this means 600 to 2000 TWh could be dedicated to eSAF.

The potential for SAF does exist, and the main stumbling block to more widespread deployment today is not yet the access to feedstocks but cost of production and therefore prices which are not yet accepted by the air mobility sector. The strategy of incorporation mandate seems indeed to be well thought.

In the longer term, the question of volumes has to be addressed, with the potential the max potential being around 150 Mt for biofuels (130-230 Mt min-max), to which could be added approximately 30 Mt of efuel (20-80 Mt min-max). This represents the equivalent of 150 Mt in a mean scenario, and up to 307 Mt in an optimistic scenario.

Proposed 2050 scenario Min - High, in Mt / year	Mean	Optimistic
HEFA	33	44
from UCO, Tallows	20	20
from Jatropha on degraded lands	7	14
from oil cover crops	6	10
ATJ - FT	100	183
Cellulosic cover crops	37	48
Agricultural residues	20	20
Forest residues	13	39
Wood processing wastes	7	21
MSW	23	35
Algae / biotech	0	20
eFuels	23	80
TOTAL	156	307

TABLE 43 Proposed scenario for SAF production in 2050, in Mt. source Jean-Baptiste Jarin with data from Creutzig et al ⁶⁸, Searle and Malins ⁵⁴⁶, IEEP ⁵⁵⁴, TotalEnergies ⁵⁵⁵, IEA ⁵⁵⁶, Argus Media ⁵⁵⁷

⁵⁵⁴ <https://ieep.eu/publications/mobilising-cereal-straw-in-the-eu-to-feed-advanced-biofuel-production/> accessed August 13, 2024

⁵⁵⁵ SAF working group 2022-2023

⁵⁵⁶ <https://www.iea.org/reports/renewables-2020> accessed August 13, 2024

⁵⁵⁷ <https://view.argusmedia.com/rs/584-BUW-606/images/Brochure%20-%20Spotlight%20on%20European%20SAF%20Market%20-%20Countdown%20to%202025.pdf?version=0> page 5, accessed August 13, 2024

II.III.3. SAF impacts on air mobility economics

The conclusions of the two previous chapters conclude that while all SAF are not equal, they all will be significantly more expensive than CAF while the needed feedstock volumes would most probably be below the expectations.

As addressed in the Introduction, energy is the heart of our economies, and of air mobility. When oil, and more recently oil and gas, prices spike, inflation and recession are in sight within our economies.

Completing, then replacing jet fuel, which ranged an average 500 to 1000 \$/ton in the past 2 decades, weighing up to 30% (Part I, Chapter III) of airlines cost, will significantly harm the air mobility industry. While the profits of airlines should not suffer, if and when they accept to rationalize their networks and pace of growth by increasing the ticket price, the industry as a whole will have to evolve.

As of now, after avoiding the issue for the past 3 decades, decarbonization is in the agenda, forced by regulations. Still, only one airline has been found to announce ambitions greater than those imposed by regulations and most, and it not all are considering applying strictly the regulation, i.e. ReFuel EU in Europe (Part II, Chapter II) rather than being proactive in implementing SAF and boosting their decarbonization roadmap. This being highlighted by the recent decision of Air New Zealand to remove its 2030 science-based carbon intensity reductions target and withdraw from the Science Based Targets initiative, mentioning “the availability of new aircraft, the affordability and availability of alternative jet fuels, and global and domestic regulatory and policy support”⁵⁵⁸.

As of today, the availability of SAF is not a major issue, as highlighted by the report of major SAF production sites discussed above. The affordability is, indeed, the issue, as the current price for airlines being close to 3000 \$/ton. While it could technically go down to 1500 to 2000 \$/ton for some SAF such as HEFA-UCO, the recent introduction in the regulation of mandatory use of eFuel by 2030, the most expensive SAF to produce, will most probably boost the price of SAF to the 3500-4500 \$/ton range for the operators which did not secure volumes (offtakes).

II.III.3.1. Impact for airlines, the Norge scenario

Indeed, as shown in FIGURE 142 below, the impact for the airlines is significant. This best case scenario for climate is seen as a worst case scenario for Air Mobility since the operating costs would significantly increase. This scenario is therefore named Norge as this country has recently implemented an aggressive decarbonization regulation which includes aviation, with a minimum of 30% SAF by 2030 associated to a carbon tax, equivalent to the European ETS (Emission Trading Scheme) which might apply to the total eCO₂ emissions including those of SAF which are excluded within the ReFuel EU regulation. The main hypothesis considered is an average SAF price of 4425 \$/ton to reflect the higher price of SAF induced by the imposition of eFuel, and for CAF 720 \$/ton, this value being similar to the current cost of CAF as shown in FIGURE 141 below. The selected period goes from 2005 to 2019 to introduce the jet fuel price evolution during the 3rd oil shock in 2008. This has a small impact on the average but it illustrates how airlines considered price increase: conjunctural.

The carbon tax (2000 NOK, equivalent to 240 \$/ton)⁵⁵⁹ and the minimum share of SAF (30%)⁵⁶⁰ are not discussed since being mandatory within the Norwegian regulation.

Introducing a long period, i.e. 2007 to 2030, allows to understand that while jet fuel prices have fluctuated in history, there will be shift from a conjunctural situation, jet fuel price have always evolved, approximately 2 folds from 2007 to 2019, to a structural situation: the price of jet fuel with the introduction of SAF would most probably increase year

⁵⁵⁸ <https://www.safinvestor.com/news/145604/air-new-zealand/> accessed August 13, 2024

⁵⁵⁹ <https://www.reuters.com/article/us-climate-change-norway/norways-plans-to-raise-carbon-tax-draw-oil-industry-ire-idUSKBN29D1BD/> accessed August 13, 2024

⁵⁶⁰ <https://www.eurocontrol.int/article/sustainable-aviation-fuels-saf-europe-eurocontrol-and-ecac-cooperate-saf-map> accessed August 13, 2024

after year, dictated by the increase share of SAF in operations and the introduction of more expensive SAFs as shown in FIGURE 133.

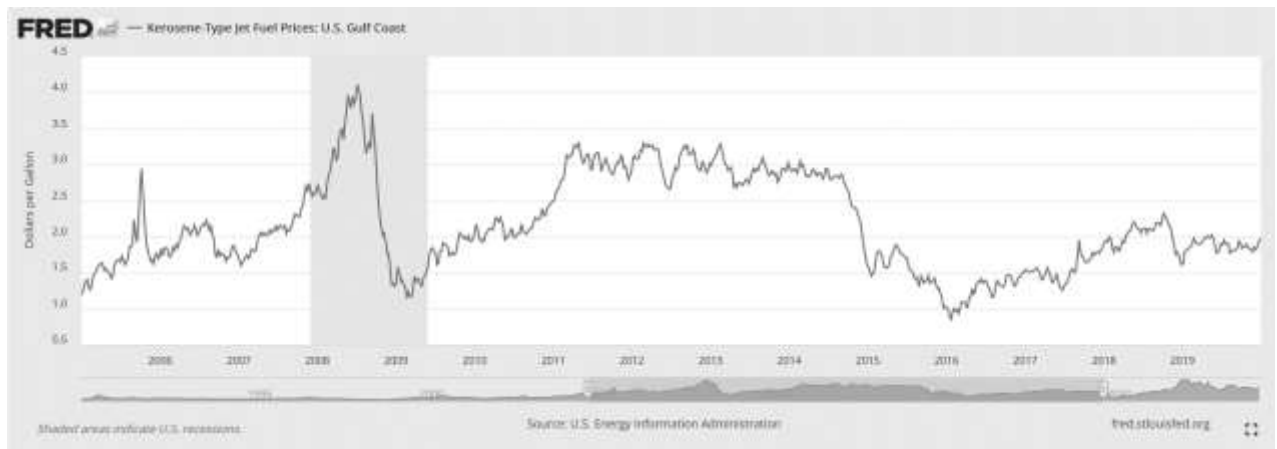

FIGURE 141 Jet fuel prices in \$/gallon, spot, source US Energy Information Administration ⁵⁶¹

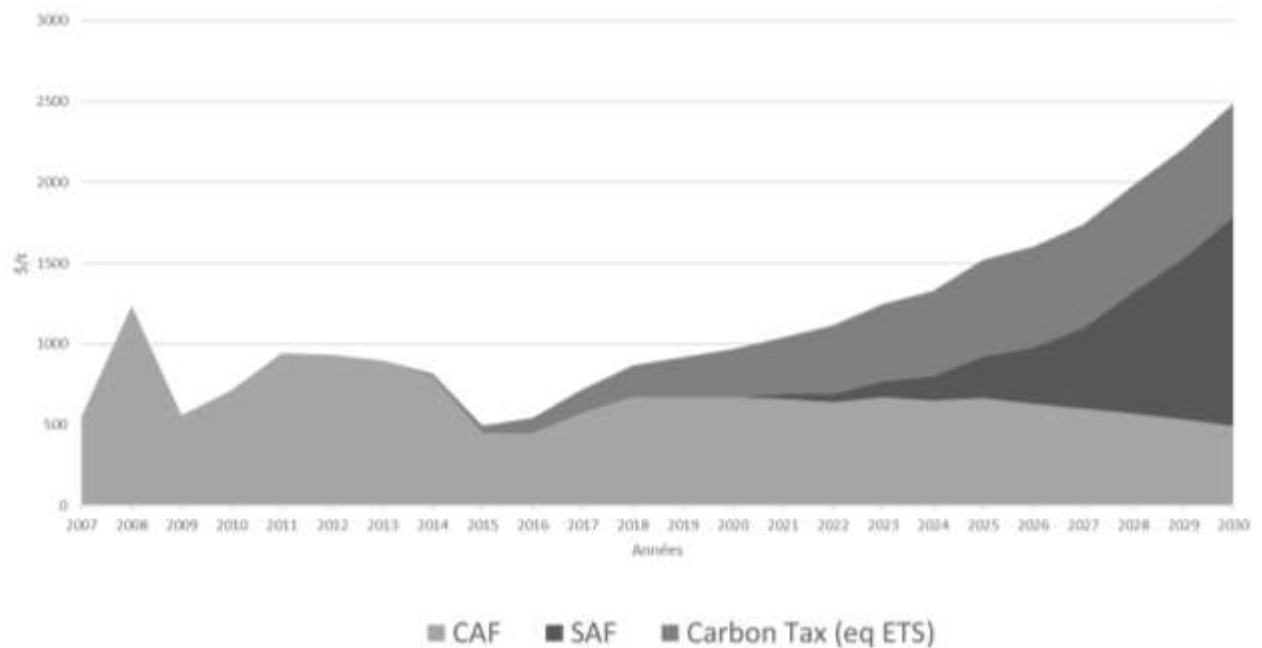

FIGURE 142 Worst case scenario for jet fuel cost by 2030, with main hypotheses being aligned with Norway scenario, i.e. 30% SAF by 2030 with a carbon tax at 2000 NOK / ton of eCO₂, CAF and SAF prices in 2030 are 720 and 4425 \$/ton respectively, source Jean-Baptiste Jarin

⁵⁶¹ <https://fred.stlouisfed.org/series/WJFUELUSGULF> accessed August 13, 2024

It is often useful to know the past to prepare for the future, and air mobility has already experienced major fluctuations in the price of jet fuel, and perhaps SAF is just one more increase, as in 2008, when the rise in the price of a barrel of oil resulted in a doubling of the jet fuel bill for airlines in the space of two years.

However, these past fluctuations do not allow us to really measure the rise in Jet Fuel prices that is about to take place, which will be more violent and, above all, more lasting.

In \$/t, prices rose from 553 in February 2007 to 1236 around 18 months later, (July 2008). The average price then fell to around 953 £/t from 2011 to 2014, before declining and stabilizing at around 635 \$/t more recently. Integrated with the Norge worse case, the historical data provides a clearer picture of the sector's future progress. In a way, the incorporation of SAF and the introduction of a carbon tax could bring stability and visibility.

A graphical visualization gives a better idea of the increase in the price of jet fuel in this configuration. While it remains hypothetical, the shift from conjunctural to structural seems ineluctable.

The impact of the carbon tax is significant, and deserves to be presented separately for several reasons. First the eCO₂ emissions related to SAF are not always counted. For instance, the ReFuel EU regulation considers that the SAF eCO₂ emissions shall be counted as 0. Although technically questionable, this feature is designed to reduce the difference between the price of SAF and CAF, to facilitate its adoption by the airline industry. Second, some applications are exempted, at least in the EU regulation: humanitarian flights, and more generally those with a societal value, do not have their eCO₂ emissions accounted for. For example, this means that nearly 80% of helicopter missions are potentially exempt from carbon tax. FIGURE 143 below details some of these exemptions while reminding that the carbon tax will be fully implemented by 2026, aviation being exempted until then.

Although justifiable in many respects, this list of exemptions allows private flights on light aircraft or helicopters, for example, to be totally exempt from carbon tax. As shown in FIGURE 143, it is likely that some of these exemptions will be lifted within a few years, particularly for VIP and tourism applications.

Missions	Carbon Tax
High Societal Added Value (EMS, Military, SAR, Training, etc.)	Excluded
Other missions with one or more of the following : <ul style="list-style-type: none"> • MTOW < 5,7 t • Not IFR • Same take-off / landing spot with no intermediate landings • Less than roughly 750 FH / Year (typically applies for small operators with 1 or 2 H/C) 	Excluded
Others (O/S today, maybe CTT + VIP + Utility in the near future tbc)	~200 €/ton (IEA 2050, Norge 2030)

▪ End of free allocations of allowances to the aviation sector by 2026. Gradual phase out, a decrease of 25% in free allocations is foreseen for 2024 and 50% for 2025

Estimation for the future of H/C:

- High Societal Added Value: will remain excluded
- CTT / VIP / Utility: shall be concerned by 2030
- O/S: applicable (current ETS price: ~90 € / ton of CO₂)
- Bonus for SAF incorporation



FIGURE 143 Detailing aviation exemption for carbon tax, source Jean-Baptiste Jarin

II.III.3.2. Impact for airlines, the EU scenarios

To better reflect the impact for airlines, a similar model is built with the ReFuel and RED regulations. Here an optimistic (OPT) and pessimistic (PESS) sensitivities are proposed in respectively FIGURE 144 and FIGURE 145. The only changed parameters being the prices of CAF and SAF. Other parameters being fixed, such as the carbon tax price hypothesis which reaches 100 € / ton in 2026 with the end of ETS exemptions for aviation, climbing to 425 € / ton in 2050, as well as SAF % as total of jet fuel, which is in line with the ReFuel Aviation regulation (70% in 2050), TABLE 17.

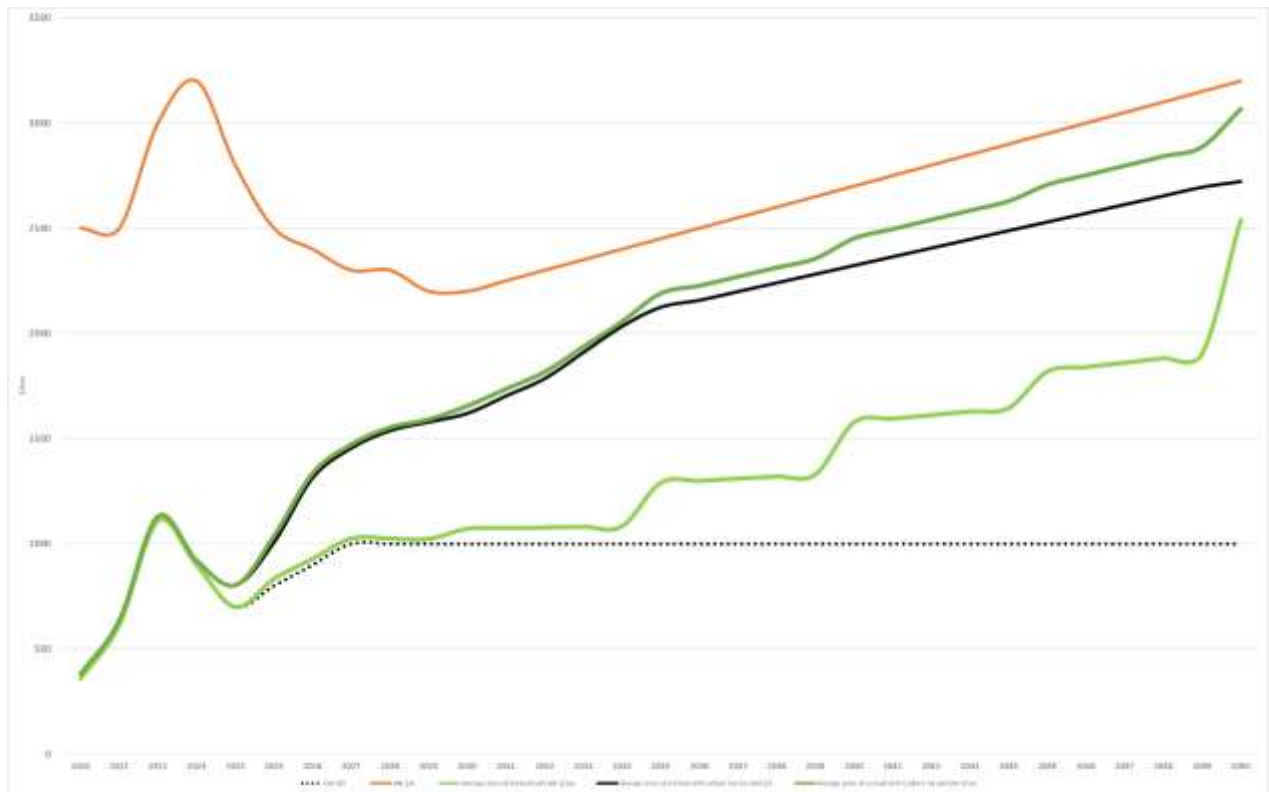

FIGURE 144 OPT ReFuel EU scenario for airlines. Price of SAF and CAF in 2030 are respectively 2200 and 1000 \$/ton, source Jean-Baptiste Jarin

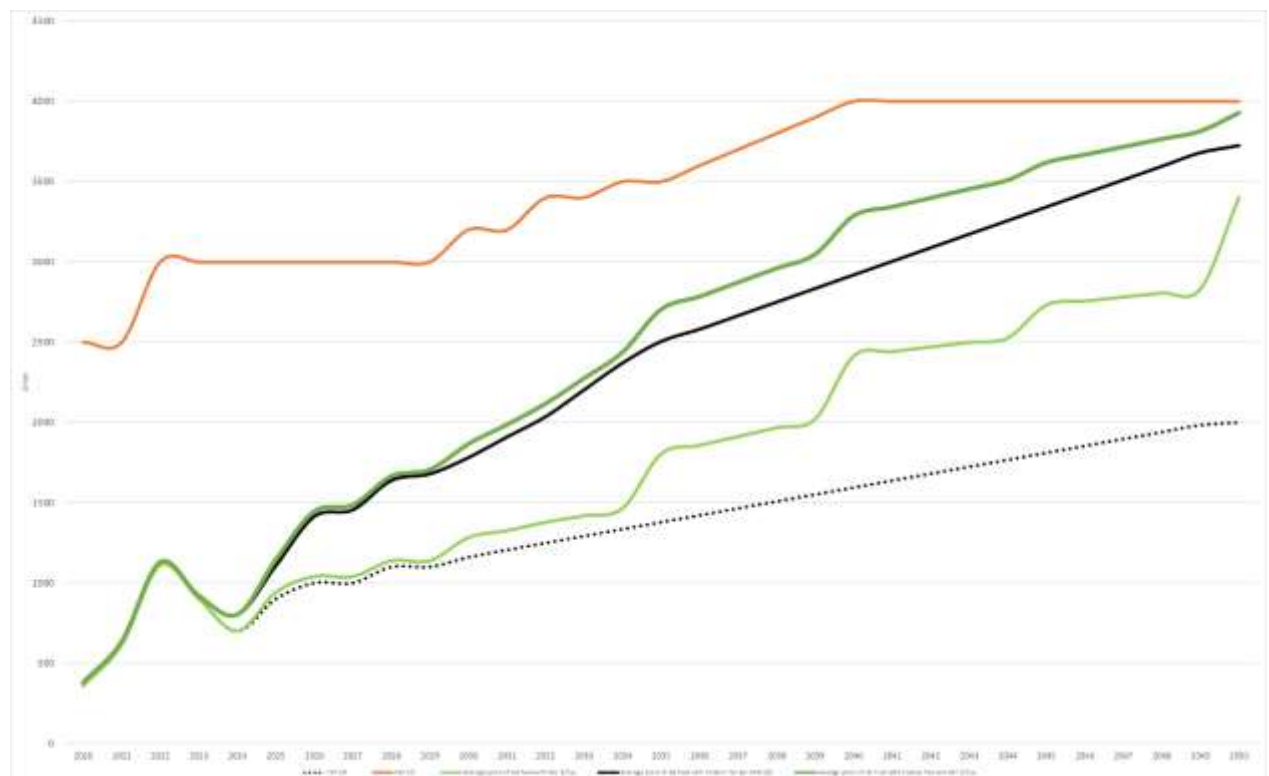

FIGURE 145 PESS ReFuel EU scenario for airlines. Price of SAF and CAF are respectively 3200 and 1160 \$/ton in 2030, reaching 4000 and 2000 \$/ton in 2050, source Jean-Baptiste Jarin

The OPT scenario envisages an average SAF price of 2200 \$/t in 2030 and 3200 \$/t in 2050, i.e. significantly lower than the conclusions of the previous chapter, reflecting a regulated market in which the price of SAF is determined by the average of the SAFs prices, not an upper alignment on the cost of the last ton produced as seen in previous chapter. CAF price climbs to 1000 \$/t in 2030 and then remain stable until 2050, reflecting a parallel decrease of production and consumption of oil.

In both scenarios the emissions are equivalent and significantly reduced in 2050, the average eCO₂ footprint of the SAF being close to 38 g eCO₂/MJ compared to the fossil baseline of 94 g eCO₂/MJ, or -60%, for a 70% share of SAF in 2050. The value considered for the carbon tax calculation is different. As explained above, to encourage the adoption of SAF by airlines the ReFuel EU regulation considers a value of 0 g eCO₂/MJ for the SAF, whatever the SAF as soon as it is accepted with the regulation. The value considered for the calculation of the carbon tax is here of 28 g eCO₂/MJ, which is the maximum authorized within the ReFuelEU Aviation and RED regulations.

The impact on aviation economics is however quite different depending of the scenario, the period 2020-2024 illustrating the price volatility of both CAF and SAF.

In both scenario the impact of the carbon tax is significant, reaching a maximum cost of 1026 \$/ton in 2039. Despite an ever-increasing price of the carbon tax, it is the increasing share of SAF, thus the decrease in eCO₂ emissions, which explains this maximum in 2039. More important the carbon tax strongly narrow the gap between fossil and SAF (green and light blue lines) whatever the scenario, which means that from a strict financial point of view there are almost no difference between a carbon tax and SAF, but the latter has a direct effect on eCO₂ emissions and it should be preferred: the role of the incorporation mandate imposed with the European regulations is found to be necessary.

In the OPT scenario the final price of jet fuel with SAF (70%) and carbon tax reaches 3070 \$/t, the jump in 2050 reflecting the increased percentage of SAF: 70% in 2050 compared to 42% from 2045-2049. In 2030 this final price for the operators would reach 1655 \$/t. In 2030 the share of SAF remains limited to 6%, and the jet fuel price increase relies more on the introduction of the carbon tax, from 2026 onwards, than on SAF. This is still the case in 2035, assuming that the carbon tax rises to 270 \$/t, and it is only from 2040 onwards, when the minimum SAF share of operations reaches 34%, that the first price-increasing factor really becomes SAF. In any case, these 2 factors add up for airlines, which will have to make significant changes to their business model, as the share of jet fuel in the Cost Index becomes preponderant, see Part I.

In the PESS scenario the final price of jet fuel with SAF and carbon tax reaches 1870 \$/t in 2030 and almost 4000 \$/t in 2050.

In both scenarios the gaps are significant compared to 2023 as shown in FIGURE 146. While 2025 does not show a significant increase, the increase is above 3 folds for the OPT scenario, and above 4 folds for the PESS scenario by 2050.

In chapter I.III the share of fuel in airlines expenses was detailed, reaching 23.7% in 2019 when the price of jet fuel was 622 \$/t. Within 10 years the price of jet fuel might well reach 2000 to 2500 \$/t, a more than 3-fold increase. A simple model, assuming a jet fuel price of 622 \$/t and 23.7% share in total expenses, shows that when the jet fuel price will reach 2000 \$/t the share of fuel costs will double, reaching 50% of total airlines expenses.

Consequently, the share of fuel in airlines expenses will increase significantly and these costs will most probably be passed to the passengers in Europe, as shown by Lufthansa⁵⁶² or Virgin⁵⁶³, but also in other part of the world⁵⁶⁴.

These levies will have an impact on demand and requires the introduction of price elasticity.

⁵⁶² <https://centreforaviation.com/analysis/reports/lufthansa-groups-green-charges-are-a-signal-to-regulators-other-airlines-may-follow-690461> accessed August 13, 2024

⁵⁶³ <https://www.dailymail.co.uk/news/article-13666413/Virgin-Atlantic-green-levy-sustainable-aviation-fuel-Saf.html> accessed August 13, 2024

⁵⁶⁴ <https://www.reuters.com/sustainability/singapore-green-jet-fuel-levy-travellers-ignites-funding-debate-2024-02-19/> accessed August 13, 2024

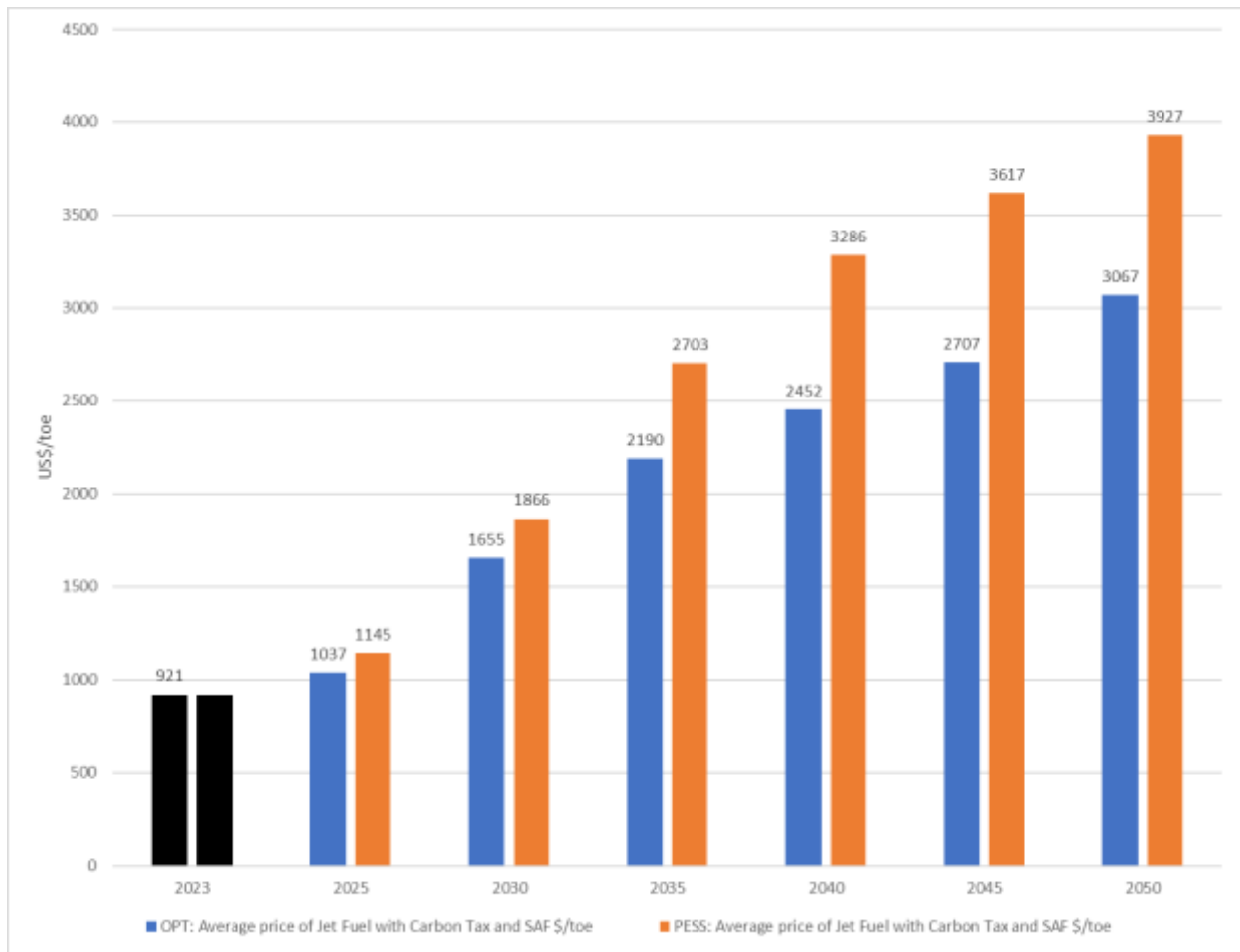

FIGURE 146 Comparing jet fuel cost till 2050, with 2023 average for both OPT and PESS scenarios, in \$/t, source Jean-Baptiste Jarin

II.III.3.3. Higher prices should impact air mobility demand

To understand the impact of a higher price of energy on the demand, and since energy represents a significant share of airlines direct operating costs, TABLE 20, and therefore of ticket fares, it is proposed to introduce here the price elasticity of demand to understand the potential effects on demand.

Price elasticity of demand (e_D) measures the responsiveness of the quantity demanded or supplied of a good to a change in its price. It is computed as the percentage change in quantity (q) demanded (D) divided by the percentage change in price (p). It is a simple equation, $e_D = \frac{\Delta qD/qD}{\Delta p/p}$. In most cases price and quantity variations have opposite signs, consequently, the price elasticity of demand is generally negative. When $e_D = 0$, the quantity requested is not modified by a price change. When $0 < e_D < 1$, demand is said to be inelastic. This is because the variation in quantity demanded is less than the variation in price. When $e_D = 1$, demand has a unitary elasticity, so variations in quantities and prices have the same value. When $e_D > 1$, demand is said to be elastic, since any variation in price translates into an even greater variation (in absolute terms) in the quantity demanded.

Here, the elasticity of demand measures the variation in the quantity demanded of air mobility, expressed in PKM (passenger kilometer) as a function of the ticket price, the latter being impacted by the rise in the price of jet fuel, whether under the effect of SAF incorporation mandates and/or taxes.

Several studies from 1994 to 2022 have been reviewed^{565 566 567 568 569 570 571 572}, and while all conclude that there shall be an impact on demand, the price elasticity shows no clear conclusions as significant differences were found, as shown in TABLE 44 below.

Historically, demand for business air transport has tended to be slightly inelastic ($0 < e_D < 1$), meaning that the volume of demand does not vary as much as a price change, in percentage terms. This sensitivity could be explained by the inability to conduct business remotely, which IT technologies have been challenging in recent years. In contrast, leisure demand for air travel is assumed to be much more elastic ($e_D > 1$), meaning that the percentage response of total demand is greater than the percentage change in price.

It can therefore be concluded that short haul and leisure trips are more impacted by a price increase. The effect of modal shift and travel necessity being the most reasons according the various authors.

While progressive, the impact of jet fuel cost including SAF and carbon tax will be massive and it seems complicated to apply these results to the air demand CAGR. As shown in FIGURE 147 below, the impact of SAF, here using the PESS scenario value of 4000 \$/ton of SAF, would significantly increase the cost of energy, and therefore the ticket price. Such an increase could jeopardize the elasticity price models discussed above.

⁵⁶⁵ Alperovich, G., & Machnes, Y. (1994). The Role of Wealth in the Demand for International Air Travel. *Journal of Transport Economics and Policy*, 28(2), 163–173. <http://www.jstor.org/stable/20053033>

⁵⁶⁶ J.D. Jorge-Calderón, A demand model for scheduled airline services on international European routes, *Journal of Air Transport Management*, Volume 3, Issue 1, 1997, Pages 23-35, ISSN 0969-6997, [https://doi.org/10.1016/S0969-6997\(97\)82789-5](https://doi.org/10.1016/S0969-6997(97)82789-5)

⁵⁶⁷ Gillen, David & Morrison, W. & Stewart, C.. (2007). Air travel demand elasticities: Concepts, issues and measurement. *Advances in airline economics volume 2: The economics of airline institutions, operations and marketing*. https://www.researchgate.net/publication/285686194_Air_travel_demand_elasticities_Concepts_issues_and_measurement

⁵⁶⁸ Castelli, Pesenti, Ukovich – An Airline-Based Multilevel Analysis of Airfare Elasticity for Passenger Demand (2003) <https://ntrs.nasa.gov/api/citations/20050147587/downloads/20050147587.pdf>

⁵⁶⁹ <https://www.ecologie.gouv.fr/sites/default/files/documents/Energie%20total.pdf> page 8, accessed August 13, 2024

⁵⁷⁰ Nenad Njegovan, Elasticities of demand for leisure air travel: A system modelling approach, *Journal of Air Transport Management*, Volume 12, Issue 1, 2006, Pages 33-39, ISSN 0969-6997, <https://doi.org/10.1016/j.jairtraman.2005.09.003>

⁵⁷¹ Seetaram, Neelu & Song, Haiyan & Page, Stephen. (2014). "Air Passenger Duty and UK Outbound Tourism". *Journal of Travel Research*. 53. 476-487. 10.1177/0047287513500389 <http://dx.doi.org/10.1177/0047287513500389>

⁵⁷² Katrin Oesingmann, The effect of the European Emissions Trading System (EU ETS) on aviation demand: An empirical comparison with the impact of ticket taxes, *Energy Policy*, Volume 160, 2022, 112657, ISSN 0301-4215, <https://doi.org/10.1016/j.enpol.2021.112657>

Author	Year	Elasticity	Description
Alperovich and Machnes. The Role of Wealth in the Demand for International Air Travel	1994	-0,27	Authors examine air travel out of Israel. Price was found to be inelastic while income was highly elastic. This is correlated with other studies, air travel demand increasing faster than income
Jorge-Calderon. A Demand Model for Scheduled Airline Services on International European Routes	1997	-0,53	Demand was shown to be price inelastic with a tendency for elasticities to increase with distance but fall in the long-haul sector. Highly discounted fares have a positive effect on traffic
Gillen, Morrison, Stewart. Air Travel Demand Elasticities: Concepts Issues and Measurement	2002	-0,27 long haul business to -1,52 short haul leisure	Survey of a large group of studies. Elasticities are different upon short / long haul and business / leisure: -0.27 (long-haul int.business), -1.04 (long-haul int.leisure), -1.15 (long-haul dom. business), -1.10 (long-haul dom.leisure), -0.7 (short-haulbusiness), -1.52 (short-haul leisure)
Castelli, Pesenti, Ukovich. An Airline-Based Multilevel Analysis of Airfare Elasticity for Passenger Demand	2003	-1,058	Price elasticity of regional aviation in Italy. Price elasticity was found to vary across the various routes – from -0.75 to -1.62
Schwach. Seminar Energy & Aviation	2005	-7 to -10%	Price elasticity function of the price of fuel, from 30 to 60\$ in 2003, -7% short haul, -9% medium haul and -10% long haul
Njegovan. Elasticities of Demand for Leisure Air Travel: A System Modelling Approach	2006	-0,7	Leisure travel demand elasticities in the UK. Found that elasticity with respect to air fare changes is inelastic
Seetaram, Song, Page. Air Passenger Duty and UK Outbound Tourism	2014	-0,37 long haul and -0,89 short haul	Studies followed the introduction of the APD in the UK. The income and price elasticities obtained, ranged between 0.36 and 4.11 and -0.05 and -2.02 respectively
Katrin Oesingmann. The effect of EU ETS on aviation demand: An empirical comparison with the impact of ticket taxes	2022	-0,89 to -1,23 upon route	While focused on ETS which are not yet effective, the study additionally controls for the impact of the Austrian and German air transportation tax on aviation demand. The ticket tax brings about statistically significant and robust demand reductions on the affected country-pairs.

TABLE 44 Review of studies on price elasticities for air demand, source Jean-Baptiste Jarin with data from various studies ⁵⁶⁵ 566 567 568 569 570 571 572

For the Paris to New-York round trip, the cost of energy would increase from 132 \$ per passenger for a return trip, assuming an average cost of jet fuel 500 \$/t, to 1056 \$ in the PESS scenario discussed above.

These conclusions are in contradiction with the latest ICAO environmental report which concludes that the potential impact on price ticket for a similar trip would be limited, ranging from 26 to 76 \$ ⁵⁷³. Assuming 100% SAF by 2050, this impact could reach up to, for a return trip, 112 \$ to 182 \$ for short haul, and 924 to 1344 \$ for long haul.

The recent green charges applied by some airlines on air mobility could soon provide important data. As for now, the hypothesis is to maintain a baseline CAGR of 3.1% as proposed in chapter I.III, understanding that the offer could be constraint by the SAF availability as discussed above, therefore limiting the demand and / or impacting the SAF prices to higher levels.

⁵⁷³ <https://www.icao.int/environmental-protection/Documents/EnvironmentalReports/2022/ICAO%20ENV%20Report%202022%20F4.pdf> page 407, accessed August 13, 2024

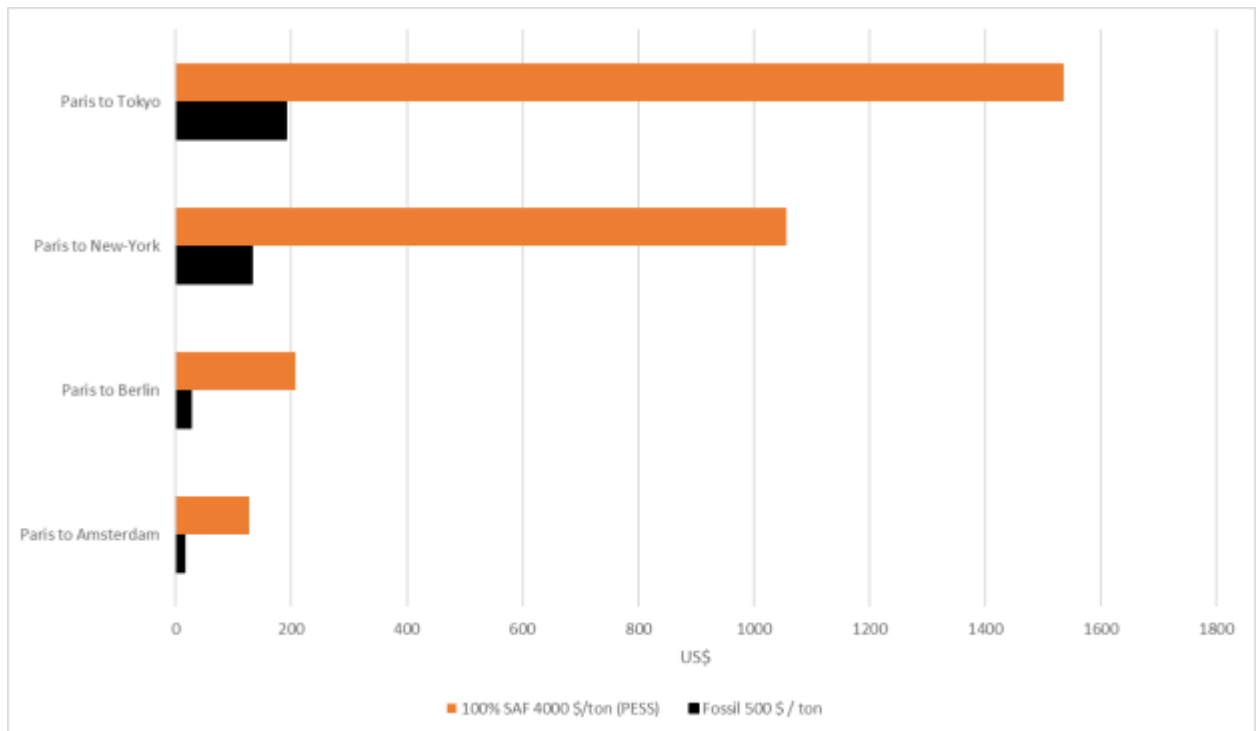

FIGURE 147 Comparing the cost of energy between CAF and SAF (100% SAF, PESS value of 4000 \$/ton), for short, medium, and two long haul destinations, return trip, source Jean-Baptiste Jarin

II.III.3.4. Impact on airlines profit margin

With such a context, it is important to highlight that airlines revenues might be impacted, but that earnings could be maintained, and probably improved. As concluded by Wand and Gao in Oil price dynamics and airline earnings predictability⁵⁷⁴, “demand-driven oil shocks positively affect airline earnings, suggesting the dominating revenue effect over the fuel cost effect”. It can therefore be concluded, that the recent decision of some airlines to pass those costs directly to the passengers, goes into the right direction.

Airlines have in the past faced significant jet fuel price increase, such as in 2008, when the jet fuel price increased strongly, above 4 \$/gallon. The airlines responded then with cutting capacities and increasing fares⁵⁷⁵.

Analyzing the US Airlines key performance indicators from 2000 to 2010 using the data provided by the Air Transport Association⁵⁷⁶ shows that the profitability of airlines seems not connected to jet fuel price, as shown in TABLE 45 and FIGURE 148 below. This period is relevant insofar as the price of a barrel of oil, and therefore of jet fuel, has increased more than 5-fold.

⁵⁷⁴ Huabing Wang, Xiang Gao, Oil price dynamics and airline earnings predictability, Journal of Air Transport Management, Volume 87, 2020, 101854, ISSN 0969-6997, <https://doi.org/10.1016/j.jairtraman.2020.101854>

⁵⁷⁵ https://money.cnn.com/2008/06/27/news/companies/airlines_capacity/ accessed August 13, 2024

⁵⁷⁶ <https://airlines.org/wp-content/uploads/2014/08/2011.pdf> accessed August 13, 2024

KPI US Airlines from 2000-2010		2000	2001	2002	2003	2004	2005	2006	2007	2008	2009	2010
Revenue Passenger Miles (RPM)	millions	692757	651700	642374	657290	733956	779014	797414	829422	812360	769397	798008
Available Seat Miles (ASM)	millions	956950	930511	894455	894555	971935	1003334	1006324	1037667	1021308	957087	972565
Load factor	%	72,40%	70,00%	71,80%	73,50%	75,50%	77,60%	79,20%	79,90%	79,50%	80,40%	82,10%
Jet fuel price	\$/ton	286	236	229	273	380	568	640	703	979	555	705
Jet fuel consumed	Gallons (Billions)	20,6	19,5	18,2	18,2	19,9	20,4	20,2	20,4	19,4	17,9	18,4
Net profit margin	%	1,90%	-7,20%	-10,60%	-1,50%	-6,80%	-18,00%	11,00%	4,40%	-12,80%	-1,70%	2,10%
Ratio Jet Fuel consumed / RPM	liters / 100 km	4,881	4,912	4,651	4,545	4,451	4,299	4,158	4,037	3,920	3,819	3,785
Safety	fatal accident per 100.000 departures	0,018	0,019	0,000	0,020	0,009	0,028	0,019	0,000	0,000	0,011	0,000

TABLE 45 Review of airlines (USA) net profit margins and related inputs from 2000 to 2010, source Jean-Baptiste Jarin with data from various reports of ATA

In TABLE 45 the shaded grey columns correspond to an economic downturn within the United States. The net profit of airlines is significantly affected during a recession, but not by the fuel price. This is confirmed in FIGURE 147, which show no correlation, R^2 0.027, between price of jet fuel and net profit margin.

Indeed, the 2001 downturn was accompanied with low jet fuel price, an average of 337 \$/t for the considered period 2001-2005 as it took 5 years for airlines to recover profitability: the net profit margins being always negative during that period, ranging from -1.5% to -18%. Meanwhile the available seats per miles (ASM), which describes the expansion of traffic, increase from 930 511 to 1 003 334, or 8%.

Comparing these conclusions with the 2008 downturn, which was driven by the 3rd oil shock along with the subprime crisis, FIGURE 154, the jet fuel price was high with an average of 746 \$/t during the period considered 2008-2010. It only took 2 years for US airlines to return to profitability, but meanwhile the airlines had decided to improve capacity discipline, focusing on the most profitable routes, seeking efficiency: the ASM decreased 5% while the fuel efficiency kept improving thanks to load factors, weight saving onboard and the removal of the oldest aircrafts from the fleets⁵⁷⁷.

It is noted here, as highlighted in Part I, that safety, as always, is never compromised, even when airlines face severe losses.

⁵⁷⁷ <https://www.theguardian.com/business/2008/may/22/theairlineindustry> accessed August 13, 2024



FIGURE 148 Airlines net profit margin (%) in the USA, function of jet fuel price (US\$). Comparing jet fuel price in x-axis, and airlines net profit margin in y-axis for the period 2000-2010, does not shown any correlation, source Jean-Baptiste Jarin with data from various ATA reports

II.IV. Part II conclusions

Decarbonizing energy for air mobility is technically realistic, and desirable, from an emissions point of view. Emissions, eCO₂, but also other gazes such as CO or soot, are significantly reduced. But this comes at a cost, and has limits, since the feedstocks considered, electricity and biomass, are limited and subject to increasing competition. The need for efficiency shall apply to the entire value chain, from choosing the least inefficient energy carrier, to speed optimization. Still the rising costs will affect demand, and the myth of an infinite growth needs to be revisited. More important, energy justice shall be considered as the impact for human societies will be important.

Among the energy carriers being considered to decarbonize the energy dedicated to air mobility, SAF is the least inefficient when considering the energy efficiency from well to wake, or well to propeller. Moreover, beyond this better performance, when compared with hydrogen, or even battery electric, which are often cited in the media, the associated development timetable is not compatible with the objective of total eCO₂ emissions below 325 Mt / year before 2050.

It has also been found that the pollutant emissions of SAF, such as CO, Smoke or Nox, are better, or equivalent, than with CAF. The 100% SAF Drop In must be widely accepted, and deployed, as it is ultimately the only one that will be compatible, for technical reasons, with the 2050 objective, which requires 100% SAF incorporation in all flights. Air mobility is characterized by inertia, as developing a new aircraft takes an average of 10 years, while it would remain in operation for 20 to 30 years. The vast majority of the 2050 fleet is currently in production, and 100% Drop In SAF is therefore not an option.

Non-Drop In SAF, or H₂, or even Hybrid Electric routes may exist, but they are found to be less efficient, while having a very long timeframe. Such options may, paradoxically, delay the decarbonization of the sector. As such it should be handled carefully.

SAF will significantly increase the price of energy for aviation, from a factor 2 to 6. While the average fluctuation of fossil jet fuel during the past 3 decades was found to be between 500 and 1000/t, SAF is found to be an energy carrier with very low ERoEi, and therefore with a high production cost, of around 2000 to 3000 \$/t for most biofuels. The price of efuels will be above these numbers.

More important, it is found that SAF volumes are limited, as access to biomass and low-carbon electricity are under constraint. A projection of between 156 Mt, the reference, and 307 Mt, the maximum case, is far from the sector's needs of 440 Mt, once all lever deployed, such as speed reduction, modal shift, and entry into service of more efficient aircrafts based on Propfans (Part I conclusions). Choosing between climate change and traffic growth should not be asked, and as there should be a firm cap on eCO₂ emissions, it should come with a firm cap on SAF volumes, to limit the pressure on biomass and low carbon electricity.

The economic impact of SAF will ultimately be significant for air mobility. With jet fuel currently accounting for around 25% of the total operation costs of airlines, a threefold increase in fuel costs is bound to have a significant impact on the price of a plane ticket. Although the various studies on price elasticity converge on an elasticity of between -0.27 and -1.52, no study can model a doubling or tripling of the price of an airfare. It is therefore likely to have a significant, but undetermined, impact on its annual growth rate, which prior to the COVID crisis was 4.57% / year, and which is still projected at 3.1% / year, up to 2050, by the industry.

Still, airlines have historically shown greater profitability when traffic growth rates are low, or even declining, whereas it was found that there is no correlation between airlines profitability and jet fuel price: the impact being passed on to ticket prices, while most airlines showed greater discipline in opening and closing routes.

However, the current paradigm being growth, supported by low cost of energy and low taxes, it is highly probable that despite some press announcements, the aviation industry will fiercely fight against massive SAF introduction, while asking for subsidies, to maintain the current model. There is therefore a need for a paradigm shift.

For more than 60 years, increasing speed and traffic was encouraged and supported by societies, the gains in fuel efficiency serving traffic growth, not eCO₂ emissions reduction. Now, by hook or by crook, i.e. through higher operating costs, thus higher ticket prices limiting the demand, and / or through regulation and volume cap, air mobility will have to shift. Failing to do so, it shall acknowledge that its global eCO₂ emissions will keep rising. This is still currently the way proposed in a free market, acknowledged, and even encouraged, by ICAO in its latest resolution A41-21⁵⁷⁸.

The thesis defends that climate change and energy transition are non-negotiable, therefore requiring the following paradigm shift: higher speed and lower prices should become lower speed and higher prices, not only to reflect the economics of SAF, but also to lower the demand, limiting collateral damage to other sectors due to conflicts of use.

Assuming this paradigm shift, and that price elasticity should have a significant impact on CAGR traffic, it is found that there is still a path for aviation.

As concluded in Part I, it is found that fuel efficiency can reach a -0.85 % CARR. It is also concluded that even the most demanding of regulations, ReFuelEU Aviation, is not enough, as not 70%, but 100% SAF, is needed in air operations to meet the 325 Mt eCO₂ target. Accepting a 100% SAF in all flights by 2050 comes with respecting true sustainability for the production of SAF, which must reach an average of 18.85 g eCO₂/MJ. Deploying modal shift and imposing speed reduction were also found to be necessary (Mach 0.45 for commuter, regional, short and medium haul segments, with turboprop, and Mach 0.75 for long haul, with open rotor). With all these levers, eCO₂ emissions could be limited to 390 Mt, which is still above the objective of 325 Mt.

Quite a shift, but still not sufficient, and the traffic CAGR of 3.1% should be revisited. Not only to match the eCO₂ global emissions objective, but also to consider the limits found in biomass and low carbon electricity availabilities, as 390 Mt eCO₂ emissions is equivalent to 440 Mt of SAF. This is significantly above both the mean scenario, 156 Mt of SAF, and even above the optimistic scenario, 307 Mt, as concluded in TABLE 43.

FIGURE 149 below proposes several CARG scenarios, from -0.5% to 2%, to match with the SAF volumes found in the mean and the optimistic scenarios. Here, a traffic CAGR downgraded from 3.1% to 2%, while matching with the aviation objective to reduce eCO₂ emissions below 325 Mt, is not appropriate, as 379 Mt of SAF per year would be necessary, which is significantly above the optimistic figure.

To cope with the estimated volume of SAF available, it can be concluded that by 2050:

- While aviation must replace fossil jet fuel by 100% SAF, it needs to burn less than 390 Mt of 100% SAF, to meet its objective to reduce eCO₂ emissions to 325 Mt per year. This only if there are no limits in feedstocks availabilities
- Introducing feedstock availabilities, aviation needs to reduce its traffic CAGR to:
 - o 1.6% in the optimistic scenario, with approximately 307 Mt of SAF / year in 2050
 - o -0.5% in the mean scenario, with approximately 156 Mt of SAF / year in 2050

⁵⁷⁸ https://www.icao.int/environmental-protection/Documents/Assembly/Resolution_A41-21_Climate_change.pdf pages 5-12, accessed August 13, 2024

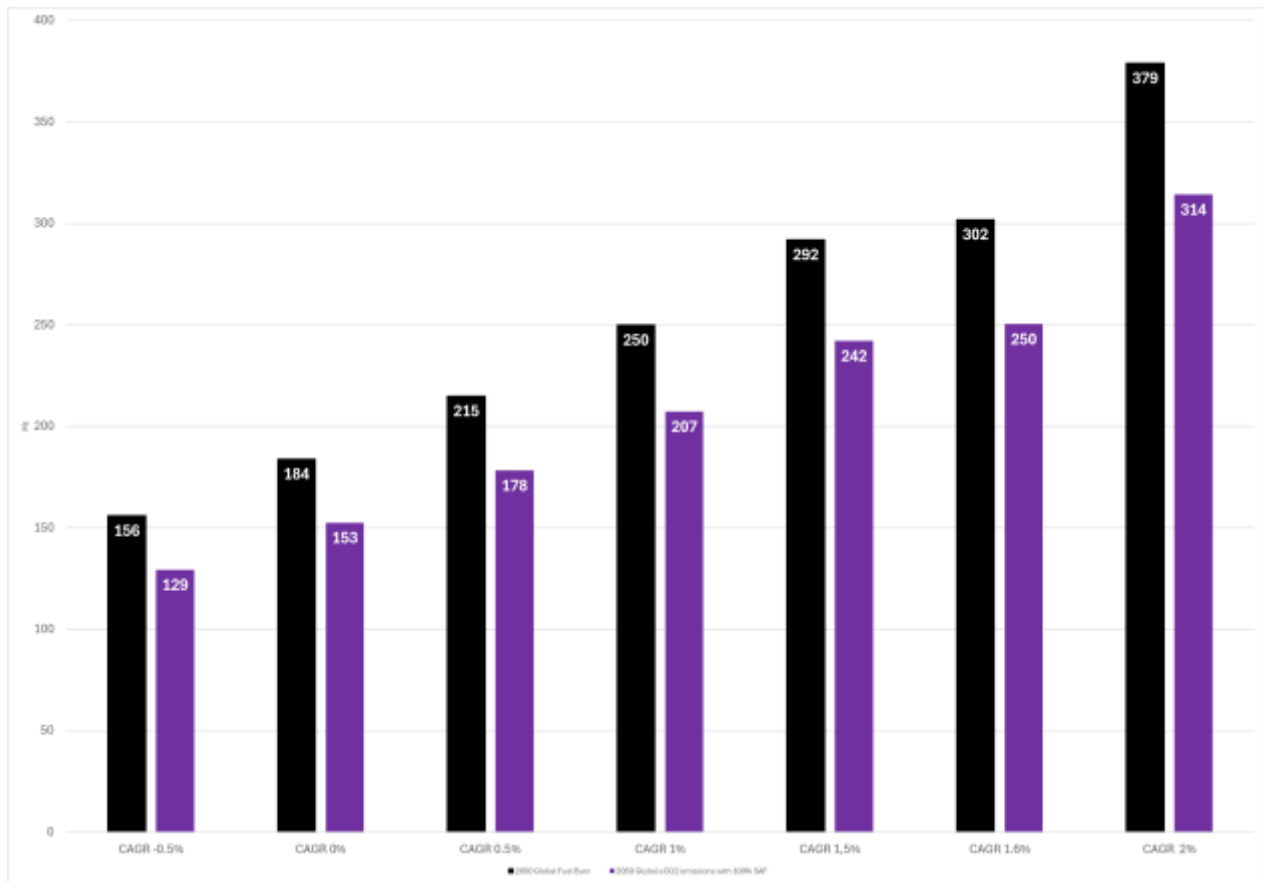

FIGURE 149 Air mobility global fuel burn, in Mt, and associated eCO₂ emissions, in Mt, in 2050, with different CAGR, assuming all levers are deployed: 100% SAF, Lower Speed, Modal Shift. The SAF volumes mean scenario supposes a CAGR of -0.5%, the high scenario 1.6%, source Jean-Baptiste Jarin

Even when assuming the optimistic scenario, 307 Mt of SAF, this means that airlines should now focus on profits rather than growth, developing a new business model based on higher energy costs and shifting the cost index from time priority to fuel burn priority.

Meanwhile, the aircraft and engine manufacturers along with their supply-chain should steer their R&D in the direction of lower speeds, by proposing future short- and medium-haul turboprop aircraft, with propfans taking over the long-haul market. Public policies could incentivize accordingly.

Regulation should evolve accordingly, and ICAO has a duty to accompany these changes, by placing eCO₂ emissions reduction at the heart of its mandate and not on its periphery. It is likely that this organization has the legitimacy to distribute efforts and growth scenarios among the various countries. Meanwhile EU should keep steering and lead by example.

More important for societies, such an approach means access to feedstocks, namely biomass and electricity. Air mobility could expect that these would be granted, and even in some occasions prioritized, to the sector. While the merit of order for electricity is very low, and therefore should be used with caution, a significant part of the biomass could be directed to SAF production, while ground mobilities get electrified (Introduction, Chapter 2). This would be a major counterpart of societies toward air mobility decarbonization roadmap.

In return, the cost for human societies needs to be evaluated, and energy justices should play a major role in this process, as it could affect human societies, such as higher food and energy prices. Switching from fossil to low carbon and renewables could also reshuffle the cards in the energy world, impacting on countries sovereignty and global trade, while offering job opportunities: this is the subject of Part III.



PART III. THE ROLE OF ENERGY JUSTICE WITHIN THE AIR MOBILITY DECARBONIZATION ROADMAP



III.I. SAF impacts within our societies

In order to take account of the impacts of climate change and the challenges associated with conflicts of use, air mobility must, in order to meet a reasonable target of 325 Mt of eCO₂ per year by 2050, accept the massive incorporation of more expensive energy, SAF, and orient its technologies and uses towards marked energy sobriety, which would translate into a significant reduction in speed. It is also likely that the sum of these impacts on operating costs will result in a very significant rise in air mobility tariffs, which would impact its traffic growth rate. In any case, this CAGR needs to remain between -0.5% and 1.6% per year to maintain the sector's decarbonization trajectory as concluded in part II. Air mobility should embrace the constraints imposed by climate change and the necessary energy transition in limiting its growth, reducing its speed, encouraging modal shift, and accepting higher operating costs thus higher ticket prices.

Still, this paradigm shift, which should be imposed on air mobility, would have its counterparts, notably access to the limited feedstocks such as the biomass and low-carbon electrons identified in the previous section.

This access to feedstocks can be envisaged in two ways: through direct regulation with signposting of feedstocks, or the law of supply and demand. The current situation being dominated by the law of supply and demand, with certain safeguards provided by regulation. But increased competition on vital commodities such as biomass and electricity would have a price for human societies, and it needs to be evaluated. Switching from fossil to low carbon and renewables could also reshuffle the cards in the energy world, impacting on countries sovereignty and global trade while offering job opportunities and this needs also to be evaluated.

It is therefore important to understand that decarbonizing air travel requires decarbonizing its energy, and that energy irrigates all aspects of our society (chapter 1.2.). This is not without risks for human societies, and energy justice must be the cornerstone of our future public policies on the subject.

III.I.1. The impacts of offer and demand

In 2023, the volumes of SAF are found to be, still, quite limited, 0.5 Mt in 2023⁵⁷⁹. It is notable that a single airline accounts for almost 20% of this volume⁵⁸⁰, and the regulatory situation⁵⁸¹ which imposes but also supports via a complex aid mechanism, is probably not unrelated to this.

It is however possible to measure the impacts of offer and demand related to the biomass for biofuels thanks to the development in the past twenty years of road transportation biofuels.

III.I.1.1. Impacts of biofuel demand on feedstocks prices

As shown in FIGURE 150 below, the largest producer, with almost half of the global production, are the United States of America, followed by Brazil. Unlike fossil fuels, biofuels are largely consumed where they are produced as it is often not only subsidized, but also part of sovereignty policies.

The European Union, but firstly USA, 1st producer and consumer, and Brazil, 2nd producer, have implemented specific policies to support and deploy the use of biofuels, mostly in road transportation, but as discussed above, SAF have now been added to such policies.

⁵⁷⁹ <https://www.iata.org/en/pressroom/2023-releases/2023-12-06-02/> accessed August 13, 2024

⁵⁸⁰ <https://www.airfranceklm.com/fr/newsroom/air-france-klm-reaffirme-ses-engagements-en-matiere-de-decarbonation-du-transport-aerien> accessed August 13, 2024

⁵⁸¹ https://www.senat.fr/amendements/2023-2024/127/Amdt_I-18.html accessed August 13, 2024

In the USA, the US Renewable Fuel Standard is the world's largest biofuels program, and the country currently produces almost half the world's biofuels, with a production being close to 0.8 boepd (barrels of oil equivalent per day) in 2023 according to Rystad Energy⁵⁸², accounting for 5% of the total energy used in transport⁵⁸³.

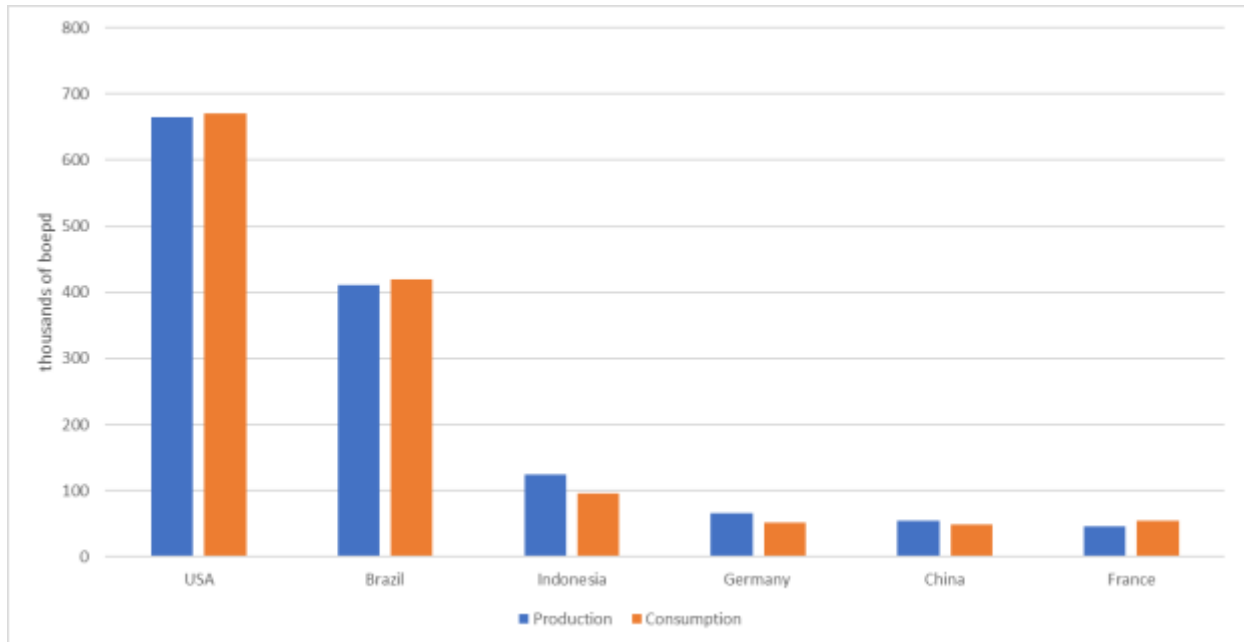

FIGURE 150 Global biofuels production and consumption in 2019, here in thousands of boepd (y-axis), source Jean-Baptiste Jarin with data from BP statistical review 2022⁵⁸⁴

Yet, despite its importance, the US Renewable Fuel Standard is found to have limited effects on GHG, while having significant effects on commodity prices, as found by Lark et al in Environmental outcomes of the US Renewable Fuel Standard⁵⁸⁵. Even without considering the likely effects on international land use, the authors found that corn-based ethanol (1G) production in the USA “has failed to meet policy targets for greenhouse gas emissions, and has had a negative impact on other aspects such as water quality, the amount of land used for conservation and other ecosystem processes” (see Introduction, Chapter I).

In economic terms, FIGURE 151, the authors found that the Renewable Fuel Standard has increased corn prices by 31%, and other crop prices such as soybean or wheat by 20%, since the policy enactment in 2008. This in turn has increased US corn cultivation by almost 9% during the same period. According to the authors, these changes have significant other side effects, such as an increased annual fertilizer use, or water quality degradation, and these side effects “caused enough land-use change emissions that the carbon intensity of corn ethanol produced under the Renewable Fuel Standard is no less than that of gasoline, and is likely to be at least 24% higher”. This is in line with the conclusions discussed above, FIGURE 53 (Chapter I.III.1.4.).

These conclusions are important as (even if the considered biofuel is 1st generation, and as such that it shall not be included with the SAF feedstocks options) it is demonstrated that, even a limited volume, here 5%, it can have a significant outcomes for the populations, due to commodity price increase.

⁵⁸² https://www.rigzone.com/news/usa_biofuels_industry_is_booming-01-apr-2024-176258-article/ accessed August 13, 2024

⁵⁸³ <https://www.energy.gov/energysaver/transportation-fuels> accessed August 13, 2024

⁵⁸⁴ <https://www.bp.com/content/dam/bp/business-sites/en/global/corporate/pdfs/energy-economics/statistical-review/bp-stats-review-2022-full-report.pdf> pages 48-49, accessed August 13, 2024

⁵⁸⁵ Tyler J. Lark, Nathan P. Hendricks, Aaron Smith, Nicholas Pates, Seth A. Spawn-Lee, Matthew Bougie, Eric G. Booth, Christopher J. Kucharik, Holly K. Gibbs, Environmental outcomes of the US Renewable Fuel Standard, Journal Article, 2022, Proceedings of the National Academy of Sciences, <https://www.pnas.org/doi/full/10.1073/pnas.2101084119>

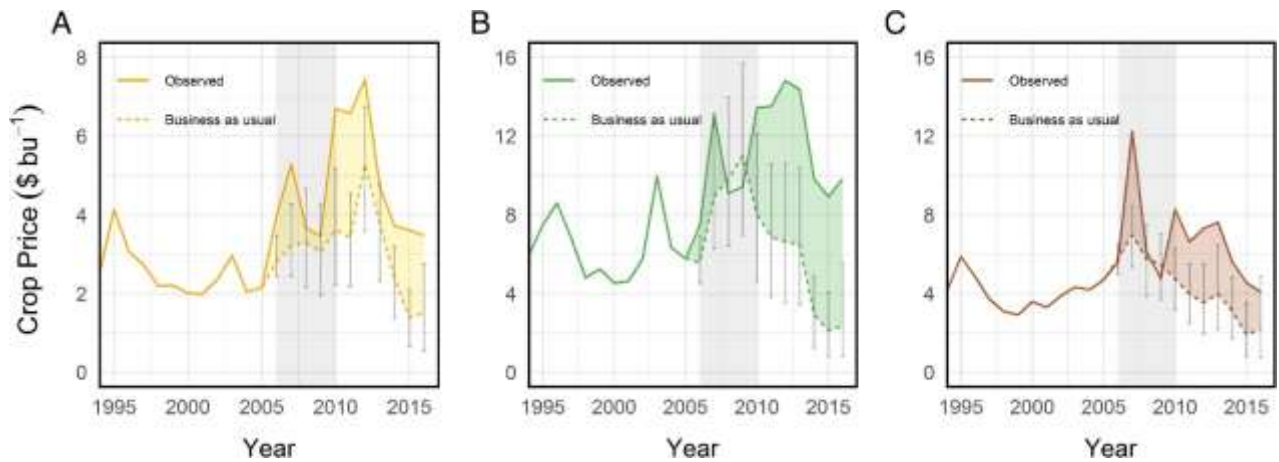

FIGURE 151 Observed vs Business as Usual crop prices for Corn (A), Soybeans (B) and Wheat (C) in the USA. Source Lark et al, originally Figure 1 in *Environmental outcomes of the US Renewable Fuel Standard*. It is found that the development of biofuels policies for transportation increased corn prices of 31%, wheat and soybeans of 20 and 19% respectively

Indeed, in 2021 the Biden administration in the USA already faced the food industry critics since energy companies tapped into vegetable oil and fat supplies in pursuit of renewable targets, which in turn tripled the soybean oil prices, leading to a “diesel vs doughnut” dilemma ⁵⁸⁶.

After two decades of implementation, the impacts on commodity prices are found to be already significant, not only within the USA, but also globally as concluded by Eckart Woertz, in *Agriculture and Development in the Wake of the Arab Spring* ⁵⁸⁷. The author highlights that for countries which are importing cereals, sometime heavily, such as Middle-East and North Africa, rising food prices have significant drawbacks for the populations, mostly the most vulnerable ones, and that the “effects of biofuels on the demand side are noticeable”.

For other feedstocks than crops, such as Used Cooking Oil (UCO), while it is considered as 2nd generation (2G), as based on wastes or intermediate energy crop, therefore not competing on subsistence crops, it is found an equivalent trend. In FIGURE 152 are shown the UCO stock prices from 2017 to 2022 ⁵²³. As discussed in the previous chapters, UCO is by far the main feedstock used today to produce SAF. The HEFA pathway, using UCO, has been developed for two decades, first to produce biofuels for road transportation. While further upgrading is required to produce SAF, the supply-chain, from recycling to production, is in place. It is highlighted here that this is one of the best examples of waste management. However, as addressed in chapter II.III.2. above, there are already several conflicts of use on going, as this feedstock is already serving several markets such as road transportation, heating, or energy feed additive for livestock products. Adding new usages to an existing commodity, when the offer is under constraint, influences prices, as for the crops.

The 2nd Generation, while more virtuous than the 1st, is indeed not without impact on our economies and societies. For Declerck et al ⁵⁸⁸, the rise in vegetable oil prices, such as palm, soybean, rapeseed, and sunflower oils, is mostly due to food and fuel sector demands. The authors also conclude that biofuel policies have unique effects on vegetable oil prices, increasing not only prices, but also volatility, and the used cooking oil is no exception, as shown in FIGURE 152, and as concluded by de Paula Leite et al, in *Impact of agricultural and energy prices on the biofuels market* ⁵⁸⁹.

⁵⁸⁶ <https://www.ft.com/content/b5839a04-a06a-49c1-8622-2974cbb9a84a> accessed August 13, 2024

⁵⁸⁷ Eckart Woertz, “Agriculture and Development in the Wake of the Arab Spring”, *International Development Policy | Revue internationale de politique de développement*, 7 | 2017, <https://doi.org/10.4000/poldev.2274>

⁵⁸⁸ Francis Declerck, Prince Hikouatcha, Guillaume Tchoffo, Roméo Tédongap, *Biofuel policies and their ripple effects: An analysis of vegetable oil price dynamics and global consumer responses*, *Energy Economics*, Volume 128, 2023, 107127, ISSN 0140-9883, <https://doi.org/10.1016/j.eneco.2023.107127>

⁵⁸⁹ Ana Catarina de Paula Leite, Liliana Marques Pimentel, Leandro de Almeida Monteiro, *Impact of agricultural and energy prices on the biofuels market through a VAR-VEC model*, *Renewable Energy*, Volume 232, 2024, 121130, ISSN 0960-1481, <https://doi.org/10.1016/j.renene.2024.121130>

While the scope of the study being limited to Portugal, the conclusions of the authors highlighted that biodiesel FAME has an impact on agricultural commodities, but also on fossil fuels, and that “policies and incentives, to diversify feedstocks and promote advanced biofuels, are essential for maintaining FAME’s competitiveness, and mitigating diesel price impacts”.

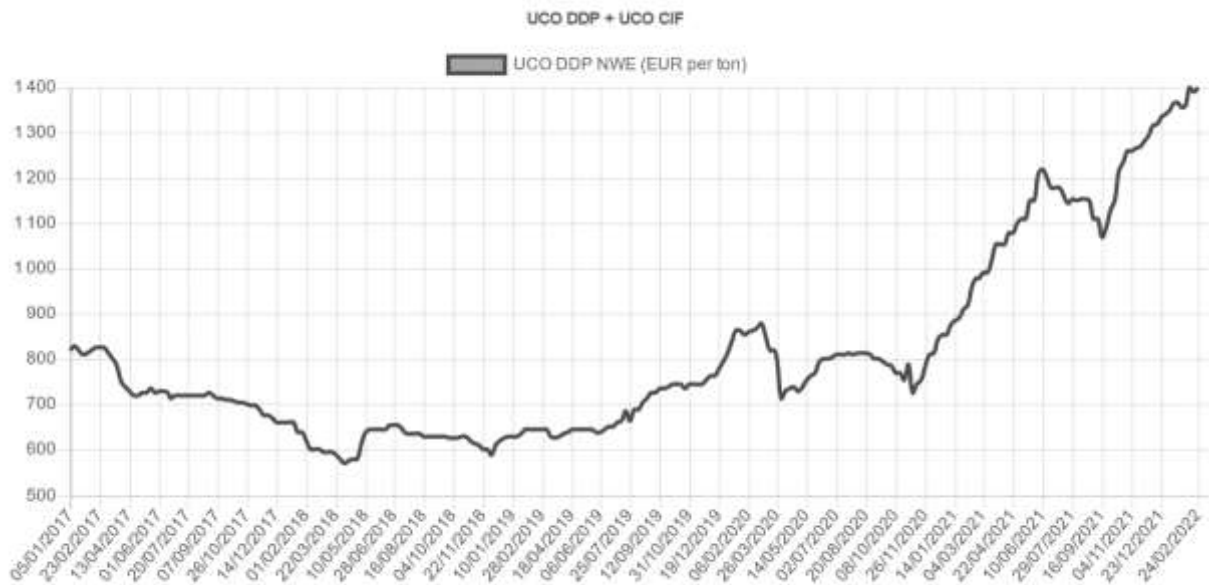

FIGURE 152 Used Cooking Oil stock prices from 2017 to 2022, in €/ton, source Greenea ⁵²³

Until now, the development of biofuels has significantly controlled the inflation of crude oil prices, adding a limited, but welcome, offer to the energy markets, as shown in FIGURE 153 below. This is also the conclusion of Chiu et al in Modeling the price relationships between crude oil, energy crops and biofuels ⁵⁹⁰. The authors concluded that “the development of ethanol (biofuel) demand has significantly controlled the inflation of crude oil price...while a long-run causal relationship among these three prices is found, and depends on the level of the crude oil price”. This was also the conclusion of chapter II.III.1.3.

Numbers in FIGURE 153 shows that during the considered period, the CAGR of crude oil and condensates, which includes shale oil and tar sands, was limited to 1.3%, while the natural gas to liquids (NGL) CAGR was 5%, and biofuels 6%. Since biofuels have higher costs and lower EROEI than crude oil and NGL, such a push in biofuel production reinforces the authors' conclusion, but more important raises the question of whether this trend could be reversed in the years to come, as the biomass is limited.

⁵⁹⁰ Fan-Ping Chiu, Chia-Sheng Hsu, Alan Ho, Chi-Chung Chen, Modeling the price relationships between crude oil, energy crops and biofuels, Energy, Volume 109, 2016, Pages 845-857, ISSN 0360-5442, <https://doi.org/10.1016/j.energy.2016.05.016>

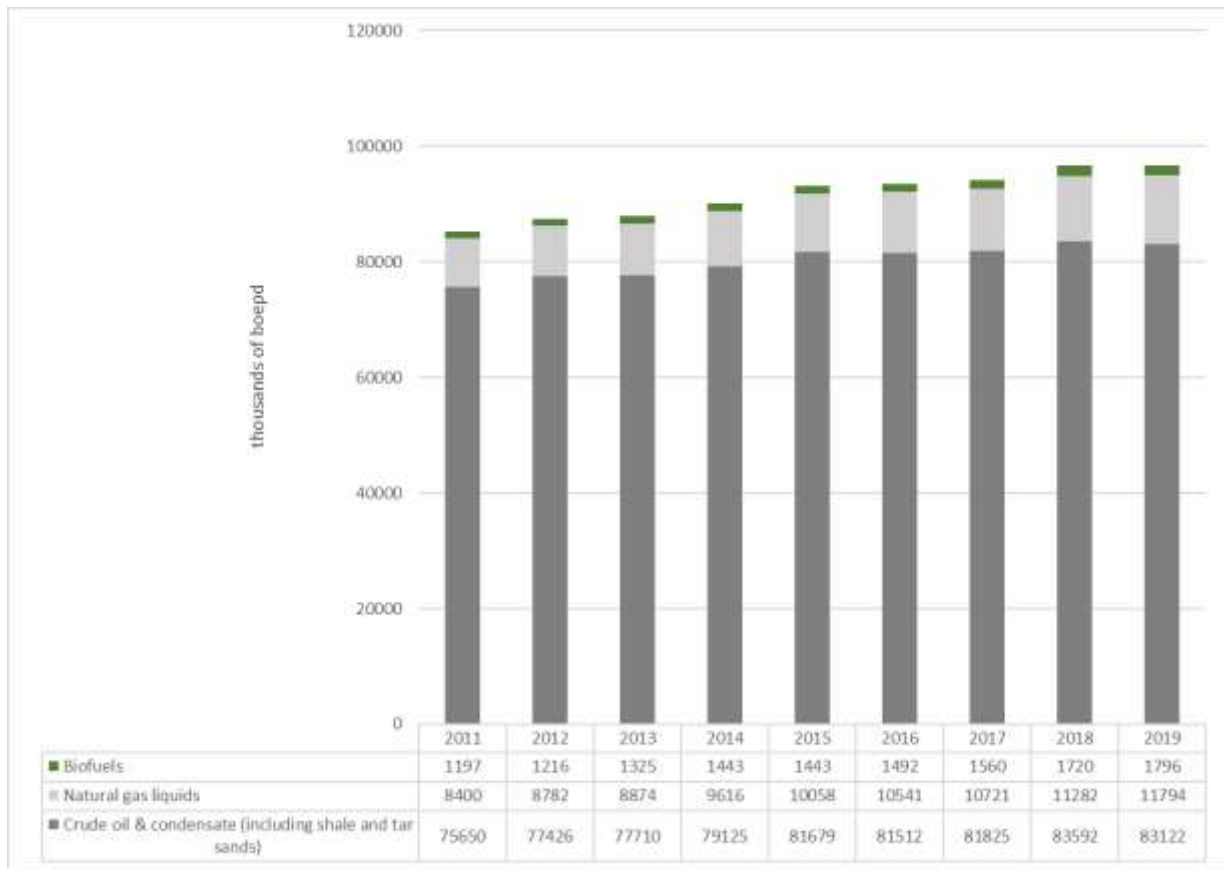

FIGURE 153 Global oil production from 2011 to 2019, in thousands boepd, detailing the share of crude and condensate (including shale oil and tar sands), natural gas to liquids, and biofuels, source Jean-Baptiste Jarin with data from BP Statistical Review of World Energy ⁵⁹¹

III.I.1.2. Impacts of demand in future oil prices

In addition to the impact on the prices of various commodities (biomass and electricity), it is also likely that significant demand for low-carbon fuels could have an impact on oil prices.

Any increase in oil price has a significant impact within our societies and replacing crude oil with biofuels is a challenge, both industrial and economic. But establishing a reference price for the main source of energy we collectively have decided to replace becomes necessary when intending to measure the associated economic and social impacts.

Because of crude oil volatility, it is complicated to propose a forecast. Instead, it is proposed here to isolate volatility to define a reference channel that could serve as a benchmark for future comparisons.

Several factors explain the volatility of the price of oil. Oil prices do not follow a classic supply-demand curve, since there is a unique combination of a highly capital-intensive sector, with very low operating costs in relation to sales, at least for the conventional crude oil which is still most of the oil produced in 2018 ⁵⁹².

The oil industry is highly capital-intensive since locating and bringing an oil field into production requires several billion euros and long lead time, 17 years from discovery to production according to the latest IEA report ⁵⁹³. In parallel, the

⁵⁹¹ <https://www.bp.com/content/dam/bp/business-sites/en/global/corporate/pdfs/energy-economics/statistical-review/bp-stats-review-2022-full-report.pdf> accessed August 13, 2024

⁵⁹² Global prospects of unconventional oil in the turbulent market: a long term outlook to 2040, Nikita O. Kapustin, Dmitry A. Grushevenko, Oil Gas Sci. Technol. – Rev. IFP Energies nouvelles 73 67 (2018), <https://doi.org/10.2516/ogst/2018063>

⁵⁹³ <https://www.iea.org/data-and-statistics/charts/global-average-lead-times-from-discovery-to-production-2010-2019> accessed August 13, 2024

low operating costs in relation to sales is explained by the oil fields properties, as in most cases the gas associated with the oil in the reservoir will push the oil out, while an oil field will generally produce over several decades (except for shale and tar sands). It is important to note here that, for geological reasons, it is complicated to significantly reduce production from a producing oil well in response, for example, to a sudden change in price. This can explain why the oil price was negative during a few days during the Covid crisis.

These reasons explain the low elasticity of supply ^{594 595}, in the short (2 years) and medium term (5 years). In the long term (10 years), production start-ups may fall, provided that oil prices remain durably low. In practice, this is not happening but the recent development of shale oil, in the USA, and tar sands, in Canada could marginally affect the supply elasticity, since their share in the global production is increasing ⁵⁹⁶, while conventional oil production has peaked around 2005 for the authors (field oils, offshore).

In parallel, demand is found to be also very inelastic. This can be explained by the absence of substitute products since the 1970s oil shocks. During this period soaring oil prices due to a supply shock led to sobriety in the use of oil: the latter was henceforth reserved for mobility and chemicals, with all other uses, those for which a substitute product could be found, turning to other primary energy sources. This is the case in France, for example, with the deployment of nuclear electricity production and quick shift in heating with the end of oil-fired heating. Globally oil is mainly used in transportation and industry, the other usages such as residential or electricity production being marginal ⁵⁹⁷.

This low elasticity is reflected in the main INSEE study on the subject, Calvet and Marical ⁵⁹⁸, in which the authors highlight disparities between urban and rural, affluent and modest populations, showing that a sharp 10% increase impacts demand in the short term by only 2.5 to 3.5%, depending on the population, and 6 to 7% in the long term. The situation is much the same in North America, an area far more dependent on oil than France, as illustrated by A.B. Askin and J.Kraft in "econometric dimensions of energy supply & demand" ⁵⁹⁹, TABLE 46 below.

⁵⁹⁴ Lutz Kilian, Understanding the estimation of oil demand and oil supply elasticities,

Energy Economics, Volume 107, 2022, 105844, ISSN 0140-9883, <https://doi.org/10.1016/j.eneco.2022.105844>

⁵⁹⁵ <https://www.investopedia.com/ask/answers/040915/how-does-law-supply-and-demand-affect-oil-industry.asp> accessed August 13, 2024

⁵⁹⁶ Louis Delannoy, Pierre-Yves Longaretti, David J. Murphy, Emmanuel Prados, Peak oil and the low-carbon energy transition: A net-energy perspective, Applied Energy, Volume 304, 2021, 117843, ISSN 0306-2619, <https://doi.org/10.1016/j.apenergy.2021.117843>

⁵⁹⁷ <https://www.eia.gov/energyexplained/oil-and-petroleum-products/use-of-oil.php> accessed August 13, 2024

⁵⁹⁸ Lucie Calvet et François Marical, Consommation de carburant : effets des prix à court et à long terme par type de population, Economie et statistiques, 2011, 446, pp.25-44, https://www.persee.fr/doc/estat_0336-1454_2011_num_446_1_9655 accessed August 13, 2024

⁵⁹⁹ A.Bradley Askin, John Kraft, Econometric Dimensions of Energy Demand and Supply, Lexington books, 1976, <https://www.osti.gov/biblio/7144386> accessed August 13, 2024

Product	Impact	One Year	Two Years	Three Years	Long Run
Motor gasoline	0.186	0.304	0.378	0.425	0.505
Distillates	0.128	0.194	0.227	0.244	0.263
Residual	0.172	0.215	0.225	0.228	0.229
Kerosene-type jet fuel	0.210	0.210	0.210	0.210	0.210
Liquefied gases	0.181	0.181	0.181	0.181	0.181
Other	0.178	0.284	0.347	0.347	0.440
Weighted average for all products	0.132	0.188	0.218	0.240	0.264

TABLE 46 Oil demand elasticity in the USA, source Askin and Kraft in *Econometric dimensions of energy demand and supply*, 1976

Isolating volatility requires proposing a channel, which will be all the broader the higher its price positioning.

Using data from BP Statistical Review of World Energy ⁵⁹¹, it is proposed to break the evolution of the oil price since 1861 into 4 major periods, FIGURE 154, enabling to propose a channel built around a pivot price, that can always be multiplied, or divided, by two or +100% / - 50%. With such an approach, the higher the pivot price, the greater the volatility, which explains the increase in the channel due to the inelasticity of supply combined with that of demand.

As detailed below, it is found that the pivot price is mostly due to physical reasons (geology combined with technology), while the volatility is mostly explained by geopolitics and markets behaviors.

For more details on the concept of price – demand elasticity, please see chapter II.III.3.3.

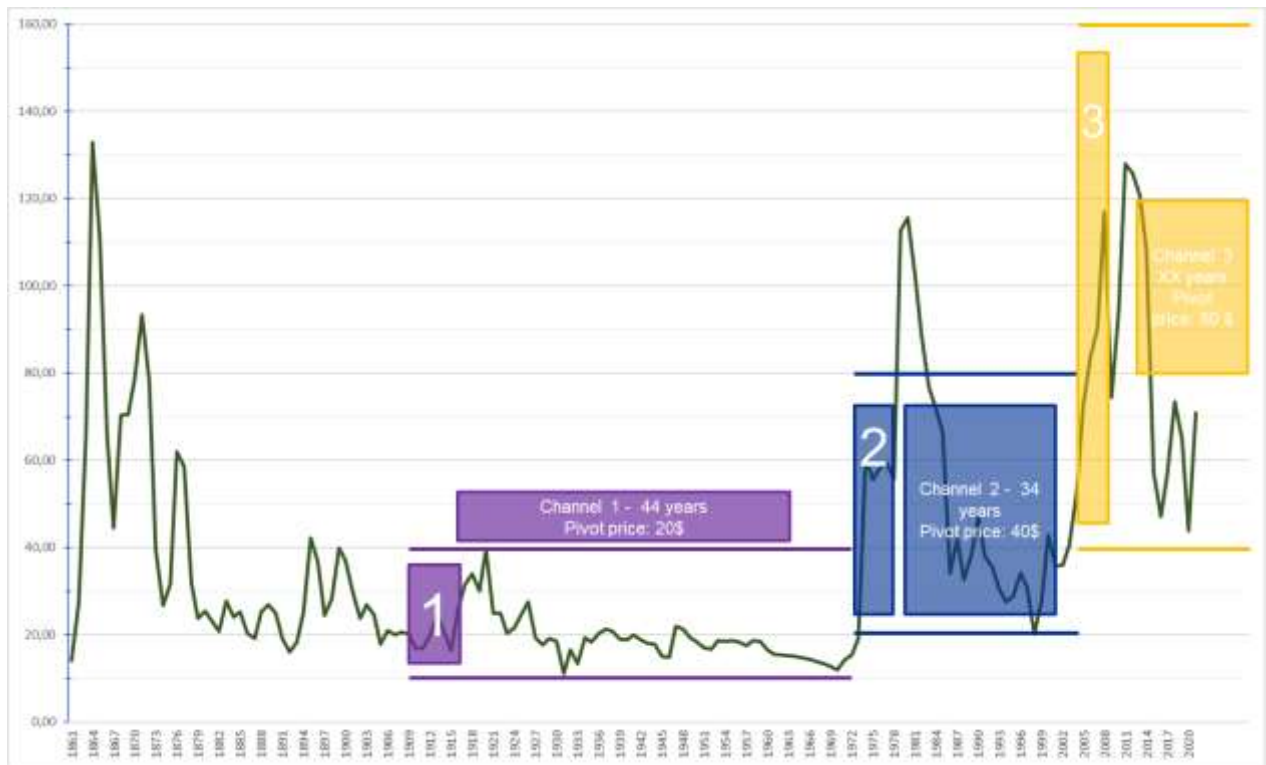

FIGURE 154 Introducing 3 channels to isolate oil price volatility, source Jean-Baptiste Jarin with data from BP Statistical Review of World Energy for the crude oil prices from 1861 to 2021 (yearly average in US\$ 2021, deflated with US CPI)

Period 0: the chaotic beginnings of oil.

First used as a lubricant, its potential as a source of energy for the internal combustion engine came at the beginning of the 20th century along with a very high price volatility, which can be explained by incipient logistics and the absence of quality standards. There's oil and there's oil, and accidents were plentiful. History will record that it was an accountant, J.D. Rockefeller, who first understood the importance of establishing a standard and ensuring consistent quality by controlling refining.

Period 1 / Channel 1: industrialists and governments alike understood the strategic nature of oil, and from 1928 onwards it can be considered that its price was administered. The Achnacarry agreement⁶⁰⁰, between the main producers, stabilized the price of a barrel of oil, which was henceforth based on the reference domestic price in the USA, the world's leading oil producer until the 70's (and still the world first consumer), the gulf basing point, to which transportation costs were added.

This first period goes from 1928 to 1972, the first oil shock. It lasted 44 years with very stable prices and an average constant price of 17 \$/boe. The channel illustrated in purple in FIGURE 154 goes from 10 to 40 \$/boe with a pivot price of 20 \$/boe (barrel of oil equivalent).

Period 2 / Channel 2: while World War 2 had little impact on oil prices, geopolitical tensions in the Middle East triggered a tsunami of price movements. First between 1972-1973, then even more strongly in 1979-1980. If these tensions explain a certain nervousness on the oil market, notably the Iranian crisis of 1979 which saw the country's production divided by 4 in 3 years when Iran produced more than 10% of the world's oil in the mid-1970s, it is reduced to 2.3% in 1980, more structural factors exist.

First oil shock: in 1973 the world's leading producer, the USA which until then had produced the equivalent of the whole of the Middle East, with just over 11 million boepd, passed its production peak, after having become a net importer in the 1960s. It is noted here that since 2010, shale oil has offered a vigorous rebound to US production,

⁶⁰⁰ <https://www.actu-environnement.com/ae/news/secret-7-soeurs-france-5-13750.php4> accessed August 13, 2024

which currently exceeds its 1973 output, and, for a time, the country has once again become the world's first producer (while it remains a net importer).

Second oil shock: in 1979 with liquids consumption doubling in 15 years to 64 Mbd, and discoveries continuing to fall, consumption for the first time came close to annual discoveries. The gap never ceased to widen since, and the yearly discoveries since the two past decades generally cover, at best, only a few dozen days of consumption. This despite ever-increasing exploration expenditure (FIGURE 7). At a time when consumers are discovering that addiction cannot be infinite, and new producers are discovering a new power, a second channel is introduced, in blue in FIGURE 154 above.

This second period goes from 1973 to 2007, the third oil shock. It lasted 34 years, with more volatility, and an average price of 53 \$/boe. The channel is drawn around a pivot price of 40 \$/boe, from 20 to 80 \$/boe, with the exception of the Iran crisis from 1979 to 1981 which immediately wiped out 8% of global production.

Period 3 / Channel 3: the subprime crisis masks, for some, finds its roots, for others, in the marked and continuous rise in oil prices from 2002, 36 \$/boe, to 2008, 117 \$/boe with a peak of 147 \$/boe, in July of the same year. Whatever the cause, it was in 2008 that the International Energy Agency (IEA) peaked the world's conventional oil production at 69 Mbd, which explains this structural rise. Since then, growth has been driven by other types of oil, which often have a poorer eCO₂ balance such as condensates, shale oil, tar sands oil, or natural gas to liquids. As discussed above biofuels are introduced, and while still marginal, they offer the highest CAGR in the past decade. All these substitutes have a lower ERoEI (TABLE 38) and are more expensive to extract or produce, boosting the oil prices and introducing a new channel, in orange in FIGURE 154 above.

This third period starts in 2008 and has not yet ended. The average price during that period, until 2022, is 85 \$/boe and the channel is built around the pivot price of 80 \$/boe, or 40 à 160 \$/boe.

What role for the biofuel and which characteristics for the next channel?

Isolating volatility means significantly extending the limits of the channel, but the average price over the period shows that it is close to the production cost of the last well brought on stream. As with the kWh price observed in 2022 in Europe, it is the last production facility called upon that sets the energy price for all production as concluded by Zakari et al in the role of natural gas in setting electricity prices in Europe ⁶⁰¹, the authors highlighting that gas was determining electricity prices for more than 80% of the hours in 2021 in most European countries while generating only 18% of the volume.

Knowing the cost of production of the last well called up to meet demand differs from period to period, but there is concordance with the channels, which could make it possible to identify the positioning of the next channel. The impact of ERoEI is an important datum for validating production costs as it enables one to compare the physical profitability of the energy extracted and made available. The conclusions of Hall et al for fossil fuels, in ERoEI of different fuels and the implications for society (table 1) ¹⁴⁰, can be directly transposed to the three different channels detailed above.

Channel 1 and its average price of 17 \$/boe corresponds to the era of oil with a high ERoEI, from 30 and up to 100 for Middle Eastern fields. These are onshore fields, large and easy to operate, requiring proportionately less investments than recent fields and more importantly very low operating costs. The cost of production is usually around \$10 in the Middle East, with \$20 for the last barrels called, USA ⁶⁰².

Channel 2 and its average price of 53 \$/boe correspond to the beginnings of offshore oil. North Sea for UK and Norway, or Gulf of Mexico in the 1970s. Deep and ultra deep offshore started from the 2000s onwards with even lower ERoEI thus higher costs. Fields are shrinking in size, exploration-production budgets are rising, but above all operating costs are rising sharply as an oil rig in the North Sea requires extensive logistics and maintenance. ERoEI is significantly

⁶⁰¹ Behnam Zakeri, Iain Staffell, Paul E. Dodds, Michael Grubb, Paul Ekins, Jaakko Jääskeläinen, Samuel Cross, Kristo Helin, Giorgio Castagneto Gissey, The role of natural gas in setting electricity prices in Europe, Energy Reports, Volume 10, 2023, Pages 2778-2792, ISSN 2352-4847, <https://doi.org/10.1016/j.egy.2023.09.069>

⁶⁰² https://www.energy.ca.gov/sites/default/files/2021-09/2021-09_Petroleum_Watch_ADA.pdf accessed August 13, 2024

reduced for this fields, between 20 and 30 at the beginning of the period, and 8 to 15 at the end with the development of ultra deep offshore. The production cost of the last barrel called is 82 \$/boe⁶⁰³ with the channel ranging from 20 to 80 \$/boe. The average cost per barrel is much lower for most countries such as UAE or KSA, and such producing countries see their profits increasing significantly.

Channel 3 and its average price of \$85, starting 2008, corresponds to the peak of conventional oil⁶⁰⁴ which means that the least expensive fields to exploit are in decline, indicating that the average EROEI falls more rapidly. This period sees the rapid progression of non-conventional oils, EROEI between 5 and 10, and then biofuels EROEI between 0.8 and 3. The cost of the last barrel of oil produced is increasing, 85 \$/boe for shale oil, 105 \$/boe for tar sands and up to 110 \$/boe, before subsidies, for biodiesel⁶⁰⁵. The channel moves up, ranging from 40 to 160 \$/boe. It is worth noting once again that the average cost per barrel is lower, particularly for onshore fields that are still producing as in the Middle East, which means considerable profits for the entities concerned, now including Qatar thanks to natural gas liquids.

With annual discoveries now equivalent to just a few dozen days of consumption in the recent years⁶⁰⁶, it is important to realize that annual discoveries have been fluctuating between 1 and 10 billion barrels for the last two decades. This may seem like a lot, but when compared with current consumption of 97 million boepd in 2019, or 35 billion/year, it is unlikely that the next channel will be downward. More important this consumption requires not only new fields but also non-conventional oil, natural gas to liquids and biofuels as illustrated in FIGURE 152 above.

Therefore, the next channel will most likely see the combination of a sharply declining EROEI and the cost of the last barrel shifting to synthetic fuels, first biofuels, and later efuels, as their share in the global production should increase.

If the latest barrel to come onto the market is based on PtL (Power to Liquid) technologies (efuel), it has been concluded in the previous chapters that its production cost, largely driven by the price of electricity, should be above 3000 \$/t, being equivalent to 393 \$/boe.

This uncertainty adds volatility to volatility, making it very difficult to define not only the upper limit of the next channel but also when it could start. The beginning of the next period could start around 2026-2027 if Rystad's forecasts, which anticipate the beginning of the "all-oil" decline (conventional and unconventional oils), are borne out. It is therefore likely that the next channel will be triggered by sudden variations in the price of a barrel of oil, given the uncertainty surrounding the cost of producing the last barrel.

Such a price increase could have major impacts within our societies as there is a strong bidirectional relationship between oil prices and GDP^{607 608}. It is therefore a common responsibility to not only minimize the demand, but also to investigate the possibility to decouple the biofuels and oil markets in general, and SAF in particular, since low carbon liquid fuel is the only path available to decarbonize this hard to abate sector.

⁶⁰³ <https://knoema.fr/infographics/vyronoe/cost-of-oil-production-by-country> Deep water, accessed August 13, 2024

⁶⁰⁴ Is the oil industry able to support a world that consumes 105 million barrels of oil per day in 2025? Pierre Hacquard, Marine Simoën and Emmanuel Hache, Oil Gas Sci. Technol. – Rev. IFP Energies nouvelles, 74 (2019) 88 ,DOI: <https://doi.org/10.2516/ogst/2019061>

⁶⁰⁵ <https://knoema.fr/infographics/vyronoe/cost-of-oil-production-by-country> Brazilian offshore and European biodiesel, accessed August 13, 2024

⁶⁰⁶ <https://www.bloomberg.com/news/videos/2016-08-31/oil-discoveries-lowest-since-1947> accessed August 13, 2024

⁶⁰⁷ Bentley, R & Mushalik, M. & Wang, J.. (2020). The Resource-Limited Plateau in Global Conventional Oil Production: Analysis and Consequences. Biophysical Economics and Sustainability. 5. 10. 10.1007/s41247-020-00076-1 <https://link.springer.com/article/10.1007/s41247-020-00076-1>

⁶⁰⁸ Muhammad Shahbaz, Suleman Sarwar, Wei Chen, Muhammad Nasir Malik, Dynamics of electricity consumption, oil price and economic growth: Global perspective, Energy Policy, Volume 108, 2017, Pages 256-270, ISSN 0301-4215, <https://doi.org/10.1016/j.enpol.2017.06.006>

III.I.2. A National & Regional assessment

The ability of air mobility to decarbonize is not so much a matter of technology as of societal choices, as the scaling up of solutions raises numerous problems.

The broad outlines of a new relationship between air mobility and societies are taking shape: significantly lower speeds, traffic growth contained between -0.5 and +1.6% CAGR accompanied with a significant rise in ticket prices, against the allocation and prioritization of biomass and electricity resources, while taking into account the collateral effects on direct and indirect land use change, conflicts of use, management of carbon sinks, notably forestry, and a potential rise in energy prices for our economies as a whole.

It is therefore of interest to transpose the above global conclusions to the national and regional levels not only to double check the results but also measure the impacts within societies at a lower scale. This allows one to better identify the bottlenecks but also the potential collateral benefits, such as employments if the energy is no longer imported but produced locally.

III.I.2.1. National assessment: France

Jet fuel consumption in 2019 is 7.1 Mt according to Insee ⁶⁰⁹, or 2.44% of the world jet fuel consumption.

In FIGURE 155 below, are introduced 3 different scenarios for 2050, in order to quantify the need, reflecting this ratio of 2.44% with global consumption:

- A business-as-usual scenario (BAU), with no constraint on speed or modal shift, along with a traffic CAGR of 3.1%,
- The mean SAF scenario, which means constraint on speed, modal shift, and a traffic CAGR of -0.5%, limiting the global need to 156 Mt of SAF (TABLE 43)
- The optimistic SAF scenario, with a different CAGR, +1.6%, to reflect the high availability SAF scenario at 307 Mt per year (TABLE 43)

For France, in 2050, the demand would be 16.4 Mt in the BAU scenario, 3.8 Mt in the mean SAF scenario and 7.4 Mt in the optimistic SAF scenario.

France has unique assets for producing SAF. Indeed, except for the HEFA pathway, which requires used cooking oil and tallows, the country is gifted when compared to other countries, with significant quantities of biomass for second-generation biofuels, mostly agricultural and forestry residues. At the same time, the country has a significant installed base of low-carbon electricity generation, both in terms of volume and availability. As a result, France is one of the world's top 5 producers of low-carbon electricity ⁶¹⁰.

Aside from the jobs opportunities associated with the local production of SAF, it would be a nonsense for France to rely on importation with such assets, except maybe for a share of HEFA-UCO, since the associated feedstocks is far from being sufficient. It is in fact quite the opposite, and France should see itself as a major producer, within the limits discussed above.

Based on the SNBC (French national bioenergy strategy), corrected for the latest analyses by France Stratégie ⁶¹¹, France could have 30 Mtoe of bioenergy available (i.e. 67 Mt of dry biomass). In its impact study, in support of the

⁶⁰⁹ <https://www.insee.fr/fr/statistiques/2119673> accessed August 13, 2024

⁶¹⁰ <https://ourworldindata.org/grapher/carbon-intensity-electricity> accessed August 13, 2024

⁶¹¹ <https://www.strategie.gouv.fr/sites/strategie.gouv.fr/files/atoms/files/fs-ns - biomasse agricole - quelles ressources pour quel potentiel - 29-07-21.pdf> accessed August 13, 2024

ReFuelEU directive on sustainable aviation, the European Commission assumes that 10% of available bioenergy will be used to produce SAF⁶¹². Applying such assumption to France leads to a maximum of 6.7 Mt of dry biomass.

Considering a selectivity of 60% of the SAF cut in biofuel production (40% co-products such as bio-diesel), and using the most efficient process, which supposes the introduction of H₂ during the conversion of the dry biomass into SAF (see next section), this would allow to envisage a maximum production in France equal to 1.8 Mtoe per year. When adding the potential production of HEFA in France⁶¹³, the total would be close to 2 Mtoe, well below the demand: 13% for BAU, 28% for optimistic, and 53% for the mean scenario.

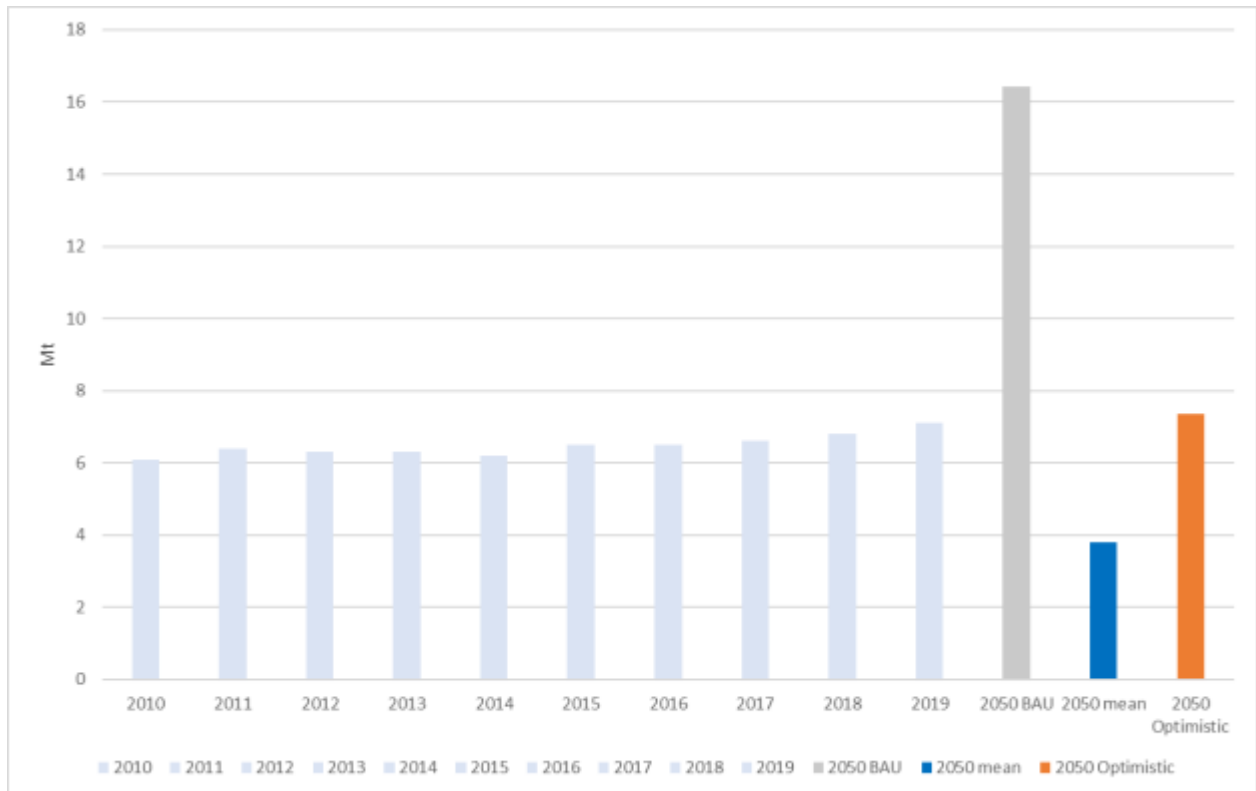

FIGURE 155 Jet fuel consumption in France from 2010 to 2019 in Mt, with 3 different scenarios for 2050: Business as Usual, mean and optimistic SAF availability, source Jean-Baptiste Jarin

The introduction of a share of efuels is therefore necessary to meet the demand, this would mean 14.4 / 5.4 / 1.8 Mt of efuel in respectively the BAU, the high and the mean scenarios.

As discussed in the previous chapters, this route is based on capturing CO₂ from the air, producing syngas (H₂+CO) by electrolysis of water for hydrogen, with low carbon electricity, and for CO by co-electrolysis of CO₂ and/or reaction of the gas with reverse water (with additional hydrogen consumption). It is then synthesized in a Fischer-Tropsch reactor and distilled using conventional petrochemical techniques. With the exception of the capture of CO₂ from the air (direct air capture – DAC), these technologies have reached a good level of maturity, and biogenic CO₂ is a mature technology which can replace, or complete, DAC.

Aside from the issues of scaling up industrial investment, the limiting factor for efuel production, and the main challenge, is first and foremost the availability of a sufficient volume of low-carbon, low-cost electricity. Most of the energy consumed by efuel production processes is linked to the production of hydrogen and CO. The use of high-

⁶¹² European Commission: Directorate-General for Mobility and Transport, Giannelos, G., Humphris-Bach, A., Davies, A., Baxter, B. et al., Study supporting the impact assessment of the ReFuelEU Aviation initiative – Final report, Publications Office of the European Union, 2021, <https://data.europa.eu/doi/10.2832/219963>

⁶¹³ <https://totalenergies.com/fr/medias/actualite/communiqués-presse/totalenergies-accelere-carburants-aeriens-durables-plateforme> accessed August 13, 2024

temperature electrolysis technologies appears to be the preferred option here. These technologies offer electrical efficiency close to 100%, thanks to a heat input that can be supplied free of charge from the exothermic Fischer-Tropsch reaction as this reaction converts 20% of the injected chemical energy into heat, with 80% going into the synthesized fuel.

As discussed in the previous chapters, the production of efuel requires 35 to 37 TWh per Mt, and, when introducing selectivity, 22 to 28 TWh of low carbon electricity per Mt of eSAF (the share of efuel dedicated to aviation fuel).

In parallel the need to produce H₂ to increase the conversion yield of the biofuel would require 10 TWh of electricity per Mt⁶¹⁴.

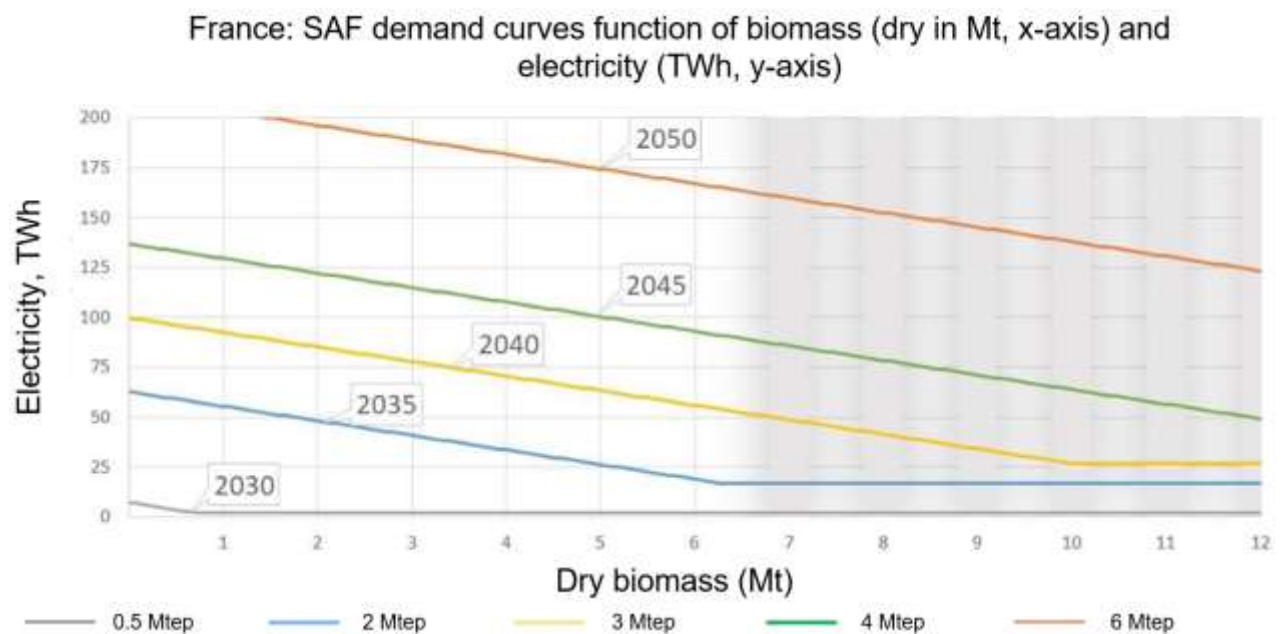

FIGURE 156 SAF demand curves for SAF in France function of the biomass availability. When bioenergy is sufficient, the SAF demand is met by ebioSAF processes, mobilizing 10 MWh per ton of SAF. When this is no longer the case, the residual need is met by efuel processes, mobilizing 35 MWh per ton of SAF to reflect a 60% selectivity. Graphic adapted with the courtesy of the original author, Dr Daniel Iracane

In FIGURE 156 above, each curve represents a quantitative SAF target, to be set against the progression of needs. The operating points in the shaded area would imply a mobilization of bioenergy for the aviation sector alone in excess of 10% of available bioenergy, and is therefore not considered here. The quantities of electricity and biomass devoted to SAF production are considerable, and will need to be the subject of a public policy designed to secure them over the long term. The optimum would be to minimize the amount of low-carbon electricity required within the limits of available biomass. The figure shows that when mobilizing the maximum biomass available, i.e. 6.7 Mt, there is a need of 210 TWh in 2050 to meet the optimistic SAF demand, or slightly under 85 TWh to meet the mean SAF scenario.

⁶¹⁴ <https://www.academie-technologies.fr/publications/la-decarbonation-du-secteur-aerien-par-la-production-de-carburants-durables-rapport-et-avis/> Working Group 2022-2023

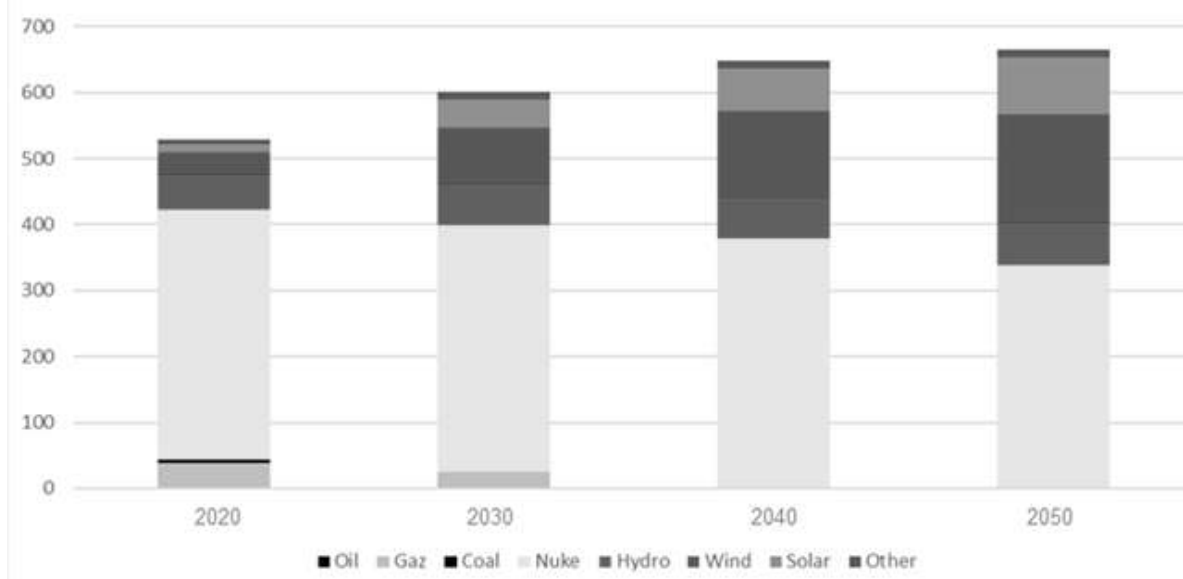

FIGURE 157 Total electricity production in France in 2050 according to RTE N03 reference scenario, in TWh, source RTE ⁶¹⁵

As shown in FIGURE 157 above, the production of electricity in France, according to the national distributor RTE will climb from just above 500 in 2020, to 645 TWh per year in 2050. While the carbon intensity of the electricity, as well as the availability, are not a concern, the 645 TWh should be considered as a maximum since it supposes a +30% increase compared to 2020, along with the replacement of most of the nuclear plant currently in service in the country. A challenge in itself.

The SAF BAU scenario is out of reach, as it would require more than 500 TWh, equivalent to almost the total electricity production of the country in 2050. As for the rest of the world, and despite significant assets in biomass and electricity production, France is no exception, and cannot accept a business-as-usual scenario. The mean scenario, 85 TWh, would require 13% of the total electricity production, while the high scenario, 210 TWh would reach 32%. These needs are not considered in none of the RTE scenarios.

The differences between the mean, 85 TWh, and the high, 210 TWh, is significant, but this goes beyond the need for additional production. Indeed, in the above-mentioned reference mix, a significant amount of additional electricity is produced in excess of the grid requirements of conventional consumers, due to intermittency, from 80 to 100 TWh. This additional flow of electricity can be harnessed by new electro-intensive economic applications, such as the production of efuel, without jeopardizing the supply of conventional consumers, if the production units are fully integrated ⁷⁴. This additional electricity is characterized by a guaranteed availability rate of less than 100%. Thus, the above reference mix makes it possible to generate a low-carbon electricity reserve which would be equal to 80 TWh, with an availability factor of over 80% ⁶¹⁴. It is important to note that this additional electricity does not require the addition of any generator specific to the efuel production, as it is the natural by-product of a mix sized to satisfy the grid of usual consumers if the proportion of intermittency is significant. It is also important to note that such intermittency should remain macro, as electrolyzers do not cope well with inputs fluctuations, and planned. It is considered that the load factor must be above 80% to allow electrolyzers to run efficiently, while allowing a decent return on investment ⁶¹⁶. Within the current scenarios of RTE, this means that efuel production will compete with export for up to 100 TWh, which could be in line with the mean scenario. For the high scenario, the difference, approximately another 100 TWh, would most probably need to be imported.

⁶¹⁵ https://assets.rte-france.com/prod/public/2021-10/Futurs-Energetiques-2050-principaux-resultats_0.pdf pages 16 and 17, accessed August 13, 2024

⁶¹⁶ Interviews and SAF Working Group with Khimod, Elyse Energy, Académie des Technologies

III.I.2.2. Regional assessment: Nouvelle Aquitaine

The proposed assessment for the region is based on the E-CHO project which is located in Lacq, Nouvelle Aquitaine.

There are several reasons to justify this proposal: France's largest region by area, Nouvelle Aquitaine is larger than half the countries in the European Union and it holds one of the largest European forests⁶¹⁷, 1.3 million hectares, and therefore a significant potential in forestry residues. Third region by the population, it has significant low carbon electricity production and it is a net exporting region, producing 52.7 TWh in 2023⁶¹⁸, representing 10.7% of the country's production.

The region has therefore significant assets to host a SAF production unit such as E-CHO.

The E-CHO project is led by Elyse Energy⁶¹⁹ with several other partners: Avril, Axens and IFP Investissements, aiming to use the BioTJet technology⁶²⁰ to produce ebiofuel (in this process the biomass conversion yield is increased with adding H₂). Three units are planned, all located within the same perimeter: production of 72 000 tons of H₂ per year from water electrolysis produced using low carbon electricity, including nuclear power; production of 75 000 tons of efuel along with 35 000 tons of naphtha from forestry and possibly agricultural residues with adjunction of hydrogen via gasification and the Fischer-Tropsch process; production of 200 000 tons of e-methanol.

It is noted here that the process proposed by E-CHO is highly efficient since adding H₂ during the gasification of the biomass double the conversion yield. Instead of producing biofuel on one hand and efuel on the other hand, it is indeed much more efficient to boost the available with H₂ before completing with efuel. The process can be summarized: biomass → gasification + H₂ input → syngas → FT synthesis → ebiofuel. As such 1 Mt of ebiofuel requires 10 TWh of electricity for the H₂ production, and 3.6 Mt of dry biomass⁶¹⁴.

The inputs to produce these molecules are 300 000 tons of dry forestry residues and potentially agricultural residues, equivalent to 500 000 tons of wet biomass, and 4 TWh of electricity. These numbers are significant, moreover since these inputs shall be issued from local feedstocks. This project therefore raises the delicate issue of scaling up, and by the same token the need for sober use.

The project itself seems however to be relevant because it responds to:

- The need to decarbonize the energy for air mobility
- The need to answer the regulation, as ReFuel Aviation requires a share of efuel as soon as 2030, and ebiofuel should fall within this category
- Feedstocks optimization since, as long as biomass is accessible, doubling the biomass yield with H₂ injection production increases the overall efficiency (rather than a separate efuel / biofuel production)

While issues with importations are addressed in the next chapter, it is highlighted here that producing within the European Union (EU) provides safeguards as it means complying with strict regulations, including a strict control of the type of resources authorized whether the carbon intensity of electricity and biomass or CO₂ sources.

Scaling up: Compared to the demand BAU, optimistic and mean SAF scenarios, E-CHO will offer 0.5% / 1.3% / 4% of the required SAF volume, respectively. Yet it should mobilize the equivalent of 8% of the electricity production and 41 to 57 % of the forestry residues available in the Nouvelle Aquitaine region⁶²¹. Not mentioning the effects on climate change, there are many issues associated with managing forest biomass, ranging from the preservation of nature and biodiversity in a naturalistic approach, to the management and maintenance proposed by silviculturists, but also land pressure and urban sprawl, as emphasized by Aude Pottier in *the forest of Landes de Gascogne as a natural heritage?*

⁶¹⁷ <https://inventaire-forestier.ign.fr/spip.php?article875> accessed August 13, 2024

⁶¹⁸ <https://www.rte-france.com/actualites/bilan-electrique-nouvelle-aquitaine-2023> accessed August 13, 2024

⁶¹⁹ Interviews with Elyse Energies

⁶²⁰ <https://www.ifpenergiesnouvelles.com/innovation-and-industry/our-expertise/renewable-energies/biofuels-and-e-fuels/our-solutions> accessed August 13, 2024

⁶²¹ Pierre Biscay, analyse E-CHO, pages 20 and 21,

<https://docs.google.com/document/d/1bD7ZYeHg5mMVymwW5uSEya8oMT9nDcFE/edit?pli=1> accessed August 13, 2024

Scales, stakes, values, part 4 chapter 10 ⁶²². Indeed, several NGOs are contesting this project ⁶²³, while the existing biomass users are underlining the associated conflicts of use.

It is therefore highly likely that the region will not be able to support more than 1 site such as E-CHO due to biomass access. Extrapolating these results to France, there could be a maximum of 1 to 2 similar units. It is noted here that the resources in water (pure), are not yet considered.

As introduced above, the region of Nouvelle Aquitaine has significant biomass and low carbon electricity assets, and it could be extrapolated that such limits would apply to most countries. Access to biomass combined with access to significant volumes of low-carbon electricity with a high load factor is a difficult equation and only a few regions in the world are currently combining these two assets: France, Sweden, Norway, Quebec, and North of Brazil.

As for the national assessment, the regional assessment concludes that if there is an opportunity to produce SAF, scalability is a major issue, and SAF will be produced in limited quantities. The mean scenario, 156 Mt of SAF, being more credible than the high, 307 Mt.

III.1.2.3. Impact on Jobs

Producing a man-made fuel requires feedstocks, capital, but also workforce, and the jobs associated to the transition should have a positive impact within our societies.

Jobs are found to be mainly associated to farming, logistic and processing for biofuels while engineering, equipment, and construction are mainly at stake for producing efuels.

While data are found for biofuels in IEA World Energy Employment report 2023 ⁶²⁴, a specific model for efuels, including ebiofuel, has to be proposed since no specific data were found. This model includes the entire value chain: from the construction and maintenance of low carbon electricity production and distribution, to the SAF production and final delivery to airports.

In the IEA report it was found that the global power sector employment, 20 million in 2022, including jobs associated for the construction and maintenance of power grids: transmission, distribution and storage. Storage refers only to battery storage, including both on grid and distributed batteries while pumped storage hydro is included in hydropower in the report. More than half of power sector jobs, or around 11 million, are in the operations and maintenance of existing capacity: these are perennials and mostly qualified and non-exportable jobs once the production units are in operation.

Manufacturing power system equipment totals approximately 3 million jobs while building power plants, dams, grids and mounting systems for solar PV panels employs just above 6 million jobs. Global power generation accounted for an estimated 12.5 million jobs in 2022, of which 3.9 million worked in solar PV, 2 million in hydropower and 1.7 million in coal power. Wind power, including onshore and offshore, employed slightly over 1.5 million and nuclear power 1 million. Employment in hydropower surpassed that in coal power generation in 2022, ranking second only to solar PV. Clean energy accounted for more than 75% of all the jobs in power generation. The report also highlights that the transition for brown jobs to green jobs should take approximately 4 weeks, which could provide the required skills to build and maintain a significant quantity of SAF production units.

For biofuels, for each Mt produced, there are 37 000 jobs. If the feedstock is imported, the split is found to be 32 000 jobs for farming, collecting, transporting, and 5 000 jobs for processing ⁶²⁵.

⁶²² Aude Pottier, the forest of Landes de Gascogne as a natural heritage ? *Scales, stakes, values, part 4 chapter 10* <https://theses.fr/2012PAUU1011> accessed August 13, 2024

⁶²³ <https://www.e-cho-concertation.fr/2/1698/lire-les-cahiers-dacteurs-deposes/contributions> accessed August 13, 2024

⁶²⁴ <https://www.iea.org/reports/world-energy-employment-2023> accessed August 13, 2024

⁶²⁵ https://transport.ec.europa.eu/transport-themes/clean-transport/alternative-fuels-sustainable-mobility-europe/renewable-and-low-carbon-fuels-value-chain-industrial-alliance_en RLCF SAF working group 2022-2024

For fuels, the hypothesis are based on production units equivalent to the size of E-CHO, mentioned above, or 0.1 kt of efuel for aviation per year. Each unit must be associated with low carbon electricity production, with an overall lifetime of 20 years for all production units.

The main hypotheses are:

- No co-products: 100% of the production is dedicated to efuel for aviation (SAF)
- Slight improvement in efficiency: 0.1 Mt requires 2,5 TWh of electricity and 4 GW of electrolyzers
- Associated CAPEX: 1 B€ / 0.1 Mt for efuel production unit (including electrolyzers) + 3.5 B€ for the electricity generation and associated grid (2.5 TWh)
- Jobs as share of CAPEX break down in 10 to 15% for engineering, 30 to 35% for construction and 30 to 35% for equipment (including stacks)⁶²⁶
- Locations are 100% within EU for engineering, 100% within EU for construction, 40 to 50% within EU for equipment's
- Running the plant: 200 jobs (benchmark E-CHO) + 20 jobs for transport (in and out)

eFuel / Jobs		2029	2030	2031	2032	2033	2034	2035	2036	2037	2038	2039	2040	2041	2042	2043	2044	2045	2046	2047	2048	2049	2050
0.1 Mt eFuel Units	built / year	1	1	1	1	1	1	1	1	1	1	1	1	1	1	1	1	1	1	1	1	1	1
Units in Operations	total in op	1	2	3	4	5	6	7	8	9	10	11	12	13	14	15	16	17	18	18	18	18	18
TWh of electricity	2,5	3	5	8	10	13	15	18	20	23	25	28	30	33	35	38	40	43	45	45	45	45	45
O&M jobs / unit	200	200	400	600	800	1000	1200	1400	1600	1800	2000	2200	2400	2600	2800	3000	3200	3400	3600	3600	3600	3600	3600
T&D jobs / unit	20	20	40	60	80	100	120	140	160	180	200	220	240	260	280	300	320	340	360	360	360	360	360
CAPEX Unit, M€	1000	1000	1000	1000	1000	1000	1000	1000	1000	1000	1000	1000	1000	1000	1000	1000	1000	1000	1000	1000	1000	1000	1000
CAPEX Lce + grid, M€	2750	2750	2750	2750	2750	2750	2750	2750	2750	2750	2750	2750	2750	2750	2750	2750	2750	2750	2750	2750	2750	2750	2750
Eng.jobs CAPEX / Lce	10%	1375	1375	1375	1375	1375	1375	1375	1375	1375	1375	1375	1375	1375	1375	1375	1375	1375	1375	1375	1375	1375	1375
Eng.jobs CAPEX / Unit	15%	750	750	750	750	750	750	750	750	750	750	750	750	750	750	750	750	750	750	750	750	750	750
Construction jobs CAPEX / Lce	35%	9625	9625	9625	9625	9625	9625	9625	9625	9625	9625	9625	9625	9625	9625	9625	9625	9625	9625	9625	9625	9625	9625
Construction jobs CAPEX / Unit	25%	2500	2500	2500	2500	2500	2500	2500	2500	2500	2500	2500	2500	2500	2500	2500	2500	2500	2500	2500	2500	2500	2500
Equipment Jobs CAPEX / Lce	30%	2200	2200	2200	2200	2200	2200	2200	2200	2200	2200	2200	2200	2200	2200	2200	2200	2200	2200	2200	2200	2200	2200
Equipment Jobs CAPEX / Unit	40%	1333	1333	1333	1333	1333	1333	1333	1333	1333	1333	1333	1333	1333	1333	1333	1333	1333	1333	1333	1333	1333	1333
Total Jobs in France for 1.8 Mt		18003	18223	18443	18663	18883	19103	19323	19543	19763	19983	20203	20423	20643	20863	21083	21303	21523	21743	21743	21743	21743	21743
Total CAPEX / Year	M€	3750	3750	3750	3750	3750	3750	3750	3750	3750	3750	3750	3750	3750	3750	3750	3750	3750	3750	3750	3750	3750	3750

TABLE 47 Number of jobs and break down per activity for 18 units producing 0.1 Mt of efuel each in 2050, here according to the mean SAF scenario, source Jean-Baptiste Jarin

In TABLE 47 above are provided the break down and total sum of jobs for the mean SAF scenario, which would require 1.8 Mt of efuel, for France. These 22 000 jobs, or 12 000 jobs per Mt of efuel, are direct jobs which means that indirect and induced jobs would increase this number.

While most of the jobs are non-exportable, it is important to understand, as shown in FIGURE 158 which details the associated job break-down, that most of the jobs are associated with the development and construction of the production units. The hypothesis being that a unit lifetime being 20 years, there would be a permanent rotation of one construction unit per year, thus safeguarding jobs and skills.

With these numbers, the SAF mean scenario for France (2 Mt of biofuel and 1.8 Mt of efuel), would generate almost 100 000 direct jobs, mostly in the biomass and the construction sectors, if the molecules are fully produced within the country. Along with sovereignty, this impact on jobs could facilitate public acceptance.

⁶²⁶ Interviews with Khimod, Elyse Energy, UPEI, Exxon, RLCF SAF working group

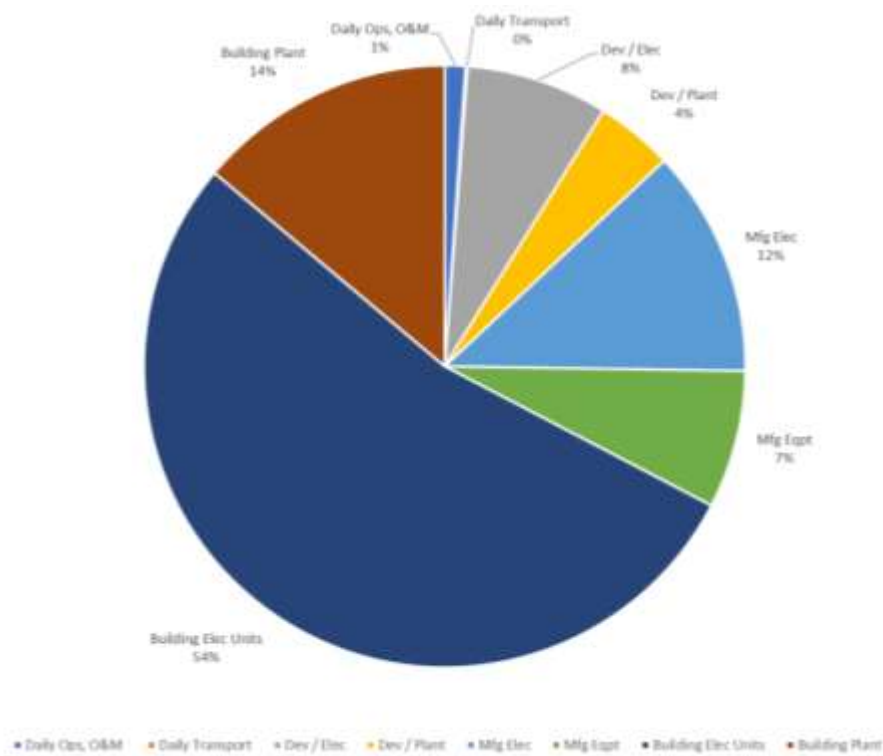

FIGURE 158 Evaluation of jobs associated to the efuel production, with breakdown by category. 12 000 direct jobs per Mt production unit when including low carbon electricity production and distribution, source Jean-Baptiste Jarin

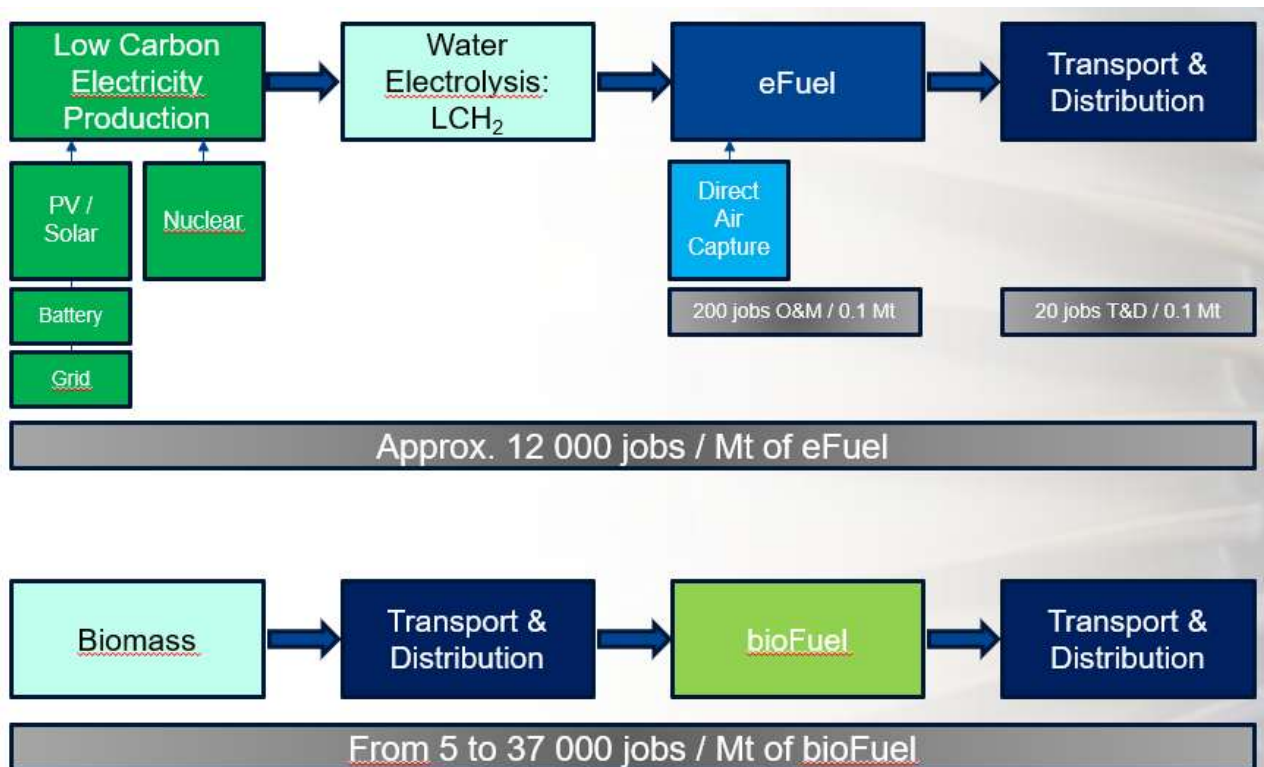

FIGURE 159 Value chain and jobs overview for biofuel and efuel production, source Jean-Baptiste Jarin

III.II. Limits associated with importation and the role of energy justice

As discussed above, producing locally provides significant advantages, but it also would impose decision makers to integrate the reality of feedstocks limits, and therefore the necessity of order of merit. Passing these efforts on to others not only seems anachronistic, but could also be a recipe for energy injustice ⁶²⁷.

Still, while most other forms of energies are generally consumed close to where they were produced, the liquid fuels have allowed for international trade, and in 2023 oil tankers accounted for around 29 percent of global seaborne trade ⁶²⁸. Importing SAF is therefore on the agenda of most developed countries, as well as in the agenda of the potential exporting countries.

In the previous chapter, it has been highlighted the extraordinary sum of assets required to produce biofuels and efuels. Even a gifted country, in both biomass and low carbon electricity, such as France, would struggle in producing more than a couple million tons of SAF per year, which is far from covering its own needs.

It is found therefore necessary to evaluate the possibility of importing SAF, and most broadly efuels, and producing low carbon hydrogen and / or efuel is looked after by many countries, organizations, and consulting firms, some already qualifying the Global South, such as Africa, as a new “*green hydrogen El Dorado*” ⁶²⁹.

This evaluation should come with the prism of energy justice, as most of the countries cited have not yet reached the development level of the potential importers, namely European Union, USA and Japan. A north vs south is emerging, and avoiding replicating the oil curse, which means ensuring that the global south has not only a physical potential, but also a societal potential. And since low carbon electricity is at stake, it will also be important to evaluate this potential with the countries NDCs commitments, to avoid that newly installed low carbon electricity production serves export, instead of the country’s decarbonization.

III.II.1. Exporting from the Global South

This chapter is built upon the work jointly realized with co-authors, led by Halima Hussein, and published in the Journal of Energy and Natural Resources Law ⁶³⁰.

As discussed above, aviation is a hard to abate sector and efuels are found to be necessary. This production of efuel would require significant volumes of low carbon dihydrogen (H₂) to be produced. Some estimation places green hydrogen poised to become a US\$10 trillion addressable market by 2050 ⁶³¹, with significant geopolitical impacts ⁶³².

The majority of the conversation analyzing policies and strategies for green hydrogen is confined to the Global North, driven by academic interest, concern and funding ⁶³³. However, in the near future, population growth, carbon

⁶²⁷ <https://www.socialeurope.eu/eu-hydrogen-import-targets-a-neo-colonial-resource-grab> accessed August 13, 2024

⁶²⁸ <https://www.statista.com/statistics/267605/capacity-of-oil-tankers-in-the-world-maritime-trade-since-1980/> accessed August 13, 2024

⁶²⁹ <https://www.spglobal.com/commodityinsights/en/ci/research-analysis/africa-green-hydrogen.html> accessed August 13, 2024

⁶³⁰ Hussein, H. I., Heffron, R. J., Phillips, A., Jarin, J. B., & Basil, C. V. (2024). Future-proofing for green hydrogen in the Global South: a procedural justice perspective. *Journal of Energy & Natural Resources Law*, 42(3), 343–361. <https://doi.org/10.1080/1031461X.2024.2345007>

⁶³¹ Goldman Sachs, ‘Green Hydrogen: The next transformational driver of the utilities industry’, <https://www.goldmansachs.com/intelligence/pages/gs-research/green-hydrogen/report.pdf> accessed August 13, 2024

⁶³² R. Scita et al, ‘Green hydrogen: the holy grail of decarbonization? An analysis of the technical and geopolitical implications of the future hydrogen economy’, FEEM Working Paper No. 13.2020

https://papers.ssrn.com/sol3/papers.cfm?abstract_id=3709789 accessed August 13, 2024

⁶³³ Benjamin K. Sovacool, Chad M. Baum, Sean Low, Reviewing the sociotechnical dynamics of carbon removal, Joule,

emissions, economic power and technological innovations will shift to the Global South⁶³⁴. In addition, green hydrogen policy and regulation is still in its formative stage, giving policy makers a unique opportunity to formulate legal frameworks aligned to the best practices in the sector⁶³⁵, what is also known as future-proofing⁶³⁶. Using a combination of doctrinal and comparative law methodologies, this chapter analyses green hydrogen plans and policies in Brazil, Chile, South Africa, and Namibia, using the lens of procedural justice.

III.II.1.1. Procedural justice

Energy justice⁹¹ has established itself as a leading interdisciplinary energy research subject in the past decade. It is a conceptual framework which identifies when and where injustices occur, especially in low carbon transitions, and how best legal frameworks can address these injustices⁶³⁷. To deliver energy justice, five forms of justice are critical, and these include distributive, procedural, restorative, recognition, and cosmopolitan justice. Given that green hydrogen policy is very much still in the formative stage, energy justice is the perfect theory to identify injustices before they occur.

Establishing whether legal process has been followed, considering the development of the legal system and whether there is access to justice is defined as procedural justice⁶³⁸. Droubi and others add to this definition in providing that procedural justice concerns whether all the required legal steps are adhered to and that the full steps ordinarily required in an environmental impact assessment are also complied with⁶³⁹. Vega-Araujo define procedural justice to be whether due process has been followed including whether '*affected stakeholders took part in the decision-making*'⁶⁴⁰.

Procedural justice being implemented through a social contract shall consider three issues : governance issues in the energy sector to ensure all energy activities are treated as part of one system; due process in the design of the energy system that entails both public participation as well as transparency when making decisions; and disclosure of information and information asymmetry across energy activities and across different jurisdictions⁶⁴¹.

III.II.1.2. Future Proofing

Future proofing is important because the world is changing and in future decision-makers will not be able to rely on their political or corporate office to escape charges of contributory negligence on the decisions they made on energy in light of negative climate change impacting future generations. In essence, future proofing means that in the future,

Volume 7, Issue 1, 2023, Pages 57-82, ISSN 2542-4351, <https://doi.org/10.1016/j.joule.2022.11.008>

⁶³⁴ Benjamin K. Sovacool, Expanding carbon removal to the Global South: Thematic concerns on systems, justice, and climate governance, *Energy and Climate Change*, Volume 4, 2023, 100103, ISSN 2666-2787, <https://doi.org/10.1016/j.egycc.2023.100103>

⁶³⁵ Green Hydrogen Organization, Green hydrogen contracting - policy and regulatory Developments, https://greenhydrogen2.org/sites/default/files/2022-05/1.%20Brief%20on%20Policy%20and%20regulatory%20developments%20-%20reviewed%20by%20HSF%20and%20GREEN%20HYDROGEN%20-%20for%20final%20WG%20comment_0.pdf accessed August 13, 2024

⁶³⁶ R J Heffron, 'Repurposing for the just transition: energy companies need to future-proof their structure and strategy' *The Journal of World Energy Law & Business*, Volume 16, Issue 3, June 2023, Pages 302-307

⁶³⁷ R.J. Heffron and D. McCauley, 'Achieving sustainable supply chains through energy justice', *Appl. Energy*, 123 (2014), pp. 435-437, and B.K. Sovacool and M.H. Dworkin, 'Energy justice: conceptual insights and practical applications' *Appl. Energy*, 142 (2015), pp. 435-444

⁶³⁸ Raphael J. Heffron, Applying energy justice into the energy transition, *Renewable and Sustainable Energy Reviews*, Volume 156, 2022, 111936, ISSN 1364-0321, <https://doi.org/10.1016/j.rser.2021.111936>

⁶³⁹ Sufyan Droubi, Raphael J. Heffron, Darren McCauley, A critical review of energy democracy: A failure to deliver justice?, *Energy Research & Social Science*, Volume 86, 2022, 102444, ISSN 2214-6296, <https://doi.org/10.1016/j.erss.2021.102444>

⁶⁴⁰ José Vega-Araújo, Raphael J. Heffron, Assessing elements of energy justice in Colombia: A case study on transmission infrastructure in La Guajira, *Energy Research & Social Science*, Volume 91, 2022, 102688, ISSN 2214-6296, <https://doi.org/10.1016/j.erss.2022.102688>

⁶⁴¹ Heffron, Raphael & de Fontenelle, Louis. (2023). Implementing energy justice through a new social contract. *Journal of Energy & Natural Resources Law*. 41. 141-155. 10.1080/02646811.2023.2186626 <http://dx.doi.org/10.1080/02646811.2023.2186626>

an energy stakeholder must be able to state at a respective juncture in the past, when they had to make a strategic decision, they made a decision that relied on existing best practice in that field ⁶³⁶. This resonates with the aforementioned notion of technological neutrality ⁴⁰⁶.

Inclusion of methodologies in energy studies has become established in the past decade ⁶⁴². The law itself must be analyzed, here the primary sources of law for green hydrogen including statutes or regulations. Using comparative legal research method ⁶⁴³ allows to study the similarities, and dissimilarities ⁶⁴⁴, of the green hydrogen pathways of the different countries reviewed.

Selection of Countries

These countries must share similarities as well as differences ⁶⁴⁵. Still, they must be issued from the Global South and are considered green hydrogen policy pathways of Brazil, Chile, South Africa, and Namibia.

The first set of similarities is that each of these countries has either formulated a green hydrogen policy, strategy, or law, or given an indication to do so, and has gone further to either produce a green hydrogen project, or has one in the pipeline. All these countries satisfy these two criteria.

In addition, and in order to have reliable outcomes from the comparative legal methodology, some differences among the nine countries must exist. Again, here with varied differences in population, electricity access, Gross Domestic Product (GDP), energy production, renewables share in the electricity grid, Carbon dioxide (CO₂) emissions and Paris Agreement emission targets. These dissimilarities provide an opportunity for other countries to compare their situations with those most similar to them amongst these countries, and learn from their lessons, which would not have been the case had countries that have similar economic rankings, energy scenarios or green hydrogen statuses been chosen.

Analysis of Existing Green Hydrogen Literature

There is limited literature in the area of green hydrogen and energy justice. Indeed, existing authors who have attempted to discuss this topic agree on this issue ^{646 647 648}, and there is a need for more research in the social sciences and humanities as *“it cannot currently cope with the pace of political action and technological development”*.

The International Renewable Energy Agency (IRENA) in a survey report on the impact of hydrogen on sustainable development posits that a shift towards the hydrogen economy would promote just outcomes ⁶⁴⁹. More research

⁶⁴² James Goodman, Jonathan Paul Marshall, Problems of methodology and method in climate and energy research: Socialising climate change?, *Energy Research & Social Science*, Volume 45, 2018, Pages 1-11, ISSN 2214-6296, <https://doi.org/10.1016/j.erss.2018.08.010>

⁶⁴³ Tuomas Ylä-Anttila, Antti Gronow, Mark C.J. Stoddart, Jeffrey Broadbent, Volker Schneider, David B. Tindall, Climate change policy networks: Why and how to compare them across countries, *Energy Research & Social Science*, Volume 45, 2018, Pages 258-265, ISSN 2214-6296, <https://doi.org/10.1016/j.erss.2018.06.020>

⁶⁴⁴ L. Hantrais, *International Comparative Research: Theory, (Palgrave Macmillan, Methods and Practice, 2009)*

⁶⁴⁵ G. Dannemann, *Comparative Law: Studies of Similarities or Differences*, in *The Oxford Handbook of Comparative Law*, OUP, 2006, p. 397 & 398, <http://dx.doi.org/10.1093/oxfordhb/9780199296064.013.0012>

⁶⁴⁶ Matthew Scott, Gareth Powells, Towards a new social science research agenda for hydrogen transitions: Social practices, energy justice, and place attachment, *Energy Research & Social Science*, Volume 61, 2020, 101346, ISSN 2214-6296, <https://doi.org/10.1016/j.erss.2019.101346>

⁶⁴⁷ Pasquale Marcello Falcone, Michael Hiete, Alessandro Sapio, Hydrogen economy and sustainable development goals: Review and policy insights, *Current Opinion in Green and Sustainable Chemistry*, Volume 31, 2021, 100506, ISSN 2452-2236, <https://doi.org/10.1016/j.cogsc.2021.100506>

⁶⁴⁸ F. Hanusch and M. Schad, Hydrogen research: technology first, society second? *GAIA Ecol Perspect Sci Soc*, 30 (2) (2021), pp. 82-86, <http://dx.doi.org/10.1016/j.erss.2019.101346>

⁶⁴⁹ IRENA, *Geopolitics of the energy transformation: the hydrogen factor* <https://www.irena.org/publications/2022/Jan/Geopolitics-of-the-Energy-Transformation-Hydrogen> accessed August 13, 2024

disagree^{650 651 652}, and they warn that the assumption that justices related to low carbon development pathways will be inherently positive is misguided if there is in essence no procedural justice mechanism to operate the sector. Further research^{653 654} support this latter position and states that just as energy systems undergo environmental sustainability assessments so must the hydrogen economy undergo a justice analysis. There is also research which explores hydrogen and the United Nations Sustainable Development Goals (SDGs) and this found that while the hydrogen economy supports SDG 7 on affordable, clean and modern energy accessibility for all, there are also trade-offs: it identified injustices on the distribution of finance, technology and geopolitics⁶⁴⁷.

None of the literature addresses completely procedural justice in its discussion of green hydrogen, and yet they propose solutions that in essence are about the application and implementation of procedural justice. Following the above analysis, it is evident that there is limited literature in the area of green hydrogen and energy justice in general. There is yet also limited literature in procedural justice, internationally and in the global south.

III.II.1.3. Review of Green Hydrogen Policy and Energy Scenarios for the selected countries

As discussed above producing efuel and / or hydrogen requires significant quantities of electricity and there shall be a priority to decarbonize current energy systems⁶⁵⁵.

It is thus important to identify the current renewable energy sources in the selected countries, and identify the potential for scale up of this renewable energy through the published climate targets of each country, TABLE 48.

Country	Energy Sources and Climate targets
Brazil	In Brazil, the target of net zero by 2050 is backed by emission targets of 53.1% relative to the 2005 business as usual scenario ⁶⁵⁶ . However, with 386 Mt of carbon dioxide emissions as of 2020 ⁶⁵⁷ and increasing droughts impacting the hydroelectric production, the renewables currently at 80% of the electricity grid will reduce as the country is increasing its fossil fuel electricity production, and the correspondent CO ₂ emissions is expected to increase in the coming years ⁶⁵⁸ .

⁶⁵⁰ Sovacool, B.K., Martiskainen, M., Hook, A. *et al.* Decarbonization and its discontents: a critical energy justice perspective on four low-carbon transitions. *Climatic Change* **155**, 581–619 (2019). <https://doi.org/10.1007/s10584-019-02521-7>

⁶⁵¹ W.F. Lamb, et al, What are the social outcomes of climate policies? A systematic map and review of the ex-post literature *Environ Res Lett*, (2020) 15 (11),113006 <https://iopscience.iop.org/article/10.1088/1748-9326/abc11f>

⁶⁵² Noel Healy, Jennie C. Stephens, Stephanie A. Malin, Embodied energy injustices: Unveiling and politicizing the transboundary harms of fossil fuel extractivism and fossil fuel supply chains, *Energy Research & Social Science*, Volume 48, 2019, Pages 219-234, ISSN 2214-6296, <https://doi.org/10.1016/j.erss.2018.09.016>

⁶⁵³ K. Raworth, Doughnut economics: seven ways to think like a 21st-century economist, <http://dx.doi.org/10.33568/rbs.2409>

⁶⁵⁴ Mo Li, Thomas Wiedmann, Kai Fang, Michalis Hadjikakou, The role of planetary boundaries in assessing absolute environmental sustainability across scales, *Environment International*, Volume 152, 2021, 106475, ISSN 0160-4120, <https://doi.org/10.1016/j.envint.2021.106475>

⁶⁵⁵ Alessandro Giocoli, Vincenzo Motola, Nicolae Scarlat, Nicola Pierro, Sebastiano Dipinto, Techno-economic viability of renewable electricity surplus to green hydrogen and biomethane, for a future sustainable energy system: Hints from Southern Italy, *Renewable and Sustainable Energy Transition*, Volume 3, 2023, 100051, ISSN 2667-095X, <https://doi.org/10.1016/j.rset.2023.100051>

⁶⁵⁶ UNFCCC, Brazil first NDC 2023 adjustment, <https://unfccc.int/sites/default/files/NDC/2023-11/Brazil%20First%20NDC%202023%20adjustment.pdf> accessed August 13, 2024

⁶⁵⁷ International Energy Agency, China, <https://www.iea.org/countries/china> accessed August 13, 2024

⁶⁵⁸ Cuartas, L.A.; Cunha, A.P.M.d.A.; Alves, J.A.; Parra, L.M.P.; Deusdará-Leal, K.; Costa, L.C.O.; Molina, R.D.; Amore, D.; Broedel, E.; Seluchi, M.E.; et al. Recent Hydrological Droughts in Brazil and Their Impact on Hydropower Generation. *Water* **2022**, *14*, 601. <https://doi.org/10.3390/w14040601>

Chile	Chile targets net zero by 2050 ⁶⁵⁹ . Given its 83 Mt of carbon dioxide emissions as of 2020 ⁶⁶⁰ it seeks to reduce these emissions by 45 % relative to the business as usual scenario. Its energy generation comes from hydro, gas, oil, and coal, with renewables constituting 49% of the electricity grid ⁶⁶¹ . Given wind capacities with load factors of up to 60% in the south, hydrogen projects have become a priority of the government ⁶⁶² .
Namibia	Namibia targets net zero goals by 2050 ⁶⁶³ . Given its 3.5 Mt of carbon dioxide emissions as of 2020 ⁶⁶⁴ it seeks to reduce these emissions by 14% relative to the business as usual scenario. Namibia's main energy sources are hydropower, imported electricity and imported coal and oil ⁶⁶⁵ . Renewables make up 24% of the grid installed energy while the country is one of the ten-largest uranium sources in the world providing 8.2% of global production ⁶⁶⁶ .
South Africa	South Africa targets net zero goals by 2050 ⁶⁶⁷ . Given its 386 Mt of carbon dioxide emissions as of 2020 ⁶⁶⁸ it seeks to reduce these emissions by a range of 350-420 metric tons of carbon dioxide equivalent relative to the business as usual scenario. Coal which constitutes 70% of installed capacity is still today the backbone of South Africa's electricity system ⁶⁶⁹ . South Africa is looking to transition justly from coal through in its 2019 Integrated Resource Plan ⁶⁷⁰ .

TABLE 48 Overview of the selected countries, source Jean-Batiste Jarin and Halima Hussein

As the above table evidences, South Africa at 20%, Namibia at 24% shares of renewables in the electricity mix need to rapidly increase their renewables production in order to first decarbonize their electricity mix before potentially absorbing green hydrogen into the energy mix. While Brazil has 80% of renewable electricity in its grid, the recent drought affected the hydro-electricity production and it should be carefully considered whist the wind potential in the north east of the county represent a potential opportunity. Similarly, Chile at 49% renewables in the electricity grid has wind capacities with load factors up to 60% in the south, which indicates some potential of scale up of renewable energy for green hydrogen.

III.II.1.4. Green Hydrogen Policies

While no countries are yet in position to propose low carbon electricity to produce low carbon hydrogen as it would in parallel increase their grid carbon intensity, some countries have a potential for scaling up low carbon electricity from renewables. However, the socio-economic makeup of the selected countries as well as their policy and legislation is not always capable of supporting such a green hydrogen economy, this is addressed in the next chapter (III.II.2.). A

⁶⁵⁹ UNFCCC, Submission of Chile,

[https://unfccc.int/sites/default/files/resource/Submission%20 of%20Chile %20KCI Act.11%20-%20rev.pdf](https://unfccc.int/sites/default/files/resource/Submission%20of%20Chile%20KCI%20Act.11%20-%20rev.pdf) accessed August 13, 2024

⁶⁶⁰ International Energy Agency, China, <https://www.iea.org/countries/china> accessed August 13, 2024

⁶⁶¹ International Energy Agency, Chile, <https://www.iea.org/countries/chile> accessed August 13, 2024

⁶⁶² Mattar, C.; Cabello-Españon, F.; Alonso-de-Linaje, N.G. Towards a Future Scenario for Offshore Wind Energy in Chile: Breaking the Paradigm. Sustainability 2021, 13, 7013. <https://doi.org/10.3390/su13137013>

⁶⁶³ UNFCCC, Namibia's NDC Update, [https://unfccc.int/sites/default/files/NDC/2022-](https://unfccc.int/sites/default/files/NDC/2022-06/Namibia%27s%20Updated%20NDC%20FINAL%2025%20July%202021.pdf)

[06/Namibia%27s%20Updated%20NDC %20FINAL%2025%20July%202021.pdf](https://unfccc.int/sites/default/files/NDC/2022-06/Namibia%27s%20Updated%20NDC%20FINAL%2025%20July%202021.pdf) accessed August 13, 2024

⁶⁶⁴ International Energy Agency, Namibia, <https://www.iea.org/countries/namibia> accessed August 13, 2024

⁶⁶⁵ USAID, Power Africa in Namibia, <https://www.usaid.gov/powerafrica/namibia> accessed August 13, 2024

⁶⁶⁶ International Energy Agency, Namibia, <https://www.iea.org/countries/namibia> accessed August 13, 2024

⁶⁶⁷ UNFCCC, South Africa's Intended Nationally determined Contribution, <https://unfccc.int/sites/default/files/NDC/2022-06/South%20Africa.pdf> accessed August 13, 2024

⁶⁶⁸ International Energy Agency, South Africa, <https://www.iea.org/countries/southafrica> accessed August 13, 2024

⁶⁶⁹ International Energy Agency, Namibia, <https://www.iea.org/countries/namibia> accessed August 13, 2024

⁶⁷⁰ Department of Mineral Resources and Energy, Integrated Resource Plan, 2019, Department of Mineral Resources and Energy, 2020, <https://www.energy.gov.za/irp/2019/IRP-2019.pdf> accessed August 13, 2024

similarity in Namibia, South Africa, Brazil, and Chile⁶⁷¹, is that the Federal Government of Germany appears either as a partner or investor in the green hydrogen projects and policies of these countries. There are however significant dissimilarities in the existence of policies, the socio economics of the respective countries, as well as the existence of green hydrogen projects.

In Brazil, even though the public flow to renewables keeps growing, almost US \$1B by 2020⁶⁷², droughts have impacted hydroelectric production, shifting the country towards fossil fuels and carbon emissions raised⁶⁷³. In early 2023, the Brazilian government attempted to put a stop gap to this by publishing a decree to kickstart offshore wind power in the country⁶⁷⁴. Yet, Brazil does not have a legal framework to govern green hydrogen, and it only has skeletal Guidelines for a National Hydrogen Program published in 2021⁶⁷⁵. There are currently only two small green hydrogen units are operational in the North East, cumulating less than 1 kt of green H₂⁶⁷⁶. In November, 2023, Brazil's lower house passed Bill No. 2308/2023, on green hydrogen⁶⁷⁷ and sent it to the Senate for approval in a push to promote green hydrogen production.

Chile seems to have potential and could use its future renewable electricity capacities, especially in wind, in becoming a major producer of green hydrogen in the coming years⁶⁷⁸. Still, the country does not have in place a legislation to govern green hydrogen development despite a hydrogen strategy and this hampers potential swift progress of the industry⁶⁷⁹. Even so, while only a few production facilities are operating with a very limited 0.25 kt annual green hydrogen production, several projects (6) are currently under feasibility studies, mainly in the southern part of the country, which offers significant wind capacities with load factors of up to 60%⁶⁸⁰. The potential final investment decisions could decide if, whether or not, it is possible to produce hydrogen from intermittent electricity sources, and if long distance transportation is worth the investment. These are significant hurdles, which comes along the need for the country to demonstrate its capacity in decarbonizing its current electricity production.

With more than 70% of coal within its electricity production⁶⁸¹ South Africa presents the hardest challenge to the take up of green hydrogen in Africa. Policy is currently lacking, as the two roadmaps released by the Department of Science and Innovation, are not enough to support their presented emission reduction targets⁶⁸². Indeed, South Africa shall not consider hydrogen production before decades, prioritizing the decarbonization of its electricity mix.

⁶⁷¹ See respective country pages of Namibia, South Africa, Brazil and Chile for policies and projects, having German affiliation, in Green Hydrogen Organisation, GH₂ Country Portal, Green Hydrogen Organisation, 2023, <https://gh2.org/countries/> accessed August 13, 2024

⁶⁷² A. Isah et al, Financing renewable energy: policy insights from Brazil and Nigeria. *Energ Sustain Soc* 13, 2, 2023 <https://doi.org/10.1186/s13705-022-00379-9>

⁶⁷³ L A Cuartas et al, Recent Hydrological Droughts in Brazil and Their Impact on Hydropower Generation, *Water* 2022, 14, <https://doi.org/10.3390/w14040601>

⁶⁷⁴ C. Demony, Exclusive: Brazil aims to pass offshore wind, green hydrogen laws by year-end, energy minister says, <https://www.reuters.com/sustainability/climate-energy/brazil-aims-pass-offshore-wind-green-hydrogen-laws-by-year-end-energy-minister-2023-06-27/> accessed August 13, 2024

⁶⁷⁵ Green Hydrogen Organisation, GH₂ Country Portal-Brazil, Green Hydrogen Organisation, 2023, <https://gh2.org/countries/brazil> accessed August 13, 2024

⁶⁷⁶ Ministerio de Minas e Energia, 2031 10 year Energy Expansion Plan, Ministerio de Minas e Energia, 2020, https://www.gov.br/mme/pt-br/assuntos/secretarias/sntep/publicacoes/plano-decenal-de-expansao-de-energia/pde-2031/english-version/relatorio_pde2031_cap12_eus.pdf accessed August 13, 2024

⁶⁷⁷ R. Parkes, Brazil's lower house passes key legislation defining green hydrogen and enabling ten-year subsidies <https://www.hydrogeninsight.com/policy/brazils-lower-house-passes-key-legislation-defining-green-hydrogen-and-enabling-ten-year-subsidies/2-1-1563291> accessed August 13, 2024

⁶⁷⁸ C Mattar et al, A techno-economic assessment of offshore wind energy in Chile, *Energy*, Volume 133, 2017, Pages 191-205 < <https://doi.org/10.1016/j.energy.2017.05.099>

⁶⁷⁹ Ministry of Energy, Government of Chile, National Green Hydrogen Strategy, Ministry of Energy, Government of Chile, 2020, https://energia.gob.cl/sites/default/files/national_green_hydrogen_strategy_-_chile.pdf accessed August 13, 2024

⁶⁸⁰ Green Hydrogen Organisation, GH₂ Country Portal-Chile, Green Hydrogen Organization, 2023, <https://gh2.org/countries/chile> accessed August 13, 2024

⁶⁸¹ International Energy Agency, South Africa, 2020, <https://www.iea.org/countries/south-africa> accessed August 13, 2024

⁶⁸² Green Hydrogen Organization, GH₂ Country Portal-South Africa, Green Hydrogen Organisation, 2023, <https://gh2.org/countries/south-africa> accessed August 13, 2024

Despite 53 % electricity access in the country, 76% of which is obtained from fossil fuels ⁶⁸³ Namibia is very active in pushing green hydrogen policy and take up by industry, in light of its abundant solar power ⁶⁸⁴. Namibia has in existence a Green Hydrogen Council which launched the country's existing policy in the field- the green hydrogen strategy, at COP27 in Egypt, to support the country's decarbonization goals ⁶⁸⁵. In 2022, the government partnered with German owned Hyphen Hydrogen Energy to develop a 300 kt / year green hydrogen project in solar and wind rich Tsau Khaeb National Park, worth \$9.4 billion ⁶⁸⁶. As for South Africa, the decarbonization of the Namibian electricity production should be the priority, along with providing electricity to its population. Indeed, as of August 2024 no projects are funded or operational, and only 2 demonstration units are under construction, with a total production below 1 kt / year ⁶⁸⁷.

III.II.1.5. Improving Procedural Justice for Green Hydrogen

The energy system should be viewed as one system encompassing the energy life cycle and it is important that countries adopt green hydrogen whilst viewing the energy system as one, with interconnected activities, as opposed to separate activities, to improve governance in the energy sector. There is a need for due process needs to be followed in the design of the energy system. Due process in designing the energy system must include both public participation and transparency in decision making to enable stakeholders make informed decisions, especially when it comes to inclusion of new forms of energy, such as green hydrogen.

South Africa's integrated resource plan updated in 2019 purports to encourage deployment of renewable energy in the country but gives no specific allocation to green hydrogen ⁶⁸⁸. South Africa lacks a specific hydrogen energy policy with only footprints and local initiatives and without a long-term green hydrogen strategy, South Africa cannot attract sustainable investments in the sector ⁶⁸⁹.

In further contrast, even though the Namibian government has taken active steps to invest in green hydrogen projects, to anchor green hydrogen into the country's energy mix and attract bigger private sector players, Namibia must revise its 1998 White Paper on Energy Policy ⁶⁹⁰ that is the mainstay of renewable energy policy in the country ⁶⁹¹. Further, and as mentioned earlier, Germany has been instrumental in the formulation of green hydrogen policies and strategies as well as investments into green hydrogen projects in Namibia. However, relying on available donor funds to commit to green hydrogen, as opposed to looking at the energy system as a whole to identify its priorities potentially could promote injustice and this country, among others, will be further studied in the next chapter.

⁶⁸³ International Energy Agency, Namibia, 2020, <https://www.iea.org/countries/namibia> accessed August 13, 2024

⁶⁸⁴ S.O'Farrell, Explainer | How green hydrogen put Namibia on the map, FDI Intelligence, 2023, <https://www.fdiintelligence.com/content/news/explainer-how-green-hydrogen-put-namibia-on-the-map-83146> accessed August 13, 2024

⁶⁸⁵ Green Hydrogen Organization, GH₂ Country Portal-South Africa, Green Hydrogen Organisation, 2023, <https://gh2.org/countries/south-africa> accessed August 13, 2024

⁶⁸⁶ Green Hydrogen Namibia, Namibia announces progress with Hyphen Hydrogen Energy to unlock \$10 Billion Investment for first green hydrogen project to help power the energy transition, Green Hydrogen Namibia, 2022, <https://gh2namibia.com/namibia-announces-progress-with-hyphen-hydrogen-energy-to-unlock-us10bn-investment-for-first-green-hydrogen-project-to-help-power-the-energy-transition/> accessed August 13, 2024

⁶⁸⁷ <https://www.iea.org/data-and-statistics/data-tools/hydrogen-production-projects-interactive-map> accessed August 13, 2024

⁶⁸⁸ Department of Mineral Resources and Energy, Integrated Resource Plan, 2019, 2020, <https://www.energy.gov.za/irp/2019/IRP-2019.pdf> accessed August 13, 2024

⁶⁸⁹ K. Imasiku et al, 'A Policy Review of Green Hydrogen Economy in Southern Africa' Sustainability 2021, 13(23), 13240, <https://doi.org/10.3390/su132313240>

⁶⁹⁰ Ministry of Mines and Energy Namibia, Energy Policy, 1998, https://www.mme.gov.na/files/publications/1e3_energy_policy_whitepaper.pdf accessed August 13, 2024

⁶⁹¹ K. Imasiku et al, 'A Policy Review of Green Hydrogen Economy in Southern Africa' Sustainability 2021, 13(23), 13240; <https://doi.org/10.3390/su132313240>

In contrast, even though Brazil's green hydrogen strategy and legal framework may be forthcoming in the coming months⁶⁹², the idea that severe drought impacting its hydroelectricity production means an automatic pivot to oil and gas needs a jolt of transparency in this misguided decision making. If Brazil were transparent in decision making, its windy coastline whose offshore wind power could supplement its hydropower and boost its green hydrogen production⁶⁹³ would be admitted and prioritized not just for green hydrogen, but to decarbonize its fertilizer industry which remain heavily carbonized⁶⁹⁴. This means that Brazil should prioritize its internal needs as opposed to potential transport to the global north.

Chile has a national green hydrogen strategy that was published in November 2020⁶⁹⁵ while having the strongest geographical assets in South America with the Atacama desert in the north and windy coasts in the south. It could therefore become a major green hydrogen producer given its regular and strong winds in the south and exceptional solar radiation in the north⁶⁹⁶. However, yet only 48 % of its energy mix is from renewables, and this needs urgent scale up.

The Federal Government of Germany has positioned itself as a key partner and investor in green hydrogen projects in Namibia, South Africa, Brazil and Chile⁶⁹⁷, as well as other countries not considered here such as Thailand⁶⁹⁸ or Vietnam⁶⁹⁹. No other western country consistently appears in green hydrogen development plans of the reviewed countries, as Germany does. It is found that Germany bets on wind and solar for its electricity production, this requires short and long term storage. Germany must also replace gas for its industrial production, and low carbon hydrogen could serve this need. This requires significant volumes of low carbon hydrogen. Second Germany intends to develop, produce and sell abroad the required equipment's for hydrogen production. Germany acknowledges it cannot produce enough green hydrogen to satisfy its demand⁷⁰⁰. Even as Namibia, South Africa, Brazil, Chile, or even Thailand and Vietnam readily take in Germany's funds, it must disclose the priorities of its German partners to its citizens, and analyses whether these priorities which entails shipping green hydrogen over long distances to foreign countries with significant losses, aligns with internal priorities which have been disclosed above.

⁶⁹² C Demony, Exclusive: Brazil aims to pass offshore wind, green hydrogen laws by year-end, energy minister says, Reuters, 2023, <https://www.reuters.com/sustainability/climate-energy/brazil-aims-pass-offshore-wind-green-hydrogen-laws-by-year-end-energy-minister-2023-06-27/> accessed August 13, 2024

⁶⁹³ World Bank, The energy to drive Brazil's future comes from the windy seas, 2020, <https://www.worldbank.org/en/news/feature/2020/05/27/energia-eolica-offshore-brasil-esmap> accessed August 13, 2024

⁶⁹⁴ T. Grundt and K. Christiansen, Hydrogen by water electrolysis as basis for small scale ammonia production. A comparison with hydrocarbon based technologies, International Journal of Hydrogen Energy, Volume 7, Issue 3, 1982, Pages 247-257, <[https://doi.org/10.1016/0360-3199\(82\)90088-X](https://doi.org/10.1016/0360-3199(82)90088-X)

⁶⁹⁵ Ministry of Energy, Government of Chile, National Green Hydrogen Strategy, 2020, https://energia.gob.cl/sites/default/files/national_green_hydrogen_strategy_-_chile.pdf accessed August 13, 2024

⁶⁹⁶ Green Hydrogen Organisation, GH₂ Country Portal-Chile, Green Hydrogen Organisation, 2023, <https://gh2.org/countries/chile> accessed August 13, 2024

⁶⁹⁷ See respective country pages of Kenya, Namibia, South Africa, Brazil and Chile for policies and projects, having German affiliation, in Green Hydrogen Organisation, GH₂ Country Portal, Green Hydrogen Organisation, 2023, <https://gh2.org/countries/> accessed August 13, 2024

⁶⁹⁸ N Phathanathavorn, H₂Uppp Southeast Asia's Green Hydrogen and Power-to-X Conference showcase regional clean energy potential, Thai German Cooperation, 2023, https://www.thai-german-cooperation.info/en_US/h2uppp-southeast-asias-green-hydrogen-and-power-to-x-conference-showcases-regional-clean-energy-potential/ accessed August 13, 2024

⁶⁹⁹ The Investor Vafie Magazine, Germany invests \$5.4 million in Vietnam's green hydrogen industry, 2023, <https://theinvestor.vn/germany-invests-54-million-in-vietnams-green-hydrogen-industry-d6453.html> accessed August 13, 2024

⁷⁰⁰ The Federal Government of Germany, National Hydrogen Strategy, The Federal Government of Germany, 2023), <https://www.bundesregierung.de/breg-en/news/hydrogen-technology-2204238> accessed August 13, 2024

III.II.2. Avoiding replicating the oil curse

As discussed in the previous chapter, some Global South countries might have the opportunity to produce, and export, low carbon hydrogen / efuel, and policies are already in place in some countries.

Since developed countries, mostly Germany and, by extension, the European Union, are seen as major low carbon hydrogen importers, it seems appropriate to identify the associated socio-economic impacts, to avoid replicating the oil curse, and duplicating a neo-colonialist model ⁷⁰¹. While reviewing these socio-economics impacts and the associated responsibility of the importers, it is important to remind the numbers associated with the production and importation of low carbon hydrogen.

The hydrogen hype is mostly led by consulting firms and organizations such as IEA ⁷⁰², Deloitte ⁷⁰³ or McKinsey ⁷⁰⁴. It is therefore to remain extremely cautious with the conclusions they proposed. Despite some important differences in the numbers, all mention the low carbon H₂ energy carrier as an important tool to fuel the energy transition. The role of energy in our economies is unquestionably important, as discussed in the first chapter of Part I, and access to energy by populations is a key indicator of well-being ^{705 706}. Electrification is key to decarbonize our economies, and its share in our final total consumption should progress from 20% in 2020, to almost 50% in a Net 0 scenario ⁷⁰⁷. Electricity will mostly be used directly to power heat pumps or electric vehicles, but for hard to abate sectors, such as aviation, but also fertilizers, steel, and maritime, direct electrification is out of reach, and hydrogen is often considered as an energy carrier. H₂ can be used either directly or indirectly, through low carbon molecules such as ammonia (NH₃) or efuels ⁷⁰⁸. Its share within our primary energy use could reach up to 20% by 2050 according to BP ⁷⁰⁹, therefore requiring vast amount of low carbon electricity. Whatever the final energy carrier, H₂ needs to be produced with low carbon electricity to truly decarbonize our economies, allowing us to meet the Paris Agreement objective, which aims to reduce carbon emissions below 10 Gt / year by 2050 ⁷¹⁰.

The energy pathways proposed by the IEA and other companies such as BP, Mc Kinsey, or Deloitte, all consider electrification and low carbon H₂ as the main tools to reach or get close to the above objective. As such, from 28 334 TWh in 2021, the electricity supply which shall reach 73 232 TWh by 2050, of which 70 315 TWh issued from renewables (64 500 TWh) and low carbon (nuclear, 5810 TWh) production ⁷¹¹.

A significant share of this low carbon electricity should be dedicated to H₂ according to IEA (Global Hydrogen Demand in Net 0, 2023), BP (Energy Outlook 2023), Mc Kinsey (Global Energy Perspective 2023: Hydrogen outlook) or Deloitte

⁷⁰¹ <https://www.socialeurope.eu/eu-hydrogen-import-targets-a-neo-colonial-resource-grab> accessed August 13, 2024

⁷⁰² IEA Global Hydrogen Review 2023; <https://www.iea.org/reports/global-hydrogen-review-2023/executive-summary> accessed August 13, 2024

⁷⁰³ Deloitte's 2023 global green hydrogen outlook; <https://www.deloitte.com/global/en/issues/climate/green-hydrogen.html> accessed August 13, 2024

⁷⁰⁴ McKinsey Global Energy Perspective 2023: Hydrogen outlook; <https://www.mckinsey.com/industries/oil-and-gas/our-insights/global-energy-perspective-2023-hydrogen-outlook> accessed August 13, 2024

⁷⁰⁵ Jackson, Robert B., Anders Ahlström, Gustaf Hugelius, Chenghao Wang, Amilcare Porporato, Anu Ramaswami, Joyashree Roy, and Jun Yin. 2022. "Human Well-Being and Per Capita Energy Use." *Ecosphere* 13(4): e3978. <https://doi.org/10.1002/ecs2.3978>

⁷⁰⁶ Tho Pesch, G.; Einarsdóttir, A.K.; Dillman, K.J.; Heinonen, J. Energy Consumption and Human Well-Being: A Systematic Review. *Energies* 2023, 16, 6494. <https://doi.org/10.3390/en16186494>

⁷⁰⁷ BP Energy Outlook 2023, page 62 ; <https://www.bp.com/content/dam/bp/business-sites/en/global/corporate/pdfs/energy-economics/energy-outlook/bp-energy-outlook-2023.pdf> accessed August 13, 2024

⁷⁰⁸ Ken Oshiro, Shinichiro Fujimori, Role of hydrogen-based energy carriers as an alternative option to reduce residual emissions associated with mid-century decarbonization goals, *Applied Energy*, Volume 313, 2022, 118803, ISSN 0306-2619, <https://doi.org/10.1016/j.apenergy.2022.118803>

⁷⁰⁹ BP Energy Outlook 2023, page 18 ; <https://www.bp.com/content/dam/bp/business-sites/en/global/corporate/pdfs/energy-economics/energy-outlook/bp-energy-outlook-2023.pdf> accessed August 13, 2024

⁷¹⁰ IPCC Special Report, Global Warming of 1.5°C; <https://www.ipcc.ch/sr15/graphics/> accessed August 13, 2024

⁷¹¹ IEA World Energy Outlook, table 6.1 page 281; <https://iea.blob.core.windows.net/assets/830fe099-5530-48f2-a7c1-11f35d510983/WorldEnergyOutlook2022.pdf> accessed August 13, 2024

(Deloitte’s 2023 global green hydrogen outlook). From less than a Mt in 2022, the low carbon H₂ demand could reach up to 598 Mt by 2050, according to these reports, as shown in TABLE 49.

World LCH ₂ demand in Mt according to various organizations in a Net 0 or equivalent scenario	IEA ⁷¹²		BP ⁷¹³		Deloitte ⁷¹⁴		Mc Kinsey ⁷¹⁵	
	2030	2050	2030	2050	2030	2050	2030	2050
	63	388	50	460	172	598	est. 70	585

TABLE 49 World LCH₂ demand in Mt according to IEA and some consulting firms (mean / max), source Jean-Baptiste Jarin with data from IEA, BP, Deloitte, McKinsey

III.II.2.1. Oil curse

It is first noted that these numbers, TABLE 49, are highly questionable, as these LCH₂ (Low Carbon H₂) quantities would require more electricity than the 2023 world total electricity production, and more than half of the production expected in 2050. Since the methodology is not detailed, and since it has already been mentioned, chapter II.III.1.2., that the scientific consensus is often far from the conclusions proposed by consulting firms, these numbers mostly highlight the view of some, probably in an attempt to capture the regulators, as well as incentives. Still, the focus here is to evaluate the potential and the risk of replicating the some of the most cited countries in the above reports when addressing exporting H₂ to the EU.

The oil curse, here described by Michael Ross ⁷¹⁶, can be summarized as a situation of energy injustice, in which the presence of significant energy resources in a country can finally led to a situation of energy injustice, with the population not enjoying the benefits of this abundance of energy resources. This situation can arise when power remains concentrated among too few people, as demonstrated by Tornell & Lane in *the voracity effect* ⁷¹⁷. In a worst-case scenario, the presence of oil could even have fueled political instability by being associated with weakening institutions ⁷¹⁸.

The European Union is at the edge of decarbonization, and climate neutrality is seen as “no longer a question of choice, but it is beyond doubt a necessity” ⁷¹⁹. While publishing several delegated acts to ensure that the LCH₂ is truly low

⁷¹² IEA Global Hydrogen Demand in Net 0, 2023; <https://www.iea.org/data-and-statistics/charts/global-hydrogen-demand-in-the-net-zero-scenario-2022-2050> accessed August 13, 2024

⁷¹³ BP Energy Outlook 2023, page 70; <https://www.bp.com/content/dam/bp/business-sites/en/global/corporate/pdfs/energy-economics/energy-outlook/bp-energy-outlook-2023.pdf> accessed August 13, 2024

⁷¹⁴ Deloitte’s 2023 global green energy outlook; page 13; <file:///C:/Users/jib/Downloads/deloitte-green-hydrogen-report-2023-1.pdf> accessed August 13, 2024

⁷¹⁵ McKinsey Global Energy Perspective 2023: Hydrogen, 2024; <https://www.mckinsey.com/industries/oil-and-gas/our-insights/global-energy-perspective-2023-hydrogen-outlook> accessed August 13, 2024

⁷¹⁶ Ross, Michael L. The Oil Curse: How Petroleum Wealth Shapes the Development of Nations. STU-Student edition, Princeton University Press, 2012. JSTOR, <http://www.jstor.org/stable/j.ctt7s3wz>. Chapter 2, pages 29-62, accessed August 13, 2024

⁷¹⁷ <http://www.econ.ucla.edu/people/papers/Tornell/Tornell699.pdf> accessed August 13, 2024

⁷¹⁸ Bhattacharya, Rina and Ghura, Dhaneshwar, Oil and Growth in the Republic of Congo, 2006. IMF Working Paper No. 06/185, Available at SSRN: <https://ssrn.com/abstract=926240> accessed August 13, 2024

⁷¹⁹ 5 facts EU climate neutrality; <https://www.consilium.europa.eu/en/5-facts-eu-climate-neutrality/> accessed August 13, 2024

carbon⁷²⁰, the EU recently set an objective of 20 Mt of LCH₂ within the EU by 2030, of which 10 Mt would be imported⁷²¹.

This objective of 10 Mt of imported H₂, while challenging, could be explained by the triple constraints of climate change, social acceptance, and technical capabilities.

- Climate change: The Paris Agreement Objectives and the associated NDCs⁷²². EU objectives being -55% eCO₂ emissions by 2030 compared to 1990 and climate neutral by 2050^{723 724}.
- Social acceptance: H₂ is seen as an important molecule to maintain the standard of living of the citizens in a green growth economy perspective⁷²⁵.
- Technical capabilities: Producing 20 Mt of LCH₂ within the EU by 2030 would mean roughly 1000 TWh of low carbon electricity: more than the production issued from renewable sources and almost half of the total EU electricity production in 2022⁷²⁶.

This thirst for LCH₂ is widely spread in developed countries but mostly in Germany, as highlighted by the high number of reports or press articles⁷²⁷, and this seems similar to one of the conclusions of Ross, in *The Oil Curse*, as it is Global South countries which are considered to produce and export “...*global thirst for oil is causing companies to drill in increasingly poor nations...spreading the oil curse*”.

Meanwhile producing and exporting LCH₂ is seen as an economic stimulus for the less developed countries. This could be explained by the fact that most organizations such as IEA, Deloitte, McKinsey, KPMG⁷²⁸ or BP see LCH₂ as an opportunity to feed the “*green growth*” in the developed countries in conjunction with the objective of most governments to maintain the standard of living of their citizens⁷²⁹.

The EU objective to import 10 Mt of LCH₂ per year by 2030 would confirm these assessments and is seen as powerful stimulus for many countries to produce and export this molecule, most of which are in the global south as detailed in the previous chapter⁷³⁰. For instance, S&P Global, a leading data and technology provider, sees Africa as “*the new green hydrogen El Dorado*”⁷³¹. The main reason for this is that LCH₂ would be produced from renewable electricity issued from wind and / or solar, and that most countries within the global south have a real potential to produce

⁷²⁰ European hydrogen delegated acts : https://energy.ec.europa.eu/topics/energy-systems-integration/hydrogen/hydrogen-delegated-acts_en accessed August 13, 2024

⁷²¹ The EU hydrogen’s strategy ; https://energy.ec.europa.eu/topics/energy-systems-integration/hydrogen_en accessed August 13, 2024

⁷²² The Paris Agreement, Legally binding, UN International Treaty; <https://unfccc.int/process-and-meetings/the-paris-agreement> accessed August 13, 2024

⁷²³ EU Climate Action 2030 ; https://climate.ec.europa.eu/eu-action/climate-strategies-targets/2030-climate-energy-framework_en accessed August 13, 2024

⁷²⁴ EU Climate Action 2050 ; https://climate.ec.europa.eu/eu-action/climate-strategies-targets/2050-long-term-strategy_en accessed August 13, 2024

⁷²⁵ OECD Better Policies for Better lives, Green Hydrogen; <https://www.oecd.org/cefim/green-hydrogen/> accessed August 13, 2024

⁷²⁶ EU electricity production in 2022 ; <https://www.consilium.europa.eu/en/infographics/how-is-eu-electricity-produced-and-sold/> accessed August 13, 2024

⁷²⁷ S&P, green hydrogen projects in Africa; <https://www.spglobal.com/commodityinsights/en/ci/research-analysis/africa-green-hydrogen.html> accessed August 13, 2024

⁷²⁸ KPMG, Hydrogen in Europe, the future of energy; <https://kpmg.com/fr/fr/blogs/home/posts/2021/11/l-hydrogene-decarbone-une-energie-d-avenir.html> accessed August 13, 2024

⁷²⁹ World Bank, hydrogen for inclusive growth and better jobs, 2023; <https://blogs.worldbank.org/energy/scaling-green-hydrogen-inclusive-growth-better-jobs-and-lower-emissions> accessed August 13, 2024

⁷³⁰ The global south is on the rise, 2023; <https://theconversation.com/the-global-south-is-on-the-rise-but-what-exactly-is-the-global-south-207959> accessed August 13, 2024

⁷³¹ S&P Global, Will Africa become the new green hydrogen “El Dorado”, 2022; <https://www.spglobal.com/commodityinsights/en/ci/research-analysis/africa-green-hydrogen.html> accessed August 13, 2024

renewable electricity thanks to high sunshine and / or constant winds^{732 733}. This seems like the voracity effect studied by Tornell & Lane “voracity effect, by which a shock, such as windfall, perversely generates a more-than-proportionate increase in fiscal redistribution and reduces growth”.

Therefore, to evaluate the socio-economics impacts the concept of minimum energy for decent living should be introduced as well as energy justice so populations are considered. Along with the merit of orders when producing and exporting H₂, these safeguards are found necessary to avoid having the importer, European Union, favorizing replicating the oil curse in the producing countries.

III.II.2.2. Review of the European regulations

All imported LCH₂ shall meet the EU delegated acts announced in June 2023⁷³⁴. While the LCH₂ projects considered must therefore comply with this LCH₂ definition, the role of the Carbon Border Adjustment Mechanism (CBAM)⁷³⁵ shall also be considered and it is detailed below.

The European Union's "fit for 55" package aims to reduce GHG emissions by at least 55% by 2030 compared with 1990 levels. This ambitious target is accompanied by a set of proposals to revise and update EU legislation⁷³⁶. It also aims to ensure a fair and socially equitable transition, and it is in this sense that strict compliance with this doctrine must apply to hydrogen imported into the EU.

The European Union has therefore passed legislation to regulate hydrogen production on its territory, as well as imports via the Carbon Border Adjustment Mechanism (CBAM).

CBAM: "CBAM targets imports of products from carbon-intensive industries. The aim of the CBAM is to ensure - in full compliance with international trade rules - that the EU's efforts to reduce greenhouse gas emissions are not offset by an increase in emissions outside its borders resulting from the relocation of production to third countries (whose climate change policies are less ambitious than those of the EU) or from an increase in imports of more carbon-intensive products. CBAM is designed to operate in parallel with the EU Emissions Trading Scheme (EU ETS), of which it would be the counterpart and complement for imported goods. It will gradually replace existing EU mechanisms designed to address the risk of carbon leakage, in particular the free allocation of allowances under the EU ETS". Hydrogen is one of the products covered by this mechanism⁷³⁷ which encourages the import into the EU, by companies from third countries, of goods that meet the high climate standards applicable in the EU member states.

The definition of low-carbon hydrogen is also strictly framed by Delegated Act (EU) 2023/1184 of February 10, 2023⁷³⁸ in addition to Directive (EU) 2018 with the help of several articles and in particular:

Article 5 - Additionality: “Installations producing renewable electricity were commissioned no earlier than 36 months before the installation producing renewable liquid and gaseous fuel for the transport sector, of non-biological origin”. This approach avoids, at least in part, the risk of cannibalization that could occur with the addition of strong demand without a real increase in upstream supply.

Article 6 – Temporal correlation: "From January 1, 2030, the temporal correlation condition is deemed to be met if renewable liquid and gaseous fuel for the transport sector, of non-biological origin, is produced during the same one-

⁷³² Gulagi et al, A Cost Optimized Fully Sustainable Power System for Southeast Asia and the Pacific Rim, Energies, 2017; <https://doi.org/10.3390/en10050583> accessed August 13, 2024

⁷³³ De Souza et al, Hydro, wind and solar power as a base for a 100% renewable energy supply for South and Central America, Plos One, 2017; <https://doi.org/10.1371/journal.pone.0173820> accessed August 13, 2024

⁷³⁴ https://energy.ec.europa.eu/news/renewable-hydrogen-production-new-rules-formally-adopted-2023-06-20_en accessed August 13, 2024

⁷³⁵ https://taxation-customs.ec.europa.eu/carbon-border-adjustment-mechanism_en accessed August 13, 2024

⁷³⁶ <https://www.consilium.europa.eu/fr/policies/green-deal/fit-for-55-the-eu-plan-for-a-green-transition/> accessed August 13, 2024

⁷³⁷ <https://www.consilium.europa.eu/fr/press/press-releases/2022/12/13/eu-climate-action-provisional-agreement-reached-on-carbon-border-adjustment-mechanism-cbam/> accessed August 13, 2024

⁷³⁸ <https://eur-lex.europa.eu/legal-content/EN/TXT/?uri=CELEX%3A32023R1184> accessed August 13, 2024

hour period as the renewable electricity produced under the renewable electricity purchase agreement, or from renewable electricity from a new storage asset located behind the same grid connection point as the electrolyser or installation producing renewable electricity, and charged during the same one-hour period in which the electricity covered by the renewable electricity purchase agreement was produced". The one-hour temporal correlation between production and consumption should thus prevent the transfer of CO₂ emissions between consumers and display the real emissions balance of hydrogen production, since the load factor of electrolysers, at around 90%, is significantly higher than the average of ENRs, respectively 14.5% for photovoltaic (PV), 19.6% for onshore wind, and 21.55% for offshore wind according to Franke et al ⁷³⁹. The article underlines that these numbers could be significantly improved in carefully selected areas such as the Atacama Desert for PV (28.1%) or the coast of Chile for onshore (77.4%) and offshore (80.8%) wind.

Article 7 – Geographical correlation: "the facility producing renewable electricity under the renewable electricity purchase agreement is located, or was located at the time of its commissioning, in the same bidding zone as the electrolyser" is the main clause in article 7.

The aim is to avoid linking electricity production that is not physically interconnected to electrolysers.

With these delegated acts, the European Union is laying down strict rules governing the production of hydrogen on its territory. They directly or indirectly protect the consumer by avoiding the major side-effects that could be generated by massive additional demand for electricity, while limiting the risk of seeing the EU's electricity decarbonization trajectory jeopardized by an uncontrolled rise in demand.

However, outside the CBAM, and even though developing countries are the first concerned, these rules do not to apply.

III.II.2.3. Selected countries

The purpose being to assess the utility of adopting energy justice in green hydrogen policies in selected countries, they must share similarities as well as differences, as indeed Dannemann recommends ⁶⁴⁵. Still most countries considered face significant electricity production issues, with a significant share of their population having limited access to electricity and understanding that *"the total energy poor is far higher than the official count of people lacking electricity access...60% higher than the global estimate"* ⁷⁴⁰

Are therefore considered 4 countries from the global south, Chile in South America, Mauritania and Morocco in North Africa, Namibia in South Africa, and UAE in the middle-east. For comparison a developed country in the north and potential importer, France, is introduced.

LCH₂ projects in Mauritania, Morocco, Namibia, Chile, and UAE are detailed summarizing data from S&P and IEA. Only projects with production capacity indicated are considered and projects are classed by size but also development status. Sized are expressed in kt of H₂ or equivalent and development status: Concept, Feasibility study, Final Investment Decision (FID), Operational. Concept means the idea is just being explored. Feasibility study means limited investment are launched to validate the business case. FID means the project is validated and funded and / or under construction.

Among the 43 projects studied, 2 projects are FID / Under Construction, but with a very limited production of 0.7 kt / year. These projects are closer to a laboratory scale than a production facility. All other projects are under feasibility study or conceptual phase and there are no operational production units in these countries yet.

⁷³⁹ Katja Franke, Joshua Fragoso Garcia, Christoph Kleinschmitt, Frank Sensfuß, Assessing worldwide future potentials of renewable electricity generation: Installable capacity, full load hours and costs, Renewable Energy, 2024, 120376, ISSN 0960-1481, <https://doi.org/10.1016/j.renene.2024.120376>

⁷⁴⁰ Brian Min, Zachary P. O'Keeffe, Babatunde Abidoye, Kwawu Mensan Gaba, Trevor Monroe, Benjamin P. Stewart, Kimberly Baugh, Bruno Sánchez-Andrade Nuño, Lost in the dark: A survey of energy poverty from space, Joule, Volume 8, Issue 7, 2024, Pages 1982-1998, ISSN 2542-4351, <https://doi.org/10.1016/j.joule.2024.05.001>

Mauritania

Seen as “Africa’s global green hydrogen hub” ⁷⁴¹, Mauritania and EU recently agreed to team to develop green hydrogen in this country ⁷⁴². Mauritania has currently no operational production, but is studying a total capacity production of 4.8 Mt of LCH₂ / year. This significant amount of LCH₂ would require more than 300 TWh of low carbon electricity.

LCH ₂ Projects, data from IEA https://www.iea.org/data-and-statistics/data-tools/hydrogen-production-projects-interactive-map				
Project Name	Projected Volume in kt / Year	TWh of Low Carbon Electricity required @ 65 kWh / kg H ₂	Status	Country
Project Nour	1200	78	Feasability	Mauritania
Green Ammonia Phase 1	69	4	Concept	Mauritania
Aman	3600	234	Feasability	Mauritania
Total	4869	316		

TABLE 50 LCH₂ projects being currently evaluated in Mauritania, source Jean-Baptiste Jarin with data from IEA

Morocco

Three projects are currently being considered, and the country is seen as a “pioneer of green energy in Africa” ⁷⁴³. The proximity of Morocco with the EU could be attractive to investors but no project are currently operational neither under FID.

LCH ₂ Projects, data from IEA https://www.iea.org/data-and-statistics/data-tools/hydrogen-production-projects-interactive-map				
Project Name	Projected Volume in kt / Year	TWh of Low Carbon Electricity required @ 65 kWh / kg H ₂	Status	Country
OCP Group Ammonia Project	360	23,4	Concept	Morocco
Hevo Morocco	103	6,695	Feasability	Morocco
Masen - Kfw	17	1,105	Feasability	Morocco
Total	480	31,2		

TABLE 51 LCH₂ projects being currently evaluated in Morocco, source Jean-Baptiste Jarin with data from IEA

Namibia

“Massive green hydrogen project in Namibia and Botswana” ⁷⁴⁴ have been announced in February 2022 but to date only two limited projects, cumulating less a 1 kt of LCH₂, have passed the FID gate.

LCH ₂ Projects, data from IEA https://www.iea.org/data-and-statistics/data-tools/hydrogen-production-projects-interactive-map				
Project Name	Projected Volume in kt / Year	TWh of Low Carbon Electricity required @ 65 kWh / kg H ₂	Status	Country
O&L Group	0,69	0	FID	Namibia
Swakopmund	4	0	Feasability	Namibia
Hyphen	520	34	Feasability	Namibia
Daures green Phase 1	0,01	0	FID	Namibia
Daures green Phase 2	65	4	Concept	Namibia
Total	589,7	38		

TABLE 52 LCH₂ projects being currently evaluated in Namibia, source Jean-Baptiste Jarin with data from IEA

⁷⁴¹ Mauritania : Africa’s global green hydrogen hub, press article published April 2023

<https://energycapitalpower.com/mauritania-global-green-hydrogen-hub/> accessed August 13, 2024

⁷⁴² https://ec.europa.eu/commission/presscorner/detail/en/ip_23_5268 accessed August 13, 2024

⁷⁴³ <https://www.atalayar.com/en/articulo/economy-and-business/morocco-ranks-among-the-world-leaders-in-green-hydrogen-production/20230629151706187459.html> accessed August 13, 2024

⁷⁴⁴ <https://reglobal.org/green-hydrogen-project-expands-to-5-gw-in-botswana-and-namibia/> accessed August 13, 2024

UAE

UAE announced in July 2023 “big hydrogen plans”⁷⁴⁵ but to date only one production facility is operational, with a limited 0.19 kt of LCH₂ produced per year.

Project Name	Projected Volume in kt / Year	TWh of Low Carbon Electricity required @ 65 kWh / kg H ₂	Status	Country
IHI-ENOC	120	8	Concept	UAE
MB Rashid	0,19	0	Operationnal	UAE
Kizad Phase 1	21	1	Feasability	UAE
Kizad Phase 2	99	6	Feasability	UAE

TABLE 53 LCH₂ projects being currently evaluated in the UAE, source Jean-Baptiste Jarin with data from IEA

Chile

With almost 10% of the LCH₂ projects being currently evaluated in the world, Chile “accelerating its green hydrogen industry”⁷⁴⁶ shows an impressive number of projects (28) cumulating a production potential of 4.73 Mt of LCH₂ per year. Five production facilities are operational, but once again with a very limited production, below 0.3 kt per year. The only project which has passed the FID gate will not add significant production (0.01 kt / year).

Project Name	Projected Volume in kt / Year	TWh of Low Carbon Electricity required @ 65 kWh / kg H ₂	Status	Country
Magallanes	1386	90	Feasability	Chile
Gente Grande	630	41	Feasability	Chile
Vientos	146	9	Concept	Chile
HNH	225	15	Feasability	Chile
Haru Oni Phase 1	0,15	0	Operationnal	Chile
Haru Oni Phase 2	62	4	Feasability	Chile
Faraday	347	23	Feasability	Chile
Volta	174	11	Concept	Chile
Pauna H2	17	1	Feasability	Chile
Pauna NH3	52	3	Feasability	Chile
Adelaida	0,52	0	Feasability	Chile
HyEx	347	23	Feasability	Chile
Pionero	315	20	Feasability	Chile
H1	170	11	Feasability	Chile
Selknam	85	6	Concept	Chile
Faro	42	3	Feasability	Chile
Kosten Aike	2	0	Feasability	Chile
UCSC	0,01	0	FID	Chile
H2V	2	0	Feasability	Chile
Wally	0,1	0	Operationnal	Chile
Las Tortolas	0,01	0	Operationnal	Chile
HyPro	3	0	Feasability	Chile
Verde Bahia	2	0	Feasability	Chile
AES	71	5	Feasability	Chile
H2GN	0,01	0	Operationnal	Chile
Hy-Fi	475	31	Concept	Chile
Los Amigos	180	12	Concept	Chile
Cerro Pabellon	0,01	0	Operationnal	Chile
Total	4733,81	308		

TABLE 54 LCH₂ projects being currently evaluated in Chile, source Jean-Baptiste Jarin with data from IEA

⁷⁴⁵ <https://www.reuters.com/world/middle-east/uaes-revised-energy-strategy-includes-big-hydrogen-plans-2023-07-11/> accessed August 13, 2024

⁷⁴⁶ <https://www.worldbank.org/en/news/press-release/2023/06/29/chile-to-accelerate-its-green-hydrogen-industry-with-world-bank-support> accessed August 13, 2024

In parallel to these announcements, the 2020-2050 socio-energetic situation of the selected countries is detailed in TABLE 55 below. Data are collected from OWID ⁷⁴⁷ except when mentioned.

Are considered:

- Total electricity production of the country for the year 2019: this figure is important to evaluate the capacity of the country to absorb the input of future LCH₂ production.
- % of population with access to electricity: this figure is a key indicator for the final destination of low carbon electricity. If newly installed electricity production units are designated for exporting H₂ leaving aside the local population, the energy justice principles are flouted.
- kWh per capita: another key indicator as access to electricity does not guarantee enough electricity to ensure a decent living.
- Transport & Distribution losses: this figure allows one to evaluate the quality of the existing infrastructure in the country. Adding new electricity production units with an inadequate T&D network would results in significant losses.
- Share of fossil fuels in the electricity production: a key indicator to ensure that the production of LCH₂ will not impact the decarbonization roadmap of the country. While the delegated acts prevent the past situation, the question is raised for the newly installed units: shall they serve the decarbonization roadmap of the country first?
- SDG score: exporting LCH₂ requires significant amount of energies and a country which has a too low score should give priority to improving its SDG score before exporting low carbon energy.

Data: OWID 2019 except when mentioned	Electricity Production in TWh	% population with access to electricity (above 4 hours / day)	kWh par capita	Transport-Distribution losses (in %, data from World Bank, 2014)	Share of fossil fuels in the electricity production	SDG Score / 100 (https://dashboards.sdgindex.org/rankings)	Share of fossil fuels projected in 2030
France	565,72	100%	8785	6%	9,46%	82,05	5% https://assets.rte-france.com/prod/public/2022-01/Energy%20pathways%202050_Key%20results.pdf
Namibia	1,36	55,18%	556	36%	2,94%	64,28	Shall remain below 3%
Chile	77,39	100%	4065	7%	58,35%	78,22	20% https://ember-climate.org/insights/research/wind-and-solar-overtake-coal-in-chile/
UAE	129,65	100%	14075	7%	97,07%	69,71	70% https://www.eiu.com/n/uae-raises-targets-for-sustainable-energy-in-2030/
Morocco	39,98	100%	1085	15%	82,39%	70,97	48% https://www.morocoworldnews.com/2023/09/357760/report-moroccos-2030-green-energy-target-is-most-credible-in-mena
Mauritania	1,82	45,83%	415	16,1% (Enerdata)	74,73%	57,23	50% https://www.enerdata.net/estore/energy-market/mauritania/

TABLE 55 Global South Countries considered, energy key criteria, with France for comparison, source Jean-Baptiste Jarin

III.II.2.4. Decent living and energy justice

As discussed above, the production of green hydrogen and its main derivatives (NH₃, efuel) requires significant production of low-carbon electricity and high-quality infrastructures. Imposing such production on countries that do not have secured the energy bases necessary for the well-being of their populations can legitimately raise questions, even though the EU is committed to *the "just transition" to "leave no one by the wayside"* ⁷⁴⁸. The approach adopted

⁷⁴⁷ <https://ourworldindata.org/energy> accessed August 13, 2024

⁷⁴⁸ https://commission.europa.eu/strategy-and-policy/priorities-2019-2024/european-green-deal/finance-and-green-deal/just-transition-mechanism_fr accessed August 13, 2024

here is based on the energy justice triangle proposed by Heffron & Mc Cauley in The concept of energy justice across the disciplines⁷⁴⁹, in order to propose a holistic approach that would enable all decisions to be guided by the prism of energy justice for all. As the authors emphasize, the public policies that will be translated into law must succeed in balancing economic, environmental and energy security issues in order to offer the best solutions, or at the very least the best compromise, to populations. This is as true for the EU as it is for the countries concerned by the possible production and export of their resources, in this case their electricity production in the form of hydrogen.

As such energy security for population should be the corner stone of any country before exporting energy. Priority should be given to ensuring minimum access for the populations of the countries concerned before any exports. This means that 100% of the population should have access to electricity, this is even more true as the definition of access to electricity is limited to 4 hours / day. It also seems necessary to respect a minimum per capita energy requirement, as proposed by Millward-Hopkins et al in Providing decent living with minimum energy: a global scenario⁷⁵⁰, which concludes that the minimum would be between 12 and 24 GJ per capita per year in an optimized scenario.

While extrapolating these data to electricity is complex and not perfect as electrification is not always a possibility, it is possible to assume a massive electrification for all basic needs such as heating, cooling, lighting or cooking. This approach is explained by the will to give priority to the local populations before exporting energy: avoiding replicating the oil curse⁷⁵¹. 12 to 24 GJ of energy per capita would mean 3324 to 6648 kWh of electricity, which must be low carbon. This is significantly less than in France (8785 kWh), a country which has already a significant share of electricity in its energy mix. Still, this is much more than in most of the countries considered in this study. The upper value proposed by Millward-Hopkins et al, or 6648 rounded to 6700 kWh per capita per year, seems therefore the right value to consider.

III.II.2.5. Conclusions

TABLE 56 below provides an overview of the socio-energetic indicators for the selected countries with the above criteria shaded in green if the criteria is passed, orange if criteria can be passed within a decade therefore allowing room for small projects, and red if the criteria is out of reach. Before detailing the ranking of the considered countries with a merit of order approach, it is found impressive that some countries show a ratio LCH₂ expected / Electricity produced above 1. This ratio measures the existing electricity production to the expected electricity requirements to produce LCH₂. A ratio above 1 means that the country must double its electricity production, by 2030 in most cases, just to feed the LCH₂ expected production, i.e. without improving the other criteria or meeting population growth. By itself this ratio explains the hope and hype waves surrounding hydrogen and most probably the reason with the IEA had to significantly reduce its 2030 forecast⁷⁵². With a ratio of 3.95 Chile remains behind Namibia and well behind Mauritania, 173.63. A ratio above 0.15 means the electricity production and the associated grid should improve by at least 15% by 2030. Although not insurmountable, this is a significant step to take, and the ratio is rated orange. A ratio of 0.5 implies increasing production by 50% in 6 years, which appears insurmountable. Bear in mind that producing 5 to 6 TWh is the equivalent of a nuclear power plant, so it would be very difficult to build such a generating fleet in just a few years.

Ensuring a decent living for local populations means that they have access to sufficient electricity to fulfill their basic needs. The definition of 100% access to electricity was found not sufficient as the definition is a minimum of 4 hours access per day with no attached quantities. This is why, to meet these criteria, the considered country should demonstrate that 100% of its population have access to electricity, as well as a minimum of 6700 kWh per capita to

⁷⁴⁹ Raphael J. Heffron, Darren McCauley, The concept of energy justice across the disciplines, Energy Policy, Volume 105, 2017, Pages 658-667, ISSN 0301-4215, <https://doi.org/10.1016/j.enpol.2017.03.018> figure 5

⁷⁵⁰ Joel Millward-Hopkins, Julia K. Steinberger, Narasimha D. Rao, Yannick Oswald, Providing decent living with minimum energy: A global scenario, Global Environmental Change, Volume 65, 2020, 102168, ISSN 0959-3780, <https://doi.org/10.1016/j.gloenvcha.2020.102168>

⁷⁵¹ <https://press.princeton.edu/books/paperback/9780691159638/the-oil-curse> Chapter 2 pages 27-62, accessed August 13, 2024

⁷⁵² <https://www.reuters.com/business/energy/iea-lowers-renewables-forecast-clean-hydrogen-2024-02-01/> accessed August 13, 2024

ensure a decent living to its population as discussed above. Only France, UAE, and to a certain extent Chile in some years, can meet the criteria of decent living for their population.

H ₂ production key criteria Data: OWID 2019 except when mentioned	Country Total Electricity Production, in TWh	2030 LCH ₂ total production expected in TWhe (data from IEA 2023)	2030 LCH ₂ total production expected in TWhe (data from IEA 2023)	2030 Ratio LCH ₂ electricity need vs Country Total Electricity Production	% of population with access to electricity	kWh of electricity per capita	T&D losses (data World Bank, 2014)	Share of fossil fuels in the 2019 electricity mix	Share of fossil fuels in the 2030 electricity mix
		65	65 TWh _e / Mt for liquid LCH ₂	Below 0.15: Green 0.15 to 1: Orange Above 1: Red	Below 100% = Red	Below 4000 kWh: Red 4000 to 6700 kWh: Orange	Below 10% = Green 10 to 15% = Orange Above 15.1% = Red	Below 10% = Green 10 to 30% = Orange Above 30% = Red	Below 8% = Green 8.1 to 11.9% = Orange Above 12% = Red
France	565,72	1,31	85,2	0,15	100%	8785	6%	9,46%	5,00%
Namibia	1,36	0,597	38,8	28,53	55,18%	556	36%	2,94%	2,94%
Chile	77,39	6,63	431,0	5,57	100%	4065	7%	58,35%	20,00%
UAE	129,65	0,275	17,9	0,14	100%	14075	7%	97,07%	70,00%
Morocco	39,98	0,481	31,3	0,78	100%	1085	15%	82,39%	48,00%
Mauritania	1,82	4,871	316,6	173,96	45,83%	415	16,10%	74,73%	50,00%

TABLE 56 Socio-energetic overview of the selected countries, source Jean-Baptiste Jarin

The criteria of transportation and distribution (T&D) losses is important as it demonstrates, or not, that there are the foundations not only to develop new infrastructures, but also maintain those infrastructures. A ratio above 10% means the grid is not properly maintain, adding pressure to the electricity production to compensate.

In parallel, all countries except Namibia cannot meet the EU LCH₂ criteria by 2030. As discussed above, electricity carbon intensity must be below of 53 g eCO₂ / kWh to produce LCH₂. This means that as long as there is more than 8% of fossil in the electricity mix the H₂ production cannot be considered as low H₂. By 2030 it would still be possible for a country to develop and displace low carbon electricity for H₂ production, but this would be at the expense of the overall decarbonization of electricity production, which ultimately means that the country concerned would fall behind its own decarbonization / NDCs targets. This is found not to be acceptable and having the European Union at the root of such decision would harm equity and energy justice principles.

Imports are not only limited, but still require safeguards.

As shown in TABLE 56 above no country can propose yet a plan to produce LCH₂ and / or efuels without collateral damages to the populations and / or the overall decarbonization of their economy.

The European Union should therefore add criteria to the CBAM and delegated act on hydrogen to make sure that the import of H₂ does not foster energy injustice abroad.

Some of those criteria could be:

- 100% of the population with access to electricity.
- The country provides a decent living to its population, with an average above 6700 kWh of electricity per citizen.
- Low carbon electricity: the 2030 and 2050 energy forecast shall be consistent with the EU delegated acts demonstrating an average electricity carbon intensity within the grid less than 53 g eCO₂/kWh, the equivalent of no more than 7% of fossil fuel within the electricity mix.

Europe's objective to import 10 Mt of LCH₂ by 2030 comes not only with technological hurdles, but in fact mostly with societal challenges, from sovereignty⁷⁵³ to energy justice. Increased efficiency and sobriety, which means lowering the demand for most usages, which includes air mobility, seems to be a prerequisite to avoid replicating the oil curse in the Global South and fueling energy injustice globally.

The more we consume, the more we import, the greater the pressure on energy justice and the global decarbonization trajectory: policies should now combine technological sobriety, i.e. efficiency, with usage sobriety.

⁷⁵³ https://www2.assemblee-nationale.fr/static/16/presse/DP_re-souverainete-energetique.pdf accessed August 13, 2024

III.III Introducing energy justice within our public policies

Understanding that without constraint, air mobility will not decarbonize while the options to support this needed decarbonization path are limited is a challenge. Worse, the main lever for decarbonizing air mobility, SAF, requires inputs which are or will be under constraints, having significant collateral damages for societies.

As reviewed in the previous chapters, these collateral damages go from increased prices for food and energy and / or side effects on countries NDCs, and up to the risk of replicating the oil curse in Global South. Air mobility is both domestic and international, and so are the effects.

It is therefore necessary to propose a new social contract between air mobility and societies as keeping the pace in traffic increase, speed, and / or new usages is not compatible with climate change objectives, and more broadly planet boundaries.

The physical limits, from technologies to feedstocks being clarified and now that the socio-energetic aspects have been investigated, it is possible to assess the role of taxes and public policies in proposing a new social contract.

This evaluation should come with the prism of energy justice for the citizens. While the approach was focused on the Global South since developed countries are looking after their exporting potential to feed their growth, the focus is now on the developed countries since those are the ones which concentrate most flights. As concluded in Part I, even in a wealthy area such as the European Union, 2/3 of the flights rely on the wealthiest 1%. Detailing taxes and energy policies are indeed focused on the main SAF feedstock within European Union and most particularly France which not only already within our taxation schemes but is also the corner stone of our modern world : electricity.

Since electricity meets people's most basic needs, the introduction of secondary and tertiary needs that would require large quantities of electricity must be carefully assessed in the light of tax policies and final prices for people. As such, the implementation of transformational policies and strategies aimed at achieving low-emissions should not interfere with energy justice.

III.III.1. Understanding the role of electricity in societies and the influence of tax and policies

III.III.1.1. Electricity in our societies

Energy is at the heart of the European Union (EU) since its beginning, the roots of the EU being coal and steel (the European Steel & Coal Community was signed 1951⁷⁵⁴). Energy remains today a significant pillar of the European Union⁷⁵⁵ with close coordination, even more following the Russian invasion of Ukraine which has highly impacted the EU energy markets⁷⁵⁶.

The energy transition magnifies the growing role of low carbon electricity within our economies and all sectors are concerned, including air mobility. While the ongoing decarbonization of electricity requires a strong policy framework within the EU⁷⁵⁷, it has been found that the introduction of low carbon hydrogen carriers using water electrolysis for

⁷⁵⁴ https://europa.eu/ecsc/index_en.htm accessed August 13, 2024

⁷⁵⁵ https://energy.ec.europa.eu/topics/energy-strategy/energy-union_en accessed August 13, 2024

⁷⁵⁶ <https://www.consilium.europa.eu/en/policies/eu-response-ukraine-invasion/impact-of-russia-s-invasion-of-ukraine-on-the-markets-eu-response/> accessed August 13, 2024

⁷⁵⁷ Szabó, L., Kelemen, Á., Mezósi, A., Pató, Z., Kácsor, E., Resch, G., & Liebmann, L. (2019). South East Europe electricity roadmap – modelling energy transition in the electricity sectors. *Climate Policy*, 19(4), 495–510.
<https://doi.org/10.1080/14693062.2018.1532390>

efuel and particularly eSAF ⁷⁵⁸ could significantly increase the electricity demand ⁷⁵⁹ ⁷⁶⁰ as efuel is an energy carrier which requires significant amount of electricity to be produced ⁷⁶¹. Several studies confirming that the majority of the levelized cost of production of an efuel is based on the cost of the electricity required by the various processes needed during its fabrication, such as water electrolysis ⁷⁶².

As such, electricity and electricity-based energy carriers are seen as an important lever of the decarbonization pathways for effective climate policy ⁷⁶³ and this even more true for hard to abate sectors such as aviation. ESAF will be mandatory in aviation within the EU as soon as 2030 ⁷⁶⁴ and its production could rapidly represent a significant share of the electricity production.

Therefore, policies and taxation of electricity-based energy carriers should be carefully evaluated since a demand increase tends to increase the prices. Indeed, Finon concluded in *The transition of the electricity system towards decarbonization: the need for change in the market regime that “the transition from market coordination to public coordination is inevitable”* ⁷⁶⁵ and that “tariffs and policies should improve accordingly”.

Energy tax policies can serve different objectives. Historically, the goals were to serve fiscal objectives and promote economic development. More recently, the objective to reduce the demand for limiting the importations and enhanced national security appeared ⁷⁶⁶ and during the last two decades the environmental objectives were introduced within the energy tax policies ⁷⁶⁷.

In France, this stacking of objectives and norms led to vast exemptions to preserve some fragile or vital share of our economies. The concept of “end use” is already applied within energy tax policies and the French Goods & Services Taxation Code (CIBS : Code des Impositions sur les Biens et Services) ⁷⁶⁸ does for instance proposes specific or reduced tariffs, up to full exemption (article L312-27 and L312-28) for specific end use applications such as products consumed for the production of energy (L312-31), electro-intensive industries (L312-65), taxis (L312-52), maritime (L312-54 to L312-57), agriculture (L312-61 and L312-62), or even air mobility (L312-58 and L312-59).

These policies are generally adapted not only to the final use, but also to the form of the energy. For instance, liquid fuels and electricity have generally different tax rates within the same application.

This could also pose a problem if we maintain this existing tax scheme and rates as electricity applications include the most vital ones such as heating, cooling, lighting, or cooking. Applying the existing energy policies for electricity dedicated to electricity-based energy carriers such as efuel for air mobility which enjoys full tax exemption, could

⁷⁵⁸ Annex I of REGULATION (EU) 2023/2405 OF THE EUROPEAN PARLIAMENT AND OF THE COUNCIL of 18 October 2023 on ensuring a level playing field for sustainable air transport (ReFuelEU Aviation) <https://eur-lex.europa.eu/legal-content/EN/TXT/HTML/?uri=CELEX:02023R2405-20231031&qid=1714118275778#tocId21> accessed August 13, 2024

⁷⁵⁹ <https://www.academie-technologies.fr/wp-content/uploads/2023/03/Rapport-decarbonation-secteur-aerien-production-carburants-durables-AT-Mars-2023.pdf> accessed August 13, 2024

⁷⁶⁰ IEA report, the role of efuels in decarbonizing transport, page 21 and 46 <https://www.iea.org/reports/the-role-of-efuels-in-decarbonising-transport> accessed August 13, 2024

⁷⁶¹ Peters et al, A Techno-Economic Assessment of Fischer-Tropsch Fuels Based on Syngas from Co-Electrolysis, <https://doi.org/10.3390/pr10040699>

⁷⁶² <https://theicct.org/wp-content/uploads/2022/02/fuels-us-europe-current-future-cost-ekerosene-us-europe-mar22.pdf> accessed August 13, 2024

⁷⁶³ Bataille, C., Waisman, H., Colombier, M., Segafredo, L., Williams, J., & Jotzo, F. (2016). The need for national deep decarbonization pathways for effective climate policy. *Climate Policy*, 16(sup1), S7–S26.

<https://doi.org/10.1080/14693062.2016.1173005>

⁷⁶⁴ https://transport.ec.europa.eu/news-events/news/final-adoption-refueleu-aviation-completes-fit-55-legislation-putting-eu-track-exceed-2030-targets-2023-10-09_en accessed August 13, 2024

⁷⁶⁵ Finon, D. (2013). The transition of the electricity system towards decarbonization: the need for change in the market regime. *Climate Policy*, 13(sup01), 130–145. <https://doi.org/10.1080/14693062.2012.741832>

⁷⁶⁶ Energy Tax Policy: Historical Perspectives on and Current Status of Energy Tax Expenditures, M.F. Sherlock, Congressional Research, 2011, <https://sgp.fas.org/crs/misc/R41227.pdf> accessed August 13, 2024

⁷⁶⁷ Energy Tax Policy: History and Current Issues, S.Lazzari, Congressional Research, 2006,

https://www.everycrsreport.com/files/20060728_RL33578_648085332c513cf668ab67f5c9cd607fc74537c2.pdf accessed August 13, 2024

⁷⁶⁸ https://www.legifrance.gouv.fr/codes/texte_lc/LEGITEXT000044595989/ accessed August 13, 2024

therefore lead to significant energy injustice and it is necessary to introduce the distributive justice concept to evaluate the role and the impacts of the electricity prices for the populations.

Although based on EU regulations applied to France as part of its energy taxation directive, the methodology and conclusions could most probably be transposed to other countries, at least with the EU.

III.III.1.2. Review of current and future use of electricity and evaluation of electricity volumes for eSAF

Reaching 28 660 terawatt-hours (TWh) in 2022 in the world ⁷⁶⁹, electricity is key to decarbonize our economies and its share in our final total consumption should progress from 20% in 2020 to almost 50% in a Net 0 scenario ⁷⁷⁰. Electricity is a final energy with a wide range of applications, such as heating, cooling, freezing, cooking, or lighting. Electricity is also seen as a major lever to decarbonize the road transportation with the Electric Vehicles (EV). For hard to abate sector, such as fertilizers, steel, maritime or air transport, direct electrification is out of reach and hydrogen (H₂) based energy carriers, such as efuels for air & maritime applications, are often considered.

In France, in 2022, the yearly electricity consumption was 424 TWh, the residential usages reaching 38% while the industry was 26% of this amount ⁷⁷¹. For 2050, the reference scenario of RTE ⁷⁷² forecasts a significant increase in electricity consumption with 645 TWh. While residential usages will remain stable, reaching 135 TWh, road transportation will significantly increase from approximately 2 TWh in 2022 to 81.5 TWh in 2050.

H₂ based energy carrier's consumptions will also significantly increase by 2050, from 0 TWh today to 50 TWh by 2050 in the reference scenario. As shown in FIGURE 160 below, residential applications would reach 135 TWh, road transportation would be massively electrified, reaching 84 TWh, while H₂ based molecules, including those required for eSAF, would reach 50 TWh. Residential applications include basic needs such as cooking, heating home and water, cooling home and food, lighting. Since France currently produces almost 900 kt of hydrogen ⁷⁷³ from coal and gas for its own industrial needs, 50 TWh of electricity dedicated to the production of low carbon hydrogen would only displace the existing hydrogen production.

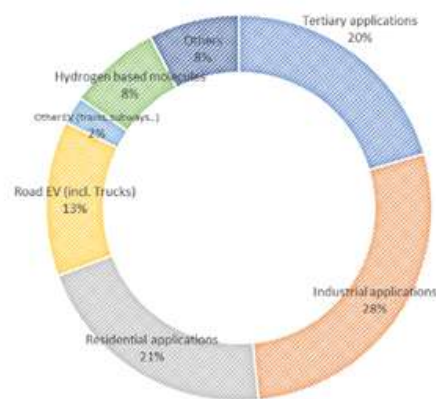

FIGURE 160 Electricity consumption in France in 2050, share of electricity in %, H₂ includes efuel for aviation among other usages, data from RTE

⁷⁶⁹ Hannah Ritchie and Pablo Rosado (2020) - "Electricity Mix" Published online at OurWorldInData.org. Retrieved from: '<https://ourworldindata.org/electricity-mix>' accessed August 13, 2024

⁷⁷⁰ IEA, Net 0 by 2050, page 45 https://iea.blob.core.windows.net/assets/deebef5d-0c34-4539-9d0c-10b13d840027/NetZeroBy2050-ARoadmapfortheGlobalEnergySector_CORR.pdf accessed August 13, 2024

⁷⁷¹ <https://www.statistiques.developpement-durable.gouv.fr/edition-numerique/chiffres-cles-energie-2023/pdf/chiffres-cles-de-lenergie-2023.pdf> page 70, accessed August 13, 2024

⁷⁷² <https://rte-futursenergetiques2050.com/trajectoires/trajectoire-de-reference> accessed August 13, 2024

⁷⁷³ <https://www.nortonrosefulbright.com/en-fr/knowledge/publications/c4693578/lhydrogene-en-franceetat-des-lieux-et-perspectives> accessed August 13, 2024

It has been concluded in the previous chapters that efuel is an energy carrier which requires significant amount of electricity to be produced, requiring 22 to 28 kWh, without co-products, for 1 kg, which in return contains 12 kWh of energy (LHV). This means an EROEI ranging from 0.4 to 0.6^{774 775 776}. Half of the energy is lost during the manufacturing process, but this is the price to pay to concentrate the energy which will allow a heavier than air to fly: the perfect definition of a hard to abate sector.

Within the European green deal, the ReFuel EU regulations new law agreed to cut aviation emissions by promoting sustainable aviation fuels (SAF). Aviation accounted for 14.4% of EU transport emissions in 2018⁷⁷⁷. While it cannot be considered as a tax, the regulation (EU) 2023/2405 of 18 October 2023 on ensuring a level playing field for sustainable air transport (Refuel EU Aviation)⁷⁷⁸ stipulates in article 4 and in annex I that starting 2025 each year a minimum quantity of SAF must be incorporated into the jet fuel: from 2% in 2025 it reaches 70% by 2050. The share of synthetic aviation fuel (efuel) is 35% in 2050.

Evaluation of electricity volumes for eSAF

The BAU, mean and optimistic SAF scenarios reviewed in the previous chapters proposed a demand of 14.4 / 5.4 / 1.8 Mt of eSAF respectively for France. To simplify the comparisons, for tariffs and policies, it is here summarized to a Min / Max scenario so an efficiency sensitivity can be introduced. Such an approach was found necessary to respond to an essential point made in many reports: technological progress will make it possible to meet growing demand. The sensitivity proposed here goes from 22 kWh / kg to 28 kWh / kg of electricity per kg of eSAF. 28 kWh / kg being the efficiency targeted by most producers such as Engie or Elyse Energy, and 22 kWh / kg being the optimum, very close to the theoretical value⁷⁷⁹.

The Min scenario proposed in this section is on purpose close to the mean SAF scenario, 1.9 Mt. The Max scenario is in between the High and BAU, with 9 Mt. This approach is explained by the impossibility to reach the BAU while limiting the CAGR to 1.6% (optimistic SAF scenario above), which is below the ambition of the aviation industry.

While this section focuses on France, it can be extrapolated to the European Union, or even the world, to better understand the scalability and the impact on the electricity consumption. It is reminded here that electricity is difficult to store and all electric systems are yet designed to match consumption with production.

One can notice in FIGURE 161 below that while technology could further increase the yields in efuel production, reaching the optimum 22.8 kWh / kg instead of 28 kWh / kg, the volume requirement is by far the main trigger:

- 1.9 Mt of efuel would require 44 to 53 TWh per year, or 8% of the total electricity consumption projected in 2050, a figure close to the one experienced today within the oil consumption.
- 9 Mt of efuel would mean 207 to 252 TWh, up to 40% of the country's electricity consumption projected in 2050.

⁷⁷⁴ Rapport de l'académie des technologies <https://www.academie-technologies.fr/la-decarbonation-du-secteur-aerien-par-la-production-de-carburants-durables-rapport-et-avis/> accessed August 13, 2024

⁷⁷⁵ Rojas-Michaga et al 2023 Energy Conversion and Management, <https://doi.org/10.1016/j.enconman.2023.117427>

⁷⁷⁶ Maria Grahn et al 2022 Prog. Energy 4 032010 DOI 10.1088/2516-1083/ac7937, <https://iopscience.iop.org/article/10.1088/2516-1083/ac7937/meta>

⁷⁷⁷ <https://www.consilium.europa.eu/en/infographics/fit-for-55-refueleu-and-fueleu/> accessed August 13, 2024

⁷⁷⁸ https://eur-lex.europa.eu/legal-content/EN/TXT/HTML/?uri=OJ:L_202302405&qid=1706201983664 accessed August 13, 2024

⁷⁷⁹ Interviews and SAF Working Group with Engie, Elyse Energy, Académie des Technologies

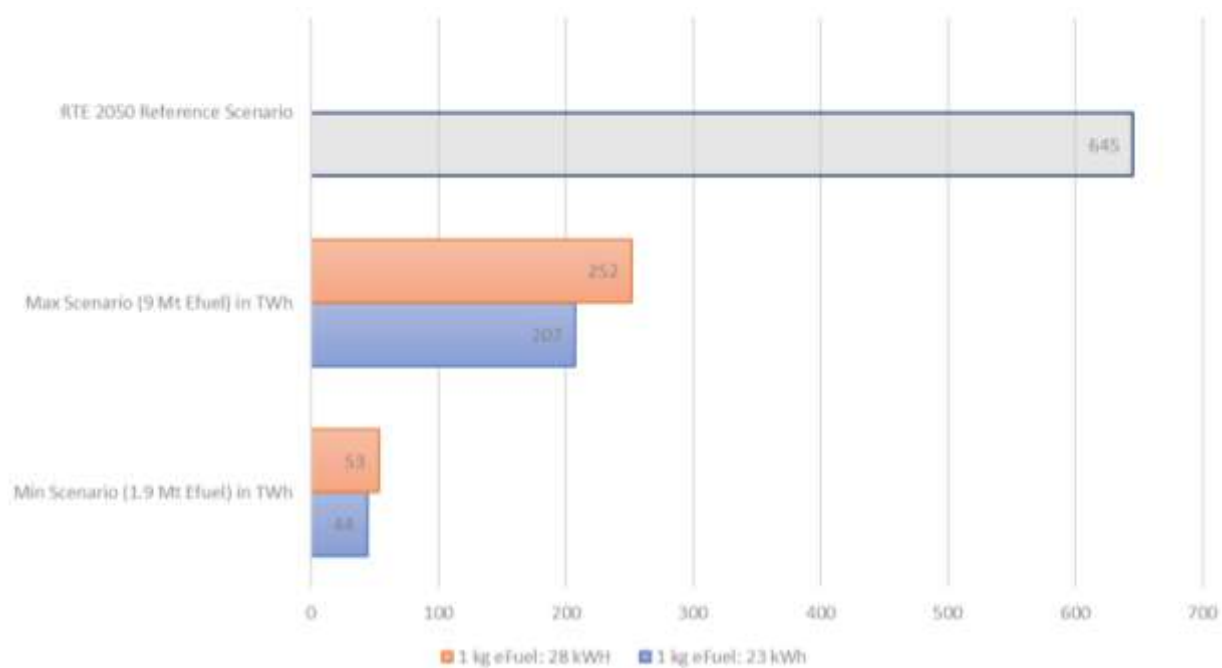

FIGURE 161 eSAF electricity requirements in France, min / max hypothesis with 2050 RTE reference scenario, source Jean-Baptiste Jarin with data from RTE and IATA

For reference, in 2022, the total output of the French nuclear production was 279 TWh⁷⁸⁰.

Whatever the scenario, 8 to 40% share within the total electricity consumption is a significant figure, and conflicts of use could be significant in the coming years. Since the price of electricity is impacted by the offer and demand law, a significant increase in the demand for electricity would most likely increase its prices for all consumers, not only during peak hours^{781 782}, but also on longer periods as experienced recently in Europe following the disruption of the gas supplies: a slightly impact on the offer led to significant price increases⁷⁸³.

III.III.1.3. Review of the taxation policies

Electricity

Tax directive on energies is regulated by the European laws through the directives 2003/96/CE 784 and 2020/262⁷⁸⁵ which entered into force in February 2023.

Transposed into the French law, the excises duties are regulated within the “code des impositions sur les biens et services” (CIBS)⁷⁸⁶ which translates the Article 184 of the 2019-1479 law with the ordinance 2021-1848.

⁷⁸⁰ <https://www.edf.fr/en/the-edf-group/dedicated-sections/investors/financial-and-extra-financial-performance/operational-performance/nuclear-generation> accessed August 13, 2024

⁷⁸¹ Dmitriy O. Afanasyev, Elena A. Fedorova, Viktor U. Popov, Fine structure of the price–demand relationship in the electricity market: Multi-scale correlation analysis, Energy Economics, Volume 51, 2015, Pages 215-226, ISSN 0140-9883, <https://doi.org/10.1016/j.eneco.2015.07.011>

⁷⁸² EIA, Factors affecting electricity prices, <https://www.eia.gov/energyexplained/electricity/prices-and-factors-affecting-prices.php> accessed August 13, 2024

⁷⁸³ <https://www.euronews.com/business/2023/10/31/energy-crisis-who-has-the-priciest-electricity-and-gas-in-europe> accessed August 13, 2024

⁷⁸⁴ <https://eur-lex.europa.eu/LexUriServ/LexUriServ.do?uri=OJ:L:2003:283:0051:0070:FR:PDF> accessed August 13, 2024

⁷⁸⁵ <https://eur-lex.europa.eu/legal-content/EN/TXT/PDF/?uri=CELEX:32020L0262> accessed August 13, 2024

⁷⁸⁶ https://www.legifrance.gouv.fr/codes/section_lc/LEGITEXT000044595989/LEGISCTA000044598327/#LEGISCTA000044603893 accessed August 13, 2024

According to article L.312-21 of the CIBS, energies are spitted in three categories: fuels for transportation (L.312-22), other fuels (L.312-23) and electricity (L.312-24). Within the fuels for transportation, the Jet Fuel is recognized as Jet A1 (L.312-22), which is the international norm ⁷⁸⁷.

The VAT (Value Added Tax) is supposed to be applied on all the above products according to the directive 2006/112/CE ⁷⁸⁸. The normal rate of 20% is considered for electricity.

The CTA (Contribution Tarifaire d'Acheminement) which applies to the transportation and distribution of electricity proposes 2 tariffs: 10.11% for consumers requiring more than 50 kVA of power, mostly industries, and 21.93% when below this power, mostly households. The VAT is applied to the CTA at a reduced rate of 5.5%. Electro-intensive consumers are generally exempt from the CTA ⁷⁸⁹.

The tariff of the excise tax on electricity is mentioned in article L312-37 of the CBIS. For 2023, the tariff is 32,0625 € / MWh for households while for industries it ranges from 22.5 € to 25.6875 / MWh.

To produce efuel, several articles of the CIBS would apply.

Article L312-65, L312-66 and L312-73 would apply as efuel is an electro-intensive process. Water electrolysis is specifically mentioned in article L312-66. With an electro-intensity above 13.5% and international competition ⁷⁹⁰, the reduced tariff would be 0.5 € / MWh.

Article L312-31 of the CBIS stipulates that taxable products consumed to produce energy products are exempted from excise duty. This would mean that the electricity supplied to produce efuels could in fact be fully exempted from excise duty.

Jet Fuel

While the transportation fuel normal rate for VAT is 20% in France, the article 148 ⁷⁹¹ of the EU VAT Directive provides an exemption for fueling and provisioning of aircraft with Jet Fuel on international routes.

Jet Fuel for commercial operations is also exempted of excise duty per Energy Tax Directive 2003/96/EC. Article 14 states that Member States shall exempt energy products from taxation. While Member States may abolish this exemption for intra-Community and domestic flights exemption, there are currently no EU Member States that waive the tax exemption on jet fuel on domestic flights.

The EU tax exemption of aircraft fuel is based on the international provisions of the 1944 ICAO Chicago Convention ⁷⁹². ICAO however does not explicitly prohibit the taxation of jet fuel. Article 24 states that *"fuel on board an aircraft of a contracting state, on arrival in the territory of another contracting State and retained on board on leaving the territory of the State shall be exempt from customs duty, inspection fees or similar national or local duties and charges"*. This implies that the jet fuel tax exemption only applies to the taxation of fuel which is already on board, but not on the intake of fuel in another state. This a translation, not an obligation, of the Chicago convention (see Part I, Chapter II.2).

France applies this directive within its CIBS in articles L312-27 and L312-28 which stipulates that when a reduced tariff (L312-27) or a particular tariff (L312-28) exist, the lowest tariff applies.

⁷⁸⁷ <https://www.astm.org/d1655-22.html> accessed August 13, 2024

⁷⁸⁸ <https://eur-lex.europa.eu/legal-content/FR/TXT/PDF/?uri=CELEX:32006L0112> accessed August 13, 2024

⁷⁸⁹ <https://www.edf.fr/entreprises/le-mag/le-mag-entreprises/decryptage-du-marche-de-l-energie/evolution-des-taxes-et-contributions-appliquees-sur-l-electricite-au-1er-fevrier-2022> accessed August 13, 2024

⁷⁹⁰ <https://www.iea.org/data-and-statistics/data-tools/hydrogen-production-projects-interactive-map> accessed August 13, 2024

⁷⁹¹ https://taxation-customs.ec.europa.eu/exemptions-right-deduct_en accessed August 13, 2024

⁷⁹² <https://www.icao.int/publications/pages/doc7300.aspx> accessed August 13, 2024

While article L312-35 mentions the normal tariff of 76,826 € / MWh in 2022, article L312-48 and L312-58 stipulates that the reduced tariff for jet fuel is 0 € / MWh.

It is noted here that beyond Jet Fuel, the overall activities related to air transportation are VAT exempted according to ICAO policy doc 8632 (2021)793: The *“normal practice with respect to the sale or use of international transport is to apply a 0 VAT rate”*. IATA argues that a 0 VAT rate should be applied because international air transport generally takes place outside any tax jurisdiction. On some occasions, domestic routes can face a higher VAT rate, 10% in France.

SAF

Until ReFuel EU applies in 2025, France has in place an incentive tax on the use of renewable energy in transport (tax incitative relative à l'utilisation d'énergie renouvelable dans les transports, TIRUERT). This tax is a so-called behavioral tax that aims to encourage the inclusion of a target percentage of sustainable air fuels.

It sets an objective for the use of SAF beyond which the amount due under this tax is nil for the liable entity. This target is 1% of jet fuel in 2023, reaching 1.5% as of January 1, 2024. If this target is not met, a penalty of 1.68€ per missing liter is paid by the providers. This penalty is supposed to be 2.80 € per missing liter in 2025 before being replaced by the ReFuel EU regulation.

It is noted here that within the review of the 2024 financial legislation, an amendment has been proposed to decrease this tax to 1.25 € per missing liter in 2024 and nil in 2025 ^{794 795}. It could be interpreted as prioritizing the profits over the environment as highlighted by Grote et al in Direct carbon dioxide emissions from civil aircraft in 2014, *“environmentally a global regulator with teeth is urgently required”* ¹⁵⁴. This amendment was prepared with the support of the FNAM ⁷⁹⁶, the French Commercial Aviation Association.

In return, public policy plans to provide massive support for the entire industry through three mechanisms ⁷⁹⁷:

- Creation of a tax incentive scheme for the adaptation and renewal of aircraft, and for airport fueling infrastructure
- Budgetary support for the production of sustainable aviation fuels
- Long-term financing tools for the purchase of SAF

As discussed in the previous chapter, procedural justice would here be appropriate as it seems that the rationale used to subsidize airlines, airport and SAF producers goes against the necessity to significantly increase the price to contain the demand. Moreover, the assessment behind these mechanisms could be questioned:

- *“The industry is struggling to obtain supplies of sustainable aviation fuels (SAF) in Europe, due to a lack of availability in sufficient quantities and at competitive prices”*: while there are no issues with competition since the cost of SAF is and will remain higher than CAF as reviewed in previous chapters, it is available in Europe and there will be enough SAF produced in France as soon as 2024 and until the next ratchet, 6%, scheduled for 2030 (400 000 tons, TotalEnergies).
- *“Today, and for the years to come, the production of SAF on European soil is not sufficient to meet the mandates for incorporation, which will push airlines to source their supplies outside our borders, causing a terrible loss of earnings and strategic independence”*: as mentioned above there is enough SAF produced in France until 2030, and even in Europe. The recent announcements of major players such as BP and Shell to postpone their investments in SAF units in Europe is driven by the lack of demand as airlines will only supply the quantities they have to due to regulations (2% in 2025, 6% in 2030). There are no losses in earning and

⁷⁹³ https://www.icao.int/publications/Documents/8632_3ed_sup_aug21_en.pdf accessed August 13, 2024

⁷⁹⁴ <https://www.senat.fr/enseance/2023-2024/127/Amdt I-299.html> accessed August 13, 2024

⁷⁹⁵ <https://www.assemblee-nationale.fr/dyn/16/amendements/1680A/AN/3184.pdf> accessed August 13, 2024

⁷⁹⁶ <https://www.fnam.fr/> accessed August 13, 2024

⁷⁹⁷ <https://www.senat.fr/amendements/2023-2024/127/Amdt I-18.html> accessed August 13, 2024

strategic independence, indeed it is quite the opposite as CAF is 100% imported as France has no major producing oil fields on its soil.

- *“Indeed, the significant additional cost of purchasing SAF compared with kerosene (between 3 and 10 times) constitutes a competitive disadvantage for French and European airlines, which are particularly subject to the measures of the European “FitFor55” package”*: There are no significant disadvantages for French and European airlines as discussed in Part I: all airlines fueling in Europe, including foreign airlines, have to apply the ReFuel EU regulations. The only consideration would be for long distances hub strategies and indeed an airline flying from USA to Middle-East could be tempted to refuel in Turkey rather than in Europe, but these flights are marginal. Still the industry is requiring additional policy support ⁷⁹⁸.
- *“While France has not yet taken any measures to support the production of SAF in sufficient quantities to meet the objectives of the incorporation mandates, the United States has decided on the opposite strategy, investing massively to launch the creation of a sustainable and attractive industry. Part of the \$370 billion budget earmarked in the Inflation Reduction Act (IRA) for measures to support green industrial policy in the United States has been allocated to the development of this industry, which today contributes to the fact that the American industry offers SAF at half the price of European or French production”*: The issue is not cost but volumes and the US approach differs from the European’s one. Subsidies along with the authorization to use feedstocks competing with food in the USA allow this country to propose a lower cost of SAF. However, as discussed in previous chapters, SAF units within the USA are struggling and the offer remains limited. As of 2024, 99% of the SAF proposed worldwide is HEFA made from used cooking oil, with the largest production units located in Asia and Europe (Porvoo, Rotterdam). As mentioned above TotalEnergies has invested in France, aiming to produce 285 000 tons per year, a figure close to the 6% required by the EU regulation in 2030.

It is found that as of today policies in place are subsidizing SAF to lower their cost, either via direct or indirect mechanisms.

III.III.1.4. Review of electricity consumptions

To evaluate the impact of taxation policies and their effects on the final prices of energy for the final customer who is often the citizen, it is found necessary to compare the prices of the final energy with the final use.

In France, according to Engie ⁷⁹⁹, a family of 4 living in a 100 square meters house will consume 16 975 kWh per year for its basic needs: heating, cooking, hot water and home appliances. Or approximately 4200 kWh per person per year. An efficient electric vehicle (EV) would have an energy consumption of 16 kWh / 100 km ⁸⁰⁰. For an average of 10 000 km per year in 2021 ⁸⁰¹ this would mean 1600 kWh per car per year.

A round trip flight from Paris to New-York would mean 11680 kilometers with an average of 2.8 liters per passenger for 100 km ⁸⁰² or 327 liters of fuel per person according to the Direction Générale de l’Aviation Civile (DGAC). With 28 kWh of electricity to produce 1 kg of efuel, or 22.4 kWh per liter (jet fuel density 0.800 kg/L), this would mean 7 324 kWh of electricity.

TABLE 57 below summarizes the above data.

⁷⁹⁸ <https://www.weforum.org/publications/guidelines-for-a-sustainable-aviation-fuel-blending-mandate-in-europe/> page 22, accessed August 13, 2024

⁷⁹⁹ <https://particuliers.engie.fr/electricite/conseils-electricite/conseils-tarifs-electricite/consommation-electrique-moyenne-logement-par-superficie.html> accessed August 13, 2024

⁸⁰⁰ <https://ev-database.org/cheatsheet/energy-consumption-electric-car> accessed August 13, 2024

⁸⁰¹ <https://fr.statista.com/statistiques/484345/distance-parcourue-en-moyenne-par-voiture-france/> accessed August 13, 2024

⁸⁰² <https://eco-calculateur.aviation-civile.gouv.fr/> accessed August 13, 2024

Yearly Electricity Consumption per person, rounded value in kWh	
Heating	2600
Hot Water	500
Cooking	300
Lighting & other home appliances	800
Car (average 2 passengers)	800
Round trip Paris to New-York 1 passenger	7300

TABLE 57 Average electricity consumption per application and per person / year, source Jean-Baptiste Jarin with data from Engie, ev-database, Statista and Aviation Civile (DGAC)

One can notice that for a single person, a unique trip to New-York would represent more electricity than all its vital and basic needs: heating + hot water + cooking + lighting + all home appliances + 10 000 km by car as shown in FIGURE 162 below, which summarizes these electricity consumptions. In green are the primary needs (heating, lighting, hot water, cooking), in blue the secondary needs (local mobility) and in orange tertiary needs (long distance mobility).

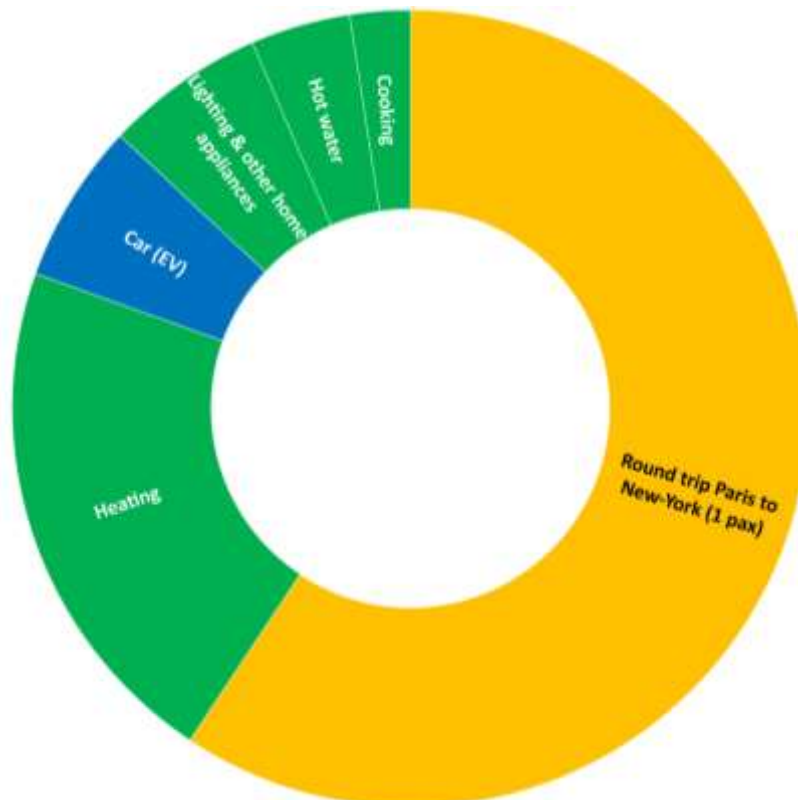

FIGURE 162 Share of electricity consumption in kWh per person (yearly consumption for heating, cooking, hot water, lighting, home appliances and electric car, single return trip for air mobility), source Jean-Baptiste Jarin

It is noted here that the values used (€ / kWh or € / MWh) are S1 2021. This period has been chosen to neutralize the effects of the invasion of Ukraine by Russia, which led to strong policies support in various forms within the EU starting S1 2022.

The price of electricity covers the production costs and the associated taxes. As presented above, and while the production costs would not differ from the typology of consumers, taxes are not equally distributed. This leads to significant differences in final prices, with an average of 220.3 € / MWh within the EU and 194.6 € / MWh in France for household consumers during the first semester of 2021⁸⁰³. These prices are cost of transmission and distribution and tax included, including VAT. This is consistent with the value presented by the French Ministère de la Transition Energétique, 193.1 € / MWh⁸⁰⁴.

Since household consumers are not tax exempted, the rounded value of 194 € / MWh (0.194 € / kWh) for France is used.

For industries consuming between 500 and 2000 MWh per year, therefore excluding electro-intensive industries, the average within the EU during the same period is 128.5 € / MWh excluding taxes and levies. In France the price is slightly lower, reaching 105.7 € / MWh⁸⁰⁵.

As described above, the impact of the tax could significantly increase these production prices, as with taxes and levies included the final price for the same period reaches 156.7 € / MWh, average within the EU, and 125.5 € / MWh in France⁸⁰⁶.

For the electro-intensive facilities, efuel and therefore eSAF production should fall within this category as a 0.1 Mt production unit requires the production of almost one nuclear plant, the prices before and after taxes are significantly lower. This is explained before taxes by the volumes associated and the ability for these industries to firm long-term contracts. There are also often sovereignty concerns while the rationale being that the final product would be taxed. The taxation is indeed significantly lower or even inexistant. The average within the EU during S1-2021 is 58 € / MWh excluding taxes and levies. In France the price is 54.3 € / MWh. The impact of the tax would increase these costs, and taxes and levies when included increased prices for the same period to 92.1 € / MWh, average within the EU countries, and 65.5 € / MWh in France. With the existing tax scheme, the price for producing eSAF would be 54.3 € / MWh.

While it has been found that volumes of electricity required for air mobility would benefit to a fraction of households while overpassing the vital and basic needs combined, FIGURE 162, it appears that the existing tax scheme for electricity would lead to energy injustice since the final product, eSAF, would remain untaxed. As shown in FIGURE 163 below, the gap between the price paid for vital and basic needs is significantly higher than the price paid for air mobility (eSAF), the gap with the rest of the industries being also significant.

⁸⁰³ https://ec.europa.eu/eurostat/statistics-explained/index.php?title=Electricity_price_statistics#Electricity_prices_for_non-household_consumers accessed August 13, 2024

⁸⁰⁴ https://www.ecologie.gouv.fr/sites/default/files/Datalab_essentiel%20prix_elec_2021_051022_TD_bis_0.pdf accessed August 13, 2024

⁸⁰⁵ https://ec.europa.eu/eurostat/databrowser/view/nrg_pc_205/default/table?lang=en accessed August 13, 2024

⁸⁰⁶ https://ec.europa.eu/eurostat/databrowser/view/nrg_pc_205_custom_9528487/default/table?lang=en accessed August 13, 2024

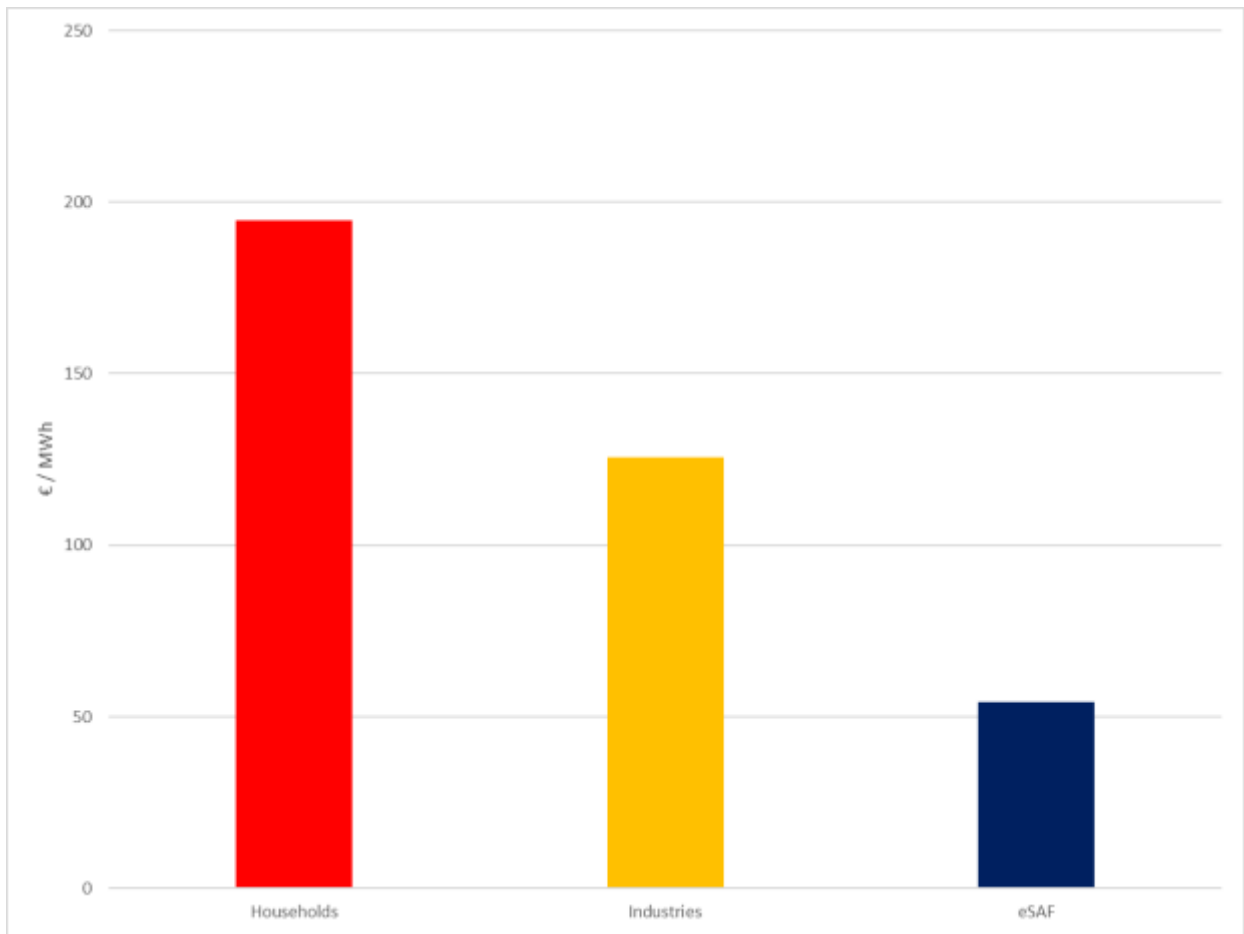

FIGURE 163 Electricity prices in France in S1 2021 for household (red), industries (from 500 to 2000 MWh per year, in orange) and eSAF production (blue), in €/MWh, source Jean-Baptiste Jarin

As for the change of paradigm needed in air mobility, there is an urgent necessity to review the rationale behind current tariffs and public policies since the mechanisms in place are not only not taxing but subsidizing the energy dedicated for air mobility, from the production to the usage.

Since it was found that 88% of the flights are realized by the 10% wealthiest in Europe (FIGURE 165), such policies could be questioned, even more since subsidizing can only support the demand, which could lead to significant side effects in societies. Within energy justice, both procedural justice, to evaluate the current and future policies, and distributive justice, to evaluate the fairness of energy policies, should be considered.

III.III.2. Energy justice within tax policies

The previous chapter concludes that the current tariffs and policies schemes need to be revised to support a new social contract for air mobility and that procedural justice would be adapted.

Energy justice can support such a revision, and the distributive justice should play a major role.

Electricity is the cornerstone of a future low carbon economy and with the perspective of future low carbon energy carriers based on electricity, the taxation scheme associated has a central place to avoid any future inequalities. Policies are therefore needed to drive not only the production but also the consumption within a distributive justice perspective. Taxation policy should be elaborated accordingly.

The energy justice approach proposed relies on the energy justice triangle proposed in The concept of energy justice across the disciplines⁸⁰⁷, the objective being to propose a holistic approach that would guide any decision through the lens of energy justice for all. As highlighted by the two authors, public policies that will be translated into laws must balance economic, environmental and energy security issues to offer the best solutions, at least the best compromise, to the populations.

The EU explicitly aims to enable a just transition towards a low-carbon energy system⁹⁶. It is therefore the prism of distributive justice, through tax policies, which should ensure that rates applied to electricity are not disadvantageous to purposes that may be vital compared to more exclusive applications.

Within the just transition, *“a more inclusive approach to the development of a low carbon economy”*⁸⁰⁸ is required.

As such the increasing role of electricity within our energy production and consumption must come with fair taxation since taxation being the cornerstone of equality⁸⁰⁹. Distributive justice is related to the taxation and the distribution of benefits from the energy sector and as highlighted by Heffron in *Achieving a Just Transition to a Low Carbon Economy*⁸⁰⁸ *“from a distributive perspective, a just transition to low carbon / carbon neutral societies is as much about tangible changes as it is about changing energy sources”*.

This includes jobs, levels of services, but above all energy supplies.

Electricity for heating, lighting, or cooking are recognized as vital needs all over the world. Even in less developed countries, such as the Philippines or South Africa, electricity is seen as a *“lifeline”* and free basic electricity allotments are for example provided to the citizens: 120 kWh/year per connection in the Philippines, 600 kWh/year per household in South Africa⁸¹⁰.

On the opposite, air mobility is a more exclusive application.

III.III.2.1. Air mobility and energy justice

In 2018, according to Gössling and Humpe in *The global scale, distribution and growth of aviation: Implications for climate change*, only 2 to 4% of the world population flew internationally¹⁵¹ and the authors found that while less than 0.7% of the low income population were flying, this percentage reached 40% for the high income population.

⁸⁰⁷ <https://www.sciencedirect.com/science/article/pii/S0301421517301593> accessed August 13, 2024

⁸⁰⁸ R. J. Heffron, *Achieving a Just Transition to a Low-Carbon Economy*, https://doi.org/10.1007/978-3-030-89460-3_3

⁸⁰⁹ Gribnau, Hans and Vording, Henk, *The Birth of Tax as a Legal Discipline* (February 1, 2017). <http://dx.doi.org/10.2139/ssrn.2919003>

⁸¹⁰ Shonali Pachauri, *reaching an international consensus on defining modern energy access*, *Current Opinion in Environmental Sustainability*, Volume 3, Issue 4, 2011, Pages 235-240, ISSN 1877-3435, <https://doi.org/10.1016/j.cosust.2011.07.005>

Even in Europe, one of the wealthiest world economic area, air mobility remains an activity which is mostly used by the high-income households.

In *The unequal distribution of household carbon footprints in Europe and its link to sustainability*⁹⁰, Ivanova and Wood highlighted that air mobility is almost inexistant for 90% of the EU populations, from 0 to 0.1 ton of eCO₂ emissions associated to air mobility per year, while the top 1% would emit more than 22 tons per year, FIGURE 164.

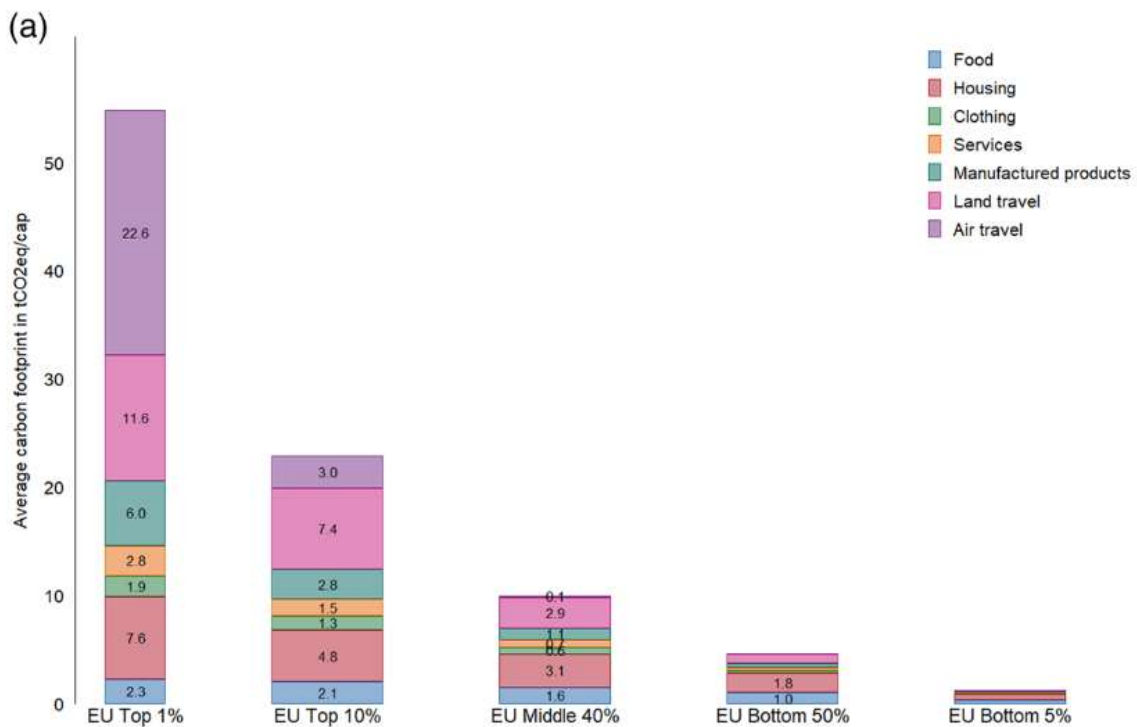

FIGURE 164 Average carbon footprint distribution (in ton eCO₂) by consumption category in the European Union. Originally figure 3a of *The unequal distribution of household carbon footprints in Europe and its link to sustainability*, Ivanova and Wood. With courtesy of first author

Using the data provided by first author, it is possible to focus on air mobility eCO₂ emissions within the European Union.

There are currently 448 million inhabitants within the EU, and it can be calculated that:

- Bottom 50%: 224 million European citizens do not fly
- Middle 40%: 179 million European citizens, with a 0.1-ton CO₂eq / year, fly an average of 800 km per year⁸¹¹
- Top 9%: 40.5 million European citizens, with an average of 0.8 tons-CO₂eq / year, fly an average of 8500 km per year, the equivalent of 5 return trip Paris to Berlin⁸¹¹, or one travel within Europe every 2 months.
- Top 1%: 4.5 million European citizens, with an average of 22.8 tons-CO₂eq / year. This is equivalent of 2 return trip per month from Paris to New-York⁸¹¹, or more than 300 000 km per year.

eCO₂ emissions in air mobility are indeed exponential with income, as shown in FIGURE 165 below.

⁸¹¹ <https://eco-calculateur.aviation-civile.gouv.fr/> accessed August 13, 2024

This is in direct contradiction with the recent allegations of the World Economic Forum which stated that “low-cost airlines have democratized travel”⁸¹², the wealthiest part of the population, here the top 10% within the EU, represents 88% of the air mobility eCO₂ emissions.

Still, it receives very low policy attention, with 1% of policies targeting air mobility⁸¹³. Worse, air mobility, including energy dedicated to air mobility, remains not only largely untaxed, but often subsidized, as concluded in the previous chapter.

This raises substantial ethical and equity questions, justifying the need to introduce the distributive justice concept in future policies.

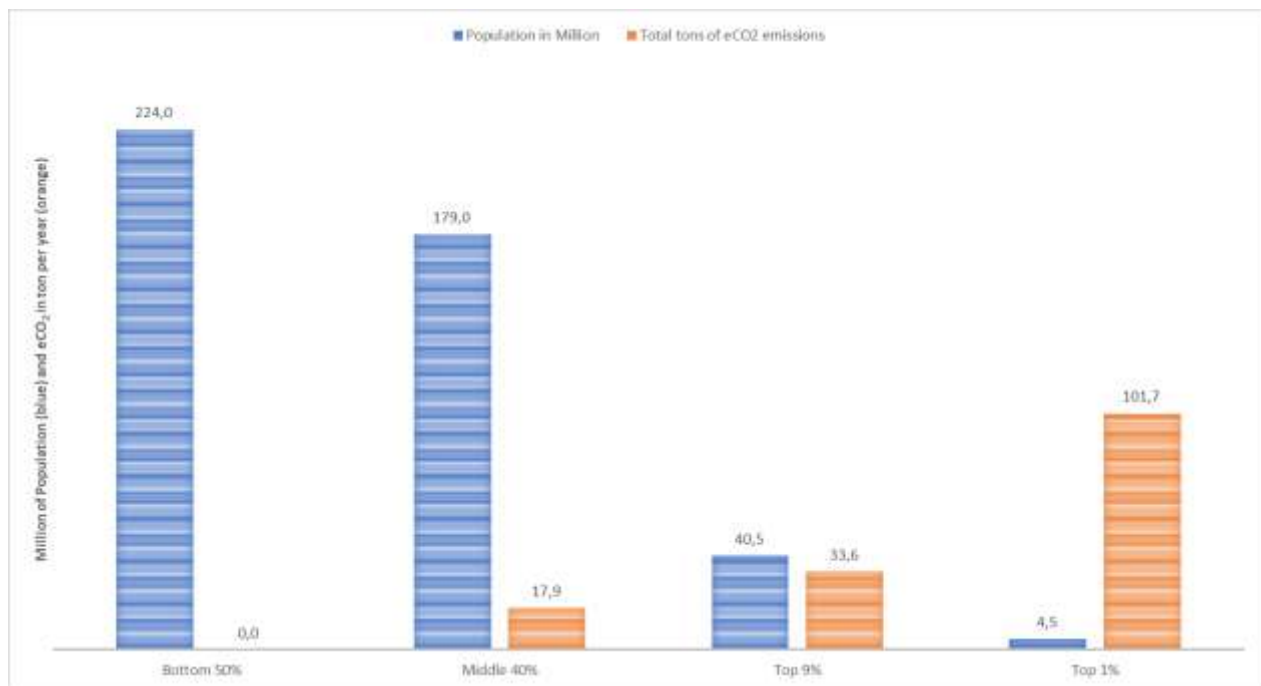

FIGURE 165 eCO₂ emissions from air mobility according to the income within the EU population, source Jean-Baptiste Jarin with data provided by Ivanova & Wood “The unequal distribution of household carbon footprints in Europe and its link to sustainability”, with kind authorization of first author Dr Ivanova

III.III.2.2. Effects of current tax schemes and final electricity prices

As discussed above, there are currently no distributive justice principles applied to energy for air mobility, and the effects within our societies would significantly grow if the social contract remains unchanged.

Comparing the effects of the current energy policies for households provides the necessary food for thought to introduce distributive justice and propose a new social contract.

While considered for France and to a certain extent the European Union, the approach and conclusions can be extrapolated to the world.

Electricity for households (cooking, heating, lighting, home appliances)

⁸¹² <https://www.weforum.org/agenda/2017/04/low-cost-airlines-have-democratized-travel-it-s-time-airports-did-their-part/> accessed August 13, 2024

⁸¹³ Dubois et al, it starts at home? Climate policies targeting household consumption and behavioral decisions are key to low-carbon futures, Energy Research & Social Science, Volume 52, 2019, Pages 144-158, ISSN 2214-6296, <https://doi.org/10.1016/j.erss.2019.02.001>

As discussed in the previous chapter, households are concerned with the electricity production cost, the transport & distribution cost, the CTA, the excise tax (L312-37) and the VAT. The breakdown is:

- Production: 74 € / MWh
- T&D: 55 € / MWh
- CTA: 5 € / MWh
- Excise tax: 32 € / MWh
- VAT: 28 € / MWh

The average price in S1 2021 is 194 € / MWh, or 0.194 € / kWh, as concluded in the previous chapter and summarized here in FIGURE 166.

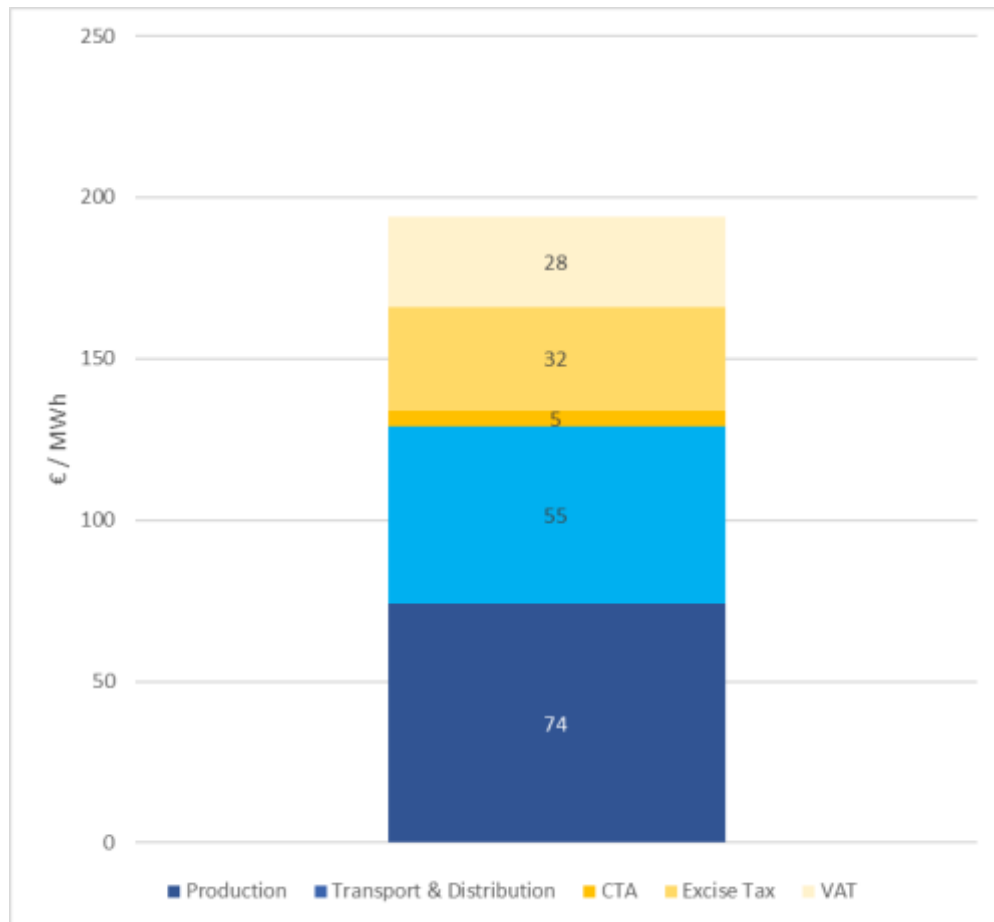

FIGURE 166 Electricity price for the household in France in 2021 expressed in € / MWh detailing the share of production, T&D and taxes, source Jean-Baptiste Jarin

Electricity for eSAF

The focus is eSAF as efuels could serve other needs, such as maritime or road transportation, which would have different tax schemes. Indeed, even it would be highly energy inefficient as concluded in the part I and II, if efuels were used in cars the tax scheme would be significantly different (higher) since several taxes are already in place: fossil fuel for car are concerned by VAT and excise tax for instance.

Tax directive on energies is regulated by the European laws through the directives 2003/96/CE⁷⁸⁴ and 2020/262⁸¹⁴ which entered into force in February 2023. Transposed into the French law, the excises duties are regulated within

⁸¹⁴ <https://eur-lex.europa.eu/legal-content/EN/TXT/PDF/?uri=CELEX:32020L0262> accessed August 13, 2024

the “code des impositions sur les biens et services” (CIBS) ⁷⁸⁶ which translates the Article 184 of the 2019-1479 law with the ordinance 2021-1848. According to article L.312-21 of the CIBS, energies are spitted in three categories:

- Fuels for transportation (L.312-22)
- Other fuels (L.312-23)
- Electricity (L.312-24)

Within the fuels for transportation, the Jet Fuel is recognized as Jet A1 (L.312-22), which is the international norm ⁷⁸⁹.

To produce efuel, article L312-31 of the CBIS stipulating that taxable products consumed to produce energy products are exempted from excise duty. This means that the electricity supplied to produce efuels and therefore eSAF is exempted from excise duty.

As discussed in section 2.b, the CTA (Contribution Tarifaire d’Acheminement), electro-intensive consumers are generally exempted from the CTA ⁸¹⁵ and this is the hypothesis here. Indeed, if the CTA would be applied, this could be an incentive to produce abroad.

As reviewed in the previous section, the electricity price for electro-intensive consumers for the 1st semester 2021 in France is 54.3 € / MWh, excluding tax and levies

While the transportation fuel normal rate for VAT is 20% in France, the article 148 ⁸¹⁶ of the EU VAT Directive provides an exemption for fueling and provisioning of aircraft with Jet Fuel on international routes. This means that VAT will not be applied for the production neither sale of eSAF (this would be different for efuels for cars as mentioned above).

The electricity price for the manufacturing of eSAF is therefore limited to the electricity production price: 54.3 € / MWh. One can notice that the absence of any taxation comes also with the exemption of the infrastructure costs as Transport & Distribution costs do not apply:

- Production: 54.3 € / MWh
- T&D: none
- CTA: none
- Excise tax: none
- VAT: none

TABLE 58 and FIGURE 167 summarize the prices for households and eSAF.

⁸¹⁵ <https://www.edf.fr/entreprises/le-mag/le-mag-entreprises/decryptage-du-marche-de-l-energie/evolution-des-taxes-et-contributions-appliquees-sur-l-electricite-au-1er-fevrier-2022> accessed August 13, 2024

⁸¹⁶ https://taxation-customs.ec.europa.eu/exemptions-right-deduct_en accessed August 13, 2024

Electricity Price in France, S1 2021, in € / MWh		
	Household	eSAF
Production	74	54,3
Transport & Distribution	55	0
CTA	5	0
Excise Tax	32	0
VAT	28	0
Total	194	54,3
Ratio	3,6	

TABLE 58 Electricity prices in France in S1 2021 for household (primary, secondary, tertiary needs) and eSAF for air mobility (tertiary need) in € / MWh, source Jean-Baptiste Jarin

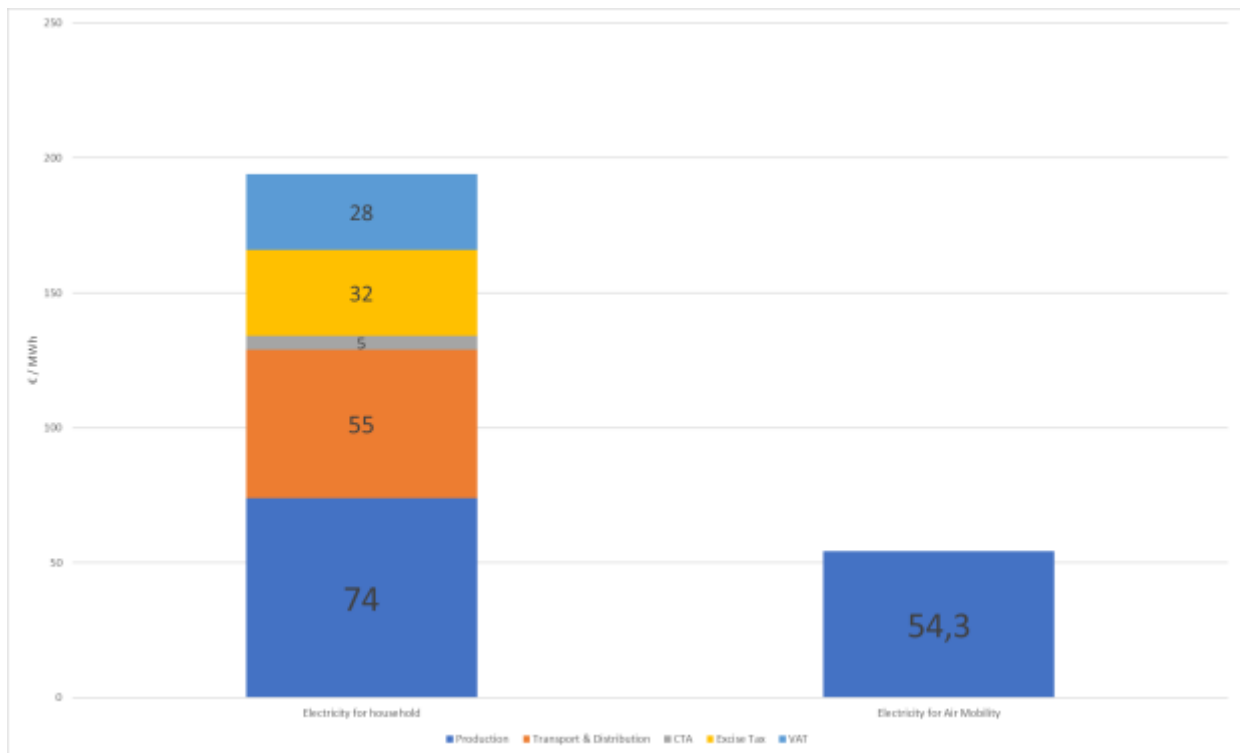

FIGURE 167 Electricity prices in France in S1 2021 for household (primary, secondary, tertiary needs) and eSAF for air mobility (tertiary need) in € / MWh, source Jean-Baptiste Jarin

Within the current tax scheme and tariffs, the electricity price for households, including vital (primary) and basic (secondary) needs, is 3 times higher than the electricity price for air mobility, a more exclusive tertiary need.

With these numbers, the yearly electricity budget for the primary needs can be calculated and it is estimated at 960 € per person. This includes heating, hot water, cooking, lighting, and all home appliances but excludes electric mobility which would require a further 155 € / year per person, as shown in TABLE 59 below.

Yearly Electricity Consumption, prices and budget per person, rounded value in kWh and €				€	€
Heating			2600	0,194	504,4
Hot Water			500	0,194	97
Cooking			300	0,194	58,2
Lighting & other home appliances			800	0,194	155,2
Car (average 2 passengers)			800	0,194	155,2

TABLE 59 Yearly budget per person for vital needs and ground mobility, source Jean-Baptiste Jarin

For air mobility, the quantities and prices of electricity required for different destinations are detailed in FIGURE 167 below. The cost associated with the air mobility is here directly proportional to the distance travelled, i.e. a trip from Paris to Amsterdam would require an equivalent of 900 kWh of electricity to produce the associated quantity of efuel per passenger (for comparison the same trip would require approximately 30 kWh in high-speed train and 80 kWh with an electric car). A trip from Paris to New-York would require more than 7300 kWh. These calculations are detailed in chapter III.III.1.5. above with data from DGAC ⁸¹¹.

Since no taxes are applied, the current price of electricity considered here for eSAF is 5.4 cents / kWh (54.3 €/MWh) as shown in TABLE 58 above.

As such, the cost of energy for a return trip Paris to Amsterdam would be 49 €. This is the price for energy only, not considering other costs supported by the operator such as landing fees, salaries, or aircraft amortization.

Similarly, a long-distance trip such as Paris to New-York would mobilize more than 7300 kWh, more than the yearly consumption of a single person for all its vital and basic needs including ground mobility. The cost of energy being 401 €. One can notice that while requiring almost twice the electricity in volume compared to the vital and basic needs, here 7300 kWh vs 4000 kWh, the return trip from Paris to New-York requires a budget being only 1/3 of the one required for the vital and basic needs, 401 € compared to 1115 €.

III.III.2.3. Distributive justice

Energy justice means the consideration of human rights in the energy life cycle and it therefore starts with extraction and production of energy carriers such as biofuels and efuels ⁹¹. It is a conceptual framework which identifies when and where injustices occur and how best legal frameworks can address these injustices. To deliver energy justice, five forms of justice are critical, and these include distributive, which can be implemented through national courts ⁶³⁸. Given that eSAF policy is very much still in the formative stage energy justice is the perfect theory to identify injustices before they occur, to ensure “... also the provision of a more fair, equal, equitable and inclusive transition”.

The EU explicitly aims to enable a just transition towards a low-carbon energy system ⁹⁶. It is therefore the prism of distributive justice, through tax policies, which should ensure that rates applied to electricity are not disadvantageous to purposes that may be vital compared to more exclusive applications.

As such the increasing role of electricity within our energy production and consumption must come with fair taxation since taxation being the cornerstone of equality ⁸¹⁷. Distributive justice is related to the taxation and the distribution of benefits from the energy sector and as highlighted by Heffron in Achieving a Just Transition to a Low Carbon Economy ⁸⁰⁸ “from a distributive perspective, a just transition to low carbon / carbon neutral societies is as much about tangible changes as it is about changing energy sources”.

⁸¹⁷ Gribnau, Hans and Vording, Henk, The Birth of Tax as a Legal Discipline (February 1, 2017). <http://dx.doi.org/10.2139/ssrn.2919003>

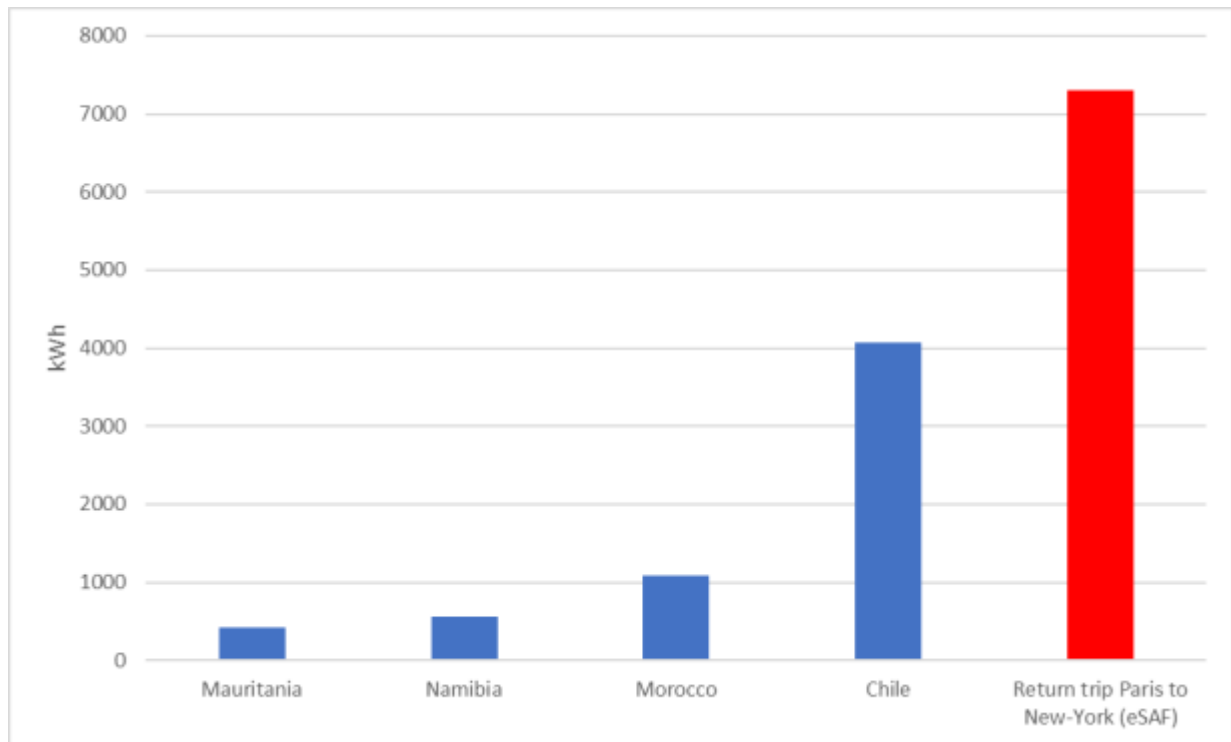

FIGURE 168 Comparing Capita / Year electricity consumption in Global South countries considered for H₂/ eSAF production and electricity consumption for a return trip (1 pax) Paris to New-York with eSAF, data from TABLE 56 Socio-energetic overview of the selected countries, source Jean-Baptiste Jarin

While the focus being here the fair taxation of energy applied to primary, secondary and tertiary needs within a country or an economic area such as the European Union, global energy justice should later be considered and FIGURE 168 above highlights the significant gaps between different populations across the globe. Understanding that a single trip from Paris to New-York is 17 folds the yearly electricity consumption of a Mauritanian for all its needs should raise some concern and at least support the paradigm shift required for air mobility.

Among the conflicts of use associated with the decarbonization of the energy for air mobility, the introduction of a synthetic fuel based on electricity, eSAF, needs to be carefully evaluated and applying the distributive justice prism should guide our future tax policies to avoid significant energy injustice for the populations.

While the existing tax scheme promotes air mobility versus ground mobility, the CIBS⁷⁸⁶ tariffs for the same fossil fuel being 76,826 € / MWh for personal cars (L312-35) and 0 € / MWh (L312-58) for air mobility, results show that keeping the same tax scheme and tariffs for eSAF would significantly foster energy injustice even in developed countries like France, not only when comparing different forms of mobility, as this is the case today between cars, but also trains which electricity is taxed, and air mobility, but now with the different usages of an energy which serves vital and basic needs: distributive justice shall be implemented to ensure that rates applied to electricity are not disadvantageous to purposes that may be vital compared to more exclusive applications within the population.

Indeed, the vast amount of electricity required to produce efuels and even more eSAF poses several risks, namely access to low carbon electricity and conflicts of use, which generally translates into higher prices for the populations due to supply and demand imbalance. Electricity supply and demand imbalance has short term⁸¹⁸ and long-term⁸¹⁹ impacts on prices for the final user not only with higher prices but also a lower economic growth rate and a higher inflation.

⁸¹⁸ Eicke et al, Electricity balancing as a market equilibrium: An instrument-based estimation of supply and demand for imbalance energy, Energy Economics, 2021; <https://doi.org/10.1016/j.eneco.2021.105455>

⁸¹⁹ <https://www.spglobal.com/marketintelligence/en/mi/research-analysis/supply-imbalances-bring-higher-inflation-lower-global-growth.html> accessed August 13, 2024

It is noted here that extrapolating to other countries would require further analysis. Within the EU, all countries follow the same tax directive on energies through the directives 2003/96/CE and 2020/262⁷⁸⁴ which entered into force in February 2023 and while the focus is limited to France and while the methodology can be transposed to other countries, the electricity prices in Europe vary for each country.

III.III.3 Proposals

The shift of paradigm required for air mobility to be sustainable have been explained and detailed (Part I and II) and the counter parts, namely access to low carbon electricity and a significant share of the biomass for energy, identified (Part III). The collateral effects have been identified and measured to some extent, and energy justice is found to be necessary to not only avoiding replicating the oil curse in the Global South but also avoiding to foster energy injustice within populations in developed countries with unfair tax schemes.

As such it is proposed here that the taxation rate should be proportional to the final purpose of the energy, this is therefore detailed in III.III.3.1. and III.III.3.2. before addressing general proposals.

This approach is somehow similar to the one proposed by the IMF for water *“when you do not get prices right for water, you end up with misallocation of water today and misallocation tomorrow”*⁸²⁰ and it could be applied to electricity, which is almost as vital as water in our modern societies.

Introducing a progressive tariff for electricity, as proposed for water based on the volume of use in some parts of the world, is considered since a couple of decades⁸²¹, but the predicted electricity savings and cost effects depend crucially on tariff, as demonstrated recently in South Korea⁸²².

III.III.3.1. Adapting the Pyramid of Needs to energy justice

As discussed in the previous chapter, the introduction of energy justice is crucial, and it is proposed here to consider pyramid of needs proposed by Maslow when addressing distributive energy justice.

In 1954, Abraham Maslow stated that *“a person who is lacking food, safety, love, and esteem would most probably hunger for food more strongly than for anything else”*⁸²³, leading to the hierarchy now known as Maslow's pyramid as shown in FIGURE 169. The main principle being that a human being needs first to secure the base of the pyramid before progressing. As such, any drawback on the immediate *“physiological needs or safety needs would not allow a person to consider the upper stages of love of esteem, not mentioning self-actualization”*. We can therefore classify needs based on how urgent they are in our lives:

- Primary needs are vital and basic needs (physiological needs and safety). We must be able to fulfill them or it affects our survival: breathing, but also food, drink, clothing, and shelter fall in this category. Most of these vital and basic needs require electricity in our modern world.
- Secondary needs – additional needs. We fulfill them after fulfilling primary needs: non-essential furniture's, meeting with friends, work and going to work. Local mobility falls within this category.
- Tertiary needs – the least essential needs and arise when we have met the primary and secondary needs. Luxury, sports cars, vacations abroad are tertiary needs. Air mobility falls within this category.

⁸²⁰ <https://www.imf.org/en/Blogs/Articles/2016/03/22/the-case-for-reforming-the-price-of-water> accessed August 13, 2024

⁸²¹ <http://climatepolicyinitiative.org/wp-content/uploads/2011/12/Tews-Progressive-Tariffs-for-Residential-Electricity-Consumption.pdf> accessed August 13, 2024

⁸²² Steven Jige Quan, Kyungdo Kim, Did new electricity progressive tariff system change energy usage pattern in Seoul apartments? Evidence from integrated multisource dataset and combined analytical models, Energy and Buildings, Volume 287, 2023, 112979, ISSN 0378-7788, <https://doi.org/10.1016/j.enbuild.2023.112979>

⁸²³ <https://psychclassics.yorku.ca/Maslow/motivation.htm> accessed August 13, 2024

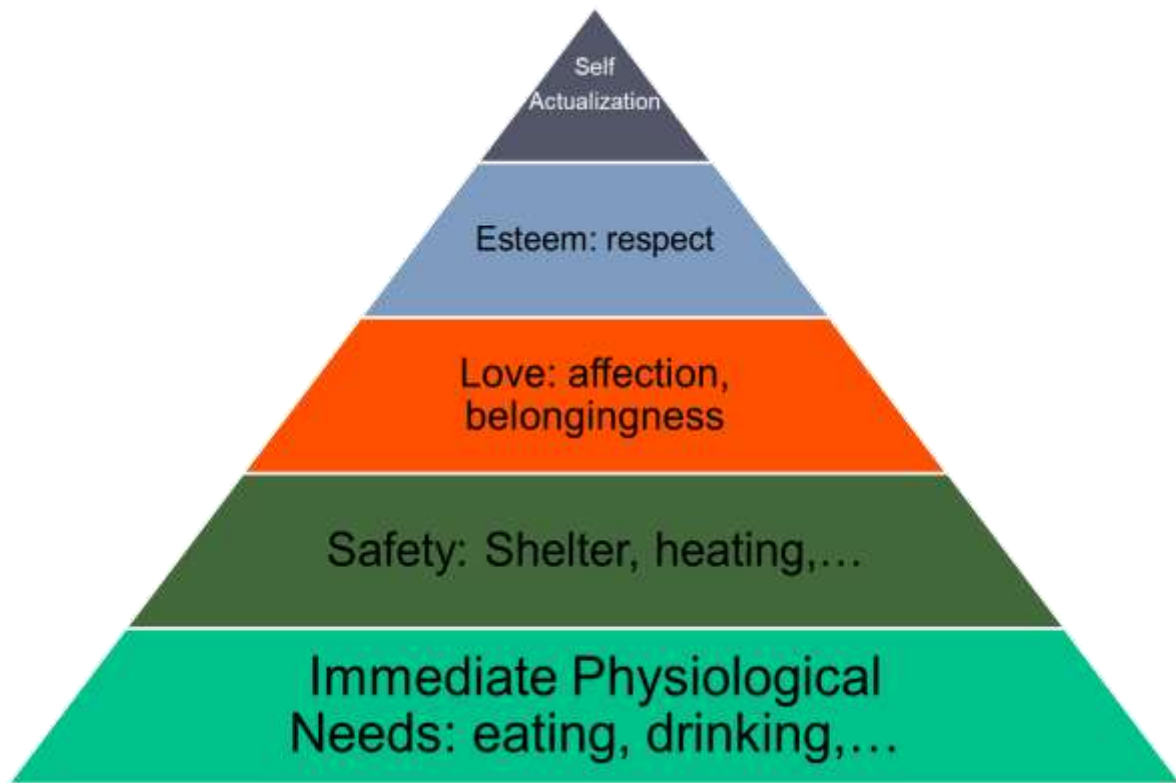

FIGURE 169 Maslow's pyramid of needs, adapted from Maslow

For a brief overview of primary, secondary, tertiary and other needs, the reader can have access to ⁸²⁴.

As of today, few articles are connecting this hierarchy with energy. In 2004 Christoph Frei proposed in *The Kyoto protocol—a victim of supply security?: or: if Maslow were in energy politics* ⁸²⁵ that energy policy priorities can be stratified similar to the way Maslow structured the pyramid of human needs. But it did not cover distributive justice despite addressing energy supply security, energy costs, environmental issues, and social acceptance.

Adapting distributive justice to the energy human needs, through tax policies, should ensure that rates applied to electricity are not disadvantageous to purposes that may be vital compared to more exclusive applications. While the distributive justice is not addressed in *Providing decent living with minimum energy: A global scenario* ⁷⁵⁰, Millward-Hopkins et al covered the distribution and the associated minimum energy which are necessary to provide a decent living to the populations. This distribution is used here to propose the adequate policies and the appropriate level of electricity tax.

It has been found in the previous chapter that with the current tax scheme and tariffs in France and within the EU that electricity for vital and basic needs is taxed while the electricity for air mobility, a tertiary need, would remain untaxed, leading to energy injustice within the populations.

Applied to the Maslow's pyramid of needs the electricity required for cooking, lighting, or cooling (home or shelters, but also food) would fall within the first two blocks of the pyramid: immediate physiological needs (eating, drinking, sanitation) and safety (home): these are primary needs.

Local mobility such as mass transportation of cars would fall in the third block (belongingness): secondary needs.

Most if not all of air mobility would fall in the upper blocks: esteem and / or self-actualization: tertiary needs.

⁸²⁴ <https://www.bfi.co.id/en/blog/kebutuhan-primer-dan-kebutuhan-lainnya> accessed August 13, 2024

⁸²⁵ Christoph W Frei, *The Kyoto protocol—a victim of supply security?: or: if Maslow were in energy politics*, *Energy Policy*, Volume 32, Issue 11, 2004, Pages 1253-1256, <https://doi.org/10.1016/j.enpol.2003.12.012>

FIGURE 170 below describes these primary – secondary – tertiary needs here adapted to energy with a focus on electricity: the Pyramid of Human Energy Needs (PHEN).



FIGURE 170 Proposed Pyramid of Human Energy Needs (PHEN) with Primary Needs in Green, Secondary Needs in Blue and Tertiary Needs in Orange, source Jean-Baptiste Jarin

III.III.3.2. Comparing Tax Policies with the Pyramid of Energy Needs and the impacts for air mobility

As discussed in the previous chapter, the introduction of energy justice is crucial, and it is proposed here to compare the PHEN with the existing tax scheme before measuring the related impacts on air mobility (cost of energy within a fair taxation scheme).

As shown in FIGURE 171, using data from Electricity prices in France in S1 2021 for household (primary, secondary, tertiary needs) and eSAF for air mobility (tertiary need) in € / MWh (TABLE 58), while the primary and secondary needs are taxed (adding 65 € / MWh) and concerned with the Transport & Distribution (T&D) costs (55 € / MWh), the tertiary need Air Mobility is neither concern by taxes nor T&D.



FIGURE 171 Comparing the Pyramid of Human Energy Needs (PHEN) with the current tax schemes including Transport & Distribution (T&D), excise tax, transmission tariff contribution (CTA) and VAT, source Jean-Baptiste Jarin. The % of the population concerned by each stage of the PHEN in France is 100% for basic needs, above 90% for the secondary needs with internet access as reference ⁸²⁶ and below 10% for air mobility when assuming a long-distance trip per year (FIGURE 165 eCO₂ emissions from air mobility according to the income within the EU population, source Jean-Baptiste Jarin with data provided by Ivanova & Wood “The unequal distribution of household carbon footprints in Europe and its link to sustainability”, with kind authorization of first author Dr Ivanova)

This tax scheme is therefore in direct contradiction with the PHEN, and therefore energy justice, with a final factor of 3 on the final price of electricity (TABLE 58).

This means that the cost of energy to fulfill a vital need, 100% of the world population is concerned, is 3-fold more expensive than the cost of the same energy to fulfill a tertiary need such as flying internationally, 2 to 4% of the world population is concerned ¹⁵¹.

Among the conflicts of use associated with the decarbonization of the energy for air mobility, the introduction of a synthetic fuel based on electricity such as eSAF needs to be carefully evaluated, and applying the distributive justice prism should guide our future tax policies to avoid significant energy injustice for the populations.

Finally, we should acknowledge that adjusting electricity tariffs to the final purpose using the PHEN would have a significant impact on the air mobility prices.

In FIGURE 172 below are compared the associated costs for air mobility. The short, medium and long-haul values are calculated using the French DGAC calculator ⁸¹¹ to retrieve the associated fuel burn as in previous chapters. This value is then multiplied by 2 to simulate a return trip using the average fuel density of 0.8. To obtain the eSAF value in kWh of electricity this result is multiplied by 28 kWh / kg of eSAF as discussed above.

For reference, the price of the fossil the jet fuel is introduced, using the 2023 average value of 902 \$/ton.

One can notice that even with tax exemptions, the replacement of fossil jet fuel with eSAF would already mean a significant price increase, with roughly a factor 2. This is the cost of electricity only (excluding T&D costs, CTA, excise

⁸²⁶ <https://www.insee.fr/fr/statistiques/2385835> accessed August 13, 2024

tax and VAT), and it shall be considered as a minimum since producing eSAF would require CAPEX amortization, risk provisions and net profit. As highlighted in FIGURE 133, the cost of eSAF would most probably be 2 folds higher.

When distributive justice is introduced, thus applying at least the same tariffs to electricity for eSAF than for households, the impact is quite significant, a 6-fold increases, and this could significantly impact the air mobility demand, as shown in FIGURE 172, when comparing the impact of energy price for eSAF and fossil fuel.

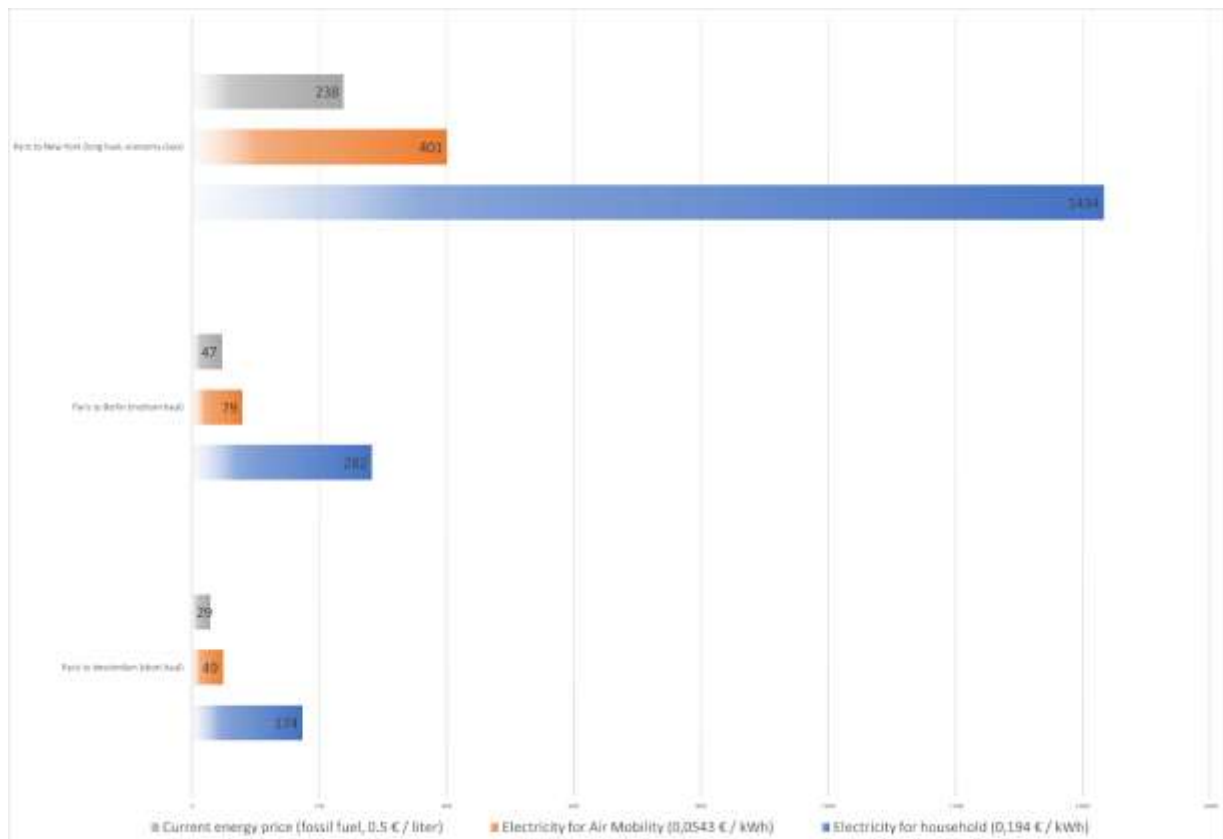

FIGURE 172 Comparing, for various destinations (return trip), the impact of the energy prices with current tax scheme for eSAF (no taxes nor contributions, 0.0543 € / kWh) and proposed tax scheme based on PHEN (same electricity prices for tertiary needs than for primary and secondary needs, 0.194 € / kWh), source Jean-Baptiste Jarin

In order to better understand the impact this rise in energy costs could have on airfares, and to better reflect recent developments in long-haul air mobility, it is proposed to introduce data associated with the development of ultra-long-haul flights. The recent launch of the longest flight on earth, from Singapore to New-York, is introduced in FIGURE 173, completing FIGURE 172.

It is found that such flights considerably increase the energy required per passenger / kilometer, thus the costs but also the eCO₂ emissions. This recent development, on the part of both airlines and manufacturers, seems to run counter to the necessary decarbonization of the sector.

To achieve such a result, the plane is modified in an Ultra Long Range (ULR) configuration, with added fuel tanks and a wider cabin configuration since the flight last more than 18 hours (only business and premium economy seats are proposed). The result being 161 000 liters of jet fuel for 161 passengers, or approximately 1000 liters per passenger per trip when considering fuel reserve and load factor.

In kWh of electricity per passenger, for a return trip, the value would be 44 800 kWh, the equivalent total electricity consumption of more than 100 Mauritians for a year (TABLE 56), or 10 years of primary and secondary consumption for an average French citizen.

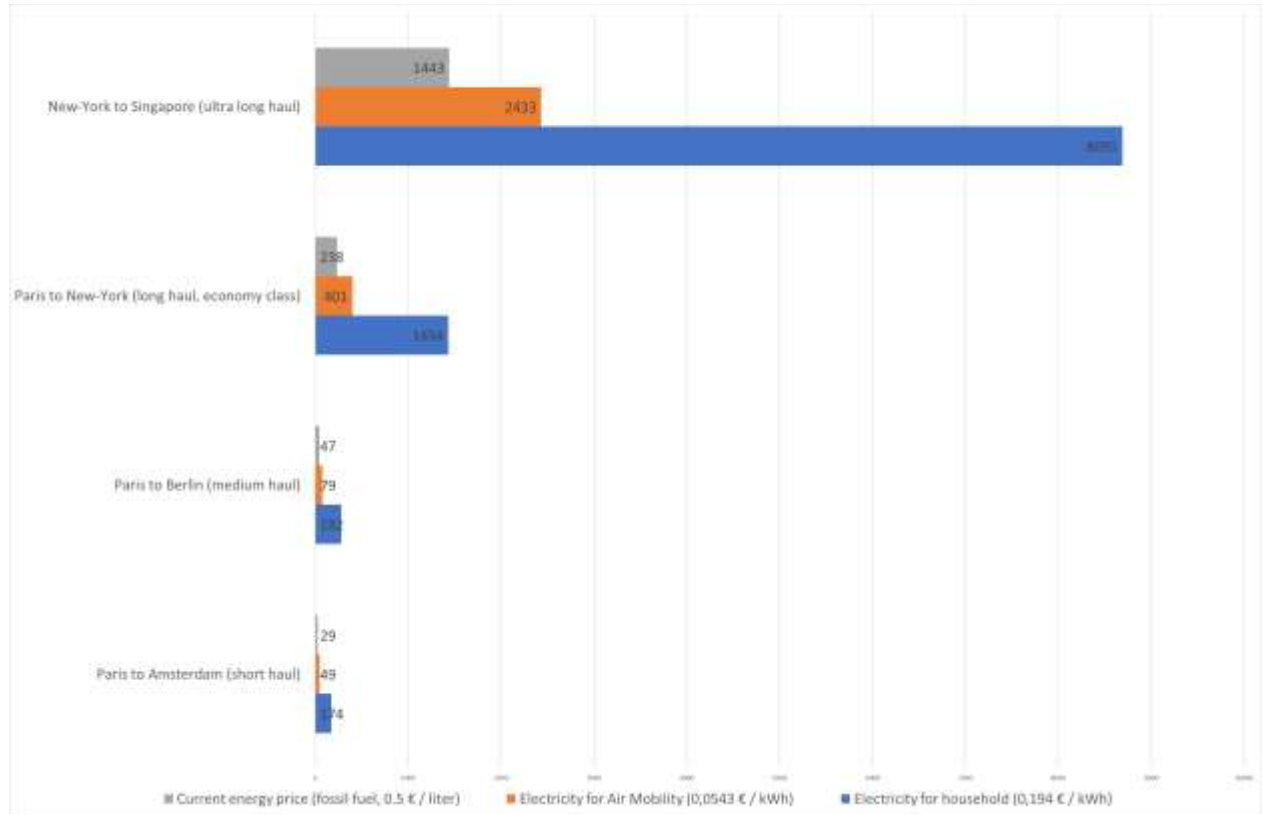

FIGURE 173 Completing FIGURE 172 with Ultra Long-Haul flights, here the world longest flight which is operated in 2024 by Singapore Airlines with an Airbus A350-900 ULR, source Jean-Baptiste Jarin with data from ⁸²⁷ ⁸²⁸ (161.000 liters for 161 seats, hypothesis of 95% load factor being equivalent to 44 800 kWh per passenger for a return trip)

To better illustrate these impacts on the current airfares, TABLE 60 below allows one to understand the impact associated with a rising of energy to the air mobility sector, remembering that the share of energy in total operation costs of an airline is approximately 25% (TABLE 20) .

⁸²⁷ https://www.lepoint.fr/economie/l-airbus-a350-ulr-pare-pour-le-vol-le-plus-long-au-monde-25-09-2018-2254006_28.php#11

⁸²⁸ <https://upgradedpoints.com/travel/airlines/longest-nonstop-flights-in-the-world/>

Price of Energy for return trip (1 pax), in € (parity € / \$ 1 to 1)	With fossil Jet Fuel 2023 Average	With eSAF based on current electricity tax scheme (5.4 cents / kWh)	With eSAF based on households electricity prices (19.4 cents / kWh)	Current price ticket (return trip for 1 pax from September 12th - 25th 2024)
Short-haul (Paris to Amsterdam)	28,9	48,7	173,8	157 € (Air France, economy)
Medium-haul (Paris to Berlin)	46,9	79,1	282,5	169 € (Air France, economy)
Long-haul (Paris to New-York)	238,1	401,4	1434,0	1063 € (Air France, economy)
Ultra long-haul (New-York to Singapore)	1443,2	2432,6	8691,2	1572 € (Singapour Airlines, Premium Economy)

TABLE 60 Comparing the cost of energy for short, medium, long, and ultra long-haul flights, with August 2024 ticket price, source Jean-Baptiste Jarin

Data for price tickets are issued from major airlines: Singapore Airlines ⁸²⁹ for the ultra-long-haul and Air France for the other flights ⁸³⁰, simulating September 2024 flights, with departure 12th and return 25th for all flights considered.

One can notice that the ultra-long-haul flight raises some questions, as the price ticket is almost similar to the cost of the fossil jet fuel alone. Since the cost of fuel is supposed to represent approximately 25% of the airline total operation costs, this would mean a significant dumping practice. For the other destinations, it can be assumed that this ratio is respected.

More important, air mobility costs, and therefore ticket prices, would significantly increase when introducing eSAF.

Considering that:

- The cost of SAF (100% SAF by 2050) is equivalent to the highest production cost as concluded in Chapter II.III.1.3.
- The household electricity price of 19.4 cents per kWh is applied (equivalent to 5400 € / ton eSAF)
- The share of fuel in total operation costs is 25%
- Other total operation costs for airlines remain stable

The ticket price increase could reach +225%, as shown in TABLE 61, would airlines pass the energy cost to the passenger, which is the conclusion of chapter II.III.3.4.

This is significant, but not out of reach, and most probably the price to pay to keep the just transition within our societies, at least until abundant and low carbon electricity are available for the entire world, but this will take more than several decades as more than 80% of the world primary energy still rely on fossil fuels ⁸³¹, while the emergency of climate change does not allow any delays nor drawback.

It is also acknowledged that the introduction of energy justice, within electricity prices per primary-secondary and tertiary needs, would make sense, but it has a limit as shown in TABLE 61 : applying strictly the same taxes and therefore final prices as for households would already significantly increase the price of air mobility. Some could find unfair that the price of electricity be equivalent for vital needs as for air mobility, but this probably the right balance between the different stakeholders assuming no subsidies are introduced (Chapter III.III.1.4.).

⁸²⁹ <https://www.singaporeair.com/flightsearch/searchFlight.form#/booking> accessed August 13, 2024

⁸³⁰ <https://www.airfrance.fr/search/search-summary> accessed August 13, 2024

⁸³¹ BP Statistical review, page 10, <https://www.bp.com/content/dam/bp/business-sites/en/global/corporate/pdfs/energy-economics/statistical-review/bp-stats-review-2022-full-report.pdf> accessed August 13, 2024

Simulating Ticket Price with 100% SAF (eSAF)	Share of Energy with fossil Jet Fuel 2023, Average	Ticket Price estimated with share of energy as 25% total operation cost	Ticket Price with eSAF based on households electricity prices (19.4 cents / kWh)
Short-haul (Paris to Amsterdam)	28,9	115,5	260,4
Medium-haul (Paris to Berlin)	46,9	187,6	423,2
Long-haul (Paris to New-York)	238,1	952,5	2148,4
Ultra long-haul (New-York to Singapore)	1443,2	5772,8	13020,8

TABLE 61 Ticket Price simulation for short, medium, long, and ultra-long-haul flights (return, 1 pax), considering price of electricity of households for SAF production and considering the share of fuel being 25% in 2024 airlines total operation costs, source Jean-Baptiste Jarin

Still, it is highly probable that the aviation industry will refuse such a commitment, and as highlighted 10 years ago by Grote et al in Direct carbon dioxide emissions from civil aircraft, “A global regulator with ‘teeth’ is required but likely to be resisted”¹⁵⁴.

Meanwhile this reinforces the need to shift the paradigm and aviation industry should rather focus on developing and using efficient turboprops and propfans rather than ultra-long-range aircrafts.

III.III.3.3. Elements for public policies

At this stage of the thesis, it is now possible to propose and / or summarize the required elements for public policies.

Aside from the public policies required to support the air mobility paradigm shift, these are of two different natures:

- Accompany the production of SAF with the allocation of biomass and low carbon electricity
- Deploy a fair taxation respecting the energy justice principles

The precautionary principle is used here as an approach to risk management. This principle is set in Article 191 of the Treaty on the Functioning of the European Union⁸³² and states that “if it is possible that a given policy or action might cause harm to the public or the environment and if there is still no scientific agreement on the issue, the policy or action in question should not be carried out”.

While the cause and effects of climate change have been made clear for years, this principle should apply before deploying technologies, or delay any actions, which could impact our eCO₂ emissions objectives. A recent publication, Möller et al⁸³³, highlighting the need more than ever to strictly limit our emissions (see also the Introduction chapter), the authors concluding that “Achieving and maintaining at least net zero greenhouse gas emissions by 2100 is paramount to minimize tipping risk in the long term. Our results underscore that stringent emission reductions in the current decade are critical for planetary stability”.

⁸³² <https://eur-lex.europa.eu/legal-content/EN/TXT/HTML/?uri=CELEX:12016E191> accessed August 13, 2024

⁸³³ Möller, T., Högner, A.E., Schleussner, C.F. et al. Achieving net zero greenhouse gas emissions critical to limit climate tipping risks. Nat Commun 15, 6192 (2024). <https://doi.org/10.1038/s41467-024-49863-0>

As such while the development of new technologies should always be supported, the deployment of technologies which have not proven to be more energy efficient and / or less emissive on a global scale, which means compared to other means of mobility and including potential rebound effects, should not be granted.

Indeed, the development of Urban Air Mobility, even low carbon (electric VTOL) is a concern since it would replace more efficient and lower emissions mean of transportation (electric cars or mass transportation), as such there are no other possibilities to a net increase in eCO₂ emissions whatever the architecture and associated energy carrier ⁸³⁴.

Another example is the continuous improvement of fuel burn seen during the past decades. As concluded in Part I, when expressed in fuel burn per passenger kilometer, the current air mobility metric, the results are positive (when considering the introduction of jets vs prop), but when measured on a global scale, total eCO₂ emissions have exploded (+400%).

SAF Production

It has been concluded that reaching between 156, mean scenario, and even more 307 Mt, optimistic scenario, of SAF per year by 2050 requires many conditions.

It involves setting up a capital-intensive industrial sector, integrating innovative technologies, and mobilizing resources whose supply must be guaranteed on a large scale.

The challenge is considerable, and involves establishing an international SAF market that is viable in financial, regulatory, and competitive terms. All this must be achieved in the face of growing competition for access to physical resources, namely the conflict of use for biomass and low-carbon electricity, TABLE 42, FIGURE 140.

The production of the energy carriers needed to decarbonize will require a large volume of low-carbon resources (hydro, wind, solar, biomass, nuclear), as well as other inputs (soil, materials, water,...).

As discussed in Chapter III.I.1.1., it is becoming necessary to plan and control the use of these resources using an approach that is necessarily cross-sectoral, multi-criteria and endowed with an integrated, long-term vision: It would seem difficult to imagine that market forces alone can bring about the best allocation of these resources.

Indeed, if the market alone were to prevail, competition between different economic sectors would be regulated according to the purchasing power of these sectors. It might be thought that the air mobility sector would find it easier than the domestic heating sector to adjust its demand-price curve (i.e. its tolerance of price increases) in order to preempt the biomass and / or low carbon electrons it needs.

As discussed above this then leads to higher biomass prices and the gradual exclusion of less economically powerful sectors from the market. More precisely, the equilibrium price of biomass is then induced by the abatement cost of an alternative technology, such as eSAF, available to the air mobility industry. This equilibrium price then determines the biomass and / or low carbon electrons access ratio for each economic sector, with the most economically powerful sector driving the process and depending on the cost of alternative technologies. The natural market behavior described above is not without its difficult social issues, which require political arbitration.

The allocation of biomass as well as low carbon electricity between different economic sectors is a central issue that will require inclusive approaches and not just at marginal costs.

It has been seen in the previous chapters that access to biomass or low-carbon electricity determined by a free market is not necessarily optimal for society; it will then be the role of regulation to frame market tensions and build the desired equilibrium. Given the heavy investments required, the guaranteed availability, over two or three decades, of critical inputs (biomass, low-carbon electricity) is a condition for the industrial ramp-up of SAF.

⁸³⁴ Frederico Afonso, Ana Ferreira, Inês Ribeiro, Fernando Lau, Afzal Suleman, On the design of environmentally sustainable aircraft for urban air mobility, Transportation Research Part D: Transport and Environment, Volume 91, 2021, 102688, ISSN 1361-9209, <https://doi.org/10.1016/j.trd.2020.102688>

Whatever the resource mobilized to produce SAF, it is either already used by one or more other economic sectors, or is in the process of being so. Economic or geopolitical tensions can accelerate conflicts of use or modify their contours, not mentioning the risk to replicate the oil curse as discussed in Chapter III.II.2. In the case of agricultural waste, for example, the priority given to biogas has increased significantly following the conflict in Ukraine, and could in the long-term complicate access to this primary resource on European territory. All the above challenges and uncertainties justify clarifying public policy for the 2030-2050 period as soon as possible.

Thus, the role of public policies should include:

- Clarify the strategic criteria (sovereignty, environmental commitments) and socio-economic criteria (social balance in the arbitration of uses, impact of industrialization on territories and on the balance of trade) that will motivate industrial policy for SAF production
- Draw up a public industrial policy for large-scale SAF production from 2025 onwards. Such a policy would put in place incentive and support mechanisms to align economic players with shared objectives, stabilize an efficient regulatory framework, ensure coherence with energy policy in terms of planning the biomass and low-carbon electricity that can be mobilized, and finally provide a framework for conflicts of use linked to these resources
- The above support being framed by the energy justice principles (see next paragraph)

The relevance and robustness of such a policy framework are ultimately a central condition for the emergence of a new large-scale industrial sector, as required for the production of SAF. There are a number of factors conditioning the scaling-up of SAF production. Among the elements currently being acquired, it is found that the ReFuel EU regulation is particularly well suited as it provides visibility for both producers and users. Users can plan accordingly (see previous chapters) while producers obtain the necessary visibility to invest.

This is key as large-scale industrial projects should be initiated as early as 2025 in anticipation of the market. Encouraging the emergence of such projects is a first challenge for public action over the next few years while no large-scale investment can be deployed without guaranteeing the availability of the associated inputs over at least two decades. This long-term vision of the physical availability of inputs is a central point for a public policy targeting the acceleration of SAF production.

Competition for inputs between different economic sectors requires a delicate political trade-off, but one that is necessary to provide the visibility needed to launch the considerable investments required by SAF production. This is a constituent element of the industrial public policy yet to be defined.

Taxes

As discussed in the previous chapter, there is the need to introduce energy justice within the public policies and while the progressive tariffication of electricity according to primary-secondary-tertiary needs was found to be inappropriate as the impacts on air mobility costs would be very high, aligning the tax and tariffs of electricity dedicated to eSAF to the household's ones is a necessity as otherwise energy injustice could foster public rejection.

Still, it is found that such a policy would lead to a minimum of a 6-fold increase in energy costs when compared to the price of fossil jet fuel (FIGURE 172), which would translate in +225% in ticket price (TABLE 61).

Since it was found that producing locally, in the European Union and most particularly in France, has positive effects on jobs but also on limiting the potential to replicate the oil curse in the Global South, public policies should at the same time tax the energy without encouraging delocalization.

As such, taxing directly electricity used to produce eSAF would be counter-productive, increasing the gap with the bioSAF production costs and encouraging delocalization. Taxation of the final product should therefore be proposed and the European Union (EU) Energy Taxation Directive (ETD) could be the appropriate mechanism even if Jet Fuel and even more SAF are not yet included.

The Energy Taxation Directive 2003/96/EC⁸³⁵ is the European Union's framework for the taxation of energy products including electricity, motor, and most heating fuels. It sets minimum rates of excise duty with the intention of encouraging a low-carbon and energy efficient economy. But its placing of all energy sources on an equal footing, whether carbon-emitting or not, is not aligned with wider EU climate objectives and according to the European Court of Auditors the directive's rules are in contradiction with the EU's climate policy⁸³⁶.

While currently excluding air mobility, the revision of the Energy Taxation Directive (ETD) is ongoing and air mobility shall be included. The updates propose a new structure of tax rates based on the energy content and environmental performance of the fuels and electricity while broadening the taxable base, which would then for instance include jet fuel (which is currently fully exempted).

In its revision of the ETD Questions & Answers⁸³⁷, the European Commission quoted that:

- *"Kerosene used as fuel in the aviation industry and heavy oil used in the maritime industry will no longer be fully exempt from energy taxation for intra-EU voyages in the EU. This is a crucial measure given the role of these sectors in energy consumption and pollution. Over a period of ten years, the minimum tax rates for these fuels will gradually increase while sustainable fuels for these sectors will benefit from a minimum rate of zero to foster their uptake"*
- *"The tax for aviation fuel will be introduced gradually before reaching the final minimum rate after a transitional period of ten years. This means that ten years after the entry into force of the new rules, kerosene used in the aviation industry to power planes for intra-EU flights would be taxed at least €10.75 /GJ EU-wide, as for petrol used in road transport. To encourage the use of cleaner energy in both the aviation and maritime sectors, sustainable and alternative fuels will enjoy a zero rate minimum tax rate for a transitional period of 10 years when used for air and waterborne navigation"*

The tax envisaged by the European Commission for flights within Europe is 10.75 €/GJ, which is equivalent to an eCO₂ tax of €114/t eCO₂ considering 94 g eCO₂/MJ and 44 MJ/kg of jet fuel as defined in the RED II directive. The additional cost for the fossil jet fuel being 473 € / ton.

But, as the lowest rate of 0.15 €/GJ applies to electricity regardless of its use as well as for SAF either produced from the biomass or low carbon electricity (as long as the SAF produced are RED compliant), this could fuel energy injustice within the existing tax scheme as previously discussed.

Public policies should therefore consider aligning the future ETD rate of SAF to reflect the upper households electricity price while maintaining the gap with fossil jet fuel and / or impose that the minimum fare of a plane ticket being the cost of the associated calculated energy, which is somehow similar to the path proposed by the Austrian government when it introduced a minimum air ticket price (40 €) to *"minimize the social and environmental impact of the airline industry"*⁸³⁸.

This approach would limit air traffic growth while not impacting airlines profit margins but more important would allow a faster implementation of 100% SAF since the associated costs would always be covered by the minimum fare. Competition would also remain since if speed limits are imposed, the airlines having to differentiate on services and global efficiencies.

The values would be similar to the ones proposed in TABLE 60 above, or close to 60 € for short-haul single trip, 140 € for medium-haul single trip, 700 € for long-haul single trip...and 4300 € for a ultra-long-haul single trip.

⁸³⁵ <https://eur-lex.europa.eu/legal-content/EN/TXT/HTML/?uri=CELEX:32003L0096> accessed August 13, 2024

⁸³⁶ https://www.euractiv.com/section/energy/news/eus-energy-taxation-policy-contradicts-climate-goals-auditors-say/?_ga=2.226837405.1804596152.1713960848-1853704577.1713960848 accessed August 13, 2024

⁸³⁷ https://ec.europa.eu/commission/presscorner/api/files/document/print/en/qanda_21_3662/QANDA_21_3662_EN.pdf accessed August 13, 2024

⁸³⁸ <https://www.ch-aviation.com/news/91957-austria-introduces-minimum-air-fare> accessed August 13, 2024

In an ideal world, it is not the European Union which would endorse such an approach, but ICAO. However, the analysis of the recent ICAO resolutions tends to show that the organization is in a Nash equilibrium that is not very virtuous, with growth and business as usual being favored to the detriment of the climate.

III.IV. Part III and General conclusions

III.IV.1. Part III conclusions

While decarbonizing energy for air mobility is a must while being technically realistic and desirable from an emissions point of view, it is found it has not only limits but also significant on societies.

As such the decarbonization of air mobility cannot and must not be prepared in silos, but holistically, to take into account all the collateral effects that will inevitably impact civil society. As such, energy justice must be considered.

For instance, it has been found that the pressure on inputs, namely biomass and low carbon electricity, with growing competition turning into conflicts of use, as already a direct impact for the citizens, with price increases on food and energy. The recent paper of the US National Academy of Science ⁴¹⁵, which details how the public policies supporting biofuel production in the USA impacted, in less than a decade, not only land use but also that it increased corn prices by 30% and the prices of other crops by 20% should ring as a warning bell since the current production only represents a fraction of what is now eyed by the airline industry.

While offering some opportunities such as jobs creations and re-industrialization, one must understand that the limits are from now on not the technology, but the availabilities of land (biomass) and / or the possibility to produce continuous low carbon electrons. The national and regional assessments confirming that even in gifted areas such as France and Nouvelle Aquitaine, which boasts cutting-edge agriculture, significant forests areas and a proven ability to produce and transport a significant amount of low-carbon electricity on a continuous basis, the production of SAF (bioSAF and eSAF) is severely constrained.

Importing low carbon energies such as SAF, while attractive in theory, faces the same major hurdles as above and few countries in the world have been found to dispose of the necessary assets to produce and export significant volumes of SAF, at least not in the expect scalability. Moreover, the risk of replicating the oil curse is a reality and even the gifted countries in biomass and / or low carbon electricity potentials have been found to have not only limited infrastructure but also facing other priorities such as their own human development and decarbonization roadmaps. The situation of Mauritania is for instance a paradox, the country being seen, and aiming to, as a major H₂ producer ⁸³⁹, the raw material of SAF, while its current infrastructure and more important its population has almost no access to electricity. This electricity being heavily carbonized (TABLE 56).

Energy justice has also been found to be a cornerstone in the public policies which must accompany the development and deployment of SAF. Given that eSAF policy is very much still in the formative stage energy justice is the perfect theory to identify injustices before they occur, to ensure “... *also the provision of a more fair, equal, equitable and inclusive transition*” ⁶³⁸. While procedural justice should take place to ensure that the past, present and future public policies provide a fair and inclusive transition, distributive justice must be a pillar of the future SAF tax policies. For instance, understanding that with the current tax schemes the electricity for households, therefore for vital and basic needs, would 3.6 time higher than the same electricity dedicated to air mobility via the production of low carbon H₂ and eSAF raises ethical concerns.

Hopefully, the EU explicitly aims to enable a just transition towards a low-carbon energy system ⁹⁶. It is therefore the prism of distributive justice, through tax policies, which should ensure that rates applied to electricity are not disadvantageous to purposes that may be vital compared to more exclusive applications such as air mobility.

While desirable from an ethical perspective, the progressive tariffication of electricity seems out of sight, and accepting that the tax scheme of electricity would be identical from primary to tertiary needs sounds as a good balance and could lay the foundation of a new social contract between air mobility and the societies.

Since the price of aviation fuel will increase significantly with the incorporation of SAF, the impact on ticket fares will be significant, and it was found that most flights could face a +225% increase. While the aviation industry would most probably at first sight such measures, delaying and / or requiring subsidies, it should be seen as an opportunity not

⁸³⁹ <https://www.globalafricanhydrogensummit.com/conference/mauritania-spotlight/> accessed August 13, 2024

only for the climate and to benefits of populations, but also to the airlines profit margins as concluded in Part II. However, we should acknowledge that prioritizing the profits over the environment is the current business model and that, as highlighted by Grote et al in Direct carbon dioxide emissions from civil aircraft in 2014, “*environmentally a global regulator with teeth is urgently required*”¹⁵⁴.

It is therefore recommended that public policies include SAF within the future Energy Tax Directive (ETD) so the applied rate would see the final product (SAF) be taxed at the same level of electricity for households. An equivalent measure could be implementing a minimum air ticket price based on the facial price of electricity for households. In both situations the objective being to send a double signal: encouraging modal shift and limiting air mobility, while teaching citizens that mobility requires energy and that energy has a cost. Such an approach if deployed earlier could have limited the development of ultra-long-haul flights, which have shown to have an impressive energy consumption per passenger of 44 800 kWh of electricity (FIGURE 173), this is the equivalent of 10 years for the average French citizen for all its needs (heating, hot water, cooking, cooling, lighting, home appliances, and 10 000 kilometers in an electric car).

Still, it would be necessary that public policies still support the development and deployment of SAF production units, on their territories and in some cases abroad.

Indeed, producing between 156 and 307 Mt of SAF by 2050, the mean and the optimistic scenarios, requires many conditions, and it involves setting up a capital-intensive industrial sector, integrating innovative technologies, and mobilizing resources whose supply must be guaranteed on a large scale in the face of growing competition for access to physical resources, namely the conflict of use for biomass and low-carbon electricity. As such it is becoming necessary to plan and control the use of these resources, using an approach that is necessarily cross-sectoral, multi-criteria and endowed with an integrated, long-term vision. It would seem difficult to imagine that market forces alone can bring about the best allocation of these resources as the allocation of biomass as well as low carbon electricity between different economic sectors is a central issue that requires inclusive approaches and not just at marginal costs.

Framed by energy justice principles and while clarifying the social balance in the arbitration of uses, public policies put in place support mechanisms to align economic players with shared objectives while providing the framework for conflicts of use linked to these resources. The support could include subsidies, which are often necessary to initiate a new business model, as long as the final product (SAF) evolves according to the same taxation scheme as described above.

III.IV.2. General conclusions

At the end of this holistic approach, necessary to explore the challenges of decarbonizing air mobility, it is important to summarize the problem, the main elements studied and their interrelationships, as well as the conclusions to which these leads.

The thesis is set against a backdrop of climate targets for limiting global warming to +2°C, which for air mobility translates into a maximum of 325 Mt of annual eCO₂ emissions by 2050.

To reach this objective, 6 main levers have been identified, and developed: demand, modal shift, speed, load factor, energy efficiency and finally the carbon intensity of energy, FIGURE 11.

In this context, and after recalling the main challenges of climate change for air mobility, but also for our societies, as well as the inextricable links between mobility and energy, then energy and economic development, the thesis formulates the following questions: how can we align the air mobility sector with this objective of limiting its eCO₂ emissions to a maximum of 325 Mt, and what would be the effects on our societies?

To answer these questions, the thesis develops and explores 3 main parts:

- In the first part, a breakdown of emissions and identification of their main drivers, the role of regulations as well as air mobility technical and economic issues are detailed, in order to propose a credible trajectory based on realistic levers: the decarbonization roadmap of air mobility.

- In the second part, the main levers are confronted with techno-economic realities under the prism of energy efficiency, in order to identify what the collateral effects could be for air mobility, but also and above all for our civil societies: the effects on our societies.

- The third part looks at highlighting the role of energy justice and the implications for public policies of these effects

The first lesson learned is the limited number of levers currently used by the air mobility sector to decarbonize. Of the 6 levers identified, only 2 are currently activated, and a 3rd is in the process of being activated. As it happens, the first 2 levers activated - higher load factors and better fuel efficiency - are those that keep fueling traffic growth via lower costs, and therefore lower ticket prices. This explains the Jevon's paradox which is ongoing, as while the fuel burn and associated eCO₂ emissions per passenger have declined since the jet age – but are stable when compare to the 1950's piston airliners – the increase of the traffic has led to quadrupling the global eCO₂ emissions. The 3rd lever, energy carbon intensity, is currently being activated, but for the first time, a lever is coming up against a rise in costs that would be detrimental to traffic growth, which is slowing down its adoption. Despite press announcements, the introduction of SAF within air mobility operations remain at a very low level due to higher prices, and it was found that without regulation, it would most probably remain a purely “*public relation exercise*”, to quote Qatar Airways CEO, June 2023⁸⁴⁰.

The second lesson learned is that all 6 levers need to be activated to build a credible decarbonization trajectory for air mobility. This approach clashes with the sector's growth ambitions, because beyond the first two levers identified above, they are all likely to constrain the growth of air mobility due to rising costs and lower productivity. The role of speed is for instance highly underestimated, while the role of SAF is found to be fundamental.

The third lesson concerns the difficulty of accurately identifying the sector's emissions, both in volume and in fuel carbon intensity, but also its ability to extricate itself from the main climate policies. Announced climate targets are rarely met, and ICAO resolutions on the subject are little or not at all binding, the 2050 objective being qualified by ICAO itself as a “*long term aspirational goal*”. Nearly 30 years will have elapsed between the request to establish a decarbonization trajectory in 1997, and the implementation of a regulation specific to the sector, CORSIA, which will not be fully effective until 2027, or 30 years later. It should also be noted that these regulations are found to be too

⁸⁴⁰ <https://edition.cnn.com/2023/06/05/business/qatar-airways-net-zero-aviation/index.html> accessed August 13, 2024

weak to really influence the sector's eCO₂ emissions, and it is likely that emissions will continue to rise significantly in the years ahead, despite the commitment to stabilize eCO₂ emissions at 2019 "*carbon neutral growth*" level. At present, only European regulations seem capable of influencing air mobility emissions. Unfortunately, the scope of these regulations is still essentially limited to the European Union, but they can serve as an example and raise awareness worldwide.

The fourth lesson concerns the limitations of the main lever: SAF. Technically feasible and environmentally desirable when produced from the right feedstocks, they are more than necessary for decarbonizing the sector. Still, SAF are and will remain costly, but also, and above all, limited in volume. The 2 feedstocks at stake, biomass and low-carbon electrons, are found to be too precious to be wasted, and it is highly probable that the SAF production would remain between 156 and 307 Mt per year. This should be considered as a maximum output, while air mobility shall engage to 100% SAF adoption. This by itself set a cap in air mobility.

Consequently, the fifth lesson concerns the collateral effects of a massive deployment of SAF on civil societies: impact on soil, but also on the price of raw materials, such as food and energy. Man-made energy has a cost for end users, but also a price for societies, and it was found that replacing earth made fossil fuels by man-made fuels considerably lowers the Energy Return on Energy Invested (ERoEI). A direct collateral damage is the price increase of food, but also of energy in general for our societies. This magnifies the need to maintain the SAF volumes within the limits addressed above.

The sixth and final lesson concerns the need to integrate energy justice into our public policies. Since air mobility benefits mostly to the wealthiest part of the population, and while the collateral effects of the sector's decarbonization will affect societies in globality, it is urgent to review our tax schemes with the prism of energy justice. A policy of resource allocation seems desirable, the counterpart being an overhaul of energy taxation applied to air mobility, in strict compliance with climate objectives.

Since the emergence of air mobility, almost a century ago, progress has been made. However, this thesis concludes that technology alone has been, remains, and will remain insufficient to reduce emissions. Air mobility benefitting to the upper classes which have most of the power, we should accept that with great power comes great responsibilities, and air mobility should lead by example the global decarbonization. The future must be written by ensuring that technology serves energy sobriety, and combining this energy sobriety with sobriety of use is now a necessity to maintain harmony with our human societies.

III.IV.3. Research perspectives

This multi-disciplinary thesis has raised numerous questions in a wide range of disciplines. Some of the proposed answers, although well-founded, still need to be explored in greater depth, opening up a wide range of research prospects.

In the field of energy, it seems necessary to pursue studies on the classification of energy carriers, according to the different uses that may be made of them. The holistic approach proposed, with an analysis of the effects of integration with the carrier, should be reinforced by taking into account the entire distribution ecosystem, notably airports, and the effects of boil-off, the dispersion of unburned H₂ molecules in the atmosphere being a recent cause for concern. On the economic front, CAPEX and maintenance costs for each system would also make sense, increasing data accuracy.

In combustion, we need to continue our work on Drop In, with a particular focus on SAFs based on the ATJ and FT processes, which are due to come onto the market in the near future. The ATJ / FT comparison will be decisive, as the same feedstocks will essentially be used. The FT process appears to be more efficient, with a better EROEI ratio, and therefore a better CO₂ balance. However, the current market structure means that ATJ, which is less virtuous, could dominate, as it is well suited to existing refineries. In addition, determining the right aromatics composition and sources, the right level of aromatics within the SAF, and the associated emissions, particularly of nVPM, is essential, both for air quality and for the effects on contrail formation.

Future research will mostly focus on energy justice and just transition. Once again, the lines of research are numerous, yet closely interlinked. We have seen that European regulations, although more advanced on the subject, deserve to be enriched. The issues of sovereignty, and therefore of regional production and public acceptance, need to be explored in greater depth. At the same time, conflicts of use, and hence resource allocation, are a subject in their own right. A key area of research therefore concerns the allocation of inputs, their classification by order of merit, and the implementation of fair taxation. This presupposes upstream determination of the best allocation of resources, and projects currently under development, particularly in the regions, offer interesting prospects in this respect. As the allocation of biomass and electricity is a matter for the regulator, but also for civil society, the best way to allocate this biomass needs to be investigated, all the more so as the simple law of the market does not always seem to be the most virtuous, if only because air transport users have far greater purchasing power. Tensions in civil society are already perceptible, despite the fact that the modest-scale projects under study have not yet seen the light of day. Biomass and electricity are vital resources for our modern societies, which could be described as a common good, with often limited potential despite an increasing list of feedstocks. The absence of regulation would therefore be mortifying. If we take the example of forest waste, civil society feels dispossessed of a common good, this sense of possession being twofold: "our forests", but also "our wood heating". And yet, when we compare the energy yields of biofuel/efuel for air travel, and wood/heat pump for domestic use, the conclusion seems obvious: biomass first for air travel, electricity first for heating. Research must therefore enlighten both regulators, and civil society, on these issues.

In return for sovereign production, we have shown that even a country like France, richly endowed with biomass and low-carbon electricity, cannot meet all its own needs. Imports of low-carbon molecules for air transport, which are necessary, should be subject to strict rules. This remains to be refined and deployed, both to avoid unfair competition with our European producers, and to avoid reproducing the oil curse in exporting countries, mostly located in the Global South.

The notion of governance is also a key issue. Even if the EU has the critical mass to legislate effectively on its territory, and even if other nations, notably in Asia, seem to be following suit, setting an example is not enough, and it is up to the ICAO to take up the issue. To date, the ICAO has maintained a Nash equilibrium between doing nothing and doing nothing, which prevents it from implementing a policy and rules commensurate with the stakes involved. It is therefore essential to take a closer look at the deployment of potential flight speed regulations, and the incorporation of 100% SAF before 2050, through ICAO, so that no one is left behind, nor is free-rider. A model based on the absence of taxes, in return for an anticipation of the right price on SAF, with, if necessary, a limit on the volumes identified in this thesis, would be worth studying, as would the effects of the price elasticity of demand. The proposed line of work

could be based on a single SAF price, equivalent to the maximum price, 100% efuel, applicable from 2030 and then stable, for example. The effects on demand would then be anticipated, with all airlines on an equal footing. Above all, it would be possible to dedicate the additional revenues generated during the transition period to financing SAF production projects in isolation. A gradual, real incorporation of SAF, along the lines of ReFuelEU Aviation, for example from 20% in 2030 to 100% in 2050, against a reference price based on the most expensive SAF, would free up substantial financial resources for the aviation ecosystem. This would be to the detriment of demand, and the associated effects have yet to be measured.

Finally, the methodology for calculating emissions and the associated databases, HeloCarb', can also be enriched, while enriching the ecosystem as a whole. In addition to a roll-out to asset and fleet managers, joint work with the EEA, once the patent has been filed, should be studied.

III.IV.4. List of publications

Jarin, J, Champion-Réaud, J, Lambert, P, Mendes, C, Jeuland, N, May-Carle, J, Doucet, C, & Picard, F. "Gas Concentration Maps Within a Turbomachine Combustor Fueled With Jet-A1 or Sustainable Aviation Fuel (SAF)." Proceedings of the ASME Turbo Expo 2023: Turbomachinery Technical Conference and Exposition. Volume 3A: Combustion, Fuels, and Emissions. Boston, Massachusetts, USA. June 26–30, 2023. V03AT04A024. ASME. <https://doi.org/10.1115/GT2023-101375>

Jarin, J.-B.; Beddok, S.; Haritchabalet, C. Techno-Economic Comparison of Low-Carbon Energy Carriers Based on Electricity for Air Mobility. *Energies* 2024, 17, 1151. <https://doi.org/10.3390/en17051151>

Jarin, J, Champion-Réaud, J, Sallinen, R, & Steenwinkel, E. "Emissions Comparison of 100% SAF With Bio-Aromatics and Conventional (Fossil) Jet Fuel." Proceedings of the ASME Turbo Expo 2024: Turbomachinery Technical Conference and Exposition. Volume 2: Ceramics and Ceramic Composites; Coal, Biomass, Hydrogen, and Alternative Fuels. London, United Kingdom. June 24–28, 2024. V002T03A012. ASME. <https://doi.org/10.1115/GT2024-124002>

Hussein, H. I., Heffron, R. J., Phillips, A., Jarin, J. B., & Basil, C. V. (2024). Future-proofing for green hydrogen in the Global South: a procedural justice perspective. *Journal of Energy & Natural Resources Law*, 42(3), 343–361. <https://doi.org/10.1080/1031461X.2024.2345007>

Report of the Académie des Technologies: decarbonizing the aviation sector through the production of sustainable fuels, chapters VI and VII, pages 81-108, 2023, <https://www.academie-technologies.fr/wp-content/uploads/2023/03/Rapport-decarbonation-secteur-aerien-production-carburants-durables-AT-Mars-2023.pdf>

Le droit des mobilités, choosing energy for mobility, pages 359-367, 2024, <https://www.appeldulivre.fr/product/1245851/le-droit-des-mobilites>





ECOLE DOCTORALE

ED 481 - Sciences sociales et humanités

LABORATOIRE

TREE

