



HAL
open science

A methodological framework to support sustainable value creation in collaborative innovation contexts

Martha Stephany Orellano Carrasquilla

► To cite this version:

Martha Stephany Orellano Carrasquilla. A methodological framework to support sustainable value creation in collaborative innovation contexts. Chemical and Process Engineering. Université de Lyon, 2019. English. NNT: 2019LYSEM030 . tel-04909655

HAL Id: tel-04909655

<https://theses.hal.science/tel-04909655v1>

Submitted on 24 Jan 2025

HAL is a multi-disciplinary open access archive for the deposit and dissemination of scientific research documents, whether they are published or not. The documents may come from teaching and research institutions in France or abroad, or from public or private research centers.

L'archive ouverte pluridisciplinaire **HAL**, est destinée au dépôt et à la diffusion de documents scientifiques de niveau recherche, publiés ou non, émanant des établissements d'enseignement et de recherche français ou étrangers, des laboratoires publics ou privés.



N° d'ordre NNT : 2019LYSEM030

THÈSE de DOCTORAT DE L'UNIVERSITÉ DE LYON
opérée au sein de
L'École des Mines de Saint-Étienne

École Doctorale N° 488
Sciences, Ingénierie, Santé

Spécialité de doctorat : Génie Industriel

Soutenue publiquement le 28/11/2019, par :

Martha Orellano Carrasquilla

**A methodological framework to support sustainable
value creation in collaborative innovation contexts**

**Cadre méthodologique pour l'accompagnement de la création de valeur durable
dans un contexte d'innovation collaborative**

Devant le jury composé de :

<i>MCALOONE, Tim</i>	<i>Professeur, DTU, Danemark</i>	<i>Rapporteur</i>
<i>NORESE, Maria Franca</i>	<i>Professeur associé, Politecnico di Torino, Italie</i>	<i>Rapporteuse</i>
<i>GRABOT, Bernard</i>	<i>Professeur, ENIT Tarbes, France</i>	<i>Examinateur</i>
<i>GZARA, Lilia</i>	<i>Professeur associé, INP Grenoble, France</i>	<i>Examinatrice</i>
<i>PEZZOTTA, Giuditta</i>	<i>Professeur associé, Università degli Studi di Bergamo, Italie</i>	<i>Examinatrice</i>
<i>NEUBERT, Gilles</i>	<i>Professeur, emlyon, France</i>	<i>Directeur</i>
<i>MEDINI, Khaled</i>	<i>Maître de Conférences, Mines Saint-Étienne, France</i>	<i>Co-encadrant</i>
<i>LAMBEY-CHECCHIN, Christine</i>	<i>Maître de Conférences, Université Clermont Auvergne, France</i>	<i>Co-encadrante</i>
<i>BILLOT, Geoffroy</i>	<i>Direction des Achats, EDF, France</i>	<i>Invité</i>

Spécialités doctorales
 SCIENCES ET GENIE DES MATERIAUX
 MECANIQUE ET INGENIERIE
 GENIE DES PROCÉDES
 SCIENCES DE LA TERRE
 SCIENCES ET GENIE DE L'ENVIRONNEMENT

Responsables :
 K. Wolski Directeur de recherche
 S. Drapier, professeur
 F. Gruy, Maître de recherche
 B. Guy, Directeur de recherche
 D. Graillet, Directeur de recherche

Spécialités doctorales
 MATHEMATIQUES APPLIQUEES
 INFORMATIQUE
 SCIENCES DES IMAGES ET DES FORMES
 GENIE INDUSTRIEL
 MICROELECTRONIQUE

Responsables
 O. Roustant, Maître-assistant
 O. Boissier, Professeur
 J.C. Pinoli, Professeur
 N. Absi, Maître de recherche
 Ph. Lalevée, Professeur

EMSE : Enseignants-chercheurs et chercheurs autorisés à diriger des thèses de doctorat (titulaires d'un doctorat d'État ou d'une HDR)

ABSI	Nabil	MR	Génie industriel	CMP
AUGUSTO	Vincent	CR	Image, Vision, Signal	CIS
AVRIL	Stéphane	PR2	Mécanique et ingénierie	CIS
BADEL	Pierre	MA(MDC)	Mécanique et ingénierie	CIS
BALBO	Flavien	PR2	Informatique	FAYOL
BASSEREAU	Jean-François	PR PR2	Sciences et génie des matériaux	SMS
BATTON-HUBERT	Mireille		Sciences et génie de l'environnement	FAYOL
BEIGBEDER	Michel	MA(MDC)	Informatique	FAYOL
BLAYAC	Sylvain	MA(MDC)	Microélectronique	CMP
BOISSIER	Olivier	PR1	Informatique	FAYOL
BONNEFOY	Olivier	PR	Génie des Procédés	SPIN
BORBELY	Andras	MR(DR2)	Sciences et génie des matériaux	SMS
BOUCHER	Xavier	PR2	Génie Industriel	FAYOL
BRODHAG	Christian	DR	Sciences et génie de l'environnement	FAYOL
BRUCHON	Julien	MA(MDC)	Mécanique et ingénierie	SMS
CAMEIRAO	Ana	MA(MDC)	Génie des Procédés	SPIN
CHRISTEN	Frédéric	PR	Science et génie des matériaux	SMS
DAUZERE-PERES	Stéphane	PR1	Génie Industriel	CMP
DEBAYLE	Johan	MR	Sciences des Images et des Formes	SPIN
DEGEORGE	Jean-Michel	MA(MDC)	Génie industriel	Fayol
DELAFOSSÉ	David	PR0	Sciences et génie des matériaux	SMS
DELORME	Xavier	MA(MDC)	Génie industriel	FAYOL
DESRAYAUD	Christophe	PR1	Mécanique et ingénierie	SMS
DJENZIAN	Thierry	PR	Science et génie des matériaux	CMP
BERGER-DOUCE	Sandrine	PR1	Sciences de gestion	FAYOL
DRAPIER	Sylvain	PR1	Mécanique et ingénierie	SMS
DUTERTRE	Jean-Max	MA(MDC)		CMP
EL MRABET	Nadia	MA(MDC)		CMP
FAUCHEU	Jenny	MA(MDC)	Sciences et génie des matériaux	SMS
FAVERGEON	Loïc	CR	Génie des Procédés	SPIN
FEILLET	Dominique	PR1	Génie Industriel	CMP
FOREST	Valérie	MA(MDC)	Génie des Procédés	CIS
FRACZKIEWICZ	Anna	DR	Sciences et génie des matériaux	SMS
GARCIA	Daniel	MR(DR2)	Sciences de la Terre	SPIN
GAVET	Yann	MA(MDC)	Sciences des Images et des Formes	SPIN
GERINGER	Jean	MA(MDC)	Sciences et génie des matériaux	CIS
GOEURIOT	Dominique	DR	Sciences et génie des matériaux	SMS
GONDRAN	Natacha	MA(MDC)	Sciences et génie de l'environnement	FAYOL
GONZALEZ FELJU	Jesus	MA(MDC)	Sciences économiques	FAYOL
GRAILLOT	Didier	DR	Sciences et génie de l'environnement	SPIN
GROSSEAU	Philippe	DR	Génie des Procédés	SPIN
GRUY	Frédéric	PR1	Génie des Procédés	SPIN
HAN	Woo-Suck	MR	Mécanique et ingénierie	SMS
HERRI	Jean Michel	PR1	Génie des Procédés	SPIN
KERMOUCHE	Guillaume	PR2	Mécanique et Ingénierie	SMS
KLOCKER	Helmut	DR	Sciences et génie des matériaux	SMS
LAFORÉST	Valérie	MR(DR2)	Sciences et génie de l'environnement	FAYOL
LERICHE	Rodolphe	CR	Mécanique et ingénierie	FAYOL
MALLIARAS	Georges	PR1	Microélectronique	CMP
MOLIMARD	Jérôme	PR2	Mécanique et ingénierie	CIS
MOUTTE	Jacques	CR	Génie des Procédés	SPIN
NAVARRO	Laurent	CR		CIS
NEUBERT	Gilles			FAYOL
NIKOLOVSKI	Jean-Pierre	Ingénieur de recherche	Mécanique et ingénierie	CMP
NORTIER	Patrice	PR1	Génie des Procédés	SPIN
O CONNOR	Rodney Philip	MA(MDC)	Microélectronique	CMP
PICARD	Gauthier	MA(MDC)	Informatique	FAYOL
PINOLI	Jean Charles	PR0	Sciences des Images et des Formes	SPIN
POURCHEZ	Jérémy	MR	Génie des Procédés	CIS
ROUSSY	Agnès	MA(MDC)	Microélectronique	CMP
ROUSTANT	Olivier	MA(MDC)	Mathématiques appliquées	FAYOL
SANAUR	Sébastien	MA(MDC)	Microélectronique	CMP
SERRIS	Eric	IRD		FAYOL
STOLARZ	Jacques	CR	Sciences et génie des matériaux	SMS
TRIA	Assia	Ingénieur de recherche	Microélectronique	CMP
VALDIVIESO	François	PR2	Sciences et génie des matériaux	SMS
VIRICELLE	Jean Paul	DR	Génie des Procédés	SPIN
WOLSKI	Krzysztof	DR	Sciences et génie des matériaux	SMS
XIE	Xiaolan	PR0	Génie industriel	CIS
YUGMA	Gallian	CR	Génie industriel	CMP

Supervisor

Gilles Neubert, emlyon, France

Co-supervisor

Khaled Medini, Mines Saint-Étienne, France

Christine Lambey-Checchin, Université Clermont Auvergne, France

Jury

Tim McAloone, DTU, Denmark

Maria Franca Norese, Politecnico di Torino, Italy

Bernard Grabot, ENIT Tarbes, France

Lilia Gzara, INP Grenoble, France

Giuditta Pezzotta, Università degli Studi di Bergamo, Italy

Geoffroy Billot, EDF, France

Opponent

Martha Orellano Carrasquilla

Contact information

Environmental and Organisation Engineering

Henri Fayol Institute, Mines Saint-Étienne

158 cours Fauriel, F-42023 Saint-Étienne cedex 2, France

Email address: webmaster@emse.fr

URL: <https://www.mines-stetienne.fr/>

Telephone: +33 (0)4 77 42 01 23

Fax: +33 (0)4 77 42 00 00

Spécialités doctorales
 SCIENCES ET GENIE DES MATERIAUX
 MECANIQUE ET INGENIERIE
 GENIE DES PROCÉDES
 SCIENCES DE LA TERRE
 SCIENCES ET GENIE DE L'ENVIRONNEMENT

Responsables :
 K. Wolski Directeur de recherche
 S. Drapier, professeur
 F. Gruy, Maître de recherche
 B. Guy, Directeur de recherche
 D. Graillet, Directeur de recherche

Spécialités doctorales
 MATHEMATIQUES APPLIQUEES
 INFORMATIQUE
 SCIENCES DES IMAGES ET DES FORMES
 GENIE INDUSTRIEL
 MICROELECTRONIQUE

Responsables
 O. Roustant, Maître-assistant
 O. Boissier, Professeur
 J.C. Pinoli, Professeur
 N. Absi, Maître de recherche
 Ph. Lalevée, Professeur

EMSE : Enseignants-chercheurs et chercheurs autorisés à diriger des thèses de doctorat (titulaires d'un doctorat d'État ou d'une HDR)

ABSI	Nabil	MR	Génie industriel	CMP
AUGUSTO	Vincent	CR	Image, Vision, Signal	CIS
AVRIL	Stéphane	PR2	Mécanique et ingénierie	CIS
BADEL	Pierre	MA(MDC)	Mécanique et ingénierie	CIS
BALBO	Flavien	PR2	Informatique	FAYOL
BASSEREAU	Jean-François	PR PR2	Sciences et génie des matériaux	SMS
BATTON-HUBERT	Mireille		Sciences et génie de l'environnement	FAYOL
BEIGBEDER	Michel	MA(MDC)	Informatique	FAYOL
BLAYAC	Sylvain	MA(MDC)	Microélectronique	CMP
BOISSIER	Olivier	PR1	Informatique	FAYOL
BONNEFOY	Olivier	PR	Génie des Procédés	SPIN
BORBELY	Andras	MR(DR2)	Sciences et génie des matériaux	SMS
BOUCHER	Xavier	PR2	Génie Industriel	FAYOL
BRODHAG	Christian	DR	Sciences et génie de l'environnement	FAYOL
BRUCHON	Julien	MA(MDC)	Mécanique et ingénierie	SMS
CAMEIRAO	Ana	MA(MDC)	Génie des Procédés	SPIN
CHRISTEN	Frédéric	PR	Science et génie des matériaux	SMS
DAUZERE-PERES	Stéphane	PR1	Génie Industriel	CMP
DEBAYLE	Johan	MR	Sciences des Images et des Formes	SPIN
DEGEORGE	Jean-Michel	MA(MDC)	Génie industriel	Fayol
DELAFOSSÉ	David	PR0	Sciences et génie des matériaux	SMS
DELORME	Xavier	MA(MDC)	Génie industriel	FAYOL
DESRAYAUD	Christophe	PR1	Mécanique et ingénierie	SMS
DJENZIAN	Thierry	PR	Science et génie des matériaux	CMP
BERGER-DOUCE	Sandrine	PR1	Sciences de gestion	FAYOL
DRAPIER	Sylvain	PR1	Mécanique et ingénierie	SMS
DUTERTRE	Jean-Max	MA(MDC)		CMP
EL MRABET	Nadia	MA(MDC)		CMP
FAUCHEU	Jenny	MA(MDC)	Sciences et génie des matériaux	SMS
FAVERGEON	Loïc	CR	Génie des Procédés	SPIN
FEILLET	Dominique	PR1	Génie Industriel	CMP
FOREST	Valérie	MA(MDC)	Génie des Procédés	CIS
FRACZKIEWICZ	Anna	DR	Sciences et génie des matériaux	SMS
GARCIA	Daniel	MR(DR2)	Sciences de la Terre	SPIN
GAVET	Yann	MA(MDC)	Sciences des Images et des Formes	SPIN
GERINGER	Jean	MA(MDC)	Sciences et génie des matériaux	CIS
GOEURIOT	Dominique	DR	Sciences et génie des matériaux	SMS
GONDRAN	Natacha	MA(MDC)	Sciences et génie de l'environnement	FAYOL
GONZALEZ FELJU	Jesus	MA(MDC)	Sciences économiques	FAYOL
GRAILLOT	Didier	DR	Sciences et génie de l'environnement	SPIN
GROSSEAU	Philippe	DR	Génie des Procédés	SPIN
GRUY	Frédéric	PR1	Génie des Procédés	SPIN
HAN	Woo-Suck	MR	Mécanique et ingénierie	SMS
HERRI	Jean Michel	PR1	Génie des Procédés	SPIN
KERMOUCHE	Guillaume	PR2	Mécanique et Ingénierie	SMS
KLOCKER	Helmut	DR	Sciences et génie des matériaux	SMS
LAFOREST	Valérie	MR(DR2)	Sciences et génie de l'environnement	FAYOL
LERICHE	Rodolphe	CR	Mécanique et ingénierie	FAYOL
MALLIARAS	Georges	PR1	Microélectronique	CMP
MOLIMARD	Jérôme	PR2	Mécanique et ingénierie	CIS
MOUTTE	Jacques	CR	Génie des Procédés	SPIN
NAVARRO	Laurent	CR		CIS
NEUBERT	Gilles			FAYOL
NIKOLOVSKI	Jean-Pierre	Ingénieur de recherche	Mécanique et ingénierie	CMP
NORTIER	Patrice	PR1	Génie des Procédés	SPIN
O CONNOR	Rodney Philip	MA(MDC)	Microélectronique	CMP
PICARD	Gauthier	MA(MDC)	Informatique	FAYOL
PINOLI	Jean Charles	PR0	Sciences des Images et des Formes	SPIN
POURCHEZ	Jérémy	MR	Génie des Procédés	CIS
ROUSSY	Agnès	MA(MDC)	Microélectronique	CMP
ROUSTANT	Olivier	MA(MDC)	Mathématiques appliquées	FAYOL
SANAUR	Sébastien	MA(MDC)	Microélectronique	CMP
SERRIS	Eric	IRD		FAYOL
STOLARZ	Jacques	CR	Sciences et génie des matériaux	SMS
TRIA	Assia	Ingénieur de recherche	Microélectronique	CMP
VALDIVIESO	François	PR2	Sciences et génie des matériaux	SMS
VIRICELLE	Jean Paul	DR	Génie des Procédés	SPIN
WOLSKI	Krzysztof	DR	Sciences et génie des matériaux	SMS
XIE	Xiaolan	PR0	Génie industriel	CIS
YUGMA	Gallian	CR	Génie industriel	CMP

Acknowledgements

I am convinced that for any achievement in the life, everybody has someone to thank for. I have many people to thank, and I will try to summarize it into a few worlds.

First, I would like to thank the jury for being able to review my thesis manuscript. Thanks to the reviewers, Maria Franca Norese and Tim McAlone for sharing with me years of expertise throughout their valuable remarks that provide me a critical regard of my work. Thanks for doing it with such an extraordinary kindness. Particularly, thanks to Maria Franca for submerging me in the discipline of multi-criteria decision aiding during my stage in Politecnico di Torino.

Thanks to the examiners, Giuditta Pezzotta, and Lilia Gzara for their valuable comments that contribute to the improvement of my research work. A deep thanks to Bernard Grabot for granting me the honour of presiding my Ph.D. dissertation.

This thesis has been, undoubtedly, the result of the collaborative work with my supervisors. I thank Khaled for maintaining the focus on industrial engineering with high-quality and honest insights, and for introducing me to the world of teaching. Thanks to Christine for providing me the methodological rigour and the rich perspective of management sciences that enriched my research work. Thanks also for being always available despite the geographical distance.

A deep thanks to my Ph.D. director, Gilles, whose work methodology represents the perfect balance between exigence and flexibility. Thanks for transforming every single meeting into a space of creativity and positiveness. Thousand thanks for choosing with extremely carefulness the right words to guide me during these three years. I think all those qualities are fundamental to encourage learning in others.

I would like to thank very specially my partners in the PEAK research team, Jean and Fabienne. Thanks for providing the pragmatic regard to my thesis work, always constructive and challenging. Particularly thanks for being the connection between my academic work and the industry throughout the ICOVET project.

Thanks to EDF for providing me the empirical context for the development and validation of my thesis contributions. Specially, thanks to Geoffroy Billot for his active participation during the entire development of the ICOVET project.

Thanks to Fayol Institute for welcoming me to the adventure of research. The third-floor colleagues for all the interesting discussions during the coffee break and lunchtime. The PSS team for providing me a unique space to improve my communication and analytic skills. A deep thanks to Zahia for her precious support in

all the administrative issues, always with a big smile.

Of course, thanks to my lovely friends in Fayol. To my dear Colombians, Andrés, and Laura, thanks for their unconditional support and for sharing their knowledge with me. Thanks to my co-workers: Fabien, Anastasia, Nahla, Benjamin, Zeinab, and now Jalila, who followed closely my Ph.D. evolution, always encouraging me during the hard moments. Thanks also to Jérémy, Marie, Camilo, Safi Audrey, Souraya, Omar, and Elaheh for all the nice and thoughtful moments inside and outside Fayol.

Thanks to my dear friends in Saint-Étienne, Mary, Stefany, Camilo, and Mathilde, they all make this city the best place to live in France.

To Jérémy, thanks for his support and patience at the end of my writing period.

Finally, I would like to thank my family from the deepest of my heart for supporting me during my entire life with an extraordinary force. Thanks for providing me the courage and principles to achieve all my goals. To my parents, a deep thanks for teaching me, with their example, that there are no limits where there are will and passion.

Papi, Maty, Cleo, and Jairo, *gracias por estar siempre presentes, y por haber viajado 10.000 KM para acompañarme en este día tan importante para mí.*

France, November 2019
Martha Orellano Carrasquilla

^oAuvergne Rhone-Alpes Region (France) supports this research through a doctoral thesis allocation into the ARC 8. The sponsors of this research within the framework of the PEAK Cluster: THESAME, Funds F2I/UIMM, French Plan *d'Investissement d'Avenir* and its financial operator *Caisse des Dépôts*, the ACE project of PFA (French Automotive Industry).

A methodological framework to support sustainable value creation in collaborative innovation contexts

Martha Orellano Carrasquilla

Génie de l'Environnement et des Organisations

Institut Fayol, Mines Saint-Étienne

158 cours Fauriel, F-42023 Saint-Étienne cedex 2, France

martha.orellano@emse.fr

Introduction

La création de valeur durable traduit l'intérêt des entreprises envers les objectifs du développement durable à travers des modèles économiques innovants. Au-delà des intérêts économiques, les entreprises dites durables, sont de plus en plus soucieuses de la protection de l'environnement et de la garantie du bien-être social. En accord avec la recherche académique, la création de valeur durable peut être analysée à trois niveaux différents : l'entreprise, la chaîne logistique, et la société au sens large (Boons and Lüdeke-Freund, 2013; Bocken et al., 2014). Tout d'abord, au niveau de l'entreprise, l'adoption d'une stratégie axée sur le développement durable représente une opportunité de s'aligner sur les tendances actuelles du marché, ainsi qu'une source précieuse d'avantage compétitive (Hart et al., 2003; Matinheikki et al., 2017; Brown et al., 2019). Deuxièmement, au niveau de la chaîne logistique, la création de valeur durable nécessite de l'alignement stratégique des acteurs dans une dynamique de collaboration étroite, ayant pour but le partage des ressources et des responsabilités vis-à-vis des besoins de durabilité (Maestrini et al., 2017; Arnold, 2017). Enfin, la société comprend les acteurs non-économiques qui sont impactés par l'activité économique. Cela représente les pressions externes qui poussent les entreprises à adopter des pratiques plus vertueuses, favorisant la préservation de l'environnement et le bien-être commun (Bocken et al., 2014; Boons and Lüdeke-Freund, 2013; Baldassarre et al., 2017).

Bien que l'adoption de pratiques durables semble fondamentale dans le milieu industriel actuel, elle nécessite des transformations radicales aux niveaux interne et externe des entreprises. Par exemple, les entreprises sont amenées à innover dans leurs produits, leurs processus, et leurs modèles d'aff pour atteindre le triple objectif de la durabilité (i.e., croissance économique, protection de l'environnement et bien-être social) (Ballantyne et al., 2011; Baldassarre et al., 2017). Par conséquent, le rôle de l'entreprise dans la création d'une société plus durable est un défi complexe mais puissant, qui peut transformer les modes de production et de consommation de la société.

Des nombreuses recherches académiques ont traité la question de la création de valeur, analysée du point de vue de plusieurs domaines de la connaissance, en dégageant des

pistes prometteuses (Ueda et al., 2009; Bocken et al., 2014; Joyce and Paquin, 2016; Aquilani et al., 2018). En soulignant les travaux de Bocken et al. (2014), ces auteurs mettent en lumière le potentiel durable des modèles économiques innovants tels que les systèmes produits-services (PSS), l'économie de la fonctionnalité, et l'économie circulaire. Dans la même direction, Pieroni et al. (2019) démontre le lien existant entre les modèles économiques en boucle fermée et la réalisation de la valeur durable. Cependant, en dépit de l'importance de transformer les modèles d'entreprise envers le développement durable, il n'existent toujours pas de mécanismes concrets pour y parvenir. La recherche académique a mis en évidence deux grands défis pour la suite : premièrement, il est nécessaire de trouver un consensus sur le concept de valeur durable à travers la construction d'un cadre conceptuel général (Kaihara et al., 2018). Deuxièmement, des recherches supplémentaires sont nécessaires pour développer des méthodologies opérationnelles, permettant d'orienter les entreprises vers la durabilité (Bocken et al., 2015).

Cette thèse, a donc pour objectif de répondre à ces besoins relevés dans la littérature. D'abord un cadre méthodologique pour soutenir la création de valeur durable a été proposé. Concrètement, ce travail propose en premier lieu une conceptualisation de la valeur durable basée sur une vaste revue de la littérature. Ensuite, un cadre méthodologique pour aider à la prise de décisions dans la conception d'offres innovantes, tenant compte de la durabilité, est proposé. L'ensemble des contributions s'inscrit dans une perspective stratégique de relations de collaboration entre plusieurs acteurs industriels. Enfin, la méthodologie proposée a été en partie construite et appliquée suivant une démarche de recherche-intervention dans le cas d'une entreprise Française (Groupe EDF - Electricité de France).

Organisation du manuscrit et contenu des chapitres

Le manuscrit est structuré en quatre parties (y compris la partie introductive I) et composé par un total de sept chapitres. La deuxième partie présente l'état de l'art en appui de cette recherche, et se divise en trois chapitres. La troisième partie présente le cadre méthodologique proposé et illustre son application à travers un cas industriel, comprenant les chapitres 5 et 6. Enfin, la quatrième partie présente les conclusions, en distinguant les contributions scientifiques de celles managériales, ainsi que les perspectives de recherche.

Dans la Partie II, le chapitre 2 concerne la caractérisation de la création de valeur durable. Une vaste revue de la littérature sur le concept de création de valeur dans différentes disciplines et au fil du temps est développée. Cette revue de littérature a pour objectif de parvenir à une conceptualisation structurée de la création de valeur dans le contexte actuel autour de la durabilité et de l'innovation des entreprises. À la fin du chapitre, un cadre conceptuel pour caractériser la valeur durable est fourni, contribuant ainsi au premier axe de recherche de ce travail de thèse. Ensuite, le chapitre 3 a pour objectif de montrer

le lien entre l'innovation collaborative et la création de valeur durable dans les relations inter-organisationnelles. À la fin de ce chapitre, les éléments permettant d'analyser et de modéliser les relations collaboratives entre plusieurs acteurs industriels sont mises en lumière. Enfin, le chapitre 4 explore à la fois les approches de modélisation des systèmes et des méthodes d'analyse multicritères. D'un côté, les méthodes de modélisation de systèmes sont explorées pour comprendre les relations menées entre les acteurs à travers leurs échanges de valeur. De l'autre côté, les approches d'analyse multicritères sont étudiées pour aboutir à des pistes pour l'évaluation de la valeur dans le contexte de la conception collaborative d'offres innovantes.

Concernant la Partie III de cette thèse, le chapitre 5 développe le cadre méthodologique proposé. Suivant une approche progressive, les éléments retenus dans la littérature, et adaptés au contexte de création de valeur durable, sont couplés dans un cadre méthodologique global composé de quatre phases : i) analyse de la création de valeur, ii) modèle d'alignement de la valeur, iii) la modélisation des préférences, et iv) le processus de consensus. En fin de ce chapitre, la reproductibilité de la méthodologie proposée est discutée. En complément, le chapitre 6 détaille l'application du cadre méthodologique à un cas industriel. Dans ce chapitre, l'évolution méthodologique de la proposition est illustrée à travers le cas d'étude. Les résultats obtenus lors de la mise en œuvre de la proposition sont analysés et débouchent sur un ensemble d'implications en matière de gestion et de perspectives pour l'entreprise, en soulignant les effets sur la stratégie des achats, pour favoriser les politiques RSE (Responsabilité Sociétale des Entreprises) de l'entreprise.

La dernière Partie IV est consacrée au chapitre 7, contenant les conclusions et les perspectives de recherche dégagées de ce travail de thèse. Cette partie présente donc, les principales contributions vis-à-vis de l'état de l'art. Ensuite, les limites de la recherche concernant l'approche méthodologique et les théories et méthodes mobilisées sont spécifiées. À partir de l'étude de cas, les implications managériales sont discutées. Enfin, les sujets non couverts sont présentés en tant que perspectives de recherche.

Conclusions

Ce travail de thèse contribue à la littérature sur la durabilité, l'innovation et la création de valeur. Plus précisément, le cadre proposé contribue à la conceptualisation, à la modélisation et à l'évaluation de la création de valeur durable dans les contextes d'innovation collaborative entre plusieurs acteurs industriels. Le cadre a été construit à partir d'une solide base conceptuelle obtenue d'une revue de la littérature dans les domaines de la création de valeur, la gestion de l'innovation, la modélisation des systèmes et l'aide à la décision. Notre proposition est donc le résultat de la convergence de plusieurs disciplines, démontrant ainsi la complexité autour du sujet de la création de valeur durable.

Le cadre méthodologique proposé a nécessité la mobilisation de plusieurs méthodes dans chaque phase. Ainsi, le cadre a été testé dans un cas réel lié au développement de l'innovation pour la durabilité. La démarche adoptée a permis de structurer les attentes des acteurs clés en termes de création de valeur, et d'analyser leur compatibilité. Enfin, l'ensemble de la démarche aboutit à une aide à la décision du point de vue stratégique par rapport à la conception d'offres innovantes.

Du point de vue managérial, la méthodologie proposée suit une logique participative, permettant la communication et le travail collaboratif entre plusieurs parties prenantes au sens d'un projet d'innovation commun. Dans le cas concret de EDF, la méthodologie a permis d'identifier les conditions pour le développement d'une innovation radicale autour des vêtements de travail, en faisant parti tous les acteurs de la chaîne logistique. Ainsi, ce travail a permis d'améliorer la performance de la fonction achats en ce qui concerne la stratégie RSE de l'entreprise. Enfin, étant le but principal d'une démarche d'innovation collaborative, la méthodologie proposée a abouti à la mise en relation collaborative, avec un horizon étendue, entre EDF et ses anciens et nouveaux prestataires dans la chaîne logistique des vêtements de travail.

Contents

List of Figures	xv
List of Tables	xvii
I General introduction	1
1 Introduction	3
1.1 Research context	3
1.2 Research questions and objectives	4
1.3 Research methodology design	5
1.4 Structure of the manuscript	6
1.4.1 Part II: Theoretical Background	6
1.4.2 Part III: Proposal Development	7
1.4.3 Part IV: General conclusion	8
II Theoretical background	9
2 Characterisation of sustainable value creation	11
2.1 Introduction.....	11
2.2 Literature review methodology.....	13
2.2.1 Identification of sources	13
2.2.2 Selection fi.....	14
2.2.3 Descriptive analysis	15
2.2.4 Content analysis	15
2.3 The notion of value throughout the time	17
2.3.1 Economic value.....	17
2.3.2 Customer value	18
2.3.3 Sustainable value	19
2.3.4 Multi-stakeholder value.....	20
2.4 Sustainable value creation in B2B markets.....	22
2.5 Proposed framework for the characterisation of sustainable value creation	25

2.6	Conclusion.....	26
3	Collaborative innovation for sustainable value creation	27
3.1	Introduction.....	28
3.2	Literature review methodology.....	28
3.2.1	Sources identification.....	29
3.2.2	Conceptual structure.....	29
3.2.3	Thematic analysis	30
3.3	Collaborative innovation: key concepts.....	34
3.4	Triggers of collaborative innovation (why?)	35
3.4.1	Technology-push approach	35
3.4.2	Demand-pull approach.....	35
3.5	Types of innovation (what?).....	36
3.5.1	According to the innovation object.....	36
3.5.2	According to the innovation strategy.....	37
3.5.3	According to the degree of collaboration.....	37
3.6	Collaborative innovation in today's business to business relationships (how?)	39
3.6.1	The requisites for successful collaborative innovation	39
3.6.2	The process of collaborative innovation	41
3.6.3	Collaborative innovation and sustainable value creation in the supply chain	42
3.7	Conclusions	43
4	Decision making in multidimensional and multi-stakeholder value creation	45
4.1	Introduction.....	46
4.2	Literature review methodology.....	47
4.3	Multi-Criteria Decision Analysis (MCDA).....	49
4.3.1	Basic elements in MCDA.....	49
4.3.2	Elements in multi-stakeholder MCDA	50
4.3.3	MCDA process	51
4.3.4	Holding consensus in multi-stakeholder decisions	52
4.3.5	MCDA methods.....	53
4.4	Problem structure modelling in multi-stakeholder MCDA.....	54
4.5	MCDA application in the context of sustainable value creation.....	55
4.5.1	Choosing a MCDA method.....	55
4.5.2	MCDA domains of application	56
4.5.3	Implementing MCDA in industry	56
4.6	Retained elements for proposal development.....	57
4.6.1	The Analytic Hierarchy Process (AHP)	57
4.6.2	Searching a consensus	59
4.6.3	<i>i</i> * Goal Modelling framework for problem structure modelling . .	61
4.7	Conclusions	64

III	Proposal development	67
5	Framework to support sustainable value creation in collaborative innovation	69
5.1	Introduction.....	70
5.2	Value creation analysis	71
5.2.1	Stakeholder analysis.....	71
5.2.2	Value characterisation	72
5.3	Problem structure modelling.....	74
5.3.1	Value alignment framework.....	74
5.3.2	Criteria defi.....	76
5.3.3	Alternative identification	77
5.4	Preference modelling	78
5.4.1	Preparation	78
5.4.2	Performing the evaluation process	79
5.5	Researching a consensus	81
5.5.1	Clustering process.....	81
5.5.2	Actors' prioritization	83
5.6	Conclusions	84
6	Framework application to the case of ICOVET project	85
6.1	Introduction.....	85
6.2	ICOVET project description	86
6.3	Research methodology	87
6.3.1	Development phases	87
6.3.2	Managerial objectives	88
6.4	Development of the proposed framework.....	88
6.4.1	Value creation analysis	88
6.4.2	Problem structure modelling	96
6.4.3	Preference modelling.....	101
6.4.4	Researching a consensus.....	106
6.5	Conclusions	112
IV	General conclusion	113
7	Conclusions and research perspectives	115
7.1	Further discussion.....	115
7.2	Scientific contributions and implications	116
7.3	Managerial contributions and implications	117
7.4	Limits of the study.....	118
	References	123

V Appendices

137

List of Figures

- 1.1 Structure of the manuscript. 7
- 2.1 Systematic literature review methodology 13
- 2.2 Number of publications over time using the keywords “value creation” (2000-2018). 14
- 2.3 Distribution of articles on value creation according to the research domains. 15
- 2.4 Value co-creation process according to Service-Dominant Logic (SDL) (Vargo and Lusch, 2008)..... 22
- 2.5 Value creation configuration: supplier network (left) and demand network (right). 23
- 2.6 Value creation configuration: business ecosystem. 23
- 3.1 Research design framework. 29
- 3.2 Cluster analysis of the scientific research in collaboration, innovation and sustainability (between 1975 and 2019). 30
- 3.3 Thematic map of the selected articles. 31
- 4.1 Research framework. 47
- 4.2 Generic decision process according to Friend (1987) 52
- 4.3 Hierarchical structure of AHP 59
- 4.4 *i** meta-model (Yu et al, 2011). 62
- 4.5 Actor notation and associations. 63
- 4.6 actors’ dependence notation. 63
- 4.7 Intentional element notation. 63
- 4.8 Representation of intentional element associations. 64
- 5.1 Overview of the proposal..... 71
- 5.2 Sustainable value creation model framework (Orellano et al, 2018b,a). . 73
- 5.3 Generic framework for collaborative offer development (Orellano et al, 2019a). 75
- 6.1 Current stakeholders in the supply chain of safety clothing of EDF..... 89
- 6.2 Key stakeholders included in ICOVET project. 90
- 6.3 Clustering of internal actors interviews obtained from ALCESTE. 91

6.4	Current business model of the safety clothing between EDF and its providers.	93
6.5	Expected business model of the safety clothing between EDF and its providers.....	94
6.6	Extract of the Goal Modelling between EDF and the supply chain actors.	96
6.7	Hierarchical model of the Beginning of life (BOL).....	102
6.8	Hierarchical model of the middle of life (MOL).....	102
6.9	Hierarchical model of the End of life (EOL).....	103
6.10	Cluster dendrogram of actors' priorities at the beginning of life.....	107
6.11	Cluster dendrogram of actors' priorities at the middle of life.....	107
6.12	Cluster dendrogram of actors' priorities at the end of life.....	108

List of Tables

- 2.1 Content analysis of the selected articles on value creation.....16
- 2.2 Evolution of the research on value creation.....22
- 3.1 Content analysis of the selected articles.....32
- 4.1 Most used multi-criteria decision making techniques according to [Chai et al. \(2013\)](#) and [Kumar et al. \(2017\)](#).....48
- 4.2 MCDA methods and applications of the reviewed articles.....48
- 4.3 Comparative analysis of multi-criteria decision techniques based on the quality criteria proposed by [De Montis et al. \(2005\)](#).....55
- 4.4 Scale of preferences of AHP ([Saaty, 1990](#)).....59
- 4.5 Criteria of stakeholder importance ([Mitchell et al., 1997](#)).....61
- 4.6 Associations between intentional elements.....64
- 5.1 Criteria building template.....77
- 5.2 Alternative generation template.....78
- 5.3 Random indexes of reciprocal matrices.....80
- 6.1 Interviews conducted during 2017 with internal and external actors in ICOVET project.....90
- 6.2 Interviews with users and external actors in ICOVET project (2018). . . 91
- 6.3 Actors’ perceptions of major topics in ICOVET project.....92
- 6.4 Consequence analysis along the life cycle of the current system of safety clothing in EDF (internal workshop 2017).....95
- 6.5 Criteria for the evaluation of sustainable safety clothing offers.....98
- 6.6 Relative importance of the value dimensions and criteria at the beginning of life of the safety clothing system.....104
- 6.7 Relative importance of the alternatives at the beginning of life.....104
- 6.8 Relative importance of the value dimensions and criteria at the middle of life of the safety clothing system.....105
- 6.9 Relative importance of the alternatives at the middle of life.....105
- 6.10 Relative importance of the value dimensions and criteria at the end of life of the safety clothing system.....105
- 6.11 Relative importance of the alternatives at the end of life.....106

6.12	Results aggregation at the beginning of life according to decisional profi	110
6.13	Results aggregation at the middle of life according to decisional profi .	111
6.14	Results aggregation at the end of life according to decisional profi . .	111

Part I

General introduction

Chapter 1

Introduction

Contents

1.1 Research context	3
1.2 Research questions and objectives	4
1.3 Research methodology design	5
1.4 Structure of the manuscript	6
1.4.1 Part II: Theoretical Background.....	6
1.4.2 Part III: Proposal Development.....	7
1.4.3 Part IV: General conclusion.....	8

1.1 Research context

Value creation is undergoing profound transformations in current industry, going beyond economics and increasingly concerned with environmental and social aspects. In academic research, such a transformation is known as sustainable value creation (Boons and Lüdeke-Freund, 2013; Bocken et al., 2014), and can be analysed from three different levels: the firm, the supply chain and the society. Firstly, from the firm level, adopting a sustainability-oriented strategy could represent an opportunity to fit the current market trends and to get competitive advantage (Hart et al., 2003; Matinheikki et al., 2017; Brown et al., 2019). Secondly, at the supply chain level, creating sustainable value requires the entailment of collaborative relationships between the actors, seeking for sharing resources and responsibilities (Maestrini et al., 2017; Arnold, 2017). Finally, the society comprehends non-economic actors, and represents the external pressures that push companies towards sustainability-oriented practices, seeking for environment preservation and people well-being (Bocken et al., 2014; Boons and Lüdeke-Freund, 2013; Baldassarre et al., 2017).

Although the adoption of sustainable practices appears to be fundamental in today's businesses, it requires drastic transformations of the internal and external organisations of any company. For instance, companies should be able to innovate in their products, processes, and business models to achieve the triple bottom line of sustainability.

Furthermore, sustainable value creation necessitates a collaborative integration of several and heterogeneous actors, which increase the business complexity in terms of relationships management (Ballantyne et al., 2011; Baldassarre et al., 2017). Hence, the role of the company to achieve a more sustainable society is complex and powerful, since it can transform the current patterns of production and consumption.

A plethora of academic researches have treated the question of sustainable value creation drawing out some promising directions (Ueda et al., 2009; Bocken et al., 2014; Joyce and Paquin, 2016; Aquilani et al., 2018). For instance, Bocken et al. (2014) highlight the potential of product-service systems (PSS), functional economy, and circular economy as sustainable business archetypes. In the same perspective, Pieroni et al. (2019) demonstrate the existing link between circular oriented business models and the achievement of sustainable value. Other authors propose generic frameworks for the evolution of business models towards sustainability (Boons and Lüdeke-Freund, 2013; Joyce and Paquin, 2016).

Although several contributions demonstrate the importance of transforming business models towards sustainability, concrete mechanisms to achieve it are still missing. Two main challenges have been highlighted in academic research, first, it is necessary to build a consensus about the concept of sustainable value (Kaihara et al., 2018). Secondly, further research is needed to build holistic and operational methodologies for guiding companies in the pursuit of sustainability (Bocken et al., 2015). Concretely, while the economic aspect is well mastered, environmental, social, and other intangible aspects are still hardly integrated into the business mindset. Throughout this thesis, a methodological framework to support sustainable value creation has been proposed. Concretely, this work proposes first a conceptualization of sustainable value based on literature review. Then, a methodological framework to support decision-making at early development phases of innovative offers. The entire contribution is framed into a strategic perspective of collaborative relationships between industrial actors.

1.2 Research questions and objectives

The main objective of this thesis work is to guide companies in their transition towards sustainable value creation. Certainly, such a transformation impacts the organisation at internal and external levels, needing the development of new activities and skills, and entailing collaborative relationships with the external actors. As a potential answer to the challenges that a company faces, this thesis provides a methodological framework to support sustainable value creation in collaborative business innovation. The proposed framework enables the visualization of the value creation process in a collaborative context. A focus on sustainability is adopted, considering the life cycle of innovative offers development.

In this thesis, a strategic positioning is adopted with respect to value creation, rather than studying the productive processes of a company. Thus, from a strategic point of view, we analyse and model the relationships between several actors, considering

their interdependence in terms of value expectations and propositions. Furthermore, we approach the collaborative innovation process as a multi-stakeholder decisional problem, with the aim of supporting early phases of innovative offer design.

Our proposal comprehends three main axes of research, further detailed into specific questions.

Research axe 1 – Conceptualization of sustainable value creation.

- What is the nature of sustainable value in collaborative contexts?
- What are the effects of sustainability on a company, regarding value proposition, value structure and value creation?

Research axe 2 – Modelling of the collaborative innovation process.

- Who are the relevant stakeholders to integrate into collaborative innovation processes?
- What are the factors involved in collaborative relationships between several actors?
- How to align actors' value expectations?

Research axe 3– Value assessment in early phases of collaborative innovation.

- How to assess the value created within collaborative businesses considering a multidimensional and multi-actor perspective?
- How to reach a consensus between diverse actors' perspectives regarding value creation?

1.3 Research methodology design

From a methodological point of view, this research has adopted a research-intervention approach, aiming at the complementarity between theory and practice (David, 2000).

From the theoretical point of view, to answer the previous research questions, this research is based on the following frameworks:

- Based on the framework of Sustainable Business Models (SBM) (Boons and Lüdeke-Freund, 2013), we explore the triggers of sustainable innovation, and the effects on value proposition, value structure, and value creation (Orellano et al., 2018a,b).
- We propose a called value alignment framework, implemented throughout the Goal Modelling technique (GM). The aim of this proposal is to visualize the value co-creation process between several actors at early phases of offer design, considering the alignment between actors' expectations (Orellano et al., 2019a).

- We apply a multi-criteria decision approach in early phases of innovative offers design, by integrating sustainability criteria. Concretely, we propose the implementation of Analytic Hierarchy Process (AHP) to prioritize the different dimensions of value creation, considering multiple actors points of view (Orellano et al., 2019b). Then, we couple AHP with clustering techniques and stakeholder-based methodologies to facilitate the consensus process between actors.

From a practical point of view, this research is built within the frame of a French project called ICOVET (*Innovation Collaborative dans les Vêtements de Travail*, in French). The project represents an initiative of collaborative innovation applied to the supply system of safety clothing in EDF (*Electricité de France*, in French), the first producer and distributor of energy in France. The project consists in the transformation of a product-purchasing model into a service-based offer of safety clothes. The aim of the project is to manage the entire life cycle of the safety clothes, to reduce the economic expenses, and to mitigate environmental and social impacts. The three theoretical approaches, explained above, were applied to the case study, providing valuable evidence about the support of sustainable value creation in B2B contexts. From a scientific perspective, the case study contributes to enrich theory about sustainable value creation in a context of collaborative innovation.

1.4 Structure of the manuscript

The manuscript is structured in four parts (including the preliminary part I) and a total of seven chapters. Part II introduces the state of the art supporting this research, divided into three chapters. Part III presents the methodological framework proposed through this research and its application to an industrial case, comprehending chapters 5 and 6. Part IV reports the conclusions, differentiating between scientific and managerial contributions, and research perspectives.

1.4.1 Part II: Theoretical Background

Chapter 2: Characterization of sustainable value creation. This chapter presents a literature review about the concept of value creation from different disciplines along the time. The aim of the literature review is to reach a structured conceptualization of value creation regarding the current context of sustainability and business innovation. At the end of the chapter, a conceptual framework to characterise sustainable value is provided, contributing to the first research axe of this thesis work.

Chapter 3: Collaborative innovation enabling sustainable value creation in B2B relationships. The main intend of this chapter is to establish the link between collaborative innovation and the creation of sustainable value. To this end, the starting questions are why?, how? and to do what? companies collaborate in innovation

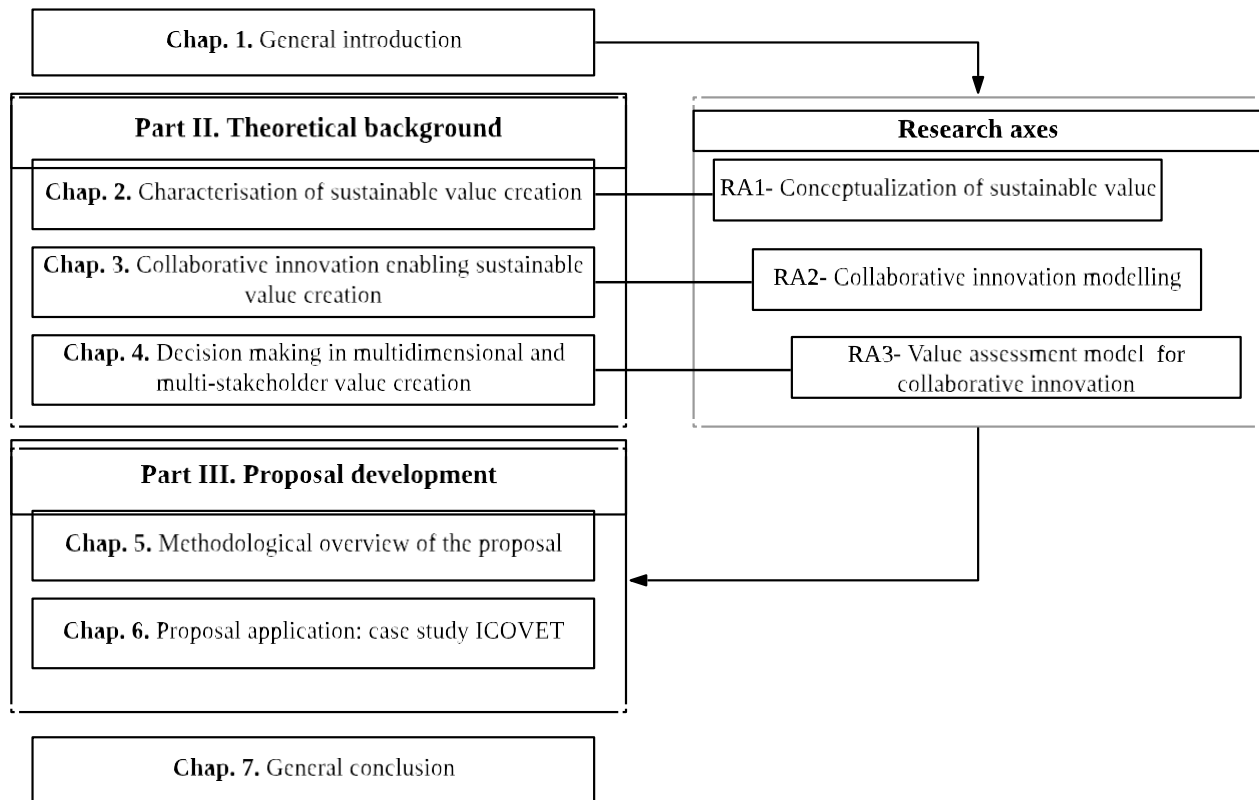

Figure 1.1: Structure of the manuscript.

development. The aim of this chapter is to identify a typology of collaborative relationships enabling sustainable value creation in innovative businesses. At the end of this chapter, the elements to analyse collaborative relationships are identified.

Chapter 4: Decision making in multidimensional and multi-stakeholder value creation. This chapter explores both system modelling and multi-criteria analysis approaches to support the process of collaborative value creation. On the one side, system modelling methods are explored to understand actors' relationships with respect to their value exchanges. On the other side, multi-criteria analysis approaches are investigated for value assessment in early stages of innovation development, considering multiple actors perspectives.

1.4.2 Part III: Proposal Development

Chapter 5: Framework to support sustainable value creation in collaborative innovation. This chapter presents the methodological proposal for the analysis and decision-making around the creation of sustainable value in collaborative businesses.

Following a step-by-step approach, the elements retained from the literature and adapted to the context of sustainable value creation are integrated into a holistic methodological framework composed by four main phases: i) value creation analysis, ii) value alignment model, iii) preference modelling, and iv) consensus process. At the end of the chapter, the robustness and reproducibility of the proposed methodology is discussed.

Chapter 6: Case study application - ICOVET project. In this chapter the methodological development of the proposal is illustrated through a real case study at EDF (*Electricité de France*, in French), a big-sized company in France. The results obtained from the proposal implementation are analysed, leading into a set of managerial implications, and perspectives for the company, pointing out its purchasing strategy.

1.4.3 Part IV: General conclusion

Chapter 7: Conclusions and research perspectives. This part outlines the main contributions of the thesis regarding the state of the art and the research question. Then, it presents the limits of the research regarding the methodological approach and the mobilised theories and methods. From the case study, the managerial implications are discussed. Finally, the uncovered topics are mentioned as research perspectives.

Part II

Theoretical background

Chapter 2

Characterisation of sustainable value creation

Contents

2.1 Introduction	11
2.2 Literature review methodology	13
2.2.1 Identification of sources.....	13
2.2.2 Selection filtering.....	14
2.2.3 Descriptive analysis.....	15
2.2.4 Content analysis.....	15
2.3 The notion of value throughout the time	17
2.3.1 Economic value	17
2.3.2 Customer value	18
2.3.3 Sustainable value.....	19
2.3.4 Multi-stakeholder value	20
2.4 Sustainable value creation in B2B markets	22
2.5 Proposed framework for the characterisation of sustainable value creation	25
2.6 Conclusion	26

2.1 Introduction

The increase of environmental and social needs demands the adoption of more sustainable practices in the industry, which should focus on the creation of value other than economic (Brown et al., 2019). For international institutions, as the United Nations, the European Union, and the World Business Council for Sustainable Development (WBCSD), the sustainability approach seeks for a trade-off between the environmental, social and economic pillars. Some companies adopt this approach in

their CSR strategy (Corporate Social Responsibility), as an opportunity to fit with the market trends and to differentiate themselves from competitors (Hart et al., 2003).

From an academic perspective, value creation is considered as the principal objective of any business activity, and it is generally addressed as both an economic and marketing issue. In economics, the definition of value is narrowly linked to the market price of products and services (Bowman and Ambrosini, 2000). Historically, the notion of value has been studied in marketing literature (Payne and Holt, 1999), which explains the strong customer orientation observed until the last decade (Eggert et al., 2006; Xing et al., 2013; Patala et al., 2016; Eggert et al., 2018). Here, value is defined as the trade-off between benefits and sacrifices perceived by the customer with respect to an offer (Eggert et al., 2006, 2018). During the 2000s, the concept of “value in use” appeared with the growing importance of the service in the global market as a source of competitiveness, focusing on the customer experience (Vargo and Lusch, 2008). Currently, businesses are evolving in accordance with the global need for sustainability, integrating economic, environmental and social objectives to their strategies (Bocken et al., 2015; Patala et al., 2016; Baldassarre et al., 2017; Hankammer and Kleer, 2018). Moreover, sustainability businesses require the integration of several stakeholders into the value creation process (Bocken et al., 2015; Lacoste, 2016; Reypens et al., 2016). The literature makes it evident that the concept of value is in constant evolution, according to the market context. Therefore, in the current industrial context, increasingly concerned with environmental and social needs, a re-conceptualization of value creation is required.

The aim of this literature review is first to analyse the evolution of the concept of value in business-to-business (B2B) relationships throughout the time; then, to characterise the value from a sustainability approach. The following research questions guide this review:

- *RQ1. How has the notion of value been approached in different research fields since 2000?*
- *RQ2. What does the notion of sustainable value mean in B2B relationships?*
- *RQ3. What are the research challenges about sustainable value creation?*

Following a systematic literature review methodology, 50 papers published after 2000 in peer-reviewed journals in the field of industrial engineering, management, marketing and environmental sciences have been analysed. Two principal features were taken into account to conduct this literature review. First, we included papers providing a conceptualization of value and a description of the value creation process. Second, we included studies addressing sustainable business models in B2B contexts. The literature analysis revealed four main categories of the conceptualization of value: economic, customer, sustainable, and multi-stakeholder value. The results were discussed and synthesized into a structured framework for sustainable value characterisation in B2B contexts. The conclusions elucidate the main directions for this research field.

2.2 Literature review methodology

To address the research questions, a systematic literature review has been conducted. Systematic literature review methodology is a replicable, scientific, and transparent process that makes it possible to retain a reliable sample of scientific publications (Maestrini et al., 2017). The research methodology has been structured in three main steps: i) identification of sources, ii) selection by inclusion criteria, and iii) descriptive and content analysis of articles. Figure 2.1 summarizes the entire process of the systematic literature review, showing the results at each stage.

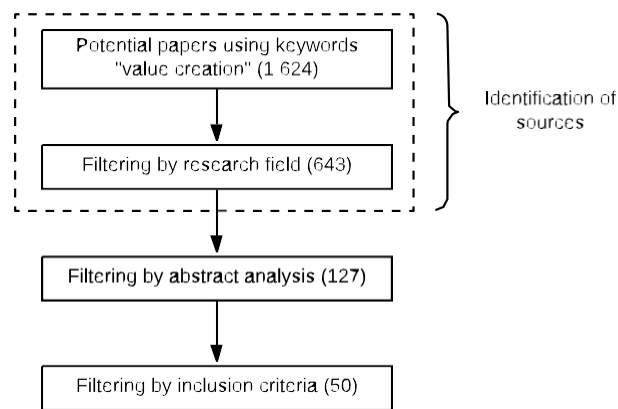

Figure 2.1: Systematic literature review methodology.

2.2.1 Identification of sources

The selected databases to perform the research were Web of Science (WOS) and Science Direct (SD). The criteria for selecting the databases were the quality of the sources based on the impact factor of the journal and the scope of research of the databases, including management, engineering and environmental sciences (Harzing and Alakangas, 2016). The research was limited to peer-reviewed papers published from 2000 to 2018, considering that from the year 2000 on, the concept of value creation has gained greatly in importance in research thanks to the emerging field of business models innovation (Chesbrough and Rosenbloom, 2002). This research was conducted through searching by "topic" in WOS and by "title, abstract and keywords" in SD. The single keyword used to start the research was "value creation" in order to address the notion of value in business and industrial contexts, further developed in the subsequent field steps. As for the results, 661 papers from WOS and 963 from SD were found, a total of 1 624 potential papers. These papers belong to the general field of engineering and management, which correspond to our scope of research. Thus, the research domains focusing on natural sciences, agriculture, operations research, tourism, finance and civil engineering were

discarded by using the filters options of the databases. Hence, 306 papers from WOS and 337 papers from SD were selected, totalling 643 papers for further analysis. Figure 2.2 shows the number of publications over time in both databases, demonstrating that the subject under study has gained in importance in research since the last decade. We obtained 27 journals from WOS and 14 from SD, with six journals overlapping in both databases. The resulting journals come from a variety of disciplines: marketing, management, environmental sciences, and operations management.

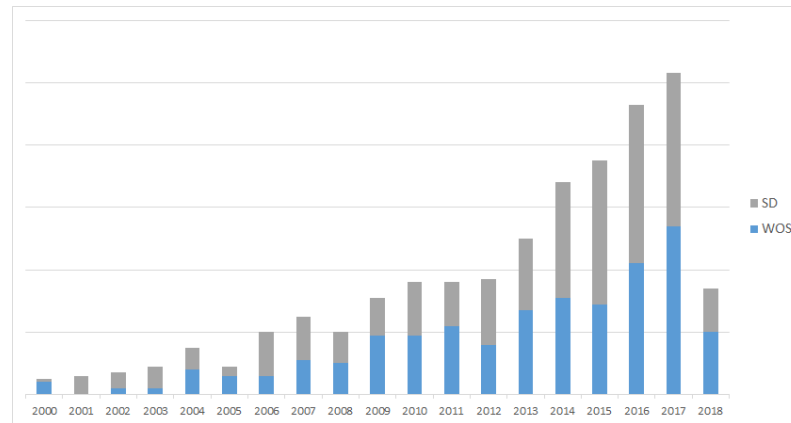

Figure 2.2: Number of publications over time using the keywords “value creation” (2000-2018).

2.2.2 Selection filtering

643 peer-reviewed papers constitute the initial sample to start the filtering process. First, the analysis of the abstract and the objectives of each article was effectuated, leading to a sample of 127 articles. The papers related exclusively to the financial definition of value (e.g., accounting) and the ones addressing the value from the production point of view (e.g., value stream mapping) were excluded. Then, the articles selection was effectuated according to two criteria of inclusion:

- **Conceptualization of value:** papers discussing the nature of the value concept from different historical contexts and disciplines.
- **Value creation process:** papers discussing the organisational configurations and drivers to enable value creation in B2B relationships.

During this step, new keywords were identified: “business models innovation”, “sustainable business models”, “value co-creation” and “sustainable value”. Accordingly, we retained some papers referring to these topics to have a broader scope of literature about value creation in relation to sustainability. Finally, 50 peer-reviewed articles were retained for further analysis.

2.2.3 Descriptive analysis

The 50 selected articles belong to 23 different international journals, classified into four research domains and according to the WOS suggested categories. Figure 2.3 illustrates the distribution of articles over time according to the research domains. The domain of marketing management focuses on customer value and represents 37% of the sample. The domain of operations, production and technology management comprehends 23% of the selected articles. This domain mainly focuses on supply chain management. The domain of management, business and economics, focusing on the strategic perspective of value creation, represents 21% of the contributions. The field of environmental sciences covers 18% of the sample, and shows a growth on the integration of sustainability issues within the value creation literature between 2014 and 2018. This domain focuses on the integration of environmental and social impacts to economic activities.

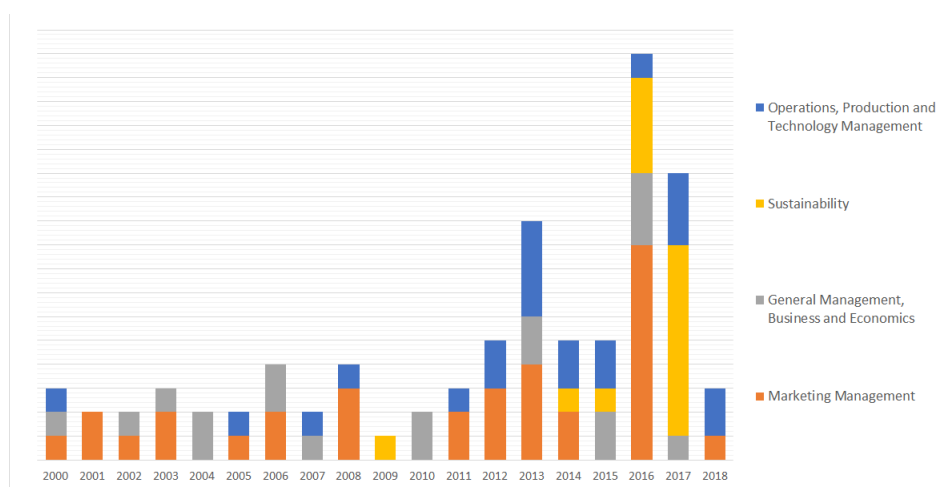

Figure 2.3: Distribution of articles on value creation according to the research domains.

2.2.4 Content analysis

Regarding the conceptualization of value, four different approaches were identified over time: Firstly, value has been studied as an economic concept (Bowman and Ambrosini, 2000). Secondly, being highly influenced by the relational marketing perspective, the concept of value has been studied in relation with the customer, known as customer value (Vargo and Lusch, 2008). Thirdly, over the last two decades, the notion of value has been addressed from a sustainability perspective, going beyond economics and integrating environmental and social aspects into its definition known as sustainable value (Hart et al., 2003). Finally, the multi-stakeholder definition of value defends the idea that value is always co-created from the interaction of several actors (Baldassarre et al., 2017). Table 2.1 lists the retained articles from the literature review, classified into the four approaches to value conceptualization.

Table 2.1: Content analysis of the selected articles on value creation.

N	Author	Journal	Conceptualization of value			
			Economic	Customer	Sustainable	Multi-stakeholder
1	Best et al. (2018)	IJOP				X
2	Kähkönen and Lintukangas (2018)	IJOP				X
3	Kaihara et al. (2018)	CIRP			X	X
4	Aquilani et al. (2018)	JCP			X	X
5	Hankammer and Kleer (2018)	JCP			X	X
6	Arnold (2017)	JCP			X	
7	Baldassarre et al. (2017)	JCP			X	X
8	Hänninen and Karjaluoto (2017)	JCP		X		
9	Yan and Wagner (2017)	IJPE				X
10	Matinheikki et al. (2017)	JCP				X
11	Yan et al. (2017)	JPSM				X
12	Volschenk et al. (2016)	IMM			X	X
13	Wang et al. (2016)	LRP				X
14	Lacoste (2016)	IMM			X	
15	Lages (2016)	JBR	X			X
16	Zacharias et al. (2016)	JBR		X		
17	Joyce and Paquin (2016)	JCP			X	X
18	Manda et al. (2016)	JCP			X	X
19	Ekman et al. (2016)	IMM				X
20	Reypens et al. (2016)	IMM				X
21	Patala et al. (2016)	IMM			X	
22	Schenkel et al. (2015)	JPSM			X	X
23	Buxel et al. (2015)	BH			X	
24	Bocken et al. (2015)	JIPE			X	X
25	Coutelle-Brillet et al. (2014)	JBIM		X		X
26	Grönroos and Voima (2013)	JAMS		X		
27	Ford and Mouzas (2013)	IMM		X		
28	Jaakkola and Hakanen (2013)	IMM				X
29	Dominguez-Péry et al. (2013)	IJPE				X
30	Xing et al. (2013)	IJPR		X	X	
31	Haas et al. (2012)	IMM	X	X		
32	Corsaro et al. (2012)	IMM	X	X		X
33	Hsieh et al. (2012)	Technov.	X			
34	Ballantyne et al. (2011)	IMM				X
35	Wagner et al. (2010)	JBR	X			
36	Westerlund and Svahn (2008)	IMM				X
37	Vargo and Lusch (2008)	JAMS		X		
38	Payne et al. (2008)	JAMS		X		
39	Kumar et al. (2007)	IJPR		X		
40	Huemer (2006)	LRP	X			
41	Eggert et al. (2006)	IMM		X		
42	Prahalad and Ramaswamy (2004)	S&L		X		
43	Harmsen and Jensen (2004)	JBR	X			
44	Hart et al. (2003)	AME		X		
45	Möller and Tönen (2003)	IMM	X			
46	Kothandaraman and Wilson (2001)	IMM		X		
47	Walter et al. (2001)	IMM	X			
48	Dumond (2000)	IJOPM		X		
49	Lapierre (2000)	JBIM		X		
50	Bowman and Ambrosini (2000)	BJM	X			

2.3 The notion of value throughout the time

2.3.1 Economic value

The seminal definition of value has its origins in classical economics theory coming into use at the end of 18th century. The value of something was defined by the amount of labour required to produce it (Bowman and Ambrosini, 2000). During the 1990's, resources management became the dominant paradigm in enterprise management. For instance, the resource-based view (RBV) motivated a more sophisticated vision of the economic value (Bowman and Ambrosini, 2000; Möller and Tönen, 2003; Huemer, 2006). In this paradigm, a valuable thing is anything that generates or economizes money, or that improves the company's efficiency. Indeed, the resources of a company are its main source of value if they are managed strategically, in a way that they provide competitive advantages. In line with the classical economic theory of value, Bowman and Ambrosini (2000) highlight that the value should be understood from two perspectives, value in exchange and value in use. The former, created during the sales-purchasing process, and the latter, during the customer consumption process. In both cases, value is defined as the marginal utility.

Besides, considering customer-supplier relationships, Walter et al. (2001) integrate non-monetary attributes to the definition of economic value, as market positioning and competitiveness. In this logic, the authors define economic value from the supplier perspective as a function of customer-supplier relationships. Here, the economic value for a supplier depends on how much a customer is profitable in terms of purchasing volume, cash-flow, and loyalty (Walter et al., 2001). Several authors agree that supplier's value depends on having good relationships with the customers (Möller and Tönen, 2003; Wagner et al., 2010; Hsieh et al., 2012; Corsaro et al., 2012; Haas et al., 2012; Lages, 2016). Nevertheless, the supplier potential of value creation also depends on internal drivers, for instance, price level, efficient processes, diversity of the customer portfolio, innovation capabilities, access to resources, and market positioning. For instance, Harmsen and Jensen (2004), demonstrate throughout an empirical study, that economic value creation depends on the company's flexibility to fit market changes, and to rapidly develop new products and skills. Besides, Lages (2016) considers that economic value results from the ability of a company to capture new customers throughout business model innovation. Finally, for Corsaro et al. (2012) and Haas et al. (2012) economic value not only depends on the provider understanding of the customer behaviour, but it is created only by integrating resources, activities and knowledge with the customer. These authors observe value as the result of a mirror process, in which the value is created for the provider as for the customer simultaneously.

In conclusion, from the economic perspective, value can be characterised as market value and fit value, and it depends on the level of knowledge a supplier company has about its customers. Market value corresponds to the profit generated from innovation and ability to fit market trends; while fit value concerns the utility margins generated from the routine company's sales. Economic value is created by the

provider through a transactional relationship between the provider and the customer. Afterwards, with the evolution of services in the early 2000s', a strong customer orientation was adopted by the companies, introducing the idea that value is a subjective construction depending on the customer perception (Eggert et al., 2006, 2018). This research stream focused on the customer, represents a counterpart of the supplier orientation, which is predominant in the conceptualization of economic value.

2.3.2 Customervalue

With the increase of market competitiveness, the concept of value evolved, integrating the perception of the customer in its definition. In marketing, value has been strongly studied from the customer perspective, known as customer value, which constitutes a research priority in this field (Kothandaraman and Wilson, 2001; Eggert et al., 2006; Westerlund and Svahn, 2008; Corsaro et al., 2012; Haas et al., 2012; Coutelle-Brillet et al., 2014; Eggert et al., 2018). Two streams of customer value were identified through the literature review, one from the marketing perspective, and the other one influenced by service development theories.

Firstly, the marketing literature defines customer value as the trade-off between customer's perceived benefits and sacrifices associated to an offer purchasing (Dumond, 2000; Kothandaraman and Wilson, 2001; Eggert et al., 2006; Hänninen and Karjaluoto, 2017; Eggert et al., 2018). According to this definition, the value created by any business is subjectively perceived by the customer rather than objectively defined by the seller. In this logic, value creation depends narrowly on the attributes of the offer that provides customer satisfaction, for instance, the product quality, the level of customization and the responsiveness of the provider company (Lapierre, 2000; Prahalad and Ramaswamy, 2004). Nevertheless, some researchers in marketing consider that this vision does not capture the full meaning of customer value, and need to be further developed. For instance, Coutelle-Brillet et al. (2014) evoke the idea that value is characterised by several intangible dimensions, as efficiency, emotions, and altruism. In the same perspective, Ford and Mouzas (2013) sustain that customer value results from the aggregation of psychological, functional, and economics benefits perceived by the customer. Hänninen and Karjaluoto (2017) propose a characterisation of customer value by a set of technical, economic, social, and image benefits. Considering the idea of the multidimensionality of value, Hänninen and Karjaluoto (2017) highlight the importance of defining customer criteria to measure the level of value obtained from a business transaction.

Secondly, with the emergence of Service-Dominant Logic (SDL) proposed by Vargo and Lusch (2008), the definition of customer value was influenced by the relational nature of services. In this context, the main source of value is the knowledge generated from the interaction between the customer and the provider instead of the transactional exchange (Payne et al., 2008; Grönroos and Voima, 2013; Ballantyne et al., 2011; Ekman et al., 2016). SDL reinforced the idea of "value in use", claiming that any form of value is exclusively created by the customer during the consumption process (Vargo and

Lusch, 2008; Grönroos and Voima, 2013; Ekman et al., 2016). From this perspective, the main challenge for companies is meeting several customers' value expectations through customized value propositions (Ballantyne et al., 2011; Zacharias et al., 2016).

To summarize, customer value is based on marketing and service development literature. From these perspectives, the value created by any offer is an individual and cognitive construction of the customer, and takes place during the consumption process. The value depends on the set of attributes of an offer, observed by customers with respect to their own needs, and comparing with similar offers in the market. From this vision, three fundamental characteristics define the notion of value: subjectivity, multidimensionality and competition (Eggert et al., 2006, 2018).

2.3.3 Sustainable value

With the influence of marketing research, the idea of value multidimensionality opened new debates about the conceptualization and assessment of value. Besides, the global challenges, including climate change, resource depletion and extreme poverty, have pushed the industrial transformation towards the consideration of environmental and social benefits in their business strategies (Bocken et al., 2015; Buxel et al., 2015; Schenkel et al., 2015; Patala et al., 2016; Ekman et al., 2016; Manda et al., 2016; Aquilani et al., 2018). This panorama triggered a re-definition of the concept of value regarding the sustainability issues.

In general, sustainable value is defined as the simultaneous creation of economic, environmental and social benefits from a business activity (Bocken et al., 2015). Nevertheless, a plethora of authors still consider that the major challenge regarding sustainable value is achieving a clear conceptualization. For instance, Bocken et al. (2015) propose a mapping tool that describes economic, environmental and social dimensions of value in terms of value destroyed and value opportunities for different actors. Besides, Schenkel et al. (2015) determine some strategic factors of success to achieve sustainable value. Finally, Volschenk et al. (2016) consider that sustainable value supposes the integration of several actors, therefore, a knowledge dimension should be considered for its characterisation. In spite of the conceptual effort verified in the literature, there is not a clear consensus between the authors about the concept of sustainable value. Furthermore, the authors point out the need for formal methods to assess the sustainable value created by a company (Schenkel et al., 2015; Kaihara et al., 2018). In the literature, two main streams to assess sustainable value have been identified.

Firstly, from a compensatory vision, the three dimensions of sustainable value are considered interchangeable (known as Triple Bottom Line or weak sustainability) (Pope et al., 2004; Patala et al., 2016). In this case, the degradation of one dimension is considered acceptable since it is compensated by the improvement on another one. From this approach, sustainable value creation is often translated into monetary benefits. For instance, Hart et al. (2003) propose a strategic framework to improve sustainable value in companies by implementing technology innovation, waste reduction strategies, and

stakeholders integration. Besides, [Patala et al. \(2016\)](#) propose a monetisation-based method that translates economic, environmental and social benefits and impacts, into economic gains, expenses and financial risks. Although monetisation-based methods are attractive for business decisions, some metrics can be selected arbitrary (e.g., price per Kg. of CO_2), which could provide unrealistic results. Moreover, these kind of approaches has been largely criticised since they focus on avoiding non-sustainability and extra-costs, rather than on researching real sustainable solutions ([Pope et al., 2004](#)).

Secondly, non-compensatory approaches defend a clear multidimensional concept of sustainable value, rejecting any monetisation approach (for instance eco-efficiency and societal approaches) ([Pope et al., 2004](#); [Vezzoli et al., 2014](#)). In this line, [Xing et al. \(2013\)](#) propose a coupling of different methods to evaluate efficiency, costs and environmental impacts derived from an offer development in an independent way. Besides, [Buxel et al. \(2015\)](#) and [Manda et al. \(2016\)](#) propose the implementation of Life Cycle Assessment (LCA) to determine the sustainable value procured by a given offer expressed in terms of environmental quality. In general, non-compensatory approaches aim at confronting the economic mind-set of the industry with the urgency of the environmental and social needs, encouraging a reliable adoption of sustainable practices ([Lacoste, 2016](#)). Nevertheless, these authors point out the complexity of conducting a proper assessment of sustainable value, given the heterogeneity of the metrics, the involvement of non-tangible attributes (e.g., social well-being), the difficulty to collect reliable data (e.g., biodiversity degradation), the context dependency of the results (e.g., resource depletion, employment, society growth, among others). Particularly, LCA-based methods are very time-consuming and data-intensive, not always suitable to be implemented for guiding business decisions ([Manda et al., 2016](#)).

An important aspect highlighted in recent literature on sustainable value creation is the need for collaboration between a broader set of stakeholders ([Reypens et al., 2016](#)). Therefore, sustainable value is not only a multidimensional concern, but also implies multiple stakeholders ([Ekman et al., 2016](#)). For companies, creating sustainable value represents a source of competitiveness, being an opportunity to improve the company's reputation. From the academic point of view, a clear definition of sustainable value creation, and the development of value assessment methods constitute important research streams in management and engineering fields ([Xing et al., 2013](#); [Ueda et al., 2009](#); [Kaihara et al., 2018](#)).

2.3.4 Multi-stakeholder value

Recent literature evidences that sustainable value creation requires including relevant stakeholders, who are different from the customer and the provider ([Ballantyne et al., 2011](#); [Bocken et al., 2015](#); [Reypens et al., 2016](#); [Lacoste, 2016](#); [Joyce and Paquin, 2016](#); [Baldassarre et al., 2017](#); [Hankammer and Kleer, 2018](#); [Aquilani et al., 2018](#); [Best et al., 2018](#)). As cited by [Aquilani et al. \(2018\)](#), sustainable value is always co-created with actors inside and outside a company's boundaries, and should be equitably appropriated by all the stakeholders. Moreover, [Ballantyne et al. \(2011\)](#) and [Eggert et al. \(2018\)](#) suggest

that a company co-develops value propositions with its external partners envisioning a reciprocal and fair exchange of the value created. Here, each actor determines what value is in its own terms. The term “reciprocal” evokes the collaborative character of value creation, and the term “fair” is associated with the symmetry in the distribution of value between the different actors concerned. Two main knowledge streams have studied the notion of multi-stakeholder value, the resource-based view (RBV) and the relational marketing.

On the one side, from RBV perspective, value in relationships is determined by the access to new resources, which include knowledge, experience, and skills (Westerlund and Svahn, 2008; Jaakkola and Hakanen, 2013; Kähkönen and Lintukangas, 2018). Moreover, value creation takes place during creative interaction processes, which allows developing new products, services or more sophisticated knowledge. Dominguez-Péry et al. (2013) evoke the necessity of inter-organisational relationships to achieve tangible and intangible forms of value, for instance, the access to new physical and financial assets, human capital, knowledge, brand image, and market position. Besides, Schenkel et al. (2015) name the value created from stakeholders interaction as informational value, which is defined as the ability to learn and to collect and share information throughout the supply chain. For the authors, informational value can enable the acquisition of other types of value (e.g., economic, environmental, social) (Schenkel et al., 2015).

On the other side, from the relational marketing perspective, each stakeholder represents a social actor, whose relationships are influenced by power interdependencies (Reypens et al., 2016). In this literature stream, relationships are a means to achieve some sort of value and not a value itself (Coutelle-Brillet et al., 2014; Reypens et al., 2016; Arnold, 2017). Coutelle-Brillet et al. (2014) distinguish four value dimensions created from multiple actors interactions, named as efficiency, social, emotional and ethical. Similarly, Reypens et al. (2016) consider relationships as a means to achieve innovation, knowledge and relational outcomes. The first can be translated into process improvement, the second one into technological and managerial improvements, and the last one into powerful positioning. In contrast, Ekman et al. (2016) conducted an empirical study, finding that relationships are considered as a form of value by itself, known in industry as brand value.

In general, both RBV and relational marketing perspectives consider multi-stakeholder value mostly as a means than as an objective itself. One of the biggest challenges on multi-stakeholder value creation in B2B markets is to guarantee the reciprocity and fairness in the value distribution among the actors (Reypens et al., 2016; Aquilani et al., 2018). Although there exist several frameworks in the literature addressing this research question, there is not proper measurement mechanisms to operationalize them. Under this panorama, current research should be oriented to propose collaborative mechanisms to create, assess and distribute value in multi-actor relationships.

Table 2.2 summarizes the results obtained from the literature review, highlighting the evolution of the value concept in relation to the context, the value drivers, the mobilised theories, and the kinds of relationships between the involved actors.

Table 2.2: Evolution of the research on value creation.

	Economic value	Customer value	Sustainable value	Multi-stakeholder value
Representative research	Bowman and Ambrosini (2000)	Vargo and Lusch (2008)	Hart et al. (2003)	Reypens et al. (2016)
Industrial context	Mass production	Service development	Circular economy	Open innovation
Value driver	Utility margin	Customer satisfaction	Resource efficiency	Knowledge
Actors' Relationships	Transactional Economic theory of value	Dyadic co-creation	Networked co-creation	Networked co-creation
Mobilised Theories	Resource-based view (RBV)	Service-Dominant Logic (SDL)	Strong and weak sustainability	Stakeholder theory

2.4 Sustainable value creation in B2B markets

Value creation process. Past research, in economic and marketing fields considered the value creation as a delivery activity from the provider to the customer (Bowman and Ambrosini, 2000; Eggert et al., 2006). Currently, two main approaches to value creation are observed in the industry from the process perspective: the dyadic co-creation between the provider and the customer, and the networked collaboration. In dyadic value co-creation processes, value is classified into value in exchange and value in use (Vargo and Lusch, 2008). From the perspective of the value in exchange, the provider creates value in monetary terms. Value in use, in contrast, is associated to the customer perception according to the fulfilment of its needs during the use phase, translated into customer satisfaction. According to the Service-Dominant Logic, figure 2.4 illustrates the process of value co-creation from a dyadic relationship between provider and customer.

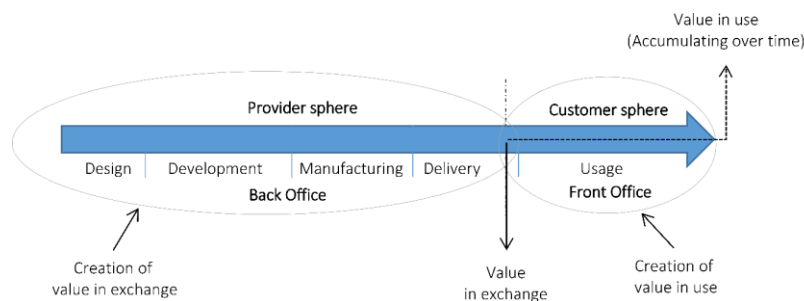

Figure 2.4: Value co-creation process according to Service-Dominant Logic (SDL) (Vargo and Lusch, 2008)

In current business configurations, value is created and perceived by a networked set of actors, and not only by dyadic provider-customer relationships (Corsaro et al., 2012; Reypens et al., 2016; Aquilani et al., 2018). Actually, Integrating sustainability within a company's value creation process, needs the participation of economic and non-economic

actors (i.e., suppliers, public actors, research entities, local communities, customers, among others), triggering the organizational transformation of the company (Schenkel et al., 2015; Joyce and Paquin, 2016; Lacoste, 2016; Geissdoerfer et al., 2017; Baldassarre et al., 2017). The level of sustainability achieved is conditioned by the engagement of each individual stakeholder, who evaluates differently the importance of environmental and social issues within the process of value creation (Ballantyne et al., 2011; Schenkel et al., 2015; Baldassarre et al., 2017; Aquilani et al., 2018). Moreover, multiple stakeholder integration takes place at different levels, enabling different configurations of the value creation process (Schenkel et al., 2015; Jaakkola and Hakanen, 2013; Lacoste, 2016). For instance, demand and supply networks (Yan et al., 2017) (figure 2.5); and business ecosystems (Bocken et al., 2015) (figure 2.6).

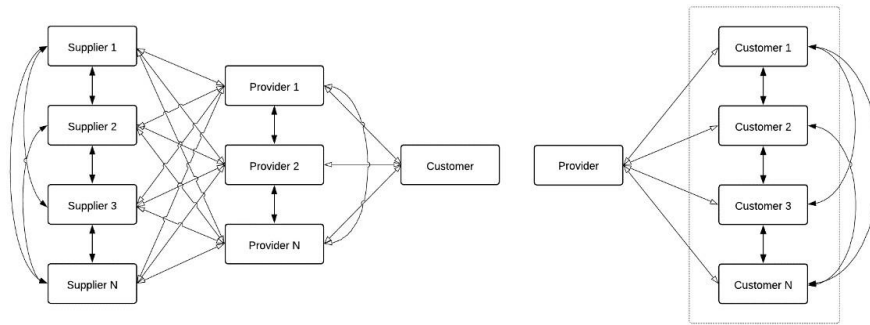

Figure 2.5: Value creation configuration: supplier network (left) and demand network (right).

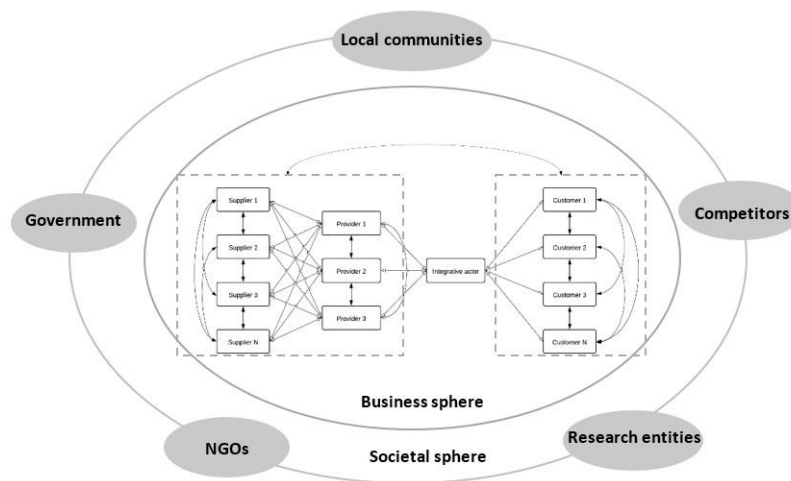

Figure 2.6: Value creation configuration: business ecosystem.

Sustainable value propositions development. Sustainable value propositions refer to offers of products or services, which are designed by for the reduction of resource consumption, emissions to the environment, and human damage (Manda et al., 2016). Although there is not a standard pathway to develop sustainable value propositions, the literature proposes various sustainability-oriented solutions such as product-service systems, functional economy, circular economy, industrial symbiosis, among others (Bocken et al., 2014). Several studies focused on the value proposition as the core element on the business exchange (Wang et al., 2016; Ballantyne et al., 2011; Lacoste, 2016). To develop sustainable value proposition, suppliers should collaborate with their customers, involving them into the different stages of the offer development. The offer co-development favours knowledge sharing, and the monitoring of the offer performance during the use phase.

Relational ambiguities in value creation. Taking into account the need for collaboration between several actors, the systematic review revealed the risk of relational ambiguities in value co-creation processes. The greater the number of stakeholders, the greater the risk of relational ambiguities and misunderstandings of individual expectations (Ballantyne et al., 2011). Sjödin et al. (2016) propose a set of relational ambiguities that can occur when sharing sensitive information and resources in an intensive relational context. These ambiguities can render the value co-creation process difficult. Such ambiguities can involve some subsequent relational risks, namely, opportunistic behaviours and conflicts of interest, which can affect the stability of the relationships. To reduce the risk of conflict and ambiguity, Kohtamäki and Rajala (2016) propose establishing the roles and the relational governance between actors before the start of the value co-creation process. In this regard, in a multi-stakeholder context, value creation becomes a question of trust between actors, depending on the ethics each actor (Coutelle-Brillet et al., 2014; Reypens et al., 2016).

2.5 Proposed framework for the characterisation of sustainable value creation

Considering the literature background, sustainable value is mainly constituted by the three classical dimensions contained into the triple bottom line approach to sustainability (i.e., economic, environmental, and social dimensions). Nevertheless, the value in sustainable oriented businesses also integrates a relational dimension. This fourth dimension is a fundamental element to access to resources and knowledge from the different key stakeholders concerned with sustainability. Additionally, integrating the marketing and engineering perspectives of value, the main intend of a business activity is creating value to their customers. Certainly, customer value is achieved throughout the provision of functionalities that fit the customer expectations. Considering the above, five dimensions have been proposed to characterize the creation of sustainable value in current business models.

- (E) Economics:** this dimension of value is determined by the benefits and cost savings achieved by the stakeholders involved in the offer development. Achieving the expected economic benefits involves integration of different risks, uncertainties and return on investments in long-term horizons.
- (N) Environmental:** this dimension explains the environmental impact of an offer throughout its life cycle. There is the need to perform an input-output analysis of the offer during its life cycle. Input analysis addresses resource consumption, while output analysis addresses emissions of substances to the environment (air, soil, water, biodiversity).
- (S) Social :** explains the impact of an offer on the well-being of the economic and non-economic stakeholders. The social value is defined in terms of respect for the human rights, dignify employment conditions, and development of local economies.
- (R) Relational:** this dimension explains the value derived from the relationships maintained between the actors, going beyond a simple monetary transaction, and which are based on the level of trust and commitment. The value is derived from the quality of the relationships between the actors, enabling the common construction of knowledge.
- (F) Functional:** this dimension focuses on the functional purpose of the offering, that is, the provision of product and service functionalities that meet the customer needs.

2.6 Conclusion

This chapter presented a review of the value concept in business-to-business (B2B) relationships as a multidisciplinary subject, which has evolved over time. We conduct a content analysis of 50 papers published between 2000 and 2018. Three principal features about the concept of the value. Firstly, value is a multidimensional concept, involving economic, environmental, social and other forms of value as knowledge and customer satisfaction. Secondly, achieving sustainable value needs a close collaboration between a broaden set of actors in the value chain. Thirdly, one of the main underpinnings of the multi-stakeholder context is the subjective character of value. Regarding the research questions proposed at the beginning of the chapter, the findings can be detailed as follows:

- *RQ1. How has the notion of value been approached in different fields since 2000?* The subject of value creation has been studied mostly in marketing and operations management literature, in which value is an important topic of research, since the 1990s. Moreover, over the last five years, the literature on value creation has integrated issues concerning sustainability and actors' collaboration as research priorities.
- *RQ2. What does the notion of sustainable value mean in B2B relationships?* Value creation in B2B relationships continues to be an area of relevance and interest to academics and practitioners. Recent studies recognize the multi-dimensional character of the value and the need for multi-stakeholder participation in the value creation process. Recently, researches in industrial marketing adopted the triple bottom line approach, integrating economic, environmental, and social dimensions to assess sustainable value. Through the thematic analysis, we concluded that the notion of value is multidimensional, subjective and contextual. Then, we proposed an extended characterization of the value concept according to five dimensions: economic, environmental, social, relational and functional (section 2.5).
- *RQ3. What are the research challenges about sustainable value creation?* Current literature demonstrates that the main challenge on value research is to define formal frameworks that make it possible to perceive, evaluate and communicate value among a broader set of stakeholders. In this sense, this thesis work aims at contributing to this challenge, integrating multidimensional and multi-stakeholder perspective of value creation. In this chapter, the conceptualization of value has been treated, providing a five scheme to characterise value creation.

Chapter 3

Collaborative innovation for sustainable value creation

Contents

3.1 Introduction	28
3.2 Literature review methodology	28
3.2.1 Sources identification.....	29
3.2.2 Conceptual structure.....	29
3.2.3 Thematic analysis.....	30
3.3 Collaborative innovation: key concepts	34
3.4 Triggers of collaborative innovation (why?)	35
3.4.1 Technology-push approach	35
3.4.2 Demand-pull approach	35
3.5 Types of innovation (what?)	36
3.5.1 According to the innovation object.....	36
3.5.2 According to the innovation strategy	37
3.5.3 According to the degree of collaboration.....	37
3.6 Collaborative innovation in today's business to business relationships (how?)	39
3.6.1 The requisites for successful collaborative innovation .	39
3.6.2 The process of collaborative innovation.....	41
3.6.3 Collaborative innovation and sustainable value creation in the supply chain	42
3.7 Conclusions	43

3.1 Introduction

According to the literature, any company has the sufficient skills to fulfil by its own the current market requirements related to sustainability issues (Rohrbeck et al., 2013; Hellström et al., 2015; Baldassarre et al., 2017; Aquilani et al., 2018; Hankammer and Kleer, 2018; Brehmer et al., 2018; Brown et al., 2019). In this sense, companies are pushed to collaborate with other actors in the business ecosystem (i.e., customers, suppliers, competitors, research institutions, among others) to develop competent and sustainable value offers (Chesbrough, 2007; Geum et al., 2013; Baldassarre et al., 2017; Jugend et al., 2018). However, the collaboration between multiple actors is a complex process that implies the understanding of actors' expectations, the efficient management of the relationships, and setting up collaborative decision-making processes (Ueda et al., 2009). Indeed, collaboration between several actors goes beyond of simply putting resources together, instead, it refers to the co-creation of value thought strategic alignment (Chester Goduscheit and Faullant, 2018; Grimm et al., 2014; Nudurupati et al., 2015; Kohtamäki and Rajala, 2016; Baldassarre et al., 2017; Brown et al., 2019). One of the main objectives of multiple actors collaboration is the development of unique innovations, achieved through the strategic combination of resources and knowledge (Neutzling et al., 2017). Such innovations are key drivers in the creation of sustainable value (Neutzling et al., 2017; Calabrese et al., 2018; Brown et al., 2019).

The objective of this chapter is to show and analyse the link between collaboration and sustainable value creation throughout the lens of innovation in B2B contexts. To fulfil this aim, the research questions guiding this chapter are the following:

- *RQ1. Why do companies collaborate in B2B?*
- *RQ2. What is the meaning of collaborative innovation in B2B?*
- *RQ3. How do companies collaborate in B2B?*
- *RQ4. How does collaboration enable the creation of sustainable value in B2B?*

3.2 Literature review methodology

A bibliometric analysis was conducted to identify the linkage points between different disciplines of the literature with respect to a specific research subject (Geissdoerfer et al., 2017). Moreover, this methodology allows representing the conceptual evolution of the subject, facilitating the identification of the current research interests and gaps (Aria and Cuccurullo, 2017). The aim of this research is to identify papers related to collaborative innovation as a driver of sustainable value creation. We performed the research methodology following three main phases: i) sources identification, ii) conceptual structure representation, and iii) thematic analysis. The research framework used to structure the literature review is represented in Figure 3.1. The figure

illustrates the two triggers for adopting a collaborative approach in companies (technology-push and demand-pull). Then, the aim of the collaborative process is to perform a type of innovation, necessary for achieving sustainable value creation.

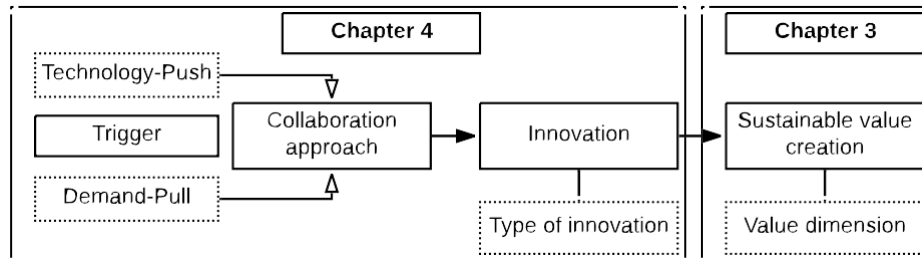

Figure 3.1: Research design framework.

3.2.1 Sources identification

Following a classic methodology of literature review, we performed a research by generic keywords in the field of interest. We crossed the key words “collab*” AND “innovat*” AND “sustainab*” in Web of Sciences (WOS). We obtained a first sample of 1 813 papers published between 1975 and 2019. We filtered the contributions, choosing only peer-reviewed journals, then reducing the sample to 944 papers. We excluded all the papers corresponding to the field of art, ergonomics, archaeology, chemistry, and biology. As a result, we obtained a sample of 291 contributions corresponding to engineering, environmental sciences, and management, which are in line with the scope of this research.

3.2.2 Conceptual structure

With the base of the pre-selected 291 articles, a clustering technique based on Multiple Correspondence Analysis (MCA) of the articles’ keywords was performed. The results lead to the representation of the conceptual structure of the research subject (Aria and Cuccurullo, 2017). This analysis was performed using the package *bibliometrix* in *R Studio* developed by Aria and Cuccurullo (2017). Five clusters were identified, corresponding to different topic areas in which the subjects of collaboration, innovation and sustainability have been studied together between 1975 and 2019 (Figure 3.2). C1 is related to the strong sustainability approach, characterised by an ecological and normative perspective. C2 corresponds to the topic of sustainable development through organisational innovation and networking. C3 corresponds to product innovation development as a means to improve firm competitive advantage. C4 refers to the role of R&D in the improvement of technological innovation. Finally, C5 corresponds to the collaborative practices implemented in supply chain management. Regarding the conceptual structure of the subject, the clusters C2 and C5 are selected for further

analysis in this chapter, since they consider the notion of collaboration from an organisational point of view. The three remaining clusters are considered out of our research scope. This process resulted in 40 articles, in which 35 correspond original researches and five are literature reviews in innovation management (Di Stefano et al., 2012; West and Bogers, 2016; Edwards-Schachter, 2018), value creation (Kaihara et al., 2018), and supply chain collaboration (Chen et al., 2017).

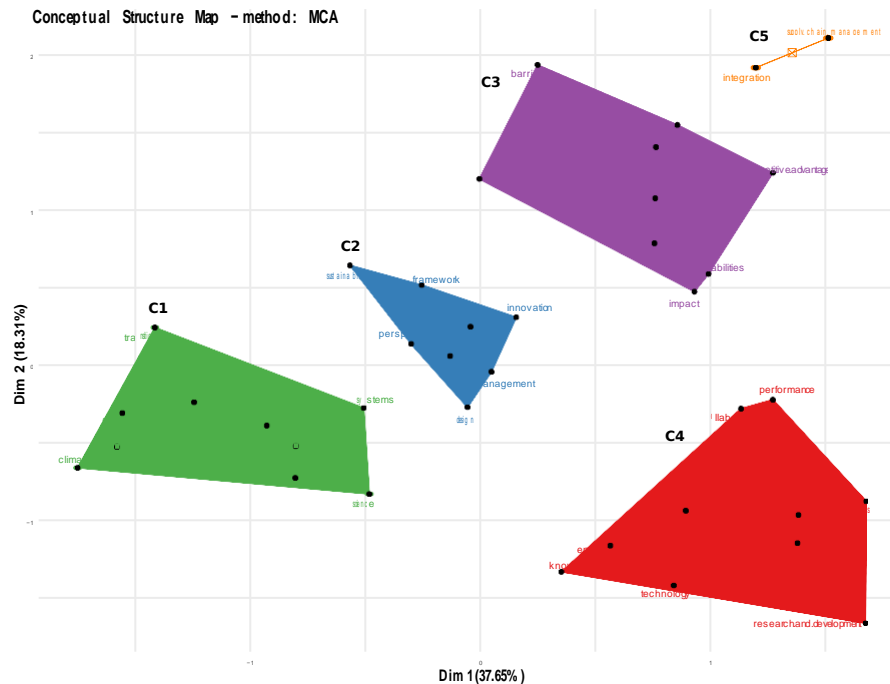

Figure 3.2: Cluster analysis of the scientific research in collaboration, innovation and sustainability (between 1975 and 2019).

3.2.3 Thematic analysis

A thematic analysis of the selected sample was performed. A co-word analysis was performed by means of the *bibliometrix* package in *R Studio* (Aria and Cuccurullo, 2017). This technique allows representing a thematic map of the selected papers (Figure 3.3). The thematic map allows classifying the articles according to the two dimensions of centrality and density, resulting in four quadrants of characterisation. The interpretation of each quadrant is as follows: i) upper-right quadrant indicates the motor-themes; ii) lower-right quadrant refers to the basic themes; iii) lower-left quadrant contains the emerging or disappearing themes; and iv) upper-left quadrant covers the very specialized themes (Cobo et al., 2011). Five clusters were obtained, indicating different themes or research fields: Value creation, collaboration networks, innovation management, supply chain integration and sustainable oriented innovation.

Given the conceptual proximity of the themes of value creation and collaborative networks, we decided to consider them as a single theme. We obtained 37% of the articles addressing value creation and collaborative business models, which are considered basic themes in the research on collaborative innovation for sustainability (Payne et al., 2008; Rohrbeck et al., 2013; Hallikas et al., 2014; Hellström et al., 2015; Kohtamäki and Rajala, 2016; Matinheikki et al., 2017; Hankammer and Kleer, 2018; Brehmer et al., 2018). 26% of the contributions belongs to the field of innovation management, which is a motor theme (Huizingh, 2011; Shaw and Burgess, 2013; Geum et al., 2013; Maine et al., 2014; Lancker et al., 2016; Chester Goduscheit and Faullant, 2018; Jugend et al., 2018). 26% of the articles addresses the collaborative practices in supply chain management, which is a specialized theme (Schiele, 2006; Walker and Preuss, 2008; Derrouiche et al., 2010; Kang and Kang, 2014; Nudurupati et al., 2015; Wang et al., 2016). Finally, Sustainable-Oriented Innovation (SOI) is an emerging theme constituting the 11% of the total of analysed articles (Hellström, 2007; Neutzling et al., 2017; Calabrese et al., 2018; Brown et al., 2019). A detailed content analysis of the articles was performed to obtain more precise insights about the relationship between collaborative innovation and sustainable value creation. Table 3.1 shows the list of the articles classified by theme, specifying the elements of collaborative innovation (i.e., trigger, collaboration approach, and innovation object), which impact on the dimensions of value creation (c.f., Chapter 2) indicated by “X”. The results obtained are developed in the next sections.

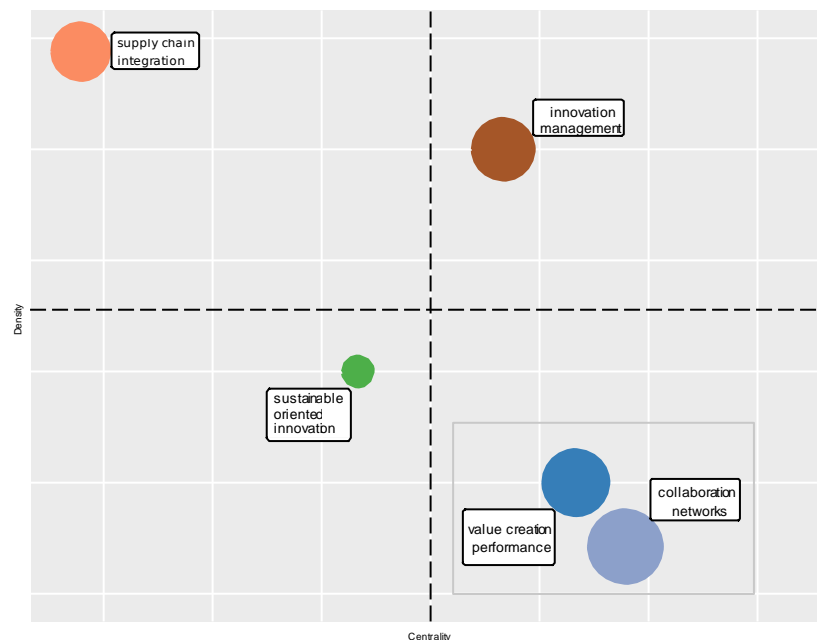

Figure 3.3: Thematic map of the selected articles.

Table 3.1: Content analysis of the selected articles.

N	Theme / Author	Journal	Approach	Trigger		Innov. type	Collaboration approach	Value creation				
				TP	DP			Econ.	Env.	Soc.	Rel.	Func.
Supply chain management												
1	Schiele (2006)	<i>IMM</i>	New product development Resource-based view	X		Offer	Dyadic collaboration	X			X	X
2	Walker and Preuss (2008)	<i>JCP</i>	CSR		X	Organisation Offer	Public-NGO partnership	X	X	X		
3	Derrouiche et al. (2010)	<i>PPC</i>	Supply chain integration	X		Organisation	Dyadic collaboration Supply chain	X			X	X
4	Seuring and Gold (2013)	<i>JCP</i>	Triple bottom line	X		Organisation	partnership	X	X	X		
5	Kang and Kang (2014)	<i>JPIM</i>	Service innovation Theory of CSF		X	Offer	Joint development	X			X	X
6	Grimm et al. (2014)	<i>IJPE</i>	Stakeholder theory		X	Organisation Offer	Dyadic collaboration	X	X	X		
7	Nudurupati et al. (2015)	<i>IJPE</i>	Stakeholder theory		X	Organisation Offer	Intermediated value network	X			X	X
8	Wang et al. (2016)	<i>LRP</i>	Resource-based view	X		Organisation	Collaborative value network	X			X	X
9	Yan et al. (2017)	<i>JPSM</i>	Resource-based view		X	Organisation Offer	Supplier innovation network				X	X
Innovation management												
10	Huizingh (2011)	<i>Technov.</i>	Open innovation	X		Organisation	Intermediated value network	X			X	X
11	Hsieh et al. (2012)	<i>Technov.</i>	Service dominant logic Resource-based view Performance management	X		Offer	Service cluster	X			X	X
12	Shaw and Burgess (2012)	<i>PPC</i>	Open innovation management	X		Process Offer Process	Inter-organisational network	X	X			X
13	Geum et al. (2013)	<i>JETM</i>	Open innovation	X		Offer	Inter-organisational R&D collaboration inter-organisational R&D collaboration	X			X	X
14	Maine et al. (2014)	<i>JETM</i>	Open innovation Resource-based view Stakeholder theory	X		Process Offer	Inter-organisational R&D collaboration	X				X
15	Lancker et al. (2016)	<i>Technov.</i>	Open innovation Service dominant logic	X		Organisation	Innovation network	X			X	X
16	Chester Goduscheit and Faullant (2018)	<i>JPIM</i>	Open innovation Service dominant logic	X		Organisation	Value network	X				X
17	Jugend et al. (2018)	<i>Technov.</i>	Open innovation	X	X	Organisation	Public-private partnership				X	
18	Schweizer and He (2018)	<i>Drug Disc. Tod.</i>	Open innovation	X		Organisation Offer	Innovation networks				X	X

(Continuation Table 3.1)

N	Theme / Author	Journal	Approach	Trigger		Innov. type	Collaboration approach	Value creation				
				TP	DP			Econ.	Env.	Soc.	Rel.	Func.
Value creation												
19	Payne et al. (2008)	<i>JAMS</i>	Service dominant logic	X		Organisation	Co-creation with the customer				X	
20	Ueda et al. (2009)	<i>CIRP Ann.</i>	Theory of externalities Complex systems	X		Organisation Offer	Co-creation with the customer	X	X	X	X	X
21	Romero and Molina (2011)	<i>PPC</i>	CSR Network theory	X		Organisation Offer	Networked organisations Virtual communities Collaborative business	X	X		X	X
22	Rohrbeck et al. (2013)	<i>IJTM</i>	BMI		X	Organisation	model	X	X	X		
23	Hallikas et al. (2014)	<i>IJPE</i>	Service dominant logic		X	Organisation Offer	Intermediated value network	X			X	X
24	Hellström et al. (2015)	<i>JCP</i>	BMI	X		Organisation Offer	Industrial and innovation ecosystem	X	X	X	X	
25	Kohtamäki and Rajala (2016)	<i>IMM</i>	Service dominant logic	X		Offer	Co-creation with the customer	X			X	X
26	Volschenk et al. (2016)	<i>IMM</i>	Stakeholder theory	X		Organisation	Coopetition	X	X	X	X	
27	Reypens et al. (2016)	<i>IMM</i>	Resource-based view Stakeholder theory	X		Organisation Offer	Public-private partnership Industrial clusters				X	
28	Matinheikki et al. (2017)	<i>JCP</i>	Shared value CSR		X	Organisation	Public-private partnership	X		X		
29	Hankammer and Kleer (2018)	<i>JCP</i>	BMI	X		Organisation Process	Crowd-sourcing	X	X	X	X	X
30	Baldassarre et al. (2017)	<i>JCP</i>	BMI Stakeholder theory	X		Organisation Offer	User-driven innovation	X	X	X		
31	Brehmer et al. (2018)	<i>JCP</i>	BMI	X		Organisation Offer	Multi-sided platform		X	X		
Sustainable innovation												
32	Yoon et al. (2017)	<i>Sustain.</i>	Resource-based view	X		Offer	Offshore / Joint venture	X			X	X
33	Neutzling et al. (2017)	<i>JCP</i>	Sustainable oriented innovation	X	X	Organisation Offer Market	Supply chain integration	X	X	X	X	X
34	Calabrese et al. (2018)	<i>JCP</i>	Sustainable oriented innovation	X	X	Organisation Process Offer	Public-private partnership	X	X	X		
35	Brown et al. (2019)	<i>Sustain.</i>	Sustainable oriented innovation	X	X	Organisation Process Offer	Cross-sectoral collaboration	X	X	X	X	X

3.3 Collaborative innovation: key concepts

Innovation has been traditionally defined as the set of technical, industrial and commercial improvements that enables organisations to perform efficiently their economic activities (Rothwell, 1992). In general terms, innovation means the introduction of “something new” in a specific context (Schiele, 2006). Although the definition of innovation has not changed significantly with respect to the object (i.e., product, process, organisation, etc.), the way to develop it has changed drastically along the time (Huizingh, 2011). In this sense, innovation has shifted from a closed process inside a company’s boundaries to a complex process of collaboration between multiple actors (Chesbrough, 2007; Huizingh, 2011; Hsieh et al., 2012; Lancker et al., 2016; Jugend et al., 2018). For instance, Lancker et al. (2016) consider innovation as the iterative process of learning, which needs intensive collaboration between a broader set of actors to improve a company value creation.

From the content analysis of the selected articles, (c.f., subsection 3.2.3) four main themes were identified in which the notion of collaborative innovation has been studied. Those are value creation, innovation management, supply chain management, and sustainable oriented innovation. Literature on value creation addresses customer satisfaction and sustainability issues through business models innovation (e.g., Kohtamäki and Rajala (2016)). In innovation management, the collaboration between several actors focuses on the exchange and generation of knowledge (e.g., Huizingh (2011)). In supply chain management there is an increasing interest in the integration of sustainability criteria in supply chain decisions. Here, the purchasing function has a fundamental role in pursuing sustainable practices (e.g., Chen et al. (2017)). Finally, sustainability oriented innovation, is a new stream that establishes the link between innovation and value creation, referring to sustainable policies and corporate social responsibility applied to offers, processes and organisations (e.g., Brown et al. (2019)).

Crossing these four research fields, we explored the three features that contribute to answer our research questions in this chapter: i) the triggers of collaborative innovation, ii) the type of innovation, and iii) the collaboration approach adopted by a given company.

Firstly, the triggers of collaborative innovation address the first research question of this chapter, concerning to the motivation of companies to perform collaborative innovation. The literature develops two major triggers of collaborative innovation referred as the technology-push and demand-pull approaches, respectively (Di Stefano et al., 2012). Secondly, different types of innovation can be identified according to the object, the strategy and the degree of collaboration. According to the object, it can be the offer, the process, or the organisation (Neutzling et al., 2017; Edwards-Schachter, 2018). According to the adopted strategy, innovation can be incremental or radical, and modular or systemic (Shaw and Burgess, 2013; Edwards-Schachter, 2018). Finally, depending on the openness of the focal company to external actors, there is a continuum between closed and collaborative innovation (Chesbrough, 2007; Huizingh, 2011). In the following, these key concepts are further developed.

3.4 Triggers of collaborative innovation (why?)

3.4.1 Technology-push approach

The technology-push approach highlights the key role of technology and the existing company's knowledge as major triggers of innovation, which is initiated by a provider company (Di Stefano et al., 2012). This approach defends the idea that technology is the main source of innovation development, aiming at pushing an innovative offer to the market (Di Stefano et al., 2012). In this case, the customer demand is taken into account as a complement to guide the innovation in the right economic direction. From the technology-push perspective, collaboration in B2B consists of exchanges between the supplier network and the customer. In general, the customer participates at last stages the process of innovation as a resource integrator (c.f., Resource-based view (Barney, 1991; Möller and Tönen, 2003)). According to the literature review performed by Di Stefano et al. (2012), the technology-push approach is mostly related to technology development, product innovation, and technological diff in the market. In the technology-push approach, the principal motivations that push to adopt collaborative innovation strategy are: increasing the customer satisfaction with innovative offers (Payne et al., 2008; Chester Goduscheit and Faullant, 2018); achieving competitive advantage (Derrouiche et al., 2010; Kohtamäki and Rajala, 2016; Neutzling et al., 2017; Chester Goduscheit and Faullant, 2018; Jugend et al., 2018); capitalization of knowledge (Huizingh, 2011; Geum et al., 2013; Brown et al., 2019); sharing resources, risks and costs (Shaw and Burgess, 2013; Maine et al., 2014); and, recently, addressing sustainability issues (Hellström et al., 2015; Neutzling et al., 2017; Hankammer and Kleer, 2018; Brehmer et al., 2018; Calabrese et al., 2018; Brown et al., 2019).

3.4.2 Demand-pull approach

In the demand-pull approach, innovation is the result of market demand, which directly triggers the development of innovations to respond to unmet customer needs (Di Stefano et al., 2012). The principal actors in demand-pull approach are the ones directly involved in customer-provider relationships (e.g., the purchasing function in B2B markets) (Di Stefano et al., 2012). Given the predominance of the technology-push approach in theory and practice, the literature review reveals a lack of knowledge concerning the collaborative practices when the innovation initiative comes from the customer side (Yan et al., 2017). The demand-pull approach to innovation is seen as a complement to the technology-push one, which help to fi the real market needs. According to Möller and Tönen (2003), the main features of the demand-pull approach are the central role of the customer, the complex relationships with old and new actors in the value chain (Nudurupati et al., 2015), the intensive knowledge exchange between the actors (Kang and Kang, 2014; Reypens et al., 2016), and the radical transformation of internal and external value chains (Möller and Tönen, 2003; Nudurupati et al., 2015). The literature reveals that in a demand-pull approach is often diffi to distinguish the exact role of the customer

from that of the supplier in the value co-creation process (Möller and Tönen, 2003). Some of the motivations of the demand-pull approach found in the literature are: increasing customer value in use (Hallikas et al., 2014; Nudurupati et al., 2015); creating societal value (Matinheikki et al., 2017); sharing resources and risks (Kang and Kang, 2014); creating sustainable value (Hellström, 2007; Walker and Preuss, 2008; Rohrbeck et al., 2013; Calabrese et al., 2018; Brown et al., 2019); and knowledge capitalization (Hellström, 2007). It is noticed that sustainability issues is a major preoccupation in the demand-pull approach. Usually, the need to integrate sustainability aspects in a company's strategy comes from governmental policies (Brown et al., 2019), which implies the involvement of actors from the public sector (i.e., policy-oriented partnerships) (Hellström, 2007; Walker and Preuss, 2008; Matinheikki et al., 2017; Calabrese et al., 2018).

3.5 Types of innovation (what?)

3.5.1 According to the innovation object

In a recent literature review, Edwards-Schachter (2018) explains the multidimensionality of the concept of innovation, and highlights the difficulty to get a clear conceptualization of the term. Nevertheless, innovation has been traditionally associated with “a new way to do something”, supposing a technological change in a given context (Edwards-Schachter, 2018). Moreover, there exist three well-established types of innovation corresponding to product, process, and organisation, derived from the seminal Schumpeterian innovation theory (Ueda et al., 2009).

Firstly, product innovation is the oldest approach to innovation, highly studied in the literature of New Product Development (NPD) (Schiele, 2006; Edwards-Schachter, 2018). It corresponds to the improvements on a given product, allowing completely new usages (Shaw and Burgess, 2013; Geum et al., 2013; Maine et al., 2014), or enabling the management of environmental impacts (e.g., eco-innovation) (Hellström, 2007; Garcia et al., 2019).

Secondly, process innovation refers to the new ways to perform organisational and production activities into a company (Shaw and Burgess, 2013; Geum et al., 2013; Maine et al., 2014; Wang et al., 2016; Edwards-Schachter, 2018; Brown et al., 2019). The change can be produced from the introduction of new technologies or from activity optimization. It is closely related to product innovation, since the product is the result of a process.

Finally, organisational innovation corresponds to a complex level of innovation that implies a holistic transformation in a company's internal and external structures (Chesbrough, 2007; Shaw and Burgess, 2013; Chester Goduscheit and Faullant, 2018; Jugend et al., 2018; Brown et al., 2019). Company's internal and external structure refers to the relationships between the actors and the different processes taking place at the systemic level. (Huizingh, 2011; Shaw and Burgess, 2013; Lancker et al., 2016; Chester Goduscheit and Faullant, 2018; Jugend et al., 2018). Business model innovation is a form of organisational innovation (Chesbrough, 2007; Rohrbeck et al., 2013;

Hellström et al., 2015; Hankammer and Kleer, 2018; Brehmer et al., 2018), and deals with the transformation in the way a company creates and captures value.

3.5.2 According to the innovation strategy

Traditionally, the output of the innovation process has been categorised as incremental or radical (Rothwell, 1992; Shaw and Burgess, 2013; Edwards-Schachter, 2018; Chester Goduscheit and Faullant, 2018), and modular or systemic (Hellström, 2007; Shaw and Burgess, 2013). On the one side, this categorisation is related to the level of disruptiveness a company is aiming to achieve (Maine et al., 2014; Edwards-Schachter, 2018). On the other side, this refers to the scope of the innovation (Shaw and Burgess, 2013).

From incremental to radical innovation. Incremental innovation refers to small and cumulative improvements in the object of innovation (i.e., offer, process, organisation) (Chester Goduscheit and Faullant, 2018; Edwards-Schachter, 2018). Incremental innovation is often related with the exploitation of company's internal knowledge and resources (Chester Goduscheit and Faullant, 2018; Edwards-Schachter, 2018). Radical innovation, in contrast, needs the integration of external knowledge, since it refers to the development of completely new offers, processes or organisations with the aim to create new markets (Chester Goduscheit and Faullant, 2018; Edwards-Schachter, 2018). In both cases, the innovation effort relies on the capability of the company to exploit knowledge in order to create higher value than in the current situation.

From modular to systemic innovation. Innovation can be also modular or systemic (Hellström, 2007; Shaw and Burgess, 2013). Modular innovation addresses one or some parts of a system to be innovated, without changing the entire system. It could take places when, for example, one or more modules nested within a larger system are replaced to improve the system performance. Besides, systemic innovation implies a complete transformation of the object of innovation, which is translated into a completely different functioning of the system. In general, modular and systemic innovation correspond to incremental and radical innovation, respectively. Nevertheless, in some cases, a modular innovation can derive into the transformation of the whole system functioning (Shaw and Burgess, 2013).

3.5.3 According to the degree of collaboration

According to Lancker et al. (2016), innovation involves an evolutionary, non-linear and iterative learning process, which requires intense communication and collaboration between different actors in the value system. This assumption has its antecedents from the well-known Stakeholder Theory (Freeman et al., 2010), which defines economic and non-economic actors as part of the business ecosystem. Adopting a collaborative

approach has some implications to the internal company's configuration and its relationship with the external environment (Freeman et al., 2010). Indeed, adopting an innovation strategy needs the focal company to entail internal and external collaboration processes (Schiele, 2006; Huizingh, 2011; Yoon et al., 2017). According to the willingness of a company to collaborate with its environment, several configurations can take place going from closed to open innovation strategies. Huizingh (2011) proposes four types of innovation according to the degree of openness of the focal company to the external environment:

Closed innovation. As stated on previous work (Rothwell, 1992), closed innovation development is based on the internal R&D capabilities of the focal firm in isolation. It is the oldest innovation model, corresponding to the mass production era, in which the main issues are R&D efficiency, intellectual property and technological development. In this model, value creation depends on the company ability to capitalize and exploit its own knowledge to create differentiated products compared to the competitors. In this context, company's intellectual property is a critical driver of value creation, while collaboration is absent from the managerial concerns .

Out-bound open innovation. Refers to the ability of a company to commercialize internal knowledge in the external environment (Huizingh, 2011). This model requires some degree of collaboration of the focal firm with external actors, which are the customers of the innovation. Here, collaborative practices are key value drivers, which allows the focal company to understand the external needs and processes.

In-bound open innovation. Corresponds to the sourcing and acquisition of expertise from outside the focal company, and the ability to exploit it internally (Huizingh, 2011). In this case there is a need for an intensive internal collaboration coupled with a strategic external collaboration. The internal collaboration is crucial to align the firm culture and capabilities to the external knowledge, allowing the integration into the company processes.

Collaborative innovation. It is a general notion covering all the relationships based on the collaboration and the long-term engagement between two or more industrial actors. Neutzling et al. (2017) affirm that inter-organisational collaboration is essential to achieve effective innovation development in a given industrial sector. There exist several sub-categories going from dyadic collaboration (i.e., provider-customer value co-creation) (Schiele, 2006; Payne et al., 2008; Derrouiche et al., 2010; Grimm et al., 2014; Kohtamäki and Rajala, 2016) to networked approaches (Romero and Molina, 2011; Shaw and Burgess, 2013; Nudurupati et al., 2015; Hellström et al., 2015; Reypens et al., 2016; Wang et al., 2016; Lancker et al., 2016), in which several actors on the extended value chain are integrated, including economic and non-economic ones (i.e., customer, suppliers, competitors, governmental organisations, communities, etc.). The

literature reveals that one of the most updated approaches of collaborative innovation is known as open innovation (Chesbrough, 2007; Geum et al., 2013; Maine et al., 2014; Jugend et al., 2018), referring to inside-out and out-side in flows of knowledge between the actors in a long term engagement strategy.

3.6 Collaborative innovation in today's business to business relationships (how?)

3.6.1 The requisites for successful collaborative innovation

The basis of collaborative innovation is the management of the relationships between actors (Shaw and Burgess, 2013; Maine et al., 2014; Matinheikki et al., 2017; Hellström, 2007). The major aspect to focus on is to characterise relationships in a collaborative context (Derrouiche et al., 2010; Lancker et al., 2016; Yoon et al., 2017). Relationships between the customer and the providers implies relational elements beyond a simple transactional process (e.g., trusts and commitment). Derrouiche et al. (2010) propose to characterise relationships through some criteria related to relational quality, for instance, the degree of commitment between the actors, the long-term vision on the relationships, and the balance on the inter-dependency. In general, collaboration needs an initial effort of the actors at the strategic level which corresponds to define mutual objectives, establishing integrated policies and performing collaborative decision-making processes (Ueda et al., 2009; Derrouiche et al., 2010; Reypens et al., 2016). The willingness of the companies to collaborate is essential but not sufficient. In this sense, some operational prerequisites that make collaboration possible are highlighted in the literature and can be classified as preliminary, internal collaboration and external collaboration requisites.

Preliminary requisites. First, it is necessary identify the focal firm which is the company initiating the innovation project. Inside the company, it is necessary to identify a corresponding “leader” or “champion” and a leading group formed by internal key actors (Nudurupati et al., 2015; Reypens et al., 2016). The leading group coordinates and monitor the project development inside and outside the company boundaries. Once the focal firm and the respective champion and leading group are set, it is necessary to prepare the company to collaborate inside (cross-functional collaboration) and outside its boundaries (inter-organisational collaboration).

Internal collaboration requisites. It is necessary to establish the conditions for collaboration at the company's internal level. Intra-organisational collaboration involves a cross-functional approach that depends very much on the company culture (Huizingh, 2011; Reypens et al., 2016; Yoon et al., 2017). First, the focal company should be able to recognise and forecast the value opportunity in the collaboration. Second, it is required to be aware to invest on internal competences and resources (Neutzling et al., 2017). Finally, the focal company should provoke an inter-functional collaboration with the aim

of achieving internal goal-alignment (Grimm et al., 2014; Yoon et al., 2017). In line with Schiele (2006), a robust and organised internal collaboration is the base of a successful external collaboration.

External collaboration requisites. Inter-organisational collaboration is much more complex than internal collaboration, since it involves heterogeneous actors with their own organisational culture and interests (Romero and Molina, 2011; Reypens et al., 2016; Baldassarre et al., 2017). The main motivation for the actors to collaborate in a value network is the expected value to be captured, which is superior to the invested efforts (Romero and Molina, 2011; Hellström et al., 2015). Inter-organisational collaboration has its antecedents in the Resource-based view (Barney, 1991), referring to the strategic management of external resources. For Hallikas et al. (2014) and Neutzling et al. (2017), collaboration is much more than putting resources together, instead, it is creating unique capabilities from resources and knowledge integration. Thus, the actors in the value network should be conscious about being part of a network, and not isolated actors looking exclusively for its own benefit.

Indeed, some of the requisites for successful external collaboration are, first, having the capability to integrate external knowledge into the internal know-how, which is known as “absorption capacity” (Huizingh, 2011; Yoon et al., 2017). Secondly, good quality of actors relationships, determined by the level of trust, adaptation, communication, participation, problem-solving orientation, among others (Schiele, 2006; Yoon et al., 2017). Thirdly, a clear understanding of the value expected for each actor, as well as the interdependence relationships between the actors (i.e., goals, resources, capabilities, activities, etc.) (Hellström et al., 2015). Finally, it is necessary to identify the potential sources of conflicts (e.g., information asymmetry, opportunistic behaviour) (Spekman, 1988; Yoon et al., 2017).

The most critical point for a successful collaborative innovation is to ensure the alignment of the actors’ objectives at internal and external levels (Derrouiche et al., 2010; Reypens et al., 2016; Baldassarre et al., 2017; Matinheikki et al., 2017). This condition supposes a cognitive alignment between actors that are highly heterogeneous. To this end, it is necessary to recognise the opportunity to create superior value from joint innovation development instead of isolated value creation (Matinheikki et al., 2017). The way in which the collaboration process is held by the actors depends on the individual need for engaging the collaboration (i.e., related to the company progress), the constraints linked to the confidentiality information (i.e., risk of information asymmetries), and the stage of the development life cycle of the innovation (i.e., idea generation, conceptualization, development, etc.) (Lancker et al., 2016). The analysis of the evolution of the relationships in B2B with an extended vision is indispensable to understand value creation within complex collaborative business ecosystems.

3.6.2 The process of collaborative innovation

Any process of collaborative innovation starts with the recognition of an opportunity to create high value in a networked organisation (Kang and Kang, 2014). Then, the opportunity recognition is translated into an innovation project. However, there exist different configurations in the collaborative innovation process, depending on the industrial context, the origin of the innovation project, the investment capabilities of the actors, among others factors (Schiele, 2006). It should be noted that the healthcare industry is a rich source of collaborative innovation practices, since it involves a high level of actor's heterogeneity in terms of knowledge, financial structure and governance (Walker and Preuss, 2008; Nudurupati et al., 2015; Reypens et al., 2016). For instance, Schweizer and He (2018) performed an empirical study in the pharmaceutical industry, which leads to the identification of three main phases that characterise any process of collaborative innovation, described below.

Inception. The focal company (i.e., initiator of innovative project of value creation) identifies an innovative opportunity for value creation. Similarly, the need to collaborate into a mutual interest project with external actors is identified. Then, it is necessary to draw out the synergistic values between the potential collaborators, which determines the motivations to adhering the project (Reypens et al., 2016). At this stage, the focal company entails a strong internal communication with the aim of unlocking the cultural barriers to collaborate with external actors. The output of this stage is the general goal of the collaborative innovation project, the identification of the potential external actors to collaborate with, the anticipation of the value to be created, and an initial set of actions to deal with the intra-organisational barriers to the project development (Reypens et al., 2016; Schweizer and He, 2018).

Ignition. The aim of this step is to perform a goal alignment between the different actors regarding the main goal of the project (Reypens et al., 2016; Baldassarre et al., 2017). The expected benefits of the actors and the individual investments should be discussed, achieving a fair agreement between the parties. The outputs of this phase are the list of actors to participate in the collaborative process, and a synthesis of the actor's value expectations. Parties should be ready for full collaboration in intellectual and contractual terms (Reypens et al., 2016).

Implementation. In line with the model proposed by Rohrbeck et al. (2013), this phase corresponds to the launch of the innovation in operational and commercial terms. The collaboration takes place on the operational planning alignment in terms of resources and activities needed for joint production. This phase is concerned with the offer commercialization and the value capture. At the end it is possible to conduct an assessment of the value created for each actor.

3.6.3 Collaborative innovation and sustainable value creation in the supply chain

An important body of literature recognises the importance of collaborative approach in the supply chain as a key driver to create sustainable value (Chen et al., 2017). Here, the role of the purchaser is fundamental to enable innovation development (Spekman, 1988; Schiele, 2006). In B2B markets, sourcing has been considered as an strategic activity that allows the access to new resources and knowledge that enables innovation in the buyer company (Spekman, 1988; Nudurupati et al., 2015). In the context of sustainable business models, the role of the purchaser has gained in importance (Grimm et al., 2014).

In past literature (Spekman, 1988), the role of the purchaser appears to be strictly prescriptive. The purchaser was limited to establish a set of requirements, and looking for a competent supplier able to fulfil them. The criteria of supplier selection in that context were the classical triad quality, price and delivery time (Spekman, 1988). In that context, the purchaser adopted an “adversary approach” face of its suppliers, using the power positioning to get the best cost-benefit relation in the business transaction (Spekman, 1988). In the current industrial context, the role of the purchasing function has been drastically transformed (Schiele, 2006; Nudurupati et al., 2015). The purchaser is facing a context in which the price is not the only element of the negotiation with its key suppliers, entailing a discussion about perceived value from different actors’ perspective (Nudurupati et al., 2015). Besides, external exigencies, related to the management of the environmental impacts and the strategic need of being socially responsible, push companies to transform the sourcing strategies in B2B contexts (Walker and Preuss, 2008; Seuring and Gold, 2013; Chen et al., 2017). This panorama makes it possible to entail a conversation around the innovation as a source of sustainability.

In the context of collaborations, the purchaser takes the role of “integrator” or “mediator” in the interactions between the actors along the value network (Hallikas et al., 2014). The integrator is at the centre of the collaborative project, being able to coordinate the relationships and the information sharing during the entire process of co-creation. In B2B relationships, the purchasing function is the direct link between suppliers and manufacturers with the customer needs (Kang and Kang, 2014). The integrators should have the skills to manage the project at the relational level, which means to establish a dialogue between actors from different domains of expertise, facilitating the alignment of their objectives. In this context, the role of the purchaser requires the ability to identify innovative suppliers and provoke an opportunity for collaboration (Schiele, 2006). Identifying innovative suppliers is a necessary but not sufficient condition. The purchaser should be also a facilitator of the firm to integrate and exploit external knowledge and resources.

In this context, the activity of sourcing becomes a central element in the organisational strategy to achieve sustainable value (Grimm et al., 2014). For these authors, managing sourcing appropriately increases the efficiency of innovation development. Some of the aspects to be considered in sourcing strategies in the context of collaborative innovation are summarized as follows:

- **Considering the offer life cycle:** from a supply management perspective, it allows increasing the knowledge about the functioning of the actors in the supply chain, enabling the design a robust and holistic prescription (Nudurupati et al., 2015).
- **Identifying actors interdependencies:** concerns to the primary tasks of objective alignment between the different actors. The collaborative relationship should be based on declared interdependencies and not in one sense dependency. This aspect avoid, for example, the technical dependency of the purchaser to a single supplier (Nudurupati et al., 2015; Matinheikki et al., 2017).
- **Dynamic supplier selection:** instead of having a static panel of suppliers, the purchasing function should be and perform a flexible and extended panel of stakeholders depending on a specific purpose. This leads to the management of multiple stakeholders sourcing strategies (Rohrbeck et al., 2013; Grimm et al., 2014).
- **Integrative role:** instead of the traditional and exclusive negotiation role, the purchaser should be an mediator of the collaboration process, integrating a heterogeneous panel of stakeholders into a common goal. The purchasing focus should change from a cost-benefit discussion to a value-based one (Hallikas et al., 2014; Huizingh, 2011; Kang and Kang, 2014).

3.7 Conclusions

Pursuing sustainable value creation needs the collaboration between multiple actors in a orchestrated network. Through this chapter, we mobilized an important amount of literature addressing the notion of collaborative innovation from four different research streams: value creation, innovation management, supply chain management and sustainable oriented innovation. The classical theories influencing the current literature on collaborative innovation are the stakeholder theory (Freeman et al., 2010) and the resource-based view (Barney, 1991). Some insights contributing to research questions guiding this chapter are summarized as follows:

- *RQ1. Why do companies collaborate in B2B?* Adopting a collaborative approach is motivated by the access to resources and knowledge. The aim is to perform radical and systemic innovations, oriented towards sustainable solutions, at the offer, process or organisational level, that a single company cannot achieve.
- *RQ2. What is the meaning of collaborative innovation in B2B?* In B2B markets, collaborative innovation means value co-creation between economic and non-economic actors in the value network. It implies the strategic alignment of goals, resources and knowledge between several actors into a business ecosystem.

- *RQ3. How do companies collaborate in B2B?* Collaboration in B2B needs to take into account preliminary, internal collaboration, and external collaboration requisites. The main requisite for a successful collaboration concerns to the strategic alignment of actors' goals. Several forms of collaboration can take place depending on the trigger of innovation (i.e., technology push or demand pull), the type of actor involved in the collaborative process (i.e., public actors, manufacturers, ONG's, research centres, among others), and the quality of the relationships between them.
- *RQ4. How does collaboration enable the creation of sustainable value in B2B?* In the context of collaborative innovation, sustainable value is defined as the improvements in the offer, process, or organisation that simultaneously create economic, environmental, social, relational and functional value. The aim is ensuring economic growth and advanced social well-being. In B2B markets, the role of the purchasing function becomes central, being the key actor in sustainable sourcing strategies.

For the development of the chapters corresponding to the proposed framework (Part III; chapters 5 and 6), the elements retained from this chapter can be summarized as follows:

- Adopting a focus on the collaborative innovation at the supply chain level.
- The external triggers of collaborative innovation (demand-pull and technology-push) and its impacts on the organisation.
- The requisites for entailing a process of collaborative innovation with external actors, classified as preliminary, internal and external.
- The three main phases of the collaborative innovation process: inception, ignition, and implementation.
- The role of the purchaser as integrative actor in the process of collaboration.

Chapter 4

Decision making in multidimensional and multi-stakeholder value creation

Contents

4.1	Introduction	46
4.2	Literature review methodology	47
4.3	Multi-Criteria Decision Analysis (MCDA)	49
4.3.1	Basic elements in MCDA	49
4.3.2	Elements in multi-stakeholder MCDA.....	50
4.3.3	MCDA process	51
4.3.4	Holding consensus in multi-stakeholder decisions . . .	52
4.3.5	MCDA methods	53
4.4	Problem structure modelling in multi-stakeholder MCDA	54
4.5	MCDA application in the context of sustainable value creation	55
4.5.1	Choosing a MCDA method.....	55
4.5.2	MCDA domains of application.....	56
4.5.3	Implementing MCDA in industry	56
4.6	Retained elements for proposal development	57
4.6.1	The Analytic Hierarchy Process (AHP).....	57
4.6.2	Searching a consensus.....	59
4.6.3	<i>i</i> * Goal Modelling framework for problem structure modelling.....	61
4.7	Conclusions	64

4.1 Introduction

Sustainable value creation is a major issue in current industry (Thabrew et al., 2009; Boström et al., 2015; Schögl et al., 2016; Brown et al., 2019). The systemic nature of sustainability requires multifaceted knowledge, only achieved through the collaboration between several economic and non-economic actors (Govindan et al., 2014). As shown in chapters 2 and 3, achieving sustainable value creation implies two major issues, on the one hand, it is concerned with multiple dimensions of value creation (defined in chapter 2 as economic, environmental, social, relational, and functional); on the other hand, it faces the multiple perspectives of the set actors involved in the collaborative process (Reypens et al., 2016). The current business environment is characterised by actor's interdependences and conflicting objectives, leading to complex group decision making processes (Baudry et al., 2018). This problem can be addressed from two levels of analysis, fi level and system level. The fi level is concerned with the set of value expectations each actor has with respect to the collaborative process. The system level refers to the interdependences (generated from the value exchanges) and conflicts between the actors in the collaborative process. The major issue at the fi level is the individual defi of the value expectations, while at the system level is the fair distribution of the value created among all the actors, in a way to achieve a consensus. To determine whether value has been created or not for a given actor, it is necessary to implement value assessment mechanisms (Baldassarre et al., 2017). Many authors have approached the problem of sustainable value creation as a multi-stakeholder and multi-criteria decision problem (Ueda et al., 2009; Hajkovicz, 2008; García-Melón et al., 2016; Schillo et al., 2017; Baudry et al., 2018). Moreover, a mandatory aspect dealing with complex decision problems is adopting a systemic vision, including all the relevant elements to the decision, and representing the best the complexity of the decision situation (Roy, 1991; Norese, 2006; Bruno et al., 2016). The objective of this chapter is to provide the conceptual basis to address the problem of sustainable value creation in the context of multiple value dimensions and multiple stakeholders. The research questions guiding this chapter are the following:

- *RQ1. What are the existing approaches addressing multi-stakeholder and multi-criteria decision situations in industry?*
- *RQ2. How to represent multi-stakeholder and multi-criteria decision situations in the context of sustainable value creation?*
- *RQ3. How to achieve a consensus between multi-stakeholder expectations in collaborative decisions?*

To answer these questions, a literature review is conducted, seeking for multi-criteria and multi-stakeholders decision methods successfully implemented in industrial cases. Then, these methods are analysed according to the specific context of sustainable value creation. Figure 4.1 shows the principal elements to be explored in this chapter and the linkage with the previous chapters (i.e., chapters 2 and 3).

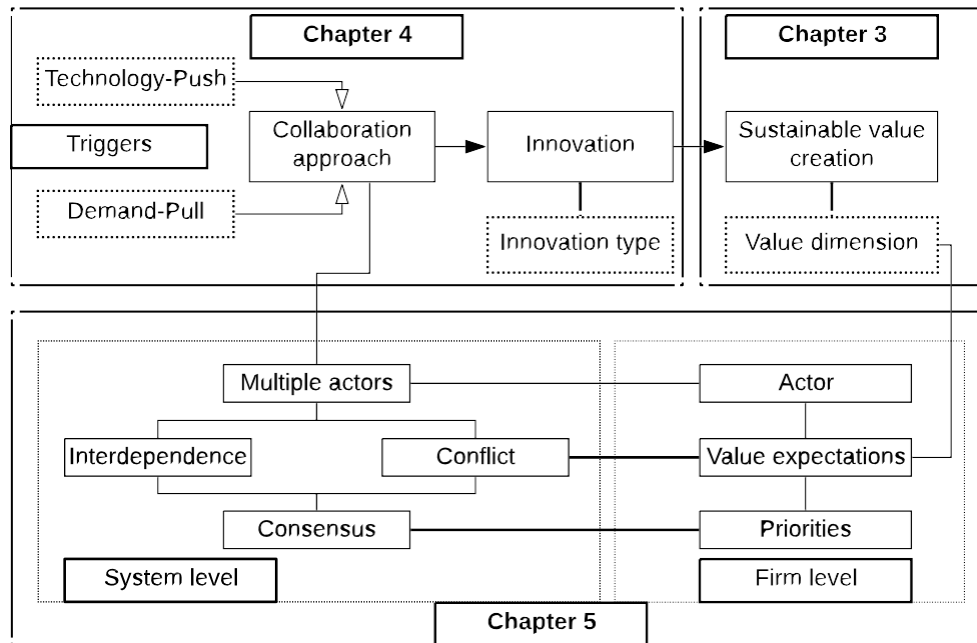

Figure 4.1: Research framework.

4.2 Literature review methodology

Firstly, we performed a research using the key words “multi-criteria decision” AND “multi-stakeholder*” OR “multi-actor*”. The research was performed for titles, abstract and keywords in Web of Sciences (WOS) between 2010 and 2019. We obtained a first sample of 789. Then, we filtered the contributions choosing only peer-reviewed journals in the field of engineering, management, environmental sciences, and computer science, obtaining a sample of 128 research works. Starting with the base of the 128 articles, we performed a filtering process by reading titles, keywords and abstracts. 17 papers were retained for further analysis. Three articles correspond to literature reviews (Chai et al., 2013; Kumar et al., 2017; Santos et al., 2019), and highlight the strengths, weaknesses and application areas of the most used MCDA methods in industry. 14 articles present the application of MCDA methods for multi-stakeholder decisions through specific case studies (Table 4.2). To address specifically MCDA in the context of multiple stakeholders, some insights were taken from a prominent literature review conducted in the field of decision making (Chai et al., 2013). The authors analysed 123 articles between 2008 and 2012 related to decision making techniques. This work has a great influence in the field of supply chain management concerning strategic sourcing decisions. Chai et al. (2013) classify existing methods for decision making into multi-criteria techniques, mathematical programming techniques, and artificial intelligence techniques. Our research is positioned

4 Decision making in multidimensional and multi-stakeholder value creation

48

in the fi group. In table 4.1, eight of the most infl tial methods in this category are listed from the most to the least used in real industrial cases (see for instance Kumar et al. (2017)). Regarding the 14 papers selected for our literature review, only SMART method is not longer evoked in recent researches. Instead, another multi-criteria method well used in the context of sustainable value creation is the life cycle assessment (LCA) (Ren et al., 2015; Liu and Qian, 2019; Santos et al., 2019) (Table 4.2).

Table 4.1: Most used multi-criteria decision making techniques according to Chai et al. (2013) and Kumar et al. (2017).

N	Multi-criteria decision making techniques	Abbreviation
1	Analytic hierarchy process	AHP
2	Technique for order performance by similarity to ideal solution	TOPSIS
3	Analytic network process	ANP
4	Elimination and choice expressing reality	ELECTRE
5	Multi-criteria optimization and compromise solution	VIKOR
6	Decision making trial and evaluation laboratory	DEMATEL
7	Preference ranking organization method for enrichment evaluation	PROMETHEE
8	Simple multi-attribute rating technique	SMART

Table 4.2: MCDA methods and applications of the reviewed articles.

N	Reference	Journal	Method	Application context
1	Erdođmuş et al. (2006)	<i>Renew Sust Energ Rev</i>	ANP	Energy policy development
2	Norese (2006)	<i>Land Use Policy</i>	ELECTRE III	Incinerator location
3	Lin et al. (2010)	<i>Expert Syst Appl</i>	ANP - ISM	Industrial vendor selection
4	Macharis et al. (2012)	<i>Decis Support Syst</i>	AHP - PROMETHEE	Transport project evaluation
5	Govindan et al. (2014)	<i>J Clean Prod</i>	Fuzzy DEMATEL	Policy identification in mining industry
6	Ren et al. (2015)	<i>Int J Life Cycle Assess</i>	LCA-AHP-VIKOR	Bio-ethanol production
7	Igoulalene et al. (2015)	<i>Expert Syst Appl</i>	Fuzzy theory	Supplier selection problem
8	Bruno et al. (2016)	<i>Expert Syst Appl</i>	Fuzzy TOPSIS	Supplier selection problem
9	Schillo et al. (2017)	<i>Energy policy</i>	Fuzzy AHP	Energy policy development
10	Baudry et al. (2018)	<i>Eur J Oper Res</i>	QFD - AHP	Biofuel selection
11	Chen and Ren (2018)	<i>J Air Trans Manag</i>	Range-based AHP-PROMETHEE	Aviation fuel evaluation
12	Mathivathanan et al. (2018)	<i>Resour Conserv Recy</i>	Fuzzy ANP - Fuzzy grey relational analysis	Identification of sustainable supply management practices
13	Liu et al. (2019)	<i>J Clean Prod</i>	DEMATEL	Innovation design
14	Liu and Qian (2019)	<i>J Clean Prod</i>	Fuzzy DEMATEL	Construction project evaluation
			Social-LCA	

In the following the theoretical background of MCDA approaches is presented, pointing out on the key elements, multi-stakeholder related elements, MCDA process, and existing methods.

4.3 Multi-Criteria Decision Analysis (MCDA)

In general, multi-criteria decision approaches are concerned with the understanding, modelling and solution of complex decision problems, generally supported by a mathematical basis (Saaty, 1990; Roy, 1991). Nevertheless, different visions have been developed in parallel from the origin of multi-criteria decision theories, deriving in two main streams (Roy, 1991). The first one oriented to the selection of “the best” solution for a given problem (multi-criteria decision making - MCDM), while the other one oriented to guide the decision process (multi-criteria decision aiding - MCDA). In line with Baudry et al. (2018) and Macharis et al. (2012), both approaches can be considered as complementary, resulting into comprehensive methodological frameworks for guiding the entire decision process (multi-criteria decision analysis). In this sense, MCDA approaches should satisfy both methodological and operational requirements, always considering the context of application (Baudry et al., 2018). The first requirement for implementing MCDA is problem structuring, which involves a systemic vision of relevant actors, their value systems and their interactions in the decision situation (Roy, 1991; Keeney, 1996). From the literature review, it is possible to distinguish first, the basic elements required to perform a MCDA; secondly, the characteristics of multi-stakeholder decision problem, thirdly, the general pathways to their implementation for solving a given decision problem; finally, the existing MCDA methods, their strengths and weaknesses.

4.3.1 Basic elements in MCDA

Three elements are fundamental to perform a MCDA approach: actors, criteria and alternatives.

Actor. Most of the reviewed papers define an “actor”, designated as “stakeholder” in the business context, according to the Stakeholder Theory of Freeman (1984) (Norese, 2006; Macharis et al., 2012; Govindan et al., 2014; Igoulalene et al., 2015; Bruno et al., 2016; Schillo et al., 2017; Liu and Qian, 2019). The “actor” or “stakeholder” is defined as any group or individual, who can affect or be affected by the achievement of organizational goals. The stakeholder has inherent interests and goals expected to be achieved through a given decision (cf. Chapter 3).

Criterion. It is a reference element through which an alternative can be judged. In MCDA a criterion can have either qualitative or quantitative nature. The characteristics of an adequate set of criteria to perform a MCDA approach are: completeness, non-redundancy, operationality, minimality and homogeneity (Roy, 1991; Macharis et al., 2012). Completeness implies that all the relevant points of view are taken into account during the decision process. Operationality refers to the meaningfulness of each criterion regarding the decision context, and the ability to measure it. The non-redundancy means that two or more criteria should not express the

same idea, or one criterion should not be contained into another one. The minimality suggest that the problem should be kept simple enough to be understood and treatable, but representative of the real problem. Finally, the homogeneity means that a given set of criteria shares the same level of detail, enabling a specific level of analysis.

Alternative. It represents a possible solution to the decision problem. It is the element being judged by the actors according to the predefi criteria. According to Roy (1991), alternatives can be partial (need to be combined with other partial alternatives to fulfil the entire decision problem) or complete (provides by itself a comprehensive solution to the decision problem).

4.3.2 Elements in multi-stakeholder MCDA

In the application of a MCDA approach, the following elements characterise a decision situation involving multiple stakeholders.

Value system. Values are highly abstract concepts that explain the interest of the actors participating in a decision. The value system represents the set of principles and global objectives of an actor, guiding its decisions. The value system can be observed in individuals, organizations or societies (Keeney, 1996).

Preference. The preference is the result of a value judgement emitted by a stakeholder when comparing two or more elements. It depends on the stakeholder value system and indicates the relative importance of an element with respect to another under a common criterion (Saaty, 1990; Keeney, 1996).

Conflict. A common characteristic of multi-stakeholder decision making processes is the presence of conflicting objectives (Macharis et al., 2012; Dowling et al., 2016; Baudry et al., 2018). Conflicts arise due to the existence of opposite objectives between two or more stakeholders. Mathematically, a conflict arises when no alternative reaches the Pareto efficiency, which means, there is no a single alternative that allows improving one objective without degrading another one. To solve conflicting situations, a trade-off between stakeholders' priorities is necessary, achieving a form of consensus.

Consensus. It represents a major issue in multi-stakeholder decision making (Macharis et al., 2012; Dowling et al., 2016). It can be defi as the agreement between all the stakeholder with respect to a decision. Mathematically, a consensus means the aggregation of stakeholders' preference functions, looking for a global satisfaction (Igoulalene et al., 2015; Li et al., 2016; Schillo et al., 2017; Baudry et al., 2018). MCDA literature provides some valuable insights to achieve a consensus through mathematics modelling techniques. For instance, Schillo et al. (2017) propose the use of Quality Function Deployment (QFD) in order to capture the "voice of the stakeholder",

leading to stakeholders' importance factors. Similarly, [Macharis et al. \(2012\)](#) argue that each stakeholder should define its own value structure and criteria independently, then, aggregating their preferences through a stakeholders' weighting procedure. AHP and ANP solve the question of consensus through two different methods, the *aggregation of individual judgements* (AIJ) and the *aggregation of individual priorities* (AIP) (see for instance [Basak and Saaty \(1993\)](#), more detailed in section 4.6).

Complexity. Refers to the degree of difficulty in analysing and solving a decision situation. Complexity is an inherent characteristic of multi-stakeholder decision processes, characterised by diverse and conflicting objectives ([Igoulalene et al., 2015](#); [Macharis et al., 2012](#); [Bruno et al., 2016](#); [Schillo et al., 2017](#); [Baudry et al., 2018](#)). Depending on the decision problem nature, the complexity comes from various sources. It could be linked to a lack of clarity on the main decision objective, incompleteness or overwhelming amount of information, highly heterogeneity of actors (associated to competencies, power asymmetries, culture, etc.), among others (see for instance [Keeney \(1996\)](#)).

4.3.3 MCDA process

MCDA is above all a global logic based on human rationality, aiming at facilitating decision making in complex situations, in which several criteria and actors are considered ([Roy, 1991](#)). As presented in table 4.2, many MCDA methods are available in literature ([Kumar et al., 2017](#)), all of them proposing their own implementation procedure. For instance, [Saaty \(1990\)](#) proposes the well known pathway of AHP method corresponding to three main steps: 1) structuring the decision problem into a hierarchy of objectives, criteria and alternatives, 2) performing pairwise comparison in each level, and 3) calculating alternatives priorities, leading to a decision. Besides, [Macharis et al. \(2012\)](#) propose a comprehensive and methodological MCDA framework called MAMCA, which includes seven steps: 1) problem scope definition, 2) alternatives and criteria identification, 3) criteria weights allocation, 4) alternatives performance assessment, 5) decision method application and consensus, 6) results analysis, and 7) decision recommendations. Those are different procedures, however, the underlying logic is very similar. The seminal works on decision making for complex problems (see for example [Roy \(1991\)](#); [Keeney \(1996\)](#); [Friend and Hickling \(1987\)](#)), and provide a systemic view of the MCDA process, in which actors (with their corresponding value systems), alternatives and criteria interact within a system. For these authors, in order to help individuals make good decisions in a complex environment, it is necessary to follow a generic framework, guiding the entire decision process. Particularly, [Friend and Hickling \(1987\)](#) propose an iterative process for strategic decision aid called the Strategic Choice Approach (SCA). This framework is composed by four generic steps necessary to perform any MCDA approach (figure 4.2):

Four modes of the decision process are explained in the SCA framework. 1) In the shaping mode, the stakeholders structure the decision situation, setting the main objective and identifying the key actors and values. 2) The designing mode allows to

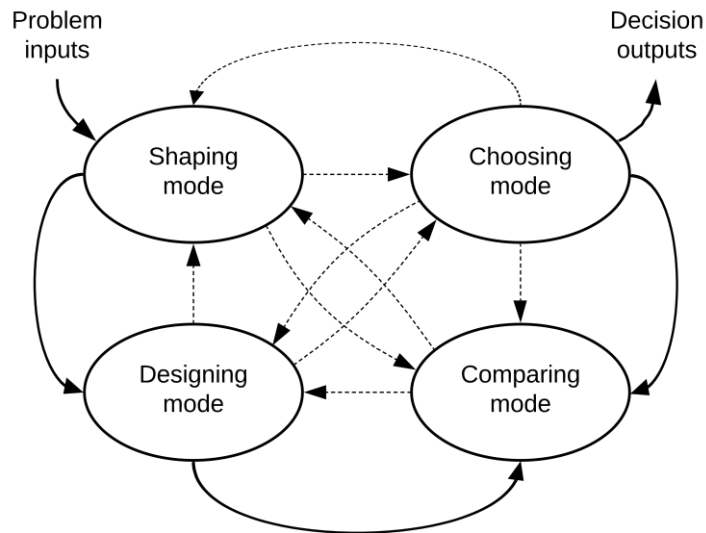

Figure 4.2: Generic decision process according to Friend (1987).

represent the decision situation into a model, in which the elements, their relations and possible combinations are represented. At this stage, consequence analysis of the alternatives is performed. 3) The comparing mode refers to the modelling of actors preferences respect to the designed alternatives. Finally, 4) the choosing mode corresponds to the generation of actor's priorities, consensus process, and recommendation for the final decision.

4.3.4 Holding consensus in multi-stakeholder decisions

Particularly, in the case of multi-stakeholder decision making processes, the satisfaction of the actors with the final decision should be considered, which implies a search for consensus (Li et al., 2016; Dowling et al., 2016). Baudry et al. (2018) identify two different ways to hold group decisions, one is a normative approach, in which a powerful actor (for instance, an authority entity) makes the final decision. The second approach is the consensus one, seeking for a trade-off between all the actors points of view (Li et al., 2016; Dowling et al., 2016). As a partial answer to the question of consensus, mathematical aggregation techniques are available in the literature (for instance, Aczél and Saaty (1983)).

Multi-stakeholder decision processes are particularly complex for large and heterogeneous groups. Several authors have tried to overcome this problem combining both mathematics and social techniques (Macharis et al., 2012; Li et al., 2016; Igoulalene et al., 2015; Dowling et al., 2016). Moreover, achieving a consensus requires first to identify the conflicting points (Li et al., 2016). Conflicts, instead of being a negative aspect, reflect the positioning of a determined actor or group of actors with respect to the decision problem. Thus, conflicts can be seen as an important source of

knowledge, necessary for succeeding any decision process. Regarding the literature, some authors approach the consensus process, or more precisely, the conflict identification process, through the implementation of clustering techniques (Zahir, 1999; Giordano et al., 2007; Srdjevic et al., 2013). In the context of decision making, these techniques provide the operational support for analysing actors' preferences.

4.3.5 MCDA methods

MCDA methods can be classified into three subcategories: i) Multi-attribute utility methods (also known as value measurement methods); ii) Outranking methods; and iii) Compromise-oriented methods (Chai et al., 2013). The first subcategory aims at assigning an utility value to each of the alternatives being evaluated. The utility value is the mathematical representation of the actors' preferences, leading to the choice of the best alternative within a set of alternatives. AHP and ANP are widely used multi-attribute utility methods (Erdoğan et al., 2006; Lin et al., 2010; Macharis et al., 2012; Ren et al., 2015; Bruno et al., 2016; Schillo et al., 2017; Baudry et al., 2018; Chen and Ren, 2018). Outranking methods as ELECTRE and PROMETHEE, assume that the stakeholders know in advance the weights of the evaluation criteria as well as the performance values of the alternatives being evaluated (Chai et al., 2013). The aim of these methods is to rank alternatives establishing a binary outranking relation between them (i.e., alternative a is as good as alternative b with no enough evidence to affirm the opposite). The result of these methods is the ranking of the alternatives rather than the choice of the best one (Norese, 2006; Macharis et al., 2012; Baudry et al., 2018). Compromise-oriented methods include TOPSIS and VIKOR (Ren et al., 2015; Igoulalene et al., 2015). In this case, the best solution is the one with the shortest distance to an ideal solution, which is an existing or imagined reference model, which can be modelled. Finally, there exist other MCDA techniques as DEMATEL and LCA, which are out of the above main categories. DEMATEL aims at the identification of cause-effect relations between complex evaluation criteria, establishing the interdependence relationships between them (Govindan et al., 2014; Mathivathanan et al., 2018; Liu et al., 2019). LCA is a method broadly used in environmental evaluation. Despite it is implemented as a MCDA method in some research papers (Thabrew et al., 2009; Liu and Qian, 2019), it is rather a methodological guideline for a very detailed evaluation of the environmental impacts.

4.4 Problem structure modelling in multi-stakeholder MCDA

Most of the authors highlight the need for developing consistent models at the early stages of the MCDA process, more precisely in the case of unstructured or ill-defined decision problems (Roy, 1991; Norese, 2006; Bruno et al., 2016; Macharis et al., 2012; Igoulalene et al., 2015; Schillo et al., 2017; Baudry et al., 2018). In contrast, well-defined problems can be solved through mathematical modelling, implementing traditional Operational Research techniques (Mingers and Rosenhead, 2004; Chai et al., 2013). A suitable model should represent the principal elements in the decision process: actors, criteria, and alternatives, and their interrelationships. In this aspect, Bruno et al. (2016) use stakeholder map to represent the key actors and their value exchanges (i.e., money, knowledge, resources, among others). Lin et al. (2010) propose a relational map performed through the Interpretive Structural Modelling (ISM) technique, which allows representing the interrelationships between the elements of the decision problem and determining their correlation. Norese (2006) recommends the use of a cognitive map with the aim of delimiting the problem and representing actors' points of view, identifying both shared and conflicting objectives.

The above modelling methodologies are framed into a literature stream known as Problem Structuring Modelling (PSM), which focuses on unstructured or ill-defined decision problems (Mingers and Rosenhead, 2004). These types of problems are characterised by the multiple actors, conflicting objectives, incommensurable criteria and multiple sources of uncertainty (Keeney, 1996; Mingers and Rosenhead, 2004). These approaches seek for problem representation, based on actors as the central element (Keeney, 1996; Macharis et al., 2012; Govindan et al., 2014). Furthermore, the importance of adopting a standard language is highlighted, since it allows the capitalisation and reproducibility of knowledge. The main objective of PSM methodologies are mapping stakeholders, representing their values, and their shared and conflicting objectives in a systemic way (Mingers and Rosenhead, 2004). Some frameworks from the field of system engineering have addressed the problem of multi-stakeholder modelling. For instance, Goal Modelling (GM) is an approach of requirement engineering developed to capture the intentions of different actors interacting in a system. A well-used GM framework is i^* (*i-star*), which models organisational collaboration based on actors' dependence relationships (Yu, 2009; Yu et al., 2011). This framework has been developed in the field of system engineering to analyse and model stakeholders' requirements in early stages of system development, focusing on intentions and strategic goals.

4.5 MCDA application in the context of sustainable value creation

4.5.1 Choosing a MCDA method

The selection of a proper MCDA method to hold complex decisions is an important preoccupation for analysts, experts and stakeholders at the beginning of any decision process (Erdoğan et al., 2006; Macharis et al., 2012; Bruno et al., 2016; Schillo et al., 2017; Baudry et al., 2018). Certainly, there is not a MCDA method that fit with any decision situation. The selection of a particular method should be in line with the context of application and the nature of the problem (Baudry et al., 2018). An appropriate MCDA method has the ability to provide a structured and realistic representation of the problem being treated, capturing its complexity in a way to be understandable for all the actors (Macharis et al., 2012). De Montis et al. (2005) propose a list of criteria based on the common preoccupations in sustainability related problems (table 4.3).

Table 4.3: Comparative analysis of multi-criteria decision techniques based on the quality criteria proposed by De Montis et al. (2005).

N	Criteria	AHP	ANP	ELECTRE	PROMETHEE	TOPSIS	VIKOR	DEMATEL	LCA
Operational aspects									
1	Weights transparency	X	X						
2	Considers interdependencies		X					X	
3	Combination with other methods	X	X		X	X	X		
4	Robustness analysis			X	X				X
5	Trade-off oriented results					X	X		
Usability									
6	Efficiency (cost and time)	X	X			X	X		
7	Stakeholder participation	X	X	X	X				
8	Problem structuring	X	X	X					X
9	Mathematical simplicity	X				X	X	X	
Data characteristics									
10	Scale heterogeneity	X	X	X	X				X
11	Qualitative and quantitative data	X	X	X	X	X	X	X	
12	Information incompleteness	X							
13	Consideration of uncertainties			X	X				
14	High amount of data processing			X	X	X	X	X	X

Three main categories of the criteria are proposed according to identified needs in sustainability related problems. Firstly, the operational aspects refer to the theoretical foundations of the method. It is concerned with the construction of the evaluation criteria, the weighting procedures, the mathematical robustness, among others. Secondly, the usability deals with the ease of use of the method regarding the specific context, and the simplicity of mathematics operations to be done. For example, whether the method enables participation of multiple actors in a collaborative way, or the possibility for non experts to use the method. Thirdly, the data characteristics, which is an important aspect in the context of sustainability, refer to data heterogeneity (i.e., quantitative and qualitative data, incomplete data, uncertainties, etc.), type of measurement scales, amount of data, among others.

4.5.2 MCDA domains of application

Decisions concerning sustainability can be approached as multi-criteria decision problems, and require the participation of several actors (Macharis et al., 2012; Baudry et al., 2018). Literature review reveals that MCDA approaches have been largely implemented to solve different problems in relation with sustainability. For instance, supplier selection for sustainability (Lin et al., 2010; Igoulalene et al., 2015); energy policy development (Erdoğan et al., 2006; Schillo et al., 2017); energy production assessment (Ren et al., 2015; Baudry et al., 2018; Chen and Ren, 2018); urban transport project evaluation (Macharis et al., 2012; Bruno et al., 2016); sustainable practices identification (Govindan et al., 2014; Mathivathanan et al., 2018); urban waste management (Norese, 2006); product-service systems development (Doualle et al., 2019; Liu et al., 2019); and project performance assessment (Medini et al., 2015; Liu and Qian, 2019).

Authors agree that these problems comprehend several dimensions related to the interests of the actors involved (see for instance Norese (2006); Macharis et al. (2012); Bruno et al. (2016)). In the consulted articles, multiple dimensions of value (i.e., also called macro-categories) are included in the problem modelling phase. For instance, economic, environmental, social, relational, functional (defined in chapter 2), and others as legal and political (Erdoğan et al., 2006; Norese, 2006; Macharis et al., 2012; Govindan et al., 2014). Particularly, most of the cases involving critical environmental and social issues involve non-economic actors as governmental entities and local communities (Norese, 2006; Govindan et al., 2014).

4.5.3 Implementing MCDA in industry

Using MCDA approaches goes beyond selecting a good alternative to solve a given problem. Instead, MCDA is considered as a powerful tool to structure complex problems and to facilitate the communication among a heterogeneous group of actors (Erdoğan et al., 2006; Norese, 2006; Macharis et al., 2012; Igoulalene et al., 2015; Bruno et al., 2016; Schillo et al., 2017; Liu and Qian, 2019). MCDA is useful to: structure a common vision with respect to a decision situation (Norese, 2006; Igoulalene et al., 2015); increase

collective knowledge and skills for future decisions (Bruno et al., 2016; Schillo et al., 2017); enable transparency and mutual trust along the decision process (Schillo et al., 2017); among others. Applying MCDA in real cases in industry have both operational and methodological requirements (Medini et al., 2015). Operational requirements concern the identification of actors, criteria and alternatives, as well as technical requisites related to the selected MCDA method. From the methodological point of view, any MCDA method integrates two main phases, modelling and evaluation. Most of authors agree the modelling phase is fundamental to get realistic and useful results at the end of the decision process (Norese, 2006; Lin et al., 2010; Macharis et al., 2012; Schillo et al., 2017; Baudry et al., 2018; Liu and Qian, 2019).

Firstly, during the problem modelling, actors, alternatives and criteria should be identified. Actors are selected according to the context of decision, regarding the resources and knowledge needs. For instance, in complex contexts involving sustainability-related problems, the actors correspond to the supply chain, governmental entities, communities, research institutions, etc. Alternatives and criteria can be obtained by combining literature review and actors knowledge, performing interviews, workshops and meetings (Erdoğan et al., 2006; Norese, 2006; Macharis et al., 2012; Chen and Ren, 2018; Mathivathanan et al., 2018; Liu et al., 2019). Moreover, the criteria can be designed following two different approaches, top-down and bottom-up (Keeney, 1996; Baudry et al., 2018). In the former, the criteria are obtained after a consequence analysis of real or hypothetical alternatives, allowing identifying needs from the different actors perspectives. In the latter, the global goal is decomposed into macro-categories, then into refined objectives, leading to a criteria set.

Secondly, for the evaluation phase, Macharis et al. (2012) identify three different approaches that can be adopted: analyst approach, expert approach, and stakeholder approach. Depending on the selected approach, the analyst, the experts or the stakeholders are responsible for performing the evaluation process. They should be able to provide value judgements about the relative importance of criteria and alternatives. Most of the authors agree that stakeholder approach is the most suitable for defining and prioritizing criteria, while expert approach is preferred for carrying out an accurate evaluation process of the alternatives (Norese, 2006; Macharis et al., 2012; Govindan et al., 2014; Schillo et al., 2017; Mathivathanan et al., 2018; Liu et al., 2019).

4.6 Retained elements for proposal development

4.6.1 The Analytic Hierarchy Process (AHP)

Motivations to use AHP in the context of sustainable value creation. An evaluation of the eight consulted methods was performed using the criteria set proposed by De Montis et al. (2005), and the content analysis of the reviewed articles (Table 4.3). AHP and ANP are placed among the most suitable methods to be used in the context of sustainability related projects, followed by the outranking methods ELECTRE

and PROMETHEE. The above affirmation is supported by the findings in the literature review, in which AHP and ANP have been used alone or in combination with other methods in a plethora of domains (Erdoğan et al., 2006; Lin et al., 2010; Macharis et al., 2012; Ren et al., 2015; Bruno et al., 2016; Schillo et al., 2017; Baudry et al., 2018; Chen and Ren, 2018). The main aspects motivating the use of AHP and ANP in real contexts are: the simplicity of the evaluation process for non-experts, the consideration of subjectivity, the transparency of the weighting process and the detection of inconsistencies in actor's judgements (Macharis et al., 2012; Bruno et al., 2016; Schillo et al., 2017). Additionally, as shown in a recent literature review by Santos et al. (2019), AHP is one of the preferred MCDA methods in sustainability related problems. The authors found that between 2014 and 2018 this method have been largely implemented to guide decision in eco-design, product-life cycle management, sustainable supplier selection, assessment of manufacturing processes, among others, showing the flexibility of the method. Similarly, Chai et al. (2013) perform a literature review between 2008 and 2012, and found out the preference to use AHP in the context of supply chain management instead of another MCDA technique. The authors highlight that one important motivations for using AHP is the possibility to be combined with other MCDA techniques.

Theoretical background of AHP. The Analytic Hierarchy Process (AHP) is a MCDA method introduced by Prof. Thomas Saaty (Saaty, 1990). The main base of AHP is psychological, seeking at integrating actors' judgement to the decision process. AHP aims at systematizing actors' subjectivity instead of eliminating it (Saaty, 1990). It consists on two main phases: modelling and evaluation. The modelling phase aims at structuring the problem into a hierarchy, involving the levels of goals, criteria and alternatives (figure 4.3). The bottom level of the hierarchy is constituted by the alternatives; the top level corresponds to the main decisional goal; the middle comprehends n levels of criteria and sub-criteria, depending on the problem size, available information, and desired level of detail.

From the theoretical point of view, AHP is based on three main axioms:

1. *Homogeneity*: elements in the same category should be comparable.
2. *Hierarchy*: elements in each level of the hierarchy should be independent.
3. *Reciprocity*: expressed as $a_{ij} = 1/a_{ji}$

The evaluation phase performs a pair comparison between the elements of each level of the hierarchy, by using an ordinal scale proposed by Saaty (Table 4.4). The process of pair comparison takes into account the following mathematics rules: for n elements, a matrix $A \in \mathbf{R}^{n \times n}$ of comparisons is obtained, which is positive and reciprocal. Only $n \times (n - 1)/2$ comparisons a_{ij} are needed, taking into account that $a_{ii} = 1$ and $a_{ij} = 1/a_{ji}$, $\forall i \in \{1, \dots, n\}$. This process results in a set of judgements matrix A for each category of comparison.

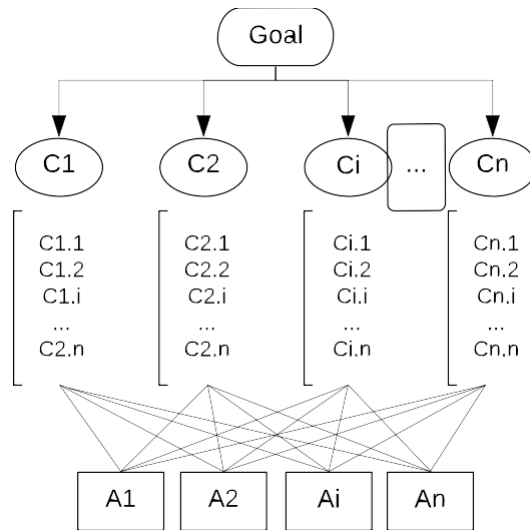

Figure 4.3: Hierarchical structure of AHP.

Table 4.4: Scale of preferences of AHP (Saaty, 1990).

Importance level of i over j ^a	Verbal scale
1	i and j are equally preferred
3	Weak preference of i over j
5	Net preference of i over j
7	Very strong preference of i over j
9	Absolute preference of i over j

^awith 2,4,6, and 8 as intermediary values.

AHP deals with heterogeneous data, since it is based on an ordinal scale to express actors' value judgements 4.4. Furthermore, AHP allows integrating several actors in the decision process (Saaty, 1990). Thus, this method appears to be suitable for complex problems facing uncertainties, multiple actors, and diverse types of data. Using this method for preliminary decision analysis provides two main benefits: i) illustrating actors priorities (i.e., weighting evaluation criteria) and their compatibility, and ii) verifying the adequacy of the problem structuring (i.e., hierarchical model constituted by value dimensions, criteria, and alternatives).

4.6.2 Searching a consensus

From the perspective of the Stakeholder Theory (evoked in chapter 3), the consensus between actors goes beyond mathematical aggregation. It entails a discussion about the

power interrelationships between actors and their influence in the final decision (Li et al., 2016; Macharis et al., 2012; Schillo et al., 2017). To address this issue, two solutions found in literature are developed in the following.

Priority aggregation with AHP. Given the flexibility of AHP, it has been broadly implemented for guiding group or multi-stakeholder decision problems (Basak and Saaty, 1993; Escobar and Moreno-jiménez, 2007). The central question in multi-stakeholder decisions is the achievement of a consensus (Macharis et al., 2012; Dowling et al., 2016; Li et al., 2016). Mathematically, it means the aggregation of stakeholders' preference functions (Saaty, 1990; Igoulalene et al., 2015; Li et al., 2016; Schillo et al., 2017; Baudry et al., 2018). In AHP, there are two techniques to aggregate individual results, *aggregation of individual judgements* (AIJ) and *aggregation of individual priorities* (AIP) (Aczél and Saaty, 1983). On the one side, performing the AIJ implies to build a group pair comparison matrix by aggregating the individual judgements. Such an aggregation should be done using the geometric mean of the value judgements for each pair of elements of the hierarchy (i.e., the geometric mean, in contrast to the arithmetic mean, guarantee the respect of the reciprocity condition in the matrices) (Aczél and Saaty, 1983). Then, the priority vector is calculated as in the normal procedure by using the group judgement matrix. On the other side, in the AIP approach, the individual priority vectors are aggregated by using two possibilities, the arithmetic mean or the geometric mean (Aczél and Saaty, 1983). These methods are simple and work well for small and homogeneous decision groups. Otherwise, an effect of compensation between two values mathematically very different occurs. Two major issues can be observed in these aggregation methods. Firstly, the effect of compensation can provide unrealistic results that do not represent properly any actor preference. Secondly, both methods assume the same importance for all the actors, which is not always the case on real decision problems.

Similarity-based priority aggregation using clustering technique. Several clustering techniques are available and there is not a single solution for a determined typology of problem (Jain, 2010). Instead, a clustering technique should be selected in function of the problem nature, the objective of the clustering process, and the *a priori* knowledge about the data (Zahir, 1999; Jain, 2010; Srdjevic et al., 2013). Two main techniques can be distinguished, partitioning and hierarchical clustering. In the final category, the *k*-means algorithm is one of the most used given its efficiency (Jain, 2010). This technique requires the definition of the number of cluster to be formed, as well as a random value (cluster centroid) to initiate the partitioning process. Considering the randomness of the initial point, each iteration of the algorithm results in different clustering results. The hierarchical clustering technique does not require the specification of the number of clusters. Particularly, in the agglomerative hierarchical clustering, the process starts by considering each element of the data frame as a single cluster. Then the clusters are aggregated by calculating the shortest distance between them, and the process stops when all the elements are assigned to a cluster (Jain, 2010).

At the end of the process, the hierarchical clustering technique provides a unique

configuration of clusters for a given data set, represented in a dendrogram or tree-like graph. This technique is more appropriated for multi-stakeholder decision problems than the partitioning one, since does not require the definition *a priori* of the number of clusters, favouring the transparency of the decisional process. Moreover, since the result obtained is unique for a given context, it is more appropriated to analyse actors preferences.

Actors' prioritization. Li et al. (2016); Macharis et al. (2012); Schillo et al. (2017) highlight the need for ranking stakeholders in some complex situations, according to their degree of influence over the final decision. In collaborative decision process, the power interrelationships between actors can influence the final decision (Li et al., 2016; Macharis et al., 2012; Schillo et al., 2017). These authors highlight the need for ranking stakeholders in some complex situations, according to their degree of influence over the final decision. For instance, Schillo et al. (2017) claims that stakeholder weighting reflects the importance of a given stakeholder to achieve the strategic goals of the focal organisation. This author propose the use of a Likert scale to determine the weights, by directly asking to the focal company. Li et al. (2016) use the framework proposed by Mitchell et al. (1997), in which a stakeholder importance is determined according to three criteria: power (P), legitimacy (L), and urgency (U). Similarly to Schillo et al. (2017), Li et al. (2016) use a Likert scale to calculate the stakeholder weights. In mathematical terms, the stakeholder weighting should be included into the aggregation results obtained from the AHP, obtaining different results in function of the stakeholder importance. The interest of using the framework proposed by Mitchell et al. (1997) is the standard base to judge the stakeholder importance. Table 4.5 describes the criteria of stakeholder importance according to Mitchell et al. (1997).

Table 4.5: Criteria of stakeholder importance (Mitchell et al., 1997).

Criteria	Definition
Power	A relationship among actors, in which one of them can push another one to do something without a declared opposition.
Legitimacy	A general perception that actions or judgements issued by an actor are right and proper within a social system of norms and values.
Urgency	Degree to which an actor claims immediateness regarding a situation, based on its criticality and time-sensitivity.

4.6.3 *i** Goal Modelling framework for problem structure modelling

There is a need for developing structured frameworks to model collaborative relationships among actors in early stages of the decision process. A system engineering

based methodology as i^* could be useful to develop consistent and reusable models. Moreover, since i^* is a called social-modelling framework (based on actors and goals), it is possible to combine it with some insights from Stakeholder Theory in order to provide a organisational-oriented tool for multi-stakeholders decision making. Goal Modelling (GM) is an approach to requirement engineering developed to model socio-technical problems. It has been applied to business-related problems, precisely to support knowledge generation involved in organisational transformation (Yu et al., 2011). GM aims at capturing stakeholders' intentions and modelling strategic relationships (of dependence) between them. The central elements in this framework are the actors and their intentional elements (i.e., goals, soft-goals, tasks and resources). The interaction between actors and their intentional elements results in a set of dependence relationships. Such dependencies suppose reciprocal relationships of gains and losses, which needs making strategic decisions.

Figure 4.4 illustrates the i^* meta-model.

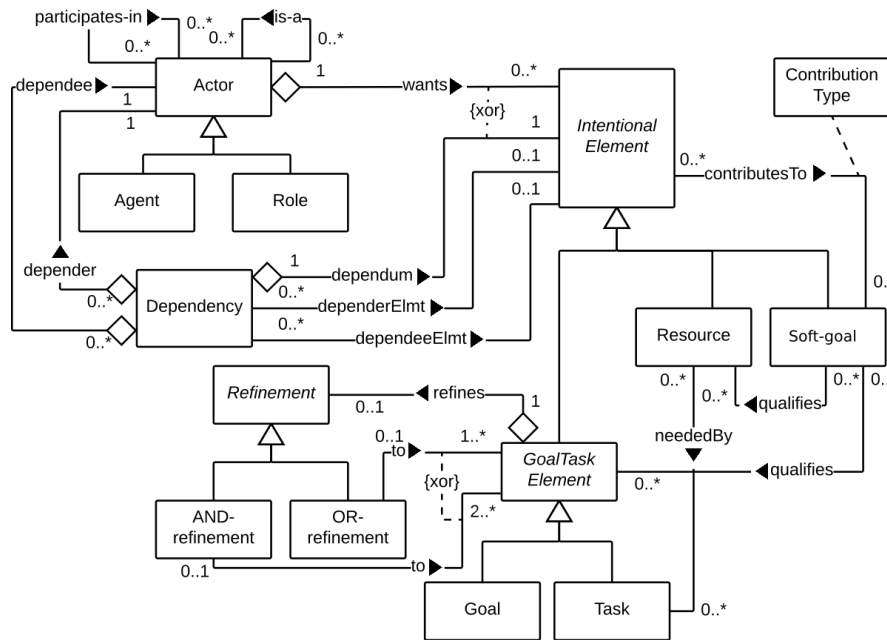

Figure 4.4: i^* meta-model (Yu et al., 2011).

Elements on i^* framework. It is composed by two abstract elements: intentional element, and actor. The intentional element is the abstract representation of goals, criteria, tasks and resources of a set of actors. The element actor represents the strategic stakeholders involved in the system and their relationships. Each actor has a corresponding role according to its function in the system. In the following, the main objects contained in the goal model are explained based on Dalpiaz et al. (2016).

- **Agent**: an actor with a concrete identity (e.g., an organisation, an individual)

- Role: the behaviour of an actor according to its specialized domain of competences.
- Goal: high-level intentions of strategic actors. What they want to achieve through the design of the system.
- Criterion: evaluates the level of accomplishment of a goal.
- Task: actions to be executed in order to achieve the determined goal.
- Resource: physical or informational elements required to perform a task.

Notation on *i framework.** There are two different notation families, one related to the element actor, and the other one to the intentional element. Actors association links can be *is-a* or *participates in*, and link a single actor to another single actor (figure 4.5). There exist dependence links between actors (figure 4.6) according to the type of *dependum* (goal, soft-goal, task or resource) (Dalpiaz et al., 2016). Intentional elements are represented as shown in figure 4.7, and can be linked to other intentional elements (table 4.6, figure 4.8).

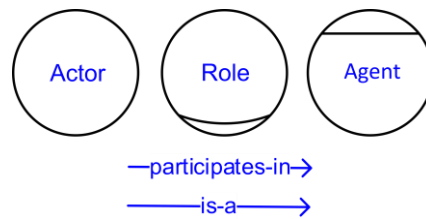

Figure 4.5: Actor notation and associations.

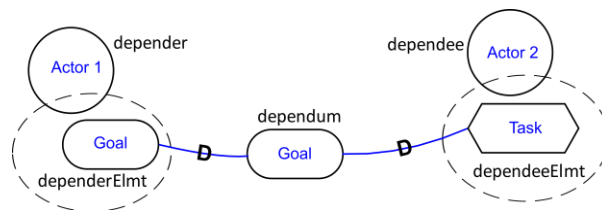

Figure 4.6: actors' dependence notation.



Figure 4.7: Intentional element notation.

Table 4.6: Associations between intentional elements.

From/to	Goal	Soft-goal	Task	Resource
Goal	Refinement	Contribution	Refinement	n/a
Soft-goal	Qualification	Contribution	Qualification	Qualification
Task	Refinement	Contribution	Refinement	n/a
Resource	n/a	Contribution	NeededBy	n/a

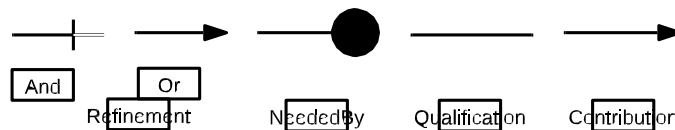

Figure 4.8: Representation of intentional element associations.

4.7 Conclusions

The objective of this chapter is to provide the conceptual basis to address the problem of sustainable value creation in the context of multiple value dimensions and multiple stakeholders. Based on the research questions guiding this chapter, the following conclusions are drawn out:

- *RQ1. What are the existing approaches addressing multi-stakeholder and multidimensional decision situations in industry?.* Several approaches to guide a multi-stakeholder and multi-criteria decision situation are available in the literature. In general, the existing methods are classified into multi-attribute utility, outranking and compromise oriented techniques. The selection of a method depends on the nature of the problem (i.e., choice, outranking, classification, etc.); the type of available data (e.g., whether alternatives, criteria, and actors are known from the beginning of the process or not; qualitative or quantitative data, etc.); and the power relationships between the actors (i.e., whether all the actors have the same importance in the decision process or not). The preferred methods are those easy to use, and which facilitate actors' learning and participation. Based on those criteria, one of the most used methods in the context of sustainability-related projects an supply chain management is the Analytic Hierarchy Process (AHP) (Saaty, 1990; Chai et al., 2013). This multi-attribute utility method is particularly interesting for modelling unstructured decision situations.
- *RQ2. How to model multi-stakeholder and multidimensional decision situations in the context of sustainable value creation?.* The literature reveals that most of the

sustainability-related projects entails complex decision situations, including several actors and conflicting goals. This type of situations need to be modelled (i.e., visual representation) before applying a specific MCDA method, which allow the collective understanding, and reduce the probability to get incoherent decisions or results. It exists a literature stream known as Problem Structure Modelling (PSM), proposing techniques for modelling unstructured problems. Some of the PSM techniques are based on of system engineering, enabling knowledge capitalisation and transfer. For modelling unstructured problems, a system engineering-based framework called i^* (*i-star* appears to be suitable (Yu et al., 2011)). This framework allows capturing stakeholders' intentions and modelling their strategic relationships of dependence.

- *RQ3. How to achieve a consensus between conflicting multi-stakeholder expectations in collaborative decisions?*. Achieving a consensus is a major issue in multi-stakeholder MCDA, but also a big challenge. Mathematically, there exist several methods to aggregate individual priorities, obtaining almost satisfactory results. Nevertheless, the multi-stakeholder approach goes beyond arithmetic aggregation, and it is rather concerned with social agreement. To this end, the Stakeholder Theory provides some insights that enable the incorporation of stakeholder weighting into the selected MCDA method. Hence, the criteria of power, legitimacy, and urgency are adopted from Mitchell et al. (1997), with the aim of capturing the voice of the stakeholder in the decision process.

Part III

Proposal development

Chapter 5

Framework to support sustainable value creation in collaborative innovation

Contents

5.1	Introduction	70
5.2	Value creation analysis	71
5.2.1	Stakeholder analysis.....	71
5.2.2	Value characterisation.....	72
5.3	Problem structure modelling	74
5.3.1	Value alignment framework.....	74
5.3.2	Criteria definition.....	76
5.3.3	Alternative identification.....	77
5.4	Preference modelling	78
5.4.1	Preparation.....	78
5.4.2	Performing the evaluation process.....	79
5.5	Researching a consensus	81
5.5.1	Clustering process.....	81
5.5.2	Actors' prioritization.....	83
5.6	Conclusions	84

5.1 Introduction

The preceding chapters presented the conceptual basis of this thesis work. This chapter aims at developing the methodological proposal for the analysis and decision-making around the creation of sustainable value in collaborative businesses. Following a step-by-step approach, the elements retained from the literature and adapted to the context of sustainable value creation are integrated into a holistic methodological framework presented in fi 5.1. Four main phases are included in the proposed framework: i) value creation analysis, ii) value alignment model, iii) preference modelling, and iv) consensus process. Each phase is refined into sub-stages, which are developed along the chapter.

The fi phase aims at performing an internal analysis of the focal company, considered as a system of value creation. Three levels of analysis are considered: external environment, strategical level, and operational level. Although, the value analysis is placed into the operational level of the company, it is infl by the strategic level and the external environment. Precisely, the notion of value is analysed following three elements: value proposition, value structure, and value creation. The output of this phase is the identification of relevant stakeholders, and the characterization of value creation in terms of needs of the focal company along the life cycle. The company needs are expressed as strategic objectives.

The second phase allows moving from the internal to a collaborative analysis. Here, the needs of the focal company are confronted with the external relevant actors. Then, a two-fold modelling methodology is performed to identify the convergence between customer needs (value expectations) and providers capabilities (value propositions). The output is a set of criteria supporting the measurement of strategic objectives of the focal company, and a set of feasible alternatives proposed by the providers.

The third phase uses as inputs the actors, the criteria, and the alternatives defi in the previous phases. With these elements, the Analytic Hierarchy Process (AHP) is implemented to model actors' priorities with respect to the criteria set and alternatives. The output of this phase corresponds to the declared priorities of the strategic actors regarding sustainable value creation model.

The fourth and last phase corresponds to a consensus process. Here a conflict analysis is approached through a clustering technique, and a process of actors' prioritization is proposed to guide the strategic decisions. Then, the degree of acceptance of the actors regarding the possible decisions is measured, and some recommendations are presented.

The proposal aims at contributing to the following research axes, introduced in detail at the beginning of this thesis work:

Research axe 1 – Exploring sustainable value creation opportunities within a company and the effects on its internal and external organizations.

Research axe 2 – Modelling the collaborative innovation process between multiple actors to enable sustainable value creation.

Research axe 3 – Conducting value assessment in collaborative business models innovation.

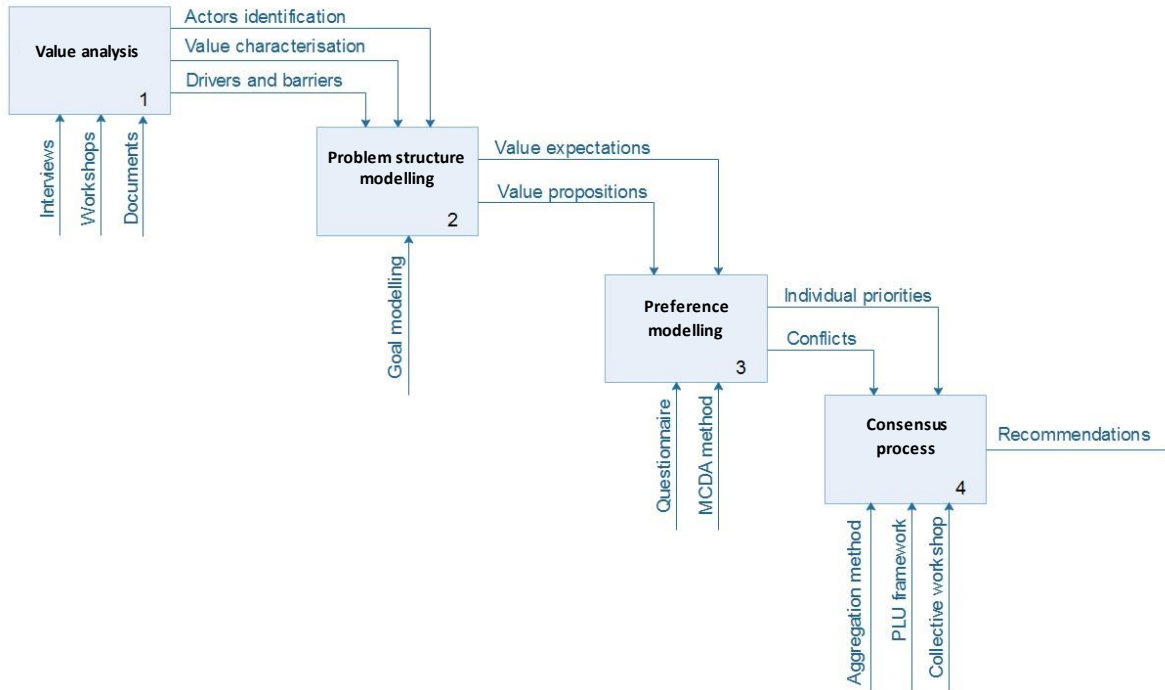

Figure 5.1: Overview of the proposal.

5.2 Value creation analysis

This phase has a threefold aim. Firstly, identifying external pressures that trigger sustainable value creation into a company. Secondly, analysing the influence of decision-makers on pursuing sustainable value creation. Thirdly, drawing out a set of value propositions and actors' configurations, which enable sustainable value creation.

5.2.1 Stakeholder analysis

This step aims at defining the set of relevant stakeholders that should be integrated to the collaborative project. According to the Stakeholder Theory (Freeman et al., 2010), stakeholders exist at three different levels, as follows:

- **Focal-firm level:** company's shareholders, managers and employees.
- **Operating environment:** suppliers, customers, competitors and financial intermediaries.

- **External environment:** sociocultural forces (e.g., local communities, activist groups), political/legal forces (e.g., governmental entities), and technological change (e.g., innovation entities).

In this stage of the methodology, the stakeholders should be identified for each stage of the life cycle, considering the context and the scope of the collaborative project. It should be noticed that the consideration of life cycle is a prerequisite for the development of sustainable innovative offerings, in contrast to traditional product-based ones (Vezzoli et al., 2014).

Interest of the stakeholder analysis. Including all the relevant stakeholders to the process of sustainable value creation has two main objectives, from the relational and instrumental points of view. From the relational perspective, it allows mitigating the resistance that some stakeholders can impose to the project development. From the instrumental perspective, it facilitates the access to new resources and knowledge necessary for the project development. Concerning this thesis work, the stakeholder theory contributes with its supporting framework to analyse stakeholders relationships, which have been largely accepted and tested in different industrial contexts. Moreover, it is suitable to innovative and sustainability related projects, since it integrates a strategic vision of the stakeholder management, with the aim of equitably creating value (Freeman et al., 2010).

5.2.2 Value characterisation

In this stage, the factors of value creation are analysed according to three elements: value proposition, value structure, and dimensions of value creation. The framework of Boons and Lüdeke-Freund (2013) has been enriched with literature on innovation and sustainability, resulting in a generalized framework for value analysis (figure 5.2). This conceptual framework allows analysing current and future value systems throughout the lens of value creation. There are three levels of analysis in the framework, external environment, strategic and operational levels.

External environment. Concerns the external pressures (market behaviour, legal context, etc.) the company is confronted with. It allows identifying the factors triggering the transformation of a given model of value creation. According to Freeman et al. (2010), external pressures can be legal, coercive, technological, or market-related.

- **Legal pressures:** come from the governmental stakeholders.
- **Coercive pressures:** are exerted by organisations and communities claiming specific rights in front of the business activity.
- **Technological pressures:** are induced by competitors or knowledge development in a specific industrial sector.

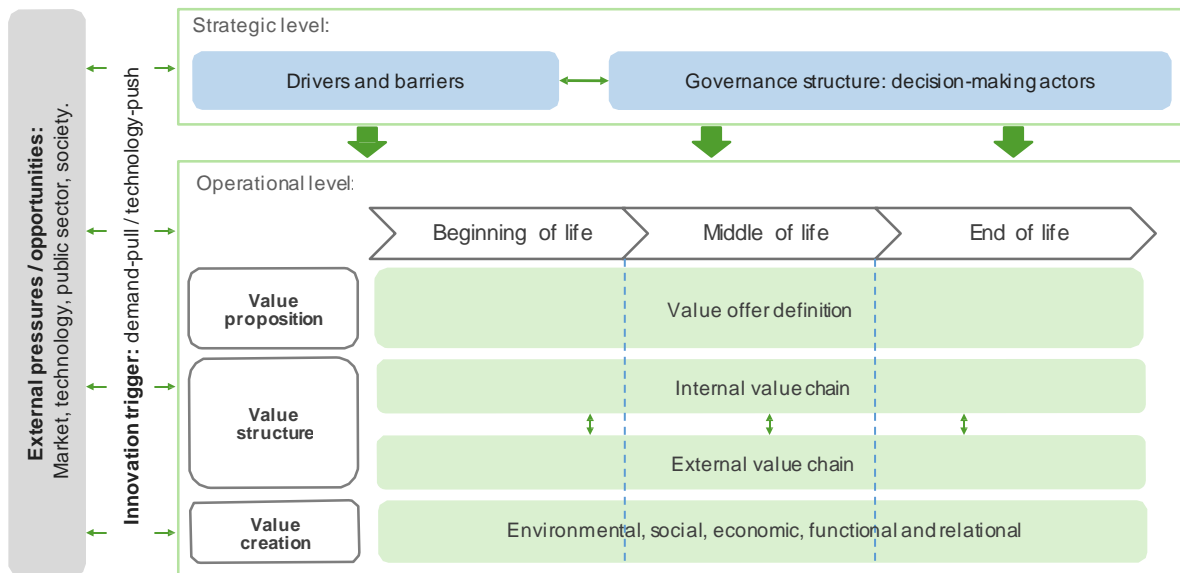

Figure 5.2: Sustainable value creation model framework (Orellano et al., 2018b,a).

- **Market pressures:** emerge with a change on the consumer behaviour, provoking new market needs.

Identifying the nature of external pressures guides the development of the company's strategy.

Strategic level. The internal strategic objectives, drivers, and barriers conditioning the system of value creation are identified. Moreover, the governance structure (i.e., decision-makers) is defined. This phase allows to define the strategic objectives of the company to guide the operationalization of value creation. Particularly, it is necessary to include all the decision-makers, who are the promoters of the organizational transformation towards sustainability.

Operational level. It covers the value proposition, the value structure and the value creation, and their dynamics along the life cycle.

- **Value proposition:** is related to the offer developed to fulfil specific customer needs. We consider that at the beginning of life (BOL), the value proposition is likely to be a product-oriented offer, in which the product has an important role and it is surrounded by a set of services. At the middle of life (MOL) and at the end of life (EOL), the value proposition evolves, and services gain an important role.

- **Value structure:** refers to the set of internal and external actors involved in the required processes and the relationships between them. On the one side, the needs for intra-organisational collaboration (across the different functions) should be identified.

On the other side, the dynamic perspective induced by life cycle vision, allows designing collaborative actors' configurations following a modular logic. It means that for each phase of the life cycle, it could exist different partnerships according to the needs in terms of resources, skills, and activities. This analysis allows identifying the degree of integration of each actor according to the life cycle phases. It is conditioned by the degree of trust, maturity, and power positioning of the actors.

- **Value creation:** concerns the performance of the business activity along the life cycle, in terms of the five value dimensions defined in chapter 2 (i.e., economic, environmental, social, relational and functional). These dimensions of value evolve through the life cycle phases and depend on the actors involved.

The output of this phase is a global overview of the value creation from the focal company perspective. It is summarized in terms of expected value propositions, needs for internal and external actors' configurations, and needs for value creation expressed as company's strategic objectives.

Interest of the value characterisation model A dynamic vision of the value creation system contributes to frame the complexity, uncertainty and unpredictability of a given business sector. It helps to react to changes in the external environment (e.g., evolution of sustainability exigencies), in a faster and appropriate way. Furthermore, adopting the life cycle vision allows analysing the elements of the value creation model in each phase, and enabling iterative feedbacks between them.

5.3 Problem structure modelling

5.3.1 Value alignment framework

This phase aims at confronting customer needs with providers' innovation capabilities. We propose a generic two-fold approach illustrated in figure 5.3. The model establishes the link between actors' strategic objectives (expressed here as value expectations), and operational capabilities of the provider network (value propositions), seeking for a strategic value alignment. Since this thesis work aims at supporting early stages of innovative offers development, there is neither a set of well-defined value propositions (alternatives), nor a predefined set of criteria to evaluate them. The aim of this step is to represent and generate suitable alternatives for sustainable value creation, based on the customer needs. The elements of the model are explained in the following.

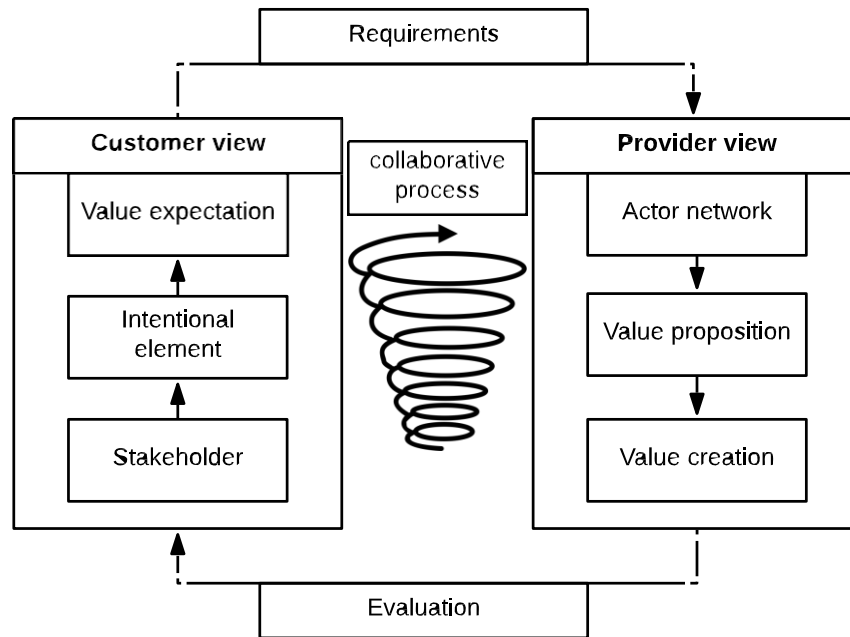

Figure 5.3: Generic framework for collaborative offer development (Orellano et al., 2019a).

Customer view. The left side of the model contains the customer view of the value co-creation process. It covers three elements: value expectation, intentional element, and actor. The element value expectation represents the benefits that the customer expects from the innovative offer development. The intentional element is the abstract representation of strategic goals of the customer in relationship with the offer development. Finally, the element actor represents the decision-makers involved in the collaborative process. The output of the goal model are the customer value expectations, translated into strategic objectives.

Provider view. The right side of the model represents the operational view of the process of value co-creation, deployed by the providers. The core element is the set of value propositions enabling the fulfilment of customer needs or value expectations. Value propositions are the means to achieve value creation, decomposed into the five dimensions of value.

Collaborative process. The collaborative process between customer and providers takes place in three main stages corresponding to the innovation development: inception, ignition, and implementation (reported in chapter 3). Each actor has a boundary space and a shared space of interaction determined by the interdependence

relationship. Our framework is positioned in the inception and ignition phases of the collaborative process, the early stages of innovation development from the strategic point of view. The operational development of the offer corresponds to the next stages, which are not covered in this thesis work.

The value alignment framework is operationalized throughout a formal system modelling language belonging to the Goal Modelling methodologies. A specific modelling framework called i^* has been selected to visualize actors interdependence relationships (introduced in chapter 4). The i^* modelling process is carried out with the aid of the software OpenOME. The resulting models allow to identify the set of criteria refining the strategic objectives of the customer, as well as the feasible alternatives matching those criteria. The following sections describe the process for building criteria and alternatives.

Interest of the value alignment model and the goal modelling framework.

The main idea behind the proposed two-fold logic of the value alignment model is to confront customer needs to provider capabilities, leading to feasible value propositions or alternatives. The modelling framework helped to visualize the information coming from the different actors in early steps of the offer development. This visualization enabled to have more informed decisions and facilitated a transparent communication between the actors.

5.3.2 Criteria definition

Based on the outputs from the value analysis and the value alignment model, the evaluation criteria can be defined. According to the decision-aiding principles (Keeney, 1996), and to recent empirical research (see for instance, Baudry et al. (2018)), criteria can be defined following two main approaches:

- **Bottom-up:** consists on analysing the consequences of real or hypothetical alternatives, which elucidate the necessity to consider a determined set of criteria.
- **Top-down:** the process is carried out from prior defined strategic objectives, which are gradually refined into criteria.

We consider both approaches as complementary, and adopt a stakeholder-based approach for the criteria definition performed through focus group methodology (Brown et al., 2019). Hence, the key internal stakeholders (customer view) should define the criteria based on two inputs: i) a consequence analysis of the current model, from the company knowledge and supported by literature review, and ii) a refinement of the company's strategic objectives into evaluation criteria, sub-criteria... indicators (i.e., depending on the level of available information). Table 5.1 presents the methodological guide to be completed by the participants.

The participants in the focus group should design a set of criteria following the rules of completeness, non-redundancy, operability, minimality and homogeneity (detailed

Table 5.1: Criteria building template.

Value dimension	Consequence analysis	Strategic objectives	Criteria	Sub-criteria	Indicator
(E) Economic	List of negative impacts of current model	$SO - 1$ $SO - i$... $SO - n$	$C - 1$ $C - i$... $C - n$	$SC - 1.1$ $SC - 1.i$... $SC - 1.n$	$I - 1.1.1$ $I - 1.1.i$... $I - 1.1.n$
(N) Environmental	:	:	:	:	:
(S) Social					
(R) Relational					
(F) Functional	:	:	:	:	:

in chapter 4). The five dimensions of value defined in chapter 2 constitute the starting basis for criteria definition.

5.3.3 Alternative identification

In this step, a participatory approach is suitable to generate the alternatives or value propositions (allowing interaction between the customer and the provider). Based on insights from innovation literature (reported in chapter 3), this approach is pertinent in the context of offer innovation, taking as starting point the customer unmet needs, and collaboratively building possible solutions (Calabrese et al., 2018).

The customer criteria, built in the previous step, are the input to start alternatives generation process, as follows:

- Each criterion is translated in terms of innovation type (i.e., offer-oriented, technological, or organisational).
- A brainstorming of value propositions is conducted, regarding customer criteria and innovation type.
- The potential value propositions are analysed in terms of maturity and barriers for further development, depending on their current state (i.e., idea, prototyping, or production).
- Finally, the feasible value propositions are selected through an agreement between the customer and the providers.

Table 5.2: Alternative generation template.

VD ^a	Customer criteria	Innovation needs			Value propositions	Innovation stage		
		Offer	Tech.	Org.		Idea	Prototyping	Production
E	$C - 1$	to be marked as "X"			$VP - 1$	to be marked as "X"		
	$C - i$				$VP - i$			
			
	$C - n$				$VP - n$			
N	⋮		⋮	⋮			⋮	
S								
R								
F	⋮		⋮	⋮			⋮	

^aVD = Value dimensions; E=Economics; N=Environmental; S=Social; R=Relational; F=Functional

5.4 Preference modelling

This phase is deployed by using a multi-criteria decision analysis method (MCDA). The selected method to perform the preference modelling is the Analytic Hierarchy Process (AHP). This method is suitable for three main reasons: i) systematic calculation of criteria priorities, ii) consideration of subjective information in a systematic way, and iii) possibility to be coupled with other MCDA methods, enabling further detailed in chapter 4).

This phase seeks for the analysis and quantification of the actors' preferences with respect to the elements considered on the decision situation, namely, criteria and alternatives. The preferences about the criteria express the basis from which actors desire to evaluate the alternatives. The preferences about the alternatives express the global degree in which an alternative i satisfies the set of criteria.

To perform the preference modelling, it is necessary to determine a sub-set of actor named "evaluators", and the means to collect the information about their preferences (i.e., verbally expressed for pragmatic ease). These elements are detailed in the following sections.

5.4.1 Preparation

Actors selection. This stage aims at selecting key actors to perform the evaluation process, named "evaluators". At a prerequisite, the actors should belong to one of the stakeholder groups defined at in the first phase: focal-firm, operating environment, or external environment (see chapter 5, subsection 5.2.1). Then, the selection of evaluators is performed based on two criteria: i) strategic positioning on the project development,

and ii) expertise on the decisional domain (experimental or academic knowledge).

Questionnaire building. The questionnaire approach has been selected as a viable methodology to collect the information from the evaluators. An on-line questionnaire represents a suitable option, since it enables an easy diffusion, data capitalization, and data transfer (e.g., ability to use and to process the data with other informatics tools).

To successfully implement AHP in an industrial context, the questionnaire should: i) follow the hierarchical structure of AHP in the questions, and ii) use only the verbal scale for the pairwise comparison process.

5.4.2 Performing the evaluation process

Pairwise comparison matrices. Following the AHP theory, the evaluation phase consists on a pairwise comparison between the elements of each level of the AHP hierarchy. To this end, the ordinal scale proposed by Saaty (Saaty, 1990) is implemented, resulting into a set of judgements $a_{ij} \in \{1, 9\}$ (reported in 4).

To remind, the pairwise comparison process takes into account the following mathematics rules:

- For n elements, a matrix $A \in \mathbf{R}^{n \times n}$ of comparisons is obtained, which is positive and reciprocal.
- Only $n \times (n - 1)/2$ comparisons are needed, taking into account that $a_{ij} = 1/a_{ji}$ and $a_{ii} = 1, \forall i \in \{1, \dots, n\}$. Where $a_{ij} \in \{1, 9\}$ is the relative importance of the element i over the element j with respect to an element k in the next level up on the hierarchical model.

$$A = \begin{matrix} & 1 & \dots & n \\ \begin{matrix} 1 \\ \vdots \\ n \end{matrix} & a_{11} & \dots & a_{1n} \\ & \vdots & \ddots & \vdots \\ & a_{n1} & \dots & a_{nn} \end{matrix}$$

This process results in a set of judgements matrices $A \in \mathbf{R}^{n \times n}$ for each level of the hierarchical model and for each individual actor.

Priority calculation. To calculate the priorities, it is necessary to normalize the values on the columns of each matrix A , then calculate the average of the rows, obtaining the called *eigenvector* or priority vector Saaty (1990). The vectors are obtained from equation 5.1.

$$w_i = \frac{\sum_{j=1}^n a_{ij}}{\sum_{i,j=1}^n a_{ij}}, \forall i \in \{1, \dots, n\} \quad (5.1)$$

Then, given an alternative $j \in \{1, \dots, m\}$ with a priority vector \mathbf{v}_j , its global priority P is calculated from the following equation 5.2:

$$P = \prod_{i=1}^m w_i \times v_j, \forall j \in \{1, \dots, m\} \tag{5.2}$$

At the end of this process, the individual priorities of criteria and alternatives are obtained for each actor j .

Verifying consistency ratio of comparison matrices. Once the priorities are calculated, the consistency of the matrices should be verified. To this end, AHP proposes the *eigenvalue* method Saaty (1990). The consistency ratio (CR) is calculated from equation 5.3, and using the random consistency indexes established for reciprocal matrices (RI), presented in table 5.3.

$$CR = \frac{\lambda_{max}}{RI}, \tag{5.3}$$

where n is the number of compared elements, and λ_{max} is the maximum value among the eigenvalues of the judgement matrix $A \in \mathbf{R}^{n \times n}$, and can be obtained from equation 5.4.

$$\lambda_{max} = \prod_{i=1}^n \prod_{j=1}^n a_{ij} \times w_j \tag{5.4}$$

where a_{ij} is the initial judgement value between the elements i and j , and w_j is the priority of the element j .

Table 5.3: Random indexes of reciprocal matrices.

n	3	4	5	6	7	8
RI	0,58	0,9	1,12	1,24	1,32	1,41

A judgement matrix is consistent when $CR \leq 0.1$ (Saaty, 1990). In case of inconsistent matrices, the corresponding evaluations should be either repeated or rejected from the final analysis. Typically, inconsistencies reflect unclear or poor modelling of the decision problem, a lack of knowledge from the evaluator, or a lack of accuracy during the evaluation process.

Given the exploratory nature of innovation problems related to sustainability, we consider important to keep inconsistency matrices as an input for further analysis of the decision situation. For instance, information provided by inconsistent matrices can be useful to discuss the limits of the decision model and improve it (e.g., criteria clarity, elimination or inclusion of new alternatives, among others), but also to develop training programs for industrial actors.

5.5 Researching a consensus

This phase presents a guideline to facilitate the consensus process between industrial actors, considering the context of collaboration for sustainable value creation. As introduced in chapter 4, in multi-stakeholder MCDA problems, a fundamental aspect is achieving a consensus between divergent points of view. AHP proposes two simple methods, the aggregation of individual judgements (AIJ), and the aggregation of individual priorities (AIP). Nevertheless, the main disadvantage of these methods is the effect of compensation between two values mathematically very different. To deal with this issue, we propose on the one side an analytical approach based on a clustering technique to support further consensus building. Then, on the other side, a pragmatic approach based on actors' prioritization through weighted arithmetic mean.

Interest of adopting a stakeholder-approach in the consensus process.

Considering individual actor positioning during the consensus process evokes the perspective of the Stakeholder Theory of Freeman et al. (2010) (chapter 3). Here, the consensus between actors' priorities goes beyond a mathematical aggregation. It entails a discussion about power interrelationships between actors and the individual influence on the final decision (Li et al., 2016; Macharis et al., 2012; Schillo et al., 2017). In the following, two ways to facilitate a form of consensus are described.

5.5.1 Clustering process

This step is related to the problem of conflict analysis stated in the literature about group decision-making (Li et al., 2016; Dowling et al., 2016). The aim of the clustering process is to reveal actors' positioning with respect to a determined set of sustainability-oriented strategies.

Building similarity matrices. Before performing the clustering process, it is necessary to build a set of similarity matrices, which are the input to perform the clustering procedure. Each similarity matrix is built from the pairwise comparison between the individual priority matrices of the actors. The process is applied to each level of the hierarchical model. The similarity is calculated by applying the following equation (Giordano et al., 2007):

$$S_{ijk} = 1 - |w_{ik} - w_{jk}|, \quad (5.5)$$

where S_{ijk} is the similarity degree between the priorities of actor i and actor j regarding the element k . And, w_{ik} and w_{jk} are the priorities of the element k judged by the actors i and j , respectively. Here, $0 \leq S_{ijk} \leq 1$, being 1 the maximum value of similarity between two actor's priorities, representing equal opinions. A set of symmetric matrices $B \in \mathbf{R}^{n \times n}$ are obtained, with n being the number of actors compared. Then, an aggregated similarity

matrix is generated, calculating the arithmetic mean of the set of similarity matrices for the elements being judged (e.g., criteria and alternatives). The resulting matrix is:

$$B = \begin{bmatrix} S_{11} & \dots & S_{1n} \\ \vdots & \ddots & \vdots \\ S_{n1} & \dots & S_{nn} \end{bmatrix}, 0 \leq S_{ij} \leq 1$$

Applying clustering technique. The hierarchical clustering technique has been selected to perform this step. As reported in chapter 4, this technique is more appropriated for multi-stakeholder decision problems than the partitioning one, since does not require the definition *a priori* of the number of clusters, favouring the transparency of the decisional process. Moreover, since the result obtained is unique for a given context, it is more appropriated to analyse actors preferences.

Firstly, using the aggregated similarity matrix, a distance matrix should be calculated. This can be computed automatically using *R Studio*, throughout the following steps:

- Generating the distance matrix.
- Implementing agglomerative hierarchical clustering technique to generate the clusters.
- Calculating the distance in each clustering iteration using the ward’s minimum variance method or any other desired method (see chapter 4).
- Finally, the clusters can be represented as a dendrogram (tree-like graph).

Using the dendrogram representation, one can identify the actors’ sub-groups. The dendrogram is interpreted based on the *y - axis*, which represents the distance at which two points are assigned to a cluster (Jain, 2010). The shortest distance, the biggest similarity between the two points. The simplest rule to choose the number of clusters from the dendrogram consists on drawing an horizontal line at a height in which the maximum distance up and down is reached without intersecting any merging point (Jain, 2010). However, selecting the number of clusters depends also on the knowledge about the problem and the data.

Identifying decisional profiles based on sustainability. The resulting clusters can be compared and assigned to one of the three sustainability decisional profiles supported by literature on sustainability (Pope et al., 2004; Vezzoli et al., 2014), aforementioned in chapter 2: eco-efficiency, societal, and triple bottom line (TBL).

- **DP1- Eco-efficiency:** the vision of sustainable value creation is product-oriented, focusing on the functional dimension of value as a means to achieve environmental sustainability.

- **DP2- Societal:** in this decisional profile environmental and social dimensions are the priority along the innovation process. Sustainable value creation corresponds to the global standards related to environmental protection and social well-being.
- **DP3- Triple bottom line (TBL):** in sustainability literature, this profile can be aligned to the weak sustainability approach. It allows the compensation between the different dimensions of value, which supposes achieving gains on one dimension by degrading another one.

Priority aggregation according to the sustainability decisional profile. All the priorities of the actors belonging to a specific decisional profile should be aggregated by using one of the two aggregation methods of AHP, namely AIJ or AIP. It corresponds to the geometric mean of the judgements or the arithmetic mean of the priorities, respectively. Then, a priority vector \mathbf{v}_ρ is generated for each decisional profile ρ .

Interest of sustainability-oriented decisional profiles. The decisional profiles provide a characterisation of actors' interests, which can be considered as a base for further discussion and negotiation. In any case, the decision-makers should take a specific positioning guiding the final decision, seeking for the highest possible collective acceptance. It is possible to obtain some clusters out of the three decisional profiles. Such a case probably reflects a lack of engagement of a given actor or group of actors with respect to the sustainability goals. Thus, "isolated" actors profiles can provide precious information about the weak points in the CSR (Corporate Social Responsibility) strategy of a given company. For instance, it can be useful to design communication strategies or training programs related to sustainability for the company employees.

5.5.2 Actors' prioritization

Calculating preferences based on heterogeneous actor prioritization.

Considering the case of heterogeneous actor importance, we propose to use the (P, L, U) framework proposed by Mitchell et al. (1997) (introduced in chapter 4), derived from the stakeholder theory. This framework defines the stakeholder importance according to the level of power (P), legitimacy (L), and urgency (U) in relation to the decision problem. For instance, according to the three decisional profiles defined above, the actors can be prioritized differently.

The importance of each actor can be calculated using a 1 to 5 Likert scale (where 1 = very low and 5 = very high) as suggested and applied by Li et al. (2016); Schillo et al. (2017). The importance coefficient μ_i of the actor i is calculated from equation 5.6:

$$\mu_i = \frac{P_i + L_i + U_i}{\sum_{j=1}^n (P_j + L_j + U_j)}, \forall i \in \{1, \dots, n\} \quad (5.6)$$

Finally, the aggregated priority of a given element j , considering all the actors, is calculated through equation 5.7.

$$P_j = \sum_{i=1}^n \mu_i \times p_{ji}, \forall j \in \{1, \dots, n\}, \quad (5.7)$$

where, p_{ji} is the individual priority of the element j judged by the actor i .

5.6 Conclusions

This chapter presented a methodological framework supporting sustainable value creation in collaborative business contexts. The proposal is described following a step-by-step approach, which favours the clear understanding and the reproducibility in different industrial contexts. Two main objectives guided the development of this chapter, on the one side, describing the different methods supporting the proposal, and on the other side, exhibiting the harmony between the different phases of the methodological framework.

The proposal covers four main phases, which are divided into specific stages. Each phase is supported by different frameworks issued from the literature review and an analytical effort to consolidate them into a holistic framework. First, a called *value analysis* phase helps to characterise the elements of value creation, namely value proposition, value structure and value dimensions. Moreover, it enables the identification of value creation opportunities from the point of view of the focal company. Then, the second phase named as *Problem structure modelling* introduces a two-fold modelling framework aiming at confronting customer needs with providers' capabilities, resulting in the selection of feasible value propositions. The third phase corresponding to the *preference modelling* is supported on the Analytic Hierarchy Process (AHP), and aims at capturing actors' subjective preferences with respect to a set of criteria and alternatives. Finally, the fourth phase consists on a *consensus process*, allowing to take into consideration individual opinions, favouring the negotiation process. Specially, in this phase, different decisional profiles have been identified from literature review on sustainable value creation, crossed with the preference modelling results to get rigorous insights.

The result of this holistic proposal is a powerful tool facilitating knowledge generation and decision aiding in complex innovation projects, specifically oriented towards sustainability issues. The entire methodology helps to structure a decision situation from the very beginning of customer's needs expression. Furthermore, it provides a systematic set of coupled methods that help to reduce the problem complexity until the achievement of a satisfactory solution. The proposal is useful to support the early development stages of innovative offerings from a strategic perspective. The scope of the proposal does not address the operational development of the offers.

In the next chapter, the holistic framework is applied to a real case of innovation development, illustrating the framework applicability and usefulness for guiding strategic decisions.

Chapter 6

Framework application to the case of ICOVET project

Contents

6.1 Introduction	85
6.2 ICOVET project description	86
6.3 Research methodology	87
6.3.1 Development phases	87
6.3.2 Managerial objectives.....	88
6.4 Development of the proposed framework	88
6.4.1 Value creation analysis	88
6.4.2 Problem structure modelling.....	96
6.4.3 Preference modelling.....	101
6.4.4 Researching a consensus.....	106
6.5 Conclusions	112

6.1 Introduction

Chapter 5 presented the methodological development of the proposed framework. In this chapter, the framework is applied to the case of EDF (*Electricité de France* in French), a large-sized company in France, involved in a collaborative project of innovation for sustainability. EDF is the main producer and distributor of energy in France. In 2017, the company launched a two-years innovation project called ICOVET concerned with the transformation of its safety clothing system. The aim of the project is to move from a product-based offer towards a global solution. The problem faced in ICOVET project is a non-typical example of innovation development for three major reasons. Firstly, the innovation in this case is triggered by the customer (EDF) instead of the provider, corresponding to the demand-pull approach to innovation (see chapter 3). Secondly, since the desired offer is not available in the market, it pushes EDF to develop a radical

innovation in collaboration with current and potential providers. Thirdly, the expected offer seeks for the creation of sustainable value. Considering the above characteristics, the decision problem faced by EDF is a complex strategic problem that implies a global management of its safety clothing supply chain. Moreover, the collaborative dimension is essential to the project, integrating economic and non-economic actors.

6.2 ICOVET project description

EDF (*Electricité de France*, in French) is the main producer and distributor of energy in France, and a leading company on the world in the energy sector. Given the safety risks associated to the company's activity, one of the most important support processes of the company is the provision of safety clothing to the employees. About 44000 employees of EDF-France wear safety clothes and should be re-provisioned each year. It represents near six millions € of purchasing and almost 300 tons of material at the end of life per year (data obtained from EDF purchasing reports).

From a general perspective, the textile industry is one of the largest on the world in terms of production and contribution to the global employment (Karthik and Gopalakrishnan, 2014). The textile supply chain is categorised as a global supply chain, since it includes several actors geographically dispersed. According to ADEME (*Agence de l'Environnement et de la Maîtrise de l'Energie*, in French), at 2010, 60% of the textile consumption in the European Union (EU) has been imported from China, Turkey, India, Bangladesh, and Tunis ¹. This implies critical issues concerning sustainability and business ethics at the three stages of the life cycle. According to Karthik and Gopalakrishnan (2014), the production of safety clothing, primarily in cotton, is characterised by the consumption of huge amounts of water, energy and a variety of chemical products that pollute air and water. Furthermore, the consumption in developed countries as France implies long-circuits transportation, translated into a high carbon footprint. Finally, the principal mechanisms at the end of life of safety clothing in France is the incineration, which involves sanitary risks for the surrounding communities. ¹To mitigate the inherent risks linked to the textile value chain, the Ministry of ecology, sustainable development and energy of France launched a decree on 2017 to improve the regulation of textile waste treatment ². Other requirements regard the beginning of life, in which the main determinants comprehend the use of sustainable best production practices, limited use of dangerous substances, and extension of the products lifespan. Certainly, these legal aspects impact the functioning of European companies engaged in Corporate Social Responsibility (CSR) policies.

Considering the above panorama, the purchasing direction of EDF launched a two-years project of innovation called ICOVET (*Innovation Collaborative des Vêtements de Travail*,

¹http://www.ademe.fr/ecolabel_eu

²for further information, see: <https://www.legifrance.gouv.fr/>

in French), over the period 2017-2019. The aim of the project is to transform the current system of safety clothing by considering its entire life cycle. Pragmatically, the company aims at moving from traditional product purchasing towards the acquisition of a global solution, which fits the best the CSR strategy of the company. The project involves several members of EDF group, some of them are Enedis, *Electricité de Strasbourg*, and EDF Luminus, and the direction of purchasing is the project leader.

6.3 Research methodology

The research-intervention framework proposed by David (2000) has been adopted to guide the deployment of ICOVET project. In this approach the knowledge is generated from the iterative confrontation between theory and reality. The empirical research starts by setting the customer needs and corresponding objectives, then identifying key actors, and finally, drawing out a set of possible alternatives in collaboration with the providers. Then, Problem Structure Modelling (PSM) and Analytic Hierarchy Process (AHP) are applied. Finally, several points of view of actors resulted in divergent results, which are analysed and conciliated following a consensus process, completing the holistic framework application.

Hence, the theoretical effort presented in Part II has been developed in parallel with an empirical work in EDF, structured in three main phases: i) context analysis, ii) definition of the future model, and iii) transformation of the purchasing strategy.

6.3.1 Development phases

Context analysis (Sept. 2017 – March 2018). The aim of this phase is the identification of key internal and external actors, the characterisation of the value creation and the understanding of the key actors' expectations. Firstly, a workshop with the employees from the departments of purchasing, prescription, sustainable development, human resources, and research & development (R&D) was conducted, with the aim of setting their objectives and expectations. Secondly, a workshop with key contractual and potential providers belonging to the field of confection, transportation, washing and end of life treatment was deployed. The aim was to understand providers' expectations, interest to participate in the project, and capabilities to meet EDF needs throughout their value propositions.

Definition of the future model (April 2018 – March 2019). The aim of this phase is to identify possible models for the evolution of the current model of safety clothing towards a sustainable solution. Collaborative workshops between internal and external actors were carried out to identify alternatives responding to the EDF needs, to formalize and prioritize evaluation criteria, and to perform an evaluation process of the selected alternatives.

Transformation of the purchasing strategy (April 2019 – Dec. 2019). this phase aims at delivering some recommendations for the improvements the purchasing strategy throughout the inclusion of CSR criteria. A single workshop with internal actors was carried out to validate the results obtained from the previous phases. Moreover, it is expected to incentive new configuration of the supply chain in terms of actors and collaborative relationships in the horizon 2025.

Furthermore, an internal mechanism of governance was implemented to coordinate the project development. The three phases were piloted by an internal steering committee, composed by the internal strategic actors of the project.

6.3.2 Managerial objectives

ICOVET project has been launched to satisfy the following managerial objectives defi by the direction of EDF purchasing department.

- Identifying the conditions to stimulate the development of radical innovation in both the offer and the organisation of the actors implied in the safety clothing value chain
- Enhancing the global performance of the purchasing function concerning the CSR strategy
- Improving the corporate image of the company throughout the inclusion of sustainability criteria on the purchasing strategy
- Encouraging long-term relationships with the providers along the offer life cycle.

6.4 Development of the proposed framework

6.4.1 Value creation analysis

Stakeholder analysis

Given the holistic nature of the problem, the project involves several internal and external actors, classified according to the following categories:

- **Focal-firm level:** two groups are identified, strategic actors and users. the former comprehends the departments of purchasing (project leader), prescription, sustainable development, human resources and research & development (R&D). The latter is composed by operational employees, who wear safety clothes to develop their daily activities.
- **Operating environment:** it comprehends the supply chain actors: confectioners, logistics providers, washing service providers, and end of life service providers. The actors belonging to the manufacturing processes are excluded from the project given

the geographical distance (principally India, China and North Africa), however their activities are considered through the confectioners' information. Moreover, other buying companies are integrated into the project with the perspective of reaching large volumes of safety clothing at the end of life, but also to explore circular economy opportunities.

- **External environment:** it comprehends two categories, economic and non-economic actors. The first category Non-economic actors (e.g., research institutions, recycling entities and social organizations) are integrated to the project with the aim at identifying sustainable-oriented opportunities (e.g., innovative first development, circular economy, short-circuits transport models, among others).

Figure 6.1 illustrates the current supply chain of safety clothing in EDF, while Figure 6.2 represents the key stakeholders considered within the scope of ICOVET project.

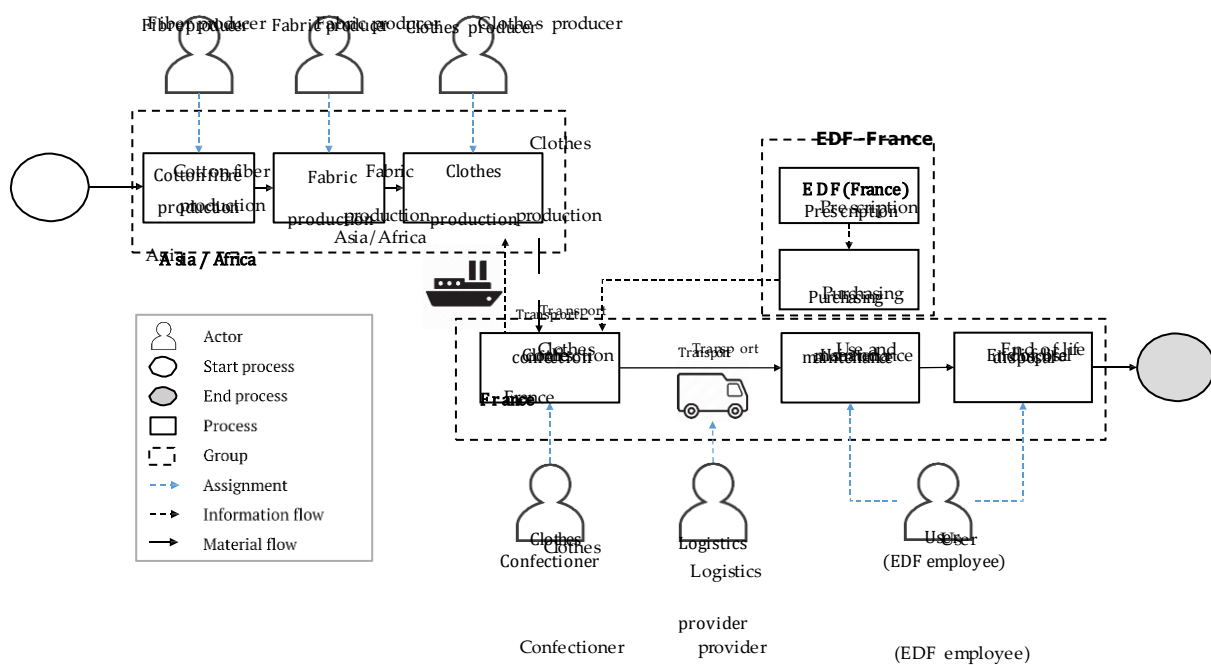

Figure 6.1: Current stakeholders in the supply chain of safety clothing of EDF.

The key stakeholders were analysed through an semi-structured interview approach. The analysed sample have diverse profiles, for instance, operative employees, managers and CEOs of the implied organizations. In the following the data collection and analysis techniques are described.

Data collection. Primary and secondary data were exploited. The former was collected throughout workshops and semi-structured interviews (see Annex A and B,

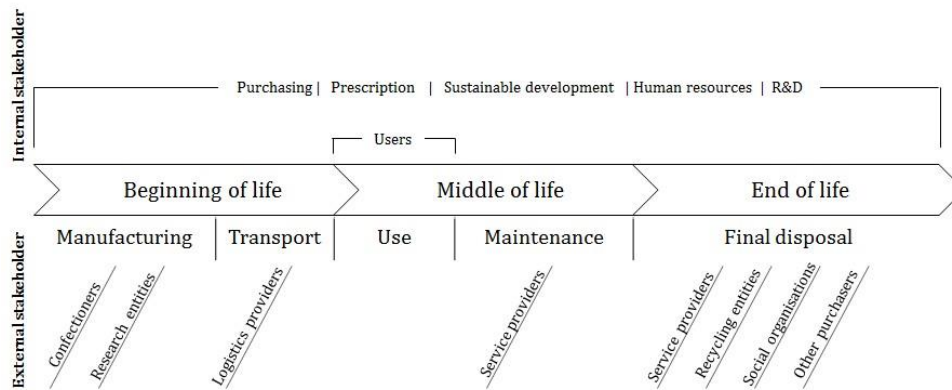

Figure 6.2: Key stakeholders included in ICOVET project.

V). The latter comprehends corporative documents of EDF. The interviews were addressed to the three main groups of actors in the different phases of the project (tables 6.1 and 6.2).

Table 6.1: Interviews conducted during 2017 with internal and external actors in ICOVET project.

Internal actors	Date	Function	Time (hh/mm/ss)
1	31/10/2017	Purchasing department (group interview)	01:34:23
2	31/10/2017	Purchasing	00:47:39
3	31/10/2017	Purchasing - distribution	00:48:19
4	31/10/2017	Purchasing - Nuclear safety clothing	00:49:01
5	14/11/2017	Sustainable development direction	00:56:25
6	14/11/2017	R&D engineering	00:40:10
7	14/11/2017	Sustainable development direction	00:47:44
8	14/11/2017	Prescription (Industrial security)	00:51:39
9	14/11/2017	Human Resources	01:38:48
10	14/11/2017	Prescription	00:45:52
11	14/11/2017	Prescription- Waste management	01:41:46
12	27/11/2017	Social dialogue direction - CSR	00:39:53
13	04/12/2017	Human resources - Normative expert	00:30:28
External actors			
14	05/12/2017	Confectioner	00:44:55
15	05/12/2017	Logistics provider	00:40:17
16	05/12/2017	Washing service provider	00:45:18
17	05/12/2017	Logistics, washing and location service provider	00:46:55
18	05/12/2017	Waste management - energy recovery	00:18:30
19	19/12/2017	Recycling organisation	01:42:21
20	17/12/2017	Security service provider	00:46:00

The interviews were built based on literature review, starting by the identification of main topics, and then refined into questions. The interviews were structured into two major sections, one oriented to the study of the safety clothing market, and the other one considering the organizational impacts provoked by innovation development. The specific topics treated on the interviews were value creation factors, textile supply chain,

Table 6.2: Interviews with users and external actors in ICOVET project (2018).

Users	Date	Function	Time (hh/mm/ss)
1	17/09/2018	Project management- environment	00:34:45
2	17/09/2018	Mechanic team management	00:22:16
3	17/09/2018	National preventer	00:26:57
4	17/09/2018	Operator - EDF renewable energy	00:20:41
5	17/09/2018	Operator - Enedis	00:31:41
6	17/09/2018	Operator - EDF renewable energy	00:24:21
7	01/10/2018	Operator - <i>Electricité de Strasbourg</i>	00:22:30
8	08/10/2018	Operator - EDF group	00:30:00
External actors			
9	11/12/2018	Confectioner	00:30:00
10	11/12/2018	Confectioner	00:30:00
11	11/12/2018	Confectioner	00:30:00
12	11/12/2018	Confectioner	00:30:00
13	11/12/2018	Confectioner	00:30:00
14	11/12/2018	Confectioner	00:30:00
15	11/12/2018	Confectioner	00:30:00
16	11/12/2018	Confectioner	00:30:00
17	11/12/2018	Confectioner	00:30:00
19	11/12/2018	Logistics, washing and location service provider	00:30:00
18	11/12/2018	Recycling organisation	00:30:00

and actors relationships. The interviews were recorded and transcribed *ad verbatim*. Finally, a lexical analysis was performed by using the software ALCESTE.

Data analysis. ALCESTE is an statistics-based tool that allows performing qualitative data analysis. The software calculates n clusters that represent the major topics associated to a specific group of interviewed actors, by the means of keywords analysis. Figure 6.3 shows an example of clustering extracted from the internal actors interviews. The main aim of this study was to confront actors' perspectives regarding the main issues treated in the project. Table 6.3 summarizes the obtained results.

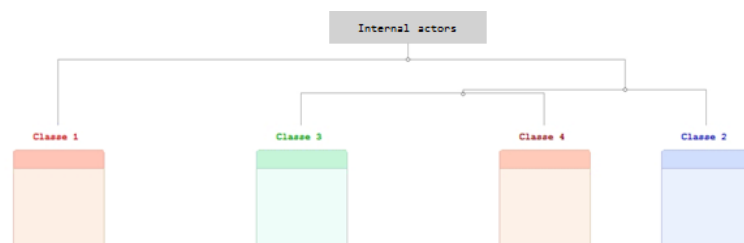

Figure 6.3: Clustering of internal actors interviews obtained from ALCESTE.

Value characterisation

Since EDF is interested in reviewing the entire value chain associated to the safety clothing, the problem has been broken down into the three stages of the offer life cycle:

Table 6.3: Actors' perceptions of major topics in ICOVET project.

Topic	Internal actors	Users	External actors
Innovation project development	The transformation of the business model is perceived as a project of sustainability, with a strong ecological and social orientation. Moreover, it represents a political and collaborative challenge. The economic component is not perceived as an important aspect.	It is perceived as an environmental project of EDF group, but also as an opportunity to improve the employees satisfaction. A possible barrier can be created from the suppression of the monetary aid given by EDF to the employees for managing the middle and end of life of the clothing.	The project represents high financial risks, however it could improve provider's corporate image. The technical requirements of the future safety clothing system is a major issue, and could represent a strong constraint. Ecological and social aspects are within the providers interests.
Safety clothing as a product	High volumes and standard purchasing of safety clothes is essential for maintaining EDF purchasing performance. Besides, the corporate image of EDF linked to the destine of the safety clothes at the end of life is a major preoccupation.	It is perceived as the way to guarantee the safety and comfort of employees. The value of the safety clothing depends on the capability to fulfil users activities in complete comfort.	The safety clothes represent a physical way to provide services to EDF.
Supply chain management	There is a urgent need to develop analysis tools for the global monitoring of the processes. Logistics related to washing and the end of life are the critical points of the project.	There is not a preoccupation about the life cycle of the safety clothes, linked to a lack of knowledge in this aspect.	Focus on distribution and logistics processes, but also in the opportunity to develop collaborative partnership, especially related to the economic aspect (e.g. sharing prototyping costs).

beginning of life (BOL), middle of life (MOL) and end of life (EOL). The value characterisation comprehends the description of the value proposition, the value structure and the value creation of a given system or business model.

We implemented the sustainable value analysis framework with the aim of shaping current and future models of the safety clothing in EDF, from the internal point of view (figure 6.4 and 6.5, respectively).

Current model. The current model supporting the safety clothing system in EDF (figure 6.4) presents the following characteristics. At *the strategic* level the principal decision-maker is the prescription department, which defi the requirements, the quantity and the lead time for the safety clothing. Then, purchasing department is able to select the providers and to launch the command to the market. Besides, the department of human resources (HR) manages a premium assignment to the employees, which are responsible for the middle and end of life of the safety clothing.

Concerning the *operational level*, fi , the value proposition is defi as the annual endowment of the safety clothing, determined by the volume of purchased products at the beginning of life. The criteria to select a value proposition are the traditional triad price, quality and delivery time, with a special focus on the best possible price. Secondly, the value structure reveals an internal organisation by silos, in which each department work separately. Moreover, there are not specific procedures for managing the middle

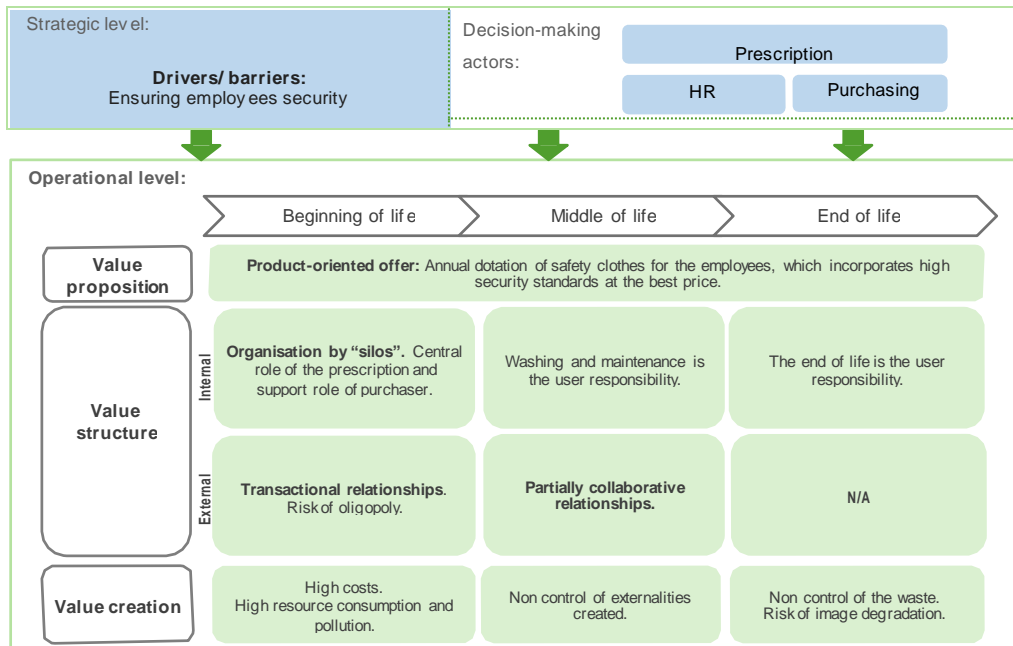

Figure 6.4: Current business model of the safety clothing between EDF and its providers.

and end of life of the clothing, which are entirely managed by the users. The external value structure shows a pure transactional relationship between EDF and their providers at the beginning of life, while a partial collaboration with the logistics providers thought the deployment of productivity partnerships (i.e., aiming at developing logistics service portfolios). At the end of life there is not any formal relationship with any provider, however, in some dependencies of EDF group (e.g., *Enedis*), a small percentage of the clothing is sent to social organisations for recycling, destined to charity. Thirdly, through the interviews, it has been found that value is being destroyed with the current system. It is evidenced through the high purchasing costs and the non control of environmental and social externalities.

Expected model. Concerning the expected model, the study reveals interesting points of evolution (figure 6.5). Firstly, *external pressures* trigger the evolution of the current model. It is concerned with the rising exigencies of the French legislation regarding waste management, precisely in relation with non-dangerous waste as textile. Besides the legal aspects, the actors highlight existent opportunities to develop new markets in France by the means of circular economy, using wasted safety clothing as a resource. The expected model conveys the transformation of both strategic and operational levels of the system. At the *strategic level*, new actors are expected to integrate the decision-making processes: besides prescription, purchasing, and human

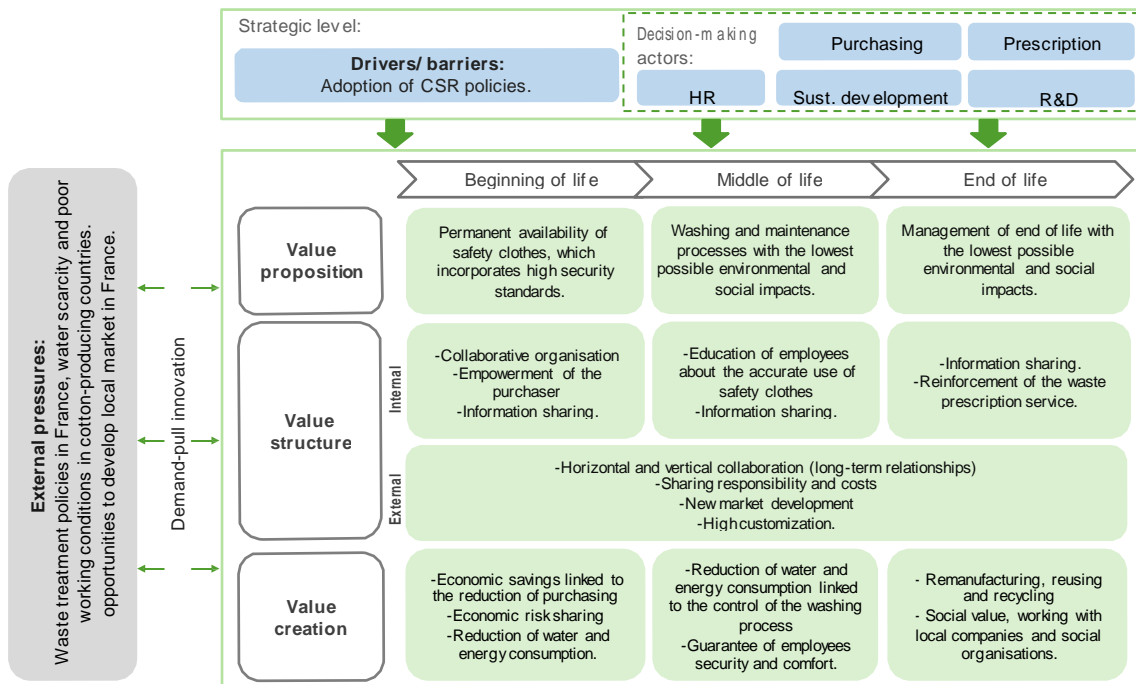

Figure 6.5: Expected business model of the safety clothing between EDF and its providers.

resources; the departments of sustainable development and R&D were found relevant for the construction of the new model. The main internal driver for the construction of the new model is the integration of sustainability exigencies contained into the Corporate Social Responsibility (CSR) strategy of EDF group. At the *operational level*, the value proposition should be transformed from a product purchasing to a global solution corresponding to the needs of each stage of the life cycle. The expected offer should focus on the availability of the safety clothing “as needed”, and the reduction of environmental and social impacts. The value structure is impacted in the following ways. The role of the purchaser becomes strategically important, since it is the integrative actor between the internal and external value chains. Moreover, there is a need for a cross-functional collaboration to redesign the offer, and the reinforcement of the prescription department regarding waste management aspects. Concerning the external value chain, horizontal and vertical partnerships should be formed to meet CSR criteria for the new offer. Vertical collaboration (i.e., between confectioners, research entities, service providers, socio-environmental organisations and EDF) is needed for innovation prototyping, reducing the risk of failure and sharing economic expenses. Horizontal collaboration between EDF and other buyer companies favours the achievement of important purchasing volumes, enabling the minimum production quantity required for the providers. Concerning value creation, table 6.4 details the actors vision in terms of value destroyed and opportunities along the life cycle.

Table 6.4: Consequence analysis along the life cycle of the current system of safety clothing in EDF (internal workshop 2017).

Stage	Impacts / value destruction	Opportunities / value creation
BOL		
Manufacturing	<p>High consumption of water and energy. Intensive use of pesticides (eco-toxicity). Soil exhaustion and intensive land use. Pollution of air and water. Degradation of human health. Poor work conditions (e.g., child labour). Socio-economic dependency of producer countries on cotton cultivation.</p>	<p>Design for the end of life. Experiment with innovative fibres (e.g., Linen, nettle, recycled fibres). Relocation of production (territorial development).</p>
Transportation	<p>High emissions of CO_2 (e.g., use of the air-plane in case of urgent delivery). Poor work conditions of conveyors (extensive work time). Economic impacts linked to delay costs.</p>	<p>Development of shortcircuits Local job generation.</p>
MOL		
Use	<p>Attachment of users to the annual provision of safety clothes (resistance to change). High storage costs. Economic impact due to the risk of inventory obsolescence. Non equilibrium between, comfort, ergonomics, safety and protection of the environment.</p>	<p>Changing allocation modalities: from annual allocation to “as needed”. Connected clothing. Development of new features of the safety clothes to increase comfort. Users training to best practices. Involvement of trade union organisations.</p>
Washing	<p>Lack of traceability of the number of washes. Risks of radioactive and chemical effluents into the washing water. Health risks associated to chemical use. Risk of the safety guarantee related to non-professional washing processes.</p>	<p>Standard washing procedure. Traceability system. On-site washing process. Additional services contained in the offer (e.g., sewing, repair).</p>
EOL		
Disposal	<p>Lack of internal skills to manage the end of life. Risk of fraudulent use of clothing. Uncertain volume of waste due to lack of traceability.</p>	<p>Turning clothes at the end of life into a resource (circular economy). Creating new markets in France. Developing solidarity economics (social organisations).</p>

6.4.2 Problem structure modelling

In the precedent sections, current and expected models of EDF’s safety clothing system have been analysed throughout the lens of value creation from the EDF perspective. In this section, the situation is analysed from the collective vision between EDF and the external actors, implementing Goal Modelling framework to represent actors interdependencies and value expectations. The application of the goal modelling technique through the *i** framework, helps to structure EDF problem, and to illustrate the collaborative process for the development of the offer. From the goal modelling between customer and the different providers along the supply chain, the evaluation criteria and alternatives (i.e., value propositions) have been defined. Both elements represent the main input to start the MCDA process, and are detailed in the following.

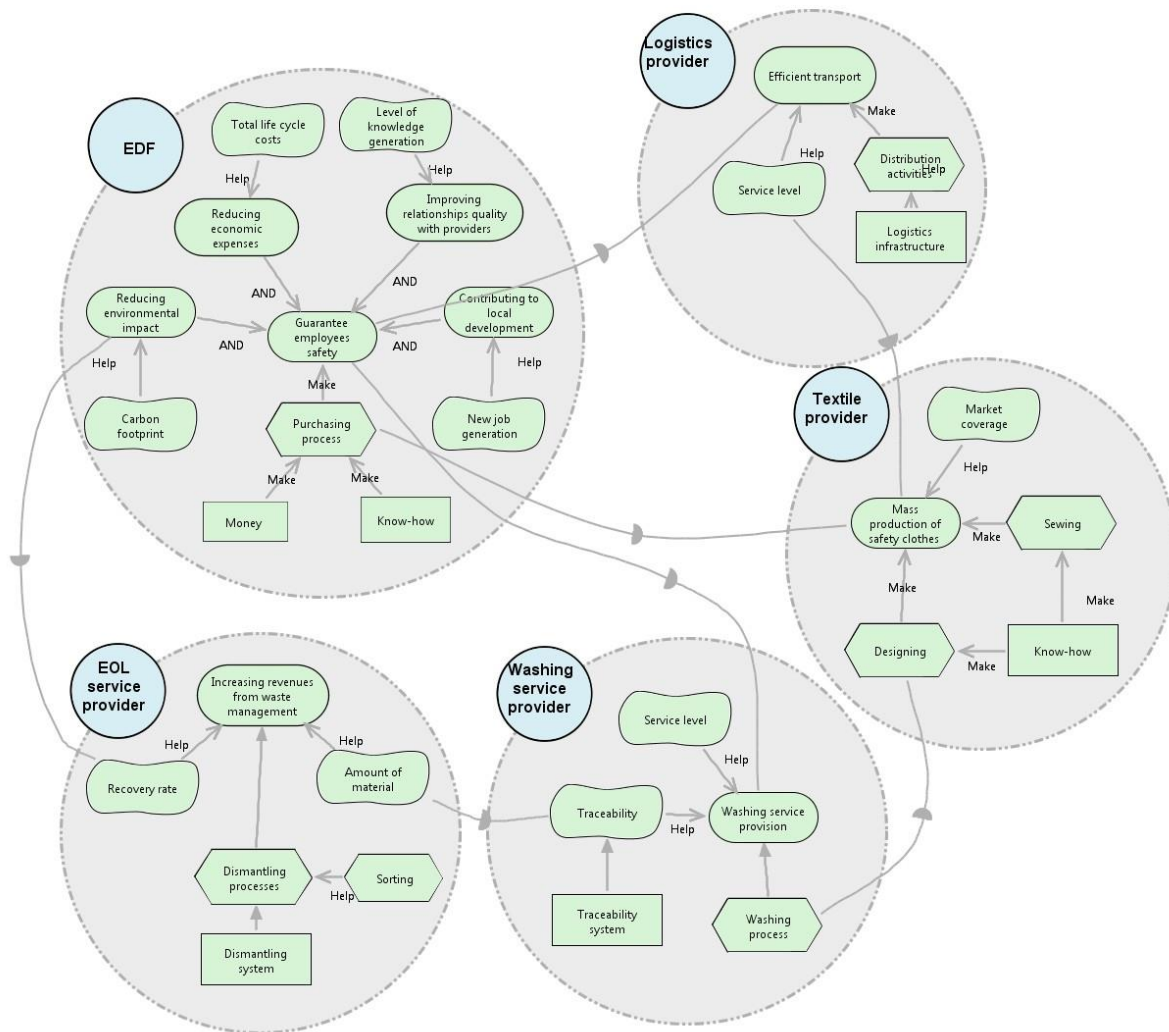

Figure 6.6: Extract of the Goal Modelling between EDF and the supply chain actors.

Criteria definition

During the development of EDF's goal model, five strategic objectives were identified, corresponding to each dimension of value creation. Then, the strategic objectives were refined into criteria. To define the criteria a combination between top-down and bottom-up approaches was implemented. Firstly, the consequence analysis of the current scenario allowed to identify the factors of value destruction, but also opportunities of value creation (see table 6.4). Secondly, the five dimensions of value were used to ask the internal actors their expected benefits throughout the project. The results of both analysis, enabled the definition of EDF strategic objectives linked to each value dimension. Then, those objectives were refined into criteria (see figure 6.6). This constituted an iterative and extensive process carried out with the key internal actors. Each group identified a set of criteria for each value dimension, establishing the link with EDF's CSR strategy. The criteria were analysed and synthesized by the research group, and then validated with the participants.

The strategic objectives were defined regarding the stages of the life cycle, defined as follows:

- (E) Economics:** reducing the purchasing costs, suppressing the users' premium, and developing circular economy in France throughout the transforming of the wasted clothing into resource. The above suggests the consideration of risks, uncertainties and return on investments in long-term horizons.
- (N) Environmental:** EDF aims at implementing an environmental management plan over the entire system, pointing out on providers management and waste treatment.
- (S) Social :** the social value for EDF is defined in terms of respect for the human rights in the manufacturing countries, dignifying conditions of employment, and development of the French economy.
- (R) Relational:** establishing long-term relationships with providers, sharing responsibilities and promoting innovation development.
- (F) Functional:** improving the lifespan of the safety clothes, establishing a system based on the availability "as needed" rather than the annual re-provisioning.

Table 6.5 details the criteria defined in collaboration with internal actors in EDF.

Table 6.5: Criteria for the evaluation of sustainable safety clothing offers.

Value dimension	Criterion	Sense	Description
Environmental(5)	Environmental quality of the fibre	+	It includes a multiple criteria evaluation taking into account: the country of production, the feasibility of production, the possibility to recycle the fibre, the emissions to the air due to the transport of raw materials, water consumption, the use of chemical products, energy consumption and the price per kg of fibre. Provider performance category according to the auditory score. Corresponds to the quantity of CO ₂ equivalent emitted to the air in the activities of transportation (from producer to the customer) and washing. Quantity of chemical used during the washing process, generating water pollution and possible health damages. Capability of the system to enable recycling expressed as the percentage of recycled material at the end of life.
	Environmental performance of providers	+	
	Carbon footprint	-	
	Chemical use	-	
	Recycling capability	+	
Economic(2)	Life cycle costs	-	Expected costs of the entire life cycle, including the cost of transforming waste.
	Purchasing cost	-	Cost to acquire a product or a service, including indirect costs.
Social(4)	Social performance of providers	+	Provider category assignment according to the auditory (bad, acceptable, good, very good).
	New job generation	+	Number of new jobs in relationship with the new system implementation (entire supply chain / life cycle of the offer).
	Employees resistance to change	+	Percentage of employees rejecting the new safety clothing system.
	Solidarity purchasing	+	Percentage of MOL and EOL services purchased to the <i>Secteur Adapté et Protégé</i> .
Relational(2)	Contribution to the brand image	+	Level of the positive impact on the image of EDF in relation to the adoption of sustainable alternatives. New knowledge (in terms of processes and competencies) acquired through the collaboration: high, medium, low, none.
	Level of innovation sharing	+	
Functional(6)	Guarantee of the fibre quality	+	Level of mechanic resistance of the fibre monitored through different type of tests (simulation, real-life). Level of service provided during the process of distribution. Considering the historical data from contractual providers. Number of washing according to historical data from service providers at MOL. Related to the ergonomics of safety clothes verified during the execution of the corresponding activities: breath-ability, adapted to weather conditions, adapted to activity, fitness with the employee needs. Level of service provided during the washing process. Considering the historical data with ancient providers. Capability to dismantle the safety clothing and use it as a resource for a new productive cycle, measured as the percentage of recovered material.
	Availability of safety clothing	+	
	Guarantee of lifespan	+	
	Comfort	+	
	Efficiency level of the traceability	+	
	Waste upgrading level	+	

Alternative identification

In the workshop taking place on December 2018, during the second phase of ICOVET project, internal and external actors worked collaboratively to generate ideas alternatives meeting EDF's criteria. Individual interviews were carried out with 11

providers (reported in table 6.2) to detail the offers. It was possible to draw out the decision focus for each stage of the life cycle.

(BOL) Beginning of life: the main decision concerns the type of fi used to manufacture the safety clothes. A critical aspect for the providers in terms of sustainability is the country of production, hence, a mix between Asian, North-African, and European production was considered. After a brainstorming integrating providers capabilities and EDF criteria for the future model, three fi options were retained.

- **Tencel:** it is a biodegradable artificial fi obtained from eucalyptus, mostly present in South Africa, but also found in European forests (e.g., Lenzing, Austria). Some of its properties include high resistance, breathability, and high absorption capacity. Concerning maintenance, high washing temperatures (up to 40°C) can produce a shrinkage of the fabric. This fi is very convenient from the environmental point of view since eucalyptus cultivation has a lower consumption water with respect to cotton, and a profit ratio between production volume and soil occupation.
- **Poly-cotton:** the main strength of using a mix with polyester is its availability on the market. Polyester is the most widely produced synthetic textile fi around the world (about 70% of synthetic fi used in the clothing industry). Poly-cotton combines the benefits of natural fibre with those of synthetic fi being cheaper than pure cotton. In terms of maintenance, this fi is fast-drying, shrinkable, almost wrinkle-less, resistant to high washing temperatures, and has a good conservation of colours after washing.
- **Organic cotton:** contrary to conventional cotton production, it is grown with natural compost that replaces chemical fertilizers and pesticides. The water consumption required for its cultivation is very less compared to conventional cotton. In terms of process, organic farming ensures the maintenance or improvement of soil fertility, dying process is done without carcinogenic substances, the fi has same structural characteristics of conventional cotton (i.e., soft, breathable, resistant, dye absorbent, and can stand up against high washing temperatures.).

(MOL) Middle of life: decisions in this stage focus on the washing system (localised or centralised) and on the type of technology used for ensuring clothes traceability (RFID tag or bar code).

- **Localised washing:** distribution model comprehending several local nodes, favouring proximity with the customer in small, well-defined areas. Some of the advantages this system offers are a good level of service in terms of order processing time and customization, and the possibility of adjusting the functioning to local needs. The above can result in cost and time savings in

terms of decision-making. Nevertheless, shipping to multiple distribution sites can negatively affect the global efficiency of the system.

- **Centralised washing:** in this model, the orders are assigned to a central base, or very few bases geographically dispersed. Fewer points of service make possible a higher level of standardization and, therefore, more efficient and easy to manage. Nevertheless, the ownership costs of large storage holds can be very high, and order processing time can be very long.
- **RFID tag:** it is an object-identification system based on non-optical proximity communication, and enables two-way communication (connected clothing). This system can be applied to inventory management, logistics, transportation, manufacturing, and product tracking. However, until nowadays the system entails some risks related to information privacy. Moreover, it presents some difficulties related to the preservation of the RFID tag due to the special conditions of washing (high temperatures for the technical clothes).
- **Bar code:** this system is commonly used for product information management to perform inventory control. It requires an optical scanner for getting the product-related information. The amount of information stored in a bar code is lower compared to RFID, nevertheless, this system does not face the security risks. Concerning EDF, this system has been already tested successfully in pilot projects in some EDF divisions.

(EOL) End of life: decisions concern the system for waste upgrading and the opportunities to develop new markets in France by using the wasted textile. Three general options are drawn out from the providers interviews.

- **New product:** this category involves some alternatives as children overalls, tennis rackets, hand towels, and car seat covers, manufactured from the recycled fibre of the wasted safety clothing. The most versatile fibre in this case is the poly-cotton, since the polyester component can be recovered in the form of plastic granules.
- **New clothing:** second-life clothing is the most desirable alternative in terms of environmental sustainability, since the transformation process is less energy consumer than the manufacturing of a different product. Nevertheless, it can produce negative impacts on employees security, since the mechanic properties of the fibre could be degraded. This alternative is suitable for safety clothes destined to low-risks activities. An important advantage of this option is the existent know-how, the available logistics and productive infrastructures, and the consolidated network of actors working on it (e.g., ADEME (*Agence de l'Environnement et de la Maîtrise de l'Energie*, in French), CETI (*Centre Européen des Textiles Innovants*, in French), French confectioners, among others).

- **Energy recovery:** it represents one of the most used practices in France for the re-valuation of non-dangerous waste. Some of the advantages of this alternative are the low cost and the possibility to treat high volumes with a high recovery rate. The disadvantages of this option are linked to air pollution and, subsequently, the increase of health risk for the surrounding communities.

6.4.3 Preference modelling

Preparation

Given the complexity of the problem treated in ICOVET project, it has been divided into three sub-problems corresponding to each stage of the life cycle, treated independently. Once the criteria and alternatives are defined the hierarchical models can be built. The first level of the hierarchy is determined by the life cycle stage general decision. The second level is determined by the dimensions of value creation, designated as E (economic), N (environmental), S (social), R (relational), and F (functional). The third level comprehends the criteria designed for each value dimension. The last level is composed by the alternatives, introduced in the above section (see figures 6.7, 6.8 and 6.9).

Analytic hierarchy process (AHP) has been used to support purchasing decisions in several contexts (Santos et al., 2019). In the particular case of ICOVET project, AHP facilitated the task of experts in manifesting their preferences, and enabled a structure collaborative approach internally to EDF, and between the company and its external stakeholders. In this case, a common hierarchical model for each stage of the life cycle has been used to perform the evaluation. The respondent actors were selected considering two criteria: first, a strategic positioning on the company and with respect to the project; and secondly, a high level of technical knowledge about the decisions treated in each stage of the offer life cycle. 16 respondents were retained for the evaluation (i.e., EDF internal actors belonging to the departments of purchasing, prescription, sustainable development, human resources, and R&D). The evaluation was performed by the means of an on-line questionnaire using the software *Sphinx*, which allows coding the collected information in Excel format for further analysis. The questionnaires were built and tested within an iterative improvement process in collaboration with the purchasing department, with the aim of ensuring the conceptual clarity and usability before launching it to the respondents. Moreover, the questionnaires were answered with the guidance of the research team involved in the project and supported by the corresponding documentation about the criteria and alternatives.

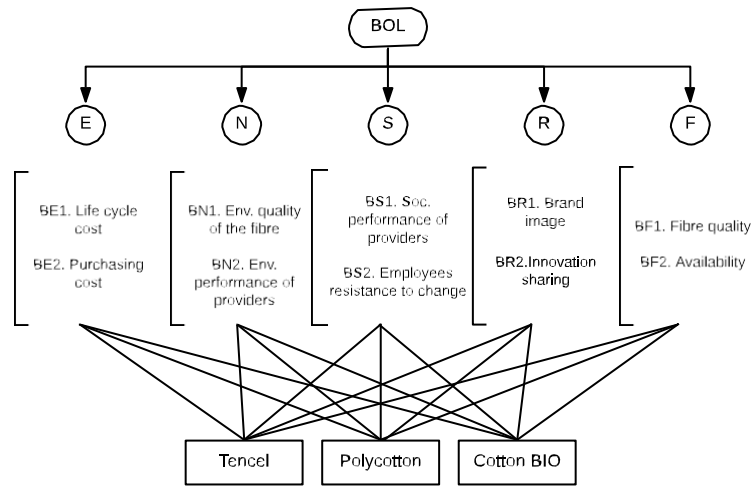

Figure 6.7: Hierarchical model of the Beginning of life (BOL).

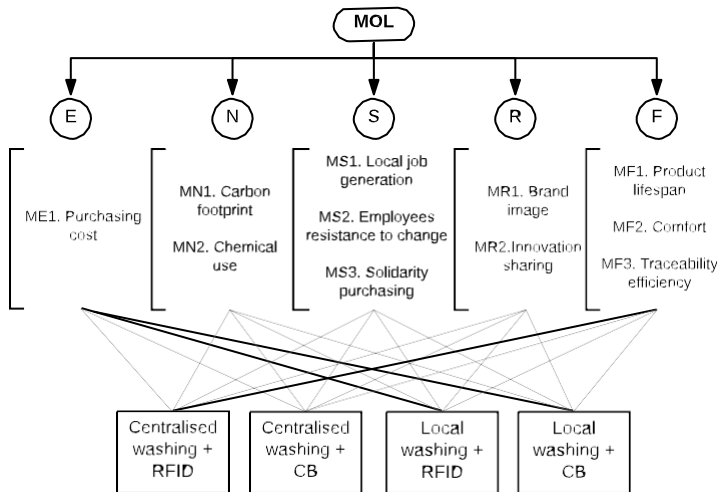

Figure 6.8: Hierarchical model of the middle of life (MOL).

Performing the evaluation process

As described in chapter 5, the evaluation process consists on the pairwise comparison between elements in each level of the hierarchical model, using the Saaty scale (Saaty, 1990). Following the recommendations of the original AHP methodology proposed by Prof. Saaty, the evaluation was carried out from the bottom to the top of the hierarchy. Hence, the respondents started by comparing the alternatives between them with respect to each criteria. Then, the criteria were compared to each other with respect to their respective value dimension. Finally the value dimensions were compared between them

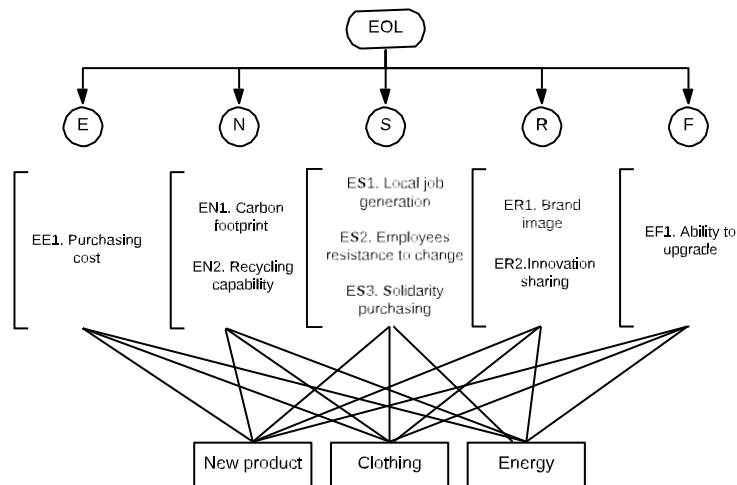

Figure 6.9: Hierarchical model of the End of life (EOL).

with respect to the main objective at the top of the hierarchical model. According to Saaty (1990), performing the evaluation from the bottom to the top facilitates the cognitive process on the respondents, since it consists on moving from the most concrete to the most abstract level of the hierarchy.

Once the evaluation was finished by all the participants, the consistency of the judgement matrices was verified throughout the calculation of the consistency ratio CR . After verification process, some of the evaluations were discarded as did not respect the threshold of acceptance in at least one of the comparison matrices. Among the 16 evaluations, 9, 12, and 8 were retained for the BOL, MOL, and EOL, respectively, since they were fully consistent ($CR < 0.1$) (see Annex D, V). The retained evaluations per stage of the life cycle represent at least one member of each key department (a sufficient condition to perform the collective analysis).

The weights were calculated for each stage of the life cycle. Tables 6.6, 6.8, and 6.10 show the results of the actors priorities with respect to value dimensions and criteria. Besides, tables 6.7, 6.9, and 6.11 present the global priorities of the alternatives defined for each stage of the life cycle. Since the evaluations were based on a common set of criteria, the aggregation of individual priorities method (AIP) (see chapter 4 for further explanation) was used to obtain the group results for value dimensions, criteria, and alternatives.

From the individual evaluations, the following insights were obtained. At the beginning of life, seven out of nine actors agree that environmental and social dimensions are a priority for the purchasing strategy regarding safety clothes (tables 6.6 and 6.7). The two remaining actors adopted a functional positioning, arguing that security should be the priority. In general economic and relational dimensions are the less important for the actors when regarding decision related to the final product. Moreover, the alternative

Table 6.6: Relative importance of the value dimensions and criteria at the beginning of life of the safety clothing system.

Criterion	A1^a	A2	A3	A4	A5	A6	A7	A8	A9	AIP
Economic	10%	5%	8%	12%	9%	9%	8%	7%	17%	9,4%
Life cycle costs	83%	88%	50%	88%	50%	88%	88%	88%	75%	77,3%
Purchasing cost	17%	13%	50%	13%	50%	13%	13%	13%	25%	22,7%
Environmental	45%	15%	42%	31%	40%	27%	44%	34%	32%	34,5%
Fibre quality	75%	50%	50%	75%	83%	83%	25%	50%	83%	63,9%
Provider performance	25%	50%	50%	25%	17%	17%	75%	50%	17%	36,1%
Social	28%	21%	15%	19%	21%	49%	25%	22%	32%	25,6%
Social performance	88%	75%	50%	17%	83%	83%	17%	88%	17%	57,4%
User resistance	13%	25%	50%	83%	17%	17%	83%	13%	83%	42,6%
Relational	14%	25%	8%	5%	18%	6%	19%	22%	12%	14,3%
Brand image	50%	83%	50%	88%	50%	50%	88%	83%	50%	65,7%
Innovation	50%	17%	50%	13%	50%	50%	13%	17%	50%	34,3%
Functional	4%	34%	27%	33%	11%	10%	4%	15%	7%	16,2%
Fibre quality	83%	50%	83%	88%	75%	25%	88%	75%	13%	64,4%
Availability	17%	50%	17%	13%	25%	75%	13%	25%	88%	35,6%

^aA= Actor; AIP= Aggregation of Individual Priorities; SAP = Solidarity purchasing

Table 6.7: Relative importance of the alternatives at the beginning of life.

Alternative	A1^a	A2	A3	A4	A5	A6	A7	A8	A9	AIP
Tencel	56%	48%	35%	35%	45%	43%	55%	36%	43%	44,1%
Poly-cotton	21%	36%	38%	37%	27%	29%	14%	20%	25%	27,5%
Cotton BIO	23%	16%	27%	28%	27%	28%	31%	44%	32%	28,5%

^aA= Actor; AIP= Aggregation of Individual Priorities

“Tencel” appears to be the most suitable regarding all the criteria and all the actors, while organic cotton is the less preferred. Nevertheless, for the two actors taking a functional positioning, the poly-cotton is the preferred alternative since it is the most available fi on the market. At the middle of life, results vary considerable from one actor to another (tables 6.8 and 6.9). A fi group of actors considers environmental and social dimensions as the priority; a second group prefers economic, functional and environmental dimensions; and the third group is rather neutral, considering that all the dimensions have a similar importance. Here, actors’ opinions are very conflicting regarding the prioritization of value dimensions, however, all the actors consider that the alternative “localised washing system ” is the most suitable to respond the decision problem at the middle of life. Finally, at the end of life, the environmental, social, and

Table 6.8: Relative importance of the value dimensions and criteria at the middle of life of the safety clothing system.

Criterion	A1 ^a	A2	A3	A4	A5	A6	A7	A8	A9	A10	A11	A12	AIP
Economic	12%	5%	10%	26%	11%	12%	10%	16%	13%	8%	14%	25%	13,6%
Environmental	49%	21%	41%	16%	25%	49%	53%	19%	38%	30%	22%	6%	30,8%
Carbon footprint	50%	50%	50%	83%	17%	83%	88%	13%	90%	50%	83%	50%	58,9%
Chemical use	50%	50%	50%	17%	83%	17%	13%	88%	10%	50%	17%	50%	41,1%
Social	24%	31%	32%	12%	24%	28%	18%	25%	10%	27%	49%	55%	28,0%
Local job	45%	24%	14%	43%	49%	45%	28%	24%	11%	45%	35%	33%	33,1%
User resistance	9%	28%	49%	14%	37%	9%	6%	21%	11%	9%	9%	33%	19,7%
SAP purchasing	45%	48%	37%	43%	14%	45%	66%	55%	78%	45%	6%	33%	43,0%
Relational	12%	21%	8%	4%	23%	5%	14%	19%	12%	9%	5%	6%	11,5%
Brand image	25%	50%	88%	83%	50%	13%	88%	17%	13%	75%	75%	50%	52,1%
Innovation	75%	50%	13%	17%	50%	88%	13%	83%	88%	25%	25%	50%	47,9%
Functional	4%	23%	9%	42%	17%	5%	4%	19%	28%	27%	9%	6%	16,1%
Lifespan	26%	14%	45%	13%	33%	66%	21%	49%	20%	44%	7%	33%	31,1%
Comfort	63%	33%	45%	75%	33%	19%	55%	37%	60%	39%	64%	33%	46,4%
Traceability	11%	52%	9%	12%	33%	16%	24%	14%	20%	17%	28%	33%	22,5%

^aA= Actor; AIP= Aggregation of Individual Priorities; SAP = Solidarity purchasing

Table 6.9: Relative importance of the alternatives at the middle of life.

Alternative	A1 ^a	A2	A3	A4	A5	A6	A7	A8	A9	A10	A11	A12	AIP
Centralised washing	33%	21%	42%	20%	41%	46%	26%	27%	12%	37%	23%	53%	32,0%
Localised washing	67%	79%	58%	80%	59%	54%	74%	73%	88%	54%	73%	47%	68,0%

^aA= Actor; AIP= Aggregation of Individual Priorities

Table 6.10: Relative importance of the value dimensions and criteria at the end of life of the safety clothing system.

Criterion	A1 ^a	A2	A3	A4	A5	A6	A7	A8	AIP
Economic	10%	5%	21%	8%	20%	20%	19%	22%	15,7%
Environmental	46%	53%	21%	41%	20%	49%	17%	16%	32,7%
Carbon footprint	17%	17%	17%	17%	17%	17%	17%	17%	16,7%
Recycling	83%	83%	83%	83%	83%	83%	83%	83%	83,3%
Social	20%	13%	12%	38%	20%	7%	54%	40%	25,5%
Local job	63%	66%	41%	72%	7%	45%	18%	41%	44,1%
User resistance	11%	16%	11%	8%	7%	9%	70%	11%	18,0%
SAP purchasing	26%	19%	48%	19%	7%	45%	11%	48%	27,9%
Relational	20%	13%	5%	6%	20%	7%	5%	10%	10,7%
Brand image	25%	50%	83%	17%	50%	50%	83%	50%	51,0%
Innovation	75%	50%	17%	83%	50%	50%	17%	50%	49,0%
Functional	4%	15%	41%	6%	20%	18%	5%	12%	15,3%

^aA= Actor; AIP= Aggregation of Individual Priorities; SAP = Solidarity purchasing

Table 6.11: Relative importance of the alternatives at the end of life.

Alternative	A1 ^a	A2	A3	A4	A5	A6	A7	A8	AIP
Other product	65%	37%	60%	27%	39%	39%	39%	37%	43,0%
New clothing	18%	49%	12%	61%	51%	29%	39%	46%	38,2%
Energy	17%	14%	28%	11%	10%	32%	22%	16%	18,9%

^aA= Actor; AIP= Aggregation of Individual Priorities

economic dimensions are the most important to take into account to evaluate the offer (tables 6.10 and 6.11). The economic dimension gained in importance with respect to the beginning and middle of life. This change reflects the actors' expectations to create new markets from circular economy strategies, but also the interest to pay as less as possible for services at the end of life, to avoid an important increase on the current purchasing costs. Concerning the alternatives, all the actors reject the energetic transformation of the safety clothes. Besides, transforming waste on a new product or on second-life safety clothing are both judged as good options by the actors, with a slightly preference by the latter.

6.4.4 Researching a consensus

Clustering process

Firstly, the similarity matrices based on actors preferences were calculated (see Annex E, V), then, the corresponding clustering algorithm reported in 5 was executed by using *R Studio*. The procedure was applied to each stage of the life cycle, aiming at identifying actor's decisional profile if they exist. A *dendrogram* (tree-like graph) corresponding to each stage of the life cycle was obtained from the clustering method (see figures 6.10, 6.11, 6.12). We implemented the procedure to the criteria priority matrices, since they show conflicting preferences between the actors, while the alternatives priority matrices are rather consensual.

After applying the dendrogram rule for clustering selection, two or three clusters can be identified for each stage of the life cycle, detailed in the following.

At the beginning of life, two main clusters were identified. $C1_{BOL}$ formed by actors A2, A3 and A4; and $C2_{BOL}$ constituted by actors A1, A5, A6, A7, A8 and A9. The first cluster comprehends actors whose priority is the functional dimension of the safety clothes, seen as a means to achieve environmental sustainability. The second cluster is formed by actors who consider environmental and social dimensions as the priority to select the type of life cycle. The common characteristic observed among all the actors is the weak importance allocated to the economic dimension.

At the middle of life, four well defined clusters can be identified. The first $C1_{MOL}$ composed by actors A1, A3, A6, and A7; $C2_{MOL}$ by actors A2, A5, and A8; $C3_{MOL}$ integrates A9, and A10; and $C4_{MOL}$ formed by actors A4, A11, and A12. Actors in

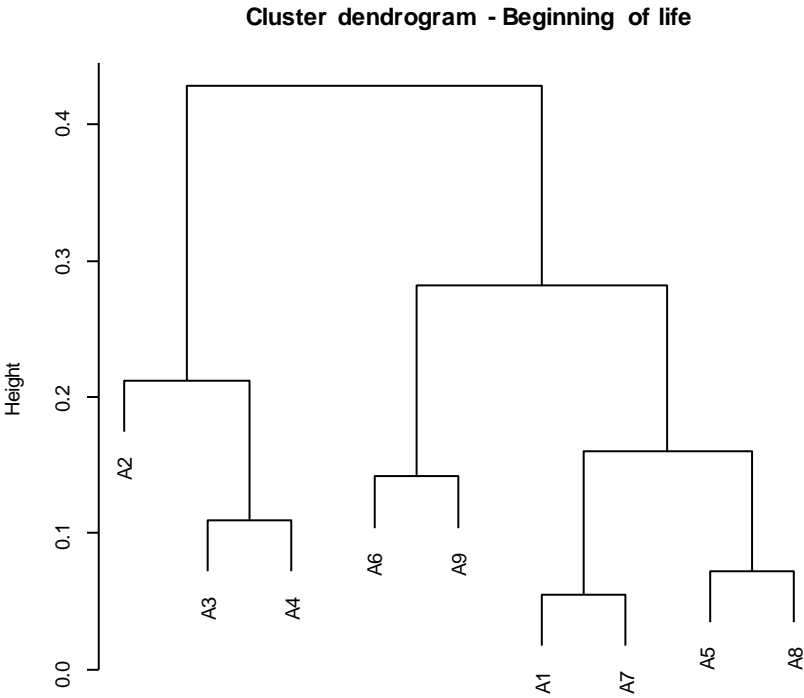

Figure 6.10: Cluster dendrogram of actors' priorities at the beginning of life.

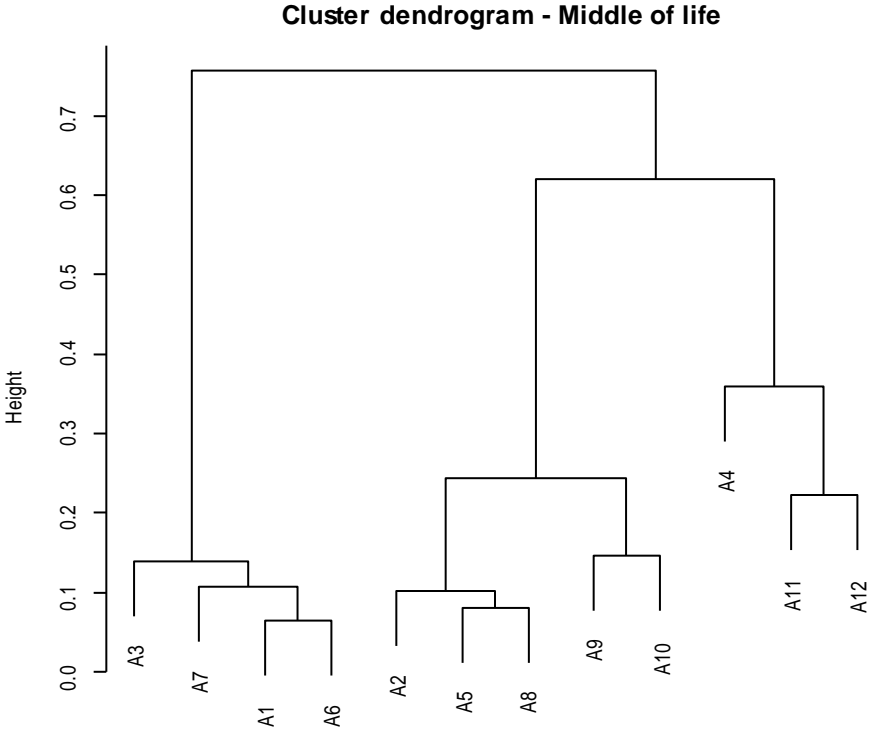

Figure 6.11: Cluster dendrogram of actors' priorities at the middle of life.

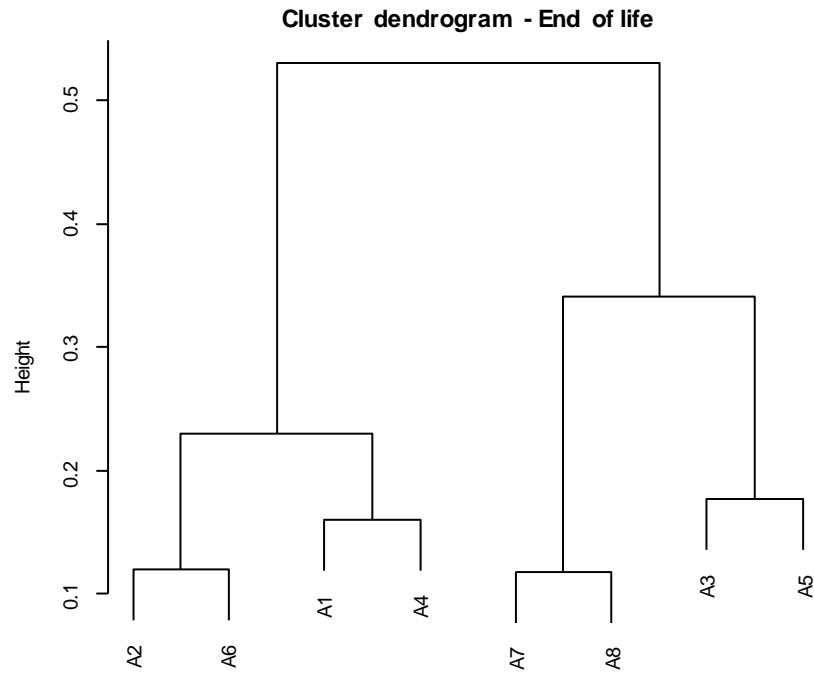

Figure 6.12: Cluster dendrogram of actors' priorities at the end of life.

$C1_{MOL}$ prioritize environmental and social dimensions. Actors in $C2_{MOL}$ allocate a similar importance to all the value dimensions, suggesting a trade-off between them. The actors in $C3_{MOL}$ consider the functional dimension as the main priority and as a means to favour environmental sustainability. Finally, $C4_{MOL}$ integrates actors with a particular and isolated positioning about the priorities, A11 mostly oriented to the socio-economical development; while A4 is an outlier element with respect to all the formed clusters.

At the end of life, two main clusters were identified, $C1_{EOL}$ formed by actors A1, A2, A4, and A6, characterised by a strong environmental positioning. $C2_{EOL}$ formed by actors A3, A5, A7 and A8, reveals an increased importance of the economic dimension in comparison with the results obtained at the beginning and middle of life.

Decisional profiles in sustainable value creation In the case of ICOVET, the resulting clusters can be assimilated to three decisional profiles: eco-efficiency, societal, and triple bottom line (TBL).

- **Eco-efficiency:** the identified clusters for this profile in the different phases of the life cycle are $C1_{BOL}$, $C3_{MOL}$, and $C2_{EOL}$.

When adopting this profile EDF is willing to reduce environmental impacts only if the economic expenses are kept stable (i.e., in relation to the current model of safety clothing). Internally, this decisional profile is translated into the combined efforts of the purchasing and prescription departments, with the support of sustainable development. Concerning the relationship with the providers, EDF

adopts a prescriptive positioning rather than collaborative, in which the purchasing function asks for eco-innovative products to the providers.

- **Societal:** in this profile clusters $C2_{BOL}$, $C1_{MOL}$, and $C1_{EOL}$ are positioned.

This profile supposes strong internal transformation to EDF. For instance, the roles of sustainable development and human resources departments gain in importance in the definition of the purchasing strategy. Besides, the purchasing department should be able to cooperate with the providers of the entire supply chain in order to accomplish sustainability goals from a normative perspective. Such a collaboration should be a common effort to transform the supply chain practices and co-create sustainable offer portfolios covering the entire life cycle.

- **Triple bottom line (TBL):** here, only the cluster $C2_{MOL}$ is identified.

In this case, EDF is willing to pay higher prices for the safety clothing washing services (i.e., degradation of economic dimension), while reducing the environmental and social impacts, and guaranteeing the traceability and the quality of the product (i.e., improvement of environmental, social, and functional dimensions).

In the case of EDF, these profiles represent an input for the transformation of the purchasing strategy.

Actors' prioritization

According to the three decisional profiles the actors have been prioritized differently. In the societal profile sustainable development and human resources departments were allocated with the highest values in the three criteria Power (P), Legitimacy (L), and Urgency (U). Regarding the eco-efficiency profile prescription and purchasing departments were prioritized with the highest scores. As for the TBL profile all actors have the same priority, the aggregation results are the same as AIP (i.e., resulting from the arithmetic mean of all the actors' priorities).

The results are presented in tables 6.12, 6.13, and 6.14, corresponding to each stage of the life cycle. The results show a slight variability on the criteria priorities, corresponding to the definition of each profile. For instance, the eco-efficiency profile reveals an increase on the priority of the functional dimension of value. In the societal profile the priorities of the environmental and social dimensions are improved. In contrast, the results regarding the alternatives on the different stages of the life cycle remains stable. The above is explained by the general agreement between the actors concerning the alternatives for all the stages of the life cycle.

Regarding the results, EDF is able to select between the more convenient profile and adopt accordingly its purchasing strategy. Nevertheless, it is recommended to evaluate the collective acceptance of the final decision.

Table 6.12: Results aggregation at the beginning of life according to decisional profi

Criterion	TBL	Eco-efficiency	Societal
Economic	9%	10%	9%
Life cycle costs	77%	75%	83%
Purchasing costs	23%	25%	17%
Environmental	34%	34%	38%
Fibre quality	64%	66%	64%
Provider env. performance	36%	34%	36%
Social	26%	24%	30%
Provider soc. Performance	57%	56%	67%
User resistance	43%	44%	33%
Relational	14%	14%	14%
Brand image	66%	65%	62%
Innovation	34%	35%	38%
Functional	16%	17%	10%
Fibre quality	64%	63%	67%
Availability	36%	37%	33%
Alternatives			
Tencel	44%	42%	50%
Poly-cotton	27%	28%	23%
Cotton BIO	28%	30%	26%

Table 6.13: Results aggregation at the middle of life according to decisional profiles.

Criterion	TBL	Eco-efficiency	Societal
Economic	14%	12%	12%
Environmental	31%	28%	40%
Carbon footprint	59%	53%	64%
Chemical use	41%	47%	36%
Social	28%	23%	24%
Local job	33%	43%	37%
User resistance	20%	17%	12%
Solidarity purchasing	43%	40%	51%
Relational	12%	12%	13%
Brand image	52%	63%	39%
Innovation	48%	37%	61%
Functional	16%	24%	11%
Lifespan	31%	32%	30%
Comfort	46%	47%	51%
Traceability	22%	22%	19%
Alternatives			
Centralised washing	32%	34%	31%
Localised washing	67%	65%	69%

Table 6.14: Results aggregation at the end of life according to decisional profiles.

Criterion	TBL	Eco-efficiency	Societal
Economic	16%	18%	11%
Environmental	33%	29%	41%
Carbon footprint	17%	17%	17%
Recycling	83%	83%	83%
Social	25%	22%	27%
Local job	44%	44%	63%
User resistance	18%	19%	12%
Solidarity purchasing	28%	37%	25%
Relational	11%	8%	12%
Brand image	51%	63%	31%
Innovation	49%	37%	69%
Functional	15%	23%	9%
Alternatives			
Other product	43%	48%	46%
New clothing	38%	29%	38%
Energy	19%	23%	16%

6.5 Conclusions

The main intention of this chapter was to illustrate the applicability of the proposed framework, resulting from this thesis work. Hence, ICOVET project was analysed, an initiative of innovation triggered by EDF (*Electricité de France*, in French), seeking for the transformation of its safety clothing system by considering sustainability goals. The project involves the participation of current and potential providers of EDF belonging to the safety clothing supply chain. This project represents a non-typical case of sustainable innovation development, in which the initiative is triggered by the customer, without any previous knowledge about the possible solutions. Moreover, from EDF's perspective, ICOVET project represents a strategic sourcing problem, centred on innovation development from the initiative of purchasing department. The project is also a way to reinforce the relationships between EDF and its providers.

The case has been analysed following the four steps of the proposed methodological framework: i) value analysis, ii) problem structure modelling, iii) preference modelling, and iv) consensus process. Several methods were implemented in each step of the framework, and the main results were discussed and confronted with the company reality, deriving into some managerial recommendations. Firstly, the framework allowed representing hidden customer needs and encouraging the industrial transformation towards sustainable and innovative businesses. Secondly, from the cognitive point of view, the approach enabled an iterative process of knowledge generation and capitalisation between the internal and external actors. Thirdly, the approach helped to elucidate the priorities of the key actors in terms of value creation, analysing their compatibility, and proposing a process to reach a form of consensus. Finally, some conclusions can be highlighted regarding the managerial implications to EDF. Particularly, the analysis of decisional profiles represent a base for the transformation of EDF's purchasing strategy.

Part IV

General conclusion

Chapter 7

Conclusions and research perspectives

Contents

7.1 Further discussion.....	115
7.2 Scientific contributions and implications.....	116
7.3 Managerial contributions and implications.....	117
7.4 Limits of the study.....	118

7.1 Further discussion

This thesis work contributes to the literature on sustainability, innovation, and value creation. Precisely, the proposed framework contributes to the conceptualization, modelling and assessment of sustainable value creation in the contexts of collaborative innovation between industrial actors. The framework has been built from solid conceptual basis obtained from literature review in the domains of value creation, innovation management, system modelling, and decision-making. Our proposal is, thus, the result of the convergence between several disciplines, demonstrating the complexity that sustainable value creation conveys.

The framework is structured in four main phases: 1) value analysis, 2) problem structure modelling, 3) preference modelling, and 4) researching a consensus. Several methods were implemented in each phase, and the framework has been tested in a real case related to sustainability improvement through collaborative innovation. The adopted approach helped to structure the expectations of the key actors in terms of value creation, analyse actors' compatibilities, and propose a decision aid for consensus building. In the following, the main contributions derived from literature review, the proposed framework, and the case study are described according to the research axes reported on chapter 1.

7.2 Scientific contributions and implications

Research axe 1 – Conceptualization of sustainable value creation. This was addressed through the phase 1 of the proposal. Indeed, we propose a framework to characterise sustainable value into five dimensions namely, economics, environmental, social, relational, and functional. The five dimensions resulted from a deep analysis of the literature on the notion of value. This framework is useful to understand and to represent the value created in sustainability-oriented businesses (e.g., circular economy, product-service systems, industrial symbiosis, among others). The value framework was implemented in the ICOVET project, allowing representing hidden customer needs. This multidimensional characterisation of value allows overcoming the barriers of economic interests, enabling the representation of new benefits emerging from the collaboration (e.g., relational value creation throughout knowledge sharing). Furthermore, the value characterisation framework represents a tool to encourage the industrial transformation towards sustainable and innovative businesses.

Research axe 2 – Modelling collaborative innovation processes. This was addressed through the phase 2 of the proposal. Supported by Problem Structure Modelling (PSM) tools, a collaborative innovation approach was proposed. This approach, named in this work “value alignment generic model” aims at aligning customer value expectations with providers’ value propositions. The generic model is implemented through goal modelling techniques. This approach allows to structure complex situations, which involve several dimensions of value creation and actors. Based on the value alignment modelling, it is possible to refine the value creation dimensions into criteria from the perspective of each actor. Then, from the criteria, feasible value propositions can be identified. This step of the framework allowed reducing the problem complexity, moving from a highly unstructured representation of actors expectations towards a structured set of criteria and alternatives. This step provided the required inputs for modelling actor’s preferences, supported by a multi-criteria decision analysis method.

Research axe 3– Value assessment in early phases of collaborative innovation. This was addressed through the phases 3 and 4 of the proposal. Sustainable value creation in the context of collaborative innovation has been approached as a multi-stakeholder and multi-criteria decision problem in this thesis work. Then, the Analytic Hierarchy Process was selected to structure the complex decision situation, and to perform preference modelling. AHP was selected since it appears suitable for unstructured and very complex problems. Moreover, it allows capturing actor’s subjectivity and knowledge lacking, which are typical characteristic of radical innovation problems. From the cognitive point of view, AHP helped to perform an iterative process of knowledge generation and capitalisation between the actors. From the practical point of view, the approach was supported by the development of an on-line questionnaire, reproducible over other decision situations beyond the safety clothing system.

Furthermore, we proposed to enrich AHP with actors' importance issued from the Stakeholder Theory, and to couple it with a clustering technique. The clustering technique allows to identify actors' positioning, that can be crossed with a set of named "sustainability profile" and "decisional profile" were proposed, based on the literature in sustainability. The output of this process provides a base for discussion and negotiation between several stakeholders, enabling a form of consensus.

7.3 Managerial contributions and implications

Considering the managerial objective described in 6.3.2, subsection 6.3.2, the main implications derived from the proposed framework are the following:

Identifying the conditions to stimulate the development of radical innovation in both the offer and the organisation of the actors implied in the safety clothing supply chain. During the first phase of the ICOVET project, several seminars were developed with internal and external actors. The main results allowed identifying the internal and external conditions to develop a radical innovative offering. For instance, internal conditions can be summarized into the following points: inter-department collaboration; transforming of the internal culture towards sustainability (i.e., eliminating the resistance to change of the employees); re-orienting the purchasing strategy overcoming the *value for money* mindset; improving internal skills with respect to sustainability practices; moving from the purchasing focus towards supply management focus. Besides, external conditions mainly evokes the following aspects: creating a market for innovative offer development; sharing costs of innovation (e.g., prototyping, technology upgrading, logistics configuration, among others); deploying vertical and horizontal collaboration schemes (i.e., integrating economic and non-economic actors); guaranteeing long-term relationships between the customer and the providers; and ensuring the willingness to pay for innovation.

Enhancing the global performance of the purchasing function concerning the CSR company strategy. The collective effort carried out along the ICOVET project resulted on a first step towards the transformation of EDF's purchasing strategy. The results obtained after the two years of the project revealed an increase of the maturity on the purchasing function. The above is reflected on a declared willingness to pay a higher price in exchange of a better offer in terms of environmental, social, and functional performance. Although, EDF is still constrained by the public procurement policies in France (i.e., any no provider can be privileged by arbitrary selection criteria). Nevertheless, the results of the ICOVET project provides a base for discussion and co-creation with the provider panel, encouraging the development of sustainable and innovative solutions. Moreover, the results represent a first step towards the consolidation of new customer needs regarding the sourcing of safety clothing, which can be reproduced within other purchasing companies.

Improving the corporate image of the company throughout the integration of sustainability criteria in the purchasing decisions. With the development of ICOVET project, EDF acquired new skills and knowledge about radical innovation development, sustainability, and collaboration with external actors. Thus, the results of the project represent a collective learning process, in which internal and external actors discovered new ways to work together for improving collective progress. Although the results can not be incorporated immediately neither on the purchasing strategy nor in the textile supply chain, they constitute a powerful communication instrument that pushes the internal and external transformation towards sustainability. In concrete terms, the project triggered the acceleration of providers' innovation processes, and promoted the consolidation of sustainability-oriented requirements regarding the safety clothing fi

Encouraging long-term relationships with the providers along the life cycle. One of the identified conditions stated by the providers to develop innovative solutions, is the guarantee of long-term relationships. After the project, new links were created between EDF and some economic and non-economic actors. Moreover the conditions to establish collaborative partnerships were discussed, concerning the contract duration, investments conditions, and knowledge sharing. However, nowadays there is no a concrete proposal from the providers to respond the emerging needs of EDF regarding the safety clothing. This fact reveals a lack of maturity of the textile industry to integrate sustainability-oriented requirements. Nevertheless, the providers consider this panorama as an opportunity to progress rather than a constraint. Certainly, further work is still needed in collaboration with the actors on the supply chain to reach concrete sustainable value propositions and collaborative agreements.

7.4 Limits of the study

The limits can be classified into two main categories, the fi one concerning to the methodological approach, and the second one regarding the implemented methods along the framework phases.

The methodological approach. Firstly, considering the empirical methodology, one major limit is about the analysis of an unique case study, making the results very context-dependant. As a perspective, the proposed framework should be implemented in diff t cases and industrial sectors, for further validation.

Secondly, the decision situation was addressed separately at each stage the life cycle of the offer development. Although this allowed holding complexity, the interdependencies between solutions at each stage of the life cycle have not been considered. Hence, as a research perspective, a combinatorial phase of analysis could enrich the decision process, providing comprehensive and more realistic results.

Thirdly, although many actors on the textile supply chain were included in the problem structuring phase, the decisional phase of the proposal was focused on EDF perspective.

For future research, the framework should be applied with a broader set of stakeholders, verifying its applicability in more complex situations.

The implemented methods. The main limits found in the proposed framework are related to the multi-stakeholder and multi-criteria decision analysis part. The first major issue concerns the subjective evaluation, given the use of the Analytic Hierarchy Process (AHP). The subjectivity character of this method becomes a weakness when the evaluators are not experts in the concerned domain. Moreover, in the presence of incomplete information, the results are subject to high uncertainty, which makes it risky for strategic decisions. Moreover, the application of AHP can be very time-consuming for a high number of compared elements.

Some research perspectives are derived from these limits. For instance, combining AHP with quantitative methods helps to reduce the uncertainty of the final decision. Moreover, when quantitative data is available, domain experts are not mandatory to perform the evaluation process.

The second point concerns the consensus process. Here, the major difficulty consists on meeting all actor's preferences. In realistic situations, only partial consensus can be reached. A research perspective in this direction is the integration of a satisfaction measure to evaluate the appropriateness of a given solution with respect to each actor.

Scientific productions

International conference articles

- Towards an integration of life cycle thinking into PSS business models. ([Orellano et al., 2018b](#))
- The demand-pull approach to business model innovation through product-service systems: a case study. ([Orellano et al., 2018a](#))
- A system modelling approach to collaborative PSS design. ([Orellano et al., 2019a](#))
- A Multi-criteria Approach to Collaborative Product-Service Systems Design. ([Orellano et al., 2019b](#))

Poster presentations

- Sustainable Business Models design for Product Service Systems: a collaborative innovation approach. *Journée de la recherche ED-SIS2019, Saint-Étienne, France.*

References

- Aczél, J. and Saaty, T. (1983). Procedures for synthesizing ratio judgements. *Journal of Mathematical Psychology*, 27(1):93–102.
- Airike, P.-E., Rotter, J. P., and Mark-Herbert, C. (2016). Corporate motives for multi-stakeholder collaboration- corporate social responsibility in the electronics supply chains. *Journal of Cleaner Production*, 131:639 – 648.
- Aquilani, B., Silvestri, C., Ioppolo, G., and Ruggieri, A. (2018). The challenging transition to bio-economies: Towards a new framework integrating corporate sustainability and value co-creation. *Journal of Cleaner Production*, 172:4001–4009.
- Aria, M. and Cuccurullo, C. (2017). bibliometrix: An r-tool for comprehensive science mapping analysis. *Journal of Informetrics*, 11(4):959 – 975.
- Arnold, M. (2017). Fostering sustainability by linking co-creation and relationship management concepts. *Journal of Cleaner Production*, 140:179–188.
- Baldassarre, B., Calabretta, G., Bocken, N. M. P., and Jaskiewicz, T. (2017). Bridging sustainable business model innovation and user-driven innovation: A process for sustainable value proposition design. *Journal of Cleaner Production*, 147:175–186.
- Ballantyne, D., Frow, P., Varey, R. J., and Payne, A. (2011). Industrial Marketing Management Value propositions as communication practice : Taking a wider view. *Industrial Marketing Management*, 40(2):202–210.
- Barney, J. (1991). Firm resources and sustained competitive advantage. *Journal of Management*, 17(1):99–120.
- Basak, I. and Saaty, T. (1993). Group decision making using the analytic hierarchy process. *Mathematical and Computer Modelling*, 17(4):101 – 109.
- Baudry, G., Macharis, C., and Valée, T. (2018). Range-based multi-actor multi-criteria analysis: A combined method of multi-actor multi-criteria analysis and monte carlo simulation to support participatory decision making under uncertainty. *European Journal of Operational Research*, 264(1):257 – 269.

- Best, B., Moffett, S., Hannibal, C., and Mcadam, R. (2018). Examining networked ngo services: reconceptualising value co-creation. *International Journal of Operations & Production Management*, 38(7):1540–1561.
- Bocken, N. M., Rana, P., and Short, S. W. (2015). Value mapping for sustainable business thinking. *Journal of Industrial and Production Engineering*, 32(1):88–102.
- Bocken, N. M. P., Short, S. W., Rana, P., and Evans, S. (2014). A literature and practice review to develop sustainable business model archetypes. *Journal of Cleaner Production*, 65:42–56.
- Boons, F. and Lüdeke-Freund, F. (2013). Business models for sustainable innovation: state-of-the-art and steps towards a research agenda. *Journal of Cleaner Production*, 45:9–19.
- Boström, M., Jönsson, A. M., Lockie, S., Mol, A. P., and Oosterveer, P. (2015). Sustainable and responsible supply chain governance: challenges and opportunities. *Journal of Cleaner Production*, 107:1 – 7.
- Bowman, C. and Ambrosini, V. V. (2000). Value creation versus value capture: towards a coherent definition of value in strategy. *British journal of management*, 11(1):1–15.
- Brehmer, M., Podoyntsyna, K., and Langerak, F. (2018). Sustainable business models as boundary-spanning systems of value transfers. *Journal of Cleaner Production*, 172:4514 – 4531.
- Brown, P., Bocken, N., and Balkenende, R. (2019). Why do companies pursue collaborative circular oriented innovation? *Sustainability*, 11(3).
- Bruno, G., Esposito, E., Genovese, A., and Simpson, M. (2016). Applying supplier selection methodologies in a multi-stakeholder environment: A case study and a critical assessment. *Expert Systems with Applications*, 43:271 – 285.
- Buxel, H., Esenduran, G., and Griffin, S. (2015). Strategic sustainability: Creating business value with life cycle analysis. *Business Horizons*, 58(1):109–122.
- Calabrese, A., Forte, G., and Ghiron, N. L. (2018). Fostering sustainability-oriented service innovation (SOSI) through business model renewal: The SOSI tool. *Journal of Cleaner Production*, 201:783 – 791.
- Chai, J., Liu, J. N., and Ngai, E. W. (2013). Application of decision-making techniques in supplier selection: A systematic review of literature. *Expert Systems with Applications*, 40(10):3872 – 3885.
- Chen, L. and Ren, J. (2018). Multi-attribute sustainability evaluation of alternative aviation fuels based on fuzzy anp and fuzzy grey relational analysis. *Journal of Air Transport Management*, 68:176 – 186.

- Chen, L., Zhao, X., Tang, O., Price, L., Zhang, S., and Zhu, W. (2017). Supply chain collaboration for sustainability: A literature review and future research agenda. *International Journal of Production Economics*, 194:73 – 87.
- Chesbrough, H. (2007). Business model innovation: it's not just about technology anymore. *Strategy & Leadership*, 35(6):12–17.
- Chesbrough, H. and Rosenbloom, R. S. (2002). The role of the business model in capturing value from innovation: evidence from Xerox Corporation's technology spin-off companies. *Industrial and Corporate Change*, 11(3):529–555.
- Chester Goduscheit, R. and Faullant, R. (2018). Paths toward radical service innovation in manufacturing companies—a service-dominant logic perspective. *Journal of Product Innovation Management*, 35(5):701–719.
- Cobo, M., López-Herrera, A., Herrera-Viedma, E., and Herrera, F. (2011). An approach for detecting, quantifying, and visualizing the evolution of a research fi A practical application to the Fuzzy Sets Theory fi *Journal of Informetrics*, 5(1):146–166.
- Corsaro, D., Ramos, C., Henneberg, S. C., and Naudé, P. (2012). The impact of network configurations on value constellations in business markets - The case of an innovation network. *Industrial Marketing Management*, 41(1):54–67.
- Coutelle-Brillet, P., Riviere, A., and Garets, V. D. (2014). Perceived value of service innovation : a conceptual framework. *Journal of Business & Industrial Marketing*, 2:164–172.
- Cunningham, S. W. and van der Lei, T. E. (2009). Decision-making for new technology: A multi-actor, multi-objective method. *Technological Forecasting and Social Change*, 76(1):26 – 38.
- Dalpiaz, F., Franch, X., and Horkoff, J. (2016). istar 2.0 language guide. *CoRR*.
- De Montis, A., De Toro, P., Droste-Franke, B., Omann, I., and Stagl, S. (2005). *Assessing the quality of different MCDA methods*, pages 99–133.
- Derrouiche, R., Neubert, G., Bouras, A., and Savino, M. (2010). B2B relationship management: a framework to explore the impact of collaboration. *Production Planning & Control*, 21(6):528 – 546.
- Di Stefano, G., Gambardella, A., and Verona, G. (2012). Technology push and demand pull perspectives in innovation studies: Current fi and future research directions. *Research Policy*, 41(8):1283–1295.
- Dominguez-Péry, C., Ageron, B., and Neubert, G. (2013). A service science framework to enhance value creation in service innovation projects. An RFID case study. *International Journal of Production Economics*, 141(2):440–451.

- Doualle, B., Medini, K., Boucher, X., Brissaud, D., and Laforest, V. (2019). Selection method of sustainable product-service system scenarios to support decision-making during early design stages. *International Journal of Sustainable Engineering*, 0(0):1–16.
- Dowling, A. W., Ruiz-Mercado, G., and Zavala, V. M. (2016). A framework for multi-stakeholder decision-making and conflict resolution. *Computers & Chemical Engineering*, 90:136–150.
- Dumond, E. J. (2000). Value management: an underlying framework. *International Journal of Operations & Production Management*, 20(9):1062–1077.
- Edwards-Schachter, M. (2018). The nature and variety of innovation. *International Journal of Innovation Studies*, 2(2):65–79.
- Eggert, A., Ulaga, W., Frow, P., and Payne, A. (2018). Conceptualizing and communicating value in business markets : From value in exchange to value in use. *Industrial Marketing Management*, 69:80–90.
- Eggert, A., Ulaga, W., and Schultz, F. (2006). Value creation in the relationship life cycle: A quasi-longitudinal analysis. *Industrial Marketing Management*, 35(1):20–27.
- Ekman, P., Raggio, R. D., and Thompson, S. M. (2016). Service network value co-creation: Defining the roles of the generic actor. *Industrial Marketing Management*, 56:51–62.
- Erdoğan, Ş., Aras, H., and Koç, E. (2006). Evaluation of alternative fuels for residential heating in turkey using analytic network process (ANP) with group decision-making. *Renewable and Sustainable Energy Reviews*, 10(3):269–279.
- Escobar, M. T. and Moreno-jiménez, J. M. (2007). Aggregation of individual preference structures in AHP-group decision making. *Group Decision and Negotiation*, 16(4):287–301.
- Ford, D. and Mouzas, S. (2013). Service and value in the interactive business landscape. *Industrial Marketing Management*, 42(1):9–17.
- Freeman, R. E., Harrison, J. S., Wicks, A. C., Parmar, B. L., and de Colle, S. (2010). *Stakeholder Theory: The State of the Art*. Cambridge University Press.
- Friend, J. and Hickling, A. (1987). *Planning under pressure: the strategic choice approach*. Urban and regional planning series. Pergamon Press.
- Garcia, R., Wigger, K., and Hermann, R. R. (2019). Challenges of creating and capturing value in open eco-innovation: Evidence from the maritime industry in denmark. *Journal of Cleaner Production*, 220:642–654.

- García-Melón, M., Gladish, B., Gómez-Navarro, T., and Méndez-Rodríguez, P. (2016). Assessing mutual funds' corporate social responsibility: a multistakeholder-AHP based methodology. *Annals of Operations Research*, 244.
- Geissdoerfer, M., Savaget, P., Bocken, N. M., and Hultink, E. J. (2017). The circular economy - a new sustainability paradigm? *Journal of Cleaner Production*, 143:757 – 768.
- Geum, Y., Kim, J., Son, C., and Park, Y. (2013). Development of dual technology roadmap (TRM) for open innovation: Structure and typology. *Journal of Engineering and Technology Management*, 30(3):309 – 325.
- Giordano, R., Passarella, G., Uricchio, V., and Vurro, M. (2007). Integrating conflict analysis and consensus reaching in a decision support system for water resource management. *Journal of environmental management*, 84:213–28.
- Govindan, K., Kannan, D., and Shankar, K. M. (2014). Evaluating the drivers of corporate social responsibility in the mining industry with multi-criteria approach: A multi-stakeholder perspective. *Journal of Cleaner Production*, 84:214 – 232.
- Grimm, J. H., Hofstetter, J. S., and Sarkis, J. (2014). Critical factors for sub-supplier management: A sustainable food supply chains perspective. *International Journal of Production Economics*, 152:159 – 173.
- Grönroos, C. and Voima, P. (2013). Critical service logic: Making sense of value creation and co-creation. *Journal of the Academy of Marketing Science*, 41(2):133–150.
- Haas, A., Snehota, I., and Corsaro, D. (2012). Creating value in business relationships: The role of sales. *Industrial Marketing Management*, 41(1):94–105.
- Hajkovicz, S. A. (2008). Supporting multi-stakeholder environmental decisions. *Journal of Environmental Management*, 88(4):607 – 614.
- Hallikas, J., Immonen, M., Pynnönen, M., and Mikkonen, K. (2014). Service purchasing and value creation: Towards systemic purchases. *International Journal of Production Economics*, 147:53 – 61.
- Hankammer, S. and Kleer, R. (2018). Degrowth and collaborative value creation: Reflections on concepts and technologies. *Journal of Cleaner Production*, 197:1711 – 1718.
- Hänninen, N. and Karjaluoto, H. (2017). Environmental values and customer-perceived value in industrial supplier relationships. *Journal of Cleaner Production*, 156:604–613.
- Harmsen, H. and Jensen, B. (2004). Identifying the determinants of value creation in the market: A competence-based approach. *Journal of Business Research*, 57(5):533–547.

- Hart, S. L., Milstein, M. B., and Ruckelshaus, W. (2003). Creating sustainable value. *Academy of Management Executive*, 17(2):56–67.
- Harzing, A.-W. and Alakangas, S. (2016). Google Scholar, Scopus and the Web of Science: a longitudinal and cross-disciplinary comparison. *Scientometrics*, 106(2):787–804.
- Hellström, M., Tsvetkova, A., Gustafsson, M., and Kim Wikstr (2015). Collaboration mechanisms for business models in distributed energy ecosystems. *Journal of Cleaner Production*, 102:226–236.
- Hellström, T. (2007). Dimensions of environmentally sustainable innovation: the structure of eco-innovation concepts. *Sustainable Development*, 15(3):148 – 159.
- Hsieh, P.-F., Lee, C.-S., and Ho, J. C. (2012). Strategy and process of value creation and appropriation in service clusters. *Technovation*, 32(7):430–439.
- Huemer, L. (2006). Supply Management. Value Creation, Coordination and Positioning in Supply Relationships. *Long Range Planning*, 39(2):133–153.
- Huizingh, E. K. (2011). Open innovation: State of the art and future perspectives. *Technovation*, 31(1):2 – 9.
- Igoulalene, I., Benyoucef, L., and Tiwari, M. K. (2015). Novel fuzzy hybrid multi-criteria group decision making approaches for the strategic supplier selection problem. *Expert Systems with Applications*, 42(7):3342 – 3356.
- Jaakkola, E. and Hakanen, T. (2013). Value co-creation in solution networks. *Industrial Marketing Management*, 42(1):47–58.
- Jain, A. K. (2010). Data clustering: 50 years beyond k-means. *Pattern Recognition Letters*, 31(8):651 – 666.
- Joyce, A. and Paquin, R. L. (2016). The triple layered business model canvas: A tool to design more sustainable business models. *Journal of Cleaner Production*, 135(Supplement C):1474–1486.
- Jugend, D., Jabbour, C. J. C., Alves Scaliza, J. A., Rocha, R. S., Junior, J. A. G., Latan, H., and Salgado, M. H. (2018). Relationships among open innovation, innovative performance, government support and firm size: Comparing Brazilian firms embracing different levels of radicalism in innovation. *Technovation*, 74:54 – 65.
- Kähkönen, A.-K. and Lintukangas, K. (2018). Key dimensions of value creation ability of supply management. *International Journal of Operations & Production Management*.
- Kaihara, T., Nishino, N., Ueda, K., Tseng, M., Váncza, J., and Sch P. (2018). Value creation in production: Reconsideration from interdisciplinary approaches. *CIRP Annals*, 67(2):791 – 813.

- Kang, K. H. and Kang, J. (2014). Do external knowledge sourcing modes matter for service innovation? empirical evidence from south korean service fi *Journal of Product Innovation Management*, 31(1):176 – 191.
- Karthik, T. and Gopalakrishnan, D. (2014). *Environmental Analysis of Textile Value Chain: An Overview*, pages 153–188. Springer Singapore, Singapore.
- Keeney, R. L. (1996). Value-focused thinking: Identifying decision opportunities and creating alternatives. *European Journal of Operational Research*, 92(3):537 – 549.
- Kohtamäki, M. and Rajala, R. (2016). Theory and practice of value co-creation in B2B systems. *Industrial Marketing Management*, 56:4 – 13.
- Kothandaraman, P. and Wilson, D. T. (2001). The Future of Competition: Value-Creating Networks. *Industrial Marketing Management*, 30(4):379–389.
- Kumar, A., Sah, B., Singh, A. R., Deng, Y., He, X., Kumar, P., and Bansal, R. (2017). A review of multi criteria decision making (MCDM) towards sustainable renewable energy development. *Renewable and Sustainable Energy Reviews*, 69:596 – 609.
- Kumar, V., Shirodkar, P. S., Camelio, J. A., and Sutherland, J. W. (2007). Value flow characterization during product lifecycle to assist in recovery decisions. *International Journal of Production Research*, 45(18-19):4555–4572.
- Lacoste, S. (2016). Sustainable value co-creation in business networks. *Industrial Marketing Management*, 52:151–162.
- Lages, L. F. (2016). VCW Value Creation Wheel: Innovation, technology, business, and society. *Journal of Business Research*, 69(11):4849–4855.
- Lancker, J. V., Mondelaers, K., Wauters, E., and Huylenbroeck, G. V. (2016). The organizational innovation system: A systemic framework for radical innovation at the organizational level. *Technovation*, 52-53:40 – 50.
- Lapierre, J. (2000). Customer-perceived value in industrial contexts. *Journal of Business & Industrial Marketing*, 15(2/3):122–145.
- Lee, S., Geum, Y., Lee, S., and Park, Y. (2015). Evaluating new concepts of PSS based on the customer value: Application of ANP and niche theory. *Expert Systems with Applications*, 42:4556–4566.
- Li, T. H. Y., Ng, S. T., and Skitmore, M. (2016). Modeling multi-stakeholder multi-objective decisions during public participation in major infrastructure and construction projects: A decision rule approach. *Journal of Construction Engineering and Management*, 142(3):04015087.

- Lin, Y.-T., Lin, C.-L., Yu, H.-C., and Tzeng, G.-H. (2010). A novel hybrid MCDM approach for outsourcing vendor selection: A case study for a semiconductor company in taiwan. *Expert Systems with Applications*, 37(7):4796 – 4804.
- Lindgreen, A. and Wynstra, F. (2005). Value in business markets: What do we know? Where are we going? *Industrial Marketing Management*, 34(7):732–748.
- Liu, S. and Qian, S. (2019). Evaluation of social life-cycle performance of buildings: Theoretical framework and impact assessment approach. *Journal of Cleaner Production*, 213:792 – 807.
- Liu, Z., Ming, X., and Song, W. (2019). A framework integrating interval-valued hesitant fuzzy DEMATEL method to capture and evaluate co-creative value propositions for smart PSS. *Journal of Cleaner Production*, 215:611 – 625.
- Lusch, R. F. and Vargo, S. L. (2006). Service-dominant logic: reactions, reflections and refinements. *Marketing Theory*, 6(3):281–288.
- Macharis, C., Turcksin, L., and Lebeau, K. (2012). Multi actor multi criteria analysis (mamca) as a tool to support sustainable decisions: State of use. *Decision Support Systems*, 54(1):610 – 620.
- Maestrini, V., Luzzini, D., Maccarrone, P., and Caniato, F. (2017). Supply chain performance measurement systems: A systematic review and research agenda. *International Journal of Production Economics*, 183(Part A):299–315.
- Maine, E., Thomas, V., and Utterback, J. (2014). Radical innovation from the confluence of technologies: Innovation management strategies for the emerging nanobiotechnology industry. *Journal of Engineering and Technology Management*, 32:1 – 25.
- Manda, B. M. K., Bosch, H., Karanam, S., Beers, H., Bosman, H., Rietveld, E., Worrell, E., and Patel, M. K. (2016). Value creation with life cycle assessment: an approach to contextualize the application of life cycle assessment in chemical companies to create sustainable value. *Journal of Cleaner Production*, 126(Supplement C):337–351.
- Mathivathanan, D., Kannan, D., and Haq, A. N. (2018). Sustainable supply chain management practices in indian automotive industry: A multi-stakeholder view. *Resources, Conservation and Recycling*, 128:284–305.
- Matinheikki, J., Rajala, R., and Peltokorpi, A. (2017). From the profit of one toward benefitting many - Crafting a vision of shared value creation. *Journal of Cleaner Production*, 162:S83–S93.
- Medini, K., Cunha, C. D., and Bernard, A. (2015). Tailoring performance evaluation to specific industrial contexts – application to sustainable mass customisation enterprises. *International Journal of Production Research*, 53(8):2439–2456.

- Mingers, J. and Rosenhead, J. (2004). Problem structuring methods in action. *European Journal of Operational Research*, 152(3):530 – 554.
- Mitchell, R. K., Agle, B. R., and Wood, D. J. (1997). Toward a theory of stakeholder identification and salience: Defining the principle of who and what really counts. *The Academy of Management Review*, 22(4):853–886.
- Möller, K. K. and Tönen, P. (2003). Business suppliers' value creation potential: A capability-based analysis. *Industrial Marketing Management*, 32(2):109–118.
- Neutzling, D. M., Land, A., Seuring, S., and Nascimento, L. (2017). Linking sustainability-oriented innovation to supply chain relationship integration. *Journal of Cleaner Production*, 172.
- Norese, M. F. (2006). ELECTRE III as a support for participatory decision-making on the localization of waste-treatment plants. *Land Use Policy*, 23(1):76 – 85.
- Nudurupati, S. S., Bhattacharya, A., Lascelles, D., and Caton, N. (2015). Strategic sourcing with multi-stakeholders through value co-creation: An evidence from global health care company. *International Journal of Production Economics*, 166:248 – 257.
- Orellano, M., Lambey-Checchin, C., Medini, K., and Neubert, G. (2018a). The demand-pull approach to business model innovation through product-service systems: A case study. In Moon, I., Lee, G. M., Park, J., Kiritsis, D., and von Cieminski, G., editors, *IFIP International Conference on Advances in Production Management Systems (APMS)*, volume AICT-535, pages 201–210. Springer International Publishing.
- Orellano, M., Lambey-Checchin, C., Medini, K., and Neubert, G. (2018b). Towards an integration of lifecycle thinking into pss business models. *Procedia CIRP*, 73:291 – 296.
- Orellano, M., Medini, K., Lambey-Checchin, C., and Neubert, G. (2019a). A system modelling approach to collaborative pss design. *Procedia CIRP*, 83:218 – 223.
- Orellano, M., Medini, K., Lambey-Checchin, C., Norese, M.-F., and Neubert, G. (2019b). A multi-criteria approach to collaborative product-service systems design. In Ameri, F., Stecke, K. E., von Cieminski, G., and Kiritsis, D., editors, *Advances in Production Management Systems. Towards Smart Production Management Systems*, pages 481–489. Springer International Publishing.
- Patala, S., Jalkala, A., Keränen, J., Väisänen, S., Tuominen, V., and Soukka, R. (2016). Sustainable value propositions: Framework and implications for technology suppliers. *Industrial Marketing Management*, 59:144–156.
- Payne, A. and Holt, S. (1999). A Review of the 'Value' Literature and Implications for Relationship Marketing. *Australian Marketing Journal*, 7.

- Payne, A. F., Storbacka, K., and Frow, P. (2008). Managing the co-creation of value. *Journal of the Academy of Marketing Science*, 36(1):83–96.
- Pieroni, M., McALOone, T., and Pigosso, D. (2019). Business model innovation for circular economy and sustainability: A review of approaches. *Journal of Cleaner Production*, 215.
- Pope, J., Annandale, D., and Morrison-Saunders, A. (2004). Conceptualising sustainability assessment. *Environmental Impact Assessment Review*, 24(6):595 – 616.
- Prahalad, C. K. and Ramaswamy, V. (2004). Co-creating unique value with customers. *Strategy & Leadership*, 32(3):4–9.
- Ren, J., Manzardo, A., Mazzi, A., Zuliani, F., and Scipioni, A. (2015). Prioritization of bioethanol production pathways in china based on life cycle sustainability assessment and multicriteria decision-making. *The International Journal of Life Cycle Assessment*, 20(6):842–853.
- Reypens, C., Lievens, A., and Blazevic, V. (2016). Leveraging value in multi-stakeholder innovation networks: A process framework for value co-creation and capture. *Industrial Marketing Management*, 56:40–50.
- Rohrbeck, R., Konnertz, L., and Knab, S. (2013). Collaborative business modelling for systemic and sustainability innovations. *International Journal of Technology Management*, 63(1 - 2):4 – 23.
- Romero, D. and Molina, A. (2011). Collaborative networked organisations and customer communities: value co-creation and co-innovation in the networking era. *Production Planning & Control*, 22(5-6):447–472.
- Rothwell, R. (1992). Developments towards the fifth generation model of innovation. *Technology Analysis & Strategic Management*, 4(1):73–75.
- Roy, B. (1991). The outranking approach and the foundations of elective methods. *Theory and Decision*, 31(1):49–73.
- Saaty, T. L. (1990). How to make a decision: The analytic hierarchy process. *European Journal of Operational Research*, 48(1):9 – 26.
- Saebi, T. and Foss, N. J. (2015). Business models for open innovation: Matching heterogeneous open innovation strategies with business model dimensions. *European Management Journal*, 33(3):201–213.
- Santos, P. H. D., Neves, S. M., Sant’Anna, D. O., de Oliveira, C. H., and Carvalho, H. D. (2019). The analytic hierarchy process supporting decision making for sustainable development: An overview of applications. *Journal of Cleaner Production*, 212:119 – 138.

- Schenkel, M., Krikke, H., Caniels, M. C. J., and van der Laan, E. (2015). Creating integral value for stakeholders in closed loop supply chains. *Journal of Purchasing and Supply Management*, 21(3):155–166.
- Schiele, H. (2006). How to distinguish innovative suppliers? identifying innovative suppliers as new task for purchasing. *Industrial Marketing Management*, 35(8):925 – 935.
- Schillo, R. S., Isabelle, D. A., and Shakiba, A. (2017). Linking advanced biofuels policies with stakeholder interests: A method building on quality function deployment. *Energy Policy*, 100:126 – 137.
- Schöggl, J.-P., Fritz, M. M. C., and Baumgartner, R. J. (2016). Sustainability assessment in automotive and electronics supply chains—a set of indicators defined in a multi-stakeholder approach. *Sustainability*, 8(11).
- Schweizer, L. and He, J. (2018). Guiding principles of value creation through collaborative innovation in pharmaceutical research. *Drug Discovery Today*, 23(2):213 – 218.
- Seuring, S. and Gold, S. (2013). Sustainability management beyond corporate boundaries: from stakeholders to performance. *Journal of Cleaner Production*, 56:1 – 6.
- Shaw, N. E. and Burgess, T. F. (2013). Innovation-sharing across a supply network: barriers to collaboration. *Production Planning & Control*, 24(2 - 3):181 – 194.
- Sjödin, D. R., Parida, V., and Wincent, J. (2016). Value co-creation process of integrated product-services: Effect of role ambiguities and relational coping strategies. *Industrial Marketing Management*, 56:108–119.
- Spekman, R. E. (1988). Strategic supplier selection: Understanding long-term buyer relationships. *Business Horizons*, 31(4):75 – 81.
- Srdjevic, B., Srdjevic, Z., Blagojevic, B., and Suvocarev, K. (2013). A two-phase algorithm for consensus building in AHP-group decision making. *Applied Mathematical Modelling*, 37(10):6670 – 6682.
- Thabrew, L., Wiek, A., and Ries, R. (2009). Environmental decision making in multi-stakeholder contexts: applicability of life cycle thinking in development planning and implementation. *Journal of Cleaner Production*, 17(1):67 – 76.
- Turcksin, L., Bernardini, A., and Macharis, C. (2011). A combined AHP-PROMETHEE approach for selecting the most appropriate policy scenario to stimulate a clean vehicle fleet. *Procedia - Social and Behavioral Sciences*, 20:954 – 965.
- Ueda, K., Takenaka, T., Váncza, J., and Monostori, L. (2009). Value creation and decision-making in sustainable society. *CIRP Annals*, 58(2):681 – 700.

- Uлага, W. (2003). Capturing value creation in business relationships: A customer perspective. *Industrial Marketing Management*, 32(8):677–693.
- Vargo, S. L. and Lusch, R. F. (2008). Service-dominant logic: continuing the evolution. *Journal of the Academy of Marketing Science*, 36(1):1–10.
- Vezzoli, C., Kohtala, C., and Srinivasan, A. (2014). *Product-Service System Design for Sustainability*.
- Volschenk, J., Ungerer, M., and Smit, E. (2016). Creation and appropriation of socio-environmental value in cooperation. *Industrial Marketing Management*, 57:109–118.
- Wagner, S. M., Eggert, A., and Lindemann, E. (2010). Creating and appropriating value in collaborative relationships. *Journal of Business Research*, 63(8):840–848.
- Walker, H. and Preuss, L. (2008). Fostering sustainability through sourcing from small businesses: public sector perspectives. *Journal of Cleaner Production*, 16(15):1600 – 1609.
- Walter, A., Ritter, T., and Gemünden, H. G. (2001). Value Creation in Buyer-Seller Relationships: Theoretical Considerations and Empirical Results from a Supplier's Perspective. *Industrial Marketing Management*, 30(4):365–377.
- Wang, X., Persson, G., and Huemer, L. (2016). Logistics Service Providers and Value Creation Through Collaboration: A Case Study. *Long Range Planning*, 49(1):117–128.
- West, J. and Bogers, M. (2016). Open innovation: current status and research opportunities. *Innovation*, pages 1 – 8.
- Westerlund, M. and Svahn, S. (2008). A relationship value perspective of social capital in networks of software SMEs. *Industrial Marketing Management*, 37(5):492–501.
- Xing, K., Wang, H.-F. F., and Qian, W. (2013). A sustainability-oriented multi-dimensional value assessment model for product-service development. *International Journal of Production Research*, 51(19):5908–5933.
- Yan, T. and Wagner, S. M. (2017). Do what and with whom? Value creation and appropriation in inter-organizational new product development projects. *International Journal of Production Economics*, 191(May):1–14.
- Yan, T., Yang, S., and Dooley, K. (2017). A theory of supplier network-based innovation value. *Journal of Purchasing and Supply Management*, 23(3):153–162.
- Yang, M., Evans, S., Vladimirova, D., and Rana, P. (2017). Value uncaptured perspective for sustainable business model innovation. *Journal of Cleaner Production*, 140:1794–1804.

-
- Yoon, C., Lee, K., Yoon, B., and Toulan, O. (2017). Typology and success factors of collaboration for sustainable growth in the it service industry. *Sustainability*, 9.
- Yu, E. S. (2009). *Social Modeling and i**, pages 99–121. Springer Berlin Heidelberg, Berlin, Heidelberg.
- Yu, S., Giorgini, P., Maiden, N., and Mylopoulos, J. (2011). *Social modeling for requirements engineering*. Mit Press.
- Zacharias, N. A., Nijssen, E. J., and Stock, R. M. (2016). Effective configurations of value creation and capture capabilities: Extending Treacy and Wiersema’s value disciplines. *Journal of Business Research*, 69(10):4121–4131.
- Zahir, S. (1999). Clusters in a group: Decision making in the vector space formulation of the analytic hierarchy process. *European Journal of Operational Research*, 112(3):620 – 634.
- Zhang, X. and Chen, R. (2008). Examining the mechanism of the value co-creation with customers. *International Journal of Production Economics*, 116(2):242–250.

Part V
Appendices

Annex A: Interview guidelines Internal actors

Interlocuteur (Nom, fonction):

L'objet spécifique de cet entretien est de connaître les processus internes d'achat, approvisionnement, entretien et fin de vie des vêtements de travail chez EDF et leurs relations avec les acteurs externes, ainsi que les opportunités d'innovation visées.

Parmi les points évoqués ce matin sur les questions d'impact et les opportunités d'amélioration au niveau de la valeur à chaque étape du cycle de vie, est-ce que vous avez des remarques, interrogations.... ? Voulez-vous revenir sur un élément ?

Connaissance de l'Interlocuteur (Nom, fonction, ancienneté...):**L. Première phase : Diagnostic Marché des Vêtements de travail****1.1. Généralités du Marché / Développement de Filière innovante**

Question d'ouverture : Comment caractérisez-vous, décrivez-vous le marché du vêtement de travail ? (Stable, diversifié, hostile, coopératif?)

Sous-thèmes	Informations à recueillir	Questions
Acteurs en présence	<ul style="list-style-type: none"> • Nombre, poids et caractéristiques, Intermédiaires • Caractéristiques offre/demande • Relations entre les acteurs 	<ol style="list-style-type: none"> 1. Quelle est votre perception sur le marché ? Peut-on parler de marché dominé par quelques fournisseurs ? 2. Veillez-vous à ce que les acteurs impliqués sur les différentes étapes du processus de fabrication se connaissent ? <ul style="list-style-type: none"> - Entretiennent-ils des relations collaboratives ?
Contexte et Evolution du Marché / nouveaux entrants	<ul style="list-style-type: none"> • Tendances du marché : passés, actuelles, futures • Réglementation (évolution des normes et contexte légal) • Evolutions technologiques • Enjeux <p>SWOT</p> <ul style="list-style-type: none"> • Opportunités • Contraintes • Menaces 	<ol style="list-style-type: none"> 1. A votre avis, quelles sont et seront les tendances du marché ? (<i>Les acteurs, les prix, les évolutions des fibres, ennoblissement, l'ergonomie, la sécurité, l'usage, customisation.</i>) 2. Quels sont les besoins d'innovation produit en fonction des priorités chez EDF ? <ul style="list-style-type: none"> - Y-a-t-il dans le marché actuel des offres qui répondent à ces besoins ? - Quelles sont les principales difficultés rencontrées ? - Quels sont les obstacles à leur résolution ? 3. Y-a-t-il des nouveaux entrants au marché ? Sont-ils innovants ? quelles sont ses forces ?
Développement de nouvelles filières (Lin-chanvre, ortie)	<ul style="list-style-type: none"> • Opportunités • Contraintes • Menaces • Enjeux 	<ol style="list-style-type: none"> 1. La direction parle de filière lin-chanvre et d'autres, qu'en pensez-vous ? 2. A votre avis quelle serait la plus-value de cette filière ? 3. A quelle condition pourrait-elle représenter une plus-value ? 4. Quels seraient les freins à la prise en compte de cette filière lin-chanvre dans vos achats ? les leviers pour les lever ?

1.2. Politique Produit - vêtements de travail

Question d'ouverture : En ce qui concerne les vêtements de travail, quel regard portez-vous ? Quels sont les éléments clés de la politique produit ?

1.3. Politique Fournisseur

Sous-thèmes	Informations à recueillir	Questions
Elaboration de la stratégie achats chez EDF	<ul style="list-style-type: none"> Ethique, qualité, politiques produits et fournisseurs Gouvernance 	<ol style="list-style-type: none"> Vous choisissez vos prestataires sur une stratégie de mieux disance. Mais au final, est-ce que vous choisissez le moins cher ? De quelle manière réalisez-vous un benchmark des pratiques des donneurs d'ordres ? Quelles sont les ressources extérieures (les parties prenantes) que vous mobilisez pour vous aider à déterminer votre stratégie achats ? Quel poids est accordé au critère monétaire ? et aux critères non monétaires (DD, innovation.) ? Avez-vous apporté des modifications sur ces critères ? lesquelles ?
Prix	<ul style="list-style-type: none"> Coût Marge 	<ol style="list-style-type: none"> Comment vous assurez-vous que les prix garantissent la pérennité économique des fournisseurs ?
Aspects contractuels	<ul style="list-style-type: none"> Consultation Négociation Contractualisation 	<ol style="list-style-type: none"> Quelles sont les étapes clés du déroulement de la négociation ? Quelles sont les améliorations qui ont pu être apportées dans le cadre des partenariats productivité ?
Nature des relations	<ul style="list-style-type: none"> Plan Ethique Partage d'information, Transparence Interdépendance Index PCI (justice,, courage, tempérance, patience) 	<ol style="list-style-type: none"> Comment percevez-vous les relations entre EDF et ses fournisseurs (hors Bétrancourt)? Quels sont les éléments déterminants dans la nature de ses relations ? Y-a-t-il des difficultés chez les fournisseurs qui nuisent au processus achat? Percevez-vous des opportunités de collaboration complémentaires avec les fournisseurs en place?

Conclusion de la première partie : Synthèse du diagnostic sur stratégie achat.

II. Deuxième phase : Diagnostic et identification des processus internes et de l'organisation

2.1. Description du Processus (internes et externes) et acteurs concernés

- Qui sont les parties prenantes avec lesquelles vous êtes amenées à collaborer sur la question des vêtements de travail (internes, externes, ...) ?
- Comment qualifiez-vous les relations entretenues avec la prescription ? En phase de définition du besoin ? dans la phase de négociation ? Dans le suivi du marché ?
- Pensez-vous à des acteurs externes qui seraient ou pourraient être impliqués dans la requalification du besoin ou sur la réalisation du marché ?

- Quel est le processus de retour d'expérience*

- Comment évaluez-vous la politique achats en matière de vêtements de travail ?
- Comment mesurez-vous la performance achats ? Y-a-t-il des indicateurs spécifiques ?
- Comment se formalise le retour d'expérience ?

2.2. Identifications des opportunités et points d'amélioration

- De votre point de vue, quelles sont les opportunités d'amélioration ?

De façon globale, quelles difficultés majeures trouvez-vous dans les processus internes liés au vêtements de travail ? Quelles perspectives ?

Conclusion de la deuxième partie : Synthèse du diagnostic processus. Cartographie à demander.

III. Troisième phase : Diagnostic du marché et Développement d'une offre collaborative / innovante

Sous-thèmes	Informations à recueillir	Questions
Innovation de l'offre de VT (basé service)	<ul style="list-style-type: none"> Motivations Freins et leviers Besoins de transformations organisationnelles 	<ol style="list-style-type: none"> Pourriez-vous reformuler votre besoin sous forme d'une unité fonctionnelle ? (<i>Besoin d'usage, performance.</i>) Avez-vous déjà eu l'occasion d'expérimenter d'autres formes de mises à disposition des vêtements de travail (location, location-entretien ?...) Si oui, quelles ont été vos retours d'expériences par rapport à ces formes de prestations ? <ul style="list-style-type: none"> Quelles seraient vos motivations à (re)développer ce type de pratique VT chez EDF ? Le numérique est-il de nature à améliorer les offres proposées ? Avez-vous déjà des propositions sur le sujet ? Quelles seraient les transformations induites par une dotation à l'usure dans votre organisation ? La mise en place d'un système produits-service pourrait-elle remettre en question les prestataires actuels ? Quelle valeur ajoutée en attendre ? Quels risques ? Avez-vous déjà recensé des prestataires susceptibles de vous aider ?
Pratiques collaboratives	<ul style="list-style-type: none"> Collaboration interne et externe actuel Besoins de collaboration pour le futur 	<p>Comment appréciez-vous la qualité et le niveau de la collaboration en interne?</p> <ul style="list-style-type: none"> Comment les faire évoluer ? Sur quels points il sera difficile de les faire évoluer ? <p>Et en externe</p> <ul style="list-style-type: none"> Qui sont les autres PP extérieures au groupe et aux prestataires avec qui vous collaborez sur ce thème ? <ul style="list-style-type: none"> Quels sont leurs rôles ? Quelle relation ?
Impact sur le service Achat	<ul style="list-style-type: none"> Impact du changement du modèle dans le processus achats Impact sur la valeur de l'offre Impact sur votre métier d'acheteur 	<ol style="list-style-type: none"> Si vous deviez aujourd'hui repasser un marché, quelles seraient les améliorations ? <ul style="list-style-type: none"> Vous proposeriez quel type de stratégie ? Quels bénéfices pour EDF, vous, les usagers... ? quelles difficultés ? Comment voyez-vous évoluer votre métier d'acheteur ? Quelles sont ou quelles seraient les compétences à développer pour intégrer une offre SPS ? les changements de processus ?

Avez-vous d'autres éléments que nous n'avons pas abordés et qui vous viennent à l'esprit, vous paraissent importants de nous mentionner.

Conclusion globale finale.

Merci de votre participation

L'objet spécifique de cet entretien est de connaître la contribution du service DD chez EDF au marché et à la mise à disposition des vêtements de travail et de connaître le positionnement du service DD face aux opportunités d'innovation visées.

Parmi les points évoqués ce matin sur les questions d'impact et les opportunités d'amélioration au niveau de la valeur à chaque étape du cycle de vie, est-ce que vous avez des remarques, interrogations...? Voulez-vous revenir sur un élément ?

Connaissance de l'Interlocuteur (Nom, fonction, ancienneté...):

Première phase : Généralités politique de Développement Durable / Développement de Filière innovante

Du point de vue du DD quel regard portez-vous sur le sujet des VT en lien avec la fonction achats du groupe ?

Sous-thèmes	Questions
Comprendre le rôle actuel de l'acteur	<ul style="list-style-type: none"> - Quelle est votre contribution au marché du vêtement de travail ? Avec quelle organisation ? <ul style="list-style-type: none"> o Depuis combien de temps travaillez-vous sur ce sujet ? o Avec qui travaillez-vous ? Externe ? interne ? o A quelles étapes ? - Comment envisagez-vous les innovations en matière de textile ?
Contribution au marché Vêtements	<ul style="list-style-type: none"> - Avez-vous des attentes particulières ? - Une des opportunités d'amélioration réside dans le développement de nouvelles filières lin-chanvre, ortie, ... Quel est votre regard à ce sujet ? <ul style="list-style-type: none"> o Avez-vous pensé à d'autres alternatives ? - Quelle pourrait être votre contribution ?
Perception de la transformation de l'offre et rôle dans la transformation	<ul style="list-style-type: none"> - Comment à votre avis peut être modifiée la valeur? Sur quels aspects du DD peut travailler ? Quelle valeur ajoutée ? - Pour vous, la transformation de l'offre s'accompagne t'elle d'un changement au niveau de votre service ? lequel ? - Quels bénéfices percevez-vous pour votre service, entreprise, usagers ? Quels freins au développement identifiez-vous ? - Quels risques ?
Stratégie de Développement Durable et les achats	<ul style="list-style-type: none"> - EDF est engagé sur Six objectifs de DD (changement climatique, développement humain, précarité énergétique, efficacité énergétique, Dialogue et concertation, biodiversité) - Quelle est la contribution des achats à ces objectifs ? - Quels sont les critères que vous avez prescrits en matière d'achats de vêtements de travail ? - Y-a-t'il des indicateurs de performance qui vous sont remontés sur ce marché ?

- Sinon, comment évaluez-vous la **performance environnementale** et sociale en matière de vêtements de travail ?
- A votre avis, quels sont les **points critiques du parcours des VT** qui pourraient être améliorés en regardant la politique RSE-DD de EDF ?
Matières premières, tissage, distribution, usage, fin de vie...?
- Quels pourraient être les **freins** à l'amélioration de ces pratiques ?
- Comment **communiquez**-vous en interne les **changements** au niveau des axes du DD ?

Conclusion de la première partie : Synthèse du diagnostic sur stratégie RSE-DD en lien avec les achats.

Deuxième phase : Développement d'une offre collaborative / innovante

Sous-thèmes	Questions
Innovation de l'offre de VT (basé service)	<ul style="list-style-type: none"> - Pourriez-vous reformuler votre besoin sous forme d'une unité fonctionnelle? J'ai besoin d'un vêtement conçu pour X Et Y utilisations ? et comportementale ? qui va servir à quoi ? pourquoi ? - Avez-vous déjà eu l'occasion d'expérimenter d'autres formes de mises à disposition des vêtements de travail (location, location-entretien ?...) Si oui, quels ont été vos retours d'expériences par rapport à ces formes de prestations ?
Condition de collaboration	<ul style="list-style-type: none"> - Comment qualifiez-vous la qualité de la collaboration avec les acteurs internes au groupe qui interviennent sur le vêtement de travail ? Avez-vous l'occasion de travailler avec les usagers ? - Avez-vous l'occasion de rencontrer les acteurs impliqués dans la fourniture des produits ou les prestations de service ? Quelle est votre perception sur ces prestataires ? - Avez-vous l'occasion de rencontrer d'autres acteurs qui ne sont pas titulaires de ces marchés mais qui pourraient l'être à l'avenir ? - Ces offres peuvent-elles être de nature à changer la représentation du besoin ? - Comment appréciez-vous la qualité de la relation avec les prestataires avec lesquels vous êtes en contact ?
Condition de collaboration avec les autres PP	<ul style="list-style-type: none"> - Qui sont les autres PP extérieures au groupe et aux prestataires avec qui vous collaborez sur ce thème ? - Quels sont leurs rôles ? Quelle relation ?

Avez-vous d'autres éléments que nous n'avons pas abordés et qui vous viennent à l'esprit, vous paraissent importants de nous mentionner.

Merci de votre participation

Annex B: Interview guidelines External actors

Interlocuteur (Nom, fonction):

Première phase : Diagnostic du Marché des Vêtements de travail

1.1. Généralités du Marché / Développement de Filière innovante

Question d'ouverture : Comment caractérisez-vous, décrivez-vous le marché du vêtement de travail ?
(Stable, diversifié, hostile, coopératif ?)

Sous-thèmes	Informations à recueillir	Questions
Acteurs en présence	<ul style="list-style-type: none">• Nombre, poids et caractéristiques, Intermédiaires• Caractéristiques offre/demande• Relations entre les acteurs	<ol style="list-style-type: none">1. Quelle est votre perception sur le marché ? Peut-on parler de marché dominé par quelques fournisseurs ?2. Comment vous positionnez-vous ?3. Avez-vous des contacts avec l'ensemble des acteurs de la filière (culture, tissage, ennoblissement, confection, logistique, mise à disposition, fin de vie ?) - Qui ? Où ils se trouvent ?4. Comment qualifiez vous :<ul style="list-style-type: none">- la qualité de la relation ? (Rythme, fréquence, projets collaboratifs, ...)
Contexte et Evolution du Marché / nouveaux entrants	<ul style="list-style-type: none">• Tendances du marché : passés, actuelles, futures• Réglementation (évolution des normes et contexte légal)• Evolutions technologiques• Enjeux <p>SWOT</p> <ul style="list-style-type: none">• Opportunités• Contraintes• Menaces	<ol style="list-style-type: none">1. A votre avis, quelles sont et seront les tendances du marché ? (<i>Les acteurs, les prix, les évolutions des fibres, ennoblissement, l'ergonomie, la sécurité, l'usage, customisation, la réglementation</i>)2. Quels sont les nouveaux besoins que vous ressentez de la part de vos clients ?3. Où vous positionnez vous par rapport à ces nouvelles tendances ? Avez-vous déjà fait des expériences d'innovation ? lesquelles ? Dans quel contexte ?4. Y-a-t-il des nouveaux entrants au marché ? Sont-ils innovants ? quelles sont ses forces ?

1.2. Politique Fournisseur

Sous-thèmes	Informations à recueillir	Questions
Elaboration de la stratégie achats chez EDF	<ul style="list-style-type: none"> Ethique, qualité, politiques produits et fournisseurs Gouvernance 	<ol style="list-style-type: none"> Quelle place occupe EDF dans votre portefeuille de clients ? Est-ce que EDF a des exigences, des modes de travail spécifiques par rapport aux autres grands comptes ? Comment percevez-vous la politique achats EDF en termes de CDC et critères de sélection ? Quelles sont les difficultés que vous rencontrez à leur égard (relationnelles, contractuelles, techniques, tarifaires...)
Prix	<ul style="list-style-type: none"> Coût Marge 	<ol style="list-style-type: none"> Est-ce que les prix vous permettent d'assurer votre pérennité économique en tant que fournisseurs ?
Aspects contractuels	<ul style="list-style-type: none"> Consultation Négociation Contractualisation 	<ol style="list-style-type: none"> Etes vous soumis à des partenariats de productivité ? Si oui, quels sont les bénéfices que vous tirez d'un tel dispositif ? Quelles améliorations souhaiteriez voir appliquées à ce partenariat ?
Nature des relations	<ul style="list-style-type: none"> Collaboration interne et externe actuel Plan Ethique Partage d'information, Transparence Interdépendance Index PCI (justice, courage, tempérance, patience) 	<ol style="list-style-type: none"> Depuis combien de temps travaillez-vous avec EDF ? Avec quels acteurs internes êtes-vous en contact ? Avec quels services de chez EDF êtes-vous amené à collaborer ? Comment percevez-vous les relations avec EDF ? Comment appréciez-vous la qualité et le niveau de la collaboration avec EDF ? Observez vous des différences de comportement significatives entre les différents publics auxquels vous êtes confrontés (prescripteurs, acheteurs, autres acteurs de la chaîne de valeur, ...). Quelles sont les difficultés auxquelles vous pouvez être confrontés ? Quels sont les éléments déterminants dans la nature de ses relations ? Percevez-vous des opportunités de création de valeur supplémentaires avec EDF?

Conclusion de la première partie : Synthèse du diagnostic sur stratégie achat.

I. Deuxième phase : Développement d'une offre collaborative // innovante

Sous-thèmes	Informations à recueillir	Questions
Innovation de l'offre de VT (basé service)	<ul style="list-style-type: none"> • Motivations • Freins et leviers • Besoins de transformations organisationnelles 	<ol style="list-style-type: none"> 1. EDF s'intéresse à de nouvelles filières (filière lin-chanvre) et d'autres, qu'en pensez-vous ? <ul style="list-style-type: none"> - Pourriez-vous prendre en compte ces nouvelles attentes dans votre processus et répondre aux attentes EDF ? 2. Aviez-vous déjà entendu parler de l'économie de fonctionnalité ? 3. Aviez-vous déjà entendu parler des systèmes produits-services ? 4. Avez-vous déjà eu l'occasion d'expérimenter d'autres formes de mises à disposition des vêtements de travail (location, location-entretien ?...) Si oui, quelles ont été vos retours d'expériences par rapport à ces formes de prestations ? <ul style="list-style-type: none"> - Quelles seraient vos motivations à (re)développer ce type de pratique VT chez EDF ? - Percevez-vous les transformations à mener dans votre organisation pour y parvenir ? - Quelles sont les difficultés que vous pourriez rencontrer dans la transformation de votre modèle économique ? - Sentez-vous un risque ou une opportunité à développer cette offre avec EDF ? 5. Le numérique est-il de nature à améliorer les offres proposées ? Avez-vous déjà des propositions sur le sujet ? 6. Avez-vous déjà recensé des prestataires susceptibles de vous aider ?
Co-création de valeur		<ol style="list-style-type: none"> 1. A votre avis, quelle est la valeur ajoutée lors du développement d'une offre innovante ? 2. Quels sont les bénéfices et sacrifices que vous percevez en relation au développement d'une telle offre par rapport à l'offre ancienne ? <ul style="list-style-type: none"> - Pouvez-vous préciser par rapport aux bénéfices et sacrifices tangibles et non tangibles ? 3. Chez vous, quelles conditions seront nécessaires pour créer une telle valeur ajoutée ?
Innovation collaborative	<ul style="list-style-type: none"> • Besoins de collaboration pour le futur 	<ol style="list-style-type: none"> 1. Avez-vous le besoin de collaborer différemment avec EDF pour répondre aux enjeux d'innovation attendus ? 2. Ressentez-vous le besoin de développer des collaborations avec d'autres acteurs de la chaîne de valeur ? lesquels ?
Impact sur les processus actuels	<ul style="list-style-type: none"> • Impact du changement du modèle dans les processus actuels de l'entreprise • Impact sur la valeur de l'offre • Impact sur votre métier 	<ol style="list-style-type: none"> 1. Si vous deviez aujourd'hui répondre au marché, quelles seraient les avantages de votre offre ? Que pourriez-vous mettre en avant ? <ul style="list-style-type: none"> - Quels bénéfices pour EDF, vous, les usagers... d'autres acteurs ? quelles difficultés ? 2. Comment voyez-vous évoluer votre métier ? Quelles sont ou quelles seraient les compétences à développer pour intégrer une offre SPS ? quels changements dans le processus ?

Avez-vous d'autres éléments que nous n'avons pas abordés et qui vous viennent à l'esprit, vous paraissent importants de nous mentionner. Conclusion globale finale.

Annex C: Template for alternative generation

GRILLE ANALYSE PROCESSUS INNOVATION COLLABORATIVE – Entretiens fournisseurs du 11 décembre 2018

NOM DU FOURNISSEUR – NOM ET FONCTION DE L'INTERLOCUTEUR :

.....

	SOLUTIONS POTENTIELLES PROPOSEES PAR LE FOURNISSEUR	CONDITIONS DE COLLABORATION TOUT AU LONG DE LA CHAINE DE VALEUR	LES OPPORTUNITES DE CREATION DE VALEUR
Les attendus	<ul style="list-style-type: none"> - Temporalité (capacité à répondre dans le délais imparti) - Capacité à répondre sur les différents sites géographiques et en termes de volume - Opportunité de répondre dans le cadre normatif et réglementaire d'un marché public - Accompagnement de EDF dans la gestion de projet 	<ul style="list-style-type: none"> - Connaissances des acteurs impliqués dans la chaîne de valeur a mont et aval - Capacité à évaluer les risques et les impacts dans un logique cycle de vie - Capacité à garantir une traçabilité tout au long de la chaîne de valeur - Compétences pour engager une collaboration dans une perspective d'économie circulaire 	<ul style="list-style-type: none"> - Conditions de financement du dispositif d'innovation - Mesure de la création de valeur sur les thématiques de la grille multicritères (fonctionnelle, relationnelle, sociale, économique, environnementale)
Les réponses du fournisseur			
Risques et leviers			

Annex D-1: Evaluation matrices Beginning of life

Actor A1

I. ALTERNATIVES COMPARISON

CRITERION 1 : Economic

SUBCRITERION 1 : LCC

	Tencel	Poly Coton	Coton BIO	Normalized			Priority vector	Imax
Tencel	1	5	3	2/3	0,55555556	0,692307692	0,63334572	1,945621206
Poly Coton	1/5	1	1/3	0,130434783	0,111111111	0,076923077	0,106156324	0,31965812
Coton BIO	1/3	3	1	0,217391304	0,333333333	0,230769231	0,260497956	0,790082167
Total	1 1/2	9	4 1/3					
Priority vector	0,63334572	0,106156324	0,260497956					
							Imax	3,055361493
							CI	0,027680747
							RC	0,58
							CR	0,047725425

SUBCRITERION 2 : Purchasing cost

	Tencel	Poly Coton	Coton BIO	Normalized			Priority vector	Imax
Tencel	1	1/3	1	0,2	0,217391304	0,142857143	0,186749482	0,563008972
Poly Coton	3	1	5	0,6	0,652173913	0,714285714	0,655486542	2,004554865
Coton BIO	1	1/5	1	0,2	0,130434783	0,142857143	0,157763975	0,475610766
Total	5	1 1/2	7					
Priority vector	0,186749482	0,655486542	0,157763975					
							Imax	3,043174603
							CI	0,021587302
							RC	0,58
							CR	0,037219485

CRITERION 2 : Environmental

SUBCRITERION 1 : Fiber quality

	Tencel	Poly Coton	Coton BIO	Normalized			Priority vector	Imax
Tencel	1	5	3	0,652173913	0,555555556	0,692307692	0,63334572	1,945621206
Poly Coton	1/5	1	1/3	0,130434783	0,111111111	0,076923077	0,106156324	0,31965812
Coton BIO	1/3	3	1	0,217391304	0,333333333	0,230769231	0,260497956	0,790082167
Total	1 1/2	9	4 1/3					
Priority vector	0,63334572	0,106156324	0,260497956					
							Imax	3,055361493
							CI	0,027680747
							RC	0,58
							CR	0,047725425

SUBCRITERION 2 : Provider performance

	Tencel	Poly Coton	Coton BIO	Normalized			Priority vector	Imax
Tencel	1	1	3	0,428571429	0,454545455	0,333333333	0,405483405	1,22991823
Poly Coton	1	1	5	0,428571429	0,454545455	0,555555556	0,47955748	1,45983646
Coton BIO	1/3	1/5	1	0,142857143	0,090909091	0,111111111	0,114959115	0,346031746
Total	2 1/3	2 1/5	9					
Priority vector	0,405483405	0,47955748	0,114959115					
							Imax	3,035786436
							CI	0,017893218
							RC	0,58
							CR	0,030850376

CRITERION 3 : Social

SUBCRITERION 1 : Provider performance

	Tencel	Poly Coton	Coton BIO	Normalized			Priority vector	Imax
Tencel	1	5	3	0,652173913	0,625	0,666666667	0,64794686	1,948470209
Poly Coton	1/5	1	1/2	0,130434783	0,125	0,111111111	0,122181965	0,366706924
Coton BIO	1/3	2	1	0,217391304	0,25	0,222222222	0,229871176	0,690217391
Total	1 1/2	8	4 1/2					
Priority vector	0,64794686	0,122181965	0,229871176					
							Imax	3,005394525
							CI	0,002697262
							RC	0,58
							CR	0,004650453

SUBCRITERION 2 : User resistance

	Tencel	Poly Coton	Coton BIO	Normalized			Priority vector	Imax
Tencel	1	5	1/3	0,238095238	0,384615385	0,225806452	0,282839025	0,866162511
Poly Coton	1/5	1	1/7	0,047619048	0,076923077	0,096774194	0,073772106	0,222252607
Coton BIO	3	7	1	0,714285714	0,538461538	0,677419355	0,643388869	2,008310686
Total	4 1/5	13	1 1/2					
Priority vector	0,282839025	0,073772106	0,643388869					
							Imax	3,096725804
							CI	0,048362902
							RC	0,58
							CR	0,083384313

CRITERION 4 : Relational

SUBCRITERION 1 : Brand image

	Tencel	Poly Coton	Coton BIO	Normalized			Priority vector	Imax
Tencel	1	7	3	0,677419355	0,538461538	0,714285714	0,643388869	2,008310686
Poly Coton	1/7	1	1/5	0,096774194	0,076923077	0,047619048	0,073772106	0,222252607
Coton BIO	1/3	5	1	0,225806452	0,384615385	0,238095238	0,282839025	0,866162511
Total	1 1/2	13	4 1/5					
Priority vector	0,643388869	0,073772106	0,282839025					
							Imax	3,096725804
							CI	0,048362902
							RC	0,58
							CR	0,083384313

SUBCRITERION 2 : Innovation

	Tencel	Poly Coton	Coton BIO	Normalized			Priority vector	Imax
Tencel	1	3	3	3/5	0,6	0,6	0,6	1,8
Poly Coton	1/3	1	1	0,2	0,2	0,2	0,2	0,6
Coton BIO	1/3	1	1	0,2	0,2	0,2	0,2	0,6
Total	1 2/3	5	5					
Priority vector	0,6	0,2	0,2					
							Imax	3
							CI	0,00%
							RC	0,58
							CR	0,00%

CRITERION 5 : Functional

SUBCRITERION 1 : fiber quality

	Tencel	Poly Coton	Coton BIO	Normalized			Priority vector	Imax
Tencel	1	3	3	0,6	0,6	0,6	0,6	1,8
Poly Coton	1/3	1	1	0,2	0,2	0,2	0,2	0,6
Coton BIO	1/3	1	1	0,2	0,2	0,2	0,2	0,6
Total	1 2/3	5	5					
Priority vector	0,6	0,2	0,2					
							Imax	3
							CI	0,00%
							RC	0,58
							CR	0%

SUBCRITERION 2 : availability

	Tencel	Poly Coton	Coton BIO	Normalized			Priority vector	Imax
Tencel	1	1/5	1/3	0,111111111	0,130434783	0,076923077	0,106156324	0,31965812
Poly Coton	5	1	3	0,555555556	0,652173913	0,692307692	0,63334572	1,945621206
Coton BIO	3	1/3	1	0,333333333	0,217391304	0,230769231	0,260497956	0,790082167
Total	9	1 1/2	4 1/3					
Priority vector	0,106156324	0,63334572	0,260497956					
							Imax	3,055361493
							CI	0,027680747
							RC	0,58
							CR	0,047725425

II.SUB-CRITERIA COMPARISON

CRITERION 1 : Economic				
	LCC	Purchasing cost	Priority vector	Global priority
LCC	1	5	0,833333333	0,081278172
Purchasing cost	1/5	1	0,166666667	0,016255634
Total	1 1/5	6		

CRITERION 2 : Environmental				
	Fiber quality	Provider performance	Priority vector	Global priority
Fiber quality	1	3	0,75	0,335403832
Provider performance	1/3	1	0,25	0,11801277
Total	1 1/3	4		

CRITERION 3 : Social				
	Social performance	User resistance	Priority vector	Global priority
Social performance	1	7	0,875	0,24263727
User resistance	1/7	1	0,125	0,034662467
Total	1 1/7	8		

CRITERION 4 : Relational				
	Brand image	Innovation	Priority vector	Global priority
Brand image	1	1	0,5	0,067742685
Innovation	1	1	0,5	0,067742685
Total	2	2		

CRITERION 5 : Functional				
	fiber quality	availability	Priority vector	Global priority
fiber quality	1	5	0,833333333	0,035396648
availability	1/5	1	0,166666667	0,00707933
Total	1 1/5	6		

III.CRITERIA COMPARISON

	Economic	Environmental	Social	Relational	Functional	Normalized				
Economic	1	1/5	1/5	1	3	0,081081081	0,09953	0,04225	0,122	0,1429
Environmental	5	1	3	3	7	0,405405405	0,49763	0,6338	0,3659	0,3333
Social	5	1/3	1	3	5	0,405405405	0,16588	0,21127	0,3659	0,2381
Relational	1	1/3	1/3	1	5	0,081081081	0,16588	0,07042	0,122	0,2381
Functional	1/3	1/7	1/5	1/5	1	0,027027027	0,07109	0,04225	0,0244	0,0476
Total	12 1/3	2	4 3/4	8 1/5	21					
priority vector	0,097533806	0,447205109	0,277299737	0,13548537	0,042475977					

IV.ALTERNATIVES PRIORITIZATION

	Economic	Environmental	Social	Relational	Functional	Ranking
Tencel	0,558913014	0,519414563	0,602308381	0,621694435	0,52	0,56003772
Poly Cotton	0,19771136	0,292856902	0,116130732	0,136886053	0,27	0,212562716
Coton BIO	0,243375626	0,187728536	0,281560887	0,241419512	0,21	0,227399564
Total	1	1	1	1	1	1
Priority vector	0,097533806	0,447205109	0,277299737	0,13548537	0,042475977	

	LCC	PC	Economic
Tencel	0,63334572	0,186749482	0,558913014
Poly Cotton	0,106156324	0,655486542	0,19771136
Coton BIO	0,260497956	0,157763975	0,243375626
Priority	0,833333333	0,166666667	

	Fiber quality	Provider performance	Environmental
Tencel	0,63334572	0,405483405	0,519414563
Poly Cotton	0,106156324	0,47955748	0,292856902
Coton BIO	0,260497956	0,114959115	0,187728536
Priority	0,5	0,5	

	Social performance	User resistance	Social
Tencel	0,64794686	0,282839025	0,602308381
Poly Cotton	0,122181965	0,073772106	0,116130732
Coton BIO	0,229871176	0,643388869	0,281560887
Priority	0,875	0,125	

	Brandimage	Innovation	Relational
Tencel	0,643388869	0,6	0,621694435
Poly Cotton	0,073772106	0,2	0,136886053
Coton BIO	0,282839025	0,2	0,241419512
Priority	0,5	0,5	

	fiber quality	availability	Functional
Tencel	0,6	0,11	0,517692721
Poly Cotton	0,2	0,63	0,272224287
Coton BIO	0,2	0,26	0,210082993
Priority	0,833333333	0,166666667	

Actor A2

I. ALTERNATIVES COMPARISON

CRITERION 1 : Economic

SUBCRITERION 1 : LCC

	Tencel	Poly Coton	Coton BIO	Normalized			Priority vector	Imax
Tencel	1	2	5	0,588235294	0,625	0,454545455	0,555926916	1,715129234
Poly Coton	1/2	1	5	0,294117647	0,3125	0,454545455	0,353721034	1,083444742
Coton BIO	1/5	1/5	1	0,117647059	0,0625	0,090909091	0,09035205	0,27228164
Total	1 2/3	3 1/5	11				Imax	3,070855615
Priority vector	0,555926916	0,353721034	0,09035205				CI	0,035427807
							RC	0,58
							CR	0,061082427

SUBCRITERION 2 : Purchasing cost

	Tencel	Poly Coton	Coton BIO	Normalized			Priority vector	Imax
Tencel	1	2	5	0,588235294	0,625	0,454545455	0,555926916	1,715129234
Poly Coton	1/2	1	5	0,294117647	0,3125	0,454545455	0,353721034	1,083444742
Coton BIO	1/5	1/5	1	0,117647059	0,0625	0,090909091	0,09035205	0,27228164
Total	1 2/3	3 1/5	11				Imax	3,070855615
Priority vector	0,555926916	0,353721034	0,09035205				CI	0,035427807
							RC	0,58
							CR	0,061082427

CRITERION 2 : Environmental

SUBCRITERION 1 : Fiber quality

	Tencel	Poly Coton	Coton BIO	Normalized			Priority vector	Imax
Tencel	1	2	5	0,588235294	0,625	0,454545455	0,555926916	1,715129234
Poly Coton	1/2	1	5	0,294117647	0,3125	0,454545455	0,353721034	1,083444742
Coton BIO	1/5	1/5	1	0,117647059	0,0625	0,090909091	0,09035205	0,27228164
Total	1 2/3	3 1/5	11				Imax	3,070855615
Priority vector	0,555926916	0,353721034	0,09035205				CI	0,035427807
							RC	0,58
							CR	0,061082427

SUBCRITERION 2 : Provider performance

	Tencel	Poly Coton	Coton BIO	Normalized			Priority vector	Imax
Tencel	1	1	1	0,333333333	0,333333333	0,333333333	0,333333333	1
Poly Coton	1	1	1	0,333333333	0,333333333	0,333333333	0,333333333	1
Coton BIO	1	1	1	0,333333333	0,333333333	0,333333333	0,333333333	1
Total	3	3	3				Imax	3
Priority vector	0,333333333	0,333333333	0,333333333				CI	0
							RC	0,58
							CR	0

CRITERION 3 : Social

SUBCRITERION 1 : Provider performance

	Tencel	Poly Coton	Coton BIO	Normalized			Priority vector	Imax
Tencel	1	1	1	0,333333333	0,333333333	0,333333333	0,333333333	1
Poly Coton	1	1	1	0,333333333	0,333333333	0,333333333	0,333333333	1
Coton BIO	1	1	1	0,333333333	0,333333333	0,333333333	0,333333333	1
Total	3	3	3				Imax	3
Priority vector	0,333333333	0,333333333	0,333333333				CI	0
							RC	0,58
							CR	0

SUBCRITERION 2 : User resistance

	Tencel	Poly Coton	Coton BIO	Normalized			Priority vector	Imax
Tencel	1	1	1	0,333333333	0,333333333	0,333333333	0,333333333	1
Poly Coton	1	1	1	0,333333333	0,333333333	0,333333333	0,333333333	1
Coton BIO	1	1	1	0,333333333	0,333333333	0,333333333	0,333333333	1
Total	3	3	3				Imax	3
Priority vector	0,333333333	0,333333333	0,333333333				CI	0
							RC	0,58
							CR	0

CRITERION 4 : Relational

SUBCRITERION 1 : Brand image

	Tencel	Poly Coton	Coton BIO	Normalized			Priority vector	Imax
Tencel	1	5	7	0,744680851	0,714285714	0,777777778	0,745581448	2,257908364
Poly Coton	1/5	1	1	0,14893617	0,142857143	0,111111111	0,134301475	0,403534842
Coton BIO	1/7	1	1	0,106382979	0,142857143	0,111111111	0,120117078	0,360930188
Total	1 1/3	7	9				Imax	3,022373394
Priority vector	0,745581448	0,134301475	0,120117078				CI	0,011186697
							RC	0,58
							CR	0,019287408

SUBCRITERION 2 : Innovation

	Tencel	Poly Coton	Coton BIO	Normalized			Priority vector	Imax
Tencel	1	2	5	0,588235294	0,625	0,454545455	0,555926916	1,715129234
Poly Coton	1/2	1	5	0,294117647	0,3125	0,454545455	0,353721034	1,083444742
Coton BIO	1/5	1/5	1	0,117647059	0,0625	0,090909091	0,09035205	0,27228164
Total	1 2/3	3 1/5	11				Imax	3,070855615
Priority vector	0,555926916	0,353721034	0,09035205				CI	0,035427807
							RC	0,58
							CR	0,061082427

CRITERION 5 : Functional

SUBCRITERION 1 : fiber quality

	Tencel	Poly Coton	Coton BIO	Normalized			Priority vector	Imax
Tencel	1	2	7	0,608695652	0,636363636	0,466666667	0,570575318	1,761220905
Poly Coton	1/2	1	7	0,304347826	0,318181818	0,466666667	0,363065437	1,112867809
Coton BIO	1/7	1/7	1	0,086956522	0,045454545	0,066666667	0,066359245	0,199736495
Total	1 2/3	3 1/7	15				Imax	3,073825209
Priority vector	0,570575318	0,363065437	0,066359245				CI	0,036912604
							RC	0,58
							CR	0,063642421

SUBCRITERION 2 : availability

	Tencel	Poly Coton	Coton BIO	Normalized			Priority vector	Imax
Tencel	1	1/3	3	0,230769231	0,225806452	0,272727273	0,243100985	0,730606311
Poly Coton	3	1	7	0,692307692	0,677419355	0,636363636	0,668696895	2,015414693
Coton BIO	1/3	1/7	1	0,076923077	0,096774194	0,090909091	0,08820212	0,26476391
Total	4 1/3	1 1/2	11				Imax	3,010784914
Priority vector	0,243100985	0,668696895	0,08820212				CI	0,005392457
							RC	0,58
							CR	0,00929734

II.SUB-CRITERIA COMPARISON

CRITERION 1 : Economic				
	LCC	Purchasing cost	Priority vector	Global priority
LCC	1	7	0,875	0,042537312
Purchasing cost	1/7	1	0,125	0,006076759
Total	1 1/7	8		

CRITERION 2 : Environmental				
	Fiber quality	Provider performance	Priority vector	Global priority
Fiber quality	1	1	0,5	0,077252432
Provider performance	1	1	0,5	0,077252432
Total	2	2		

CRITERION 3 : Social				
	Social performance	User resistance	Priority vector	Global priority
Social performance	1	3	0,75	0,157760639
User resistance	1/3	1	0,25	0,05258688
Total	1 1/3	4		

CRITERION 4 : Relational				
	Brand image	Innovation	Priority vector	Global priority
Brand image	1	5	0,833333333	0,209278557
Innovation	1/5	1	0,166666667	0,041855711
Total	1 1/5	6		

CRITERION 5 : Functional				
	fiber quality	availability	Priority vector	Global priority
fiber quality	1	1	0,5	0,167699639
availability	1	1	0,5	0,167699639
Total	2	2		

III.CRITERIA COMPARISON

	Economic	Environmental	Social	Relational	Functional	Normalized				
Economic	1	1/5	1/3	1/5	1/7	0,04761905	0,0217	0,07692	0,05405405	0,04273504
Environmental	5	1	1	1/2	1/5	0,23809524	0,1087	0,23077	0,13513514	0,05982906
Social	3	1	1	1	1	0,14285714	0,1087	0,23077	0,27027027	0,2991453
Relational	5	2	1	1	1	0,23809524	0,2174	0,23077	0,27027027	0,2991453
Functional	7	5	1	1	1	0,33333333	0,5435	0,23077	0,27027027	0,2991453
Total	21	9 1/5	4 1/3	3 5/7	3 1/3					
priority vector	0,04861407	0,154504863	0,210347519	0,251134269	0,335399279					

IV.ALTERNATIVES PRIORITIZATION

	Economic	Environmental	Social	Relational	Functional	Ranking
Tencel	0,555926916	0,444630125	0,333333333	0,713972359	0,41	0,48159538
Poly Cotton	0,353721034	0,343527184	0,333333333	0,170871401	0,52	0,35632611
Coton BIO	0,09035205	0,211842692	0,333333333	0,11515624	0,08	0,16207851
Total	1	1	1	1	1	1
Priority vector	0,04861407	0,154504863	0,210347519	0,251134269	0,335399279	

	LCC	PC	Economic
Tencel	0,555926916	0,555926916	0,555926916
Poly Cotton	0,353721034	0,353721034	0,353721034
Coton BIO	0,09035205	0,09035205	0,09035205
Priority	0,875	0,125	

	Fiber quality	Provider performance	Environmental
Tencel	0,555926916	0,333333333	0,444630125
Poly Cotton	0,353721034	0,333333333	0,343527184
Coton BIO	0,09035205	0,333333333	0,211842692
Priority	0,5	0,5	

	Social performance	User resistance	Social
Tencel	0,333333333	0,333333333	0,333333333
Poly Cotton	0,333333333	0,333333333	0,333333333
Coton BIO	0,333333333	0,333333333	0,333333333
Priority	0,75	0,25	

	Brand image	Innovation	Relational
Tencel	0,745581448	0,555926916	0,713972359
Poly Cotton	0,134301475	0,353721034	0,170871401
Coton BIO	0,120117078	0,09035205	0,11515624
Priority	0,833333333	0,166666667	

	fiber quality	availability	Functional
Tencel	0,570575318	0,24	0,406838152
Poly Cotton	0,363065437	0,67	0,515881166
Coton BIO	0,066359245	0,09	0,077280683
Priority	0,5	0,5	

Actor A3

L. ALTERNATIVES COMPARISON

CRITERION 1 : Economic

SUBCRITERION 1 : LCC

	Tencel	Poly Coton	Coton BIO	Normalized			Priority vector	Imax
Tencel	1	1/5	1	0,142857143	0,142857143	0,142857143	0,142857143	0,428571429
Poly Coton	5	1	5	0,714285714	0,714285714	0,714285714	0,714285714	2,142857143
Coton BIO	1	1/5	1	0,142857143	0,142857143	0,142857143	0,142857143	0,428571429
Total	7	1 2/5	7					
Priority vector	0,142857143	0,714285714	0,142857143					

Imax	3
CI	0%
RC	0,58
CR	0%

SUBCRITERION 2 : Purchasing cost

	Tencel	Poly Coton	Coton BIO	Normalized			Priority vector	Imax
Tencel	1	1/5	1	0,142857143	0,142857143	0,142857143	0,142857143	0,428571429
Poly Coton	5	1	5	0,714285714	0,714285714	0,714285714	0,714285714	2,142857143
Coton BIO	1	1/5	1	0,142857143	0,142857143	0,142857143	0,142857143	0,428571429
Total	7	1 2/5	7					
Priority vector	0,142857143	0,714285714	0,142857143					

Imax	3
CI	0%
RC	0,58
CR	0%

CRITERION 2 : Environmental

SUBCRITERION 1 : Fiber quality

	Tencel	Poly Coton	Coton BIO	Normalized			Priority vector	Imax
Tencel	1	5	1	0,454545455	0,625	0,4	0,493181818	1,554545455
Poly Coton	1/5	1	1/2	0,090909091	0,125	0,2	0,138636364	0,421363636
Coton BIO	1	2	1	0,454545455	0,25	0,4	0,368181818	1,138636364
Total	2 1/5	8	2 1/2					
Priority vector	0,493181818	0,138636364	0,368181818					

Imax	3,114545455
CI	0,057272727
RC	0,58
CR	0,098746082

SUBCRITERION 2 : Provider performance

	Tencel	Poly Coton	Coton BIO	Normalized			Priority vector	Imax
Tencel	1	5	1	0,454545455	0,625	0,4	0,493181818	1,554545455
Poly Coton	1/5	1	1/2	0,090909091	0,125	0,2	0,138636364	0,421363636
Coton BIO	1	2	1	0,454545455	0,25	0,4	0,368181818	1,138636364
Total	2 1/5	8	2 1/2					
Priority vector	0,493181818	0,138636364	0,368181818					

Imax	3,114545455
CI	0,057272727
RC	0,58
CR	0,098746082

CRITERION 3 : Social

SUBCRITERION 1 : Provider performance

	Tencel	Poly Coton	Coton BIO	Normalized			Priority vector	Imax
Tencel	1	5	1	0,454545455	0,625	0,4	0,493181818	1,554545455
Poly Coton	1/5	1	1/2	0,090909091	0,125	0,2	0,138636364	0,421363636
Coton BIO	1	2	1	0,454545455	0,25	0,4	0,368181818	1,138636364
Total	2 1/5	8	2 1/2					
Priority vector	0,493181818	0,138636364	0,368181818					

Imax	3,114545455
CI	0,057272727
RC	0,58
CR	0,098746082

SUBCRITERION 2 : User resistance

	Tencel	Poly Coton	Coton BIO	Normalized			Priority vector	Imax
Tencel	1	1/7	1	0,111111111	0,111111111	0,111111111	0,111111111	0,333333333
Poly Coton	7	1	7	0,777777778	0,777777778	0,777777778	0,777777778	2,333333333
Coton BIO	1	1/7	1	0,111111111	0,111111111	0,111111111	0,111111111	0,333333333
Total	9	1 2/7	9					
Priority vector	0,111111111	0,777777778	0,111111111					

Imax	3
CI	0
RC	0,58
CR	0

CRITERION 4 : Relational

SUBCRITERION 1 : Brand image

	Tencel	Poly Coton	Coton BIO	Normalized			Priority vector	Imax
Tencel	1	7	1	0,466666667	0,636363636	0,428571429	0,510533911	1,600865801
Poly Coton	1/7	1	1/3	0,066666667	0,090909091	0,142857143	0,1001443	0,302851646
Coton BIO	1	3	1	0,466666667	0,272727273	0,428571429	0,389321789	1,2002886
Total	2 1/7	11	2 1/3					
Priority vector	0,510533911	0,1001443	0,389321789					

Imax	3,10406047
CI	0,052003023
RC	0,58
CR	0,089660385

SUBCRITERION 2 : Innovation

	Tencel	Poly Coton	Coton BIO	Normalized			Priority vector	Imax
Tencel	1	5	1	0,454545455	0,625	0,4	0,493181818	1,554545455
Poly Coton	1/5	1	1/2	0,090909091	0,125	0,2	0,138636364	0,421363636
Coton BIO	1	2	1	0,454545455	0,25	0,4	0,368181818	1,138636364
Total	2 1/5	8	2 1/2					
Priority vector	0,493181818	0,138636364	0,368181818					

Imax	3,114545455
CI	0,057272727
RC	0,58
CR	0,098746082

CRITERION 5 : Functional

SUBCRITERION 1 : fiber quality

	Tencel	Poly Coton	Coton BIO	Normalized			Priority vector	Imax
Tencel	1	1/7	1	0,111111111	0,111111111	0,111111111	0,111111111	0,333333333
Poly Coton	7	1	7	0,777777778	0,777777778	0,777777778	0,777777778	2,333333333
Coton BIO	1	1/7	1	0,111111111	0,111111111	0,111111111	0,111111111	0,333333333
Total	9	1 2/7	9					
Priority vector	0,111111111	0,777777778	0,111111111					

Imax	3
CI	0
RC	0,58
CR	0

SUBCRITERION 2 : availability

	Tencel	Poly Coton	Coton BIO	Normalized			Priority vector	Imax
Tencel	1	1	1	0,333333333	0,333333333	0,333333333	0,333333333	1
Poly Coton	1	1	1	0,333333333	0,333333333	0,333333333	0,333333333	1
Coton BIO	1	1	1	0,333333333	0,333333333	0,333333333	0,333333333	1
Total	3	3	3					
Priority vector	0,333333333	0,333333333	0,333333333					

Imax	3
CI	0
RC	0,58
CR	0

II.SUB-CRITERIA COMPARISON

CRITERION 1 : Economic

	LCC	Purchasing cost	Priority vector	Global priority
LCC	1	1	0,5	0,038855443
Purchasing cost	1	1	0,5	0,038855443
Total	2	2		

CRITERION 2 : Environmental

	Fiber quality	Provider performance	Priority vector	Global priority
Fiber quality	1	1	0,5	0,211769126
Provider performance	1	1	0,5	0,211769126
Total	2	2		

CRITERION 3 : Social

	Social performance	User resistance	Priority vector	Global priority
Social performance	1	1	0,5	0,074451727
User resistance	1	1	0,5	0,074451727
Total	2	2		

CRITERION 4 : Relational

	Brand image	Innovation	Priority vector	Global priority
Brand image	1	1	0,5	0,040885294
Innovation	1	1	0,5	0,040885294
Total	2	2		

CRITERION 5 : Functional

	fiber quality	availability	Priority vector	Global priority
fiber quality	1	5	0,833333333	0,223397349
availability	1/5	1	0,166666667	0,04467947
Total	1 1/5	6		

III.CRITERIA COMPARISON

	Economic	Environmental	Social	Relational	Functional	Normalized				
Economic	1	1/3	1/3	1	1/5	0,07692308	0,1493	0,04	0,077	0,045455
Environmental	3	1	5	5	2	0,23076923	0,4478	0,6	0,385	0,454545
Social	3	1/5	1	1	1	0,23076923	0,0896	0,12	0,077	0,227273
Relational	1	1/5	1	1	1/5	0,07692308	0,0896	0,12	0,077	0,045455
Functional	5	1/2	1	5	1	0,38461538	0,2239	0,12	0,385	0,227273
Total	13	2 1/4	8 1/3	13	4 2/5					
priority vector	0,077710886	0,423538253	0,148903455	0,081770588	0,268076819					

IV.ALTERNATIVES PRIORITIZATION

	Economic	Environmental	Social	Relational	Functional	Ranking
Tencel	0,142857143	0,493181818	0,302146465	0,501857864	0,15	0,34572587
Poly Cotton	0,714285714	0,138636364	0,458207071	0,119390332	0,70	0,38086346
Coton BIO	0,142857143	0,368181818	0,239646465	0,378751804	0,15	0,27341067
Total	1	1	1	1	1	1
Priority vector	0,077710886	0,423538253	0,148903455	0,081770588	0,268076819	

	LCC	PC	Economic
Tencel	0,142857143	0,142857143	0,142857143
Poly Cotton	0,714285714	0,714285714	0,714285714
Coton BIO	0,142857143	0,142857143	0,142857143
Priority	0,5	0,5	

	Fiber quality	Provider performance	Environmental
Tencel	0,493181818	0,493181818	0,493181818
Poly Cotton	0,138636364	0,138636364	0,138636364
Coton BIO	0,368181818	0,368181818	0,368181818
Priority	0,5	0,5	

	Social performance	User resistance	Social
Tencel	0,493181818	0,111111111	0,302146465
Poly Cotton	0,138636364	0,777777778	0,458207071
Coton BIO	0,368181818	0,111111111	0,239646465
Priority	0,5	0,5	

	Brand image	Innovation	Relational
Tencel	0,510533911	0,493181818	0,501857864
Poly Cotton	0,1001443	0,138636364	0,119390332
Coton BIO	0,389321789	0,368181818	0,378751804
Priority	0,5	0,5	

	fiber quality	availability	Functional
Tencel	0,111111111	0,33	0,148148148
Poly Cotton	0,777777778	0,33	0,703703704
Coton BIO	0,111111111	0,33	0,148148148
Priority	0,833333333	0,166666667	

II.SUB-CRITERIA COMPARISON

CRITERION 1 : Economic

	LCC	Purchasing cost	Priority vector	Global priority
LCC	1	7	0,875	0,103319933
Purchasing cost	1/7	1	0,125	0,01475999
Total	1 1/7	8		

CRITERION 2 : Environmental

	Fiber quality	Provider performance	Priority vector	Global priority
Fiber quality	1	3	0,75	0,233127185
Provider performance	1/3	1	0,25	0,077709062
Total	1 1/3	4		

CRITERION 3 : Social

	Social performance	User resistance	Priority vector	Global priority
Social performance	1	1/5	0,166666667	0,031449967
User resistance	5	1	0,833333333	0,157249835
Total	6	1 1/5		

CRITERION 4 : Relational

	Brand image	Innovation	Priority vector	Global priority
Brand image	1	7	0,875	0,043854308
Innovation	1/7	1	0,125	0,006264901
Total	1 1/7	8		

CRITERION 5 : Functional

	fiber quality	availability	Priority vector	Global priority
fiber quality	1	7	0,875	0,290731716
availability	1/7	1	0,125	0,041533102
Total	1 1/7	8		

III.CRITERIA COMPARISON

	Economic	Environmental	Social	Relational	Functional	Normalized				
Economic	1	1/2	1/3	3	1/3	0,107142857	0,164835165	0,0442478	0,15789474	0,11627907
Environmental	2	1	3	5	1	0,214285714	0,32967033	0,3982301	0,26315788	0,34883721
Social	3	1/3	1	5	1/3	0,321428571	0,10989011	0,1327434	0,26315789	0,11627907
Relational	1/3	1/5	1/5	1	1/5	0,035714286	0,065934066	0,0265487	0,05263158	0,06976744
Functional	3	1	3	5	1	0,321428571	0,32967033	0,3982301	0,26315788	0,34883721
Total	9 1/3	3	7 1/2	19	2 6/7					
priority vector	0,118079923	0,310836247	0,188699802	0,050119209	0,332264819					

IV.ALTERNATIVES PRIORITIZATION

	Economic	Environmental	Social	Relational	Functional	Ranking
Tencel	0,093723346	0,745304227	0,202898551	0,642032359	0,11	0,349995795
Poly Coton	0,747209874	0,086643048	0,179434092	0,107252626	0,64	0,368197069
Coton BIO	0,159066781	0,168052725	0,617667357	0,250715016	0,25	0,281807136
Total	1	1	1	1	1	1
Priority vector	0,118079923	0,310836247	0,188699802	0,050119209	0,332264819	

	LCC	PC	Economic
Tencel	0,089978214	0,119939271	0,093723346
Poly Coton	0,767102397	0,607962213	0,747209874
Coton BIO	0,14291939	0,272098516	0,159066781
Priority	0,875	0,125	

	Fiber quality	Provider performance	Environmental
Tencel	0,767102397	0,723506057	0,745304227
Poly Coton	0,089978214	0,083307883	0,086643048
Coton BIO	0,14291939	0,19318606	0,168052725
Priority	0,5	0,5	

	Social performance	User resistance	Social
Tencel	0,428571429	0,157763975	0,202898551
Poly Coton	0,142857143	0,186749482	0,179434092
Coton BIO	0,428571429	0,655486542	0,617667357
Priority	0,166666667	0,833333333	

	Brand image	Innovation	Relational
Tencel	0,63334572	0,702838828	0,642032359
Poly Coton	0,106156324	0,11492674	0,107252626
Coton BIO	0,260497956	0,182234432	0,250715016
Priority	0,875	0,125	

	fiber quality	availability	Functional
Tencel	0,106156324	0,14	0,110743926
Poly Coton	0,63334572	0,71	0,64346322
Coton BIO	0,260497956	0,14	0,245792854
Priority	0,875	0,125	

Actor A5

I. ALTERNATIVES COMPARISON

CRITERION 1 : Economic								
SUBCRITERION 1 : LCC								
	Tencel	Poly Coton	Coton BIO	Normalized			Priority vector	I _{max}
Tencel	1	1/3	1/5	0,11111111	0,076923077	0,130434783	0,106156324	0,31965812
Poly Coton	3	1	1/3	0,33333333	0,230769231	0,217391304	0,260497956	0,790082167
Coton BIO	5	3	1	0,55555556	0,692307692	0,652173913	0,63334572	1,945621206
Total	9	4 1/3	1 1/2				I _{max}	3,055361493
Priority vector	0,106156324	0,260497956	0,63334572				CI	0,027680747
							RC	0,58
							CR	0,047775425

SUBCRITERION 2 : Purchasing cost								
	Tencel	Poly Coton	Coton BIO	Normalized			Priority vector	I _{max}
Tencel	1	1	1	0,33333333	0,33333333	0,33333333	0,33333333	1
Poly Coton	1	1	1	0,33333333	0,33333333	0,33333333	0,33333333	1
Coton BIO	1	1	1	0,33333333	0,33333333	0,33333333	0,33333333	1
Total	3	3	3				I _{max}	3
Priority vector	0,33333333	0,33333333	0,33333333				CI	0
							RC	0,58
							CR	0

CRITERION 2 : Environmental								
SUBCRITERION 1 : Fiber quality								
	Tencel	Poly Coton	Coton BIO	Normalized			Priority vector	I _{max}
Tencel	1	7	5	0,744680851	0,777777778	0,714285714	0,745581448	2,257908364
Poly Coton	1/7	1	1	0,106382979	0,111111111	0,142857143	0,120117078	0,360930188
Coton BIO	1/5	1	1	0,14893617	0,111111111	0,142857143	0,134301475	0,403534842
Total	1 1/3	9	7				I _{max}	3,022373394
Priority vector	0,745581448	0,120117078	0,134301475				CI	0,011186697
							RC	0,58
							CR	0,019287408

SUBCRITERION 2 : Provider performance								
	Tencel	Poly Coton	Coton BIO	Normalized			Priority vector	I _{max}
Tencel	1	1	1	0,33333333	0,33333333	0,33333333	0,33333333	1
Poly Coton	1	1	1	0,33333333	0,33333333	0,33333333	0,33333333	1
Coton BIO	1	1	1	0,33333333	0,33333333	0,33333333	0,33333333	1
Total	3	3	3				I _{max}	3
Priority vector	0,33333333	0,33333333	0,33333333				CI	0
							RC	0,58
							CR	0

CRITERION 3 : Social								
SUBCRITERION 1 : Provider performance								
	Tencel	Poly Coton	Coton BIO	Normalized			Priority vector	I _{max}
Tencel	1	1	1	0,33333333	0,33333333	0,33333333	0,33333333	1
Poly Coton	1	1	1	0,33333333	0,33333333	0,33333333	0,33333333	1
Coton BIO	1	1	1	0,33333333	0,33333333	0,33333333	0,33333333	1
Total	3	3	3				I _{max}	3
Priority vector	0,33333333	0,33333333	0,33333333				CI	0
							RC	0,58
							CR	0

SUBCRITERION 2 : User resistance								
	Tencel	Poly Coton	Coton BIO	Normalized			Priority vector	I _{max}
Tencel	1	1	1	0,33333333	0,33333333	0,33333333	0,33333333	1
Poly Coton	1	1	1	0,33333333	0,33333333	0,33333333	0,33333333	1
Coton BIO	1	1	1	0,33333333	0,33333333	0,33333333	0,33333333	1
Total	3	3	3				I _{max}	3
Priority vector	0,33333333	0,33333333	0,33333333				CI	0
							RC	0,58
							CR	0

CRITERION 4 : Relational								
SUBCRITERION 1 : Brand image								
	Tencel	Poly Coton	Coton BIO	Normalized			Priority vector	I _{max}
Tencel	1	7	5	0,744680851	0,636363636	0,789473684	0,723506057	2,272591537
Poly Coton	1/7	1	1/3	0,106382979	0,090909091	0,052631579	0,083307883	0,251061244
Coton BIO	1/5	3	1	0,14893617	0,272727273	0,157894737	0,19318606	0,58781092
Total	1 1/3	11	6 1/3				I _{max}	3,111463701
Priority vector	0,723506057	0,083307883	0,19318606				CI	0,055731851
							RC	0,58
							CR	0,096089398

SUBCRITERION 2 : Innovation								
	Tencel	Poly Coton	Coton BIO	Normalized			Priority vector	I _{max}
Tencel	1	7	5	0,744680851	0,636363636	0,789473684	0,723506057	2,272591537
Poly Coton	1/7	1	1/3	0,106382979	0,090909091	0,052631579	0,083307883	0,251061244
Coton BIO	1/5	3	1	0,14893617	0,272727273	0,157894737	0,19318606	0,58781092
Total	1 1/3	11	6 1/3				I _{max}	3,111463701
Priority vector	0,723506057	0,083307883	0,19318606				CI	0,055731851
							RC	0,58
							CR	0,096089398

CRITERION 5 : Functional								
SUBCRITERION 1 : fiber quality								
	Tencel	Poly Coton	Coton BIO	Normalized			Priority vector	I _{max}
Tencel	1	1/5	1	0,142857143	0,130434783	0,2	0,157763975	0,475610766
Poly Coton	5	1	3	0,714285714	0,652173913	0,6	0,655486542	2,004554865
Coton BIO	1	1/3	1	0,142857143	0,217391304	0,2	0,186749482	0,563008972
Total	7	1 1/2	5				I _{max}	3,043174603
Priority vector	0,157763975	0,655486542	0,186749482				CI	0,021587302
							RC	0,58
							CR	0,037219485

SUBCRITERION 2 : availability								
	Tencel	Poly Coton	Coton BIO	Normalized			Priority vector	I _{max}
Tencel	1	1/5	1/2	0,125	0,090909091	0,2	0,138636364	0,421363636
Poly Coton	5	1	1	0,625	0,454545455	0,4	0,493181818	1,554545455
Coton BIO	2	1	1	0,25	0,454545455	0,4	0,368181818	1,138636364
Total	8	2 1/5	2 1/2				I _{max}	3,114545455
Priority vector	0,138636364	0,493181818	0,368181818				CI	0,057272727
							RC	0,58
							CR	0,098746082

II.SUB-CRITERIA COMPARISON

CRITERION 1 : Economic				
	LCC	Purchasing cost	Priority vector	Global priority
LCC	1	1	0,5	0,046889751
Purchasing cost	1	1	0,5	0,046889751
Total	2	2		

CRITERION 2 : Environmental				
	Fiber quality	Provider performance	Priority vector	Global priority
Fiber quality	1	5	0,833333333	0,333130587
Provider performance	1/5	1	0,166666667	0,066626117
Total	1 1/5	6		

CRITERION 3 : Social				
	Social performance	User resistance	Priority vector	Global priority
Social performance	1	5	0,833333333	0,176199422
User resistance	1/5	1	0,166666667	0,035239884
Total	1 1/5	6		

CRITERION 4 : Relational				
	Brand image	Innovation	Priority vector	Global priority
Brand image	1	1	0,5	0,090130391
Innovation	1	1	0,5	0,090130391
Total	2	2		

CRITERION 5 : Functional				
	fiber quality	availability	Priority vector	Global priority
fiber quality	1	3	0,75	0,086072779
availability	1/3	1	0,25	0,028690926
Total	1 1/3	4		

III.CRITERIA COMPARISON

	Economic	Environmental	Social	Relational	Functional	Normalized				
Economic	1	1/5	1/5	1	1	0,07692308	0,08451	0,0384615	0,1579	0,11111
Environmental	5	1	2	3	3	0,38461538	0,42254	0,3846154	0,4737	0,33333
Social	5	1/2	1	1	1	0,38461538	0,21127	0,1923077	0,1579	0,11111
Relational	1	1/3	1	1	3	0,07692308	0,14085	0,1923077	0,1579	0,33333
Functional	1	1/3	1	1/3	1	0,07692308	0,14085	0,1923077	0,0526	0,11111
Total	13	2 3/8	5 1/5	6 1/3	9					
priority vector	0,093779501	0,399756705	0,211439306	0,180260782	0,114763706					

IV.ALTERNATIVES PRIORITIZATION

	Economic	Environmental	Social	Relational	Functional	Ranking
Tencel	0,219744828	0,539457391	0,333333333	0,723506057	0,15	0,4547156
Poly Cotton	0,296915645	0,226725205	0,333333333	0,083307883	0,61	0,27454583
Coton BIO	0,483339527	0,233817404	0,333333333	0,19318606	0,23	0,27073858
Total	1	1	1	1	1	1
Priority vector	0,093779501	0,399756705	0,211439306	0,180260782	0,114763706	

	LCC	PC	Economic
Tencel	0,106156324	0,333333333	0,219744828
Poly Cotton	0,260497956	0,333333333	0,296915645
Coton BIO	0,63334572	0,333333333	0,483339527
Priority	0,5	0,5	

	Fiber quality	Provider performance	Environmental
Tencel	0,745581448	0,333333333	0,539457391
Poly Cotton	0,120117078	0,333333333	0,226725205
Coton BIO	0,134301475	0,333333333	0,233817404
Priority	0,5	0,5	

	Social performance	User resistance	Social
Tencel	0,333333333	0,333333333	0,333333333
Poly Cotton	0,333333333	0,333333333	0,333333333
Coton BIO	0,333333333	0,333333333	0,333333333
Priority	0,833333333	0,166666667	

	Brand image	Innovation	Relational
Tencel	0,723506057	0,723506057	0,723506057
Poly Cotton	0,083307883	0,083307883	0,083307883
Coton BIO	0,19318606	0,19318606	0,19318606
Priority	0,5	0,5	

	fiber quality	availability	Functional
Tencel	0,157763975	0,14	0,152982072
Poly Cotton	0,655486542	0,49	0,614910361
Coton BIO	0,186749482	0,37	0,232107566
Priority	0,75	0,25	

II.SUB-CRITERIA COMPARISON

CRITERION 1 : Economic				
	LCC	Purchasing cost	Priority vector	Global priority
LCC	1	7	0,875	0,078389875
Purchasing cost	1/7	1	0,125	0,011198554
Total	1 1/7	8		

CRITERION 2 : Environmental				
	Fiber quality	Provider performance	Priority vector	Global priority
Fiber quality	1	5	0,833333333	0,223960752
Provider performance	1/5	1	0,166666667	0,04479215
Total	1 1/5	6		

CRITERION 3 : Social				
	Social performance	User resistance	Priority vector	Global priority
Social performance	1	5	0,833333333	0,40495882
User resistance	1/5	1	0,166666667	0,080991764
Total	1 1/5	6		

CRITERION 4 : Relational				
	Brand image	Innovation	Priority vector	Global priority
Brand image	1	1	0,5	0,029745728
Innovation	1	1	0,5	0,029745728
Total	2	2		

CRITERION 5 : Functional				
	fiber quality	availability	Priority vector	Global priority
fiber quality	1	1/3	0,25	0,024054157
availability	3	1	0,75	0,072162472
Total	4	1 1/3		

III.CRITERIA COMPARISON

	Economic	Environmental	Social	Relational	Functional	Normalized				
Economic	1	1/5	1/5	3	1/2	0,075	0,0423	0,1066	0,17647	0,04762
Environmental	5	1	1/3	5	3	0,375	0,2113	0,17766	0,29412	0,28571
Social	5	3	1	7	5	0,375	0,6338	0,53299	0,41176	0,47619
Relational	1/3	1/5	1/7	1	1	0,025	0,0423	0,07614	0,05882	0,09524
Functional	2	1/3	1/5	1	1	0,15	0,0704	0,1066	0,05882	0,09524
Total	13 1/3	4 3/4	1 7/8	17	10 1/2					
priority vector	0,089588428	0,268752903	0,485950585	0,059491456	0,096216629					

IV.ALTERNATIVES PRIORITIZATION

	Economic	Environmental	Social	Relational	Functional	Ranking
Tencel	0,642289313	0,555555556	0,290805491	0,723506057	0,44	0,4339713
Poly Coton	0,249461411	0,222222222	0,35032375	0,19318606	0,28	0,2905315
Coton BIO	0,108249276	0,222222222	0,358870759	0,083307883	0,28	0,2754972
Total	1	1	1	1	1	1
Priority vector	0,089588428	0,268752903	0,485950585	0,059491456	0,096216629	

	LCC	PC	Economic
Tencel	0,723506057	0,073772106	0,642289313
Poly Coton	0,19318606	0,643388869	0,249461411
Coton BIO	0,083307883	0,282839025	0,108249276
Priority	0,875	0,125	

	Fiber quality	Provider performance	Environmental
Tencel	0,777777778	0,333333333	0,555555556
Poly Coton	0,111111111	0,333333333	0,222222222
Coton BIO	0,111111111	0,333333333	0,222222222
Priority	0,5	0,5	

	Social performance	User resistance	Social
Tencel	0,333333333	0,078166278	0,290805491
Poly Coton	0,333333333	0,435275835	0,35032375
Coton BIO	0,333333333	0,486557887	0,358870759
Priority	0,833333333	0,166666667	

	Brand image	Innovation	Relational
Tencel	0,723506057	0,723506057	0,723506057
Poly Coton	0,19318606	0,19318606	0,19318606
Coton BIO	0,083307883	0,083307883	0,083307883
Priority	0,5	0,5	

	fiber quality	availability	Functional
Tencel	0,777777778	0,33	0,444444444
Poly Coton	0,111111111	0,33	0,277777778
Coton BIO	0,111111111	0,33	0,277777778
Priority	0,25	0,75	

Actor A7

I. ALTERNATIVES COMPARISON

CRITERION 1 : Economic

SUBCRITERION 1 : LCC

	Tencel	Poly Coton	Coton BIO	Normalized			Priority vector	Imax
Tencel	1	7	3	0,677419355	0,538461538	0,714285714	0,643388869	2,008310686
Poly Coton	1/7	1	1/5	0,096774194	0,076923077	0,047619048	0,073772106	0,222252607
Coton BIO	1/3	5	1	0,225806452	0,384615385	0,238095238	0,282839025	0,866162511
Total	1 1/2	13	4 1/5				Imax	3,096725804
Priority vector	0,643388869	0,073772106	0,282839025				CI	0,048362902
							RC	0,58
							CR	0,083384313

SUBCRITERION 2 : Purchasing cost

	Tencel	Poly Coton	Coton BIO	Normalized			Priority vector	Imax
Tencel	1	1/5	3	0,157894737	0,14893617	0,272727273	0,19318606	0,58781092
Poly Coton	5	1	7	0,789473684	0,744680851	0,636363636	0,723506057	2,272591537
Coton BIO	1/3	1/7	1	0,052631579	0,106382929	0,090909091	0,083307883	0,251061244
Total	6 1/3	1 1/3	11				Imax	3,111463701
Priority vector	0,19318606	0,723506057	0,083307883				CI	0,055731851
							RC	0,58
							CR	0,096089398

CRITERION 2 : Environmental

SUBCRITERION 1 : Fiber quality

	Tencel	Poly Coton	Coton BIO	Normalized			Priority vector	Imax
Tencel	1	9	6	0,782608696	0,692307692	0,818181818	0,764366069	2,387503801
Poly Coton	1/9	1	1/3	0,086956522	0,076923077	0,045454545	0,069778048	0,209992906
Coton BIO	1/6	3	1	0,130434783	0,230769231	0,136363636	0,165855883	0,502584372
Total	1 2/7	13	7 1/3				Imax	3,100081078
Priority vector	0,764366069	0,069778048	0,165855883				CI	0,050040539
							RC	0,58
							CR	0,086276792

SUBCRITERION 2 : Provider performance

	Tencel	Poly Coton	Coton BIO	Normalized			Priority vector	Imax
Tencel	1	9	6	0,782608696	0,692307692	0,818181818	0,764366069	2,387503801
Poly Coton	1/9	1	1/3	0,086956522	0,076923077	0,045454545	0,069778048	0,209992906
Coton BIO	1/6	3	1	0,130434783	0,230769231	0,136363636	0,165855883	0,502584372
Total	1 2/7	13	7 1/3				Imax	3,100081078
Priority vector	0,764366069	0,069778048	0,165855883				CI	0,050040539
							RC	0,58
							CR	0,086276792

CRITERION 3 : Social

SUBCRITERION 1 : Provider performance

	Tencel	Poly Coton	Coton BIO	Normalized			Priority vector	Imax
Tencel	1	1	7	0,466666667	0,428571429	0,636363636	0,510533911	1,600865801
Poly Coton	1	1	3	0,466666667	0,428571429	0,272727273	0,389321789	1,2002886
Coton BIO	1/7	1/3	1	0,066666667	0,142857143	0,090909091	0,1001443	0,302851646
Total	2 1/7	2 1/3	11				Imax	3,10406047
Priority vector	0,510533911	0,389321789	0,1001443				CI	0,052003023
							RC	0,58
							CR	0,089660385

SUBCRITERION 2 : User resistance

	Tencel	Poly Coton	Coton BIO	Normalized			Priority vector	Imax
Tencel	1	1	1/3	0,2	0,25	0,181818182	0,210606061	0,634343434
Poly Coton	1	1	1/2	0,2	0,25	0,272727273	0,240909091	0,725757576
Coton BIO	3	2	1	0,6	0,5	0,545454545	0,548484848	1,662121212
Total	5	4	1 5/6				Imax	3,022222222
Priority vector	0,210606061	0,240909091	0,548484848				CI	0,011111111
							RC	0,58
							CR	0,019157088

CRITERION 4 : Relational

SUBCRITERION 1 : Brand image

	Tencel	Poly Coton	Coton BIO	Normalized			Priority vector	Imax
Tencel	1	9	1	0,473684211	0,529411765	0,466666667	0,489920881	1,4749914
Poly Coton	1/9	1	1/7	0,052631579	0,058823529	0,066666667	0,059373925	0,178196035
Coton BIO	1	7	1	0,473684211	0,411764706	0,466666667	0,450705194	1,35624355
Total	2 1/9	17	2 1/7				Imax	3,009430985
Priority vector	0,489920881	0,059373925	0,450705194				CI	0,004715492
							RC	0,58
							CR	0,008130159

SUBCRITERION 2 : Innovation

	Tencel	Poly Coton	Coton BIO	Normalized			Priority vector	Imax
Tencel	1	7	1	0,466666667	0,466666667	0,466666667	0,466666667	1,4
Poly Coton	1/7	1	1/7	0,066666667	0,066666667	0,066666667	0,066666667	0,2
Coton BIO	1	7	1	0,466666667	0,466666667	0,466666667	0,466666667	1,4
Total	2 1/7	15	2 1/7				Imax	3
Priority vector	0,466666667	0,066666667	0,466666667				CI	0
							RC	0,58
							CR	0

CRITERION 5 : Functional

SUBCRITERION 1 : fiber quality

	Tencel	Poly Coton	Coton BIO	Normalized			Priority vector	Imax
Tencel	1	1	1	0,333333333	0,333333333	0,333333333	0,333333333	1
Poly Coton	1	1	1	0,333333333	0,333333333	0,333333333	0,333333333	1
Coton BIO	1	1	1	0,333333333	0,333333333	0,333333333	0,333333333	1
Total	3	3	3				Imax	3
Priority vector	0,333333333	0,333333333	0,333333333				CI	0
							RC	0,58
							CR	0

SUBCRITERION 2 : availability

	Tencel	Poly Coton	Coton BIO	Normalized			Priority vector	Imax
Tencel	1	1/7	1	0,111111111	0,111111111	0,111111111	0,111111111	0,333333333
Poly Coton	7	1	7	0,777777778	0,777777778	0,777777778	0,777777778	2,333333333
Coton BIO	1	1/7	1	0,111111111	0,111111111	0,111111111	0,111111111	0,333333333
Total	9	1 2/7	9				Imax	3
Priority vector	0,111111111	0,777777778	0,111111111				CI	0
							RC	0,58
							CR	0

II. SUB-CRITERIA COMPARISON

CRITERION 1 : Economic

	LCC	Purchasing cost	Priority vector	Global priority
LCC	1	7	0,875	0,065742954
Purchasing cost	1/7	1	0,125	0,009391851
Total	1 1/7	8		

CRITERION 2 : Environmental

	Fiber quality	Provider performance	Priority vector	Global priority
Fiber quality	1	1/3	0,25	0,110904051
Provider performance	3	1	0,75	0,332712152
Total	4	1 1/3		

CRITERION 3 : Social

	Social performance	User resistance	Priority vector	Global priority
Social performance	1	1/5	0,166666667	0,040889203
User resistance	5	1	0,833333333	0,204446016
Total	6	1 1/5		

CRITERION 4 : Relational

	Brand image	Innovation	Priority vector	Global priority
Brand image	1	7	0,875	0,169467424
Innovation	1/7	1	0,125	0,024209632
Total	1 1/7	8		

CRITERION 5 : Functional

	fiber quality	availability	Priority vector	Global priority
fiber quality	1	7	0,875	0,036957127
availability	1/7	1	0,125	0,00527959
Total	1 1/7	8		

III. CRITERIA COMPARISON

	Economic	Environmental	Social	Relational	Functional	Normalized				
Economic	1	1/5	1/5	1/5	3	0,06122449	0,09952607	0,0408163	0,03125	0,14286
Environmental	5	1	3	3	7	0,30612245	0,49763033	0,6122449	0,46875	0,33333
Social	5	1/3	1	2	5	0,30612245	0,16587678	0,2040816	0,3125	0,2381
Relational	5	1/3	1/2	1	5	0,30612245	0,16587678	0,1020408	0,15625	0,2381
Functional	1/3	1/7	1/5	1/5	1	0,02040816	0,07109005	0,0408163	0,03125	0,04762
Total	16 1/3	2	5	6 2/5	21					
priority vector	0,075134805	0,443616202	0,245335219	0,193677056	0,042236717					

IV. ALTERNATIVES PRIORITIZATION

	Economic	Environmental	Social	Relational	Functional	Ranking
Tencel	0,587113518	0,764366069	0,260594036	0,487014104	0,31	0,55435985
Poly Coton	0,15498885	0,069778048	0,265644541	0,060285518	0,39	0,135873
Coton BIO	0,257897632	0,165855883	0,473761424	0,452700378	0,31	0,30976715
Total	1	1	1	1	1	1
Priority vector	0,075134805	0,443616202	0,245335219	0,193677056	0,042236717	

	LCC	PC	Economic
Tencel	0,643388869	0,19318606	0,587113518
Poly Coton	0,073772106	0,723506057	0,15498885
Coton BIO	0,282839025	0,083307883	0,257897632
Priority	0,875	0,125	

	Fiber quality	Provider performance	Environmental
Tencel	0,764366069	0,764366069	0,764366069
Poly Coton	0,069778048	0,069778048	0,069778048
Coton BIO	0,165855883	0,165855883	0,165855883
Priority	0,5	0,5	

	Social performance	User resistance	Social
Tencel	0,510533911	0,210606061	0,260594036
Poly Coton	0,389321789	0,240909091	0,265644541
Coton BIO	0,1001443	0,548484848	0,473761424
Priority	0,166666667	0,833333333	

	Brand image	Innovation	Relational
Tencel	0,489920881	0,466666667	0,487014104
Poly Coton	0,059373925	0,066666667	0,060285518
Coton BIO	0,450705194	0,466666667	0,452700378
Priority	0,875	0,125	

	fiber quality	availability	Functional
Tencel	0,333333333	0,11	0,305555556
Poly Coton	0,333333333	0,78	0,388888889
Coton BIO	0,333333333	0,11	0,305555556
Priority	0,875	0,125	

Actor A8

1. ALTERNATIVES COMPARISON

CRITERION 1 : Economic

SUBCRITERION 1 : LCC

	Tencel	Poly Coton	Coton BIO	Normalized			Priority vector	I _{max}
Tencel	1	1/5	1/3	0,1111111111	0,130434783	0,076923077	0,106156324	0,31965812
Poly Coton	5	1	3	0,555555556	0,652173913	0,692307692	0,63334572	1,945621206
Coton BIO	3	1/3	1	0,333333333	0,217391304	0,230769231	0,260497956	0,790082167
Total	9	1 1/2	4 1/3				I _{max}	3,055361493
Priority vector	0,106156324	0,63334572	0,260497956				CI	0,027680747
							RC	0,58
							CR	0,047725425

SUBCRITERION 2 : Purchasing cost

	Tencel	Poly Coton	Coton BIO	Normalized			Priority vector	I _{max}
Tencel	1	1/7	1/3	0,090909091	0,096774194	0,076923077	0,08820212	0,26476391
Poly Coton	7	1	3	0,636363636	0,677419355	0,692307692	0,668696895	2,015414693
Coton BIO	3	1/3	1	0,272727273	0,225806452	0,230769231	0,243100985	0,730606311
Total	11	1 1/2	4 1/3				I _{max}	3,010784914
Priority vector	0,08820212	0,668696895	0,243100985				CI	0,005392457
							RC	0,58
							CR	0,00929734

CRITERION 2 : Environmental

SUBCRITERION 1 : Fiber quality

	Tencel	Poly Coton	Coton BIO	Normalized			Priority vector	I _{max}
Tencel	1	5	3	0,652173913	0,555555556	0,692307692	0,63334572	1,945621206
Poly Coton	1/5	1	1/3	0,130434783	0,111111111	0,076923077	0,106156324	0,31965812
Coton BIO	1/3	3	1	0,217391304	0,333333333	0,230769231	0,260497956	0,790082167
Total	1 1/2	9	4 1/3				I _{max}	3,055361493
Priority vector	0,63334572	0,106156324	0,260497956				CI	0,027680747
							RC	0,58
							CR	0,047725425

SUBCRITERION 2 : Provider performance

	Tencel	Poly Coton	Coton BIO	Normalized			Priority vector	I _{max}
Tencel	1	3	1	0,428571429	0,272727273	0,466666667	0,389321789	1,2002886
Poly Coton	1/3	1	1/7	0,142857143	0,090909091	0,066666667	0,1001443	0,302853646
Coton BIO	1	7	1	0,428571429	0,636363636	0,466666667	0,510533911	1,600865801
Total	2 1/3	11	2 1/7				I _{max}	3,104006047
Priority vector	0,389321789	0,1001443	0,510533911				CI	0,052003023
							RC	0,58
							CR	0,089660385

CRITERION 3 : Social

SUBCRITERION 1 : Provider performance

	Tencel	Poly Coton	Coton BIO	Normalized			Priority vector	I _{max}
Tencel	1	5	1	0,454545455	0,384615385	0,466666667	0,455275835	1,312665113
Poly Coton	1/5	1	1/7	0,090909091	0,076923077	0,066666667	0,078166278	0,234729715
Coton BIO	1	7	1	0,454545455	0,538461538	0,466666667	0,486557887	1,468997669
Total	2 1/5	13	2 1/7				I _{max}	3,016392496
Priority vector	0,435275835	0,078166278	0,486557887				CI	0,008196248
							RC	0,58
							CR	0,014133462

SUBCRITERION 2 : User resistance

	Tencel	Poly Coton	Coton BIO	Normalized			Priority vector	I _{max}
Tencel	1	1	1/3	0,2	0,142857143	0,217391304	0,186749482	0,563008972
Poly Coton	1	1	1/5	0,2	0,142857143	0,130434783	0,157763975	0,475610766
Coton BIO	3	5	1	0,6	0,714285714	0,652173913	0,655486542	2,004554865
Total	5	7	1 1/2				I _{max}	3,043174603
Priority vector	0,186749482	0,157763975	0,655486542				CI	0,021587302
							RC	0,58
							CR	0,037219485

CRITERION 4 : Relational

SUBCRITERION 1 : Brand image

	Tencel	Poly Coton	Coton BIO	Normalized			Priority vector	I _{max}
Tencel	1	3	1/5	0,157894737	0,230769231	0,152542373	0,180402113	0,544335415
Poly Coton	1/3	1	1/9	0,052631579	0,076923077	0,084745763	0,071433473	0,21469689
Coton BIO	5	9	1	0,789473684	0,692307692	0,762711864	0,748164414	2,293076237
Total	6 1/3	13	1 1/3				I _{max}	3,052108542
Priority vector	0,180402113	0,071433473	0,748164414				CI	0,026054271
							RC	0,58
							CR	0,044921157

SUBCRITERION 2 : Innovation

	Tencel	Poly Coton	Coton BIO	Normalized			Priority vector	I _{max}
Tencel	1	7	3	0,677419355	0,538461538	0,714285714	0,643388869	2,008310686
Poly Coton	1/7	1	1/5	0,096774194	0,076923077	0,047619048	0,073772106	0,222252607
Coton BIO	1/3	5	1	0,225806452	0,384615385	0,238095238	0,282839025	0,866162511
Total	1 1/2	13	4 1/5				I _{max}	3,096725804
Priority vector	0,643388869	0,073772106	0,282839025				CI	0,048362902
							RC	0,58
							CR	0,083384313

CRITERION 5 : Functional

SUBCRITERION 1 : fiber quality

	Tencel	Poly Coton	Coton BIO	Normalized			Priority vector	I _{max}
Tencel	1	1/2	1	0,25	0,272727273	0,2	0,240909091	0,725757576
Poly Coton	2	1	3	0,5	0,545454545	0,6	0,548484848	1,662121212
Coton BIO	1	1/3	1	0,25	0,181818182	0,2	0,210606061	0,634343434
Total	4	1 5/6	5				I _{max}	3,022222222
Priority vector	0,240909091	0,548484848	0,210606061				CI	0,011111111
							RC	0,58
							CR	0,019157088

SUBCRITERION 2 : availability

	Tencel	Poly Coton	Coton BIO	Normalized			Priority vector	I _{max}
Tencel	1	1/5	1/3	0,1111111111	0,130434783	0,076923077	0,106156324	0,31965812
Poly Coton	5	1	3	0,555555556	0,652173913	0,692307692	0,63334572	1,945621206
Coton BIO	3	1/3	1	0,333333333	0,217391304	0,230769231	0,260497956	0,790082167
Total	9	1 1/2	4 1/3				I _{max}	3,055361493
Priority vector	0,106156324	0,63334572	0,260497956				CI	0,027680747
							RC	0,58

II.SUB-CRITERIA COMPARISON

CRITERION 1 : Economic				
	LCC	Purchasing cost	Priority vector	Global priority
LCC	1	7	0,875	0,063661639
Purchasing cost	1/7	1	0,125	0,00909452
Total	1 1/7	8		

CRITERION 2 : Environmental				
	Fiber quality	Provider performance	Priority vector	Global priority
Fiber quality	1	1	0,5	0,168428356
Provider performance	1	1	0,5	0,168428356
Total	2	2		

CRITERION 3 : Social				
	Social performance	User resistance	Priority vector	Global priority
Social performance	1	7	0,875	0,194096028
User resistance	1/7	1	0,125	0,027728004
Total	1 1/7	8		

CRITERION 4 : Relational				
	Brand image	Innovation	Priority vector	Global priority
Brand image	1	5	0,833333333	0,181890397
Innovation	1/5	1	0,166666667	0,036378079
Total	1 1/5	6		

CRITERION 5 : Functional				
	fiber quality	availability	Priority vector	Global priority
fiber quality	1	3	0,75	0,112720965
availability	1/3	1	0,25	0,037573655
Total	1 1/3	4		

III.CRITERIA COMPARISON

	Economic	Environmental	Social	Relational	Functional	Normalized				
Economic	1	1/3	1/3	1/3	1/3	0,07692308	0,111111	0,059	0,076923	0,04
Environmental	3	1	3	1	3	0,23076923	0,333333	0,529	0,230769	0,36
Social	3	1/3	1	1	3	0,23076923	0,111111	0,176	0,230769	0,36
Relational	3	1	1	1	1	0,23076923	0,333333	0,176	0,230769	0,12
Functional	3	1/3	1/3	1	1	0,23076923	0,111111	0,059	0,230769	0,12
Total	13	3	5 2/3	4 1/3	8 1/3					
priority vector	0,072756159	0,336856712	0,221824032	0,218268477	0,15029462					

IV.ALTERNATIVES PRIORITIZATION

	Economic	Environmental	Social	Relational	Functional	Ranking
Tencel	0,103912048	0,511333755	0,404210041	0,257566573	0,21	0,3568328
Poly Coton	0,637764617	0,103150312	0,08811599	0,071823245	0,57	0,20199403
Coton BIO	0,258323335	0,385515933	0,507673969	0,670610182	0,22	0,44117317
Total	1	1	1	1	1	1
Priority vector	0,072756159	0,336856712	0,221824032	0,218268477	0,15029462	

	LCC	PC	Economic
Tencel	0,106156324	0,08820212	0,103912048
Poly Coton	0,63334572	0,668696895	0,637764617
Coton BIO	0,260497956	0,243100985	0,258323335
Priority	0,875	0,125	

	Fiber quality	Provider performance	Environmental
Tencel	0,63334572	0,389321789	0,511333755
Poly Coton	0,106156324	0,1001443	0,103150312
Coton BIO	0,260497956	0,510533911	0,385515933
Priority	0,5	0,5	

	Sodal performance	User resistance	Social
Tencel	0,435275835	0,186749482	0,404210041
Poly Coton	0,078166278	0,157763975	0,08811599
Coton BIO	0,486557887	0,655486542	0,507673969
Priority	0,875	0,125	

	Brand image	Innovation	Relational
Tencel	0,180402113	0,643388869	0,257566573
Poly Coton	0,071433473	0,073772106	0,071823245
Coton BIO	0,748164414	0,282839025	0,670610182
Priority	0,833333333	0,166666667	

	fiber quality	availability	Functional
Tencel	0,240909091	0,11	0,207220899
Poly Coton	0,548484848	0,63	0,569700066
Coton BIO	0,210606061	0,26	0,223079034
Priority	0,75	0,25	

Actor A9

I. ALTERNATIVES COMPARISON

CRITERION 1 : Economic									
SUBCRITERION 1 : LCC									
	Tencel	Poly Coton	Coton BIO	Normalized			Priority vector	Imax	
Tencel	1	5	3	0,652173913	0,555555556	2/3	0,63334572	1,945621206	
Poly Coton	1/5	1	1/3	0,130434783	0,111111111	0,07692308	0,106156324	0,31965812	
Coton BIO	1/3	3	1	0,217391304	0,333333333	0,23076923	0,260497956	0,790082167	
Total	1 1/2	9	4 1/3				Imax	3,055361493	
Priority vector	0,63334572	0,106156324	0,260497956				CI	0,027680747	
							RC	0,58	
							CR	0,047725425	

SUBCRITERION 2 : Purchasing cost									
	Tencel	Poly Coton	Coton BIO	Normalized			Priority vector	Imax	
Tencel	1	5	3	0,652173913	0,555555556	0,69230769	0,63334572	1,945621206	
Poly Coton	1/5	1	1/3	0,130434783	0,111111111	0,07692308	0,106156324	0,31965812	
Coton BIO	1/3	3	1	0,217391304	0,333333333	0,23076923	0,260497956	0,790082167	
Total	1 1/2	9	4 1/3				Imax	3,055361493	
Priority vector	0,63334572	0,106156324	0,260497956				CI	0,027680747	
							RC	0,58	
							CR	0,047725425	

CRITERION 2 : Environmental									
SUBCRITERION 1 : Fibre quality									
	Tencel	Poly Coton	Coton BIO	Normalized			Priority vector	Imax	
Tencel	1	5	2	0,588235294	0,454545455	0,625	0,55926916	1,715129234	
Poly Coton	1/5	1	1/5	0,117647059	0,090909091	0,0625	0,09035205	0,27228164	
Coton BIO	1/2	5	1	0,294117647	0,454545455	0,3125	0,353721094	1,083444742	
Total	1 2/3	11	3 1/5				Imax	3,070855615	
Priority vector	0,55926916	0,09035205	0,353721094				CI	0,035427807	
							RC	0,58	
							CR	0,061082427	

SUBCRITERION 2 : Provider performance									
	Tencel	Poly Coton	Coton BIO	Normalized			Priority vector	Imax	
Tencel	1	1	1	0,333333333	0,333333333	0,333333333	0,333333333	1	
Poly Coton	1	1	1	0,333333333	0,333333333	0,333333333	0,333333333	1	
Coton BIO	1	1	1	0,333333333	0,333333333	0,333333333	0,333333333	1	
Total	3	3	3				Imax	3	
Priority vector	0,333333333	0,333333333	0,333333333				CI	0	
							RC	0,58	
							CR	0	

CRITERION 3 : Social									
SUBCRITERION 1 : Provider performance									
	Tencel	Poly Coton	Coton BIO	Normalized			Priority vector	Imax	
Tencel	1	1	1	0,333333333	0,333333333	0,333333333	0,333333333	1	
Poly Coton	1	1	1	0,333333333	0,333333333	0,333333333	0,333333333	1	
Coton BIO	1	1	1	0,333333333	0,333333333	0,333333333	0,333333333	1	
Total	3	3	3				Imax	3	
Priority vector	0,333333333	0,333333333	0,333333333				CI	0	
							RC	0,58	
							CR	0	

SUBCRITERION 2 : User resistance									
	Tencel	Poly Coton	Coton BIO	Normalized			Priority vector	Imax	
Tencel	1	1	1	0,333333333	0,333333333	0,333333333	0,333333333	1	
Poly Coton	1	1	1	0,333333333	0,333333333	0,333333333	0,333333333	1	
Coton BIO	1	1	1	0,333333333	0,333333333	0,333333333	0,333333333	1	
Total	3	3	3				Imax	3	
Priority vector	0,333333333	0,333333333	0,333333333				CI	0	
							RC	0,58	
							CR	0	

CRITERION 4 : Relational									
SUBCRITERION 1 : Brand image									
	Tencel	Poly Coton	Coton BIO	Normalized			Priority vector	Imax	
Tencel	1	3	1	0,428571429	0,333333333	0,454545455	0,405483405	1,22991823	
Poly Coton	1/3	1	1/5	0,142857143	0,111111111	0,09090909	0,114959115	0,346031746	
Coton BIO	1	5	1	0,428571429	0,555555556	0,454545455	0,47955748	1,45983646	
Total	2 1/3	9	2 1/5				Imax	3,035786436	
Priority vector	0,405483405	0,114959115	0,47955748				CI	0,017893218	
							RC	0,58	
							CR	0,030850376	

SUBCRITERION 2 : Innovation									
	Tencel	Poly Coton	Coton BIO	Normalized			Priority vector	Imax	
Tencel	1	3	1	0,428571429	0,428571429	0,42857143	0,428571429	1,285714286	
Poly Coton	1/3	1	1/3	0,142857143	0,142857143	0,14285714	0,142857143	0,428571429	
Coton BIO	1	3	1	0,428571429	0,428571429	0,42857143	0,428571429	1,285714286	
Total	2 1/3	7	2 1/3				Imax	3	
Priority vector	0,428571429	0,142857143	0,428571429				CI	0	
							RC	0,58	
							CR	0	

CRITERION 5 : Functional									
SUBCRITERION 1 : Fibre quality									
	Tencel	Poly Coton	Coton BIO	Normalized			Priority vector	Imax	
Tencel	1	1	1	0,333333333	0,333333333	0,333333333	0,333333333	1	
Poly Coton	1	1	1	0,333333333	0,333333333	0,333333333	0,333333333	1	
Coton BIO	1	1	1	0,333333333	0,333333333	0,333333333	0,333333333	1	
Total	3	3	3				Imax	3	
Priority vector	0,333333333	0,333333333	0,333333333				CI	0	
							RC	0,58	
							CR	0	

SUBCRITERION 2 : availability									
	Tencel	Poly Coton	Coton BIO	Normalized			Priority vector	Imax	
Tencel	1	1/3	5	0,238095238	0,225806452	0,38461538	0,282839025	0,866162511	
Poly Coton	3	1	7	0,714285714	0,677419355	0,53846154	0,643388869	2,008310686	
Coton BIO	1/5	1/7	13	0,047619048	0,096774194	0,07692308	0,073772106	0,222252607	
Total	4 1/5	1 1/2	1				Imax	3,096725804	
Priority vector	0,282839025	0,643388869	0,073772106				CI	0,048362902	
							RC	0,58	
							CR	0,083384313	

II. SUB-CRITERIA COMPARISON

CRITERION 1 : Economic

	LCC	Purchasing cost	Priority vector	Global priority
LCC	1	3	0,75	0,131062322
Purchasing cost	1/3	1	0,25	0,043687441
Total	1 1/3	4		

CRITERION 2 : Environmental

	Fibre quality	Provider performance	Priority vector	Global priority
Fibre quality	1	5	0,833333333	0,263177138
Provider performance	1/5	1	0,166666667	0,052635428
Total	1 1/5	6		

CRITERION 3 : Social

	Social performance	User resistance	Priority vector	Global priority
Social performance	1	1/5	0,166666667	0,052635428
User resistance	5	1	0,833333333	0,263177138
Total	6	1 1/5		

CRITERION 4 : Relational

	Brand image	Innovation	Priority vector	Global priority
Brand image	1	1	0,5	0,059324391
Innovation	1	1	0,5	0,059324391
Total	2	2		

CRITERION 5 : Functional

	Fibre quality	availability	Priority vector	Global priority
Fibre quality	1	1/7	0,125	0,009372041
availability	7	1	0,875	0,065604284
Total	8	1 1/7		

III. CRITERIA COMPARISON

	Economic	Environmental	Social	Relational	Functional	Normalized				
Economic	1	1/3	1/3	3	3	0,13	0,11	0,11	0,29	0,23
Environmental	3	1	1	3	3	0,39	0,33	0,33	0,29	0,23
Social	3	1	1	3	3	0,39	0,33	0,33	0,29	0,23
Relational	1/3	1/3	1/3	1	3	0,04	0,11	0,11	0,10	0,23
Functional	1/3	1/3	1/3	1/3	1	0,04	0,11	0,11	0,03	0,08
Total	7 2/3	3	3	10 1/3	13					
priority vector	0,174749763	0,315812565	0,315812565	0,118648781	0,074976325					

IV. ALTERNATIVES PRIORITIZATION

	Economic	Environmental	Social	Relational	Functional	Ranking
Tencel	0,63334572	0,444630125	0,333333333	0,417027417	0,29	0,4275269
Poly Coton	0,106156324	0,211842692	0,333333333	0,128908129	0,60	0,2513521
Coton BIO	0,260497956	0,343527184	0,333333333	0,454064454	0,11	0,321121
Total	1	1	1	1	1	1
Priority vector	0,174749763	0,315812565	0,315812565	0,118648781	0,074976325	

	LCC	PC	Economic
Tencel	0,63334572	0,63334572	0,63334572
Poly Coton	0,106156324	0,106156324	0,106156324
Coton BIO	0,260497956	0,260497956	0,260497956
Priority	0,75	0,25	

	Fibre quality	Provider performance	Environmental
Tencel	0,555926916	0,333333333	0,444630125
Poly Coton	0,09035205	0,333333333	0,211842692
Coton BIO	0,353721034	0,333333333	0,343527184
Priority	0,5	0,5	

	Social performance	User resistance	Social
Tencel	0,333333333	0,333333333	0,333333333
Poly Coton	0,333333333	0,333333333	0,333333333
Coton BIO	0,333333333	0,333333333	0,333333333
Priority	0,166666667	0,833333333	

	Brand image	Innovation	Relational
Tencel	0,405483405	0,428571429	0,417027417
Poly Coton	0,114959115	0,142857143	0,128908129
Coton BIO	0,47955748	0,428571429	0,454064454
Priority	0,5	0,5	

	Fibre quality	availability	Functional
Tencel	0,333333333	0,28	0,289150813
Poly Coton	0,333333333	0,64	0,604631927
Coton BIO	0,333333333	0,07	0,106217259
Priority	0,125	0,875	

Annex D-2: Evaluation matrices Middle of life

Actor A1

I. ALTERNATIVES COMPARISON

CRITERION 1 : Economic			
SUBCRITERION 1 : Purchasing cost			
	LC	LL	Priority vector
LC	1	5	0,833333333
LL	1/5	1	0,166666667
Total	1 1/5	6	

CRITERION 2 : Environmental			
SUBCRITERION 1 : Carbon footprint			
	LC	LL	Priority vector
LC	1	1/5	0,166666667
LL	5	1	0,833333333
Total	6	1 1/5	

SUBCRITERION 2 : Chemical use			
	LC	LL	Priority vector
LC	1	1/3	0,25
LL	3	1	0,75
Total	4	1 1/3	

CRITERION 3 : Social			
SUBCRITERION 1 : Local job			
	LC	LL	Priority vector
LC	1	1/7	0,125
LL	7	1	0,875
Total	8	1 1/7	

SUBCRITERION 2 : User resistance			
	LC	LL	Priority vector
LC	1	1/5	0,166666667
LL	5	1	0,833333333
Total	6	1 1/5	

SUBCRITERION 3 : SAP purchasing			
	LC	LL	Priority vector
LC	1	1/5	0,166666667
LL	5	1	0,833333333
Total	6	1 1/5	

CRITERION 4 : Relational			
SUBCRITERION 1 : Brand image			
	LC	LL	Priority vector
LC	1	1/5	0,166666667
LL	5	1	0,833333333
Total	6	1 1/5	

SUBCRITERION 2 : Innovation			
	LC	LL	Priority vector
LC	1	5	0,833333333
LL	1/5	1	0,166666667
Total	1 1/5	6	

CRITERION 5 : Functional			
SUBCRITERION 1 : Lifespan			
	LC	LL	Priority vector
LC	1	1	0,5
LL	1	1	0,5
Total	2	2	

SUBCRITERION 2 : Confort			
	LC	LL	Priority vector
LC	1	1	0,5
LL	1	1	0,5
Total	2	2	

SUBCRITERION 3 : Traceability			
	LC	LL	Priority vector
LC	1	3	0,75
LL	1/3	1	0,25
Total	1 1/3	4	

II.SUB-CRITERIA COMPARISON

CRITERION 2 : Environmental				
	Carbon footprint	Chemical use	Priority vector	Global priority
Carbon footprint	1	1	0,5	0,243417326
Chemical use	1	1	0,5	0,243417326
Total	2	2		

CRITERION 3 : Social									
	Local job	User resistance	SAP purchasing	Normalized			Priority vector	Global priority	Imax
Local job	1	5	1	0,454545455	0,454545455	0,454545455	0,454545455	0,108070093	1,36363636
User resistance	1/5	1	1/5	0,090909091	0,090909091	0,090909091	0,090909091	0,021614019	0,27272727
SAP purchasing	1	5	1	0,454545455	0,454545455	0,454545455	0,454545455	0,108070093	1,36363636
Total	2 1/5	11	2 1/5						Imax 3
Priority vector	4/9	0	4/9						CI 0
									RC 0,58
									CR 0

CRITERION 4 : Relational				
	Brand image	Innovation	Priority vector	Global priority
Brand image	1	1/3	0,25	0,029428094
Innovation	3	1	0,75	0,088284281
Total	4	1 1/3		

CRITERION 5 : Functional									
	Lifespan	Confort	Traceability	Normalized			Priority vector	Global priority	Imax
Lifespan	1	1/3	3	0,230769231	0,217391304	0,333333333	0,260497956	0,010416374	0,79008217
Confort	3	1	5	0,692307692	0,652173913	0,555555556	0,63334572	0,025325211	1,94562121
Traceability	1/3	1/5	1	0,076923077	0,130434783	0,111111111	0,106156324	0,004244809	0,31965812
Total	4 1/3	1 1/2	9						Imax 3,05536149
Priority vector	1/4	5/8	1/9						CI 0,02768075
									RC 0,58
									CR 0,04772543

III.CRITERIA COMPARISON

	Economic	Environmental	Social	Relational	Functional	Normalized				
Economic	1	1/5	1/3	1	5	0,098039216	0,106598985	0,068493151	0,09803922	0,2173913
Environmental	5	1	3	5	7	0,490196078	0,532994924	0,616438356	0,49019608	0,3043478
Social	3	1/3	1	3	5	0,294117647	0,177664975	0,205479452	0,29411765	0,2173913
Relational	1	1/5	1/3	1	5	0,098039216	0,106598985	0,068493151	0,09803922	0,2173913
Functional	1/5	1/7	1/5	1/5	1	0,019607843	0,076142132	0,04109589	0,01960784	0,0434783
Total	10 1/5	1 7/8	4 7/8	10 1/5	23					
priority vector	0,117712374	0,486834653	0,237754205	0,117712374	0,039986394					

IV.ALTERNATIVES PRIORITIZATION

	Economic	Environmental	Social	Relational	Functional	Ranking
LC	0,833333333	0,208333333	0,147727273	0,666666667	0,53	0,334169627
LL	0,166666667	0,791666667	0,852272727	0,333333333	0,47	0,665830373
Total	1	1	1	1	1	1
Priority vector	0,117712374	0,486834653	0,237754205	0,117712374	0,039986394	

	Carbon footprint	Chemical use	Environmental
LC	0,166666667	0,25	0,208333333
LL	0,833333333	0,75	0,791666667
Priority	0,5	0,5	

	Local job	User resistance	SAP purchasing	Social
LC	0,125	0,166666667	0,166666667	0,147727273
LL	0,875	0,833333333	0,833333333	0,852272727
Priority	0,454545455	0,090909091	0,454545455	

	Brand image	Innovation	Relational
LC	0,166666667	0,833333333	0,666666667
LL	0,833333333	0,166666667	0,333333333
Priority	0,25	0,75	

	Lifespan	Confort	Traceability	Functional
LC	0,5	0,50	0,75	0,526539081
LL	0,5	0,50	0,25	0,473460919
Priority	0,260497956	0,63334572	0,106156324	

I. ALTERNATIVES COMPARISON

CRITERION 1 : Economic			
SUBCRITERION 1: Purchasing cost			
	LC	LL	Priority vector
LC	1	1/5	0,166666667
LL	5	1	0,833333333
Total	6	1 1/5	

CRITERION 2 : Environmental			
SUBCRITERION 1: Carbonfootprint			
	LC	LL	Priority vector
LC	1	1/3	0,25
LL	3	1	0,75
Total	4	1 1/3	

SUBCRITERION 2: Chemicaluse			
	LC	LL	Priority vector
LC	1	1/3	0,25
LL	3	1	0,75
Total	4	1 1/3	

CRITERION 3 : Social			
SUBCRITERION 1: Local job			
	LC	LL	Priority vector
LC	1	1/5	0,166666667
LL	5	1	0,833333333
Total	6	1 1/5	

SUBCRITERION 2: User resistance			
	LC	LL	Priority vector
LC	1	1/5	0,166666667
LL	5	1	0,833333333
Total	6	1 1/5	

SUBCRITERION 3: SAP purchasing			
	LC	LL	Priority vector
LC	1	1/3	0,25
LL	3	1	0,75
Total	4	1 1/3	

CRITERION 4 : Relational			
SUBCRITERION 1: Brand image			
	LC	LL	Priority vector
LC	1	1/3	0,25
LL	3	1	0,75
Total	4	1 1/3	

SUBCRITERION 2: Innovation			
	LC	LL	Priority vector
LC	1	1/5	0,166666667
LL	5	1	0,833333333
Total	6	1 1/5	

CRITERION 5 : Functional			
SUBCRITERION 1: Lifespan			
	LC	LL	Priority vector
LC	1	1/5	0,166666667
LL	5	1	0,833333333
Total	6	1 1/5	

SUBCRITERION 2: Confort			
	LC	LL	Priority vector
LC	1	1/5	0,166666667
LL	5	1	0,833333333
Total	6	1 1/5	

SUBCRITERION 3: Traceability			
	LC	LL	Priority vector
LC	1	1/5	0,166666667
LL	5	1	0,833333333
Total	6	1 1/5	

II.SUB-CRITERIA COMPARISON

CRITERION 2 : Environmental

	Carbon footprint	Chemical use	Priorityvector	Global priority
Carbon footprint	1	1	0,5	0,10318934
Chemical use	1	1	0,5	0,10318934
Total	2	2		

CRITERION 3 : Social

	Local job	User resistance	SAP purchasing	Normalized	Priorityvector	Global priority	Imax
Local job	1	1/3	1	0,2	0,052631579	0,454545454	0,235725678
User resistance	3	1	1/5	0,6	0,157894737	0,090909091	0,282934609
SAP purchasing	1	5	1	0,2	0,789473684	0,454545454	0,481339713
Total	5	6 1/3	2 1/5				Imax
Priority vector	1/4	2/7	1/2				CI
							RC
							CR

CRITERION 4 : Relational

	Brand image	Innovation	Priorityvector	Global priority
Brand image	1	1	0,5	0,104976118
Innovation	1	1	0,5	0,104976118
Total	2	2		

CRITERION 5 : Functional

	Lifespan	Confort	Traceability	Normalized	Priorityvector	Global priority	Imax
Lifespan	1	1/3	1/3	0,142857143	0,1	0,181818182	0,141558442
Confort	3	1	1/2	0,428571429	0,3	0,272727273	0,333766234
Traceability	3	2	1	0,428571429	0,6	0,545454545	0,524675325
Total	7	3 1/3	1 5/6				Imax
Priority vector	1/7	1/3	1/2				CI
							RC
							CR

III.CRITERIA COMPARISON

	Economic	Environmental	Social	Relational	Functional	Normalized
Economic	1	1/7	1/7	1/3	1/5	0,043478261
Environmental	7	1	1/3	1	1	0,304347826
Social	7	3	1	1	1	0,304347826
Relational	3	1	1	1	1	0,130434783
Functional	5	1	1	1	1	0,217391304
Total	23	6 1/7	3 1/2	4 1/3	4 1/5	
priorityvector	0,046474418	0,206378681	0,309851124	0,209952236	0,227343541	

IV.ALTERNATIVES PRIORITIZATION

	Economic	Environmental	Social	Relational	Functional	Ranking
LC	0,166666667	0,25	0,206778309	0,208333333	0,17	0,205041538
LL	0,833333333	0,75	0,793221691	0,791666667	0,83	0,794958462
Total	1	1	1	1	1	1
Priorityvector	0,046474418	0,206378681	0,309851124	0,209952236	0,227343541	

	Carbon footprint	Chemical use	Environmental
LC	0,25	0,25	0,25
LL	0,75	0,75	0,75
Priority	0,5	0,5	

	Local job	User resistance	SAP purchasing	Social
LC	0,166666667	0,166666667	0,25	0,206778309
LL	0,833333333	0,833333333	0,75	0,793221691
Priority	0,235725678	0,282934609	0,481339713	

	Brand image	Innovation	Relational
LC	0,25	0,166666667	0,208333333
LL	0,75	0,833333333	0,791666667
Priority	0,5	0,5	

	Lifespan	Confort	Traceability	Functional
LC	0,166666667	0,17	0,17	0,166666667
LL	0,833333333	0,83	0,83	0,833333333
Priority	0,141558442	0,333766234	0,524675325	

Actor A3

ALTERNATIVES COMPARISON

CRITERION 1 : Economic			
SUBCRITERION 1: Purchasing cost			
	LC	LL	Priority vector
LC	1	1	0,5
LL	1	1	0,5
Total	2	2	

CRITERION 2 : Environmental			
SUBCRITERION 1: Carbon footprint			
	LC	LL	Priority vector
LC	1	1/7	0,125
LL	7	1	0,875
Total	8	1 1/7	

SUBCRITERION 2: Chemical use			
	LC	LL	Priority vector
LC	1	1	0,5
LL	1	1	0,5
Total	2	2	

CRITERION 3 : Social			
SUBCRITERION 1: Local job			
	LC	LL	Priority vector
LC	1	1/7	0,125
LL	7	1	0,875
Total	8	1 1/7	

SUBCRITERION 2: User resistance			
	LC	LL	Priority vector
LC	1	1	0,5
LL	1	1	0,5
Total	2	2	

SUBCRITERION 3: SAP purchasing			
	LC	LL	Priority vector
LC	1	1	0,5
LL	1	1	0,5
Total	2	2	

CRITERION 4 : Relational			
SUBCRITERION 1: Brand image			
	LC	LL	Priority vector
LC	1	1/5	0,166666667
LL	5	1	0,833333333
Total	6	1 1/5	

SUBCRITERION 2: Innovation			
	LC	LL	Priority vector
LC	1	1	0,5
LL	1	1	0,5
Total	2	2	

CRITERION 5 : Functional			
SUBCRITERION 1: Lifespan			
	LC	LL	Priority vector
LC	1	7	0,875
LL	1/7	1	0,125
Total	1 1/7	8	

SUBCRITERION 2: Confort			
	LC	LL	Priority vector
LC	1	7	0,875
LL	1/7	1	0,125
Total	1 1/7	8	

SUBCRITERION 3: Traceability			
	LC	LL	Priority vector
LC	1	7	0,875
LL	1/7	1	0,125
Total	1 1/7	8	

II. SUB-CRITERIA COMPARISON

CRITERION 2 : Environmental				
	Carbon footprint	Chemical use	Priority vector	Global priority
Carbon footprint	1	1	0.5	0.206962857
Chemical use	1	1	0.5	0.206962857
Total	2	2		

CRITERION 3 : Social									
	Local job	User resistance	SAP purchasing	Normalized			Priority vector	Global priority	Imax
Local job	1	1/5	1/2	0.125	0.090909091	0.2	0.138636364	0.044209177	0.421363636
User resistance	5	1	1	0.625	0.454545455	0.4	0.493181818	0.157268713	1.554545455
SAP purchasing	2	1	1	0.25	0.454545455	0.4	0.368181818	0.117407979	1.138636364
Total	8	2 1/5	2 1/2						3.114545455
Priority vector	1/7	1/2	3/8						0.057272727
									CI
									RC
									CR

CRITERION 4 : Relational				
	Brand image	Innovation	Priority vector	Global priority
Brand image	1	7	0.875	0.067553279
Innovation	1/7	1	0.125	0.009650468
Total	1 1/7	8		

CRITERION 5 : Functional									
	Lifespan	Confort	Traceability	Normalized			Priority vector	Global priority	Imax
Lifespan	1	1	5	0.454545455	0.454545455	0.454545455	0.454545455	0.039320942	1.363636364
Confort	1	1	5	0.454545455	0.454545455	0.454545455	0.454545455	0.039320942	1.363636364
Traceability	1/5	1/5	1	0.090909091	0.090909091	0.090909091	0.090909091	0.007864188	0.272727273
Total	2 1/5	2 1/5	11						Imax
Priority vector	4/9	4/9	0						CI
									RC
									CR

III. CRITERIA COMPARISON

	Economic	Environmental	Social	Relational	Functional	Normalized				
Economic	1	1/7	1/5	3	1	0.069767442	0.056179775	0.069767442	0.230769231	0.090909091
Environmental	7	1	1	5	5	0.488372093	0.393258427	0.348837209	0.384615385	0.454545455
Social	5	1	1	3	3	0.348837209	0.393258427	0.348837209	0.230769231	0.272727273
Relational	1/3	1/5	1/3	1	1	0.023255814	0.078651685	0.11627907	0.076923077	0.090909091
Functional	1	1/5	1/3	1	1	0.069767442	0.078651685	0.11627907	0.076923077	0.090909091
Total	14 1/3	2 1/2	2 7/8	13	11					
priority vector	0.103478596	0.413925714	0.31888587	0.077203747	0.086506073					

IV. ALTERNATIVES PRIORITIZATION

	Economic	Environmental	Social	Relational	Functional	Ranking
IC	0.5	0.3125	0.448011364	0.208333333	0.88	0.415732505
IL	0.5	0.6875	0.551988636	0.791666667	0.13	0.584267495
Total	1	1	1	1	1	1
Priority vector	0.103478596	0.413925714	0.31888587	0.077203747	0.086506073	

	Carbon footprint	Chemical use	Environmental
IC	0.125	0.5	0.3125
IL	0.875	0.5	0.6875
Priority	0.5	0.5	

	Local job	User resistance	SAP purchasing	Social
IC	0.125	0.5	0.5	0.448011364
IL	0.875	0.5	0.5	0.551988636
Priority	0.138636364	0.493181818	0.368181818	

	Brand image	Innovation	Relational
IC	0.166666667	0.5	0.208333333
IL	0.833333333	0.5	0.791666667
Priority	0.875	0.125	

	Lifespan	Confort	Traceability	Functional
IC	0.875	0.88	0.88	0.875
IL	0.125	0.13	0.13	0.125
Priority	0.454545455	0.454545455	0.090909091	

Actor A4

I. ALTERNATIVES COMPARISON

CRITERION 1 : Economic

SUBCRITERION 1 : Purchasing cost

	LC	LL	Priority vector
LC	1	1/3	0,25
LL	3	1	0,75
Total	4	1 1/3	

CRITERION 2 : Environmental

SUBCRITERION 1 : Carbon footprint

	LC	LL	Priority vector
LC	1	1/5	0,166666667
LL	5	1	0,833333333
Total	6	1 1/5	

SUBCRITERION 2 : Chemical use

	LC	LL	Priority vector
LC	1	1/3	0,25
LL	3	1	0,75
Total	4	1 1/3	

CRITERION 3 : Social

SUBCRITERION 1 : Local job

	LC	LL	Priority vector
LC	1	1/5	0,166666667
LL	5	1	0,833333333
Total	6	1 1/5	

SUBCRITERION 2 : User resistance

	LC	LL	Priority vector
LC	1	1	0,5
LL	1	1	0,5
Total	2	2	

SUBCRITERION 3 : SAP purchasing

	LC	LL	Priority vector
LC	1	1	0,5
LL	1	1	0,5
Total	2	2	

CRITERION 4 : Relational

SUBCRITERION 1 : Brand image

	LC	LL	Priority vector
LC	1	1/5	0,166666667
LL	5	1	0,833333333
Total	6	1 1/5	

SUBCRITERION 2 : Innovation

	LC	LL	Priority vector
LC	1	1/5	0,166666667
LL	5	1	0,833333333
Total	6	1 1/5	

CRITERION 5 : Functional

SUBCRITERION 1 : Lifespan

	LC	LL	Priority vector
LC	1	1/7	0,125
LL	7	1	0,875
Total	8	1 1/7	

SUBCRITERION 2 : Confort

	LC	LL	Priority vector
LC	1	1/7	0,125
LL	7	1	0,875
Total	8	1 1/7	

SUBCRITERION 3 : Traceability

	LC	LL	Priority vector
LC	1	1/7	0,125
LL	7	1	0,875
Total	8	1 1/7	

II.SUB-CRITERIA COMPARISON

CRITERION 2 : Environmental				
	Carbon footprint	Chemical use	Priority vector	Global priority
Carbon footprint	1	5	0,83333333	0,131450241
Chemical use	1/5	1	0,16666667	0,026290048
Total	1 1/5	6		

CRITERION 3 : Social									
	Local job	User resistance	SAP purchasing	Normalized			Priority vector	Global priority	Imax
Local job	1	3	1	0,428571429	0,428571429	0,428571429	0,428571429	0,052720348	1,285714286
User resistance	1/3	1	1/3	0,142857143	0,142857143	0,142857143	0,142857143	0,017573449	0,428571429
SAP purchasing	1	3	1	0,428571429	0,428571429	0,428571429	0,428571429	0,052720348	1,285714286
Total	2 1/3	7	2 1/3						
Priority vector	3/7	1/7	3/7						
								Imax	3
								CI	0
								RC	0,58
								CR	1

CRITERION 4 : Relational				
	Brand image	Innovation	Priority vector	Global priority
Brand image	1	5	0,83333333	0,033158996
Innovation	1/5	1	0,16666667	0,006631799
Total	1 1/5	6		

CRITERION 5 : Functional									
	Lifespan	Confort	Traceability	Normalized			Priority vector	Global priority	Imax
Lifespan	1	1/5	1	0,142857143	0,14893617	0,111111111	0,134301475	0,056491235	0,403534842
Confort	5	1	7	0,714285714	0,744680851	0,777777778	0,745581448	0,313613953	2,257908364
Traceability	1	1/7	1	0,142857143	0,106382979	0,111111111	0,120117078	0,050524851	0,360930188
Total	7	1 1/3	9						
Priority vector	1/7	3/4	1/8						
								Imax	3,022373394
								CI	0,011186697
								RC	0,58
								CR	0,019287408

III.CRITERIA COMPARISON

	Economic	Environmental	Social	Relational	Functional	Normalized				
Economic	1	3	3	5	1/3	0,205479452	0,38961039	0,326086957	0,217391304	0,1555556
Environmental	1/3	1	2	5	1/3	0,068493151	0,12987013	0,217391304	0,217391304	0,1555556
Social	1/3	1/2	1	5	1/3	0,068493151	0,064935065	0,108695652	0,217391304	0,1555556
Relational	1/5	1/5	1/5	1	1/7	0,04109589	0,025974026	0,02173913	0,043478261	0,0666667
Functional	3	3	3	7	1	0,616438356	0,38961039	0,326086957	0,304347826	0,4666667
Total	4 6/7	7 5/7	9 1/5	23	2 1/7					
priority vector	0,258824732	0,157740289	0,123014146	0,039790795	0,420630039					

IV.ALTERNATIVES PRIORITIZATION

	Economic	Environmental	Social	Relational	Functional	Ranking
LC	0,25	0,208333333	0,357142857	0,166666667	0,13	0,200712921
LL	0,75	0,791666667	0,642857143	0,833333333	0,88	0,799287079
Total	1	1	1	1	1	1
Priority vector	0,258824732	0,157740289	0,123014146	0,039790795	0,420630039	

	Carbon footprint	Chemical use	Environmental
LC	0,166666667	0,25	0,208333333
LL	0,833333333	0,75	0,791666667
Priority	0,5	0,5	

	Local job	User resistance	SAP purchasing	Social
LC	0,166666667	0,5	0,5	0,357142857
LL	0,833333333	0,5	0,5	0,642857143
Priority	0,428571429	0,142857143	0,428571429	

	Brand image	Innovation	Relational
LC	0,166666667	0,166666667	0,166666667
LL	0,833333333	0,833333333	0,833333333
Priority	0,833333333	0,166666667	

	Lifespan	Confort	Traceability	Functional
LC	0,125	0,13	0,13	0,125
LL	0,875	0,88	0,88	0,875
Priority	0,134301475	0,745581448	0,120117078	

Actor A5

I. ALTERNATIVES COMPARISON

CRITERION 1 : Economic

SUBCRITERION 1 : Purchasing cost

	LC	LL	Priority vector
LC	1	1	0,5
LL	1	1	0,5
Total	2	2	

CRITERION 2 : Environmental

SUBCRITERION 1 : Carbon footprint

	LC	LL	Priority vector
LC	1	3	0,75
LL	1/3	1	0,25
Total	1 1/3	4	

SUBCRITERION 2 : Chemical use

	LC	LL	Priority vector
LC	1	1	0,5
LL	1	1	0,5
Total	2	2	

CRITERION 3 : Social

SUBCRITERION 1 : Local job

	LC	LL	Priority vector
LC	1	1/3	0,25
LL	3	1	0,75
Total	4	1 1/3	

SUBCRITERION 2 : User resistance

	LC	LL	Priority vector
LC	1	1	0,5
LL	1	1	0,5
Total	2	2	

SUBCRITERION 3 : SAP purchasing

	LC	LL	Priority vector
LC	1	1	0,5
LL	1	1	0,5
Total	2	2	

CRITERION 4 : Relational

SUBCRITERION 1 : Brand image

	LC	LL	Priority vector
LC	1	1/5	0,166666667
LL	5	1	0,833333333
Total	6	1 1/5	

SUBCRITERION 2 : Innovation

	LC	LL	Priority vector
LC	1	1/3	0,25
LL	3	1	0,75
Total	4	1 1/3	

CRITERION 5 : Functional

SUBCRITERION 1 : Lifespan

	LC	LL	Priority vector
LC	1	1/3	0,25
LL	3	1	0,75
Total	4	1 1/3	

SUBCRITERION 2 : Confort

	LC	LL	Priority vector
LC	1	1/3	0,25
LL	3	1	0,75
Total	4	1 1/3	

SUBCRITERION 3 : Traceability

	LC	LL	Priority vector
LC	1	1	0,5
LL	1	1	0,5
Total	2	2	

II SUB-CRITERIA COMPARISON

CRITERION 2 : Environmental				
	Carbon footprint	Chemical use	Priority vector	Global priority
Carbon footprint	1	1/5	0,16666667	0,042262086
Chemical use	5	1	0,83333333	0,211310429
Total	6	1 1/5		

CRITERION 3 : Social									
	Local job	User resistance	SAP purchasing	Normalized			Priority vector	Global priority	Imax
Local job	1	1	5	0,45454545	0,4	0,625	0,493181818	0,120573883	1,55454545
User resistance	1	1	2	0,45454545	0,4	0,25	0,368181818	0,090013682	1,138636364
SAP purchasing	1/5	1/2	1	0,090909091	0,2	0,125	0,138636364	0,033894041	0,421363636
Total	2 1/5	2 1/2	8						
Priority vector	1/2	3/8	1/7						
								Imax	3,11454545
								CI	0,057272727
								RC	0,58
								CR	0,098746082

CRITERION 4 : Relational				
	Brand image	Innovation	Priority vector	Global priority
Brand image	1	1	0,5	0,113149894
Innovation	1	1	0,5	0,113149894
Total	2	2		

CRITERION 5 : Functional									
	Lifespan	Confort	Traceability	Normalized			Priority vector	Global priority	Imax
Lifespan	1	1	1	0,33333333	0,33333333	0,33333333	0,33333333	0,0564812	1
Confort	1	1	1	0,33333333	0,33333333	0,33333333	0,33333333	0,0564812	1
Traceability	1	1	1	0,33333333	0,33333333	0,33333333	0,33333333	0,0564812	1
Total	3	3	3						
Priority vector	1/3	1/3	1/3						
								Imax	3
								CI	0
								RC	0,58
								CR	0

III CRITERIA COMPARISON

	Economic	Environmental	Social	Relational	Functional	Normalized				
Economic	1	1/3	1	1/3	1/3	0,090909091	0,086956522	0,230769231	0,076923077	0,0454545
Environmental	3	1	1	1	2	0,272727273	0,260869565	0,230769231	0,230769231	0,2727273
Social	1	1	1	1	3	0,090909091	0,260869565	0,230769231	0,230769231	0,4090909
Relational	3	1	1	1	1	0,272727273	0,260869565	0,230769231	0,230769231	0,1363636
Functional	3	1/2	1/3	1	1	0,272727273	0,130434783	0,076923077	0,230769231	0,1363636
Total	11	3 5/6	4 1/3	4 1/3	7 1/3					
priority vector	0,106202493	0,253572514	0,244481605	0,226299787	0,1694436					

IV ALTERNATIVES PRIORITIZATION

	Economic	Environmental	Social	Relational	Functional	Ranking
LC	0,5	0,625	0,376704545	0,208333333	0,33	0,407308389
LL	0,5	0,375	0,623295455	0,791666667	0,67	0,592691611
Total	1	1	1	1	1	1
Priority vector	0,106202493	0,253572514	0,244481605	0,226299787	0,1694436	

	Carbon footprint	Chemical use	Environmental
LC	0,75	0,5	0,625
LL	0,25	0,5	0,375
Priority	0,5	0,5	

	Local job	User resistance	SAP purchasing	Social
LC	0,25	0,5	0,5	0,376704545
LL	0,75	0,5	0,5	0,623295455
Priority	0,493181818	0,368181818	0,138636364	

	Brand image	Innovation	Relational
LC	0,166666667	0,25	0,208333333
LL	0,833333333	0,75	0,791666667
Priority	0,5	0,5	

	Lifespan	Confort	Traceability	Functional
LC	0,25	0,25	0,50	0,333333333
LL	0,75	0,75	0,50	0,666666667
Priority	0,333333333	0,333333333	0,333333333	

Actor A6

I. ALTERNATIVES COMPARISON

CRITERION 1 : Economic			
SUBCRITERION 1 : Purchasing cost			
	LC	LL	Priority vector
LC	1	5	0,833333333
LL	1/5	1	0,166666667
Total	1 1/5	6	

CRITERION 2 : Environmental			
SUBCRITERION 1 : Carbon footprint			
	LC	LL	Priority vector
LC	1	1	0,5
LL	1	1	0,5
Total	2	2	

SUBCRITERION 2 : Chemical use			
	LC	LL	Priority vector
LC	1	1	0,5
LL	1	1	0,5
Total	2	2	

CRITERION 3 : Social			
SUBCRITERION 1 : Local job			
	LC	LL	Priority vector
LC	1	1/7	0,125
LL	7	1	0,875
Total	8	1 1/7	

SUBCRITERION 2 : User resistance			
	LC	LL	Priority vector
LC	1	1/7	0,125
LL	7	1	0,875
Total	8	1 1/7	

SUBCRITERION 3 : SAP purchasing			
	LC	LL	Priority vector
LC	1	1/7	0,125
LL	7	1	0,875
Total	8	1 1/7	

CRITERION 4 : Relational			
SUBCRITERION 1 : Brand image			
	LC	LL	Priority vector
LC	1	1/5	0,166666667
LL	5	1	0,833333333
Total	6	1 1/5	

SUBCRITERION 2 : Innovation			
	LC	LL	Priority vector
LC	1	3	0,75
LL	1/3	1	0,25
Total	1 1/3	4	

CRITERION 5 : Functional			
SUBCRITERION 1 : Lifespan			
	LC	LL	Priority vector
LC	1	5	0,833333333
LL	1/5	1	0,166666667
Total	1 1/5	6	

SUBCRITERION 2 : Confort			
	LC	LL	Priority vector
LC	1	1	0,5
LL	1	1	0,5
Total	2	2	

SUBCRITERION 3 : Traceability			
	LC	LL	Priority vector
LC	1	7	0,875
LL	1/7	1	0,125
Total	1 1/7	8	

II.SUB-CRITERIA COMPARISON

CRITERION 2 : Environmental

	Carbon footprint	Chemical use	Priority vector	Global priority
Carbon footprint	1	5	0,833333333	0,409002162
Chemical use	1/5	1	0,166666667	0,081800432
Total	1 1/5	6		

CRITERION 3 : Social

	Local job	User resistance	SAP purchasing	Normalized			Priority vector	Global priority	Imax
Local job	1	5	1	0,454545455	0,454545455	0,454545455	0,454545455	0,128858555	1,363636364
User resistance	1/5	1	1/5	0,090909091	0,090909091	0,090909091	0,090909091	0,025771711	0,272727273
SAP purchasing	1	5	1	0,454545455	0,454545455	0,454545455	0,454545455	0,128858555	1,363636364
Total	2 1/5	11	2 1/5						
Priority vector	4/9	0	4/9						
								Imax	3
								CI	0
								RC	0,58
								CR	0

CRITERION 4 : Relational

	Brand image	Innovation	Priority vector	Global priority
Brand image	1	1/7	0,125	0,006705769
Innovation	7	1	0,875	0,046940386
Total	8	1 1/7		

CRITERION 5 : Functional

	Lifespan	Confort	Traceability	Normalized			Priority vector	Global priority	Imax
Lifespan	1	3	5	0,652173913	0,6	0,714285714	0,655486542	0,035164333	2,004554865
Confort	1/3	1	1	0,217391304	0,2	0,142857143	0,186749482	0,010018392	0,563008972
Traceability	1/5	1	1	0,130434783	0,2	0,142857143	0,157763975	0,008463431	0,475610764
Total	1 1/2	5	7						
Priority vector	2/3	1/5	1/6						
								Imax	3,043174603
								CI	0,021587302
								RC	0,58
								CR	0,037219488

III.CRITERIA COMPARISON

	Economic	Environmental	Social	Relational	Functional	Normalized				
Economic	1	1/5	1/5	3	3	0,085714286	0,109947644	0,043478261	0,176470588	0,176470588
Environmental	5	1	3	7	7	0,428571429	0,54973822	0,652173913	0,411764706	0,411764706
Social	5	1/3	1	5	5	0,428571429	0,183246073	0,217391304	0,294117647	0,294117647
Relational	1/3	1/7	1/5	1	1	0,028571429	0,078534031	0,043478261	0,058823529	0,058823529
Functional	1/3	1/7	1/5	1	1	0,028571429	0,078534031	0,043478261	0,058823529	0,058823529
Total	11 2/3	1 5/6	4 3/5	17	17					
priority vector	0,118416273	0,490802595	0,28348882	0,053646156	0,053646156					

IV.ALTERNATIVES PRIORITIZATION

	Economic	Environmental	Social	Relational	Functional	Ranking
LC	0,833333333	0,5	0,125	0,677083333	0,78	0,457558855
LL	0,166666667	0,5	0,875	0,322916667	0,22	0,542441145
Total	1	1	1	1	1	1
Priority vector	0,118416273	0,490802595	0,28348882	0,053646156	0,053646156	

	Carbon footprint	Chemical use	Environmental
LC	0,5	0,5	0,5
LL	0,5	0,5	0,5
Priority	0,5	0,5	

	Local job	User resistance	SAP purchasing	Social
LC	0,125	0,125	0,125	0,125
LL	0,875	0,875	0,875	0,875
Priority	0,454545455	0,090909091	0,454545455	

	Brand image	Innovation	Relational
LC	0,166666667	0,75	0,677083333
LL	0,833333333	0,25	0,322916667
Priority	0,125	0,875	

	Lifespan	Confort	Traceability	Functional
LC	0,833333333	0,50	0,88	0,777657005
LL	0,166666667	0,50	0,13	0,222342995
Priority	0,655486542	0,186749482	0,157763975	

Actor A7

ALTERNATIVES COMPARISON

CRITERION 1 : Economic			
SUBCRITERION 1 : Purchasing cost			
	LC	LL	Priority vector
LC	1	1/7	0,125
LL	7	1	0,875
Total	8	1 1/7	

CRITERION 2 : Environmental			
SUBCRITERION 1 : Carbon footprint			
	LC	LL	Priority vector
LC	1	1/7	0,125
LL	7	1	0,875
Total	8	1 1/7	

SUBCRITERION 2 : Chemical use			
	LC	LL	Priority vector
LC	1	1	0,5
LL	1	1	0,5
Total	2	2	

CRITERION 3 : Social			
SUBCRITERION 1 : Local job			
	LC	LL	Priority vector
LC	1	1/7	0,125
LL	7	1	0,875
Total	8	1 1/7	

SUBCRITERION 2 : User resistance			
	LC	LL	Priority vector
LC	1	3	0,75
LL	1/3	1	0,25
Total	1 1/3	4	

SUBCRITERION 3 : SAP purchasing			
	LC	LL	Priority vector
LC	1	1/7	0,125
LL	7	1	0,875
Total	8	1 1/7	

CRITERION 4 : Relational			
SUBCRITERION 1 : Brand image			
	LC	LL	Priority vector
LC	1	1/7	0,125
LL	7	1	0,875
Total	8	1 1/7	

SUBCRITERION 2 : Innovation			
	LC	LL	Priority vector
LC	1	1	0,5
LL	1	1	0,5
Total	2	2	

CRITERION 5 : Functional			
SUBCRITERION 1 : Lifespan			
	LC	LL	Priority vector
LC	1	1	0,5
LL	1	1	0,5
Total	2	2	

SUBCRITERION 2 : Confort			
	LC	LL	Priority vector
LC	1	1	0,5
LL	1	1	0,5
Total	2	2	

SUBCRITERION 3 : Traceability			
	LC	LL	Priority vector
LC	1	3	0,75
LL	1/3	1	0,25
Total	1 1/3	4	

II.SUB-CRITERIA COMPARISON

CRITERION 2 : Environmental				
	Carbon footprint	Chemical use	Priority vector	Global priority
Carbon footprint	1	7	0,875	0,466278348
Chemical use	1/7	1	0,125	0,066611193
Total	1 1/7	8		

CRITERION 3 : Social									
	Local job	User resistance	SAP purchasing	Normalized	Priority vector	Global priority	Imax		
Local job	1	6	1/3	0,24	0,375	0,230769231	0,281923077	0,050625857	0,860192308
User resistance	1/6	1	1/9	0,04	0,0625	0,076923077	0,059807692	0,010739865	0,179935897
SAP purchasing	3	9	1	0,72	0,5625	0,692307692	0,658269231	0,118207578	2,042307692
Total	4 1/6	16	1 4/9						
Priority vector	2/7	0	2/3						
								Imax	3,082435897
								CI	0,041217949
								RC	0,58
								CR	0,071065429

CRITERION 4 : Relational				
	Brand image	Innovation	Priority vector	Global priority
Brand image	1	7	0,875	0,12325567
Innovation	1/7	1	0,125	0,017607953
Total	1 1/7	8		

CRITERION 5 : Functional									
	Lifespan	Confort	Traceability	Normalized	Priority vector	Global priority	Imax		
Lifespan	1	1/3	1	0,2	0,181818182	0,25	0,210606061	0,008962688	0,634343434
Confort	3	1	2	0,6	0,545454545	0,5	0,548484848	0,023341677	1,662121212
Traceability	1	1/2	1	0,2	0,272727273	0,25	0,240909091	0,010252283	0,725757576
Total	5	1 5/6	4						
Priority vector	1/5	5/9	1/4						
								Imax	3,022222222
								CI	0,011111111
								RC	0,58
								CR	0,019157088

III.CRITERIA COMPARISON

	Economic	Environmental	Social	Relational	Functional	Normalized	Priority vector	Global priority	Imax	
Economic	1	1/5	1/3	1	3	0,096774194	0,114754098	0,044247788	0,12195122	0,1428571
Environmental	5	1	5	5	7	0,483870968	0,573770492	0,663716814	0,609756098	0,3333333
Social	3	1/5	1	1	5	0,290322581	0,114754098	0,132743363	0,12195122	0,2380952
Relational	1	1/5	1	1	5	0,096774194	0,114754098	0,132743363	0,12195122	0,2380952
Functional	1/3	1/7	1/5	1/5	1	0,032258065	0,081967213	0,026548673	0,024390244	0,047619
Total	10 1/3	1 3/4	7 1/2	8 1/5	21					
priority vector	0,104116888	0,532889541	0,1795733	0,140863622	0,042556648					

IV.ALTERNATIVES PRIORITIZATION

	Economic	Environmental	Social	Relational	Functional	Ranking
LC	0,125	0,3125	0,162379808	0,171875	0,56	0,256754001
LL	0,875	0,6875	0,837620192	0,828125	0,44	0,743245999
Total	1	1	1	1	1	1
Priority vector	0,104116888	0,532889541	0,1795733	0,140863622	0,042556648	

	Carbon footprint	Chemical use	Environmental
LC	0,125	0,5	0,3125
LL	0,875	0,5	0,6875
Priority	0,5	0,5	

	Local job	User resistance	SAP purchasing	Social
LC	0,125	0,75	0,125	0,162379808
LL	0,875	0,25	0,875	0,837620192
Priority	0,281923077	0,059807692	0,658269231	

	Brand image	Innovation	Relational
LC	0,125	0,5	0,171875
LL	0,875	0,5	0,828125
Priority	0,875	0,125	

	Lifespan	Confort	Traceability	Functional
LC	0,5	0,50	0,75	0,560227273
LL	0,5	0,50	0,25	0,439772727
Priority	0,210606061	0,548484848	0,240909091	

Actor A8

I. ALTERNATIVES COMPARISON

CRITERION 1 : Economic			
SUBCRITERION 1 : Purchasing cost			
	LC	LL	Priority vector
LC	1	1/3	0,25
LL	3	1	0,75
Total	4	1 1/3	

CRITERION 2 : Environmental			
SUBCRITERION 1 : Carbon footprint			
	LC	LL	Priority vector
LC	1	1/7	0,125
LL	7	1	0,875
Total	8	1 1/7	

SUBCRITERION 2 : Chemical use			
	LC	LL	Priority vector
LC	1	1	0,5
LL	1	1	0,5
Total	2	2	

CRITERION 3 : Social			
SUBCRITERION 1 : Local job			
	LC	LL	Priority vector
LC	1	1/7	0,125
LL	7	1	0,875
Total	8	1 1/7	

SUBCRITERION 2 : User resistance			
	LC	LL	Priority vector
LC	1	1	0,5
LL	1	1	0,5
Total	2	2	

SUBCRITERION 3 : SAP purchasing			
	LC	LL	Priority vector
LC	1	1/7	0,125
LL	7	1	0,875
Total	8	1 1/7	

CRITERION 4 : Relational			
SUBCRITERION 1 : Brand image			
	LC	LL	Priority vector
LC	1	1/9	0,1
LL	9	1	0,9
Total	10	1 1/9	

SUBCRITERION 2 : Innovation			
	LC	LL	Priority vector
LC	1	1/9	0,1
LL	9	1	0,9
Total	10	1 1/9	

CRITERION 5 : Functional			
SUBCRITERION 1 : Lifespan			
	LC	LL	Priority vector
LC	1	1	0,5
LL	1	1	0,5
Total	2	2	

SUBCRITERION 2 : Confort			
	LC	LL	Priority vector
LC	1	1	0,5
LL	1	1	0,5
Total	2	2	

SUBCRITERION 3 : Traceability			
	LC	LL	Priority vector
LC	1	1	0,5
LL	1	1	0,5
Total	2	2	

II. SUB-CRITERIA COMPARISON

CRITERION 2 : Environmental				
	Carbon footprint	Chemical use	Priority vector	Global priority
Carbon footprint	1	1/7	0,125	0,024340659
Chemical use	7	1	0,875	0,170384615
Total	8	1 1/7		

CRITERION 3 : Social									
	Local job	User resistance	SAP purchasing	Normalized			Priority vector	Global priority	Imax
Local job	1	1	1/2	0,25	0,2	0,272727273	0,240909091	0,060677323	0,725757576
User resistance	1	1	1/3	0,25	0,2	0,181818182	0,210606061	0,053044955	0,634343434
SAP purchasing	2	3	1	0,5	0,6	0,545454545	0,548484848	0,138145854	1,662121212
Total	4	5	1 5/6						Imax
Priority vector	1/4	1/5	5/9						CI
									RC
									CR

CRITERION 4 : Relational				
	Brand image	Innovation	Priority vector	Global priority
Brand image	1	1/5	0,166666667	0,032454212
Innovation	5	1	0,833333333	0,162271062
Total	6	1 1/5		

CRITERION 5 : Functional									
	Lifespan	Confort	Traceability	Normalized			Priority vector	Global priority	Imax
Lifespan	1	1	5	0,454545455	0,4	0,625	0,493183818	0,096034965	1,554545455
Confort	1	1	2	0,454545455	0,4	0,25	0,368183818	0,071694306	1,138636364
Traceability	1/5	1/2	1	0,090909091	0,2	0,125	0,138636364	0,026996004	0,421363636
Total	2 1/5	2 1/2	8						Imax
Priority vector	1/2	3/8	1/7						CI
									RC
									CR

III. CRITERIA COMPARISON

	Economic	Environmental	Social	Relational	Functional	Normalized				
Economic	1	1	1/3	1	1	0,142857143	0,2	0,076923077	0,2	0,2
Environmental	1	1	1	1	1	0,142857143	0,2	0,230769231	0,2	0,2
Social	3	1	1	1	1	0,428571429	0,2	0,230769231	0,2	0,2
Relational	1	1	1	1	1	0,142857143	0,2	0,230769231	0,2	0,2
Functional	1	1	1	1	1	0,142857143	0,2	0,230769231	0,2	0,2
Total	7	5	4 1/3	5	5					
priority vector	0,163956044	0,194725275	0,251868132	0,194725275	0,194725275					

IV. ALTERNATIVES PRIORITIZATION

	Economic	Environmental	Social	Relational	Functional	Ranking
LC	0,25	0,3125	0,203977273	0,1	0,50	0,270051199
LL	0,75	0,6875	0,796022727	0,9	0,50	0,729948801
Total	1	1	1	1	1	1
Priority vector	0,163956044	0,194725275	0,251868132	0,194725275	0,194725275	

	Carbon footprint	Chemical use	Environmental
LC	0,125	0,5	0,3125
LL	0,875	0,5	0,6875
Priority	0,5	0,5	

	Local job	User resistance	SAP purchasing	Social
LC	0,125	0,5	0,125	0,203977273
LL	0,875	0,5	0,875	0,796022727
Priority	0,240909091	0,210606061	0,548484848	

	Brand image	Innovation	Relational
LC	0,1	0,1	0,1
LL	0,9	0,9	0,9
Priority	0,166666667	0,833333333	

	Lifespan	Confort	Traceability	Functional
LC	0,5	0,50	0,50	0,5
LL	0,5	0,50	0,50	0,5
Priority	0,493183818	0,368183818	0,138636364	

Actor A9

I. ALTERNATIVES COMPARISON

CRITERION 1 : Economic			
SUBCRITERION 1 : Purchasing cost			
	LC	LL	Priority vector
LC	1	1/5	0,166666667
LL	5	1	0,833333333
Total	6	1 1/5	

CRITERION 2 : Environmental			
SUBCRITERION 1 : Carbon footprint			
	LC	LL	Priority vector
LC	1	1/9	0,1
LL	9	1	0,9
Total	10	1 1/9	

SUBCRITERION 2 : Chemical use			
	LC	LL	Priority vector
LC	1	1/7	0,125
LL	7	1	0,875
Total	8	1 1/7	

CRITERION 3 : Social			
SUBCRITERION 1 : Local job			
	LC	LL	Priority vector
LC	1	1/7	0,125
LL	7	1	0,875
Total	8	1 1/7	

SUBCRITERION 2 : User resistance			
	LC	LL	Priority vector
LC	1	1/7	0,125
LL	7	1	0,875
Total	8	1 1/7	

SUBCRITERION 3 : SAP purchasing			
	LC	LL	Priority vector
LC	1	1/9	0,1
LL	9	1	0,9
Total	10	1 1/9	

CRITERION 4 : Relational			
SUBCRITERION 1 : Brand image			
	LC	LL	Priority vector
LC	1	1/9	0,1
LL	9	1	0,9
Total	10	1 1/9	

SUBCRITERION 2 : Innovation			
	LC	LL	Priority vector
LC	1	1/9	0,1
LL	9	1	0,9
Total	10	1 1/9	

CRITERION 5 : Functional			
SUBCRITERION 1 : Lifespan			
	LC	LL	Priority vector
LC	1	1/7	0,125
LL	7	1	0,875
Total	8	1 1/7	

SUBCRITERION 2 : Confort			
	LC	LL	Priority vector
LC	1	1/7	0,125
LL	7	1	0,875
Total	8	1 1/7	

SUBCRITERION 3 : Traceability			
	LC	LL	Priority vector
LC	1	1/7	0,125
LL	7	1	0,875
Total	8	1 1/7	

II.SUB-CRITERIA COMPARISON

CRITERION 2 : Environmental				
	Carbon footprint	Chemical use	Priority vector	Global priority
Carbon footprint	1	9	0,9	0,337978056
Chemical use	1/9	1	0,1	0,037553117
Total	1 1/9	10		

CRITERION 3 : Social									
	Local job	User resistance	SAP purchasing	Normalized			Priority vector	Global priority	I _{max}
Local job	1	1	1/7	0,111111111	0,111111111	0,111111111	0,111111111	0,010819885	0,333333333
User resistance	1	1	1/7	0,111111111	0,111111111	0,111111111	0,111111111	0,010819885	0,333333333
SAP purchasing	7	7	1	0,777777778	0,777777778	0,777777778	0,777777778	0,075739193	2,333333333
Total	9	9	1 2/7						
Priority vector	1/9	1/9	7/9						
								I _{max}	3
								CI	0%
								RC	0,58
								CR	0%

CRITERION 4 : Relational				
	Brand image	Innovation	Priority vector	Global priority
Brand image	1	1/7	0,125	0,014758577
Innovation	7	1	0,875	0,10331004
Total	8	1 1/7		

CRITERION 5 : Functional									
	Lifespan	Confort	Traceability	Normalized			Priority vector	Global priority	I _{max}
Lifespan	1	1/3	1	0,2	0,2	0,2	0,2	0,05505573	0,6
Confort	3	1	3	0,6	0,6	0,6	0,6	0,165167189	1,8
Traceability	1	1/3	1	0,2	0,2	0,2	0,2	0,05505573	0,6
Total	5	1 2/3	5						
Priority vector	1/5	3/5	1/5						
								I _{max}	3
								CI	0%
								RC	0,58
								CR	0%

III.CRITERIA COMPARISON

	Economic	Environmental	Social	Relational	Functional	Normalized				
Economic	1	1/5	1	1	1	0,111111111	0,068965517	0,090909091	0,125	0,2727273
Environmental	5	1	5	2	1	0,555555556	0,344827586	0,454545455	0,25	0,2727273
Social	1	1/5	1	1	1/3	0,111111111	0,068965517	0,090909091	0,125	0,0909091
Relational	1	1/2	1	1	1/3	0,111111111	0,172413793	0,090909091	0,125	0,0909091
Functional	1	1	3	3	1	0,111111111	0,344827586	0,272727273	0,375	0,2727273
Total	9	2 8/9	11	8	3 2/3					
priority vector	0,133742598	0,375531174	0,097378962	0,118068617	0,275278649					

IV.ALTERNATIVES PRIORITIZATION

	Economic	Environmental	Social	Relational	Functional	Ranking
LC	0,166666667	0,1125	0,105555556	0,1	0,13	0,121033273
IL	0,833333333	0,8875	0,894444444	0,9	0,88	0,878966727
Total	1	1	1	1	1	1
Priority vector	0,133742598	0,375531174	0,097378962	0,118068617	0,275278649	

	Carbon footprint	Chemical use	Environmental
LC	0,1	0,125	0,1125
IL	0,9	0,875	0,8875
Priority	0,5	0,5	

	Local job	User resistance	SAP purchasing	Social
LC	0,125	0,125	0,1	0,105555556
IL	0,875	0,875	0,9	0,894444444
Priority	0,111111111	0,111111111	0,777777778	

	Brand image	Innovation	Relational
LC	0,1	0,1	0,1
IL	0,9	0,9	0,9
Priority	0,125	0,875	

	Lifespan	Confort	Traceability	Functional
LC	0,125	0,13	0,13	0,125
IL	0,875	0,88	0,88	0,875
Priority	0,2	0,6	0,2	

Actor A10

I. ALTERNATIVES COMPARISON

CRITERION 1 : Economic			
SUBCRITERION 1 : Purchasing cost			
	LC	LL	Priority vector
LC	1	1	0,5
LL	1	1	0,5
Total	2	2	

CRITERION 2 : Environmental			
SUBCRITERION 1 : Carbon footprint			
	LC	LL	Priority vector
LC	1	1/5	0,166666667
LL	5	1	0,833333333
Total	6	1 1/5	

SUBCRITERION 2 : Chemical use			
	LC	LL	Priority vector
LC	1	1	0,5
LL	1	1	0,5
Total	2	2	

CRITERION 3 : Social			
SUBCRITERION 1 : Local job			
	LC	LL	Priority vector
LC	1	1/7	0,125
LL	7	1	0,875
Total	8	1 1/7	

SUBCRITERION 2 : User resistance			
	LC	LL	Priority vector
LC	1	1/5	0,166666667
LL	5	1	0,833333333
Total	6	1 1/5	

SUBCRITERION 3 : SAP purchasing			
	LC	LL	Priority vector
LC	1	1	0,5
LL	1	1	0,5
Total	2	2	

CRITERION 4 : Relational			
SUBCRITERION 1 : Brand image			
	LC	LL	Priority vector
LC	1	1/9	0,1
LL	9	1	0,9
Total	10	1 1/9	

SUBCRITERION 2 : Innovation			
	LC	LL	Priority vector
LC	1	1	0,5
LL	1	1	0,5
Total	2	2	

CRITERION 5 : Functional			
SUBCRITERION 1 : Lifespan			
	LC	LL	Priority vector
LC	1	1	0,5
LL	1	1	0,5
Total	2	2	

SUBCRITERION 2 : Confort			
	LC	LL	Priority vector
LC	1	1	0,5
LL	1	1	0,5
Total	2	2	

SUBCRITERION 3 : Traceability			
	LC	LL	Priority vector
LC	1	1	0,5
LL	1	1	0,5
Total	2	2	

II. SUB-CRITERIA COMPARISON

CRITERION 2 : Environmental				
	Carbon footprint	Chemical use	Priority vector	Global priority
Carbon footprint	1	1	0,5	0,148581607
Chemical use	1	1	0,5	0,148581607
Total	2	2		

CRITERION 3 : Social									
	Local job	User resistance	SAP purchasing	Normalized			Priority vector	Global priority	Imax
Local job	1	5	1	0,454545455	0,454545455	0,454545455	0,454545455	0,121088174	1,363636364
User resistance	1/5	1	1/5	0,090909091	0,090909091	0,090909091	0,090909091	0,024217635	0,272727273
SAP purchasing	1	5	1	0,454545455	0,454545455	0,454545455	0,454545455	0,121088174	1,363636364
Total	2 1/5	11	2 1/5						Imax 3
Priority vector	4/9	0	4/9						CI 0
									RC 0,58
									CR 0

CRITERION 4 : Relational				
	Brand image	Innovation	Priority vector	Global priority
Brand image	1	3	0,75	0,066598496
Innovation	1/3	1	0,25	0,022199499
Total	1 1/3	4		

CRITERION 5 : Functional									
	Lifespan	Confort	Traceability	Normalized			Priority vector	Global priority	Imax
Lifespan	1	1	3	0,428571429	0,4	0,5	0,442857143	0,117974478	1,33968254
Confort	1	1	2	0,428571429	0,4	0,333333333	0,387301587	0,103174813	1,16984127
Traceability	1/3	1/2	1	0,142857143	0,2	0,166666667	0,16984127	0,045244692	0,511111111
Total	2 1/3	2 1/2	6						Imax 3,020634921
Priority vector	4/9	2/5	1/6						CI 0,1031746
									RC 0,58
									CR 0,017788725

III. CRITERIA COMPARISON

	Economic	Environmental	Social	Relational	Functional	Normalized				
Economic	1	1/5	1/3	1	1/3	0,07692308	0,056603774	0,090909091	0,090909091	0,0909091
Environmental	5	1	1	3	1	0,38461538	0,283018868	0,272727273	0,272727273	0,2727273
Social	3	1	1	3	1	0,23076923	0,283018868	0,272727273	0,272727273	0,2727273
Relational	1	1/3	1/3	1	1/3	0,07692308	0,094339623	0,090909091	0,090909091	0,0909091
Functional	3	1	1	3	1	0,23076923	0,283018868	0,272727273	0,272727273	0,2727273
Total	13	3 1/2	3 2/3	11	3 2/3					
priority vector	0,081250825	0,297163214	0,266393983	0,088797994	0,26639398					

IV. ALTERNATIVES PRIORITIZATION

	Economic	Environmental	Social	Relational	Functional	Ranking
LC	0,5	0,333333333	0,299242424	0,2	0,50	0,37035275
LL	0,5	0,666666667	0,700757576	0,8	0,50	0,54166667
Total	1	1	1	1	1	0,9120194
Priority vector	0,081250825	0,297163214	0,266393983	0,088797994	0,26639398	

	Carbon footprint	Chemical use	Environmental
LC	0,166666667	0,5	0,333333333
LL	0,833333333	0,5	0,666666667
Priority	0,5	0,5	

	Local job	User resistance	SAP purchasing	Social
LC	0,125	0,166666667	0,5	0,299242424
LL	0,875	0,833333333	0,5	0,700757576
Priority	0,454545455	0,090909091	0,454545455	

	Brand image	Innovation	Relational
LC	0,1	0,5	0,2
LL	0,9	0,5	0,8
Priority	0,75	0,25	

	Lifespan	Confort	Traceability	Functional
LC	0,5	0,50	0,50	0,5
LL	0,5	0,50	0,50	0,5
Priority	0,442857143	0,387301587	0,16984127	

Actor A11

I. ALTERNATIVES COMPARISON

CRITERION 1 : Economic			
SUBCRITERION 1 : Purchasing cost			
	LC	LL	Priority vector
LC	1	1/3	0,25
LL	3	1	0,75
Total	4	1 1/3	

CRITERION 2 : Environmental			
SUBCRITERION 1 : Carbon footprint			
	LC	LL	Priority vector
LC	1	1/7	0,125
LL	7	1	0,875
Total	8	1 1/7	

SUBCRITERION 2 : Chemical use			
	LC	LL	Priority vector
LC	1	1	0,5
LL	1	1	0,5
Total	2	2	

CRITERION 3 : Social			
SUBCRITERION 1 : Local job			
	LC	LL	Priority vector
LC	1	1/7	0,125
LL	7	1	0,875
Total	8	1 1/7	

SUBCRITERION 2 : User resistance			
	LC	LL	Priority vector
LC	1	1/3	0,25
LL	3	1	0,75
Total	4	1 1/3	

SUBCRITERION 3 : SAP purchasing			
	LC	LL	Priority vector
LC	1	1/7	0,125
LL	7	1	0,875
Total	8	1 1/7	

CRITERION 4 : Relational			
SUBCRITERION 1 : Brand image			
	LC	LL	Priority vector
LC	1	1/5	0,166666667
LL	5	1	0,833333333
Total	6	1 1/5	

SUBCRITERION 2 : Innovation			
	LC	LL	Priority vector
LC	1	1/3	0,25
LL	3	1	0,75
Total	4	1 1/3	

CRITERION 5 : Functional			
SUBCRITERION 1 : Lifespan			
	LC	LL	Priority vector
LC	1	1	0,5
LL	1	1	0,5
Total	2	2	

SUBCRITERION 2 : Confort			
	LC	LL	Priority vector
LC	1	1	0,5
LL	1	1	0,5
Total	2	2	

SUBCRITERION 3 : Traceability			
	LC	LL	Priority vector
LC	1	1	0,5
LL	1	1	0,5
Total	2	2	

II.SUB-CRITERIA COMPARISON

CRITERION 2 : Environmental				
	Carbon footprint	Chemical use	Priorityvector	Global priority
Carbon footprint	1	5	0,833333333	0,184620606
Chemical use	1/5	1	0,166666667	0,036924121
Total	1 1/5	6		

CRITERION 3 : Social									
	Local job	User resistance	SAP purchasing	Normalized			Priorityvector	Global priority	Imax
Local job	1	5	5	0,714285714	0,769230769	0,047619048	0,702838828	0,346837806	2,188644689
User resistance	1/5	1	2	0,142857143	0,153846154	0,25	0,182234432	0,089929281	0,552655678
SAP purchasing	1/5	1/2	1	0,142857143	0,076923077	0,125	0,11492674	0,056714195	0,346611722
Total	1 2/5	6 1/2	8						
Priority vector	5/7	1/5	1/9						
								Imax	3,087912088
								CI	0,043956044
								RC	0,58
								CR	0,075786283

CRITERION 4 : Relational				
	Brand image	Innovation	Priorityvector	Global priority
Brand image	1	3	0,75	0,039471317
Innovation	1/3	1	0,25	0,013157106
Total	1 1/3	4		

CRITERION 5 : Functional									
	Lifespan	Confort	Traceability	Normalized			Priorityvector	Global priority	Imax
Lifespan	1	1/7	1/5	0,076923077	0,096774194	0,047619048	0,073772106	0,006865233	0,222252607
Confort	7	1	3	0,538461538	0,677419355	0,714285714	0,643388869	0,059873778	2,008310686
Traceability	5	1/3	1	0,384615385	0,225806452	0,238095238	0,282839025	0,026321004	0,866162511
Total	13	1 1/2	4 1/5						
Priority vector	0	2/3	2/7						
								Imax	3,096725804
								CI	0,048362902
								RC	0,58
								CR	0,083384313

III.CRITERIA COMPARISON

	Economic	Environmental	Social	Relational	Functional	Normalized				
Economic	1	1/3	1/5	3	3	0,10344828	0,066666667	0,106598985	0,176470588	0,2432432
Environmental	3	1	1/3	3	3	0,31034483	0,2	0,177664975	0,176470588	0,2432432
Social	5	3	1	7	5	0,51724138	0,6	0,532994924	0,411764706	0,4054054
Relational	1/3	1/3	1/7	1	1/3	0,03448278	0,066666667	0,076142132	0,058823529	0,027027
Functional	1/3	1/3	1/5	3	1	0,03448278	0,066666667	0,106598985	0,176470588	0,0810811
Total	9 2/3	5	1 7/8	17	12 1/3					
priorityvector	0,139285552	0,221544727	0,493481283	0,052628423	0,093060016					

IV.ALTERNATIVES PRIORITIZATION

	Economic	Environmental	Social	Relational	Functional	Ranking
LC	0,25	0,3125	0,147779304	0,1875	0,50	0,23337822
LL	0,75	0,6875	0,852220696	0,8125	0,50	0,734375
Total	1	1	1	1	1	0,9677532
Priorityvector	0,139285552	0,221544727	0,493481283	0,052628423	0,093060016	

	Carbon footprint	Chemical use	Environmental
LC	0,125	0,5	0,3125
LL	0,875	0,5	0,6875
Priority	0,5	0,5	

	Local job	User resistance	SAP purchasing	Social
LC	0,125	0,25	0,125	0,147779304
LL	0,875	0,75	0,875	0,852220696
Priority	0,702838828	0,182234432	0,11492674	

	Brand image	Innovation	Relational
LC	0,166666667	0,25	0,1875
LL	0,833333333	0,75	0,8125
Priority	0,75	0,25	

	Lifespan	Confort	Traceability	Functional
LC	0,5	0,50	0,50	0,5
LL	0,5	0,50	0,50	0,5
Priority	0,073772106	0,643388869	0,282839025	

Actor A12

I. ALTERNATIVES COMPARISON

CRITERION 1 : Economic			
SUBCRITERION 1 : Purchasing cost			
	LC	LL	Priority vector
LC	1	1	0,5
LL	1	1	0,5
Total	2	2	

CRITERION 2 : Environmental			
SUBCRITERION 1 : Carbon footprint			
	LC	LL	Priority vector
LC	1	1/5	0,166666667
LL	5	1	0,833333333
Total	6	1 1/5	

SUBCRITERION 2 : Chemical use			
	LC	LL	Priority vector
LC	1	1/5	0,166666667
LL	5	1	0,833333333
Total	6	1 1/5	

CRITERION 3 : Social			
SUBCRITERION 1 : Local job			
	LC	LL	Priority vector
LC	1	5	0,833333333
LL	1/5	1	0,166666667
Total	1 1/5	6	

SUBCRITERION 2 : User resistance			
	LC	LL	Priority vector
LC	1	1/5	0,166666667
LL	5	1	0,833333333
Total	6	1 1/5	

SUBCRITERION 3 : SAP purchasing			
	LC	LL	Priority vector
LC	1	5	0,833333333
LL	1/5	1	0,166666667
Total	1 1/5	6	

CRITERION 4 : Relational			
SUBCRITERION 1 : Brand image			
	LC	LL	Priority vector
LC	1	1	0,5
LL	1	1	0,5
Total	2	2	

SUBCRITERION 2 : Innovation			
	LC	LL	Priority vector
LC	1	1	0,5
LL	1	1	0,5
Total	2	2	

CRITERION 5 : Functional			
SUBCRITERION 1 : Lifespan			
	LC	LL	Priority vector
LC	1	1/5	0,166666667
LL	5	1	0,833333333
Total	6	1 1/5	

SUBCRITERION 2 : Confort			
	LC	LL	Priority vector
LC	1	1/5	0,166666667
LL	5	1	0,833333333
Total	6	1 1/5	

SUBCRITERION 3 : Traceability			
	LC	LL	Priority vector
LC	1	1	0,5
LL	1	1	0,5
Total	2	2	

II.SUB-CRITERIA COMPARISON

CRITERION 2 : Environmental				
	Carbon footprint	Chemical use	Priorityvector	Global priority
Carbon footprint	1	1	0,5	0,031802233
Chemical use	1	1	0,5	0,031802233
Total	2	2		

CRITERION 3 : Social									
	Local job	User resistance	SAP purchasing	Normalized			Priorityvector	Global priority	Imax
Local job	1	1	1	0,333333333	0,333333333	0,333333333	0,333333333	0,184774056	1
User resistance	1	1	1	0,333333333	0,333333333	0,333333333	0,333333333	0,184774056	1
SAP purchasing	1	1	1	0,333333333	0,333333333	0,333333333	0,333333333	0,184774056	1
Total	3	3	3						3
Priority vector	1/3	1/3	1/3						0
									0,58
									0

CRITERION 4 : Relational				
	Brand image	Innovation	Priorityvector	Global priority
Brand image	1	1	0,5	0,031802233
Innovation	1	1	0,5	0,031802233
Total	2	2		

CRITERION 5 : Functional									
	Lifespan	Confort	Traceability	Normalized			Priorityvector	Global priority	Imax
Lifespan	1	1	1	0,333333333	0,333333333	0,333333333	0,333333333	0,021201489	1
Confort	1	1	1	0,333333333	0,333333333	0,333333333	0,333333333	0,021201489	1
Traceability	1	1	1	0,333333333	0,333333333	0,333333333	0,333333333	0,021201489	1
Total	3	3	3						3
Priority vector	1/3	1/3	1/3						0
									0,58
									0

III.CRITERIA COMPARISON

	Economic	Environmental	Social	Relational	Functional	Normalized				
Economic	1	5	1/5	5	5	0,151515152	0,333333333	0,122807018	0,333333333	0,333333333
Environmental	1/5	1	1/7	1	1	0,030303030	0,066666667	0,087719298	0,066666667	0,0666667
Social	5	7	1	7	7	0,757575758	0,466666667	0,614035088	0,466666667	0,4666667
Relational	1/5	1	1/7	1	1	0,030303030	0,066666667	0,087719298	0,066666667	0,0666667
Functional	1/5	1	1/7	1	1	0,030303030	0,066666667	0,087719298	0,066666667	0,0666667
Total	6 3/5	15	1 5/8	15	15					
priorityvector	0,254864434	0,063604466	0,554322169	0,063604466	0,06360447					

IV.ALTERNATIVES PRIORITIZATION

	Economic	Environmental	Social	Relational	Functional	Ranking
LC	0,5	0,166666667	0,611111111	0,5	0,28	0,52625538
LL	0,5	0,833333333	0,388888889	0,5	0,72	0,47374462
Total	1	1	1	1	1	1
Priorityvector	0,254864434	0,063604466	0,554322169	0,063604466	0,06360447	

	Carbon footprint	Chemical use	Environmental
LC	0,166666667	0,166666667	0,166666667
LL	0,833333333	0,833333333	0,833333333
Priority	0,5	0,5	

	Local job	User resistance	SAP purchasing	Social
LC	0,833333333	0,166666667	0,833333333	0,611111111
LL	0,166666667	0,833333333	0,166666667	0,388888889
Priority	0,333333333	0,333333333	0,333333333	

	Brand image	Innovation	Relational
LC	0,5	0,5	0,5
LL	0,5	0,5	0,5
Priority	0,5	0,5	

	Lifespan	Confort	Traceability	Functional
LC	0,166666667	0,17	0,50	0,277777778
LL	0,833333333	0,83	0,50	0,722222222
Priority	0,333333333	0,333333333	0,333333333	

Annex D-3: Evaluation matrices End of life

Actor A1

ALTERNATIVES COMPARISON

CRITERION 1 : Economic

SUBCRITERION 2 : Purchasing cost

	Other product	New clothing	Energy	Normalized			Priority vector	Imax
Other product	1	3	1/5	0,157894737	0,272727273	0,14893617	0,19318606	0,58781092
New clothing	1/3	1	1/7	0,052631579	0,090909091	0,106382979	0,083307883	0,251061244
Energy	5	7	1	0,789473684	0,636363636	0,744680851	0,723506057	2,272591537
Total	6 1/3	11	1 1/3				Imax	3,111463701
Priority vector	0,19318606	0,083307883	0,723506057				Imax	0,055731851
							CI	0,58
							RC	0,096089398
							CR	

CRITERION 2 : Environmental

SUBCRITERION 1 : Carbon footprint

	Other product	New clothing	Energy	Normalized			Priority vector	Imax
Other product	1	5	3	0,652173913	0,714285714	0,6	0,655486542	2,004554865
New clothing	1/5	1	1	0,130434783	0,142857143	0,2	0,157763975	0,475610766
Energy	1/3	1/3	1	0,217391304	0,142857143	0,2	0,186749482	0,563008972
Total	1 1/2	7	5				Imax	3,043174603
Priority vector	0,655486542	0,157763975	0,186749482				Imax	0,021587302
							CI	0,58
							RC	0,096089398
							CR	0,037219485

SUBCRITERION 2 : Recycling

	Other product	New clothing	Energy	Normalized			Priority vector	Imax
Other product	1	5	7	0,744680851	0,789473684	0,636363636	0,723506057	2,272591537
New clothing	1/5	1	3	0,14893617	0,157894737	0,272727273	0,19318606	0,58781092
Energy	1/7	1/3	1	0,106382979	0,052631579	0,090909091	0,083307883	0,251061244
Total	1 1/3	6 1/3	11				Imax	3,111463701
Priority vector	0,723506057	0,19318606	0,083307883				Imax	0,055731851
							CI	0,58
							RC	0,096089398
							CR	0,096089398

CRITERION 3 : Social

SUBCRITERION 1 : Local job

	Other product	New clothing	Energy	Normalized			Priority vector	Imax
Other product	1	5	5	0,714285714	0,714285714	0,714285714	0,714285714	2,142857143
New clothing	1/5	1	1	0,142857143	0,142857143	0,142857143	0,142857143	0,428571429
Energy	1/5	1	1	0,142857143	0,142857143	0,142857143	0,142857143	0,428571429
Total	1 2/5	7	7				Imax	3
Priority vector	0,714285714	0,142857143	0,142857143				Imax	0,00
							CI	0,58
							RC	0,00
							CR	0,00

SUBCRITERION 2 : User resistance

	Other product	New clothing	Energy	Normalized			Priority vector	Imax
Other product	1	1	1	0,333333333	0,333333333	0,333333333	0,333333333	1
New clothing	1	1	1	0,333333333	0,333333333	0,333333333	0,333333333	1
Energy	1	1	1	0,333333333	0,333333333	0,333333333	0,333333333	1
Total	3	3	3				Imax	3
Priority vector	0,333333333	0,333333333	0,333333333				Imax	0
							CI	0,58
							RC	0
							CR	0

SUBCRITERION 2 : SAP purchasing

	Other product	New clothing	Energy	Normalized			Priority vector	Imax
Other product	1	5	7	0,744680851	0,789473684	0,636363636	0,723506057	2,272591537
New clothing	1/5	1	3	0,14893617	0,157894737	0,272727273	0,19318606	0,58781092
Energy	1/7	1/3	1	0,106382979	0,052631579	0,090909091	0,083307883	0,251061244
Total	1 1/3	6 1/3	11				Imax	3,111463701
Priority vector	0,723506057	0,19318606	0,083307883				Imax	0,055731851
							CI	0,58
							RC	0,096089398
							CR	0,096089398

CRITERION 4 : Relational

SUBCRITERION 1 : Brand image

	Other product	New clothing	Energy	Normalized			Priority vector	Imax
Other product	1	7	5	0,744680851	0,777777778	0,714285714	0,745581448	2,257908364
New clothing	1/7	1	1	0,106382979	0,111111111	0,142857143	0,120117078	0,360930188
Energy	1/5	1	1	0,14893617	0,111111111	0,142857143	0,134301475	0,403534842
Total	1 1/3	9	7				Imax	3,022373394
Priority vector	0,745581448	0,120117078	0,134301475				Imax	0,01186697
							CI	0,58
							RC	0,019287408
							CR	0,019287408

SUBCRITERION 2 : Innovation

	Other product	New clothing	Energy	Normalized			Priority vector	Imax
Other product	1	5	7	0,744680851	0,789473684	0,636363636	0,723506057	2,272591537
New clothing	1/5	1	3	0,14893617	0,157894737	0,272727273	0,19318606	0,58781092
Energy	1/7	1/3	1	0,106382979	0,052631579	0,090909091	0,083307883	0,251061244
Total	1 1/3	6 1/3	11				Imax	3,111463701
Priority vector	0,723506057	0,19318606	0,083307883				Imax	0,055731851
							CI	0,58
							RC	0,096089398
							CR	0,096089398

CRITERION 5 : Functional

SUBCRITERION 1 : fiber quality

	Other product	New clothing	Energy	Normalized			Priority vector	Imax
Other product	1	3	7	0,677419355	0,714285714	0,538461538	0,643388869	2,008310686
New clothing	1/3	1	5	0,225806452	0,238095238	0,384615385	0,282839025	0,866162511
Energy	1/7	1/5	1	0,096774194	0,047619048	0,076923077	0,073772106	0,222252607
Total	1 1/2	4 1/5	13				Imax	3,096725804
Priority vector	0,643388869	0,282839025	0,073772106				Imax	0,048362902
							CI	0,58
							RC	0,083384313
							CR	0,083384313

II. SUB-CRITERIA COMPARISON

CRITERION 2 : Environmental				
	Carbon footprint	Recycling	Priority vector	Global priority
Carbon footprint	1	1/5	0,166666667	0,076538386
Recycling	5	1	0,833333333	0,382691929
Total	6	1 1/5		

CRITERION 3 : Social									
	Local job	User resistance	SAP purchasing	Normalized			Priority vector	Global priority	Imax
Local job	1	5	3	0,652173913	0,555555556	2/3	0,63334572	0,125480418	1,94562
User resistance	1/5	1	1/3	0,130434783	0,111111111	0,076923077	0,106156324	0,02103202	0,31966
SAP purchasing	1/3	3	1	0,217391304	0,333333333	0,230769231	0,260497956	0,051610663	0,79008
Total	1 1/2	9	4 1/3						
Priority vector	0,63334572	0,106156324	0,260497956						
								Imax	3,05536
								CI	0,02768
								RC	0,58
								CR	0,04773

CRITERION 4 : Relational				
	Brand image	Innovation	Priority vector	Global priority
Brand image	1	1/3	0,25	0,049530775
Innovation	3	1	0,75	0,148592326
Total	4	1 1/3		

III. CRITERIA COMPARISON

	Economic	Environmental	Social	Relational	Functional	Normalized				
Economic	1	1/5	1/3	1/3	5	0,081967213	0	0,060240964	0,06024	0,217391
Environmental	5	1	3	3	7	0,409836066	0,497630332	0,542168675	0,54217	0,304348
Social	3	1/3	1	1	5	0,245901638	0,165876777	0,180722892	0,18072	0,217391
Relational	3	1/3	1	1	5	0,245901638	0,165876777	0,180722892	0,18072	0,217391
Functional	1/5	1/7	1/5	1/5	1	0,016393443	0,071090047	0,036144578	0,03614	0,043478
	12 1/5	2	5 1/2	5 1/2	23					
priority vector	0,103873302	0,459230315	0,198123101	0,198123101	0,040650188					

IV. ALTERNATIVES PRIORITIZATION

	Economic	Environmental	Social	Relational	Functional	Ranking
Other product	0,19318606	0,712169471	0,676247091	0,729024905	0,64	0,651687404
New clothing	0,083307883	0,187282379	0,176187975	0,174918814	0,28	0,175719034
Energy	0,723506057	0,100548149	0,147564934	0,096056281	0,07	0,172593566
Total	1	1	1	1	1,00	1
Priority vector	0,103873302	0,459230315	0,198123101	0,198123101	0,040650188	

	Carbon footprint	Recycling	Environmental
Other product	0,655486542	0,723506057	0,712169471
New clothing	0,157763975	0,19318606	0,187282379
Energy	0,186749482	0,083307883	0,100548149
Priority	0,166666667	0,833333333	

	Local job	User resistance	SAP purchasing	Social
Other product	0,714285714	0,333333333	0,723506057	0,676247091
New clothing	0,142857143	0,333333333	0,19318606	0,176187975
Energy	0,142857143	0,333333333	0,083307883	0,147564934
Priority	0,63334572	0,106156324	0,260497956	

	Brand image	Innovation	Relational
Other product	0,745581448	0,723506057	0,729024905
New clothing	0,120117078	0,19318606	0,174918814
Energy	0,134301475	0,083307883	0,096056281
Priority	0,25	0,75	

Actor A2

I. ALTERNATIVES COMPARISON

CRITERION 1 : Economic

SUBCRITERION 2 : Purchasing cost

	Other product	New clothing	Energy	Normalized			Priority vector	I _{max}
Other product	1	1	2	0,4	0,454545455	0,25	0,368181818	1,138636364
New clothing	1	1	5	0,4	0,454545455	0,625	0,493181818	1,554545455
Energy	1/2	1/5	1	0,2	0,090909091	0,125	0,138636364	0,421363636
Total	2 1/2	2 1/5	8				I _{max}	3,114545455
Priority vector	0,368181818	0,493181818	0,138636364				CI	0,057272727
							RC	0,58
							CR	0,098746082

CRITERION 2 : Environmental

SUBCRITERION 1 : Carbon footprint

	Other product	New clothing	Energy	Normalized			Priority vector	I _{max}
Other product	1	1	2	0,4	0,454545455	0,25	0,368181818	1,138636364
New clothing	1	1	5	0,4	0,454545455	0,625	0,493181818	1,554545455
Energy	1/2	1/5	1	0,2	0,090909091	0,125	0,138636364	0,421363636
Total	2 1/2	2 1/5	8				I _{max}	3,114545455
Priority vector	0,368181818	0,493181818	0,138636364				CI	0,057272727
							RC	0,58
							CR	0,098746082

SUBCRITERION 2 : Recycling

	Other product	New clothing	Energy	Normalized			Priority vector	I _{max}
Other product	1	1	2	0,4	0,454545455	0,25	0,368181818	1,138636364
New clothing	1	1	5	0,4	0,454545455	0,625	0,493181818	1,554545455
Energy	1/2	1/5	1	0,2	0,090909091	0,125	0,138636364	0,421363636
Total	2 1/2	2 1/5	8				I _{max}	3,114545455
Priority vector	0,368181818	0,493181818	0,138636364				CI	0,057272727
							RC	0,58
							CR	0,098746082

CRITERION 3 : Social

SUBCRITERION 1 : Local job

	Other product	New clothing	Energy	Normalized			Priority vector	I _{max}
Other product	1	1	2	0,4	0,454545455	0,25	0,368181818	1,138636364
New clothing	1	1	5	0,4	0,454545455	0,625	0,493181818	1,554545455
Energy	1/2	1/5	1	0,2	0,090909091	0,125	0,138636364	0,421363636
Total	2 1/2	2 1/5	8				I _{max}	3,114545455
Priority vector	0,368181818	0,493181818	0,138636364				CI	0,057272727
							RC	0,58
							CR	0,098746082

SUBCRITERION 2 : User resistance

	Other product	New clothing	Energy	Normalized			Priority vector	I _{max}
Other product	1	1	2	0,4	0,454545455	0,25	0,368181818	1,138636364
New clothing	1	1	5	0,4	0,454545455	0,625	0,493181818	1,554545455
Energy	1/2	1/5	1	0,2	0,090909091	0,125	0,138636364	0,421363636
Total	2 1/2	2 1/5	8				I _{max}	3,114545455
Priority vector	0,368181818	0,493181818	0,138636364				CI	0,057272727
							RC	0,58
							CR	0,098746082

SUBCRITERION 2 : SAP purchasing

	Other product	New clothing	Energy	Normalized			Priority vector	I _{max}
Other product	1	1	2	0,4	0,454545455	0,25	0,368181818	1,138636364
New clothing	1	1	5	0,4	0,454545455	0,625	0,493181818	1,554545455
Energy	1/2	1/5	1	0,2	0,090909091	0,125	0,138636364	0,421363636
Total	2 1/2	2 1/5	8				I _{max}	3,114545455
Priority vector	0,368181818	0,493181818	0,138636364				CI	0,057272727
							RC	0,58
							CR	0,098746082

CRITERION 4 : Relational

SUBCRITERION 1 : Brand image

	Other product	New clothing	Energy	Normalized			Priority vector	I _{max}
Other product	1	1	2	0,4	0,454545455	0,25	0,368181818	1,138636364
New clothing	1	1	5	0,4	0,454545455	0,625	0,493181818	1,554545455
Energy	1/2	1/5	1	0,2	0,090909091	0,125	0,138636364	0,421363636
Total	2 1/2	2 1/5	8				I _{max}	3,114545455
Priority vector	0,368181818	0,493181818	0,138636364				CI	0,057272727
							RC	0,58
							CR	0,098746082

SUBCRITERION 2 : Innovation

	Other product	New clothing	Energy	Normalized			Priority vector	I _{max}
Other product	1	1	2	0,4	0,454545455	0,25	0,368181818	1,138636364
New clothing	1	1	5	0,4	0,454545455	0,625	0,493181818	1,554545455
Energy	1/2	1/5	1	0,2	0,090909091	0,125	0,138636364	0,421363636
Total	2 1/2	2 1/5	8				I _{max}	3,114545455
Priority vector	0,368181818	0,493181818	0,138636364				CI	0,057272727
							RC	0,58
							CR	0,098746082

CRITERION 5 : Functional

SUBCRITERION 1 : Revaluation capability

	Other product	New clothing	Energy	Normalized			Priority vector	I _{max}
Other product	1	1	2	0,4	0,454545455	0,25	0,368181818	1,138636364
New clothing	1	1	5	0,4	0,454545455	0,625	0,493181818	1,554545455
Energy	1/2	1/5	1	0,2	0,090909091	0,125	0,138636364	0,421363636
Total	2 1/2	2 1/5	8				I _{max}	3,114545455
Priority vector	0,368181818	0,493181818	0,138636364				CI	0,057272727
							RC	0,58
							CR	0,098746082

II.SUB-CRITERIA COMPARISON

CRITERION 2 : Environmental				
	Carbon footprint	Recycling	Priorityvector	Global priority
Carbon footprint	1	1/5	0,166666667	0,088647643
Recycling	5	1	0,833333333	0,443238217
Total	6	1 1/5		

CRITERION 3 : Social									
	Local job	User resistance	SAP purchasing	Normalized			Priorityvector	Global priority	Imax
Local job	1	5	3	0,652173913	0,714285714	3/5	0,655486542	0,085152017	2,0045545
User resistance	1/5	1	1	0,130434783	0,142857143	0,2	0,157763975	0,020494579	0,4756108
SAP purchasing	1/3	1	1	0,217391304	0,142857143	0,2	0,186749482	0,024259987	0,563005
Total	1 1/2	7	5						3,0431746
Priority vector	2/3	1/6	1/5						CI 0,0215873
									RC 0,58
									CR 0,0372195

CRITERION 4 : Relational				
	Brand image	Innovation	Priorityvector	Global priority
Brand image	1	1	0,5	0,064953292
Innovation	1	1	0,5	0,064953292
Total	2	2		

III. CRITERIA COMPARISON

	Economic	Environmental	Social	Relational	Functional	Normalized				
Economic	1	1/5	1/3	1/3	1/5	0,05882353	0,111111111	0,04	0,04	0,02439
Environmental	5	1	5	5	5	0,29411765	0,555555556	0,6	0,6	0,609756
Social	3	1/5	1	1	1	0,17647059	0,111111111	0,12	0,12	0,121951
Relational	3	1/5	1	1	1	0,17647059	0,111111111	0,12	0,12	0,121951
Functional	5	1/5	1	1	1	0,29411765	0,111111111	0,12	0,12	0,121951
	17	1 4/5	8 1/3	8 1/3	8 1/5					
priorityvector	0,054864977	0,53188586	0,129906584	0,129906584	0,153435998					

IV. ALTERNATIVES PRIORITIZATION

	Economic	Environmental	Social	Relational	Functional	Ranking
Other product	0,368181818	0,368181818	0,368181818	0,368181818	0,37	0,3681818
New clothing	0,493181818	0,493181818	0,493181818	0,493181818	0,49	0,4931818
Energy	0,138636364	0,138636364	0,138636364	0,138636364	0,14	0,1386363
Total	1	1	1	1	1,00	1
Priorityvector	0,054864977	0,53188586	0,129906584	0,129906584	0,153435998	

	Carbon footprint	Recycling	Environmental
Other product	0,368181818	0,368181818	0,368181818
New clothing	0,493181818	0,493181818	0,493181818
Energy	0,138636364	0,138636364	0,138636364
Priority	0,166666667	0,833333333	

	Local job	User resistance	SAP purchasing	Social
Other product	0,368181818	0,368181818	0,368181818	0,368181818
New clothing	0,493181818	0,493181818	0,493181818	0,493181818
Energy	0,138636364	0,138636364	0,138636364	0,138636364
Priority	0,655486542	0,157763975	0,186749482	

	Brand image	Innovation	Relational
Other product	0,368181818	0,368181818	0,368181818
New clothing	0,493181818	0,493181818	0,493181818
Energy	0,138636364	0,138636364	0,138636364
Priority	0,5	0,5	

Actor A3

ALTERNATIVES COMPARISON

CRITERION 1 : Economic

SUBCRITERION 2 : Purchasing cost

	Other product	New clothing	Energy	Normalized			Priority vector	Imax
Other product	1	3	3	3/5	0,3	0,66666667	0,58888889	1,82222222
New clothing	1/3	1	1/2	0,2	0,16666667	0,11111111	0,15925925	0,48148148
Energy	1/3	2	1	0,2	0,33333333	0,22222222	0,25185185	0,76666667
Total	1 2/3	6	4 1/2				Imax	3,07037037
Priority vector	0,58888889	0,15925925	0,25185185				CI	0,03518518
							RC	0,58
							CR	0,06066412

CRITERION 2 : Environmental

SUBCRITERION 1 : Carbon footprint

	Other product	New clothing	Energy	Normalized			Priority vector	Imax
Other product	1	5	5	0,71428571	0,625	0,76923076	0,70283882	2,18864468
New clothing	1/5	1	1/2	0,14285714	0,125	0,07692307	0,11492674	0,34661722
Energy	1/5	2	1	0,14285714	0,25	0,15384615	0,18223443	0,55265567
Total	1 2/5	8	6 1/2				Imax	3,08791208
Priority vector	0,70283882	0,11492674	0,18223443				CI	0,04395604
							RC	0,58
							CR	0,07578628

SUBCRITERION 2 : Recycling

	Other product	New clothing	Energy	Normalized			Priority vector	Imax
Other product	1	7	2	0,60869562	0,46666667	0,63636364	0,57057531	1,76122095
New clothing	1/7	1	1/7	0,08695652	0,06666667	0,04545454	0,06635924	0,19973649
Energy	1/2	7	1	0,30434782	0,46666667	0,31818182	0,36306543	1,11286789
Total	1 2/3	15	3 1/7				Imax	3,07382529
Priority vector	0,57057531	0,06635924	0,36306543				CI	0,03691260
							RC	0,58
							CR	0,06364242

CRITERION 3 : Social

SUBCRITERION 1 : Local job

	Other product	New clothing	Energy	Normalized			Priority vector	Imax
Other product	1	3	1	0,42857142	0,33333333	0,45454545	0,40548340	1,22991823
New clothing	1/3	1	1/5	0,14285714	0,11111111	0,09090909	0,11495911	0,34603174
Energy	1	5	1	0,42857142	0,55555556	0,45454545	0,47955748	1,45983646
Total	2 1/3	9	2 1/5				Imax	3,03578643
Priority vector	0,40548340	0,11495911	0,47955748				CI	0,01789321
							RC	0,58
							CR	0,03085037

SUBCRITERION 2 : User resistance

	Other product	New clothing	Energy	Normalized			Priority vector	Imax
Other product	1	5	5	0,71428571	0,71428571	0,71428571	0,71428571	2,14285714
New clothing	1/5	1	1	0,14285714	0,14285714	0,14285714	0,14285714	0,42857142
Energy	1/5	1	1	0,14285714	0,14285714	0,14285714	0,14285714	0,42857142
Total	1 2/5	7	7				Imax	3
Priority vector	0,71428571	0,14285714	0,14285714				CI	-4,44089E-16
							RC	0,58
							CR	-7,65671E-16

SUBCRITERION 2 : SAP purchasing

	Other product	New clothing	Energy	Normalized			Priority vector	Imax
Other product	1	5	5	0,71428571	0,71428571	0,71428571	0,71428571	2,14285714
New clothing	1/5	1	1	0,14285714	0,14285714	0,14285714	0,14285714	0,42857142
Energy	1/5	1	1	0,14285714	0,14285714	0,14285714	0,14285714	0,42857142
Total	1 2/5	7	7				Imax	3
Priority vector	0,71428571	0,14285714	0,14285714				CI	-4,44089E-16
							RC	0,58
							CR	-7,65671E-16

CRITERION 4 : Relational

SUBCRITERION 1 : Brand image

	Other product	New clothing	Energy	Normalized			Priority vector	Imax
Other product	1	1	1	0,33333333	0,33333333	0,33333333	0,33333333	1
New clothing	1	1	1	0,33333333	0,33333333	0,33333333	0,33333333	1
Energy	1	1	1	0,33333333	0,33333333	0,33333333	0,33333333	1
Total	3	3	3				Imax	3
Priority vector	0,33333333	0,33333333	0,33333333				CI	0
							RC	0,58
							CR	0

SUBCRITERION 2 : Innovation

	Other product	New clothing	Energy	Normalized			Priority vector	Imax
Other product	1	3	2	5/9	0,6	0,5	0,54848484	1,66212121
New clothing	1/3	1	1	0,18181818	0,2	0,25	0,21060606	0,63434343
Energy	1/2	1	1	0,27272727	0,2	0,25	0,24090909	0,72575757
Total	1 5/6	5	4				Imax	3,02222222
Priority vector	0,54848484	0,21060606	0,24090909				CI	0,01111111
							RC	0,58
							CR	0,01915708

CRITERION 5 : Functional

SUBCRITERION 1 : fiber quality

	Other product	New clothing	Energy	Normalized			Priority vector	Imax
Other product	1	5	3	0,65217391	0,55555556	0,69230769	0,63334572	1,94562120
New clothing	1/5	1	1/3	0,13043478	0,11111111	0,07692307	0,10615632	0,31965812
Energy	1/3	3	1	0,21739130	0,33333333	0,23076923	0,26049795	0,79008216
Total	1 1/2	9	4 1/3				Imax	3,05536149
Priority vector	0,63334572	0,10615632	0,26049795				CI	0,02768074
							RC	0,58
							CR	0,04772542

II.SUB-CRITERIA COMPARISON

CRITERION 2 : Environmental				
	Carbon footprint	Recycling	Priority vector	Global priority
Carbon footprint	1	1/5	0,166666667	0,034839127
Recycling	5	1	0,833333333	0,174195637
Total	6	1 1/5		

CRITERION 3 : Social									
	Local job	Userresistance	SAP purchasing	Normalized			Priority vector	Global priority	Imax
Local job	1	3	1	0,428571429	0,333333333	4/9	0,405483405	0,049317449	122991823
Userresistance	1/3	1	1/5	0,142857143	0,111111111	0,090909091	0,114959115	0,013982053	034603175
SAP purchasing	1	5	1	0,428571429	0,555555556	0,454545455	0,47955748	0,058326805	145883646
Total	2 1/3	9	2 1/5						Imax 303578644
Priority vector	2/5	1/9	1/2						CI 001789322
									RC 0,58
									CR 003085038

CRITERION 4 : Relational				
	Brand image	Innovation	Priority vector	Global priority
Brand image	1	5	0,833333333	0,03840419
Innovation	1/5	1	0,166666667	0,007680838
Total	1 1/5	6		

III.CRITERIA COMPARISON

	Economic	Environmental	Social	Relational	Functional	Normalized				
Economic	1	1	3	5	1/3	0,180722892	0,180722892	0,294117647	0,23809524	0,151515
Environmental	1	1	3	5	0,333333333	0,180722892	0,180722892	0,294117647	0,23809524	0,151515
Social	1/3	1/3	1	5	1/3	0,060240964	0,060240964	0,098039216	0,23809524	0,151515
Relational	1/5	1/5	1/5	1	1/5	0,036144578	0,036144578	0,019607843	0,04761905	0,090909
Functional	3	3	3	5	1	0,542168675	0,542168675	0,294117647	0,23809524	0,454545
	5 1/2	5 1/2	10 1/5	21	2 1/5					
priority vector	0,209034764	0,209034764	0,121626307	0,046085028	0,41421913					

IV.ALTERNATIVES PRIORITIZATION

	Economic	Environmental	Social	Relational	Functional	Ranking
Otherproduct	0,588888889	0,592619237	0,589071502	0,369191919	0,63	0,59798100
Newclothing	0,159259259	0,074453827	0,131544955	0,312878788	0,11	0,12324449
Energy	0,251851852	0,332926936	0,279383542	0,317929293	0,26	0,27877450
Total	1	1	1	1	1,00	1
Priority vector	0,209034764	0,209034764	0,121626307	0,046085028	0,41421913	

	Carbon footprint	Recycling	Environmental
Otherproduct	0,702838828	0,570575318	0,592619237
Newclothing	0,11492674	0,066359245	0,074453827
Energy	0,182234432	0,363065437	0,332926936
Priority	0,166666667	0,833333333	

	Local job	User resistance	SAP purchasing	Social
Otherproduct	0,405483405	0,714285714	0,714285714	0,589071502
Newclothing	0,114959115	0,142857143	0,142857143	0,131544955
Energy	0,47955748	0,142857143	0,142857143	0,279383542
Priority	0,405483405	0,114959115	0,47955748	

	Brand image	Innovation	Relational
Otherproduct	0,333333333	0,548484848	0,369191919
Newclothing	0,333333333	0,210606061	0,312878788
Energy	0,333333333	0,240909091	0,317929293
Priority	0,833333333	0,166666667	

Actor A4

ALTERNATIVES COMPARISON

CRITERION 1 : Economic

SUBCRITERION 2 : Purchasing cost

	Other product	New clothing	Energy	Normalized			Priority vector	I _{max}
Other product	1	1/7	1/5	0,076923077	0,096774194	0,047619048	0,073772106	0,222252607
New clothing	7	1	3	0,538461538	0,677419355	0,714285714	0,643388869	2,008310686
Energy	5	1/3	1	0,384615385	0,225806452	0,238095238	0,282839025	0,866162511
Total	13	1 1/2	4 1/5				I _{max}	3,096725804
Priority vector	0,073772106	0,643388869	0,282839025				CI	0,048362902
							RC	0,58
							CR	0,083384313

CRITERION 2 : Environmental

SUBCRITERION 1 : Carbon footprint

	Other product	New clothing	Energy	Normalized			Priority vector	I _{max}
Other product	1	1/5	3	0,157894737	0,14893617	0,272727273	0,19318606	0,58781092
New clothing	5	1	7	0,789473684	0,744680851	0,636363636	0,723506057	2,272591537
Energy	1/3	1/7	1	0,052631579	0,106382979	0,090909091	0,083307883	0,251061244
Total	6 1/3	1 1/3	11				I _{max}	3,111463701
Priority vector	0,19318606	0,723506057	0,083307883				CI	0,055731851
							RC	0,58
							CR	0,096089398

SUBCRITERION 2 : Recycling

	Other product	New clothing	Energy	Normalized			Priority vector	I _{max}
Other product	1	1/5	3	0,157894737	0,14893617	0,272727273	0,19318606	0,58781092
New clothing	5	1	7	0,789473684	0,744680851	0,636363636	0,723506057	2,272591537
Energy	1/3	1/7	1	0,052631579	0,106382979	0,090909091	0,083307883	0,251061244
Total	6 1/3	1 1/3	11				I _{max}	3,111463701
Priority vector	0,19318606	0,723506057	0,083307883				CI	0,055731851
							RC	0,58
							CR	0,096089398

CRITERION 3 : Social

SUBCRITERION 1 : Local job

	Other product	New clothing	Energy	Normalized			Priority vector	I _{max}
Other product	1	1	5	0,454545455	0,428571429	0,555555556	0,47955748	1,45983646
New clothing	1	1	3	0,454545455	0,428571429	0,333333333	0,405483405	1,22991823
Energy	1/5	1/3	1	0,090909091	0,142857143	0,111111111	0,114959115	0,346031746
Total	2 1/5	2 1/3	9				I _{max}	3,035786436
Priority vector	0,47955748	0,405483405	0,114959115				CI	0,017893218
							RC	0,58
							CR	0,030850376

SUBCRITERION 2 : User resistance

	Other product	New clothing	Energy	Normalized			Priority vector	I _{max}
Other product	1	3	3	3/5	0,6	0,6	0,6	1,8
New clothing	1/3	1	1	0,2	0,2	0,2	0,2	0,6
Energy	1/3	1	1	0,2	0,2	0,2	0,2	0,6
Total	1 2/3	5	5				I _{max}	3
Priority vector	0,6	0,2	0,2				CI	0%
							RC	0,58
							CR	0%

SUBCRITERION 2 : SAP purchasing

	Other product	New clothing	Energy	Normalized			Priority vector	I _{max}
Other product	1	1/7	2	0,117647059	0,111111111	0,2	0,14291939	0,432461874
New clothing	7	1	7	0,823529412	0,777777778	0,7	0,767102397	2,397385621
Energy	1/2	1/7	1	0,058823529	0,111111111	0,1	0,089978214	0,271023965
Total	8 1/2	1 2/7	10				I _{max}	3,10087146
Priority vector	0,14291939	0,767102397	0,089978214				CI	0,05043573
							RC	0,58
							CR	0,086958155

CRITERION 4 : Relational

SUBCRITERION 1 : Brand image

	Other product	New clothing	Energy	Normalized			Priority vector	I _{max}
Other product	1	1/5	3	0,157894737	0,14893617	0,272727273	0,19318606	0,58781092
New clothing	5	1	7	0,789473684	0,744680851	0,636363636	0,723506057	2,272591537
Energy	1/3	1/7	1	0,052631579	0,106382979	0,090909091	0,083307883	0,251061244
Total	6 1/3	1 1/3	11				I _{max}	3,111463701
Priority vector	0,19318606	0,723506057	0,083307883				CI	0,055731851
							RC	0,58
							CR	0,096089398

SUBCRITERION 2 : Innovation

	Other product	New clothing	Energy	Normalized			Priority vector	I _{max}
Other product	1	1/7	2	0,117647059	0,111111111	0,2	0,14291939	0,432461874
New clothing	7	1	7	0,823529412	0,777777778	0,7	0,767102397	2,397385621
Energy	1/2	1/7	1	0,058823529	0,111111111	0,1	0,089978214	0,271023965
Total	8 1/2	1 2/7	10				I _{max}	3,10087146
Priority vector	0,14291939	0,767102397	0,089978214				CI	0,05043573
							RC	0,58
							CR	0,086958155

CRITERION 5 : Functional

SUBCRITERION 1 : recycling capability

	Other product	New clothing	Energy	Normalized			Priority vector	I _{max}
Other product	1	1/3	5	0,238095238	0,225806452	0,384615385	0,282839025	0,866162511
New clothing	3	1	7	0,714285714	0,677419355	0,538461538	0,643388869	2,008310686
Energy	1/5	1/7	1	0,047619048	0,096774194	0,076923077	0,073772106	0,222252607
Total	4 1/5	1 1/2	13				I _{max}	3,096725804
Priority vector	0,282839025	0,643388869	0,073772106				CI	0,048362902
							RC	0,58
							CR	0,083384313

II.SUB-CRITERIA COMPARISON

CRITERION 2 : Environmental				
	Carbon footprint	Recycling	Priority vector	Global priority
Carbon footprint	1	1/5	0,166666667	0,06873973
Recycling	5	1	0,833333333	0,34369865
Total	6	1 1/5		

CRITERION 3 : Social									
	Local job	Userresistance	SAP purchasing	Normalized			Priority vector	Global priority	Imax
Local job	1	7	5	0,744680851	0,636363636	4/5	0,723506057	0,272092355	2,272591537
Userresistance	1/7	1	1/3	0,106382979	0,090909091	0,052631579	0,083307883	0,031329991	0,251061244
SAP purchasing	1/5	3	1	0,14893617	0,272727273	0,157894733	0,19318606	0,072652398	0,58781092
Total	1 1/3	11	6 1/3						
Priority vector	5/7	0	1/5						
								Imax	3,11463701
								CI	0,055731851
								RC	0,58
								CR	0,096089398

CRITERION 4 : Relational				
	Brand image	Innovation	Priority vector	Global priority
Brand image	1	1/5	0,166666667	0,010685762
Innovation	5	1	0,833333333	0,053428811
Total	6	1 1/5		

III.CRITERIA COMPARISON

	Economic	Environmental	Social	Relational	Functional	Normalized				
Economic	1	1/5	1/3	1	1	0,090909091	0,08045977	0,127272727	0,058823529	0,058823529
Environmental	5	1	1	7	7	0,454545455	0,402298851	0,381818182	0,411764706	0,411764706
Social	3	1	1	7	7	0,272727273	0,402298851	0,381818182	0,411764706	0,411764706
Relational	1	1/7	1/7	1	1	0,090909091	0,057471264	0,054545455	0,058823529	0,058823529
Functional	1	1/7	1/7	1	1	0,090909091	0,057471264	0,054545455	0,058823529	0,058823529
priority vector	0,083257729	0,41243838	0,376074743	0,064114574	0,064114574					

IV.ALTERNATIVES PRIORITIZATION

	Economic	Environmental	Social	Relational	Functional	Ranking
Otherproduct	0,073772106	0,19318606	0,424557505	0,151297168	0,28	0,273319255
Newclothing	0,643388869	0,723506057	0,458224766	0,75983634	0,64	0,61426271
Energy	0,282839025	0,083307883	0,117217729	0,088866492	0,07	0,112418038
Total	1	1	1	1	1,00	1
Priority vector	0,083257729	0,41243838	0,376074743	0,064114574	0,064114574	

	Carbon footprint	Recycling	Environmental
Otherproduct	0,19318606	0,19318606	0,19318606
Newclothing	0,723506057	0,723506057	0,723506057
Energy	0,083307883	0,083307883	0,083307883
Priority	0,166666667	0,833333333	

	Local job	User resistance	SAP purchasing	Social
Otherproduct	0,47955748	0,6	0,14291939	0,424557505
Newclothing	0,405483405	0,2	0,767102397	0,458224766
Energy	0,114959115	0,2	0,089978214	0,117217729
Priority	0,723506057	0,083307883	0,19318606	

	Brand image	Innovation	Relational
Otherproduct	0,19318606	0,14291939	0,151297168
Newclothing	0,723506057	0,767102397	0,75983634
Energy	0,083307883	0,089978214	0,088866492
Priority	0,166666667	0,833333333	

Actor A5

ALTERNATIVES COMPARISON

CRITERION 1 : Economic								
SUBCRITERION 2 : Purchasing cost								
	Other product	New clothing	Energy	Normalized			Priority vector	Imax
Other product	1	1	3	0,428571429	0,466666667	0,272727273	0,389321789	1,2002886
New clothing	1	1	7	0,428571429	0,466666667	0,636363636	0,510533911	1,600865801
Energy	1/3	1/7	1	0,142857143	0,066666667	0,090909091	0,1001443	0,302851646
Total	2 1/3	2 1/7	11				Imax	3,104006047
Priority vector	0,389321789	0,510533911	0,1001443				CI	0,052003023
							RC	0,58
							CR	0,089660385

CRITERION 2 : Environmental								
SUBCRITERION 1 : Carbon footprint								
	Other product	New clothing	Energy	Normalized			Priority vector	Imax
Other product	1	1	3	0,428571429	0,466666667	0,272727273	0,389321789	1,2002886
New clothing	1	1	7	0,428571429	0,466666667	0,636363636	0,510533911	1,600865801
Energy	1/3	1/7	1	0,142857143	0,066666667	0,090909091	0,1001443	0,302851646
Total	2 1/3	2 1/7	11				Imax	3,104006047
Priority vector	0,389321789	0,510533911	0,1001443				CI	0,052003023
							RC	0,58
							CR	0,089660385

SUBCRITERION 2 : Recycling								
	Other product	New clothing	Energy	Normalized			Priority vector	Imax
Other product	1	1	3	0,428571429	0,466666667	0,272727273	0,389321789	1,2002886
New clothing	1	1	7	0,428571429	0,466666667	0,636363636	0,510533911	1,600865801
Energy	1/3	1/7	1	0,142857143	0,066666667	0,090909091	0,1001443	0,302851646
Total	2 1/3	2 1/7	11				Imax	3,104006047
Priority vector	0,389321789	0,510533911	0,1001443				CI	0,052003023
							RC	0,58
							CR	0,089660385

CRITERION 3 : Social								
SUBCRITERION 1 : Local job								
	Other product	New clothing	Energy	Normalized			Priority vector	Imax
Other product	1	1	3	0,428571429	0,466666667	0,272727273	0,389321789	1,2002886
New clothing	1	1	7	0,428571429	0,466666667	0,636363636	0,510533911	1,600865801
Energy	1/3	1/7	1	0,142857143	0,066666667	0,090909091	0,1001443	0,302851646
Total	2 1/3	2 1/7	11				Imax	3,104006047
Priority vector	0,389321789	0,510533911	0,1001443				CI	0,052003023
							RC	0,58
							CR	0,089660385

SUBCRITERION 2 : User resistance								
	Other product	New clothing	Energy	Normalized			Priority vector	Imax
Other product	1	1	3	0,428571429	0,466666667	0,272727273	0,389321789	1,2002886
New clothing	1	1	7	0,428571429	0,466666667	0,636363636	0,510533911	1,600865801
Energy	1/3	1/7	1	0,142857143	0,066666667	0,090909091	0,1001443	0,302851646
Total	2 1/3	2 1/7	11				Imax	3,104006047
Priority vector	0,389321789	0,510533911	0,1001443				CI	0,052003023
							RC	0,58
							CR	0,089660385

SUBCRITERION 2 : SAP purchasing								
	Other product	New clothing	Energy	Normalized			Priority vector	Imax
Other product	1	1	3	0,428571429	0,466666667	0,272727273	0,389321789	1,2002886
New clothing	1	1	7	0,428571429	0,466666667	0,636363636	0,510533911	1,600865801
Energy	1/3	1/7	1	0,142857143	0,066666667	0,090909091	0,1001443	0,302851646
Total	2 1/3	2 1/7	11				Imax	3,104006047
Priority vector	0,389321789	0,510533911	0,1001443				CI	0,052003023
							RC	0,58
							CR	0,089660385

CRITERION 4 : Relational								
SUBCRITERION 1 : Brand image								
	Other product	New clothing	Energy	Normalized			Priority vector	Imax
Other product	1	1	3	0,428571429	0,466666667	0,272727273	0,389321789	1,2002886
New clothing	1	1	7	0,428571429	0,466666667	0,636363636	0,510533911	1,600865801
Energy	1/3	1/7	1	0,142857143	0,066666667	0,090909091	0,1001443	0,302851646
Total	2 1/3	2 1/7	11				Imax	3,104006047
Priority vector	0,389321789	0,510533911	0,1001443				CI	0,052003023
							RC	0,58
							CR	0,089660385

SUBCRITERION 2 : Innovation								
	Other product	New clothing	Energy	Normalized			Priority vector	Imax
Other product	1	1	3	0,428571429	0,466666667	0,272727273	0,389321789	1,2002886
New clothing	1	1	7	0,428571429	0,466666667	0,636363636	0,510533911	1,600865801
Energy	1/3	1/7	1	0,142857143	0,066666667	0,090909091	0,1001443	0,302851646
Total	2 1/3	2 1/7	11				Imax	3,104006047
Priority vector	0,389321789	0,510533911	0,1001443				CI	0,052003023
							RC	0,58
							CR	0,089660385

CRITERION 5 : Functional								
SUBCRITERION 1 : fiber quality								
	Other product	New clothing	Energy	Normalized			Priority vector	Imax
Other product	1	1	3	0,428571429	0,466666667	0,272727273	0,389321789	1,2002886
New clothing	1	1	7	0,428571429	0,466666667	0,636363636	0,510533911	1,600865801
Energy	1/3	1/7	1	0,142857143	0,066666667	0,090909091	0,1001443	0,302851646
Total	2 1/3	2 1/7	11				Imax	3,104006047
Priority vector	0,389321789	0,510533911	0,1001443				CI	0,052003023
							RC	0,58
							CR	0,089660385

II.SUB-CRITERIA COMPARISON

CRITERION 2 : Environmental				
	Carbon footprint	Recycling	Priority vector	Global priority
Carbon footprint	1	1/5	0,166666667	0,033333333
Recycling	5	1	0,833333333	0,166666667
Total	6	1 1/5		

CRITERION 3 : Social									
	Local job	Userresistance	SAP purchasing	Normalized			Priority vector	Global priority	Imax
Local job	1	1	1	0,333333333	0,333333333	1/3	0,333333333	0,066666667	1
Userresistance	1	1	1	0,333333333	0,333333333	0,333333333	0,333333333	0,066666667	1
SAP purchasing	1	1	1	0,333333333	0,333333333	0,333333333	0,333333333	0,066666667	1
Total	3	3	3						3
Priority vector	1/3	1/3	1/3						0
									0,58
									0

CRITERION 4 : Relational				
	Brand image	Innovation	Priority vector	Global priority
Brand image	1	1	0,5	0,1
Innovation	1	1	0,5	0,1
Total	2	2		

III.CRITERIA COMPARISON

	Economic	Environmental	Social	Relational	Functional	Normalized				
Economic	1	1	1	1	1	0,2	0,2	0,2	0,2	0,2
Environmental	1	1	1	1	1	0,2	0,2	0,2	0,2	0,2
Social	1	1	1	1	1	0,2	0,2	0,2	0,2	0,2
Relational	1	1	1	1	1	0,2	0,2	0,2	0,2	0,2
Functional	1	1	1	1	1	0,2	0,2	0,2	0,2	0,2
	5	5	5	5	5					
priority vector	0,2	0,2	0,2	0,2	0,2					

IV.ALTERNATIVES PRIORITIZATION

	Economic	Environmental	Social	Relational	Functional	Ranking
Otherproduct	0,389321789	0,389321789	0,389321789	0,389321789	0,39	0,389321789
Newclothing	0,510533911	0,510533911	0,510533911	0,510533911	0,51	0,510533911
Energy	0,1001443	0,1001443	0,1001443	0,1001443	0,10	0,1001443
Total	1	1	1	1	1,00	1
Priority vector	0,2	0,2	0,2	0,2	0,2	

	Carbon footprint	Recycling	Environmental
Otherproduct	0,389321789	0,389321789	0,389321789
Newclothing	0,510533911	0,510533911	0,510533911
Energy	0,1001443	0,1001443	0,1001443
Priority	0,166666667	0,833333333	

	Local job	User resistance	SAP purchasing	Social
Otherproduct	0,389321789	0,389321789	0,389321789	0,389321789
Newclothing	0,510533911	0,510533911	0,510533911	0,510533911
Energy	0,1001443	0,1001443	0,1001443	0,1001443
Priority	0,333333333	0,333333333	0,333333333	

	Brand image	Innovation	Relational
Otherproduct	0,389321789	0,389321789	0,389321789
Newclothing	0,510533911	0,510533911	0,510533911
Energy	0,1001443	0,1001443	0,1001443
Priority	0,5	0,5	

II.SUB-CRITERIA COMPARISON

CRITERION 2 : Environmental				
	Carbon footprint	Recycling	Priority vector	Global priority
Carbon footprint	1	1/5	0,166666667	0,080943956
Recycling	5	1	0,833333333	0,404719779
Total	6	1 1/5		

CRITERION 3 : Social									
	Local job	Userresistance	SAP purchasing	Normalized			Priority vector	Global priority	Imax
Local job	1	5	1	0,454545455	0,454545455	4/9	0,454545455	0,031828121	1,363636364
Userresistance	1/5	1	1/5	0,090909091	0,090909091	0,090909091	0,090909091	0,006365624	0,272727273
SAP purchasing	1	5	1	0,454545455	0,454545455	0,454545455	0,454545455	0,031828121	1,363636364
Total	2 1/5	11	2 1/5						Imax 3
Priority vector	4/9	0	4/9						CI 0
									RC 0,58
									CR 0

CRITERION 4 : Relational				
	Brand image	Innovation	Priority vector	Global priority
Brand image	1	1	0,5	0,033241022
Innovation	1	1	0,5	0,033241022
Total	2	2		

III.CRITERIA COMPARISON

	Economic	Environmental	Social	Relational	Functional	Normalized				
Economic	1	1/5	3	5	1	0,13274336	0,103448276	0,230769231	0,333333333	0,176470588
Environmental	5	1	5	5	3	0,66371681	0,517241379	0,384615385	0,333333333	0,529411765
Social	1/3	1/5	1	1	1/3	0,04424778	0,103448276	0,076923077	0,066666667	0,058823529
Relational	1/5	1/5	1	1	1/3	0,02654867	0,103448276	0,076923077	0,066666667	0,058823529
Functional	1	1/3	3	3	1	0,13274336	0,172413793	0,230769231	0,2	0,176470588
priority vector	0,195352958	0,485663735	0,070021867	0,066482044	0,182479395					

IV.ALTERNATIVES PRIORITIZATION

	Economic	Environmental	Social	Relational	Functional	Ranking
Otherproduct	0,14291939	0,435247079	0,467190043	0,574826161	0,45	0,39317776
Newclothing	0,089978214	0,276546098	0,418979134	0,365775653	0,45	0,28848631
Energy	0,767102397	0,288206823	0,113830823	0,059398186	0,09	0,31833592
Total	1	1	1	1	1,00	0,68166408
Priority vector	0,195352958	0,485663735	0,070021867	0,066482044	0,182479395	

	Carbon footprint	Recycling	Environmental
Otherproduct	0,555926916	0,411111111	0,435247079
Newclothing	0,353721034	0,261111111	0,276546098
Energy	0,09035205	0,327777778	0,288206823
Priority	0,166666667	0,833333333	

	Local job	User resistance	SAP purchasing	Social
Otherproduct	0,454545455	0,723506057	0,428571429	0,467190043
Newclothing	0,454545455	0,19318606	0,428571429	0,418979134
Energy	0,090909091	0,083307883	0,142857143	0,113830823
Priority	0,454545455	0,090909091	0,454545455	

	Brand image	Innovation	Relational
Otherproduct	0,579077003	0,570575318	0,574826161
Newclothing	0,36848587	0,363065437	0,365775653
Energy	0,052437127	0,066359245	0,059398186
Priority	0,5	0,5	

II. SUB-CRITERIA COMPARISON

CRITERION 2 : Environmental				
	Carbon footprint	Recycling	Priority vector	Global priority
Carbon footprint	1	1/5	0,166666667	0,027538368
Recycling	5	1	0,833333333	0,137691841
Total	6	1 1/5		

CRITERION 3 : Social									
	Local job	Userresistance	SAP purchasing	Normalized			Priority vector	Global priority	Imax
Local job	1	1/5	2	0,153846154	0,142857143	1/4	0,182234432	0,098873062	0,552655678
Userresistance	5	1	5	0,769230769	0,714285714	0,625	0,702838828	0,381332036	2,188644689
SAP purchasing	1/2	1/5	1	0,076923077	0,142857143	0,125	0,11492674	0,06235462	0,346611722
Total	6 1/2	1 2/5	8						
Priority vector	1/5	5/7	1/9						
								Imax	3,087912088
								CI	0,043956044
								RC	0,58
								CR	0,075786283

CRITERION 4 : Relational				
	Brand image	Innovation	Priority vector	Global priority
Brand image	1	5	0,833333333	0,044579281
Innovation	1/5	1	0,166666667	0,008915856
Total	1 1/5	6		

III. CRITERIA COMPARISON

	Economic	Environmental	Social	Relational	Functional	Normalized				
Economic	1	1	1/5	5	5	0,13513513	0,132743363	0,118644068	0,294117647	0,26315789
Environmental	1	1	1/5	3	5	0,13513513	0,132743363	0,118644068	0,176470588	0,26315789
Social	5	5	1	7	7	0,67567567	0,663716814	0,593220339	0,411764706	0,36842105
Relational	1/5	1/3	1/7	1	1	0,02702702	0,044247788	0,084745763	0,058823529	0,05263158
Functional	1/5	1/5	1/7	1	1	0,02702702	0,026548673	0,084745763	0,058823529	0,05263158
	7 2/5	7 1/2	1 2/3	17	19					
priority vector	0,188759622	0,16523021	0,542559717	0,053495137	0,049955314					

IV. ALTERNATIVES PRIORITIZATION

	Economic	Environmental	Social	Relational	Functional	Ranking
Otherproduct	0,454545455	0,456565657	0,333333333	0,446825397	0,47	0,38930697
Newclothing	0,454545455	0,456565657	0,333333333	0,400529101	0,47	0,38683034
Energy	0,090909091	0,086868687	0,333333333	0,152645503	0,07	0,22386268
Total	1	1	1	1	1,00	1
Priority vector	0,188759622	0,16523021	0,542559717	0,053495137	0,049955314	

	Carbon footprint	Recycling	Environmental
Otherproduct	0,466666667	0,454545455	0,456565657
Newclothing	0,466666667	0,454545455	0,456565657
Energy	0,066666667	0,090909091	0,086868687
Priority	0,166666667	0,833333333	

	Local job	User resistance	SAP purchasing	Social
Otherproduct	0,333333333	0,333333333	0,333333333	0,333333333
Newclothing	0,333333333	0,333333333	0,333333333	0,333333333
Energy	0,333333333	0,333333333	0,333333333	0,333333333
Priority	0,182234432	0,702838828	0,11492674	

	Brand image	Innovation	Relational
Otherproduct	0,442857143	0,466666667	0,446825397
Newclothing	0,387301587	0,466666667	0,400529101
Energy	0,16984127	0,066666667	0,152645503
Priority	0,833333333	0,166666667	

Actor A8

ALTERNATIVES COMPARISON

CRITERION 1 : Economic

SUBCRITERION 2 : Purchasing cost

	Other product	New clothing	Energy	Normalized			Priority vector	Imax
Other product	1	1/5	1/5	0,090909091	0,117647059	0,0625	0,09035205	0,27228164
New clothing	5	1	2	0,454545455	0,588235294	0,625	0,55926916	1,715129234
Energy	5	1/2	1	0,454545455	0,294117647	0,3125	0,353721034	1,083444742
Total	11	1 2/3	3 1/5				Imax	3,070855615
Priority vector	0,09035205	0,55926916	0,353721034				CI	0,035427807
							RC	0,58
							CR	0,061082427

CRITERION 2 : Environmental

SUBCRITERION 1 : Carbon footprint

	Other product	New clothing	Energy	Normalized			Priority vector	Imax
Other product	1	1/2	5	0,3125	0,294117647	0,454545455	0,353721034	1,083444742
New clothing	2	1	5	0,625	0,588235294	0,454545455	0,55926916	1,715129234
Energy	1/5	1/5	1	0,0625	0,117647059	0,090909091	0,09035205	0,27228164
Total	3 1/5	1 2/3	11				Imax	3,070855615
Priority vector	0,353721034	0,55926916	0,09035205				CI	0,035427807
							RC	0,58
							CR	0,061082427

SUBCRITERION 2 : Recycling

	Other product	New clothing	Energy	Normalized			Priority vector	Imax
Other product	1	1/2	5	0,3125	0,294117647	0,454545455	0,353721034	1,083444742
New clothing	2	1	5	0,625	0,588235294	0,454545455	0,55926916	1,715129234
Energy	1/5	1/5	1	0,0625	0,117647059	0,090909091	0,09035205	0,27228164
Total	3 1/5	1 2/3	11				Imax	3,070855615
Priority vector	0,353721034	0,55926916	0,09035205				CI	0,035427807
							RC	0,58
							CR	0,061082427

CRITERION 3 : Social

SUBCRITERION 1 : Local job

	Other product	New clothing	Energy	Normalized			Priority vector	Imax
Other product	1	3	3	0,6	0,666666667	0,5	0,588888889	1,822222222
New clothing	1/3	1	2	0,2	0,222222222	0,333333333	0,251851852	0,766666667
Energy	1/3	1/2	1	0,2	0,111111111	0,166666667	0,159259259	0,481481481
Total	1 2/3	4 1/2	6				Imax	3,07037037
Priority vector	0,588888889	0,251851852	0,159259259				CI	0,035185185
							RC	0,58
							CR	0,060664112

SUBCRITERION 2 : User resistance

	Other product	New clothing	Energy	Normalized			Priority vector	Imax
Other product	1	1/3	1	0,2	0,181818182	0,25	0,210606061	0,634343434
New clothing	3	1	2	0,6	0,545454545	0,5	0,548484848	1,662121212
Energy	1	1/2	1	0,2	0,272727273	0,25	0,240909091	0,725757576
Total	5	1 5/6	4				Imax	3,022222222
Priority vector	0,210606061	0,548484848	0,240909091				CI	0,011111111
							RC	0,58
							CR	0,019157088

SUBCRITERION 2 : SAP purchasing

	Other product	New clothing	Energy	Normalized			Priority vector	Imax
Other product	1	1	5	0,454545455	0,454545455	0,454545455	0,454545455	1,363636364
New clothing	1	1/5	5	0,454545455	0,454545455	0,454545455	0,454545455	1,363636364
Energy	1/5	1/5	1	0	0	0	0,090909091	0,272727273
Total	2 1/5	2 1/5	11				Imax	3
Priority vector	0,454545455	0,454545455	0,090909091				CI	0
							RC	0,58
							CR	0

CRITERION 4 : Relational

SUBCRITERION 1 : Brand image

	Other product	New clothing	Energy	Normalized			Priority vector	Imax
Other product	1	5	7	0,744680851	0,789473684	0,636363636	0,723506057	2,272591537
New clothing	1/5	1	3	0,14893617	0,157894737	0,272727273	0,19318606	0,58781092
Energy	1/7	1/3	1	0,106382979	0,052631579	0,090909091	0,083307883	0,251061244
Total	1 1/3	6 1/3	11				Imax	3,111463701
Priority vector	0,723506057	0,19318606	0,083307883				CI	0,055731851
							RC	0,58
							CR	0,096089398

SUBCRITERION 2 : Innovation

	Other product	New clothing	Energy	Normalized			Priority vector	Imax
Other product	1	5	7	0,744680851	0,789473684	0,636363636	0,723506057	2,272591537
New clothing	1/5	1	3	0,14893617	0,157894737	0,272727273	0,19318606	0,58781092
Energy	1/7	1/3	1	0,106382979	0,052631579	0,090909091	0,083307883	0,251061244
Total	1 1/3	6 1/3	11				Imax	3,111463701
Priority vector	0,723506057	0,19318606	0,083307883				CI	0,055731851
							RC	0,58
							CR	0,096089398

CRITERION 5 : Functional

SUBCRITERION 1 : fiber quality

	Other product	New clothing	Energy	Normalized			Priority vector	Imax
Other product	1	1/3	5	0,238095238	0,225806452	0,384615385	0,282839025	0,866162511
New clothing	3	1	7	0,714285714	0,677419355	0,538461538	0,643388869	2,008310686
Energy	1/5	1/7	1	0,047619048	0,096774194	0,076923077	0,073772106	0,222252607
Total	4 1/5	1 1/2	13				Imax	3,096725804
Priority vector	0,282839025	0,643388869	0,073772106				CI	0,048362902
							RC	0,58
							CR	0,083384313

II.SUB-CRITERIA COMPARISON

CRITERION 2 : Environmental				
	Carbon footprint	Recycling	Priority vector	Global priority
Carbon footprint	1	1/5	0,166666667	0,025889356
Recycling	5	1	0,833333333	0,129446779
Total	6	1 1/5		

CRITERION 3 : Social									
	Local job	Userresistance	SAP purchasing	Normalized			Priority vector	Global priority	Imax
Local job	1	3	1	0,428571429	0,333333333	4/9	0,405483405	0,162840773	1,2299182
Userresistance	1/3	1	1/5	0,142857143	0,111111111	0,090909091	0,114959115	0,046167194	0,3460317
SAP purchasing	1	5	1	0,428571429	0,555555556	0,454545455	0,47955748	0,192588672	1,4598865
Total	2 1/3	9	2 1/5						
Priority vector	2/5	1/9	1/2						
								Imax	3,0357864
								CI	0,0178932
								RC	0,58
								CR	0,0308504

CRITERION 4 : Relational				
	Brand image	Innovation	Priority vector	Global priority
Brand image	1	1	0,5	0,048918067
Innovation	1	1	0,5	0,048918067
Total	2	2		

III.CRITERIA COMPARISON

	Economic	Environmental	Social	Relational	Functional	Normalized				
Economic	1	3	1/3	3	1	0,176470588	0,375	0,142857143	0,3	0,125
Environmental	1/3	1	1/3	2	2	0,058823529	0,125	0,142857143	0,2	0,25
Social	3	3	1	3	3	0,529411765	0,375	0,428571429	0,3	0,375
Relational	1/3	1/2	1/3	1	1	0,058823529	0,0625	0,142857143	0,1	0,125
Functional	1	1/2	1/3	1	1	0,176470588	0,0625	0,142857143	0,1	0,125
	5 2/3	8	2 1/3	10	8					
priority vector	0,223865546	0,155336134	0,401596639	0,097836134	0,121365546					

IV.ALTERNATIVES PRIORITIZATION

	Economic	Environmental	Social	Relational	Functional	Ranking
Other product	0,09035205	0,353721034	0,480976431	0,723506057	0,28	0,373442836
New clothing	0,555926916	0,555926916	0,383155752	0,19318606	0,64	0,461668302
Energy	0,353721034	0,09035205	0,135867817	0,083307883	0,07	0,164888862
Total	1	1	1	1	1,00	1
Priority vector	0,223865546	0,155336134	0,401596639	0,097836134	0,121365546	

	Carbon footprint	Recycling	Environmental
Other product	0,353721034	0,353721034	0,353721034
New clothing	0,555926916	0,555926916	0,555926916
Energy	0,09035205	0,09035205	0,09035205
Priority	0,166666667	0,833333333	

	Local job	User resistance	SAP purchasing	Social
Other product	0,588888889	0,210606061	0,454545455	0,480976431
New clothing	0,251851852	0,548484848	0,454545455	0,383155752
Energy	0,159259259	0,240909091	0,090909091	0,135867817
Priority	0,405483405	0,114959115	0,47955748	

	Brand image	Innovation	Relational
Other product	0,723506057	0,723506057	0,723506057
New clothing	0,19318606	0,19318606	0,19318606
Energy	0,083307883	0,083307883	0,083307883
Priority	0,5	0,5	

Annex E-1: Similarity matrices

Beginning of life

Economic	A1	A2	A3	A4	A5	A6	A7	A8	A9
A1	1	0,951080264	0,98017708	0,979453883	0,996245695	0,992054622	0,977600999	0,975222353	0,922784043
A2	0,951080264	1	0,970903184	0,930534147	0,954834569	0,959025642	0,973479265	0,975857911	0,873864307
A3	0,98017708	0,970903184	1	0,959630963	0,983931385	0,988122458	0,997423919	0,995045273	0,902961123
A4	0,979453883	0,930534147	0,959630963	1	0,975699578	0,971508505	0,957054882	0,954676236	0,94333016
A5	0,996245695	0,954834569	0,983931385	0,975699578	1	0,995808927	0,981355304	0,978976658	0,919029738
A6	0,992054622	0,959025642	0,988122458	0,971508505	0,995808927	1	0,985546377	0,983167731	0,914838665
A7	0,977600999	0,973479265	0,997423919	0,957054882	0,981355304	0,985546377	1	0,997621354	0,900385042
A8	0,975222353	0,975857911	0,995045273	0,954676236	0,978976658	0,983167731	0,997621354	1	0,898006396
A9	0,922784043	0,873864307	0,902961123	0,94333016	0,919029738	0,914838665	0,900385042	0,898006396	1
Environmental	A1	A2	A3	A4	A5	A6	A7	A8	A9
A1	1	0,707299754	0,976333144	0,863631138	0,952551596	0,821547793	0,996411093	0,889651603	0,868607456
A2	0,707299754	1	0,73096661	0,843668616	0,754748158	0,885751961	0,710888661	0,817648151	0,838692298
A3	0,976333144	0,73096661	1	0,887297995	0,976218452	0,84521465	0,97992205	0,913318459	0,892274312
A4	0,863631138	0,843668616	0,887297995	1	0,911079542	0,957916655	0,867220045	0,973799535	0,995023682
A5	0,952551596	0,754748158	0,976218452	0,911079542	1	0,868996198	0,956140502	0,937100007	0,91605586
A6	0,821547793	0,885751961	0,84521465	0,957916655	0,868996198	1	0,958985754	0,827579731	0,947631916
A7	0,996411093	0,710888661	0,97992205	0,867220045	0,956140502	0,958985754	1	0,89324051	0,87219663
A8	0,889651603	0,817648151	0,913318459	0,973799535	0,937100007	0,827579731	0,89324051	1	0,978955853
A9	0,868607456	0,838692298	0,892274312	0,995023682	0,91605586	0,947631916	0,87219663	0,978955853	1
Social	A1	A2	A3	A4	A5	A6	A7	A8	A9
A1	1	0,933047782	0,871603718	0,911400065	0,934139569	0,791349152	0,968035482	0,944524295	0,961487172
A2	0,933047782	1	0,938555936	0,978352283	0,998908213	0,724396934	0,9650123	0,988523487	0,894534954
A3	0,871603718	0,938555936	1	0,960203653	0,937464149	0,66295287	0,903568235	0,927079423	0,83309089
A4	0,911400065	0,978352283	0,960203653	1	0,977260496	0,702749217	0,943364582	0,96687577	0,872887237
A5	0,934139569	0,998908213	0,937464149	0,977260496	1	0,725488722	0,966104087	0,989615274	0,895626741
A6	0,791349152	0,724396934	0,66295287	0,702749217	0,725488722	1	0,759384635	0,735873448	0,829861981
A7	0,968035482	0,9650123	0,903568235	0,943364582	0,966104087	0,759384635	1	0,976488813	0,92952654
A8	0,944524295	0,988523487	0,927079423	0,96687577	0,989615274	0,735873448	0,976488813	1	0,906011467
A9	0,961487172	0,894534954	0,83309089	0,872887237	0,895626741	0,829861981	0,92952654	0,906011467	1
Relational	A1	A2	A3	A4	A5	A6	A7	A8	A9
A1	1	0,884351102	0,946285217	0,914633839	0,955224588	0,924006085	0,941808314	0,917216894	0,983163411
A2	0,884351102	1	0,830636319	0,79898494	0,929126513	0,808357187	0,942542788	0,967134208	0,867514513
A3	0,946285217	0,830636319	1	0,968348621	0,901509806	0,977720868	0,888093531	0,863502111	0,963121806
A4	0,914633839	0,79898494	0,968348621	1	0,869858427	0,990627753	0,856442153	0,831850732	0,931470428
A5	0,955224588	0,929126513	0,901509806	0,869858427	1	0,879230674	0,986583726	0,961992305	0,938388
A6	0,924006085	0,808357187	0,977720868	0,990627753	0,879230674	1	0,865814399	0,841222979	0,940842674
A7	0,941808314	0,942542788	0,888093531	0,856442153	0,986583726	0,865814399	1	0,97540858	0,924971725
A8	0,917216894	0,967134208	0,863502111	0,831850732	0,961992305	0,841222979	0,97540858	1	0,900380305
A9	0,983163411	0,867514513	0,963121806	0,931470428	0,938388	0,940842674	0,924971725	0,900380305	1
Functional	A1	A2	A3	A4	A5	A6	A7	A8	A9
A1	1	0,707076699	0,774399159	0,710211159	0,927712271	0,946259348	0,99976074	0,892181357	0,967499653
A2	0,707076699	1	0,93267754	0,99686554	0,779364427	0,76081735	0,706837438	0,814895342	0,739577046
A3	0,774399159	0,93267754	1	0,935812	0,846686887	0,82813981	0,774159898	0,882217802	0,806899506
A4	0,710211159	0,99686554	0,935812	1	0,782498887	0,76395181	0,709971898	0,818029802	0,742711506
A5	0,927712271	0,779364427	0,846686887	0,782498887	1	0,981452923	0,927473011	0,964469086	0,960212619
A6	0,946259348	0,76081735	0,82813981	0,76395181	0,981452923	1	0,946020088	0,945922009	0,978759696
A7	0,99976074	0,706837438	0,774159898	0,709971898	0,927473011	0,946020088	1	0,891942097	0,967260392
A8	0,892181357	0,814895342	0,882217802	0,818029802	0,964469086	0,945922009	0,891942097	1	0,924681704
A9	0,967499653	0,739577046	0,806899506	0,742711506	0,960212619	0,978759696	0,967260392	0,924681704	1

Annex E-2: Similarity matrices

Middle of life

Economic	A1	A2	A3	A4	A5	A6	A7	A8	A9	A10	A11	A12
A1	1											
A2	0.928762044	1										
A3	0.985766222	0.94295822	1									
A4	0.858887643	0.787649686	0.844653865	1								
A5	0.988490119	0.940271925	0.97276103	0.84737762	1							
A6	0.999296101	0.928058153	0.985062323	0.859591542	0.98778622	1						
A7	0.986404514	0.94235753	0.999361708	0.845292157	0.997914395	0.985700615	1					
A8	0.95375633	0.882518374	0.939522552	0.905131312	0.942246449	0.954460229	0.940160844	1				
A9	0.983969776	0.91273182	0.99735998	0.874917867	0.972459895	0.984673675	0.97037429	0.969786554	1			
A10	0.96353845	0.865225593	0.977772229	0.822426093	0.975048331	0.962834551	0.977133936	0.917294781	0.947508226	1		
A11	0.978426822	0.907188866	0.964193044	0.88046082	0.966916941	0.979130722	0.964831337	0.975329508	0.994457047	0.941965273	1	
A12	0.86284794	0.791609984	0.848614162	0.996039702	0.851338059	0.86355184	0.849252455	0.90909161	0.878878165	0.826386391	0.884421118	1
Environmental	A1	A2	A4	A5	A6	A7	A8	A9	A10	A11	A12	
A1	1											
A2	0.719544028	1										
A3	0.927091061	0.792452967	1									
A4	0.670905636	0.951361608	0.743814575	1								
A5	0.766737862	0.952806166	0.839646801	0.904167775	1							
A6	0.996032058	0.715576086	0.921312119	0.666937694	0.76276992	1						
A7	0.953945112	0.67348914	0.881036173	0.624850748	0.720682974	0.957913054	1					
A8	0.707890652	0.988364594	0.780799561	0.963015014	0.94115276	0.70392268	0.661835734	1				
A9	0.888696521	0.830847507	0.852061546	0.782209115	0.878041341	0.88472759	0.842641633	0.819194101	1			
A10	0.810328562	0.909215467	0.8832375	0.860577075	0.9564093	0.806360619	0.764273673	0.897562061	0.92163204	1		
A11	0.734710074	0.984831956	0.80719013	0.936195562	0.967972212	0.730742132	0.688655186	0.973180548	0.846013553	0.924381513	1	
A12	0.576769813	0.857225785	0.649678752	0.905864177	0.810031951	0.572801871	0.530714925	0.868879191	0.688073292	0.766441252	0.842059739	1
Social	A1	A2	A4	A5	A6	A7	A8	A9	A10	A11	A12	
A1	1											
A2	0.927903081	1										
A3	0.918868335	0.900965254	1									
A4	0.885259941	0.813162001	0.804128276	1								
A5	0.9327276	0.934630481	0.925595736	0.87853254	1							
A6	0.954265385	0.973637696	0.839525325	0.9660295	0.960992785	1						
A7	0.941819095	0.869722108	0.86068743	0.943440846	0.935091695	0.89608448	1					
A8	0.985886073	0.942017008	0.932982262	0.871146014	0.929613473	0.968379312	0.927705168	1				
A9	0.859624757	0.787527838	0.778493092	0.974364816	0.852897357	0.813890142	0.917805662	0.84551083	1			
A10	0.971360252	0.956562859	0.947508114	0.85620162	0.978087622	0.982905163	0.913793117	0.985474148	0.830984979	1		
A11	0.744272922	0.816369841	0.81540587	0.62952863	0.75000737	0.79000737	0.758386849	0.603897679	0.7729127	0.7729127	1	
A12	0.68342036	0.75528955	0.74563701	0.568691976	0.690159436	0.729166651	0.625251131	0.697545963	0.543056793	0.712071814	0.939159114	1
Relational	A1	A2	A3	A4	A5	A6	A7	A8	A9	A10	A11	A12
A1	1											
A2	0.907760138	1										
A3	0.959491373	0.867251511	1									
A4	0.922078421	0.829838558	0.962587047	1								
A5	0.891412587	0.829838558	0.962587047	0.813491008	1							
A6	0.935933782	0.84369399	0.962587047	0.827346369	0.886144639	1						
A7	0.976848752	0.930911386	0.936440125	0.89927172	0.914563835	0.912782533	1					
A8	0.9229871	0.984771038	0.82478473	0.84506552	0.968254888	0.858920881	0.946138348	1				
A9	0.999643757	0.908116381	0.95913513	0.921722178	0.89176883	0.93577539	0.977204995	0.923343342	1			
A10	0.97108562	0.878845758	0.9590928	0.921722178	0.862498207	0.964848161	0.89407272	0.970729377	0.970729377	1		
A11	0.934916049	0.842676186	0.975424675	0.987162372	0.82628636	0.998982267	0.9117648	0.857903148	0.934559806	0.963830428	1	
A12	0.945892091	0.853652229	0.986400718	0.976186329	0.837304679	0.99004169	0.922740843	0.868879191	0.945535849	0.974806471	0.989023957	1
Functional	A1	A2	A3	A4	A5	A6	A7	A8	A9	A10	A11	A12
A1	1											
A2	0.812642853	1										
A3	0.953480321	0.859162532	1									
A4	0.619356355	0.806713502	0.665876034	1								
A5	0.870542794	0.942100059	0.917062473	0.748813561	1							
A6	0.986340238	0.826302615	0.967140083	0.633016117	0.884202556	1						
A7	0.997429746	0.815213104	0.956050575	0.621926609	0.873113048	0.988910492	1					
A8	0.845261119	0.967381374	0.891780798	0.774095236	0.974718325	0.85928081	0.847831374	1				
A9	0.764707745	0.952064892	0.811227424	0.85446861	0.778367507	0.778367507	0.767278	0.919446626	1			
A10	0.773592411	0.960494557	0.82011209	0.845763944	0.90304617	0.87252173	0.776162665	0.928331291	0.99115335	1		
A11	0.946926378	0.865716475	0.993446057	0.672429977	0.923616416	0.96058614	0.949496632	0.898334741	0.817781367	0.826666032	1	
A12	0.976381928	0.836260928	0.972089393	0.642974427	0.829450866	0.99004169	0.978952182	0.868879191	0.788325817	0.792710482	0.9784465	1

**École Nationale Supérieure des Mines
de Saint-Étienne**

NNT: 2019LYSEM030

Martha ORELLANO CARRASQUILLA

A methodological framework to support sustainable value creation in innovative offer design

Speciality: Industrial Engineering

Keywords: value creation; collaboration; innovation; sustainability; multi-criteria decision analysis

Abstract:

The increasing environmental and social needs require the adoption of more sustainable practices in the industry. This pushes companies to integrate new criteria related to the creation of sustainable value in their innovation process, i.e. economic, but also environmental and social. The main objective of this thesis work is to provide a methodological support to companies for the integration of sustainable development criteria into their innovation processes. The contribution of this thesis is threefold. Firstly, a framework for conceptualizing sustainable value creation is proposed. This framework is based on five dimensions of value: the three dimensions of sustainable development, economic, environmental, social, to which are added two dimensions, relational and functional. Secondly, a system modelling approach is adopted to analyse the process of aligning customer value expectations with feasible alternatives in terms of suppliers' value propositions. Finally, given the diversity of stakeholders and the multidimensionality of sustainable value, a multi-criteria and multi-stakeholder decision support approach is adopted to evaluate feasible alternatives to value creation. The proposed framework is then applied to a project aiming at revisiting the provision process of safety clothing to employees of a large French company (EDF).

**École Nationale Supérieure des Mines
de Saint-Étienne**

NNT : 2019LYSEM030

Martha ORELLANO CARRASQUILLA

Cadre methodologique pour l'analyse de la valeur durable dans la conception collaborative d'offres innovantes

Spécialité : Génie Industriel

Mots clefs : création de valeur; collaboration; innovation; développement durable; aide à la décision multicritères

Résumé :

L'augmentation des pressions environnementales et sociales nécessite l'adoption de pratiques plus durables dans l'industrie. Pour les entreprises, cela se traduit par la prise en compte dans le processus d'innovation de nouveaux critères liés à la création de valeur durable, dans le sens économique, mais aussi environnementale et sociale. L'objectif principal de ce travail de thèse est de fournir un cadre méthodologique aux entreprises pour l'intégration de critères axés sur le développement durable dans leurs processus d'innovation. La contribution de cette thèse est triple. Tout d'abord, un cadre permettant de conceptualiser la valeur créée par une innovation est proposé. Ce cadre s'appuie sur cinq dimensions de la valeur : les trois dimensions du développement durable, économique, environnementale, sociale, auxquelles s'ajoutent deux dimensions, relationnelle et fonctionnelle. Deuxièmement, une approche de modélisation des systèmes est adoptée pour analyser le processus d'alignement entre les attentes des clients en termes de création de valeur et les alternatives possibles en termes de propositions de valeur par les fournisseurs. Enfin, compte tenu de la diversité des parties prenantes impliquées et du caractère multidimensionnelle de la valeur durable, une approche d'aide à la décision multicritères et multi-acteurs est adoptée pour évaluer les alternatives réalisables au regard des objectifs de création de valeur. Le cadre proposé est alors appliqué à la transformation du système de fourniture de vêtements de sécurité aux employés d'une grande entreprise française (EDF).