



HAL
open science

Improving road safety in Lebanon: a multidimensional journey from comprehensive analysis of challenges towards data integration and examining driver behaviour

Dalal Youssef

► To cite this version:

Dalal Youssef. Improving road safety in Lebanon: a multidimensional journey from comprehensive analysis of challenges towards data integration and examining driver behaviour. Human health and pathology. Université de Bordeaux, 2024. English. NNT : 2024BORD0268 . tel-04922751

HAL Id: tel-04922751

<https://theses.hal.science/tel-04922751v1>

Submitted on 31 Jan 2025

HAL is a multi-disciplinary open access archive for the deposit and dissemination of scientific research documents, whether they are published or not. The documents may come from teaching and research institutions in France or abroad, or from public or private research centers.

L'archive ouverte pluridisciplinaire **HAL**, est destinée au dépôt et à la diffusion de documents scientifiques de niveau recherche, publiés ou non, émanant des établissements d'enseignement et de recherche français ou étrangers, des laboratoires publics ou privés.

THÈSE PRÉSENTÉE
POUR OBTENIR LE GRADE DE

DOCTEUR DE
L'UNIVERSITÉ DE BORDEAUX

École doctorale Sociétés, Politique, Santé Publique
Spécialité Santé Publique, option Épidémiologie

Par Dalal YOUSSEF

AMELIORER LA SECURITE ROUTIERE AU LIBAN : UN PARCOURS
MULTIDIMENSIONNEL ALLANT DE L'ANALYSE EXHAUSTIVE DES
DEFIS A L'INTEGRATION DES DONNEES ET L'EXAMEN DU
COMPORTEMENT DES CONDUCTEURS

IMPROVING ROAD SAFETY IN LEBANON: A MULTIDIMENSIONAL
JOURNEY FROM COMPREHENSIVE ANALYSIS OF CHALLENGES
TOWARDS DATA INTEGRATION AND EXAMINING DRIVER
BEHAVIOUR

Sous la direction du : Pr. Louis-Rachid SALMI
et du : Pr. Pascale SALAMEH
Soutenue le 18 Novembre 2024

Membres du jury

Mme Simone MATHOULIN-PELISSIER, Université de Bordeaux, Directrice du Jury
M. Louis-Rachid SALMI, Professeur, Université de Bordeaux, Directeur de thèse
Mme Pascale SALAMEH, Professeur, Université Libanaise, Co-directrice de thèse
Mme Simone MATHOULIN-PELISSIER, Université de Bordeaux, Examinatrice
M. Laurent CARNIS, Directeur de recherche, Université Gustave Eiffel, Rapporteur
Mme Lucie LAFLAMME, Professeur, Karolinska Institutet, Rapporteur
M. Yarob BADR, Université Saint Joseph, Conseiller Régional ESCWA, Examineur

Améliorer la sécurité routière au Liban : Un parcours multidimensionnel allant de l'analyse exhaustive des défis à l'intégration des données et l'examen du comportement des conducteurs

RESUME

Les collisions de la route, une préoccupation mondiale en matière de santé publique et de socio-économie, coûtent la vie à 1,19 million de personnes chaque année. Le Liban, avec une population de moins de 6 millions d'habitants, enregistre chaque année près de 1 000 décès dus aux collisions de la route. Les défis sont exacerbés par la croissance démographique, la possession de véhicules au sein des foyers, la détérioration des infrastructures et les conflits régionaux, le tout compliqué par des données fragmentées. Le manque de recherches antérieures sur la sécurité routière aggrave la situation en entravant la formulation de politiques éclairées. En utilisant une approche multidimensionnelle, cette thèse entreprend une exploration exhaustive des défis de la sécurité routière, visant à combler les lacunes de la recherche et s'efforce de fournir une stratégie holistique pour améliorer la sécurité routière. Sa vision ultime s'étend à des routes plus sûres, à une réduction des décès et à l'évolution vers un système de transport durable.

La thèse se déploie en deux axes principaux : le système de management de la sécurité routière et le comportement des conducteurs. Dans le premier axe, une analyse exhaustive de la situation actuelle du système de management de la sécurité routière au Liban a été réalisée. Cette analyse examine en profondeur les défis, ainsi que les complexités historiques, institutionnelles, organisationnelles et financières qui influencent le cadre actuel de la sécurité routière. La thèse évalue les mécanismes d'application du code routier, les affectations budgétaires et propose des recommandations fondées sur des données probantes pour améliorer à la fois la sécurité routière et la durabilité au Liban. Cette analyse exhaustive souligne l'urgence d'adopter une stratégie holistique couvrant un large éventail d'aspects liés à la sécurité routière, de l'application rigoureuse des lois à l'amélioration des infrastructures, en passant par l'allocation durable des financements et la collaboration internationale active. Reconnaissant que les données sont la pierre angulaire d'une gestion efficace de la sécurité routière, la thèse aborde brièvement le problème crucial de la fragmentation et de l'incomplétude des données sur les traumatismes liées à la circulation routière au Liban.

Se penchant sur le facteur humain, le deuxième axe se concentre sur le comportement des conducteurs, élément essentiel de la sécurité routière qui a manqué d'outils validés dans le contexte libanais. La thèse comporte l'adaptation transculturelle de quatre échelles de mesure (le locus de contrôle du trafic, le questionnaire sur le comportement des conducteurs, l'échelle

de la colère au volant et l'inventaire des compétences des conducteurs) pour comprendre et atténuer les comportements dangereux des conducteurs. Ce processus complexe implique la traduction, l'adaptation transculturelle, une validation rigoureuse et l'implication de divers groupes de conducteurs libanais dans la collecte de données. Au-delà de la validation, elle explore l'association entre ce comportement et les collisions de la route, avec le potentiel d'influencer les politiques de sécurité routière et de promouvoir de bonnes pratiques de conduite.

Cette thèse sert alors de plan directeur transformateur, visant à forger des routes plus sûres, à réduire les collisions et à améliorer la qualité de vie au Liban. Il s'agit d'un appel sans équivoque à répondre à l'urgence d'agir et à promouvoir des solutions fondées sur des données probantes.

Mots clés : Sécurité routière, Liban, collisions de la route, comportement des conducteurs, validation d'échelles, système intégré.

Unité de recherche

Unité INSERM U1219, Bordeaux Population Health Center –Université de Bordeaux, 146 rue Léo Saignat 33000 Bordeaux, FRANCE

Improving road safety in Lebanon: A multidimensional journey from comprehensive analysis of challenges towards data integration and examining driver behaviour

ABSTRACT

Road traffic collisions, a global public health and socio-economic concern, claim 1.19 million lives annually worldwide. Lebanon, with a population under 6 million, contends with nearly 1,000 road fatalities each year. Challenges are amplified by population growth, increased household vehicle ownership, deteriorating infrastructure, and the enduring impact of regional conflicts, all further obscured by fragmented data. The dearth of prior research on Lebanese road safety compounds the predicament, impeding informed policy formulation and precise solutions.

The thesis unfolds along two main axes: road safety management and driver behaviour. The first axis provides a comprehensive analysis of the current state of road safety management in Lebanon. This analysis delves deeply into the challenges, as well as the historical, institutional, organizational, and financial complexities that shape the current framework for road safety. The thesis evaluates existing policies, enforcement mechanisms, budget allocations, and proposes evidence-based recommendations to improve both road safety and sustainability in Lebanon. This thorough analysis highlights the urgent need for a holistic strategy that covers a wide range of road safety aspects, from strict law enforcement to infrastructure improvements, sustainable funding allocation, and active international collaboration. Recognizing that data is the cornerstone of effective road safety management, the thesis addresses briefly the critical issue of fragmented and incomplete data on road traffic injuries in Lebanon.

Focusing on the human factor, the second axis concentrates on driver behaviour, a key element of road safety that has lacked validated tools in the Lebanese context. The thesis advocates for the cross-cultural adaptation of four measurement scales (Traffic Locus of Control, Driver Behaviour Questionnaire, Driving Anger Scale, and Driver Skills Inventory) to understand and mitigate risky driver behaviours. This complex process involves translation, cross-cultural adaptation, rigorous validation, and the involvement of various groups of Lebanese drivers in data collection. Beyond validation, it explores the relationship between driver behaviour and road collisions, with the potential to influence road safety policies and promote good driving practices.

This thesis thus serves as a transformative roadmap, aiming to create safer roads, reduce collisions, and improve the quality of life in Lebanon. It is a clarion call to address the urgent need for action and the pursuit of data-driven solutions.

Keywords: Road Safety, Lebanon, road traffic collision, driver behaviour, scale validation, integrated surveillance system,

Research unit

Unit INSERM U1219, Bordeaux Population Health Center – University of Bordeaux, 146 rue Léo Saignat 33000 Bordeaux, FRANCE

In loving memory of my father and in tribute to my resilient mother

Dedicated to the loving memory of my father, whose enduring impact, love, and wisdom have steered my academic journey. Although you are no longer by my side in the physical realm, your spirit lives on in every word, every thought, and every accomplishment. By dedicating this work to your loving memory, I strive to pay homage to the profound influence you've had on my journey and express my eternal gratitude for your guidance and love.

Additionally, I dedicate my thesis to the most remarkable woman in my life my beloved mother, a resilient stroke survivor. In the face of life's greatest challenges, your unyielding spirit has been a beacon of hope and a testament to the boundless strength of the human heart. Your resilience, motivated by an unyielding desire to overcome the aftermath of the stroke, has been an inspiration beyond measure. Even though you may not have been able to provide me with support during your own challenging times, your unwavering determination to conquer the effects of the stroke remains etched in my heart. Through every trial, your love and encouragement have been the driving force behind my pursuit of knowledge. This achievement is not just a testament to my hard work but a tribute to your enduring faith in me.

You are the true hero of this story, and I dedicate this achievement to you with tears of gratitude and a heart overflowing with love. With this thesis, I symbolize our shared triumph over adversity, offering it as a token of my immense appreciation and affection.

ACKNOWLEDGMENTS

In the intricate tapestry of my PhD journey, I have had the privilege of walking the path of knowledge alongside an extraordinary assembly of individuals whose support and contributions have been nothing short of exceptional. First and foremost, I want to express my gratitude to God. As I stand at this milestone, I wish to extend my profound appreciation to every person who has played a pivotal role in making this academic odyssey possible.

At the helm of my gratitude stands Professor Louis-Rachid Salmi, whose unwavering support, boundless scientific wisdom, infinite patience, eternal optimism, unrelenting enthusiasm, and sincere empathy have illuminated the path of my research journey. Professor Salmi, your invaluable encouragement and timely feedback have propelled me to new heights, and for this, I extend my deepest thanks. I also want to express my sincere appreciation to your wife “Marie Therese” for her warm reception during my travels.

I am indebted to my co-supervisor, Professor Pascale Salameh, whose mentorship and guidance have enriched the quality of my research outputs. Working alongside Professor Salameh has been a privilege, and I wholeheartedly thank her for her contributions. She is more than a mentor; she is an inspiration and a guiding light in my academic pursuits.

To the esteemed members of the jury, including Professor Laurent Carnis, Professor Lucie Laflamme, Professor Simone Mathoulin-Pelissier, and Professor Yarob Badr, I extend my sincere appreciation for your presence at my PhD defence and for your inspiring comments. Your valuable insights have been instrumental in this academic journey.

I would like to express my heartfelt gratitude to my dear colleague and friend, Linda Abou Abbass, for her support and companionship during some of the darkest moments in my life. Linda, your presence by my side has been a source of strength and comfort, and I cannot thank you enough for your kindness, empathy, and willingness to stand with me through thick and thin. I am truly fortunate to have you as a friend.

I want to extend my special thanks to Dr. Nada Ghosn, who has not only been a mentor and guide but also my idol. Your dedication, expertise, and commitment to your work have inspired me in countless ways. Dr. Ghosn, you have set a remarkable example that I aspire to

follow in my own journey. I am deeply grateful for the opportunity to learn from you and be inspired by your remarkable career.

I would like to emphasize my deep gratitude to my family, including Wagih, Mona, Amer, and Janet, for their support and encouragement. I am profoundly grateful for their presence in my life.

Last but most certainly not least, I reserve a special place in my heart for my mother. Your countless sacrifices, infinite patience, and boundless inspiration have been the bedrock upon which this dissertation stands.

Table of Contents

RESUME	I
ABSTRACT	III
ACKNOWLEDGMENTS	VI
TABLE OF CONTENTS	VIII
LIST OF ABBREVIATIONS	XI
LIST OF FIGURES	XIV
LIST OF TABLES	XVI
RESUME SUBSTANTIEL	XVIII
1. INTRODUCTION	1
1.1. BACKGROUND	1
1.1.1. <i>Public health impact</i>	1
1.1.2. <i>Disparities between countries</i>	2
1.1.3. <i>Socio-economic burden</i>	3
1.1.4. <i>Key advancements in road safety</i>	5
1.1.5. <i>Road safety management system</i>	7
1.1.6. <i>Driver behaviour</i>	14
1.1.7. <i>Assessing driver behaviour</i>	19
1.1.8. <i>Overview of the road safety landscape in Lebanon</i>	26
1.2. PROBLEM STATEMENT	26
1.3. RATIONALE	32
1.4. <i>Alignment of the thesis with Safe System approach</i>	32
1.4. OBJECTIVES	34
<i>Part I: Comprehensive analysis of the current road safety landscape in the country</i>	34
<i>Part II: Scales validation and behavioural analysis</i>	37
1.5. THESIS OVERVIEW	38
PART I: ANALYSIS OF ROAD SAFETY MANAGEMENT IN LEBANON	43
I.1. INTRODUCTION	43
I.2. OBJECTIVES	43
I.3. METHODS	44
I.3.1. <i>Desk review</i>	44
I.3.2. <i>Key-informant interviews</i>	45
I.3.3. <i>Focus on data system</i>	48
I.3.4. <i>Road User's Survey</i>	50
I.4. RESULTS	56
I.4.1. <i>Road safety in the geographical and historical context</i>	56
I.4.2. <i>The burden of road injury in Lebanon</i>	65
I.4.3. <i>The road safety system (desk review and interviews)</i>	70
I.4.4. <i>Case study of Hospital-based RTI surveillance data</i>	96
I.4.5. <i>Road users' perception of road safety management</i>	99
I.5. DISCUSSION	126
<i>Situational assessment of road safety management system in Lebanon</i>	126
<i>Actions proposed based on the road users survey</i>	131
<i>Limitations</i>	134
<i>Implications</i>	136
PART II: SCALES VALIDATION AND BEHAVIOURAL ANALYSIS	137
II.1. INTRODUCTION	137
II.2. OBJECTIVES	137

<i>translation and psychometric testing</i>	137
<i>Behavioural analysis</i>	137
II.3. METHODS	138
<i>Participants and sampling</i>	138
<i>Translation and psychometric testing</i>	141
<i>Scales</i>	141
<i>Adaptation, Translation and back-translation</i>	144
<i>Psychometric testing</i>	146
<i>Questionnaire development</i>	151
<i>Data collection</i>	151
<i>Statistical analysis</i>	152
II.4. RESULTS	154
<i>Translation and psychometric testing</i>	154
<i>Behavioural analysis</i>	183
II.5. DISCUSSION	211
<i>i. Translation and psychometric testing</i>	211
<i>ii. Behavioural analysis</i>	220
DISCUSSION AND CONCLUSION	238
SYNTHESIS	238
PERSPECTIVES	239
CONCLUSIONS	245
PERSONAL CONCLUSION	245
REFERENCES	246
APPENDICES	264
PUBLICATIONS	264
<i>Publications related to my PhD topic</i>	264
<i>Other publications during my PhD Journey</i>	264
<i>Articles under review</i>	266
COMMUNICATIONS	268
<i>Oral presentation</i>	268
<i>Poster communication</i>	268
OTHER RESEARCH WORK	268
OTHER ACCOMPLISHMENT	269
APPENDICES	270
<i>Appendix 1: List of documents to be gathered and reviewed during desk review</i>	270
<i>Appendix 2: List of stakeholders participating in the key informant interviews</i>	271
<i>Appendix 3: Email for KIIs</i>	272
<i>Appendix 4: Consent form for key informant interviews</i>	274
<i>Appendix 5: KII interview guide for road safety management situational assessment</i>	276
<i>Appendix 6: Thematic analysis</i>	280
<i>Appendix 7: Road user's satisfaction survey Questionnaire</i>	282
<i>Appendix 8: Road users satisfaction survey-Informed consent</i>	294
<i>Appendix 9: Hospital-based RTI reporting form</i>	295
<i>Appendix 10: Case study of Hospital-based RTI surveillance data: Descriptive results</i>	296
<i>Appendix 11: Strengths and Challenges of Hospital-Based RTI Surveillance System in Lebanon: Opportunities for Enhancement</i>	305
<i>Appendix 12: Blueprint for establishing an integrated Road traffic crashes data system in Lebanon</i>	308
<i>Appendix 13: Informed Consent for Research Participation</i>	391
<i>Appendix 14: Questionnaire of the Driver behaviour survey</i>	393

<i>Appendix 15: Modifications suggested by the review committee on the translated version of DBQ</i>	405
<i>Appendix 16: Correlation matrix for the driver behaviour questionnaire (DBQ-L) subscales</i>	417
<i>Appendix 17: Factorial structure of Driver Anger Scale (DAS-A)</i>	418

LIST OF ABBREVIATIONS

AADT: Average Annual Daily Traffic
ADAS: Advanced Driver Assistance Systems
AIDS: Acquired Immunodeficiency Syndrome
AIRSO: Arab Integrated Road Safety Observatory
AIS: Abbreviated Injury Scale
aOR: Adjusted Odds Ratio
C.I: Confidence interval
CDR: Council for Development and Reconstruction
CFA: Confirmatory factor analysis
CFI: Comparative Fit Index
CNRS: National Center for Remote Sensing
COVID-19: Coronavirus disease-2019
CVI: Content Validity Index
CVR: Content validity ratio
DALYs: Disability-adjusted life years
DAS: Driver anger scale
DAS-A: Arabic version of the Driver Anger Scale
DBQ: Driver Behaviour Questionnaire
DBQ-L: Lebanese version of the Driver Behaviour Questionnaire
DGLMT: Directorate General of Land and Maritime Transport
DGRB: Directorate General of Roads and Buildings
DSI: Driver skills inventory
ED: Emergency department
EFA: Exploratory factor analysis
EMR: Eastern Mediterranean Region
EMS: Emergency medical services
ESC: Electronic Stability Control
ESCWA: Economic and Social Commission for Western Asia
ESU: Epidemiological Surveillance Unit
GBA: Greater Beirut Area
GBD: Global Burden of Disease
GSC: Glasgow Coma Scale
GDP: Gross Domestic Product

GFI: Goodness-of-Fit Index
GIS: Geographical information system
GNP: Gross National Product
GRSF: Global Road Safety Facility
HICs: High-Income countries
HIV: Human Immunodeficiency Virus
ICD-10: International Classification of Diseases 10th version
IHME: Institute for Health Metrics and Evaluation
IPNET: Lebanese Higher Institute of Technical & Professional
IRAP: International Road Assessment Programme
IRF: International Road Federation
IRTAD: International Road Traffic and Accident Database
ISF: Internal security forces
ISS: Injury Severity Score
KMO: Kaiser–Meyer–Olkin
LCRP: Lebanon Crisis Response Plan (LCRP)
LMICs: Low- and Middle-Income Countries
LOCR: Lebanese Observatory for Road Crashes
LRC: Lebanese red cross
LSR: Lebanese State Railways
MAIS: Maximum Abbreviated Injury Scale
MDG: Millennium Development Goals
MENA: Middle East and North Africa
MoIM: Ministry of Interior and Municipalities
MOPH: Ministry of Public Health
MPWT: Ministry of Public Works and Transport
NCAP: New Car Assessment Programs
NFI: Normed Fit Index
NGO: Non-governmental organization
NPL: Natural Language Processing
NRSC: National Road Safety Council
NRSO: National Road Safety Observatory
OECD: Organization for Economic Co-operation Development
PLO: Palestine Liberation Organization

PS: Probability of survival
RMSEA: Root mean square error of approximation
RoadPOL: International Road Policing Organization
RPTA: Railway and Public Transportation Authority
RR: Respiratory Rate
RSA: Road safety audit
RTC: Road traffic crashes
RTD: Road traffic deaths
RTI: Road traffic injury
RTS: Revised Trauma Score
SBP: Systolic Blood Pressure
SDG: Sustainable Development Goals
SPSS: Statistical Package for Social Sciences
SRF: Scientific Research Foundation
SRMR: Standardized root mean square residual
SWOT: Strengths, Weaknesses, Opportunities, and Threats
TLOC: Traffic locus of control
TLOC-A: Arabic version of the traffic locus of control
UK: United Kingdom
UN: United Nations
UNDP: United Nations Development Programme
UNHCR: Office of the United Nations High Commissioner for Refugees
UNICEF: United Nations Children's Fund
UNRSC: United Nations Road Safety Collaboration
USA: United States of America
VKT: Vehicle kilometers travelled
WHO: World Health Organization

LIST OF FIGURES

Figure 1: The road safety management system (Global Road Safety Partnership, 2008).....	7
Figure 2: Data requirements for road safety management – Source (World Road Association, 2003)	11
Figure 3: Alignment of the thesis with safe system approach	33
Figure 4: Overview of the thesis.....	40
Figure 5: Method used for situational assessment of road safety management in Lebanon	44
Figure 6: Institutional management functions (Bliss and Breen)	46
Figure 7: Situational assessment steps (adapted from Data System Manual, WHO 2010).	48
Figure 8: Road traffic fatalities trend in Lebanon 2007-2021 based on the ISF data	66
Figure 9: Trends in RTC, RTF and RTI, Lebanon 2007-2021	66
Figure 10: Positioning of Lebanon in region (source Global road safety facility, Source: https://www.roadsafetyfacility.org/country/lebanon) (Aberg & Rimmo, 1998).	68
Figure 11: Key stakeholders involved in promoting road safety in Lebanon (Kobeissy & Carnis, 2021)	76
Figure 12: The hierarchical framework of Lebanon's road safety office	82
Figure 13: National car ownership rates per 1000 person in Middle Eastern countries, source: adapted from UITP (International Association of Public Transport, 2019).....	84
Figure 14: Phases of the collision cycle (Republic of Lebanon, Ministry of Public Works & Transport, 2004).....	91
Figure 15: Spatial heatmap of road crashes, source: Lebanese Observatory for Crashes on Road 2022.....	95
Figure 16: Temporal distribution of road crashes, fatalities and injuries per month for the Year 2022 in Lebanon, source LOCR.	96
Figure 17: Data flow of the hospital-based RTI surveillance system	98
Figure 18: Reasons for choosing walking as primary mode of transportation	102
Figure 19: Safety needs of pedestrian on Lebanese roads.....	103
Figure 20: Reasons influencing the choice of motorcycle as primary mode of transportation.....	106
Figure 21: Safety needs of private car users	109
Figure 22: Reasons for choosing public transport/public buses.....	110
Figure 23: Challenges encountered by private buses users'	113
Figure 24: Factors driving user preference for taxi services.....	114
Figure 25: Challenges encountered by taxi users	115
Figure 26: Reasons for minibus/vans for travel	116
Figure 27: Needs of truck users	119
Figure 28: Overall satisfaction of road users with road safety management.....	120
Figure 29: Levels of satisfaction across different aspects of road safety management in Lebanon	120
Figure 30: Satisfaction with road safety management by road user	121

Figure 31: Reasons behind dissatisfaction of road users with the current road safety management in Lebanon	122
Figure 32: Bland-Altman plot fir the DBQ	158
Figure 33: Scree plot showing the number of factors in the Arabic version of DAS	166
Figure 34:Multidimensional factor structure of the Arabic version of the Traffic Locus of Control (T-LOC) scale	181
Figure 35: Transport means used by RTI (Drivers vs passengers).....	298
Figure 36: Distribution of RTI in bekaa, Lebanon (2013-2015)	299
Figure 37: Outcome of the RTCs by road user	301
Figure 38: Distribution of RTI by anatomical site of injury.....	302
Figure 39: Injury severity by road user	304

LIST OF TABLES

Table 1: Problem statement, rationale and planned studies	29
Table 2: Summary of objectives of the thesis	36
Table 3: Methodological approach used in the thesis	41
Table 4: Predefined sampling criteria based on the available road user data in Lebanon .	55
Table 5: Political, financial, external and internal security events after year 1984, updated from Factors behind the dynamics of land use evolution: case of Lebanon (Al-Shaar & Bonin, 2021).....	59
Table 6: Evolution of the population and motorization rate in Lebanon between 1994 and 2016.....	85
Table 7: Perceived causes of RTC reported by road users.....	101
Table 8: Difficulties encountered by pedestrian when using the road	102
Table 9: Needs of cyclists to feel safe on roads.....	105
Table 10: Needs for motorcycle users in Lebanon.....	107
Table 11: Public transport user's needs	111
Table 12: Needs of private buses users	113
Table 13: Findings of the road users' survey	123
Table 14: Summary of the scales translated and tested in this part	140
Table 15: Process for cross-cultural adaptation and validation of the Arabic version of the scales among Lebanese drivers.....	148
Table 16: Socio-demographics characteristics of surveyed Lebanese drivers (N=1102) ...	155
Table 17: Mean and standard deviation of the Lebanese version of the Driver behaviour questionnaire items	156
Table 18: Four-factor solution of DBQ-L items, eigenvalues, and Cronbach's alpha coefficients, and variance of the DBQ subscales both among Lebanese drivers.....	160
Table 19: Summary statistics for the DBQ-L subscales	164
Table 20: Model fit indicators for DBQ-L	164
Table 21: Driver anger scale items mean and standard deviation	167
Table 22: Six-factor solution of DAS items, eigenvalues, Cronbach's alpha coefficients, and variance explained by each DAS subscale among Lebanese drivers	169
Table 23: Summary statistics for the DAS subscales.....	170
Table 24: Rerun of EFA after changes made to the model: Similar six-factor solution of DAS items, eigenvalues, Cronbach's alpha coefficients, and variance explained by each DAS subscale among Lebanese drivers.....	173
Table 25: Mean and standard deviation of the Arabic version of the Driver Skills inventory items.....	176
Table 26: Exploratory factor analysis of the DSI.....	177
Table 27: Confirmatory factor analysis of DSI	178
Table 28: DSI subscales statistics.....	178
Table 29: Exploratory factor analysis of the T-LOC scale among Lebanese drivers	180

Table 30: Mean scores, Cronbach's alpha coefficient, skewness, and Kurtosis of the T-LOC-A scale	181
Table 31: Key findings of the scale validation	182
Table 32: DBQ-L and sociodemographic characteristics	184
Table 33: Linear regression for each of the DBQ-L subscale	188
Table 34: Variables associated with RTC involvement	189
Table 35: Driver anger scale (DAS-A) and socio-demographics characteristics.....	191
Table 36: Pearson and partial correlations between DAS and DBQ-L subscales	194
Table 37: Summary of hierarchical multiple regression results of DAS associations with aberrant driver behaviour	196
Table 38: Multivariable logistic regression of the DAS subscales with the drivers' involvement in RTCs and being penalized for traffic offenses in the past 3 years	199
Table 39: Correlations between driver behaviour subscales and DSI factors (motor skills and safety skills).....	200
Table 40: Association between sociodemographic variables and DSI subscales.....	201
Table 41: Linear regression predicting motor skills and safety motives among Lebanese drivers (N=1102).....	202
Table 42: Summary of hierarchical multiple regression results of DSI subscales and aberrant driver behaviour	204
Table 43: Factors associated with RTC involvement.....	206
Table 44: Correlation between the traffic locus of control dimensions and the DBQ subscales.....	207
Table 45: Arabic traffic locus of control and sociodemographic characteristics	208
Table 46: Multivariable logistic regression of the T-LOC factors associated with the drivers' involvement in RTCs.....	209
Table 47: Multivariable logistic regression of the T-LOC factors associated with getting traffic offences	210
Table 48: Summary of implications and future research of the study.....	236
Table 49: Characteristics of the RTI cases admitted to the ED of the hospitals in Bekaa governorate	297
Table 50: Distribution of RTI by day-time and season of occurrence	300
Table 51: Severity of injuries using trauma scores RTS, ISS and TRISS	303
Table 52: SWOT matrix for RTI surveillance system	305

Pour répondre aux exigences de l'École Doctorale, pour une thèse rédigée en anglais, un résumé substantiel est fourni en français, résumant les contributions scientifiques et les résultats principaux de la thèse.

RESUME SUBSTANTIEL

Les collisions de la route représentent une problématique mondiale majeure, tant sur le plan de la santé publique que socio-économique, coûtant la vie à 1,19 million de personnes chaque année. Le Liban, un pays de moins de 6 millions d'habitants, n'échappe pas à cette réalité tragique. Chaque année, près de 1 000 décès dus aux collisions de la route y sont recensés. La situation est aggravée par plusieurs facteurs, notamment la croissance démographique rapide, l'augmentation du nombre de véhicules par ménage, la détérioration des infrastructures routières, ainsi que les conflits régionaux qui impactent l'organisation et la sécurité du pays. À cela s'ajoute une fragmentation des données disponibles, ce qui rend difficile la formulation de politiques efficaces et adaptées. Le manque de recherches approfondies sur la sécurité routière au Liban empêche également de concevoir des interventions fondées sur des données probantes pour remédier à ces problèmes.

Dans ce contexte, cette thèse se propose de réaliser une analyse exhaustive et multidimensionnelle des défis liés à la sécurité routière au Liban, afin de combler les lacunes de la recherche et de fournir une stratégie globale visant à améliorer la sécurité sur les routes. La thèse s'articule autour de deux grands axes : le système de management de la sécurité routière et le comportement des conducteurs.

Le premier axe de la thèse est consacré à l'analyse de la situation actuelle du système de management de la sécurité routière au Liban. Cette analyse englobe non seulement l'examen des politiques et des mécanismes institutionnels en place, mais aussi l'étude des défis historiques, organisationnels et financiers qui influencent le cadre actuel de la sécurité routière dans le pays. Elle passe en revue les politiques en vigueur, les mécanismes d'application de la loi, les affectations budgétaires, ainsi que les initiatives et collaborations en cours. L'étude souligne l'urgence de mettre en place une stratégie holistique, qui prenne en compte un large éventail d'aspects liés à la sécurité routière. Il ne s'agit pas seulement d'appliquer les lois de manière plus rigoureuse, mais aussi d'améliorer les infrastructures routières, d'allouer de manière durable des financements pour les initiatives de sécurité, et de renforcer la collaboration internationale afin de bénéficier des meilleures pratiques et des technologies avancées en matière de sécurité routière. De plus, une étude de la satisfaction des usagers de la route a été menée, explorant leurs perceptions et leur satisfaction concernant les différents composants de la sécurité routière, notamment l'état des infrastructures, la

signalisation, l'efficacité des dispositifs de contrôle et l'application des lois. Cette analyse permet de mieux comprendre les attentes des usagers et d'ajuster les politiques en fonction des besoins identifiés.

Par ailleurs, la thèse met en exergue le problème crucial de la gestion des données relatives aux traumatismes liés aux collisions de la route. Au Liban, les données sont souvent fragmentées et incomplètes, car elles proviennent de sources diverses, principalement des rapports de police qui peuvent être sous-déclarés. Cela complique l'analyse approfondie des causes des collisions et l'allocation des ressources pour les initiatives de prévention. Dans ce contexte, la thèse examine le système actuel de surveillance des traumatismes hospitaliers et propose des pistes pour une transition vers un système de surveillance intégré. Ce dernier permettrait de centraliser et de standardiser les informations, facilitant ainsi la prise de décisions éclairées et l'efficacité des interventions en matière de sécurité routière.

Le deuxième axe de la thèse porte sur le comportement des conducteurs, un facteur humain essentiel de la sécurité routière qui, jusqu'à présent, a fait l'objet de peu d'études dans le contexte libanais. Comprendre les comportements des conducteurs et leurs liens avec les collisions est primordial pour concevoir des stratégies efficaces de prévention. Toutefois, l'absence d'outils de mesure adaptés et validés pour ce contexte limite l'efficacité des interventions.

Pour pallier ce manque, la thèse se concentre sur l'adaptation transculturelle de quatre échelles de mesure reconnues : le locus de contrôle du trafic, le questionnaire sur le comportement des conducteurs, l'échelle de la colère au volant et l'inventaire des compétences des conducteurs. L'adaptation de ces échelles implique un processus complexe de traduction, d'adaptation culturelle et de validation auprès de divers groupes de conducteurs libanais. Cette démarche rigoureuse permet d'obtenir des outils fiables pour évaluer les comportements des conducteurs et d'identifier les facteurs de risque qui contribuent aux collisions de la route. En outre, la thèse explore les associations entre les comportements des conducteurs et les collisions de la route, en se fondant sur les données collectées via ces outils validés. Ces analyses ont le potentiel de fournir des informations cruciales pour orienter les politiques de sécurité routière et promouvoir de bonnes pratiques de conduite. Les résultats obtenus pourraient, par exemple, influencer la conception des campagnes de sensibilisation, des programmes de formation à la conduite, ou encore des stratégies de renforcement des lois de sécurité routière.

Dans son ensemble, cette thèse propose une vision holistique et intégrée pour améliorer la sécurité routière au Liban. Elle ne se limite pas à la simple évaluation des politiques et des

comportements, mais aspire à transformer les infrastructures institutionnelles et les mentalités en matière de sécurité routière. En intégrant une gestion des données plus rigoureuse et des outils adaptés pour comprendre les comportements des conducteurs, cette thèse vise à fournir un plan directeur transformateur. Les recommandations formulées dans cette étude prennent en compte non seulement les spécificités du contexte libanais, mais aussi les meilleures pratiques internationales. Elles mettent l'accent sur l'importance de l'éducation et de la sensibilisation, l'amélioration continue des infrastructures, la mise en œuvre de politiques publiques fondées sur des données fiables, et la coopération avec des organismes internationaux pour tirer parti de l'expertise et des innovations dans le domaine de la sécurité routière.

En conclusion, cette thèse constitue une contribution majeure à la compréhension des défis de la sécurité routière au Liban. Elle fournit non seulement une analyse approfondie des systèmes de gestion de la sécurité et des comportements des conducteurs, mais elle propose également des solutions concrètes et fondées sur des preuves pour améliorer la sécurité sur les routes libanaises. En mettant en œuvre les recommandations formulées dans cette étude, le Liban pourra non seulement réduire le nombre de collisions de la route et de décès, mais aussi améliorer la qualité de vie de ses citoyens, contribuant ainsi à la stabilité socio-économique du pays.

1. INTRODUCTION

In the vibrant and rapidly evolving landscape of global transportation, the critical issue of road safety has emerged as a pressing concern, particularly in developing countries (Chandran, Hyder, & Peek-Asa, 2010; Vos et al., 2016) like Lebanon where the death toll from Road Traffic Crashes (RTCs) remains alarmingly high (World Health Organization, 2015). The impact of RTCs extends far beyond the immediate loss of life, profoundly affecting public health and socio-economic aspects worldwide.

Globally, Road Traffic Injuries (RTI) have emerged as critical public health challenges, drawing increased attention from international organizations, governments, and civil society (World Health Organization, 2018). The urgency to address these issues is underscored by the recognition that road safety is integral to achieving the Sustainable Development Goals (SDGs) (United Nations, 2015). It is a key element of social equity, as disparities in road safety outcomes are often linked to broader social determinants such as gender, age, income, and education levels (Hyder, Hoe, Hajar, & Peden, 2022). These factors significantly influence individuals' mobility and their exposure to road traffic risks, making road safety a multidimensional issue that requires a comprehensive and inclusive approach.

Therefore, addressing road safety is not merely a matter of public health but also a critical component of socio-economic development (Van den Berghe, 2017). It demands a coordinated response that integrates policy, infrastructure, education, and enforcement (World Health Organization, 2022). By prioritizing road safety, countries can not only save lives but also foster safer, more equitable, and sustainable communities.

1.1. BACKGROUND

1.1.1. PUBLIC HEALTH IMPACT

According to the World Health Organization's (WHO) 2023 Global Status Report on Road Safety, approximately 1.19 million people lose their lives annually due to RTCs, equating to 15 Road Traffic Deaths (RTDs) per 100,000 population (World Health Organization, 2023). Notably, the number of RTDs in 2021 reflects a 5% decrease from the 1.25 million deaths recorded in 2010 (World Health Organization, 2009, 2018, 2023). This modest improvement occurred despite a doubling of the global motor vehicle fleet, significant expansion of road networks, and a nearly one billion increase in the global population (World Health Organization, 2023). While these efforts signify progress in road safety, they remain insufficient to meet the United Nations (UN) Decade of Action for Road Safety 2021–2030 target of halving deaths by 2030 (World Health Organization, 2021). Additionally, RTCs

result in 20 to 50 million injuries or disabilities annually, placing a substantial burden on families, communities, and healthcare systems worldwide (World Health Organization, 2018). Based on 2019 data on the age distribution of all-cause mortality, RTI remains the leading cause of death for children and young people aged 5–29 years, with over 500 children under 18 losing their lives in RTCs daily worldwide (World Health Organization, 2023). RTI ranks as the 12th leading cause of death across all age groups (World Health Organization, 2018). The majority of fatalities, approximately two-thirds, occur among individuals aged 18 to 59 years, leading to significant health, social, and economic consequences globally (World Health Organization, 2020).

Gender disparities in road fatalities are stark, with males consistently accounting for around 75% of global road deaths from 2012 to 2021 (World Health Organization, 2023). The impact on working-age individuals, particularly men, is further emphasized by data on work-related driver fatalities from 21 countries, where approximately 23% of these deaths are related to commuting, 16% occur during work-related driving activities, and an additional 12% involve professional drivers, predominantly males, while on duty (World Health Organization, 2023). Regarding road user categories, occupants of four-wheel vehicles accounted for 30% of global RTDs, pedestrians for 23%, and users of powered two- and three-wheelers for 21%. Cyclists represent 6% of fatalities, while the remaining 20% involve occupants of larger vehicles, such as those carrying more than 10 people, heavy goods vehicles, "other" users, and "unknown" user types (World Health Organization, 2023).

These statistics highlight the critical need for comprehensive road safety initiatives, particularly targeting young adults and addressing the growing burden of RTI in low- and middle-income countries, where the burden is disproportionately high.

1.1.2. DISPARITIES BETWEEN COUNTRIES

Despite low- and middle-income countries having around 60% of the world's vehicles, they bear 93% of the world's road traffic deaths, with a death rate more than 3.5 times higher than in high-income countries (World Health Organization, 2015). The disparity in road safety impacts is starkly evident across different income groups and regions. Nine out of ten deaths occur in low- and middle-income countries, with the highest death rates per population seen in low-income countries (Xu, Wu, Mao, & Zhang, 2024). Geographically, the WHO South-East Asia Region records the highest share of global fatalities at 28%, followed by the Western Pacific Region at 25%, the African Region at 19%, the Region of the Americas at

12%, the Eastern Mediterranean Region at 11%, and the European Region at 5% (World Health Organization, 2023).

The vast majority of RTDs (93%) occur in upper-middle, lower-middle, and low-income countries combined. Specifically, 79% of these deaths happen in lower-middle-income (44%) and upper-middle-income countries (35%), with low-income countries accounting for 13% and high-income countries for the remaining 8% (World Health Organization, 2023). Compared to high-income countries, there is a disproportionately high number of fatalities in low- and middle-income countries relative to their motor vehicle fleets and road networks. High-income countries, which have 16% of the world's population, 28% of the world's vehicle fleet, and 88% of all paved inter-urban roads, account for only 8% of fatalities. In contrast, low-income countries, with 9% of the world's population and less than 1% of the world's powered vehicle fleet and paved inter-urban roads, account for 13% of fatalities (World Health Organization, 2023).

The distribution of fatalities among road users varies significantly by region. Except for the European and Eastern Mediterranean Regions, where four-wheel vehicle occupants constitute the largest share of deaths (49% and 33%, respectively), pedestrians and powered two- and three-wheeler users comprise the majority of fatalities in most other regions. Pedestrians and cyclists are often the most vulnerable road users and, in many countries, represent the economically most disadvantaged populations (World Health Organization, 2023).

1.1.3. SOCIO-ECONOMIC BURDEN

As a leading cause of death and a significant contributor to disability, RTIs also impose a substantial economic burden on societies. Socioeconomic costs of RTCs encompass a wide range of financial and societal burdens, extending beyond immediate medical expenses and vehicle damage, encompassing broader economic, health, and social consequences (Blincoe, Miller, Zaloshnja, & Lawrence, 2015). They include lost productivity due to injuries or fatalities, and a strain on healthcare systems, rehabilitation expenses, property damage, and insurance claims. Moreover, RTCs result in intangible costs, such as the pain and suffering experienced by victims and their families, as well as the emotional toll on communities (Baroud, 2017; World Bank, 2017). Therefore, assessing the socio-economic repercussions of road traffic injuries holds utmost importance in comprehending their societal effects and making well-informed decisions regarding resource allocation, road safety policies, and prevention strategies.

Nevertheless, there exist arduous challenges, such as data limitations and underreporting, which render precise and accurate cost estimations, particularly in Low- and Middle-Income Countries (LMICs). Despite these hurdles, global and regional approximations have been attempted. A decade ago, it was estimated that RTCs accounted for 1% of Gross National Product (GNP) in low-income countries, 1.5% in middle-income countries, and 2% in high-income countries (Jacobs, Aeron-Thomas, & Astrop, 2000). These estimates encompass both direct and indirect costs and have proven reliable for various countries. However, it is probable that the actual global costs surpass these figures due to underreporting and the unquantifiable social costs associated with pain and suffering. Estimates suggest that the global macroeconomic cost of RTI could be as high as \$1.8 trillion, approximately 10–12% of the global Gross Domestic Product (GDP) (Chen, Kuhn, Prettnner, & Bloom, 2019). Consequently, RTI represent a critical health and development challenge. The economic toll of RTCs remains substantial, amounting to billions of dollars annually and equivalent to 3% of GDP in many nations (World Health Organization, 2018). While there has been a modest 5% decrease in global road deaths from 2010 to 2021, adjusting for population growth reveals a concerning 16% increase over the same period (World Health Organization, 2023). Estimating costs at regional and national levels is also a difficult task, particularly in LMICs with limited data infrastructure. Different nations report varying socio-economic valuations, with Organization for Economic Co-operation Development (OECD) countries suggesting RTC costs ranging from 1.5% to 5% of GNP (OECD, 2008). In contrast, in Africa, estimates from the IRAP propose costs as high as 7% of GNP (McInerney, TURNER, & Smith, 2010). In addition, a limited number of studies delve into road crash costing and the cost-effectiveness of interventions in Low-Income Countries (LICs) (Banstola & Mytton, 2017). Any delays in implementing road safety measures can profoundly affect a country's wealth and the well-being of its population (Martin, Lagarde, & Salmi, 2018). While estimates regarding the overall expenses of RTIs may exhibit variations contingent on the methods employed, a comprehensive study spanning 21 countries approximated the global cost of RTIs to reach a staggering US\$518 billion (Jacobs et al., 2000). Another recent analysis, conducted under the umbrella of the World Bank's Global Road Safety Facility, scrutinizing the economic repercussions of RTIs, unveiled a compelling insight. If countries could halve both mortality and morbidity resulting from RTI, maintaining this reduction over 24 years, they could potentially witness substantial GDP growth, ranging from 7% to 22% (World Bank, 2017).

Society bears a substantial socio-economic burden due to RTIs, with specific sectors facing significant costs. Within the healthcare system, LMICs grapple with the substantial strain posed by RTIs, which significantly deplete emergency medical resources. For instance, in India, patients injured in RTCs account for a substantial portion of emergency room admissions (20–50%), hospital admissions (10–30%), and individuals hospitalized (60–70%) due to traumatic brain injuries (Gururaj, 2008). Conversely, in High-income Countries (HICs), despite ongoing advancements, RTCs persist as a leading cause of both mortality and hospitalization, continuing to place immense pressure on emergency medical systems (European Commission, 2009).

Simultaneously, the literature underscores the disproportionate economic impact of RTCs on low-income households (Aeron-Thomas A, Jacobs GD, Sexton B, G, & Rahman F, 2004; Graham, Glaister, & Anderson, 2005). When a primary wage earner in a family is lost due to an RTC, households often descend into poverty, constraining their capacity to cope with the fallout. These costs encompass immediate and long-term expenses linked to medical treatment and care, alongside the economic value of forfeited earnings when a family member must abandon paid employment to provide care for the RTC victim. The financial repercussions on families have been observed to trigger heightened borrowing and indebtedness, potentially leading to reduced food consumption, as evidenced by studies (Aeron-Thomas A et al., 2004; Graham et al., 2005; World Health Organization, 2013a).

Overall, recognizing the far-reaching impacts of road traffic injuries is essential, emphasizing the urgency of increased investment in road safety to align with the considerable socio-economic benefits of preventing such RTCs.

1.1.4. KEY ADVANCEMENTS IN ROAD SAFETY

In the realm of international development, road safety has increasingly become a focal point, intertwined with broader goals such as sustainable development and poverty reduction. The integration of road safety into these agendas reflects a paradigm shift from previous development efforts that primarily focused on economic metrics (World Road Association, 2003). This modern approach aims to enhance overall quality of life, encompassing health, education, and economic participation.

Historically, international development goals like the Millennium Development Goals (MDGs) did not explicitly include targets for reducing RTDs. However, road safety aligns harmoniously with goals related to public health, environmental sustainability, and poverty alleviation. The United Nations has recognized the critical importance of road safety,

particularly through initiatives like the Decade of Action for Road Safety (2011–2020) (Krug, 2012) and its successor, the second Decade of Action (2021–2030) (World Health Organization, 2021).

Key global advancements include initiatives such as the Global Plan for the Decade of Action, which aims to halve RTD and RTI by 2030 (World Health Organization, 2021). This plan emphasizes comprehensive strategies highlighting priority areas with the road safety management replaced by multimodal transport and land use. It underscores the importance of integrated, multi-sectoral approaches tailored to local contexts, particularly in LMICs. Various international organizations, including the World Bank and the World Health organization (WHO), have played crucial roles in developing guidelines, facilitating capacity building, and promoting collaboration among governments and stakeholders.

The Safe System approach in road transportation, developed in the 1990s by the Swedish road safety expert Claes Tingvall (Larsson & Tingvall, 2013), represents a transformative strategy aimed at eliminating RTD and severe RTI, challenging the belief that such outcomes are inevitable. It shifts focus from mere RTC reduction to preventing crashes that result in fatalities or serious harm. Key principles include acknowledging human fallibility, recognizing human vulnerability to crash forces, and promoting shared responsibility among stakeholders (Larsson & Tingvall, 2013; World Road Association, 2003). Responsibility in the Safe System approach is shared among various entities including government bodies, industry organizations, health professionals, and the public. It emphasizes designing safe road environments and vehicles, enforcing speed limits, educating road users, and ensuring effective post-crash care. This approach integrates road safety into broader societal goals, such as economic development and environmental sustainability. The safe system approach is structured around four core components: institutional governance, shared responsibility, strengthening all safety pillars, and preventing exposure to significant crash forces. It operates on five primary pillars: safe roads, safe vehicles, safe road users, safe speeds, and effective road safety management, with additional supportive elements like legislation, education, and crash data analysis. Implementing the Safe System involves stages of development from initial awareness to achieving advanced, systemic safety measures across all aspects of road transportation. Effectiveness is demonstrated through various measures such as infrastructure improvements, speed management strategies, enforcement of safety laws (like seatbelt and helmet use), and advancements in vehicle safety technologies (World Road Association, 2003).

1.1.5. ROAD SAFETY MANAGEMENT SYSTEM

The foundation of the Decade of Action's Global Plan (Krug, 2012) and the Global Status Report on Road Safety 2015 (World health Organization, 2015) lies in road safety management, recognized as the primary pillar. Both initiatives stress the importance of a systematic and planned approach to enhance road safety performance, with an effective road safety management system being the key for countries and organizations to achieve this objective.

1.1.5.1. ROAD SAFETY MANAGEMENT FRAMEWORK

Countries that have the safest road networks share several common characteristics in their approach to road safety management. They prioritize achieving better safety outcomes, implement a systematic approach to interventions, and establish a range of effective institutional arrangements (Global Road Safety Partnership, 2008; OECD, 2008).

According to the International Road Assessment Programme (IRAP), a framework for assessing road safety management identifies essential elements, treating safety as a management system with three levels (Figure 1): institutional management, interventions, and results. The cornerstone of a robust country road safety management system lies within institutional management.

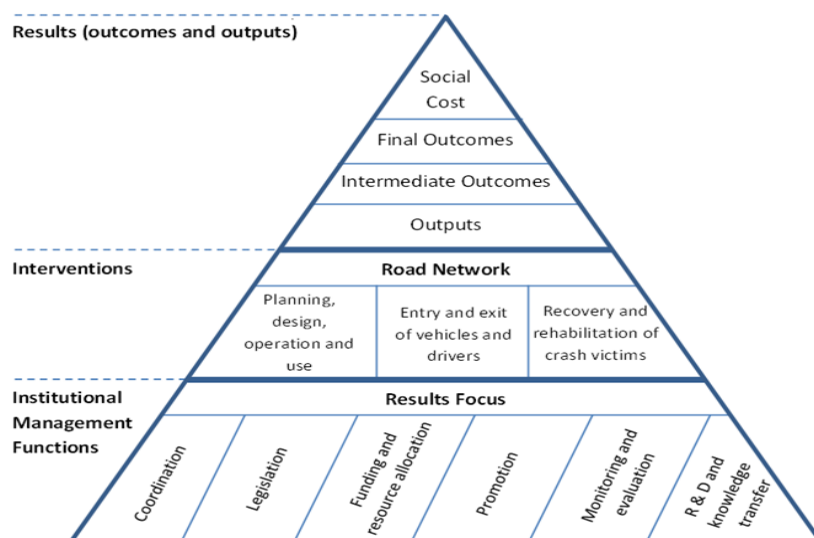

Figure 1: The road safety management system (Global Road Safety Facility, 2009)

Herein lay the fundamental components of this road safety management system

The primary objective of this management system resides in mitigating RTCs that lead to fatalities and serious injuries. It is focused on improving road safety outcomes through a rigorous performance assessment. This encompasses a meticulous examination of opportunities for reducing RTCs, the setting up of long-term goals, and short-term milestones for road safety strategies, initiatives, and projects, as well as the allocation of resources and the accountability to achieve these objectives. At the core of this pivotal function, a well-structured framework encompasses mechanisms and capacities encompassing coordination, legislative support, financial allocation, resource management, advocacy, surveillance, monitoring and evaluation, research and innovation, knowledge cultivation, and dissemination (Figure 1).

The absence of a clearly defined and accountable commitment to reducing fatal and severe RTCs can result in a lack of coherence and direction in other facets and interventions within institutional management, potentially undermining the effectiveness and impact of safety initiatives. Therefore, LMICs should exercise caution when formulating intricate targeted strategies and plans until they have access to relevant data and management capabilities. Nonetheless, it is advisable to gauge safety performance and target specific outcomes in funded area projects as a means of acquiring practical insights. Government agencies responsible for core road safety functions, including transportation, urban planning, infrastructure, justice, law enforcement, public health, occupational health and safeties, and education, chiefly implement institutional management functions.

These functions are also carried out in concert with civil society, aligning with the objectives and targets of the country. The professional and research community shoulders a pivotal role in providing guidance for effective next steps in road safety management. As previously underscored, governmental leadership and the establishment of a lead agency within the government are prerequisites for successful implementation (M. M. Peden, 2004; T & J, 2013).

The second facet of the road safety management system framework pertains to system-wide intervention, which seeks to diminish fatalities and serious injuries through strategies grounded in empirical evidence. These strategies encompass all facets of the road network, including its design, operation, and utilization, with an unwavering emphasis on safeguarding all road users. While education and training hold their significance, they assume a secondary role. Research substantiates those interventions, such as speed management, enhancements in vehicle and road safety, and the bolstering of emergency medical response, that have a

profound and positive impact on road safety. Nations with commendable road safety records deploy comprehensive intervention packages that align with established safety principles.

The ultimate element of the road safety management system is results, encompassing outcomes and outputs that are assessed through targets mirroring the desired safety performance. Notable successes in road safety are exemplified in the GRSF's Leveraging Global Road Safety Successes report (World Bank, 2013b).

Ultimate outcomes embody long-term aspirations, such as the Safe System (Larsson & Tingvall, 2013) or Vision Zero (Tingvall & Haworth, 1999), with intermediate targets charting progress. Intermediate outcomes, gauged through metrics such as traffic speeds and safety measures, contribute to enhancements in ultimate outcomes. Outputs represent tangible deliverables that support both intermediate and ultimate outcomes. Nations actively involved in road safety formulate quantifiable targets for both outcomes and, on occasion, outputs. Regardless of their stage of development, benchmarking these elements against best practices stands as a pivotal step for new projects and programs.

1.1.5.2. PIVOTAL ROLE OF THE LEAD AGENCY

To make the roads safer, it all starts with committed government leaders who prioritize road safety. They set ambitious long-term goals, targets for projects, and allocate the necessary resources. Government leadership along with clear targets plays a key role in achieving improved road safety. The World Report on Road Traffic Injury Prevention underscores the pivotal role of the lead agency for road safety and recommends establishing leadership arrangements based on successful practices (Peden, 2005). The lead agency should be a government body accountable for its performance to efficiently coordinate actions among agencies and stakeholders. Recommendations for lead agencies for road safety encompass having the authority and responsibility to make decisions and coordinate efforts across government sectors, allocating sufficient financial resources, engaging all significant groups involved in road safety, promoting awareness, communication, and collaboration, and securing influential political leaders to champion the cause of road safety (Peden, 2005)

Strong leadership and effective governance are crucial to prevent conflicting interests from overshadowing this shared responsibility (T Bliss & J Breen, 2009). Effective road safety management relies on strong leadership, cooperation, and capability within government agencies, as well as partnerships with industry, businesses, and civil society. Leadership and capability at the local level directly influence government decision-making. Vigilant

leadership and effective governance are essential to ensure that conflicting interests do not compromise this shared responsibility (T Bliss & J Breen, 2009).

1.1.5.3. EFFECTIVE MANAGEMENT AND ROAD SAFETY DATA

Preventing fatalities and serious injuries in RTCs requires a systematic and well-planned response, spearheaded by a government that is adequately resourced and accountable. While crash data plays a key role in road safety management, it constitutes just one piece of the comprehensive data needed for effective management in this field of road safety (World Road Association, 2003). Therefore, it is essential to complement crash data with a diverse range of information, including road infrastructure details, behavioural surveys, records of law enforcement actions, safety data related to the road network and vehicle fleet, as well as assessments of the quality of emergency and trauma care. Of note, capacity assessments of road safety management conducted in LMICs often reveal shortcomings in identifying and measuring road safety issues. As a result, there is an urgent need to boost capacity-building endeavours aimed at enhancing the collection, storage, analysis, and sharing of road safety data.

1.1.5.4. DATA REQUIREMENTS

The desired outcomes of road safety management are articulated as goals and targets, spanning various interconnected levels (Figure 2). These encompass institutional outputs resulting from executed policies, programs, and projects, which, in turn, influence a spectrum of intermediate outcomes. These intermediate outcomes subsequently impact final outcomes, ultimately aiming to reduce fatalities and severe injuries in alignment with Safe System principles.

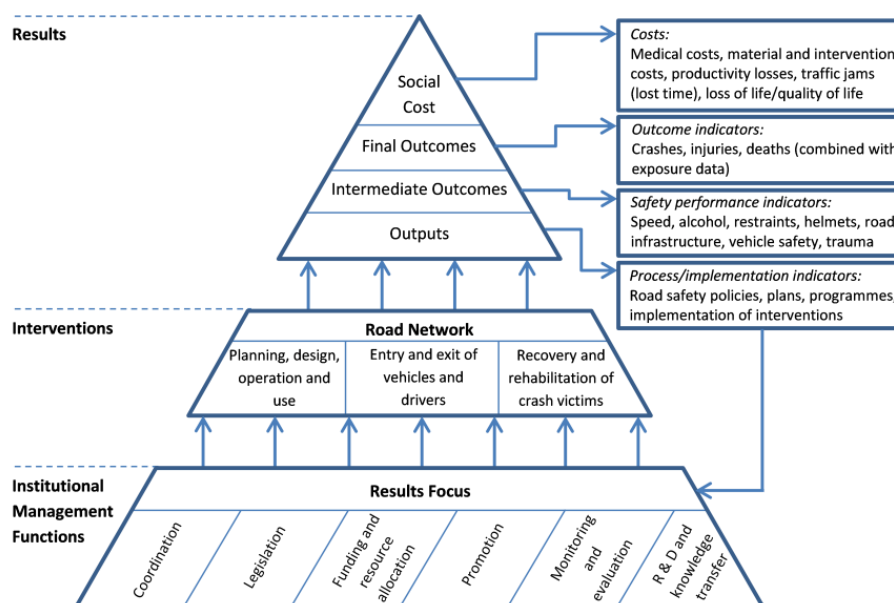

Figure 2: Data requirements for road safety management – Source: (Global Road Safety Facility, 2009; World Health Organization, 2010)

Key definitions related to data requirements are:

- Final outcomes: Outcome indicators may encompass metrics such as the count of fatalities and severe injuries, RTCs involving specific road user groups (e.g., pedestrians, motorcyclists), or categories (e.g., intersection, head-on collisions), as well as crash rates (e.g., crashes per population, vehicle registrations, or travel volume) (World Bank, 2013b; World Road Association, 2003).
- Intermediate outcomes: Safety performance indicators can include behavioural metrics like average vehicle speed, instances of drunk-driving, helmet usage rates, seatbelt compliance, data from attitude surveys; vehicle safety assessments; infrastructure metrics, including road safety evaluations, the percentage of high-volume high-speed roads divided by medians, the percentage of roads with adequate pedestrian facilities; and post-crash care indicators like emergency response times.
- Outputs: Process and implementation indicators may involve policies, plans, or programs that have been implemented, along with specifics of their execution (e.g., seatbelt usage promotion campaigns, hours of additional speed enforcement, investments in safe road infrastructure, and the number of new ambulances) (World Bank, 2013b).

To illustrate, let us consider the analysis of data which may have pinpointed vehicle speed as a risk factor. To address this risk, a policy aimed at enhancing compliance with speed limits

would necessitate heightened speed enforcement. The immediate results, or outputs, of implementing this intervention would provide evidence of an increase in enforcement activities. Moving to the intermediate level of outcomes, we might gauge these by assessing the evolution of average speeds on road sections. Observing changes in this measure, such as a decrease in speeding motorists, would help determine whether the intervention is achieving its intended impact. Finally, at the highest level, the ultimate outcome indicators would encompass the total number of deaths and serious injuries, ideally including a record of those specifically attributed to speeding. This would serve as conclusive evidence of the intervention's overall effectiveness and its ultimate benefit.

1.1.5.5. CRASH DATA SYSTEMS

Effective road safety practices recognize that no single crash injury database can provide a complete understanding of road traffic injuries. Many countries with improved road safety performance use both police-collected crash injury data and health sector data. Typically, national crash data is collected by the police and entered into database systems (International Transport Forum, 2012). This data includes crash location, time, details about those involved, road and environmental conditions, crash specifics, and vehicle factors. Police are well-positioned to gather detailed information as they often respond to crash scenes. Detailed information is collected using crash report forms, which can be paper-based or computer-based. Key variables include crash location, time, road user details, road and environmental conditions, crash circumstances, and vehicle information. Different countries may have their own minimum criteria for data collection.

There's a need to strike a balance between collecting necessary information and the time it takes to complete crash report forms (World Health Organization, 2010). Overburdening the police with data collection can hinder the process. Involving the police as key stakeholders throughout the data collection process is essential. Hospital data is vital for understanding under-reporting and obtaining more comprehensive injury information, especially when police-reported data is insufficient or unavailable. International recording and coding systems like the International Classification of Diseases (ICD) and the Abbreviated Injury Scale (AIS) are widely used to classify road traffic injuries. An internationally agreed definition of 'serious' injury is recommended, often based on criteria like the Maximum Abbreviated Injury Scale (MAIS). MAIS3+, indicating an injury with a score of 3 or greater in any body region, is commonly used to define serious injuries (International Transport Forum, 2012). These definitions are essential for consistent reporting and analysis.

Vital registration data, derived from death certificates completed by physicians specifying the cause of death, can serve as a source for road fatality information. Approximately 40% of WHO member countries collect vital registration data suitable for monitoring road traffic deaths. WHO and other organizations have established an international registration system that encompasses individuals injured in RTCs (World Health Organization, 2010).

Various additional sources of information significantly contribute to comprehensive road safety assessments could be used such as (World Road Association, 2003):

- Road inventory data, encompassing details about road class, width, intersections, and lighting, is crucial for understanding safety issues, with Geographical Information System (GIS) enhancing spatial data analysis.
- Traffic data, including metrics like Average Annual Daily Traffic (AADT), traffic mix, and vehicle speeds, is essential for calculating crash rates and evaluating safety performance, obtainable through manual or automated methods.
- Other exposure data, such as population figures and vehicle registrations, shed light on demographic and vehicular factors affecting safety.
- Attitude surveys gather opinions from drivers and residents, offering insights into program effectiveness and driver behaviour.
- Enforcement data, hospital files detailing injuries, maintenance records, expenditure data, and project history files provide essential context.
- Insurance Company data including driver and vehicle history provides additional insights into safety.
- Weather data helps comprehend the influence of weather conditions on crash occurrences. Information from periodic vehicle inspections and vehicle-related data contributes to understanding vehicle safety (World Road Association, 2003).

1.1.5.6. DATA QUALITY AND INTEGRATION

Data quality and under-reporting are significant challenges in road safety data collection, potentially compromising the entire process. These issues can arise due to missing or incomplete data, errors in data collection and entry, and variations in variable definitions (World Road Association, 2003). The consequences of poor data quality and under-reporting include reduced recognition of road safety as a public health concern, misleading information leading to ineffective safety decisions, inability to assess countermeasure success, and inaccurate cross-jurisdictional comparisons. Methods to address these issues are crucial for improving data quality and reliability. Notably, these challenges extend beyond crash data to

encompass non-crash data, emphasizing the need for careful data collection and interpretation. Human errors, inconsistent data entry, and unclear variable definitions contribute to these data quality problems, affecting both crash and non-crash data.

Integrating safety data offers several benefits, including effective safety management, comprehensive crash risk identification, and cost-effective solutions. Linked data can validate other sources and support research. Key linkages involve combining crash data with traffic, road inventory, vehicle registrations, vehicle inspection, and population data (World Health Organization, 2010). The process requires common data elements or unique identifiers and can be temporary or permanent. After linking, data can be analysed using GIS software, aiding mapping from various sources. Crash rates, like crashes per 100 000 population, per Vehicle Kilometers Travelled (VKT), and per 10 000 registered vehicles, are useful for benchmarking and risk assessment (World Road Association, 2003). Combining crash data with road inventory data can inform infrastructure safety improvements. This integration allows comparing the safety performance of different infrastructure types and levels of traffic volume, among other factors (World Health Organization, 2010).

1.1.6. DRIVER BEHAVIOUR

Driver behaviour serves as a critical factor in the realm of road safety, exerting substantial influence on the occurrence and severity of road traffic crashes. Understanding the intricate relationship between driver behaviour and these RTCs is pivotal in crafting effective strategies for RTC prevention and mitigation. Driver behaviour is subject to a myriad of determinants, each playing a unique role in shaping how individuals operate their vehicles on the road. These determinants encompass demographic characteristics, personality traits, traffic safety culture, driver skills, vehicle-related factors, and roadway and environmental influences. By delving into the complexities of these determinants, it becomes possible to gain comprehensive insights into why individuals behave in specific ways while driving and, consequently, to formulate targeted interventions aimed at fostering safer behaviours and reducing the incidence of road traffic crashes.

1.1.6.1. DRIVER BEHAVIOUR AND ROAD TRAFFIC CRASHES

It is vital to recognize that RTCs often occur as a direct consequence of human errors, and these errors are inseparably tied to driver behaviour. Moreover, the manner in which drivers assess situations, make decisions, and react to dynamic road conditions profoundly impacts the likelihood of collisions. For instance, misjudgements related to the distance and speed of other vehicles, risky lane changes, and lapses in yielding the right of way are all emblematic

behavioural factors that contribute significantly to the incidence of RTC. This intricate interplay between driver behaviour and road traffic crashes underscores the pivotal role that human actions and choices play in the realm of road safety, advocating for concerted efforts to modify and enhance driver behaviour to curtail the frequency and severity of RTCs.

The relationship between driver behaviour and RTC was extensively explored in the literature (Jafarpour & Rahimi-Movaghar, 2014). Several studies have examined the multifaceted ways in which driver behaviour serves as a critical factor of the frequency and severity of RTC. Their findings consistently uphold that specific risky behaviours play an explicit role in increasing the probability of being involved in a RTC (AlKetbi, Grivna, & Al Dhaheri, 2020; Petridou & Moustaki, 2000; Sharma, 2007).

Dangerous behaviours include speeding, distraction while driving, exemplified by texting or using a phone, and driving diverts attention away from the road (Tison, Chaudhary, & Cosgrove, 2011). Additionally, aggressive driving behaviours, such as tailgating, road rage, and reckless overtaking, escalate the risk of RTC (Love et al., 2023). The influence of alcohol and drugs on driver behaviour cannot be overstated, as impaired driving remains a significant contributor to RTC (Behnood & Mannering, 2017). Furthermore, the failure to use seatbelts compounds the vulnerability of drivers and passengers to severe road traffic injuries (Ogundele, Ifesanya, Adeyanju, & Ogunlade, 2013). A substantial proportion of RTC, particularly those resulting in catastrophic injuries or fatalities, can be directly ascribed to human errors and dangerous behaviours (Bazzaz, Zarifian, Emadzadeh, & Vakili, 2015).

1.1.6.2. DETERMINANTS OF DRIVER BEHAVIOUR

Driver behaviour is shaped by a multitude of factors (Wang, Liu, Wang, & Zhang, 2019), and within this section, we will delve into five primary determinants that significantly impact how individuals behave on the road. These determinants encompass demographic characteristics, which include factors such as age, gender, and socioeconomic background (Liu et al., 2022). Additionally, personality traits play a pivotal role in influencing driver behaviour, with traits like impulsivity and sensation-seeking potentially leading to riskier driving choices (Liu et al., 2022). Moreover, the prevailing traffic safety culture and the level of driver skills within a community or region can greatly impact how individuals behave behind the wheel (Martinussen, Møller, & Prato, 2014). Vehicle-related factors, including the type of vehicle and its condition, also contribute to driver behaviour variations. Lastly, roadway and environmental factors, such as road design, weather conditions, and traffic congestion, exert a substantial influence on how drivers interact with the road environment and make decisions

while driving. These determinants collectively shape the complex landscape of driver behaviour and play a crucial role in understanding and improving road safety.

1.1.6.3. DEMOGRAPHIC CHARACTERISTICS

The impact of sociodemographic factors, such as age, gender, and socioeconomic status, on driver behaviour was evidenced by several studies (Radzuan et al., 2022). Age is a strong factor, where young and inexperienced drivers often exhibit riskier behaviours, such as excessive speeding, reckless driving, and an elevated likelihood of being involved in RTCs (McCarty & Kim, 2024). The impact of gender is also notable, with studies revealing disparities in driving behaviours between men and women, including variations in aggression and tendencies for risk-taking (McCarty & Kim, 2024).

Furthermore, socioeconomic status also shaped driver behaviour (Grimm & Treibich, 2010). Individuals from lower socioeconomic backgrounds struggle with distinctive challenges that can deeply affect their behaviour behind the wheel (Aluja, Balada, García, & García, 2023). These challenges include limited access to quality education, which can, in turn, lead to a heightened propensity for engaging in risky driving behaviours or driving older and less well-maintained vehicles.

This examination also serves in paving the way for the development of targeted educational campaigns, tailored enforcement strategies, and infrastructure enhancements. Moreover, it underscores the utmost significance of addressing sociodemographic disparities to establish a road environment that is not only safer but also more equitable for all individuals, regardless of their background or circumstances.

1.1.6.4. PERSONALITY TRAITS

Several studies have delved into the intricate relationship between various personality traits and driver behaviour, shedding light on significant associations (Liu et al., 2022). Among these personality traits, impulsivity, sensation-seeking, and aggression emerge as main factors that wield substantial impact on driver behaviour (Pearson, Murphy, & Doane, 2013). For example, individuals with elevated levels of impulsivity and a sensation-seeking are more prone to engage in risky driving behaviours, which encompass actions like speeding, reckless overtaking, and neglecting to wear seat belts (Bachoo, Bhagwanjee, & Govender, 2013). Contrariwise, drivers with higher levels of conscientiousness tend to adopt safer driving practices, such as diligently adhering to traffic rules and maintaining unwavering focus while behind the wheel.

Consequently, understanding the interaction between personality traits and driver behaviour is instrumental in selecting interventions that precisely target specific behavioural tendencies (Goldenbeld, Levelt, & Heidstra, 2000). It opens the door to the development of personalized driver education programs and interventions that examine the underlying psychological factors contributing to risky behaviours. Moreover, acknowledging the role of personality traits in driving behaviour underscores the need for holistic approaches to road safety (Lucidi et al., 2019). These approaches should encompass not only external factors like road design and law enforcement but also investigate the intrinsic psychological characteristics of drivers. In doing so, we move closer to creating a road safety framework that is not only effective but also adjusted to the diverse psychological profiles of road users.

1.1.6.5. TRAFFIC SAFETY CULTURE AND DRIVER SKILLS

The relationship between driver behaviour and traffic safety culture, along with driver skills, forms a crucial nexus in the pursuit of road safety (Ward et al., 2020). Traffic safety culture encompasses the prevailing attitudes, beliefs, and values related to road safety within a society or community. It strongly influences how individuals perceive and engage with safe driving practices. A positive traffic safety culture promotes responsible behaviour on the road, encourages compliance with traffic rules, and fosters a sense of collective responsibility for safety (Özkan & Lajunen, 2015). In contrast, a poor traffic safety culture may normalize risky behaviours and non-compliance.

Driver skills, on the other hand, encompass the practical abilities and knowledge that drivers possess. This includes their ability to handle a vehicle, anticipate and react to potential hazards, and adhere to traffic regulations (Doubek, Salzmann, & de Winter, 2021). The relationship between driver skills and behaviour is intertwined; proficient drivers are more likely to exhibit safe behaviours, while those with deficient skills may resort to riskier actions due to a lack of competence (Lajunen, Sullman, & Gaygısız, 2022). Efforts to improve driver behaviour should consider both traffic safety culture and driver skills as integral components. Promoting a positive traffic safety culture through educational campaigns, public awareness initiatives, and law enforcement can install a sense of responsibility and encourage safe driving practices. Simultaneously, enhancing driver skills through comprehensive driver training programs, defensive driving courses, and ongoing skill development can empower individuals to make safer choices on the road.

1.1.6.6. VEHICLE FACTORS

Vehicle factors wield substantial influence over driver behaviour, profoundly impacting road safety (Sagberg, Fosser, & Saetermo, 1997). The relationship between drivers and their vehicles is multifaceted, encompassing several critical facets. Vehicle performance and safety features stand as cornerstones, as modern vehicles equipped with advanced safety technologies like anti-lock brakes and collision warning systems can significantly influence driver behaviour by providing added safety nets (Gouribhatla & Pulugurtha, 2022). Conversely, poorly maintained vehicles with mechanical issues can introduce unpredictability and elevate the risk of RTCs (National Highway Traffic Safety Administration NHTSA, 2008). Furthermore, the type and size of a vehicle can affect driver behaviour, with larger vehicles potentially fostering a sense of security that leads to riskier behaviours, while smaller vehicle drivers may exhibit greater caution (Claus & Warlop, 2022). Additionally, the age and condition of a vehicle play roles in shaping behaviour, as older vehicles may lack modern safety features, potentially affecting driver decisions (Atombo, Wu, Zhong, & Zhang, 2016). In essence, vehicle factors intertwine with driver behaviour, contributing to the overall safety landscape on the road.

1.1.6.7. ROADWAY AND ENVIRONMENTAL FACTORS

The design and condition of roadways play a pivotal role in shaping how drivers behave (Abdelrahman, Abu-Ali, & Hassanein, 2018). Well-maintained, clearly marked roads with proper signage tend to encourage safer driving practices, while poorly designed or poorly maintained roads can lead to confusion and risky behaviours. Environmental factors, such as weather conditions, visibility, and road surface conditions, also profoundly impact driver behaviour (Hamdar, Qin, & Talebpour, 2016). Adverse weather like rain, snow, or fog can reduce visibility and traction, requiring drivers to adapt their behaviour accordingly, often by reducing speed and increasing following distance. Additionally, factors like road construction, congestion, and the presence of pedestrians or cyclists can influence driver behaviour, requiring drivers to adjust their actions in response to changing conditions (G. Li et al., 2020). In summary, roadway and environmental factors are integral components of the road safety equation, as they interact with driver behaviour to determine the overall safety of the road network.

1.1.7. ASSESSING DRIVER BEHAVIOUR

1.1.7.1. IMPORTANCE OF ASSESSING DRIVER BEHAVIOUR

Assessing driver behaviour is of paramount importance for several critical reasons. Firstly, it plays a pivotal role in RTC prevention, as many RTCs are primarily attributed to driver errors and hazardous behaviours like speeding, distracted driving, aggressive manoeuvres, and impaired driving (Karrouchi et al., 2023). By meticulously studying driver behaviour, it becomes feasible to pinpoint these perilous actions and craft targeted interventions aimed at preventing RTCs and safeguarding lives. Secondly, it facilitates the creation of evidence-based policies by providing empirical insights into how drivers conduct themselves on the road, which can be instrumental in shaping the development of effective traffic laws, regulations, and policies. Moreover, assessing driver behaviour aids in the efficient allocation of resources for road safety initiatives, ensuring that interventions are cost-effective and impactful by identifying specific behaviours contributing to RTCs. Additionally, it underscores the importance of cultural adaptation, recognizing that driver behaviour can exhibit significant variations across diverse cultures and regions, enabling the tailoring of interventions to be more culturally relevant and effective. Lastly, understanding and modifying driver behaviour have direct economic implications, as RTCs impose substantial economic burdens, encompassing medical expenses, property damage, and productivity losses. Deep comprehension of driver behaviour can inform strategies that lead to substantial reductions in these economic costs, thereby contributing not only to economic stability but also to growth.

Moreover, assessing driver behaviour aligns seamlessly with the Safe System approach to road safety, which prioritizes minimizing the risk of severe injury or fatalities on road networks while recognizing the inevitability of human errors. This alignment is evident in several core principles. Firstly, it upholds the principle of shared responsibility, acknowledging that all stakeholders, including drivers, must actively contribute to road safety. Secondly, it advocates for evidence-based interventions, ensuring that actions are rooted in data and aligned with the evidence-based ethos of the Safe System approach. Thirdly, it emphasizes the importance of safe road infrastructure and understanding how drivers interact with their environment, informing the development of forgiving roadways and infrastructure. Fourthly, it considers safe vehicles by evaluating how different vehicle types and technologies influence driver behaviour, guiding vehicle safety standards. Furthermore, it takes into account cultural and societal factors, ensuring that interventions are culturally relevant and addressing societal nuances. Lastly, it aids in reducing the economic impact of road trauma by identifying cost-effective measures for behaviour modification, thereby aligning with the Safe System Approach's economic objectives.

In essence, assessing driver behaviour stands as a cornerstone of the Safe System Approach, aiding in the identification and mitigation of human factors that contribute to road crashes, ultimately contributing to the establishment of a safer road transport system that safeguards all road users from serious harm. While other components such as infrastructure quality, enforcement of traffic laws, emergency response capabilities, and public awareness campaigns are equally important, driver behaviour directly influences the occurrence and severity of RTCs. Therefore, assessing driver behaviour complements efforts in other areas by highlighting behavioural patterns that contribute to RTCs, thereby enhancing the effectiveness of holistic road safety strategies aimed at reducing fatalities and injuries on roads.

1.1.7.2. TOOLS FOR ASSESSING DRIVER BEHAVIOUR

SELF-REPORTS

Self-reports involve drivers voluntarily providing information about their own behaviour, attitudes, and experiences while on the road (Hussain, Miwa, Sato, & Morikawa, 2023; Parker, Reason, Manstead, & Stradling, 1995; Reason, Manstead, Stradling, Baxter, & Campbell, 1990). Typically collected through surveys, questionnaires, or interviews, self-reported data can shed light on various aspects of driving behaviour, including but not limited to speeding tendencies, seatbelt usage, cell phone distractions, and personal perceptions of risk. This method offers the distinct advantage of directly capturing the driver's perspective, allowing individuals to reflect on and report their own actions. However, self-reports do come with inherent limitations. They may be subject to biases, as respondents might underreport socially undesirable behaviours or overstate their adherence to safety measures. Despite these potential limitations, self-reports remain a valuable and informative tool for assessing driver behaviour, especially when used in conjunction with other assessment methods. They offer unique insights into driver attitudes, motivations, and beliefs that may not be readily observable through more objective means, thus contributing to a comprehensive understanding of driver behaviour on the road.

DIRECT-OBSERVATION

Direct-observation represents another pivotal tool for evaluating driver behaviour. In this approach, researchers directly observe and document driver actions and interactions on the road, often from a concealed vantage point to minimize observer effect (West, French, Kemp, & Elander, 1993). These approaches can provide objective insights into real-world driver

behaviours, such as compliance with traffic rules, speed choice, lane discipline, and responses to road infrastructure. By systematically recording these behaviours, researchers can discern patterns and trends, helping to identify risky behaviours and areas where interventions may be necessary. Direct observation offers a valuable counterbalance to self-reports, as they provide an external perspective on driver actions, reducing potential bias associated with self-reported data. Nevertheless, they also come with their own set of challenges, including the need for significant resources, the potential for observer bias, and ethical considerations regarding privacy. When thoughtfully designed and executed, direct observations contribute substantially to our understanding of driver behaviour, enabling the development of evidence-based strategies for enhancing road safety and aligning with the broader goals of the Safe System approach.

NATURALISTIC DRIVER BEHAVIOUR

Naturalistic driver behaviour research represents an advanced and immersive method for assessing how individuals behave on the road (Bronrott, 2010). This approach involves equipping vehicles with in-vehicle data recorders and sensors that continuously monitor various aspects of driving behaviour, including speed, braking, acceleration, lane-keeping, and more. Unlike self-reports or observational studies, naturalistic driving studies capture real-world data as drivers go about their daily routines, providing an unparalleled level of insight into actual driving behaviour (Riaz, 2016). Researchers can analyse this data to uncover patterns, identify risky behaviours, and understand the factors contributing to RTCs. It allows for the examination of complex interactions between drivers, vehicles, and the road environment over extended periods, providing a holistic view of driver behaviour (van Schagen & Sagberg, 2012).

This approach aligns seamlessly with the principles of the Safe System approach by offering several advantages. Firstly, it provides a wealth of objective data, reducing reliance on self-reported information. Secondly, naturalistic studies allow researchers to examine how drivers respond to various road conditions and infrastructure, contributing valuable insights for designing safer roads and vehicles. Thirdly, by capturing the lead-up to RTCs, these studies can reveal critical information about the events leading to crashes, shedding light on causal factors that might have otherwise remained hidden. Moreover, this method is conducive to identifying both intentional risky behaviours and errors, which is essential for comprehensive road safety strategies. However, conducting naturalistic studies requires significant investments in technology, data management, and privacy considerations. Nevertheless, it

stands as a powerful tool for advancing our understanding of driver behaviour and road safety, ultimately contributing to safer road networks in accordance with the principles of the Safe System approach.

DRIVING SIMULATORS

Driving simulators serve as sophisticated tools for assessing driver behaviour by replicating realistic driving scenarios in a controlled environment (Rizzo, McGehee, Dawson, & Anderson, 2001). These simulators provide a safe and controlled setting where researchers can observe how individuals react to various driving conditions and scenarios. Unlike self-reports, direct observational, or naturalistic research, simulators offer a highly controlled and repeatable way to evaluate driver behaviour while minimizing real-world risks. Participants in simulator studies experience a range of driving situations, such as highway merging, adverse weather conditions, and unexpected hazards, all within a virtual environment that closely mimics real-world driving.

The use of driving simulators aligns effectively with the principles of the Safe System approach in several ways. Firstly, they offer a controlled and safe environment for testing driver responses to different road conditions and infrastructure designs, contributing valuable insights for enhancing road safety. Secondly, simulators enable researchers to systematically investigate the effects of distractions, impairment, and other risky behaviours on driving performance, aiding in the development of evidence-based interventions. Thirdly, simulators allow for the study of driver behaviour in conditions that may be too dangerous or ethically challenging to replicate in real life, facilitating a deeper understanding of extreme scenarios. Moreover, simulator studies can be standardized and replicated across different regions and cultures, promoting cross-cultural research on driver behaviour.

However, while simulators offer controlled environments, they may not fully replicate the complexities of real-world driving (Pinto, Cavallo, & Ohlmann, 2008). Participants in simulator studies may exhibit different behaviours compared to on-road driving, and the simulator experience may not capture the emotional and physiological aspects of real-world driving. Despite these limitations, driving simulators represent a valuable tool in the study of driver behaviour and road safety, providing a controlled and ethical means of advancing our understanding of how drivers interact with their environment and vehicles, ultimately contributing to safer road networks in alignment with the principles of the Safe System approach.

1.1.7.3. IMPROVING DRIVER BEHAVIOUR

BEHAVIOURAL CHANGE THEORIES

A comprehensive understanding of the principles supporting behavioural change is indispensable in the design of efficacious strategies for improving driver behaviour (Gielen & Sleet, 2003). Behavioural change theories offer invaluable insights into the underlying reasons why individuals partake in risky behaviours and elucidate how interventions can effectively shape their choices (Özbay, 2017). Prominent models such as the Health Belief Model (Razmara, Aghamolaei, Madani, Hosseini, & Zare, 2018), the Theory of Planned Behaviour (Tavafian, Aghamolaei, Gregory, & Madani, 2011), and the Social Cognitive Theory furnish structured frameworks for the development of interventions that precisely target prevailing attitudes, beliefs, and motivations pertinent to driver behaviour (Victoir, Eertmans, Van den Bergh, & Van den Broucke, 2005). Through the judicious application of these theories, road safety initiatives can be meticulously tailored to address the intricate web of psychological factors that exert influence over behaviour, substantially heightening the prospects of achieving their intended outcomes.

EDUCATION AND TRAINING

Education and training programs occupy a central position in the endeavour to enhance driver behaviour. These initiatives are geared towards enriching drivers' knowledge, augmenting their awareness, and honing their skills, all with the overarching aim of fostering safer practices on the road (Mayhew, Simpson, Williams, & Ferguson, 1998). These educational campaigns can encompass a diverse array of critical topics, ranging from elucidating the perils associated with excessive speeding, elucidating the severe consequences stemming from distracted driving, emphasizing the paramount importance of seatbelt utilization, to elucidating the high risks associated with driving under the influence of alcohol or drugs (Dragutinovic & Twisk, 2006; Poulter & McKenna, 2010). By providing drivers with the essential information and tools for making responsible choices, these education and training programs make substantial contributions to RTC prevention and effectuating a notable reduction in the incidence of risky behaviours on our roads.

ENFORCEMENT

Enforcement mechanisms are crucial for ensuring that drivers adhere to traffic laws and regulations. Law enforcement agencies play a critical role in deterring unsafe behaviours through the consistent application of penalties and fines for violations. Strict enforcement of

speed limits, sobriety checkpoints, and the enforcement of laws against distracted driving sends a clear message that risky behaviours will not be tolerated. Effective enforcement serves as a deterrent and encourages compliance with road safety regulations, contributing to improved driver behaviour and a safer road environment (Castillo-Manzano, Castro-Nuño, López-Valpuesta, & Pedregal, 2019; Stanojević, Jovanović, & Lajunen, 2013).

ENGINEERING MEASURES AND SAFE VEHICLES

Engineering measures constitute a pivotal component of efforts to bolster driver behaviour, entailing the strategic design and adaptation of both road infrastructure and vehicle attributes to incentivize safer conduct (Merat & Jamson, 2013). This multifaceted approach encompasses enhancements in road design, the strategic installation of traffic-calming mechanisms, and the incorporation of cutting-edge Advanced Driver Assistance Systems (ADAS) within vehicles (Sullivan, Flannagan, Pradhan, & Bao, 2016). Road engineering measures are chiefly geared towards the creation of road environments that exhibit a degree of forgiveness, thus mitigating the severity of RTCs arising from human errors (Marsh et al., 2017). Simultaneously, ADAS offer drivers timely warnings and valuable assistance to alleviate the repercussions of risky behaviours, encompassing features such as lane departure warnings and automated emergency braking systems (van den Beukel, van der Voort, & Eger, 2016). These meticulously orchestrated engineering interventions synergize with driver education and enforcement endeavours to collectively forge a more secure and comprehensive road system, wherein safer driver behaviours are actively promoted and reinforced.

Safe vehicles are an integral component of improving driver behaviour and road safety. Vehicle manufacturers play a significant role in enhancing safety by designing vehicles with advanced safety features, including airbags, anti-lock brakes, electronic stability control, and collision avoidance systems. These technologies act as safety nets, helping drivers avoid RTCs or reducing the severity of crashes when they occur. Additionally, promoting the adoption of safer vehicle models and encouraging regular vehicle maintenance ensures that drivers are equipped with vehicles that meet modern safety standards (Gazder, 2021; Kapusta & Kalašová, 2015).

Incorporating these multifaceted approaches—education and training, enforcement, behavioural change theories, engineering measures, and safe vehicles—offers a comprehensive strategy for improving driver behaviour and, by extension, road safety. These strategies align with the principles of the Safe System approach by addressing various facets

of the road transport system to minimize the risk of severe injury or fatalities, recognizing that human errors are inevitable, and taking a holistic approach to creating safer road networks for all road users.

1.1.8. OVERVIEW OF THE ROAD SAFETY LANDSCAPE IN LEBANON

Lebanon's roads bear a heavy burden, with an annual average of 4,259 reported RTCs leading to an average of 519 fatalities and 5,760 injuries (Internal Security Forces, 2023), although it is believed that the actual death toll may be even higher, reaching a staggering 1,127 (Global Life Partners, 2024). This grim reality translates into an age-adjusted death rate of 16.6 per 100,000 inhabitants, comprising 3.3% of total fatalities. Shockingly, RTC rank as the eighth leading cause of death in Lebanon (Global Life Partners, 2024), with nearly 37% of these casualties being vulnerable road users. While Lebanon's road mortality rate fare better than some neighbouring countries, such as Saudi Arabia, Syria, Jordan, and Iraq, its rate still align with countries like the United Arab Emirates, Kuwait, Oman, and Morocco in terms of road safety performance (World Health Organization, 2018). Apart from fatalities, the serious injuries resulting from RTCs in 2015 imposed a financial cost of \$2,278 million, equivalent to 4.4% of the GDP (iRAP, 2015). Notably, these casualties predominantly affected males aged 15-49. Moreover, data revealed that road crash injuries impacted 419 years of life with disabilities per 100,000 people, with the situation exacerbated by the presence of refugees who face elevated injury rates (Ghoubaira et al., 2021).

While Lebanon has made strides in enhancing road safety policies, notably with the introduction of the New Lebanese Traffic Law number 243 (Internal Security Forces, 2012), effective enforcement has faced numerous challenges. Resource constraints, political interference, judicial inefficiencies, and a lack of awareness campaigns have hindered its full implementation. Police shortages and uneven distribution within road brigades have further impeded effective traffic management.

The country's ongoing economic crisis casts a shadow over these challenges, straining law enforcement and exacerbating budget constraints (World Bank, 2023). Therefore, addressing these pressing issues remains crucial for Lebanon to realize its full potential in improving road safety.

1.2. PROBLEM STATEMENT

The central problem addressed by this thesis is the multifaceted issue of road safety in Lebanon. This issue arises from a convergence of complex challenges, including the country's history of conflicts, economic instability, inadequate infrastructure, and the absence

of an integrated surveillance system. These factors have led to a significant toll of fatalities, injuries, and economic burdens, making RTCs among the 10 top leading causes of mortality and morbidity. Table 1 summarizes the problem statement, rationale, and the intended studies for this thesis.

Lebanon's road safety landscape is hindered by a lack of comprehensive research, which obstructs the development of evidence-based policies and targeted solutions. For example, no research has focused on road users' perspectives and their satisfaction with current road safety management, which impedes the creation of effective, targeted strategies. Understanding the needs, challenges, and satisfaction levels of road users is vital to identifying gaps in policies, infrastructure, and enforcement. Additionally, Lebanon faces challenges related to fragmented data sources, inadequate official data, and underreporting, which impede accurate assessment of RTI. These issues undermine the evaluation of current road safety measures and affect resource allocation. To effectively address road safety, resolving data fragmentation and improving data quality is crucial.

Driver behaviour is another pivotal aspect of this issue. A significant majority of RTCs are associated to unsafe driving practices, yet Lebanon lacks culturally relevant measurement scales for assessing driver behaviour. This gap impedes efforts to mitigate dangerous driving. Therefore, this thesis is structured around two main axes:

1. Analysis of road safety management landscape and data systems:

- The thesis provides a comprehensive analysis of the current state of road safety management in Lebanon, highlighting the intricate challenges and issues faced by the nation. This analysis underscores the urgent need for effective strategies and policies to enhance road safety.
- To fully understand the current state of road safety management in Lebanon, the study explored also road users' perspectives. Their experiences, challenges, and satisfaction provide critical insights into the effectiveness of existing policies and infrastructure. By examining how road safety measures are perceived and experienced by those who use the roads daily, this study aimed to identify gaps and areas for improvement, ensuring that future interventions are better aligned with the real needs of the population.
- A special focus was placed on data-related challenges, including inadequate data systems, fragmented sources, and their impact on accurate assessment and resource allocation. The thesis examined the RTI surveillance system established in 2013 by the Epidemiological Surveillance Unit (ESU) of the

Ministry of Public Health, and advocates for a more efficient data-driven approach to road safety by implementing an integrated RTI system to address existing gaps and establish a robust framework for evidence-based decision-making.

2. Validation of international tools for assessing driver behaviour:
 - The thesis explored international tools for assessing driver behaviour, deepening our understanding of the factors influencing driver behaviour and the relationship between driver behaviour and RTCs. This research provides evidence-based solutions and pathways for modifying and enhancing driver behaviour, contributing to the reduction of RTCs, saving lives, and strengthening road safety.

Table 1: Problem statement, rationale and planned studies

Problem	Planned study	Rationale	Explanation of the rationale
<p>Multifaceted Road Safety Issues</p> <p>Lebanon's road safety issues stem from historical conflicts, economic instability, inadequate infrastructure, knowledge gap in all aspects of road safety research and a lack of an integrated surveillance system. This results in high fatalities, injuries, and economic costs. Conflicts and instability have damaged infrastructure and disrupted development. Poor infrastructure increases RTC risk.</p> <p>Data system deficiencies and lack of research hampers effective policy-making and understanding of the magnitude of the problem</p>	<p>Conduct comprehensive analysis:</p> <p>Review Lebanon's current road safety management to identify key challenges and areas for improvement.</p>	Understanding the scope and scale of problems	<p>Identify specific road safety challenges in Lebanon, such as infrastructure deficiencies and ineffective policies.</p> <p>Highlight systemic issues in road safety management and coordination among stakeholders.</p>
		Inform evidence-based policy development	Provides critical data for developing evidence-based policies.
		Prioritize interventions	Allows for comparison with international best practices to identify gaps and opportunities.
		Engage stakeholders	Helps in prioritizing interventions and allocating resources effectively based on identified needs.
		Build a foundation for future research	Engages various stakeholders, fostering a collaborative approach to road safety management.
		Pinpoints areas requiring further research, providing a basis for subsequent studies and interventions.	

<p>Lack of research on road users' perspectives and satisfaction with current road safety management in Lebanon, who are primarily impacted by road safety issues in the country.</p>	<p>Conduct user-centred research: Collect data from road users about their experiences, challenges, and satisfaction with road safety management.</p>	<p>Complements the comprehensive analysis of road safety management by integrating user perspectives</p>	<p>Provides direct insights on users' experiences, needs, and satisfaction with road safety measures.</p> <p>Highlights deficiencies in current policies and infrastructure, based on users' challenges and concerns.</p> <p>Enhances policy development that addresses actual needs and challenges of road users.</p> <p>Refines road safety measures to better align with users' needs and improve overall satisfaction.</p> <p>Complements the comprehensive analysis of road safety management conducted among stakeholders by integrating road user perspectives.</p>
<p>Fragmented data and inadequate RTI surveillance: Lebanon faces challenges with fragmented data sources and inadequate RTI surveillance systems, undermining the accurate assessment and resource allocation for road safety</p>	<p>Conduct situational assessment of the data sources and develop a blueprint for an integrated RTC Surveillance System</p>	<p>Ensuring comprehensive, accurate data collection, improving the monitoring of road safety issues, and enhancing the effectiveness of interventions.</p>	<p>Understanding current conditions: Identifies the existing state of data sources, highlighting gaps, inconsistencies, and areas needing improvement.</p> <p>Informed decision making: Provides a comprehensive view of the data landscape, which is essential for making informed decisions on resource allocation and policy development.</p> <p>Identifying needs and priorities: Helps pinpoint specific needs and priorities for developing effective road safety interventions and improvements.</p>

			<p>Foundation for system development: Establishes a baseline for designing and implementing an integrated surveillance system by understanding current data management practices and challenges.</p> <p>Improving data quality: Addresses issues related to data fragmentation and accuracy, leading to more reliable and actionable information for road safety.</p> <p>Enhancing coordination: Facilitates better coordination among stakeholders by clarifying data responsibilities and improving data sharing practice</p>
<p>Unsafe driving practices and lack of culturally relevant measurement scales: Unsafe driving practices contribute to RTCs, and the lack of culturally relevant measurement scales hampers effective assessment of driver behaviour in Lebanon.</p>	<p>Adapt measurement scales: Validate and adapt international tools for driver behaviour to fit the Lebanese context.</p>	<p>Enhance the understanding of driver behaviour and improve road safety measures in Lebanon through culturally adapted and validated scales.</p>	<p>Validate and adapt scales to the Lebanese context: Ensure that psychological scales are relevant and applicable to Lebanese drivers by translating and adapting them to local cultural and societal nuances.</p> <p>Assess driver behaviour and examine the relationship between psychological factors (such as locus of control and anger) and driving skills, and their impact on RTC.</p> <p>Inform policy and raise awareness: Provide insights to influence road safety policies and raise awareness among Lebanese drivers about safe driving practices and psychological factors affecting road safety.</p>

1.3. RATIONALE

Lebanon's road safety situation is compounded by years of insufficient management and a fragmented regulatory framework. Despite a growing population, increased vehicle ownership, and worsening infrastructure, the country lacks a coordinated approach to road safety, resulting in significant risks to public health. Weak institutional support and limited financial resources hinder effective interventions and policy development. The roles of key stakeholders in road safety efforts remain unclear, leading to fragmented and often ineffective responses. The lack of cohesive policies, combined with these challenges, has led to a high incidence of RTC, RTD, and RTI (Table 1).

Furthermore, the absence of reliable data and an effective surveillance system hampers the ability to accurately assess the magnitude of the problem and implement targeted interventions. This data deficiency impedes evidence-based decision-making and the development of effective policies. Without significant government action and a coordinated effort, the road safety situation in Lebanon is likely to deteriorate further, resulting in increased RTDs and economic burdens. Therefore, this thesis provides a comprehensive analysis of Lebanon's road safety landscape, examining the historical, institutional, and organizational factors contributing to the current crisis. It identifies critical gaps and proposes evidence-based solutions to enhance road safety management, with the aim of reducing RTCs, saving lives, and improving the overall quality of life in Lebanon.

As for RTCs in Lebanon, they were largely associated to behavioural factors among drivers that are not well understood or addressed within the local cultural context. Without adapted psychological scales tailored to the unique cultural and societal dynamics of Lebanon, it is challenging to accurately measure key factors like locus of control, anger, and driving skills, which play a crucial role in influencing driver behaviour and, consequently, road safety outcomes. This gap in understanding poses a serious obstacle to reducing RTCs and enhancing safety on Lebanese roads. Therefore, this thesis focuses on understanding driver behaviour within Lebanon's unique cultural and socioeconomic context, highlighting the need to validate and adapt international tools for assessing driver behaviour. Additionally, it emphasizes the importance of developing an integrated RTI surveillance system to centralize and improve data accuracy, supporting better decision-making and road safety policies.

1.4. ALIGNMENT OF THE THESIS WITH SAFE SYSTEM APPROACH

The Safe System, a globally recognized framework, places the prevention of road traffic fatalities and severe injuries at its core, advocating for a comprehensive, integrated, and

forgiving road transport system. This thesis aligns harmoniously with the fundamental

The thesis bridges critical knowledge gaps in road safety in Lebanon, contributing to the Safe System's goals by exploring driver behavior, validating measurement scales, and addressing the key pillars of road safety.

1. Driver Behavior Focus

The research emphasizes the importance of understanding, assessing, and addressing driver behavior, particularly in the Lebanese context, resonating with the Safe System's principle of acknowledging human fallibility.

2. Data-driven approach

The thesis highlights the need for accurate road data systems and integrated surveillance, aligning with the Safe System's emphasis on data-driven decision-making and evidence-based policymaking.

3. Proactive RTCs prevention

The research prioritizes proactive RTCs prevention, resource allocation, and the reduction of road traffic fatalities and injuries, mirroring key elements of the Safe System approach.

4. Road safety management

The thesis provides a comprehensive analysis of road safety management in Lebanon, identifying challenges and opportunities for policy interventions aimed at creating a safer and more sustainable transportation system.

principles of the Safe System, emphasizing the necessity of holistic road safety measures (Figure 3).

Figure 3: Alignment of the thesis with safe system approach

By delving into the intricacies of driver behaviour and validating measurement scales tailored specifically to the Lebanese context, this research underscores the pivotal role of human actions in road safety. This resonance with the Safe System's principle acknowledging human fallibility highlights the crucial importance of understanding, assessing, and modifying driver behaviour within Lebanon's unique circumstances. Furthermore, the thesis emphasizes the urgent requirement for accurate and dependable road data systems and the establishment of an integrated surveillance system, perfectly in sync with the Safe System's data-driven approach. This alignment underscores the necessity of comprehensive and real-time data to monitor, diagnose, and manage road safety issues effectively. It recognizes that informed decision making and evidence-based policymaking are fundamental to achieving the Safe System's overarching goal, which is the reduction of road traffic fatalities and injuries. In line with the principles of the Safe System, this research places significant emphasis on proactive RTC prevention, resource allocation, and the overarching objective of reducing road traffic fatalities and injuries. These elements are central to the Safe System's approach, aiming to create a road transport system that is forgiving of human errors and ultimately safer for all road users. Moreover, a comprehensive analysis of the current road safety management status

in Lebanon reveals critical challenges and opportunities. By shedding light on the current performance of road safety management, this thesis aims to pave the way for effective policy interventions that can save lives, reduce economic burdens, and ultimately establish a safer and more sustainable transportation system in the country.

As a comprehensive endeavour rooted in the principles of the Safe System, this thesis aims to bridge critical knowledge gaps in road safety in Lebanon. It underscores the importance of robust road data systems, highlights the need for an integrated surveillance system, explores driver behaviour within the Lebanese context, and demonstrates their alignment with the requirements of the Safe System approach. By examining driver behaviour and validating measurement scales tailored to Lebanon's specific conditions, this research contributes significantly to the Safe System's objectives. Ultimately, it seeks to enhance road safety in Lebanon, making it safer and more sustainable by addressing key pillars of the Safe System while addressing the pressing challenges of road safety management in the country.

1.4. OBJECTIVES

PART I: COMPREHENSIVE ANALYSIS OF THE CURRENT ROAD SAFETY LANDSCAPE IN THE COUNTRY

The overarching goal of this comprehensive analysis is to provide a holistic understanding of the road safety challenges confronting Lebanon. This involves an in-depth examination of the multifaceted issues that permeate the country's road safety domain. Rather than merely skimming the surface, this assessment seeks to delve deep into the intricate link of institutional, organizational, and financial management intricacies that underpin Lebanon's road safety landscape. It also includes a thorough assessment of Lebanon's existing road safety policies and regulations, evaluating their alignment with international best practices, legal framework, and coherence, while pinpointing areas for improvement (Table 2).

In addition, this part includes a study that focuses on assessing road users' perspectives on road safety management in Lebanon, with an emphasis on the challenges they encounter, their specific needs, and their overall satisfaction with current safety measures. This component complements the insights obtained from a desk review and institutional assessment. The ultimate goal is to provide valuable insights and recommendations that can be translated into tangible improvements in the current road safety landscape in the country.

Another focus of this part is on the data system, aiming to provide a situational assessment of data sources to establish an integrated road traffic data system. By addressing these

multifaceted issues, the study aims to offer a deeper understanding of Lebanon's road safety challenges and provide valuable insights for planning a safer future.

Table 2: Summary of objectives of the thesis

Part	Objective	Details
Part I: Comprehensive analysis of the current road safety landscape in Lebanon	Provide a holistic understanding of road safety challenges	In-depth examination of the institutional, organizational, and financial management intricacies that shape Lebanon's road safety landscape
	Assess existing road safety policies and regulations	Evaluate Lebanon's road safety policies for alignment with international best practices, legal frameworks, and coherence. Identify areas for improvement
	Assess road users' perspectives	Assess road users' challenges, needs, and satisfaction with current road safety management in Lebanon
	Analyse road safety data systems	Provide a situational assessment of data sources, with the aim of establishing an integrated road traffic data system
	Provide recommendations for improvement	Offer recommendations for improvements in the country's road safety landscape
Part II: Scale validation and behavioural analysis	Psychometric analysis: Cross-cultural adaptation and validation of scales	Evaluate the psychometric properties of scales tailored for Lebanese drivers including Driver Behaviour Questionnaire (DBQ-L), Arabic version of the Driving Anger Scale (DAS), Traffic Locus of Control (TLOC), and Driver Skills Inventory (DSI). The focus is on reliability and validity among Lebanese drivers
	DBQ-L	<ul style="list-style-type: none"> - Explore associations between DBQ-L and sociodemographic characteristics - Examine associations between DBQ-L and travel-related variables - Identify correlations between DBQ-L scores and the occurrence of RTCs
	Arabic version of DAS	<ul style="list-style-type: none"> - Explore associations between DAS, sociodemographic factors, travel-related variables and aberrant driving behaviour - Examine associations between DAS and involvement in RTCs and offenses
	Traffic locus of control	<ul style="list-style-type: none"> - Examine associations between TLOC-A and sociodemographic characteristics, travel-related variables and aberrant driving behaviour - Examine the relationship between TLOC-A scores and self-reported RTCs
	Driver skills inventory	<ul style="list-style-type: none"> - Analyse associations between DSI and sociodemographic factors - Investigate how self-assessed perceptual-motor and safety skills are linked to aberrant driving behaviour - Examine correlations between DSI scores and self-reported RTCs, and explore the impact of self-assessed skills on road safety

PART II: SCALES VALIDATION AND BEHAVIOURAL ANALYSIS

PSYCHOMETRIC ANALYSIS: CROSS-CULTURAL AND VALIDATION OF THE SCALES AMONG LEBANESE DRIVERS

The primary focus of this part was to evaluate the psychometric properties of various scales that have been tailored for Lebanese drivers. The scales under examination include the Driver Behaviour Questionnaire among Lebanese Drivers, the Arabic version of the Driving Anger Scale, the Arabic version of the Traffic Locus of Control, and the Arabic version of the Driver Skills Inventory.

The objectives for each scale range from cross-cultural adaptation and validation to confirming reliability and validity among Lebanese drivers.

ANALYTIC ANALYSIS: EXPLORATION OF ASSOCIATIONS BETWEEN SCALES, SOCIODEMOGRAPHIC CHARACTERISTICS, AND TRAVEL-RELATED VARIABLES, EMPHASIZING ROAD TRAFFIC CRASHES

The second objective of this part was to examine the associations between the scales and various factors, placing a significant emphasis on RTC. The comprehensive exploration includes the following associations for each scale (Table 2):

DBQ-L

To unveil associations between DBQ-L and travel-related variables, contributing to a holistic understanding of how aspects like travel patterns influence driver behaviour.

To identify correlations between DBQ-L scores and the occurrence of RTCs, shedding light on the impact of driver behaviour on road safety.

Arabic version of DAS

To examine associations between DAS and sociodemographic characteristics, providing insights into how factors such as age, gender, occupation, and education relate to driving anger.

To explore associations between DAS and travel-related variables such as annual mileage, offering a nuanced understanding of the factors influencing driving anger.

To explore the association between anger-related domains measured by DAS and aberrant driving behaviour assessed by DBQ-L.

To investigate associations between DAS scores and risk involvement (RTCs and traffic offenses) addressing the impact of anger on road safety.

T-LOC-A

To examine associations between TLOC-A and sociodemographic characteristics.

To explore associations between TLOC-A and travel-related variables.

To explore the association between TLOC domains measured by TLOC and aberrant driving behaviour assessed by DBQ-L.

To explore how the perceived locus of control relates to the occurrence of self-reported RTCs, providing insights into the role of perceived control in road safety.

DSI

To explore associations between DSI and sociodemographic characteristics, offering insights into how factors such as age and driving experience influence self-assessed perceptual-motor and safety skills.

To examine how self-assessed skills associate to aberrant driving behaviour.

To investigate association between DSI scores and the occurrence of self-reported RTCs elucidating the impact of self-assessed skills on road safety.

1.5. THESIS OVERVIEW

This thesis tackles the complex road safety challenges in Lebanon using a comprehensive, multidimensional approach. It has two distinct parts: an in-depth analysis of the current road safety landscape and the validation of international tools for assessing driver behaviour. Through this sophisticated strategy, the research aims not only to uncover the intricacies of the road safety problem but also to propel evidence-based solutions, ultimately leading to a reduction in RTCs.

The organization of the thesis is displayed in Figure 4. Part I includes a comprehensive analysis of Lebanon's existing road safety landscape, spotlighting multifaceted challenges and pressing issues that demand immediate attention and action. Additionally, it assesses the data system with a special focus on data collected through the groundbreaking hospital-based road traffic injury surveillance system initiated by the Ministry of Public Health. It proposes the implementation of an integrated RTI system to address gaps and enhance the effectiveness of data-driven road safety efforts, presenting a draft protocol for this integrated system.

Part II is centered on the validation and cross-cultural adaptation of four globally recognized tools for examining driver behaviour: the Driver Behaviour Questionnaire, the Driver Anger Scale, the Traffic Locus of Control, and the Driving Skills Inventory. This part includes thorough psychometric analyses of these scales to provide a comprehensive understanding. Then, this part delves into analytical studies, uncovering insights into the determinants of driver behaviour and unraveling the nuanced associations between driver behaviour, driver

anger, driving skills inventory, traffic locus of control, and road traffic crashes. This research delivers evidence-based solutions aimed at refining and elevating driver behaviour, with the ultimate objective of curbing road traffic crashes.

Building upon the insights gained from these parts, the final section offers a general discussion that synthesizes the findings and places them in a broader context, alongside potential implications for research, clinical practice, and policy. It also suggests areas for further research. This section engages in a comprehensive dialogue, drawing meaningful conclusions from the research and connecting the dots between objectives and empirical evidence. It encapsulates the key takeaways, underscores the significance of the findings, and offers insights into the practical implications for road safety policies and interventions. This conclusion provides readers with a thorough understanding of the current road safety landscape in Lebanon and the intricate relationship between driver behaviour and road safety, reinforcing the importance of continued research and action in this vital field.

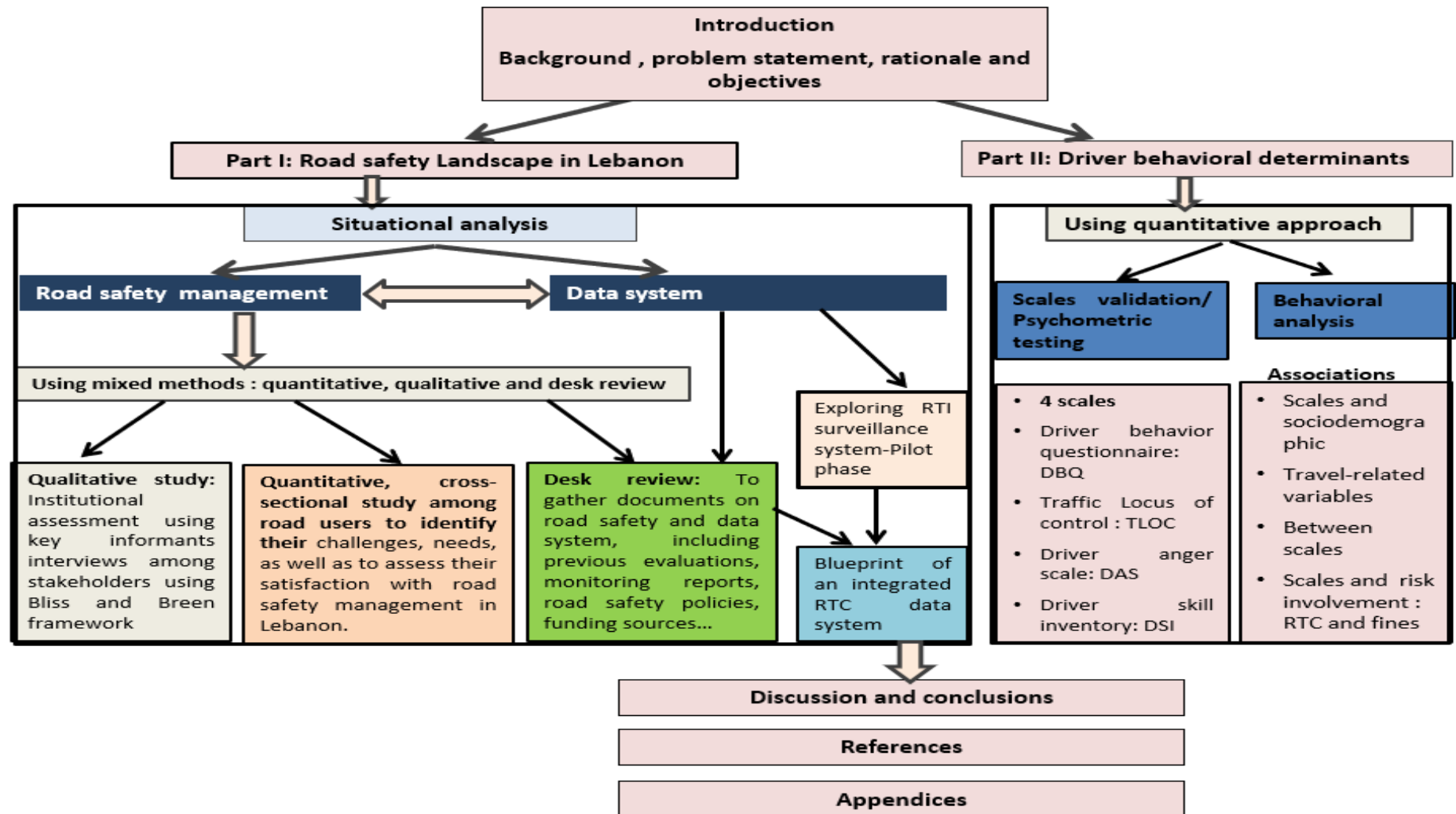

Figure 4: Overview of the thesis

This thesis used a multifaceted methodological approach to address Lebanon's road safety challenges through four key components (Table 3):

1. **Situational assessment for road safety management:** This phase involves a qualitative and quantitative analysis of Lebanon's road safety landscape. It includes a comprehensive evaluation of existing policies and regulations, assessing their alignment with international standards, and identifying gaps in institutional, organizational, and financial management.
2. **Data system:** A situational assessment of road traffic data sources is conducted to establish an integrated road traffic data system.
3. **Scale validation:** This component focuses on the validation of psychological scales for assessing driver behaviour, such as TLOC, DAS, DBQ and DSI. The process includes adapting and validating these scales within the Lebanese cultural context to ensure their relevance and accuracy.
4. **Behavioural determinants and analytical studies:** Analytical studies are conducted to examine behavioural determinants of road safety, using validated scales to explore factors like locus of control, anger, and driving skills. These studies aim to provide insights into how these factors influence driver behaviour and road safety outcomes in Lebanon.

Table 3: Methodological approach used in the thesis

Methods	Part I: Road safety landscape		Part II: Scale validations and driver behavioural determinants	
	Situational assessment for road safety management	Data system	Scale validation	Analytical studies
Qualitative	x	x		
Quantitative				
1	x			
2		x		
3			x	x
Narrative review	x	x		
Publications	2 drafted articles for submission	1 article waiting final decision	4 published articles + 1 under review	

This thesis has contributed to significant academic output, resulting in the writing of 8 articles: 4 published, 1 under revision, 1 under review and 2 submitted. These publications

cover various aspects of driving behaviour and road safety in Lebanon. Details about these publications will be presented in the corresponding sections of the thesis.

I.1. INTRODUCTION

Lebanon, located on the eastern shore of the Mediterranean Sea, is a country characterized by its rich history and diverse culture. This small Middle Eastern country has witnessed several conflicts and disruptions that have left an indelible mark on its landscape and people. This stormy history, marked by periods of internal conflict and external pressures, has had profound and long-lasting effects on the country's social, economic, and political aspects, significantly impacting its governance and stability (Center of Operational Analysis and Research, 2022). One critical and pervasive challenge encountering Lebanon in recent years has been road safety.

However, war, social disruption, economic collapse, and ongoing instability have relegated road safety to a low priority on the government's agenda. The alarming surge in RTC has resulted in substantial fatalities, injuries, and significant economic burdens over the years (Choueiri, Choueiri, & Choueiri, 2007, 2015; M Choueiri, M Choueiri, & M Choueiri, 2012). Notably, the road safety concerns in Lebanon encompass a broad spectrum of issues, including institutional and organizational deficiencies, policy inadequacies, enforcement challenges, infrastructure limitations, and behavioural factors. These issues intersect and contribute to the country's road safety crisis, making it imperative to conduct a comprehensive analysis (Farah & Laurent, 2021).

Despite Lebanon's alarming road safety record, there has been a remarkable dearth of research on this issue, hindering the country's ability to develop evidence-based strategies, learn from international best practices, and implement tailored solutions. Bridging this knowledge gap stands as an urgent imperative, not only to preserve lives but also to curtail injuries, mitigate the economic strains, and lead in a safer, more sustainable road transportation system in Lebanon. To rectify this deficiency, the comprehensive examination presented in this part delves profoundly into Lebanon's intricate landscape of road safety challenges. Addressing road safety, as a system, requires understanding its mechanisms as well as its various peculiarities: multi-causality, multidisciplinary, and multi-institutionalism.

I.2. OBJECTIVES

This comprehensive analysis delves into the multifaceted road safety challenges faced by Lebanon. This examination goes beyond the surface to examine the intricate web of institutional, organizational, and financial management issues that underlie the country's road safety landscape. It will scrutinize existing policies, assess the enforcement mechanisms,

delve into budgetary allocations, and propose evidence-based recommendations to foster a safer and more sustainable road network in Lebanon. By peeling back the layers of complexity, we aim to provide a deeper understanding of Lebanon's road safety predicament and offer valuable insights to help plan a safer course for its future.

I.3. METHODS

This research is a comprehensive situational analysis of road safety management, characterized by an exploratory aspect. This situational assessment adopts a blended mixed methods approach within its design and entails multiple steps (Figure 5). Utilizing this approach enable the acquisition of pertinent and dependable data, facilitating the understanding of stakeholder and road users' perceptions.

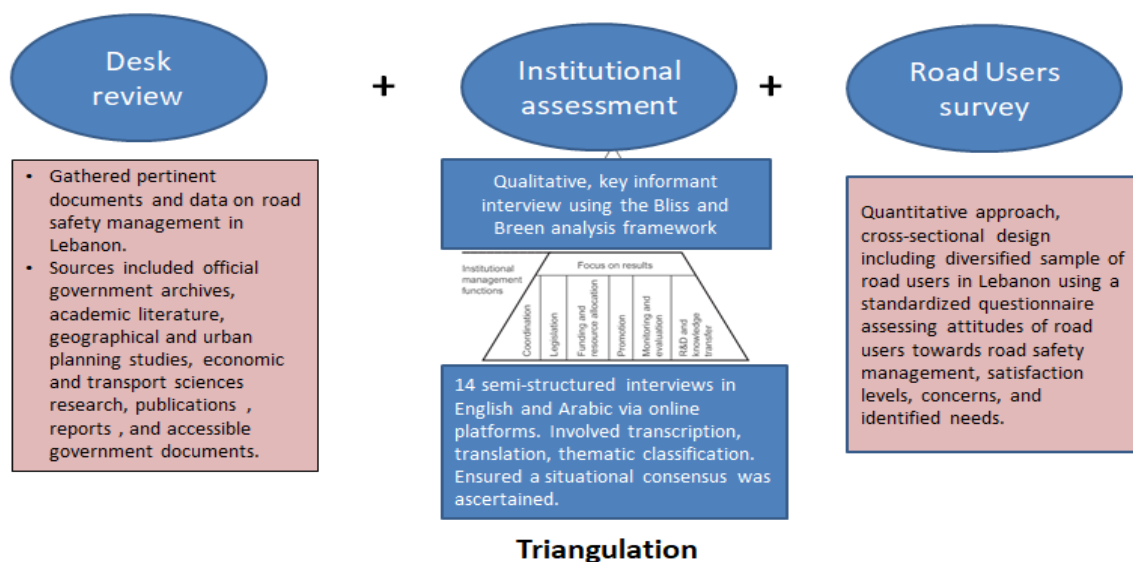

Figure 5: Method used for situational assessment of road safety management in Lebanon

I.3.1. DESK REVIEW

The first step utilized a desk review to gather pertinent documents on road safety management in Lebanon, including previous evaluations, monitoring reports, road safety policies, funding sources, legislative documents, and enforcement measures. Information was sourced from official government websites, academic journals, scientific studies in geography and urban planning, in-depth research in economics and transport sciences, publications from international organizations, non-governmental organizations' reports, and accessible government documents (Appendix 1). This step allowed us to describe the socio-economic, urban, environmental, historical, social, economic, and political factors influencing road

safety in Lebanon. Of note, information on road safety in Lebanon are scarce and challenging to obtain.

I.3.2. KEY-INFORMANT INTERVIEWS

The second step is an extension of the first. It involved interviewing relevant stakeholders and institutional actors to gather 1) insights into the current state of the road safety management system in Lebanon and 2) recommendations for addressing road safety issues at the national level. This empirical examination among institutions aimed to deepen understanding of the situation and the dysfunctions of public road safety policy in Lebanon, based on the model of Bliss and Breen (T. Bliss & J. Breen, 2009) (Figure 6).

Firstly, the population of interest for this assessment was identified. It consisted of key stakeholders from the government, private sector, academia, and law enforcement officers involved in decision-making and policy formulation regarding road safety management (Appendix 2). Secondly, diversity and variation among informants was adopted to capture various perspectives and experiences related to road safety management. Factors such as sector, role in road safety management, and expertise were taken into consideration. Triangulation of data sources ensured objectivity and enhanced the study's reliability and understanding. The saturation criterion was used to determine the endpoint of data collection, ensuring that new data would not significantly contribute to understanding the phenomenon under study. Practical constraints, such as time, budget, and stakeholder availability, were also considered. Key informants included stakeholders and individuals with direct or indirect roles in road safety management in Lebanon, selected based on their involvement in road safety management functions and their consent and willingness to collaborate.

Based on a list of stakeholders previously utilized during the preparation of the global road safety report, contact information of potential stakeholders was acquired. Subsequently, the potential key informants were contacted via phone calls to obtain their oral consent to participate, followed by an email (Appendix 3), including suggested interview dates and times.

When encountering challenge of reaching a potential stakeholder for the institutional assessment, proactive steps were taken to address the situation such as the identification of other individuals within the same institution who possess relevant knowledge related to road safety. Once alternative contacts were identified, efforts were made to reach out to them and explain the purpose of the interview, seeking their participation and willingness to provide insights. Once confirming the availability of the alternative stakeholder, the key informant

interviews proceed as planned. Changes were documented along with reasons for the replacement and relevant details about the alternative stakeholder. Interview times were determined based on the preferences of the participants.

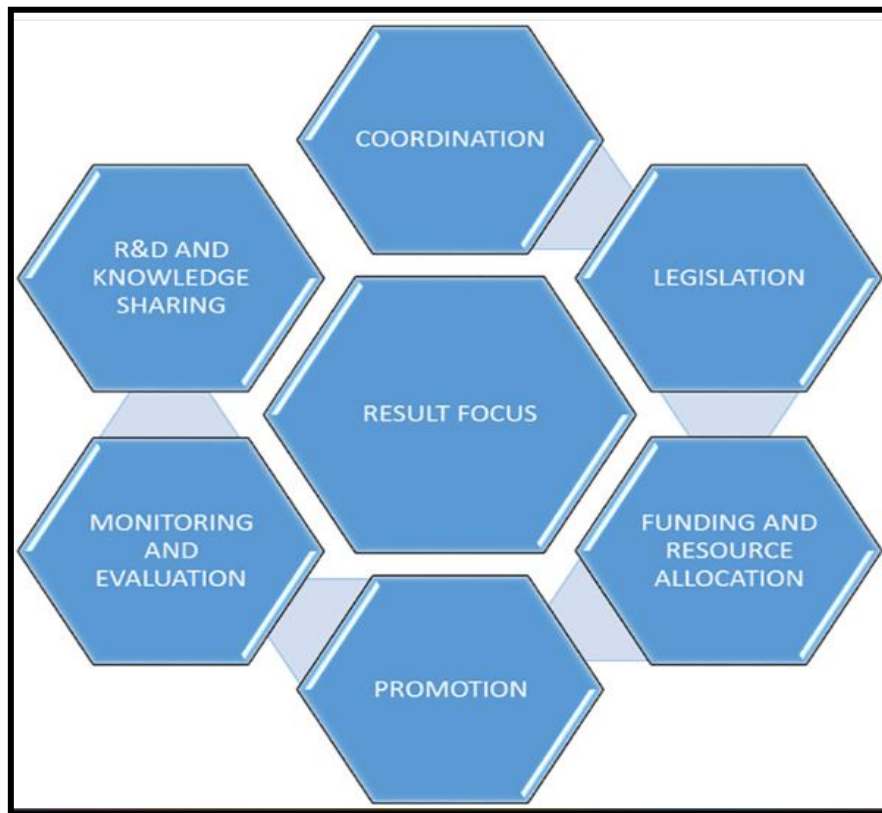

Figure 6: Institutional management functions (Bliss and Breen)

INTERVIEW PROCESS

A semi-directive interview guide was developed for the situational analysis of the road safety management system in Lebanon. This guide served as a structured framework to direct respondents through the interview process, while allowing flexibility in question sequencing. It began with a clear introduction to the study, outlining rules of engagement and ensuring respondent anonymity. It also included open-ended questions designed to elicit reliable data grounded in the knowledge and experiences of interviewees. It concluded with appreciation for participation and a reminder of confidentiality.

The guide's development involved three steps: listing points to address in the interview, highlighting Lebanese-context keywords, and creating individual records for key informants. The consent form and the interview questionnaire/guide are provided appendices 4 and 5. The success of these interviews depended on establishing a relationship of trust between the interviewer and the informant. In spite of the flexibility of individual interviews that allows

interviewees freedom of expression within the study's scope, interviewers have guided discussions back to the research topic when necessary.

A total of 17 semi-structured interviews were conducted, either in English or Arabic for convenience, between 20 March and 30 July 2020. This institutional assessment faced unique challenges amid the COVID-19 pandemic, implying an exclusively online approach to ensure the safety and well-being of participants and to comply with physical distancing recommendations issued by the Ministry of Public Health. Despite the shift to virtual platforms, proactive measures were taken to maintain the integrity and effectiveness of the assessment process. This transition presented logistical and technological hurdles, but it also offered opportunities for broader participation and flexibility in scheduling.

Participants who agreed to take part in the study underwent one hour-long interview covering various topics related to road safety management in Lebanon, including both objective questions and inquiries into their opinions and perspectives (Appendix 5). Every interviewee received an email containing a set of 26 open-ended questions and supplementary guidelines. These questions aimed to evaluate the functionality of Lebanon's road safety management, based on aspects such as the coordination among government organizations involved in road safety, the adequacy of legislation, the effectiveness of funding mechanisms, the implementation of promotional activities, monitoring and evaluation of the overall road safety program, and the outcomes of research and development endeavours. These interviews further explored facets such as the institutional framework, the presence of lead agencies or councils, budget allocations, and the existence of a national road safety strategy. Legal and financial aspects were examined, including legislation, enforcement practices, funding mechanisms, and a review of road infrastructure-related to road safety.

Information collected during these interviews was used solely for research purposes, with participant privacy protected. Upon approval and consent, interviews were either recorded with permission or only notes were taken. All information provided by participants was treated confidentially, with access restricted to authorized research members. Participants' titles and affiliations were recorded but not shared or included in any reports or publications. Participation was voluntary, with participants free to withdraw at any time without penalty, and their decision did not impact their relationship with any organization involved in this assessment. Measures were in place to minimize acknowledged minimal privacy risks.

ANALYSIS

Before starting thematic analysis, the interviews were transcribed, and then translated from Arabic to English. Ideas were classified according to themes (Appendix 6). Subsequently, the viewpoints of each institution were compared to generate a situational consensus across themes. To strengthen this analysis, a comparative assessment against international best practices and standards was undertaken, offering valuable insights into areas necessitating enhancement.

I.3.3. FOCUS ON DATA SYSTEM

A situational analysis was conducted to describe the current data systems collecting RTCs in Lebanon and to understand the strengths and weaknesses of these systems. The primary goal of this analysis is to identify gaps within the current data systems and provide insights into improving these systems, facilitating their integration with other valuable data sources.

SITUATIONAL ASSESSMENT

Following the WHO's Road Safety Manual for Decision-Makers and Practitioners (World Health Organization, 2010), a situational assessment was conducted, including four steps (Figure 7):

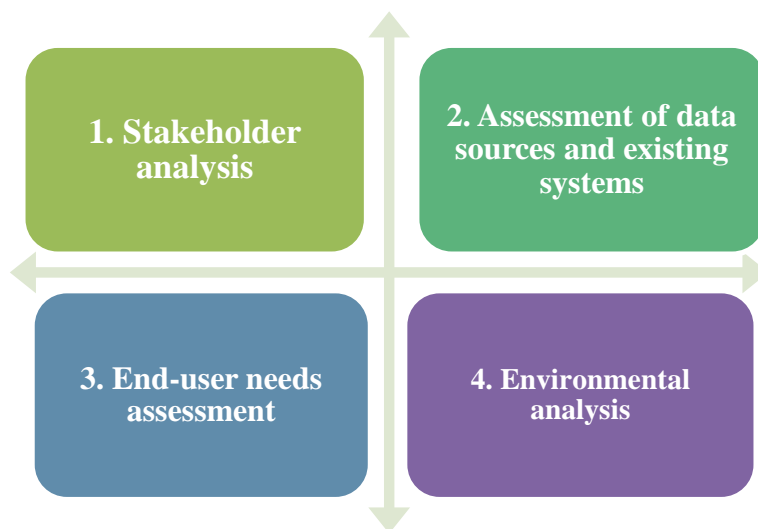

Figure 7: Situational assessment steps (adapted from Data System Manual, WHO 2010)

The stakeholder analysis focused on identifying relevant organizations, potential partners, and individuals engaged in road safety data collection and utilization. Stakeholders were grouped into three main categories: Potential stakeholders include the Lebanese Ministry of Interior and Municipalities, Ministry of Public Health, Lebanese Red Cross and EMS,

insurance companies, international organizations (WHO...), non-governmental organizations, hospitals, researchers, academics, and the Lebanese National Council for Scientific Research (CNRS). The assessment of data sources and existing system involved describing and assessing data from police, hospitals, and Emergency Medical Services (EMS) focusing on variables such as demographics, vehicle details, RTC circumstances, medical outcomes, and post-crash care.

CASE STUDY OF THE HOSPITAL-BASED RTI SURVEILLANCE SYSTEM

The piloted hospital-based RTI surveillance system was described and a retrospective analysis of the data collected round-the-clock from this system between March 2013 and December 2015, was performed using the Statistical Package for Social Sciences (SPSS) version 21.0 for analysis. The data underwent cleaning and were subjected to descriptive statistical analysis to elucidate patterns of RTI injuries. Frequencies and percentages were utilized for categorical variables. Geographical analyses, employing a GIS, were conducted to illustrate the spatial distribution of traffic crashes.

In terms of assessing injury severity, the study calculated the following trauma scores to rank the severity of RTIs:

- 1. The Revised Trauma Score (RTS):** This physiological scoring system, known for its high reliability and accuracy in predicting death, was computed using primary patient data, including the Glasgow Coma Scale (GCS), Systolic Blood Pressure (SBP), and respiratory rate. The RTS formula is as follows: $RTS = 0.9368 \text{ GCS} + 0.7326 \text{ SBP} + 0.2908 \text{ respiratory rate}$. The RTS values ranged from 0 to 7.8408, with a proposed threshold of $RTS < 4$ indicating the need for treatment at a trauma centre (Kim, Ulfarsson, Kim, & Shankar, 2013).
- 2. The Injury Severity Score (ISS):** The ISS is an anatomical scoring system that provides an overall score for patients with multiple injuries across various body regions. Each injury is assigned an AIS score, categorized into one of six body regions (Head, Face, Chest, Abdomen, Extremities, including Pelvis, and external). The AIS score is a numerical representation of the severity of an injury, typically ranging from 1 to 6, with 1 being minor and 6 being non-survivable. The AIS score for each body region is determined based on the nature and extent of injuries observed in that particular region of the body. This determination is typically made by healthcare professionals, such as emergency department physicians, who assess the injuries based on clinical examination, diagnostic tests, and medical imaging. The

highest AIS score in each body region is considered to evaluate the overall severity of injuries sustained by individuals involved in an RTC. Then, the scores of the three most severely injured body regions are squared and then summed to calculate the ISS score, which ranges from 0 to 75. If an injury is deemed non-survivable with AIS of 6, the ISS score automatically becomes 75. Major trauma is considered when $ISS > 15$. The ISS score is a widely used anatomical scoring system, linearly correlating with mortality, morbidity, hospital stay, and other measures of severity (Kim et al., 2013). Bolorunduro et al. established and confirmed the categorization of the ISS as: less than 9 for mild, 9 to 15 for moderate, 16 to 24 for severe, and 25 or higher for profound (Bolorunduro et al., 2011). Nonetheless, a significant drawback of the ISS is its limitation to assessing only one injury per body region. Consequently, this can result in the neglect of certain injuries and the inclusion of less severe injuries from other body regions in the calculation, potentially overshadowing more serious ones within the same body region (Stevenson, Segui-Gomez, Lescohier, Di Scala, & McDonald-Smith, 2001).

- 3. The Trauma Injury Severity Score (TRISS):** This score determines the probability of survival (P_s) for a patient, based on both the ISS and RTS, using the following formula: $P_s = 1/(1 + e^{-b})$, where 'b' is calculated from $b = b_0 + b_1(RTS) + b_2(ISS) + b_3(\text{AgeIndex})$ (Kim et al., 2013).

In addition, strengths and challenges associated with the implementation of this system were assessed using Strengths, Weaknesses, Opportunities, and Threats (SWOT) with a focus on opportunities for enhancement.

I.3.4. ROAD USER'S SURVEY

The primary objective of this survey was to comprehend the insights of road users regarding road safety management, challenges, needs, as well as their satisfaction with road safety management in Lebanon. This complements the insights gathered from the desk review and institutional assessment. Given the focus of this study, a cross-sectional study was conducted among Lebanese adults who used Lebanese roads on regular basis for their mobility using a self-administered questionnaire. This study is part of a large project entitled "Exploring factors associated with road users' satisfaction with road safety measures implemented in Lebanon using structural equation modelling".

QUESTIONNAIRE DEVELOPMENT

To ensure comparability with previous surveys, the majority of questions in the questionnaire were either updated from or directly taken from validated questionnaires used in Belgium and other European countries (J. Cestac, & Delhomme, P.,; Institute, 2014; Meesmann, Boets, & Silverans, 2014). The questionnaire, initially developed in English, was translated into Arabic to cater to the linguistic needs of the Lebanese population. This translation was conducted following the forward-backward translation, by two qualified translators proficient in both languages. Subsequently, another translator, who was blinded to the original English version, translated the Arabic version back into English (Appendix 7). Any discrepancies or inconsistencies between the original English version and the back-translated version were carefully examined and resolved through consensus among the translators and research team. To validate the questionnaire, both reliability and content validity were assessed. The reliability was assessed using Cronbach's alpha, to examine the extent to which the items within the questionnaire consistently measure the same underlying construct. The questionnaire had high internal consistency ($\alpha=0.83>0.7$). The content validity was ensured by reviewing the questionnaire by road safety experts to ensure that it covered all relevant aspects of road safety management and adequately represents the experiences and perceptions of road users items. Additionally, a pilot study was conducted with a sample of 56 road users from diverse regions of Lebanon to gather feedback on question clarity, comprehensibility of the questions and relevance and to update the questionnaire accordingly and generate the final version of the questionnaire.

The standardized Arabic questionnaire comprised closed-ended questions and consisted of four main sections:

- Sociodemographic characteristics of the participants, including gender, age, occupation, and education level.
- Travel patterns, encompassing variables such as distance travelled and travel regularity, purpose of travel, primary means of transportation, modal choice rationale, encountered difficulties, and needs.
- Previous experiences of road crashes, including both witnessed and experienced crashes, and perceived causes.
- Assessment of road users' satisfaction levels on various road safety-related components, utilizing a 5-point Likert Scale ranging from "most satisfied" to "most dissatisfied." Respondents were also asked to specify reasons for their dissatisfaction.

PARTICIPANTS

All Lebanese road users aged 18 or older, living in Lebanon, literate in Arabic, and willing to participate were eligible. The survey focused on respondents who were drivers, pedestrian, cyclist, motorcyclist, truck drivers or passengers, aged at least 18 years of age. The survey excluded individuals under 18 years old to focus on adult road users. The chosen respondents reflect the diversity of transportation modes and are distributed across all governorates in Lebanon (Bekaa, Baalbeck-Hermel, Beirut, Mount Lebanon, Nabatyeh, South, Akkar, North). Non-Lebanese residents were excluded to ensure the study reflected Lebanese perspectives. Illiterate participants, those unable to provide informed consent, including individuals with cognitive impairments, as well as participants who did not use Lebanon's roads during the data collection period were excluded.

SAMPLE SIZE AND SELECTION

While the minimum sample size required for a 95% confidence level and a 5% precision was 385 road users, considerations beyond this minimum were taken into account. The sampling procedure started with a decision to establish a sample size of 1 000 road users. This decision was made to ensure statistical power and enhance the reliability of the study findings. These considerations included the desired precision of survey estimates and resource constraints. By aiming for a larger sample size, the study could achieve greater accuracy in its estimates and better represent the diversity of road users across different regions of interest. Then, an allocation of the sample was made in proportion to the distribution of road users across different regions. This allowed us to gather diverse responses and comprehend how the insights of road users change with various geographical areas. In the second stage of sampling, road users were randomly selected from each region to fulfil the minimum sample size requirement, with an emphasis on achieving diversity within each region by considering various transportation modes and road user groups. Particular attention was paid to gender representation, aiming for parity by ensuring an equal number of male and female respondents, aligning with the road users' population composition of 45% women and 55% men. Additionally, efforts were made to promote diversity within the survey group by deploying data collectors to areas known for their diverse socioeconomic backgrounds.

DATA COLLECTION

The data collection procedure for the road users' satisfaction survey involved a face-to-face approach in a wide range of public settings such as streets and parking stations over a period

of three months, from the first of November 2019 until the end of January 2020. For pedestrians, cyclists, and motorcyclists, there was no difficulty in contacting the target individuals on the streets; it was simply a matter of being present on the road at the time of the data collection. For other modes of transport such as taxis, bus drivers, and public transport users, parking stations were visited. For truck transport users, companies owning truck fleets in different governorates were approached, and subsequently, the permission of the managers was sought to interview their employees.

The data collection was carried out by a team of 24 data collectors, all of whom were students pursuing majors in traffic studies at the Lebanese Higher Technical School. These students were selected for their academic background and expertise in the field. The involvement of the students in the data collection process was integrated into their academic curriculum. This practical training opportunity provided invaluable real-world experience for the students, aligning with their educational objectives and enhancing their skills in traffic studies and research methods. Prior to fieldwork, the 24 data collectors underwent training to ensure data collection quality and consistency. They were briefed on the study's objectives and research protocol, instructed on questionnaire administration, and educated on ethical principles. Training included practical exercises on interviews and survey administration, guidance on approaching participants, and adherence to standardized procedures. They also received guidelines for handling challenges during data collection. Role-playing exercises during classes and mock interviews were used to reinforce learning, allowing traffic students to practice and refine their skills before conducting surveys in the field.

To streamline the data collection process and ensure comprehensive geographical coverage, the team was organized into groups of three data collectors. Each team was assigned responsibility for conducting data collection activities within a specific governorate of Lebanon based on their proximity to the designated governorate. This division of tasks allowed for maximizing efficiency and enhancing the depth of data collection within each area. Survey participants were asked about their most frequently used mean of transportation. Based on predefined criteria (Table 4), the data collectors confirmed eligibility before administering the questionnaires. The research protocol underwent evaluation by the Higher Technical School and received ethical approval from its ethical committee. Participants received oral explanations of the study objectives and instructions, and written informed consent was obtained from willing participants. Road users participated voluntarily without incentives, with the option to withdraw at any stage. Anonymity and confidentiality of participants were maintained, and the questionnaire completion process typically lasted eight

minutes. Oral consent was obtained from participants (Appendix 8). All methods were performed following the relevant guidelines and regulations such as the “Strengthening the Reporting of Observational Studies in Epidemiology” (STROBE) guidelines for reporting observational studies. Participants have not received any compensation for their participation in the study.

DATA ANALYSIS:

Data were entered, cleaned, and analysed using SPSS software. Given the nature and the focus of this research, the analysis was limited to descriptive methods, without employing additional statistical techniques.

Table 4: Predefined sampling criteria based on the available road user data in Lebanon

Transportation mode	Governorate									Gender	
	Total	Beirut	Mont-Lebanon	Bekaa	Baalbeck-Hermel	South	Nabatyeh	North	Akkar	Male	Female
Pedestrian	210	31	53	21	21	21	21	21	21	115	95
Cyclist	40	6	10	4	4	4	4	4	4	22	18
Powered two-wheelers	140	21	35	14	14	14	14	14	14	77	63
Private car	230	35	57	23	23	23	23	23	23	126	104
User of public transport (Public buses)	80	12	20	8	8	8	8	8	8	44	36
Taxi user	100	15	25	10	10	10	10	10	10	55	45
Minibuses/vans	80	12	20	8	8	8	8	8	8	44	36
Private buses	60	9	15	6	6	6	6	6	6	33	27
Truck	60	9	15	6	6	6	6	6	6	33	27
Total	100	150	250	100	100	100	100	100	100	55	45

I. 4. RESULTS

I.4.1 ROAD SAFETY IN THE GEOGRAPHICAL AND HISTORICAL CONTEXT

With a total surface of 10 452 km², Lebanon is divided into eight administrative units or governorates (Beirut, North, Akkar, South, Nabatiye, Beqaa, Baalbeck-Hermel, and Mount Lebanon). Each of these eight governorates is further composed of several administrative units called “District/Kada,” and each Kada consists of several municipalities. The total number of districts in Lebanon is 25, and there are 1 561 municipalities in the country, with an average area of 6.7 km² per municipality.

Over the course of several millennia, the region's positioning along a prominent route connecting Europe, Asia, and Africa has exposed it to a multitude of empires and diverse cultures (Gohlke-Rouhayem, Melki, & Weinmann, 2016). Despite its relatively modest size, Lebanon is a densely populated country with approximately 6.8 million inhabitants (World Bank, 2022). A notable aspect of Lebanon's demographics is its urbanization, with a substantial 87% of this population presently residing in urban regions, with the largest portion, approximately 64%, concentrated in significant urban centres, primarily within the metropolitan areas of Beirut and Tripoli (UN-HABITAT, 2008). The Greater Beirut Area, encompassing the capital city Beirut and its adjoining southern and northern suburbs, serves as a hub which nearly half of Lebanon's population calls home (UN-HABITAT, 2021). Lebanon is renowned for its cultural, political, and economic openness to the world. In terms of human development, it occupies a middle-income position, reflecting its progress in various sectors. The nation's population is a tapestry of religious diversity, represented within a complex political system that allocates influence to various communities based on their demographics. However, Lebanon's journey has not been without its share of challenges that shape the road safety landscape in Lebanon. All these challenges constituted a fertile soil for aggravating the epidemiology of injury in Lebanon and its resulting human and financial burden.

Environmental and historical factors play a significant role in shaping the road safety landscape in Lebanon (Table 5). Geographically, Lebanon's mountainous terrain and challenging topography create winding roads, steep gradients, and narrow passages, which demand special attention to minimize risks, particularly during adverse weather conditions. The country's climate, spanning snowy winters in mountainous areas to scorching summers in lower regions, can introduce various road hazards such as snow and ice accumulation and

reduced visibility during heavy rainfall (Council for Development and Reconstruction). Lebanon is also prone to natural disasters like landslides, which can damage road infrastructure and disrupt traffic flow, and underscores the need for resilient road infrastructure (environment, 2011). Moreover, Lebanon's coastal location influences road safety through port-related traffic and cargo movement adding layers of complexity to transportation management. Urban planning and infrastructure layout, as well as natural resource extraction activities, contribute to the road safety equation (Council for Development and Reconstruction).

One of the turning points in Lebanon's history was the massive influx of Palestinian refugees following the establishment of the state of Israel in 1948. Lebanon has been an asylum for Palestinian refugees since the Arab-Israeli conflicts of the mid-20th century. This influx of Palestinian refugees had profound and lasting consequences for Lebanon (Khawaja, 2011). It not only changed the demographic composition of the country but also ignited political and social tensions. Over time, Palestinian refugee camps were established in Lebanon, and these camps became centres of political activity. The Palestine Liberation Organization (PLO), formed in the early 1960s, found a significant base of support and operational space within these camps, particularly in southern Lebanon (Dorai, 2008).

THE CIVIL WAR AND ITS AFTERMATH

The Lebanese Civil War was a dreadful conflict that raged on from 1975 to 1990. It was ignited by an intricate mix of internal and external forces, with the Palestinian issue occupying a central position in the conflict (Haugbolle, 2011). The war's devastating effects were not limited to human casualties and political divisions; its impact on the country's roads was profound. Widespread physical destruction occurred as roads, highways, bridges, and tunnels were targeted and damaged during the conflict. The war also isolated regions within Lebanon, with roads becoming frontlines and civilians struggling to travel safely between areas. Routine road maintenance ceased, resulting in further deterioration. The conflict had left the country in a state of economic turmoil. The aftermath of the civil war posed arduous challenges for the reconstruction of Lebanon's road network, including securing funding and coordinating efforts (Silva Neto, 2010). As a result, the task of rebuilding and rehabilitating the nation's infrastructure was not only daunting but also financially burdensome. The Lebanese government found itself grappling with limited fiscal resources, making the swift reconstruction of the devastated infrastructure a challenging endeavour.

In 1989, a significant turning point in Lebanon's history occurred when the nation signed the Taif Agreement, officially titled the “Document of National Entente” (Krayem, 1997.). This historic agreement represented a pivotal moment aimed at bringing an end to the prolonged civil war, fostering hopes of peace and reconciliation.

Table 5: Political, financial, external and internal security events after year 1984, updated from Factors behind the dynamics of land use evolution: case of Lebanon (Al-Shaar & Bonin, 2021).

Event and a brief description	Time period
Civil war (1975–1990)	1984–1990
Israeli conflicts with Lebanon: land occupation in South Lebanon	1984–2000
Start of Syrian tutelage	1990
Start of the post war reconstruction	
Lebanese—Israeli conflict	1993
Reconstruction of city centre	1994
Founding of Solidere company to manage the rent real estate in Beirut’s downtown	
Lebanese—Israeli conflict	1996
Pegging the Lebanese’s national currency (Lira) to the United States Dollar (USD) at 1500 for 1 USD	1997
Israeli withdrawal from the South of Lebanon	2000
11 September attacks in the United States	2001
The 11 September attacks in the United States have boosted the influx of Saudi shareholders in Lebanese companies. The attacks also diverted the Saudi funds in the United States to Lebanon and Arab countries	
Paris I conference: external loans to reinforce the Lebanese national economy	
Paris II conference: external loans to reinforce the Lebanese national economy	2002
Injection of money deposits from the Iraq after the Iraqi-US war (because of instability and violence activities) to the Lebanese banks	2003–2014
Enacting a new construction law: Significant increase in the total land exploitation, and the authorization of higher constructions	2004
Assassination of Prime Minister Rafic Hariri	2005
End of Syrian tutelage	2005
Lebanon Israel war	2006
Post Lebanon-Israel war reconstruction	2006
Stockholm conference: external loans to reinforce the Lebanese national economy	2006
War on militant terrorist organization in Nahr El Bared camp in North Lebanon	2007
Paris III conference: external loans to reinforce the Lebanese national economy	
Presidential vacuum	
World economic crisis	2008

Influx of money deposits and short-term investments from the Arabic Gulf Countries	2008–2014
Civil strife	2008
Internal security conflicts and protests	
Presidential election	
Real estate bubble: Accelerated growth in the real estate market	2008–2014
Arab Spring: Series of anti-government protests in Tunisia, Libya, Egypt, Yemen, Syria and Bahrain	2010–2012
Injection of money deposits from the Arab Spring countries (because of instability) to the Lebanese banks	
Start and spill over of the Syrian Civil war	2011
Lebanese protests against the government	
Arrival of Syrian refugees	2011–2013
Significant subsidization of housing loans by the Lebanese Central Bank through commercial banks	2012–2018
Oil crash	2014
Presidential vacuum	2014–2015
Terrorist activities—security conflicts caused by the terrorist group: “Islamic State in Iraq and the Levant (ISIS)”	2014–2017
Lebanese protests against the waste crisis	2015–2016
Presidential election	2016
Collapse of the National Economy: Start of Financial Engineering Mechanisms by the Lebanese Central Bank	2016–2020
Lebanese war on the terrorist militant group: ISIS	2017
General Parliamentary Election	2018
Start of Economy’s Deterioration: Lebanese Protests against government	2019
Drop in the value of the Lebanese Pound to US Dollar	
COVID-19	2020-2022
Beirut Blast	2020
Fuel crisis	2020-2021
Conflict Israel and Lebanon	2023

The aftermath of the war saw an essential focus, the restoration of Lebanon's transportation infrastructure. The reconstruction of transport infrastructure represented a critical element in reconnecting communities, revitalizing the economy, and reintroducing a sense of normalcy to the lives of the Lebanese population. In the wake of the Taif Agreement's signing, determined but intermittent endeavours were set in motion to tackle the urgent task of reconstructing the transportation networks. The path to full recovery was strewn with challenges and resource-intensive efforts. Lebanon grappled with a range of obstacles, including financial constraints, intricate political dynamics, and external pressures, throughout its arduous journey toward rehabilitation.

The economic hardships endured throughout the post-war era from 1995 to 2007, despite the implementation of an economic recovery plan. Lebanon's economic growth during this period failed to meet the expectations set forth, forcing the government to turn to debt-oriented strategies to sustain the country's finances. This financial strain became particularly evident as Lebanon struggled to secure adequate funding to realize the ambitious objectives laid out in the "Horizon 2000" plan. To address these pressing economic challenges, international conferences convened in Paris, marking significant efforts to bolster Lebanon's economic resurgence (France, 2007). These conferences served as tangible demonstrations of the profound economic issues confronting the nation and the urgency of external support to navigate these complexities (International Monetary Fund, 1999).

In a recurring pattern, Lebanon found itself embroiled in yet another conflict in 2006 with Israel. This 33-day devastating episode exacted a severe toll on Lebanon, encompassing extensive damage to its transportation network (Kotia, Edu-Afful, & Jun, 2014). Lebanon's main road infrastructure suffered extensive destruction. The conflict also resulted in a blockade that impeded the flow of goods and services (ReliefWeb, 2006). The toll on the business sector was significant, with more than 900 small and medium-sized enterprises being decimated by the conflict's destructive forces (2007). The assessment of the damage to Lebanon's infrastructure stands at a minimum of 3.5 billion US dollars. This total includes two billion dollars allocated for building repairs and an additional 1.5 billion dollars designated for the restoration of bridges, roads, and power plants (Deutsche Presse Agentur, 2007).

Between 2007 and 2010, during the post-conflict reconstruction phase, the government of Lebanon adopted a strategic focus on infrastructure enhancement projects designed to attract additional investments (Fund, 2007). The engagement of the private sector translated into substantial investments, infusing the country with an economic surplus that played a vital role

in its recovery (Programs, 2015). This period witnessed robust economic growth, with the economy expanding at an impressive annual rate of 8%. Moreover, Lebanon's tourism industry experienced a noteworthy resurgence, as evidenced by data from the Ministry of Tourism, which reported that over 2 million visitors explored Lebanon in 2010 (Investment development authority of Lebanon, 2013). This economic rejuvenation, fuelled by strategic infrastructure initiatives and private sector participation, not only resuscitated Lebanon's economy but also had significant implications for its road safety landscape and transportation sector development.

THE SYRIAN REFUGEES AND COVID-19 CRISES

As of 2011, the onset of the Syrian conflict introduced new and complex economic and demographic dynamics. Economic growth experienced a marked decline, plummeting to a modest 1.5% in 2011 (Özkan & Lajunen, 2005a). Paradoxically, Lebanon demonstrated remarkable resilience by hosting a significant influx of over 1 million Syrian refugees by late 2014 (United Nations High Commissioner for Refugees, 2014). According to the Lebanon Crisis Response Plan (LCRP) for the period 2017–21, updated in 2021 (United Nations High Commissioner for Refugees, 2021), Lebanon accommodates a population of 1.5 million Syrian refugees, in addition to 208 800 Palestinian refugees (LEBANON, 2020).

These changes in population dynamics not only presented Lebanon with new social and economic challenges but also had implications for road safety management, transportation infrastructure, and overall governance as the nation adapted to these evolving circumstances. Road traffic injuries constitute a significant source of harm in both resident and refugee populations. The absence of robust road safety measures, coupled with inadequate compliance and enforcement, emerges as a primary factor contributing to the elevated incidence of road traffic injuries among both local and refugee populations alike (Samar Al-Hajj, Chahrour, Nasrallah, Hamed, & Pike, 2021).

The COVID-19 pandemic has cast a complex and far-reaching impact on road safety worldwide. As lockdowns and restrictions ushered in reduced traffic volumes, a temporary decline in RTC was observed in many countries (Gong, Lu, & Yang, 2023) including Lebanon. This was revealed by the decrease in the absolute number of RTC reported by the Internal Security Forces (ISF). Moreover, the pandemic imposed significant strains on healthcare systems (Abou Hassan, Bou Hamdan, Ali, & Melhem, 2023), resulting in delayed emergency response times. Furthermore, an increase of excessive speeding has been attributed to a significant reduction in traffic volumes and the resulting empty roads and a

decrease in traffic speed enforcement, leading to RTCs. Moreover, the use of certain modes of transportation, like walking and cycling became more common during the pandemic. This shift has given rise to new types of RTCs that should be carefully monitored and included in road safety analysis using appropriate data methods. Additionally, the economic challenges stemming from the pandemic may have affected individuals' capacity to maintain their vehicles adequately, thereby potentially contributing to RTCs (Lyana Alameddine, Jawhar, & Sarah Abdallah, 2021).

THE BEIRUT PORT BLAST AND ECONOMIC COLLAPSE

On August 4, 2020, a disastrous blast rocked the port of Beirut, leaving behind a trail of widespread destruction throughout the city and its surroundings. This catastrophic event claimed the lives of a minimum of 200 individuals and inflicted damages amounting to over US\$15 billion (Devi, 2020). This heart-wrenching incident unfolded against the grim backdrop of an already crippling financial and economic crisis that had gripped Lebanon since October 2019. The Beirut blast had a profound and multifaceted impact on road safety in the city and its surroundings. Traffic congestion surged as alternative routes were sought, leading to increased RTC risks and travel delays. In addition, the explosion resulted in significant destruction to urban healthcare facilities, leading to the interruption of medical services they offered. Additionally, it caused disruptions to the medical supply chain and had a profound impact on the broader healthcare infrastructure (S. Al-Hajj, Ghamlouche, Nasser AlDeen, & El Sayed, 2023). Therefore, access to medical care for victims was also affected due to the strain on healthcare facilities around the epicentre. Moreover, the psychological impact of the blast may have caused heightened stress and anxiety among drivers and pedestrians, impacting their decision-making and increasing the risk of RTCs. Additionally, the security environment post-explosion could have led to changes in traffic patterns and restrictions.

According to the World Bank Lebanon Economic Monitor Fall 2021, the crisis's severity ranks among the top ten, possibly even the top three, most catastrophic economic collapses globally since the 1850s (Damjanović, Mičić, Matović, Jovanović, & Bulajić, 2022). Lebanon's real GDP was projected to plummet by 10.5% in 2021, following a drastic 21.4% contraction in 2020. Lebanon's GDP has fallen from its 2019 level of nearly US\$52 billion to an anticipated US\$21.8 billion in 2021, a staggering 58.1% contraction. Lebanese citizens are grappling with constrained access to their bank accounts, paucities of essential goods, overstrained healthcare facilities, and a financial crisis that hinders the government's aptitude

to maintain basic infrastructure (Bou Sanayeh & El Chamieh, 2023). The prolonged economic strain leads to adverse outcomes in the realm of road safety: aging vehicle fleets, stemming from reduced purchases of new vehicles, may lack safety features and become more susceptible to mechanical failures; vehicle owners may not be able to conduct essential maintenance, resulting in broken brake systems or worn-out tires (Lyana Alameddine et al., 2021). In addition, high stress levels and extended working hours during economic downturns can adversely affect driver concentration while driving due to fatigue and impaired mental states. Furthermore, traffic violation enforcement was squeezed by budget cuts. The lack of enforcement has encouraged risky driving behaviours. Strained healthcare systems caused delayed emergency responses.

Lebanon is currently facing a significant reckoning that has its roots in extensive corruption, a pervasive culture of patronage and cronyism, ineffective governance, and a disturbing lack of accountability. The World Bank, in a scathing critique directed at Lebanon's political leadership, has characterized the present crisis as a "deliberate depression" resulting from governmental inaction (Damjanović et al., 2022). Lebanon's perpetual political instability, characterized by frequent changes in government and ongoing social unrest, has had a profound and multi-dimensional impact on road safety. This situation has led to reduced law enforcement on the roads, resulting in a higher prevalence of traffic violations, such as speeding and reckless driving. The political instability has directly affected the government's capacity to allocate funds for road safety campaigns, infrastructure enhancements, and emergency response services. The deterioration of road infrastructure, combined with population movements driven by political turmoil, has further compounded road safety challenges. Additionally, the inconsistency in government policies and legislation due to frequent leadership changes has impeded sustained efforts to improve road safety.

The deepening fuel crisis has triggered frequent power outages in Lebanon which plunge the country into darkness and harshly impact road safety (Reason et al., 1990). The paucity of fuel has disturbed the functioning of traffic lights and signals on roads and inadequate street lighting which compromised visibility for drivers and other road users, especially during nocturnal hours. The ramifications extend beyond immediate safety concerns where traffic congestion and prolonged delays that often accompany power outages, could trigger anger and frustration among drivers, which in turn increase the propensity for risky driving behaviours. Furthermore, the prolonged waiting times in these congested areas can drain vehicle engines and systems, resulting in breakdowns or technical failures. The fuel shortage

has also prompted long queues of vehicles snake around fuel stations, leading to recurrent traffic jams.

I.4.2. THE BURDEN OF ROAD INJURY IN LEBANON

NATIONAL STATISTICS

According to the ISF, Lebanon's road safety landscape has seen a series of transformations and fluctuations over the years. From 1980 to 1985, there was a noticeable increase of 28.5% in road fatalities, with the numbers surging from 178 in 1980 to 249 in 1985. The period spanning from 1986 to 1990 marked relative stability, averaging around 230 road deaths annually. Following the end of the 15-year civil war, Lebanon witnessed a 28% increase in road fatalities, from 225 deaths in 1991 to 397 deaths in 2004. This concerning trend was exacerbated by economic challenges, a decline in public transportation services, and a surge in private vehicles. From 2005 to 2007, there was an increase of 30.5%, with fatalities rising from 345 in 2005 to 497 in 2007. This trend continued from 2008 to 2010 (Figure 9), with fatalities persistently on the rise, registering a 13% increase from 478 in 2008 to 549 in 2010 (Farah & Laurent, 2021).

The Syrian conflict in 2011, coupled with the influx of Syrian refugees into Lebanon, coincided with yet another spike in road deaths. From 2011 to 2014, road fatalities witnessed a 23% increase, rising from 508 in 2011 to 657 in 2014, marking the highest number of road deaths in Lebanon. Syrians accounted for 10.2% of the total in 2011 and surging to 26% in 2014.

Starting from 2015, there was a discernible decline in road fatalities. Between 2013-2015 and 2015-2017, RTCs and fatalities saw reductions of 22.5% and 22.1%, respectively. This decline can be attributed to more effective law enforcement by the ISF, which included the imposition of fines for traffic violations. In April 2015, the partial implementation of a new traffic law played a pivotal role in enhancing road safety. Despite a decrease in the number of RTCs from 2007 to 2021, there has been a noticeable increase in road traffic injuries (RTI) during the same period. In 2007, there were 4,421 RTCs and 6,266 RTI, with 497 road traffic deaths. By 2021, the number of RTCs had decreased to 2,648, which is significantly lower than in 2007. However, the number of RTI had increased to 3,279, indicating a rise in injuries despite fewer RTCs (Figure 9).

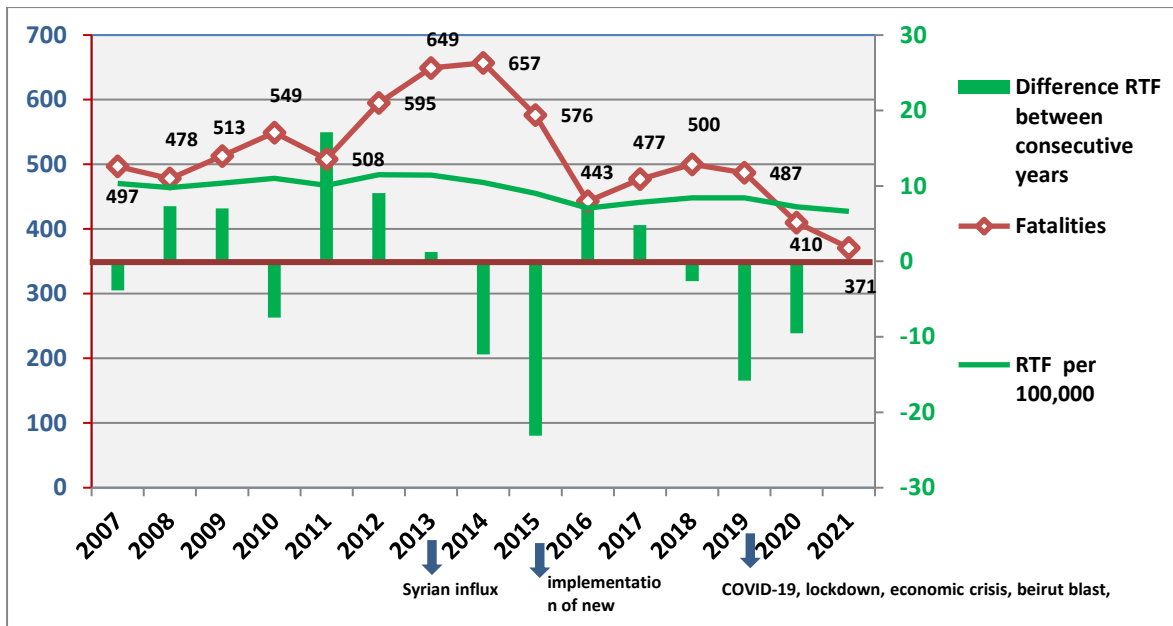

Figure 8: Road traffic fatalities trend in Lebanon 2007-2021 based on the ISF data

Road traffic deaths experienced fluctuations over the years but did not follow the same decreasing trend as collisions. In 2021, there were 371 road traffic deaths. The increase in RTIs despite a decrease in the number of RTCs over the latest years in Lebanon suggests a worrying trend (Figure 9). This pattern implies that the severity of RTCs, or the number of injuries occurring per RTC, has potentially risen during this period. In other words, each event is becoming more likely to result in injuries, indicating a heightened risk for individuals involved in RTCs.

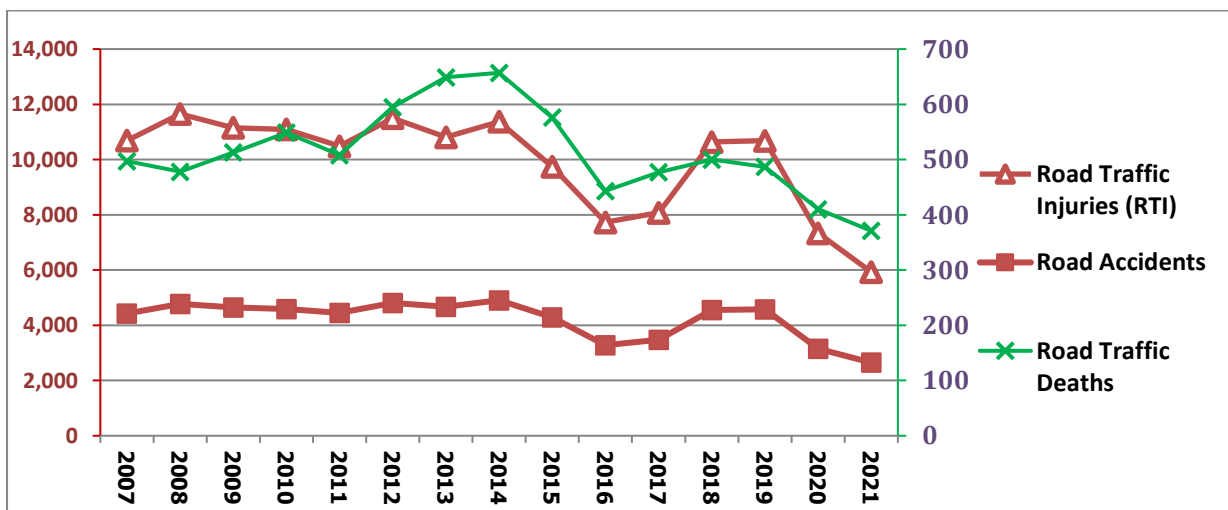

Figure 9: Trends in RTC, RTF and RTI, Lebanon 2007-2021

In 2016, Lebanon officially reported 576 road crash fatalities according to data from ISF. However, there existed significant disparities in the estimates, with the WHO offering a much higher figure of 1 090 road fatalities, while the Global Burden of Disease (GBD) study

estimated a lower count of 559 fatalities for the same year (Aberg & Rimmo, 1998). The WHO's assessment indicated a road fatality rate of 18.1 per 100 000 population within Lebanon for the year 2016. In contrast, the GBD's estimate suggested a lower rate of 6.68 per 100 000 population for the same period, a 3.4% decline in the fatality rate compared to the trend observed between 2013 and 2016.

The economic ramifications of RTCs in Lebanon were substantial, accounting for an estimated 5.4% of the country's Gross Domestic Product (GDP) in 2016, as per data provided by the WHO. Alongside the recorded fatalities, there were approximately 6 350 cases of serious injuries resulting from road crashes during that same year.

Notably, the impact of road crash fatalities and injuries was disproportionately concentrated within the economically active age groups, particularly those falling within the ages of 15 to 64 years old, accounting for approximately 81% of the incidents. Males between the ages of 15 and 49 years were found to be five times more vulnerable to experiencing fatalities compared to their female counterparts, shedding light on a specific susceptibility among this segment of the population. Additionally, it was estimated that there were 419 years of life affected by disability resulting from injuries sustained in road crashes for every 100 000 people.

In 2020, according to WHO, RTCs led to 1 127 deaths, constituting 3.3% of the total fatalities in Lebanon. The age-adjusted death rate was recorded at 16.6 per 100 000 of the population, positioning RTCs as the eighth leading cause of death in the country.

POSITIONING LEBANON IN THE REGION AND INTERNATIONALLY

Among Middle Eastern countries, the top five countries with the highest road mortality rates are Saudi Arabia, Syria, Jordan, Iraq, and Iran, all exceeding an estimated 20 deaths per 100 000 residents in the year 2016 (World Health Organization, 2018). In contrast, some neighbouring countries showed better road safety performance. For instance, the West Bank and Gaza Strip recorded 252 reported road fatalities in 2016, with an estimated fatality rate of 5.3 per 100 000 population (World Health Organization, 2018). This marked a 5.4% reduction in fatality rates from 2013 to 2016. Egypt reported 9 287 road fatalities in 2016, with an estimated fatality rate of 9.7 per 100 000 population, indicating a 4.7% decrease in fatality rates during the same three-year period (Figure 10).

Comparatively, Lebanon's road safety is better, although it still falls within a similar range as the United Arab Emirates, Kuwait, Oman, and Morocco (WHO, 2016). On a global scale, countries with robust road safety records include Switzerland, which reported 223 road fatalities in 2016, resulting in an estimated fatality rate of 2.65 per 100 000 population. This represented a 5.4% reduction in fatality rates from 2013 to 2016. Singapore recorded 155 road fatalities, with an estimated fatality rate of 2.76 per 100 000 population, experiencing a 4.9% reduction in fatality rates during the same period. Norway documented 143 road fatalities in 2016, leading to an estimated fatality rate of 2.72 per 100 000 population, despite a 2.4% increase in fatality rates from 2013 to 2016. Sweden reported 278 road fatalities in 2016, resulting in an estimated fatality rate of 2.83 per 100 000 population, along with a 3.2% reduction in fatality rates during the same three-year period.

Positioning of Country in Region (Compared to Countries with the Lowest Traffic Fatalities in the Region and Globally)

	2016 WHO Estimated Road Fatalities	2016 GBD Estimated Road Fatalities	2016 WHO Estimated Fatality Rate/100,000 pop.	2016 GBD Estimated Fatality Rate/ 100,000 pop.	% Trend in Fatality Rate/100,000 (2013-2016)	Motorization Registered Vehicles/100,000 pop.
Lebanon	1,090	559	18.1	6.68	-3.4%	31,072
BEST PERFORMING COUNTRIES IN REGION						
West Bank and Gaza Strip	252	-	5.3	-	-5.4%	5,602
Egypt	9,287	26,925	9.7	28.43	-4.7%	8,792
BEST PERFORMING COUNTRIES GLOBALLY						
Switzerland	223	334	2.65	3.89	-5.4%	71,182
Singapore	155	197	2.76	3.53	-4.9%	16,604
Norway	143	215	2.72	4.09	2.4%	75,544
Sweden	278	390	2.83	3.88	-3.2%	62,037

Figure 10: Positioning of Lebanon in region (source: (Global road safety facility, 2016))

ROAD SAFETY AMONG SYRIAN REFUGEES

Refugee status serves as a critical factor amplifying an individual's susceptibility to injuries, throughout their journey and settlements (Martinussen, Hakamies-Blomqvist, Møller, Özkan, & Lajunen, 2013; McPherson & rehabilitation, 2019). Although the vulnerable refugee population experiences a significant trauma and injury burden, the global health has primarily emphasized communicable diseases, often neglecting injuries (De Cock, Simone, Davison, & Slutsker, 2013).

Recent reports from Lebanon provide compelling evidence of these disparities, with refugees experiencing higher injury rates. In 2015, injuries constituted nearly 19.8% of hospitalizations among Syrian refugees, while the local community reported a lower rate of 14.9% (Türker Özkan, Timo Lajunen, Joannes El Chliaoutakis, Dianne Parker, & Heikki Summala, 2006a). A study examining the characteristics, risk factors, and outcomes of injuries affecting the refugee community in Lebanon showed that the majority (73.7%) of RTI resulted from motorcycle collisions. None of the injured refugees were observed using safety precautions such as helmets (head or full-face helmets), protective gear, or proper boots while riding motorcycles (Samar Al-Hajj et al., 2023).

The increased susceptibility of refugees in Lebanon to RTCs stems from a multifaceted interplay of factors, presenting a complex challenge. Firstly, the substantial presence of Syrian refugees in Lebanon, numbering over a million individuals, significantly affects the demographic landscape and intensifies road safety challenges. Within this population, a diverse age distribution prevails, with a significant segment comprising children and young adults who exhibit heightened vulnerability to RTCs. This vulnerability arises from factors such as limited road safety awareness, inexperience, and risk-prone behaviours. Moreover, an analysis of road fatalities in Lebanon from 2014 and 2015 underscores the precarious situation of Syrian youth and children in road safety contexts. This analysis reveals that 34% of road fatalities involve young individuals aged 15-29, with 30% of them being of Syrian nationality. Intriguingly, a substantial 12.4% of these fatalities are children aged 0-14, and a striking 58% of them belong to Syrian origin, illustrating their disproportionate representation in these tragic incidents (Farah & Laurent, 2021).

Additionally, the Office of the United Nations High Commissioner for Refugees (UNHCR) highlights that a considerable portion of Syrian refugees in Lebanon, exceeding 500 000, falls below the age of 18. Alarmingly, approximately 300 000 of them lack formal education and literacy skills (Lajunen, Parker, Stradling, & Behaviour, 1998). This educational gap constitutes a significant challenge, underscoring a deficiency in road safety knowledge among Syrian refugee youth, rendering them more vulnerable to RTCs. Furthermore, a notable 24% of young individuals in Lebanon belong to the Syrian nationality category, which is a pivotal aspect in the context of road safety (Chaaban & El Khoury, 2016). Both Syrian refugee youth and their Lebanese counterparts share a common susceptibility due to their age, characterized by limited road experience that may lead to riskier behaviours.

Socio-economic factors, such as restricted access to formal employment, can influence the types of transportation employed by Syrian refugees, potentially leading to a greater reliance

on informal and less regulated modes. Unfortunately, these vehicles may not meet safety standards and are often operated by untrained drivers. The living conditions within overcrowded and informal settlements may contribute to substandard road infrastructure, further elevating the likelihood of RTC. Additionally, challenges concerning vehicle ownership and documentation among Syrian refugees can impact road safety enforcement and compliance with traffic regulations.

Furthermore, Syrian refugees may encounter specific risk factors, including children walking to school, limited access to healthcare in the event of injuries, and a potentially higher prevalence of vulnerable road users among their population. Their unfamiliarity with Lebanese roads, reliance on foot travel and lack of access to formal vehicle ownership documentation contribute to their overrepresentation among vulnerable road users involved in RTCs. Additionally, a limited awareness of road safety practices, coupled with economic pressures and difficulties accessing healthcare, compounds the risk among Syrian refugees. Syrian refugees, including children and adolescents, frequently adopt walking as a mode of transportation due to limited access to other means, rendering them more susceptible to road risks. Ultimately, the lack of familiarity with road infrastructure, and divergent driver behaviour, can collectively contribute to the heightened vulnerability of refugees to road crashes.

I.4.3. THE ROAD SAFETY SYSTEM (DESK REVIEW AND INTERVIEWS)

Despite the diversity of insights and orientations of stakeholders interviewed, key informants agreed on many observations such as the inadequacy of public transportation, the non-application of the traffic law, the spread of corruption and laxity, and the seriousness of RTC statistics. However, the analysis also showed that road safety is not considered a national priority. The "political will" to act on road safety remains a limited issue, which may also explain why there is consensus on a subject that ultimately interests few.

The evaluation of road safety policies and their enforcement in Lebanon reveals a mixed landscape marked by both commendable efforts and notable deficiencies. In assessing the adequacy and enforcement of road safety policies and laws, several key factors were considered by the interviewees.

EXISTING RELEVANT LEGISLATION AND REGULATIONS

Lebanon has developed legislation and regulations aimed at enhancing road safety. These initiatives align with international best practices and address some of the pressing road safety

issues. The partial implementation of the New Lebanese Traffic Law in 2015, following its publication in 2012, represented a significant step forward. Lebanon's traffic law aims to encourage responsible driving by strictly imposing traffic regulations and utilizing technology like radar devices. Of note, the cabinet took a decision to postpone the enforcement of the new traffic law of 2012. The road safety NGOs contested the cabinet decision submitted a case to the constitutional council which disapproved the cabinet decision. The law covers various aspects of road safety, including setting speed limits, emphasizing seatbelt use, penalizing drunk driving and mobile phone use, and introducing fines for violations such as running red lights and illegal parking. It enhances pedestrian safety, regulates motorcycles, ensures public transportation safety, mandates vehicle inspections, promotes eco-friendly practices, and outlines the powers of traffic police.

The law also establishes driver's license and vehicle registration procedures and enforces penalties to deter unsafe driving and improve overall traffic management (Traffic law). In addition, it introduced several significant novelties aimed at improving road safety and regulating traffic:

- Certified driving schools: The law mandated the establishment of certified driving schools to provide standardized and structured driver education and training programs. This measure aims to enhance the quality of driver education in Lebanon and promote safer driving practices.
- Points-based driving license: The introduction of a points-based system for driving licenses allows authorities to monitor and penalize drivers for traffic violations. Accumulating a certain number of points can result in the suspension or revocation of a driver's license, encouraging compliance with traffic laws.
- "Smart" license plates: The adoption of "Smart" license plates involves the use of modern technology, such as electronic chips and advanced security features, to improve vehicle identification and registration processes.
- National Road Safety Council (NRSC): The creation of a NRSC represents a coordinated effort to address road safety issues comprehensively. This council is responsible for formulating road safety policies, strategies, and action plans to reduce RTCs and promote safer road behaviour.
- Scaled fines: The implementation of scaled fines means that traffic violations are penalized based on the severity of the offense. This approach aims to deter reckless driving and encourage compliance with traffic regulations by imposing appropriate fines

corresponding to the level of violation. The effectiveness of these penalties depends on consistent enforcement (Gras et al., 2006b).

These novelties in the new traffic law were a significant step forward in enhancing road safety, improving driver education, and strengthening traffic enforcement. They reflect the government's commitment to addressing road safety challenges.

SAFE SPEED

In Lebanon, the national speed limits are currently set at 50 km/h for urban roads, 70 km/h for rural roads, and 100 km/h for motorways. These limits vary from the recommended Safe System Speed by +20 km/h for urban roads, while rural roads adhere to appropriate limits, and motorways have a +10 km/h difference. Rural roads, which currently align with safe limits, carry a low-risk profile.

To further enhance road safety, Lebanon has implemented major speed-calming measures. These measures include vertical deflections, which involve the use of tools like speed bumps, humps, cushions, and raised pedestrian crossings to slow down traffic effectively. However, narrowing strategies, such as extending sidewalks, curb extensions, and pedestrian refuges, aimed at creating lane narrowing to prompt a reduction in speed, have not been put into practice yet. Additionally, horizontal deflections, like chicanes and pedestrian refuges, which are employed to make vehicles swerve slightly and enhance safety, have also not been implemented at this time. In addition, block or restrict access measures, which encompass median diverters and closing streets to create pedestrian zones, are not used.

ENFORCEMENT CHALLENGES

“Lebanon's traffic law encounters enforcement challenges stemming from inconsistent implementation, delays in provisions, and judicial inefficiencies. The exacerbation of these issues by the economic crisis underscores the urgency of addressing them to enhance road safety”. (verbatim)

Despite these elements included in the traffic law, this law has faced significant challenges since its implementation. According to the interviewees, enforcement has been seasonal and inconsistent due to resource limitations and a lack of efficient implementation. Additionally, the delays in putting certain provisions into action have eroded the law's deterrent effect. Moreover, the judicial system's handling of traffic violation cases has been criticized for inefficiency and delays. Public awareness campaigns and improvements in road infrastructure

have been lacking, political instability has further hindered effective implementation, and budgetary constraints have also limited the law's potential impact as well.

The issue of insufficiently trained and skilled staff law enforcement officers is multi-faceted. Firstly, a considerable number of RTCs occur due to road users' non-compliance with traffic laws. This non-compliance may be attributed to a lack of awareness or education about road safety regulations. Therefore, enhancing public awareness and education campaigns could contribute significantly to reducing RTCs. Secondly, political interference in law enforcement is a concerning factor. When influential individuals or elected officials intervene to have fines cancelled or penalties reduced, it erodes the effectiveness of traffic law enforcement. This practice not only undermines the rule of law but also sends a message that there are exemptions for certain individuals, further encouraging disregard for traffic regulations. Thirdly, the inefficiency in traffic management compounds the problem. Effective traffic management involves not only enforcing traffic laws but also optimizing road infrastructure, signage, and traffic flow. Inadequate traffic management can lead to congestion, which in turn can increase the likelihood of RTC (Aalek, 2009). This predicament is further compounded by an unaddressed issue: an inadequate number of officers within the ISF, falling far below the legally mandated count, thereby leaving them ill-prepared to confront the prevailing road safety challenges. The earmarked positions remain vacant, resulting in a staggering shortfall of 6 000 officers across various departments, including the crucial road brigades. To illustrate, the Beirut Road Police, staffed with a mere 306 officers, falls conspicuously short of the prescribed 925 budgeted positions (Aalek, 2009). Additionally, the allocation of personnel among various departments exhibits inefficiencies, particularly when viewed through the lens of road safety. It has come to attention that certain non-road departments, such as the security and guard battalion of administrations and public institutions, are operating with an excess of staff, while the road brigades, despite their importance, grapple with a shortage. This is exemplified by the department responsible for personal protection, which maintains a workforce of 1 500 guards, underscoring the challenges in resource distribution (Aalek, 2009).

Furthermore, the distribution of police officers within the 18 road brigades themselves appears suboptimal and overlooks critical factors such as geographical coverage and population density. To illustrate, the Beirut brigades employ a mere 306 police officers, whereas the densely populated southern suburbs, as reported by officers, have only 621 officers within their brigades. Efforts aimed at rectifying this distribution anomaly have faced

resistance from senior personnel, who have proffered justifications rooted in legal, personal, political, and community considerations, thereby perpetuating the status quo (Aalek, 2009). The country's political instability and government turnover have further strained law enforcement efforts. Lebanon's dire economic situation, characterized by a severe financial collapse, has diverted attention and resources away from road safety (Salameh, 2022). As the country grapples with a collapsing currency, hyperinflation, and a banking crisis, investing in road safety measures such as law enforcement has not been a priority. This can result in reduced funding for training, equipment, and infrastructure necessary for effective traffic law enforcement. The severe devaluation of police salaries has significantly hindered the enforcement of traffic laws. This devaluation has adversely affected various aspects of traffic law enforcement, including the morale and motivation of law enforcement officers responsible for upholding traffic regulations. Furthermore, the depreciation of salaries can also negatively impact the morale of law enforcement personnel, affecting their overall job satisfaction and potentially leading to decreased job performance. Some officers sought alternative employment opportunities with better financial prospects, resulting in staffing shortages in traffic enforcement units.

POLICY

"Road safety initiatives in Lebanon transitioned from civil society-led efforts to government involvement. While progress has been made, challenges persist due to the absence of a comprehensive national strategy and clear fatality reduction targets." (verbatim)

As for policy, the interviewees consider that the history of road safety initiatives in Lebanon is marked by a transition from early civil society-driven efforts to active government involvement. Initially, road safety concerns were championed by road safety associations and civil society organizations even before government authorities became actively involved. Their proactive initiatives focused on raising awareness, advocating for safer road practices, and educating the public about road safety measures (Ziad Akl, 2010). Their early efforts laid the foundation for future developments in this critical area.

Government bodies such as the Traffic, Trucks, and Vehicles Management Authority and the Directorate General of Internal Security Forces started recently to play key roles in road safety management. However, road safety only relatively recently gained prominence on the government's agenda. A significant turning point occurred with the establishment of the NRSC in 2018, chaired by the Prime Minister. International best practices emphasize seven crucial functions for institutional road safety management, including results focus,

coordination, legislation, funding, promotion, monitoring and evaluation, and research and development (T. Bliss & J. Breen, 2009). Lebanon's institutional framework for road safety is centred on the general secretariat which serves as the lead agency responsible for coordinating road safety initiatives within the country.

This council is funded through the national budget, indicating a commitment to allocating resources for road safety efforts. While Lebanon has made progress in these areas, there is a continued need for effective leadership, results-oriented actions, and the development of a comprehensive road safety action plan. Furthermore, Lebanon currently lacks a comprehensive national road safety strategy, thus hindering the establishment of specific targets and initiatives, and to allocate funding for the implementation of road safety measures. Moreover, the lack of a clear fatality reduction target further underscores the need for a comprehensive road safety strategy. Setting specific targets and objectives is essential for measuring progress and evaluating the effectiveness of road safety interventions. Ultimately, challenges such as non-compliance with traffic laws, political instability, staffing issues, and funding constraints persist, underscoring the importance of sustained efforts to enhance road safety in Lebanon.

While Lebanon's legal framework has made notable improvements, there are areas where it falls short of international best practices. For example, the lack of a comprehensive road safety action plan and strategy with achievable objectives hampers the country's ability to address emerging road safety challenges systematically. Moreover, Lebanon still lacks a national observatory for mobility and road safety capable of collecting, analysing, and interpreting statistical data and evaluating the effectiveness of measures taken.

INSTITUTIONAL FRAMEWORK

The interviewees admitted that the institutional framework in Lebanon for addressing road safety has historically adhered to a conventional structure. The Ministry of Public Works and Transport has traditionally shouldered the responsibilities related to traffic management and the maintenance of transportation infrastructure. Conversely, the Ministry of the Interior has been entrusted with the critical mission of enforcing traffic laws and regulations while also overseeing victim assistance and relief efforts in the aftermath of RTCs. In recent times, Lebanon has begun to recognize the importance of adopting an inter-ministerial approach to road safety policy. This shift aims to enhance coordination and collaboration among various government bodies and stakeholders involved in road safety initiatives. The primary motivation behind this change is to create a more streamlined and effective framework for

addressing road safety challenges comprehensively. Remaining challenges include funding, political instability, and the complexity of addressing road safety concerns in a multifaceted socio-economic context.

KEY STAKEHOLDERS

Lebanon's road safety landscape is intricately governed by a triad of pivotal policy actors, each wielding its own unique influence and responsibilities. These influential actors are closely aligned with the Prime Minister's office, closely associated with the Ministry of Public Works and Transport, and integrally linked with the Ministry of Interior (Figure 11).

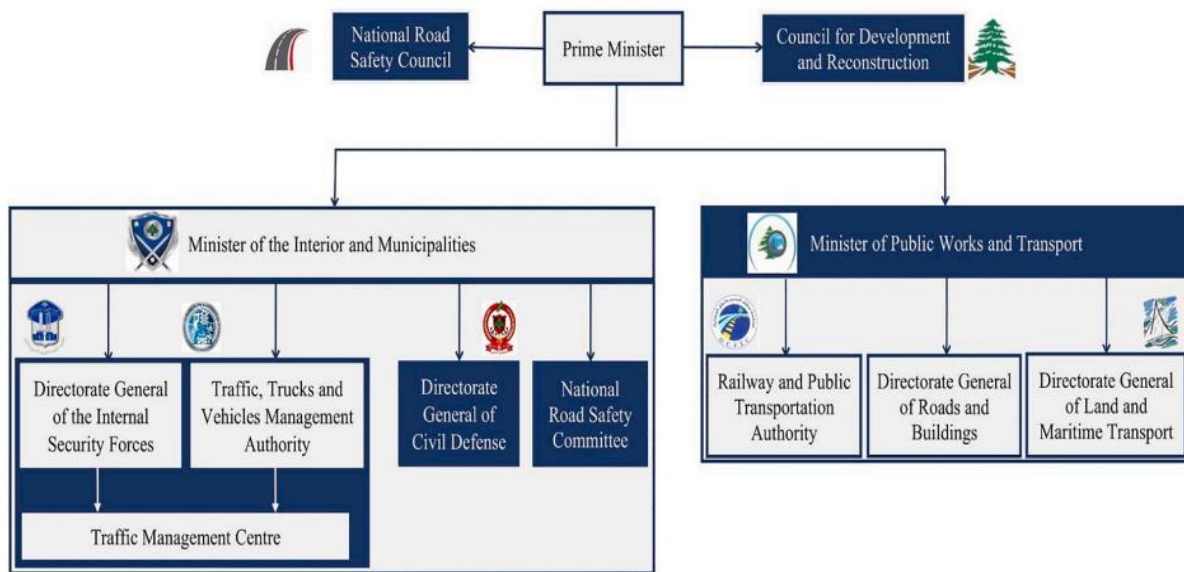

Figure 11: Key stakeholders involved in promoting road safety in Lebanon (Farah & Laurent, 2021)

THE COUNCIL FOR DEVELOPMENT AND RECONSTRUCTION

The Council for Development and Reconstruction (CDR), established in 1977, stands as a cornerstone in Lebanon's quest for infrastructure development and recovery. This institution, characterized by its institutional autonomy, functions independently while maintaining direct accountability to the Council of Ministers, primarily facilitated through the Prime Minister. Its array of responsibilities encompasses project planning, execution, funding, and urban development .

The CDR shoulders three primary responsibilities of paramount significance:

- **Strategic planning:** At its core, the CDR plays a pivotal role in formulating comprehensive plans and meticulous timetables designed to reinvigorate reconstruction and development efforts within the nation.

- Financial assurance: Equally pivotal is its responsibility to ensure the necessary funding for proposed projects, thus guaranteeing their fiscal viability and successful implementation.
- Project oversight: The CDR meticulously oversees the entire project lifecycle, from conceptualization to execution and utilization. This extends to the revitalization of public institutions, equipping them with the capacity to lead various projects under the aegis of the Council of Ministers .

Regarding road safety, the CDR actively supervises road construction, maintenance, and repair to meet rigorous safety standards. It consistently integrates safety features into infrastructure projects and actively participates in traffic management and urban planning. Its role includes ensuring that roads adhere to contemporary safety standards and receive adequate maintenance. The prioritization of safety features like road signs, traffic signals, guardrails, and pedestrian crossings in its road infrastructure projects is a key focus.

The CDR also engages proactively in urban planning and traffic management initiatives. It designs road networks and intersections with the primary objective of optimizing traffic flow, alleviating congestion, and reducing the likelihood of RTC. Additionally, it takes into account the infrastructure needs of vulnerable road users, encompassing pedestrians and cyclists, within its project considerations. The CDR places a premium on projects situated in areas with a history of hazardous road conditions or collisions.

While the CDR undoubtedly plays an indispensable role in Lebanon's ongoing efforts to reconstruct and modernize its infrastructure, it grapples with challenges tied to securing funding, navigating the complexities of political instability, and addressing the intricate socio-economic landscape of the country. Nonetheless, its contributions continue to be pivotal in propelling Lebanon's infrastructure development, fortifying its economy, and augmenting the overall well-being of its populace.

THE NATIONAL ROAD SAFETY COUNCIL

An entity presided over by the Prime Minister, the NRSC constitutes a unifying force, amalgamating the expertise of four key ministers vested with authority over road safety concerns. These ministers are the Minister of Interior and Municipalities, the Minister of Public Works and Transport, the Minister of Education and Higher Education, and the Minister of Justice. The NRSC stands as an indispensable inter-ministerial organ responsible for harmonizing road safety endeavours across various governmental domains.

This council is endowed with several pivotal missions:

- **Policy pioneering:** The NRSC takes the lead in conceptualizing and formulating government policies related to road safety, steering the nation's strategic direction in this vital realm.
- **Holistic supervision:** An integral aspect of its role is the comprehensive supervision of both public and private entities involved in traffic management and road safety.
- **Legislative enhancement:** The council actively contributes to the refinement and augmentation of traffic laws and road safety regulations.

The NRSC operates in dual capacities, wielding operational prowess in executing road safety initiatives while simultaneously donning the mantle of a vigilant supervisor overseeing the multifarious bodies vested with road safety responsibilities.

This Council plays a pivotal role in the strategic planning, coordination, and implementation of measures to foster road safety, thereby contributing to safer and more secure roadways for the benefit of the general public. While the inaugural council meeting took place in December 2015, it wasn't until March 2018 that the Prime Minister officially initiated the activities of the National Road Safety Council.

THE MINISTRY OF PUBLIC WORKS AND TRANSPORT

The Ministry of Public Works and Transport orchestrates its mission through two directorates and an authoritative body tasked with transport and road maintenance:

Railway and Public Transportation Authority (RPTA): Harking back to its inception in 1961 as the Lebanese State Railways (LSR) before its transformation into the RPTA in 1988, this entity's mission initially encompassed overseeing and managing the railway system (Hadi Baaj, 2000). While it operates under the aegis of the Minister of Public Works and Transport, it enjoys a remarkable degree of operational independence. However, financial hardships have constrained its role, confining it primarily to the management of a modest bus fleet (Osman, 2014).

Directorate General of Roads and Buildings (DGRB): Entrusted with the responsibility of designing new roads, as well as the upkeep and management of the road network, the DGRB stands as a linchpin in Lebanon's infrastructure development and safety enhancement endeavours. Of note, only the roads class belonging to the Ministry of Public Works and Transport, constituting the core national network. Many other roads are under the Ministry of Interior and Municipalities.

Directorate General of Land and Maritime Transport (DGLMT): Charged with the task of regulating the mobility of road users and the transportation of goods within Lebanese borders and beyond, the DGLMT shoulders a pivotal role. Its significance amplifies in the face of escalating vehicular traffic, transit, and freight operations.

THE MINISTRY OF INTERIOR AND MUNICIPALITIES

At the heart of road safety management in Lebanon lies the Ministry of Interior and Municipalities, which plays a pivotal role in traffic management and safety enforcement. Collaborating with three key bodies, this ministry is dedicated to combatting road insecurity:

- Directorate General of Internal Security Forces (DGISF):

The DGISF orchestrates the efforts of ten departments, three of which are intricately linked to road safety. This includes the Regional Gendarmerie Command, spanning Lebanon (except Beirut) and organised in four departmental gendarmeries, further subdivided into 13 road brigades staffed by 530 officers. The Beirut Police Command, with its multiple police units, including the Beirut Road Police features four road brigades across Beirut, reinforced by 306 police officers. Lastly, the embassies, administrations, and public institutions security command, house a road brigade within the Security and Guard Battalion of Administrations and Public Institutions. These 18 brigades jointly shoulder responsibilities ranging from traffic monitoring and law enforcement to RTC reporting and collaboration with the Ministry of Public Works and Transport in setting speed limits across all roads.

- Traffic, Trucks, and Vehicles Management Authority:

Operating under the umbrella of the Minister of the Interior and Municipalities, this authority assumes administrative supervision over its projects. Its pivotal role encompasses managing motor vehicle registration, overseeing traffic lights, conducting traffic studies, optimizing traffic flow, managing incidents, supervising parking spaces, and conducting informative campaigns targeting drivers and users to promote modern traffic management systems.

- Directorate General of Civil Defence (DGCD):

Primarily focused on disaster management and public safety, the DGCD engages in emergency response to RTCs and transporting victims to hospitals, conducts search and rescue operations, tackles firefighting and hazardous material incidents, collaborates with other government agencies, and engages in disaster preparedness planning. Collaborative efforts with the Lebanese Red Cross and training sessions on road rescue offered by non-governmental organizations and European Union agencies in Lebanon enhance its capabilities.

- National Road Safety Committee:

Chaired by the Minister of the Interior and Municipalities, this committee is a nexus, uniting stakeholder committed to road safety. Comprising nine high-ranking officials from various relevant ministries and public authorities, along with eight representatives from civil society organizations dedicated to road safety, it operates primarily as an advisory body. It provides counsel to the government on road safety policies, offers insights into road safety policy improvement, and possesses the authority to propose enhancements to the Highway Code and road safety regulations. Harnessing the expertise and perspectives of its members, the committee aims to contribute to the development of comprehensive road safety policies that prioritize the well-being and safety of all road users. Additionally, it plays a pivotal role in continually reviewing and enhancing traffic laws and regulations to align with evolving road safety needs and best practices, ultimately striving for reduced RTCs and improved road safety (Figure 12).

- National Secretariat for Road Safety (NSRS):

Chaired by a General Secretary, the NSRS constitutes a pivotal institution dedicated to the enhancement of road safety. The General Secretariat of the NRSC is placed under the Prime Minister. Its main pillars include 1) the Directorate for Road Safety Engineering Affairs, which focuses on road safety engineering research and initiatives.; 2) the Directorate for Road Safety Education and Awareness conducts educational campaigns and awareness programs to install a culture of road safety; 3) the Directorate for Traffic Law Enforcement and Follow-up Measures oversees enforcement activities and ensures adherence to traffic laws; 4) the National Observatory for Mobility and Road Safety is a comprehensive data and research hub monitoring mobility and road safety trends.

The Secretariat's primary responsibilities encompass research and development on road safety, conducting initiatives to enhance road safety measures and practices, preparing decisions for the National Council and Committee on road safety matters, and diligently following up on the implementation of decisions to ensure their effective execution and contribution to improved road safety outcomes. The National Secretariat for Road Safety assumes a pivotal role in advancing road safety initiatives and ensuring their successful implementation. It employs several support measures to bolster road safety efforts, such as the establishment of a Specialized Internal Security Forces Traffic Brigade dedicated to managing traffic-related matters and enforcing traffic laws. Additionally, the creation of a Traffic Management Centre in the Greater Beirut Area serves as a central hub for monitoring and optimizing traffic flow, reducing congestion, and ultimately improving road safety in this

densely populated region. Leveraging technology, radar is employed to detect speed violations, acting as a deterrent to speeding and promoting adherence to speed limits. Variable message signs are strategically placed at key entry points to the capital city, providing real-time traffic information and guidance to drivers, and facilitating safer and more efficient road use.

Despite limited financial resources posing a persistent obstacle to comprehensive road safety initiatives, and the need for effective coordination among various government entities and stakeholders remaining paramount, the NSRC remains committed to its crucial role in improving road safety conditions in Lebanon.

COORDINATION

“Lebanon should continue to foster collaboration among government ministries, civil society organizations, and international partners to prioritize road safety”. (verbatim)

The interviewees stressed on the need for a comprehensive approach to coordination to tackle the multifaceted challenges and progress towards desired outcomes in road safety. The significance of horizontal coordination among various agencies and vertical coordination between national, regional, provincial, and municipal agencies is widely recognized by the interviewees. While limited strides have been made in aligning interventions across these administrative levels, there are opportunities for enhancements to optimize results. Establishing strong partnerships for intervention delivery, involving agencies, industry stakeholders, communities, and the business sector, holds promise for improving road safety. While a small progress has been made in this area, achieving the intended level of collaboration and partnership requires further work. Regarding parliamentary committees and procedures supporting road safety, their significance is acknowledged, but their full alignment with road safety goals may vary. Continuous efforts are necessary to ensure that parliamentary support effectively complements road safety objectives. Although significant progress has been made, ongoing commitment is essential to fully realize the desired outcomes in the realm of road safety in the country.

In conclusion, Lebanon's evolving road safety policy landscape reflects a growing recognition of the need for inter-ministerial coordination and a comprehensive approach to address road safety challenges. To overcome these challenges effectively, Lebanon should continue to foster collaboration among government ministries, civil society organizations, and international partners to prioritize road safety and ensure the safety and well-being of all road users.

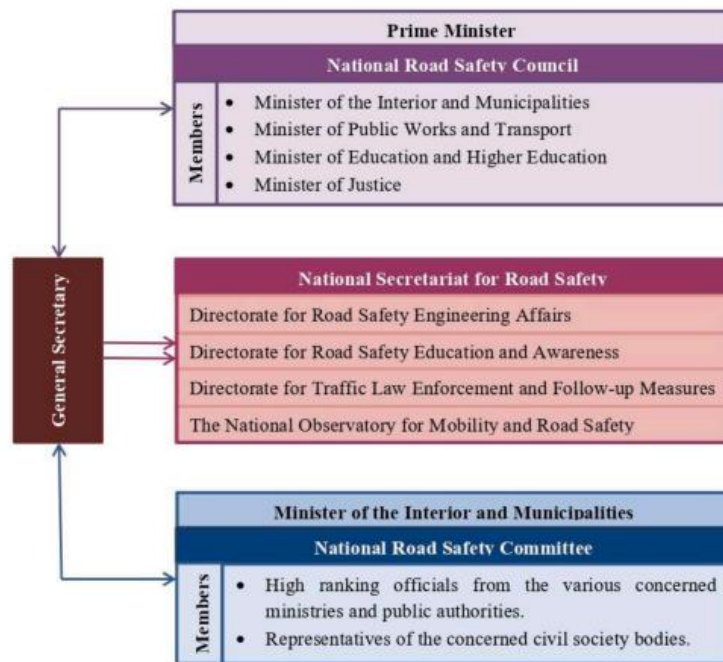

Figure 12: The hierarchical framework of Lebanon's road safety office

POST-CRASH CARE

“Urgent economic stabilization and reforms are crucial to safeguard Lebanon's healthcare infrastructure and ensure effective emergency response and post-crash care”. (verbatim)

The emergency response system encompasses various national emergency access telephone numbers, including 112 (Police), 140 (Lebanese Red Cross), and 125 (Civil defence). While it is commendable that Lebanon allocates a significant portion of its financial resources to healthcare, accounting for 8% of the GDP, the country falls slightly short of the SDG Target 3.8 Health Coverage Index, scoring 68 out of the desired 100 (Aberg & Rimmo, 1998). On the other hand, Lebanon faces persistent challenges in its post-crash care and its alignment with international standards. Notably, the absence of a unified national emergency care access number results in reliance on multiple numbers for various emergency services. Furthermore, the country lacks a Trauma Registry System, which hampers comprehensive data collection and analysis for trauma cases. Additionally, Lebanon has not undertaken a national assessment of its emergency care systems, a vital step in identifying strengths and weaknesses and facilitating necessary improvements to meet international standards in post-crash care. However, there is a formal certification system in place for pre-hospital providers. These challenges underscore the critical need for improved coordination, infrastructure development, and data-driven approaches to enhance post-crash care in Lebanon.

Despite the commendable allocation of resources to healthcare, the depreciation of the national currency has led to steep inflation, resulting in higher costs for essential medical supplies, equipment, and pharmaceuticals. This inflation has made these critical resources less accessible to both healthcare providers and the general population. Consequently, Lebanon's healthcare system faces considerable challenges, potentially affecting its ability to respond effectively to medical emergencies and provide adequate post-crash care. Urgent economic stabilization and reforms are imperative to safeguard the nation's healthcare infrastructure and ensure the well-being of its citizens.

ROAD INFRASTRUCTURE

“Despite economic plans for infrastructure, public transport remains inadequate, perpetuating reliance on cars and exacerbating traffic congestion and safety concerns”.
(*verbatim*)

The land transport sector consisted primarily of road-motorized vehicles due to the absence of suitable infrastructure for non-motorized vehicles. In the late 19th century, during the Ottoman Empire era, Lebanon initiated an ambitious project to construct an extensive railway network establishing vital connections with neighbouring nations (Hindi, 2020). However, Lebanon's civil war devastated its public transport system, resulting in its near-complete destruction. It destroyed the railway system, which included approximately 400 kilometres of rail and nearly 30 stations servicing four lines (Beirut-Damascus, Naqoura-Tripoli, Tripoli-Homs, and Rayak-Aleppo).

Despite attempts to resurrect the railways through economic stimulus packages, the astronomical costs involved and the considerable influence exerted by automobile dealerships and highway construction firms over policymakers rendered railway reconstruction unfeasible (M.Varzi, 2016). Similarly, a lone effort in the late 1990s aimed at revitalizing the public bus system through the acquisition of 200 newer-model buses proved short-lived. Today, the public bus system operates with less than 40 old-model buses, serving nine routes to accommodate a population exceeding two million individuals in the Greater Beirut Area (GBA) and its neighbouring regions (Baaj, 2002). Transportation in Lebanon is now exclusively governed by motorized vehicles due to the lack of suitable infrastructure for non-motorized modes of transport, such as bicycle lanes, secure storage facilities, and accessible and cost-effective bicycle rental systems. In 1992, the Lebanese government introduced an economic plan known as "Horizon 2000," slated for implementation between 1995 and 2007. This ambitious initiative aimed to secure approximately US\$17 billion in public investments,

with about 20% of the budget allocated for road and highway rehabilitation and 3% designated for enhancing public transport and railways (Labaki, 2003).

Moreover, there's a notable scarcity of resources required for the gradual improvement of the transport system, a situation that differs significantly from cities like Riyadh, which are actively investing in major public transport projects encompassing buses, metros, and monorails (**Figure 13**) (Transport, 2019).

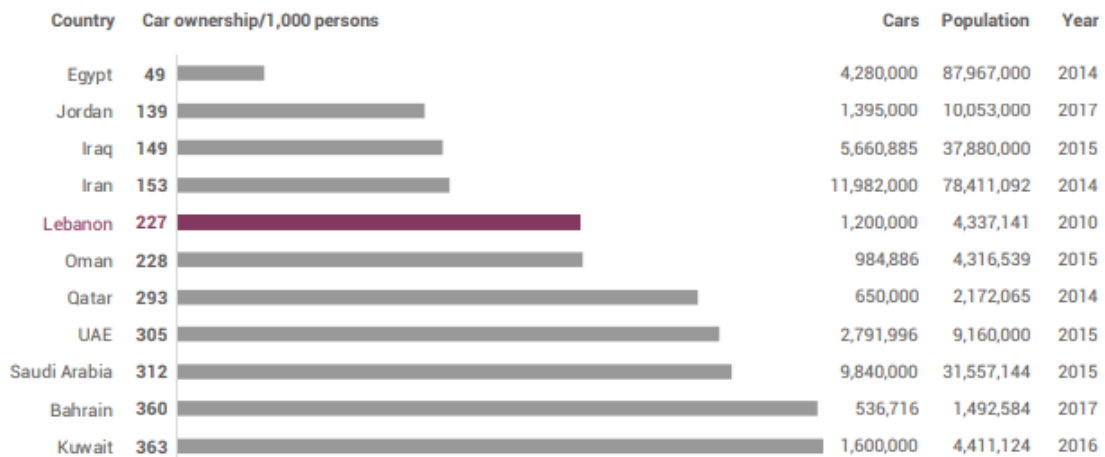

Source: Adapted from UITP (2019)

Figure 13: National car ownership rates per 1000 person in Middle Eastern countries, source: adapted from UITP (Transport, 2019).

Several factors contribute to RTCs including the inadequately developed and poorly maintained road infrastructure, which hampers traffic flow through issues such as potholes, a scarcity of street lighting and lane markings, the absence of merging and breakdown lanes, insufficient traffic signage and signals, and slippery road surfaces during wet weather conditions. Additionally, the influx of Syrian refugees into Lebanon since 2011 has further strained the transportation network. This phenomenon led to a notable increase in traffic volume, with an average surge of 20% in the GBA until 2013, escalating to as much as 50% in major cities hosting refugee populations (World Bank, 2013a).

Significant completed projects include the construction of a circular highway spanning approximately 40 kilometres, a vital initiative that has alleviated traffic congestion in Beirut. This comprehensive project encompassed the construction of bridges, tunnels, and associated utilities, with funding and support provided by the World Bank and European Bank (Boulos, 2021). Conversely, there are still pending projects aimed at enhancing public transportation,

which entail the development of new bridges, bus routes, railway lines, and associated facilities. However, these projects remain on hold due to the current economic situation.

Additionally, there is an ongoing project focused on road rehabilitation and maintenance, financially supported and backed by the World Bank. This initiative is geared towards improving road conditions and bolstering traffic safety, with a particular focus on rural areas facing infrastructure deficits. The project commenced its operations in December 2020, with the aim of enhancing road networks in these underserved regions.

VEHICLES AND MOTORIZATION DEVELOPMENT

Consequently, the nation experienced a remarkable surge in motorization rates over the last two decades, with registered vehicles increasing from around 500 000 in 1994 to 1 400 000 in 2007 (Waked, Afif, & Seigneur, 2015). Remarkably, this 64% increase substantially outpaced the 27% increase in the population over the same period, and by 2016, the number of registered vehicles had climbed to 1 866 407 (Rotter, 1966) (Table 6). However, the absence of data regarding the annual removal of vehicles from circulation, coupled with the prevalence of illegal vehicle operations without proper licensing, makes it challenging to provide a comprehensive characterization of the vehicle fleet (Ministry of Environment/LEDO, 2001). This trend, however, encountered substantial challenges due to the economic crisis that began in 2019 and the subsequent outbreak of the COVID-19 pandemic in 2020. Notably, this upsurge in travel demands was not complemented by commensurate developments in essential infrastructure and services. Furthermore, there have been no substantial initiatives aimed at encouraging and facilitating non-motorized transport alternatives within cities or on a national scale. Consequently, this has contributed to severe traffic congestion issues in urban areas and throughout the country, rendering Lebanon's transportation sector one of the least sustainable within the Middle East region (Haddad, Mansour, & Stephan, 2015).

Table 6: Evolution of the population and motorization rate in Lebanon between 1994 and 2016

Year	Population in million	Number of vehicles	Motorization rate (number of vehicles/1 000 inhabitants)
1994	2.97	500 000	168.35
2007	4.09	1 400 000	342.30
2016	6.00	1 866 407	311.07

Additionally, there are approximately 1.8 million registered vehicles as of 2016 (World Health Organization, 2018) This distribution can be delineated as follows: passenger cars accounting for around 85%, buses contributing 0.9 %, light-duty and heavy-duty vehicles constituting 7.4 %, and motorcycles comprising 5.2 % of the total (Ministry of Environment, 2015). The age distribution for passenger cars (both public and private) highlights the predominance of older vehicles within the fleet, with 71% surpassing the age of 10 years. Additionally, an analysis of the engine distribution within the passenger car fleet reveals a significant inefficiency trend, as 60% of the cars have engine displacements exceeding 2.0 Litres, while merely 8% possess engines of less than 1.4 Litres (MoE/URC/ GEF, 2012) ((Ministry of Environment, 2015).

Considering Lebanon's 2016 population of approximately 6 million (excluding Syrian refugees in border regions), this equates to an astounding ratio of over 311 cars per 1 000 individuals. Consequently, Lebanon ranks among the most motorized nations in the Middle East, largely due to the absence of viable alternatives to car utilization and the accessibility of favourable financial arrangements, such as low-interest car loans facilitated by banks and financial institutions (prior to the onset of the ongoing financial crisis) (Municipalities, 2015). The conjunction of a reliance on motor vehicles and high population density in urban centres is a major catalyst for RTCs and traffic congestion. This challenge permeates all of Lebanon's significant urban areas, with particular intensity observed in the Greater Beirut Area (GBA), which hosts over 40% of the country's population (Program, 2021). The GBA holds additional significance as Lebanon's central economic hub, witnessing an estimated five million daily private car trips in 2015. Moreover, an estimated average annual traffic growth rate of 3% for the period 2016-2020 (World Bank, 2016) exacerbates traffic congestion and increased risk of RTCs.

As for mass transport in Lebanon, it encompasses public and private buses, minivans, as well as exclusive and shared-ride taxis, all operating in an uncoordinated and ad-hoc manner. Despite the relatively high number of vehicles in the mass transport sector, the occupancy rates are notably low, with approximately 1.2 passengers per vehicle for taxis, 6 for vans, and 12 for buses (Ministry of Environment, 2012). Importantly, these services operate informally, lacking fixed routes, schedules, stops, central management, or coordination. Additionally, there is a notable absence of measures, equipment, or infrastructure to ensure accessibility for vulnerable groups such as the elderly and individuals with disabilities. Public transport in Lebanon falls significantly short of international standards, earning a reputation for being unreliable, uncomfortable, and unsafe. This subpar public transport system discourages

ridership and compels commuters to persist in relying on private vehicles. This situation contributes significantly to the overall unsustainability of the country's land transport sector. A comparison with cities worldwide, based on the modal share of private cars versus GDP per capita, places Beirut in the company of car-dependent cities with high levels of urban sprawl, resembling certain North American and Australian urban areas.

“Economic crises lead to reduced maintenance and suspended inspections, raising RTCs risks”. (verbatim)

In terms of vehicle standards, Lebanon's adherence to UN Vehicle Safety Regulations varies across different aspects. While the country has regulations in place for the import of used vehicles and import age limit, its adherence to international benchmarks, as outlined by UNECE WP.29, was notably lacking. Frontal and side impact (Reg. 94, 95) standards, electronic stability control (Reg. 140), pedestrian protection measures (Reg. 127), motorcycle anti-lock braking systems (Reg. 78) and seat belts and anchorages (Reg. 16, 14) were all absent from the regulatory framework. However, the country does conduct import inspections. Lebanon does not have provisions for periodic vehicle inspections, indicating a varied landscape of compliance with UN Vehicle Safety Regulations within the nation's regulatory framework. Additionally, Lebanese government chose to suspend or reduce the frequency of mandatory yearly vehicle inspections as a cost-saving measure during economic crises. This decision can result in a higher prevalence of vehicles with safety defects, as they may go unnoticed without regular inspections. As a result, vehicles on the road may have issues like malfunctioning lights, faulty brakes, or worn-out tires, all of which can contribute to an increased likelihood of RTC. Furthermore, the combination of reduced maintenance and fewer inspections can lead to an overall decline in vehicle safety standards.

The economic crisis had a notable impact on vehicle safety, particularly in the context of reduced vehicle maintenance and the suspension of yearly inspections. During periods of economic hardship, Lebanese vehicle owners may cut back on routine vehicle maintenance to save money, which can lead to an increase in the number of poorly maintained vehicles on the road. These vehicles are more likely to experience mechanical failures, such as brake system malfunctions or tire blowouts, posing a significant safety risk. This decline poses a danger not only to the drivers of poorly maintained vehicles but also to other road users who may become victims of RTCs caused by these unsafe vehicles.

ROAD SAFETY FUNDING

"Lebanon's economic crisis and currency depreciation have strained road safety funding. Despite interest, securing adequate funds remains critical. Limited government budget and international grants hinder comprehensive initiatives, highlighting the financial challenge in addressing RTCs." (verbatim)

The financial challenges surrounding road safety funding in Lebanon have been significantly exacerbated by the country's severe economic crisis and the rapid depreciation of its currency. Even though there has been a surge of interest in improving road safety, particularly with the establishment of the National Road Safety Council in 2018, the issue of securing adequate funding remains a critical concern. This challenge has been further amplified by the ongoing political instability and a dire economic situation, which reached a critical juncture in April 2020 when Lebanon defaulted on its financial obligations. The depreciation of the Lebanese currency has substantially eroded the purchasing power and available financial resources, making it increasingly difficult to allocate the necessary funds for road safety initiatives.

The primary source of funding for road safety efforts is expected to be the government budget; however, there are growing concerns about the actual resources that can be effectively mobilized in this economic climate. Currently, funding for the road transport sector is derived from the Ministry of Finance's budget, primarily fuelled by taxation, international grants, and loans from organizations like the World Bank and Islamic Development Bank. Additionally, the CDR relies on its own pool of funds generated from donors and backers. This complex financial landscape underscores the country's dependence on the government budget, donors, and international loans for road safety initiatives, with no dedicated fund exclusively allocated to this critical area. Moreover, the limited available funding from the Ministry of Finance is primarily directed towards essential road network maintenance projects, substantially restricting the possibilities for financing comprehensive and much-needed road safety actions. In essence, the economic crisis and currency depreciation have created an acute financial hurdle, hindering Lebanon's ability to invest adequately in road safety measures and address the pressing issue of RTCs in the country.

ROAD SAFETY PROMOTION AND EDUCATION

"Current road safety promotion and education strategies fall short, perceived as conventional and ineffectual. Urgent reforms and investments are needed to address deficiencies in Lebanon." (verbatim)

Key stakeholders unanimously stressed the pivotal significance of robust media coverage, targeted awareness campaigns, and educational initiatives aimed at reshaping the attitudes and behaviours of road users towards road safety. Nevertheless, there is a consensus among interviewees that the current strategies and interventions fall short in effectively addressing the multifaceted challenges of road safety. The messages disseminated through media campaigns and awareness-raising endeavours are often perceived as conventional and ineffectual. Furthermore, they are lamentably lacking in depth and breadth, characterized by sporadic instances rather than sustained and pervasive outreach efforts.

While there is a tacit acknowledgment of the imperative need for educational programs tailored to young road users, the organization of awareness days suffers from irregularity and inequity. This systemic disparity results in certain segments of the youth population being systematically excluded from road safety education opportunities, thereby exacerbating existing knowledge gaps and perpetuating disparities in road safety awareness.

Moreover, road safety remains conspicuously marginalized in both academic and professional circles. Despite its inherently interdisciplinary nature, road safety continues to be marginalized in research and training agendas across diverse disciplines. This glaring lack of integration stifles the development of specialized expertise in the field, contributing to a glaring shortage of professionals equipped to tackle the intricate and evolving challenges of road safety effectively.

In addition, the training afforded to law enforcement officers is woefully inadequate in addressing accidentology, the systematic study of accidents. This dearth of specialized training in this pivotal area significantly compromises the capacity of law enforcement agencies to conduct thorough investigations and implement effective measures for mitigating road traffic incidents.

MONITORING, EVALUATION AND RESEARCH

"Efforts to collect road safety data are ongoing, but several gaps remain. Dearth in research and restricted data access call for urgent improvement." (verbatim)

While there are partial and ongoing efforts to establish sustainable systems for collecting and managing data on road crashes, related factors, and road network traffic, there remain

substantial gaps. Additionally, systematic and regular safety rating surveys to ensure adherence to safety standards are notably lacking across all road categories, which is a significant area for improvement. Moreover, the collection and management of data on the output quantities and qualities of safety interventions is lacking. Regular surveys of road user and community attitudes toward safety interventions are limited, as are systems for monitoring and evaluating safety performance against targets. However, all participating agencies and partners do not have open access to the collected data, indicating a need for enhanced data sharing and accessibility.

"Unlocking Lebanon's road safety potential requires a strategic boost in research. But without an independent national research entity, progress remains at a standstill." (verbatim)

Lebanon is in dire need of a comprehensive road safety research and development strategy, which, regrettably, remains conspicuously absent. This strategy should encompass a wide array of critical factors, ranging from those concerning vehicles and highways to human behaviour, institutional aspects, and other relevant elements. The funding for research is still absent. Moreover, the establishment of an independent national road safety research entity is also pending. The inception of this entity could potentially make substantial contributions toward realizing the coveted focus on results within the domain of road safety.

Although mechanisms and channels exist for disseminating the findings of the limited road safety research, which include conferences, seminars, training initiatives, and few publications, there exists significant room for improvement. Enhancing these dissemination channels is imperative to further amplify the impact of research outcomes, ensuring they genuinely contribute to achieving the desired focus on results within the realm of road safety.

SPECIAL FOCUS ON DATA SYSTEM

"Lebanon faces challenges due to fragmented data sources on RTCs, spread across different entities with varying collection practices". (verbatim)

"To improve road safety, Lebanon requires a coordinated approach to standardize collection, promote sharing, and establish a centralized database". (verbatim)

The fragmentation of data sources on road traffic crashes in Lebanon presents a significant challenge. Data is dispersed across various entities, including government agencies, and non-governmental organizations, each with its own collection practices and objectives. Limited data sharing, inconsistent standards, and geographical disparities further contribute to this fragmentation. Efforts to integrate data and establish a centralized system have been slow. To address this issue, Lebanon needs a coordinated approach to standardize data collection,

promote data sharing, and establish a centralized RTI database to enhance road safety measures effectively.

POLICE DATA

“Lebanon's road accident data faces challenges including underreporting, missing details, and inconsistent definitions. Efforts to improve data collection since 2004 have been made, but limitations persist in data entry and analysis”. (verbatim)

The road collision data in Lebanon, as in many countries, encounters several substantial limitations and challenges that significantly impact the accuracy, comprehensiveness, and utility of the data. The true extent of the RTI problem in Lebanon remains elusive due to the sole reliance on official police statistics, which predominantly record the number of fatalities but provide limited insights into injury severity or RTC outcomes. The phases of the RTC data cycle are displayed in Figure 14 (Republic of Lebanon, Ministry of Public Works & Transport, 2004).

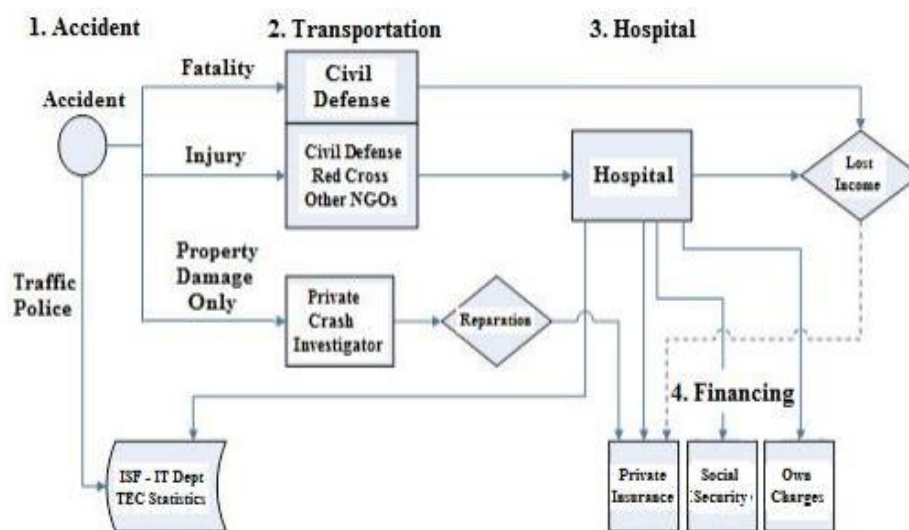

Figure 14: Phases of the collision cycle (Republic of Lebanon, Ministry of Public Works & Transport, 2004).

Data quality is compromised at various stages of the process. A major limitation lies in the underreporting of RTCs, especially minor incidents that lack injuries or significant damage. Even when RTCs are reported, critical details such as contributing factors, road conditions, and driver behaviour may be missing or incomplete, hampering comprehensive analysis. Moreover, data accuracy is further challenged by potential inaccuracies introduced by ISF officers or data entry personnel. This issue is exacerbated by the disconnection between those completing incident forms at the scene and those responsible for data entry into the database.

Additionally, some RTC reports may not make their way into the data system. These issues often result from unintentional human errors, and police officers may lack the requisite training. Furthermore, variations in the interpretation and application of variable definitions among different entities can lead to discrepancies.

ISF statistics on road fatality do not align with international definitions of fatal RTCs, only accounting for immediate deaths and rarely tracking outcomes within 30 days of the RTC, likely resulting in underestimation of fatalities (Ziad Akl, 2010). A notable shortcoming is the absence of a specific and standardized definition for injuries and clear severity distinctions. While RTCs are defined clearly, encompassing both fatal and non-fatal incidents, injuries vary widely in severity. Furthermore, the ISF crash data heavily rely on immediate reporting, often preceding thorough investigations, and this is exacerbated by a lack of training for those involved in RTC reporting. Additionally, there is inadequate monitoring of the work of investigators. The capacity in RTC analysis remains limited, primarily relying on an Excel program. This deficiency in advanced tools and technology for data analysis hinders in-depth examination of RTC patterns and trends. Selection of causes often depends on the subjective judgments and personal conclusions of the control centre team, introducing subjectivity and potential biases into RTC assessments.

Police reports were manually handwritten and contained minimal details prior to 2004. However, since that year, concerted efforts have been made to enhance data collection practices. RTC reports began to be typed, incorporating a wealth of new and comprehensive information. These reports were subsequently summarized for entry into an Excel database. Regrettably, during this transition, the absence of a standardized Excel entry form occasionally led to data entry oversights. In contrast, an Oracle database was introduced in 2016, but it encompassed a limited set of variables (Farah & Laurent, 2021; Ziad Akl, 2010). Handling errors, establishing quality metrics, implementing governance, gathering user feedback, documenting data, conducting regular audits, enriching data, and focusing on continuous improvement is essential for ensuring high-quality data for informed decision-making and road safety. Unfortunately, access to this system was not granted for assessment. The Economic and Social Commission for Western Asia (ESCWA)'s exciting new initiative introduces the Arab Integrated Road Safety Observatory (AIRSO), a dynamic project with the goal of empowering member States to craft evidence-based road safety policies, strategies, and action plans. AIRSO's missions encompass a wide array of activities that offer both depth and promise. These include the establishment of a regional crash database to bolster data-driven decision-making, efforts to bridge gaps in reported RTC data, and the regular

production of informative road safety reports. Moreover, AIRSO actively fosters the exchange of knowledge, orchestrates ground-breaking research initiatives, and provides essential logistical support for collaborative projects. This initiative holds significant potential for elevating road safety standards in the Arab region by fostering information sharing and the formulation of policies grounded in solid evidence (Lawton, Parker, Manstead, & Stradling, 1997).

EARLY RESCUE SERVICES (RED CROSS)

In Lebanon, RTC data is collected separately by the Lebanese Red Cross (LRC), who gathers statistics based on RTCs they respond to after receiving calls from involved parties or witnesses. Typically, the LRC is responsible for transporting people who have been injured in RTCs: 80% of all injured individuals in Lebanon are cared for by the Red Cross. In the case of road fatalities, the civil defence usually takes charge. These services primarily focus on providing immediate medical assistance and transportation to injured individuals, and their data collection is oriented towards this primary mission. Consequently, the data they gather may be limited in scope, often encompassing details about the injured parties, the nature of injuries, and medical care provided. However, it tends to lack comprehensive RTC data, including information about causes, contributing factors, road conditions, or details about the vehicles involved. Furthermore, early rescue services may not be involved in reporting or recording fatalities, which is typically the responsibility of other agencies like the police or civil defence. Additionally, not all RTCs result in injuries that require the attention of early rescue services, leading to underreporting. The accessibility and consistency of data collected by these services may vary, affecting its reliability for analytical purposes. Importantly, the LRC operates independently and does not collaborate with the ISF in collecting RTCs data. LRC refrains from speculating on the reasons behind the significant disparities between its reported statistics and those provided by the ISF.

THE LEBANESE OBSERVATORY FOR ROAD CRASHES (LORC)

The LOCR platform, operational since 2015 under the National Centre for Remote Sensing of the CNRS, has emerged as an innovative, real-time online platform designed to gather information on RTCs through social media channels. Since its establishment, LOCR holds significant importance in Lebanon for several reasons. On the positive side, LORC stands out as the sole real-time and openly accessible Lebanese database dedicated to RTCs. It provides immediate access to critical data on RTCs, facilitating swift responses by authorities,

emergency services, and researchers. This real-time capability is indispensable for evaluating the current road safety landscape and enabling rapid interventions when required. Its longevity provides a substantial historical dataset for trend analysis and insights into road safety developments over the years.

LORC's specialization in trend analysis of RTCs, utilizing spatiotemporal data, furnishes valuable insights into long-term road safety patterns. This permits the monitoring of progress in road safety initiatives over time, allowing authorities to assess the effectiveness of interventions and refine strategies for ongoing improvements. This also aids authorities in identifying high-risk areas and targeting interventions effectively (Figure 15). High-risk road crash areas in Lebanon are primarily concentrated in three main regions: the GBA, Nabatieh, and Zahle districts. These regions experience a clustering of road crashes, particularly along the coastal line, encompassing areas like Jounieh, Batroun, Tripoli, Byblos, and Tyre. Additionally, LORC plays a pivotal role in supporting evidence-based research and policymaking, contributing to the development of effective strategies for RTC reduction. Furthermore, government agencies benefit from LORC's data for resource allocation, directing funding and initiatives towards areas with a higher incidence of RTCs. LORC is also useful to emergency response services by promptly identifying RTC locations and severity, thus facilitating efficient resource allocation and potentially saving lives in critical situations (Figure 15).

The use of Natural Language Processing (NLP) techniques for event collection, classification, and visualization ensures efficiency and reduces human error. Moreover, the credibility of LORC's data is well-established. Lastly, LORC data has global relevance, contributing to the understanding of road safety challenges and solutions on an international scale, potentially attracting support and expertise from the global community. In summary, LORC stands as a pivotal asset in Lebanon's road safety landscape, providing real-time (Figure 16), accessible, and trend-focused data that influences various sectors, including research, policy development, emergency response, public awareness, and resource allocation, ultimately contributing significantly to efforts aimed at reducing RTCs and safeguarding lives on Lebanese roads.

However, certain limitations should be acknowledged, including the potential for data source bias due to its reliance on social media platforms like Twitter and Facebook, which may not capture all RTCs. LORC's primary focus on trend analysis means it may not offer fine-grained data, limiting its suitability for in-depth research or comprehensive investigations. Automated data collection may introduce errors, and the platform's scope primarily covers

spatiotemporal trends, omitting detailed RTC causation analysis or other factors contributing to RTC. Additionally, the sustainability of LOCR is not guaranteed and its dependency on social media platforms for data collection poses potential vulnerabilities. Therefore, users should consider these strengths and limitations when utilizing LOCR data for various applications and research endeavours.

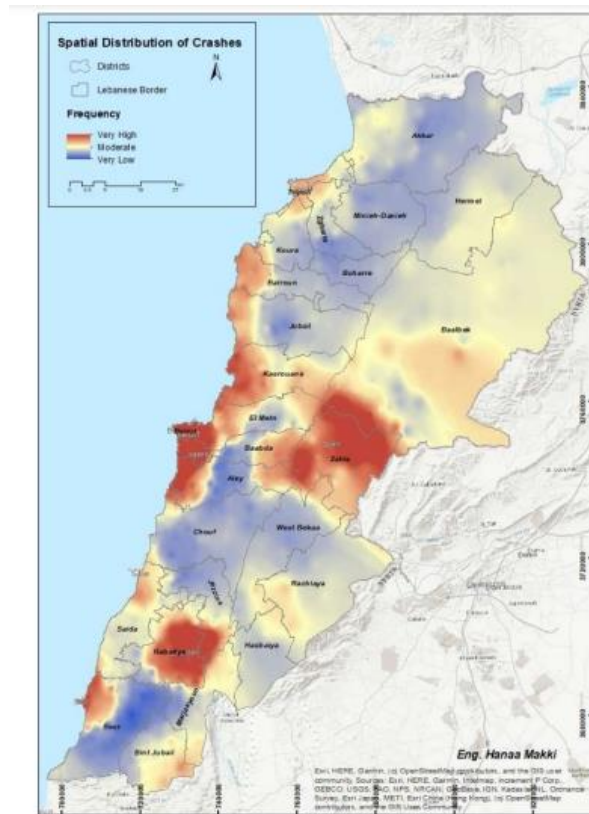

Figure 15: Spatial heatmap of road crashes, source: Lebanese Observatory for Crashes on Road 2022.



Figure 16: Temporal distribution of road crashes, fatalities and injuries per month for the Year 2022 in Lebanon, source LOCR.

THE NATIONAL ROAD SAFETY OBSERVATORY

It is a new collaborative project between the JUSTICIA Foundation for Development and Human Rights (Declaration n° 1147/2008) and the National Road Safety Council recently established in late 2023 (JUSTICIA, 2023). The JUSTICIA foundation is a non-profit civil society, organization established in Lebanon by a group of legal experts and dedicated civil society advocates who share a belief in the principles of democracy, human rights, the rule of law, and the equitable opportunities for everyone. The National Road Safety Observatory is supposed to play a pivotal role in enhancing road safety efforts in Lebanon. Recognizing the paramount importance of reliable safety and traffic data, this initiative strives to comprehensively address road safety challenges, measure economic costs related to RTCs, and craft effective safety interventions. In line with international models, such as those in Sweden and the Netherlands, the National Road Safety Observatory was designed to be exemplary network of private sector entities and stakeholders' representatives (JUSTICIA, 2023). While the establishment of such an observatory is a promising initiative, there are no tangible outputs or outcomes to assess at this early stage. Therefore, any evaluation or criticism should be made with a degree of caution, recognizing that the success or effectiveness of such an initiative may take time to materialize.

1.4.4. CASE STUDY OF HOSPITAL-BASED RTI SURVEILLANCE DATA

DESCRIPTION OF THE SYSTEM

In 2013, the Ministry of Public Health initiated the piloting of a hospital-based Road Traffic Injury surveillance system in Lebanon. This system aimed to collect 24h/7d data from Emergency Departments regarding individuals injured in RTCs. This system was operational in both private and publicly-run hospitals in Bekaa, one of Lebanon's largest governorates, centrally located in the country and inhabited by a Lebanese population of 574 465, with an additional 581 843 Syrian refugees. In 2013, a total of 25 hospitals were operating across five districts within the Bekaa governorate (Hermel, Baalbeck, Zahle, West Bekaa, and Rashaya). It's important to acknowledge that this surveillance system may have missed certain categories, such as property damage only (PDO) RTCs, minor injuries not requiring medical attention, and road traffic fatalities that arises because the system predominantly captures

individuals who sought medical attention at the Emergency Department (ED), potentially excluding those who died at the scene and were not transferred to the hospital.

Definitions: An RTC was defined as a traffic collision that occurred on a public roadway, that involved at least one motor vehicle (2, 3 or 4 wheels) and resulting in either death or injury to at least one involved person or property damage exceeding a specified monetary value (Holder et al., 2001). An RTI person was defined as a person involved in a RTC who suffered from a nonfatal injury or injuries (World health Organization, 2015). A road traffic fatality (RTF) was defined as a person involved in a RTC who either died immediately or within 30 days due to the crash (Holder et al., 2001; World health Organization, 2015). The system accounted for multiple visits by the same injured individual to the same hospital or referrals to different hospitals, considering them as single cases. Exclusions were made for injured individuals who visited the ED for reasons other than RTCs, and RTFs occurring more than 30 days after the RTC.

Data was collected using a standardized one-page Arabic form. This form was structured with closed-ended queries and thoughtfully designed to encompass both the core minimum and optional data recommended by international organizations, as well as data relevant to RTIs (World Health Organization, 2002). The form encompassed key sections, including hospital identification, demographic details of the injured individuals, information regarding the collision (date, time, location, and type), medical information about the injury such as nature of the injury, vital status, and anatomic lesions, and details about case management including the type of rescue, hospitalization, and outcome. Furthermore, this form integrated essential medical information required for the subsequent calculation of injury severity scores, as outlined in Appendix 9.

Data were reported passively from the emergency departments of Bekaa hospitals to the Epidemiological Surveillance Unit (ESU), entity responsible for diseases surveillance at the MOPH, using the provided standardized form. Typically, a physician or nurse completed the form, which was then sent via fax to the ESU for verification of completeness and clarity. In cases where information was missing, ESU staff contacted the data source to complete the RTI data form. If the required information was unavailable at the hospital level, RTI cases were contacted by phone to ensure the reporting form's completion.

The collected data were classified and coded according to the International Classification of Diseases 10th version (ICD-10) coding system, with a specific focus on Chapter XIX, "Injury, poisoning, and certain other consequences of external causes," and Chapter XX, "External causes of morbidity and mortality." Stringent measures were taken to protect patient

anonymity and the confidentiality of information. Data entry and cleaning were conducted using Epidata Software (Figure 17).

To handle missing data, training healthcare providers to report RTIs promptly to the surveillance system reduces delays and potential data loss. Furthermore, regular data quality checks conducted at the ESU identifies and addresses missing data. Follow-up with the focal person at the hospital involves reviewing data entries for completeness and accuracy and correcting any discrepancies or omissions. Additionally, some information can be obtained by contacting the patient directly. When missing data could not be addressed, transparent documentation of missing data is essential for interpreting study findings accurately.

Measures were implemented to safeguard the privacy and confidentiality of individuals' data, including secure storage, restricted access to sensitive information, and data-sharing protocols that prevent individual identification. Ethical responsibility was upheld by ensuring the accuracy and validity of collected data through rigorous methodologies, appropriate data collection techniques, and regular quality checks. Transparency regarding the purposes, methods, and findings of the surveillance system was maintained, with accountability mechanisms in place to address any ethical concerns.

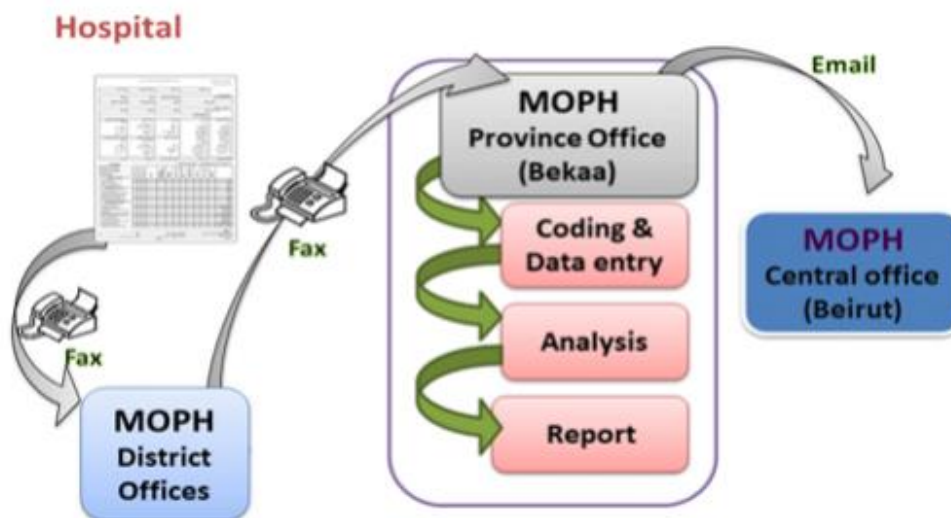

Figure 17: Data flow of the hospital-based RTI surveillance system

CONTEXTUAL NOTE

Due to the special circumstances of the conduct of this thesis in the Lebanese context (see Section 1.41., page 56), this part of the research could not be carried in satisfactory manner. The pilot of the surveillance system remained limited to hospitals in the Bekaa region. Data were collected, using the form provided in Appendix 9, but confrontation to other data

sources could not be carried out. Collected data were only used in a descriptive analysis reported in Appendix 10, and being currently under review as an article.

Ideally, the current and prospective RTI information system should have been evaluated based on standard criteria recommended by the Centres for Disease Control and the WHO to evaluate public health surveillance system. In the context, we could only carry a SWOT analysis (see methods), whose preliminary results are presented in Appendix 11. When this part of the work will eventually be completed, it could be the basis of recommendations for a new exhaustive RTI information system. On that aspect, we started to develop a blueprint which is presented in Appendix 12.

I.4.5. ROAD USERS' PERCEPTION OF ROAD SAFETY MANAGEMENT

CHARACTERISTICS OF THE STUDY POPULATION

The results reveal a diverse demographic profile among surveyed road users. Gender distribution was relatively even, with 55% being male and 45% female. The age distribution showed a predominant representation in the 18-24 years and 25-34 years age groups constituting 33% and 27% of respondents respectively. Geographically, respondents were dispersed across various governorates, with Mont-Lebanon emerging as the most prevalent at 25%, followed by Beirut at 15%. In terms of occupation, a significant proportion of respondents were students/school pupils (31.3%) and liberal professionals (17.9%). As for education, the majority possessed a high school diploma (43.5%), while 31.3% held a bachelor's degree or higher.

The majority (42.3%) of surveyed road users covered distances ranging from 5 to 10 kilometres which fell into the medium category for distance travelled. Short-distance travel, encompassing distances of 0 to 5 kilometres, was reported by 37.8% of participants, while only 19.9% indicated traveling long distances exceeding 10 kilometres.

Daily travel was the most prevalent, with 44.2% of respondents indicating daily trips. Several times a week was reported by 31.2% of participants, followed by multiple times a day (9%), and weekly (9.8%). Monthly (3.9%) and rare (1.9%) travel frequencies were less common. Work/commute was the primary reason for travel, reported by 46.3% of road users, followed by school/university (31.3%), and shopping/groceries (11.8%). Social/recreational activities (9.9%), personal business (7.9%), and medical/healthcare needs (3.6%) were also reported as reasons for travel.

Among all road users, 397 individuals (40% of respondents), reported previous witnessing of RTCs, while 192 (19%) reported previous experience of RTCs (Table 7). Among those who witnessed RTCs, the most commonly perceived reasons behind RTCs were reckless driving behaviour (35%), poor road conditions (49%), and lack of enforcement of traffic laws (30%). Distracted driving, such as mobile phone use, was also cited by 20% of respondents. Weather conditions were perceived as a contributing factor by 22% of witnesses.

Among the 192 respondents who experienced RTCs, inadequate road signage and markings (84%) and lack of driver education and training (73%) emerged as the most commonly perceived reason reported by respondents for RTCs experienced, followed by road infrastructure deficiencies (66%) and reckless driving behaviours, including aggressive overtaking (56%).

Table 7: Perceived causes of RTC reported by road users

Circumstances	Witnessed (N=397)		Experienced (N=192)	
	N	%	N	%
Lack of driver education and training	231	58%	140	73%
Poor road conditions (potholes, lack of maintenance)	193	49%	87	45%
Inadequate road signage and markings	187	47%	162	84%
Road infrastructure deficiencies (dangerous curves)	178	45%	126	66%
Reckless driving behaviours (aggressive overtaking)	139	35%	108	56%
Lack of enforcement of traffic laws and regulations	121	30%	102	53%
Road rage or aggressive behaviour on the road	111	28%	62	32%
Speeding	99	25%	65	34%
Poor visibility (e.g., at night, due to obstructions)	96	24%	39	20%
Fatigue or drowsy driving	91	23%	76	40%
Weather conditions (e.g., rain, fog)	89	22%	48	25%
Inexperienced or unlicensed drivers	79	20%	81	42%
Distracted driving (e.g., mobile phone use)	78	20%	71	37%
Tailgating or following too closely	71	18%	32	17%
Vehicle defects or mechanical failures	64	16%	49	26%
Pedestrian or cyclist negligence	25	6%	3	2%
Driving under the influence of alcohol or drugs	5	1%	1	1%
Wildlife crossing roads	4	1%	0	0%

ANALYSIS BY ROAD USER CATEGORY

PEDESTRIANS

Among surveyed pedestrians (N=210), gender distribution was balanced, with 48.1% male and 51.9% female. The majority fell within the age groups 18-24 years and 25-34 years, constituting 33.8% and 28.1% respectively. Geographically, respondents were distributed across various governorates; with Mont-Lebanon being the most represented at 25.2%. Students/school pupils formed the largest portion at 30%, followed by liberal professionals at 15.7%. In terms of education, surveyed pedestrians were diverse, with 37.2% holding a high school diploma and 32.9% having a bachelor's degree or higher. The majority of surveyed pedestrians reported short distances of 0-5 km to travel (76.2%), and the most common frequency of travel was several times a week (36.4%). The primary reason for travel among pedestrians was shopping/groceries (30%), followed by medical/healthcare (19.5%).

All surveyed pedestrians (N=210) recognized the health benefits (100%) and accessibility (100%) of walking noting that it remains accessible even when other transportation modes

are unavailable. They also concurred that weather conditions impact their decision to walk (100%). The majority acknowledged its low cost (98%), environmental friendliness (95%), and convenience for short distances (86%), with many citing habitual uses for short trips (83%) as their primary reasons for choosing walking as their main mode of transport. However, respondents highlighted limitations in carrying belongings (94%) and considered walking to offer schedule flexibility (90%). Despite its prevalence in urban areas, less than half of the respondents (47%) acknowledged walking as a common mode of transportation, with only a minority (27%) considering comfort as a factor affecting their choice of transportation mode (Figure 18).

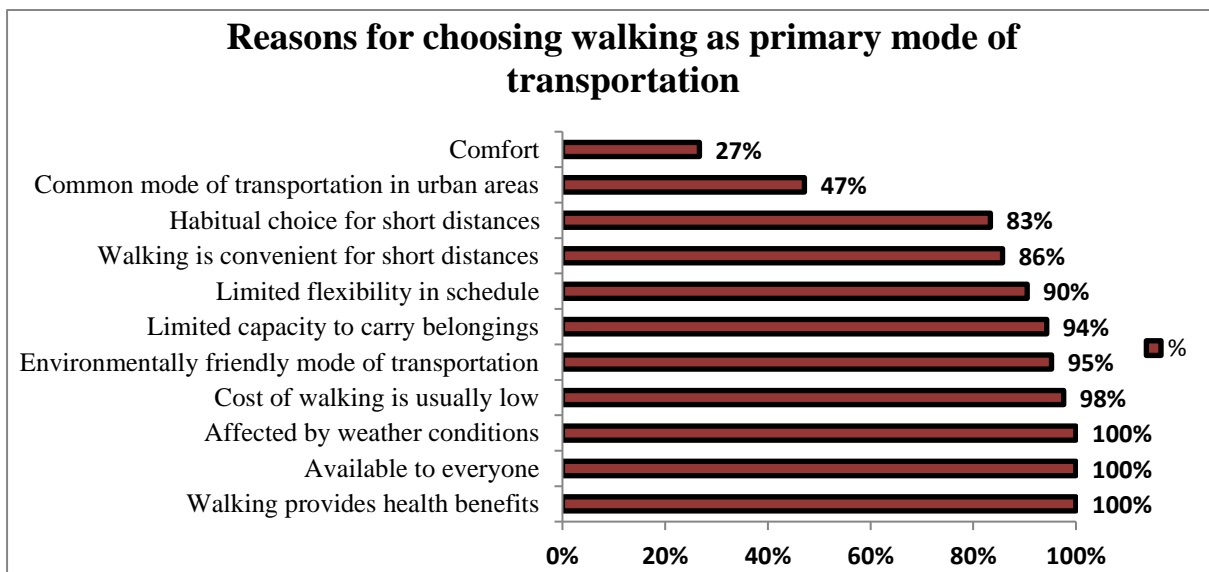

Figure 18: Reasons for choosing walking as primary mode of transportation

Pedestrians encounter numerous challenges when using the road, including a lack of sidewalks (93%), unsafe crossings (72%), safety concerns related to speeding vehicles and distracted drivers (81%), inadequate signage or road markings (95%), weather conditions (60%), accessibility barriers for individuals with disabilities (100%), conflicts with other road users (84%), noise pollution (92%), air pollution (88%), a lack of amenities along the route (99%), and security concerns (23%) (Table 8).

Table 8: Difficulties encountered by pedestrian when using the road

Challenges	N	%
Lack of sidewalks	195	93%
Unsafe crossings	151	72%
Safety concerns (e.g., speeding vehicles, distracted drivers)	170	81%

Inadequate signage or road markings	200	95%
Weather conditions (e.g., rain, snow, extreme heat)	126	60%
Accessibility barriers for individuals with disabilities	210	100%
Conflicts with other road users (e.g., cyclists, motorists)	176	84%
Noise pollution	193	92%
Air pollution	185	88%
Lack of amenities along the route (e.g., rest areas, restrooms)	208	99%
Security concerns (e.g., theft, harassment)	48	23%

Traffic calming measures emerged as the most frequent perceived need to improve safety, with 98% of surveyed pedestrians expressing a need for them (Figure 19). This was closely followed by the necessity for pedestrian-friendly infrastructure (97%), including features such as curb ramps (96%) and sidewalks (94%). Ensuring clear signage and way finding (91%) was also highlighted as essential for pedestrian safety and convenience. While pedestrian crossings (52%) and traffic signals (50%) were identified as areas of need by slightly less than half of the respondents, they still represent major concerns in ensuring pedestrian safety and accessibility in urban environments.

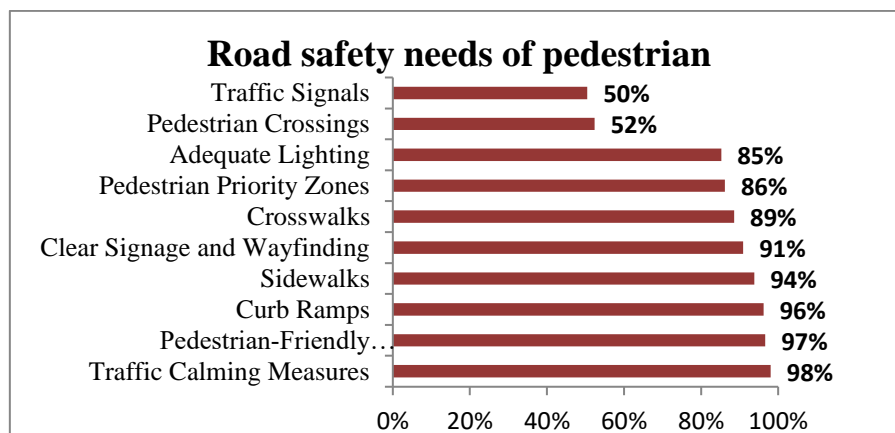

Figure 19: Safety needs of pedestrian on Lebanese roads

CYCLISTS

Out of the 40 cyclists, the majority were male (82.5%) compared to female cyclists (17.5%). The age distribution skewed towards younger individuals, with 87.5% falling within the 18-24 age groups. Cyclists were fairly evenly distributed across governorates of Lebanon, with Mont-Lebanon having the highest representation (25%) followed by Beirut (15%). Most cyclists were students or school pupils (75%), while the remaining participants were unemployed (15%) or self-employed (7.5%). Regarding education level, the majority held a bachelor's degree or higher (70%). In terms of travel distance, the majority of cyclists

travelled medium distances (5-10 km) (57.5%), followed by short distances (0-5 km) (37.5%). The frequency of travel varied, with daily (42.5%) and several times a week (42.5%) being the most common. The main reason for travel among cyclists was social, recreational activities (7.5%), and shopping.

In terms of reasons influencing cyclist choice for their mode of transportation, affordability and fuel efficiency emerged as paramount considerations, with all surveyed cyclists citing cost compared to cars and fuel efficiency as main factor. Similarly, the environmental benefits of cycling were universally recognized (100%), aligning with its reputation as an environmentally friendly mode of transportation. Additionally, cycling's contribution to physical activity during transportation was acknowledged by 98% of participants, highlighting its role in promoting a healthier lifestyle. Furthermore, the practical aspects of cycling (manoeuvrability and parking convenience) were highly valued by 95% of respondents. Accessibility (98%) and flexibility in travel schedule (98%) were also deemed important by the majority of respondents; underscoring cycling's appeal as a flexible mode of transport. However, it's worth noting that weather conditions were perceived as a potential deterrent for some cyclists, with 73% indicating their impact on cycling activities.

There was a range of challenges faced by cyclists, with all respondents identifying the absence of bike lanes (100%) and inadequate signage or road markings (100%) as major issues. Safety concerns, such as unsafe cycling conditions (85%) and fears of close passing by vehicles or dooring incidents (79%), were also prevalent among respondents. Additionally, adverse weather conditions, including rain, snow, and extreme heat (88%), noise pollution (92%) and air pollution (81%) were cited as impediments to cycling. Less frequently mentioned, lack of amenities along cycling routes (33%) and security concerns such as theft and vandalism (7%) were also noted as areas requiring attention to enhance cyclists' comfort and safety.

All surveyed cyclists unanimously identified designated bike lanes as crucial for separating cyclists from motor vehicles (Table 9). Well-maintained roads with smooth pavement were also deemed critical for preventing hazards like potholes, ensuring cyclist safety. Clear and visible road markings, particularly at intersections and crossings, were highlighted as essential for safe navigation through traffic. All cyclists emphasized the importance of cyclist-friendly infrastructure, such as specialized traffic signals, to enhance safety and convenience. Additionally, awareness campaigns promoting mutual respect between cyclists and motorists were seen as valuable for reducing conflicts and improving safety. The need for traffic calming measures and visibility enhancements, especially during low-light conditions,

was emphasized. Protection from dooring, through features like buffered bike lanes, was identified as essential for minimizing the risk of RTCs caused by opening car doors.

Table 9: Needs of cyclists to feel safe on roads

Cyclists' needs	N	%
Designated Bike Lanes for cyclists to separate them from motor vehicles	40	100%
Well-maintained roads with smooth pavement prevent hazards	40	100%
Clear and visible road markings, especially at intersections and crossings	40	100%
Cyclist-Friendly Infrastructure such as cyclist-friendly traffic signals	40	100%
Awareness Campaigns	40	100%
Traffic Calming Measures to reduce vehicle speeds in areas frequented by cyclists	40	100%
Visibility Enhancements (adequate lighting, reflective road markings...)	40	100%
Protection from Dooring	40	100%

MOTORCYCLISTS

The majority of the 140 two-wheeler riders are male, constituting 94.3% of the sample, while females account for 5.7%. The largest age group was the 18-24 age group comprising 67.9% of riders, followed by 25-34-year-olds at 20.6%. Riders were distributed across different governorates, with Mont-Lebanon having the highest representation (25%) followed by Beirut (15%). A significant portion consists of students/school pupils (42.5%) and unemployed individuals (33.3%). Education levels vary, with a large proportion having a high school diploma (44.2%). When it comes to travel patterns, most journeys are of medium distance (5-10 km), with 62.9% falling into this category. The frequency of travel varies, with daily travel being the most common (36.4%). The main reasons for travel include shopping/groceries (42.5%), social/recreational activities and work.

The choice of motorcycles as a mode of transportation is influenced by several factors (Figure 20). Cost compared to cars and fuel efficiency (94%) emerged as primary considerations, followed by accessibility (90%), speed and agility (87%). Additionally, 75% noted that the choice depends on individual ownership circumstances. Manoeuvrability and easy parking were also noted as important factors (72%), reflecting a preference for swift and nimble travel. Despite being a popular mode of transportation, reliability of service was only

mentioned by 20% of surveyed motorcycle riders. However, comfort (14%) and the capacity to carry belongings (16%) were less prioritized.

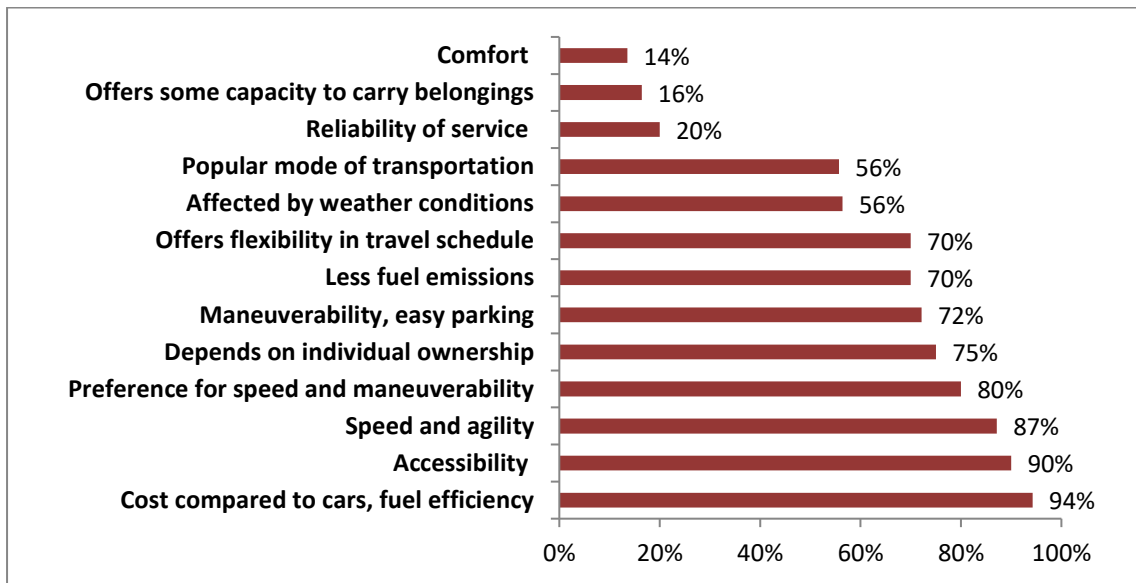

Figure 20: Reasons influencing the choice of motorcycle as primary mode of transportation

Motorcycle users in Lebanon encounter various safety challenges on the road. These include the absence of licensing procedures and compliance with safety regulations (90%), as well as feelings of vulnerability due to size and visibility (80%). Traffic congestion poses a significant problem, with 89% of respondents highlighting difficulties manoeuvring through congested areas, finding parking spots, and safely lane splitting, particularly in urban environments (82%). Weather conditions, such as rain or strong winds, also present challenges (73%), as do theft and security concerns (34%). Moreover, 69% of respondents mention facing social stigma and negative perceptions from other road users.

The majority of motorcycle riders (98%) underscored the paramount importance of ensuring proper maintenance and regular inspections of motorcycles (Table 10). Following closely behind were calls for robust rider training programs (98%), and access to high-quality safety gear such as helmet (93%). Additionally, promoting road safety awareness garnered substantial recognition (92%) as well as clear and visible road markings (91%), along with the implementation of lane filtering laws. Motorcycle-friendly infrastructure was recognized by 89% of participants as crucial for safer riding experiences and designated parking areas equipped with motorcycle racks or spaces were deemed necessary by 85% of respondents, while 83% emphasized the importance of smooth pavement, free potholes, cracks, and debris. Lastly, dedicated motorcycle lanes were recognized as essential by 82% of the surveyed riders.

Table 10: Needs for motorcycle users in Lebanon

Motorcyclist needs	N	%
Ensuring that motorcycles are maintained and regularly inspected for mechanical issues	98	98%
Training for motorcycle riders	95	95%
Access to quality helmets, protective clothing and safety equipment	93	93%
Awareness about sharing the road safely and promoting mutual respect among all road users.	92	92%
Clear and visible road markings, especially at intersections and curves	91	91%
Lane Filtering and Splitting Laws	91	91%
Motorcycle-Friendly Infrastructure	89	89%
Designated parking areas equipped with motorcycle racks or spaces help prevent theft and damage to motorcycles while parked.	85	85%
Smooth pavement free from potholes and cracks ensures better control for motorcycles	83	83%
Dedicated Motorcycle Lanes	82	82%

PRIVATE CAR USERS

Among the surveyed private car users (N=230), gender distribution is almost equally split, with females slightly outnumbering males at 55.2% compared to 44.8%. The largest age group of users was 25-34 years old, comprising 38.7% of respondents, followed by 35-44 years (27%). Geographically, users are spread across various governorates, with Mont-Lebanon having the highest representation (24.8%) as predefined figures. Occupation-wise, liberal professions constitute the highest proportion at 23%, followed closely by civil servants/employees at 18.7%. Education levels vary, with the majority holding a high school diploma (39.6%). In terms of travel distance, users are fairly equally distributed across short, medium, and long distances, with 38.7% travelling over 10 km. The majority of users travel daily (44.3%), primarily for work/commute purposes (23%) and school/university (18.7%), followed by shopping/groceries (17%).

All surveyed private car users (100%) highlighted the convenience of on-demand transportation provided by personal vehicles and emphasized the ample space available for carrying belongings (100%). Flexibility and direct routes were mentioned by 95% of

respondents, with 93% noting the flexibility in travel schedule as main reasons for choosing private cars for their travel. Other reasons included ownership or access to a vehicle (92%), and the convenience of shelter from adverse weather conditions and transportation to and from work. Furthermore, respondents mentioned that the choice of private car usage was influenced by status and independence (84%). Reliability of service (83%) and personal safety and protection (78%) were also mentioned as reasons influencing their transportation choices. However, 61% acknowledged that their choice is dependent on both the vehicle and the infrastructure. Comfort and convenience were highlighted by 57% of respondents, with only 8% mentioning the affordability of fuel, maintenance, and parking fees.

Difficulties encountered by private car users included high fuel costs affecting travel affordability (81%), vehicle breakdowns or mechanical issues (76%) and difficulty finding parking spaces, especially in busy areas (73%). Poor road conditions, such as potholes and uneven surfaces, were also highlighted by 70% of respondents, while traffic congestion delaying travel time was a concern for 43% of them. Other reasons such as weather conditions (31%), roadside emergencies like flat tires and engine overheating (28%) and safety concerns related to other motorists' behaviour (23%), including speeding and tailgating, were also mentioned by of respondents.

To feel safe on the road, personal car users highlighted designed infrastructure to enhance safety (87%), community engagement in road safety initiatives (86%), public awareness campaigns promoting safe driving behaviour (81%), driver education programs (66%), and availability of personal safety equipment like seatbelts and airbags (Figure 21). Furthermore, 43% emphasized the highlighting the role mandatory vehicle inspection programs to ensure well-maintained cars meeting safety standards.

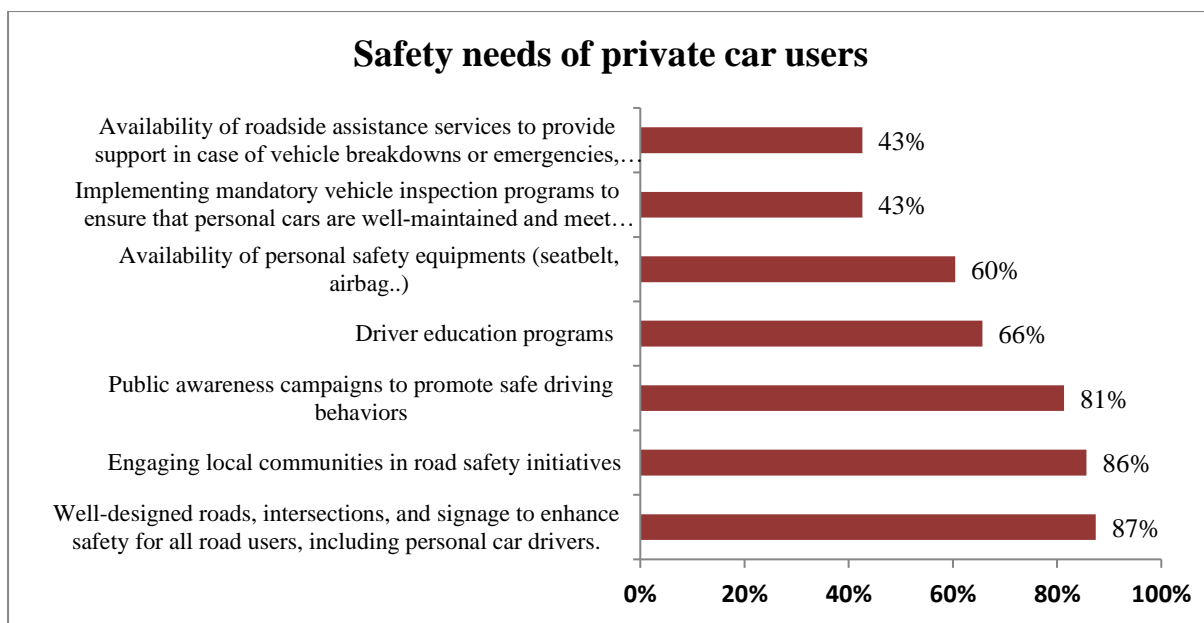

Figure 21: Safety needs of private car users

PUBLIC BUS USERS

Of the 80 public transport users participating in this study, 53.8% were male; the majority (26.3%) fell within the 35-44 age group, followed by 45-54 (23.7%). Students/school pupils were the largest group (34%), followed by civil servants/employees (29%). The majority had education levels less than high school (67.5%). The majority travelled medium distances (51.2%), followed by long distances (31.3%). Daily travel was the most common (43.7%), followed by weekly (25%) and several times a week (11.2%). The main reasons for travel were shopping/groceries (34%), followed by school/university (29%) and work/commute (12%).

Participants cited various reasons for selecting public transport (Figure 22), with the most common factors being fixed routes (79%) and fare cost (75%). Scheduled service (68%) and convenience (64%) were also important considerations. Safety, accessibility of public buses in urban areas, and transportation to/from work were mentioned by 61% of respondents. Service accessibility (54%) and weather conditions (40%) were acknowledged, while comfort (36%) and capacity to carry belongings (26%) were mentioned as areas for improvement. Reliability of service (24%) and efficiency (23%) were also considered.

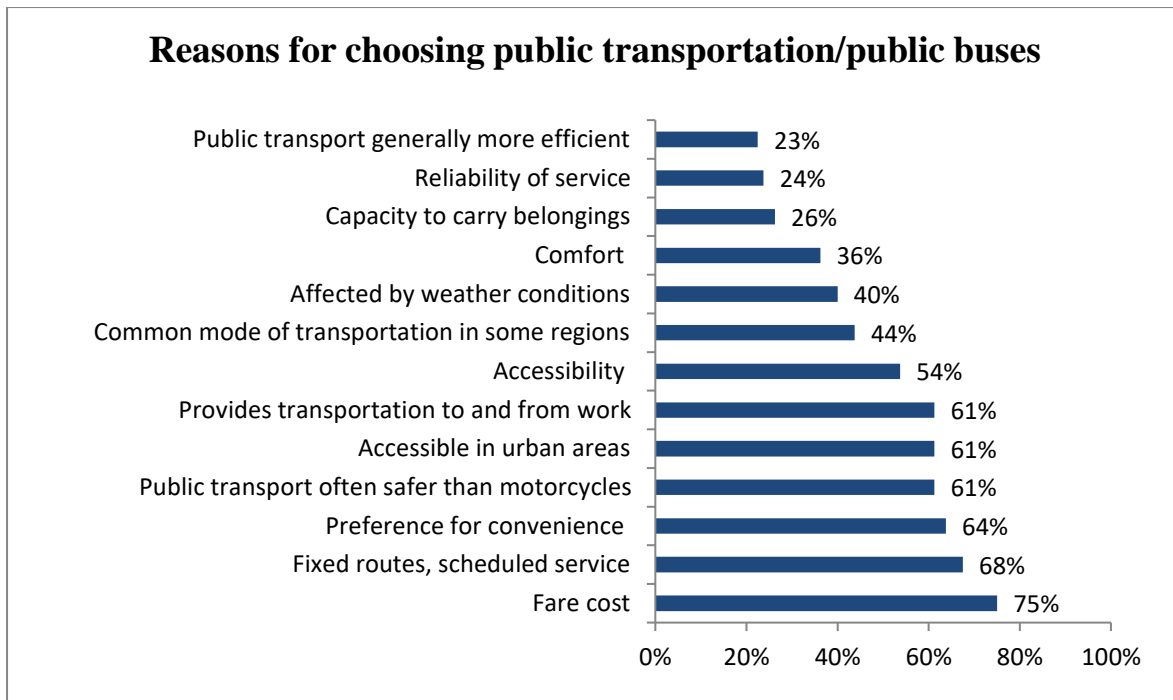

Figure 22: Reasons for choosing public transport/public buses

Public transport users identified various challenges affecting their transit experience including inadequate service coverage or frequency (81%) and traffic congestion (63%). Other commonly reported issues included safety concerns, such as overcrowding/security issues (43%), and accessibility barriers for individuals with disabilities (98%). Weather conditions, such as rain, snow, and extreme heat affecting service, were also mentioned among challenges (62%). Additionally, public transit delays were noted by 23% of respondents, indicating a notable concern among users.

The majority of surveyed public transport users emphasized the importance of implementing a strict maintenance schedule to ensure buses are in optimal condition (98%), followed by the necessity for all seats to be equipped with functional seatbelts (95%) (Table 11). Effective traffic management strategies, such as designated bus lanes and traffic lights synchronization, were also highly prioritized (93%) to reduce congestion and enhance bus flow. Emergency preparedness emerged as another key need (91%), highlighting the importance of features such as first aid kits and emergency exits.

Similarly, ensuring pedestrian safety at bus stops and intersections was deemed crucial by 91% of participants, emphasizing the need for crosswalks, sidewalks, and pedestrian islands. Other significant safety needs identified by the respondents included adequate signage (90%), regular training sessions for bus drivers (89%), and regular inspection and licensing of buses (89%). Participants also underscored the importance of well-maintained roads (86%) and a comprehensive emergency response plan for passengers (83%). Safety needs identified as

less pressing were proper lighting inside the bus (35%) and ensuring buses are equipped with accessibility features for passengers with disabilities (25%).

Table 11: Public transport user's needs

Public transport users' needs	N	%
Strict maintenance schedule to ensure buses are in optimal condition	78	98%
All seats to be equipped with functional seatbelts	76	95%
Effective traffic management strategies (bus lanes, traffic lights synchronization, and traffic calming measures, to reduce congestion and improve bus flow)	74	93%
Emergency preparedness (First aid kits, emergency exits)	73	91%
Incorporate pedestrian safety features such as crosswalks, sidewalks, and pedestrian islands	73	91%
Adequate Signage (clear road signs, including speed limits, pedestrian crossings, bus lanes...)	72	90%
Regular training sessions for bus drivers to enhance their defensive driving skills, awareness of blind spots, and handling of unexpected situations.	71	89%
Regular inspection and licensing of buses	71	89%
Well-Maintained roads with smooth surfaces, clear markings, and minimal potholes or obstructions.	69	86%
Comprehensive emergency response plan for passengers	66	83%
Enforcement of traffic laws	66	83%
Roadside assistance services for buses in case of breakdowns or emergencies.	65	81%
Accessible bus stops	61	76%
Clear and prominent signage indicating emergency exits, emergency contact numbers, and safety instructions in case of an RTC.	53	66%
Educate passengers about proper behaviour on buses and on safety protocols	53	66%
Roadside Barriers and guardrails in areas prone to RTC or where there is a risk of buses veering off the road	49	61%
Reporting mechanisms for safety concerns	47	59%
Proper lighting inside the bus to enhance visibility, especially during night-time travel, and ensure passengers feel safe and secure.	28	35%
Ensure buses are equipped with accessibility features such as ramps or lifts for passengers with disabilities	20	25%

PRIVATE BUS USERS

Among the 60 respondents who utilized private buses, 43.8% were male and 56.2% were female. The age distribution was predominantly within the 25-44 age groups. Civil servants/employees were the most prevalent (48.3%), followed by liberal professions (33.3%) and students/school pupils (18.4%). The majority had a high school diploma (42.5%), with 38.8% having less than a high school education. Private bus users primarily travelled medium distances (83.3%), with daily travel being the most common frequency (63.4%). The main reasons for travel were school/university (48.3%) and work/commute (33.3%).

The majority of participants (92%) perceived private transport as a low-cost alternative to private cars, with shared expenses being an essential factor. Additionally, 82% of respondents indicated that the effectiveness of private transport services depended on the type of service and vehicle used. Providing transportation to and from work was an important reason for 72% of participants, highlighting the utility of such services for daily commuting. Furthermore, cultural norms and economic factors were mentioned as influential by 67% of participants, indicating recognition of the broader societal context shaping private transport usage. Convenience and accessibility were also acknowledged as main reasons for selecting private transport by 65% of respondents, underscoring the importance of these factors in transportation decision-making. Comfort, was slightly less emphasized, with 62% of participants considering it in their evaluation of private transport services. Additionally, 50% of respondents noted that private transport experiences similarities with private cars, with both being contingent upon traffic conditions. Environmental considerations were also acknowledged by participants recognizing the role of shared transportation in reducing emissions (47%). Reliability of service (47%) and flexibility in travel schedule (42%) were pointed out by the respondents as important factors influencing their perceptions of private transport. Lastly, on-demand service was perceived as less critical, with only 17% of participants highlighting it as influencing their choice of private transport services.

Infrastructure-related concerns were prevalent among private bus users, with 88% expressing apprehension about the impact of infrastructure on road safety (Figure 23). Limited awareness of road safety regulations (82%) was cited as a key challenge, as was the difficulty in providing effective training and education on road safety practices. Traffic congestion (82%) and safety concerns related to reckless driving or aggressive behaviour of other passengers (78%) were also a concern.

Concerns about enforcing road safety measures (65%) and safety cultures within private bus companies (32%) were also acknowledged by the respondents. Other factors affecting road safety included overcrowded buses/vans leading to discomfort (23%), limited seating availability (13%), poor air conditioning or ventilation (10%), and irregular schedules affecting travel plans (5%).

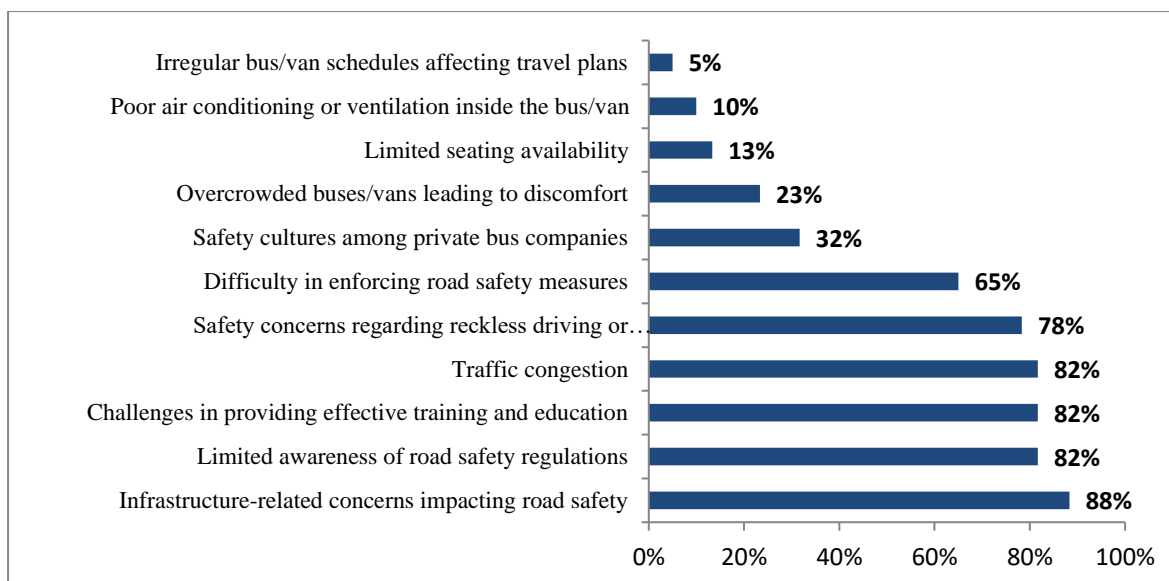

Figure 23: Challenges encountered by private buses users'

Key needs and priorities reported by surveyed private buses users included a demand for comfortable seating (97%), reliable and punctual service (97%), safe driving practices by the driver (97%), and safe road infrastructure (97%). Other essential needs included clean and well-maintained vehicles (95%), affordable fares (95%), and the availability of safety equipment such as seat belts and airbags (93%). Moreover, users emphasized the importance of better enforcement of road safety regulations (85%) and the provision of designated loading and unloading zones (85%). Additionally, there was a notable demand for traffic safety education for both drivers (82%) and passengers (78%), and clear communication about routes and schedules (78%).

Table 12: Needs of private buses users

Needs of private buses users	N	(%)
Comfortable seating	58	97%
Reliable and punctual service	58	97%
Safe driving practices by the driver	58	97%
Investment in road infrastructure	58	97%
Clean and well-maintained vehicles	57	95%
Affordable fares	57	95%
Availability of safety equipment (seat belt, Airbag...)	56	93%
Adequate space and legroom	54	90%
Implementation of vehicle safety inspections	54	90%
Better enforcement of road safety regulations	51	85%
Provision of designated loading and unloading zones	51	85%
Traffic safety education for drivers (traffic laws, defensive driving techniques, passenger safety, and vehicle maintenance, emergency management)	49	82%
Clear communication about routes and schedules	47	78%
Traffic safety education for passengers	47	78%
Accessibility for individuals with disabilities	6	10%

TAXI USERS

Among the 100 respondents who utilized taxis, 43% were male and 57% were female. The age distribution was relatively evenly spread, with the 25-34 age group being the largest (29%), followed closely by the 18-24 age group (24%). Students/school pupils constituted the largest group (33%), followed by liberal professions (28%) and civil servants/employees (24%). The majority held a high school diploma (58%), with 22% having a bachelor's degree or higher. The majority of taxi users travelled medium distances (71%), with daily travel being the most common frequency (70%). The main reasons for travel were shopping/groceries (33%), followed by work/commute (28%) and school/university (24%).

The majority of respondents (90%) favoured taxis due to their widespread availability, while 83% emphasized the importance of accessibility features for passengers with mobility challenges (Figure 24). Additionally, 81% preferred on-demand services for immediate transportation needs and cited convenience as a key factor in their choice of taxis. Safety features and adherence to regulations were prioritized by 79% of participants, while 67% considered fare costs in their decision-making process. In addition, taxis were identified as a common mode of transportation by 63% of respondents, with 60% valuing their flexibility in accommodating varying travel schedules. Vehicle condition influenced the choice of taxi service for 54% of participants, and 48% cited taxis' role in transportation to and from work. Reliability of service was prioritized by 39% of respondents, and 35% expressed a preference for comfort features. Approximately one-third of participants (32%) considered the capacity of taxis to carry belongings.

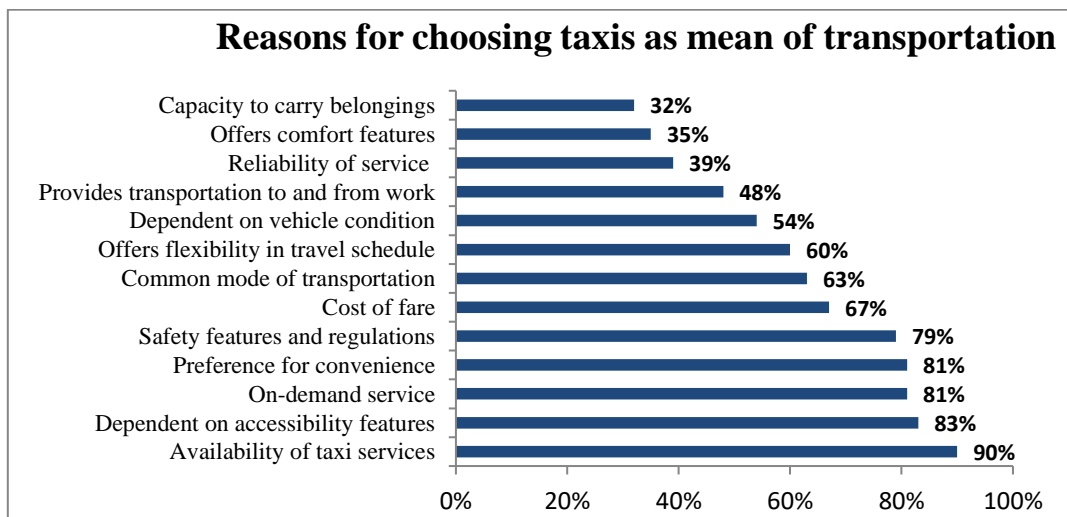

Figure 24: Factors driving user preference for taxi services

The majority of respondents (81%) encountered difficulties accessing taxis, particularly during late-night hours or in specific neighbourhoods (Figure 25). Additionally, 71% reported

challenges finding taxis during peak hours or in remote areas. Safety concerns were prevalent, with 56% expressing worries about reckless driving or aggressive behaviour by taxi drivers. Long wait times were cited by 48% of participants, especially during extreme weather or events. Communication difficulties were noted by 39% of respondents, while 35% encountered fare disputes or overcharging; 11% raised concerns about the condition or cleanliness of taxis.

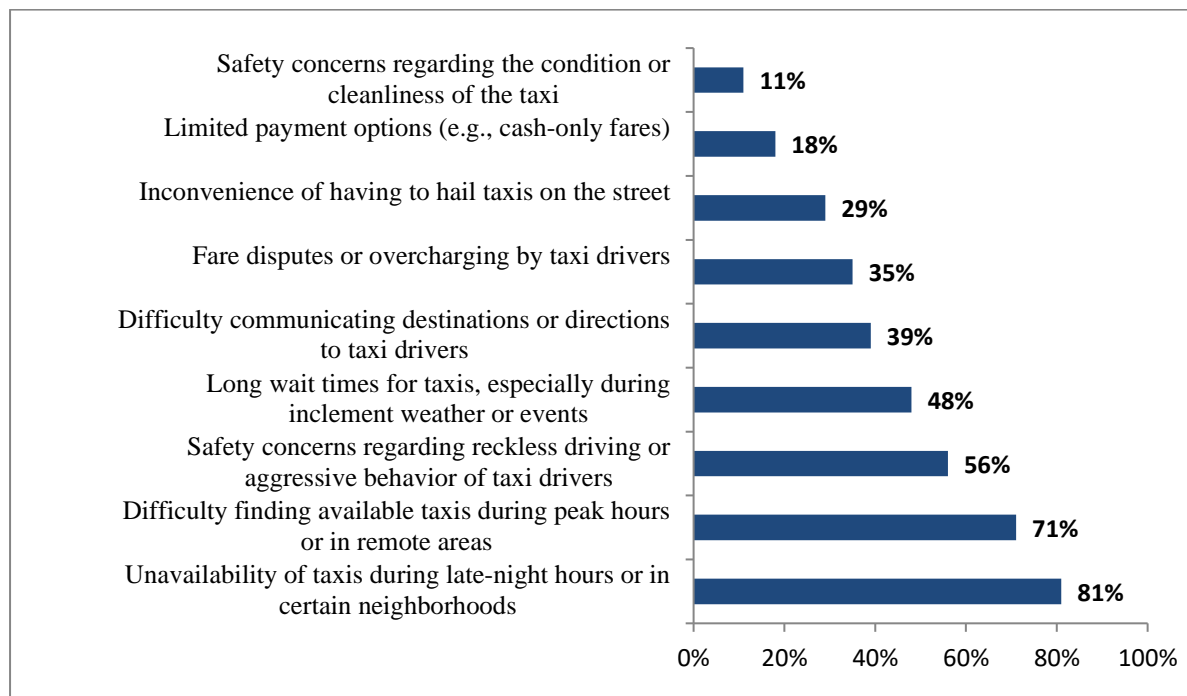

Figure 25: Challenges encountered by taxi users

The vast majority of respondents prioritize safety and reliability of taxi services. Specifically, 99% of participants emphasized the importance of courteous and professional behaviour from taxi drivers, highlighting its role in enhancing the overall user experience and fostering trust. Similarly, 97% of respondents emphasized the necessity for taxis to be equipped with safety features such as seatbelts and airbags to mitigate risks during travel. Clear fare structures were also highly valued by taxi users, with 94% of respondents expressing the importance of transparent pricing mechanisms. Respondents also underscored the significance of well-maintained taxis operated by licensed drivers, with 91% of participants emphasizing that this contributes to a sense of security. Regular maintenance of taxi vehicles was highlighted by 81% of respondents as essential for safe operation and minimizing the risk of breakdowns during service. Additionally, 65% of participants stressed the importance of taxi drivers adhering to traffic laws, indicating a desire for safe and law-abiding driving practices. Only 8% of participants emphasized the importance of accessible taxis equipped with ramps or lifts

to cater to passengers with mobility challenges. Comprehensive training programs for taxi drivers were identified as important by 61% of respondents.

MINIBUS/VANS USERS

Of 80 minibus/vans users, the majority were male (72.5%). The largest portion fell within the 45-54 age group (27.5%), closely followed by 35-44 (25%) age group. Liberal professions were the most common (41.3%), followed by students/school pupils (43.7%). The majority had a high school diploma (50%), with 40% having less than high school education. Minibus/van users primarily travelled short distances (48.8%), with daily travel being the most common frequency (37.5%). The main reasons for travel were shopping/groceries (43.7%) and work/commute (41.3%), with a smaller proportion traveling for school/university (15%).

Minibuses and vans are favoured for their flexibility in scheduling and route planning, noted by 91% of respondents (Figure 26); 89% acknowledged lower per-person costs. Convenience, especially for bulky luggage, was acknowledged by 88% of users. Environmental considerations are recognized, with 84% noting their role in reducing carbon emissions per passenger. They serve as vital connectors, acknowledged by 83%, providing essential connectivity to remote areas. Lastly, their ability to accommodate larger groups effectively facilitates convenient travel for outings, events, and excursions, recognized by 79% of users, making minibuses and vans popular choices for various transportation needs.

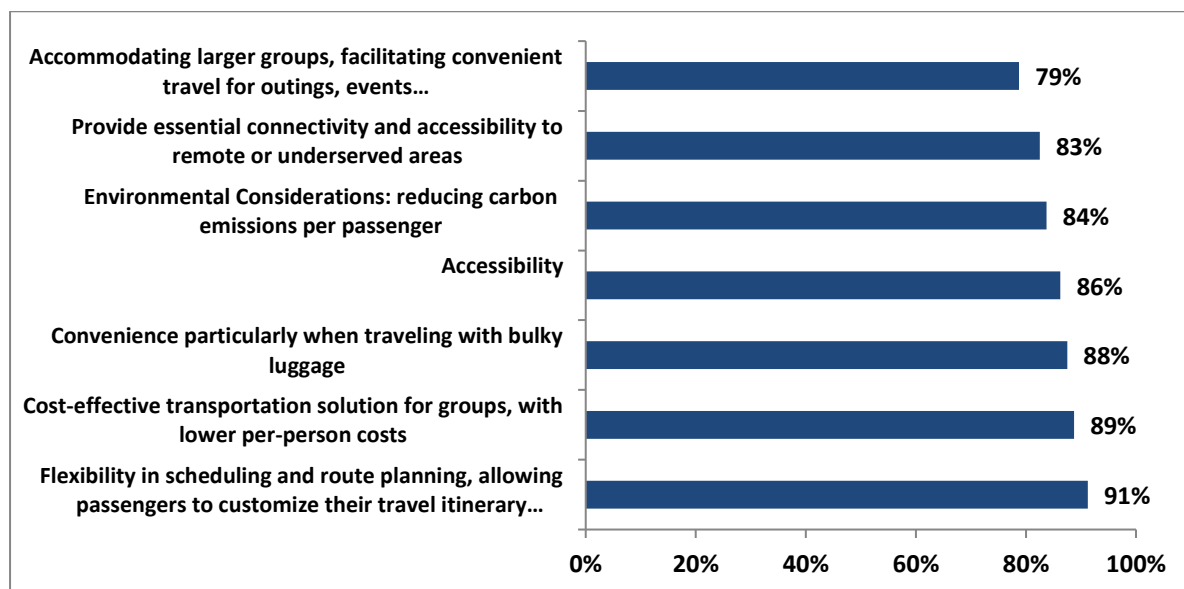

Figure 26: Reasons for minibus/vans for travel

Challenges included traffic congestion (73%), long wait times (56%), overcrowding (61%), irregular schedules (83%), limited seating availability (12%), poor air conditioning or

ventilation (92%), safety concerns (83%), difficulties boarding or alighting (48%), inadequate lighting at stops (93%), and weather-related service disruptions (54%). Needs identified by vans users included enforcing compliance with passenger safety regulations (98%), and emphasizing the importance of adhering to maximum occupancy limits, child restraint requirements, and accessibility standards for passengers with disabilities. The majority of surveyed minibuses users emphasized on providing drivers with training on emergency procedures (89%) to ensure prompt and effective responses to RTCs or medical emergencies. Equipping minibuses and vans with emergency response kits, communication devices, and first aid supplies was also acknowledged by 86% of users highlighting the necessity of having necessary resources readily available to address emergencies.

Other key needs included policies and procedures to address driver fatigue (75%), establishing strict vehicle maintenance standards (68%), and conducting regular inspections and audits to ensure compliance with relevant regulations and safety standards (60%). Specialized driver training for operators (56%) and education on proper load management practices (49%) were also identified as important factors in ensuring safe and efficient transportation services. Additionally, providing operators with tools and resources for route planning and navigation (49%), ensuring adequate insurance coverage for minibuses/vans and passengers (49%), and availability of seatbelts for passengers and enforcing their usage (46%) were highlighted as priorities by respondents.

TRUCK DRIVERS

All surveyed truck drivers (N=60) were male. The majority fell within the age group 35-44 years old range (33.3%) followed by those aged between 45-54 (31.7%). Self-employed individuals constituted the largest group (63.3%). The majority had a high school diploma (65%), with 33.3% having less than high school education. Truck users travelled short distances (51.6%) and long distances (38.4%), with daily travel being the most common frequency (32.5%).

Key reasons for choosing trucks included manoeuvrability and access to loading areas (95%) and the ample capacity trucks offer for carrying freight (95%), as primary factors. Additionally, 90% expressed a preference for the convenience and efficiency that trucks provide for work-related travel. A smaller percentage (13%) mentioned that trucks are a common mode of transportation within the freight industry, emphasizing their integral role in transporting goods.

Challenges identified included traffic congestion (80%), manoeuvring large vehicles on narrow roads (63%), and speeding or reckless driving by other drivers (78%). Additionally, fatigue and traffic-related stress (68%), truck maintenance issues or poor truck condition (81%), and dealing with disruptions to transportation schedules (76%) were reported as concerns. Unfavourable weather conditions (44%), hazards on the road such as potholes (89%), and non-compliance of speed bumps with standards (61%) also posed challenges. Furthermore, truck drivers faced issues with inadequate road networks (79%), overloaded vehicles exceeding authorized standards (67%), and a lack of clear lighting and signage (88%).

A staggering 100% of truck users emphasized the urgency of road authorities addressing any road defects or hazards promptly to ensure the safety of truck drivers and other road users (Figure 27). Furthermore, truck drivers expressed the importance of clear signage (96.7%), adequate lighting (96.7%), to enhance visibility and driving safety. Improving road capacity (95.0%) and traffic management strategies (93.3%) were also acknowledged by respondents for reducing congestion and collisions. Proper training (85.0%) and safe rest areas (83.3%) were highlighted, along with smooth road surfaces (81.7%) and well-maintained infrastructure (80.0%). Regular truck maintenance (75.0%) and access to emergency services (65.0%) were deemed essential. Stress management training (56.7%) and weather monitoring (53.3%) were also identified for road safety measures.

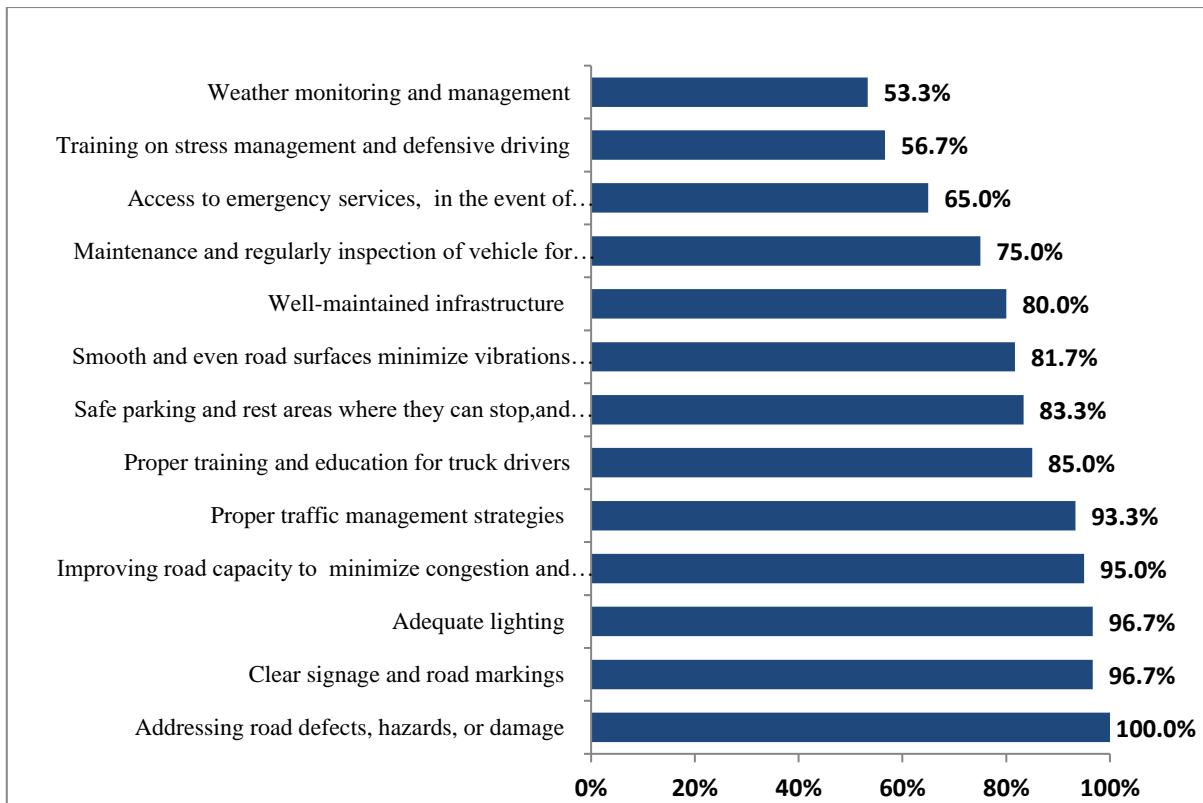

Figure 27: Needs of truck users

SATISFACTION OF ROAD USERS WITH ROAD SAFETY MANAGEMENT

A widespread dissatisfaction level with the current road safety management situation was reported with the majority (87%) being dissatisfied (Figure 28). More than half of them (54.3%) expressed being very dissatisfied, while only 5.6% expressed satisfaction. Notably, none of the respondents reported that he was "very satisfied" with the road safety management current situation.

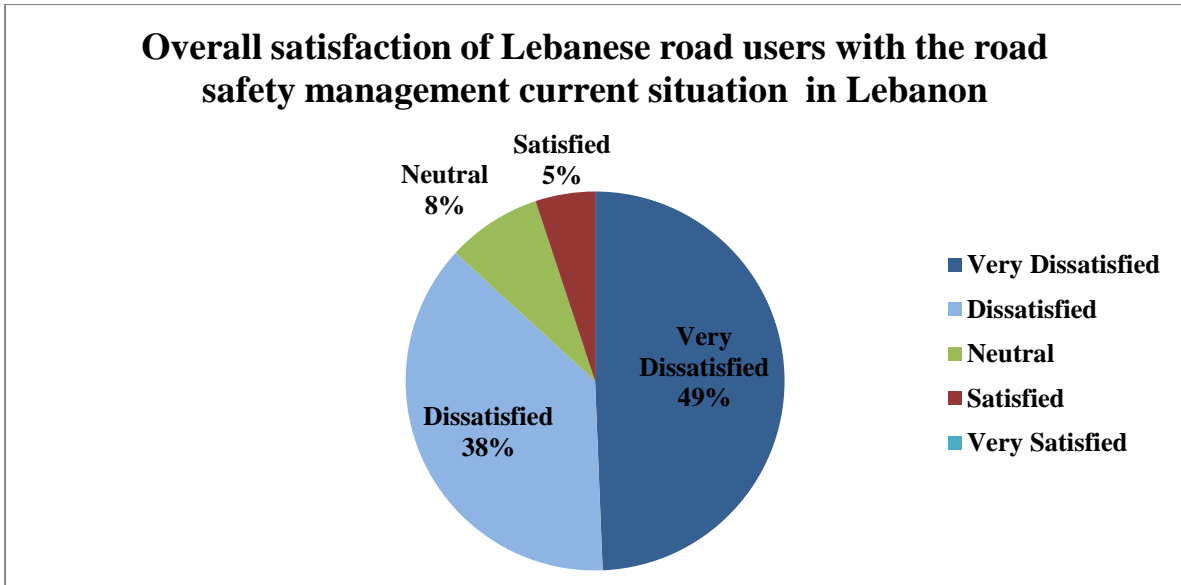

Figure 28: Overall satisfaction of road users with road safety management

These results depicted varying levels of satisfaction across different aspects of road safety management in Lebanon (Figure 29). Satisfaction levels were particularly low for the enforcement of traffic laws with 84.3% of respondents were either dissatisfied (19.1%) or very dissatisfied (65.2%) followed by the condition of road infrastructure. Conversely, respondents expressed higher levels of satisfaction with road safety post-crash (64.2%) and road safety promotion (21%).

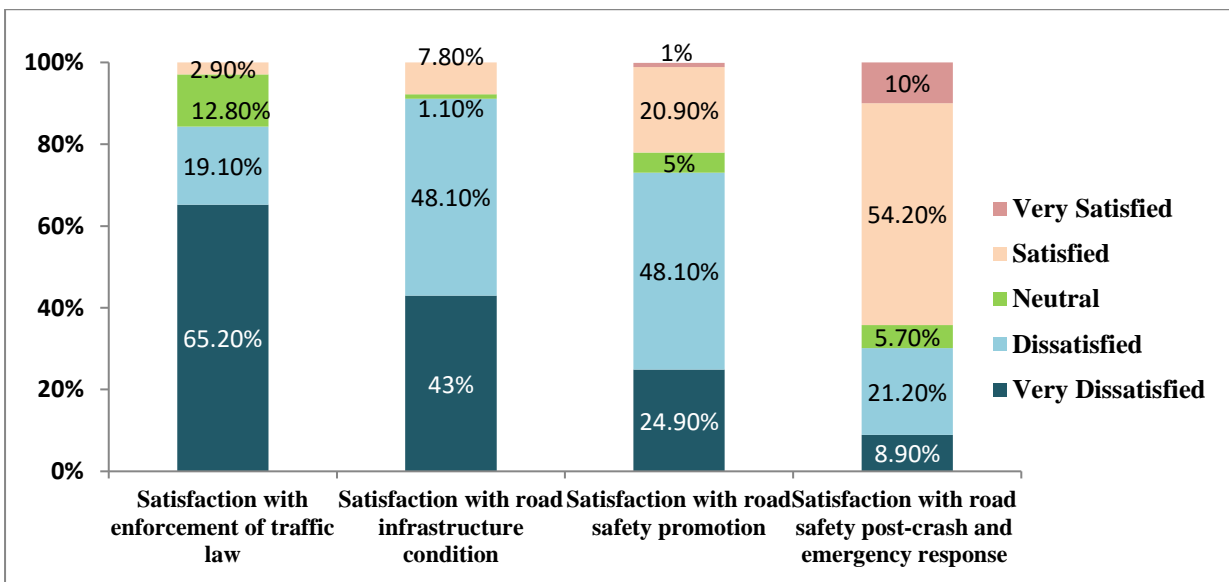

Figure 29: Levels of satisfaction across different aspects of road safety management in Lebanon

The highest level of dissatisfaction was expressed by cyclists (85%), followed by users of powered two-wheelers (82%) and public buses (80%) (Figure 30). Approximately 65% of surveyed pedestrians were dissatisfied or very dissatisfied with the current situation of road

safety management in Lebanon. Private car users showed a comparatively lower dissatisfaction level at 60%, followed by taxi users at 59%. Minibus/van users and users of private buses reported dissatisfaction rates of 70% and 72%, respectively, while truck users exhibited a dissatisfaction rate of 62%.

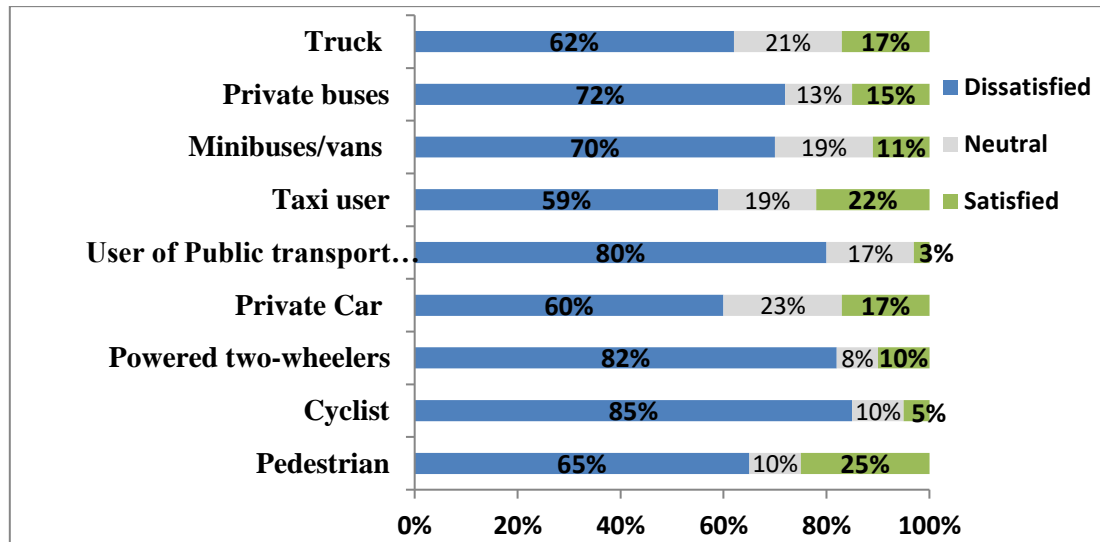

Figure 30: Satisfaction with road safety management by road user

Poor road conditions, including potholes, cracks, and uneven surfaces, emerged as the primary concern contributing to dissatisfaction of road users with road safety management in Lebanon, with 98% of respondents citing this issue (Figure 31). Limited enforcement of traffic laws and regulations and the lack of proper pedestrian crossings were also important factors, each identified by 95% of participants. Other reasons leading to dissatisfaction included the high prevalence of reckless driving behaviours (92%), the high number of road crashes (92%), and inadequate cycling infrastructure (92%). Enforcement problems, such as corruption and inconsistent enforcement, were also highlighted by 92% of respondents. Deficiencies in road safety education and awareness (90%), inadequate public transportation options and infrastructure (90%), and traffic congestion and delays (90%) were cited frequently.

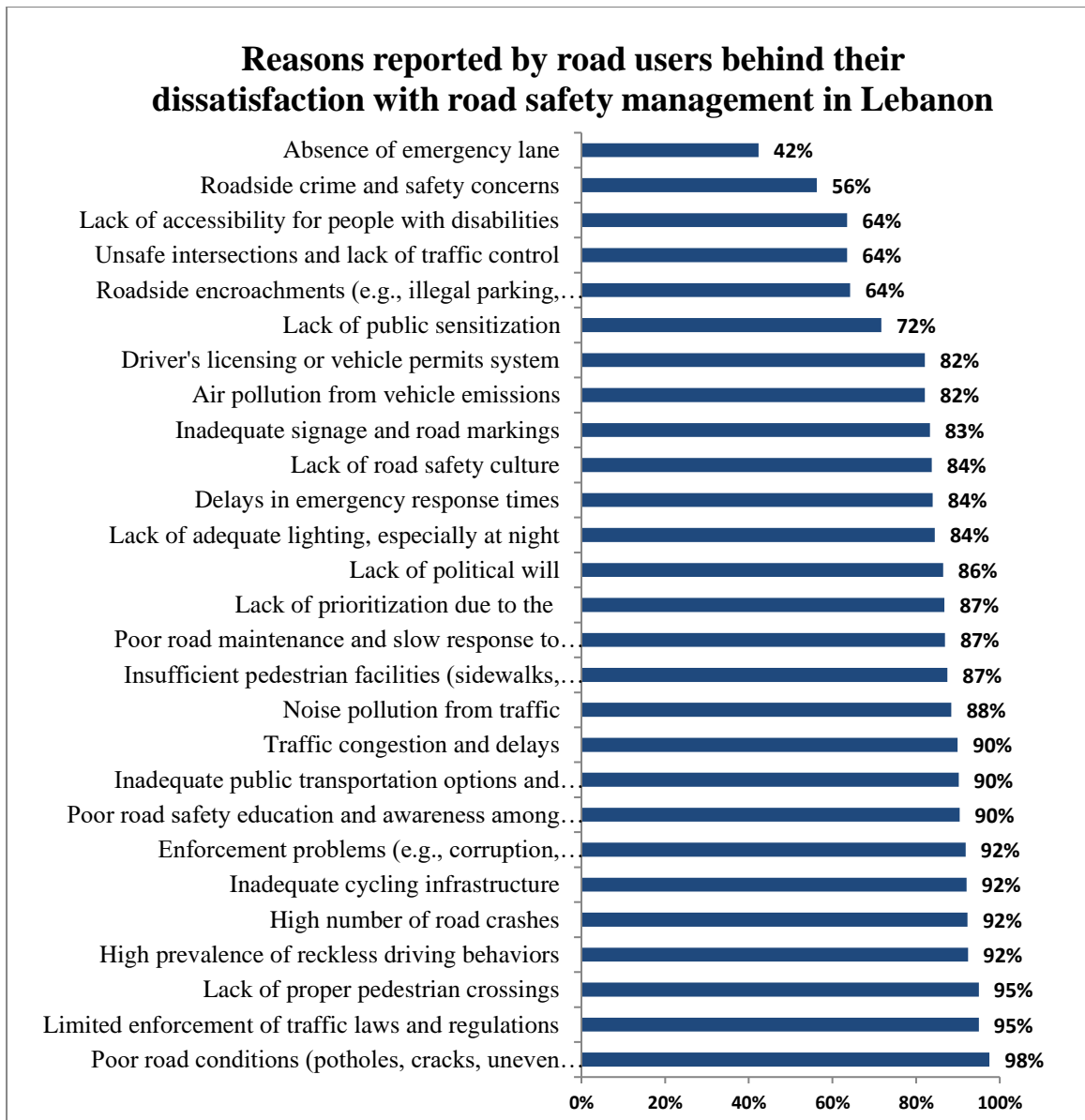

Figure 31: Reasons behind dissatisfaction of road users with the current road safety management in Lebanon

Additional concerns encompassed noise pollution from traffic (88%), insufficient pedestrian facilities (87%), poor road maintenance and slow response to hazards (87%), and a lack of prioritization (87%). Furthermore, perceived shortcomings in political will (86%), inadequate lighting, especially at night (84%), delays in emergency response times (84%), and the absence of a road safety culture (84%) were major contributors to dissatisfaction. Other factors mentioned included inadequate signage and road markings (83%), air pollution from vehicle emissions (82%), challenges with driver's licensing or vehicle permits systems (82%), lack of public sensitization (72%), roadside encroachments (64%), and unsafe intersections and traffic control (64%).

SUMMARY OF FINDINGS OF THE ROAD USERS' SURVEY

Table 13: Findings of the road users' survey

Road Category	User	Reasons for Choosing Mode of Transportation	Challenges Encountered on Roads	Safety needs on Roads	Satisfaction with road safety management		
					Dissatisfied	Neutral	Satisfied
Pedestrian		Health benefits, accessibility, low cost, environmental friendliness, convenience for short distances, habitual use for short trips, Limitations in carrying belongings, schedule flexibility	Lack of sidewalks, unsafe crossings, safety concerns related to speeding vehicles and distracted drivers, inadequate signage or road markings, weather conditions, accessibility barriers for individuals with disabilities, conflicts with other road users, noise pollution, air pollution, lack of amenities along the route, security concerns	- Traffic calming measures, pedestrian-friendly infrastructure, clear signage and pedestrian crossings, traffic signals	65%	10%	25%
Cyclist		Affordability, fuel efficiency, environmental benefits, physical activity, manoeuvrability, parking convenience, accessibility, flexibility in travel schedule, Weather conditions	- Absence of bike lanes, inadequate signage or road markings, unsafe cycling conditions, fears of close passing by vehicles or dooring incidents, adverse weather conditions, noise pollution, air pollution, lack of amenities along cycling routes, security concerns	- Designated bike lanes, well-maintained roads with smooth pavement, clear and visible road markings, cyclist-friendly infrastructure, awareness campaigns, traffic calming measures, visibility enhancements, protection from dooring	85%	10%	5%
Motorcycle		Cost compared to cars and fuel efficiency, accessibility, speed and agility, individual ownership circumstances,	- Absence of licensing procedures and compliance with safety regulations, feelings of vulnerability due to size and	- Proper maintenance and regular inspections of motorcycles, robust rider training programs, access to high-quality safety gear	82%	8%	10%

		manoeuvrability, easy parking, Reliability of service, comfort, capacity to carry belongings	visibility, traffic congestion, weather conditions, theft and security concerns, social stigma and negative perceptions	such as helmets, promoting road safety awareness, clear and visible road markings, implementation of lane filtering laws, motorcycle-friendly infrastructure, designated parking areas with motorcycle racks or spaces, smooth pavement free from hazards, dedicated motorcycle lanes			
Private Users	Car	Convenience of on-demand transportation, Ample space for belongings, Flexibility in travel schedule, Ownership or access to a vehicle	High fuel costs, Vehicle breakdowns or mechanical issues, Difficulty finding parking spaces, Poor road conditions, Traffic congestion	Well-designed infrastructure, Community engagement in road safety, Driver education programs, Availability of safety equipment like seatbelts and airbags	60%	23%	17%
Public Transport Users		Fixed routes, Fare cost, Scheduled service, Convenience, Safety	Inadequate service coverage or frequency, Traffic congestion, Safety concerns, Accessibility barriers for individuals with disabilities	Strict maintenance schedule, Functional seatbelts for all seats, Effective traffic management strategies, Pedestrian safety features at stops and intersections	80%	17%	3%
Taxi Users		Widespread availability, Accessibility features, On-demand services, Safety, Fare costs	Difficulty accessing taxis, Safety concerns, Long wait times, Communication difficulties, Fare disputes	Courteous and professional behaviour from drivers, Equipped with safety features, Transparent pricing mechanisms, Well-maintained vehicles	59%	19%	22%
Minibus/Vans Users		Flexibility in scheduling and route planning, Cost-effective group travel, Convenience	Traffic congestion, Overcrowding, Irregular schedules, Poor air conditioning or ventilation, Safety concerns	Compliance with safety regulations, Emergency response kits, Training on emergency procedures, Smooth road surfaces	70%	19%	11%

Private Buses Users	Low-cost alternative, Convenience, Providing transportation to/from work	Infrastructure-related concerns, Limited awareness of road safety regulations, Safety concerns related to reckless driving or aggressive behaviour	Comfortable seating, Reliable and punctual service, Investment in road infrastructure, Traffic safety education for both drivers and passengers	72%	13%	15%
Truck Users	Manoeuvrability and access to loading areas, Capacity for carrying freight, Convenience for work-related travel	Traffic congestion, Manoeuvring large vehicles on narrow roads, Reckless driving by other drivers, Truck maintenance issues	Prompt road repairs, Clear signage, Adequate lighting, Proper training and rest areas	62%	21%	17%

I.5. DISCUSSION

SITUATIONAL ASSESSMENT OF ROAD SAFETY MANAGEMENT SYSTEM IN LEBANON

This part adopts a holistic approach to comprehensively understand the complex road safety landscape in Lebanon. It delves into various aspects, including institutional, financial, legislative, and infrastructural dimensions. This comprehensive perspective enables a profound insight into Lebanon's road safety challenges. Notably, it sheds light on the substantial public health impact of RTCs, emphasizing the urgency of prioritizing road safety to mitigate fatalities and injuries. One of the key strengths lies in its ability to provide evidence-based policy recommendations. By rigorously evaluating existing law and enforcement mechanisms, the study offers a practical roadmap for improving road safety in Lebanon. This approach is grounded in data-driven analysis, enhancing the research's credibility. Additionally, the study emphasizes the alignment of road safety improvements with international objectives, positioning Lebanon as a responsible global participant.

Organizational structure

The organizational structure managing road safety in Lebanon is somewhat present, with multiple institutions sharing responsibilities. This lack of clear delineation of roles and responsibilities hampers sometimes effective coordination. Therefore, there is need to enhance interdepartmental collaboration, and ensure that road safety becomes an integral part of the overall institutional culture. Better coordination between these departments and units is essential for addressing road safety challenges holistically.

Policy and legislation

Compliance with international road safety regulations is inconsistent in Lebanon. While laws exist, enforcement remains weak, and legislative updates are infrequent. In tandem with these legislative and enforcement measures, strategic investments should be made to optimize traffic management and infrastructure. This includes addressing congestion issues, enhancing road signage, and implementing traffic flow management strategies, particularly in high-risk areas. These recommendations aim to address the complexities of road safety policy and legislation in Lebanon, considering both commendable efforts and existing deficiencies. Through a holistic strategy that encompasses law enforcement measures, infrastructure improvements, sustainable funding, data integration and international collaboration, Lebanon can significantly advance its road safety initiatives and ultimately reduce road fatalities while enhancing overall road safety. At the core of this comprehensive strategy lies the

development and implementation of a national road safety framework aligned with international best practices. This overarching strategy should feature clear objectives, well-defined targets, and realistic timelines. It should cover all facets of road safety, spanning enforcement, education, infrastructure enhancements, and robust data collection mechanisms. A key pillar of this strategy is the unwavering commitment to robust legislation enforcement. Adequate resources should be allocated to law enforcement agencies, particularly the traffic police, to ensure consistent and year-round implementation of road safety laws. Ensuring competitive salaries for law enforcement officers is essential to maintain their morale and motivation. Equally vital is the prevention of political interference in the enforcement process, particularly concerning traffic violations. Lastly, continuous evaluation of the effectiveness of road safety policies and interventions is vital, with regular monitoring of progress toward achieving road safety targets outlined in the national strategy.

Communication and awareness

Public awareness campaigns on road safety in Lebanon are inconsistent and often lack a cohesive strategy. To enhance their effectiveness, substantial funding should be directed towards non-technical interventions, encompassing targeted advertising campaigns, media initiatives, comprehensive driver training programs, and school-based road safety education. Therefore, it is essential to engage diverse stakeholders, including media outlets, civil society organizations, and educational institutions, to promote road safety messages consistently. Sustained public awareness campaigns should target all demographics to ensure the messaging resonates across different segments of the population. Implementing mechanisms to evaluate the effectiveness of these campaigns will allow for necessary adjustments and improvements. Additionally, establishing a comprehensive communication strategy that emphasizes responsible driving behaviours and the serious consequences of traffic violations will position road safety as a societal priority. By adopting this systematic approach, Lebanon can foster a culture of road safety and encourage adherence to traffic laws.

Data system

Data systems for road safety in Lebanon are fragmented and often unreliable. The quality of the data is frequently compromised due to underreporting and inconsistencies in how RTCs are recorded. This limits the ability to make data-driven decisions and evaluate the effectiveness of road safety interventions. Therefore, the improvement of the crash data system is essential. This involves enhancing data collection by collaborating with law enforcement agencies and relevant stakeholders to ensure that crash data is accurate and comprehensive. Details like weather conditions, road types, vehicle types, and contributing

factors should be included. Standardizing reporting protocols across different jurisdictions is equally important, as it promotes consistency in data collection and facilitates regional or national data analysis. Investing in advanced technology, such as telematics, dashboard cameras, and sensors, to gather real-time data on driving behaviour, vehicle conditions, and road conditions is also crucial in this regard. Secondly, forming partnerships with universities for research can provide valuable insights. These collaborations can involve conducting in-depth studies on specific road safety topics with the help of academic experts, specialized knowledge, resources, and research funding. Focusing on key areas like distracted driving, impaired driving, pedestrian safety, or infrastructure improvements and offering research grants to academic institutions can incentivize research that contributes to a safer road environment. Lastly, producing an analytical annual report on road safety is a powerful tool. By compiling and analysing the collected crash data, trends, hotspots, and areas of concern can be identified and made accessible to the public through data visualization tools. The annual report can also serve as a means to raise public awareness about road safety issues and safe driving practices, sharing success stories and showcasing initiatives that have led to improved safety.

Capacity building and training

While some training programs exist for traffic police and road safety professionals, their availability and effectiveness are limited. There is a critical need for capacity-building initiatives that target all levels of staff involved in road safety management. Moreover, road safety needs to be embedded in broader training agendas, ensuring that public sector employees and law enforcement officers are adequately equipped to address road safety concerns. The provision of specialized training, particularly for road engineers and policy makers, is also necessary to improve Lebanon's road safety management. Furthermore, addressing the shortage of law enforcement officers, especially within road brigades, is essential. This involves recruiting additional personnel, providing comprehensive training and optimizing their distribution based on geographical coverage and population density. Education is a cornerstone of road safety, and inclusive road safety education programs should be expanded to reach diverse populations, including refugees. These programs should focus on instilling compliance with traffic laws and cultivating responsible road behaviour.

Post-crash care

In terms of post-crash care, Lebanon can benefit from aligning with international best practices across various key areas. Firstly, the establishment of a comprehensive Trauma registry system, similar to those in developed countries, can greatly enhance care by

systematically collecting and analysing road traffic injury data. This data informs healthcare providers and policymakers for better decision-making in trauma care. Secondly, optimizing coordination among emergency response services, including police, ambulances, and medical facilities, is crucial to ensure timely and appropriate care delivery. Thirdly, standardizing trauma care training for healthcare providers, covering advanced life support, trauma management, and specialized equipment use, can elevate the quality of care. Furthermore, designating trauma centres or units within hospitals staffed by experienced professionals is essential. Beyond immediate treatment, extending post-crash care to rehabilitation services can significantly improve long-term outcomes. Aligning Lebanon's post-crash care with international best practices necessitates collaboration among government agencies, healthcare providers, and stakeholders to develop and implement comprehensive strategies for enhanced care.

Infrastructure and engineering

The state of road infrastructure in Lebanon poses significant safety risks, with many roads not meeting international safety standards. Poor road maintenance practices exacerbate the risk of RTCs while the integration of safety features such as pedestrian crossings, signage, and speed control measures into both new and existing infrastructure remains inadequate. A thorough assessment of infrastructure needs is required, with prioritization of improvements based on risk. Investment in safer road designs is critical for reducing the number and severity of RTCs. In addition, the prompt implementation of safety measures post-road infrastructure projects, including the installation of critical safety components such as road markings, guardrails, and signage, is essential.

Collaboration and partnerships

Collaboration between government agencies, NGOs, and the private sector remains a key challenge in Lebanon's road safety management. While joint projects exist, they often lack formalized structures for sustained engagement. Lebanon can benefit significantly from establishing formal partnerships with international bodies, sharing best practices, and learning from the experiences of other countries. Such collaboration would enhance the capacity of local institutions to address road safety in a more coordinated manner.

Monitoring and evaluation

There is limited monitoring and evaluation of road safety interventions in Lebanon. The absence of robust mechanisms to track progress and measure outcomes results in a lack of accountability for road safety initiatives. Establishing feedback loops for continuous

improvement and utilizing performance indicators and benchmarks is vital for evaluating the effectiveness of interventions and ensuring that road safety strategies are adjusted in response to emerging challenges.

To underpin evidence-based decision-making and policy refinement, ensuring the functioning of the national road safety observatory is imperative. While it is too early to make a definitive judgment regarding the very newly established National Road Safety Observatory's (NRSO) effectiveness, it is evident that the initiative is grounded in sound principles and intentions. Once the NRSO begins to yield tangible outputs and outcomes, it will be essential to establish a comprehensive evaluation framework to assess its impact rigorously.

However, the NRSO is a non-governmental organization initiative with no guarantees on success or sustainability. In the interim, it is of paramount importance to extend unwavering support to NRSO and closely monitor its progress. This ongoing support and vigilance will be instrumental in ensuring that NRSO fulfils its promising potential in the critical task of enhancing road safety in Lebanon and fostering a culture of safer roads throughout the broader MENA region. The proactive implementation of the observatory's strategies, continuous engagement with stakeholders, and a commitment to transparent reporting will be pivotal in its journey towards achieving meaningful road safety improvements.

Research

Several key recommendations should be implemented, particularly focusing on enhancing and funding research initiatives. First, fostering collaborations between government agencies, NGOs, universities, and research institutions can enhance knowledge sharing, with grants sought from international organizations to support these partnerships. Increasing research funding is essential, with specific budgets allocated for road safety studies and grant programs to stimulate innovative research projects. Behavioural studies should be initiated to analyse driver attitudes and perceptions. Furthermore, prioritizing research focused on the safety of vulnerable road users, such as pedestrians and cyclists, will enable targeted safety campaigns and community outreach initiatives. Lastly, evaluating existing road safety interventions is vital, requiring funding for independent assessments to measure their effectiveness.

Funding and resource allocation

Since funding is the most pronounced challenge in managing road safety in Lebanon, there is a need to expand available public funding through innovative financing mechanisms. Establishing an autonomous road fund, separate from the Ministry of Finance's jurisdiction,

offers a sustainable solution. This dedicated fund, fuelled by revenue generated from taxes and road user charges, can strategically allocate resources to fortify critical road safety measures. Specifically, the road fund can channel its resources into three pivotal domains. First, it can allocate funds for Road Safety Audits (RSAs) aimed at assessing the safety of both new road projects and existing networks, particularly in high-risk areas. International experiences underscore the efficacy of RSAs, which can avert or mitigate up to one-third of RTCs. Addressing road safety within the context of the ongoing economic crisis demands a strategic and adaptable approach. To maximize impact while managing budget constraints, prioritizing high-impact, cost-effective measures is essential. This includes directing funds toward maintaining and repairing existing road infrastructure, recognizing the vital role of well-maintained roads in enhancing safety. Streamlining data collection and seeking international support can help compensate for limited resources. Additionally, establishing a prioritization framework, along with targeted recruitment and training of law enforcement officers in high-risk areas, ensures efficient resource allocation. Public-private partnerships and innovative financing models can generate dedicated funds for road safety, while contingency plans and community engagement can enhance resilience. Ultimately, a comprehensive and adaptable road safety strategy, coupled with efficient resource management and international collaboration, is vital for making significant strides in road safety amidst economic challenges.

ACTIONS PROPOSED BASED ON THE ROAD USERS SURVEY

To effectively tackle the identified challenges and reasons for dissatisfaction among road users in Lebanon, a multifaceted approach is essential to address the diverse needs and challenges identified across different modes of transportation. The proposed actions encompass various aspects of infrastructure enhancement, safety education, service expansion, regulatory enforcement, emergency preparedness, and collaborative partnerships to create a comprehensive strategy for improving the overall transportation experience.

First and foremost, it is imperative to allocate significant investments toward enhancing infrastructure to rectify the prevalent issues concerning poor road conditions, encompassing potholes, cracks, and uneven surfaces, which have emerged as pivotal concerns for road users. This initiative also entails the enhancement of signage, road markings, and lighting to amplify visibility and safety, particularly during nocturnal travels. Moreover, implementing infrastructure upgrades at bus stops, taxi stands, and minibus/van pickup points is essential to augment safety, accessibility, and passenger comfort. Additionally, upgrading infrastructure

with designated bus lanes, bike lanes, priority traffic signals, and enhanced accessibility features will heighten efficiency and convenience for public transport users.

Furthermore, it is important to prioritize road maintenance and repair endeavours on routes frequently traversed by trucks to address issues such as road hazards, congestion, and deficient infrastructure. Implementing measures to alleviate the aftermaths of adverse weather conditions, natural disasters, and other external factors on road safety and travel efficiency is paramount.

Infrastructure enhancement projects should prioritize areas exhibiting the most pressing needs, employing contemporary construction techniques and resilient materials to ensure enduring results. It is also crucial to establish regular inspections and maintenance schedules to proactively tackle emerging issues and forestall deterioration.

However, integrating road safety considerations into infrastructure planning necessitates a comprehensive approach that prioritizes safety in conjunction with other objectives such as mobility and economic development. This involves conducting safety audits and impact assessments for proposed infrastructure projects to identify potential hazards and risks. Designing roads and intersections with safety features such as roundabouts, traffic calming measures, and pedestrian crossings are recommended to mitigate the likelihood of road traffic collisions and improve the satisfaction of road users with road safety management. Therefore, collaboration among transportation planners, engineers, and safety experts is indispensable to ensure the seamless integration of safety considerations into every phase of the planning process.

Concurrently, there must be a concerted effort to strengthen the enforcement of traffic laws and regulations, combat corruption, and ensure consistent application of laws to enhance compliance and deter reckless driving behaviours. This includes increasing the presence of law enforcement officers on the roads, deploying speed cameras and other automated enforcement systems, and implementing stricter penalties for traffic violations. Training programs should be provided to law enforcement personnel to ensure they have the necessary skills and knowledge to effectively enforce traffic laws while respecting citizens' rights. Additionally, public awareness campaigns should highlight the importance of compliance with traffic laws and the consequences of reckless driving behaviour. It is also important to strengthen regulatory enforcement to ensure fare transparency, vehicle safety standards, and compliance with traffic laws across all modes of transportation. Implement measures to address issues such as overcharging, vehicle overloading, reckless driving, and illegal parking in designated areas.

Furthermore, measures to address specific concerns, such as inadequate cycling infrastructure, insufficient pedestrian facilities, and roadside encroachments, should be implemented to improve overall satisfaction levels among road users.

In addition to enforcement measures, comprehensive road safety education programs targeting all road users are imperative to advocate safe behaviours and enhance awareness of traffic laws and regulations. These programs should encompass various components, including driver training programs tailored for specific groups such as taxi drivers, minibus/van operators, and private bus drivers. Enhancing these programs to focus on customer service, safe driving practices, and compliance with regulatory standards is essential. Specialized training on defensive driving techniques, passenger safety, emergency procedures, and cultural sensitivity should also be provided. These educational initiatives can be integrated into school curricula, driver training courses, and community outreach efforts, utilizing interactive workshops, educational materials, and multimedia campaigns to engage road users of all ages and backgrounds. Collaborations with schools, universities, NGOs, and community organizations can facilitate reaching a wider audience and reinforcing key safety messages.

Furthermore, launching comprehensive public awareness campaigns is crucial to promoting safe driving behaviours among all road users, emphasizing the importance of using safety equipment like seatbelts and airbags, adhering to traffic laws, and respecting other road users. These campaigns play a vital role in fostering a culture of safety and responsibility on the roads, ultimately contributing to a safer transportation environment for everyone.

In terms of emergency preparedness, it is imperative to develop and implement comprehensive emergency response protocols for all modes of transportation. This includes ensuring the availability of first aid kits, communication devices, and trained personnel to handle emergencies effectively. Regular drills and training sessions should be conducted for drivers to familiarize them with emergency procedures and evacuation protocols. Additionally, public awareness campaigns are essential to educate road users on what to do in the event of an emergency and how to access emergency services.

Furthermore, enhancing public transportation options and infrastructure is crucial for improving overall satisfaction levels among road users. This entails expanding service coverage, improving reliability, and enhancing accessibility. Investments in new vehicles, increased frequency of services, and the development of dedicated bus lanes and transit hubs are necessary steps in this regard. Integration with other modes of transportation, such as cycling and walking, should be prioritized to provide seamless connectivity. Moreover,

incorporating accessibility features like ramps and priority seating is essential to accommodate passengers with disabilities.

Additionally, fostering political will and governance structures that prioritize road safety is paramount. This involves advocacy at all levels of government to allocate sufficient resources to road safety initiatives, enact legislation to address key safety issues, and establish dedicated agencies or committees to oversee road safety efforts. Political leaders should be encouraged to champion road safety as a public health and development priority, emphasizing the economic and social benefits of investing in safer roads.

Collaborative partnerships are vital for developing and implementing holistic solutions to address the diverse needs and challenges of road users. This collaboration involves fostering dialogue, information sharing, and joint initiatives among transportation authorities, regulatory agencies, industry stakeholders, community organizations, and academic institutions, promoting a culture of safety, innovation, and sustainability across the transportation ecosystem. Regular evaluation of implemented measures ensures ongoing improvement and optimization of the transportation system, considering aspects such as road safety, travel efficiency, customer satisfaction, and environmental sustainability. Furthermore, engaging communities and stakeholders is essential, involving public consultations, partnerships with civil society organizations, advocacy groups, and the private sector, and implementing community-based programs like youth leadership initiatives to empower citizens in promoting road safety within their communities. By implementing these proposed actions in a coordinated and integrated manner, transportation authorities can work towards creating a safer, more accessible and efficient transportation environment that meets the evolving needs of all road users and enhances their satisfaction levels while fostering sustainable and inclusive mobility for communities.

LIMITATIONS

However, it is essential to acknowledge this part's limitations. A comprehensive analysis of road safety in a country grappling with multifaceted crises, like Lebanon, demands substantial resources in terms of data acquisition, expert consultation, and time commitment. These resources limitations have inevitably influenced the depth and scope of the study, necessitating careful consideration of its implications. In addition, Lebanon's political instability and economic challenges may hinder the implementation and long-term sustainability of the study's recommendations. Furthermore, the multifaceted nature of road

safety challenges may lead to complex findings that could be challenging to convey to a broader audience.

Regarding biases, it's crucial to consider the potential for selection bias, particularly regarding data sources. The reliance on police data as the primary official source of information regarding RTCs in Lebanon has inadvertently led to its overrepresentation in the study, while insurance data regarding RTCs was not represented. This imbalance may impact the generalizability of the findings and calls for prudence in interpretation. Researchers must remain vigilant to the risk of unintentionally emphasizing evidence that aligns with preconceived notions about road safety issues in Lebanon. This is particularly pertinent given the absence of studies on RTCs in the context of refugees and the concurrent challenges posed by COVID-19 and the economic crisis, which necessitate an impartial approach.

Key informant's interviews

The qualitative aspect of this study also presents some constraints. Firstly, qualitative data analysis is inherently subjective, relying on the interpretation of researchers, which may introduce bias and affect the reliability of findings. Moreover, the small sample size of key informant interviews may limit the diversity of perspectives captured, potentially overlooking important insights from underrepresented stakeholders. Additionally, the reliance on semi-structured interviews may constrain the depth of exploration into certain topics, as participants may not fully express their views within the confines of predetermined questions. Furthermore, the COVID-19 pandemic necessitated a shift to online interviews, which may have affected the richness of data collected compared to face-to-face interactions. Despite these limitations, the qualitative component of the study offers valuable insights into road safety management in Lebanon, providing a nuanced understanding of stakeholder perspectives and institutional dynamics.

Road users' survey

The reliance on self-administered questionnaires may introduce sampling bias, potentially limiting the representativeness of the data collected. Furthermore, response bias may have influenced the data collected, as participants may have provided socially desirable responses or inaccurately recalled their experiences. The findings may also lack generalizability beyond the context of Lebanon, given variations in cultural norms and road safety practices in other countries. Moreover, resource constraints may have impacted the sample size and duration of data collection, potentially affecting the comprehensiveness and reliability of the findings. Finally, the use of descriptive methods for data analysis may have limited the depth of insights gained from the study.

IMPLICATIONS

On the positive side, this study bears the potential to exert considerable influence on policy changes and government actions pertaining to road safety in Lebanon. This, in turn, can pave the way for substantial improvements in road conditions and a reduction in RTCs thereby enhancing public safety. By illuminating the far-reaching public health consequences of RTCs, the study has the capacity to raise public awareness regarding the critical importance of road safety. This heightened awareness may catalyse behavioural changes among drivers, contributing to safer road practices. The study's emphasis on aligning road safety improvements with global objectives, notably the SDGs, has the potential to foster international cooperation. It may attract support and resources from international organizations, further fortifying road safety initiatives in Lebanon. Moving forward, future research endeavours and policy initiatives should prioritize enhancing the quality and availability of road safety data in Lebanon. This will facilitate evidence-based decision-making, thereby strengthening road safety measures.

Given the enduring challenges posed by Lebanon's political and economic landscape, ensuring the long-term sustainability of road safety improvements is imperative. Strategies for resilience in the face of instability should be methodically devised and implemented. To address the intricacies of cultural nuances, any behavioural interventions should be thoughtfully designed to be culturally sensitive. Consultation with local communities should play a pivotal role in the development of such interventions, ensuring their effectiveness and acceptance. This analysis should serve as an enduring foundation for ongoing research on road safety in Lebanon. This will allow for the continuous assessment of the efficacy of implemented policies and strategies, ensuring that road safety remain a dynamic and evolving field of study. In summary, this analysis represents a commendable endeavour offering a comprehensive analysis of road safety in Lebanon. While it boasts several strengths, acknowledges its limitations, and vigilantly addresses potential biases, its implications reverberate beyond the realm of road safety, significantly influencing public health, sustainable development, and international cooperation. The forward trajectory entails a commitment to data enhancement, a strategic focus on sustainability, an appreciation of cultural sensitivities, and a dedication to perpetually advancing the understanding and management of road safety in Lebanon.

II.1. INTRODUCTION

Part II consists of two chapters dedicated to scale validations and behavioural analysis within the context of road safety and driver behaviour in Lebanon. This part focuses on a large-scale project of cross-cultural adaptation and validation of several psychological scales, including the Traffic Locus of Control (TLOC), Driver Behaviour Questionnaire (DBQ), Driver Anger Scale (DAS), and Driver Skill Inventory (DSI) (Table 14), along with assessing their associations and impacts on reported RTCs and fines. The initial step entails translation and cross-cultural adaptation, harmonizing these scales with Lebanese cultural nuances, language, and societal intricacies. The second step gauges the reliability and validity of these adapted scales within the Lebanese driver population. To achieve this, a substantial data collection effort was carried, engaging a diverse cross-section of drivers from all Lebanese governorates. The third step consisted in analysing the association between validated scales and reported RTCs and fines.

II.2. OBJECTIVES

TRANSLATION AND PSYCHOMETRIC TESTING

The main objective was to adapt and validate key driver behaviour assessment tools – psychological scales, including the DBQ, DAS, TLOC, and DSI – to the unique cultural context of Lebanon before embarking on exploring driver behaviour. This includes ensuring the reliability and validity of the DBQ, of an Arabic version of the DAS and adapting it for Lebanese drivers. Additionally, the primary focus extends to the adaptation and validation of the T-LOC-A as well as the Arabic version of the DSI among Lebanese drivers.

BEHAVIOURAL ANALYSIS

The main objective was to explore associations between validated tools and reported RTCs and fines. Specifically, it investigates the relationship between the adapted DBQ (DBQ-L), sociodemographic characteristics, and relevant traffic variables. Additionally, it examines how sociodemographic characteristics influence driving anger levels measured by the adapted DAS and how these levels correlate with RTC occurrence. We also explored the association between driving anger and self-reported aberrant behaviour, determining which anger dimension influences driving behaviour and the associations between T-LOC-A and RTC occurrence, as well as the impact of sociodemographic factors on self-assessed skills measured by the DSI in relation to RTCs and driver behaviour.

II.3. METHODS

PARTICIPANTS AND SAMPLING

A cross-sectional study was carried out using a convenience sampling technique among Lebanese drivers aged 18 years and above from all Lebanese provinces, from October to December 2019. To ensure the representativeness of the sample in terms of age, gender, and location, and to align the sample distribution with the population for those variables, we used an iterative proportional weighting procedure. This procedure involved setting predetermined target figures across gender and age for each Lebanese governorate (Bekaa, Baalbeck-Hermel, Mount-Lebanon, Beirut, North, Akkar, South, and Nabatyeh). The combination of convenience sampling with a weighting procedure enabled the efficient recruitment of participants while enhancing the representativeness of the sample across key demographic factors.

All Lebanese active drivers having 18 years or over, having a driving license, driving regularly, and agreeing to participate were eligible. This study excluded drivers who were not currently driving, or drove less than once a month after obtaining a driving license. Illiterate drivers who could not understand the questions and drivers who refused to participate in the study were also excluded. Written informed consent was obtained from each participant (Appendix 13)

The research protocol was reviewed and approved by the Higher Technical School. Given that the study entailed no foreseeable risks, it received exemption from ethical approval. The study focused on survey-based data collection without invasive procedures or sensitive information collection. Survey questions were crafted to prevent the solicitation of information that could potentially harm respondents. All methods were performed in accordance with the ethical standards as laid down in the Declaration of Helsinki and its later amendments (Carlson, Boyd, & Webb, 2004).

Additionally, no vulnerable populations or sensitive topics were involved in the study. To maintain participant privacy and confidentiality, several measures were implemented. Firstly, all data collected were anonymized, with participants identified only by unique identifiers rather than personal information. Confidentiality agreements were signed by all members of the research team. Additionally, data were stored securely in password-protected electronic databases accessible only to authorized personnel. Hard copies of the questionnaires (Appendix 14) were stored in locked filing cabinets to prevent unauthorized access. Access to data was restricted to authorized personnel only, with strict controls in place to prevent unauthorized access or modification.

According to Comrey and Lee (Comrey & Lee, 2013), sample size guidance indicated that five to ten observations for each scale item were necessary for establishing scale validity and reliability. Therefore, we needed 500 participants for the Exploratory Factor Analysis (EFA). To enhance the study's validity, two distinct samples were employed—one for the EFA and another for the Confirmatory Factor Analysis (CFA). To account for potential losses due to withdrawal or protocol violation, the recruitment target for each analysis (exploratory and confirmatory) exceeded 500 participants.

Table 14: Summary of the scales translated and tested in this part

Scale	Brief Explanation	Reference(s)	Validity Measures
Driver Behaviour Questionnaire (DBQ)	Measures self-reported aberrant driving behaviours (50 items)	Reason et al. (1990) (Bener, Lajunen, Özkan, & Haigney, 2006)	Factors: Violations, Errors, Lapses; Reliability: Cronbach's alpha (>0.7); Structure: Factorial structures varying across cultures
Driving Anger Scale (DAS)	Assesses driving anger as a personality trait, with subscales for different aspects of anger related to driving (33 items)	Deffenbacher et al. (1994) (Jerry L Deffenbacher, Oetting, & Lynch, 1994)	Factors: Hostile gestures, Illegal driving, Police presence, Slow driving, Discourtesy, Traffic obstructions; Reliability: Cronbach's alpha (>0.7); Structure: Varies across cultures
Traffic Locus of Control (T-LOC)	Measures an individual's perception of control over traffic-related events, distinguishing between internal and external attributions (15 items)	Özkan & Lajunen (2005) (Özkan & Lajunen, 2005a)	Factors: Self, Other drivers, Vehicle/environment, Fate; Reliability: Cronbach's alpha (>0.7); Structure: bifactorial, requires further validation across cultures
Driver Skill Inventory (DSI)	Evaluates perceptual-motor and safety skills related to driving through self-report 29 items.	Lajunen and Summala (1995) (Lajunen, Summala, & differences, 1995)	Factors: Perceptual-motor skills, Safety skills; Reliability: Cronbach's alpha (>0,7); Structure: Consistent bifactorial structure across different populations

TRANSLATION AND PSYCHOMETRIC TESTING

The validation of the Arabic version of the DBQ, DAS, TLOC and DSI scales consisted of two stages. The first stage involved the translation and cross-cultural adaptation of the scales into Arabic, while the second stage focused on testing the psychometric properties of the Arabic version of each of these scales among Lebanese drivers (Table 15).

SCALES

THE DRIVER BEHAVIOUR QUESTIONNAIRE (DBQ)

The original version of the DBQ, developed by Reason et al. (1990), consists of 50 items classified into three dimensions: violations, errors, and lapses (Reason et al., 1990). It has been tested in various cultural contexts and nationalities, including samples of British, Dutch (Lajunen, Parker, & Summala, 2004), Irish and Finnish (Mattsson, O'Brien, Lajunen, Gormley, & Summala, 2015), Italian (Lucidi, Mallia, Lazuras, & Violani, 2014; Smorti & Guarnieri, 2016), Australian (Blockey & Hartley, 1995), Turkish (Özkan & Lajunen, 2005b; Sümer, 2003), French (Obriot-Claudel & Gabaude, 2004), Qatari and United Arab Emirates drivers (Bener, Özkan, & Lajunen, 2008). The original version evaluated driver behaviour under a theoretical framework and reflected the metacognitive skills of drivers (Reason et al., 1990).

The DBQ is based on the differentiation between errors and violations, which are presumed to originate from different psychological roots and appeal to different modes of remediation (Reason et al., 1990). Violations are defined as deliberate risky behaviours, not necessarily reprehensible but with potentially detrimental consequences. Errors are defined as a failure of a planned sequence of mental or physical activities in the selection of an action to achieve the intended goal; however, their consequences could be potentially dangerous. Lapses are defined as an unwitting deviation of action from intention (Reason et al., 1990). According to Reason et al., errors reveal a cognitive dysfunction in information processing, whereas violations are derived from psychosocial and motivational origins (Reason et al., 1990). Therefore, errors pertain to driving skills, while violations refer to driving style. A driver may commit violations without errors or may commit errors without violations.

Based on the original version of the DBQ, several versions of the instrument have been developed, such as the 104-item version by Aberg and Rimmö in 1998 (Aberg & Rimmo, 1998), the 28-item version (Mattsson, 2012), and the 9-item version edited by Martinussen et al. (Martinussen et al., 2013). Although the most cited factorial structure of the DBQ endorses the original formulation of Reason et al. (Reason et al., 1990), which displays three

factors, other complex factorial structures have also been suggested, e.g., by Rowe et al. (Rowe, Roman, McKenna, Barker, & Poulter, 2015). A substantial regional difference between countries was observed in driver behaviour and driving style due to many potential interpersonal conflict areas specific to each country's traffic environment (Özkan, Lajunen, et al., 2006a).

THE DRIVER ANGER SCALE (DAS)

Deffenbacher et al. (1994) (Jerry L Deffenbacher et al., 1994) developed a 33-item scale (long form), named the Driving Anger Scale (DAS), with a latent structure of six correlated dimensions (Jerry L Deffenbacher et al., 1994): hostile gestures, illegal driving, police presence, slow driving, discourtesy, and traffic Obstructions (Jerry L Deffenbacher et al., 1994). These six subscales have been reported to show generally positive correlations with each other, which indicate a general trend for driving anger. Indeed, DAS is one of the most frequently used measurements for assessing traits driving anger and it has been tested among drivers from various countries such as the United Kingdom (Lajunen, Parker, Stradling, et al., 1998), New Zealand (M. Sullman, 2006), Spain (Gras et al., 2006b), France (Villieux & Delhomme, 2007), Australia (Hoggan & Dollard, 2007), Turkey (Yasak & Esiyok, 2009), China (F. Li, Yao, Jiang, & Li, 2014), Japan (McLinton & Dollard, 2010), Poland (Przepiorka, Błachnio, & Wiesenthal, 2014), and Malaysia (M. J. Sullman, Stephens, & Yong, 2014).

Despite that the original factorial structure of the DAS suggested by Deffenbacher et al. (Jerry L Deffenbacher et al., 1994) has been confirmed in some studies with slight adjustments in the number of items (F. Li et al., 2014; M. Sullman, 2006; M. J. Sullman et al., 2014; Yasak & Esiyok, 2009), this structure varies between different driving cultures and required specific adaption. For example, in the United Kingdom, a structure of three components (reckless driving, direct hostility, and impeded progress) was found (Lajunen, Parker, Stradling, et al., 1998), while the discourtesy component was removed from the structure in France (Villieux & Delhomme, 2007). Furthermore, validation studies have found different factor structures for the DAS suggesting that the dimensions of trait driving anger may also be context-dependent.

THE LOCUS OF CONTROL (LOC)

In the field of traffic safety, experts have recognized the LOC as a critical aspect of an individual's personality that can influence their perception of control over events (Rotter, 1966). People with different levels of LOC may have varying perceptions of their ability to

control events and outcomes in their lives. The multidimensional Traffic Locus of Control scale (T-LOC), developed by Özkan & Lajunen (Özkan & Lajunen, 2005a) is a widely used tool for assessing the LOC of drivers. Comprising 15 items, T-LOC measures an individual's LOC orientation across four factors that encompass all potential causes of RTCs. These factors are "self", "other drivers", "vehicle/environment", and "fate". "Self" represents drivers' internal beliefs, and the other three factors represent external factors (Özkan & Lajunen, 2005a).

Since its development, the T-LOC scale has been translated into several languages to facilitate cross-cultural research. The Swedish (H. W. Warner, Ozkan, & Lajunen, 2010) and Romanian (Mairean, Havarneanu, Popusoi, & Havarneanu, 2017) versions did not conserve the same factorial structure. Hence, a further component was added to the original T-LOC in both of the mentioned versions. Regarding the Swedish version, it comprises 17 items, and the component called "self" in the original version T-LOC was split into two factors known as "own skills" and "own behaviour" (H. W. Warner et al., 2010). In the Romanian version, religiosity was added as a new component and the scale was extended to include 41 items (Mairean et al., 2017). Despite the modifications between versions, the principal four factors in the original T-LOC were kept.

THE DRIVER SKILL INVENTORY (DSI)

Driving skills include driver's aptitude for vehicle control, as evidenced by their performance in driving assessments, their lightning-quick reaction to hazard perception, and their ability to properly switch their attention between critical elements. Considering the need to explore driver skills, Lajunen and Summala have developed the DSI, a 29-item self-report questionnaire to assess and quantify driver skills. This tool drew upon 20 items from Hatakka et al. (Hatakka, Keskinen, Laapotti, Katila, & Kiiski, 1992), who had requested drivers to appraise various aspects of their driving skills. Lajunen and Summala (1995) appended these with nine additional items to gauge safety motivation for driving behaviours, eventually stemming from the two distinct dimensions of safety skills and perceptual-motor skills (Lajunen et al., 1995). Hence, the DSI assesses two aspects of driving skills using a five-point rating scale (Bener et al., 2006; Martinussen et al., 2014). The perceptual-motor skills comprise technical and car-handling skills and the safety skills encompassed collision-avoidance skills.

The inclination of driver towards safety refers to safety skills and is gauged through items related to safety practices such as "maintaining an adequate following distance" and "avoiding unnecessary risks." In contrast, perceptual-motor skills relate to technical skills

required for vehicle control, and are assessed using items such as "knowing how to react in specific traffic scenarios" and "performing a hill start on a steep incline" (Martinussen et al., 2014). The DSI has garnered widespread recognition as a reliable instrument for gauging driver skills and has undergone rigorous validation in a multitude of countries. Its application encompasses Germany (Ostapczuk, Joseph, Pufal, & Musch, 2017), the United Kingdom (UK) (Lajunen, Parker, Stradling, et al., 1998), the Netherlands (Lajunen, Corry, Summala, Hartley, & differences, 1998), Australia, Finland (Lajunen, Corry, et al., 1998), Iran, Greece, Turkey (Sümer, Özkan, & Lajunen, 2006; Henriette Wallen Warner, Özkan, Lajunen, & Tzamaloukas, 2013), and Qatar (Bener et al., 2006).

ADAPTATION, TRANSLATION AND BACK-TRANSLATION

Permission to use the following scales was requested and obtained when feasible. The original 50-item version of the DBQ, the 33-item DAS, the 16-item T-LOC, and the 29-item DSI were translated into Lebanese Arabic through a process of forward-backward translation, including translation synthesis (Beaton, Bombardier, Guillemin, & Ferraz, 2000).

Two independent bilingual translators, both proficient in English and whose mother tongue was Arabic, translated the English version of these scales to Arabic. One of the translators was a road safety specialist who was aware of the concept, while the second translator was selected independently, from the language department at the Lebanese University and was unaware of the concept. The translators carefully considered the semantic nuances and cultural connotations of each item to convey the intended meaning accurately in Arabic. Any discrepancies found between the two translators were considered and discussed, and the two translated versions were synthesized into one. Subsequently, the Arabic translated versions of these scales were back-translated into English by two independent translators whose native language was English and who were also fluent in Arabic. These translators did not have a behavioural science or road safety background and did not have access to the original version of the scales. This back-translation helped identify any discrepancies or mistranslations between the two versions, ensuring linguistic consistency and fidelity to the original instrument. A committee of experts, which included a road safety specialist, a linguistic professional, a psychologist, and the principal investigator, was formed to verify the clarity and suitability of the items in terms of wording and specific features of the Lebanese context. Any inquiries raised in committee meetings were communicated to the forward and back translators. The original and back-translated versions of the scales were reviewed and compared by the experts at the end of this procedure, to discuss any discrepancies or inconsistencies in the previous stage of translation. Any changes made to the translated

version were resolved by consensus. The panel assessed the clarity, cultural appropriateness, and conceptual equivalence of each item to ensure alignment with the target population.

For the DBQ, the committee reached consensus on removing five items and incorporating their contents into other items to avoid redundancy. The removed items were as follows: (1) Become impatient with a slow driver in the outer lane and overtake on the inside; (2) On turning left, nearly hit a cyclist who has come up on your inside; (3) Fail to notice someone stepping out from behind a bus or parked vehicle until it is nearly too late; (4) Overtake a slow-moving vehicle on the inside lane or hard shoulder of a motorway; and (5) Fail to notice pedestrians crossing when turning into a side street from the main road. All modifications suggested by the review committee are presented in Appendix 15. The translators were responsible for making these changes and updating the translated version once the variations were communicated to them.

The pre-final versions of each of the translated scales were piloted on a small convenience sample of 35 drivers from different age groups and from all Lebanese governorates, to evaluate the comprehensibility of the questionnaire, resulting in minor revisions and provide final input on its language. These adjustments ensured the ultimate Arabic version of each scale was linguistically suitable for Lebanese drivers, marking its readiness for subsequent psychometric testing. The pilot study's sample size of 35 drivers was chosen considering feasibility and practical constraints, like limited resources and time. Typically, a sample size of 30-50 participants suffices to identify major issues with the instrument being tested (Bujang, Omar, Foo, & Hon, 2024). While smaller than the main study, it adequately served its purpose of identifying potential issues and refining the instrument before full validation.

After completing the questionnaire, each participant in the pilot phase was asked to elaborate and verbalize their thoughts about each item comprehension and what their corresponding response meant while responding to the questionnaire. Based on their feedback, further refinements to the translated version were made to improve the questionnaire's clarity and validity, including changing confusing words and potentially misleading items, particularly those related to technical terms not commonly used by Lebanese drivers. These were changed to lay language while conserving their meanings and ensuring that they could still be used in the relevant scale. Finally, the Arabic versions of these scales were produced and were ready for psychometric testing.

PSYCHOMETRIC TESTING

The psychometric evaluation of the Arabic version of each scale was conducted to assess its reliability and validity. These evaluations include measures of internal consistency, test-retest reliability, and construct validity (Table 15).

RELIABILITY

Internal consistency assesses the degree to which each test item measures the same construct. Internal consistency reliability was estimated using Cronbach's alpha, and a value of $\alpha \geq 0.70$ was considered satisfactory (Adamson & Prion, 2013). Test-retest reliability measures the degree to which the measurement results in one setting are consistent and stable over time (usually over two points, T1 and T2) through the correlation between scores from one administration of the scales to another (Aldridge, Dovey, & Wade, 2017).

For test-retest reliability, a small sample size is required, and a minimum of 30 drivers is considered sufficient, as such a test is commonly conducted during the initial pilot study (Rea & Parker, 2014). The questionnaire used in the retest was identical to the initial administration to minimize the potential for response bias. Prior to the retest, participants were briefed on the purpose of the study and reminded of the confidentiality of their responses. The eligibility criteria for participation in the study included being aged 18 years or older, having a driver's license, driving regularly in Lebanon, and having Arabic as the primary language. Participants were selected from the study population based on province, gender, and age-groups to ensure representativeness. Forty drivers participated in the study, completing the questionnaire twice, with an approximate three-week interval between administrations. During the initial administration, participants completed the questionnaire under standard conditions, and the same procedure was repeated after a 21-day interval to assess the stability of their responses.

Participants were required to fill out all responses before submitting the questionnaire. To match responses across the two administrations, participant codes were employed for participant identification, ensuring confidentiality and anonymity. This time interval between administrations was chosen to mitigate the risk of recall bias while providing a sufficient timeframe to capture any variability in responses over time. If a participant did not respond, another participant with similar demographics was invited until the required sample size had been reached.

Test-retest reliability was examined by calculating the Intraclass Correlation Coefficients (ICC) in a two-way random effects model with single measures and absolute agreement. The interpretation of Cronbach's α and ICC values followed this categorization: <0.50 , poor;

0.50–0.75, moderate; 0.75–0.90, good; and >0.90, excellent (Cronbach, 1951; Koo & Li, 2016).

To ascertain the magnitude of agreement between the time points rather than the relationship, we calculated the difference between each data point and the mean (mean difference) and the standard deviation. The mean difference refers to the average discrepancy between measurements taken at two different time points. It indicates whether there is a systematic bias or shift between the measurements. The standard deviation quantifies the variability or spread of the data points around the mean difference. This allowed us to determine how agreeable the measures were based on how close the data points deviated from the line of equality. Furthermore, we calculated the Standard Error of Measurement (SEM) and the Minimal Detectable Change at a 95% confidence level (MDC95%) using the following formulas: $SEM = SD\sqrt{1 - ICC}$ (SD: Standard Deviation) (Portney & Watkins, 2009); $MDC95\% = 1.96 \times \sqrt{2} \times SEM$ (Koo & Li, 2016). SEM evaluates the precision of individual measurements by examining the variability between the two instances of measurement repetition. It gauges the extent to which observed scores fluctuate around the true score.

A lower SEM indicates heightened precision. The MDC95% represents the smallest change in score that can be confidently attributed to real change rather than measurement error. It helps determine whether changes observed over time are meaningful or simply due to random variability. The 95% Limits Of Agreement (LOA) between scores of the two administrations of the Arabic version of DBQ were assessed by creating a Bland–Altman plot (Bland & Altman, 1986). LOA assesses the agreement between two measurements by calculating the range within which 95% of the differences between them lie. The Bland–Altman plot visually displays these differences against their means, allowing for the identification of any systematic bias or outliers in the data.

Table 15: Process for cross-cultural adaptation and validation of the Arabic version of the scales among Lebanese drivers

Translation and cross-cultural adaptation				Reliability	Validity
1. Translation				1. Internal Consistency Reliability	1. Content Validity
A. Forward translation: Two independent bilingual translators translated the scales from English to Arabic.	B. Backward translation: The Arabic versions were translated back into English by two independent translators who were fluent in both languages.	C. Synthesis: Discrepancies between the forward and backward translations were resolved, and a consensus version was achieved by a committee of experts.		Cronbach's alpha	- Qualitative - Quantitative
2. Pilot testing				2. Test-Retest Reliability	2. Construct & factorial validity
Pre-final versions of the translated scales were piloted on a small convenience sample of 35 drivers, resulting in minor revisions to improve comprehensibility and language				Intraclass correlation coefficients (ICC)	Kaiser-Meyer-Olkin (KMO)
3. Cognitive debriefing					Bartlett tests
Participants were asked to verbalize their thoughts about each item's comprehension and their corresponding responses to ensure clarity and understanding.					Exploratory factor analysis
4. Finalization					Confirmatory factor analysis (Modification indices)
Based on feedback from pilot testing and cognitive debriefing, further refinements were made to improve the clarity and validity of the questionnaire, ensuring that it was linguistically suitable for Lebanese drivers.					Other types of validity

CONTENT VALIDITY

Content validity is defined as “the extent to which elements of an assessment tool are relevant and fairly representative of the entire domain the tool seeks to measure (Rossiter, 2008). The content validity of each scale was determined using the viewpoints of a panel of experts including content experts as well as lay persons. Content experts were professionals who have research experience or work in the field. The criteria for selecting experts include expertise in traffic safety, psychometrics, and driving behaviour research. They should demonstrate a deep understanding of traffic psychology and be capable of evaluating instrument reliability and validity. Evaluation of their expertise considers academic qualifications, relevant work experience, and participation in previous validation studies. Lay persons were potential research subjects (drivers). Using subjects of the target group as experts ensures that the population for whom the instrument is being developed is represented. Therefore, the panel was composed of eight members, including two road safety specialists, two epidemiologists, two drivers, a psychologist/behaviour specialist, and the principal investigator.

Content validity was tested using both qualitative and quantitative approaches to confirm that each item in the construct was necessary. In the qualitative content validity method, content experts and target groups reviewed the items and made suggestions which were adopted after observing grammar, using appropriate and correct words, and applying the correct and proper order of words in items. In the quantitative content validity method, the experts were asked to specify whether an item was necessary for operating a construct in a set of items or not, using the Lawshe method (Ayre & Scally, 2014). To this end, they were requested to score each item from 1 to 3: ‘Not necessary’; ‘Useful but not essential’; ‘Essential’. The confidence was maintained in selecting the most important and correct content in an instrument, which was quantified by the Content Validity Ratio (CVR) for each item, calculated as: $CVR = \frac{Ne - \frac{N}{2}}{\frac{N}{2}}$.

“Ne” refers to the number of experts who rated an item as “essential,” and N refers to the total number of experts (C. H. Lawshe, 1975). The CVR ranges from 1 to -1 and a higher score indicates greater agreement among the panel members on the necessity of an item in an instrument. The acceptable range for the CVR depends on the number of experts on the panel. According to the criterion values provided by Lawshe, a CVR of 0.49 or higher for each item indicates an acceptable level of significance, and thus the item was retained (C. H. J. P. p.

Lawshe, 1975). The Content Validity Index (CVI) is the mean score of the retained items having a CVR of 0.49 or higher.

FLOOR AND CEILING EFFECTS

To assess the sensitivity of the scales, we calculated the floor and ceiling effects. We defined floor and ceiling effects as the percentage of respondents who scored the lowest or highest status, respectively, on the Arabic scales. Terwee et al. recommends a sample size of 50 participants to evaluate the floor and ceiling effects adequately (Mokkink et al., 2010). We considered floor and ceiling effects of more than 15% to be significant.

CONSTRUCT AND FACTORIAL VALIDITY

We used the KMO and Bartlett tests to evaluate the suitability of the data for factor analysis. We divided our data into two random samples to increase the validity, one for the EFA and the other for the CFA. We used a sample of 580 drivers to perform a factor analysis using the PAF method with varimax rotation on the retained items from the DBQ, using SPSS, to identify each scale dimensions. Based on Eigenvalues >1 and the scree plot, we determined the number of factors in each scale. A minimum factor loading of 0.40 per item was required for inclusion in the factor. We performed a Parallel Analysis (PA) to determine the number of components or factors to retain from factor analysis.

CONFIRMATORY FACTOR ANALYSES AND PSYCHOMETRIC ANALYSES

Each scale was subjected to confirmatory analysis using SPSS Amos to examine the goodness of fit of the model to Lebanese drivers and to confirm its factorial structure. CFAs were used to compare the item organization of two models: (a) the exploratory factor model, and (b) the Lebanese adapted model. To identify the best fitting model, the following goodness-of-fit statistics (Hair, 2005) were calculated using IBM AMOS 24.0. The structural models were considered having a good fit to the data when the Chi-squared value $\chi^2/\text{degree of freedom (df)}$ (χ^2/df) was less than 5 (Schermelleh-Engel, Moosbrugger, & Müller, 2003), the NFI was greater than 0.9, the GFI was greater than 0.9, the CFI was greater than 0.9, and the RMSR was less than 0.08 (MacCallum, Browne, & Sugawara, 1996). When the fit of the models was deemed poor, modification indices were examined to identify additional parameters that could enhance the goodness of fit for the models under consideration. To achieve this, covariances were allowed to be freely estimated. Additionally, items exhibiting cross-loadings, defined as items that loaded 0.40 or higher on two or more factors, were eliminated in the modified models (Byrne & Stewart, 2006).

QUESTIONNAIRE DEVELOPMENT

An anonymous, self-administered Arabic questionnaire was developed, which included a brief introduction to the study's objectives and instructions on how to complete the questionnaire. The questionnaire comprised mainly closed-ended questions and consisted of three main sections: (a) socio-demographic characteristics; (b) traffic-related variables; (c) risk involvement; and (d) the scales. The first section collected socio-demographic data on the participants, including gender, age, marital status, profession, education level, and place of residence. The second section covered traffic-related variables, where drivers were asked about their driving experience and annual mileage. The third section covered the topic of risk involvement. Drivers were queried about the number of crashes (personal injury or property damage) and the number of fines they had within the past three years. The fourth section of the questionnaire included the previously mentioned adapted Arabic version of the scales.

DATA COLLECTION

Data collectors underwent training sessions to familiarize themselves with research objectives, questionnaire administration, and protocols. Detailed instructions were provided standardize data collection procedures and minimize errors. Participants, after being screened for eligibility, were approached face-to-face. This method allowed for real-time interaction, clarification of questions, and ensures a higher level of engagement from respondents compared to other survey methods. Participants were recruited from various locations such as workplaces, universities, parking stations, and public spaces across each Lebanese governorate. Data collectors were students majoring in traffic studies at the Lebanese Higher Technical School.

Information about the study's purpose, procedures, risks, benefits, and their rights was presented both verbally and in writing, allowing participants to make an informed decision about their involvement. Written informed consent was obtained from each participant. Drivers participated voluntarily without any form of incentives, and the option to withdraw from the study was expressly permissible at any stage. The questionnaire completion process typically lasted 10-15 minutes. Ongoing monitoring was conducted by the research team to maintain adherence to protocols and address any issues encountered by data collectors. These measures were crucial in upholding data integrity, minimizing errors, and enhancing the reliability and validity of the research findings.

STATISTICAL ANALYSIS

DESCRIPTIVE AND PSYCHOMETRIC ANALYSES

The collected data was entered and analysed using SPSS, version 24.0. Since missing data constituted less than 10% of the total database, it was not substituted. Before analysis, the distribution of the items of each scale was checked for normality. The normal distribution of these variables was established by visual examination of the histogram, with skewness and kurtosis lower than 1 (Mishra et al., 2019). Descriptive analyses were conducted using counts and percentages for categorical variables and mean and standard deviation for continuous measures. Cronbach's α test were used to assess internal consistency. The test-retest reliability was assessed with the ICC. To assess the suitability for conducting the factor analysis, analyses of the correlation between the scale items were conducted using the KMO and Bartlett test. To examine the factorial structure of the scales, an exploratory factor analysis and a CFA were used to test the hypothesized dimensionality of each scale.

BEHAVIOURAL ANALYSES

A bivariate analysis used the Chi-square test to check associations between categorical variables and an ANOVA to compare means of scales/subscales and categorical variables (socio-demographic variables). The effect size d was presented, with $0.20 < d < 0.50$ considered as a small effect, $0.50 < d < 0.80$ a medium effect, and $d > 0.80$ a large effect (Arnoldo & Víctor, 2015). Linear correlation analysis between continuous variables used the Pearson correlation coefficient. For the subsequent regression analyses, all variables with a p -value less than 0.2 in the bivariate analysis were included in the model as independent variables. This threshold allows for a broader exploration of potential predictors, capturing variables that may have some association with the outcome but may not meet the conventional significance level of 0.05. To explore the associations between sociodemographic characteristics and DBQ subscales, four stepwise linear regressions were performed, taking the DBQ subscales as the dependent variable and the sociodemographic and traffic variables as independent measures. To perform linear regression, the aforementioned variables had to be modified and the number of categories was reduced (categories were merged in cases where there was no significant difference). Significance was set at p -value < 0.05 . A hierarchical binary logistic regression was conducted to explore the relationship between demographic/driving variables, aberrant driving behaviours, and previous involvement in RTCs serving as dependent variable. Demographic/driving variables and DBQ subscales were used as explanatory variables in the respective models. Hierarchical regression allows for a more controlled examination of the unique contributions of each set of

variables to explaining the variance in the DBQ subscale. Subsequent analyses focused on the association between DAS subscales and DBQ, risk involvement, and driver behaviour, respectively, utilizing hierarchical regressions and multivariable logistic analyses. To statistically control sociodemographic variables and to see whether adding DAS subscales significantly improved the model's ability to predict driver behaviour, four hierarchical regressions were performed taking the DBQ subscales as the dependent variable and the DAS subscales as independent variables to explore how aberrant driving behaviours could be predicted by a combination of variables. In each analysis, variables are added to the model in separate steps called "blocks". This aimed to unravel the sole contribution of each set of variables in explaining aberrant driving behaviours. Therefore, the demographic variables were entered in the first step. Sociodemographic variables (age, gender, annual mileage, driving experience, and occupation) were introduced into the model in the first step as controlled variables. The six subscales of DAS were entered in the second step when performing hierarchical regression. To provide linear regression, the indicators had to be modified and the number of categories was reduced (categories were merged in cases where there was no significant difference). The statistical significance level was set at 0.05.

Multivariable logistic analyses were performed to examine the association between risk involvement (RTCs and fines) considered as dependent variables and DAS subscales as independent variables. The statistical significance level was set at a p-value < 0.05. Additional investigations explored the association between T-LOC scores and risk involvement through multivariable logistic regression.

To explore the association between DSI and sociodemographic characteristics, two stepwise linear regressions were performed, taking the DSI subscales as the dependent variable and the sociodemographic and traffic variables as independent measures. This regression procedure involves iteratively adding or removing independent variables from the model based on their contribution to explaining the variance in the dependent variable. In the first step, the variable with the highest significance level (lowest p-value) is added to the model. This variable is selected based on its individual association with the outcome variable. In each subsequent step, the algorithm considers adding or removing variables based on their significance levels. If a variable is found to significantly improve the model fit, it is added to the model. Conversely, if a variable no longer contributes significantly to the model after accounting for other variables, it may be removed. The stepwise regression process continues until a stopping criterion is met. The criterion used is based on the adjusted R-squared which measures the proportion of variance in the dependent variable that is explained by the independent variables in the regression model. The model stops adding variables when the

adjusted R-squared no longer increases significantly with the addition of new variables. A significance level of $p < 0.05$ was applied to determine the inclusion or exclusion of variables at each step of the regression analysis. The final model consists of the variables that remain after the stepwise regression process is completed. These variables are considered the most significant predictors of the DSI subscale based on the chosen criteria. Prior to performing the linear regression analysis, the variables were modified to ensure consistency and reduce complexity. This involves reducing categories within categorical variables to create more meaningful groupings or merging categories where there were no significant differences in the outcome of interest. This will help in improving the stability of the regression models.

This study also explored the association between DSI and driver behaviour. To statistically control sociodemographic variables and to see whether adding DSI subscales significantly improved the model's ability to predict the driver behaviour, two hierarchical regressions were performed taking the DBQ subscales as the dependent variable and the DSI subscales/sociodemographic variables as independent variables. In this analysis, sociodemographic variables (such as age, gender, education level, and occupation) and traffic variables (such as annual mileage and driving experience) were entered into the regression equation as the first block of predictors. Subsequently, DSI subscales were entered into the regression equation as the second block of predictors, after controlling for the effects of sociodemographic and traffic variables. The change in R-squared between Model 1 and Model 2 will also be examined to assess the additional predictive value of DSI subscales after accounting for sociodemographic and traffic variables. Lastly, hierarchical linear regression was utilized to explore factors associated with RTC involvement, incorporating DSI subscales and sociodemographic variables.

II.4. RESULTS

TRANSLATION AND PSYCHOMETRIC TESTING

BASELINE INFORMATION

A total of 1 102 questionnaires were collected, a response rate of 80.7%. The age of participants ranged from 18 to 82, with a mean age of 34.6 ± 12.3 years (Table 16). Of all participants, 68.4% were male. Around 57.6% of the participants had an education level higher than secondary education and were employed in a job other than professional driving. The mean driving experience was 13.5 ± 10.8 years. More than 30% of respondents reported driving a distance of over 10 000 kilometres annually; 43.2% of surveyed drivers reported being involved in RTCs, and 46.8% reported receiving penalties for traffic violations within the past three years.

Table 16: Socio-demographics characteristics of surveyed Lebanese drivers (N=1102)

	N	%
Gender		
Male	754	68.4%
Female	348	31.6%
Marital status		
Single	466	42.3%
Married	576	52.3%
Other (Widowed, Separated.)	60	5.6%
Education level		
Secondary and below	468	42.4%
University or above	634	57.6%
Occupation		
Student	272	24.7%
Professional driver (taxi)	116	10.5%
Working other than a professional driver	630	57.2%
Other (Not working, Housewife)	84	7.6%
Annual mileage (Km)		
<6 000 km	524	47.5%
6 000-10 000 km	242	22.00%
> 10 000 km	336	30.50%
Road traffic crashes in the previous 3 years		
No	626	56.80%
Yes	476	43.20%
Fines in the last 3 years		
No	586	53.20%
Yes	516	46.80%

*S. D: Standard deviation, n frequency, % percentage, RTCs: road traffic crashes, km: Kilometres

Table 17: Mean and standard deviation of the Lebanese version of the Driver behaviour questionnaire items

#	Items	All drivers (n=1102)	
		Mean	S. D
DBQ1	Attempt to drive away from traffic lights	2.52	0.708
DBQ2	Check your speedometer and discover that you are unknowingly traveling faster than the legal limit	2.55	0.711
DBQ3	Lock yourself out of your car with the keys still inside	2.52	0.687
DBQ4	Drive as fast along country roads at night on dipped lights as on a full beam	2.55	0.731
DBQ5	Attempt to drive away without first having switched on the ignition	2.54	0.584
DBQ6	Drive especially close or “flash” the car in front as a signal for that driver to go faster or get out of your way	2.67	0.677
DBQ7	Forget where you left your car in a car parking	2.53	0.714
DBQ8	Distracted or preoccupied, realize belatedly that the vehicle ahead has slowed, and have to slam on the brakes to avoid a collision	2.55	0.637
DBQ9	Intend to switch on the windscreen wipers, but switch on the lights instead, or vice versa	2.64	0.723
DBQ10	Turn left onto the main road into the path of an oncoming vehicle that you hadn’t seen, or whose speed you had misjudged	2.58	0.577
DBQ11	Misjudge your gap in a car park and nearly (or actually) hit an adjoining vehicle	2.57	0.524
DBQ12	“Wake up” to realize that you have no clear recollection of the road along which you have just travelled	2.50	0.680
DBQ13	Miss your exit on a motorway and have to make a lengthy detour	2.42	0.624
DBQ14	Forget which gear you are currently in and have to check with your hand	2.49	0.739
DBQ15	Stuck behind a slow-moving vehicle on a two-lane highway, you are driven by frustration to try to overtake in risky circumstances	2.50	0.573
DBQ16	Intending to drive to destination A, you „wake up“ to find yourself on route to B, where the latter is the more usual journey	2.50	0.720
DBQ17	Take a chance and cross on lights that have turned red	2.56	0.797
DBQ18	Angered by another driver's behaviour, you give chase to give him/her a piece of your mind	2.61	0.607
DBQ19	Have an aversion to a particular class of road user and indicate your hostility by whatever means you can	2.61	0.547
DBQ20	Try to overtake without first checking your mirror, and then get hooted at by the car behind which has already begun its overtaking manoeuvre	2.63	0.543
DBQ21	Deliberately disregard the speed limits late at night or very early in the morning	2.52	0.715
DBQ22	Forget when your road tax/insurance expires and discover that you are driving illegally	2.57	0.783
DBQ23	Lost in thought, you forget that your lights are on the full beam until „flashed“ by other motorists	2.52	0.786
DBQ24	In a queue of vehicles turning left onto the main road, pay such close attention to the traffic approaching from the	2.48	0.758

	right that you nearly hit the car in front		
DBQ25	Drive back from a party, restaurant, or pub, even though you realize that you may be over the legal blood-alcohol limit	2.52	0.814
DBQ26	Lost in thought or distracted, you fail to notice someone waiting and crossing a pelican crossing light that has just turned red	2.59	0.634
DBQ27	Park in a no parking zone and risk a fine	2.58	0.706
DBQ28	Misjudge the speed of the oncoming vehicle when overtaking	2.56	0.685
DBQ29	Hit something when reversing that you had not previously seen	2.50	0.718
DBQ30	Plan your route badly, so that you meet traffic congestion you could have avoided	2.60	0.632
DBQ31	Overtake a single line of stationary or slow-moving vehicles, only to discover that they were queuing to get through a one-lane gap or roadwork lights	2.57	0.549
DBQ32	Cut the corner on a right-hand turn and have to swerve violently to avoid an oncoming vehicle	2.54	0.571
DBQ33	Get into the wrong lane at a roundabout or approaching a road junction	2.53	0.671
DBQ34	Fail to read the signs correctly, and exit from a roundabout on the wrong road	2.54	0.704
DBQ35	Fail to give way when a vehicle is signalling its intention to pull out	2.53	0.687
DBQ36	Ignore „give way“ signs, and narrowly avoid colliding with traffic having right of way	2.53	0.614
DBQ37	Fail to check your mirror before pulling out, changing lanes, turning, etc.	2.57	0.587
DBQ38	Attempt to overtake a vehicle that you hadn't noticed was signalling its intention to turn right	2.55	0.574
DBQ39	Deliberately drive the wrong way down a deserted one-way street	2.62	0.801
DBQ40	Disregard red lights when driving late at night along empty roads	2.60	0.760
DBQ41	Drive with only „half-an-eye“ on the road while using the mobile, changing radio channels, turning on the air conditioner...	2.58	0.761
DBQ42	Get involved in unofficial „races“ with other drivers	2.56	0.760
DBQ43	Race“ oncoming vehicles for a one-car gap on a narrow or obstructed road	2.57	0.666
DBQ44	Brake too quickly on a slippery road and/or steer the wrong way in a skid	2.55	0.606
DBQ45	Misjudge your crossing interval when turning right and narrowly miss a collision	2.55	0.586

DBQ-L VALIDATION

All items had an appropriate ICC with other items, and none of the 45 items was deleted. Mean and standard deviation of the Lebanese version of the Driver behaviour questionnaire items was provided in Table 17. The DBQ Cronbach's α was .892. No floor or ceiling effects were detected with all dimensions. Ten respondents obtained the highest status scores of 10%. The ICC was 0.82 and the DBQ-L scores had a consistent and unbiased distribution (Figure 32). The average score difference between the baseline and retest is 3.18, indicating a slight positive shift in scores on average over time. The 95% LOA ranged from -5.2 to 12.1, with the majority of score differences between the two tests being small and within this LOA range.

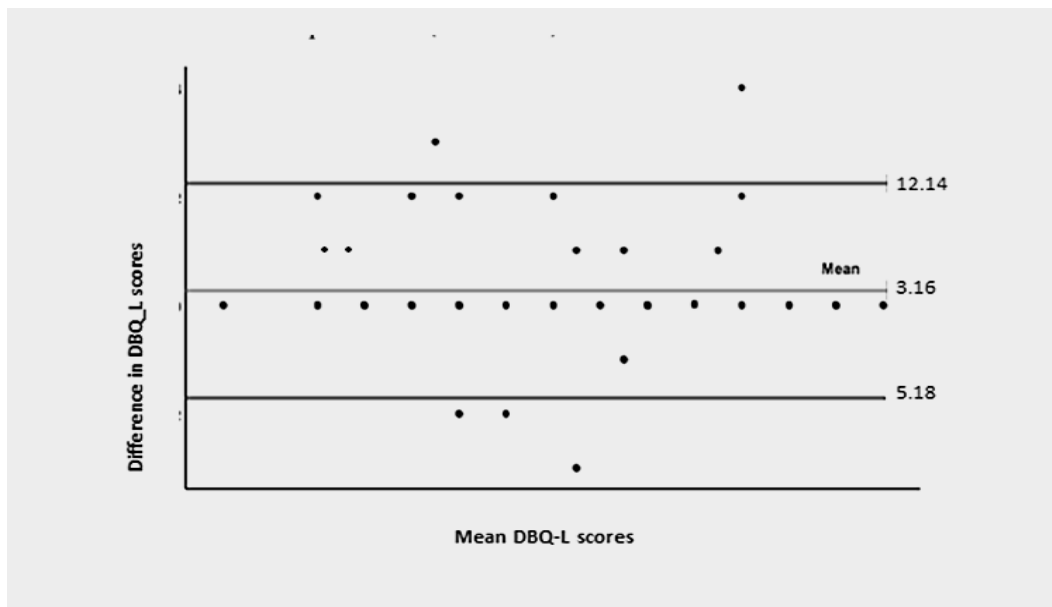

Figure 32: Bland-Altman plot for the DBQ

A sample of 580 drivers was used for conducting the EFA. Initially, using varimax rotation, items converged over a solution of four factors with eigenvalues over 1.0 and the examination of the scree plot suggested that the four-factor solution was the most interpretable one. (Factor 1 = Aggressive violations, Factor 2 = Simple/ordinary violation, Factor 3 = Errors, and Factor 4 = Lapses). The KMO was 0.935 and Bartlett's test was highly significant ($p < 0.001$). The total variance explained was 75.4%, and the Cronbach's alpha = 0.892. PA revealed that the four factors explaining 75% of the total variance would have been selected. The first factor explained 28.4% of the total variance and consisted of 15 items measuring lapses (Table 18). The second factor includes 15 items that tapped drivers' errors, accounted for 21.9% of the variance, and was labelled "errors". The third factor included 10

items about simple traffic violations and accounted for 17.4% of the variance and was named “Ordinary violations”. The fourth factor included 5 items that tapped aggressive reactions to driving situations. This factor accounted for 7.6% of the variance and was named “Aggressive violations”. One item related to ordinary violation (DBQ33: Cut the corner on a right-hand turn and have to swerve violently to avoid an oncoming vehicle) loaded in the “aggressive violation component.”

Table 18: Four-factor solution of DBQ-L items, eigenvalues, and Cronbach's alpha coefficients, and variance of the DBQ subscales both among Lebanese drivers

#	Item	DBQ Components			
		Lapses	Errors	Ordinary violations	Aggressive violations
DBQ34	Fail to read the signs correctly, and exit from a roundabout on the wrong road	0.923			
DBQ12	“Wake up” to realize that you have no clear recollection of the road along which you have just travelled	0.899			
DBQ33	Get into the wrong lane at a roundabout or approaching a road junction	0.896			
DBQ3	Lock yourself out of your car with the keys still inside	0.886			
DBQ23	Lost in thought, you forget that your lights are on the full beam until „flashed“ by other motorists	0.884			
DBQ23	Check your speedometer and discover that you are unknowingly traveling faster than the legal limit	0.884			
DBQ13	Miss your exit on a motorway and have to make a lengthy detour	0.866			
DBQ1	Attempt to drive away from traffic lights	0.862			
DBQ24	In a queue of vehicles turning left onto the main road, pay such close attention to the traffic approaching from the right that you nearly hit the car in front	0.851			
DBQ22	Forget when your road tax/insurance expires and discover that you are driving illegally	0.847			
DBQ16	Intending to drive to destination A, you „wake up“ to find yourself on route to B, where the latter is the more usual journey	0.842			
DBQ29	Hit something when reversing that you had not previously seen	0.840			
DBQ14	Forget which gear you are currently in and have to check with your hand	0.826			
DBQ35	Fail to give way when a vehicle is signalling its intention to pull out	0.807			
DBQ9	Intend to switch on the windscreen wipers, but switch on the lights instead, or vice versa	0.805			
DBQ11	Misjudge your gap in a car park and nearly (or actually) hit an adjoining vehicle		0.944		
DBQ10	Turn left onto the main road into the path of an oncoming vehicle that you hadn't seen, or whose speed you had misjudged		0.927		
DBQ26	Lost in thought or distracted, you fail to notice someone waiting and crossing a pelican crossing light that has just turned red		0.917		
DBQ45	Misjudge your crossing interval when turning right and narrowly miss a collision		0.902		
DBQ5	Attempt to drive away without first having switched on the ignition		0.842		

DBQ38	Attempt to overtake a vehicle that you hadn't noticed was signalling its intention to turn right	0.839	
DBQ28	Misjudge the speed of the oncoming vehicle when overtaking	0.825	
DBQ7	Forget where you left your car in a car parking	0.812	
DBQ20	Try to overtake without first checking your mirror, and then get hooted at by the car behind which has already begun its overtaking manoeuvre	0.807	
DBQ36	Ignore „give way“ signs, and narrowly avoid colliding with traffic having right of way	0.802	
DBQ44	Brake too quickly on a slippery road and/or steer the wrong way in a skid	0.802	
DBQ8	Distracted or preoccupied, realize belatedly that the vehicle ahead has slowed, and have to slam on the brakes to avoid a collision	0.789	
DBQ37	Fail to check your mirror before pulling out, changing lanes, turning, etc.	0.787	
DBQ31	Overtake a single line of stationary or slow-moving vehicles, only to discover that they were queuing to get through a one-lane gap or roadwork lights	0.786	
DBQ30	Plan your route badly, so that you meet traffic congestion you could have avoided	0.775	
DBQ40	Disregard red lights when driving late at night along empty roads		0.953
DBQ17	Take a chance and cross on lights that have turned red		0.941
DBQ4	Drive as fast along country roads at night on dipped lights as on full beam		0.931
DBQ21	Deliberately disregard the speed limits late at night or very early in the morning		0.929
DBQ41	Drive with only half-an-eye“ on the road while using the mobile, changing radio channel, turning on A.C		0.925
DBQ25	Drive back from a party, restaurant, or pub, even though you realize that you may be over the legal blood-alcohol limit		0.923
DBQ39	Deliberately drive the wrong way down a deserted one-way street		0.921
DBQ42	Get involved in unofficial „races“ with other drivers		0.886
DBQ27	Park in a no parking zone and risk a fine		0.867
DBQ43	Race“ oncoming vehicles for a one-car gap on a narrow or obstructed road		0.744
DBQ33	Cut the corner on a right-hand turn and have to swerve violently to avoid an oncoming vehicle		0.908
DBQ18	Angered by another driver's behaviour, you give chase to give him/her a piece of your mind		0.864
DBQ15	Stuck behind a slow-moving vehicle on a two-lane highway, you are driven by frustration to try to overtake in risky circumstances		0.858
DBQ19	Have an aversion to a particular class of road user and indicate your hostility by whatever means you can		0.854
DBQ6	Drive especially close or „flash“ the car in front as a signal for driver to go faster or get out of your		0.682

way

Eigenvalue	12.80	9.87	7.84	3.40
Cronbach alpha	0.73	0.81	0.79	0.680
Variance (%)	28.445	21.942	17.416	7.553

Note: Factor loadings below .30 were omitted for the sake of clarity, 75.36% of the variance was explained, Extraction Method: Principal Component Analysis. Rotation Method: Varimax with Kaiser Normalization.

The α -values obtained from the subscales ranged between 0.680 and 0.814, indicating good internal consistency (Table 19). The overall reliability of the DBQ-L scale was also good, with a Cronbach α of 0.85. All the subscales were reliable, with alpha reliabilities were 0.68 for aggressive violations, 0.79 for ordinary violations, 0.81 for errors, and 0.73 for lapses subscales. Skewness estimates for the four factors ranged from 0.075 to 0.967, and kurtosis estimates ranged from 0.521 to 0.714, allowing for the use of parametrical correlational analyses. Males ranked higher than females in the subscales of DBQ-L related to violations, particularly the one related to aggressive violations. Of the four subscales, the highest item mean was for aggressive violations, followed by ordinary violations, lapses, and then errors. The correlation between DBQ-L factors ranged from 0.435 to 0.572, with most of them being highly statistically significant ($p < 0.001$) and having a moderate correlation (Appendix 16). High correlation between errors (e2 and e1, e3 and e4, e1 and e5) was found using modification indices (Table 20). Model specifications performed to adjust the model for a better fit included drawing eight covariates between the following errors: e8-e15, e1-e9, e16-e18, e18-e30, e27-e29, e21-e22, e16-e17, and e17-e18, respectively. The model used in confirmatory factor analyses is presented schematically in the annexed figure FA1. This resulted in a better fit than the default model. The model fit measures of the data analysis were as follows: $\chi^2=3929.5$, $\chi^2/df = 4.221$; NFI = 0.912, CFI = 0.907, GFI = 0.906, AGFI = 0.902, RMSEA = 0.071, suggesting a reasonable model fit.

Table 19: Summary statistics for the DBQ-L subscales

#	Number of items	Item mean	All drivers (n=1102)							Male (n=754)		Female (n= 348)	
			Scale Mean	S. D	Min	Max	Alpha α	Skewness	Kurtosis	Mean	S. D	Mean	S. D
Aggressive violations	5	2.99	14.98	2.04	11	24	0.68	0.075	0.654	15.03	2.11	14.8	1.9
Ordinary violations	10	2.65	26.56	4.72	19	49	0.79	0.213	0.634	26.46	4.69	25.8	4.79
Errors	15	2.21	33.27	5.9	23	57	0.81	0.967	0.589	33.23	5.84	33.34	6.08
Lapses	15	2.52	37.8	4.8	28	65	0.73	0.579	0.521	37.84	4.97	37.73	4.43
DBQ-L scale	45	2.51	113.14	14.5	91	188	0.85	0.336	0.714	113.0	14.8	113.3	14.89

N.B: S.D refers to standard deviation, alpha referred to Cronbach alpha, min for minimum and max for maximum, Vehicle/Env refers to the vehicle and environment dimension

Table 20: Model fit indicators for DBQ-L

	χ^2	χ^2/df	NFI	CFI	GFI	AGFI	SRMR	RMSEA
Model based on EFA result	5939.232	6.325	0.822	0.845	0.703	0.736	0.0456	0.097
Adapted model	3929.514	4.221	0.912	0.907	0.906	0.902	0.048	0.071

DAS VALIDATION

After evaluating the translation and back-translation of the Arabic version of DAS, as well as testing the pre-final version on 40 drivers, slight changes have been made, including the substitution of some confusing words, to produce the final version of DAS. The back-translated version matched closely the original one. Since all DAS items obtained a CVR of more than 0.75 based on the quantitative approach used by experts, the 33 items were retained. Moreover, the overall CVI of DAS was 0.83. Therefore, the panel of experts considered the instrument appropriate to measure the driver's anger and judged that the questionnaire had good content validity. All mean values for the 33 items exceeded 1.5, indicating their suitability for subsequent analyses (Table 21).

All situations described in the scale provoked considerable amounts of anger among drivers. The highest level of anger reported was related to situations showing hostile gestures executed by other drivers such as obscene signs, honking, and yelling about their driving performance. On the contrary, items describing situations where the police are present (police monitoring, being pulled over, passing by a radar speed trap, or driving close to a police car) triggered the lowest level of anger. Both males and females reported anger while driving in these situations with slight fluctuations among gender.

The KMO was 0.891 and Bartlett's test was highly significant ($p < 0.001$). As a result of factor analysis, using Varimax rotation, items converged over a solution of six factors that had eigenvalues over 1.0 and the examination of the scree plot suggested that the six-factor solution was the most interpretable one (Figure 33). The total variance explained was 88.6%, and Cronbach's alpha = 0.93. Four factors surpassed the PA criterion, which explained also 88% of the total variance. Both analyses yielded the same results in terms of the higher factor coefficient for each of the items selected. The items for each factor were similar to those in the original scale (Table 22). As a result, the first factor with nine items was called "discourtesy", accounting for the variance of 35%, and had an eigenvalue of 11.56 ($\alpha = 0.81$). The first factor explained 35% of the total variance.

The second factor, called "traffic obstruction" included seven items, was responsible for 14.58% of the total variance ($\alpha = 0.90$) and had an eigenvalue of 4.813. These items describe traffic barriers that impede drivers' circulation. Factor 3, called "slow driving", was comprised of six items. It was responsible for 13.7% of the total variance ($\alpha = 0.92$) and had an eigenvalue of 4.538. As for factor 4, it included four items and was labelled as "police presence". It accounted for 10.6% ($\alpha = 0.85$) of the total variance and had an eigenvalue of 3.5.

Factor 5, termed “Illegal driving”, included four items, accounted for 8.1% ($\alpha=0.87$) of the total variance, and had an eigenvalue of 2.68. Factor 6, labelled “hostile gesture”, was composed of three items, was responsible for 6.48% ($\alpha=0.92$) of the total variance and had an eigenvalue of 2.1.

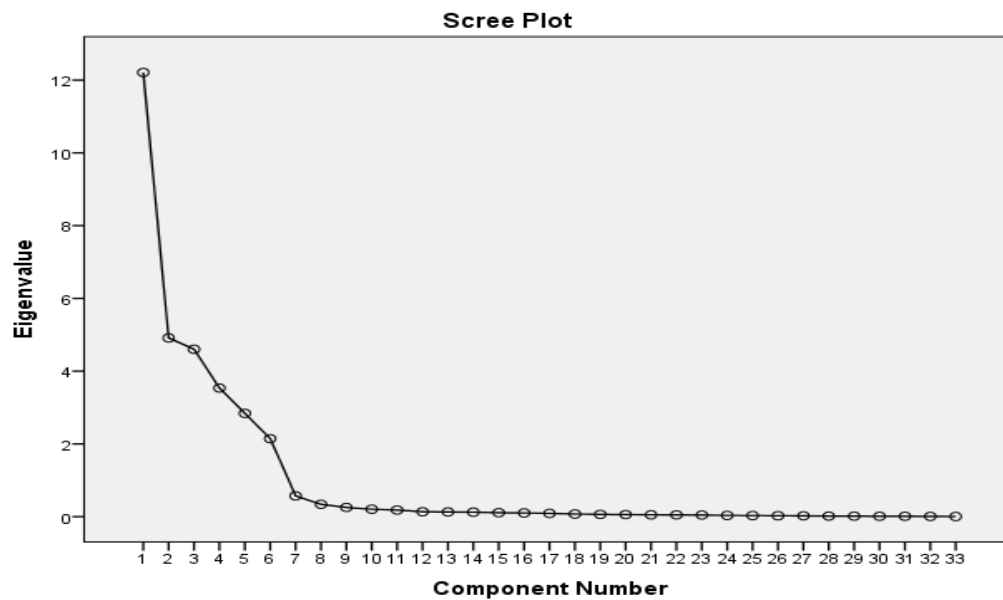

Figure 33: Scree plot showing the number of factors in the Arabic version of DAS

Table 21: Driver anger scale items mean and standard deviation

Item	Total		Male		Female		
	Mean	S.D	Mean	S.D	Mean	S.D	
DAS1	Someone in front of you does not start up when the light turns green	3.07	0.861	3.06	0.853	3.10	0.879
DAS2	Someone is driving too fast for the road conditions	3.64	0.557	3.65	0.542	3.63	0.592
DAS3	A pedestrian walks slowly across the middle of the street, slowing you	3.06	0.858	3.05	0.846	3.08	0.884
DAS4	Someone is driving too slowly in the passing lane holding up traffic	2.98	0.929	2.97	0.891	3.01	1.011
DAS5	Someone is driving very close to your rear bumper	3.36	0.699	3.33	0.684	3.42	0.729
DAS6	Someone is weaving in and out of traffic	3.69	0.705	3.67	0.709	3.73	0.695
DAS7	Someone cuts in right in front of you on the motorway	3.30	0.836	3.29	0.837	3.35	0.834
DAS8	Someone cuts in and takes the parking spot you have been waiting for	3.25	0.781	3.21	0.755	3.33	0.831
DAS9	Someone is driving slower than reasonable for the traffic flow	2.98	0.862	2.97	0.873	2.99	0.842
DAS10	A slow vehicle on a mountain road will not pull over and let people by	3.02	0.958	3.02	0.951	3.01	0.977
DAS11	You see a police car watching traffic from a hidden position.	2.30	1.071	2.34	1.111	2.19	0.970
DAS12	Someone backs right out in front of you without looking	3.27	0.778	3.25	0.775	3.34	0.783
DAS13	Someone runs a red light or stop sign	3.69	0.686	3.70	0.660	3.68	0.743
DAS14	Someone coming toward you at night does not dim their headlights	3.15	0.747	3.16	0.747	3.13	0.748
DAS15	At night someone is driving right behind you with bright lights on	3.34	0.913	3.31	0.900	3.39	0.944
DAS16	You pass a radar speed trap	2.39	1.031	2.45	1.069	2.26	0.930
DAS17	Someone speeds up when you try to pass them	3.37	0.842	3.34	0.831	3.44	0.866
DAS18	Someone is slow in parking and holding up traffic	3.02	0.963	3.02	0.954	3.01	0.986
DAS19	You are stuck in a traffic jam	3.34	0.871	3.36	0.876	3.31	0.861
DAS20	Someone pulls right in front of you when there is no one behind you	3.36	0.888	3.34	0.858	3.41	0.952
DAS21	Someone makes an obscene gesture toward you about your driving	3.81	0.679	3.79	0.661	3.85	0.718
DAS22	You hit a deep pothole that was not marked	3.38	0.797	3.38	0.800	3.39	0.792
DAS23	A police car is driving in traffic close to you	2.29	1.041	2.34	1.075	2.19	0.954
DAS24	Someone honks at you about your driving	3.79	0.665	3.78	0.654	3.82	0.691
DAS25	Someone is driving well above the speed limit	3.69	0.685	3.70	0.661	3.66	0.738
DAS26	Driving behind a truck which is material flapping around in the back	3.24	0.721	3.22	0.689	3.27	0.789
DAS27	Someone yells at you about your driving	3.76	0.635	3.74	0.613	3.81	0.680

DAS28	A motorcyclist is riding in the middle of the lane and slowing traffic	3.38	0.822	3.35	0.829	3.44	0.805
DAS29	A police officer pulls you over	2.35	1.062	2.41	1.106	2.23	0.949
DAS30	You are behind a vehicle that is smoking badly (diesel fumes)	3.33	0.910	3.34	0.907	3.30	0.917
DAS31	A truck kicks up sand or gravel on the car you are driving	3.46	0.953	3.48	0.962	3.39	0.932
DAS32	You are driving behind a large truck and cannot see around it	3.34	0.852	3.35	0.866	3.32	0.823
DAS33	You encounter road construction and detours	3.20	0.674	3.20	0.656	3.19	0.712

Table 22: Six-factor solution of DAS items, eigenvalues, Cronbach's alpha coefficients, and variance explained by each DAS subscale among Lebanese drivers

Item	DAS factors					
	Discourtesy	Traffic obstruction	Slow driving	Police presence	Illegal driving	Hostile gesture
DAS8	Someone cuts in and takes the parking spot you have been waiting for	0.835				
DAS20	Someone pulls right in front of you when there is no one behind you	0.827				
DAS14	Someone coming toward you at night does not dim their headlights	0.816				
DAS15	At night someone is driving right behind you with bright lights on	0.808				
DAS12	Someone backs right out in front of you without looking	0.807				
DAS17	Someone speeds up when you try to pass them	0.776				
DAS28	A motorcyclist is riding in the middle of the lane and slowing traffic	0.753				
DAS7	Someone cuts in right in front of you on the motorway	0.709				
DAS5	Someone is driving very close to your rear bumper	0.631				
DAS33	You encounter road construction and detours		0.855			
DAS26	You are driving behind a truck that is material flapping around in the back		0.852			
DAS19	You are stuck in a traffic jam		0.833			
DAS32	You are driving behind a large truck and cannot see around it		0.831			
DAS22	You hit a deep pothole that was not marked		0.822			
DAS31	A truck kicks up sand or gravel on the car you are driving		0.795			
DAS30	You are behind a vehicle that is smoking badly or giving off diesel fumes		0.632			
DAS18	Someone is slow in parking and holding up traffic			0.846		
DAS10	A slow vehicle on a mountain road will not pull over and let people by			0.839		
DAS4	Someone is driving too slowly in the passing lane holding up traffic			0.834		
DAS9	Someone is driving slower than reasonable for the traffic flow			0.831		
DAS2	A pedestrian walks slowly across the middle of the street, slowing you			0.817		
DAS1	Someone in front of you does not start up when the light turns green			0.795		
DAS23	A police car is driving in traffic close to you				0.850	
DAS16	You pass a radar speed trap				0.845	
DAS11	You see a police car watching traffic from a hidden position.				0.843	
DAS29	A police officer pulls you over				0.938	

DAS25	Someone is driving well above the speed limit												0.878
DAS6	Someone is weaving in and out of traffic												0.858
DAS2	Someone is driving too fast for the road conditions												0.857
DAS13	Someone runs a red light or stop sign												0.760
DAS21	Someone makes an obscene gesture toward you about your driving												0.829
DAS24	Someone honks at you about your driving												0.822
DAS27	Someone yells at you about your driving												0.808
	Eigenvalue						11.560	4.813	4.538	3.501	2.689	2.141	
	Cronbach alpha						0.919	0.908	0.921	0.914	0.868	0.917	
	Variance						35.031	14.586	13.752	10.609	8.148	6.487	

Note: 88.6% of the variance was explained, Extraction Method: PCA, Rotation Method: Varimax with Kaiser Normalization.

Table 23: Summary statistics for the DAS subscales

#	DAS subscales	Number of items	Item mean	SD	Min	Max	All drivers (n=1102)						
							Scale means	SD	Min	Max	α	Skewness	Kurtosis
D1	Discourtesy	9	3.34	0.82	1.4	4.89	30.09	7.51	13	44	0.81	-0.21	-0.94
D2	Traffic obstruction	7	3.39	0.74	2.0	7.57	23.91	5.15	14	53	0.90	0.72	0.97
D3	Slow driving	6	3.01	0.92	1.0	5.00	18.29	5.54	6	30	0.92	0.18	-0.80
D4	Police presence	4	2.33	1.04	1.0	4.50	9.37	4.16	4	18	0.85	0.24	-0.98
D5	Illegal driving	4	3.62	0.56	2.5	4.75	14.53	2.28	10	20	0.87	0.27	-0.67
D6	Hostile gesture	3	3.79	0.63	2.3	5.00	11.38	1.91	7	15	0.92	0.27	-0.67
	DAS scale	33	3.24	0.50	2.15	4.70	107.54	16.78	2.15	4.7	0.93	0.37	-0.3

N.B: S.D refers to standard deviation, alpha referred to Cronbach alpha, min for minimum, and max for maximum

The α -values obtained of the subscales ranged between 0.87 and 0.93, indicating an excellent internal consistency (Table 23). The overall reliability of the DAS-A scale was good ($\alpha=0.93$) and all the subscales were reliable. Skewness [-0.21, 0.72] and kurtosis [-1.08, 1.07] estimates for the four factors allowed the use of parametrical correlational analyses. Females ranked higher than males in the subscales of DAS related to discourtesy, illegal driving, and hostile gestures. The Pearson correlation coefficient (Pearson's r) of 0.77 indicates a positive correlation between the test and retest scores, which is satisfactory (>0.70). Additionally, the mean difference between the scores obtained at the two time points was calculated to be 2.33. The 95% LOA, which represent the range within which 95% of the differences between the test and retest scores fall, were calculated as -3.51 to 7.02. The DAS scores obtained at the second administration of the questionnaire were 2.33 points higher than those obtained at the first administration.

The CFA of the initial model resulting from EFA revealed that the default model did not adequately fit our data. Due to the high correlation between DAS32 and DAS19, DAS32 ("You are behind a large truck and cannot see around it") was removed from the analysis. Additionally, specific items were covaried to account for their shared variance: DAS11 ("You see a police car watching traffic from a hidden position") and DAS23 ("A police car is driving in traffic close to you"), as well as DAS1 ("Someone in front of you does not start up when the light turns green") and DAS3 ("A pedestrian walks slowly across the middle of the street, slowing you"), and finally DAS17 ("Someone speeds up when you try to pass them") and DAS20 ("Someone pulls right in front of you when there is no one behind you") (Appendix 17).

The CFA based on the modified model yielded improved fit indices compared to the default mode: $\chi^2 = 2013.9$, $\chi^2/df = 4.526$ (< 5) indicating an acceptable fit, NFI = 0.941, CFI = 0.953, TLI = 0.948, GFI = 0.906, AGFI = 0.902, RSMR = 0.0469 (<0.08) indicating a reasonable fit, and RMSEA = 0.071 (<0.08) indicating a reasonable fit. To further validate the consistency of the six-factor solution of the DAS among Lebanese drivers, an exploratory factor analysis (EFA) was rerun after implementing the changes, confirming a similar factor structure (Table 24).

There were significant correlations [ranging from $r = 0.178$ ($p < 0.01$) to $r = 0.510$ ($p < 0.01$)] between the subscales of DAS. As expected, there were moderate to highly positive correlations between the DAS scale and its six dimensions. The highest correlation was between the DAS scale and discourtesy ($r=0.775$, CI (0.591-0.812), $p<0.01$) showing a positive linear relationship followed by DAS and the slow driving component ($r=0.702$, CI (0.602-0.854), $p<0.01$). The relationship between driving anger and its subscales reveals the

construct validity of the DAS by demonstrating its ability to accurately assess different dimensions of driving-related anger and emotion.

Table 24: Rerun of EFA after changes made to the model: Similar six-factor solution of DAS items, eigenvalues, Cronbach's alpha coefficients, and variance explained by each DAS subscale among Lebanese drivers

	Item	DAS factors					
		Discourtesy	Traffic obstruction	Slow driving	Police presence	Illegal driving	Hostile gesture
DAS8	Someone cuts in and takes the parking spot you have been waiting for	0.875					
DAS20	Someone pulls right in front of you when there is no one behind you	0.847					
DAS14	Someone coming toward you at night does not dim their headlights	0.836					
DAS15	At night someone is driving right behind you with bright lights on	0.818					
DAS12	Someone backs right out in front of you without looking	0.817					
DAS17	Someone speeds up when you try to pass them	0.806					
DAS28	A motorcyclist is riding in the middle of the lane and slowing traffic	0.792					
DAS7	Someone cuts in right in front of you on the motorway	0.749					
DAS5	Someone is driving very close to your rear bumper	0.698					
DAS33	You encounter road construction and detours		0.848				
DAS26	You are driving behind a truck that is material flapping around in the back		0.841				
DAS19	You are stuck in a traffic jam		0.813				
DAS22	You hit a deep pothole that was not marked		0.801				
DAS31	A truck kicks up sand or gravel on the car you are driving		0.788				
DAS30	You are behind a vehicle that is smoking badly or giving off diesel fumes		0.701				
DAS18	Someone is slow in parking and holding up traffic			0.883			
DAS10	A slow vehicle on a mountain road will not pull over and let people by			0.809			
DAS4	Someone is driving too slowly in the passing lane holding up traffic			0.804			
DAS9	Someone is driving slower than reasonable for the traffic flow			0.801			

DAS2	A pedestrian walks slowly across the middle of the street, slowing you						0.777
DAS1	Someone in front of you does not start up when the light turns green						0.735
DAS23	A police car is driving in traffic close to you						0.874
DAS16	You pass a radar speed trap						0.835
DAS11	You see a police car watching traffic from a hidden position.						0.831
DAS29	A police officer pulls you over						0.901
DAS25	Someone is driving well above the speed limit					0.878	
DAS6	Someone is weaving in and out of traffic					0.858	
DAS2	Someone is driving too fast for the road conditions					0.857	
DAS13	Someone runs a red light or stop sign					0.783	
DAS21	Someone makes an obscene gesture toward you about your driving						0.879
DAS24	Someone honks at you about your driving						0.843
DAS27	Someone yells at you about your driving						0.813
	Eigenvalue	9.560	5.813	3.538	3.302	2.179	2.021
	Cronbach alpha	0.921	0.918	0.899	0.904	0.832	0.904
	Variance	35.431	14.786	13.852	10.812	8.348	7.187

Note: 88.6% of the variance was explained, Extraction Method: PCA, Rotation Method: Varimax with Kaiser Normalization.

DSI VALIDATION

Minor adjustments were made, replacing potentially ambiguous words, such as substituting "driving in a strange city" with "driving in an unfamiliar place" and swapping out one item related to performance skills with "Reverse parking into a narrow gap." The back-translation of the modified version closely paralleled the original document. All items achieved a CVR exceeding 0.75, solidifying their appropriateness and retention in the final version. The overall CVI was 0.82. All items had an appropriate ICC with other items (Table 25), and none of the 29 items was deleted. Cronbach's $\alpha = 0.902$).

All dimensions exhibited low levels of bottom and ceiling effects, each being below 15%; 15 respondents achieved the highest status scores, representing less than 10% of the participants. A high reproducibility was observed with safety skills (ICC = 0.827 (0.745, 0.906), p-value < 0.001) and perceptual-motor skills (ICC = 0.783 (0.701–0.881), p-value < 0.001). The mean difference was 3.78 with a confidence interval from -4.18 to 10.23, measured after the 21-day period.

Table 25: Mean and standard deviation of the Arabic version of the Driver Skills inventory items

Item	All drivers (N=1102)	
	Mean	SD
Performance in a critical situation.	2.36	0.585
Driving behind a slow car without getting impatient.	2.17	0.963
Managing the car through a skid.	2.47	0.896
Predicting traffic situations ahead.	2.39	0.838
Driving carefully.	2.86	0.894
Knowing how to act in particular traffic situations.	2.67	0.916
Fluent lane-changing in heavy traffic.	2.34	0.971
Fast reactions.	2.47	0.957
Showing consideration for other road-users.	2.60	0.966
Staying calm in irritating situations.	2.50	0.873
Controlling the vehicle.	2.77	0.947
Avoiding competition in traffic.	2.72	0.798
Keeping a sufficient following distance.	2.75	0.898
Make a hill start on a steep incline	2.43	0.496
Overtaking	2.55	0.931
Relinquishing" legitimate rights when necessary	2.43	0.829
Conforming to the speed limits	2.73	0.549
Avoiding unnecessary risks	2.71	0.933
Tolerating other drivers' errors calmly	2.33	0.940
Reverse parking into a narrow gap	1.92	0.662
Parking in legal places only	2.75	0.772
Conforming to the traffic rules	2.43	0.496
Obeying the traffic lights	2.55	0.931
Adjusting the speed to the conditions	2.43	0.518
Driving in a unfamiliar place	2.73	0.455
Driving in the dark	2.71	0.933
Making firm decision	2.33	0.940
Driving on a slippery road	2.33	0.932
Fluent driving	1.92	0.662

*SD: Standard deviation

In the EFA, including 580 drivers, the items converged into a solution consisting of two factors, each with eigenvalues exceeding 1. These two factors explained 60.3% of the total variance, with strong internal consistency. Factor 1, termed "Perceptual-motor skills," explained 39.5% of the variance and comprised 19 items assessing perceptual motor skills. Factor 2, labelled "Safety skills," included 10 items focusing on drivers' safety skills, explaining 21.2% of the variance. All items in the EFA demonstrated good communalities (>0.40), indicating suitability for inclusion (Table 26); therefore, no item was removed from the analysis. PA yielded consistent outcomes, with the higher factor coefficients aligning for each of the selected items. The KMO was 0.912, and Bartlett's test was highly significant ($p < 0.001$).

Table 26: Exploratory factor analysis of the DSI

Item	Perceptual skills ($\alpha= 0.83$)	motor Safety skills ($\alpha=0.78$)
DSI1	Performance in a critical situation.	0.600
DSI3	Managing the car through a skid.	0.671
DSI4	Predicting traffic situations ahead.	0.750
DSI5	Driving carefully.	0.499
DSI6	Knowing how to act in particular traffic situations.	0.676
DSI7	Fluent lane-changing in heavy traffic.	0.674
DSI8	Fast reactions.	0.577
DSI11	Controlling the vehicle.	0.581
DSI14	Make a hill start on a steep incline	0.485
DSI15	Overtaking	0.632
DSI16	Relinquishing" legitimate rights when necessary	0.548
DSI17	Conforming to the speed limits	0.608
DSI20	Reverse parking into a narrow gap	0.541
DSI24	Adjusting the speed to the conditions	0.492
DSI25	Driving in a unfamiliar place	0.523
DSI26	Driving in the dark	0.658
DSI27	Making firm decision	0.518
DSI28	Driving on a slippery road	0.497
DSI29	Fluent driving	0.676
DSI2	Driving behind a slow car without getting impatient.	0.682
DSI9	Showing consideration for other road-users.	0.764
DSI10	Staying calm in irritating situations.	0.779
DSI12	Avoiding competition in traffic.	0.712
DSI13	Keeping a sufficient following distance.	0.658
DSI18	Avoiding unnecessary risks	0.764
DSI19	Tolerating other drivers' errors calmly	0.890
DSI21	Parking in legal places only	0.797
DSI22	Conforming to the traffic rules	0.773
DSI23	Obeying the traffic lights	0.705
	Eigenvalue	4.13
	Cronbach alpha	0.89
	Variance	39.48

Note: 60.7% of the variance was explained, Extraction Method: PAF, Rotation Method: Varimax with Kaiser Normalization.

The default model resulting from the EFA was acceptable based on the fit indicators (Table 27). The two-factorial structure of DSI was confirmed. All the items from the original version of DSI which were included in the Arabic version have been maintained

Table 27: Confirmatory factor analysis of DSI

Model Fit Measures	χ^2	χ^2/df	NFI	CFI	GFI	AGFI	RMSEA
Criteria	-	< 5	> 0.9	> 0.9	> 0.9	> 0.9	< 0.08
(Schermelele-Engel et al., 2003)							(MacCallum et al., 1996)
Default model	3818.5	4.11	0.912	0.903	0.906	0.922	0.068

The α -values obtained of the subscales ranged between 0.78 and 0.83. Skewness [0.02, 0.13] and Kurtosis [0.23, 0.72] estimates for the two factors allowed the use of parametrical correlational analyses (Table 28).

Table 28: DSI subscales statistics

	Number of items	Item mean	Scale mean	Chronbach α	SD	Skewness	Kurtosis
Safety skills	10	2.55	25.47	0.83	6.37	0.02	0.23
Motor skills	19	2.58	49.07	0.78	10.91	0.13	0.72

SD: Standard deviation

T-LOC VALIDATION

Following a pilot test involving 35 drivers, minor adjustments, including the clarification of some ambiguous terms, were incorporated in the Arabic version. The back-translated variant exhibited a high degree of similarity to the original document. Every item had a CVR above 0.75; all questionnaire items were consequently retained. The overall CVI score for T-LOC was 0.88, indicative of robust content validity for the scale. The KMO measure was 0.837, and Bartlett's Test was highly significant ($p < 0.001$). The scree plot of the Eigenvalues and the bootstrapping procedure revealed a four-factor structure of the T-LOC scale, which accounted for 78% of the total variance.

The first factor, which explained 39.0% of the total variance, consisted of six items measuring causes attributed to other drivers; this factor was named "other drivers". The second factor, accounting for 15.7% of the variance, comprised five items that measured drivers' self-based causes, such as personal skills and behaviour; this factor was named "self". The third factor accounted for 14.5% of the variance and included three items measuring causes attributed to the vehicle and the environment; this factor was named "vehicle and environment". The fourth factor, which accounted for 8.8% of the variance, consisted of two items measuring causes attributed to fate and chance; this factor was named "fate" (Table 29).

In the CFA, the model displayed inadequate fit indices ($\chi^2/df = 7.226$; NFI, CFI, and GFI<0.9, SRMR=0.05, RMSEA=0.146). Further inspection of the modification indices indicated that adding error covariance between e2 and e1, e3 and e4, and e1 and e5, the fit indices significantly improved ($\chi^2/df=2.302 <5$; NFI=0.953, CFI=0.973, GFI=0.917, AGFI=0.902, RMSEA=0.038 and SRMR=0.042<0.05), confirming the adequacy of the model (Figure 34).

Table 29: Exploratory factor analysis of the T-LOC scale among Lebanese drivers

T-LOC scale items		T-LOC components			
Item		Other Drivers	Self	Vehicle Environment	& Fate
LOC15	Other drivers' dangerous overtaking	0.957			
LOC14	Other drivers driving under influence of alcohol	0.945			
LOC8	Other drivers drive often with too high speed	0.944			
LOC4	Other drivers' risk-taking while driving	0.912			
LOC10	Other drivers drive too close to my car	0.902			
LOC3	Shortcomings in other drivers' driving skills	0.842			
LOC1	Shortcomings in my driving skills		0.887		
LOC16	My own dangerous overtaking		0.886		
LOC2	My risk-taking while driving		0.809		
LOC9	If I drive too close to the car in front		0.770		
LOC7	If I drive often with too high a speed		0.593		
LOC12	Bad weather or lighting conditions			0.897	
LOC6	Dangerous roads			0.885	
LOC13	Mechanical failure in the car			0.870	
LOC11	Fate				0.836
LOC5	Bad luck				0.831
E	Eigenvalue	6.244	2.515	2.316	1.407
A	Chronbach alpha	0.907	0.883	0.859	0.657
V	Variance	39.024	15.718	14.473	8.797

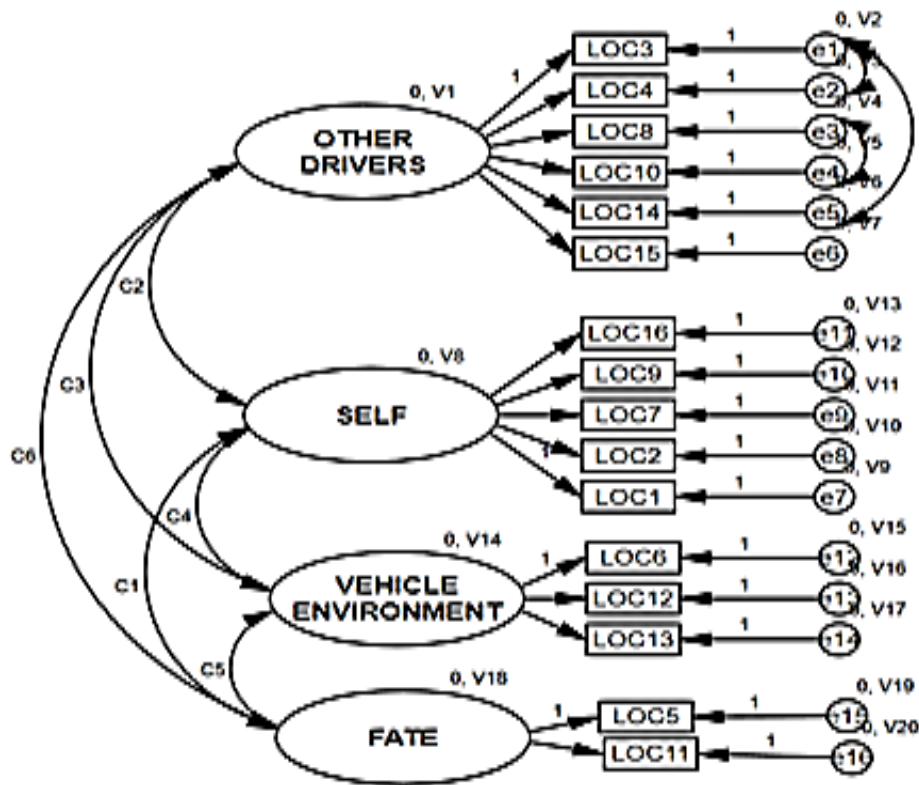

Figure 34: Multidimensional factor structure of the Arabic version of the Traffic Locus of Control (T-LOC) scale

The overall reliability of the T-LOC-A scale was good ($\alpha=0.85$). Alpha reliabilities for these subscales ranged from 0.66 to 0.91. Skewness (-0.82 to 0.04] and kurtosis (-0.28 to 0.67] estimates for the four factors allowed the use of parametrical correlational analyses (Table 30).

Table 30: Mean scores, Cronbach's alpha coefficient, skewness, and Kurtosis of the T-LOC-A scale

	All drivers (N=568)						
	Scale Mean	SD	Min	Max	Alpha α	Skewness	Kurtosis
Self-related	17.08	3.79	7	25	0.88	-0.50	0.28
Other drivers	22.74	5.31	7	30	0.91	-0.82	0.61
Fate	5.87	1.98	2	10	0.66	-0.40	-0.55
Vehicle/ Env.	10.29	2.04	3	15	0.86	-0.69	1.67
T-LOC-A scale	56.21	8.42	28	71	0.85	-0.57	0.47

SUMMARY OF SCALE VALIDATION

Table 31 displays the key findings of the scale validation axis of the thesis.

Table 31: Key findings of the scale validation

Arabic versions of the scale	Number of items	Reliability	Factor structure
Driver Behaviour Questionnaire (DBQ)	45	Good reliability ($\alpha > 0.7$) across all subscales.	Four dimensions: Aggressive violations, Ordinary violations, Errors, and Lapses.
Driving Anger Scale (DAS)	32	Good reliability ($\alpha > 0.80$) for all six subscales: Discourtesy ($\alpha = 0.81$), traffic obstruction ($\alpha = 0.90$), slow driving ($\alpha = 0.92$), police presence ($\alpha = 0.85$), illegal driving ($\alpha = 0.87$) and hostile gesture ($\alpha = 0.92$).	Confirmed original six-factor structure: Hostile gestures, Illegal driving, Discourtesy, Traffic obstruction, Police presence, and Slow driving.
Driver Stress Inventory (DSI)	29	Acceptable reliabilities for both factors Perceptual motor skills ($\alpha = 0.83$) Safety skills ($\alpha = 0.78$)	Bifactorial structure aligns with prior studies, revealing two dimensions: Perceptual motor skills ($\alpha = 0.83$) Safety skills
Traffic Locus of Control (T-LOC)	16	Good to excellent reliabilities Internal Locus of Control ("Self" ($\alpha = 0.883$), "Others Drivers" ($\alpha = 0.907$), "Fate" ($\alpha = 0.657$), and "Vehicle/environment" $\alpha = 0.859$)	Similar factorial structure to original version with four subscales: Self, Other drivers, Fate, Vehicle/environment.

BEHAVIOURAL ANALYSIS

DBQ-L AND SOCIO-DEMOGRAPHIC VARIABLES

As a result of bivariate analysis (Table 32), gender differences revealed that men reported a higher tendency to commit aggressive violations ($p=0.048 < 0.05$) and ordinary violations ($p=0.049 < 0.05$) than women. Cohen's d was very small, indicating a limited effect size. However, errors and lapses did not reveal significant differences between men and women. Moreover, the occupation and educational level of the surveyed drivers significantly affected the four dimensions of aberrant behaviours (aggressive violations, ordinary violations, errors, and lapses). Drivers with a secondary educational level or less were more prone to involve in aggressive and ordinary violations, errors, and lapses behaviour than their counterparts with the highest educational level.

In regards to the relations between DBQ-L, age, and driving experience, Pearson correlations revealed that ordinary violation ($r = -.559, p < .001$) and lapses ($r = -.544, p < .001$) were negatively correlated with age. Younger age is related to an increase in ordinary violations and lapse subscales. Errors ($r =.442, p < .001$) were positively associated with age and had a different pattern where errors decreased for young drivers. In addition, aggressive violations ($p < 0.001$), ordinary violations ($p < 0.001$), errors ($p < 0.001$), and lapses ($p=0.016 < 0.001$) increased with annual mileage. Despite violations ($r = -0.142, p < 0.001$) and lapses ($r = -0.135, p < 0.001$) decreasing with driving experience, errors were found to increase with driving experience ($r = 0.161, p < 0.001$).

Table 32: DBQ-L and sociodemographic characteristics

	Sociodemographic variables	N	Mean	S.D	F-value	P-value	Cohen's d
Gender							
Aggressive violations	Men	754	15.03	2.11	1.132	0.048	-0.098
	Women	348	14.89	1.9			
Ordinary violations	Men	754	26.81	4.69	1.275	0.049	-0.162
	Women	348	26.46	4.8			
Lapses	Men	754	37.84	4.97	0.112	0.738	-0.05
	Women	348	37.73	4.44			
Errors	Men	754	33.23	5.85	0.097	0.755	0.049
	Women	348	33.35	6.08			
Occupation							
Aggressive violations	Non-professional driver	986	14.89	2.01	20.471	<0.001	0.64
	Professional driver	116	15.79	2.25			
Ordinary violations	Non-professional driver	986	26.18	4.36	65.856	<0.001	0.775
	Professional driver	116	27.84	6.19			
Lapses	Non-professional driver	986	37.58	4.43	19.923	<0.001	0.963
	Professional driver	116	39.67	7.01			
Errors	Non-professional driver	986	32.74	5.54	80.013	<0.001	0.78
	Professional driver	116	34.6	7.05			
Education Level							
Aggressive violations	Secondary or less	468	15.12	2.18	3.195	0.074	-0.156
	University or above	634	14.89	1.94			
Ordinary violations	Secondary or less	468	27.09	5.08	10.114	0.002	-0.42
	University or above	634	26.18	4.41			
Lapses	Secondary or less	468	38.29	5.12	8.541	0.004	-0.39
	University or above	634	37.44	4.53			
Errors	Secondary or less	468	34.07	6.49	15.055	<0.001	-0.57
	University or above	634	32.68	5.39			

		Annual mileage					
Aggressive violation	≤ 6000 km	524	14.74	1.89	15.427	<0.001	0.12
	> 6000 km	578	15.22	2.15			
Ordinary violation	≤ 6000 km	524	25.75	4.02	30.726	<0.001	0.726
	> 6000 km	578	27.31	5.17			
Lapses	≤ 6000 km	524	37.29	4.07	11.528	0.001	0.45
	> 6000 km	578	38.27	5.35			
Errors	≤ 6000 km	524	32.41	5.23	21.440	<0.001	0.68
	> 6000 km	578	34.05	6.39			
		Age			Pearson	P-value	
Aggressive violation		1102	34.64	12.33	-0.047*	<0.05	
Ordinary violation					-.559**	<0.01	
Lapses					-.544**	<0.01	
Errors					.442**	<0.01	
		Driving experience					
Aggressive violation		1102	13.46	10.76	-0.038	0.203	
Ordinary violation					.142**	<0.01	
Lapses					-.135**	<0.01	
Errors					.161**	<0.01	

FACTORS ASSOCIATED WITH DBQ SUBSCALES

In terms of aggressive violations, older age, female gender, large driving experience and high education level were found negatively associated with the Lebanese driver's involvement in aggressive violations. However, increased annual mileage and being a professional driver were both positively associated with aggressive violations among these drivers. Similar associations were found between the above-mentioned sociodemographic characteristics and ordinary violations. As for errors, professional and older drivers and those who had an increased mileage were more prone to be involved in erroneous behaviour when driving. However, larger driving experience and higher education level were found negatively associated with such an erroneous behaviour. Lapses were also found positively associated with increased annual mileage and being professional drivers and negatively associated with larger driving experience and higher education level (Table 33).

DBQ AND RTC INVOLVEMENT

The results of the hierarchical regression analysis are presented in Table 34. In the first block, which included sociodemographic and travel-related variables, the model summary indicated a goodness of fit, with an R^2 value of 0.12, suggesting that 12% of the variance in RTC involvement is explained by sociodemographic and travel-related variables included in the model. Gender did not exhibit a statistically significant association with RTC involvement. Drivers with greater reported driving experience were at a reduced likelihood of being involved in RTC. Furthermore, increased age showed a negative association with RTC involvement. Occupation demonstrated a statistically significant positive association with RTC involvement, suggesting that professional drivers were more predisposed to experiencing RTCs compared to nonprofessional drivers. However, education level did not reveal a statistically significant association with RTC involvement. Drivers with higher annual mileage were more prone to experiencing RTCs.

In the subsequent block, incorporating the subscales of the Driver Behaviour Questionnaire, the model summary indicated an R^2 value of 0.21, signifying that 21% of the variance in the dependent variable was explained by the DBQ subscales included in this block. The observed change in R^2 (ΔR^2) was statistically significant ($p < 0.001$), underscoring the enhanced model fit upon the incorporation of DBQ subscales. Aggressive violations were found to be positively associated with RTC involvement. Similarly, ordinary violations and errors

demonstrated statistically significant positive associations with RTC involvement, while lapses did not manifest significant effects.

Table 33: Linear regression for each of the DBQ-L subscale

		Standardized Coefficients	Beta	t	Sig.	F	sig
<u>Aggressive Violations</u>	Age	-0.081		-1.499	0.034	4.891	<0.001
	Gender (female vs male)	-0.003		-0.109	0.024		
	Driving experience (large vs small)	-0.010		-0.184	0.044		
	Education level (high vs low)	-0.029		-0.909	0.363		
	Annual mileage	0.058		1.785	0.045		
	Occupation (professional driver vs nonprofessional driver)	0.126		3.902	<0.001		
<u>Ordinary violations</u>	Age	-0.052		-1.003	0.016	20.856	<0.001
	Gender (female vs male)	-0.069		-2.237	0.025		
	Driving experience (large vs small)	-0.163		-3.026	0.003		
	Education level (high vs low)	-0.071		-2.309	0.021		
	Annual mileage	0.128		4.061	<0.001		
	Occupation (professional vs nonprofessional driver)	0.227		7.304	<0.001		
<u>Errors</u>	Age	0.019		0.357	0.021	23.247	<0.001
	Gender (female vs male)	0.031		1.004	0.315		
	Driving experience (large vs small)	-0.236		-4.410	<0.001		
	Education level (high vs low)	-0.087		-2.849	0.004		
	Annual mileage	0.075		2.396	0.017		
	Occupation (professional vs non professional driver)	0.244		7.874	0.000		
<u>Lapses</u>	Age	0.054		1.005	0.315	10.855	<0.001
	Gender (female vs male)	-0.012		-0.375	0.708		
	Driving experience (large vs small)	-0.248		-4.502	<0.001		
	Education level (high vs low)	-0.089		-2.836	0.005		
	Annual mileage	0.104		3.215	0.001		
	Occupation (professional vs nonprofessional driver)	0.098		3.075	0.002		

Table 34: Variables associated with RTC involvement

Variable	B	P-value	aOR		95% C.I. for		Model summary		
			Lower	Upper	R ²	Δ R ²	Sig		
Gender	0.173	0.056					0.12	0.12	<0.001
Age	-0.032	0.035	0.786	0.589	0.802				
Driving experience	-0.422	0.016	0.812	0.732	0.934				
Occupation	0.877	0.001	1.938	1.254	2.996				
Education level	-0.019	0.145		0.766	1.329				
yearly mileage	0.726	0.001	2.433	1.867	3.171				
Aggressive violations	0.053	0.019	1.938	1.323	2.994	0.21	0.09	<0.001	
Ordinary violations	0.039	0.031	1.716	1.139	2.604				
Errors	0.021	0.048	1.213	1.114	2.471				
Lapses	0.017	0.218		0.813	1.388				

The reference group for gender categorical variable is male drivers; the reference group for educational level is secondary or less; for annual mileage the reference group was ≤ 6000 km; for occupation, the reference group was the "nonprofessional driver"

DAS-A AND SOCIO-DEMOGRAPHIC VARIABLES

Table 35 shows the mean reported anger levels for each of the six factors, along with overall driving anger, across various sociodemographic variables. Overall, the DAS scores differed between males and females. Hostile gestures and discourtesy were the most anger-provoking behaviours for both genders, while police presence elicited the least anger. Gender differences were observed in driving anger towards hostile gestures ($p=0.047$), discourtesy ($p<0.001$), illegal driving ($p=0.002$), police presence ($p=0.034$), and traffic obstruction ($p=0.048$), with female drivers reporting significantly higher anger levels. However, males exhibited more anger towards police presence compared to females. These differences, although statistically significant, may have been influenced by the large sample size, as indicated by the small effect size (Cohen's d).

Educational level did not significantly affect anger provoked by driving situations. Conversely, professional drivers expressed higher anger towards police presence ($p<0.001$), traffic obstruction ($p=0.034$), and slow speeding ($p<0.001$) compared to non-professional drivers. In terms of annual mileage, drivers traveling longer distances (>6000 km) exhibited more anger towards illegal driving, discourtesy, traffic obstruction, and slow speeding.

Moreover, notable variances in DAS total scores were noted concerning gender, occupation, and annual mileage. Pearson's correlation coefficients revealed that as drivers age increased, they tended to

experience less anger due to discourtesy and police presence, while anger towards illegal driving, slow speeding, and traffic obstruction increased. With increased driving experience, anger towards discourtesy, slow speeding, and illegal driving also increased, while anger prompted by police presence decreased.

Table 35: Driver anger scale (DAS-A) and socio-demographics characteristics

	Gender		F-value	P-value	Cohen's d
	Male (N=754) N (SD)	Female (N=348) N (SD)			
Hostile gesture	3.783 (0.628)	3.913 (0.659)	3.520	0.047	0.22
Illegal driving	3.306 (0.832)	3.527 (0.836)	4.988	0.026	0.265
Discourtesy	3.622 (0.564)	3.752 (0.586)	3.638	0.025	0.226
Police presence	2.386 (1.051)	2.246 (0.975)	4.481	0.034	0.138
Traffic obstruction	3.406 (0.745)	3.539 (0.718)	2.468	0.048	0.182
Slow speeding	3.027 (0.923)	3.085 (0.923)	0.770	0.380	0.063
DAS total	3.248 (0.511)	3.510 (0.504)	11.153	0.028	0.51
	Educational level				
	Secondary or less (N=468)	More than secondary (N=634)			
Hostile gesture	3.787 (0.657)	3.796 (0.624)	0.051	0.822	0.02
Illegal driving	3.651 (0.583)	3.617 (0.563)	0.928	0.336	0.06
Discourtesy	3.367 (0.841)	3.327 (0.831)	0.606	0.437	0.05
Police presence	2.403 (1.063)	2.296 (1.001)	2.884	0.090	0.103
Traffic obstruction	3.414 (0.747)	3.419 (0.728)	0.008	0.927	0.01
Slow speeding	3.089 (0.950)	3.020 (0.903)	1.507	0.220	0.08
DAS total	3.280 (0.534)	3.244 (0.489)	1.353	0.245	0.07
	Occupation				

	Non-professional driver (N=986)	Professional driver (N=116)			
Hostile gesture	3.796 (0.634)	3.767 (0.681)	0.208	0.649	0.04
Illegal driving	3.634 (0.562)	3.614 (0.643)	0.117	0.733	0.03
Discourtesy	3.334 (0.817)	3.427 (0.975)	1.287	0.257	0.104
Police presence	2.299 (0.817)	2.700 (1.001)	15.940	<0.001	0.439
Traffic obstruction	3.426 (0.736)	3.340 (0.737)	1.418	0.034	0.12
Slow speeding	3.016 (0.919)	3.337 (0.911)	12.651	<0.001	0.351
DAS total	3.248 (0.497)	3.349 (0.591)	4.139	0.042	0.19
	Annual mileage				
	≤6 000 km (N=524)	>6 000 km (N=578)			
Hostile gesture	3.782 (0.607)	3.803 (0.666)	0.296	0.586	0.02
Illegal driving	3.576 (0.693)	3.682 (0.568)	9.507	0.002	0.167
Discourtesy	3.185 (0.817)	3.488 (0.825)	37.276	<0.001	0.369
Police presence	2.332 (1.017)	2.352 (1.040)	0.104	0.747	0.019
Traffic obstruction	3.363 (0.715)	3.465 (0.752)	5.239	0.022	0.14
Slow speeding	2.945 (0.867)	3.144 (0.963)	12.814	<0.001	0.21
DAS total	3.177 (0.477)	3.333 (0.525)	25.849	<0.001	0.311
	Age	Pearson r		C.I.	P-value
Hostile gesture		0.051		(-0.131;0.098)	>0.05
Illegal driving		0.224**		(0.132;0.376)	<0.01
Discourtesy		-0.203**		(-0.344;-0.122)	<0.01
Police presence		-0.100**		(-0.298;-0.076)	<0.01
Traffic obstruction		0.060*		(0.015;0.121)	<0.05
Slow speeding		0.096**		(0.019-0.132)	<0.01
DAS total		0.151		(-0.022;0.253)	<0.01

	Year of experience		
Hostile gesture	0.028	(-0.211;0.156)	p>0.05
Illegal driving	0.179**	(0.078;0.283)	p<0.01
Discourtesy	0.151**	(-0.344;-0.122)	p<0.01
Police presence	-0.125**	(-0.202;-0.002)	p<0.01
Traffic obstruction	0.021	(-0.118;0.093)	p>0.05
Slow speeding	0.097**	(0.031-0.133)	p<0.01
DAS total	0.103**	(0.076;0.196)	p<0.01

N.B: **: p<0.01, *: p<0.05, C.I: Confidence interval

CORRELATION BETWEEN DRIVER ANGER AND DRIVER BEHAVIOUR

Aggressive violations were found to be positively correlated to hostile gesture ($r = 0.140$), slow driving ($r = 0.184$), discourtesy ($r = 0.071$), police presence ($r = 0.163$) and traffic obstruction ($r = 0.092$). Similarly, the ordinary violations subscale was positively correlated to discourtesy ($r = 0.101$), police presence ($r = 0.215$), traffic obstruction ($r = 0.061$), slow driving ($r = 0.177$) and illegal driving ($r = 0.112$). Meanwhile, lapses were only positively correlated to police presence ($r = 0.216$) and traffic obstruction ($r = 0.114$). Errors were positively correlated to anger prompted by the police presence ($r = 0.284$) and slow driving ($r = 0.111$). Interestingly, only one correlation was found between the anger instigated by illegal driving and the violation subscale (Table 36).

Table 36: Pearson and partial correlations between DAS and DBQ-L subscales

Subscale	Hostile gesture	Illegal driving	Discourtesy	Police presence	Traffic obstruction	Slow speeding
Aggressive violation	0.040*	0.030	0.071*	0.163**	0.092**	0.184**
Ordinary violation	0.007	0.002*	0.101**	0.215**	0.061*	0.177**
Lapses	0.012	0.015	0.025	0.216**	0.114**	0.130**
Errors	-0.029	0.014	0.000	0.284**	0.052	0.111**

Note. Pearson correlations in the first row, ** $p < 0.01$. * $p < 0.05$.

HIERARCHICAL REGRESSION

The first model that included in its first step of regression analysis the sociodemographic factors, explained 16% of the variation and was statistically significant ($p < 0.001$) (Table 37). Older age ($\beta = -0.084$, 95% CI (-0.127: -0.009), $p = 0.018$) and female gender ($\beta = -0.181$, 95% CI (-0.353: -0.089) $p = 0.048$) were protector factors against committing aggressive violations. Being a professional driver ($\beta = 0.126$, 95% CI (0.029–0.527), $p = 0.001$) and increasing annual mileage ($\beta = 0.058$, 95% CI (0.033–0.174), $p = 0.045$) were positively associated with the involvement of driver in aggressive violations.

In the second step, the six subscales of DAS were included in the model in addition to the demographic variables which additionally explained 11% of the model and it is also statistically significant. Anger prompted by hostile gesture ($\beta = 0.125$, 95% CI (0.030–0.169), $p = 0.047$), discourtesy ($\beta = 0.015$, 95% CI (0.009–0.190), $p = 0.014$), police presence ($\beta = 0.114$, 95% CI (0.103–0.352), $p < 0.001$), traffic obstruction ($\beta = 0.152$, 95% CI (0.137–0.312), $p = 0.014$), and slow driving ($\beta = 0.142$, 95% CI (0.109–0.484), $p < 0.001$), were found

positively associated with aggressive violation. In terms of ordinary violation, the first model explained 9.8% of the variation ($p < 0.001$). Being female, increasing age, and higher educational level were found protective factors reducing the risk of drivers' involvement in traffic violations. On the contrary, extensive years of driving experience, increased annual mileage, and being a professional driver were associated with violations among drivers. The second step explained 15.4% of the variation with 5.1% further explanation than demographic variables. All the DAS subscales instigated by hostile gestures ($\beta = 0.145$, 95% CI (0.037–0.325), $p = 0.04$), discourtesy ($\beta = 0.099$, 95% CI (0.076–1.176), $p = 0.009$), traffic obstruction ($\beta = 0.116$, 95% CI (0.078–0.194), $p < 0.001$), police presence ($\beta = 0.151$, 95% CI (0.034–0.578), $p < 0.001$), illegal ($\beta = 0.075$, 95% CI (0.036–0.097), $p = 0.039$) and slow driving ($\beta = 0.114$, 95% CI (0.042–0.431), $p < 0.001$) were found to be associated with ordinary violations. The variation of errors was explained with 11.3% by demographic variables. Larger driving experience and education higher than secondary level were protectors from erroneous driving behaviour. Conversely, older age, increasing annual mileage, and working as a professional driver were positively associated with the errors among drivers. The inclusion of DAS subscales increased the explanation of errors by 6.2%. Anger originated from police presence ($\beta = 0.227$, 95% CI (0.130–0.685), $p < 0.001$) and slow driving ($\beta = 0.164$, 95% CI (0.101–0.972), $p = 0.045$) were positively associated with erroneous driving behaviour. No association was found between the remaining DAS subscales such as hostile gestures, traffic obstruction, discourtesy, illegal driving, and the errors committed while driving.

Regarding lapses, the first model including only socio-demographic variables explained 5.6% of the variation. Alike the errors dimension, larger driving experience and education higher than secondary level were negatively associated with lapses and increasing annual mileage and working as a driver were negatively associated with erroneous driving behaviour. Conversely, they were associated with errors among drivers. However, the second step which comprised DAS dimensions described additionally 4.7% of the lapses. Only anger provoked by the presence of police ($\beta = 0.167$, 95% CI (0.119–1.068), $p < 0.001$), traffic obstruction ($\beta = 0.086$, 95% CI (0.046–0.651), $p = 0.007$) and the slow driving ($\beta = 0.087$, 95% CI (0.045–0.823), $p = 0.01$) were found positively associated with lapses.

Table 37: Summary of hierarchical multiple regression results of DAS associations with aberrant driver behaviour

Model		Standardized coefficients β	t	P	95% CI		Model summary		
					Lower	Upper	R ²	Δ R ²	Sig
<u>Aggressive violations</u>	Age	-0.084	-1.565	0.018	-0.127	-0.009	0.16	0.16	<0.001
	Gender	-0.181	-0.257	0.048	-0.353	-0.089			
	Year of experience	-0.006	-0.1	0.921	-0.025	0.016			
	Occupation	0.126	3.902	0.001	0.029	0.527	0.27	0.11	<0.001
	Education Level	-0.029	-0.909	0.363	-0.426	0.101			
	Annual mileage	0.058	1.785	0.045	0.033	0.974			
	Hostile gesture	0.125	0.323	0.047	0.030	0.169			
	Illegal driving	0.025	0.663	0.508	0.041	0.194			
	Discourtesy	0.015	0.367	0.014	0.009	0.190			
	Police presence	0.114	3.725	<0.001	0.103	0.352			
	Traffic obstruction	0.152	1.627	0.014	0.137	0.312			
	Slow speeding	0.142	4.157	<0.001	0.109	0.484			
	<u>Ordinary violations</u>	Age	-0.054	-1.052	0.023	-0.087	-0.043	0.098	0.098
Gender		0.064	2.126	0.034	-0.165	0.933			
Year of experience		0.144	2.721	0.007	0.167	1.057			
Occupation		0.196	6.382	<0.001	0.129	0.238	0.154	0.051	<0.001
Education Level		-0.066	-2.191	0.029	-1.902	-0.040			
Annual mileage		0.107	3.407	0.001	0.024	0.644			
Hostile gesture		0.145	1.478	0.04	0.037	0.725			
Illegal driving		0.075	2.062	0.039	0.036	0.097			
Discourtesy		0.099	2.629	0.009	0.076	1.176			
Police presence		0.151	5.175	<0.001	0.034	0.878			
Traffic obstruction		0.116	0.529	0.017	0.078	0.194			
Slow speeding		0.114	3.498	<0.001	0.042	0.431			
<u>Errors</u>		Age	0.02	0.395	0.013	0.014	0.084	0.113	0.113
	Gender	0.048	1.609	0.108	0.015	0.976			
	Year of experience	0.205	3.92	<0.001	0.021	0.489			

	Occupation	0.216	7.134	<0.001	0.193	1.123			
	Education Level	-0.076	-2.582	0.01	-1.027	-0.026			
	Annual mileage	0.176	2.453	0.014	0.779	1.542			
	Hostile gesture	0.056	1.862	0.063	0.036	1.063	0.175	0.062	<0.001
	Illegal driving	0.047	1.312	0.19	0.032	1.238			
	Discourtesy	0.063	1.69	0.091	-0.016	0.106			
	Police presence	0.227	7.913	<0.001	0.130	0.685			
	Traffic obstruction	0.032	1.049	0.294	-0.300	0.261			
	Slow speeding	0.164	2.011	0.045	0.101	0.972			
Lapses	Age	0.053	0.991	0.317	0.008	0.074	0.056	0.056	<0.001
	Gender	-0.013	-0.109	0.913	-0.711	-0.007			
	Year of experience	-0.219	-4.02	0.001	-0.353	-0.058			
	Occupation	0.078	2.456	0.014	0.577	1.724			
	Education Level	-0.081	-2.637	0.008	-0.494	-0.022			
	Annual mileage	0.088	2.718	0.007	0.020	0.970			
	Hostile gesture	-0.027	-0.853	0.394	-0.658	0.261	0.094	0.047	<0.001
	Illegal driving	-0.004	-0.106	0.916	-0.601	0.631			
	Discourtesy	-0.036	-0.92	0.358	-0.723	-0.026			
	Police presence	0.167	5.561	<0.001	0.119	1.068			
	Traffic obstruction	0.086	2.723	0.007	0.046	0.651			
	Slow speeding	0.087	2.589	0.01	0.045	0.823			

Note: The reference group for gender categorical variable is male drivers; the reference group for educational level is secondary or less; for annual mileage the reference group was $\leq 6000\text{km}$; for occupation, the reference group was the "nonprofessional driver"

ASSOCIATION BETWEEN DRIVER ANGER AND RISK INVOLVEMENT

displays the multivariable logistic regression of the DAS subscales with the drivers' involvement in RTCs and being penalized for traffic offenses in the past 3 years. After adjusting for potential confounders, drivers who reported higher levels of anger due to illegal driving (aOR=1.771, 95% C.I. 1.332-2.354), discourtesy (aOR=1.806, 95% C.I. 1.657-1.988), slow speeding (aOR=1.163, 95% C.I. 1.017-1.358), and police presence (aOR=1.341, 95% C.I. 1.182-1.520) were more likely to have been involved in RTCs compared to those reporting lower anger levels. Conversely, regarding traffic offenses, only drivers who reported higher anger levels due to traffic obstruction (aOR=1.330, 95% C.I. 1.108-1.595) were more likely to receive penalties for traffic offenses.

Table 38: Multivariable logistic regression of the DAS subscales with the drivers' involvement in RTCs and being penalized for traffic offenses in the past 3 years

	Involvement in RTC				Getting traffic offenses			
	P-value	aOR	95% CI		P-value	aOR	95% CI	
			Lower	Upper			Lower	Upper
Gender	0.056				0.984			
Occupation	<0.001				<0.001			
Non-professional driver	Ref				Ref			
Professional driver	0.003	1.938	1.254	2.996	0.001	2.138	1.358	3.367
Annual mileage (km)	<0.001				<0.001			
≤6000km	Ref				Ref			
>6000km	<0.001	2.433	1.867	3.171	<0.001	2.063	1.580	2.694
Age	0.035	0.786	0.589	0.802	0.540			
Years of experience	0.016	0.812	0.732	0.934	0.530			
Education level (more than secondary vs. less than secondary)	0.145				0.055			
Hostile gesture	0.123				0.655			
Illegal driving	<0.001	1.771	1.332	2.354	0.261			
Discourtesy	0.038	1.806	1.657	1.988	0.737			
Police presence	<0.001	1.341	1.182	1.520	0.102			
Traffic obstruction	0.693	0.964	0.801	1.159	0.002	1.330	1.108	1.595
Slow speeding	0.045	1.163	1.017	1.358	0.936			

aOR: adjusted odds ratio, CI confidence interval

CORRELATION BETWEEN THE DRIVER SKILLS INVENTORY DIMENSIONS AND THE DBQ SUBSCALES

Low positive correlation was found between the 2 factors of DSI. DSI safety skills showed a negative correlation with aggressive violation ($r = -0.134$, $p < 0.01$), ordinary violation ($r = -0.228$, $p < 0.01$), lapses ($r = -0.129$, $p < 0.01$), and errors ($r = -0.250$, $p < 0.01$). DSI motor skills exhibited a positive correlation with aggressive violation ($r = 0.318$, $p < 0.01$), ordinary violation ($r = 0.178$, $p < 0.01$), lapses ($r = 0.102$, $p < 0.01$), and errors ($r = 0.193$, $p < 0.01$) (Table 39).

Table 39: Correlations between driver behaviour subscales and DSI factors (motor skills and safety skills)

	DSI safety skills	DSIs motor skills	Aggressive violation	Ordinary violation	Lapses	Errors
DSI safety skills	1					
DSIs motor skills	0.125**	1				
Aggressive violation	-0.134**	0.318**	1			
Ordinary violation	-0.228**	0.178**	0.559**	1		
Lapses	-0.129**	0.102**	0.442**	0.572**	1	
Errors	-0.250**	0.193**	0.544**	0.750**	0.635**	1

* $p < 0.05$, ** $p < 0.01$

DSI AND SOCIO-DEMOGRAPHIC VARIABLES

Male drivers had lower safety skills scores ($M=2.347$) but higher motor skills scores ($M=2.638$) compared to females ($p < 0.001$). Those with secondary education or less scored slightly higher in safety skills ($M=2.56$) but significantly higher in motor skills ($M=2.662$) than those with higher education. Occupation showed no significant differences. However, drivers traveling over 6 000 km annually scored higher in both safety and motor skills compared to those traveling less, with significant differences in motor skills. Age and years of driving experience were positively correlated with both safety ($r = 0.219$ and $r = 0.250$, respectively, $p < 0.01$) and motor skills ($r = 0.407$ and $r = 0.453$, respectively, $p < 0.01$) (Table 40).

Table 40: Association between sociodemographic variables and DSI subscales

	Sociodemographic variables		F-value	P-value
	Gender			
	Male (N=754)	Female (N=348)		
DSI subscales	M(SD)	M(SD)		
Safety skills	2.347(0.594)	2.638(0.635)	0.387	<0.001
Motor skills	2.638(0.561)	2.355(0.535)	0.541	<0.001
	Educational level			
	Secondary or less (N=468)	More than secondary (N=634)		
Safety skills	2.461(0.661)	2.637(0.594)	0.77	0.009
Motor skills	2.662(0.583)	2.355(0.535)	11.153	0.018
	Occupation			
	Non-professional Driver (N=986)	Professional driver (N=116)		
Safety skills	2.529(0.632)	2.689(0.661)	0.241	0.649
Motor skills	2.564(0.562)	2.735(0.643)	0.003	0.733
	Travelled distance			
	≤6 000 km (N=524)	>6 000 km (N=578)		
Safety skills	2.341(0.483)	2.498(0.551)	12.211	0.586
Motor skills	2.404(0.447)	2.533(0.587)	10.973	0.002
		Pearson r	C.I.	P-value
Safety skills	Age	0.219**	(0.131;0.478)	p<0.01
Motor skills		0.407**	(0.132;0.776)	p<0.01
Safety skills	Year of experience	0.250**	(0.198;0.476)	p<0.01
Motor skills		0.453**	(0.215;0.621)	p<0.01

N: frequency, M: mean, SD: standard deviation

FACTORS ASSOCIATED WITH MOTOR SKILLS AND SAFETY MOTIVE

Table 41 displays the last stage in the stepwise regression process, with the key variables associated with safety and motor skills among 1102 Lebanese drivers. For safety skills, age ($B = 0.073$, $p = 0.017$) and years of experience ($B = 0.148$, $p = 0.007$) exhibited positive and significant effects, while annual mileage displayed a positive impact, albeit marginally significant ($B = 0.042$, $p = 0.040$). Conversely, the number of fines within the last year demonstrated a negative and significant effect ($B = -0.146$, $p = 0.018$), as did RTCs reported in the previous 3 years ($B = -0.016$, $p = 0.033$). Regarding motor skills, age ($B = 0.131$, $p = 0.047$) and years of experience ($B = 0.159$, $p = 0.004$) emerged as positive and significant predictors. Additionally, annual mileage exhibited a positive significant effect ($B = 0.053$, $p = 0.046$), while gender had a highly significant negative impact ($B = -0.216$, $p < 0.001$). Notably, the number of fines within the last year did not significantly influence motor skills

($B = 0.092$, $p = 0.379$), whereas RTCs in the previous 3 years had a negative and significant effect ($B = -0.035$, $p = 0.012$).

Table 41: Linear regression predicting motor skills and safety motives among Lebanese drivers (N=1102)

Variables	Standardized	P-value	95% Confidence Interval for B	
	Beta		Lower Bound	Upper Bound
Safety skills				
Age	0.073	0.017	0.026	0.193
Year of experience	0.148	0.007	0.024	0.151
Annual mileage (Km)	0.042	0.040	0.104	0.497
Number of fines last 3 years	-0.146	0.018	-0.674	-0.074
RTC in the previous 3 years	-0.016	0.033	-0.367	-0.007
Motor skills				
Age	0.131	0.047	0.068	0.224
Year of experience	0.159	0.004	0.051	0.272
Annual mileage	0.053	0.046	0.088	1.234
Gender (male vs. female)	-0.216	<0.001	-6.514	-3.655
Number of fines last 3 years	0.092	0.379	-0.672	0.690
RTC in the previous 3 years	-0.035	0.012	-0.759	-0.009

DRIVER SKILL AND DRIVER BEHAVIOUR

Table 42 displays the associations between sociodemographic variables, safety skills, motor skills, and different dimensions of driving behaviour. In the initial model for aggressive violations, sociodemographic factors alone explained 16% of the variation ($p < 0.001$). Upon adding safety skills and motor skills in the second step, an additional 8% of the variation was elucidated ($p < 0.001$), resulting in a total of 24% explained variation. Similarly, for ordinary violations, the initial model accounted for 9.8% of the variation ($p < 0.001$).

Subsequently, with the incorporation of safety skills ($\beta = -0.145$, $p = 0.012$) and motor skills ($\beta = -0.075$, $p = 0.039$) in the second step, further explanation of the variation (18%) in ordinary violations was observed. Regarding errors, the initial model explained 11.3% of the variation ($p < 0.001$) solely based on sociodemographic and travel-related variables. However,

with the inclusion of safety skills ($\beta = -0.036$, $p = 0.043$) and motor skills ($\beta = -0.017$, $p = 0.019$) in the subsequent step, the explanation of errors was augmented (3.5%). Lastly, for lapses, the initial model accounted for 5.6% of the variation ($p < 0.001$). The addition of safety skills and motor skills in the second step further contributed to explaining the variation in lapses.

Table 42: Summary of hierarchical multiple regression results of DSI subscales and aberrant driver behaviour

Model	Standardized coefficients β	t	P	95% CI		Model summary			
				Lower	Upper	R ²	Δ R ²	Sig	
Aggressive violations	Age	-0.084	-1.565	0.018	-0.127	-0.009	0.16	0.16	<0.001
	Gender	-0.181	-0.257	0.048	-0.353	-0.089			
	Year of experience	-0.006	-0.1	0.921	-0.025	0.016			
	Occupation	0.126	3.902	0.001	0.029	0.527			
	Education Level	-0.029	-0.909	0.363	-0.426	0.101			
	Annual mileage	0.058	1.785	0.045	0.033	0.974			
	Safety skill	-0.125	-0.813	0.047	-0.332	-0.082	0.24	0.08	<0.001
	Motor skill	0.316	1.736	0.023	0.141	0.794			
Ordinary violations	Age	-0.054	-1.052	0.023	-0.087	-0.043	0.098	0.098	<0.001
	Gender	0.064	2.126	0.034	-0.165	0.933			
	Year of experience	0.144	2.721	0.007	0.167	1.057			
	Occupation	0.196	6.382	<0.001	0.129	0.238			
	Education Level	-0.066	-2.191	0.029	-1.902	-0.040			
	Annual mileage	0.107	3.407	0.001	0.024	0.644			
	Safety skill	-0.145	-1.718	0.012	-1.037	-0.085	0.283	0.185	<0.001
	Motor skill	0.075	2.113	0.039	0.036	0.097			
Errors	Age	0.020	0.395	0.013	0.014	0.084	0.113	0.113	<0.001
	Gender	0.048	1.609	0.108	0.015	0.976			
	Year of experience	0.205	3.92	<0.001	0.021	0.489			
	Occupation	0.216	7.134	<0.001	0.193	1.123			
	Education Level	-0.076	-2.582	0.01	-1.027	-0.026			
	Annual mileage	0.176	2.453	0.014	0.779	1.542			
	Safety skill	-0.036	-1.862	0.043	-0.408	-0.013	0.148	0.035	<0.001
	Motor skill	0.017	1.312	0.019	0.012	1.478			

<u>Lapses</u>	Age	0.053	0.991	0.317	0.008	0.074	0.056	0.056	<0.001
	Gender	-0.013	-0.109	0.913	-0.711	-0.007			
	Year of experience	-0.219	-4.02	0.001	-0.353	-0.058			
	Occupation	0.078	2.456	0.014	0.577	1.724			
	Education Level	-0.081	-2.637	0.008	-0.494	-0.022			
	Annual mileage	0.088	2.718	0.007	0.020	0.970			
	Safety skill	-0.027	-0.853	0.024	-0.658	0.261	0.114	0.058	<0.001
	Motor skill	0.004	0.106	0.036	0.002	0.331			

Note: The reference group for gender categorical variable is male drivers; the reference group for educational level is secondary or less; for annual mileage the reference group was ≤ 6000 km; for occupation, the reference group was the "nonprofessional driver"

ASSOCIATION BETWEEN MOTOR AND SAFETY SKILLS AND RTC INVOLVEMENT

In the initial hierarchical regression model, sociodemographic factors alone explained 11% of the variation (Table 43). Male drivers reporting having a higher likelihood of previous RTC involvement compared to female drivers. Non-experienced drivers reported greater likelihood of being involved in RTCs compared to experienced drivers. Non-professional drivers had a significantly higher likelihood of RTC involvement compared to professional drivers ($B = 0.877$, $p = 0.001$). Education level, when comparing lower to higher education, did not exhibit a significant association with RTC involvement ($B = 0.019$, $p = 0.949$).

Lastly, annual mileage exceeding 6 000 km was associated with a higher likelihood of RTC compared to driving less than 6 000 km per year ($B = 0.726$, $p = 0.001$). Upon adding safety skills and motor skills in the second step after controlling sociodemographic and travel related variables, an additional 5% of the variation in reported RTC was elucidated, resulting in a total of 16% explained variation. Safety skills exhibited a negative association ($B = -0.011$, $p = 0.047$, $aOR = 0.789$) with RTC involvement, suggesting that higher safety skills are associated with a decreased likelihood of RTC. Conversely, motor skills revealed a positive association with previous involvement in RTC

Table 43: Factors associated with RTC involvement

	B	P-value	95% CI for		Model summary		
			Lower	Upper	R ²	ΔR^2	Sig
Gender	0.273	0.048	1.020	1.760	0.11	0.11	<0.001
Driving experience	0.422	0.016	1.083	2.148			
Occupation	0.877	0.001	1.546	3.736			
Education level	0.019	0.949	0.766	1.329			
yearly mileage	0.726	0.001	1.324	3.214			
Safety skills	-0.011	0.047	0.653	0.994	0.09	0.03	<0.001
Motor skills	0.018	0.019	1.139	2.004			

The reference group for gender categorical variable is male drivers; the reference group for educational level is secondary or less; for annual mileage the reference group was ≤ 6000 km; for occupation, the reference group was the "nonprofessional driver"

CORRELATION BETWEEN THE TRAFFIC LOCUS OF CONTROL DIMENSIONS AND THE DBQ SUBSCALES

The correlations between T-LOC-A factors ranged from 0.11 to 0.40, most of them being statistically significant ($p < 0.05$) with a low to very low correlation (Table 44). The results indicated that the other drivers' dimension of T-LOC-A was positively correlated with aggressive violations ($r = 0.387, p < 0.05$). Notably, the self-dimension, representing internal T-LOC-A, was also positively correlated to aggressive violations ($r = 0.155, p < 0.05$). Furthermore, the fate dimension showed positive correlations with aggressive violation ($r = 0.11, p < 0.001$) and lapses ($r = 0.217, p < 0.05$). Additionally, the other drivers' subscale was positively correlated with errors ($r = 0.320, p < 0.05$), while the vehicle and environment subscale was found to be correlated with lapses ($r = 0.131, p < 0.05$).

Table 44: Correlation between the traffic locus of control dimensions and the DBQ subscales

Dimension	Self-related	Other drivers	Vehicle and environment	Fate
Self-related	1	-0.401**	0.13*	-0.11*
Other drivers	-0.401**	1	0.01	-0.06
Vehicle and environment	0.13*	0.01	1	-0.02
Fate	-0.11*	0.06	-0.02	1
Aggressive violation	0.155*	.387*	0.057	.110**
Ordinary violation	-0.019	-0.012	-0.09	0.047
Errors	0.037	0.320*	0.038	0.006
Lapses	0.009	-0.026	0.031*	0.217*

Note: * Correlation is significant $p < 0.05$, ** Correlation is significant at the 0.001 level ($p < 0.001$)

ASSOCIATION BETWEEN T-LOC-A AND SOCIO-DEMOGRAPHIC VARIABLES

Table 45 displays the gender differences in T-LOC-A subscales. Men tended to attribute responsibility for driving situations to other drivers more than women (Mean 22.69 (SD=4.95) for men versus Mean 23.45 (SD=5.19) for women, $p = 0.024$, Cohen's $d = 0.21$). On the other hand, women believed more in fate and luck than men did (Mean 5.84 (SD=2.06) for men versus Mean 6.24 (SD=1.81) for women, $p = 0.012$, Cohen's $d = 0.30$). However, no significant differences were observed between men and women in the "self" and "vehicle and environment" subscales. Moreover, fate was negatively correlated with age ($r = -$

0.149, $p < 0.001$) and years of experience ($r = -0.198$, $p < 0.001$) and was also associated with annual mileage ($p < 0.001$).

The "other drivers" scale was positively correlated with all variables in the analysis, including age ($r = 0.098$, $p < 0.05$), years of experience ($r = 0.128$, $p < 0.001$), and annual mileage ($p = 0.007$). Finally, the vehicle/environment subscale was positively related to annual mileage ($p = 0.029$).

Table 45: Arabic traffic locus of control and sociodemographic characteristics

Dimension	Gender		P-value
	Male (N=392)	Female (N=176)	
	N (SD)	N (SD)	
Self	17.25 (3.74)	16.7 (3.90)	0.26
Other drivers	22.69 (4.95)	23.45 (5.19)	0.024
Vehicle & environment	10.3 (2.16)	10.28 (1.76)	0.13
Fate	5.84(2.06)	6.24(1.81)	0.012
	Annual mileage		
	≤ 6000 km (N=278)	> 6000 Km (N=290)	
Self	17.02(3.67)	16.93(3.78)	0.586
Other drivers	21.49(4.33)	24.63(5.12)	0.007
Vehicle & environment	9.01(2.11)	11.18(3.05)	0.029
Fate	5.09(3.03)	7.21(2.71)	< 0.001
	Age	Pearson r	P-value
Self		0.051	$p > 0.05$
Other drivers		0.098	$P < 0.05$
Vehicle & environment		-0.103	$p > 0.05$
Fate		-0.198**	$p < 0.001$
	Year of experience		
Self		0.028	$p > 0.05$
Other drivers		0.128**	$p < 0.01$
Vehicle & environment		0.151**	$p < 0.01$
Fate		-0.125**	$p < 0.01$

N.B: ** : $p < 0.01$, * : $p < 0.05$

TRAFFIC LOCUS OF CONTROL AND ROAD TRAFFIC CRASHES

The logistic regression analysis revealed significant associations between various factors related to T-LOC and the likelihood of driver involvement in RTCs (Table 46). Notably, higher annual mileage (≥ 6000 km) was positively associated (p -value = 0.048, aOR=2.147), with the risk of being involved in RTCs. Drivers covering distances exceeding 6000 km were more prone to RTCs compared to those covering 0-6000 km. Furthermore, the "LOC self" factor exhibited a significant protective effect ($p < 0.001$, aOR = 0.922), suggesting that as the "LOC self" score increases, the odds of RTC involvement decrease. Conversely, the "LOC

other drivers" factor showed a highly significant association (p-value < 0.001) with increased odds of RTC involvement (aOR = 1.205). Additionally, the "LOC vehicle/environment" factor demonstrated a significant association (p-value = 0.019), with higher scores associated with increased odds of RTC involvement (aOR = 1.109).

Table 46: Multivariable logistic regression of the T-LOC factors associated with the drivers' involvement in RTCs

Involvement in RTCs				
	P-value	aOR	95% C.I. for aOR	
			Lower	Upper
Gender	0.732			
Male				
Female				
Age groups (years)	0.097			
Less than 20				
20-29				
30-39				
40-49				
50 and above				
Educational level	0.745			
12 years or less				
>12 years				
Occupation	0.234			
Professional driver				
Non-professional driver				
Annual Mileage (Km)	0.048	2.147	1.110	4.153
0-6000 km				
>6000 km				
Year of driving experience	0.123			
10 years or less				
More than 10 years				
LOC fate	0.568			
LOC self	0.001	0.922	0.877	0.970
LOC other drivers	<0.001	1.205	1.062	1.849
LOC vehicle/environment	0.019	1.109	1.017	1.209

N.B: Educational level of 12 years is equivalent to secondary level, *p-value<0.05 is considered significant

TRAFFIC LOCUS OF CONTROL AND TRAFFIC OFFENSES

Age groups, occupation and educational levels did not show significant correlations with traffic offenses, implying uniform likelihoods across different age and educational categories. In contrast, annual mileage emerged as a highly significant factor, revealing that drivers covering at least 6 000 km had significantly higher odds of committing offenses compared to their counterparts covering 0-6 000 km. Additionally, the number of years of driving

experience did not exhibit a significant association with traffic offenses. Regarding the LOC factors, "LOC fate" displayed a significant association with traffic offenses, suggesting that higher scores increased the likelihood of offenses. Conversely, "LOC self" exhibited a protective effect, with higher scores correlating with decreased odds of committing offenses. However, "LOC other drivers" and "LOC vehicle/environment" did not show significant associations with traffic offenses (Table 47).

Table 47: Multivariable logistic regression of the T-LOC factors associated with getting traffic offences

	Traffic offenses in the past 3 years			
	P-value	aOR	95% C.I. Lower	Upper
Gender	0.332			
Male				
Female				
Occupation	0.074			
Professional driver				
Non-professional driver				
Age groups (years)	0.736			
Less than 29				
30-49				
50 and above				
Educational level	0.449			
12 years or less				
>12 years				
Annual mileage (Km)	<0.001	4.071	2.212	7.493
0-6 000 km				
>6 000 km				
Year of driving experience	0.189			
10 years or less				
More than 10 years				
LOC fate	0.015	1.117	1.022	1.220
LOC self	0.019	0.949	0.908	0.991
LOC other drivers	0.593			
LOC vehicle/environment	0.807			

N.B: Educational level of 12 years is equivalent to secondary level, *p-value<0.05 is considered significant

II.5. DISCUSSION

I. TRANSLATION AND PSYCHOMETRIC TESTING

This project was designed to adapt and validate essential driver behaviour scales used in traffic psychology, such as the DBQ, DAS, TLOC, and DSI, within the distinctive cultural framework of Lebanon. This process entails ensuring the reliability and validity, as well as customizing an Arabic version of each of these scales to align with local nuances for Lebanese drivers.

VALIDATION OF THE DBQ

Given that human factors, including driver behaviour, are major contributors to RTCs (De Ona, López, Mujalli, & Calvo, 2013; Lambert-Bélangier, Dubois, Weaver, Mullen, & Bedard, 2012; Tractinsky, Ram, & Shinar, 2013), improving driver behaviour is one of the overriding goals of road safety.

Our findings indicate that the DBQ-L has adequate psychometric properties, revealing good reliability across all subscales. The DBQ-L factorial structure was comparable to the structure proposed by Harrison et al. (Harrison, 2009a), revealing four dimensions, namely aggressive violations, ordinary violations, errors, and lapses. Despite small differences in the theoretical four-factor structure of the DBQ, the overall factor structure has been confirmed in different samples (Bener et al., 2008; Gras et al., 2006a; Lajunen et al., 2004; Mesken, Lajunen, & Summala, 2002).

The four factors also had acceptable reliabilities, with the lowest one for "aggressive violation". The DBQ-L multidimensional structure is statistically supported by satisfactory fit indices when running a confirmatory analysis. The factorial solution of the DBQ-L also matches the meaning of the four broad facets of the 28-item version among Australian drivers (AN Stephens & M Fitzharris, 2016). However, other studies have established diverse item and factor structures that fit their data better using other forms of the DBQ, such as the 32-item four-factor Swedish DBQ (Rimmö, 2002); the 22-item four-factor Persian DBQ, and the 50-item four-factor solution based on data from drivers in Australia (Blockey & Hartley, 1995). Such discrepancies in factor configuration could be attributed to the misunderstanding and different interpretations of certain items by participants.

Of the four subscales, the highest item mean score was for aggressive violations, followed by ordinary violations, lapses, and then errors. Our results were inconsistent with the findings of a study conducted among Australian drivers that showed the highest mean score was for lapses, followed by aggressive violations and violations. The scores for the current sample

were higher than those found by Harrison et al (Harrison, 2009a). In addition, the frequencies of the DBQ responses among Lebanese drivers ranged from "never" to "hardly ever" and rarely "occasionally," which was in line with the findings of previous studies (Aberg & Rimmo, 1998; Blockey & Hartley, 1995; Mesken et al., 2002). However, Lebanese drivers, in general, scored higher in all DBQ items than Arab Gulf drivers (Qatari and United Arab Emirati (Bener et al., 2008)), much higher than British (Reason et al., 1990), Australian (Blockey & Hartley, 1995), Finnish and Dutch (Lajunen et al., 2004), and even higher than Greek and Turkish (Ozkan et al., 2006b) drivers. This is consistent with a tendency found in the study by Ozkan et al. (Özkan, Lajunen, et al., 2006a). The DBQ factor structure might become more indistinct as the occurrence of the behaviour gets higher when moving from West/North to East/South. The interpretation of errors and aggressive violations factors differs from country to country. Shinar et al. suggested that aggressive driving would be highly influenced by the cultural context (Shinar, 1998), violations are affected by contextual factors (Reason et al., 1990) and errors are mainly related to the cognitive processes of the individual or the lack of supportive social and physical context (Özkan, Lajunen, et al., 2006a).

No floor or ceiling effects were detected for the DBQ-L. This indicates a good distribution of scores for the -DBQ-L, good content validity, and additional support of adequate reliability. In the present study, the obtained internal consistency indicates good homogeneity of items of the adapted questionnaire, which is a significant feature of a questionnaire, especially if all items are assessing the same concept. The test-retest reliability of the DBQ-L was found good as well.

VALIDATION OF THE DAS

The propensity to become angry behind the wheel (trait-driving anger) has been the subject of many studies focusing on how emotional and personality factors influence traffic behaviour and RTC involvement. The objective of the current research was to examine the psychometric properties of the Arabic version of DAS in terms of internal consistency reliability, and construct validity among Lebanese driver. The present study showed the DAS-A with its 33 items has satisfactory psychometric properties. Each factor loading was significant, with values greater than 0.60; and all six subscales had good to excellent reliability, with alpha coefficients greater than 0.80. The confirmatory factor analysis confirmed the original six-factor solution found by Deffenbacher et al. (1994) which provided a good fit to our data namely hostile gestures, illegal driving, discourtesy, traffic

obstruction, police presence, and slow driving. The high correlations between the adapted Arabic version of DAS and its subscales for Lebanese drivers, the high alpha reliability, and the fit of the data to the factorial structure indicated that the Arabic version of DAS could be used to measure driving anger traits among Lebanese drivers and in further studies as well. The overall DAS score among Lebanese drivers was 107.5 which is considered high compared to other countries and Lebanese drivers exhibited significantly higher anger towards situations including hostile gestures, traffic obstruction, and illegal driving compared to other drivers from different countries. Lastly, drivers who exhibited anger toward illegal driving, slow speeding, and police presence were more likely to report prior involvement in RTCs than their counterparts who didn't experience such emotions. In terms of traffic fines, only drivers who were provoked by traffic obstruction were more likely to be penalized for traffic offenses.

Our findings regarding the multidimensional structure of DAS were similar to the findings of Sullman et al. (2007) (M. Sullman, 2006) and to those found in a study conducted among Chinese drivers (F. Li et al., 2014). Of note, some studies, where some minor changes were made concerning the number of items, have also confirmed the original factor structure of the DAS (F. Li et al., 2014; M. Sullman, 2006; M. J. Sullman et al., 2014; Yasak & Esiyok, 2009). However, this factorial structure was different from the findings of other studies such as the study conducted by Lajunen et al. (Lajunen, Parker, & Stradling, 1998) that found a multifactorial structure consisting of only three factors rather than the six subscales. In New Zealand, a four-factor solution of DAS was found (M. Sullman, 2006) and the discourtesy factor was deleted in France (Villieux & Delhomme, 2007). These differences among these factor structures could be related to methodological dissimilarities. Of note, the inter-correlations found in the present study among the six factors were at median level with a range from 0.178 to .610, suggesting these six subscales might be loaded on multiple constructs.

In comparison with driving anger across samples of drivers from various countries, the overall DAS score among Lebanese drivers was 107.5 which is considered high. Our findings are comparable to the United States where the average score of DAS was 109.0 (Hernández-Hernández, Siqueiros-García, Robles-Belmont, & Gershenson, 2019). However, an average score for the complete DAS was only 69.2 among Japanese drivers (McLinton & Dollard, 2010). The level of anger that drivers reported on the six subscales of the DAS differed from country to country. The international comparisons of driving anger based on the original factorial structure of DAS showed that the "police presence" subscale was the lowest anger

trigger among Lebanese drivers. These results were compatible with those obtained from American (Jerry L Deffenbacher et al., 1994), French (Villieux & Delhomme, 2007), Turkish drivers (Yasak & Esiyok, 2009), and Chinese drivers (F. Li et al., 2014). Concerning the hostile gestures subscale, it ranked as the top driving stimuli that provoked anger among Lebanese drivers. In opposition to other studies (Jerry L Deffenbacher et al., 1994; F. Li et al., 2014; Yasak & Esiyok, 2009), discourtesy was not the major trigger of anger in Lebanese drivers. Our findings showed that Lebanese drivers get angry the most when exposed to hostile gestures.

Remarkably, Lebanon ranked the top among Americans, and Turkish, in terms of anger related to hostile gestures (3.79), traffic obstruction (3.39), and illegal driving (3.62) compared to other countries (Jerry L Deffenbacher et al., 1994; Hernández-Hernández et al., 2019; F. Li et al., 2014; Yasak & Esiyok, 2009). However, the discourtesy subscale was significantly lower among Lebanese drivers compared to American (Jerry L Deffenbacher et al., 1994), New Zealanders (M. Sullman, 2006), German (Brandenburg & Oehl, 2021), Chinese (F. Li et al., 2014), and Turkish (Yasak & Esiyok, 2009) drivers but this level was similar to the one reported by Spanish drivers (M. J. M. Sullman, Gras, Cunill, Planes, & Font-Mayolas, 2007). As for the police presence subscale, Lebanese drivers have a similar level of anger to Chinese drivers. However, this level was significantly higher than the one reported by German, British, Spanish, and New-Zealander drivers (Brandenburg & Oehl, 2021; Gras et al., 2006b; M. Sullman, 2006; M. J. M. Sullman et al., 2007). Conversely, it is significantly lower than American drivers. Lastly, levels of anger prompted by traffic obstruction among Lebanese and Spanish (M. J. M. Sullman et al., 2007) drivers were similar. While methodological factors may contribute to differences in reported levels of driving anger between Lebanon and other countries, the propensity for driving anger observed in Lebanon could be attributed to cultural differences, as the display of heated emotions is commonplace in Lebanese daily life. Lebanese people are known for easily flaring up over minor incidents, including traffic-related frustrations, although such anger tends to dissipate quickly. Several psychological and sociological theories can shed light on the differences in driving anger across different cultural contexts. For example, theories of emotion regulation highlight how cultural norms shape the expression of emotions. In Lebanon, where outward expression of emotions like anger is more acceptable, individuals may be less inclined to suppress their driving-related frustrations, leading to higher levels of driving anger. Lebanon's cultural landscape, like that of any country, is shaped by unique norms, values, and social dynamics that influence behaviour, including reactions to driving anger. With its

diverse population comprising various backgrounds, Lebanon sees a spectrum of driving styles and expressions of anger on the road. Social identity theory suggests that individuals derive their sense of self from their social group memberships, which can influence their attitudes towards driving. Moreover, societal norms surrounding traffic etiquette and the tolerance for aggressive driving behaviours may differ from those in other countries. According to social learning theory, individuals acquire driving behaviours through observation and reinforcement within their social environment. In Lebanon, where there may be greater acceptance of aggressive driving behaviours, people may readily adopt and display such behaviours while driving. Additionally, Lebanon's history of instability, economic challenges, and social tensions can heighten stress levels among drivers, potentially exacerbating driving anger. Recognizing and understanding these cultural factors are essential for accurately interpreting the results of the DAS within the Lebanese context and for comparing them with findings from studies conducted in different cultural settings. Moving forward, future studies focusing on the cultural influences on driving anger are warranted to deepen our understanding of this phenomenon

VALIDATION OF THE DSI

The primary objectives of the present study were to adapt the DSI into an Arabic version and to confirm the reliability and the validity of this version among Lebanese drivers. The findings indicate that the Arabic version of DSI has adequate psychometric properties. The two factors also had acceptable reliabilities, with the lowest one shown in the subscale related to "safety skills". The Arabic version of the DSI bifactorial structure is statistically supported by satisfactory fit indices when running a confirmatory analysis. The factorial solution of the DSI also matches the meaning of the two broad facets of the German version of DSI (Ostapczuk et al., 2017). The correlations among the Arabic version of the DSI and driving behaviour, sociodemographic parameters, and crash involvement indicate that the version used in the current study had good criterion validity.

The bifactorial structure of the Arabic version of the DSI closely aligns with the structure proposed by several prior studies, consistently revealing two distinct dimensions. Our findings harmonize seamlessly with the existing literature where the DSI has undergone extensive validation and application in a multitude of countries, spanning Germany (Ostapczuk et al., 2017), the UK (Lajunen, Parker, Stradling, et al., 1998), the Netherlands (Lajunen, Corry, et al., 1998), Australia, and Finland (Lajunen, Corry, et al., 1998) as well as Iran, Greece, Turkey (Sümer et al., 2006; Henriette Wallen Warner et al., 2013), and Qatar

(Bener et al., 2006). Impressively, these prior inquiries have consistently unearthed the same two fundamental factors within the DSI, irrespective of the diverse cultural contexts in which it was applied.

VALIDATION OF THE T-LOC

Our findings indicate that the T-LOC-A has adequate psychometric properties revealing good to excellent reliabilities. The results from the EFA showed that the factorial structure of the T-LOC-A was similar to that of the original version (Özkan & Lajunen, 2005a) revealing the same multidimensional structure with four subscales namely internal locus of control called “self”, “others drivers”, “fate”, and “vehicle/environment”. All four factors had acceptable reliability. Its multidimensional structure is statistically supported by satisfactory fit indices. The factorial solution of T-LOC-A is consistent with the four broad facets found in the Chinese (Sun, Ma, & Hua, 2020), Swedish (H. W. Warner et al., 2010), and Romanian (Mairean et al., 2017) versions, despite variations in factorial structure and content revealed by the number of items (Mairean et al., 2017). Furthermore, the differentiation between external and internal beliefs is consistent with previous studies (Arthur & Doverspike, 1992; Guastello & Guastello, 1986; Iversen & Rundmo, 2002; Levenson, 1981; Montag & Comrey, 1987; Özkan & Lajunen, 2005a). Our study demonstrated that the correlations between the internal and external T-LOC factors were low to moderate, which is in line with previous studies on T-LOC scale development (Mairean et al., 2017; Montag & Comrey, 1987; Özkan & Lajunen, 2005a).

The pattern of correlations between the T-LOC-A factors was mostly similar to those reported in previous studies (Alper & Özkan, 2015; H. W. Warner et al., 2010). Specifically, we observed that other drivers and fate were negatively correlated with self (Mairean et al., 2017), while self was positively correlated with the vehicle/environment dimension. These results are consistent with earlier research that also found a positive correlation between the self-scale and the vehicle/environment dimension (Mairean et al., 2017; Özkan & Lajunen, 2005a; H. W. Warner et al., 2010). However, our study did not find any significant correlation between the external dimensions, which is in contrast to previous research indicating that other driver's dimensions were positively correlated with fate and vehicle/environment, and that fate was positively correlated with vehicle/environment (Mairean et al., 2017). Further research is needed to explain these particular findings among Lebanese drivers.

STRENGTHS AND LIMITATIONS OF THE STUDY

The adaptation and validation of essential driver behaviour scales, including the DBQ, DAS, TLOC, and DSI, within the cultural framework of Lebanon presents a critical step towards understanding and mitigating road safety challenges in the country. Through meticulous validation processes, this study ensures the reliability and validity of these scales, tailoring them to align with the intricacies of Lebanese driving culture. The study's strengths lie in its response to local road safety challenges in Lebanon, where escalating vehicle numbers and a high fatality rate underscore the urgency for effective interventions. The study addresses a notable scarcity of research on driver behaviour in Lebanon, filling a crucial knowledge gap and providing valuable insights for RTC reduction and resource allocation. By acknowledging Lebanon's distinctive cultural context, the study demonstrates cultural sensitivity by adapting and validating assessment tools to align with local norms and expectations, ensuring the accuracy and cultural appropriateness of its findings. The validated scales demonstrated very good to excellent reliability, and the sample size had adequate power for conducting the factorial analysis. Through its alignment with global best practices in traffic psychology, the study not only contributes to improving road safety conditions within Lebanon but also facilitates meaningful cross-cultural comparisons and the identification of best practices worldwide.

On the other hand, this study does have several important limitations that deserve careful consideration. Firstly, the study's cross-sectional design does not allow for deriving causal relationships of the main associations. Although the sample was stratified by gender, age, and geographical regions, selection bias might be present due to the use of the convenience sampling technique, as the sample included a high percentage of university-educated participants. Thus, there are concerns related to the representativeness of the sample. Future research should aim to incorporate more diverse samples to ensure the generalizability of findings. By including a more diverse range of participants, including individuals from different age groups, socio-economic backgrounds, and geographical locations, future studies could better capture the variability in driving behaviour across populations.

Secondly, the data collection was based solely on drivers' self-report data and no observations were made. The reliance on self-reported data rather than an objective assessment, although commonly used and validated in previous research (Lajunen, Summala, & behaviour, 2003; Ostapczuk et al., 2017) has two main limitations: social desirability and cognitive distortions. Drivers were informed about the topic of the study and maybe they could have provided a "perfect driver profile" to meet the social norms. It should be noted,

however, that the participants were volunteers and they were assured anonymity and confidentiality and would not benefit from embellishing their responses. While efforts were made to ensure confidentiality, some degree of social desirability bias may have influenced the results. In a recent study conducted by Yılmaz et al. (Yılmaz et al., 2022), driving-specific social desirability was found associated with aberrant driver behaviours, with drivers inclined to engage in impression management, one of the factors of driving social desirability scale displayed fewer aggressive violations, while those displaying self-deception reported more ordinary violations. Additionally, positive driver behaviours were prone to social desirability, with drivers holding a positively biased self-view more likely to report frequent positive behaviours. Driving skills were also found associated with social desirability, with drivers less concerned about impressing others reporting higher perceptual-motor skills, while those more susceptible to overrating their abilities reported higher safety skills.

In addressing social desirability bias in future traffic-related research, it is advisable to utilize specific driver social desirability scales tailored specifically for driving contexts. This will allow for a more targeted assessment of drivers' behaviours, thereby providing more accurate insights. Additionally, ensuring participants' anonymity and confidentiality, as emphasized by Ozkan & Lajunen (Özkan & Lajunen, 2021), alongside the preference for self-administration over face-to-face interviews and private administration over public settings, as recommended by Lajunen & Summala (Lajunen & Summala, 2003) and Sullman & Taylor (M. J. M. Sullman & Taylor, 2010), respectively, can help mitigate social desirability bias. Furthermore, employing statistical techniques to control for and mitigate the potential impact of social desirability bias (A. E. af Wåhlberg, 2010; A. E. af Wåhlberg, Dorn, & Kline, 2010; Ostapczuk et al., 2017) can enhance the accuracy of study results. Moreover, the utilization of implicit measures can complement self-reports and provide additional insights into drivers' attitudes and behaviours.

However, taking into account the somewhat internalizing nature of driving anger and the fact that it could be difficult to measure it via observational methods, self-reports represent a quite feasible approach. Researchers should consider longitudinal studies to examine changes in driving anger over time and assess its long-term impact on road safety outcomes. Longitudinal research designs allow for the tracking of individual drivers' behaviours and experiences over an extended period, offering insights into the stability of driving anger levels and its association with future driving-related outcomes. Another critical aspect pertains to the measurement of RTC involvement and traffic fines, which relied on self-reported past incidents. Such an approach carries the inherent risk of underestimation, as

respondents may inadvertently omit reporting certain RTCs, a common concern in data collection of this nature.

Lastly, the target group of the present study was Lebanese drivers. Although refugees might represent a large proportion of the driver population in Lebanon, the present study was restricted to Lebanese drivers because of difficulties in data collection (e.g., difficulties to obtain representative samples). Despite the rich demographic measures, we could have missed some subgroups of the population and some factors associated with the driving anger propensity that could have changed our results, predisposing us to a residual confounding bias.

IMPLICATIONS

The validation of the Arabic versions of the DBQ, DAS, DSI, and TLOC along with their adequate psychometric properties, carries significant implications for traffic psychology and road safety in Lebanon and potentially beyond. The established reliability and validity of these instruments within the Lebanese context provides a foundation for understanding driving behaviours, driver anger triggers, and skills among Lebanese drivers. The DBQ-L indicates elevated levels of aberrant driving tendencies among Lebanese drivers compared to counterparts in other countries, while the validation of the DAS-A underscores the prevalence of driving anger traits within the Lebanese context. Validation of the DSI provides tools for identifying at-risk individuals and addressing skill deficits, while validation of the T-LOC informs efforts to promote safer driving practices by addressing misconceptions and enhancing awareness of individual responsibility.

Beyond academic research, these validated scales offer practical insights for policymakers, traffic safety professionals, and driving instructors, facilitating evidence-based interventions to reduce RTC occurrence in Lebanon. The insights gleaned from these instruments can inform the design of driver training programs, traffic management strategies, and public awareness campaigns tailored to the specific needs and challenges faced by Lebanese drivers. Moreover, the validation of these instruments opens avenues for comparative research and cross-cultural studies, enabling researchers to explore differences and similarities in driving behaviour across diverse cultural contexts and different countries. This broader perspective not only enriches our understanding of driver psychology but also facilitates the exchange of best practices and innovative approaches to promoting road safety on a global scale.

II. BEHAVIOURAL ANALYSIS

DBQ AND SOCIODEMOGRAPHIC CHARACTERISTICS

Gender, age, education level, and occupation were found to be associated with aberrant driving behaviours. Specifically, the study found that males had a higher tendency to commit aggressive and ordinary violations, while no significant difference in self-reported driving errors was found across gender. This could be related to the fact that men have a higher tendency to force others to get out of the way and consider it a submissive action. Similar results were found in previous studies where it was also stated that males exhibited driving violations more frequently than females (Aberg & Rimmo, 1998; Blockey & Hartley, 1995; Harrison, 2009b; Parker, McDonald, Rabbitt, Sutcliffe, & Prevention, 2000; Reason et al., 1990). Our results in terms of errors are consistent with the findings of the study conducted by Reason et al. (Reason et al., 1990). Of note, other studies have reported a higher tendency in females to report lapses and errors (Reason et al., 1990) which was not found among Lebanese drivers (Blockey & Hartley, 1995; Parker et al., 2000; Xie & Parker, 2002). Although the stereotype is that men are more focused on one task while driving and women are more cautious and able to multitask, this study found that women were more likely to commit errors and shortcomings related to space perception while driving. This finding may be due to Lebanese women's desire to conceal their weaknesses while driving in order to avoid stereotypes. Another possible explanation is that women tend to be more cautious while driving, which may lead to fewer errors.

Our study revealed a decreased pattern of aggressive and ordinary violations with increased age. Younger age was found to be positively correlated with an increase in both violations scores (ordinary and aggressive). This could be related to the increased maturity with age, which might mellow drivers and make them less likely to adopt aggressive driving behaviour. Consistently with other studies, our findings showed that men and younger drivers are more likely to display aggressive violations while driving. Additionally, older age was found to be positively associated with self-reported errors. This could be related to the decline in cognitive and physical abilities that often comes with age. It highlights the importance of interventions and programs aimed at older drivers to help improve their driving skills and safety on the road. Overall, this study provides important insights into the socio-demographic factors associated with aberrant driving behaviours and the need to address these factors in order to improve road safety for all road users (Shinar & Compton, 2004).

The study found that being a professional driver was positively associated with a higher tendency to commit aggressive and ordinary violations. One possible explanation is that professional drivers often have higher workloads and tight time schedules, which may lead to increased stress levels and a greater likelihood of engaging in risky driving behaviours (Dorn, Stephen, af Wåhlberg, & Gandolfi, 2010). In other words, they were more exposed to higher traffic volumes on the road and to a situation-specific emotional state that could affect their behaviour. This was consistent with the results of a study conducted in Qatar that reported a higher likelihood of risky driving among professional drivers (Timmermans, Alhajyaseen, Reinolsmann, Nakamura, & Suzuki, 2019). The study also highlighted the importance of addressing this issue, as professional drivers play a significant role in the traffic system of Lebanon, and there is a need to improve the 'Traffic Safety Culture' among Lebanese professional drivers. Additionally, it is important to examine and understand the personal acceptance of risky driving behaviours among professional drivers in order to develop effective interventions to improve road safety (J. Cestac, Paran, & Delhomme, 2011).

Additionally, a higher educational level (university degree or above) was found to be a protective factor from committing ordinary violations, lapses, and errors while driving. In other words, education could provide the driver with the necessary knowledge and skills to navigate the road safely and make better decisions while driving. Furthermore, the study highlights the importance of investing in educational programs and awareness campaigns targeting younger, less educated drivers and professional drivers to improve road safety in Lebanon.

Our findings showed that all dimensions of risky behaviour (errors, lapses, aggressive and ordinary violations) were positively associated with the increased annual mileage, whereas violations increased with larger driving experience. Comparable results were reported by a study conducted among Australian drivers (A. N. Stephens & Groeger, 2009). However, beginner drivers lack confidence in their driving performance and are still in the phase of confidence-building. Hence, the limited driving experience in handling various traffic situations makes them more anxious to perpetrate a traffic violation (de Winter & Dodou, 2010). When they get more experience, they will feel more familiar with the traffic environment and increase, therefore, their involvement in traffic violations. Similarly, a study concerning the traffic safety culture of professional drivers in Qatar indicated that experienced professional drivers are more likely to perform risky driving behaviour (Timmermans et al., 2019).

As for the driving errors dimension, it was also found affected by driver characteristics. This was consistent with other studies (González-Iglesias, Gómez-Fraguela, & Luengo-Martín, 2012; Özkan, Lajunen, & Summala, 2006; Wickens, Toplak, & Wiesenthal, 2008). More specifically, age, education as well as driving experience were found to have the highest effect on driving error in our present research. Remarkably, errors in our study exhibited a different pattern, where it was found that errors increased with age, indicating that older drivers are more likely to make driving errors. This could be explained by the fact that young drivers have better mental and physical characteristics than older drivers, thus reducing their likelihood of committing errors. A previous study has found that errors decrease for young drivers but remained quite unchangeable with age within the older samples (AN Stephens & M Fitzharris, 2016).

Both drivers' experience and education were protective factors from erroneous behaviour, indicating that a more experienced and more educated driver is less likely to perform driving errors. This finding probably means that both of these characteristics help drivers to properly manage a potentially dangerous situation and protect themselves from committing an error. There is confusion and disparity in the literature in terms of age and experience and their impact on aberrant driver behaviour. A specific insight was provided by Wells and al. (Wells, Williams, & Farmer, 2002), who reported that older drivers had consistently lower violation scores than younger drivers. In this case, the effects of age on errors could be explained by the fact that novice drivers are still in the learning phase, hence improving their skills and reducing their driving errors. A driving simulator study about errors and violations during training of pre-licensed drivers showed similar results (de Winter & Dodou, 2010). At a later age, acquired driving skills can be weakened and a further increase in errors could be expected.

ABERRANT DRIVER BEHAVIOUR AND DRIVER ANGER

Our study also showed that aberrant driver behaviour subscales were positively correlated to anger subscales such as hostile gestures, illegal driving, slow driving, discourtesy, police presence, and traffic obstruction. Different anger triggers were found to have differing impacts on aberrant driving behaviours in our study. This result is consistent with the finding of a study conducted by Zhang et al. (Zhang, Chan, & Zhang, 2015). Similar to other studies, our findings suggested that the relationship between driving anger and driver behaviour depends on different natures of anger or situational characteristics, respectively (Lajunen & Parker, 2001; F. Li et al., 2014; M. J. M. Sullman et al., 2007; Zhang et al., 2015). Based on

the frustration-aggression hypothesis, aggressive driving is a result of anger or frustration caused by thwarted goals (Dollard, Miller, Doob, Mowrer, & Sears, 1939).

Our study also found that anger prompted by hostile gestures; discourtesy, police presence; traffic obstruction, and slow driving were positively associated with aggressive violations. This finding is consistent with the driving anger factors reported by Zhang and Chan's study (Zhang et al., 2015), which either block the goal to drive safely, the "general survival goal", or the arrival goal. Previous studies showed that hindrance anger trigger was associated with aggressive driving (F. Li et al., 2014; Zhang et al., 2015). In addition, the relationship between anger and aggressive expressions has been reported in numerous studies (Berdoulat, Vavassori, & Sastre, 2013; Jerry L. Deffenbacher, Petrilli, Lynch, Oetting, & Swaim, 2003). Thus, driving anger was positively associated with aberrant driving behaviours in the sense of deliberate infringements that are most aggressive and targeted at other road users as angry drivers attempt to influence other drivers, either to achieve their driving goals or to take revenge for other road users' driving behaviours. These results are alarming, especially because the anger-aggression correlation might have become stronger in more recent years, given the increasing traffic congestion problem worldwide.

For ordinary violations, all the DAS subscales instigated by hostile gestures, discourtesy, traffic obstruction, and police presence, illegal and slow driving were found positively correlated with ordinary violations (Berdoulat et al., 2013; Jerry L. Deffenbacher et al., 2003). Many studies highlighted such kind of correlation between anger and violations. This highlights the importance of all aspects of anger originating from any driving situation described in the 33 items of DAS in leading to traffic violations and also stresses the importance to mitigate factors triggering anger on road.

In this study, we found that only anger originated from police presence and slow driving was positively associated with erroneous driving behaviour. Apart from triggering aggressive violations and deliberate traffic infractions, anger can negatively impact driving behaviour, since research has demonstrated that anger could compromise the cognitive performance of drivers including judgment and reasoning which may rise the possibility of making errors (Blanchette & Richards, 2010). Of note, the effects of driving anger on errors have been explored also in simulation-based studies where Jeon et al. found that angry drivers made more errors than the control group (Jeon, Walker, & Yim, 2014), and Stephens et al. showed that drivers who had exhibited a higher level of anger in a simulated driving situation were also more projected to miss dangerous traffic hazards (A. Stephens, Trawley, Madigan, & Groeger, 2013). Furthermore, a recent meta-analysis found a significant correlation of 0.179

between driving anger and errors (Zhang & Chan, 2016). However, previous investigations have also reported weak or non-significant relationships between driving anger and errors (Nesbit, Conger, & Conger, 2007).

With regards to lapses, our findings revealed that anger provoked by the presence of police, traffic obstruction, or slow driving could lead to lapses while driving. These results were consistent with the findings of a study conducted about dimensions of driving anger and their relationships with aberrant driving among Chinese drivers which demonstrated that the three dimensions of driving anger have different relations with aberrant driving behaviours (Zhang et al., 2015).

ABERRANT DRIVER BEHAVIOUR AND RTC INVOLVEMENT

Aggressive violations, ordinary violations, and errors were positively associated with RTC involvement, suggesting that engaging in risky driving behaviours significantly increases the likelihood of RTCs. Our findings showed that errors and violations are strong predictors of self-reported RTCs. This finding stands apart from prior research which suggested that either errors alone (DeLucia et al., 2003) or violations alone (Stradling et al., 1998) were the significant RTC predictors. However, lapses did not exhibit significant effects, indicating that momentary lapses in attention may not contribute substantially to RTCs compared to deliberate violations and errors. These findings underscore the importance of addressing risky driving behaviours, particularly aggressive and ordinary violations, through targeted interventions to reduce RTCs and enhance road safety. Further research could explore the underlying mechanisms driving the association between occupation and RTC involvement, as well as the effectiveness of interventions targeting specific risky driving behaviours identified by the DBQ.

DRIVER ANGER AND SOCIODEMOGRAPHIC AND TRAVEL-RELATED VARIABLES

Our findings showed that the overall DAS varied between males and females. Gender differences were revealed in driving anger related to all DAS subscales except slow driving. Female drivers reported discourtesy, hostile gestures, illegal driving, and traffic obstruction as significantly more anger-provoking than male drivers did. However, police presence instigated more anger among males than females. Consistently to our results, Sullman et al. (M. J. Sullman et al., 2014) found a significantly higher tendency to experience anger for females than for males in terms of traffic obstructions, and hostile gestures. Besides, Sullman et al. also found that females were more prone to become angry facing discourtesy, traffic

obstructions, and illegal driving (M. J. M. Sullman et al., 2007). Gender socialization theories propose that societal expectations regarding gender roles influence how men and women express anger while driving. In Lebanon, where traditional gender roles may differ, gender-specific patterns of driving anger may emerge.

As they get older, drivers reported that they experienced less driving anger as a result of discourtesy and police presence. Our results were comparable to a Chinese study conducted by Li et al. (F. Li et al., 2014) that found that younger drivers reported significantly higher levels of driving anger than drivers from older age groups did. Besides, a study conducted among Malaysian drivers conducted by Sullman et al. revealed a negative correlation between driving anger and age (M. J. Sullman et al., 2014). In another study, Sullman et al. (M. J. M. Sullman et al., 2007) stated that older age was related to a lower tendency toward driving anger, concerning discourtesy, police presence, and overall driving anger. Such a relationship between gender and age and a driver's tendency toward driving anger was not found in other studies in Japan and Germany (Brandenburg & Oehl, 2021; McLinton & Dollard, 2010). Hence, the extent of the relationship between driving anger and demographic variables like age and gender is still not completely distinct (J. Deffenbacher, Stephens, & Sullman, 2016).

No differences regarding anger provoked by driving situations were revealed between drivers with higher educational levels and those with lower ones. On the other hand, the occupational difference was revealed between professional drivers and non-professional drivers in terms of anger prompted by the police presence, traffic obstruction, and slow speeding with professional drivers rating slow driving, police presence, and traffic obstruction as significantly more anger-prompting than nonprofessional drivers did. This disparity was also highlighted among professional drivers (taxi, bus, truck) (Damjanović et al., 2022).

Drivers who travelled long distances expressed more anger related to illegal driving, discourtesy, traffic obstruction, and slow speeding. An extensive exposure to road situations could instigate higher level of anger especially the factors affecting the fluidity of the road (obstruction and speeding). However, increasing age was positively correlated to anger prompted by illegal driving, slow speeding, and traffic obstruction. In a study conducted among Malaysian drivers, age was found negatively related to five (discourtesy, traffic obstructions, hostile gestures, slow driving and police presence) (M. J. Sullman et al., 2014). Furthermore, several studies showed that age, anger and aggressive driving behaviour were closely associated. Younger aged drivers correlated with more driving anger, risky, reckless and aggressive driving behaviours, which may be associated with an increased risk of traffic

crash involvement (Dinh, Vu, McIlroy, Plant, & Stanton, 2020; Lawton et al., 1997; Perepjolkina & Renge, 2011).

Correspondingly to the driving experience increase, driving anger experienced in reaction to discourtesy, slow driving, and illegal driving increased. Our results were not consistent with the findings of a study that obtained a negative correlation between anger and years of a driver's license possession and more experienced drivers showed less driving anger in response to events related to discourtesy. However, anger instigated by police presence decreased with large experience.

DRIVER ANGER AND RISK INVOLVEMENT

Our study also focused on DAS general and specific DAS subscale scores in predicting an external criterion (e.g. traffic tickets, RTCs), using the six factorial solutions. Drivers who were more prone to experience anger resulting from illegal driving, discourtesy, slow speeding, and police presence were more likely to report having been involved in RTCs than their counterparts who didn't experience such emotions. Apart from that, this study also found that young drivers, less experienced drivers, long-distance driving, and drivers who were more likely to feel angry while driving reported prior involvement in RTCs. In terms of traffic fines, only drivers who were provoked by traffic obstruction were more likely to be penalized for traffic offenses. Our results were partially consistent with the findings of Sullman et al., where DAS dimensional were not directly associated to road crash involvement. However, several of the six forms of DAS were significantly associated to the crash-related conditions such as being ticketed (M. J. Sullman et al., 2014).

DRIVER SKILLS AND SOCIODEMOGRAPHIC CHARACTERISTICS

In terms of sociodemographic characteristics, the present study unveiled significant disparities in gender in self-assessed driving skills. Women tended to rate their perceptual-motor skills lower than men did, but they felt more confident in their safety skills. What's particularly interesting is that female drivers perceived their safety skills as stronger than their perceptual-motor skills, while males had the opposite perception. These findings align with previous studies conducted with Australian, Finnish, British, Dutch, Greek, Iranian, and Turkish drivers (Lajunen, Corry, et al., 1998; Sümer et al., 2006; Henriette Wallen Warner et al., 2013) which also observed similar gender-based patterns in self-assessed driving skills. This is a reminder that individual perceptions of driving abilities can be shaped by various factors, including gender, and these perceptions may not always align with objective skill

levels (Lajunen, Corry, et al., 1998; Lajunen et al., 1995; Türker Özkan, Timo Lajunen, Joannes El Chliaoutakis, Dianne Parker, & Heikki Summala, 2006b). The gender disparities in driving skills stems from a mix of social, psychological, and physiological factors. Social norms often steer males towards activities that boost motor skills and encourage risk-taking, while females are encouraged to be more cautious. Psychological factors like confidence levels and self-perception also play a role, influenced by societal expectations. Physiological differences, such as reaction times, further contribute to variations in driving abilities between genders. More research into these factors could offer deeper insights into gender disparities in driving skills.

In this study, age was found positively correlated with both self-evaluated perceptual-motor skills and safety skills. It showed that perceptual-motor skills tended to be higher in individuals with more driving experience. This improvement in perceptual-motor skills was evident when considering factors such as the number of years holding a driving license, the weekly driving distance, and the annual driving distance. Safety skills also followed a similar pattern of improvement with increased driving experience. These findings suggest that as individuals acquire more driving experience by spending more time behind the wheel; their driving skills are likely to improve. This corresponds with the idea that practice and exposure to a range of driving scenarios play a significant role in honing and advancing both perceptual-motor and safety skills. It also suggests that age and accumulated driving experience can positively impact a driver's overall skill set, potentially leading to safer and more proficient driving over time. While this finding is in line with the German version of the DSI (Ostapczuk et al., 2017) in terms of perceptual motor skills, it is discordant in terms of safety skills since perceptual-motor skills tend to improve through practice, while safety skills do not (Lajunen et al., 1995). Notably, some results found in Germany (Ostapczuk et al., 2017), Australia and Finland (Lajunen, Corry, et al., 1998; Lajunen et al., 1995), suggest that it is not physiological age but driving experience that influences perceptual-motor skill (that is, the skill of handling a car).

Remarkably, drivers with a secondary education or less exhibit slightly better safety skills than those with higher education. In contrast, those with lower educational levels excel in motor skills. This implies that formal education might have a limited influence on a driver's safety-related behaviours and decision making while on the road. Absolutely, driving skills are the result of a multifaceted interplay of numerous elements. These elements encompass a driver's experience, training, inherent personal characteristics, and more, and cannot be solely attributed to their educational background. Understanding the diverse factors that influence

driving skills is vital for developing comprehensive road safety strategies. While there may be an association between a person's education level and their driving skills, it does not suggest that one directly causes the other. Understanding this nuanced relationship can help in developing more comprehensive strategies for enhancing road safety and driver education. Interestingly, whether one holds a non-professional or professional occupation does not appear to significantly influence driver skills. This implies that the type of occupation may not be a critical factor in shaping driving skills among the surveyed drivers. Drivers who cover more than 6 000 kilometres per year tend to achieve higher scores in both safety and motor skills. This finding underscores the positive relationship between driving experience, reflected in higher annual mileage, and overall driver skills. These insights can inform targeted interventions and training programs aimed at enhancing road safety and driver competence.

CORRELATION BETWEEN DSI SAFETY SKILLS AND DSI MOTOR SKILLS

The analysis revealed a subtle but noteworthy correlation between two pivotal factors: DSI safety skills and DSI motor skills. This correlation implies that while these proficiencies are associated, this association is not particularly robust. This underscores the notion that certain drivers may excel in one facet of driving (e.g., motor skills) without necessarily excelling in the other (e.g., safety skills).

DRIVER SKILLS AND ABERRANT DRIVER BEHAVIOUR

Regarding the relationship between the DSI and DBQ variables, perceptual-motor skills displayed a positive correlation with violations, aggressive violations, lapses and errors. In essence, individuals who considered themselves skilful drivers were more inclined to engage in aberrant driving behaviours, including ordinary violations and aggressive violations.

Interestingly, as DSI safety skills increase, drivers tend to exhibit a reduction in aggressive violations, ordinary violations, lapses in attention, and errors. This observation aligns with the logical expectation that individuals with enhanced safety training and conscientiousness are inclined to engage in less risky driving conduct. These findings align with research conducted with a large sample of drivers from the Danish population, except for the positive relationship observed between violations and perceptual-motor skills in that study (Martinussen et al., 2014). This research suggests that drivers' self-assessment of their driving skills directly influences their driving behaviour. Those who report lower levels of safety skills are more likely to engage in aberrant driving behaviours. This discordance between drivers' self-

perceptions and their actual abilities has significant implications for their risk perceptions and propensity for risky behaviours, as well as for intervention development. Several studies have examined the association between driving skills and driving behaviour. For instance, Martinussen et al. (Martinussen et al., 2014) delve into the correlation between self-reported driving skill levels, appraised through the DSI, and the self-reported frequency of aberrant driving behaviours, assessed through the DBQ. This research illuminates the multifaceted interplay between drivers' perceived skill levels and their on-road behaviours, shedding light on critical aspects of road safety and driver competence. Their findings unveiled a positive correlation between perceptual-motor skills and violations, juxtaposed with negative correlations with errors and lapses.

Meanwhile, safety skills exhibited negative correlations with violations, errors, and lapses. This study emphasized the utility of both DBQ and DSI as valuable tools in traffic safety analysis. Our findings were also consistent with prior investigations (Özkan, Lajunen, et al., 2006b; Sümer et al., 2006) highlighting that drivers become particularly dangerous when possessing high perceptual-motor skills coupled with low safety skills (Martinussen et al., 2014). Building upon this, Martinussen et al. (2017b) explored the predictive capabilities of DBQ and DSI regarding RTCs. Conversely, Özkan et al. delved into disparities between safety skills and perceptual-motor skills concerning RTC involvement and penalties across six countries (Özkan, Lajunen, et al., 2006b). Finland and the Netherlands showcased a negative correlation between safety skills and RTC involvement (Lajunen, Corry, et al., 1998; Lajunen et al., 1995), whereas Iran exhibited a positive correlation between perceptual-motor skills and RTCs (Özkan, Lajunen, et al., 2006b). These outcomes hinted at an asymmetric relationship where safety skills primarily relate to safe driving behaviours, while perceptual-motor skills tend to associate with reckless driving (Özkan, Lajunen, et al., 2006b).

DRIVER SKILLS AND RISK INVOLVEMENT

Safety skills demonstrate a negative association, implying that individuals with better safety skills tend to have fewer RTCs. This underscores the importance of safety training and awareness in curbing RTCs. Conversely, motor skills show a positive association, suggesting that those with superior motor skills might, paradoxically, be more prone to RTCs. This could indicate that individuals with advanced motor skills sometimes overestimate their abilities, potentially engaging in riskier driving behaviours. A wealth of evidence suggests that experienced drivers often find themselves entangled in more frequent RTCs and accruing a higher number of traffic violations (Tao, Zhang, & Qu, 2017). Curiously, this aligns with the

pervasive belief held by a majority of drivers, namely, the conviction that their driving skills surpass those of the average motorist—a psychological phenomenon aptly labelled as overconfidence (Delhomme, 1991; Goszczyńska & Roslan, 1989). Paradoxically, this inflated self-assessment frequently dovetails with a penchant for risk-taking behaviours (Duncan, Williams, & Brown, 1991; Greening & Chandler, 1997; Krueger Jr & Dickson, 1994; Summala, 1988).

Furthermore, gender assumes a conspicuous role within the realm of RTCs, with male drivers exhibiting a heightened likelihood of RTC involvement compared to their female counterparts. This gender-based disparity can be attributed to an array of factors, encompassing disparities in risk-taking propensities, driving practices, and situational awareness. The discernible variations in road safety outcomes predicated on gender underscore the imperative nature of contemplating gender-specific strategies in the formulation of road safety interventions and policy initiatives. In addition, experience plays a pivotal role, as inexperienced drivers face a significantly greater likelihood of RTCs compared to their more seasoned counterparts. This aligns with the conventional wisdom that experienced drivers tend to handle road challenges more adeptly. Furthermore, driver occupation carries weight in RTC involvement as well, with non-professional drivers having a significantly higher likelihood of RTC compared to professional drivers. This difference may be attributed to variations in driving frequency, habits, or the nature of driving tasks between these two groups.

Conversely, educational level does not exhibit a significant association with RTC involvement in this context. This implies that, in this specific context, educational attainment does not appear to be a critical factor influencing RTC likelihood. Lastly, exceeding an annual mileage of 6 000 km stands out as a noteworthy factor, with a positive association indicating a higher likelihood of RTCs for those covering longer distances. This suggests that individuals who drive longer distances might face an elevated risk of RTCs, possibly due to increased exposure to road conditions and hazards. In summary, this analysis underscores the multifaceted nature of RTC involvement, shaped by various factors including safety and motor skills, gender, experience, driver occupation, and annual mileage. Understanding these associations can guide targeted interventions and policies aimed at reducing RTCs and enhancing overall road safety.

T-LOC AND SOCIODEMOGRAPHIC CHARACTERISTICS

Our findings revealed that there were significant gender differences in how responsibility for RTCs was attributed to internal or external factors. Specifically, men reported a higher tendency to attribute the responsibility for different driving situations and RTCs to the other drivers, while women believed more in fate and bad luck as a contributor to RTCs. Our results are similar to the findings of a study conducted among Romanian drivers, that revealed the same pattern of responsibility attributions between men and women (Montag & Comrey, 1987). Considering self and vehicle-environment scales, the results did not reveal significant differences between men and women. These results suggest that gender may play a role in the attributional processes related to driving situations and RTCs and that interventions designed to improve road safety should take into account gender differences in attributions of responsibility. The present study revealed that Lebanese female drivers had the highest scores in all the T-LOC-A factors compared to male drivers. These results were also in line with previous studies (Holland, Geraghty, & Shah, 2010; Özkan & Lajunen, 2005a) and in some cases, similar to the findings in other fields, such as health psychology (Luszczynska & Schwarzer, 2005).

T-LOC AND ABERRANT DRIVER BEHAVIOUR

Remarkably, this study has revealed a positive correlation between the concept of "self" and aggressive driving behaviour. This suggests that Lebanese drivers who tend to take personal responsibility for RTCs are more likely to engage in aggressive violations while driving. These findings align with previous studies that have shown a link between an internal locus of control and risky driving behaviours. Such behaviours may stem from drivers' overly optimistic beliefs about their ability to avoid RTCs (Arthur & Doverspike, 1992; Holland et al., 2010). In addition, our study revealed that drivers who tended to attribute the causes of RTCs to "other drivers" were also more likely to engage in dangerous driving behaviour, revealed by the aggressive violation. This might be explained by the fact that drivers who are anxious about other drivers' performances and actions on the road are more likely to react impulsively and adopt risky behaviours revealed by aggressive violations. Furthermore, we found that the belief in fate or luck as a cause of RTCs was also associated with aggressive driving behaviour. These drivers tended to absolve themselves of responsibility for RTCs and were more likely to engage in dangerous driving behaviour. Notably, we observed a weak or non-existent correlation between T-LOC subscales and lapses, which explains why lapses were not included in the analysis of the relationship between aberrant behaviour and T-LOC. Interestingly, the fate dimension was also correlated to the aggressive violation. Drivers who

blamed destiny or luck to be the causes of RTCs, tended to absolve themselves of responsibility for RTCs and were more likely to engage in dangerous driving behaviour. Notably, the weak or non-existent correlation T-LOC subscales and lapses explains why lapses were not included in the analysis of the relationship between aberrant behaviour and T-LOC.

T-LOC AND RTC INVOLVEMENT

The results highlighted a positive association between the dimensions of external T-LOC scale (other drivers, vehicle-environment) and being involved in RTCs in the last three years. The LOC "self" factor emerged as a significant protective factor, indicating that as drivers' internal control perception increases, the likelihood of RTC involvement decreases. Our results are consistent with the findings of Özkan & Lajunen, that found that self can significantly predict drivers' total number of offenses and that involvement in active RTCs was associated with internality (Özkan & Lajunen, 2005b; Sümer, 2003). However, the non-significant correlation between self and traffic crashes was found other studies (Mairean et al., 2017). Given the inherent link between being responsible for vehicle RTCs and experiencing personal culpability, it is conceivable that our participants might not have veraciously disclosed their engagement in road traffic crashes. This potential inconsistency could be attributed to a conscious effort to evade the emotional repercussions of personal guilt, social stigma, or other adverse emotional states associated with recollecting such incidents.

In contrast, the "other drivers" and the "vehicle/environment" factors exhibited a robust association with an increased likelihood of RTC involvement, highlighting the substantial impact of external factors on crash risk. These findings underscore the intricate nature of road safety, emphasizing the imperative consideration of both internal and external locus of control factors in devising targeted interventions and strategies to mitigate RTC risks. This phenomenon could be elucidated by evidence from various studies that suggests a correlation between attributing causes of RTCs to external factors and a diminished inclination to adopt precautionary measures (Montag & Comrey, 1987). However, it is apparent that respondents who have experienced RTCs and subsequent traffic offenses may consciously deflect responsibility. Consequently, they may be inclined to attribute the causes of road traffic RTCs to external factors when responding to the T-LOC-A scale. Our findings align with the research of Holland et al., 2010 (Arthur & Doverspike, 1992; Holland et al., 2010) and Özkan & Lajunen, (Özkan & Lajunen, 2005b; Sümer, 2003).

T-LOC AND TRAFFIC OFFENSES

LOC "fate" displayed a significant association with traffic offenses, suggesting that drivers attributing events to external forces are more likely to engage in offenses. Drivers who find more external causes of RTCs seem to have more traffic offences, which might be explained by the fact that these individuals are less careful and take less actions to prevent RTCs (Montag & Comrey, 1987). However, drivers who were involved in traffic offences may avoid presenting themselves as responsible for RTCs involvement, which may have led them to attribute road RTCs to external causes when responding to the T-LOC (Arthur & Doverspike, 1992; Holland et al., 2010). In contrast, the LOC "self" factor exhibited a protective effect, indicating that as drivers' internal control perception increases, the odds of committing offenses decrease. However, LOC "other drivers" and "vehicle/environment" did not show significant associations with traffic offenses, suggesting that the impact of these external factors on traffic violations might be less pronounced in this context. These nuanced findings highlight the need for a comprehensive understanding of the interplay between individual characteristics, driving behaviours, and external influences in the context of traffic offenses.

IMPLICATIONS AND FUTURE DIRECTIONS

The findings of this study carry significant implications for traffic safety initiatives and policies, not only within Lebanon but also across Arabic-speaking nations. These insights offer valuable guidance for policymakers, educators, and safety advocates, emphasizing the necessity of targeted interventions. As for DBQ, the findings emphasize the critical role of aberrant driving behaviours, specifically aggressive and ordinary violations, in increasing the likelihood of RTCs. Effective countermeasures targeting aberrant driver behaviour, such as stringent law enforcement, driver education, booster driving sessions, counselling, and training programs in multifaceted driving situations, are recommended to mitigate driver violations and distractions, thereby reducing their involvement in RTCs. Moreover, the lack of significant effects observed for lapses suggests that momentary lapses in attention may not pose as substantial a risk for RTCs compared to deliberate violations and errors. Therefore, interventions should prioritize addressing deliberate risky behaviour over momentary lapses to achieve maximum impact in reducing RTCs. Further research is warranted to delve deeper into the underlying mechanisms driving the association between occupation and RTC involvement. Understanding how occupation influences driving behaviours and RTC risk can inform targeted interventions tailored to specific occupational groups.

The observed high levels of driving anger among Lebanese drivers underscore the critical necessity for focused interventions to address this issue. One viable approach involves implementing driver educational programs aimed at raising awareness and equipping individuals with coping mechanisms to manage driving-related frustrations. These initiatives could be integrated into driver education courses, emphasizing stress management techniques and conflict resolution skills to empower drivers in navigating anger-inducing scenarios on the road. A systematic review conducted by Faus et al. demonstrated that road safety training programs for adults generally yield mild to moderate effects (Faus, Alonso, Esteban, & Useche, 2022). Notably, their efficacy is significantly enhanced when they focus on improving risk perception and decision-making abilities rather than solely imparting driving skills.

Concerted efforts should be directed towards enhancing traffic infrastructure and enforcement measures to mitigate factors contributing to driving anger, such as congestion, inadequate signage, and reckless driving behaviours, and to deter aggressive driving behaviours while ensuring compliance with traffic regulations. Investing in road safety initiatives can contribute to alleviating frustrations and fostering safer driving environments. Addressing cultural factors that shape driving behaviour and attitudes towards anger expression is also imperative. This may entail implementing policies aimed at promoting a culture of respect and civility on the roads, encouraging drivers to adopt considerate and cooperative behaviours. Public awareness campaigns, social media outreach, and community engagement endeavours serve as effective tools for fostering positive norms and attitudes towards driving. While research attention to driving anger is increasing, further investigation is needed to deepen our understanding and support intervention planning.

Our study highlights the interest of employing a mixed method, combining qualitative and quantitative approaches, to comprehensively explore the driver anger phenomenon. Longitudinal studies could assess the long-term impact of driving anger on road safety outcomes, such as involvement in RTCs or receiving traffic violations. Qualitative methods, such as in-depth interviews or focus groups, can provide insights into the underlying factors contributing to driving anger. Additionally, future research should aim to include more representative samples of the general driver population, as well as specific groups like the elderly or professional drivers. Although the severity of road rage is increasing in eastern countries, the problem has not yet received sufficient attention. Cross-cultural comparative studies could explore cultural differences in driving anger and identify culturally-specific factors contributing to driving-related frustrations. Objective measures, such as police reports

or insurance records, should be considered to evaluate the effects of driving anger more accurately. Finally, further research focusing on state driving anger is needed to understand the mechanisms underlying anger on the road.

Regarding driver skills results, designing and implementing tailored driver training and education programs should consider factors influencing driving skills, such as gender-specific perceptions and the potential overconfidence of experienced drivers. Long-distance drivers exhibit increased involvement in road traffic crashes, particularly with positive correlations with motor skills, thus interventions could include fatigue management programs. Gender differences in driving skills underscore the need for gender-sensitive interventions, such as targeted educational campaigns. Employing various communication styles and practical exercises accommodates different learning preferences, while diverse role models can challenge stereotypes and inspire confidence. Positive associations between experience, education, and driving skills highlight the benefits of investing in driver education and ongoing professional development. These insights can inform evidence-based policies and programs aimed at promoting safe driving behaviours and reducing road traffic crashes, ultimately saving lives on the roads. Emphasizing the importance of safety skills and continuous learning, even for seasoned drivers, is paramount. Additionally, awareness campaigns addressing gender-based differences in self-assessed driving skills can promote confidence-building in areas where individuals may feel less skilled. Policymakers should also consider the study's findings regarding annual mileage and driver occupation when formulating road safety regulations.

Regarding T-LOC, the findings underscore the need for targeted interventions, particularly for novice drivers, emphasizing the positive impact of developing an internal locus of control on reducing risky driving behaviour. Encouraging an internal locus of control among drivers through educational initiatives could bolster road safety efforts by empowering drivers to make wiser decisions. Public awareness initiatives should underscore the balance between acknowledging external influences and maintaining personal responsibility on the road. The integration of traffic locus of control principles into driver training programs may enhance their effectiveness in instilling safe driving habits. Future research should explore longitudinal studies to untangle causal relationships, develop and assess targeted interventions, compare cross-cultural variations, and explore technological integration for real-time support. Exploring these pathways could deepen our understanding of traffic locus of control and inform discreet, data-driven interventions aimed at curbing road traffic incidents and fostering safer driving environments.

Table 48: Summary of implications and future research of the study

Aspect	Description
Implications	<ul style="list-style-type: none"> - Validation of psychological scales carries significant implications for traffic psychology and road safety - Foundation for understanding driving behaviour, anger triggers, and skills among Lebanese drivers - Practical insights for policymakers, traffic safety professionals, and driving instructors - Facilitating evidence-based interventions to reduce road traffic collisions - Opening avenues for comparative research and cross-cultural studies - Guidance for targeted interventions in Lebanon and Arabic-speaking nations
Future research	<ul style="list-style-type: none"> - Further refinement and adaptation of psychological scales for Lebanese context - Ensuring cultural sensitivity and validity across diverse groups in the Lebanese population - Conducting longitudinal studies to track changes in driving behaviours and road safety measures over time - In-depth exploration of specific driving behaviours and their underlying determinants in Lebanon - Evaluating the effectiveness of evidence-based interventions and policy measures implemented based on research findings - Comparative studies across different countries and cultural contexts to understand variations in driver behaviour and road safety outcomes - Employing a mixed methodology approach to comprehensively explore driver behaviour and driver anger phenomenon - Assessing long-term impact of driving anger on road safety outcomes - Exploring cultural differences in driving anger and identifying culturally-specific factors contributing to driving-related frustrations - Investigating state driving anger and its underlying mechanisms
Social desirability	<ul style="list-style-type: none"> - Incorporating a social desirability scale to assess and mitigate the potential influence of participants' tendencies to provide responses perceived as socially acceptable or desirable - Ensuring the accuracy and reliability of data collected by addressing response biases related to social desirability - Employing strategies to mitigate consistency motif bias and discrepancies between self-reported behaviours and real-world crash data

LIMITATIONS

The study relies solely on self-reported crash data, which may be susceptible to underreporting bias. Drivers may report fewer crashes than they were actually engaged in due to memory lapses, fear of penalties, and social desirability bias. Traffic safety can be better understood with the use of real-world crash data. Therefore, it is essential to investigate the relationships between subjective assessments of human factors and real-world crash data. The scales used present inherent biases due to their reliance on self-reported data, including tendencies for individuals to overestimate their skills, embellish them, and conform to social desirability. In addition to the limitations mentioned the discussion of part I, a significant concern is the "consistency motive" bias, where correlations between self-reported behaviours and RTCs measured concurrently may inflate or create spurious correlations. Strategies to mitigate this bias include correlating with objective criteria, assessing correlations between behaviours of different individuals, and spacing out questionnaire intervals. Additionally, discrepancies exist between zero-order effects and those reported in multivariate analysis, with zero-order correlations often proving stronger predictors of RTCs. Variability in correlations can stem from factors like dichotomization, data transformations, and regression analysis methods. Common scale anchors may introduce bias, potentially leading to spurious correlations between errors and violations in the DBQ.

DISCUSSION AND CONCLUSION

This thesis represents a comprehensive examination of road safety challenges in Lebanon. It combines institutional assessments with road user perspectives alongside studies of individual driving behaviours, providing insights that align with international standards.

SUMMARY OF ACQUIRED KNOWLEDGE

In the comprehensive management analysis, which included a desk review and KIIs, significant challenges in road safety management in Lebanon were identified. These challenges include unclear institutional roles and poor coordination, weak enforcement of traffic laws, legislative gaps, and inconsistent public awareness efforts. The data systems are fragmented, with underreporting and a lack of standardization, while capacity-building programs for professionals and traffic police are insufficient. Post-crash care is underdeveloped, lacking a trauma registry and adequate emergency response coordination. Road infrastructure frequently fails to meet safety standards due to poor maintenance and insufficient safety features. Collaboration among stakeholders is weak, monitoring and evaluation mechanisms are limited, and research on road safety in all its aspects is scarce. Additionally, financial constraints and the absence of dedicated funding streams hinder the implementation of critical road safety initiatives.

In the road users' survey, participants expressed concerns about unsafe infrastructure, inconsistent law enforcement, and a lack of targeted safety education. Across all groups, there was significant dissatisfaction with road safety in Lebanon, ranging from 59% to 85% across the seven road safety components, particularly regarding infrastructure and regulations. Finally, the common concerns highlighted by stakeholders and road users in Lebanon primarily centered on improving infrastructure, enhancing safety measures, and ensuring better road conditions.

The validation of psychometric scales assessing driving behaviour yielded several important findings. All the scales studied were found reliable and valid. The DBQ-L demonstrated good reliability, with Lebanese drivers exhibiting higher aggressive driving scores than drivers from Gulf countries, Europe, and Australia. As for DAS, it showed excellent reliability, with Lebanese drivers reporting higher levels of driving anger compared to drivers in countries like Japan and Germany, with significant anger triggered by hostile gestures, traffic obstruction, and illegal driving. In addition, anger toward illegal driving, slow speeding, and police presence predicted reported RTCs, demonstrating the scale's predictive validity. The

DSI confirmed its reliability, effectively measuring safety and control skills, while the TLOC-A demonstrated good reliability, with moderate correlations between internal and external factors.

The behavioural analysis study revealed gender differences in driving behaviour, anger, and skills. Males were more prone to aggressive and ordinary violations, while younger drivers committed more violations, and older drivers reported more errors. Females exhibited higher anger toward discourtesy, hostile gestures, illegal driving, and traffic obstruction, while males showed greater anger toward police presence. Women rated their safety skills higher but their motor skills lower than men. Professional drivers displayed more violations, likely due to stress, while higher education was associated with fewer violations and errors. Anger from hostile gestures, discourtesy, and other triggers was linked to violations and errors, which correlated strongly with reported RTCs. Men were more involved in RTCs due to riskier behaviours, influenced by skills, gender, experience, education, occupation, and mileage. Better safety skills reduced the risk of being involved in RTCs, while higher motor skills increased RTC likelihood due to overconfidence. An internal LOC reduced risky behaviours, whereas an external LOC and belief in fate increased risks and traffic offenses.

STRENGTHS AND LIMITATIONS

The thesis demonstrates several notable strengths across its two main components, the institutional study and the behavioural analysis. The comprehensive analysis of the institutional, legislative, financial, and infrastructural dimensions of road safety in Lebanon aligns with global road safety objectives, providing critical insights into the institutional and policy gaps that hinder road safety efforts in the country. In-depth semi-structured interviews with key informants, including policymakers, enforcement agencies, and civil society representatives offered diverse perspectives and enriched the understanding of Lebanon's road safety challenges and stakeholder needs. Additionally, the road user survey is the first study to assess Lebanese road users' perspectives and satisfaction with the road safety management system. This survey identified key needs, preferences, and areas of dissatisfaction, providing a baseline for monitoring changes in road safety perceptions and guiding future policy reforms.

The validation of scales allowed adapting and validating internationally recognized traffic psychology tools for use in Lebanon. By employing culturally sensitive measures of driving anger, traffic locus of control, and aberrant driving behaviours, the study addresses key psychological factors influencing road safety. The methods used were appropriate relative to

the available means. The resulting outcome provided, for the first time, valuable psychometric data and validated tools of excellent reliability and cultural relevance to the Arabic-speaking regions.

The behavioural analysis further underscores the thesis's contributions by highlighting significant variations in traffic behaviour across demographic groups. It establishes meaningful associations between psychological constructs, such as driving anger and traffic locus of control, and risky driving behaviour. The study also links these validated scales to RTCs and traffic offenses, advancing the understanding of predictors of risky driving behaviour and crash risk.

Despite these strengths, several limitations must be acknowledged. In the institutional study, resource constraints hindered the depth of data acquisition and consultation with subject-matter experts. The description of collisions and their consequences heavily relied on police data, which may introduce selection bias and inaccuracies due to underreporting or misclassification. Additionally, limited access to critical administrative records prevented a more thorough understanding of policy implementation and enforcement dynamics.

In the key informant interviews with stakeholders, COVID-19 restrictions necessitated online interviews, which compromised the richness of the qualitative data. The descriptive analysis used in the study also limited the depth of the analysis, preventing more advanced inferential findings that could provide deeper insights into the data. For the road user survey, sampling reduced the generalizability of the findings, especially due to the merging of taxi and service drivers. Furthermore, the exclusion of non-Lebanese drivers, such as refugees and migrant workers, missed insights into a key demographic group in Lebanon's road safety landscape.

In the validation of scales, validity testing was limited to construct validity and reliability to internal consistency, with additional testing such as criterion validity still needed. The convenience sampling method, combined with a lack of diversity in the sample, may have reduced the generalizability of the findings across different sociodemographic groups. Moreover, the exclusion of non-Lebanese drivers, such as refugees, led to the non-applicability of the scales to these subgroups. Additionally, the exclusion of this subgroup potentially underestimated the role of contextual factors in road safety outcomes. In the behavioural analysis, convenience sampling, which overrepresented university-educated participants, limited the generalizability of the findings to less educated or rural populations.

Furthermore, the cross-sectional design of the study prevented causal inference about the directionality of relationships between psychological constructs and reported behaviours. The lack of longitudinal data also prevented the ability to determine whether the measured constructs predict future involvement in RTCs or offenses. Although many associations were explored through correlational analyses, the study was limited in its ability to assess mediating relationships between the psychological constructs. Social desirability, memory bias, and reluctance to disclose unsafe behaviours also introduced potential information biases in self-reported responses during the validation phase. Reliance on self-reported RTCs and offense data introduced risks of recall bias, underreporting, and inaccuracies.

Finally, the study did not explore external validation using objective measures of driving behaviour, which could have provided a more robust understanding of real-world driving behaviour. The socio-demographic data may not have captured all potential confounders, such as income level or prior exposure to road safety interventions, which could have influenced driving behaviour, leading to residual confounding despite the use of multivariable analyses.

IMPLICATIONS

POLICY, GOVERNANCE AND PUBLIC HEALTH IMPLICATIONS

The findings of this thesis offer a solid foundation for exploring the development of evidence-based policies. For example, the study advocates stricter enforcement measures. It also highlights the need for urban planning reforms that prioritize road safety and proposes improvements to the trauma care system, ensuring that victims of RTCs receive timely and adequate medical attention. The thesis also underscores the importance of strengthening institutional frameworks and enhancing interdepartmental collaboration. Effective road safety management requires coordination across various sectors. By fostering interagency cooperation and providing continuous professional development, Lebanon could build the capacity needed for sustainable improvements in road safety. Finally, a key recommendation from this thesis is the establishment of culturally relevant communication strategies. These strategies should aim to harmonize efforts and address common misconceptions about road safety and driving practices, fostering a culture of safety among road users.

To move forward, it is crucial to form a taskforce operating within the framework of the National Secretariat for Road Safety. This taskforce will leverage the existing structure of the Secretariat while addressing operational gaps, ensuring alignment with national and

international road safety goals. Membership would include technical representatives from government agencies, civil society organizations, academia, the private sector, and local authorities, selected through a structured nomination and screening process overseen by the National Council for Road Safety. Chaired by a senior official from the Secretariat, the taskforce should comprise sectoral leads for specialized input and advisory members for external expertise. Its responsibilities would include prioritizing road safety recommendations using a multi-criteria analysis framework, developing a detailed implementation roadmap with timelines and key performance indicators, and monitoring progress through a robust evaluation framework. Meetings could be held bi-monthly or more frequently during critical implementation phases, with clear agendas to ensure focused discussions and timely decision-making. Subcommittees should meet independently as needed to address specific focus areas, such as data system integration, educational campaigns, and policy reviews, and will report their progress to the main taskforce. A structured communication framework, incorporating digital collaboration platforms, would facilitate efficient coordination among members, enabling document sharing, progress tracking, and real-time updates. Additionally, the taskforce should leverage expert consultations and capacity-building initiatives to enhance its effectiveness. By integrating its activities with the directorates for engineering, education, and enforcement, as well as the National Observatory for Mobility and Road Safety, the taskforce would ensure a coordinated, data-driven approach to improving road safety outcomes. This initiative aims to foster multi-sectoral collaboration, prioritize evidence-based interventions, and achieve measurable reductions in road traffic injuries and fatalities.

RESEARCH IMPLICATIONS

To further refine the proposed interventions and enhance the evidence required to base decisions, complementary studies should be undertaken:

To complement the SWOT analysis used for the evaluation of the pilot RTI surveillance system in the Bekaa (Appendix 11), an evaluation based on the CDC guidelines is needed to ensure effectiveness, scalability, and alignment with global best practices. Key evaluation criteria include data quality (accuracy, completeness, timeliness, specificity, sensitivity, consistency), operational efficiency (integration, scalability, and ease of use), and practicality (geographical coverage and cost-effectiveness). These criteria will benchmark the system's performance against global best practices, enabling a comprehensive gap analysis to identify areas for improvement while leveraging local strengths and opportunities. The analysis would also ensure the system meets core surveillance standards, such as robust data collection,

integration capabilities, ethical adherence, and usability, providing a roadmap for national scalability and alignment with international frameworks.

Establishing an integrated data system: This should begin with creating a multidisciplinary data taskforce comprising representatives from all data sources and stakeholders. The taskforce's would lead the development of an integrated RTC data system in Lebanon. This involves a four-stage process aimed at developing a comprehensive framework. The first stage focuses on preliminary conceptualization, involving a situational analysis and extensive literature review of national and international RTC data systems, to identify effective practices and key features for integration. The situational analysis aims to evaluate the strengths and weaknesses of existing systems using WHO and CDC guidelines, in collaboration with key stakeholders. This analysis includes stakeholder mapping to identify roles, attitudes, and participation levels, emphasizing the critical contributions of data collectors, managers, and users. A comprehensive assessment of data sources examines quality, coverage, formats, accuracy, completeness, and timeliness across data sources, while an end-user needs assessment focuses on accessibility and usability of road safety information. Additionally, an environmental analysis reviews political support, policies, and departmental roles to address deficiencies and advocate for improvements. In the second stage, the system's characteristics are evaluated against the SMART criteria—specificity, measurability, achievable, realistic, and time bounded—grouping them into data quality, operational, and practical categories. The third stage utilizes a Modified Delphi method to gather expert judgments, facilitating a consensus on the system's core features through structured, anonymous feedback rounds. Finally, the fourth stage establishes a rating system for the system's characteristics, ensuring alignment with international standards, local requirements, ethical protocols, and robust data security measures. External reviewers from diverse disciplines would validate and refine the conceptual model, encompassing aims, data components, and an organizational matrix, to ensure its effectiveness and applicability (Appendix 12). Following the assessment, the taskforce would develop a standardized framework for data collection, ensuring compatibility across sectors and alignment with international best practices. Real-time data collection tools should be integrated to enhance accuracy and timeliness. The taskforce would also oversee the development of a centralized digital platform to consolidate, manage, and analyse data, incorporating advanced analytics to generate actionable insights. This initiative would not only improve data quality but also foster collaboration between stakeholders, paving the way for evidence-based interventions to enhance road safety outcomes.

Study on driver behaviour using enhanced methods

To address the limitations of the study presented in this thesis, a new investigation into driver behaviour is proposed, employing a more comprehensive, multi-method approach to analyze the relationship between driving behaviours and road safety outcomes. This study would involve recruiting a diverse, representative sample of drivers across various demographics, with a particular focus on subgroups such as young drivers, refugees, and migrant workers. A stratified cluster sampling approach would be utilized by first identifying communities from a list compiled through the Lebanese Central Administration of Statistics; the identified communities would include local clusters of drivers. These clusters could be based on various factors, such as geographic regions, specific populations or even different road types. Within each selected cluster, participants will be randomly chosen to ensure that different socio-economic and demographic groups are well represented. This method enables efficient data collection when it is difficult to sample the entire population, allowing for a more manageable and cost-effective study design while still ensuring diversity across the sample.

The proposed study would use direct observations of drivers in real-world settings to capture risky behaviours, supplemented by self-reported surveys and validated psychometric scales. The validation of these psychometric scales will incorporate criterion validity to ensure their predictive utility across diverse sociodemographic groups. Contextual factors such as income level, regional differences, and prior exposure to road safety interventions would also be considered. Objective measures, such as in-vehicle monitoring systems or driving simulators, would be integrated to cross-validate self-reported data and provide a more accurate depiction of real-world driving behaviours. Additionally, official RTC and traffic offense data would be collected and triangulated with survey and observational data to validate findings. Advanced inferential techniques, including structural equation modelling, would be employed to explore mediating relationships between psychological factors and risky driving behaviours.

Moreover, validation of additional international scales, such as the Driving Anger Expression Inventory and the Positive Driver Behaviour Scale, would involve incorporating mechanisms to measure and account for social desirability bias in self-reported data. This will include using the Social Desirability Scale, enhancing the accuracy and reliability of the self-reported data. Comparative studies would be conducted between Lebanon and other regions to investigate how cultural differences influence driving behaviour. These studies would help assess whether cultural factors, such as societal attitudes toward road safety, driving norms, and enforcement of traffic laws, significantly impact driving behaviour and, consequently, road safety outcomes.

CONCLUSION

This thesis has provided a comprehensive, evidence-based approach to understanding Lebanon's road safety challenges. It advocates for a phased, sustainable framework that integrates enforcement, infrastructure improvements, and public awareness with medium- and long-term efforts to enhance data systems, build institutional capacity, and secure funding. The validated tools offer practical applications for targeted interventions and support cross-cultural research that fosters global road safety collaboration. The findings call for immediate prioritization of road safety within national agendas, with stakeholders—including policymakers, law enforcement, and the public—working collaboratively to implement the recommended interventions. By adopting this framework, Lebanon could reduce the public health burden of RTCs and establish a model for sustainable road safety initiatives in similar socio-economic contexts.

PERSONAL CONCLUSION

My Ph.D. journey has been an extraordinary odyssey, a profound intersection of academic challenges and life-altering personal experiences that have profoundly shaped my resilience and determination. Within the rigorous confines of doctoral research, an unexpected sequence of significant life events unfolded, leaving an indelible mark on my trajectory.

Set against the backdrop of a severe economic crisis, further compounded by the lack of any scholarship and the concurrent devaluation of my salary, my academic pursuit gained layers of complexity. These trials necessitated a blend of resourcefulness and financial acumen, compelling me to devise innovative solutions to navigate the labyrinth of financial uncertainties and constraints. This experience imparted a keen understanding of meticulous financial planning and instilled within me a profound appreciation for the value of every hard-earned dollar.

Moreover, my role as a caregiver during my mother's haemorrhagic stroke marked one of the most emotionally taxing chapters of my journey. It demanded not just physical, financial and logistical flexibility but, more significantly, an unwavering capacity for empathy. The delicate juggling act of balancing caregiving with work and academic responsibilities tested my resilience and adaptability to their limits.

Amidst these challenging personal trials, my Ph.D. studies emerged as an island of solace and motivation. They bestowed upon me a sense of purpose and a meticulously structured routine

that offered sanctuary amidst the tumultuous uncertainties of life. Each research milestone achieved during this period became a poignant symbol of my strength and determination in the face of adversity.

This extraordinary journey has transformed me into a more resilient, empathetic, and adaptable individual. It has perpetually underlined the paramount importance of unwavering perseverance and the innate human ability to discover silver linings even in the darkest of times. As I approach the culmination of this profound journey, I carry with me not just a thesis but a profound sense of personal growth and an unshakable conviction in my ability to overcome life's most formidable challenges while wholeheartedly pursuing my academic and personal aspirations.

DECLARATION OF USE OF ARTIFICIAL INTELLIGENCE (AI) TOOLS

In my PhD thesis, I utilized AI-assisted technologies during the writing process exclusively to enhance the readability and clarity of the manuscript. These tools were employed under strict human oversight, with all AI-generated outputs thoroughly reviewed, edited, and verified for accuracy and relevance to ensure the work's integrity.

The use of AI was confined to language refinement and did not influence the research content, data analysis, or insights. In adherence to ethical guidelines, AI technologies were not listed as authors or co-authors, nor were they attributed responsibilities beyond their scope.

This approach aligns with the principles of transparency and accountability in scientific writing, as I, the sole author, retain full responsibility for the manuscript's originality, accuracy, and compliance with ethical publishing standards.

REFERENCES

- Aalek, H. (2009). Un an en moins pour resoudre le probleme de la circulation (en Arabe). *Al-Akhbar*.
- Abdelrahman, A., Abu-Ali, N., & Hassanein, H. S. (2018). *On the effect of traffic and road conditions on the drivers' behavior: A statistical analysis*. Paper presented at the 2018 14th International Wireless Communications & Mobile Computing Conference (IWCMC).

- Aberg, L., & Rimmo, P.-A. (1998). Dimensions of aberrant driver behaviour. *Ergonomics*, 41(1), 39-56.
- Abou Hassan, F. F., Bou Hamdan, M., Ali, F., & Melhem, N. M. (2023). Response to COVID-19 in Lebanon: update, challenges and lessons learned. *Epidemiol Infect*, 151, e23. doi:10.1017/s0950268823000067
- Abounoas, Z., Raphael, W., Badr, Y., Faddoul, R., & Guillaume, A. (2020). Crash data reporting systems in fourteen Arab countries: challenges and improvement. *Archives of transport*, 56(4), 73-88.
- Adamson, K. A., & Prion, S. (2013). Reliability: measuring internal consistency using Cronbach's α . *Clinical simulation in Nursing*, 9(5), e179-e180.
- Aeron-Thomas A, Jacobs GD, Sexton B, G, G., & Rahman F. (2004). *The Impact of Crashes on the Poor*. Retrieved from Crowthorne:
- af Wåhlberg, A. E. (2010). Social desirability effects in driver behavior inventories. *Journal of Safety Research*, 41(2), 99-106. doi:<https://doi.org/10.1016/j.jsr.2010.02.005>
- af Wåhlberg, A. E., Dorn, L., & Kline, T. (2010). The effect of social desirability on self reported and recorded road traffic accidents. *Transportation Research Part F: Traffic Psychology and Behaviour*, 13(2), 106-114. doi:<https://doi.org/10.1016/j.trf.2009.11.004>
- Al-Hajj, S., Chahrour, M. A., Nasrallah, A. A., Hamed, L., & Pike, I. (2021). Physical trauma and injury: A multi-center study comparing local residents and refugees in Lebanon. *Journal of global health*, 11.
- Al-Hajj, S., Ghamlouche, L., Nasser AlDeen, K., & El Sayed, M. (2023). Beirut Blast: The Experiences of Acute Care Hospitals. *Disaster Med Public Health Prep*, 17, e318. doi:10.1017/dmp.2022.288
- Al-Hajj, S., Moustafa, M., El Hechi, M., Chahrour, M. A., Nasrallah, A. A., & Kaafarani, H. (2023). Physical injuries and burns among refugees in Lebanon: implications for programs and policies. *Conflict and Health*, 17(1), 42. doi:10.1186/s13031-023-00539-4
- Al-Shaar, W., & Bonin, O. (2021). Factors behind the dynamics of land use evolution: case of Lebanon. *SN Applied Sciences*, 3(6), 677.
- Aldridge, V. K., Dovey, T. M., & Wade, A. (2017). Assessing test-retest reliability of psychological measures. *European Psychologist*.
- AlKetbi, L. M. B., Grivna, M., & Al Dhaheri, S. (2020). Risky driving behaviour in Abu Dhabi, United Arab Emirates: a cross-sectional, survey-based study. *BMC Public Health*, 20, 1-11.
- Alper, S., & Özkan, T. (2015). Do internals speed less and externals speed more to cope with the death anxiety? *Transportation Research Part F: Traffic Psychology and Behaviour*, 32, 68-77. doi:<https://doi.org/10.1016/j.trf.2015.05.002>
- Aluja, A., Balada, F., García, O., & García, L. F. (2023). Psychological predictors of risky driving: the role of age, gender, personality traits (Zuckerman's and Gray's models), and decision-making styles. *Front Psychol*, 14, 1058927. doi:10.3389/fpsyg.2023.1058927
- Arnoldo, T., & Víctor, C.-V. (2015). Effect size, confidence intervals and statistical power in psychological research. *Psychology in Russia: State of the art*, 8(3), 27-46.
- Arthur, W., & Doverspike, D. (1992). Locus of control and auditory selective attention as predictors of driving accident involvement: A comparative longitudinal investigation. *Journal of Safety Research*, 23(2), 73-80. doi:[https://doi.org/10.1016/0022-4375\(92\)90023-3](https://doi.org/10.1016/0022-4375(92)90023-3)
- Atombo, C., Wu, C., Zhong, M., & Zhang, H. (2016). Investigating the motivational factors influencing drivers intentions to unsafe driving behaviours: Speeding and overtaking

- violations. *Transportation Research Part F: Traffic Psychology and Behaviour*, 43, 104-121. doi:<https://doi.org/10.1016/j.trf.2016.09.029>
- Ayre, C., & Scally, A. J. (2014). Critical Values for Lawshe's Content Validity Ratio. *Measurement and Evaluation in Counseling and Development*, 47(1), 79-86. doi:10.1177/0748175613513808
- Baaj, M. H. (2002). Restructuring the Lebanese Railway and Public Transport Authority (RPTA): From losing operator to effective regulator. *Transport Reviews*, 22(1), 103-113.
- Bachoo, S., Bhagwanjee, A., & Govender, K. (2013). The influence of anger, impulsivity, sensation seeking and driver attitudes on risky driving behaviour among post-graduate university students in Durban, South Africa. *Accident Analysis Prevention*, 55, 67-76.
- Banstola, A., & Mytton, J. (2017). Cost-effectiveness of interventions to prevent road traffic injuries in low-and middle-income countries: A literature review. *Traffic Inj Prev*, 18(4), 357-362.
- Baroud, M. (2017). Improving healthcare access for persons with disabilities in Lebanon: together for justice in service provision. *Beirut: AUB Policy Institute*.
- Bazzaz, M. M., Zarifian, A., Emadzadeh, M., & Vakili, V. (2015). Driving behaviors in Iran: a descriptive study among drivers of Mashhad City in 2014. *Global journal of health science*, 7(7), 39.
- Beaton, D. E., Bombardier, C., Guillemin, F., & Ferraz, M. B. (2000). Guidelines for the process of cross-cultural adaptation of self-report measures. *Spine (Phila Pa 1976)*, 25(24), 3186-3191. doi:10.1097/00007632-200012150-00014
- Behnood, A., & Mannering, F. L. (2017). The effects of drug and alcohol consumption on driver injury severities in single-vehicle crashes. *Traffic Inj Prev*, 18(5), 456-462. doi:10.1080/15389588.2016.1262540
- Bener, A., Lajunen, T., Özkan, T., & Haigney, D. (2006). The effect of mobile phone use on driving style and driving skills. *International Journal of Crashworthiness*, 11(5), 459-465.
- Bener, A., Özkan, T., & Lajunen, T. (2008). The driver behaviour questionnaire in Arab gulf countries: Qatar and United Arab Emirates. *Accident Analysis & Prevention*, 40(4), 1411-1417.
- Berdoulat, E., Vavassori, D., & Sastre, M. T. M. (2013). Driving anger, emotional and instrumental aggressiveness, and impulsiveness in the prediction of aggressive and transgressive driving. *Accident Analysis Prevention*, 50, 758-767.
- Blanchette, I., & Richards, A. (2010). The influence of affect on higher level cognition: A review of research on interpretation, judgement, decision making and reasoning. *Cognition and Emotion*, 24(4), 561-595. doi:10.1080/02699930903132496
- Bland, J. M., & Altman, D. (1986). Statistical methods for assessing agreement between two methods of clinical measurement. *The lancet*, 327(8476), 307-310.
- Blincoe, L., Miller, T. R., Zaloshnja, E., & Lawrence, B. A. (2015). *The economic and societal impact of motor vehicle crashes, 2010 (Revised)(Report No. DOT HS 812 013)*. Retrieved from Washington, DC: <http://www-nrd.nhtsa.dot.gov/Pubs/812013.pdf>
- Bliss, T., & Breen, J. (2009). *Country guidelines for the conduct of road safety management capacity reviews and the specification of lead agency reforms, investment strategies and safe system projects*. Retrieved from Washington DC 20433.:
- Bliss, T., & Breen, J. (2009). *Implementing the Recommendations of the World Report on Road Traffic Injury Prevention. Country guidelines for the Conduct of Road Safety Management Capacity Reviews and the Specification of Lead Agency Reforms*,

- Investment Strategies and Safe System Projects*. Washington DC.: World Bank Global Road Safety Facility,.
- Blockey, P., & Hartley, L. R. (1995). Aberrant driving behaviour: errors and violations. *Ergonomics*, 38(9), 1759-1771.
- Bolorunduro, O. B., Villegas, C., Oyetunji, T. A., Haut, E. R., Stevens, K. A., Chang, D. C., . . . Haider, A. H. (2011). Validating the Injury Severity Score (ISS) in different populations: ISS predicts mortality better among Hispanics and females. *J Surg Res*, 166(1), 40-44. doi:10.1016/j.jss.2010.04.012
- Bou Sanayeh, E., & El Chamieh, C. (2023). The fragile healthcare system in Lebanon: sounding the alarm about its possible collapse. *Health Economics Review*, 13(1), 21. doi:10.1186/s13561-023-00435-w
- Boulos, T. (2021). *Road traffic safety in Lebanon*. Paper presented at the Euromed transport support project, Beirut, Lebanon.
- Bourrée, F., Michel, P., & Salmi, L. R. (2008). Consensus methods: review of original methods and their main alternatives used in public health. *Revue d'épidémiologie et de sante publique*, 56(6), e13-e21.
- Bowles, S., Cunningham, C. J., Gabriel, M., & Picano, J. (2007). Coaching leaders in middle and executive management: Goals, performance, buy-in. *Leadership & Organization Development Journal*, 28(5), 388-408.
- Brandenburg, S., & Oehl, M. (2021). Driving anger in Germany: Validation of the driving anger scale for German drivers. *Transportation Research Part F: Traffic Psychology and Behaviour*, 81, 317-328. doi:<https://doi.org/10.1016/j.trf.2021.06.006>
- Bronrott, B. (2010). *FMCSA uses of naturalistic driving data*. Paper presented at the Second International Naturalistic Driving Research Symposium, Panel Session: Driving Transportation Policy with Naturalistic Data, September.
- Bujang, M. A., Omar, E. D., Foo, D. H. P., & Hon, Y. K. (2024). Sample size determination for conducting a pilot study to assess reliability of a questionnaire. *Restor Dent Endod*, 49(1), e3. doi:10.5395/rde.2024.49.e3
- Byrne, B. M., & Stewart, S. M. (2006). Teacher's corner: The MACS approach to testing for multigroup invariance of a second-order structure: A walk through the process. *Structural equation modeling*, 13(2), 287-321.
- Carlson, R. V., Boyd, K. M., & Webb, D. J. (2004). The revision of the Declaration of Helsinki: past, present and future. *British journal of clinical pharmacology*, 57(6), 695-713.
- Castillo-Manzano, J. I., Castro-Nuño, M., López-Valpuesta, L., & Pedregal, D. (2019). From legislation to compliance: The power of traffic law enforcement for the case study of Spain. *Transport policy*, 75, 1-9.
- Center of Operational Analysis and Research. (2022). *Conflict analysis-Lebanon-National level*. Retrieved from Cyprus: Available at: <https://coar-global.org/2022/01/14/conflict-analysis-lebanon-national-level/>
- Cestac, J., & Delhomme, P.,. (2012). European road users' risk perception and mobility. The SARTRE 4 survey. . *IFSTTAR*.
- Cestac, J., Paran, F., & Delhomme, P. (2011). Young drivers' sensation seeking, subjective norms, and perceived behavioral control and their roles in predicting speeding intention: How risk-taking motivations evolve with gender and driving experience. *J Safety science*, 49(3), 424-432.
- Chaaban, J., & El Houry, A. (2016). Spotlight on youth in Lebanon. *JBeirut, Lebanon: United Nations Development Programme*.
- Chandran, A., Hyder, A. A., & Peek-Asa, C. (2010). The global burden of unintentional injuries and an agenda for progress. *Epidemiologic reviews*, 32(1), 110-120.

- Chen, S., Kuhn, M., Prettner, K., & Bloom, D. E. (2019). The global macroeconomic burden of road injuries: estimates and projections for 166 countries. *The Lancet Planetary Health*, 3(9), e390-e398.
- Choueiri, E., Choueiri, G., & Choueiri, B. (2007). An overview of road safety in Lebanon with particular attention to non-urban roads. *Advances in transportation studies*, 11, 75-91.
- Choueiri, E., Choueiri, G., & Choueiri, B. (2015). Road safety in Lebanon: magnitude, cost and potential countermeasures. *Advances in transportation studies*(35).
- Claus, B., & Warlop, L. (2022). The Car Cushion Hypothesis: Bigger Cars Lead to More Risk Taking-Evidence from Behavioural Data. *J Consum Policy (Dordr)*, 45(2), 331-342. doi:10.1007/s10603-022-09511-w
- Comrey, A. L., & Lee, H. B. (2013). *A first course in factor analysis*. New York.: Psychology press.
- Council for Development and Reconstruction. (2021). *Environmental and social management framework*. Retrieved from Lebanon: Available at : <https://www.cdr.gov.lb/CDR/media/CDR/StudiesandReports/Roads%20and%20Employment/ESMF.pdf>
- Cronbach, L. J. (1951). Coefficient alpha and the internal structure of tests. *Psychometrika*, 16(3), 297-334. doi:10.1007/BF02310555
- Custer, R. L., Scarcella, J. A., & Stewart, B. R. (1999). The modified Delphi technique-A rotational modification. *ejournal. JVTE v15n2*.
- Damjanović, M., Mičić, S., Matović, B., Jovanović, D., & Bulajić, A. (2022). Differences in Driving Anger among Professional Drivers: A Cross-Cultural Study. *International journal of environmental research and public health*, 19(7), 4168. doi:10.3390/ijerph19074168
- De Cock, K. M., Simone, P. M., Davison, V., & Slutsker, L. (2013). The new global health. *J Emerging Infectious Diseases*, 19(8), 1192.
- De Ona, J., López, G., Mujalli, R., & Calvo, F. J. (2013). Analysis of traffic accidents on rural highways using Latent Class Clustering and Bayesian Networks. *Accident Analysis & Prevention*, 51, 1-10.
- de Winter, J. C., & Dodou, D. (2010). The Driver Behaviour Questionnaire as a predictor of accidents: A meta-analysis. *Journal of safety research*, 41(6), 463-470.
- Deffenbacher, J., Stephens, A., & Sullman, M. J. (2016). Driving anger as a psychological construct: Twenty years of research using the Driving Anger Scale. *Transportation research part F: traffic psychology behaviour*, 42, 236-247.
- Deffenbacher, J. L., Oetting, E. R., & Lynch, R. S. (1994). Development of a driving anger scale. *Psychological reports*, 74(1), 83-91.
- Deffenbacher, J. L., Petrilli, R. T., Lynch, R. S., Oetting, E. R., & Swaim, R. C. (2003). The Driver's Angry Thoughts Questionnaire: A Measure of Angry Cognitions When Driving. *Cognitive Therapy and Research*, 27(4), 383-402. doi:10.1023/A:1025403712897
- Delhomme, P. (1991). Comparing one's driving with others': assessment of abilities and frequency of offences. Evidence for a superior conformity of self-bias? *Accident Analysis Prevention*, 23(6), 493-508.
- Deutsche Presse Agentur. (2007). Background: Facts and figures about 2006 Israel-Hezbollah war [Press release]
- Devi, S. (2020). Lebanon faces humanitarian emergency after blast. *The lancet*, 396(10249), 456.

- Dinh, D., Vu, N., McIlroy, R., Plant, K., & Stanton, N. (2020). Examining the roles of multidimensional fatalism on traffic safety attitudes and pedestrian behaviour. *Safety Science*, 124, 104587.
- Dollard, J., Miller, N. E., Doob, L. W., Mowrer, O. H., & Sears, R. R. (1939). *Frustration and aggression*. New Haven (CT): Yale University Press.
- Doraï, M. K. (2008). *L'exil palestinien au Liban. Le temps des origines (1947-1952)*. Paris (France): Éditions Karthala.
- Doraï, M. K. (2013). Les réfugiés palestiniens du Liban: une géographie de l'exil. [Press release]
- Dorn, L., Stephen, L., af Wählberg, A., & Gandolfi, J. (2010). Development and validation of a self-report measure of bus driver behaviour. *Ergonomics*, 53(12), 1420-1433.
- Doubek, F., Salzmann, F., & de Winter, J. (2021). What makes a good driver on public roads and race tracks? An interview study. *Transportation research part F: traffic psychology behaviour*, 80, 399-423.
- Dragutinovic, N., & Twisk, D. (2006). The effectiveness of road safety education: A literature review. *SWOV Institute for Road Safety Research*.
- Duncan, J., Williams, P., & Brown, I. (1991). Components of driving skill: experience does not mean expertise. *Ergonomics*, 34(7), 919-937.
- environment, M. o. (2011). *Climate change vulnerability and adaptation. Human settlements and infrastructure* Retrieved from Lebanon: Available at :<https://climatechange.moe.gov.lb/viewfile.aspx?id=43>
- European Commission. (2009). *Public consultation of the European Road Safety Action Programme 2011-2020*. Retrieved from Brussels.:
- Farah, K., & Laurent, C. (2021). The excuse is worse than the fault: It's time now to improve road safety in Lebanon. *Case Studies on Transport Policy*, 9(2).
- Faus, M., Alonso, F., Esteban, C., & Useche, S. A. (2022). Are adult driver education programs effective? A Systematic Review of evaluations of accident prevention training courses. *International Journal of Educational Psychology*, 1(1), XX.
- France, G. o. (2007). International conference on Lebanon's reconstruction: The international community's economic aid for Lebanon [Press release]
- Fund, I. M. (2007). Lebanon: Use of Fund Resources: Request for Emergency Post-Conflict Assistance: Staff Report; and Press Release on the Executive Board Discussion
Publisher: International Monetary Fund. ISBN: 9781451822717. ISSN: 1934-7685. Pages: 82. *Volume 2007: Issue 177*.
- Gazder, U. (2021). *Awareness of Vehicle Safety Features and Their Use and Impact on Accidents*. Paper presented at the 2021 Third International Sustainability and Resilience Conference: Climate Change.
- Ghoubaira, J., Diab, M., Nassereldine, H., Tamim, H., Saadeh, S., Price, R., . . . Al-Hajj, S. (2021). Road traffic injury in Lebanon: A prospective study to assess injury characteristics and risk factors. *Health science reports*, 4(4), e396.
- Gielen, A. C., & Sleet, D. (2003). Application of behavior-change theories and methods to injury prevention. *Epidemiologic reviews*, 25(1), 65-76.
- Global Life Partners. (2024). Lebanon: Road Traffic Accidents. Retrieved from <https://www.worldlifeexpectancy.com/lebanon-road-traffic-accidents>
- Global Road Safety Facility. (2009). *Implementing the Recommendations of the World Report on Road Traffic Injury Prevention. Country guidelines for the Conduct of Road Safety Management Capacity Reviews and the Specification of Lead Agency Reforms, Investment Strategies and Safe System* Retrieved from Washington DC:
- Global road safety facility. (2016). Lebanon country profile 2016. Positioning of Lebanon in region

- Global Road Safety Partnership. (2008). *Speed management: a road safety manual for decision-makers and practitioners, Module 1*. Retrieved from Washington (DC):
- Gohlke-Rouhayem, J., Melki, N., & Weinmann, C. D. (2016). *Employment and Labour Market Analysis (ELMA)*. Retrieved from Lebanon:
- Goldenbeld, C., Levelt, P. B. M., & Heidstra, J. (2000). Psychological perspectives on changing driver attitude and behaviour. *Recherche-Transports-Sécurité*, 67, 65-81.
- Gong, Y., Lu, P., & Yang, X. T. (2023). Impact of COVID-19 on traffic safety from the "Lockdown" to the "New Normal": A case study of Utah. *Accid Anal Prev*, 184, 106995. doi:10.1016/j.aap.2023.106995
- González-Iglesias, B., Gómez-Fraguela, J. A., & Luengo-Martín, M. Á. (2012). Driving anger and traffic violations: Gender differences. *J Transportation research part F: traffic psychology behaviour*, 15(4), 404-412.
- Goszczyńska, M., & Roslan, A. (1989). Self-evaluation of drivers' skill: A cross-cultural comparison. *Accident Analysis Prevention*, 21(3), 217-224.
- Gouribhatla, R. P., & Pulugurtha, S. S. (2022). Vehicles, advanced features, driver behavior, and safety: a systematic review of the literature. *Journal of Transportation Technologies*, 12(3), 420-438.
- Graham, D., Glaister, S., & Anderson, R. (2005). The effects of area deprivation on the incidence of child and adult pedestrian casualties in England. *Accident Analysis Prevention*, 37(1), 125-135.
- Gras, M. E., Sullman, M. J., Cunill, M., Planes, M., Aymerich, M., & Font-Mayolas, S. (2006a). Spanish drivers and their aberrant driving behaviours. *Transportation Research Part F: Traffic Psychology and Behaviour*, 9(2), 129-137.
- Gras, M. E., Sullman, M. J., Cunill, M., Planes, M., Aymerich, M., & Font-Mayolas, S. (2006b). Spanish drivers and their aberrant driving behaviours. *Transportation Research Part F: Traffic Psychology and Behaviour*, 9(2), 129-137.
- Greening, L., & Chandler, C. C. (1997). Why It Can't Happen to Me: The Base Rate Matters, But Overestimating Skill Leads to Underestimating Risk 1. *Journal of Applied Social Psychology*, 27(9), 760-780.
- Grimm, M., & Treibich, C. (2010). Socio-economic determinants of road traffic accident fatalities in low and middle income countries. *ISS Working Paper Series/General Series*, 504, 1-44.
- Guastello, S. J., & Guastello, D. D. (1986). The relation between the locus of control construct and involvement in traffic accidents. *The Journal of Psychology: Interdisciplinary and Applied*, 120(3), 293-297. doi:10.1080/00223980.1986.10545255
- Gururaj, G. (2008). Road traffic deaths, injuries and disabilities in India: current scenario. *National Medical Journal of India*, 21(1), 14.
- Haddad, M., Mansour, C., & Stephan, J. (2015). *Unsustainability in emergent systems: A case study of road transport in the Greater Beirut Area*. Paper presented at the 2015 International Conference on Industrial Engineering and Operations Management (IEOM).
- Hadi Baaj, M. (2000). The Public Land Transport Sector in Lebanon. *Journal of Public Transportation*, 3(3), 87-108. doi:<https://doi.org/10.5038/2375-0901.3.3.5>
- Hair, J. (2005). Anderson, RE/Tatham, RL/Black, WC (1998): Multivariate data analysis. *PrenticeYHall, Upper saddle river, NJ*.
- Hamdar, S. H., Qin, L., & Talebpour, A. (2016). Weather and road geometry impact on longitudinal driving behavior: Exploratory analysis using an empirically supported acceleration modeling framework. *Transportation research part C: emerging technologies*, 67, 193-213.

- Harrison, W. A. (2009a). Reliability of the Driver Behaviour Questionnaire in a sample of novice drivers. In (Vol. 13). In Proceedings of the Australasian road safety research, policing and education conference, Monash University: Austroads.
- Harrison, W. A. (2009b). *Reliability of the Driver Behaviour Questionnaire in a sample of novice drivers*. Paper presented at the Proceedings of the Australasian road safety research, policing and education conference.
- Hatakka, M., Keskinen, E., Laapotti, S., Katila, A., & Kiiski, H. (1992). Driver's self confidence-the cause or the effect of mileage [conference abstract]. *Journal of traffic medicine*, 21(Suppl), 313-315.
- Haugbolle, S. (2011). The historiography and the memory of the Lebanese civil war. *Online encyclopedia of mass violence.*, 25, 1-14.
- Hernández-Hernández, A. M., Siqueiros-García, J. M., Robles-Belmont, E., & Gershenson, C. (2019). Anger while driving in Mexico City. *PLoS One*, 14(9), e0223048.
- Hindi, N. (2020). Narrating Beirut Public Spaces Westernization. An urban perspective from the late 19th century. *J Méditerranée. Revue géographique des pays méditerranéens/Journal of Mediterranean geography*(131).
- Hoggan, B. L., & Dollard, M. F. (2007). Effort-reward imbalance at work and driving anger in an Australian community sample: is there a link between work stress and road rage? *Accid Anal Prev*, 39(6), 1286-1295. doi:10.1016/j.aap.2007.03.014
- Holder, Y., Peden, M., Krug, E., Lund, J., Gururaj, G., & Kobusingye, O. (Eds.). (2001). *Injury surveillance guidelines*. Geneva (Switzerland): World Health Organization.
- Holland, C., Geraghty, J., & Shah, K. (2010). Differential moderating effect of locus of control on effect of driving experience in young male and female drivers. *Personality and Individual Differences*, 48, 821-826. doi:10.1016/j.paid.2010.02.003
- Holliman, R., Johnson, J., & Adjei, O. (2006). The objective assessment of international collaboration between pathology laboratories. *Journal of Evaluation in Clinical Practice*, 12(1), 1-7.
- Hussain, B., Miwa, T., Sato, H., & Morikawa, T. (2023). Subjective evaluations of self and others' driving behaviors: A comparative study involving data from drivers in Japan, China, and Vietnam. *Journal of Safety Research*, 84, 316-329. doi:<https://doi.org/10.1016/j.jsr.2022.11.007>
- Hyder, A. A., Hoe, C., Hajar, M., & Peden, M. (2022). The political and social contexts of global road safety: challenges for the next decade. *The lancet*, 400(10346), 127-136.
- Institute, B. R. S. (2014). *Nationale VerkeersONVeiligheidsenquête 2014 (NVOV)*. Retrieved from Belgium:
New Traffic Law 243 (2012).
- Internal Security Forces. (2023). *Road accidents data*. Retrieved from Lebanon:
- International Monetary Fund. (1999). *Back to the Future. Postwar Reconstruction and Stabilization in Lebanon*. Retrieved from Washington DC,:
- International Transport Forum. (2012). *Reporting on serious road traffic casualties: combining and using different data sources to improve understanding of non-fatal road traffic crashes*: IRTAD, International Traffic Safety Data and Analysis Group.
- International Transport Forum. (2022). *The Safe System Approach in Action, Research Report*, . Retrieved from Paris.:
- Investment development authority of Lebanon. (2013). *Tourism fact book. Technical report*. Retrieved from Lebanon: Accessed on <https://investinlebanon.gov.lb/Content/upload>
- iRAP. (2015). *Six year programme improving road safety in Lebanon*. Retrieved from Lebanon: accessed on <https://irap.org/2022/05/six-year-programme-improving-road-safety-in-lebanon/>

- Iversen, H., & Rundmo, T. (2002). Personality, Risky Driving and Accident Involvement Among Norwegian Drivers. *Personality and Individual Differences*, 33, 1251-1263. doi:10.1016/S0191-8869(02)00010-7
- Jacobs, G., Aeron-Thomas, A., & Astrop, A. (2000). Estimating global road fatalities.
- Jafarpour, S., & Rahimi-Movaghar, V. (2014). Determinants of risky driving behavior: a narrative review. *Medical journal of the Islamic Republic of Iran*, 28, 142.
- Jeon, M., Walker, B. N., & Yim, J.-B. (2014). Effects of specific emotions on subjective judgment, driving performance, and perceived workload. *Transportation Research Part F: Traffic Psychology and Behaviour*, 24, 197-209. doi:<https://doi.org/10.1016/j.trf.2014.04.003>
- JUSTICIA. (2023). The National Road Safety Observatory. Road Safety.
- Kapusta, J., & Kalašová, A. (2015). *Motor vehicle safety technologies in relation to the accident rates*. Paper presented at the Tools of Transport Telematics: 15th International Conference on Transport Systems Telematics, TST 2015, Wrocław, Poland, April 15-17, 2015. Selected Papers 15.
- Karrouchi, M., Nasri, I., Rhiat, M., Atmane, I., Hirech, K., Messaoudi, A., . . . Kassmi, K. (2023). Driving behavior assessment: A practical study and technique for detecting a driver's condition and driving style. *Transportation Engineering*, 14, 100217. doi:<https://doi.org/10.1016/j.treng.2023.100217>
- Khawaja, B. (2011). *War and memory: the role of Palestinian refugees in Lebanon*. . Retrieved from Lebanon: https://digitalcommons.macalester.edu/history_honors/13
- Kim, J.-K., Ulfarsson, G. F., Kim, S., & Shankar, V. (2013). Driver-injury severity in single-vehicle crashes in California: a mixed logit analysis of heterogeneity due to age and gender. *Accident Analysis Prevention*, 50, 1073-1081.
- Klaucke, D. N., Buehler, J. W., Thacker, S. B., Parrish, R. G., & Trowbridge, F. L. (1988). *Guidelines for evaluating surveillance systems*. Retrieved from Atlanta:
- Koo, T. K., & Li, M. Y. (2016). A Guideline of Selecting and Reporting Intraclass Correlation Coefficients for Reliability Research. *Journal of Chiropractic Medicine*, 15(2), 155-163. doi:<https://doi.org/10.1016/j.jcm.2016.02.012>
- Kotia, E. W., Edu-Afful, F., & Jun. (2014). The Lebanon-Israel War of 2006: Global Effects and its Aftermath. *J Journal Article*, 11(9), 03am.
- Krayem, H. (1997.). The Lebanese civil war and the Taif Agreement." Conflict resolution in the Arab world: Selected essays (1997): 411-436.
- Krueger Jr, N., & Dickson, P. R. J. D. s. (1994). How believing in ourselves increases risk taking: Perceived self-efficacy and opportunity recognition. 25(3), 385-400.
- Krug, E. (2012). *Decade of action for road safety 2011–2020* (0020-1383). Retrieved from Geneva:
- Labaki, B. (2003). Politiques de l'État et reconstructions: Bilan de la décennie 1991-2001. *Confluences Méditerranée*(4), 37-55.
- Lajunen, T., Corry, A., Summala, H., Hartley, L. J. P., & differences, I. (1998). Cross-cultural differences in drivers' self-assessments of their perceptual-motor and safety skills: Australians and Finns. 24(4), 539-550.
- Lajunen, T., & Parker, D. (2001). Are aggressive people aggressive drivers? A study of the relationship between self-reported general aggressiveness, driver anger and aggressive driving. *Accident Analysis & Prevention*, 33(2), 243-255. doi:[https://doi.org/10.1016/S0001-4575\(00\)00039-7](https://doi.org/10.1016/S0001-4575(00)00039-7)
- Lajunen, T., Parker, D., & Stradling, S. G. (1998). Dimensions of driver anger, aggressive and highway code violations and their mediation by safety orientation in UK drivers. *Transportation Research Part F: Traffic Psychology and Behaviour*, 1(2), 107-121. doi:[https://doi.org/10.1016/S1369-8478\(98\)00009-6](https://doi.org/10.1016/S1369-8478(98)00009-6)

- Lajunen, T., Parker, D., Stradling, S. G. J. T. R. P. F. T. P., & Behaviour. (1998). Dimensions of driver anger, aggressive and highway code violations and their mediation by safety orientation in UK drivers. *1*(2), 107-121.
- Lajunen, T., Parker, D., & Summala, H. (2004). The Manchester driver behaviour questionnaire: a cross-cultural study. *Accident Analysis & Prevention*, *36*(2), 231-238.
- Lajunen, T., Sullman, M. J. M., & Gaygısız, E. (2022). Self-Assessed Driving Skills and Risky Driver Behaviour Among Young Drivers: A Cross-Sectional Study. *Front Psychol*, *13*. doi:10.3389/fpsyg.2022.840269
- Lajunen, T., & Summala, H. (2003). Can we trust self-reports of driving? Effects of impression management on driver behaviour questionnaire responses. *Transportation Research Part F: Traffic Psychology and Behaviour*, *6*(2), 97-107. doi:[https://doi.org/10.1016/S1369-8478\(03\)00008-1](https://doi.org/10.1016/S1369-8478(03)00008-1)
- Lajunen, T., Summala, H. J. P., & differences, i. (1995). Driving experience, personality, and skill and safety-motive dimensions in drivers' self-assessments. *19*(3), 307-318.
- Lajunen, T., Summala, H. J. T. r. p. F. t. p., & behaviour. (2003). Can we trust self-reports of driving? Effects of impression management on driver behaviour questionnaire responses. *6*(2), 97-107.
- Lambert-Bélanger, A., Dubois, S., Weaver, B., Mullen, N., & Bedard, M. (2012). Aggressive driving behaviour in young drivers (aged 16 through 25) involved in fatal crashes. *Journal of Safety Research*, *43*(5-6), 333-338.
- Larsson, P., & Tingvall, C. (2013). *The safe system approach—A road safety strategy based on human factors Principles*. Paper presented at the Engineering Psychology and Cognitive Ergonomics. Applications and Services: 10th International Conference, EPCE 2013, Held as Part of HCI International 2013, Las Vegas, NV, USA, July 21-26, 2013, Proceedings, Part II 10.
- Lawshe, C. H. (1975). A quantitative approach to content validity. *Personnel psychology*, *28*(4), 563-575.
- Lawshe, C. H. J. P. p. (1975). A quantitative approach to content validity. *28*(4), 563-575.
- Lawton, R., Parker, D., Manstead, A. S., & Stradling, S. G. J. J. o. a. s. p. (1997). The role of affect in predicting social behaviors: The case of road traffic violations. *27*(14), 1258-1276.
- LEBANON, U. (2020). SITUATIONAL ANALYSIS ALPHA. Development Pathways 2021. The situation of children and young people in the Lebanese crisis.
- Levenson, H. (1981). Differentiating among internality, powerful others, and chance. *Research with the locus of control construct*, *1*, 15-63.
- Li, F., Yao, X., Jiang, L., & Li, Y. (2014). Driving anger in China: Psychometric properties of the Driving Anger Scale (DAS) and its relationship with aggressive driving. *Personality and Individual Differences*, *68*, 130-135. doi:<https://doi.org/10.1016/j.paid.2014.04.018>
- Li, G., Lai, W., Sui, X., Li, X., Qu, X., Zhang, T., . . . Prevention. (2020). Influence of traffic congestion on driver behavior in post-congestion driving. *141*, 105508.
- Liu, X.-k., Chen, S.-l., Huang, D.-l., Jiang, Z.-s., Jiang, Y.-t., Liang, L.-j., & Qin, L.-l. (2022). The influence of personality and demographic characteristics on aggressive driving behaviors in eastern Chinese drivers. *J Psychology research behavior management*, 193-212.
- Locke, E. A., & Latham, G. P. (1990). *A theory of goal setting & task performance*: Prentice-Hall, Inc.
- Love, S., Truelove, V., Rowland, B., Kannis-Dymand, L., Ross, D., Sullman, M., . . . behaviour. (2023). The antecedents, regulation and maintenance of anger on the road:

- A qualitative investigation on the factors influencing driver anger and aggression. *93*, 118-132.
- Lucidi, F., Girelli, L., Chirico, A., Alivernini, F., Cozzolino, M., Violani, C., & Mallia, L. J. F. i. p. (2019). Personality traits and attitudes toward traffic safety predict risky behavior across young, adult, and older drivers. *10*, 536.
- Lucidi, F., Mallia, L., Lazuras, L., & Violani, C. (2014). Personality and attitudes as predictors of risky driving among older drivers. *Accident Analysis & Prevention*, *72*, 318-324.
- Luszczynska, A., & Schwarzer, R. (2005). The Role of Self-Efficacy in Health Self-Regulation. In *The adaptive self: Personal continuity and intentional self-development*. (pp. 137-152). Ashland, OH, US: Hogrefe & Huber Publishers.
- Lyana Alameddine, Jawhar, S., & Sarah Abdallah. (2021). Lebanon's crushing crisis prevents more and more Lebanese from maintaining their cars. *L'Orient le jour*.
- M Choueiri, E., M Choueiri, G., & M Choueiri, B. (2012). An overview of road safety in Lebanon. *ITE journal*.
- M.Varzi. (2016). Promenade le long des voies ferrees abandonne'es du Liban. .
- MacCallum, R. C., Browne, M. W., & Sugawara, H. M. (1996). Power analysis and determination of sample size for covariance structure modeling. *Psychological methods*, *1*(2), 130.
- Mairean, C., Havarneanu, G., Popusoi, S., & Havarneanu, C. (2017). Traffic locus of control scale – Romanian version: Psychometric properties and relations to the driver's personality, risk perception, and driving behavior. *Transportation Research Part F Traffic Psychology and Behaviour*, *45*, 131–146. doi:10.1016/j.trf.2016.12.008
- Marsh, B., Lautner, B., Fournier, L., Klang, J., Anelli, P., Kang, W.-E., . . . Cota, K. (2017). The Role of Road Engineering in Combatting Driver Distraction and Fatigue Road Safety Risks.
- Martin, A., Lagarde, E., & Salmi, L. R. J. T. i. p. (2018). Burden of road traffic injuries related to delays in implementing safety belt laws in low-and lower-middle-income countries. *19*(sup1), S1-S6.
- Martinussen, L. M., Hakamies-Blomqvist, L., Møller, M., Özkan, T., & Lajunen, T. (2013). Age, gender, mileage and the DBQ: The validity of the Driver Behavior Questionnaire in different driver groups. *Accident Analysis & Prevention*, *52*, 228-236.
- Martinussen, L. M., Møller, M., & Prato, C. G. (2014). Assessing the relationship between the Driver Behavior Questionnaire and the Driver Skill Inventory: Revealing sub-groups of drivers. *Transportation research part F: traffic psychology behaviour*, *26*, 82-91.
- Mattsson, M. (2012). Investigating the factorial invariance of the 28-item DBQ across genders and age groups: an exploratory structural equation modeling study. *Accident Analysis & Prevention*, *48*, 379-396.
- Mattsson, M., O'Brien, F., Lajunen, T., Gormley, M., & Summala, H. (2015). Measurement invariance of the Driver Behavior Questionnaire across samples of young drivers from Finland and Ireland. *Accident Analysis & Prevention*, *78*, 185-200.
- Mayhew, D. R., Simpson, H. M., Williams, A. F., & Ferguson, S. A. J. J. o. p. h. p. (1998). Effectiveness and role of driver education and training in a graduated licensing system. *19*, 51-67.
- McCarty, D., & Kim, H. W. (2024). Risky behaviors and road safety: An exploration of age and gender influences on road accident rates. *PLoS One*, *19*(1), e0296663. doi:10.1371/journal.pone.0296663
- McInerney, R., TURNER, B., & Smith, G. (2010). *A world free of high risk roads*. Paper presented at the ARRB Conference, 24th, 2010ARRB.

- McLinton, S. S., & Dollard, M. F. (2010). Work stress and driving anger in Japan. *Accident Analysis & Prevention*, 42(1), 174-181. doi:<https://doi.org/10.1016/j.aap.2009.07.016>
- McPherson, J. I. J. D., & rehabilitation. (2019). Traumatic brain injury among refugees and asylum seekers. *41*(10), 1238-1242.
- Meesmann, U., Boets, S., & Silverans, P. (2014). *Appendix Methodology & Questionnaire - Results of the BIVV/IBSR three-yearly road safety attitude survey*. Retrieved from Brussels, Belgium: <https://www.vias.be/en/research/notre-publications/bijlage-methodologie-en-vragenlijst/>
- Merat, N., & Jamson, A. H. (2013). The effect of three low-cost engineering treatments on driver fatigue: A driving simulator study. *J Accident Analysis Prevention*, 50, 8-15.
- Mesken, J., Lajunen, T., & Summala, H. (2002). Interpersonal violations, speeding violations and their relation to accident involvement in Finland. *Ergonomics*, 45(7), 469-483.
- Ministry of Environment. (2012). *Lebanon: Technology Needs Assessment for Climate Change*. Retrieved from Beirut: Available from: <https://climatechange.moe.gov.lb/viewfile.aspx?id=150>
- Ministry of Environment. (2015). *National greenhouse gas inventory report and mitigation analysis*. Retrieved from Lebanon:
- Ministry of Environment/LEDO. (2001). Lebanon State of the Environment Report
- Mishra, P., Pandey, C. M., Singh, U., Gupta, A., Sahu, C., & Keshri, A. J. A. o. c. a. (2019). Descriptive statistics and normality tests for statistical data. *22*(1), 67.
- Mitchell, R. J., Williamson, A. M., & O'Connor, R. (2009). The development of an evaluation framework for injury surveillance systems. *BMC Public Health*, 9(1), 1-14.
- Mokkink, L. B., Terwee, C. B., Knol, D. L., Stratford, P. W., Alonso, J., Patrick, D. L., . . . De Vet, H. C. (2010). The COSMIN checklist for evaluating the methodological quality of studies on measurement properties: a clarification of its content. *BMC medical research methodology*, 10(1), 1-8.
- Montag, I., & Comrey, A. L. (1987). Internality and externality as correlates of involvement in fatal driving accidents. *Journal of Applied Psychology*, 72(3), 339-343. doi:10.1037/0021-9010.72.3.339
- MTC. (2007). MOBILITY: A NATION UNDER SIEGE.
- Municipalities, M. o. I. a. (2015). Vehicle Fleet Database, Beirut: Ministry of Interior and Municipalities.
- National Highway Traffic Safety Administration NHTSA. (2008). National motor vehicle crash causation survey: Report to congress. *811*, 059.
- Nesbit, S., Conger, J., & Conger, A. (2007). A quantitative review of the relationship between anger and aggressive driving. *Aggression and Violent Behavior - AGGRESSIVE VIOLENT BEHAVIOR*, 12, 156-176. doi:10.1016/j.avb.2006.09.003
- Obriot-Claudel, F., & Gabaude, C. (2004). The Driver Behaviour Questionnaire: A French study applied to elderly drivers. *Proceedings of the ICTTP*.
- OECD. (2008). Ambitious road safety targets and the Safe System approach.
- Ogundele, O. J., Ifesanya, A. O., Adeyanju, S. A., & Ogunlade, S. O. (2013). The impact of seat-belts in limiting the severity of injuries in patients presenting to a university hospital in the developing world. *Niger Med J*, 54(1), 17-21. doi:10.4103/0300-1652.108888
- Osman, A. (2014). Lebanese transport: A case study for state planning in weak states. *London school of economics*.
- Ostapczuk, M., Joseph, R., Pufal, J., & Musch, J. (2017). Validation of the German version of the Driver Skill Inventory (DSI) and the Driver Social Desirability Scales (DSDS). *Transportation Research Part F: Traffic Psychology and Behaviour*, 45, 169-182. doi:<https://doi.org/10.1016/j.trf.2016.12.003>

- Özbay, İ. (2017). *The Relationship between the health belief model constructs and driver behaviors: mediating role of driving skills*. Middle East Technical University,
- Özkan, T., & Lajunen, T. (2005a). Multidimensional Traffic Locus of Control Scale (T-LOC): Factor structure and relationship to risky driving. *Personality and Individual Differences*, 38, 533-545. doi:10.1016/j.paid.2004.05.007
- Özkan, T., & Lajunen, T. (2005b). A new addition to DBQ: Positive driver behaviours scale. *Transportation Research Part F: Traffic Psychology and Behaviour*, 8(4-5), 355-368.
- Özkan, T., & Lajunen, T. (2021). From Self-Reports to Auto-Tech-Detect (ATD)-Based Self-Reports in Traffic Research. *International Encyclopedia of Transportation*, 2-7. doi:10.1016/b978-0-08-102671-7.10648-7
- Özkan, T., Lajunen, T., Chliaoutakis, J. E., Parker, D., & Summala, H. (2006a). Cross-cultural differences in driving behaviours: A comparison of six countries. *Transportation Research Part F: Traffic Psychology and Behaviour*, 9(3), 227-242. doi:<https://doi.org/10.1016/j.trf.2006.01.002>
- Özkan, T., Lajunen, T., Chliaoutakis, J. E., Parker, D., & Summala, H. (2006b). Cross-cultural differences in driving skills: A comparison of six countries. 38(5), 1011-1018.
- Özkan, T., Lajunen, T., & Summala, H. (2006). Driver Behaviour Questionnaire: A follow-up study. 38(2), 386-395.
- Özkan, T., & Lajunen, T. J. T. P., European Commission, RISE Programme. (2015). A general traffic (Safety) culture system (G-TraSaCu-S).
- Parker, D., McDonald, L., Rabbitt, P., Sutcliffe, P. J. A. A., & Prevention. (2000). Elderly drivers and their accidents: the Aging Driver Questionnaire. 32(6), 751-759.
- Parker, D., Reason, J. T., Manstead, A. S., & Stradling, S. G. J. E. (1995). Driving errors, driving violations and accident involvement. 38(5), 1036-1048.
- Pearson, M. R., Murphy, E. M., & Doane, A. N. (2013). Impulsivity-like traits and risky driving behaviors among college students. *Accid Anal Prev*, 53, 142-148. doi:10.1016/j.aap.2013.01.009
- Peden. (2005). The world report on road traffic injury prevention: getting public health to do more.
- Peden, M. M. (2004). *World report on road traffic injury prevention*: World Health Organization.
- Perepjolkina, V., & Renge, V. (2011). Drivers' Age, Gender, Driving Experience, and Aggressiveness as Predictors of Aggressive Driving Behaviour. *J Signum Temporis*, 4(1), 62.
- Petridou, E., & Moustaki, M. J. E. j. o. e. (2000). Human factors in the causation of road traffic crashes. 16, 819-826.
- Pinto, M., Cavallo, V., & Ohlmann, T. J. L. t. h. (2008). The development of driving simulators: Toward a multisensory solution. 71(1), 62-95.
- Portney, L. G., & Watkins, M. P. (2009). *Foundations of clinical research: applications to practice* (Vol. 892): Pearson/Prentice Hall Upper Saddle River, NJ.
- Poulter, D. R., & McKenna, F. P. (2010). Evaluating the effectiveness of a road safety education intervention for pre-drivers: An application of the theory of planned behaviour. *J British journal of educational psychology*, 80(2), 163-181.
- Program, U. N. D. (2021). *Lebanon sustainable low-emission transport systems* Retrieved from Lebanon: Available on: <https://www.undp.org/lebanon/projects/lebanon-sustainable-low-emission-transport-systems>
- Programs, U. n. D. (2015). *Technical report, Lebanon. Private Sector Strategy*. Retrieved from Lebanon:

- Przepiora, A., Błachnio, A., & Wiesenthal, D. (2014). The determinants of driving aggression among Polish drivers. *Transportation Research Part F: Traffic Psychology and Behaviour*, 27, 69–80. doi:10.1016/j.trf.2014.09.007
- Radzuan, N. Q., Hassan, M. H. A., Abu Kassim, K. A., Ab. Rashid, A. A., Mohd Razelan, I. S., & Othman, N. A. (2022, 2022//). *The Association of Socio-demographic Characteristics Towards Driver Behaviour and Traffic Fatality in Selangor, Malaysia*. Paper presented at the Human-Centered Technology for a Better Tomorrow, Singapore.
- Razmara, A., Aghamolaei, T., Madani, A., Hosseini, Z., & Zare, S. J. B. p. h. (2018). Prediction of safe driving Behaviours based on health belief model: the case of taxi drivers in Bandar Abbas, Iran. *18*, 1-8.
- Rea, L. M., & Parker, R. A. (2014). *Designing and conducting survey research: A comprehensive guide*. New Jersey: John Wiley & Sons.
- Reason, J., Manstead, A., Stradling, S., Baxter, J., & Campbell, K. (1990). Errors and violations on the roads: a real distinction? *Ergonomics*, 33(10-11), 1315-1332.
- ReliefWeb. (2006). *Lebanon: Infrastructure damage*. Retrieved from Lebanon:
- Riaz, M. S. (2016). *Naturalistic Behaviour Observation of Road Users: A Scoping Review*. Master of Transportation Sciences-Traffic Safety), Universiteit Hasselt ..., Hasselt.
- Rimmö, P.-A. (2002). Aberrant driving behaviour: homogeneity of a four-factor structure in samples differing in age and gender. *Ergonomics*, 45(8), 569-582.
- Rizzo, M., McGehee, D. V., Dawson, J. D., & Anderson, S. N. (2001). Simulated car crashes at intersections in drivers with Alzheimer disease. *J Alzheimer Disease Associated Disorders*, 15(1), 10-20.
- Rossiter, J. R. (2008). Content Validity of Measures of Abstract Constructs in Management and Organizational Research. *British Journal of Management*, 19(4), 380-388. doi:<https://doi.org/10.1111/j.1467-8551.2008.00587.x>
- Rotter, J. B. (1966). Generalized expectancies for internal versus external control of reinforcement. *Psychological Monographs: General and Applied*, 80(1), 1-28. doi:10.1037/h0092976
- Rowe, R., Roman, G. D., McKenna, F. P., Barker, E., & Poulter, D. (2015). Measuring errors and violations on the road: A bifactor modeling approach to the Driver Behavior Questionnaire. *Accident Analysis & Prevention*, 74, 118-125.
- Sagberg, F., Fosser, S., & Saetermo, I. A. (1997). An investigation of behavioural adaptation to airbags and antilock brakes among taxi drivers. *Accid Anal Prev*, 29(3), 293-302. doi:10.1016/s0001-4575(96)00083-8
- Salameh, R. (2022). Behind the numbers: How Lebanon's crisis is felt on the roads. *L'orient le jour*.
- Schermelleh-Engel, K., Moosbrugger, H., & Müller, H. (2003). Evaluating the fit of structural equation models: Tests of significance and descriptive goodness-of-fit measures. *Methods of psychological research online*, 8(2), 23-74.
- Shahin, A., & Mahbod, M. A. (2007). Prioritization of key performance indicators: An integration of analytical hierarchy process and goal setting. *International Journal of Productivity and Performance Management*, 56(3), 226-240.
- Sharkey, S. B., & Sharples, A. Y. (2001). An approach to consensus building using the Delphi technique: developing a learning resource in mental health. *Nurse education today*, 21(5), 398-408.
- Sharma, B. (2007). Preventing injuries by addressing human factors in causation of road traffic crashes. *Indian Journal*.
- Shinar, D. (1998). Aggressive driving: the contribution of the drivers and the situation. *Transportation Research Part F: Traffic Psychology and Behaviour*, 1(2), 137-160.

- Shinar, D., & Compton, R. (2004). Aggressive driving: an observational study of driver, vehicle, and situational variables. *Accident analysis prevention*, 36(3), 429-437.
- Silva Neto, F. V., Harb, J. (2010). *A case study for state planning in weak states*. London.: London school of economics. Recupere sur Impacts of Wars and Terrorism on Tourism in Lebanon. Tech. rep., Modul Vienna University. .
- Smorti, M., & Guarnieri, S. (2016). Do aggressive driving and negative emotional driving mediate the link between impulsiveness and risky driving among young Italian drivers? *The Journal of social psychology*, 156(6), 669-673.
- St-Louis, E., Paradis, T., Landry, T., & Poenaru, D. (2018). Factors contributing to successful trauma registry implementation in low-and middle-income countries: a systematic review. *Injury*, 49(12), 2100-2110.
- Stanojević, P., Jovanović, D., & Lajunen, T. (2013). Influence of traffic enforcement on the attitudes and behavior of drivers. *J Accident Analysis Prevention*, 52, 29-38.
- Stephens, A., & Fitzharris, M. (2016). Validation of the driver behaviour questionnaire in a representative sample of drivers in Australia. *Accident Analysis & Prevention*, 86, 186-198.
- Stephens, A., & Fitzharris, M. (2016). Validation of the driver behaviour questionnaire in a representative sample of drivers in Australia. *Accident Analysis Prevention*, 86, 186-198.
- Stephens, A., Trawley, S., Madigan, R., & Groeger, J. (2013). Drivers Display Anger-Congruent Attention to Potential Traffic Hazards. *Applied Cognitive Psychology*, 27, 178-189. doi:10.1002/acp.2894
- Stephens, A. N., & Groeger, J. (2009). Situational specificity of trait influences on drivers' evaluations and driving behaviour. *Transportation Research Part F: Traffic Psychology and Behaviour*, 12(1), 29-39.
- Stevenson, M., Segui-Gomez, M., Lescohier, I., Di Scala, C., & McDonald-Smith, G. (2001). An overview of the injury severity score and the new injury severity score. *Inj Prev*, 7(1), 10-13. doi:10.1136/ip.7.1.10
- Stewart, B. R., & Bristow, D. H. (1997). Tech Prep Programs: The Role and Essential Elements. *Journal of vocational and technical education*, 13(2), 54-69.
- Sullivan, J. M., Flannagan, M. J., Pradhan, A. K., & Bao, S. (2016). Literature review of behavioral adaptations to advanced driver assistance systems. *AAA Foundation for Traffic Safety*.
- Sullman, M. (2006). Anger amongst New Zealand drivers. *Transportation Research Part F: Traffic Psychology Behaviour*, 9(3), 173-184.
- Sullman, M. J., Stephens, A. N., & Yong, M. (2014). Driving anger in Malaysia. *Accid Anal Prev*, 71, 1-9. doi:10.1016/j.aap.2014.04.019
- Sullman, M. J. M., Gras, M. E., Cunill, M., Planes, M., & Font-Mayolas, S. (2007). Driving anger in Spain. *Personality and Individual Differences*, 42(4), 701-713. doi:<https://doi.org/10.1016/j.paid.2006.08.014>
- Sullman, M. J. M., & Taylor, J. E. (2010). Social desirability and self-reported driving behaviours: Should we be worried? *Transportation Research Part F: Traffic Psychology and Behaviour*, 13(3), 215-221. doi:<https://doi.org/10.1016/j.trf.2010.04.004>
- Sümer, N. (2003). Personality and behavioral predictors of traffic accidents: testing a contextual mediated model. *Accident Analysis & Prevention*, 35(6), 949-964.
- Sümer, N., Özkan, T., & Lajunen, T. (2006). Asymmetric relationship between driving and safety skills. *Accident Analysis Prevention*, 38(4), 703-711.

- Summala, H. (1988). Risk control is not risk adjustment: The zero-risk theory of driver behaviour and its implications. *Ergonomics*, 31(4), 491-506.
- Sun, L., Ma, Y., & Hua, L. (2020). Adaptation and validity of the traffic locus of control scale in Chinese drivers. *Personality and Individual Differences*, 159, 109886. doi:<https://doi.org/10.1016/j.paid.2020.109886>
- T, B., & J, B. (2013). *Road Safety Management Capacity Reviews and Safe System Projects*, . Retrieved from Washington, DC.:
- Tao, D., Zhang, R., & Qu, X. (2017). The role of personality traits and driving experience in self-reported risky driving behaviors and accident risk among Chinese drivers. *J Accident Analysis Prevention*, 99, 228-235.
- Tavafian, S. S., Aghamolaei, T., Gregory, D., & Madani, A. (2011). Prediction of seat belt use among Iranian automobile drivers: application of the theory of planned behavior and the health belief model. *Traffic Inj Prev*, 12(1), 48-53.
- Timmermans, C., Alhajyaseen, W., Reinolsmann, N., Nakamura, H., & Suzuki, K. (2019). Traffic safety culture of professional drivers in the State of Qatar. *J IATSS research*, 43(4), 286-296.
- Tingvall, C., & Haworth, N. (1999). *Vision Zero-An ethical approach to safety and mobility*. Paper presented at the 6th ITE international conference road safety & traffic enforcement: Beyond 2000.
- Tison, J., Chaudhary, N., & Cosgrove, L. (2011). *National phone survey on distracted driving attitudes and behaviors*. Retrieved from United States.:
- Tractinsky, N., Ram, E. S., & Shinar, D. (2013). To call or not to call—That is the question (while driving). *Accident Analysis & Prevention*, 56, 59-70.
- Transport, T. I. A. o. P. (2019). *MENA Transport Report, 2019*. Retrieved from United Arab Emirates: Available from: <https://www.uitp.org/publications/mena-transport-report-2019/>
- UN-HABITAT. (2008). *Country Programme Document 2008-2009 Lebanon*. . Retrieved from Lebanon: Retrieved in December 6, 2010 from : <http://www.unHABITAT.org/pmss/listItemDetails.aspx?publicationID=2706>
- UN-HABITAT. (2021). *Beirut city profile* Retrieved from Lebanon:
- United Nations, D. o. E. a. S. A. U. (2015). *Transforming our world: The 2030 agenda for sustainable development*. Retrieved from Geneva:
- United Nations general assembly resolution. (2001). United Nations general assembly resolution adopted by the general assembly. *Revue internationale de droit pénal*, 72(2001/3), 963-974.
- United Nations High Commissioner for Refugees. (2014). The number of Syrian refugees in Lebanon passes the 1 million mark [Press release]
- United nations high Commissioner for Refugees. (2021). *Update of the Lebanon Crisis Response Plan (LCRP 2017-2021)*. Retrieved from Lebanon: Available : <https://data2.unhcr.org/en/documents/details/85374>
- Van den Berghe, W. (2017). The Association between Road Safety and Socioeconomic Situation (SES) An International Literature Review. *Vias Institute—Knowledge Centre Road Safety*.
- van den Beukel, A. P., van der Voort, M. C., & Eger, A. O. (2016). Supporting the changing driver's task: Exploration of interface designs for supervision and intervention in automated driving. *Transportation Research Part F: Traffic Psychology and Behaviour*, 43, 279-301. doi:<https://doi.org/10.1016/j.trf.2016.09.009>
- van Schagen, I., & Sagberg, F. (2012). The Potential Benefits of Naturalistic Driving for Road Safety Research: Theoretical and Empirical Considerations and Challenges for

- the Future. *Procedia - Social and Behavioral Sciences*, 48, 692-701. doi:<https://doi.org/10.1016/j.sbspro.2012.06.1047>
- Victoir, A., Eertmans, A., Van den Bergh, O., & Van den Broucke, S. (2005). Learning to drive safely: Social-cognitive responses are predictive of performance rated by novice drivers and their instructors. *Transportation Research Part F: Traffic Psychology and Behaviour*, 8(1), 59-74.
- Villieux, A., & Delhomme, P. (2007). Driving Anger Scale, French adaptation: further evidence of reliability and validity. *Percept Mot Skills*, 104(3 Pt 1), 947-957. doi:10.2466/pms.104.3.947-957
- Vos, T., Allen, C., Arora, M., Barber, R. M., Bhutta, Z. A., Brown, A., . . . Chen, A. Z. (2016). Global, regional, and national incidence, prevalence, and years lived with disability for 310 diseases and injuries, 1990–2015: a systematic analysis for the Global Burden of Disease Study 2015. *The lancet*, 388(10053), 1545-1602.
- Waked, A., Afif, C., & Seigneur, C. (2015). Assessment of source contributions to air pollution in Beirut, Lebanon: a comparison of source-based and tracer-based modeling approaches. *J Air Quality, Atmosphere*, 8, 495-505.
- Wang, X., Liu, Y., Wang, J., & Zhang, J. (2019). Study on influencing factors selection of driver's propensity. *Transportation Research Part D: Transport and Environment*, 66, 35-48. doi:<https://doi.org/10.1016/j.trd.2018.06.025>
- Ward, N. J., Finley, K., Otto, J., Kack, D., Gleason, R., & Lonsdale, T. (2020). Traffic safety culture and prosocial driver behavior for safer vehicle-bicyclist interactions. *Journal of Safety Research*, 75, 24-31. doi:<https://doi.org/10.1016/j.jsr.2020.07.003>
- Warner, H. W., Ozkan, T., & Lajunen, T. (2010). Can the traffic locus of control (T-LOC) scale be successfully used to predict Swedish drivers' speeding behaviour? *Accid Anal Prev*, 42(4), 1113-1117. doi:10.1016/j.aap.2009.12.025
- Warner, H. W., Özkan, T., Lajunen, T., & Tzamaloukas, G. (2013). Cross-cultural comparison of driving skills among students in four different countries. *Safety Science*, 57, 69-74.
- Wells, J. K., Williams, A. F., & Farmer, C. (2002). Seat belt use among African Americans, Hispanics, and whites. *Accident Analysis Prevention*, 34(4), 523-529.
- West, R., French, D., Kemp, R., & Elander, J. (1993). Direct observation of driving, self reports of driver behaviour, and accident involvement. *Ergonomics*, 36(5), 557-567.
- Wickens, C. M., Toplak, M. E., & Wiesenthal, D. L. (2008). Cognitive failures as predictors of driving errors, lapses, and violations. *Accident Analysis Prevention*, 40(3), 1223-1233.
- World Bank. (2013a). *Lebanon Economic and Social Impact Assessment of the Syrian Conflict - Executive Summary*. Retrieved from Beirut: : Available from: <https://www.worldbank.org/content/dam/Worldbank/document/MNA/LBN-ESIA%20of%20Syrian%20Conflict-%20EX%20SUMMARY%20ENGLISH.pdf>
- World Bank. (2013b). *Leveraging Global Road Safety Successes*, . Retrieved from Washington, DC:
- World Bank. (2016). *Urban Transport Development Project - Implementation Completion and Results Report*. . Retrieved from Available from: <http://www.databank.com.lb/docs/ICR3868-P034038-Box396273B-PUBLICdisclosed-7-6-16.pdf>
- World Bank. (2017). *The high toll of traffic injuries: unacceptable and preventable*: World Bank.
- World Bank. (2022). *Lebanon Economic Monitor Time for An Equitable Banking Resolution*. Retrieved from Lebanon:

- World Bank. (2023). *Lebanon's Fragile Economy Pulled Back into Recession*. Retrieved from Lebanon: Available : <https://www.worldbank.org/en/news/press-release/2023/12/21/lebanon-s-fragile-economy-pulled-back-into-recession>
- World Health Organization. (2002). Gender and road traffic injuries.
- World Health Organization. (2009). *Global status report on road safety: time for action*. Geneva: World Health Organization,.
- World Health Organization. (2010). *Data systems: a road safety manual for decision-makers and practitioners* (6051496939). Retrieved from Geneva:
- World Health Organization. (2013a). *Global Status Report on Road Safety*. Retrieved from Geneva:
- World health Organization. (2015). *The Global Health Observatory. Vehicles standards*. Retrieved from Geneva: Available from: <https://www.who.int/data/gho/indicator-metadata-registry/imr-details/4652>
- World Health Organization. (2018). *Global Health Estimates*. . Retrieved from Geneva: Available from: http://www.who.int/healthinfo/global_burden_disease/en
- World Health Organization. (2020). *Global Health Estimates 2020: Deaths by Cause*. Retrieved from Geneva:
- World Health Organization. (2021). *Decade of Action for Road Safety 2021–2030*. Retrieved from Geneva:
- World Health Organization. (2022). *Regional approach to the decade of action for road safety 2021-2030*. Retrieved from Geneva:
- World Health Organization. (2023). *Global Status Report on Road Safety* Retrieved from Geneva:
- World Road Association. (2003). *Road safety manual*. Retrieved from <https://roadsafety.piarc.org/en/strategic-global-perspective-scope-road-safety-problem/impact-public-health>
- Xie, C.-q., & Parker, D. (2002). A social psychological approach to driving violations in two Chinese cities. *Transportation Research Part F: Traffic Psychology Behaviour*, 5(4), 293-308.
- Xu, T., Wu, B., Mao, Y., & Zhang, L. (2024). Why is the difference so large in road death rates among countries. *Transportation Engineering*, 16, 100229. doi:<https://doi.org/10.1016/j.treng.2024.100229>
- Yasak, Y., & Esiyok, B. (2009). Anger amongst Turkish drivers: Driving Anger Scale and its adapted, long and short version. *Safety Science*, 47, 138-144. doi:10.1016/j.ssci.2008.02.003
- Yılmaz, Ş., Arslan, B., Öztürk, İ., Özkan, Ö., Özkan, T., & Lajunen, T. (2022). Driver social desirability scale: A Turkish adaptation and examination in the driving context. *Transportation Research Part F: Traffic Psychology and Behaviour*, 84, 53-64. doi:<https://doi.org/10.1016/j.trf.2021.11.009>
- Youssef, D., Salameh, P., Al Shaar, W., Ghosn, N., & Salmi, L.-R. (2024). Exploring characteristics and severity of road traffic injuries in Lebanon using emergency department hospital-based data: the necessity of an integrated surveillance system. *Scientific report*.
- Zhang, T., & Chan, A. H. (2016). The association between driving anger and driving outcomes: A meta-analysis of evidence from the past twenty years. *Accident Analysis Prevention*, 90, 50-62.
- Zhang, T., Chan, A. H., & Zhang, W. (2015). Dimensions of driving anger and their relationships with aberrant driving. *Accident Analysis Prevention*, 81, 124-133.
- Ziad Akl. (2010). Principal Road Safety Actors in Lebanon.

APPENDICES

PUBLICATIONS

PUBLICATIONS RELATED TO MY PHD TOPIC

1. **Youssef D**, Salameh P, Abou-Abbas L, Salmi LR. Driving anger dimensions and their relationship with aberrant driver behavior in Lebanon: Results from a national self-reported survey. **PLoS one**. 2023 Mar 17;18(3):e0283293.
2. **Youssef, D.**, Salameh, P., Abou-Abbas, L. *et al*. Examining self-reported aberrant behavior among Lebanese drivers using the Driver Behavior Questionnaire (DBQ). *Discov Soc Sci Health* 3, 25 (2023). <https://doi.org/10.1007/s44155-023-00056-y>
3. **Youssef D**, Salameh P, Salmi L-R (2024) Exploring the association between the Arabic version of the Traffic Locus of Control, driving behavior, and road traffic crashes: A multidimensional approach. **PLoS ONE** 19(5): e0303518. <https://doi.org/10.1371/journal.pone>
4. **Youssef D**, Salameh P, Salmi LR. Exploring the association between the Arabic version of the Traffic Locus of Control, driving behavior, and road traffic crashes: A multidimensional approach. *PLoS One*. 2024 May 23;19(5):e0303518. doi: 10.1371/journal.pone.0303518. PMID: 38781239; PMCID: PMC11115203.

OTHER PUBLICATIONS DURING MY PHD JOURNEY

1. [Vaccination against influenza among Lebanese health care workers in the era of coronavirus disease 2019.](#)
Youssef D, Berry A, Youssef J, Abou-Abbas L. **BMC Public Health**. 2022 Jan 18;22(1):120. doi: 10.1186/s12889-022-12501-9. PMID: 35039009
2. [Prevalence and correlates of burnout among physicians in a developing country facing multi-layered crises: a cross-sectional study.](#)
Youssef D, Youssef J, Abou-Abbas L, Kawtharani M, Hassan H. **Sci Rep**. 2022 Jul 23;12(1):12615. doi: 10.1038/s41598-022-16095-5. PMID: 35871153 **Free PMC article**.
3. [Practice of non-pharmaceutical interventions against COVID-19 and reduction of the risk of influenza-like illness: a cross-sectional population-based study.](#)

Youssef D, Issa O, Kanso M, Youssef J, Abou-Abbas L, Abboud E. J Pharm Policy Pract. 2022 Aug 30;15(1):54. doi: 10.1186/s40545-022-00450-y. PMID: 36042506 Free PMC article

4. [Feeling the burn in the era of COVID-19: cross-cultural adaptation and validation of the Arabic version of the Copenhagen Burnout Inventory among community pharmacists.](#)

Youssef D, Abou-Abbas L, Youssef J. J Pharm Policy Pract. 2022 Mar 17;15(1):21. doi: 10.1186/s40545-022-00419-x. PMID: 35300730 Free PMC article.

5. [Prevalence and correlates of burnout among Lebanese health care workers during the COVID-19 pandemic: a national cross-sectional survey.](#)

Youssef D, Abboud E, Abou-Abbas L, Hassan H, Youssef J. J Pharm Policy Pract. 2022 Dec 16;15(1):102. doi: 10.1186/s40545-022-00503-2. PMID: 36527056 Free PMC article.

6. [Determinants of acceptance of Coronavirus disease-2019 \(COVID-19\) vaccine among Lebanese health care workers using health belief model.](#)

Youssef D, Abou-Abbas L, Berry A, Youssef J, Hassan H. PLoS One. 2022 Feb 22;17(2):e0264128. doi: 10.1371/journal.pone.0264128. eCollection 2022. PMID: 35192664 Free PMC article.

7. [Converting the existing disease surveillance from a paper-based to an electronic-based system using district health information system \(DHIS-2\) for real-time information: the Lebanese experience.](#)

Youssef D, Yaghi A, Jouny A, Abou-Abbas L, Chammaa H, Ghosn N. BMC Health Serv Res. 2022 Mar 25;22(1):395. doi: 10.1186/s12913-022-07773-1. PMID: 35337327 Free PMC article.

8. [Following the COVID-19 playbook and battling another infodemic: conspiracy beliefs around human monkeypox among the Lebanese population.](#)

Youssef D, Bleibel L, Abboud E. J Pharm Policy Pract. 2023 Jun 13;16(1):72. doi: 10.1186/s40545-023-00580-x. PMID: 37312223 Free PMC article.

9. [Pharmacists as immunizers in Lebanon: a national survey of community pharmacists' willingness and readiness to administer adult immunization.](#)

Youssef D, Abou-Abbas L, Farhat S, Hassan H. Hum Resour Health. 2021 Oct 24;19(1):131. doi: 10.1186/s12960-021-00673-1. PMID: 34689762

10. [Exploring determinants of community pharmacist-led influenza vaccination in a Middle Eastern country: a national web-based cross-sectional study.](#)

Youssef D, Abou-Abbas L, Hassan H. J Pharm Policy Pract. 2021 Sep 20;14(1):77. doi: 10.1186/s40545-021-00367-y. PMID: 34544502 Free PMC article.

11. [Unveiling the unknown: first comprehensive assessment of the knowledge, attitudes and practices of hospital cleaning services staff regarding COVID-19 in Lebanon during the pandemic.](#)

Youssef D, Abou-Abass L, Hassan H. **Arch Public Health.** 2023 Jul 17;81(1):134. /doi: 10.1186/s13690-023-01149-5.PMID: 37461121 **Free PMC article.**

12. [Prevalence and risk factors of burnout among Lebanese community pharmacists in the era of COVID-19 pandemic: results from the first national cross-sectional survey.](#)

Youssef D, Youssef J, Hassan H, Abou-Abbas L.**J Pharm Policy Pract.** 2021 Dec 24;14(1):111. doi: 10.1186/s40545-021-00393-w.PMID: 34952654

13. [When a neglected tropical zoonotic disease emerges in non-endemic countries: need to proactively fill the unveiled knowledge gaps towards human monkeypox among the Lebanese population.](#)

Youssef D, Abboud E, Kawtharani M, Zheim Z, Abou Arrage N, Youssef J.**J Pharm Policy Pract.** 2023 Mar 7;16(1):39. doi: 10.1186/s40545-023-00544-1.PMID: 36882801 **Free PMC article.**

14. [Phased repatriation of Lebanese expatriates stranded abroad during coronavirus disease 2019 \(COVID-19\) pandemic.](#)

Youssef D, Berry A, Ghosn N, Zalzali M, Fadlallah R, Abou-Abbas L, Hassan H .**Arch Public Health.** 2021 Nov 23;79(1):206. doi: 10.1186/s13690-021-00740-y.PMID: 34814944

ARTICLES UNDER REVIEW

1. Barriers to Implementing a Pharmacist-Run Immunization Service, as Perceived by community Pharmacists in a Middle Eastern Country: A cross sectional web-based survey, <https://doi.org/10.21203/rs.3.rs-861898/v1> BMC health services
2. Assessing the Suitability of the Residential Setting for Home Care for Coronavirus Disease 2019 (COVID-19) positive cases, Discover social sciences and health
3. Anger hits the road: Validation and cross-cultural adaptation of the Arabic version of driving anger scale and its association with road traffic crashes and fines. Scientific reports

Pre-print articles

1. Anger hits the road: Validation and cross-cultural adaptation of the Arabic version of driving anger scale and its association with road traffic crashes and fines, Dalal

Youssef, Pascale Salameh, Linda Abou-Abbas et al. 29 September 2022, PREPRINT (Version 1) available at Research Square [<https://doi.org/10.21203/rs.3.rs-1846930/v1>]

2. Exploring characteristics and severity of road traffic injuries in Lebanon using emergency department hospital-based data: the necessity of an integrated surveillance system, Dalal Youssef, Pascale Salameh, Nada Ghosn et al. 12 July 2022, PREPRINT, available at Research Square

COMMUNICATIONS

ORAL PRESENTATION

1. When a neglected tropical zoonotic disease emerges in non-endemic countries: Need to proactively fill the unveiled knowledge gaps towards human monkeypox among the Lebanese population, **Malaysia, International Congress of Infectious diseases, November 2022**
2. Following the COVID19 playbook and battling another infodemic: Conspiracy beliefs around human Monkeypox among the Lebanese population, **World Health Congress, Rome 2023**
3. Integrating the Health Belief model to determine factors associated with COVID-19 Vaccine Acceptance in Lebanon: Differences between health care workers and non-healthcare workers, **IMED 2021, USA**
4. Knowledge, attitudes, and practices among Lebanese Obstetricians and gynecologists toward Coronavirus Disease-2019 (COVID-19) and pregnancy: Emphnet Seventh EMPHNET Regional Conference, **Amman 2021**
5. Public Health system and Management of Non-communicable diseases, FETP cohort 3, level intermediate, Doha, Qatar 2024

POSTER COMMUNICATION

1. Factors associated with COVID-19 Vaccine Acceptance in Lebanon
2. Vaccination des enfants âgés de 5 à 17 ans contre le coronavirus au Liban: Facteurs Influençants et Attitudes Parentales, ADELFF-EPITER, **Limoges, France 2024**

OTHER RESEARCH WORK

- Consultant for the Lebanese Integrated Micronutrient assessment (LIMA 2023), conducted by the Ministry of Public Health, UNICEF, MERCY-USA and American university of Beirut
- Senior assessment officer for the multisectoral needs assessment (MSNA 2022) conducted by REACH (6 months consultancy)
- Consultant for the Outcome Evaluation Study for Reducing Economic Barriers to Accessing Health Services Long Term PHCC Subsidization Protocol II (REBAHS-LPSP II)
- Associate Editor in International Journal of Infectious Diseases

- Editorial member in PLOS One
- Associate member in Inspect Lb: <https://inspect-lb.org/dalal-youssef/>

OTHER ACCOMPLISHMENT

- Appreciation certificate from the minister of Public Health for outstanding performance and exceptional efforts during the response to COVID-19 pandemic in Lebanon.
- Nominated Emerging Leader in International Infectious Diseases by the International Society of Infectious diseases. <https://isid.org/emergingleaders/>.

APPENDICES

APPENDIX 1: LIST OF DOCUMENTS TO BE GATHERED AND REVIEWED DURING DESK REVIEW

- Previous Evaluations/Assessments conducted prior to this research.
- Monitoring Activities Reports.
- Road Safety Policies and Regulations in Lebanon, particularly the traffic law.
- Published Funding Sources and Allocation for Road Safety Initiatives.
- Existing Data Systems for Road Traffic Crashes and Fatalities.
- Infrastructure Assessment Report for Roads and Highways.
- Enforcement Measures Implemented for Road Safety.
- Public Awareness Campaigns and Their Effectiveness.
- Reports on Previous Road Safety Studies or Assessments in Lebanon.
- Statistics on Road Traffic Accidents and Fatalities in Recent Years.
- Road Safety Action Plans or Strategies Implemented by Governmental Bodies.
- International Best Practices in Road Safety Management for Comparative Analysis.

Where to Find this Information:

- **Official Websites of Government Agencies:** Visit websites of government agencies related to transportation and road safety in Lebanon (Ministry of interior and municipalities, Traffic management center, Ministry of Public Health)
- Academic Journals: platforms like Google Scholar, PubMed, or ResearchGate to access research articles, studies, and papers on road safety management in Lebanon.
- Websites of International Organizations such as the World Health Organization (WHO), the World Bank, and the International Road Federation (IRF) for relevant reports, publications, and resources related to road safety in Lebanon.
- Websites of NGOs working on road safety or public health in Lebanon, as they often publish reports, case studies, and best practices related to road safety initiatives.
- Government reports: annual reports, strategic plans, and policy documents released by the Ministry of Interior and Municipalities, Ministry of Public Works and Transport, or other relevant government departments in Lebanon.

APPENDIX 2: LIST OF STAKEHOLDERS PARTICIPATING IN THE KEY INFORMANT INTERVIEWS

Institutions	Number of participants
Directorate General of Internal Security Forces (DGISF)	3
Driving Schools	1
Ministry of Health	1
Ministry of Justice	1
Ministry of Education	1
Research Institutions, Universities	2
Technical Institutes, Vocational Schools	1
Emergency Medical Services (EMS)	1
Civil Defence	1
Hospitals (University-affiliated and non-university)	2
Council for Development and Reconstruction (CDR)	1
NGO responsible for road safety	1
Ministry of Public Works and Transport	1

APPENDIX 3: EMAIL FOR KIIS

Dear Sir/Madam,

This is Dalal Youssef, Manager of the clinical trials program at the Ministry of Public Health in Lebanon. I am currently pursuing my PhD research, focusing on road safety management in Lebanon. Your expertise and insights are highly valued for this study.

You are invited to participate in a project entitled "Assessment of Road Safety Management Situation in Lebanon". The aim of this study is to evaluate the current road safety management situation in Lebanon and identify areas for improvement.

The main objective of this assessment is to analyze the existing road safety policies, regulations, funding, data systems and infrastructure in Lebanon, as well as to assess the effectiveness of enforcement measures and public awareness campaigns in reducing road traffic accidents and fatalities. Your participation in this study is crucial to gather insights and perspectives from key stakeholders involved in road safety management in Lebanon. Your expertise and input will greatly contribute to the development of recommendations for enhancing road safety measures in the country. Please note that your participation in this study is voluntary and you will not receive any payment for your involvement. All data collected will be treated with strict confidentiality and anonymity.

If you agree to participate, please confirm your availability for an interview or meeting at your earliest convenience. Your valuable contribution to this assessment is highly appreciated.

Best Regards,

Dalal Youssef

Ministry of Public Health, Lebanon

النسخة العربية

محتوى البريد الإلكتروني المرسل للمشاركين

سيدي العزيز / سيدتي العزيزة،

كجزء من دراسة الدكتوراه في أنا دلال يوسف، مديرة برنامج التجارب السريرية في وزارة الصحة العامة في لبنان جامعة بوردو الفرنسية حول إدارة السلامة المرورية في لبنان.

أنت مدعو للمشاركة في دراسة بعنوان "تقييم وضع إدارة السلامة المرورية في لبنان". هدف هذه الدراسة هو تقييم الوضع الحالي لإدارة سلامة الطرق في لبنان وتحديد المجالات التي يمكن تحسينها.

الهدف الرئيسي من هذا التقييم هو تحليل السياسات والتشريعات والتمويل ونظم البيانات والبنية التحتية الحالية لسلامة الطرق في لبنان، بالإضافة إلى تقييم فعالية التدابير التنفيذية وحملات التوعية العامة في الحد من حوادث المرور والوفيات.

مشاركتم في هذه الدراسة أمر بالغ الأهمية لجمع وجهات النظر والآراء من الأطراف المعنية الرئيسية في إدارة سلامة الطرق في لبنان. ستسهم خبرتكم ومدخلاتكم بشكل كبير في تطوير التوصيات لتعزيز تدابير سلامة المرورية في

يرجى أخذ العلم أن مشاركتكم في هذه الدراسة طوعية، ولن تتلقوا أي مقابل مادي لمشاركتكم. سيتم التعامل مع جميع لبنان. البيانات المجمعة بسرية تامة وسرية.

يرجى ملاحظة أنك لن تتلقى اي مقابل مادي للمشاركة في هذا المشروع.

سرية المعلومات

ستبقى البيانات التي تم جمعها سرية ومجهولة المصدر.

المشاركة والانسحاب

إذا وافقت طواعية على المشاركة في هذه الدراسة ، فيمكنك تغيير رأيك والانسحاب في أي وقت دون عواقب من أي نوع. لن يترتب على رفض المشاركة أو الانسحاب من المشروع أي عقوبة أو خسارة ، ولن يؤثر ذلك على علاقتكم مع وازرة الصحة العامة. إذا وافقتم على المشاركة، يرجى إعلامنا عندما تكون متاحًا لإجراء مقابلة عن بعد أو اجتماع عبر الانترنت في أقرب وقت ممكن. تقديرنا الكبير لمساهمتم القيمة في هذا التقييم.

دلال يوسف مديرة برنامج التجارب السريرية

وزارة الصحة العامة، لبنان

أطيب التحيات

APPENDIX 4: CONSENT FORM FOR KEY INFORMANT INTERVIEWS

ENGLISH VERSION

We are conducting a situational analysis for Road Safety Management Situation in Lebanon as part of a PhD project in Bordeaux University. If you agree to be part of this study, you will be asked to take part in an interview that will take approximately one hour. At the end of the interview, we will clarify any questions you have and will provide you with an electronic copy of this form for your records.

Purpose of the Study

The goal of this study is to assess the road safety management situation in Lebanon. The objective is to evaluate existing road safety policies, regulations, funding, data systems, infrastructure, enforcement measures, and public awareness campaigns. Your insights will contribute to the improvement of road safety measures in Lebanon.

Interview Process

If you agree to participate, we will ask you some questions about the topics described above. Some questions will be objective, while others will explore your opinions and perspectives. We will only use the information collected for research purposes and will protect your privacy. If you do not want us to record the conversation, please let us know. If you agree, your interview will be audio-recorded with your permission and transcribed.

Confidentiality

The information collected from you will be treated with strict confidentiality. Access to any identifiable information will be restricted to authorized members of the research team and transcription professionals. Your title and institutional affiliation will be recorded but will not be shared with third parties or included in any reports or publications.

Voluntary Participation and Withdrawal

Your participation in this study is voluntary. If you choose to participate, you may withdraw at any time without penalty. Your decision to participate or not will not affect your relationship with any organization involved. You will not be required to answer questions you do not feel comfortable addressing.

Risks and Benefits

Participating in this study may involve privacy risks, but measures are in place to minimize these risks. Your contribution will help improve road safety measures in Lebanon.

By signing below, you confirm that you have been informed about the study and agree to participate.

Signature by the Interviewee:

By signing below, I certify that I have read and understood the information provided and agree to participate in the study.

Signature:

Date:

الملاحق رقم 4: الموافقة المستنيرة للمشاركة في المقابلة

نحن نقوم بدراسة حول الوضع الحالي لإدارة السلامة المرورية في لبنان كجزء من مشروع لحصول على شهادة الدكتوراه في جامعة بوردو. إذا وافقت على أن تكون جزءًا من هذه الدراسة، سيطلب منك المشاركة في مقابلة ستستغرق حوالي ساعة واحدة. في نهاية المقابلة، سنوضح لك أي أسئلة لديك وسنقدم لك نسخة إلكترونية من هذا النموذج للاحتفاظ بها في سجلاتك.

غرض الدراسة

الهدف من هذه الدراسة هو تقييم الوضع الحالي لإدارة السلامة المرورية ويتضمن ذلك القوانين ووالتشريعات، والتمويل، وأنظمة البيانات، والبنية التحتية، وتدابير الإنفاذ، وحملات التوعية العامة. ستساهم مشاركتك بالحصول على فهم معمق للمشكلات وبالتالي اتخاذ التدابير البناءة لتحسين السلامة المرورية في لبنان

عملية إجراء المقابلة

إذا وافقت على المشاركة ، فسنتطرح عليك بعض الأسئلة حول الموضوعات الموضحة أعلاه. ستكون بعض الأسئلة موضوعية ؛ سوف يستكشف الآخرون آرائك ووجهات نظرك. سوف نستخدم المعلومات التي تم جمعها خلال هذه المقابلة فقط للأغراض البحثية المذكورة أعلاه. لن نسجل اسمك أو المسمى الوظيفي أو معلومات الاتصال لحماية خصوصيتك. سيتم إتلاف التسجيل الصوتي بعد نسخ المعلومات التي تشاركها معنا. إذا كنت لا تريد منا تسجيل المحادثة ، فيرجى إخبارنا بذلك. إذا وافقت ، فسيتم تسجيل مقابلتك صوتيًا بعد الحصول على إذن منك ونسخها. إذا أجريت المقابلة عبر الإنترنت ، فقد تكون الكاميرا مغلقة.

سرية المعلومات

سيتم التعامل مع المعلومات التي نجمعها منك بسرية تامة. الوصول إلى أي ملف ستقتصر المعلومات التي يمكن تحديدها على الأعضاء المصرح لهم من فريق البحث والمهنيين المسؤولين عن النسخ. سيتم تسجيل المسمى الوظيفي والانتماء المؤسسي الخاص بك ولكن لن تتم مشاركتها مع أطراف ثالثة ولن يتم تضمينها في أي تقارير أو منشورات.

المخاطر والفوائد

قد تتضمن المخاطر الوحيدة المتعلقة بمشاركتك في هذه الدراسة غزوًا لك الخصوصية من خلال مشاركة المعلومات السرية مع الآخرين. الإجراءات المذكورة أعلاه محاولة للحد من هذه المخاطر. توفر المشاركة في الدراسة فرصة للمساهمة بخبرتك وآرائك ووجهات نظرك في تحسين المشاريع المستقبلية لتحسين السلامة المرورية في لبنان.

بمجرد أن تقرأ (أو تم شرحها لك) المعلومات حول هذا المشروع كما وردت في ورقة المعلومات هذه ، فلا تتردد في طرح أي أسئلة قد تكون لديك. بمجرد الإجابة على هذه الأسئلة بما يرضيك ، يمكنك الموافقة أو رفض المشاركة.

موافقتك تؤكد ما يلي:

تم شرح هذه الدراسة لي.

أنا أتطوع للمشاركة في هذه الدراسة.

توقيع المحاور:

بالتوقيع أدناه ، أقر بأنني قد قرأت ورقة المعلومات هذه لفهم الشخص الذي تمت مقابلاته.
التوقيع:
تاريخ:

APPENDIX 5: KII INTERVIEW GUIDE FOR ROAD SAFETY MANAGEMENT SITUATIONAL ASSESSMENT

English Interview guidelines for key stakeholders involved in road safety management in Lebanon.

General Introduction

Thank you for agreeing to participate in this interview aimed at understanding the road safety institutional management landscape in Lebanon. Your insights as a key stakeholder are invaluable for identifying strengths, challenges, and opportunities in road safety management. The interview will focus on various functions essential for effective road safety management, including coordination, legislation, research and knowledge sharing, monitoring and evaluation, promotion, and resource allocation and funding.

Interviewee information:

1. Can you introduce yourself and describe your current role in road safety institutional management in Lebanon? What are your primary responsibilities within this role?
2. Reflecting on your involvement with road safety initiatives in Lebanon, how would you characterize your experience with managing these functions?
3. Please elaborate on your perspective regarding this experience.
4. Could you share specific aspects or instances that contributed to your positive (or negative) assessment of road safety institutional management functions?

Organizational Structure

1. Structure of road safety management within the institution
2. Clarity of roles and responsibilities
3. Coordination mechanisms between different departments or units
4. Integration of road safety considerations into overall institutional structure and culture.

Policy and legislation

1. Existence and adequacy of road safety policies and laws
2. How would you assess the existing road safety legislation in Lebanon in terms of comprehensiveness and enforcement?
3. What are the major gaps or areas of improvement in road safety laws and regulations?

4. How can legislative measures be strengthened to better address road safety challenges, such as speeding, drunk driving, and seat belt usage?
5. Enforcement mechanisms and compliance levels.
6. Alignment with international standards and conventions
7. What strategies can be employed to enhance the enforcement of road safety laws and ensure compliance among road users?

Training and Capacity Building

1. Availability and effectiveness of training programs
2. Capacity building initiatives for staff at all levels
3. Integration of road safety into broader training agendas
4. Provision of specialized training for road safety professionals

Coordination

1. How would you describe the current level of coordination among road safety stakeholders in Lebanon?
2. What mechanisms or platforms are in place for coordinating road safety efforts among different agencies and organizations?
3. In your opinion, what are the key challenges hindering effective coordination in road safety management?
4. Are there any successful examples of collaboration or coordination initiatives that have yielded positive results in improving road safety?

Collaboration and Partnership

1. Engagement with other government agencies, NGOs, and private sector stakeholders
2. Collaboration on joint projects and initiatives
3. Sharing of best practices and lessons learned
4. Establishment of formal partnerships and agreements.

Research and Knowledge Sharing

1. What role does research play in informing road safety policies and interventions in Lebanon?
2. Are there any notable research initiatives or studies focusing on road safety issues in the country?

3. How is knowledge about effective road safety practices shared among stakeholders in Lebanon?
4. What are the primary barriers to accessing and utilizing research findings in road safety decision-making processes?
5. Monitoring and Evaluation
6. How is the effectiveness of road safety measures currently monitored and evaluated in Lebanon?
7. What indicators or metrics are used to assess the impact of road safety interventions?

Monitoring and evaluation:

1. Are there any challenges or limitations in the current monitoring and evaluation framework for road safety?
2. How can monitoring and evaluation efforts be enhanced to facilitate evidence-based decision-making and resource allocation?

Promotion

1. What initiatives or campaigns are implemented to promote road safety awareness among the Lebanese population?
2. How are different communication channels utilized to reach various target audiences, including drivers, pedestrians, and cyclists?
3. In your opinion, what are the most effective strategies for promoting positive road safety behaviours?
4. How can public engagement and participation be increased in road safety promotion activities?
5. Evaluation of effectiveness of these campaigns?

Resource Allocation and Funding

1. How are resources allocated for road safety initiatives in Lebanon, including infrastructure improvements, enforcement activities, and public awareness campaigns?
2. What challenges exist in securing adequate funding for road safety programs?
3. Are there any alternative funding mechanisms or partnerships that have been successful in supporting road safety efforts?
4. What criteria or priorities guide resource allocation decisions in the context of road safety management?

Infrastructure and Engineering

1. Standards and guidelines for safe road infrastructure.
2. Maintenance practices to ensure safety
3. Integration of safety features into new and existing infrastructure
4. Assessment of infrastructure needs and prioritization of improvements.

Emergency Response

1. Preparedness and response capabilities for RTCs
2. Availability and adequacy of emergency services
3. Coordination with healthcare facilities and law enforcement
4. Training of emergency responders and medical personnel.

Conclusion

Would you like to add anything to this discussion that might be useful for evaluating road safety institutional management in Lebanon, particularly focusing on coordination, legislation, research and knowledge sharing, monitoring and evaluation, promotion, resource allocation, and funding aspects?

Thank you once again for your valuable insights and contributions to the discussion on road safety institutional management in Lebanon. Your perspectives will inform efforts to enhance road safety policies, practices, and collaborations in the country.

APPENDIX 6: THEMATIC ANALYSIS

Theme	Description
Policy and Legislation	Existence and adequacy of road safety policies and laws
	Enforcement mechanisms and compliance levels.
	Integration with national and local regulations
	Alignment with international standards and conventions.
Organizational Structure	Structure of road safety management within the institution
	Clarity of roles and responsibilities
	Coordination mechanisms between different departments or units
	Integration of road safety considerations into overall institutional structure and culture.
Training and Capacity Building	Availability and effectiveness of training programs
	Capacity building initiatives for staff at all levels
	Integration of road safety into broader training agendas
	Provision of specialized training for road safety professionals
Data Collection and Analysis	Systems for collecting, recording, and analyzing road safety data
	Use of data for decision-making and program evaluation
	Quality and reliability of data sources
	Accessibility of data for stakeholders and researchers.
Infrastructure and Engineering	Standards and guidelines for safe road infrastructure.
	Maintenance practices to ensure safety
	Integration of safety features into new and existing infrastructure
	Assessment of infrastructure needs and prioritization of improvements.
Communication and Awareness	Public awareness campaigns and educational initiatives
	Communication strategies for promoting road safety messages
	Engagement with media and stakeholders
	Evaluation of the effectiveness of communication efforts.
Funding and Resource Allocation	Budget allocation for road safety initiatives
	Sources of funding and sustainability of financing
	Resource allocation for specific programs and projects
	Mechanisms for leveraging external funding and partnerships.
Monitoring and Evaluation	mechanisms for monitoring progress and outcomes

	Evaluation of the effectiveness of interventions
	Feedback loops for continuous improvement
	Utilization of performance indicators and benchmarks for Evaluation purposes
Collaboration and Partnership	Engagement with other government agencies, NGOs, and private sector stakeholders
	Collaboration on joint projects and initiatives
	Sharing of best practices and lessons learned
	Establishment of formal partnerships and agreements.
Legislative Compliance	Compliance with national and international road safety regulations
	Monitoring of legislative changes and updates
	Implementation of measures to address non-compliance issues
	Reporting mechanisms for compliance status.
Research and Innovation	Support for research initiatives related to road safety
	Adoption of innovative technologies and practices
	Collaboration with research institutions and academia
	Integration of research findings into policy and practice.
Emergency Response	Preparedness and response capabilities for RTCs
	Availability and adequacy of emergency services
	Coordination with healthcare facilities and law enforcement
	Training of emergency responders and medical personnel.

APPENDIX 7: ROAD USER'S SATISFACTION SURVEY QUESTIONNAIRE

Thank you for participating in our Road User's Satisfaction Survey. Your feedback is invaluable in helping us understand the experiences, preferences, and concerns of road users like yourself. This survey aims to gather insights into various aspects of road usage, safety, infrastructure, and services, with the ultimate goal of enhancing the quality of transportation and improving road user satisfaction. Your participation in this survey will contribute to the development of evidence-based strategies and initiatives aimed at creating safer, more efficient, and more user-friendly road networks. By sharing your opinions and experiences, you play a crucial role in shaping the future of road transportation in our community. The survey consists of a series of questions covering different aspects of road usage and experiences. Your responses will remain anonymous and confidential, and they will be used solely for research and analysis purposes. Your honest feedback is highly appreciated, as it will help us identify areas for improvement and prioritize initiatives that address the needs and concerns of road users. We thank you for taking the time to participate in this survey. Your input is instrumental in our efforts to create a better road environment for everyone. Let's work together to make our roads safer, more accessible, and more enjoyable for all.

Governorate

Road user:

Part I: General information

Gender:

Male

Female

Age Group:

Under 18 years

18-24 years

25-44 years

45-64 years

65 years or older

Occupation:

Liberal professions (e.g., lawyer, doctor, architect)

Civil servants/employees (e.g., government worker, office clerk)

Students/school pupils (e.g., university student, high school student)

Self-employed

Unemployed

Student

Retired

Disabled/Unable to work

Other (please specify)

Place of residence

North

Akkar

Beirut
Mount Lebanon
South
Nabatyeh
Bekaa
Baalbeck-Hermel
Level of Education:
Less than high school
High school diploma
Bachelor's degree or more
Part II: travel pattern
Distance to Travel:
Short (0-5 km)
Medium (5-10 km)
Long (over 10 km)
Main reason for displacement
Work/Commute
School/University
Shopping/Groceries
Social/Recreational
Medical/Healthcare
Personal business
Other
Frequency of travel
Multiple times a day
Daily
Several times a week
Weekly
Monthly
Rarely
Primary Mode of Transportation:
Personal car
Public transport (bus, van)
Bicycle
Walking
Motorbike
Taxi (including Uber)
Truck
Other (please specify)

Difficulties encountered by each category of road users (select one or more options)

For Pedestrians
Lack of sidewalks
Unsafe crossings
Safety concerns (e.g., speeding vehicles, distracted drivers)
Inadequate signage or road markings
Weather conditions (e.g., rain, snow, extreme heat)
Accessibility barriers for individuals with disabilities
Conflicts with other road users (e.g., cyclists, motorists)
Noise pollution
Air pollution
Lack of amenities along the route (e.g., rest areas, restrooms)

Security concerns (e.g., theft, harassment)

For Public transport users:

Public transit delays

Safety concerns (e.g., overcrowding, security issues)

Accessibility barriers for individuals with disabilities

Inadequate service coverage or frequency

Traffic congestion

For Bus/Van Users

Traffic congestion delaying bus/van travel time

Long wait times at bus/vans stops/stations

Overcrowded buses/vans leading to discomfort

Irregular bus/van schedules affecting travel plans

Limited seating availability

Poor air conditioning or ventilation inside the bus/van

Inadequate lighting or visibility at bus stops, especially at night

For Private Car Users

Traffic congestion delaying travel time

Difficulty finding parking spaces, especially in busy areas

Road construction/repairs causing detours or delays

High fuel costs affecting travel affordability

Vehicle breakdowns or mechanical issues

Roadside emergencies (e.g., flat tires, engine overheating)

Poor road conditions (e.g., potholes, uneven surfaces)

Lack of rest areas or amenities along the route

For Taxi Users

Fare disputes or overcharging by taxi drivers

Inconvenience of having to hail taxis on the street

Limited payment options (e.g., cash-only fares)

For trucks drivers

Traffic congestion

Maneuvering large vehicles on narrow roads

Speeding or reckless driving of other drivers

Fatigue/Traffic-related stress

Truck maintenance issues/poor condition of the truck

Dealing with disruptions to transportation schedules

Unfavorable weather conditions

Hazards on the road (potholes...)

Non-compliance of speed bumps with standards

Illegal parking

Inadequate road network

Overloaded vehicles exceeding authorized standards

Lack of clear Lighting and signage

Cyclist

Inadequate Cycling Infrastructure (lack of bike lanes and dedicated paths)

Poor Maintenance of roads (potholes, debris...)

Congested and Chaotic Traffic

Hilly Terrain (Uphill climbs and steep slopes in many areas)

Environmental Factors

Motorists' and pedestrians' lack of awareness of cyclists' rights and safety measures.

Scarcity of secure and convenient bike parking facilities

Road Hazards (Irregular road surfaces, loose gravel, and road construction)

Aggressive Drivers behaviour

Theft and Vandalism

Lack of Cycling Culture

Limited social acceptance and support for cycling as a sustainable mode of transportation.

Motorcycle

Feeling vulnerable on the road due to smaller size and visibility compared to other vehicles.

Weather Conditions

Traffic Congestion

Challenges manoeuvring through congested traffic, finding parking spots, and lane splitting safely in urban areas.

Theft and Security

Lack of licensing procedures, insurance requirements, and safety regulations compliance.

Social Stigma and Perception of other road users

Needs

Truck drivers

Well-maintained infrastructure (free from potholes, cracks, and other hazards)

Clear signage and road markings to navigate safely and make informed decisions

Adequate lighting especially during night time or in poorly lit areas, to improve visibility

Smooth and even road surfaces minimize vibrations and jolts, providing a more comfortable and stable driving experience

Safe parking and rest areas where they can stop, and rest during their journeys.

Road authorities should promptly address any road defects, hazards, or damage to ensure the safety of truck drivers and other road users.

Improving road capacity to accommodate the volume of traffic, minimizing congestion, and RTCs

Truck drivers need access to emergency services, including roadside assistance and medical assistance, in the event of breakdowns, RTC, or other emergencies

Weather monitoring and management

Proper traffic management strategies (lane control, speed enforcement, and intersection management), to regulate traffic flow and reduce the risk of RTC

Training on stress management and defensive driving

Ensuring that trucks are properly maintained and regularly inspected for mechanical issues

Proper training and education for truck drivers

Cyclists'needs

Designated Bike Lanes for cyclists to separate them from motor vehicles

Well-maintained roads with smooth pavement prevent hazards such as potholes that can cause cyclists to lose control.

Clear and visible road markings, especially at intersections and crossings, to help cyclists navigate safely through traffic.

Cyclist-Friendly Infrastructure such as cyclist-friendly traffic signals make the road environment safer and more convenient for cyclists.

Awareness Campaigns that emphasize sharing the road and promoting mutual respect between cyclists and motorists

Traffic Calming Measures to reduce vehicle speeds in areas frequented by cyclists

Visibility Enhancements (adequate lighting, reflective road markings...) to improve visibility for cyclists, especially during low-light conditions or at night.

Protection from Dooring: design features such as buffered bike lanes or separate bike lanes placed to the left of parked cars

Motorcycle

Ensuring that motorcycles are properly maintained and regularly inspected for mechanical issues

Training for motorcycle riders

Access to quality helmets, protective clothing and safety equipment

Awareness about sharing the road safely and promoting mutual respect among all road users.

Clear and visible road markings, especially at intersections and curves

Lane Filtering and Splitting Laws

Motorcycle-Friendly Infrastructure

Designated parking areas equipped with motorcycle racks or spaces help prevent theft and damage to motorcycles while parked.

Smooth pavement free from potholes, cracks, and debris ensures better traction and control for motorcycles

Dedicated Motorcycle Lanes

For Taxi Users

Ensuring that taxis are well-maintained and operated by licensed drivers contributes to a sense of security

Accessible taxis equipped with ramps or lifts cater to passengers with mobility challenges, ensuring inclusivity and convenience for all users

Clear Fare Structure

Taxis to be equipped with safety features such as seatbelts, and airbags to mitigate risks during travel

Courteous and professional behaviour from taxi drivers enhances the overall user experience, fostering trust and reliability

Adherence and compliance of taxi drivers to traffic law

Regular maintenance of the taxi vehicle ensures safe operation and minimizes the risk of breakdowns during service

Comprehensive training programs to equip taxi drivers with the necessary skills and knowledge

Access to GPS navigation systems or mobile apps helps drivers navigate efficiently to their destinations, reducing travel time and improving customer satisfaction

Personal Safety

For Personal Car Users

Driver education programs

Implementing mandatory vehicle inspection programs to ensure that personal cars are well-maintained and meet safety standards

Public awareness campaigns to promote safe driving behaviours

Well-designed roads, intersections, and signage to enhance safety for all road users, including personal car drivers.

Availability of roadside assistance services to provide support in case of vehicle breakdowns or emergencies, helping to reduce the risks associated with stranded motorists.

Engaging local communities in road safety initiatives

Availability of personal safety equipments (seatbelt, airbag...)

For Minibuses and Vans users

Specialized Driver Training: for operators of minibuses and vans

Establishing strict vehicle maintenance standards for minibuses and vans (regular inspections...)

Availability of seatbelts for passengers and enforcing their usage

Educating operators on proper load management practices

Enforcing compliance with passenger safety regulations, including maximum occupancy limits, child restraint requirements...

Policies and procedures to address driver fatigue

Providing operators with tools and resources for route planning and navigation

Equipping minibuses and vans with emergency response kits, communication devices, and first aid supplies

Providing drivers with training on emergency procedures to ensure prompt and effective responses to accidents or medical emergencies.

Adequate insurance coverage for minibus/van and passengers
 Conducting regular inspections and audits to ensure that operators comply with relevant regulations, licensing requirements, and safety standards, and imposing penalties for non-compliance to uphold safety standards and protect passengers.

Pedestrian Needs
 Traffic Calming Measures
 Pedestrian-Friendly Infrastructure
 Curb Ramps
 Sidewalks
 Clear Signage and Wayfinding
 Crosswalks
 Pedestrian Priority Zones
 Adequate Lighting
 Pedestrian Crossings
 Traffic Signals

Part III: HISTORY OF INVOLVEMENT/WITNESS ROAD ACCIDENTS

Previous witnessing of RTC Y/N

Previous experience of RTC Y/N

Reasons for Road Traffic Crashes (RTCs) as Perceived by Road Users

	Witnessed RTCs	Experienced RTCs
--	----------------	------------------

Lack of driver education and training		
Poor road conditions (e.g., potholes, lack of maintenance)		
Inadequate road signage and markings		
Road infrastructure deficiencies (e.g., dangerous curves)		
Reckless driving behaviours (e.g., aggressive overtaking)		
Lack of enforcement of traffic laws and regulations		
Road rage or aggressive behaviour on the road		
Speeding		
Poor visibility (e.g., at night, due to obstructions)		
Fatigue or drowsy driving		
Weather conditions (e.g., rain, fog)		
Inexperienced or unlicensed drivers		

Distracted driving (e.g., mobile phone use)
 Tailgating or following too closely
 Vehicle defects or mechanical failures
 Pedestrian or cyclist negligence
 Driving under the influence of alcohol or drugs
 Wildlife crossing roads

Part IV: Road users satisfaction with the current situation of Road Safety in the country

Please rate your overall satisfaction with the road safety management current situation in Lebanon

Very Dissatisfied Dissatisfied Neutral Satisfied

Please rate your overall satisfaction with the following components of road safety management in Lebanon

Enforcement of traffic law

	Very Dissatisfied	Dissatisfied	Neutral	Satisfied	V. satisfied
Enforcement of Distracted Driving Laws (e.g., mobile phone use while driving)					
Enforcement of Reckless Driving Laws (e.g., aggressive driving, tailgating)					
Enforcement of driving under alcohol					
Enforcement of wearing seatbelts					
Enforcement of refraining from driving under the influence of drugs.					
Enforcement of Vehicle					

Equipment Violations (e.g., broken headlights, faulty brakes)					
Enforcement of traffic signal violations (e.g., illegal lane changes, failure to signal)					
Enforcement of Vehicle Inspection Laws (e.g., ensuring vehicles are roadworthy and meet safety standards)					
Enforcement of Vehicle Registration (e.g., ensuring vehicles are properly registered and licensed)					
Enforcement of Vehicle Weight and Load Limitations (e.g., preventing overloading of vehicles)					
Enforcement of ownership of registration documents					
Enforcement of ownership of mandatory Insurance Certificate					
Enforcement of ownership of vehicle mechanical Inspection Certificate					
Scaled fines					
Enforcement of illegal parking					
Enforcement of obeying speed limit					
Satisfaction about road infrastructure conditions					

Overall satisfaction about road infrastructure condition	Very Dissatisfied	Dissatisfied	Neutral	Satisfied	Very satisfied
	Very Dissatisfied	Dissatisfied	Neutral	Satisfied	Very satisfied
Guardrails and Barriers					
Crash Cushions and Impact Attenuators					
Traffic Cones and Barriers					
Roadside Reflectors and Delineators					
Speed Bumps and Humps					
Pedestrian Crossings and Signals					
Traffic Islands and Median Strips					
Road Maintenance					
Signage and Markings					
Street Lighting					
Satisfaction about road safety promotion	Very Dissatisfied	Dissatisfied	Neutral	Satisfied	Very satisfied

	Very Dissatisfied	Dissatisfied	Neutral	Satisfied	Very satisfied
Effectiveness of Campaigns					
Relevance of Messaging					
Accessibility of Information (e.g., availability of educational materials)					
Frequency and visibility of public awareness campaigns promoting road safety					

Extent of target audience reached by the campaigns					
Impact of road safety campaigns in increasing awareness and knowledge about safe driving practices					
Impact of road safety campaigns on positive change in behaviour among road users					
Adequacy of road safety campaigns in addressing the specific needs and concerns of different road user groups					
Easy to access information about road safety, such as through websites, mobile apps, or community events					
Road Safety Post-Crash and Emergency Response Satisfaction					
Overall satisfaction about Emergency Response Services	Very Dissatisfied	Dissatisfied	Neutral	Satisfied	Very Satisfied
	Very Dissatisfied	Dissatisfied	Neutral	Satisfied	Very Satisfied
Availability of Ambulance Services					
Response Time of Emergency Services					
Quality of Emergency Medical Care					
Access to Emergency Services:					

Communication and coordination	Very Dissatisfied	Dissatisfied	Neutral	Satisfied	Very Satisfied
	Very Dissatisfied	Dissatisfied	Neutral	Satisfied	Very Satisfied
Coordination among Emergency Responders (e.g., ambulance services, police, fire department) during an emergency situation					
How satisfied are you with the coordination and collaboration among different emergency responders ?					

Knowledge and Training of Emergency Personnel responding to road accidents

	Very Dissatisfied	Dissatisfied	Neutral	Satisfied	Very Satisfied
Access to medical care and treatment upon arrival at the hospital following a road accident or medical emergency					
Responsiveness of hospital staff in attending to your medical needs upon arrival					

Reasons for dissatisfaction	
Reasons for dissatisfaction	Yes No
Poor road conditions (potholes, cracks, uneven	

surfaces)		
Limited enforcement of traffic laws and regulations		
Lack of proper pedestrian crossings		
High prevalence of reckless driving behaviours		
High number of road crashes		
Inadequate cycling infrastructure		
Enforcement problems (e.g., corruption, inconsistent enforcement)		
Poor road safety education and awareness among road users		
Inadequate public transportation options and infrastructure		
Traffic congestion and delays		
Noise pollution from traffic		
Insufficient pedestrian facilities (sidewalks, crosswalks)		
Poor road maintenance and slow response to road hazards		
Lack of prioritization due to the		
Lack of political will		
Lack of adequate lighting, especially at night		
Delays in emergency response times		
Lack of road safety culture		
Inadequate signage and road markings		
Air pollution from vehicle emissions		
Driver's licensing or vehicle permits system		
Lack of public sensitization		
Roadside encroachments (e.g., illegal parking, obstructions)		
Unsafe intersections and lack of traffic control		
Lack of accessibility for people with disabilities		
Roadside crime and safety concerns		
Absence of emergency lane		

APPENDIX 8: ROAD USERS SATISFACTION SURVEY-INFORMED CONSENT

Before proceeding with the Road User's Satisfaction Survey, we would like to provide you with some important information about the survey and request your consent to participate.

1. Purpose of the Survey: The Road User's Satisfaction Survey aims to gather feedback from road users like yourself to better understand your experiences, preferences, and concerns regarding road transportation. The information collected will be used for research and analysis purposes to improve road infrastructure, safety measures, and overall satisfaction with road usage.

2. Voluntary Participation: Participation in this survey is entirely voluntary. You are under no obligation to participate, and your decision will not affect your rights or privileges in any way. You may choose to withdraw from the survey at any time without providing a reason.

3. Confidentiality: Your responses to the survey will remain anonymous and confidential. No personally identifiable information will be collected unless you choose to provide it voluntarily. Your responses will be aggregated with those of other participants and reported in a summarized format to ensure anonymity.

4. Use of Data: The data collected from this survey will be used solely for research and analysis purposes. It may be used to inform policy decisions, develop initiatives, or improve road infrastructure and services. Your responses will not be used for any commercial or marketing purposes.

5. Risks and Benefits: Participating in this survey involves minimal risks. You may experience discomfort or inconvenience when answering some questions, but there are no known risks associated with participation. The potential benefits include contributing to the improvement of road transportation and having your voice heard in decision-making processes.

6. Contact Information: If you have any questions or concerns about the survey, you may contact Dalal Youssef at +96171239633. Additionally, if you encounter any technical issues or require assistance while completing the survey, please don't hesitate to reach out for support.

By proceeding with the survey, you indicate that you have read and understood the information provided above, and you voluntarily consent to participate in the Road User's Satisfaction Survey.

Thank you for your participation and contribution to improving road transportation for everyone.

APPENDIX 9: HOSPITAL-BASED RTI REPORTING FORM

استمارة ايلاع عن اصابة حالات سير				الجمهورية اللبنانية وزارة الصحة العامة	
رقم الاصابة	تاريخ دخول الطوارئ	اسم المعلق	اسم المستشفى		
أ- تعريف المريض					
الاسم الكامل عند الولادة:		تاريخ الولادة (أو العمر):		الجنس:	
الإقامة:		البلد:		رقم هاتف المصاب:	
				رقم هاتف احد الأقارب:	
ب- معلومات عن الحادث					
مكان الحادث:		البلد:		القضاء:	
				التاريخ:	
				الساعة:	
الحى/الطريق/التقاطع:					
وسيلة النقل للمريض:		اصطدام مع:		النصاب كان:	
1. مشاة		1. مشاة		1. نعم بشكل سليم	
2. سيارة خاصة		2. سائق		2. نعم بشكل غير سليم	
3. سيارة اجرة		3. راكب		3. كلا	
4. حافلة باس bus		4. حافلة باس bus		4. غير معروف	
5. حافلة فان van		5. حافلة فان van		5. لا ينطبق	
6. دراجة هوائية		6. دراجة هوائية			
7. دراجة نارية		7. دراجة نارية			
8. دراجة رياضية		8. دراجة رياضية			
9. بيه اب		9. بيه اب			
10. شاحنة كبيرة		10. شاحنة كبيرة			
11. مركبة زراعية		11. مركبة زراعية			
12. حرة		12. شى جاند / حرة			
13. غير معروف		13. حرة			
14. غير معروف		14. غير معروف			
طريقة نقل المريض:		1. سيارة اسعاف		2. أتى مع أفراد/اصحاب	
				3. أتى بمفرده	
				4. حرة	
ج- معلومات عن الاصابة (ضع اشارة ✓ في الخانات المناسبة)					
ON ARRIVAL		Severity			
Blood pressure systolic		Crushing, a rupture, internal organ	Blood vessel	nerve, joint cont	dislocation, joint strain
Blood pressure diastolic		fracture			
Respiratory rate		Open wound	Superficial injury		
Best eye response					
1. No eye opening					الرأس
2. Open to pain only					الوجه
3. Open to verbal command					الرقبة
4. Open spontaneously					التعوى
Best motor response					الانحنى
1. No motor response					الانقباض
2. Abnormal extension (decerebrate)					الصدر
3. Abnormal flexion (decorticate)					الظهر
4. Withdrawal to painful stimuli					اليدن
5. Localizes painful stimuli					الوجه/الاصابع
6. Obeys commands for movement					الكوع/الساعد
Best verbal response					المعصم/اليد/اصابع
1. No verbal response					الورم/الفتحة
2. Incomprehensible speech					الركبة/الساقن
3. Inappropriate words					الكاحل/القدم/اصابع
4. Confused but can answer questions					غيره
5. Orientated					
Best verbal response (if <2 yrs)					
1. No vocal response					
2. Cries and inconsolable					
3. Inconsistently consolable, moaning					
4. Cries but consolable					
5. Persistent crying to pain					
6. Babbles appropriately, oriented					
		3 استشفاه في نفس المستشفى		1 معالجة في الطوارئ وارسل الى المنزل	
5 وفاة		4 احالة الى مستشفى		2 رفخص الاستشفاه	
6 حرة					
التاريخ:					
الإمضاء:					

APPENDIX 10: CASE STUDY OF HOSPITAL-BASED RTI SURVEILLANCE DATA: DESCRIPTIVE RESULTS

Characteristics and severity of RTI collected by the emergency department hospital-based data

During the selected period, a total of 1 576 cases of RTIs were reported by the EDs of the hospitals to the ESU. Among these, 614 RTI cases were recorded in 2013, 500 in 2014, and 462 in 2015. There was a decrease in the number of reported RTIs and RTFs in Bekaa between 2013 and 2015. In comparison, there has been an increase in the population during that period, rising from 552,559 in 2013 to 1,156,308 in 2015.

Characteristics of the study population

Male predominance was evident in RTIs across all three years (2013, 2014, and 2015), with males comprising 68.4% of cases in 2015. The male-to-female ratio remained consistently higher each year (2.44 in 2013, 3.03 in 2014, and 2.16 in 2015). The highest proportion of victims fell within the 15 to 29 age group (44.4% in 2015), followed by those aged 30 to 39. Approximately 65.4% of victims were under 40 years old, while only 6.3% were over 60 years old in 2015. Age group distribution remained relatively stable between 2013 and 2015, with a slight 2% decrease observed in the [0-4] age group. There was an increase in cases in the [5-14] age group in 2015, warranting further investigation. Lebanese individuals constituted 80% of RTI cases, followed by Syrians at 16%, with a slight decrease in Syrian involvement over the years (**Error! Reference source not found.**).

RTI case characteristics

The majority of RTI cases (43%) were drivers, followed by passengers (39%) and pedestrians (18%) in the year 2015. The percentage of cases involving drivers increased over the years (from 35% in 2013 to 43% in 2015) while the percentage of occupants decreased. However, the percentage of affected pedestrians remained relatively stable.

Table 49: Characteristics of the RTI cases admitted to the ED of the hospitals in Bekaa governorate

Year	2013		2014		2015	
	N	%	N	%	N	%
Gender						
Male	436	71.0%	376	75.20%	316	68.40%
Female	178	29.0%	124	24.80%	146	31.60%
Sex Ratio	2.44		3.03		2.16	
Age groups (years)						
[0-4]	26	4.2%	17	3.40%	10	2.16%
[5-14]	68	11.1%	48	9.60%	65	14.07%
[15-29]	276	44.9%	227	45.40%	205	44.37%
[30-44]	138	22.5%	121	24.20%	103	22.30%
[45-59]	68	11.1%	43	8.60%	49	10.61%
[60-69]	15	2.4%	22	4.40%	11	2.38%
>70	23	3.7%	22	4.40%	19	4.11%
Nationality						
Lebanese	498	81.11%	405	81.00%	397	85.93%
Syrian	104	16.94%	86	17.20%	60	12.99%
Other	12	1.95%	9	1.80%	5	1.10%
Patient status						
Pedestrian	117	19%	90	18%	83	18%
Occupant	282	46%	215	43%	180	39%
Driver	215	35%	195	39%	199	43%
Mean of rescue						
Alone	15	2.40%	15	3%	4	0.90%
Relatives	231	37.60%	195	39%	153	33.10%
Rescue	280	45.60%	268	53.60%	295	63.90%
Other	88	14.3%	22	4.40%	10	2.10%
ER decision						
ER then home	258	42.02%	227	45.40%	192	41.60%
Admission	253	41.21%	205	41.00%	220	47.60%
Death	38	6.19%	24	4.80%	21	4.50%
Refusal	29	4.72%	15	3.00%	9	2.00%
Referral	28	4.56%	26	5.20%	19	4.10%
Other	8	1.30%	3	0.60%	1	0.20%
Outcome of the crash						
Injuries	576	93.81%	476	95.20%	441	95.45%
Deaths	38	6.19%	24	4.80%	21	4.55%
Total	614			500	462	

N: frequency, %: Percentage, ER: emergency room

Transport means

The most commonly used transport means were private cars (59% for drivers and 67% for passengers), followed by motorcycle drivers (26%) and passengers (13%) (**Error! Reference source not found.**).

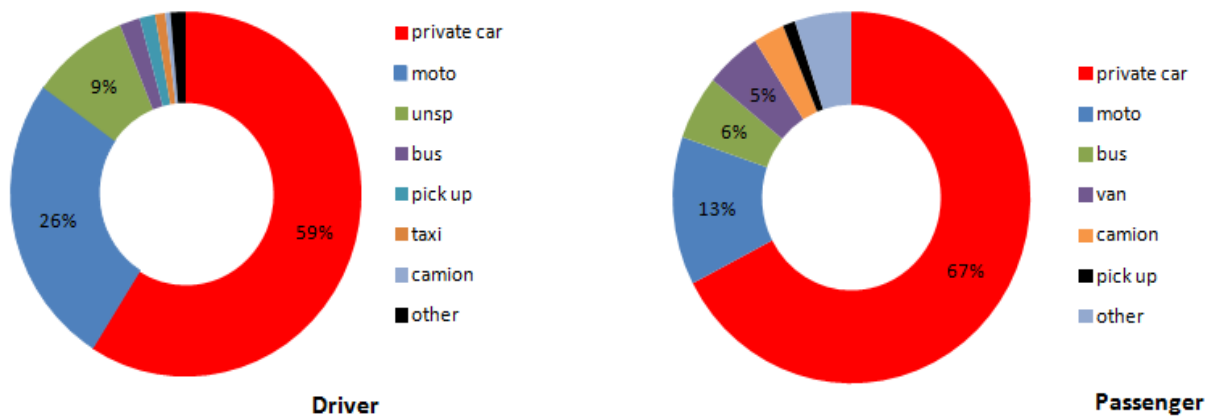

Figure 35: Transport means used by RTI (Drivers vs passengers)

Type of collision

The recorded RTIs in 2015 were primarily the result of four types of collisions: car occupants injured in collisions with a fixed object (25.8%), car occupants injured in collisions with cars or trucks (23.2%), pedestrians injured in collisions with cars or trucks (15.2%), and motorcycle riders in collisions with cars and trucks (12.1%). These main collision types remained predominant throughout the three-year period.

Place of the accident

The GIS map identified Baalbeck as a significant hotspot, where more than 100 RTI cases stemmed from accidents in this city (**Error! Reference source not found.**). Additionally, various other localities, including Zahleh, Douris, Bouday, and Aadous, demonstrated notable RTI figures. Baalbeck witnessed a decline in reported RTIs, decreasing from 100 cases in 2013 to 73 in 2015. In contrast, Zahleh city experienced an increase in RTIs, with the numbers rising from 20 to 30 RTIs in 2013 to a higher range of 30 to 50 RTIs in 2015. Furthermore, not all reported accidents were confined to the Bekaa governorate, as some road traffic crashes originating from other governorates were directed to nearby hospitals in Bekaa for medical treatment.

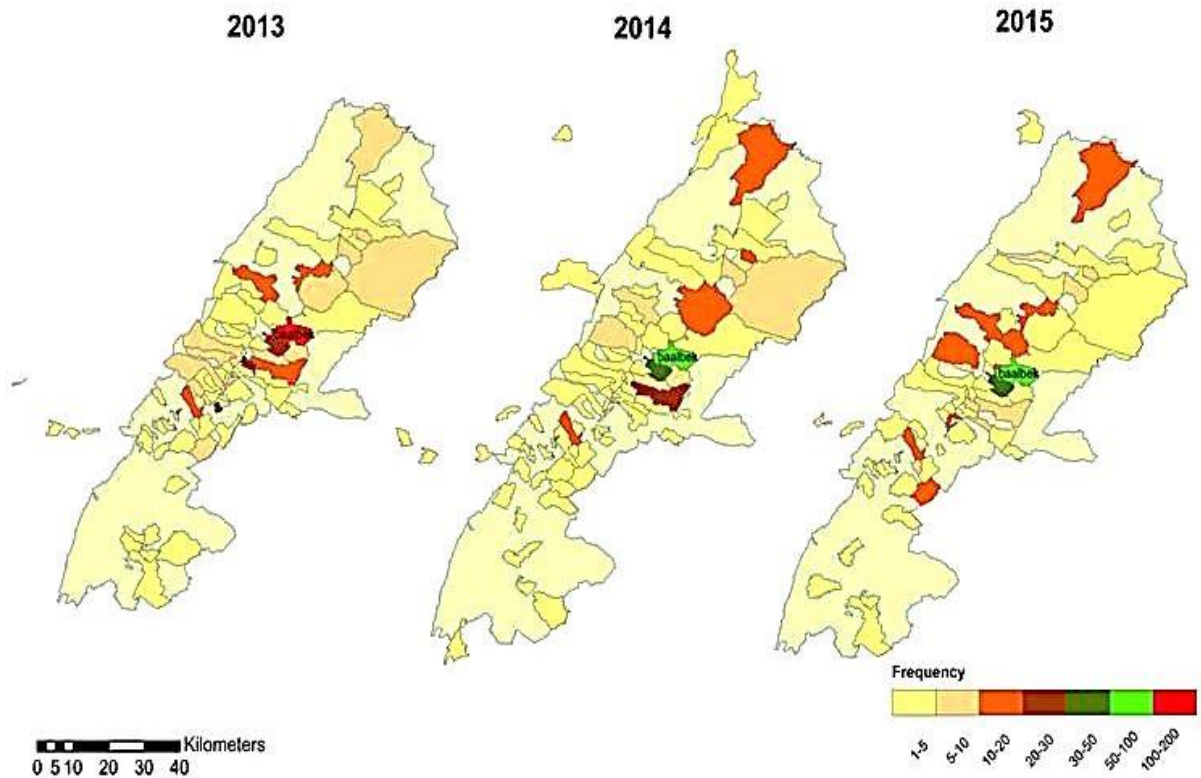

Legend 1:The pale yellow color represents territories that are not reporting RTI.

Figure 36: Distribution of RTI in bekaa, Lebanon (2013-2015)

Time of accident

In 2013, there were a relatively low percentage of cases during the first quarter (2.7%), while the majority occurred in the second (37.5%) and third (35.8%) quarters (Table 8). In contrast, 2014 witnessed a notable increase in cases during the first quarter (21.8%), accompanied by a decline in the second (25.6%) and third (19.8%) quarters. The year 2015 marked a substantial surge in cases during the third quarter (42.7%), with fewer cases in the first (26.2%) and second (20.0%) quarters.

There was a noticeable decrease in cases during the fourth quarter (11.1%). The highest number of cases occurred in the afternoon (1 pm - 6 pm), constituting 48.8% in 2013, 40.1% in 2014, and a significant increase to 53.9% in 2015. The evening period (6 pm - 12 am) also featured a substantial share of cases in 2013 (29.5%) and 2014 (35.0%), but this percentage decreased in 2015 (19.6%). In contrast, the early morning period (1 am - 6 am) consistently reported the lowest percentage of cases across the three years, ranging from 1.7% to 4.8%. The morning period (6 am - 12 pm) demonstrated relative stability in its share of cases.

Table 50: Distribution of RTI by day-time and season of occurrence

	2013		2014		2015	
	N	%	N	%	N	%
Quarter of the year						
First quarter	16	2.7%	109	21.8%	121	26.3%
Second quarter	222	37.5%	128	25.7%	92	20.0%
Third quarter	212	35.8%	99	19.8%	197	42.7%
fourth quarter	142	24.0%	163	32.7%	51	11.0%
Total	592	100%	499	100%	461	100%
Period						
1am-6 am	27	4.8%	7	1.7%	9	1.9%
6am-12am	96	16.9%	96	23.2%	113	24.6%
1pm-6 pm	276	48.8%	166	40.1%	248	53.9%
6 pm-12 pm	167	29.5%	145	35.0%	90	19.6%
Total	566	100%	414	100%	460	100%

N:frequency, %: Percentage

First quarter: January, February, March, Second quarter: April, May, and June, Third quarter: July, August, and September, Fourth quarter: October, November & December

Type of rescue

The most common rescue means used was the professional rescue (emergency transport services mainly Red Cross) (63.9%) followed by being transported by relatives (33.1%). There was a notable increase in the percentage of cases being rescued by the rescue services in 2015, indicating potential shifts in the methods used to respond to road traffic injuries (RTIs) (**Error! Reference source not found.**).

Outcome of RTIs

The majority of injured people were managed in the ER then discharged to their home. There were a rising percentage of cases admitted to hospitals over the years. Only 1.9% of RTIs cases refused to be treated (2015).

The majority of cases resulted in injuries, underscoring the predominantly non-fatal nature of RTIs. A decrease in reported death was observed between 2013 (6.2%) and 2015 (4.1%). The majority of deaths occurred among pedestrians (10%) (**Error! Reference source not found.**).

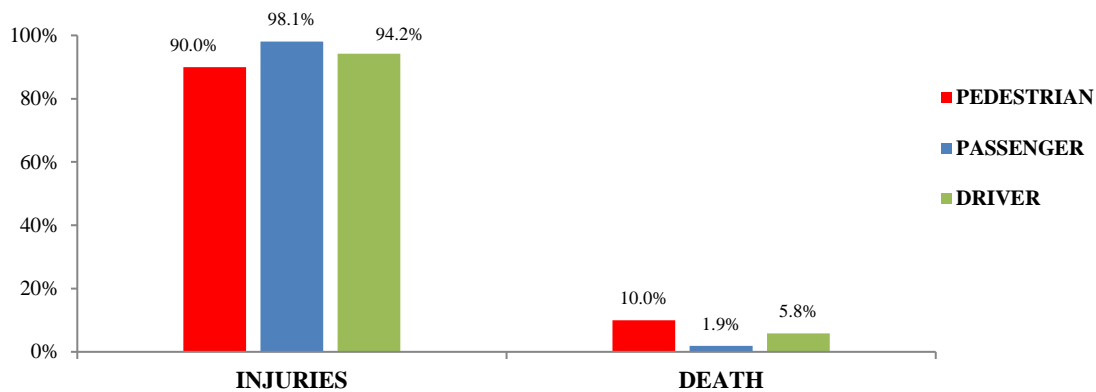

Figure 37: Outcome of the RTCs by road user

Anatomical site of injury

Head injuries constituted the most prevalent type of injury across the majority of cases, accounting for 36.4% in 2013, 45.1% in 2014, and 46.3% in 2015. Following closely, lower extremity injuries, which encompass injuries to the knees, legs, hips, and ankles, ranked as the second most common (40.1% in 2015). Upper extremity injuries, affecting areas like the shoulders, arms, wrists, hands, elbows, and forearms, stood as the third most frequently observed injury type in road traffic crashes (35.2% of patients experienced upper extremity injuries in 2015). Abdominal injuries (13.4%) and chest injuries (13.1%) collectively accounted for 26% of cases. There were no significant differences in the distribution of injury sites observed during the study period. Head injuries exhibited a 10% increase among RTI cases between 2013 and 2015 (**Error! Reference source not found.**).

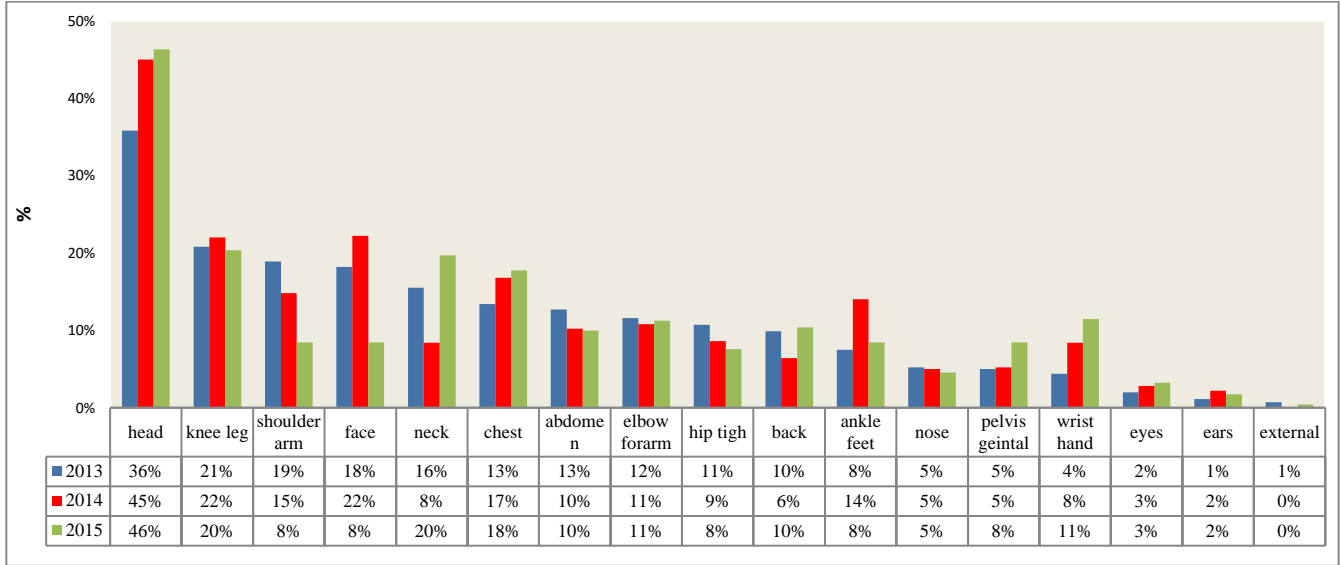

Figure 38: Distribution of RTI by anatomical site of injury

Severity of injury

The majority of cases had an RTS of more than 4, with 96.7% in 2013, 95.8% in 2014, and 97.4% in 2015. A significant majority of cases had an ISS of less than 15, accounting for 91.1% in 2013, 91.3% in 2014, and 87.2% in 2015. For the Trauma Injury Severity Score (TRISS), the highest percentage of cases fell within the [0.9-1] range, which indicates a high probability of survival. Specifically, 86.1% fell within this range in 2013, 92.3% in 2014, and 94.1% in 2015 (**Error! Reference source not found.**). This pattern suggests that the majority of RTI cases had a favorable prognosis for survival, with only a small percentage falling into lower TRISS ranges, indicating a lower likelihood of survival.

Injury severity score by road user:

The distribution of patient status based on Injury Severity Score (ISS) categories is presented in **Error! Reference source not found.** Pedestrians and occupants had higher ISS scores, indicative of more severe injuries, comprised a larger proportion compared to those with lower ISS scores. Conversely, a higher proportion of drivers had ISS scores of 15 or less, suggesting comparatively less severe injuries among this group.

Table 51: Severity of injuries using trauma scores RTS, ISS and TRISS

	2013		2014		2015	
	N	%	N	%	N	%
Trauma score						
RTS						
less than 4	20	3.3	21	4.2	12	2.6
more than 4	579	96.7	475	95.8	449	97.4
Total	599	100	496	100	461	100
ISS						
less than 15	555	91.1	454	91.3	402	87.2
more than 15	54	8.9	43	8.7	59	12.8
Total	609	100	497	100	461	100
TRISS						
[0-0.1[19	3.2	20	4.0	13	2.8
[0.1-0.2[3	0.5	1	0.2	0	0.0
[0.2-0.3[4	0.7	1	0.2	3	0.7
[0.3-0.4[31	5.3	8	1.6	1	0.2
[0.4-0.5[4	0.7	2	0.4	0	0.0
[0.5-0.6[2	0.3	0	0.0	2	0.4
[0.6-0.7[3	0.5	0	0.0	3	0.7
[0.7-0.8[7	1.2	4	0.8	3	0.7
[0.8-0.9[9	1.5	2	0.4	2	0.4
[0.9-1[507	86.1	458	92.3	434	94.1
Total	589	100.0	496	100.0	461	100.0

N:frequency, : Percentage

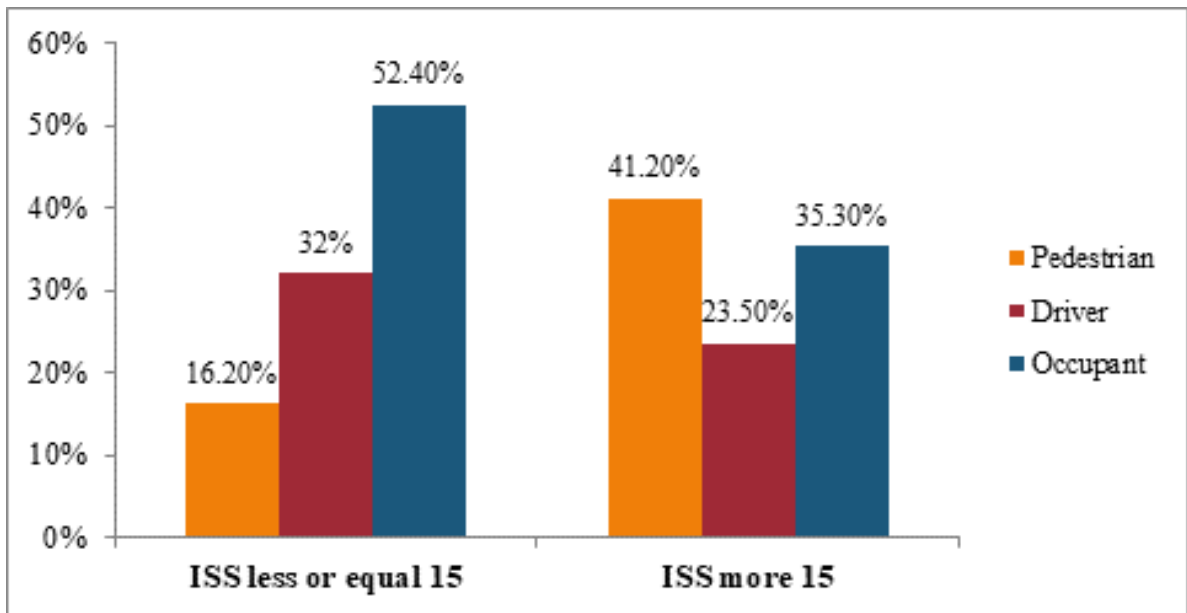

Figure 39: Injury severity by road user

APPENDIX 11: STRENGTHS AND CHALLENGES OF HOSPITAL-BASED RTI SURVEILLANCE SYSTEM IN LEBANON: OPPORTUNITIES FOR ENHANCEMENT

The SWOT analysis for the RTI surveillance system in Lebanon reveals a comprehensive overview of its current status and potential areas for improvement (**Error! Reference source not found.**).

Table 52: SWOT matrix for RTI surveillance system

Strengths	Weaknesses
<ul style="list-style-type: none"> • Structured Data Collection • Spatial Analysis • Objective Injury Severity Assessment • Ethical Considerations • Skilled Workforce 	<ul style="list-style-type: none"> • Underreporting Bias • Passive Reporting • Information Bias • Limited Geographical Coverage • Resource Constraints • Lack of Real-time Data
Opportunities	Threats
<ul style="list-style-type: none"> • Enhanced Data Quality • Data Integration • Resource-Efficient Strategies • Addressing Cultural Sensitivity • Leveraging Technological Advancements • National and International Collaborations 	<ul style="list-style-type: none"> • Limited Coverage • Legislative Changes • Resource Attrition • External Disruptions • Persistent Underreporting Bias • Data Collection Biases

Strengths

The RTI surveillance system in Lebanon demonstrates a structured approach to gathering data related to RTIs. This systematic method ensures consistency and reliability in the data, facilitating accurate analysis and interpretation of trends over time. Moreover, utilizing spatial analysis techniques allows for a comprehensive examination of RTI patterns and distribution across geographical areas. By identifying hotspots and areas with higher incidence rates, targeted interventions and resource allocation can be implemented effectively to address specific needs. Furthermore, the system employs standardized methods for assessing the severity of injuries sustained in RTC. These

objective assessment criteria ensure consistency and accuracy in categorizing injuries, which is vital for providing appropriate treatment and allocating resources efficiently. Ethical principles and guidelines are integrated into the data collection and reporting processes of the surveillance system. This includes maintaining patient confidentiality, and ensuring the ethical use of data for research and policy purposes, demonstrating a commitment to ethical standards. Finally, the presence of a skilled and trained workforce contributes to the efficiency and effectiveness of the RTI surveillance system. These trained personnel are equipped to collect, analyze, and interpret data accurately, leading to more informed decision-making and improved outcomes in RTI prevention and management efforts.

Weaknesses

Despite the structured approach to data collection, underreporting bias remains a challenge within the system. Not all RTIs are reported, leading to an incomplete picture of the true burden of RTIs in the population and impacting the accuracy of data and subsequent interventions. Additionally, reliance on passive reporting mechanisms, where RTIs are voluntarily reported by healthcare facilities or individuals, contributes to underreporting bias. Passive reporting may result in missed cases and delays in data collection, affecting the timeliness and completeness of surveillance data. Furthermore, inaccuracies or errors in the data collected, known as information bias, can arise from various sources such as incomplete medical records or misclassification of RTI. These biases can distort the interpretation of RTI trends and undermine the reliability of surveillance data. The RTI surveillance system may have limited coverage in terms of geographic areas (limited to Bekaa region). This limited coverage hinders the identification of disparities in RTI rates and the implementation of targeted interventions in underserved communities. Lastly, resource constraints, including limited funding, personnel, and infrastructure, pose challenges to the functioning of the RTI surveillance system. Insufficient resources may impact data collection efforts, data quality, and the implementation of preventive measures.

Opportunities

Opportunities exist to improve the quality of RTI surveillance data through measures such as training and capacity building for data collectors, standardizing data collection tools and procedures, and implementing quality assurance protocols. Furthermore, integrating RTI surveillance data with other health information systems can enhance data completeness, accuracy, and utility, providing a more

comprehensive understanding of the burden of RTIs and facilitating coordinated responses across different sectors. Exploring resource-efficient strategies such as leveraging existing infrastructure and technologies, streamlining data collection processes, and promoting multi-sectoral collaboration can optimize the use of available resources for RTI surveillance. Recognizing and addressing cultural sensitivities in data collection and reporting processes can improve community engagement and participation in RTI surveillance activities, enhancing the acceptability and effectiveness of interventions among diverse populations. In addition, harnessing technological advancements such as mobile health applications, electronic reporting tools can enhance the efficiency, accuracy, and timeliness of RTI surveillance activities. Lastly, collaborating with national and international partners, including government agencies, academic institutions, and non-governmental organizations, can provide opportunities for knowledge sharing, capacity building, and resource mobilization to strengthen RTI surveillance efforts.

Threats

The threat of limited coverage refers to the risk of incomplete or uneven surveillance coverage across geographic areas. Limited coverage compromises the representativeness and reliability of surveillance data, hindering effective decision-making and resource allocation. In addition, changes in legislation or policies related to RTI reporting, data sharing, or privacy regulations can impact the functioning of the surveillance system, requiring adjustments to data collection and reporting procedures. Resource attrition, including funding cuts or staff turnover, can undermine the sustainability and effectiveness of RTI surveillance efforts, leading to gaps in data collection, decreased data quality, and challenges in maintaining surveillance activities over time. External disruptions such as, political instability, or public health emergencies can disrupt RTI surveillance activities and compromise data collection efforts, requiring rapid adaptation and resource allocation to ensure continuity of operations. The ongoing challenge of accurately capturing all RTIs within the surveillance system highlights the threat of persistent underreporting bias. Addressing this bias requires targeted strategies to improve reporting mechanisms, enhance community awareness, and strengthen data collection efforts. Biases in data collection processes can introduce inaccuracies and distortions in surveillance data, undermining the reliability and utility of the data for informing decision-making and policy development.

APPENDIX 12: BLUEPRINT FOR ESTABLISHING AN INTEGRATED ROAD TRAFFIC CRASHES DATA SYSTEM IN LEBANON

1. Introduction

RTCs are a global concern, inflicting immense human suffering and imposing heavy economic burdens. Annually, these crashes claim the lives of 1.3 million individuals and result in 20 to 50 million non-fatal injuries. Furthermore, RTIs stand as the eighth leading cause of death worldwide, and projections indicate they may escalate to the third leading cause of disease burden by 2030 (Lajunen et al., 2003). Alarmingly, nearly 90% of these fatalities occur in Low- and Middle-Income Countries (LMICs) (Lajunen et al., 2003). In the Arab region, the fatality rate attributed to road accidents in 2016 was estimated at 18.91 fatalities per 100,000 people¹, surpassing the global average of 18.2 fatalities per 100,000 people and exceeding the European region's average by more than threefold, which stands at 5.9 fatalities per 100,000 people². Within the Eastern Mediterranean Region, which contributes about 9.2% of global traffic-related deaths, an unusual scenario unfolds as high-Income Countries (HICs) in the region exhibit a higher road traffic death rate than LMICs (Rotter, 1966).

To combat the burden of RTIs, one of the most effective strategies is the acquisition of context-specific data. This strategy heavily relies on systematic data collection, enabling stakeholders to identify issues, untangle complex risk factors, and prioritize critical areas for intervention. In the context of the safe system approach, data-driven insights provide the means to continuously analyze and manage road safety challenges, fostering a safer, more informed, and strategically-oriented

¹ The rate is calculated for 16 ESCWA countries for which data is available in the global report of road safety for 2018, which are: Egypt, Iraq, Jordan, Kuwait, Lebanon, Libya, Mauritania, Morocco, Oman, Palestine, Qatar, Saudi Arabia, Sudan, Syria, Tunisia and United Arab Emirates (With a total of 60.566 road crash fatalities among 321.020.460 inhabitants).

² This rate is calculated for 27 EU countries for which data is available in the global report of road safety for 2018, Austria, Belgium, Bulgaria, Croatia, Cyprus, Czechia, Denmark, Eswatini, Finland, France, Germany, Greece, Hungary, Ireland, Italy, Latvia, Lithuania, Luxembourg, Malta, Netherlands, Poland, Portugal, Romania, Slovakia, Slovenia, Spain and Sweden.

approach to road safety management (World Health Organization, 2010). In terms of policy, trustworthy and accurate data serve as an undeniable potency, meticulously documenting the true extent and nature of the RTI problem, accumulating compelling evidence of intervention effectiveness in preventing RTC and mitigating RTI. This evidence-based approach has the potential to reshape the political landscape, compelling decision-makers to prioritize road safety as they witness the tangible benefits of investments in injury prevention. Furthermore, it presents a compelling economic case, elucidating the substantial reductions in socio-economic costs attainable through effective preventive measures. At its core, the strategic utilization of reliable data to identify and address road safety challenges represents a foundational pillar of the Safe System approach which transcends conventional road safety paradigms, ushering in a new era where data-driven insights and evidence-based policymaking reign supreme, promising safer roads, safeguarded lives, and a transformed transportation landscape for countries (International Transport Forum, 2022). These data are not mere statistics; they represent lives saved, injuries prevented, and economic resources conserved.

However, in spite of the worldwide burden of RTF and RTIs, there often exists a dearth of comprehensive data, hindering the implementation of evidence-based interventions. HICs have made substantial investments in robust registry systems, such as trauma registries and comprehensive surveillance systems (St-Louis, Paradis, Landry, & Poenaru, 2018). Regrettably, such systems are not universally available in many LMICs. A survey conducted in 2018 among ESCWA member States uncovered serious shortcomings in road safety management and data collection. These deficiencies undermine the accuracy and comparability of police data on road safety, resulting in a significant 70% gap between reported and WHO-estimated crash fatalities. Limited use of digital forms for data collection pose challenges (Abounoas, Raphael, Badr, Faddoul, & Guillaume, 2020). Consequently, alternative data sources, including police databases, mortuary reports, and newspaper articles, are explored in these settings. Police-derived data, while valuable for RTIs surveillance in resource-constrained environments, may carry limitations and potential biases in reporting. Furthermore, the COVID-19 has led to shifts in active mobility modes such as walking, cycling, and scootering, requiring the inclusion of these new road crash patterns in analysis with relevant data. The improvement in RTC data quality can aid

governments in prioritizing road safety alongside other public health concerns and ensuring proper resource allocation within national budgets.

In Lebanon, the urgency of road safety is underscored by a death rate of 18.1 per 100 000 individuals, ranking RTC as the eighth leading cause of death in the country (Rotter, 1966). The country witnesses around 11 990 road traffic deaths or serious injuries annually. Consequently, this issue perpetrates a shocking cost of USD\$2.28 billion on the national economy, equivalent to 4.4% of the Gross Domestic Product (GDP) (Rotter, 1966). Beyond the immediate human toll, these RTC bear far-reaching consequences, entailing long-term public health challenges. Despite its undeniable significance to the population, Lebanon has not given RTIs the attention they deserve. One pivotal factor contributing to this oversight is the scarcity of reliable data that accurately depict the magnitude of injuries, as well as the lack of mature data sources and well-established surveillance systems despite recent progress towards understanding the broad patterns. The primary source of fatal road traffic injury data is the police, which has limitations. Overlapping data collection mechanisms among different entities hinder integration. These issues hinder progress towards achieving Sustainable Development Goal 3.6.

The recommendation number 14 of the UN General Assembly resolution A/RES/74/299 adopted on August 31, 2020 (United Nations general assembly resolution, 2001), urges member states to strengthen their institutional capacity through the provision of sufficient training and capacity-building in the realm of road safety. This capacity-building is intended to empower these states to gather, analyze, and distribute detailed data to facilitate evidence-based policymaking and execution. Thus, the first step towards achieving the Decade Plan of Action in Lebanon is to provide better and more reliable and sustained data on RTCs and the factors responsible for the different types. This can be done through the establishment of an integrated RTI data system, which is paramount, serving as a unifying platform that consolidates data from diverse sources. The collected data could then be used to inform policy-makers about the scope and the severity of the RTI problem in Lebanon and, in turn, to argue for greater attention, allocation of more resources and for prevention efforts.

2. Objectives

The central aim of this protocol, designed for the establishment of an integrated RTI data system, is to meticulously create a structured and all-encompassing framework. This framework is dedicated to the meticulous collection, efficient management, and thorough analysis of data related to road traffic

accidents and injuries. The protocol has been thoughtfully organized to achieve a myriad of crucial objectives. Its purpose extends beyond merely enhancing the quality and uniformity of data. It also actively promotes and facilitates robust collaboration among diverse stakeholders, ultimately empowering data-driven decision-making processes. The ultimate outcome is a reduction in the far-reaching impacts of road traffic injuries, emphasizing the protocol's significance in enhancing road safety.

3. Methods

Before embarking on establishing an integrated road traffic crashes data system, it is necessary and a prerequisite to perform a situation analysis to understand the strengths and weaknesses of the data systems collecting RTC in Lebanon using general assessment methods for surveillance systems and registries (World Health Organization and Center for Disease Control) (Klaucke, Buehler, Thacker, Parrish, & Trowbridge, 1988). Such assessment should be carried out in close collaboration with the lead agency (NRSC), Ministry of Public Health (MoH) and the Ministry of Interior and municipalities (MoIM) and other data sources (Emergency medical services (EMS), insurance companies...). This analysis will identify gaps and help in building the existing system and integration with other data sources. The primary objective of this analysis is to identify the gaps within the current data systems, shedding light on areas of improvement and facilitating the integration of these disparate systems with other valuable data sources.

3.1. Situational assessment for understanding the RTI data system

Based on the WHO's data system (World Health Organization, 2010), which is a road safety manual for decision-makers and practitioners, there are four steps to be followed for conducting a situational assessment (**Error! Reference source not found.**):

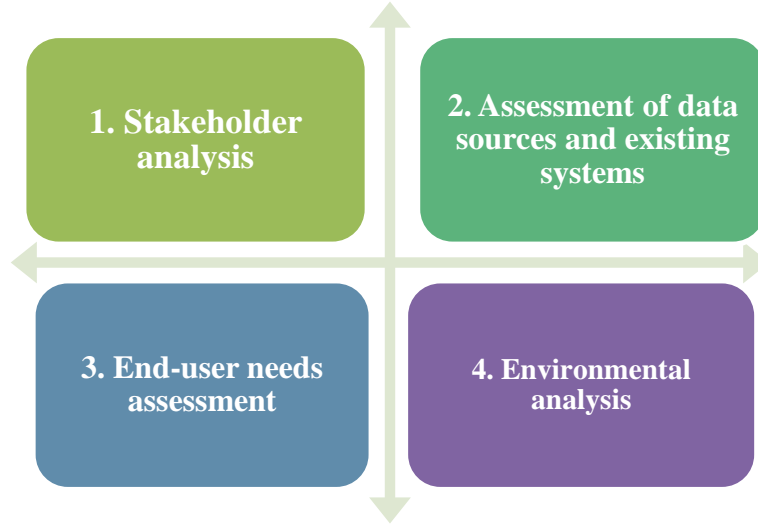

Situational assessment steps (Updated from data system manual, WHO(World Health Organization, 2010))

3.1.1. Stakeholder analysis

This process entails recognizing the relevant organizations, potential partners, and individuals interested in the collection and utilization of road safety data. It involves a comprehensive analysis of the functions undertaken by various stakeholders, which can be categorized into data collectors, data managers, and data users. Additionally, it is crucial to assess the stance of each stakeholder, whether they actively support or oppose the proposed system. Furthermore, the nature and extent of their involvement should be determined; this can range from serving as advisers or consultants, actively participating as collaborating partners, becoming members of dedicated working groups, engaging individually, or representing larger groups of stakeholders. Such a multifaceted examination ensures that the system can incorporate the expertise and contributions of a diverse set of stakeholders effectively (World Health Organization, 2010).

Here's a list of potential stakeholders:

- Lebanese Ministry of Interior and Municipalities (Internal Security Forces (ISF)
- Ministry of transport and public works
- Lebanese Ministry of Public Health (Epidemiological surveillance program, statistical department...)
- Lebanese Red Cross and other EMS : Provides emergency medical services and maintains injury data.

- Insurance Companies: Handle accident claims and maintain extensive data on accidents and injuries.
- International Organizations (e.g., WHO): Provide guidance on injury prevention and data collection at a global level.
- Non-Governmental Organizations (NGOs): Kunhadi: Advocates for road safety awareness and advocacy, Youth Association for Social Awareness (YASA): Engages in road safety awareness and response.
- Hospitals and Healthcare Facilities: Collect and maintain data on accident-related injuries but may have limited influence on overall road safety policies.
- Emergency Medical Services: Including the Lebanese Red Cross and other ambulance services, they play a critical role in accident response but may have limited influence on data policies.
- Researchers and Academics/universities: Conduct studies and research related to accident and injury data, providing valuable insights and recommendations.
- CNRS (Lebanese National Council for Scientific Research): LOCR: Engages in scientific research and may influence data-related research efforts.
- Scientific Research Foundation (SRF): Contributes to research efforts and may influence data utilization through research findings.

Information Gathering

Relevant information about each stakeholder was collected. This includes their objectives, priorities, resources, previous involvement in road safety initiatives, and their stance on road safety issues. Then, stakeholders were categorized based on their level of interest and influence in road safety data utilization in Lebanon. This can help prioritize engagement and collaboration efforts. Here's a categorization of the listed stakeholders. Then a stakeholder mapping matrix was created to help visualize the relationships between stakeholders and identify key decision-makers, influencers, supporters, and potential opponents in Lebanon's road safety and injury data management context. Below is an expanded stakeholder mapping matrix. For further information, please refer to Chapter 7 appendices.

Roles, attitudes, and levels of participation of each stakeholder in the proposed RTI data system

Lebanese Ministry of Interior and Municipalities (Internal Security Forces - ISF) serves as essential data collectors, taking responsibility for enforcing traffic laws, overseeing accident data, and conducting crash investigations. They are strong supporters of the RTC data system. The ISF plays an active role as advisers and consultants, collaborating closely as partners. They hold a pivotal position in ensuring data accuracy and the effective enforcement of traffic laws, especially through their role in investigating accidents. This collaboration is integral to enhancing road safety in Lebanon, as the ISF actively contributes to law enforcement, thereby advancing the overarching goal of creating safer roads in the country.

The Ministry of Public Health plays a pivotal role in the RTI data system. As data collectors, they are responsible for gathering essential information related to road traffic injuries. The Epidemiological Surveillance Program within the Ministry is particularly instrumental in this regard, as they oversee the systematic collection of data pertaining to RTIs. Simultaneously, the Ministry serves as data managers by organizing and maintaining the collected data. This entails ensuring data accuracy, reliability, and security. They also engage in data analysis to derive insights from the information they've collected, contributing to a comprehensive understanding of the RTI problem in Lebanon. In their capacity as data users, the Ministry of Public Health employs the gathered data to shape evidence-based policies, strategies, and interventions aimed at reducing RTIs and their associated burden. They analyze the data to identify trends, risk factors, and critical areas that require attention. In terms of attitudes, the Ministry of Public Health is a key supporter of the integrated RTI surveillance system. They recognize the importance of robust data in addressing the RTI problem comprehensively and acknowledge the potential of evidence-based approaches in achieving safer roads and reducing the impact of accidents. The Ministry's participation in the system is multifaceted. They act as advisers and consultants by providing expert guidance on data collection, management, and analysis. They are collaborating partners with other stakeholders in the system, working in tandem to achieve common road safety goals. Additionally, they may also have representatives as members of a working group dedicated to RTI surveillance. Overall, the Ministry of Public Health plays a central and supportive role in the proposed system, actively contributing to the collection, management, and utilization of data for road safety improvement.

Emergency Medical Services (EMS), exemplified by the Lebanese Red Cross and other ambulance services, play a multifaceted role. They act as both data collectors and users through their active

response to accidents and the provision of emergency medical services, which significantly contributes to data collection. Their supportive attitude is reflected in their roles as advisers and consultants, as they actively collaborate as partners in ensuring effective emergency responses.

The Lebanese Civil Defense plays a pivotal role within the RTC data system, primarily acting as data collectors responsible for responding to fatal accidents and recording vital emergency data. This active participation contributes significantly to emergency services, ensuring timely and accurate data reporting. Their unwavering support for the RTC data system underscores their commitment to enhancing road safety and preventing injuries. In addition to their roles as collectors, they also act as advisers and consultants, actively collaborating as partners to provide valuable emergency response data. The Lebanese Civil Defense is a staunch supporter of the proposed system, actively contributing to emergency response efforts and emergency data collection, thereby enhancing overall road safety and injury prevention in Lebanon.

Hospitals and Healthcare Facilities are indispensable contributors to road safety initiatives. Their roles extend to being data collectors as they actively treat accident-related injuries, ensuring comprehensive records of the extent of injuries. This active participation signifies their commitment to road safety, and they readily offer advisory support. Moreover, they serve as collaborative partners, making significant contributions to the comprehensive collection of injury data. Their expertise plays a crucial role in the development of data-driven strategies aimed at enhancing road safety and reducing accidents.

Insurance Companies play a pivotal role in the context of data collection. They primarily gather data by handling accident claims and meticulously maintaining extensive records of accidents and injuries. Beyond collectors, they function as data managers, responsible for the organization and integrity of this valuable data. Their attitude is inherently supportive, as they recognize the data's importance in shaping effective road safety policies. Acting as advisers, they collaborate closely as partners within the system, actively participating in the management of accident-related data. Their pivotal role significantly contributes to the development of effective policies and preventive measures, thereby enhancing road safety.

Non-Governmental Organizations (NGOs) constitute a robust support system for road safety endeavors. Kunhadi, with its focus on road safety awareness and advocacy, actively contributes to the system's goals. Their involvement encompasses advisory roles and active collaboration as

partners in shaping road safety strategies. Similarly, the Youth Association for Social Awareness (YASA) passionately engages in raising awareness and addressing road safety challenges, acting as advisers and collaborative partners. The Lebanese Red Cross Youth actively participate in ensuring efficient emergency responses and road safety initiatives, demonstrating their commitment to enhancing safety measures and reducing accidents and injuries.

Researchers and Academics are unwavering in their dedication to advancing road safety. They actively conduct studies and research related to accident and injury data, leveraging their expertise to generate invaluable insights. Beyond their roles as collectors, they serve as data managers and users, significantly influencing data analysis and interpretation. Their support is evident in their advisory and consultancy roles, which extend to active collaboration as partners.

International Organizations, exemplified by the WHO, serve as international beacons of support for road safety. They provide guidance on injury prevention and data collection, emphasizing their dedication to global road safety efforts. Their attitude is inherently supportive, and they actively participate as partners in the development of the system. Their vast expertise in injury prevention and data collection significantly bolsters road safety initiatives in Lebanon.

The Lebanese National Council for Scientific Research CNRS and LOCR play a crucial role in advancing road safety through scientific research. Their supportive attitude aligns with their roles as advisers and collaborative partners. They offer essential consultation and participate actively in supporting road safety endeavors. Their contributions, rooted in scientific research insights, significantly strengthen ongoing efforts to improve road safety. Likewise, the Scientific Research Foundation (SRF) serves as a fundamental research partner, actively contributing to research efforts related to road safety. Their supportive roles, as advisers, providers of consultancy, and collaborative partners, are pivotal in enhancing research endeavors aimed at improving road safety (Appendices Chapter 7)

Data needs, concerns and expectations of stakeholders

The data needs of stakeholders vary based on their responsibilities and objectives. Collaborative efforts among these sectors can lead to more effective road safety management. The data needs of different sectors related to road safety in Lebanon were provided in chapter 7 appendices.

Understanding these considerations is vital for tailoring road safety strategies to meet the specific needs and expectations of each stakeholder while addressing their concerns.

3.1.2. Assessment of data sources and existing systems:

This encompassed a comprehensive assessment of data sources, including organizations such as the police, hospitals, emergency services, and insurance companies. Variables examined covered demographic, vehicle, crash, road, person-related, pre-hospital, transport, medical, and outcome details. The assessment included an evaluation of data collection formats, storage methods, and processing approaches. Furthermore, it involved an in-depth review of data systems, including the population or area covered, estimates of coverage, incident types (fatalities, injuries, damage-only), used definitions, data transfer methods and reporting requirements, with a focus on linkages and data accessibility. Data quality assessment probed standard definitions, completeness, accuracy, under-reporting, validation procedures, missing data, coding errors, timeliness, and data accessibility, ensuring a thorough evaluation of RTI data quality and systems (World Health Organization, 2010). A detailed assessment of the data sources is provided in Chapter 7, appendix G5.

3.1.3. End-user needs assessment

This is crucial for setting up and expanding the Road safety information system to enhance its usability of the system. It includes: the definition of the users of data systems based on the circumstances or situations that lead to requiring road safety information, the sources of information users currently relying on, the required type of information, and the preferred format in which users would like to access information as well as the factors that affect or determine their access to, and use of, road safety information (World Health Organization, 2010) (Appendix G6).

3.1.4. Environmental analysis

It comprises an overview of the political environment: the presence of a lead agency responsible for road safety and its main function, main government departments involved in road safety decision making, the role does each department, existing policies in transport, law enforcement, health, and finance that are relevant to road safety, data components, political environment factors driving or opposing change, and adequate capacity for implementation/improvement of data collection, data processing, data analysis, and dissemination and use of data (Chapter 7, appendix G7). Of note, having political backing, both in terms of financial resources and human capital investment, is crucial for developing robust road safety data systems. Without this support, implementing the necessary changes for effective data systems can be quite challenging. In cases where the situational assessment reveals significant deficiencies and there is a lack of support to address these issues, the data collected during the assessment can be employed for advocacy purposes. This data can help highlight the extent of the RTI problem and underscore the significance of addressing road safety data by bringing attention to data quality and underreporting issues (World Health Organization, 2010).

3.2. The establishment of an integrated RTI surveillance

The establishment of an integrated RTI surveillance system will comprises the development of a framework for all essential parts of a registry, including stakeholder relations and a comprehensive quality assurance system. There will be four main stages in the development of framework for RTC data systems (Mitchell, Williamson, & O'Connor, 2009) (**Error! Reference source not found.**).

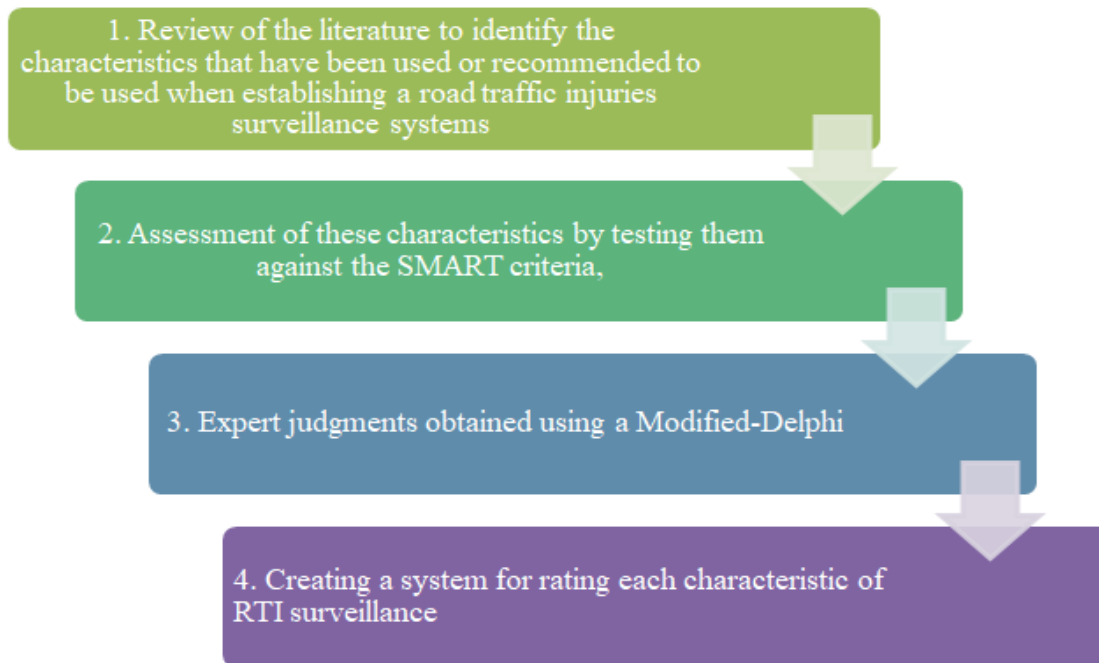

Stages for the development of a framework for RTC data system

3.2.1. FIRST stage: preliminary conceptualization and review of the literature

In the first stage, we will aim to define the fundamental features of developing the integrated road traffic injury data system and outline the key components of the conceptual model. This preliminary conceptualization will be driven by a comprehensive situation analysis that will draw on a review of the existing. Our primary objective will be to gain an understanding of the current landscape regarding the measurement of road traffic injuries in Lebanon and to identify the characteristics that have been used or recommended to be used when establishing effective injury surveillance or road traffic injuries surveillance systems previously. To achieve this, we will conduct an extensive literature review that will encompass both national and international experiences with traffic data collection systems within the domain of road safety. Our intention will not be to undertake an exhaustive systematic review but rather to pinpoint various international registries for practical applicability. Nevertheless, we will adhere to fundamental standards for conducting literature reviews. In this preliminary review, we will explore a wide array of sources, including databases like PubMed, Web of Science, Science Direct, SCOPUS, EMBASE, and Google Scholar. Given the context of our work, which revolves around the development of the Lebanese Road Traffic Injury Registry, we will also conduct searches on official websites to access grey literature, including

platforms like Google.com, along with the official websites of Lebanese organizations such as the internal security forces, traffic management center...

For these searches, we will employ a set of targeted key terms like ["crash(s)" OR "accident(s)" OR "collision(s)" OR "road traffic injury" OR "Road traffic accidents" OR "road safety" OR "trauma*" OR "injury(ies)"] AND ["surveillance" OR "data" OR "registry" OR "database" OR "variable(s)"] OR "implementation" OR "evaluation". As a result of this process, we will identify 14 distinct international data collection tools from countries such as Australia, India, China, and the UK. These tools will serve as valuable references in our efforts to develop the Integrated Road Traffic Injury Registry.

In addition to the literature review aimed at identifying global experiences in road traffic injury surveillance systems, a situational assessment of the current road crashes data systems operating in Lebanon will be performed. This will help us uncover the specific data currently being collected across various domains related to traffic accidents in Lebanon. Furthermore, the existing national legislations and regulations in this field will be scrutinized, with our overarching goals aligning with the provisions set forth by the traffic law. This comprehensive approach will lay the groundwork for the development of an integrated traffic injury registry, serving as a vital step in this endeavour (Mitchell et al., 2009).

3.2.2. SECOND stage: Assessment against SMART criteria

In the second stage, the characteristics will be assessed by testing them against the five criteria of the Specific – Measurable – Appropriate – Reliable and Time-consistent (SMART) framework and characteristics that do not meet the criteria will be removed (Bowles, Cunningham, Gabriel, & Picano, 2007; Holliman, Johnson, & Adjei, 2006; Locke & Latham, 1990; Shahin & Mahbod, 2007). These criteria's are as follows:

- Specificity: Each characteristic should offer a high level of detail and specificity.
- Measurability: It should be feasible to objectively evaluate or track the characteristic.
- Appropriateness: The characteristic should be well-suited for assessing an injury surveillance system and should supply essential information for injury surveillance.
- Reliability: The characteristic should be capable of delivering consistent and dependable information.
- Temporal consistency: It should be possible to consistently measure or track the characteristic over time.

The SMART criteria will be adapted to evaluate the characteristics of the RTC data system. The characteristics will be grouped into three categories based on the nature of the information they

provide on RTI surveillance. These will be: (1) data quality characteristics, which will provide evaluative information regarding the quality of the information obtained from a surveillance system; (2) operational characteristics, which will describe key aspects of processes governing the way a surveillance system works; and (3) practical characteristics, which will describe the functional capabilities and practical elements of a surveillance system (Mitchell et al., 2009). Each characteristic will be assessed using the SMART criteria. The characteristics that meet all of these criteria will be moved to the next stage of RTI surveillance development.

There is no one-size-fits-all method for determining the number of individuals or panels to include in each study, as it can vary depending on several factors. The recommended panel size will be influenced by the specific topics being addressed, the diversity of perspectives needed, and time, and budget constraints. It will be generally advisable to have a mix of individuals with different specialties, favoring heterogeneous groups over homogeneous ones. In this context, a core team of researchers and road safety professionals will be established, comprising health officers, senior police personnel, and designated road safety experts from the National Road Safety Council. The selection of expert panel members will be based on several criteria: (i) their active involvement in the field of road injury prevention, (ii) their familiarity with surveillance systems, (iii) their understanding of the strengths and limitations of such systems, (iv) their knowledge of RTI data collection methods, and (v) their willingness to contribute to the study. This approach will ensure that the panel consists of individuals who are well-versed in the subject matter and bring a diverse range of expertise to the table, ultimately enhancing the quality and effectiveness of the study.

3.2.3. THIRD stage: expert judgment

In the third stage, expert judgments will be obtained using a Modified Delphi study to assess the remaining characteristics (Bourrée, Michel, & Salmi, 2008; Custer, Scarcella, & Stewart, 1999; Stewart & Bristow, 1997). The two-round Modified Delphi study is a well-structured research method designed to tap into the expertise of the panel of experts. It will allow panel members to provide their point of view anonymously, and all opinions will be considered, which is not always possible during in-person meetings. Its main goal will be to either reach a consensus among the experts or gain valuable insights into a specific subject or research question.

The process will unfold in two rounds. In the first round, the expert panel will commence its proceedings with a concise introduction outlining the objectives and a summary presentation of the

conducted review. Facilitated by the principal investigator, the team will collectively embark on discussions to determine the core features and components of the Integrated Road Traffic data system. Experts will be presented with a set of open-ended questions, statements, or issues related to the topic being explored. Each expert will independently offer their opinions, insights, or responses to these questions. After the initial responses are collected and analyzed, the research team or facilitators will ensure the experts' feedback remains anonymous and then combine the data. This aggregated data, often summarized, will then be shared with the same group of experts in the second round. In this round, the experts will have access to both the compiled responses from the first round and any relevant statistical data or analysis that can help them better understand the collective opinions of the group.

During the second round, the experts will revisit their initial feedback and reflect on whether their opinions have shifted in light of the aggregated data and the input from their peers. They may choose to revise their responses, assign importance ratings to specific items, or engage in further discussions to reach a consensus or make more informed conclusions. Such an approach is commonly used in fields like healthcare, policy development, and business strategy to effectively collect and synthesize expert opinions.

3.2.4. Fourth stage: System rating

Lastly, the final stage will create a system for rating each characteristic of the RTC data system. Over the course of these stages, the preliminary conceptual model and core features of the integrated RTI surveillance system will be defined.

The core features identified by the panel will encompass various elements, such as efficient coverage, adaptability, multifaceted linkage and integration capabilities, the provision of geographical information system outputs, the use of unique identifiers at different levels, validation tools, adherence to international registry standards, alignment with local requirements, approved ethical protocols, phased implementation, data usage guidelines, data quality assurance, and robust database security with encryption measures in place. The consensus reached by the panel of research experts will result in the development of a preliminary conceptual model consisting of three main components: the aims component, the data component, and the organizational matrix (Sharkey & Sharples, 2001).

To ensure the robustness of the developed model, it will be further subjected to scrutiny by external reviewers from diverse disciplines, including experts from the health sector, database management, law enforcement, and emergency medical services. Their feedback and assessments regarding the relevance and adequacy of the model will be actively sought and considered in the refinement process.

3.3. Components of the Integrated Road Traffic Accident Data System

3.3.1. COMPONENT 1: Aims and Core Definitions

Aims

Establishing a robust Integrated RTC data system is a multifaceted endeavor that demands meticulous attention to several key aspects. To begin, a comprehensive needs assessment is a fundamental step, aimed at pinpointing the precise requirements and objectives of the system. This entails identifying the crucial data elements and variables essential for conducting in-depth analyses of road safety while simultaneously evaluating the existing infrastructure and available resources for effective data collection and management.

The data integration for road accident data sources in Lebanon is driven by several fundamental objectives:

- Enhancing road safety throughout the country by identifying high-risk areas, analyzing accident causation patterns, and crafting targeted interventions.
- Creation of a national data repository for RTC-related information
- Reducing the overall number and severity of accidents by leveraging integrated data to understand accident trends and contributing factors.
- Tailoring and implementing Lebanon-specific processes, tools, guidelines, methods, and indicators for road safety data, ensuring alignment with best practices both at global levels
- Closing the gap between reported national RTC data and estimates by the World Health Organization (WHO)
- Enhancement of emergency response procedures and medical care following accidents, aiming to save lives and minimize the impact of RTCs.
- Promoting data-driven decision-making, empowering authorities and policymakers to make informed choices regarding road safety measures and regulations.

- Ensuring that resources are directed efficiently toward areas with the highest accident rates and the greatest need for intervention.
- Facilitating continuous monitoring and evaluation of road safety measures, allowing for timely adjustments based on real-time insights.
- Identifying areas requiring further analysis and research,
- Producing an annual national report on the status of road
- Facilitating knowledge exchange among stakeholders and other countries by creating a shared interactive dashboard for the translation from data/information to knowledge supporting evidence-based policies strategies and action plans.

Together, these objectives aim to create a safer and more efficient road environment in Lebanon, improving the quality of life for all road users.

Core definitions

Data collection was expected to adhere to specified definitions and standards outlined in this protocol. The core definitions of IRTIR are as follows:

Road traffic crash: Any accident involving at least one road vehicle in motion on a public road or private road accessible to the public, resulting in at least one injured or killed person. This definition covered collisions between vehicles, vehicle-pedestrian accidents, accidents involving animals or fixed obstacles, and accidents involving a single road vehicle. This definition was deliberately broader than the current national reference, allowing flexibility for potential changes in national definitions and facilitating international comparisons of Lebanese traffic injury statistics (Holder et al., 2001).

Road Traffic Injury: Defined as fatal or non-fatal injuries sustained as a result of a road traffic crash. (World health Organization, 2015).

Traffic Injury Fatality: This referred to a fatality occurring within 30 days of the road traffic crash. These core definitions were established to provide clarity and consistency in data collection processes and ensure the adaptability of the integrated RTI to evolving national and international standards (Holder et al., 2001; World health Organization, 2015).

3.3.2. COMPONENT 2: Legal framework and ethical consideration

The implementation of a robust legal framework is imperative to ensure the system's full compliance with pertinent data privacy and protection laws. This framework serves the dual purpose of

establishing the necessary legal provisions that facilitate seamless data sharing among relevant authorities and agencies and providing clear delineations of responsibilities and liabilities associated with data management and usage. Legal compliance is a foundational pillar, ensuring that the system adheres to all pertinent laws and regulations, with particular emphasis on data privacy, sharing protocols, and reporting requirements. Data privacy and confidentiality should be embedded within the system.

Additionally, comprehensive documentation and regular reporting on integrated data should be maintained. The integrated system should be designed with scalability in mind, allowing for seamless expansion and integration of new data sources and emerging technologies, thus ensuring the longevity and adaptability of the system. This comprehensive approach leads to an efficient, reliable, and robust integrated data system that enhances road safety, emergency response, and informed policymaking.

3.3.3. COMPONENT 3: Stakeholder engagement and collaboration framework:

The active involvement of key stakeholders previously identified is central to the system's success. Collaboration agreements and data-sharing protocols should be developed with relevant agencies, such as ISF, MOPH, EMS, and insurance companies to foster cooperation in road safety initiatives.

3.3.4. COMPONENT 4: Data collection and standardization

Establishing a standardized digital dataset with essential data elements is crucial for robust road safety data systems. This dataset ensures consistent and compatible data collection for comprehensive national analysis and road safety improvements. To maintain uniform crash data, minimize changes to data elements and definitions. The proposed minimum data elements, based on the Common Accident Dataset (CADaS), promote data consistency and quality (**Error! Reference source not found.**). This common dataset can be incrementally integrated into existing systems with minimal changes. It focuses on RTC causing injuries and allows for the inclusion of additional variables. In addition, the development of standardized protocols and standard operating procedures (SOPs) for data collection, which all participating agencies must diligently adhere to, is of paramount importance. To capture RTC details efficiently, mechanisms for real-time or near-real-time data entry should be instituted. This includes the meticulous gathering of crucial information such as RTC location, date, time, road conditions, vehicle specifications, and comprehensive details about the individuals involved. The overarching goal of this integrated approach is to not only

guarantee compliance with legal standards but also to actively engage stakeholders and collect data that is indispensable for shaping well-informed decisions and policies pertaining to road safety based on their needs.

Crash related	Road related	Vehicle related	Person related
<ul style="list-style-type: none"> • Crash identifier (unique reference number assigned to the crash, usually by police) • Crash data • Crash time • Crash municipality/place • Crash location • Crash type • Impact type • Weather conditions • Light conditions • Crash severity^o 	<ul style="list-style-type: none"> • Type of roadway* • Road functional class* • Speed limit* • Road obstacles • Road surface conditions* • Junction • Traffic control at junction* • Road curve* • Road segment grade* 	<ul style="list-style-type: none"> • Vehicle number • Vehicle type† • Vehicle make† • Vehicle model† • Vehicle model year† • Engine size† • Vehicle special function† • Vehicle manoeuvre (what the vehicle was doing at the time of the crash) 	<ul style="list-style-type: none"> • Person ID • Occupant's vehicle number • Pedestrian's linked vehicle number • Date of birth • Sex • Type of road user • Seating position • Injury severity • Safety equipment • Pedestrian manoeuvre • Alcohol use suspected • Alcohol test • Drug use • Driving licence issue date • Age^o

^o Derived or calculated from other data elements.
^{*} Depending on the quality and detail of road inventory and hardware data available, it may be possible to obtain this data element through linkage to other databases.
[†] Depending on the existence, quality and detail of a motor vehicle registration database, it may be possible to obtain this data element through linkage to motor vehicle registration files.

Minimum data elements (source: data system Manual, WHO (World Health Organization, 2010))

Integrating data on RTCs from various sources is a complex yet crucial process that involves harmonizing diverse datasets to create a unified and comprehensive view of road safety accidents. To achieve this integration successfully, several key steps must be taken.

First, data sources must be identified and assessed to understand their quality, structure, and compatibility. We need also to identify current gaps and loopholes in the collection, processing, and analysis of data sources concerning RTI across data sources (refer to situational analysis).

Then, a meticulous review of data element definitions should be performed to guarantee that they are crystal clear and consistently understood. The aim here is to establish a shared understanding of the terminology used in the context of road safety data among diverse data sources. This approach not only simplifies the reporting process but also contributes to a more comprehensive documentation of injury crashes. It is essential to develop factsheets detailing the current data processes relevant to road crash information within the different data sources.

An upgrade to data collection tools is also needed. This can be done through examination of the most effective methods for data recording, then tailoring these best practices to align with local requirements and specifications of data sources in Lebanon. We aim to make the forms more user-friendly, digital, complete, and simple. This activity involves the customization of the prototype for the harmonized digital data form to align it with the specific needs and requirements of the participating countries and relevant stakeholders. This activity involves the customization of the prototype for the harmonized digital form to align it with the specific needs and requirements of the participating countries and relevant stakeholders. Then, we bring together representatives from all data sources representatives to receive their feedback. This collaborative approach aims to ensure that the prototype is well-received and functional in diverse regional contexts. Following the feedback and improvement phase, the final version of the prototype will undergo validation. It will then be officially endorsed through a legal instrument, solidifying its adoption and use in the participating countries. This step is crucial in enhancing the overall quality of the data we collect. Additionally, we are focusing on improving the precision of crash location data. The ultimate goal is to provide an accurate description of each crash's location

In addition to the common data definitions, data standardization involves the establishment of common formats, and quality control measures to ensure consistency. Data from different sources come in various formats, including electronic records, paper reports, and even real-time feeds. Transformation and data cleaning processes are necessary to convert all these formats into a cohesive dataset.

Data linkage techniques using deterministic matching stands out as a highly effective method due to its precision and dependability. This technique relies on exact matches between predefined data elements, creating precise links based on common identifiers or key fields. Given the critical nature of accident data, which includes patient information, injury specifics, and accident location, the

ability to establish exact connections is of paramount importance. Deterministic matching helps to establish clear and unambiguous relationships between related records and significantly reduce the risk of errors or mismatched data.

Accurate linkage of accident data from multiple sources hinges on the use of common variables or unique identifiers shared among datasets. Among these variables, the unique identifier, the date and time of the accident are equally crucial for temporal alignment, enabling records with matching time stamps to be linked seamlessly. Additionally, location information, whether presented through latitude and longitude coordinates, road names, or geographic codes, proves invaluable in linking records of accidents that occurred at the same geographical location. Furthermore, the names and Personal Identifiers of individuals involved in accidents offer a means of linkage, especially in cases where the same individuals are involved in multiple incidents.

Moreover, a comprehensive data integration strategy should involve a robust data governance framework that defines roles, responsibilities, and data stewardship. This ensures data security, compliance with privacy regulations, and maintenance of data quality throughout the integration process. Data validation and quality assurance procedures, including outlier detection and error correction, are critical to maintaining data integrity.

To achieve the standardization of accident data across a multitude of stakeholders, encompassing hospitals, emergency medical services, police, and insurance companies, a systematic approach to guarantee uniformity in data collection, definitions, and formats is needed. A series of steps must be undertaken:

1. Identify key data elements: Initiate the process by identifying critical data elements that necessitate standardization, including patient information, injury severity, accident location, causal factors, and treatment details. These elements must maintain consistency across all participating stakeholders.
2. Define standard data formats: Establish standardized data formats and structures for each data element, which may encompass defining data types (e.g., text, date, numerical), units of measurement, and acceptable values.
3. Utilize common data standards: Whenever feasible, make use of existing national or international data standards. For medical data, the adoption of standards like ICD-10 can prove

highly beneficial, while standardized accident report forms can be employed by law enforcement agencies.

4. Develop data collection protocols: Craft explicit data collection protocols or guidelines for each stakeholder, delineating how, when, and where data should be collected.
5. Implement data validation checks: deploy validation checks to verify that the data adheres to the defined standards. These checks can encompass range checks, consistency checks, and assessments of data completeness.
6. Data entry software: develop or select data entry software or systems that guide users in entering data according to standardized formats. This may involve user-friendly interface like District Health Information System (DHIS-2).

3.3.5. COMPONENT 5: Quality Assurance

It is important to implement quality control measures to validate data accuracy, completeness, and consistency. Conduct regular audits to identify and rectify errors or discrepancies. Establish a feedback mechanism enabling stakeholders to report issues or propose improvements in the standardization process. The pursuit of continuous improvement is essential for keeping the standards current and relevant.

3.3.6. COMPONENT 6: Data storage

Following the successful integration of various accident data sources, it is essential to establish a secure and easily accessible data repository. This repository serves as the centralized hub for storing the amalgamated data. Opting for a secure data warehouse or a cloud-based platform is pivotal to ensure data integrity, accessibility, and reliability. A data warehouse provides structured storage and efficient management, maintaining the data's security while offering standardized tools for retrieval and analysis. On the other hand, cloud-based platforms offer the advantage of scalability and remote accessibility, permitting authorized users to access the data from anywhere. Regardless of the choice between a data warehouse and a cloud-based system, the primary objective remains to create a robust repository that guarantees the security of the integrated data. This repository is the cornerstone for data utilization, playing a crucial role in advancing road safety, facilitating coordinated emergency responses, and evidence-based policymaking to reduce accidents and their associated impacts.

The preparation of guidelines on how to use the digital form on handheld devices effectively as well as the preparation of guidelines for the retrieval and transfer of data from handheld devices to a local or server database are required.

3.3.7. COMPONENT 7: Data analysis

To gain actionable insights from this integrated dataset, advanced analytics techniques like data science should be applied to uncover trends, patterns, and risk factors contributing to accidents. It is also necessary to utilize reporting tools. These tools, encompassing data visualization software and reporting dashboards, play a pivotal role in gleanable valuable insights from the integrated data. Guidelines for using the desktop application for data analysis, crucial for formulating road safety policies, strategies, and action plans are also needed. Implement training programs to ensure personnel's comprehension and adherence to these protocols.

3.3.8. COMPONENT 8: Training and education

Training and education are pivotal aspects of the integrated road accident data system's establishment. Their significance lies in equipping personnel across different data sources with a profound understanding of the essential role data integration plays. Through comprehensive training programs, individuals gain insights into the nuances of data integration and adhere rigorously to established protocols. This encompasses not only the theoretical aspects but also practical training on utilizing specialized data entry software effectively. Moreover, personnel receive education on the legal and ethical considerations, especially concerning data privacy and confidentiality, ensuring that sensitive information is handled with the utmost care. This comprehensive approach to training fosters a culture of data integrity and guarantees that all contributors are well-prepared to uphold the standards, ultimately enhancing road safety, emergency response, and evidence-based policymaking. Of note, it is essential to train designated stakeholders on data recording, transfer, and storage practical real-case data recording for three consecutive months to identify necessary modifications. Instruction about data processing, including converting raw data to indicators, creating blackspot maps, and data mining is also needed. Training also includes the effective use of processed data to identify problems, risk factors, prioritize areas, and set goals, including performance monitoring. The success of these training activities is evaluated through real-case tests, trainee assessments, and post-training surveys, ensuring effective capacity building to support the development of evidence-based road safety policies and strategies.

3.3.9. COMPONENT 9: Reporting and dissemination

Establishing an effective system for reporting and sharing accident data is of paramount importance in enhancing road safety. This holistic approach guarantees that data is accessible to a wide audience, which includes data providers, the general public, stakeholders, and policymakers. Regular reports should be generated and published, encompassing vital statistics, emerging trends, and valuable insights. Interactive data visualization dashboards should provide real-time exploration of accident data, offering customizable views for deeper insights. Geospatial visualization tools must be employed to map accident locations and assess intervention impacts. Public awareness campaigns, stakeholder engagement, and feedback mechanisms should be actively pursued. Tailored reports for policymakers are essential, ensuring data informs policies. Data accessibility should be facilitated through user-friendly platforms, while educational programs rooted in accident data must promote safe driving practices

3.3.10. COMPONENT 10: Monitoring and evaluation

Continuous monitoring is imperative to guarantee compliance with data standards, and any instances of non-compliance must be swiftly addressed. To promote continuous improvement, a feedback mechanism should be in place, enabling stakeholders to report issues and propose enhancements to the data integration process.

3.3.11. COMPONENT 12: Funding and resource allocation

Adequate funding and resource allocation is essential for the inception, maintenance, and continuous enhancement of this system, guaranteeing its longevity and effectiveness.

3.3.12. COMPONENT 13: Research and development

A forward-thinking strategy encompasses research and development, with a commitment to ongoing advancements. This entails regular investment in improving the system's capabilities, aligning it with the latest technological innovations and evolving best practices in road safety. By embracing these core components, the integrated data system not only thrives but also stays at the forefront of road safety initiatives.

In conclusion, the establishment of an Integrated Road Accident Data System in Lebanon is a critical step toward improving road safety and emergency response. While the outlined protocol provides a comprehensive theoretical framework, it is essential to acknowledge and address the potential challenges, including political complexities, resource limitations, and privacy concerns. Success will

require a concerted effort to overcome these obstacles and ensure that the system is both effective and sustainable. Ultimately, a data-driven approach to road safety has the potential to save lives, reduce accidents, and inform evidence-based policies, thereby enhancing the safety and quality of life for all road users in Lebanon.

Synthesis

The blueprint for an Integrated RTI Surveillance System in Lebanon takes a holistic approach to address the issue RTIs in Lebanon. It recognizes the need for an integrated system that involves multiple stakeholders, including healthcare institutions, law enforcement bodies and emergency management services. This holistic perspective ensures that all aspects of RTI surveillance are considered, leading to a more effective and inclusive system. By focusing on data integration and standardization, this protocol aims to resolve the problem of data fragmentation. This is a significant strength as integrated data provides a complete and more accurate picture of RTIs. Integrated data enhances the ability to identify trends, risk factors, and hotspots, enabling more precise interventions. In addition, the emphasis on real-time data reporting and analysis ensures that decision-makers have access to up-to-date information. This can lead to more timely interventions and improved road safety measures. Timely data can be a lifesaver in emergency response situations and is essential for evidence-based policymaking. Furthermore, the study promotes collaboration among various stakeholders. Involving healthcare professionals, law enforcement agencies, and relevant entities enhances the likelihood of successful implementation. Collaborative engagement fosters a sense of shared responsibility and expertise, increasing the chances of comprehensive data collection and effective policy implementation.

However, establishing and maintaining an integrated RTI surveillance system is resource-intensive. It may require significant financial and human resources, which could be a limitation for Lebanon given its economic challenges. Finding sustainable funding sources and efficient resource allocation will be critical to addressing this limitation. In addition, handling sensitive health data and sharing it among different entities raises concerns about data privacy and security. Ensuring robust data protection measures will be essential but challenging. Developing stringent protocols and safeguards to protect data integrity and privacy is imperative. Furthermore, implementing a new system often faces resistance from existing processes and stakeholders. Convincing all parties to adopt the proposed changes may be a barrier. Therefore, effective change management strategies, including stakeholder engagement and communication, will be crucial in overcoming this resistance.

In terms of implications, a successful integrated RTI surveillance system can significantly improve road safety in Lebanon. Timely and accurate data will inform evidence-based interventions, leading to a reduction in RTIs. Lives can be saved, and injuries reduced through targeted safety measures. In

addition, policymakers will have access to data-driven insights, allowing them to formulate effective road safety policies. This can lead to better resource allocation and targeted interventions. Evidence-based policies are more likely to yield positive outcomes and protect the public. Of note, the data collected can also support further research and analysis on RTIs, contributing to the body of knowledge in this field. This research can benefit not only Lebanon but also provide valuable insights for global road safety efforts.

Of note, to ensure the successful implementation of the integrated RTI surveillance system in Lebanon, a set of crucial strategies and connectors can be strategically employed. Initially, engaging with international organizations and potential donors is of paramount importance. This will not only help secure the necessary funding but also tap into technical expertise required for the establishment of the system. Additionally, collaboration with legal experts and organizations specializing in data protection and privacy is essential. Developing robust legislation that aligns with international data protection standards is crucial to safeguard sensitive health data. Furthermore, fostering inter-agency cooperation among healthcare institutions, law enforcement bodies, and other relevant entities is pivotal for effective collaboration. Leveraging existing public health networks and associations can provide a valuable pathway for engaging healthcare professionals in training and capacity-building programs. Transparent and open communication channels, including regular meetings and workshops, should be established to facilitate ongoing stakeholder engagement and consensus-building.

Incorporating technology partnerships is vital for enabling real-time data reporting and analysis solutions, which can significantly enhance the system's effectiveness. Collaborating with research institutions can contribute to the broader body of knowledge regarding RTIs, fostering a culture of continuous learning and improvement. Civil society organizations can play a critical role in advocating for the system and promoting its benefits to the wider community.

Drawing guidance from experienced practitioners in the field is invaluable, as their insights can help navigate potential challenges and ensure the system's success. Moreover, regular monitoring and evaluation mechanisms should be integrated to serve as connectors for assessing the system's effectiveness and identifying areas for improvement. This iterative approach will enable Lebanon to overcome its resource and data privacy challenges, establishing a robust, evidence-based road safety system that ultimately saves lives and reduces injuries on its roads

Appendix G1: Stakeholders' objectives, priorities, resources, previous involvement in Road safety initiatives and stance on road safety issues

Stakeholder	Objectives and Priorities	Resources	Previous Involvement	Stance on Road Safety
Ministry of Public Health	- Protect and improve public health and injury prevention.	- Public health data, healthcare policymaking.	- Piloting of hospital RTI surveillance system	Focusing on healthcare aspects of RTCs
MoIM (ISF)	- Enforce traffic laws, ensure public safety, oversee accident data, accident investigation,	- Law enforcement agencies, traffic management.	- Actively involved in road safety enforcement and regulations. Crash investigation	Committed to improving road safety through law enforcement.
Lebanese Civil Defense	- Respond to accidents and emergencies, transport RTF	- Personnel, equipment, accident response training.	- Responds to accident scenes, collaborates with agencies.	Committed to improving accident response and reducing injuries.
Lebanese Red Cross and other EMS	- Provide timely emergency medical services, maintain injury data.	- Ambulances, medical personnel, emergency response expertise.	- Respond to accident scenes, maintain injury records.	Supportive of road safety measures to reduce injuries.
Insurance Companies	- Handle accident claims, contribute data for risk assessment.	- Vast databases of accident-related data.	- Actively involved in providing data for research.	Supportive of measures that reduce accidents and claims.
International Organizations (WHO)	- Provide global guidance on RTI prevention and data collection.	- Expertise, research, global best practices.	- Collaborates with countries to improve road safety policies.	Advocate for evidence-based road safety
Non-Governmental Organizations	- Promote road safety awareness, advocate for policy changes.	- Volunteers, awareness campaigns, advocacy efforts.	- Active in promoting road safety through education, advocacy.	Strong advocates for road safety improvements.
Hospitals and Healthcare Facilities	- Provide medical care to accident victims, contribute to injury data.	- Medical staff, facilities, patient data.	- Treating RTIs, data collection.	Supportive of measures to reduce RTIs

Re Researchers/Academics	- Conduct research on accident and injury data for insights.	- Research expertise, resources.	facilities, academic	- Contribute valuable research findings to road safety efforts.	Advocates for evidence-based road safety policies.
CNRS	- Engage in scientific research, influence data-related research.	- Research expertise.	facilities,	- Actively involved in scientific research related to road safety.	Advocates for research-driven approaches to improve road safety.
Scientific Research Foundation	- Contribute to research efforts, influence data utilization.	- Research expertise, collaboration networks.		- Actively involved in supporting research initiatives.	Supports evidence-based road safety measures.

AppendixG2: Level of interest and influence of stakeholders in road safety data utilization in Lebanon

Stakeholder	Level of Influence	Level of Interest	Role/Position
MOPH	High	High	Key Decision-Maker, Influencer, data provider
MoIM/ISF	High	High	Key Decision-Maker, Influencer, data provider
Lebanese Civil Defense	Moderate	High	Influencer, Supporter
Lebanese Red Cross and other EMS	Moderate	High	Influencer, Supporter, data provider
Insurance Companies	High	Moderate	Influencer, Data Provider
International Organizations (e.g., WHO)	Moderate	Moderate	Influencer, Global Standards Provider
NGOs such as YASA and Kunhadi	Moderate	High	Influencer, Supporter, Advocate
Hospitals and Healthcare Facilities	Moderate	Moderate	Data Provider, Potential Influencer
Emergency Medical Services	Moderate	High	Influencer, Supporter, Data provider
Researchers and Academics/universities	Moderate	Moderate	Influencer, Knowledge Provider
CNRS /LOCR	Moderate	Moderate	Research, Data provider and Knowledge Provider
Scientific Research Foundation	Moderate	Moderate	Research and Knowledge Provider

Appendix G3: Roles, attitudes, and levels of participation of each stakeholder in the proposed RTI data system

Stakeholder	Roles	Attitude	Participation
MOPH/ESU	Data collectors, data managers, data users	Supporter	Advisers, consultants, collaborating partners, members of a working group
MoIM/ISF	Data collectors	Supporter	Advisers, consultants, collaborating

			partners
Lebanese Civil Defense	Data collectors	Supporter	Advisers, consultants, collaborating partners
Hospitals and Healthcare Facilities	Data collectors	Supporter	Advisory support, collaborative partners
Insurance Companies	Data collectors, data managers	Supporter	Advisers, collaborative partners
NGOs		Supporter	Advocacy, awareness
Kunhadi	Advocacy for road safety	Supporter	Advisers, consultants, collaborating partners
YASA	Road safety awareness	Supporter	Advisers, collaborating partners
Emergency Medical Services (LRC)	Data collectors, data managers, data users	Supporter	Advisers, consultants, collaborating partners
Researchers and Academics	Conduct studies, data managers, data users	Supporter	Advisory support, collaborative partners
International Organizations (WHO)	Guidance on injury prevention, data collection	Supporter	Collaborative partners
CNRS/LOCR	Scientific research related to road safety	Supporter	Advisers, consultation, collaborating partners
SRF	Research efforts related to road safety	Supporter	Advisers, consultancy, collaborating partners

Ministry of Transport	Road infrastructure and regulatory oversight	Supporter	Advisers, consultants, collaborating partners
------------------------------	--	-----------	---

Appendix G4: Stakeholders needs, Expectations and concerns

Stakeholder	Needs	Expectations	Concerns
Ministry of Public Health	- Accurate injury data for policy and trauma care allocation.	- Timely access to comprehensive accident and injury data.	- Insufficient data quality or coverage hindering public health responses.
MoiM/ISF	- Reliable accident data for traffic management and law enforcement.	- Timely and accurate accident reports for enforcing traffic laws.	- Incomplete or delayed data potentially impacting traffic safety measures.
Ministry of Transport	Traffic data, infrastructure, RTC data, blackspots	Reliable data and accurate location of accidents	-Inaccurate RTC locations
Lebanese Civil Defense	- Data on accident locations and severity for emergency response.	- Access to accurate and up-to-date accident information.	- Lack of real-time data access potentially delaying response efforts.
EMS (Lebanese Red Cross)	- Timely injury data to enhance emergency medical services.	- Access to accurate injury data for efficient emergency response.	- Delayed or incomplete data hindering timely medical assistance.
Insurance Companies	- Detailed and accurate accident data for risk assessment.	- Reliable and comprehensive accident and injury information.	- Incomplete/unreliable data affecting risk assessment and claims processing.
International NGOs (WHO)	- Comprehensive and standardized accident data for global comparisons and guidance.	- Access to high-quality injury data for developing global standards.	- Inconsistent or incomplete data limiting their ability to provide effective guidance.
NGOs (e.g., Kunhadi and YASA)	- Reliable data to support	- Access to accurate road	- Limited data access potentially

	advocacy and awareness	crash data for informing initiatives.	hindering advocacy efforts.
Hospitals and Healthcare Facilities	- Injury data for medical treatment and research.	- Access to timely and comprehensive RTI information.	- Delayed or incomplete data affecting patient care and research efforts.
Researcher/Academics	- Access to accident and injury data for research purposes.	- Reliable and comprehensive data for meaningful research.	- Limited data access potentially hindering research efforts.
CNRS/LOCR	- Quality accident and injury data for scientific research.	- Access to comprehensive and reliable data for research projects.	- Limited data availability potentially affecting research outcomes.
SRF	- Access to data for research support.	- Reliable data facilitating research initiatives.	- Data limitations impacting their ability to support research effectively.

Appendix G5: Assessment of data sources

Appendix G5-A: Police data

The police data in Lebanon encompasses a nationwide scope, managed and maintained by various regional police departments. However, while it provides data on RTCs there are significant limitations regarding completeness, precision in location data, and the reporting of minor incidents with no injuries or significant damage. The data primarily focuses on RTI and offers insights into the causes of crashes. Yet, it is essential to note that minor RTCs are commonly underreported, which could introduce inaccuracies. There's a lack of standardized definitions for injuries and severity distinctions, affecting data accuracy. While it serves traffic management and law enforcement purposes, there's a need for advanced tools and technology for more in-depth data analysis. The subjectivity in accident analysis, variations in interpreting variable definitions, and a disconnect between those completing incident forms and data entry personnel may introduce discrepancies. These factors collectively shape the data landscape of ISF data in Lebanon, providing both valuable insights and challenges for road safety assessments and policy-making.

On the positive side, opportunities for enhancement police data include improving data quality through comprehensive training for law enforcement officers and data entry personnel. Standardization efforts to develop clear definitions for injuries and severity distinctions could contribute to more accurate and consistent data. Investment in advanced tools and technology for data analysis could enable a deeper exploration of accident patterns and trends. Collaborating with international organizations and experts presents the opportunity to align data reporting with international standards, fostering greater accuracy and relevance.

However, there are also notable threats to the reliability and utility of this data source. Inaccurate reporting of RTCs and RTIs, especially in the absence of standardized definitions, poses a significant threat to data accuracy. Data gaps resulting from missing reports or errors in data entry may hinder coanalysis and limit the insights gained from the data. Resource constraints, both financial and human, could restrict efforts to improve data quality and analysis capabilities, limiting the potential for informed decision-making. Subjective judgments in accident analysis introduce the risk of inconsistent assessments and reporting, impacting the reliability of the data. Additionally, strict data

access limitations driven by privacy concerns may hinder external research and analysis efforts, limiting the broader utility of the data.

When it comes to reporting RTCs, various factors come into play that can determine whether the police are informed and involved in the RTC. Police availability is not always guaranteed especially during the economic crisis, as their response depends on their proximity to the accident location. There are also situations where the police arrive at the scene but choose not to formally register the RTC. This can occur if the accident is relatively minor, and the parties involved agree to handle the follow-up themselves. It may also happen when there are no immediate injuries apparent at the accident site. Even when a RTC is formally registered, it doesn't guarantee comprehensive data collection. This is often due to attending officers lacking the necessary training, expertise, interest, or time to accurately record all essential details. Such limitations can lead to inaccuracies in the documented information, including the misclassification of injury severity. Furthermore, data recorded at the accident scene may not always find its way into the central crash database, and errors can be introduced during the data entry process. The transfer of accident data from decentralized locations to a central processing hub can be challenging and may result in data loss or errors. For further information, refer to Part III, chapter 1.

Assessment of police data	
Data Source	ISF (Police) data in Lebanon
Strengths	<ul style="list-style-type: none"> - Comprehensive data on road traffic crashes. - Contains information about road user types, vehicle involvement, and crash locations. - Provides insights into the causes of crashes as assessed by law enforcement officers. - Data collection is usually standardized using a form and systematic. - Reliable data for fatal crashes due to legal reporting requirements.
Timeliness	<ul style="list-style-type: none"> - Can serve as a foundation for traffic safety analysis and policy development. - Investigation and data collection occurs promptly after crash accident. - Timely reporting of fatal crashes (legal requirements)
Completeness	<ul style="list-style-type: none"> - Lack data on minor crashes or incidents with no injuries or significant damage. - Completeness may vary across regions in Lebanon - Precise location data (e.g., map coordinates) may not be consistently available
Data Quality	<ul style="list-style-type: none"> - Data quality is compromised due to potential inaccuracies introduced at various stages of the data process. - Underreporting of road accidents, especially minor incidents, may lead to inaccuracies in representing road safety issues. - Critical details such as contributing factors, road conditions, and driver behaviours may be missing or incomplete. - Inaccuracies may be introduced by ISF officers or data entry personnel - Disconnect between those completing incident forms at the scene and data entry personnel. - Variations in the interpretation and application of variable definitions can lead to discrepancies.

- Lack of standardized definition for injuries and clear severity distinctions.
- Limited capacity for accident analysis due to the absence of advanced tools and technology for data analysis.
- Subjective judgments and personal conclusions of police officers may introduce subjectivity into accident assessments.
- Some elements of crash assessment are subjective, such as determining the primary cause of RTCs

Underreporting	- Common underreporting of non-fatal crashes and minor incidents.
Subjectivity	- Subjective judgments and personal conclusions in accident analysis.
Definitions	- Fatal definition not standardized, they didn't adopt the definition of RTF. A road traffic fatality (RTF) was defined as a person involved in a RTC who either died immediately or within 30 days due to the crash [12]. Lack of proper assessment of accident and injury severity.
Jurisdiction	- Nationwide coverage within Lebanon. - Managed and maintained by various regional police departments.
Data Processing	- Data is typically collected at the crash scene by police officers and entered into electronic databases (Oracle) - May involve manual entry reporting systems.
Accessibility	- Accessible to law enforcement agencies and government authorities for traffic management and law enforcement purposes. - Limited external access due to privacy concerns, unless authorized for specific research or reporting. - May be used for traffic safety assessments, policy-making, and targeted enforcement efforts.

Appendix G5-B: RTI-hospital based surveillance system

The Hospital-based RTI surveillance system in Lebanon provides comprehensive data on RTI in Bekaa province. The dataset employs standardized forms, ICD-10 coding, and severity scores for accuracy. The data undergoes a meticulous verification process, including categorization and coding using ICD-10 and the application of severity scores like RTS, ISS, and TRISS. However, it faces underreporting and potential bias due to varying reporting practices in private hospitals (Youssef, Salameh, Al Shaar, Ghosn, & Salmi, 2024). Additionally, the passive reporting approach may introduce bias, potentially impacting the representativeness of the dataset. Geographically limited to Bekaa, external disruptions like COVID-19 and economic crises affect operationalism of the system. Accessibility is restricted to the MOPH and authorized researchers, subject to privacy regulations.

It is noteworthy that this system currently stands in a state of dormancy due to the acute shortage of human resources, which affects not only the MOPH but also hospitals, rendering the system's operation and maintenance an uphill task. Additionally, the system faces stiff competition from other pressing priorities, diverting both attention and resources away from its vital functions. Consequently, this invaluable data source, which has the potential to offer crucial insights into road traffic injuries, remains untapped and silent. To reawaken and maintain the system, substantial investments will be imperative, encompassing the recruitment of skilled personnel, infrastructural enhancements, financial support, and, above all, a renewed dedication to tackling road safety challenges within the nation. For further information, refer to Part III, Chapter 1.

	Assessment of hospital-based RTI surveillance data
Data Source	Road Traffic Injury Hospital-based Data, MOPH, Lebanon
Strengths	<p>Comprehensive data collection from Bekaa province's Emergency Departments (EDs), Capturing both fatal and non-fatal injuries resulting from RTCs.</p> <p>Standardized data collection forms aligned with international recommendations.</p> <p>Rigorous data verification, categorization, and coding using ICD-10 of RTI</p> <p>Use of severity scores (RTS, ISS, and TRISS)</p> <p>Efficient data entry and cleaning through Epidata Software.</p> <p>Provides valuable insights into RTIs for research and policymaking.</p>
Limitations	<p>Underreporting: Variability in reporting practices among privately-run hospitals in the Bekaa region may lead to underreporting. Injuries treated at hospitals may go unrecorded, as they might not participate in surveillance or be obligated to document RTI data.</p> <p>Passive reporting approach may introduce bias affecting dataset representativeness.</p> <p>Information Quality: Information bias is possible when RTI cases provide inaccurate or incomplete contact information.</p> <p>Reliability: Data from RTI cases or their families may be unreliable due to desirability bias.</p> <p>Coverage: Limited national coverage. Disruptions: Impact from COVID-19 pandemic and economic crisis.</p> <p>Timeliness: Delays in data availability.</p> <p>Limitations in data dissemination may hinder its wider use and impact.</p> <p>Individuals with minor injuries often avoid seeking formal medical attention.</p> <p>Limited access of injured people to healthcare facilities is a barrier.</p> <p>Some injuries may lack a clear cause or may not be disclosed by the patient.</p>

	Health workers may not record all necessary injury details due to insufficient training, expertise, interest, or time.
Jurisdiction	Focus on the Bekaa province and its EDs.
Data Movement Process	Passive reporting from Bekaa province hospitals to ESU via standardized forms. ESU verifies data completeness and clarity, actively contacts data sources for missing information. Data categorized, coded, and cleaned using ICD-10 and Epidata Software.
Accessibility	Accessible to the MOPH and authorized researchers, subject to data privacy regulations and permissions. Limited national coverage may affect data accessibility beyond the Bekaa province.
Completeness	Data Completeness: may be compromised if hospitals in the Bekaa region do not consistently report all RTIs Timeliness: Delays in reporting may hinder the dataset's timeliness and its ability to capture the most recent RTI trends.
Timeliness	Data Reporting: Timely reporting from Bekaa province hospitals to the ESU is critical for the dataset's usefulness in monitoring and responding to RTIs. Any delays in data reporting may limit the dataset's ability to capture and respond to emerging trends promptly. Analysis: Once received, timely data entry, categorization, and cleaning are essential to ensure that the dataset is up-to-date and ready for analysis by public health officials and researchers.
Data Capture	Standardization: Standardized data collection forms and a passive reporting system enable the systematic capture of RTI-related information from EDs in the Bekaa province. The ESU's meticulous verification process ensures that the captured data is complete, clear, and accurate, enhancing its reliability for subsequent analysis.

Appendix G5-C: Ministry of Public Health: Hospital-based mortality surveillance

This data source is focused on fatalities arising from road accidents and pertains to healthcare facilities within its jurisdiction, covering the geographical areas in proximity to these facilities. This dataset is robust in terms of the availability of estimates of population coverage and completeness, providing comprehensive insights into fatalities occurring within the scope of healthcare facilities' reporting. It functions as a census, diligently capturing data on all road traffic fatalities within its defined jurisdiction, rather than relying on a sample.

The primary focus of this data source is on documenting fatalities, and it is highly specialized in this regard, with a particular emphasis on fatalities resulting from road accidents. Non-fatal injuries and damage-only crashes fall outside its core scope. While the data source doesn't explicitly provide a standardized definition for fatalities, it is geared toward capturing fatalities within the healthcare jurisdiction. Data transfer from crash scenes to the central database is typically conducted in near-real-time, ensuring that fatalities are recorded promptly. The employment of electronic reporting methods further enhances the accuracy and timeliness of data transfer. Accessibility to this dataset is typically regulated and requires authorization from the MOPH.

Once granted access, authorized personnel can harness the data for research and analysis focused on road traffic fatalities within healthcare facilities. While it might not have formal linkages with other databases or sectors, its utilization is primarily informal, concentrated on research within the healthcare context. Data quality is bolstered by the participation of healthcare professionals in data collection, ensuring a certain level of training and expertise in data systems and medical accuracy. However, it's important to note that the uniformity of training among staff at various healthcare facilities may vary, potentially introducing variations in data quality.

Hospital-based mortality surveillance

Aspect	Description
Strengths	<ul style="list-style-type: none"> - Provides detailed and reliable data on fatalities resulting from road accidents. - Offers insights into the causes and circumstances of fatal accidents. - Can help identify trends and high-risk areas. - Involves healthcare professionals in data collection, ensuring medical accuracy. - Records fatalities promptly as they occur, providing near-real-time data on fatal accidents. - Typically provides timely data on fatal accidents, as fatalities are reported promptly. - Data is coded using ICD-10 for analysis, enhancing research capabilities. -Electronic reporting method
Limitations	<ul style="list-style-type: none"> - Passive reporting method -Does not provide a comprehensive view of road traffic injuries, as it focuses solely on fatalities. - May miss fatalities that occur outside healthcare facilities or where medical attention is not sought. - Reporting practices may vary between healthcare facilities. - Limited to fatal accidents and does not capture non-fatal injuries. - Accuracy and completeness depend on the diligence of healthcare facility staff.
Timeliness	<ul style="list-style-type: none"> - Records fatalities promptly as they occur, ensuring near-real-time data on fatal accidents. - Allows for quick response to emerging road safety issues.
Completeness	<ul style="list-style-type: none"> - Provides complete data on fatal accidents within the scope of its jurisdiction. - Includes comprehensive details on the circumstances and causes of fatalities.

Data processing	- Data processing includes coding for analysis, enhancing its utility for research and policy development.
Accessibility	- Data is accessible to authorized personnel for analysis and research purposes after approval of the MOPH
Data Quality	- Involves healthcare professionals in data collection, contributing to data accuracy and quality.
Jurisdiction	- Covers fatalities within the jurisdiction of hospitals and healthcare facilities involved in patient care and reporting road accident fatalities.

APPENDIX G5-d: EMERGENCY medical services (Red cross)

The data managed by the Red Cross is primarily dedicated to cataloging RTC that entail injuries necessitating early rescue services (Banstola & Mytton, 2017). Its geographical scope coincides with the areas in Lebanon where the Red Cross operates to provide immediate medical assistance. While the provided information does not explicitly state estimates of population coverage or completeness, it can be reasonably inferred that this data source encompasses a substantial share of accidents involving injuries demanding the intervention of early rescue services. The completeness of the data might fluctuate depending on the extent of the Red Cross's involvement.

This data source functions as an exhaustive census of incidents, encompassing the entire spectrum of accidents within its predefined scope. It is committed to capturing all relevant incidents that necessitate early rescue services and does not rely on sampling methods. The paramount focus of this data source is the meticulous documentation of accidents involving injuries that demand immediate medical attention. It predominantly concentrates on non-fatal injuries that require critical care and does not extensively cover fatalities or accidents leading solely to property damage (PDO).

As for data transfer from the crash scene to the database, the procedure for collecting data predominantly involves swift data transfer from the accident scene to the central database. The central objective is to record accidents as they transpire, concurrently ensuring the provision of immediate care. Electronic reporting methods are employed to streamline data transfer, consequently enhancing both the promptness and accuracy of this process. Access to the data sourced from the Red Cross may fluctuate, typically mandating authorization from the organization. Once this authorization is secured, users can obtain access to the data for analytical and research purposes. Data quality is bolstered by the direct involvement of healthcare professionals in the data collection process, ensuring a certain degree of training and expertise in data systems and medical accuracy. However, the absence of integration with other databases may impede comprehensive data linkage and cross-referencing for more holistic analyses.

Assessment of EMS data

Aspect	Description
Strengths	<ul style="list-style-type: none"> - Provides data on road accidents for cases involving injuries requiring immediate medical assistance. - Offers insights into the nature of injuries sustained by accident victims and the medical care provided. - Focuses on responding to accidents and providing critical care to injured individuals. - Collects data related to accidents it responds to promptly. - Handles a significant portion of injured individuals in Lebanon, offering a broad dataset.
Limitations	<ul style="list-style-type: none"> - Data collection is primarily focused on injured parties and the medical care provided, lacking comprehensive accident details. - Does not typically transport fatalities and only recorded fatalities that occurred immediately, as this responsibility often falls to other agencies like the police or civil defense. - May not be involved in reporting all accidents, leading to underreporting. - Data may lack information on accident causes, contributing factors, road conditions, and vehicle details. - Accessibility and data consistency may vary, impacting reliability for analysis. <p>Not all injured individuals are transported by early rescue services, as severity of injuries may vary.</p> <ul style="list-style-type: none"> - No information about RTCs leading to property damage only (PDO)
Timeliness	<ul style="list-style-type: none"> - Collects data related to accidents it responds to promptly, providing timely information for injuries requiring immediate care.
Completeness	<ul style="list-style-type: none"> - Provides a comprehensive dataset for accidents requiring their services.
Jurisdiction	<ul style="list-style-type: none"> - Focuses on accidents involving injuries and requiring early rescue services within Lebanon.

Data Processing	- Data processing may be limited in terms of in-depth analysis, as the primary focus is on immediate medical care.
Accessibility	- Data may vary in accessibility impacting its use for analytical purposes. Not integrated with
Data Quality	- Data quality may vary depending on the diligence of Red Cross teams, potentially affecting data accuracy and reliability.

APPENDIX G5-E: Insurance companies

The scope of this data source extends across the entire nation and encompasses all RTCs leading to insurance claims within the country. It is dedicated to capturing accidents associated with insurance claims, serving the population engaged with insurance policies. However, the completeness of this data may fluctuate depending on the diverse reporting practices and policies of individual insurance companies. The primary focus of this data source revolves around the documentation of RTCs that result in insurance claims which encompass a spectrum of occurrences, ranging from minor damage-only crashes to more severe RTCs involving non-fatal injuries. While fatalities may also find their way into this dataset, their inclusion is secondary to the core focus on insurance-related aspects. This data source doesn't lay out specific definitions for the types of events it captures, whether they be fatalities, injuries, or damage-only crashes. Typically, the process of data transfer here revolves around the submission of insurance claims. This process can exhibit variability but often leverages electronic reporting methods, thereby augmenting the promptness and precision of data transfer. Claims-related information, which includes details about RTCs, makes its way into insurance databases, often via real-time electronic reporting systems. Access to data from this source is contingent upon the policies and practices of individual insurance companies. This data source primarily caters to internal purposes within the insurance industry, particularly concerning risk assessment and policy pricing. Personnel involved in data systems typically receive training to guarantee data accuracy and reliability, although the extent of training and the tools employed can vary among different insurance entities and organizations. Data accessibility may encounter restrictions attributed to privacy and confidentiality concerns.

INSURANCE COMPANIES DATA

Aspect	Description
Strengths	<ul style="list-style-type: none"> - Offers a rich dataset on road accidents, including claims and insurance-related information. - Provides a broad and varied source of accident data due to its extensive involvement in compensation and policy pricing - Utilizes vast databases of accident-related data for risk assessment - Has access to comprehensive information on accidents and claims submitted by policyholders. - Actively contributes data for road safety research and analysis, enhancing its utility.
Limitations	<ul style="list-style-type: none"> - Focuses on accidents that lead to claims, potentially underrepresenting minor accidents and incidents without claims. - May not collect comprehensive accident details such as contributing factors, road conditions, or injury specifics. - Data availability depends on the reporting practices and policies of insurance companies. - Privacy and confidentiality concerns can restrict external access to data. - Data may primarily pertain to accidents that result in insurance claims, leading to potential gaps in the dataset. - Not all accidents may result in claims, limiting the dataset's scope.
Timeliness	<ul style="list-style-type: none"> - Provides timely data based on claims submitted to insurance companies.
Completeness	<ul style="list-style-type: none"> - Offers a comprehensive dataset for accidents that result in insurance claims.
Jurisdiction	<ul style="list-style-type: none"> - Captures accidents nationwide that result in insurance claims, providing a broad perspective.
Data Processing	<ul style="list-style-type: none"> - Often uses advanced data analysis tools and expertise to assess risk and inform policy pricing.
Accessibility	<ul style="list-style-type: none"> - Accessibility to data may be restricted due to privacy and confidentiality concerns.
Data Quality	<ul style="list-style-type: none"> - Data quality can be high due to the extensive use of insurance data for risk assessment and policy pricing.

APPENDIX G5-f: Vital statistics

The civil registration system has a deep-rooted legal framework dating back to the early 20th century (Martin et al., 2018). The first registration law was established in 1924, setting the stage for the comprehensive registration of life events like births, deaths, marriages, and divorces. Subsequently, a pivotal decree in 2000 brought about substantial changes to the civil registration system, addressing issues related to citizenship and further reinforcing its legal foundation. This system operates under a centralized organizational structure, overseen by the General Directorate of Civil Affairs, a key administrative body functioning under the Ministry of Interior and Municipalities. Its primary mandate revolves around meticulously registering vital events, ensuring the accuracy and integrity of these records. From a technical perspective, the registration of deaths in Lebanon necessitates a medical certificate that explicitly indicates the cause of death. Moreover, the presence of witness (es) corroborates the documentation process. The civil registration system offers comprehensive coverage, encompassing the entire population of the country and providing a thorough registration of deaths. Vital statistics originate from two primary agencies: the general directorate of civil affairs and the central administration for statistics. However, it's worth noting that while data on deaths are available, information regarding infant deaths or foetal deaths may not be comprehensively recorded. Despite its strengths, the civil registration and vital statistics systems encounter notable limitations. Challenges related to human resources and technological capacities are apparent, often stemming from staffing shortages and inadequate training. Furthermore, the vital statistics system faces issues like coverage, completeness, missing data, and misclassification, impacting the accuracy and reliability of cause of death information.

VITAL STATISTIC DATA

Aspect	Description
Legal Framework	- The legal framework dates back to the first law in 1924, which specified the registration of births, deaths, marriages, and divorces. A decree in 2000 restructured the civil registrar, including citizenship-related issues.
Organizational Structure	- Centralized under the General Directorate of Civil Affairs, which is under the MoIM. It is responsible for registering vital events such as births, deaths, marriages, and divorces.
Technical Aspects	- For death registration, a medical certificate indicating the cause of death and the presence of witness(es) are required.
Coverage	-Covers the entire population in the country. - The registration of deaths is likely to be complete
Sources of Vital Statistics	- Two agencies in Lebanon produce vital statistics: the General Directorate of Civil Affairs and the Central Administration for Statistics (CAS).The General Directorate of Civil Affairs compiles statistics based on civil registration. The CAS for Statistics collects vital statistics through sample surveys and other sources. Data on deaths are available. No data on infant/foetal deaths.
Limitations	- Challenges in human and technology capacities, including a lack of staff and training. Coverage: Percentage of the population covered by medical certification of the cause of death. - Completeness: Percentage of all deaths assigned a medically certified cause of death. - Missing Data: Occurrence of missing data on death certificates. Misclassification occurs when doctors aren't sufficiently trained to record and code the underlying cause of death accurately.

APPENDIX G5-G: LOCR

The LOCR database offers real-time access to Lebanon's road accident data, aiding authorities, emergency services, and researchers . It provides a long-term dataset for trend analysis, aiding road safety insights and interventions. Its reliability and global relevance make it valuable for research and policymaking. However, it relies on social media for data, potentially introducing bias, lacks fine-grained data, and focuses on trends, not causation analysis. Despite these limitations, it is timely, covers Lebanon comprehensively, and utilizes NLP for efficient data handling.

LOCR data

Aspect	Description
Strengths	<ul style="list-style-type: none">- Real-Time Accessibility: LOCR is the sole real-time and openly accessible Lebanese database dedicated to spatio-temporal road accidents, enabling swift responses by authorities, emergency services, and researchers.- Longitudinal Data: It offers a substantial historical dataset for trend analysis and insights into road safety developments over the years.- Trend Analysis: Specialization in trend analysis of road accidents utilizing spatio-temporal data, furnishing valuable insights into long-term road safety patterns.- High-Risk Area Identification: Helps identify high-risk areas and target interventions effectively.- Support for Research and Policy: Supports evidence-based research and policymaking for the development of effective strategies for accident reduction.- Resource Allocation: Government agencies benefit from LOCR's data for resource allocation, directing funding and initiatives to areas with a higher incidence of accidents.- Utility for Emergency Services: Provides utility to emergency response services by promptly identifying accident locations and severity for efficient resource allocation.- Data Reliability: LOCR's data credibility is well-established, having been employed in multiple research projects.- Global Relevance: The data contributes to the understanding of road safety challenges and solutions on an international scale, attracting potential support and expertise from the global community.
Limitations	<ul style="list-style-type: none">- Data Source Bias: LOCR relies on social media platforms like Twitter and Facebook for data collection, potentially introducing data source bias as it may not capture all road accidents.- Limited Detailed Data: The platform primarily focuses

on trend analysis and may not offer fine-grained data, limiting its suitability for in-depth research or comprehensive investigations. - Automated Data Collection: Automated data collection may introduce errors. - Scope: LOCR's scope primarily covers spatio-temporal trends, omitting detailed accident causation analysis or other factors contributing to accidents.

- Dependency on Social Media: The dependency on social media platforms for data collection poses potential vulnerabilities. Users should consider these strengths and limitations when utilizing LOCR data for various applications and research endeavors.

Timeliness - Provides real-time data on road accidents, facilitating immediate responses.

Completeness - Offers comprehensive data on spatio-temporal road accidents.

Jurisdiction - Covers the entire territory of Lebanon, providing a national perspective on road safety.

Data Processing - Utilizes Natural Language Processing (NLP) techniques for event collection, classification, and visualization, ensuring efficiency and reducing human error.

Accessibility - Provides open access to data, enhancing its utility for various sectors and research purposes.

Data Quality - The credibility of LOCR's data is well-established, as it has been employed in multiple research projects, attesting to its reliability as a valuable data source.

Appendix G6: End users assessment

Traffic Police	RTC reporting, law enforcement	RTC reports, witnesses	RTC date and time	Digital Dashboards	reports,	RTC type,	Number of casualties	
		RTC investigation	Location				Vehicle types involved	
		RTC scene photographs	Vehicle involved				Weather conditions	
MoIM/ ISF	Policy development, law enforcement	Government data, policy documents	Policy related data	Summaries, reports		Traffic flow data,	Road construction plans,	Environmental data
		Traffic management, safety improvement	Public safety reports, traffic flow data	in various formats		Safety awareness info,	Communityspecific data	
Ministry of Transport and Public Works	Road planning, safety improvement	Government data, policy documents	Road construction plans	Detailed digital data	reports,	Traffic flow data,	Road construction plans,	Environmental data
MOPH/ESU	Public health programs, injury surveillance	Health records, public health data	Injury description, Treatment provided	Electronic data analysis	records,	Injury severity,	Medical outcome, case management	
EMS/LCR	Emergency medical services, injury data	Emergency response data, injury reports	Injury details, Treatment details	Digital reports, data feeds		Injury severity,	case management, Medical outcome	
Insurance Companies	Claims processing, risk assessment	Policyholder claims, RTC reports	Policyholder details, RTC details	Digital reports, data feeds		Injury severity,	Claim amount	

WHO	Global injury prevention, data collection	injury data	International guidelines, data sources	Comprehensive road safety data	Digital reports, global standards	Road safety statistics, Policy and safety indicators
NGOs	Road safety advocacy and awareness	NGO reports, public awareness campaigns	Advocacy data, Awareness	Digital reports, awareness materials	Safety awareness info	
Hospitals and Healthcare Facilities	Medical treatment, research	Medical records, injury severity data	Patient demographics, Injury description	Electronic records, data analysis	Injury severity, Medical outcome	
Emergency Medical Services	Emergency response, data collection	Emergency response data, injury reports	Injury details, Treatment details	Digital reports, data feeds	Injury severity, Medical outcome	
Researchers /Academics	Academic research, data analysis	Academic journals, research data	Historical RTC data, Traffic data	Research papers, comprehensive data sets	Socioeconomic variables, Policy and safety indicators	
CNRS	Scientific research, data utilization	Research documents, scientific data	Research data, Scientific findings	Research papers, scientific formats	Research variables	
Scientific Research Foundation (SRF)	Research contributions, data utilization	Research materials, data sources	Research data, Utilization findings	Research papers, comprehensive data sets		
Local Communities	Community road safety initiatives, safety awareness	Local community reports, surveys	Local RTC data	Userfriendly maps, accessible reports	Safety awareness info	
	Civic engagement	Online forums, social media	Safety awareness campaigns		Communityspecific data	
		Local government input				
Commercial Transportation Companies	Route planning, incident response,	Realtime traffic data, incident reports	Realtime traffic data	Realtime alerts, digital feeds	RTC details	

	Fleet management, driver safety	GPS tracking data, weather information	Road conditions, closures, incidents	RTC location, time	
Academic Research Institutions	and Scholarly research, data analysis	Academic publications, research data	Research data	Research papers, comprehensive data sets	Research variables Socioeconomic variables
	Road safety studies, policy assessment	Government reports, traffic data	Traffic data Historical RTC data	Policy and safety indicators	
	Data driven decision-making	Academic journals, road safety research	Road safety data		

Appendix G7: Environmental analysis

Is there a lead agency responsible for road safety? What is it and what is its main function?	National Road Safety Council, which serves as the lead agency responsible for coordinating road safety initiatives within the country
Which are the main government departments involved in road safety decision making, and what role does each department play?	Check key stakeholders shaping road safety in Lebanon, Part II, chapter 3
What is the nature of interagency relationships?	- Interagency relationships vary, with varying degrees of collaboration. Ministries may cooperate on specific road safety projects.
Is there a road safety strategy, and does it include a data component?	No
What is the current budget for road safety in the country? Are there priorities in the budget for improvements in the field of road safety? Are there funds that might be accessed for road safety data systems?	- The specific budget allocation for road safety is not readily available. However, road safety improvements are funded through various sources, including government funds, international aid, and grants. - Adequate funding remains a critical concern. This challenge has been further amplified by the ongoing political instability and a dire economic situation. The depreciation of the

	<p>Lebanese currency has substantially eroded the purchasing power and available financial resources, making it increasingly difficult to allocate the necessary funds for road safety initiatives.</p>
<p>What are the existing policies in transport, law enforcement, health, and finance that are relevant to road safety? Do they have data components?</p>	<ul style="list-style-type: none"> - Transport: Policies include infrastructure development, vehicle safety, and public transportation improvements, with data components to monitor their impact. - New Lebanese Traffic Law aims to encourage responsible driving by strictly imposing traffic regulations, and utilizing technology like radar devices. The law covers various aspects of road safety, including setting speed limits, emphasizing seatbelt use, penalizing drunk driving and mobile phone use, and introducing fines for violations such as running red lights and illegal parking (New traffic law). It enhances pedestrian safety, regulates motorcycles, ensures public transportation safety, mandates vehicle inspections, promotes ecofriendly practices, and outlines the powers of traffic police. - Law Enforcement: Inconsistent, need improvement and enforcement policies - Health: Health policies address postaccident medical care and rehabilitation, utilizing data for healthcare planning. Finance: Financial policies allocate resources for road safety measures.
<p>Which factors in the political environment will drive change, and which will oppose it?</p>	<ul style="list-style-type: none"> - Factors driving change include increasing public awareness of road safety issues and international support for safer roads. - Factors opposing change may include budget constraints and resistance to regulatory measures.
<p>Is there adequate capacity for the implementation /improvement of data collection, data processing, data analysis, and dissemination and use of data?</p>	<ul style="list-style-type: none"> - There is a need for capacity building and coordination to enhance data collection, processing, analysis, and utilization for road safety.

Appendix G8: Proposed form for integrated data system updated from IRIS India

Proposed form: Integrated Road Traffic accident data system, Lebanon				
N.B: This form was updated from IRIS India				
Q. No.	Question	Data entry rule	Values Assigned	
FORM I				
A	PERSONAL IDENTIFICATION			
1	Governorate Code	Dropdown	Akkar	1
			North	2
			Mount Lebanon	3
			Beirut	4
			South	5
			Nabatieh	6
			Bekaa	7
			Baalbeck Hermel	8
2	Hospital Code	Dropdown	Public sector health facility	1
			Private sector health facility	2
3	Hospital name	Dropdown	The exhaustive list of hospitals	
4	User code	Numeric Box	Jan-99	
5	IRIS ID	Auto-generated. Should not allow entering or editing the field.	Will constitute the Centre code, Hospital code, User code and Serial No.	
			For e.g. IRTAD:ID: Governorate/hospcode/number of case	

Once IRIS ID is generated it should be displayed as the header of the form in display. One can save the form only after filling up to IRIS ID, before which the form cannot be saved and should be discarded. Every form should be saved with its IRISID as name.				
6	Medical Record Number (Inpatient/Out	Text Box		
7	AR Number (Accident Register	Numeric box		
8	Admission Date	Calendar pick	dd/ mm/ yyyy	
9	Admission Time	Time pick	hh:mm	
10	Respondent Name	Text Box (Alpha only)		
11	How are you related to the injured?	Dropdown	Self	1
			Family member	2
			Friend	3
			Driver	4
			Co-passenger	5
			Unknown passerby	6
			Others	997
12	Specify Relationship with injured	Text Box		
13	Do you have a	Radio button	Yes	1
			No	2

			Unknown	998
14	Enter Mobile Number of the	Numeric Box	8 digit mobile number	
15	What is the name of the Injured?	Text Box (Alpha only)		
16	Do you have mobile number? (Injured)	Radio button	Yes	1
			No	2
			Unknown	998
17	Enter Mobile number of the injured	Numeric Box	8 digit mobile number	
18	Do you know the address of the injured?	Radio Button	Yes	1
			No	2
19	Governorate of Injured	Dropdown	All Lebanese governorates	
20	District of Injured	Dropdown	Districts of selected	

			governorate	
21	Village/Area of Injured	Dropdown	Localities of the selected district	
B	SOCIO DEMOGRAPHICAL DETAIL			
1	Age of Injured	Radio button (Text box is enabled based on Q1. If 1 is selected Text box1 and unknown is enabled, If 2 is selected Text box2 and unknown is enabled)	< 1year (In Months) – Text box1	998
			>1 year (In Years) – Text box2	
			Unknown	
2	Gender of Injured	Dropdown	Male	1
			Female	2
			Unknown	9
3	Educational status of the Injured	Dropdown	Illiterate	1
			Primary	2
			High School	3
			Higher Secondary	4
			Diploma/Certified course	5
			Graduate and above	6
			Unknown	998
4	Occupation of the Injured	Dropdown	Business	1
			Self Employed/Medium Business	2
			Professional/Executive/Managers	3
			Employee (Govt./Private)	4

			Skilled Manual (Artisians, Agriculture, Fishery...	5
			Unskilled Manual (Labour)	6
			Home maker	7
			Student	8
			Unemployed	9
			Others	997
			Unknown	998
5	Specify Occupation of the injured	Text Box		
C	ACCIDENT IDENTIFICATION DETAILS			
1	Date of accident	Date pick	dd/mm/yyyy	
2	Time of accident	Time pick (Scroll)	hh:mm	
3	Governorate of accident	Dropdown	All Lebanese governorates	
4	District of accident	Dropdown	District of selected governorate	
5	Village/Town of accident site	Dropdown	Village/town of the selected district	
6	Nearest landmark of accident site	Text Box	(GIS mapping- insert map)	
7	What is the type of accident?	Dropdown	Self-fall/Skid	1
			Crash with pedestrian	2
			Crash with parked vehicle	3
			Crash with fixed obstacle	4
			Crash with non-fixed	5

			obstacle	
			Crash between two vehicles	6
			Crash with two or more vehicles	7
			Crash with animal	8
			Others	997
			Unknown	998
9	Specify Type of Accident	Text Box		
10	What was the weather condition at the time of accident?	Dropdown	Clear	1
			Hot/dry weather	2
			Rainy	3
			Fog/Mist/Smoke/Smog	4
			Sever winds	5
			Landslide	6
			Snow	7
			Others	997
			Unknown	998
11	Specify weather condition	Text Box		
12	What was the light condition at the time of accident?	Dropdown	Excess Light	1
			Sufficient Light	2
			Partial light	3
			Insufficient Light	4
			Unknown	998
D	ROAD RELATED DETAILS			
1	What is the type of road of the accident site?	Dropdown	National highway	1
			Major District Roads (MDR)	3
			Other District roads	4

			Village Roads (VR)	5
			Unknown	998
2	What is the sub-type of the accident site	Multiple Choice	One way road	1
			Two way road	2
			Single lane	3
			Two lane road	4
			Four or above lane road	5
			Cross Road	6
			Round about	7
			Railway crossing	8
			Curve road/ Blind curve	9
			Gradient road	10
			T or Staggered junction	11
			Multiple Junction	12
			Unknown	998
3	Traffic Controlled by	Multiple choice	Traffic signal/ Rail road barrier	1
			Traffic personnel/ Railway personnel	2
			Concerned Institute/ organization personnel	3
			Public Volunteer	4
			Uncontrolled	5
			Others	997
			Unknown	998
4	Specify Traffic Control	Text Box		

5	How were the road conditions at the accident site	Dropdown	Safe	1
			Slippery (Wet/Oily)	2
			Muddy	3
			Rutted/Pot holed	4
			Flooded	5
			Snow	6
			Work under progress	7
			Others	997
			Unknown	998
6	Specify Road Condition	Text Box		
7	Do you know the Speed limit of the Road?	Dropdown	Yes	1
			No	2
			Not applicable	996
8	Enter the Speed Limit	Numeric Box		
E	VEHICLE INFORMATION			
1	How many vehicles involved in the crash?	Numeric Box		
<p>The following Questions Q2 to Q13 should repeat based on the number entered in Q1. The variable name should change with the number. For example, if 3 is entered in Q1, 3 times the Questions 2 to 13 will be repeated each time variable name number will change (Eg: E02_TypeVehcl_1 first time, E02_TypeVehcl_2 Second time and E02_TypeVehcl_3 Third time). Each set should have the label “Vehicle (number-1) Details”, the number is based on the number of times the Question set is repeated. For example, first set will have the label “Vehicle 2 Detail” and so on up to 5.</p>				
2	What was the type of vehicle involved in the accident?	Dropdown	Bicycle/ Cycle rickshaw	1
			Bullock cart	2
			Two wheeler geared	

				3
			Two wheeler non-gear	4
			Auto rickshaw	5
			Car	6
			Tempo traveler/Va n/ City ride	7
			Bus/Mini Bus	8
			Trucks/Tra ctors	9
			Lorry	10
			Others	997
			Unknown	998
3	Specify Vehicle:	Text Box		
4	What is the special function of the vehicle?	Dropdown	Personnel private vehicle	1
			Public passenger vehicle	2
			Private passenger vehicle	3
			Goods vehicle (Public/Commercial)	4
			Govt. official vehicle	5
			Others	997
			Unknown	998
5	Specify vehicle function	Text Box		
6	Vehicle manoeuvre (action taken by vehicle immediately before it become involved in crash)	Dropdown	Normal straight driving	1
			Changing lane	2
			Reversing	3
			Turning	4
			Over taking	5

			Slowing/stopping/moving off	6
			Parked	7
			Driving off the lane/ road	8
			Others	997
			Unknown	998
7	Specify vehicle manoeuvre	Text Box		
8	What is the driving licensure status of the vehicle driver?	Dropdown	Present Valid	1
			Present Invalid	2
			Absent	3
			Learners License	4
			Unknown	998
			Not applicable	996
9	Was the vehicle over speeding at the time of accident?	Dropdown	Yes	1
			No	2
			Unknown	998
10	What was the driving quality of the vehicle at the time of accident?	Dropdown	Safe driving	1
			Distracted Driving	2
			Uncontrolled d Driving	3
			Sleepless/worn out driving	4
			Unsafe driving due to health Impairment	5
			Unknown	998
F	PERSON RELATED DATA			

1	What type of road user was the injured person?	Dropdown	Driver
			Passenger
			Pedestrian
			Unknown
2	What is the seating position of the passenger	Dropdown	Front
			Rear middle
			Rear side
			On the roof
			Standing inside/ on vehicle
			Foot Board
			Pillion rider (sitting behind in two wheeler)
Unknown			
3	Pedestrian activity at the time of accident?	Dropdown	Crossing road
			Standing middle of the road
			Walking/standing along shoulder of the road
			Walking/standing in the footpath
			Unknown
4	What were the safety precautions taken by injured person at the time of accident?	Multiple choice	Seat belt worn
			Helmet worn
			Airbag present in vehicle
			Followed traffic signal
			Used Zebra crossing

			Unknown	
			Not applicable	
5	Who were Drunken/ consumed alcohol during accident?	Multiple choice	Driver of the injured vehicle	1
			Passenger/ Co-passenger of the injured vehicle	2
			Driver of the counterpart vehicle	3
			Passenger/Co-passenger of the counterpart vehicle	4
			Pedestrian	5
			Unknown	998
6	Blood Alcohol level of the injured	Numeric Box		
7	Who used Mobile phone during accident?	Multiple choice	Driver of the injured vehicle	1
			Driver of the counterpart vehicle	2
			Pedestrian	3
			Unknown	998
G	PRE-HOSPITAL ADMISSION DATA			
1	What was the time duration taken for rescue efforts after the accident happened?	Time Format		
			hh:mm	
2	How was the injured person rescued?	Dropdown	Self	1
			Known Person (Friends/ Relatives)	2

			Driver/Passenger/Co-Passenger	3
			Local People/ Passerby	4
			Police	5
			Army	6
			Disaster Response Force (State/ National)	7
			Others	997
			Unknown	998
3	Specify how was the injured person rescued	Text Box		
4	What was the reason for delay in rescuing the injured person?	Dropdown	Noticed Late	1
			Late Information given to rescue team/ Emergency transport	2
			Access difficulty (Difficult terrain or difficult to access site)	3
			Weather conditions	4
			Emergency Transport Vehicle arrived late	5
			Others	997
			Unknown	998
			Not applicable	996
5	Specify the reason for delay in rescuing the injured person	Text Box		
6	How was the injured person taken from the accident site to	Dropdown	Stretcher	1
			Sheets	2
			Hold by 2-4 peoples	3

	the transport vehicle?		Carried by people on their back	4
			Others	997
			Unknown	998
			Not applicable	996
7	Specify how was the injured person taken from the accident site to the transport vehicle	Text Box		
8	Was the injured person given first aid?	Dropdown	Yes	1
			No	2
			Unknown	998
9	Where was the first aid given?	Dropdown	At the accident site	1
			Nearby Govt. Hospital	2
			Nearby Private clinic	3
			Ambulance	4
			Others	997
			Unknown	998
10	Specify where was the first aid given	Text Box		
11	Who gave the first aid?	Dropdown	Health worker/ Nurse	1
			Ambulance technician	2
			Doctor	3
			Public	4
			Police	5
			Family members	6
			Others	997
			Unknown	998

12	Specify who gave the first aid	Text Box		
13	How was the injured person transported to health facility?	Dropdown	Self	1
			Government Ambulance	2
			Private Ambulance	3
			Commercial passenger vehicle	4
			Commercial goods vehicle	5
			Private vehicle	6
			Govt. Official vehicle	7
			Others	997
Unknown	998			
14	Specify how was the injured person transported to health facility	Text Box		
15	Number of hospitals/health facilities visited before attending the registering hospital	Numeric Box		
16	What was the first referral hospital?	Dropdown	Primary health care facility	1
			District Government Hospitals	2
			Other Government Hospitals	3
			Private hospitals	4
			Private nursing home	5
			Unknown	998
17	What was the Last referral hospital?	Dropdown	Primary health care facility	1
			District Government	2

			Hospitals	
			Other Government Hospitals	3
			Private hospitals	4
			Private nursing home	5
			Unknown	998
18	Last Referral hospital State	Dropdown	All States in India	
19	Last Referral hospital District	Dropdown	District of selected state	
20	Last Referral hospital Taluk	Dropdown	Taluk of Selected District	
21	Last Referral hospital Village/ Town/ Area	Text Box	(GIS mapping- insert map)	
22	Reason for shifting from the referral hospital?	Dropdown	Not equipped for the treatment required	1
			Specialist doctors not available	2
			Bed not available	3
			Patient's desire	4
			Others	997
			Unknown	998
23	Specify reason for shifting from the referral hospital	Text Box		
H	Emergency transport details (This section appears only if 1 or 2 is selected in Q12 of G section else skip)			
1	Whether ambulance details available?	Radio button	Yes	1

			No	2
2	Date of the call received by ambulance personnel regarding the accident? (Date)	Calendar Format	dd/mm/yyyy	
3	Time of the call received by ambulance personnel regarding the accident? (Time)	Time Format (Scroll)	hh:mm	
4	Date - ambulance reached the accident site? (Date)	Calendar Format	dd/mm/yyyy	
5	Time- ambulance reached the accident site? (Time)	Time Format (Scroll)	hh:mm	
6	Date patient dropped at the hospital? (Date)	Calendar Format	dd/mm/yyyy	
7	Time patient dropped at the hospital? (Time)	Time Format (Scroll)	hh:mm	
8	How was the patient managed in the transport vehicle during the transport from accident site to hospital?	Multiple choice	CPR	1
			Electrical defibrillation	2
			Maintained airway	3
			Bleeding controlled	4
			IV Fluid	5
			IV Blood	6

			IV / IM Drugs	7
			Positioning of the patient	8
			Others	997
			Not applicable	996
9	Specify how was the patient managed in the transport vehicle	Text Box		
10	Ambulance has the facility to record and monitor	Multiple choice	Pulse rate	1
			BP	2
			Respiratory Rate	3
			Oxygen Saturation	4
			GCS	5
			None	994
			Unknown	998
11	Ambulance pulse rate	Numeric box1 (First)		
		Numeric box2 (Last)		
12	Ambulance Systolic Blood Pressure	Numeric box1 (First)		
		Numeric box2 (Last)		
13	Ambulance Diastolic Blood Pressure	Numeric box1 (First)		
		Numeric box2 (Last)		
14	Ambulance Respiratory Rate	Numeric box1 (First)		
		Numeric box2 (Last)		

15	Ambulance oxygen saturation	Numeric box1 (First)		
		Numeric box2 (Last)		
16	Ambulance Glasgow Coma Scale (GCS)	Numeric box1 (First)		
		Numeric box2 (Last)		
I	CLINICAL DETAILS (On the day of admission)			
1	What was status of injured at the time of admission	Dropdown	Unconscious	1
			Conscious	2
			Unknown	998
2	Co morbidity Level	Dropdown	Healthy	1
			Non-Limiting	2
			Limiting	3
			Constant Threat to life	4
			Unknown	998
			Not documented	999
3	Pulse rate	Numeric box		
4	Systolic BP	Numeric box		
5	Diastolic BP	Numeric box		
6	Respiratory rate	Numeric box		
7	Oxygen Saturation	Numeric box		
8	Glasgow Coma Scale (GCS)	Numeric box		
	FORM II			
J	CLINICAL, TREATMENT AND OUTCOME DETAILS (Follow up- to be submitted during discharge/ death/ abscond / referral of the patient)			
1	User code	Numeric Box	Jan-99	
2	IRIS ID		Dropdown of the User code synced IRIS-ID	
3	What are the parts of the body	Dropdown	Head	1

	injured		Neck	2
			Thorax	3
			Abdomen, lower back, lumbar spine and pelvis	4
			Shoulder and upper arm	5
			Elbow and forearm	6
			Wrist and hand	7
			Hip and thigh	8
			Knee and lower leg	9
			Ankle and foot	10
			Multiple body regions	11
			Injuries to unspecified part of trunk limb and body	12
4	What was the nature of injuries sustained	Dropdown	Superficial injury	1
			Open wound	2
			Fracture	3
			Dislocation, sprain and strain	4
			Injury to nerves and spinal cord	5
			Injury to blood vessels	6
			Muscles and Tendons	7
			Crushing Injury	8
			Traumatic amputation	9
			Injury to internal organs	10
			Foreign body in natural orifice	11
			Burns and corrosions	12

			Other unspecified Injurie	13
5	Type of fracture	Radio button	Open	1
			Closed	2
6	Describe the injury	Text Box		
7	Injury classification as per ICD_10	Dropdown	Include only Chapter XIX up to Burns and corrosion, Certain early complications of trauma and Sequel of injuries. Cascade based on response from Q2 and Q5	
8	How is the severity of injury	Dropdown	Minor	1
			Moderate	2
			Serious	3
			Severe	4
			Critical	5
			Maximum (Untreatable)	6
9	Abbreviated injury Scale (AIS)	Dropdown	AIS 2008 code set. Cased based on Q2, Q4, Q6 And Q7.	
10	FAST Result	Dropdown	Done-Positive	1
			Done-Negative	2
			Equivocal	3
			No Facility	994
			Not done	996
			Unknown	998
11	What is the patient treatment status?	Dropdown	First Aid Provided	1
			Stabilized	2
			Treated in emergency room	3

			Definitive care (Comprehensive care)	4
			LAMA	5
			Others	997
12	Specify Treatment status	Text Box		
13	What is the Patient admission status?		Referred	1
			In hospital care (Shifted to IP/ Remains admitted)	2
			Abscond/ Left	3

14	What was the time taken to initiate treatment? (Time between admission and first aid/ stabilization/ treatment/ to declare brought dead based on options selected in Q18)	Date pick	Date format	
		Time pick	Time format	
15	Reason for delay in treatment?	Dropdown	Delay to get investigation results	1
			Doctors not available	2
			Delay in blood availability	3
			Others	997
			Not applicable	996
16	Specify, reason for delay in treatment	Text box		
17	Outcome	Dropdown	Alive	1
			Dead	2
18	Date of discharge	Calendar Format	dd/mm/yyyy	
19	Discharge summary	Text Box		
20	What is the centre referred?	Text	Primary health care facility	1
			Government Hospital	2
			Private hospitals	3
			Unknown	998

21	What was mode of transport for shifting the patient to higher centre?	Dropdown	Emergency transportation services (red cross...)	1
			Private Ambulance	2
			Private vehicle	3
			Others	997
			Unknown	998
22	Specify mode of transport for shifting patient	Text Box		
23	Date of referral	Calendar Format	dd/mm/yyyy	
24	Time of referral	Time Format	hh:mm	
25	Reason for referral	Dropdown	Not equipped for the treatment required	1
			Specialist doctors not available	2
			Bed not available	3
			Patient's desire	4
			Others	997
			Unknown	998
26	Specify reason for referral	Text Box		
27	Date of death	Calendar Format	dd/mm/yyyy	
28	Time of death	Time format	Hh:mm	
29	Cause of death	Text Box		

Appendix G9: Components of the Integrated Road Traffic Accident Data System

Component	Description
1. Aims and Core Definitions	<ul style="list-style-type: none"> - Establishing system objectives through needs assessment - Enhancing road safety by analyzing accident data - Creation of a national data repository - Closing gap between reported data and estimates - Improving emergency response and medical care - Promoting data-driven decision-making - Directing resources efficiently - Continuous monitoring and evaluation - Producing annual national reports - Facilitating knowledge exchange
2. Legal Framework and Ethical Considerations	<ul style="list-style-type: none"> - Ensuring legal compliance - Establishing data sharing protocols - Providing clear responsibilities and liabilities - Maintaining documentation and reporting
3. Stakeholder Engagement and Collaboration Framework	<ul style="list-style-type: none"> - Developing collaboration agreements - Establishing data-sharing protocols with relevant agencies
4. Data Collection and Standardization	<ul style="list-style-type: none"> - Establishing standardized digital dataset - Developing standardized protocols for data collection - Ensuring real-time or near-real-time data entry
5. Quality Assurance	<ul style="list-style-type: none"> - Implementing quality control measures - Conducting regular audits - Establishing a feedback mechanism

Component	Description
6. Data Storage	- Establishing secure and accessible data repository - Opting for data warehouse or cloud-based platform
7. Data Analysis	- Applying advanced analytics techniques - Utilizing reporting tools and dashboards
8. Training and Education	- Training personnel on data integration and protocols - Educating on legal and ethical considerations
9. Reporting and Dissemination	- Generating regular reports - Providing interactive data visualization dashboards - Employing geospatial visualization tools - Conducting public awareness campaigns
10. Monitoring and Evaluation	- Continuous monitoring for compliance - Establishing a feedback mechanism for improvements
11. Funding and Resource Allocation	- Ensuring adequate funding and resource allocation
12. Research and Development	- Commitment to ongoing advancements and improvements

APPENDIX 13: INFORMED CONSENT FOR RESEARCH PARTICIPATION

Study Title: Driver Behaviour Study in Lebanon

Principal Investigator: Dalal Youssef

You are invited to participate in a research study investigating driver behaviour in Lebanon. This study aims to gain insights into various aspects of driver behaviour, its impact on road safety, and how it may relate to individual characteristics and cultural factors specific to Lebanon. Please read this informed consent form carefully to ensure that you fully understand the nature of the study and your role in it. If you have any questions or concerns about the study, feel free to contact the principal investigator using the provided contact information.

The purpose of this study is to examine driver behaviour in Lebanon to enhance road safety measures and better understand the factors influencing driving conduct. Your participation

will contribute to a deeper understanding of road safety challenges in the country, potentially leading to improved road safety policies and interventions. There will be no foreseeable risks for this study. While there are no direct benefits to you as a participant, the findings from this study may lead to improvements in road safety measures in Lebanon, potentially benefitting the general public. Your responses will be kept strictly confidential, and all data collected will be de-identified. No personally identifiable information will be linked to your survey responses. Data will be stored securely, and only authorized researchers will have access to it. Your participation in this study is entirely voluntary. You are under no obligation to participate, and you may withdraw at any time without penalty or consequences. Your participation in this study will require approximately 10 to 15 minutes. If you have questions at any time about this study, you may contact the researcher whose contact information is provided below: dalalyoussef.esu@gmail.com

Required

By checking the box, I agree that:

I have read and I understand the provided information*

I understand that my participation is voluntary and that I am free to withdraw at any time, without giving a reason and without cost *

I voluntarily agree to take part in this study *

The participants can continue the questionnaire by agreeing to all the over mentioned statements

Date: _____

Researcher's Statement: I have explained the nature, purpose, and potential risks and benefits of the study to the participant. I have provided the participant with contact information for any questions or concerns. The participant has freely given their informed consent to participate in the study.

Researcher's Name _____

Researcher's Signature: _____

Date: _____

APPENDIX 14: QUESTIONNAIRE OF THE DRIVER BEHAVIOUR SURVEY

استبيان الدراسة حول سلوك السائقين في لبنان

هذا الاستبيان هو جزء من مشروع بحث حول تقييم السائق لسلوكه وقدراته كما ومعرفة كيفية تفاعله مع المواقف المختلفة التي تصادفه أثناء القيادة ، وعلاقة ذلك بسماته الشخصية وتأثير ذلك على احتمالية إنخراطه في صدام مروري. يتكون هذا الاستبيان من خمسة أقسام تشمل معلومات ديمغرافية حول السائق ، سلوكياته وقدراته وكل ذلك بناءً على وجهة نظره الشخصية وتقييمه الذاتي. من يقوم بتعبئة هذا الاستبيان سوف يبقى مجهول الهوية ولن يطلب منه اي معلومات شخصية. ونشير الى أن المعلومات الواردة في هذا الاستبيان هي لغرض البحث العلمي وسيتم التعامل معها بسريّة عالية. يتطلب هذا الاستبيان 10-15 دقيقة لاكماله. كما ونشجع المشاركين في هذه الدراسة على الاجابة على الأسئلة بشكل موضوعي. مشاركتك في هذه الدراسة _ dalalyoussef.ipnet@gmail.com طوعية وستكون محل تقدير كبير. لمزيد من المعلومات يمكن الاتصال عبر البريد الالكتروني:

في حال موافقتك على المشاركة، الرجاء تعبئة الموافقة المستنيرة المرفقة ومن ثم القيام بتعبئة الإستمبيان

القسم الأول : معلومات ديمغرافية

	العمر	1
2. أنثى	الجنس	1. ذكر
4. غيره	الجنسية	1. لبناني 2. سوري 3. فلسطيني
4. عاطل عن العمل	الوظيفة	1. طالب 2. أعمل كسائق 3. أعمل ولكن ليس كسائق
4. مطلق	الوضع الإجتماعي	1. اعزب 2. متزوج 3. أرمل
5. ماستر أو أكثر	المستوى التعليمي	1. لا أجد القراءة أو الكتابة 2. ابتدائي /متوسط 3. BTثانوي أو TSجامعي أو 4.
.....	عدد افراد الاسرة	7

أقل من مليون ليرة	1 مليون مليون	2 مليونين - ملايين	3 أكثر من 4 ملايين	الدخل الشهري للأسرة	8
لا يوجد	1	2 (2-3)	3 أكثر من 3	عدد السيارات في المنزل	9
نعم	1	2 لا	3	رخصة قيادة	10
خصوصي	1	2 عمومي	3	نوع رخصة القيادة	11
سيارة	1 سيارة / 2 BUS فان / 3 دراجة نارية	4 شاحنة	5	نوع المركبة	12
الترفيه/ الزيارات الاجتماعية	1 الذهاب والعودة الى العمل	2	3	الاستعمال الأساسي للمركبة	13
2 wheels	1	2 4 wheels	3	قوة المركبة	14
				عدد سنوات الخبرة في القيادة	15
0-2000 km	1 2000-4000 km	2 4000-6000 km	3 6000-8000 km	عدد الكيلومترات المقطوعة سنويا	16
نعم	1	2 لا	3	صدامات مرورية في السنوات الثلاث الماضية	18
				عدد الصدامات مرورية في السنوات الثلاث الماضية	19

20	أنواع الصدمات المرورية(1)	1. أضرار مادية	2. إصابات جسدية	3. وفاة
20	أنواع الصدمات المرورية(2)	1. أضرار مادية	2. إصابات جسدية	3. وفاة
21	عدد المرات التي تم ضبطك من قبل شرطة السير في السنة الماضية			
22	أنواع المخالفات التي تم ضبطك	1. مخالفات السرعة	2. الاشارات الضوئية	3. حزام الامان
		4. مخالفات استخدام الهاتف اثناء القيادة	5. قياده (عكس السير)	6. الاصطاف (الركن) الخاطئ
				7. مخالفات اخرى (يرجى التحديد)

القسم الثاني: سلوك السائق

يرجى الاجابة عن الاسئلة التالية استنادا الى افضل تقدير لديكم، يرجى اختيار اجابة واحدة فقط عن كل سؤال						
دائما	معظم الاحيان	غالبا	احيانا	نادرا	ابدا	
5	4	3	2	1	0	تحاول الابتعاد والتملص من اشارات المرور
5	4	3	2	1	0	عند التحقق من عداد السرعة، اكتشفت انك تقود بسرعة أكبر من السرعة المسموح بها

5	4	3	2	1	0	تخرج من السيارة وتنسى المفاتيح في الداخل	3
5	4	3	2	1	0	تقود بنفس السرعة في الليل على الطرقات المعتمة كما على الطرقات المضاءة	4
5	4	3	2	1	0	تحاول الخروج بالمركبة من خط او من من موقف(صفة) دون اعطاء اشارة تحذيرية	5
5	4	3	2	1	0	ضويلا وطفيلا) كإشارة لحث السائق الذي أمامكFlash تقترب كثيرا من المركبة التي أمامك او تشغل الضوء (على الإسراع أو افساح الطريق	6
5	4	3	2	1	0	Parking)تنسى أين ركنت مركبتك في موقف للسيارات)	7
5	4	3	2	1	0	بسبب التلهي أو الإنشغال، أدركت متأخرا أن المركبة التي أمامك تباطأت وأن عليك الدوس على الفرامل لتجنب الصدام(الحادث)	8
5	4	3	2	1	0	كنت تنوي تشغيل ماسحات الزجاج الأمامي(المساحات) ، ولكنك قمت بتشغيل الأنوار بدلاً من ذلك ، أو العكس	9
5	4	3	2	1	0	انعطفت نحو طريق رئيسي ذو حركة سير معاكسة وتفاجأت بمركبة (سيارة، دراجة نارية...) قادمة حيث أنك لم ترها أو أخطأت في تقدير السرعة	10
5	4	3	2	1	0	أسأت تقدير المساحة اللازمة لركن المركبة في موقف/على الطريق واصطدمت (ضربت) بالسيارة المجاورة.	11
5	4	3	2	1	0	لا تتذكر بشكل واضح الطريق التي سلكتها للتو	12
5	4	3	2	1	0	فاتك المخرج (المكان المخصص للخروج من الطريق) وعليك أن تقوم بجولة (لقة) طويلة للعودة	13
5	4	3	2	1	0	وأنت تقود المركبة نسيت الغيار الذي تستعمله و عليك التأكد من ذلك بيدك	14
5	4	3	2	1	0	عالق وراء مركبة تسير ببطء على طريق سريع يدفعك انزعاجك لمحاولة تجاوزها إما من الجهة الخاطئة أو من الجهة الصحيحة على الرغم من خطورة ذلك	15
5	4	3	2	1	0	تريد الذهاب المكان (أ) فتنتبه انك تقود المركبة على الطريق الخاطئ (ب) لكونه الطريق الذي تسلكه بالعادة	16
5	4	3	2	1	0	تجازف بالمرور والاشارة تحولت الى اللون الأحمر	17
5	4	3	2	1	0	اغضبك تصرف أحد السائقين،تشتتمه أو تستخدم الزمور أو تقوم بحركة بذيئة أو تلاحقته لتوبيخه و للتعبير عن	18

						انزعاجك	
5	4	3	2	1	0	لديك فوراً من فئة معينة من مستخدمي الطريق ، تحاول ابراز امتعاضك و عداؤك بأي وسيلة يمكنك من خلالها ذلك	19
5	4	3	2	1	0	حاولت التجاوز بدون النظر (تفحص) في المرايا فكادت أن تصدم بك سيارة من الخلف حيث أنها كانت قد باشرت بالتجاوز قبلك	20
5	4	3	2	1	0	تتجاهل عمدا السرعة المحددة على الطريق اذا كنت تقود في وقت متأخر من الليل أو في وقت باكر في الصباح أو في غياب شرطي	21
5	4	3	2	1	0	تتسى تاريخ انتهاء صلاحية التأمين او رسوم الميكانيك أو صلاحية رخصة السوق(أوراق السيارة)...وتكتشف أنك تقود سيارتك بطريقة غير قانونية	22
5	4	3	2	1	0	(FLASH)نسيت المصابيح الأمامية (مضاءة) الى أن قام أحد السائقين بتنبيهك ب)	23
5	4	3	2	1	0	تنتبه جيداً لحركة المرور اذا كان هناك خط من المركبات التي تتعطف إلى الطريق الرئيسي حيث أنت موجود	24
5	4	3	2	1	0	، تقود المركبة على الرغم من أنك تدرك أنه من الممكن أنك تجاوزت PUB عند العودة من حفلة أو مطعم أو الحد القانوني لنسبة الكحول الدم	25
5	4	3	2	1	0	وانت غارق في أفكارك وانتباهك مشتت(تلهي)، لم تلاحظ وجود شخص ينتظر العبور عند ممر المشاة أو شخص يخرج من وراء حافلة أو يريد الذهاب إلى شارع جانبي من طريق رئيسي	26
5	4	3	2	1	0	تركن (توقف السيارة) في مكان ممنوع الوقوف على الرغم من خطر الغرامة	27
5	4	3	2	1	0	تخطئ في تقدير سرعة للمركبة القادمة باتجاهي عند التجاوز	28
5	4	3	2	1	0	اصطدمت بشيء عند الرجوع الى الخلف لم يسبق لك رؤيته أو التنبه له	29
5	4	3	2	1	0	لم تقم بتخطيط مسارك بشكل جيد ، فواجهت ازدحام المروري كان من الممكن أن تتفاداه	30
5	4	3	2	1	0	تجاوزت خط واحد من المركبات التي تتحرك ببطء ، فقط لتكتشف أنها تنتظر لتعبر من فتحة (حارة) واحدة	31

						أوبسبب أشغال	
5	4	3	2	1	0	بتقص الكوع" اي تقطع الزاوية على المنعطف الأيمن وتضطر إلى اللف " الانحناء (اللف) بعنف لتفادي مركبة قادمة	32
5	4	3	2	1	0	دخلت في الطريق الخطأ عند المستديرة (الدوار) أو عند الاقتراب من تقاطع طريق	33
5	4	3	2	1	0	فشلت في قراءة الارشادات (الاشارات) بشكل صحيح ، خرجت من المستديرة الى الطريق الخطأ	34
5	4	3	2	1	0	سيارة (اعطت اشارة بنيئها بالخروج من "الصفة" او تغيير الخط،Bus, Van لم تنتبه لمركبة)	35
5	4	3	2	1	0	تجاهلت اشارة ,,إفسح الطريق" ، وأصبح عليك أن تتجنب بصعوبة الاصطدام بالمركبات المتجهة في الطريق الصحيح	36
5	4	3	2	1	0	فشلت في التحقق من المرأة قبل الانسحاب ، وتغيير الممرات والانعطاف....	37
5	4	3	2	1	0	حاولت تجاوز مركبة لم تكن قد لاحظتها تشير إلى عزمها على التوجه إلى اليمين	38
5	4	3	2	1	0	تتعهد السير في الطريق الخطأ في شارع في اتجاه واحد ولكنه قليل الحركة	39
5	4	3	2	1	0	تتجاهل الأضواء الحمراء والصفراء عند القيادة في ساعة متأخرة من الليل	40
5	4	3	2	1	0	تقوم أثناء القيادة بالتلهي بتغيير قناة راديو ، المكيف، استعمال الهاتف...إلخ.	41
5	4	3	2	1	0	تنخرط(تدخل) في سباقات غير رسمية مع السائقين الآخرين	42
5	4	3	2	1	0	تسابق السيارات القادمة على طريق ضيق باتجاه فتحة صغيرة (مخرج)	43
5	4	3	2	1	0	تدوس على الفرامل بقوة على طريق زلق أو توجه بطريقة خاطئة في طريق منزلق	44
5	4	3	2	1	0	تسيء تقدير الوقت اللازم للعبور الخاص بي عندما تتعطف وبصعوبة تتجنب الصدام.	45

القسم الثالث: قدرات السائق						
هناك العديد من الاختلافات بين السائقين ، خاصة في ما يتعلق بمهارات القيادة. نحن جميعا لدينا عناصر قوية وضعيفة. يرجى من حضرتك تقييم قدراتك ومهارتك بصراحة من خلال اختيار الإجابة التي تناسب كل عنصر.						
قوي بكل تأكيد 4 =	قوي =3	ليس ضعيف قوي وليس قوي 2=	ضعيف =1	بكل ضعيف تأكيد 0=		
4	3	2	1	0	القيادة والأداء في الحالة مرورية حرجة.	1
4	3	2	1	0	القيادة خلف سيارة بطيئة دون نفاذ(فقدان) الصبر.	2
4	3	2	1	0	إدارة السيارة والسيطرة عليها خلال الترحيل.	3
4	3	2	1	0	توقع الحالات المرورية المقبلة.(ازدحام، صدام، تغيير طريق....)	4
4	3	2	1	0	القيادة بتأنٍ وحذر.	5
4	3	2	1	0	معرفة كيفية التصرف في الحالات المرورية الطارئة والاستثنائية.	6
4	3	2	1	0	التنقل بطلاقة من خط لخط (المناوره) عندما تكون حركة السير كثيفة.	7
4	3	2	1	0	ردود فعل سريعة على أي طارئ.	8
4	3	2	1	0	الأخذ بعين الاعتبار مستخدمي الطريق الآخرين.	9
4	3	2	1	0	الحفاظ على الهدوء في المواقف المزعجة.	10
4	3	2	1	0	السيطرة على السيارة.	11

4	3	2	1	0	تجنب المزاحمة في القيادة.	12
4	3	2	1	0	الحفاظ على مسافة أمان كافية مع السيارة التي أتبعها.	13
4	3	2	1	0	القيادة على التل عند منحدر حاد	14
4	3	2	1	0	تجاوز المركبات	15
4	3	2	1	0	التخلي عن الأحقية المشروعة في قانون السير عند الضرورة	16
4	3	2	1	0	احترام حدود السرعة	17
4	3	2	1	0	تجنب المخاطر غير الضرورية	18

القسم الرابع : الغضب أثناء القيادة

4	3	2	1	0	تقبل أخطاء السائقين الآخرين بهدوء	19
4	3	2	1	0	ركن السيارة في مكان ضيق عكس السير	20

تخيل أنك موجود في المواقف التي تم وصفها أدناه. أجب بصراحة عما كان سيحدث لك فعليًا عبر بتقييم مقدار الغضب الذي تشعر به. الرجاء اختيار إجابة واحدة						
#	لاشيء على الإطلاق	قليلا	بعض الشيء	كثير	كثيرا	جدا
1	1	2	3	4	5	شخص ما في سيارة أمامك لا يتحرك على الفور عندما تتحول الإشارة إلى اللون الأخضر
2	1	2	3	4	5	يقود بسرعة كبيرة بالنسبة لظروف الطريق شخص ما
3	1	2	3	4	5	يسير أحد المشاة ببطء في منتصف الشارع ، مما يجبرك على التباطؤ
4	1	2	3	4	5	شخص ما يقود ببطء شديد خارج الخطر(الحارة)، ويعطل حركة المرور
5	1	2	3	4	5	شخص ما يقود ويقترب كثيرا بسيارته من الجزء الخلفي لسيارتك
6	1	2	3	4	5	شخص ما يناور داخل وخارج حركة المرور
7	1	2	3	4	5	تقطع الطريق أمامك مباشرة على الطريق السريع سيارة
8	1	2	3	4	5	شخص ما يقوم بأخذ مكان وقوف السيارة الذي تنتظره
9	1	2	3	4	5	شخص ما يقود ببطء أكثر مما يتماشى حركة المرور
10	1	2	3	4	5	سيارة بطيئة على طريق متعرج لا تسمح لك بالمرور وتسمح للناس بالمرور
11	1	2	3	4	5	ترى سيارة شرطة تراقب حركة المرور من موقع مخفي .
12	1	2	3	4	5	شخص ما يتراجع أمامك مباشرة دون النظر في المرايا
13	1	2	3	4	5	(Flasher) شخص ما يضع إشارة توقف
14	1	2	3	4	5	سيارة قادمة باتجاهك ولا تضيء المصابيح الأمامية في الليل
15	1	2	3	4	5	في الليل ، شخص ما يقود سيارته خلفك ويشعل الأضواء ساطعة(العالية)

5	4	3	2	1	قطعت طريق مراقب برادار مخفي	16
5	4	3	2	1	سائق سيارة ما يقوم بزيادة السرعة عندما تحاول تجاوزه	17
5	4	3	2	1	شخص بطيء في ركن السيارة ويعيق حركة المرور	18
5	4	3	2	1	أنت عالق في ازدحام المرور (عجقة سير)	19
5	4	3	2	1	شخص ما يندفع بلا مبالاة أمامك مباشرة	20
5	4	3	2	1	شخص ما يقوم بحركة فاحشة حول قيادتك	21
5	4	3	2	1	حفرة عميقة لم تكن ملحوظة نزلت في.	22
5	4	3	2	1	سيارة شرطة تقود بالقرب من سيارتك	23
5	4	3	2	1	شخص ما يزمرك لك اعتراضا على سلوكك في قيادة السيارة	24
5	4	3	2	1	شخص ما يقود أكثر بكثير من الحد الأقصى للسرعة	25
5	4	3	2	1	أنت تقود السيارة خلف شاحنة تحتوي على مواد غير مثبتة جيدا وتتطاير من الخلف	26
5	4	3	2	1	شخص يصرخ عليك بسبب طريقة قيادتك للسيارة	27
5	4	3	2	1	سائق دراجة نارية يمر في منتصف الممر ويبطئ حركة المرور	28
5	4	3	2	1	تم إيقافك من قبل شرطي السير	29
5	4	3	2	1	أنت تقود السيارة وراء مركبة ينبعث منها الدخان بقوة	30
5	4	3	2	1	الشاحنة التي تسير أمامك تقذف الرمال أو الحصى على السيارة التي تقودها	31
5	4	3	2	1	أنت تقود خلف شاحنة كبيرة تعيق لك الرؤيا ولا تستطيع أن ترى من حولها	32
5	4	3	2	1	واجهت أشغال عامة(بناء, صيانة) واضطرت للعودة	33

القسم الخامس : أسباب الصدمات

في هذا المقياس ، ستجد قائمة بالأسباب المحتملة للحوادث. يرجى الإشارة إلى أي مدى كان من الممكن أن تكون هذه الأسباب الستة عشر قد تسببت أو ستنسبب في وقوع حادث وذلك وفقاً لأسلوب وظروف القيادة الخاصة بك.					
#	غير ممكن أبداً	غير ممكن	ليس ممكن وليس غير ممكن	ممكن	ممكن للغاية
1	1	2	3	4	5
2	1	2	3	4	5
3	1	2	3	4	5
4	1	2	3	4	5
5	1	2	3	4	5
6	1	2	3	4	5
7	1	2	3	4	5
8	1	2	3	4	5
9	1	2	3	4	5
10	1	2	3	4	5

					متاخم (قريب جدا) من سيارتي	
5	4	3	2	1	وقوع حادث سيارة أو لا: يرتبط غالباً بالقضاء والقدر	11
5	4	3	2	1	الجوية أو ظروف الإضاءة ووقوع حادث سيارة أو لا: يرتبط بسوء الأحوال .	12
5	4	3	2	1	وقوع حادث سيارة أو لا: يرتبط بحصول عطل ميكانيكي في السيارة	13
5	4	3	2	1	وقوع حادث سيارة أو لا: يرتبط غالبا بسائقين آخرين يقودون تحت تأثير الكحول	14
5	4	3	2	1	وقوع حادث سيارة أو لا: يرتبط غالبا بالتجاوز الخطير الذي يقوم به السائقون الآخرون	15
5	4	3	2	1	وقوع حادث سيارة أو لا: يرتبط غالبا بالتجاوز الخطير الذي أقوم به	16

APPENDIX 15: MODIFICATIONS SUGGESTED BY THE REVIEW COMMITTEE ON THE TRANSLATED VERSION OF DBQ

Item	Translation	Sentence in the English DBQ	Minor modifications added in English	Suggested modification in Arabic	Final (Updated to the Slang language)
DBQ1	تحاول الابتعاد والتخلص من اشارات المرور	Attempt to drive away from traffic lights		تحاول التهرب من اشارات المرور	بتحاول تتهرب من إشارات السير
DBQ2	عند التحقق من عداد السرعة، اكتشفت انك تقود بسرعة أكبر من السرعة المسموح بها	Check your speedometer and discover that you are unknowingly travelling faster than the legal limit		اكتشفت أنك تسوق بسرعة أكبر من السرعة المحددة على الطريق عند التحقق من عداد السرعة	اكتشفت لما اطلعت على عداد السرعة أنك سابق أكثر من السرعة المسموحة على الطريق
DBQ3	تخرج من السيارة وتنسى المفاتيح في الداخل	Lock yourself out of your car with the keys still inside		وجدت نفسك خارج السيارة وقد نسيت مفاتيحك في الداخل	بتطلع من السيارة وبتترك المفاتيح بقلبا
DBQ4	تقود بنفس السرعة في الليل على الطرقات المظلمة كما على	Drive as fast along country roads at night		أنت تسوق بالسرعة نفسها ليلاً على الطرقات المعتمة كما على الطرقات	بتسوق بنفس السرعة بالليل على الطرقات المعتمة مثل ما بتسوق عالطرقات المضيوية

	الطرق المضاءة	on dipped lights as on full beam	المضاءة	
DBQ5	تحاول الخروج بالمركبة من خط او من موقف (صفة) دون اعطاء اشارة تحذيرية	Attempt to drive away without first having switched on the ignition	تحاول الخروج بالمركبة من خط او صفة بدون اعطاء اشارة	بتطلع من خط أو من صفة بلا ما تعطي إشارة
DBQ6	تقترب كثيرا من المركبة التي أمامك او تشغل الضوء العالي (ضويلا وطفيلا) كإشارة Flash) لحث السائق الذي أمامك على الإسراع أو افساح الطريق	Drive especially close or “flash” the car in front as a signal for that driver to go faster or get out of your way	تقوم بالاقتراب كثيرا من المركبة التي أمامك وبتضويلا وبتطفيل لدفع السائق الي أمامك للإسراع أو فتح الطريق أمامك	بتقرب كثير من السيارة التي قدامك وبتضويلا وبتطفيل لتجبر السائق الذي قدامك يسرع أو يعطيك طريق
DBQ7	تنسى أين ركنت (صفيت) مركبتك (سيارتك) في موقف (Parking للسيارات)	Forget where you left your car in a car parking	تنسى أين ركنت (صفيت) مركبتك (Parking) (سيارتك) في موقف للسيارات)	بتنسى وين صفيت سيارتك في موقف (Parking للسيارات)
DBQ8	بسبب التلهي أو الإنشغال، أدركت متأخرا أن المركبة التي أمامك تباطأت وأن عليك الدوس على الفرامل (تدعس فريم) لتجنب (الصادم) الحادث	Distracted or preoccupied, realize belatedly that the vehicle ahead has slowed, and have to	بسبب التلهي أو الإنشغال، أدركت متأخرا أن المركبة التي أمامك تباطأت وأن عليك الضغط على الفرامل (تدعس فريم) لتجنب (الصادم) الحادث	بسبب أنك كنت ملتهى أو منشغل انتبهت متأخرا إنو المركبة التي قدامك تباطأت وإنو لازم تدعس فريم لتفادي الحادث

		slam on the brakes to avoid a collision			
DBQ9	كنت تنوي تشغيل مساحات الزجاج الأمامي(المساحات) ، ولكنك قمت بتشغيل الأضواء بدلاً من ذلك ، أو العكس	Intend to switch on the windscreen wipers, but switch on the lights instead, or vice versa		كنت تنوي تشغيل مساحات الزجاج الأمامي(المساحات) ، ولكنك قمت بتشغيل الأضواء بدلاً من ذلك ، أو العكس	كنت ناوي تشغل المساحات بس شغلنا الأضوية بالغلط أو أي شي ثاني أو بالعكس
DBQ10	انعطفت نحو طريق رئيسي ذو حركة سير معاكسة وتفاجأت بمركبة (سيارة، دراجة نارية....) قادمة حيث أنك لم ترها أو أخطأت في تقدير السرعة	Turn left on to a main road into the path of an oncoming vehicle/cyclist that you hadn't seen, or whose speed you had misjudged	Motorist/Cyclist was added	انعطفت نحو طريق رئيسي ذو حركة سير معاكسة وتفاجأت بمركبة (سيارة، دراجة نارية....) قادمة حيث أنك لم ترها أو أخطأت في تقدير السرعة	لفيت باتجاه طريق وحركة سير معاكسة وتفاجأت بمركبة (سيارة، دراجة نارية....)جايي باتجاهك بس إنت ما كنت شايفها وأخطأت في تقدير السرعة
DBQ11	أسأت تقدير المساحة اللازمة لركن المركبة في موقف/على الطريق واصطدمت (ضربت) بالسيارة المجاورة.	Misjudge your gap in a car park and nearly (or actually) hit adjoining vehicle		أسأت تقدير المساحة اللازمة لركن المركبة في موقف/على الطريق واصطدمت (ضربت) بالسيارة المجاورة.	أسأت تقدير المساحة اللازمة لصف المركبة في موقف/على الطريق واصطدمت (ضربت) بالسيارة المجاورة.
DBQ12	لا تتذكر بشكل واضح الطريق التي سلكتها للتو	“Wake up” to realize that you have no clear		لا تتذكر بشكل واضح الطريق التي سلكتها للتو	لا تتذكر بشكل واضح الطريق التي سلكتها للتو

		recollection of the road along which you have just travelled			
DBQ13	فاتك المخرج (المكان المخصص للخروج من الطريق) وعلّيك أن تقوم بجولة (لّفة) طويلة للعودة	Miss your exit on a motorway and have to make a lengthy detour		فاتك المخرج (المكان المخصص للخروج من الطريق) وعلّيك أن تقوم بجولة (لّفة) طويلة للعودة	فاتك المخرج (المكان المخصص للخروج من الطريق) وعلّيك أن تقوم بجولة (لّفة) طويلة للعودة
DBQ14	وأنت تقود المركبة نسيت الغيار الذي تستعمله وعلّيك التأكد من ذلك بيدك	Forget which gear you are currently in and have to check with your hand		وأنت تقود المركبة نسيت الغيار الذي تستعمله وعلّيك التأكد من ذلك بيدك	وأنت تقود المركبة نسيت الغيار الذي تستعمله وعلّيك التأكد من ذلك بيدك
DBQ15	عالق وراء مركبة تسير ببطء على طريق سريع يدفعك انزعاجك لمحاولة تجاوزها إما من الجهة الخاطئة أو من الجهة الصحيحة على الرغم من خطورة ذلك	Stuck behind a slow-moving vehicle on a two-lane highway, you are driven by frustration to try to overtake in risky circumstances (on the inside, or hard shoulder of a		عالق وراء مركبة تسير ببطء على طريق سريع يدفعك انزعاجك لمحاولة تجاوزها إما من الجهة الخاطئة أو من الجهة الصحيحة على الرغم من خطورة ذلك	عالق وراء سيارة تسير ببطء على طريق سريع يدفعك انزعاجك من ذلك لمحاولة تجاوزها إما من الجهة الخاطئة أو من الجهة الصحيحة على الرغم من خطورة الأمر

		motorway)			
DBQ16	تريد الذهاب الى المكان (أ) فتنبته انك تقود المركبة على الطريق الخاطئ (ب) لكونه الطريق الذي تسلكه بالعادة	Intending to drive to destination A, you „wake up“ to find yourself on route to B, where the latter is the more usual journey		تريد الذهاب الى المكان (أ) فتنبته انك تقود المركبة على الطريق الخاطئ (ب) لكونه الطريق الذي تسلكه بالعادة	تنوي الذهاب الى المكان (أ) فتنبته انك تسوق السيارة على الطريق الخاطئ باتجاه المكان(ب) حيث أنه الطريق الذي تسلكه عادة
DBQ17	تجازف بالمرور والاشارة تحولت الى اللون الأحمر	Take a chance and cross on lights that have turned red		تجازف بالمرور على الرغم من تحول اشارة السير الى اللون الأحمر	تجازف بالمرور على الرغم من تحول اشارة السير الى اللون الأحمر
DBQ18	اغضبك تصرف أحد السائقين،تشتمه أو تستخدم الزمور أو تقوم بحركة بذينة أو تلاحقه لتوبيخه و للتعبير عن انزعاجك	Angered by another driver's behaviour, you give chase with the intention of giving him/her a piece of your mind		اغضبك تصرف أحد السائقين،تشتمه أو تستخدم الزمور أو تقوم بحركة بذينة أو تلاحقته لتوبيخه و للتعبير عن انزعاجك	اغضبك تصرف أحد السائقين، تشتمه أو تستخدم الزمور أو تقوم بحركة بذينة أو تلحقه لتوبيخه و للتعبير عن انزعاجك
DBQ19	لديك نفورًا من فئة معينة من مستخدمي الطريق ، تحاول ابراز امتعاضك و عداؤك بأي وسيلة	Have an aversion to a particular class of road user and indicate		لديك نفورًا من فئة معينة من مستخدمي الطريق ، تحاول ابراز امتعاضك و عداؤك بأي وسيلة يمكنك من خلالها ذلك	لديك نفورًا من فئة معينة من مستخدمي الطريق ، تحاول اظهار انزعاجك منهم بأي وسيلة ممكنة

	يمكنك من خلالها ذلك	your hostility by whatever means you can			
DBQ20	حاولت التجاوز بدون النظر (تفحص) في المرايا فكادت أن تصدم بك سيارة من الخلف حيث أنها كانت قد باشرت بالتجاوز قبلك	Try to overtake without first checking your mirror, and then get hooted at by the car behind which has already begun its overtaking maneuver		حاولت التجاوز بدون تفحص المرايا فكادت السيارة التي خلفك تصطم بك حيث أنها كانت قد باشرت بالتجاوز قبلك	حاولت التجاوز بدون تفحص المرايا فكادت السيارة التي خلفك تصطم بك حيث أنها كانت قد باشرت بالتجاوز قبلك
DBQ21	تتجاهل عمدا السرعة المحددة على الطريق اذا كنت تقود في وقت متأخر من الليل أو في وقت باكر في الصباح أو في غياب شرطي	Deliberately disregard the speed limits late at night or very early in the morning	in the absence of police or radar	تتجاهل عمدا السرعة المحددة على الطريق اذا كنت تسوق في وقت متأخر من الليل أو في وقت باكر في الصباح أو في غياب شرطي	تتجاهل عمدا السرعة المحددة على الطريق اذا كنت تسوق في وقت متأخر من الليل أو في وقت باكر في الصباح أو في غياب شرطي
DBQ22	تنسى تاريخ انتهاء صلاحية التأمين أو رسوم الميكانيك أو صلاحية رخصة السوق(أوراق السيارة)...وتكتشف أنك أقود سيارتك بطريقة غير قانونية	Forget when your road tax/insurance expires and discover that you are driving illegally		تنسى تاريخ انتهاء صلاحية التأمين أو رسوم الميكانيك أو صلاحية رخصة السوق(أوراق السيارة)...وتكتشف أنك أقود سيارتك بطريقة غير قانونية	تنسى تاريخ انتهاء صلاحية التأمين أو رسوم الميكانيك أو صلاحية رخصة السوق(أوراق السيارة)...وتكتشف أنك أقود سيارتك بطريقة غير قانونية

DBQ23	نسيت المصابيح الأمامية (مضاءة) الى أن قام أحد السائقين بتنبيهك ب (FLASH)	Lost in thought, you forget that your lights are on full beam until „flashed“ by other motorists	نسيت الأضواء الأمامية في سيارتك مضاءة الى أن قام أحد السائقين بتنبيهك (FLASH)	نسيت الأضواء الأمامية في سيارتك مضاءة الى أن قام أحد السائقين بتنبيهك (FLASH أو غيره)
DBQ24	تنتبه جيدًا لحركة المرور اذا كان هناك خط من المركبات التي تنعطف إلى الطريق الرئيسي حيث أنت موجود	In a queue of vehicles turning left on to a main road, pay such close attention to the traffic approaching from the right that you nearly hit the car in front	انت في خط من المركبات التي تلتف يسارًا نحو الطريق الرئيسي ، تقوم بالتركيز على حركة المرور التي تقترب من اليمين بحيث كادت تصطدم بالسيارة التي أمامك	انت في خط من المركبات التي تلتف يسارًا نحو الطريق الرئيسي ، تقوم بالتركيز على حركة المرور التي تقترب من اليمين بحيث كادت تصطدم بالسيارة التي أمامك
DBQ25	عند العودة من حفلة أو مطعم أو ، تقوم بالقيادة على الرغم من PUB أنك تدرك أنه من الممكن أنك تجاوزت الحد القانوني لنسبة الكحول الدم	Drive back from a party, restaurant, or pub, even though you realize that you may be over the legal blood-alcohol limit	، PUB عند العودة من حفلة أو مطعم أو تقوم بالقيادة على الرغم من أنك تدرك أنه من الممكن أنك تجاوزت الحد القانوني لنسبة الكحول الدم	تقوم بالقيادة عند العودة من حفلة على الرغم من أنك تعرف أنه من الممكن ان تكون تجاوزت الحد القانوني لنسبة الكحول الدم (المشروب)
DBQ26	وانت غارق في أفكارك وانتباهك	Lost in thought or	وانت متلهي وغارق في أفكارك ، حدث أنك	وانت متلهي وغارق في أفكارك ، حدث

	مشئت(تلهي)، لم تلاحظ وجود شخص ينتظر العبور عند ممر المشاة أو شخص يخرج من وراء حافلة	distracted, you fail to notice a pedestrian waiting to cross a pelican crossing or someone someone stepping out from behind a bus or parked vehicle		لم تلاحظ وجود شخص يريد قطع الطريق عند ممر المشاة أو شخص يخرج من وراء باص/مركبة متوقفة	أنك لم تلاحظ سواء وجود شخص يريد قطع الطريق عند ممر المشاة أو شخص يخرج من وراء باص
DBQ27	تركن (توقف السيارة) في مكان ممنوع الوقوف على الرغم من خطر الغرامة	Park on a no parking zone and risk a fine	No parking zone (this could include second parking)	تقوم بصف سيارتك في مكان ممنوع الوقوف فيه على الرغم من الغرامة التي ممكن أن تنتج عن ذلك	تقوم بصف سيارتك في مكان ممنوع الوقوف فيه على الرغم من الغرامة التي ممكن أن تدفعها بسبب ذلك
DBQ28	تخطئ في تقدير سرعة للمركبة القادمة باتجاهي عند التجاوز	Misjudge speed of oncoming vehicle when overtaking		أخطأت في تقدير سرعة السيارة القادمة باتجاهك عند قيامك بتجاوز سيارة أخرى	أخطأت في تقدير سرعة السيارة القادمة باتجاهك عند قيامك بتجاوز سيارة أخرى
DBQ29	اصطدمت بشيء عند الرجوع الى الخلف لم يسبق لك رؤيته أو التنبه له	Hit something when reversing that you had not previously seen		اصطدمت بشيء جامد لم يسبق لك رؤيته أو التنبه له عند الرجوع الى الخلف	اصطدمت بشيء جامد لم يسبق لك رؤيته أو التنبه له عند الرجوع الى الخلف
DBQ30	لم تقم بتخطيط مسارك بشكل جيد ، فواجهت ازدحام المروري كان من	Plan your route badly, so that you		لم تقم بتخطيط مسارك بشكل جيد ، فواجهت ازدحام المروري كان من الممكن أن تتفاداه	لم تقم بالتخطيط للطريق الي ستسلكه بشكل جيد ، فواجهت ازدحام المروري كان من

	الممكن أن تتفاداه	meet traffic congestion you could have avoided		الممكن أن تتفاداه
DBQ31	تجاوزت خط واحد من المركبات التي تتحرك ببطء ، فقط لتكتشف أنها تنتظر لتعبر من فتحة (حارة) واحدة أو بسبب أشغال	Overtake a single line of stationary or slow-moving vehicles, only to discover that they were queuing to get through a one-lane gap or roadwork lights		قمت بتجاوز خط واحد من المركبات التي تتحرك ببطء ، فقط لتكتشف أنها تنتظر لتعبر من فتحة واحدة أو أنه يوجد منطقة أشغال
DBQ32	بتقص الكوع" اي تقطع الزاوية على المنعطف الأيمن وتضطر إلى اللف " الانحناء (اللف) بعنف لتفادي مركبة قادمة	Cut the corner on a right-hand turn and have to swerve violently to avoid an oncoming vehicle		بتقص الكوع" وتضطر إلى اللف " الاللتفت بعنف لتفادي الاصطدام بمركبة قادمة
DBQ33	دخلت في الطريق الخطأ عند المستديرة (الدوار) أو عند الاقتراب من تقاطع طريق	Get into the wrong lane at a roundabout or approaching a road junction		دخلت في الطريق الخطأ عند المستديرة (الدوار) أو عند الاقتراب من تقاطع طريق

DBQ34	فشلت في قراءة الارشادات (الاشارات) بشكل صحيح ، خرجت من المستديرة الى الطريق الختأ	Fail to read the signs correctly, and exit from a roundabout on the wrong road	فشلت في قراءة الارشادات (الاشارات) بشكل صحيح ، خرجت من المستديرة الى الطريق الختأ	فشلت في قراءة الارشادات (الاشارات) بشكل صحيح ، خرجت من المستديرة الى الطريق الختأ
DBQ35	سيارة, Van, Bus لم تنتبه لمركبة) اعطت اشارة بنيته بالخروج من "الصفة" او تغيير الخط	Fail to give way when a vehicle is signaling its intention to pull out	سيارة (اعطت, Van, Bus لم تنتبه لمركبة) اشارة بنيته بالخروج من "الصفة" او تغيير الخط	سيارة (Van, لم تنتبه لمركبة) باص, اعطت اشارة بنيته الخروج من "الصفة" او تغيير الخط
DBQ36	تجاهلت اشارة ,,إفسح الطريق" ، وأصبح عليك أن تتجنب بصعوبة الاصطدام بالمركبات المتجهة في الطريق الصحيح	Ignore ,,give way" signs, and narrowly avoid colliding with traffic having right of way	تجاهلت اشارة ,,إفسح الطريق" ، وأصبح عليك أن تتجنب بصعوبة الاصطدام بالمركبات المتجهة في الطريق الصحيح	تجاهلت اشارة ,,إفسح الطريق" ، وأصبح عليك أن تتجنب بصعوبة الاصطدام بالمركبات المتجهة في الطريق الصحيح
DBQ37	فشلت في التحقق من المرآة قبل الانسحاب ، وتغيير الممرات والانعطاف.....	Fail to check your mirror before pulling out, changing lanes, turning, etc.	فشلت في التحقق من المرآة قبل الانسحاب . والانعطاف..... ، وتغيير الممرات	فشلت في التحقق من المرآة قبل الخروج . من الصفة ، وتغيير خط السير والانعطاف.....
DBQ38	حاولت تجاوز مركبة لم تكن قد لاحظتها تشير إلى عزمها على التوجه إلى اليمين	Attempt to overtake a vehicle that you hadn't noticed was	حاولت تجاوز مركبة لم تكن قد لاحظتها تشير إلى عزمها على التوجه إلى اليمين	حاولت تجاوز مركبة لم تنتبه أنها أعطت إشارة تريد التوجه إلى اليمين

		signaling its intention to turn right			
DBQ39	تتعمد السير في الطريق الخاطئ في شارع في اتجاه واحد ولكنه قليل الحركة	Deliberately drive the wrong way down a deserted one-way street		تتعمد السير في الطريق الخاطئ في شارع في اتجاه واحد ولكنه قليل الحركة	تتعمد السير في الطريق الخاطئ في شارع في اتجاه واحد كون حركة السير فيه خفيفة
DBQ40	تتجاهل الأضواء الحمراء والصفراء عند القيادة في ساعة متأخرة من الليل	Disregard red lights when driving late at night along empty roads		تتجاهل الأضواء الحمراء والصفراء عند القيادة في ساعة متأخرة من الليل	تتجاهل الاشارات الحمراء والصفراء عند القيادة في ساعة متأخرة من الليل
DBQ41	تقوم أثناء القيادة بالتلهي بتغيير قناة راديو ، المكيف، استعمال الهاتف....إلخ.	Drive with only „half-an-eye“ on the road while using the mobile, changing radio channel, turning on air conditioner...	Mobile was added	تقوم أثناء القيادة بالتلهي بتغيير قناة راديو ، المكيف، استعمال الهاتف....إلخ.	أثناء القيادة تقوم بالتلهي بتغيير قناة راديو ، بالمكيف، استعمال الهاتف....إلخ.
DBQ42	تتخرط(تدخل) في سباقات غير رسمية مع السائقين الآخرين	Get involved in unofficial „races“ with other drivers		تتخرط(تدخل) في سباقات غير رسمية مع السائقين الآخرين	تقوم بسباقات غير رسمية مع السائقين الآخرين
DBQ43	تسابق السيارات القادمة على	Race“ oncoming		تسابق السيارات القادمة على طريق ضيق	تسابق السيارات القادمة باتجاه فتحة

	طريق ضيق باتجاه فتحة صغيرة (مخرج)	vehicles for a one-car gap on a narrow or obstructed road		باتجاه فتحة صغيرة (مخرج)	صغيرة (مخرج) على طريق ضيق
DBQ44	تدوس على الفرامل بقوة على طريق زلق أو توجه بطريقة خاطئة في طريق منزلق	Brake too quickly on a slippery road and/or steer the wrong way in a skid		تدوس على الفرامل بقوة على طريق زلق أو توجه بطريقة خاطئة في طريق منزلق	تفرمل بقوة أو توجه المقود بطريقة خاطئة على طريق منزلق (بزحط)
DBQ45	تسيء تقدير الوقت اللازم للعبور الخاص بك عندما تتعطف وبصعوبة تتجنب الصدام.	Misjudge your crossing interval when turning right and narrowly miss collision		تسيء تقدير الوقت اللازم للعبور الخاص بك عندما تتعطف وبصعوبة تتجنب الصدام.	تسيء تقدير الوقت اللازم للعبور الخاص بك عندما تتعطف وبصعوبة تتجنب الصدام.

Note: Highlighted items incorporated the content of the five removed items

APPENDIX 16: CORRELATION MATRIX FOR THE DRIVER BEHAVIOUR QUESTIONNAIRE (DBQ-L) SUBSCALES

	Aggressive violation	Ordinary violation	Lapses	Errors
Aggressive violation	1	.559**	.442**	.544**
Ordinary violation		1	.572**	.550**
Lapses			1	.435**
Errors				1

Note: ** Correlation is significant at the 0.001 level ($p < 0.001$), * Correlation is significant $p < 0.05$

APPENDIX 17: FACTORIAL STRUCTURE OF DRIVER ANGER SCALE (DAS-A)

Factorial structure of Driver Anger Scale (DAS)

