



**HAL**  
open science

# Role and regulation of UHRF1 ubiquitination in cancer cells

Naif Almalki

► **To cite this version:**

Naif Almalki. Role and regulation of UHRF1 ubiquitination in cancer cells. Human health and pathology. Université de Strasbourg, 2022. English. ⟨NNT : 2022STRAJ007⟩. ⟨tel-05580669⟩

**HAL Id: tel-05580669**

**<https://theses.hal.science/tel-05580669v1>**

Submitted on 4 Apr 2026

HAL is a multi-disciplinary open access archive for the deposit and dissemination of scientific research documents, whether they are published or not. The documents may come from teaching and research institutions in France or abroad, or from public or private research centers.

L'archive ouverte pluridisciplinaire HAL, est destinée au dépôt et à la diffusion de documents scientifiques de niveau recherche, publiés ou non, émanant des établissements d'enseignement et de recherche français ou étrangers, des laboratoires publics ou privés.



HAL Authorization



University of Strasbourg (Unistra)  
Doctoral School of Life and Health Sciences (ED 414)  
Institute of Genetics and Molecular and Cellular Biology (IGBMC)

Thesis submitted for obtaining the degree of

**DOCTOR OF PHILOSOPHY (PhD)**

**Role and Regulation of UHRF1 Ubiquitination  
in Cancer Cells**

Presented by

**Naif Abdullah R. ALMALKI (21803439)**

**Discipline:** Molecular and Cellular Biochemistry

**Specialization:** Molecular and cellular aspects of biology

**Date of Public Defense: March 1<sup>st</sup>, 2022**

• **THE JURY MEMBERS**

Dr. Christian BRONNER

Pr. Philippe BOUCHER

Dr. Hugues de ROCQUIGNY

Pr. Jean-Luc BUEB

• **THE REPRESENTATION**

**Thesis Supervisor**

**Internal Examiner**

**External Rapporteur**

**External Rapporteur**

---

Dr. Ali HAMICHE

**Invited Member**

Dr. Marc MOUSLI

**Invited Member**

Dr. Mahmoud ALHOSIN

**Invited Member**

◆ **To cite this Thesis:**

Almalki N. A. R. (2022). Role and Regulation of UHRF1 Ubiquitination in Cancer Cells. PhD Thesis, Supervised by BRONNER C., Co-Supervised by HAMICHE A., Institut de Génétique et de Biologie Moléculaire et Cellulaire (IGBMC), Department of Functional Genomics and Cancer, Chromatin and Epigenetic Regulation - HAMICHE Team, CNRS\_UMR 7104 - Inserm U 1258, University of Strasbourg, Illkirch-Graffenstaden, France.

◆ **To contact the Researcher:**

E. Mail: [naralmalki@kau.edu.sa](mailto:naralmalki@kau.edu.sa)



@NARAlmalki

@naif\_almalki

◆ **To contact the Supervisors:**

E. Mail 1: [Bronnerc@igbmc.fr](mailto:Bronnerc@igbmc.fr)

E. Mail 2: [Hamiche@igbmc.fr](mailto:Hamiche@igbmc.fr)



*Quoted Wisdom*

*“The Sciences Attracts Minds,  
While the Ethics Attracts Hearts”*

I

## *Dedication*

*To My Great Parents: My Paradis, My **Mother** and My Crown, My **Father***

*To My Lovely Sisters: **Nouf** and **Mashael** and My Supporter Brother: **Meshal***

*To My **Family** members especially My Sweetheart: My Daughter **Layal***

*To My Moral Motivators: **Aunts, Uncles, Grandmothers** and **Grandfathers***

*To My Dears **Cousins** Specially **Mansour** and **Abdulaziz** and their Families*

*To My Loyal **Best Friends, Godfathers, Teachers** and **Colleagues***

*To My Backers in Scholarship: **Dr. Mahmoud** and **Dr. Abdulkhaleg***

*To All of the Members of Biochemistry Department at KAU*

*To All of the Kind Members of Altaawon School*

*To All of my Honorable Old and Future Students “Inshallah”*

*To All of the Good People Who May Enter My Life in The Future “Inshallah”*

*To All of Whom Wish Me a Good Luck, Success, and the Best*

*Your Sincerely*

***Naif***

## Acknowledgements

In the first of all, praise be to my God, almighty **Allah** (ﷻ), the most gracious, the most merciful, for everything, for all the Graces he gave to me, for the good manners he guided me to, for his guidance and blessing in my whole the life and peace be upon his servant and messenger, my role model, prophet, **Muhammad** (ﷺ), his household, his companions and his ideal followers until Doomsday.

I am especially grateful to my Supervisor, **Dr. Christian BRONNER**, for his guidance, kindness and patience in helping me during my thesis. I appreciated very much the opportunity he gave me to discover the epigenetic field and the time he spent to have highly interesting scientific discussion with me. He helped me how to think scientifically, and provided me many helpful suggestions, important expert advice and constant encouragement over the years of my thesis.

I would like to express my sincere gratitude to our Team Leader and Co-supervisor, **Dr. Ali HAMICHE** for giving me the opportunity to join his valuable laboratory. He welcomed me in very kind way and promised me to be enriched in knowledge and that what exactly happened. He was eager to provide for all of us all the necessities to facilitate doing the practical experiments. Thank you, Big Brother Ali.

I am deeply grateful to my Guider post-doctoral fellow, **Dr. Abdulkhaleg IBRAHIM** for his enthusiasm, guidance and stimulating discussions throughout all the period we worked together. He worked with me to figure out reasons whenever I had problems in experiments and provided kindly recommended solutions. I deeply appreciate what you have done for me (M. Prince Libyen).

In no particular order, I thank my Colleagues, Doctors; **Hatem, Tajith, Arslan, Dimitra, Catherine, Philippe, Christophe** and the lab manager Mme. Isabelle. Thank you all, for sharing some aid and for your kindness indeed, and best luck for new members.

My special thanks are going to the **Pr. Philippe BOUCHER, Dr. Hugues de ROCQUIGNY** and **Pr. Jean-Luc BUEB** for their acceptance to be members in my Thesis Jury and for their valuable time spent to critically read and comment on my thesis work. I would like to thank, as well as **Dr. Marc Mousli** for being a member of Thesis Follow-up Committee / Comité de suivi de thèse (CST) and for his valuable evaluation and cooperation.

I would like to thank the facilities' members of Cell culture, Flow cytometry, Imaging and Administration people for their effort in achieving my affairs easier.



I appreciate all the team of Language institute STRALANG for their effort teach us the French, especially **TOK family** for their keen about us and collaboration all the time.

I am grateful for the financial support from the King Abdulaziz University (KAU) represented in the heads of Scholarship administration **Dr. Mustafa ZEYADI (Abu Adnan)** and **Prof. Saud ALSOLAMI**, who were standing for the interests of the scholarship students without any delay.

Thanks for the Saudi Culture Attaché in the Saudi embassy in Paris represented in **Dr. Jamal ALSHEIBANI** and **Dr. Abdullah ALTHONAYAN** for their efforts to facilitate my staying in France during my study and for their kind collaboration.

I would like to thank all my **Scholarship Friends**, the members of Saudi students' club in Alsace (SSCA), for sharing their experiences and instructions, for their kindness and for spending many nice moments during soft and hard times.

I am deeply grateful to KAU Guider colleague: Dr. Mahmoud ALHOSIN (Abu Adame), for his suggestion to study the PhD in France, for his guidance even from distance, for dealing with me as a brother, for supporting me with a positive energy.

My special thanks are going to **Dr. Mazin ZAMZAMI (Abu Majed)** and **Dr. Salman Howsawi (Abu Ibrahim)**, as presidents of the Biochemistry department, Faculty of sciences, KAU, for facilitating all the requirements I needed during my scholarship period without any delay.

I appreciate all the people who supported me and helped me during all the study journey starting from the **good teachers of Altaawon School**, followed by the biochemistry department staff at KAU specially who guided me finalizing **Bachelor project** and to people who gave me a hand to achieve the **Master's Degree**.

All the words in the dictionaries that expresses the thankful won't be enough to say to my Great Mother, Alshaikhah/ Halimah bint Jarallah ALMALKI, my Great Father, Alshaikh/ Abdullah bin Raddah ALMALKI and all my family for their support since childhood until adulthood.

*Thank you, Thank you, Thank you ,,,*

Your Sincerely

**Naif**

## Opening Word

What an amazing world! We are living on a planet that floats in a vast space, we don't recognize the dimensions of the sky either the limits of the universe. Humans have realized their near surroundings with simple scales from centimeters to kilometers by naked eyes, and with curiosity, they aspired to explore **beyond the surroundings**, so that they delved into astronomy to study a very far places from their surroundings to exceed outlook horizons with a scale of billions of kilometers to millions of light-years by inventing telescopes and arriving with spacecraft, shuttles, rockets and probes to unimaginable remote points.

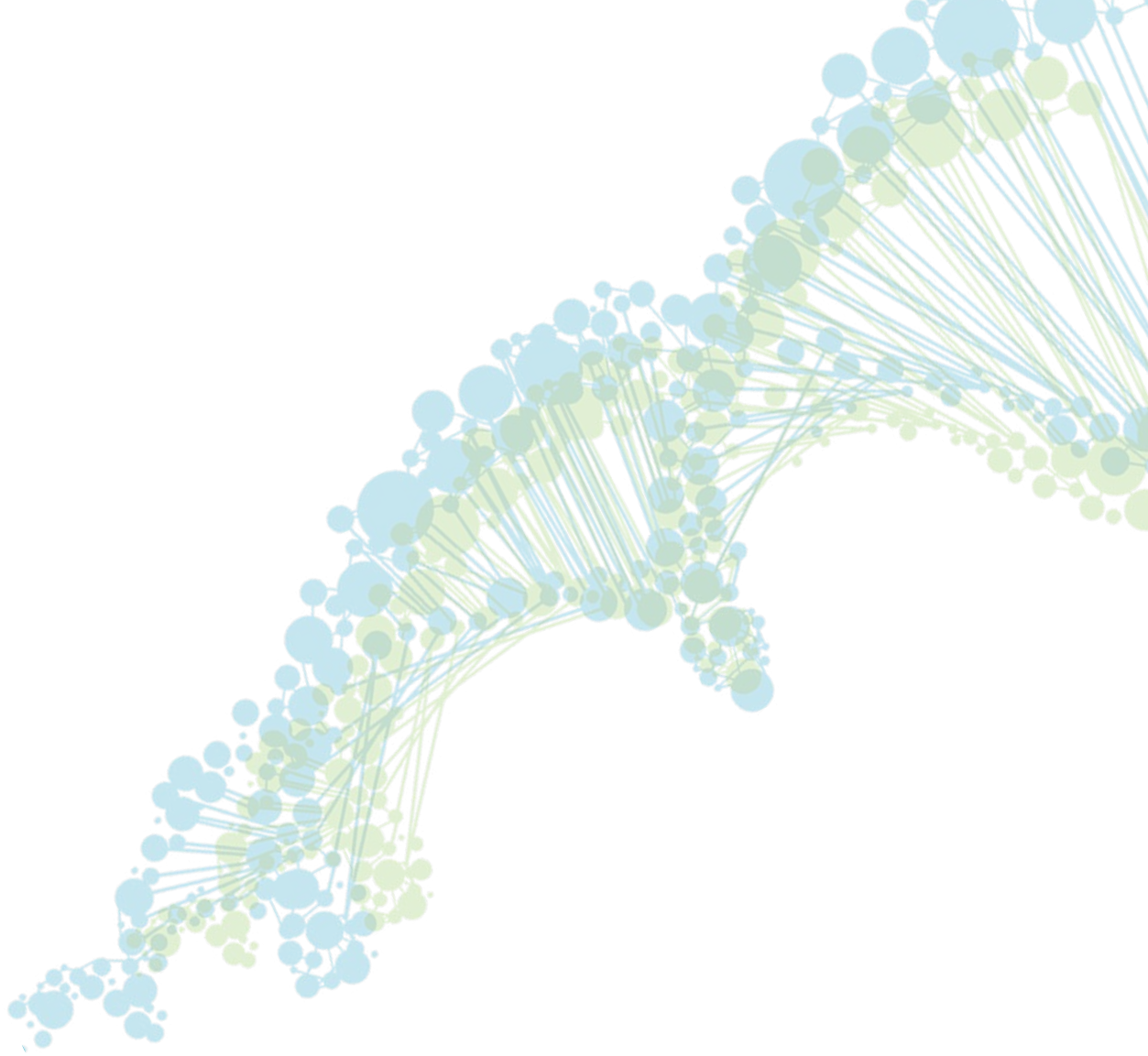
Curiosity didn't stop until this limit, but vice versa they went to **beneath the entity**. The magnifiers leaded the scientists to explore the tiny things until they were invented the microscopes and X-ray crystallography technology that allow them to observe a scale of micrometers to less than nanometers. It has been found inside a single cell a millions of proteins and inside the nucleus a compacted DNA if we try to elongate it, it will stretch into thousands of kilometers, so you think that you are a tiny creature! But actually, as if the universe is folded inside you.

No matter how much knowledge a human reached, he remains incapable to study the **Prescience** which includes the mysteries of the universe, the soul, the mind, specify the gender of the fetus, knowing the date of death, destiny ... etc. Therefore, we must realize our reasonable limits and think about the wonderful creatures, and let's spread the science and enrich more knowledge, benefits the others and get the benefit from the others. First and foremost (The soul is of the affair of my Lord, and you "mankind" have not been given of knowledge except a little) (The Prophet Muhammad; on the tongue of God, 610-632).

*“At last, most importantly from all of that, let's be kind before becoming learned”*

Written by  
*The researcher*

V



Preapprehension  
Preamble



## Abstract

In many physiologic and pathological processes, DNA methylation is a significant epigenetic mark. UHRF1/DNMT1 tandem ensures the transmission of DNA methylation patterns from mother to daughter cells during mitosis. A significant number of tumor suppressor genes are silenced by UHRF1 through processes that are yet completely unknown. Thymoquinone, a naturally occurring anti-cancer medication, has been shown to boost or reactivate the expression of tumor suppressor genes, which we were interested in investigating in our work. DNA damage results in the auto-ubiquitination of UHRF1 by reactive oxygen species, as we discovered. UHRF1, even when poly-ubiquitinated, can still silence the tumor suppressor gene *p16<sup>INK4A</sup>*, as we were able to show. This shows that re-expression of tumor suppressor genes requires the entire removal of UHRF1, including the poly-ubiquitinated form. Poly-ubiquitination of UHRF1 does not play a role in its degradation. TQ-induced auto-ubiquitination can be shown to be linked to Tip60 activity. It is known that UHRF1 ubiquitination is controlled by the glucocorticoid receptor (GR), which is a nuclear receptor co-factor. Dexamethasone activation of the GR had no effect on UHRF1 auto-ubiquitination. On the other hand, we found that UHRF1 regulates the expression of GR, and that TQ decreased its level of expression and poly-ubiquitinated it. Mass spectrometry study of FLAG-HA-tagged UHRF1 showed UHRF1 partners engaged in DNA repair and that TQ strengthened their affiliation with UHRF1, showing that poly-ubiquitination of UHRF1 is involved in the DNA repair process.

## Keywords

- Epigenetics
- UHRF1
- E3 Ligase
- RING domain
- Oncogenes (OGs)
- Auto-polyubiquitination
- Tip60
- GR
- Dexamethasone
- DNA repair
- Ku70/Ku80
- *p16<sup>INK4A</sup>*
- Cancer
- Anticancer
- MPTE
- Thymoquinone (TQ)
- ROS
- Apoptosis

## Highlighted Facts

- In **2000**, Bronner and his colleagues identified a new protein named **ICBP90** in humans. In **2004**, HGNC organization has gave an official nomenclature to be **UHRF1**.
- UHRF1 located on the **Chromosome 19** (19p13.3) in humans and it consist of 3,898 nucleotides that expresses 793 amino acids.
- UHRF1 is an acronym of Ubiquitin-like, containing PHD and RING finger domains, 1.
- UHRF1 has a five-domain protein (UBL, TTD, PHD, SRA and RING) which has multi-function in the epigenetic level within cell nucleus.
- The UHRF1 domains acronyms, UBL of Ubiquitin-like domain, TTD of Tandem Todor domain, PHD of Plant-Homeo Domain, SRA of Set and Ring Finger Associated domain, and RING of Really Interesting New Gene Finger domain.
- UHRF1 is a subfamily of RING-finger type E3 ubiquitin ligases which has ability to ubiquitinate other protein for regulation or polyubiquitinate them for degradation.
- UHRF1 governs the interconnection between DNA methylation, ubiquitination and deacetylation of histone H3.
- UHRF1 binds to hmDNA during S-phase while DNA replication and recruits the DNMT1 to maintain the DNA methylation.
- UHRF1 considered as an oncogene in order to a high probability of causing cancer by observing an overexpression.
- An Auto-polyubiquitinate of UHRF1 is a mechanism observed by applying an anticancer phytochemical drug, Thymoquinone (TQ).
- UHRF1 main partners: PCNA (DNA clamp cofactor), DNMT1, EHMT2/G9a (HMT), KAT5/Tip60 (HAT), HDAC1, USP7/HAUSP (DUB), Glucocorticoid's receptor (GR).
- UHRF1 has a related pseudogene (UHRF1P) hosted in the PDE3A gene, exists on chromosome 12 (12p12.2) and it consist of 1470 nucleotides as an Intron-less / Single exon gene that may expresses a competing endogenous (ceRNA).
- UHRF1 may be upregulated by UHRF1P ceRNA by competing with UHRF1 mRNA indirectly, by sponging the miRNA and obstacle its effects on UHRF1 mRNA.

## Scientific Methodology

An **observations** have been spotted that generated a curious **questions** floated in our minds about Thymoquinone (TQ) phytochemical drug effects on UHRF1 oncoprotein by showing an ubiquitination smear and a 55 kDa band frequently detected by SRA domain antibody in the Western blotting technique. Many **Literatures** were **reviewed**. A **hypothesis** was **proposed**, and objectives were determined to answer these questions by **planning and designing** some **practical experiments** and applying them. Several **results** were obtained and **analyzed** to **answer** the posed questions and **explain** our observation. The results were **discussed** and **compared** with other previous works. Lastly, it has been reached to the **conclusion** which might be close to the logic **explanations**. Then, perspectives were suggested to complete understanding the observations. All the **references** that have been **cited** were listed in the end. The project was supported with some **appendix** to help understanding the complicated points and **connect** the information with each other and the principal **Theories**.

The thesis has been written in the (**Scientific Writing**) style, initiated with an Introduction, followed by objectives, Materials and Methods, Results and Discussion, Conclusion and perspectives and ended with References. The Name of organisms mentioned in the thesis have been written in the (**Scientific Name**) style, a binomial nomenclature utilizing the Latin name of the organism, begin with *genus* followed with *species* in Italic font. The large numbers have been written in the (**Scientific Notation**) style, with the form ( $m \times 10^n$ ) rather than the classic decimal form, for example, the 2000000 (two million) cells written  $2 \times 10^6$  Cells.

The quoted information from the references were **Paraphrased** and before the submission of the Thesis, it has been **Proofread**, the percentage of **Plagiarism** was **checked** to not pass the set limit and the **Layout design** was applied as instructed.

Parts of this thesis **Scientific Data** were participated in a **Scientific Poster** in the **Scientific Conference** (22<sup>nd</sup> EMBL PhD Symposium: The Roaring 20s: A New Decade for Life Sciences, 2020), written as manuscript, submitted and published as a **Scientific Paper / Article** (PMID: 34897340) in the **Scientific Journal** (Food and Function, Impact Score, IS: 4.94). Another part of the thesis was written as manuscript to be submitted and published soon after.

# Table of Contents

---

<b>SUBJECT</b>	<b>PAGE</b>
Quoted Wisdom	I
Dedication	II
Acknowledgements	III
Opining Word	V
Abstract and Keywords	VI
Highlighted Facts	VII
Scientific Methodology	VIII
Index of Figures	IX
List of Abbreviations	XI

## Chapter I: REVIEW OF LITERATURE

<b>1. Introduction</b>	<b>001</b>
<b>1.1. Cell Biology and Physiology</b>	<b>003</b>
1.1.1. Cell Structure and Functions	003
1.1.2. Genotyping and Phenotyping	004
1.1.3. Central Dogma and Regulation	005
1.1.4. Cell Communication and Reproduction	006
1.1.5. Cancer Disease	008
<b>1.2. Epigenetics</b>	<b>013</b>
1.2.1. Genome Organization	014
1.2.2. Definition of the epigenetic code	016
1.2.3. Epigenetic Mechanisms	027
1.2.4. DNA methylation and regulation of gene expression	028
1.2.5. Histones Post-translational modifications and regulation of gene expression	032
<b>1.3. The UHRF subfamily of RING-finger type E3 ubiquitin ligases</b>	<b>035</b>
1.3.1. The UHRF Members	035
1.3.2. Ubiquitin like with PHD and Ring Finger domain 1 (UHRF1)	038
1.3.3. Structural domains of UHRF1	039
1.3.3.1. Ubiquitin-like domain (UBL domain)	039
1.3.3.2. Tandem Tudor domains (TTD domains)	040
1.3.3.3. Plant-Homeo Domain (PHD domain)	041
1.3.3.4. Set and Ring Finger Associated domain (SRA domain)	042
1.3.3.5. Really Interesting New Gene Finger domain (RING Finger domain)	045
<b>1.4. Ubiquitination activity of UHRF1 RING domain</b>	<b>046</b>
1.4.1. Mono-Ubiquitination by UHRF1	048
1.4.2. Poly-Ubiquitination by UHRF1	048
1.4.3. Auto-Ubiquitination of UHRF1	049

<b>1.5. Roles and functional mechanisms of UHRF1</b>	<b>049</b>
1.5.1. Expression of UHRF1 in cancer and during the cell cycle	049
1.5.2. The UHRF1 complex	052
1.5.3. Pharmacological regulation of UHRF1	055

## **Chapter II: OBJECTIVES OF RESEARCH**

<b>2. Purposes of study</b>	<b>057</b>
-----------------------------	------------

## **Chapter III: SCIENTIFIC OUTPUT**

<b>3.1 Article (I): Maritime pine tannin extracts from bark exhibit anticancer properties by targeting the epigenetic UHRF1/DNMT1 tandem leading to re-expression of p73</b>	<b>060</b>
<b>3.2 Manuscript (I): Role and regulation of UHRF1 auto-ubiquitination induced by Thymoquinone</b>	<b>076</b>

## **Chapter IV: GENERAL DISCUSSION**

<b>4. Discussion of Results</b>	<b>102</b>
4.1. MPTE exhibit anticancer properties by targeting the epigenetic UHRF1/DNMT1 tandem	102
4.2. Auto-ubiquitination has a regulatory role on the of UHRF1 induced by Thymoquinone (TQ)	104
4.3. UHRF1 as a prognostic factor and a potential therapeutic target	107

## **Chapter V: CONCLUSION & PERSPECTIVES**

<b>5. Conclusion and Perspectives</b>	<b>110</b>
---------------------------------------	------------

## **Chapter VI: BIBLIOGRAPHY REFERENCES**

<b>6.1. Publications, Articles and Books</b>	<b>113</b>
<b>6.2. Websites Links</b>	<b>133</b>

<b>SUPPLEMENTARY APPENDIX</b>	<b>135</b>
-------------------------------	------------

<b>RÉSUMÉ DE THÈSE EN FRANÇAIS</b>	<b>149</b>
------------------------------------	------------

## Index of Figures

- Figure 1.1.** The existence of the human species (*Homo Sapiens*).
- Figure 1.2.** Reproduction.
- Figure 1.3.** An animal cell.
- Figure 1.4.** Biological systems multi-omics.
- Figure 1.5.** The Central Dogma
- Figure 1.6.** Intracellular Signaling Pathways in Tumorigenesis and Cancer Progression.
- Figure 1.7.** Common Risk Factors for Cancer.
- Figure 1.8.** The main steps in the formation of a metastasis.
- Figure 1.9.** Metabolic Alterations in Cancer.
- Figure 1.10.** Map of All malignancies worldwide in 2020.
- Figure 1.11.** Estimated number of new cases of Cancer in 2020.
- Figure 1.12.** Statistical information about Epigenetics.
- Figure 1.13.** Overview of some chemical functional groups and molecules as an epigenetic code and genetic regulators.
- Figure 1.14.** Overview of genome organization and corresponding size scales.
- Figure 1.15.** The different actions of chromatin remodeling factors.
- Figure 1.16.** Overview of composition and function of selected chromatin remodeling complexes.
- Figure 1.17.** Overview of histone deposition mechanisms and implicated chaperones.
- Figure 1.18.** Induction and regulation of heat shock protein expression.
- Figure 1.19.** Overview of the core nucleosome structure.
- Figure 1.20.** The main stages of chromatin assembly.
- Figure 1.21.** Two models for chromatin secondary structure.
- Figure 1.22.** Human core and linker histone variants.
- Figure 1.23.** Overview of epigenetic mechanisms.
- Figure 1.24.** Overview of DNA methylation on Carbon 5 of Cytosine.
- Figure 1.25.** Overview of the fate of hemimethylated DNA.
- Figure 1.26.** A model of DNA methylations patterns in Normal and Cancer status.
- Figure 1.27.** The major / most documented post-translational modifications of histones.
- Figure 1.28.** The UHRF family.
- Figure 1.29.** The structure of UHRF1.
- Figure 1.30.** Structure of TTD-PHD of UHRF1 in complex with H3-K9me3.
- Figure 1.31.** Structure of SRA–DNA complex.
- Figure 1.32.** Fluorescence monitoring of the flipping of methylated cytosine by the SRA domain of the protein UHRF1.
- Figure 1.33.** The ubiquitin–proteasome system and the structures of RING-type E3 ligases.
- Figure 1.34.** Types of ubiquitylation on substrate.
- Figure 1.35.** Overexpression of UHRF1 promotes tumorigenesis in different cancers.
- Figure 1.36.** Implication of the protein UHRF1 in different biological mechanisms.
- Figure 1.37.** Working model for dynamic regulation of UHRF1 macromolecular complex during cell cycle.
- Figure 1.38.** Changes in the conformation of UHRF1 from close state to open state mediated by hmDNA.

## **Index of Supplementary Appendix Figures**

**Figure S.1.** Level of organization (Scale from nm to m)

**Figure S.2.** Periodic Table of The Elements

**Figure S3A.** Functional Groups (The main players)

**Figure S3B.** Functional Groups (Supporting actors)

**Figure S.4.** Chemical Structure of DNA

**Figure S.5.** Genetic Code

**Figure S.6.** Amino Acids Structures and Characteristics

**Figure S.7.** Protein Structure Levels and Representation Diagrams

**Figure S.8.** Molecular Machinery

**Figure S.9.** Epigenetic Modifications

**Figure S.10.** Human body systems and the main cell lines

**Figure S.11.** The main selected biological buffers with their rang of pH

**Figure S.12.** The Electromagnetic spectrum

## List of Abbreviations

Abbreviation	Full form
AA / a.a.	Amino Acid
Ab	Antibody
Ag	Antigen
AGE	Agarose Gel Electrophoresis
Akt	Protein kinase B (PKB), first discovered in the AKR mouse strain model that develops spontaneous thymic lymphomas
APS	Ammonium peroxydisulfate
Bcl-2	B-cell lymphoma 2
BER	Base Excision Repair
BLAST	Basic Local Alignment Search Tool
BLS	Basic Life Support
BME	$\beta$ -Mercaptoethanol
BORIS	Brother of the regulator of the imprinted site
bp	Base Pair
BSA	Bovine Serum Albumin
C	Cytosine
CaCl <sub>2</sub>	Calcium Chloride
Caspases	Cysteine- <b>asp</b> artic proteases
CDK	Cyclin- <b>de</b> pendent kinase
cDNA	Complementary DNA
CDS	Coding Sequence
CD25	Cluster of <b>d</b> ifferentiation No. 25 (IL2RA)
ceRNA	Competing Endogenous RNA
CGI	CpG Island

<b>ChIP</b>	<b>Chromatin Immunoprecipitation</b>
<b>c-Myc</b>	<b>Cellular Myelocytomatosis</b>
<b>COVID-19</b>	<b>Corona virus disease (discovered in 2019)</b>
<b>CO<sub>2</sub></b>	<b>Carbon dioxide</b>
<b>CpG</b>	<b>Cytosine-phosphate-Guanine</b>
<b>CRISPR</b>	<b>Clustered Regularly Interspaced Short Palindromic Repeats</b>
<b>Cas9</b>	<b>CRISPR associated protein 9</b>
<b>Cas Nickase</b>	<b>CRISPR associated protein Nickase</b>
<b>CTCF</b>	<b>Chromatin insulator CCCTC-binding factor</b>
<b>CuSO<sub>4</sub></b>	<b>Cupric Sulfate / Copper(II) Sulfate</b>
<b>CXXC</b>	<b>Cysteine rich region (XX: means many)</b>
<b>Da</b>	<b>Dalton, a unit expressed from MW, to measure protein size</b>
<b>DAPI</b>	<b>4',6-diamidino-2-phenylindole (DNA dye)</b>
<b>DIP-seq</b>	<b>DNA-ImmunoPrecipitation-sequencing</b>
<b>DMEM</b>	<b>Dulbecco's modified Eagle's medium</b>
<b>DMSO</b>	<b>Dimethyl sulfoxide</b>
<b>DNA</b>	<b>Deoxyribonucleic acid</b>
<b>DNMT</b>	<b>DNA methyltransferase</b>
<b>dNTPs</b>	<b>deoxyribonucleoside triphosphates</b>
<b>DTT</b>	<b>Dithiothreitol (Cleland's reagent)</b>
<b>ECL</b>	<b>Enhanced Chemiluminescence</b>
<b>ECREM</b>	<b>Epigenetic Code Replication Machinery</b>
<b>EDTA</b>	<b>Ethylenediaminetetraacetic acid</b>
<b>ER</b>	<b>Endoplasmic reticulum</b>
<b>ESCs</b>	<b>Embryonic Stem Cells</b>
<b>EtBr</b>	<b>Ethidium Bromide (DNA dye)</b>

<b>FACS</b>	<b>Fluorescence-activated Cell Sorting</b> “Flowcytometry”
<b>FASTA</b>	<b>Fast All</b> [FASTN: Fast Nucleic acid – FASTP: Fast Protein]
<b>FBS</b>	<b>Fetal Bovine Serum</b>
<b>FLAG-tag</b>	An octapeptide / epitope recognized by an Ab (DYKDDDDK)
<b>G</b>	<b>Guanine</b>
<b>g</b>	<b>Gravitational force of Earth (rcf)</b>
<b>GαM</b>	<b>Goat anti Mouse</b>
<b>GαR</b>	<b>Goat anti Rabbit</b>
<b>GAPDH</b>	<b>Glyceraldehyde 3-phosphate dehydrogenase</b>
<b>gDNA</b>	<b>Genomic DNA</b>
<b>gRNA</b>	<b>Guide RNA</b>
<b>GFP</b>	<b>Green Fluorescent Protein</b>
<b>HA-tag</b>	<b>Hemagglutinin</b> , a peptide / epitope recognized by an Ab (YPYDVPDYA)
<b>His-tag</b>	6 - 10 <b>Histidine</b> AA bound by a nickel (HHHHHH)
<b>HRP</b>	<b>Horseradish peroxidase</b>
<b>H3K27ac</b>	Histone H3 Lys27 acetylation
<b>H3K4me3</b>	Histone H3 tri-methylated on Lysine 4
<b>H3K9ac</b>	Histone H3 Lys27 acetylation
<b>HAT</b>	<b>Histone Acetyltransferase</b>
<b>HAUSP</b>	<b>Herpes virus-Associated Ubiquitin-Specific Protease (USP7)</b>
<b>HBS</b>	<b>HEPES Buffer Saline / Solution</b>
<b>HC</b>	<b>Heavy Chain</b>
<b>HCl</b>	<b>Hydrochloric acid</b>
<b>HDAC</b>	<b>Histone Deacetylase</b>
<b>HEPES</b>	(4-(2- <b>hydroxyethyl</b> )-1- <b>piperazineethanesulfonic acid</b> )
<b>HEK</b>	<b>Human Embryonic Kidney cells</b>

<b>HeLa XLP</b>	<b>Henrietta Lacks X-linked Lymphoproliferative disease</b>
<b>HEPA</b>	<b>High-efficiency particulate air / absorbing / arrestance</b>
<b>HGF</b>	<b>Hepatocyte growth factor</b>
<b>HGNC</b>	<b>HUGO Gene Nomenclature Committee (See HUGO)</b>
<b>HGPRT</b>	<b>Hypoxanthine-guanine phosphoribosyl-transferase</b>
<b>hmDNA</b>	<b>Hemi-methylated DNA</b>
<b>HP1</b>	<b>Heterochromatin Protein1</b>
<b>Hsp</b>	<b>Heat shock proteins</b>
<b>HUGO</b>	<b>Human Genome Organization</b>
<b>hUHRF1<sup>TTD-F152A</sup></b>	Human <b>UHRF1</b> mutated in <b>TTD</b> domain of <u>Phenylalanine</u> No. <b>152</b> in sequence to <u>Alanine</u>
<b>hUHRF1<sup>TTD-Y188A</sup></b>	Human <b>UHRF1</b> mutated in <b>TTD</b> domain of <u>Tyrosine</u> No. <b>188</b> in sequence to <u>Alanine</u>
<b>H<sub>2</sub>O</b>	<b>Hydrogen Oxide (Water)</b>
<b>H<sub>2</sub>O (d) (f) (up) (a)</b>	<b>Water (Distilled) (Filtered) (Ultra purified) (Autoclaved)</b>
<b>H<sub>2</sub>O<sub>2</sub></b>	<b>Hydrogen Peroxide / Hydroperoxyl</b>
<b>IAP</b>	<b>Intracisternal A Particle</b>
<b>ICBP90</b>	<b>Inverted CCAAT box Binding Protein of 90 kDa</b>
<b>ICC</b>	<b>Immunocytochemistry</b>
<b>IF</b>	<b>Immunofluorescence</b>
<b>Ig</b>	<b>Immunoglobulin</b>
<b>IL2RA</b>	<b>Interleukin-2 receptor alpha chain (CD25)</b>
<b>IP</b>	<b>Immunoprecipitation</b>
<b>IPTG</b>	<b>Isopropyl β-D-1-thiogalactopyranoside</b>
<b>kbp</b>	<b>Kilo Base Pair</b>
<b>KCl</b>	<b>Kalium Chlorum / Potassium Chloride</b>
<b>kDa</b>	<b>Kilo Dalton</b>
<b>KD</b>	<b>Knock-down</b>

<b>KH<sub>2</sub>PO<sub>4</sub></b>	Monopotassium phosphate [ <b>P</b> otassium dihydrogen- <b>p</b> hosphate]
<b>KI</b>	<b>K</b> nock- <b>i</b> n
<b>KO</b>	<b>K</b> nock- <b>o</b> ut / Mutant (- / -)
<b>LB Broth</b>	Lysogeny / <b>L</b> ennox / <b>L</b> uria <b>B</b> ertani Broth
<b>LC</b>	<b>L</b> ight <b>C</b> hain
<b>LN<sub>2</sub></b>	<b>L</b> iquid <b>N</b> itrogen
<b>mAb</b>	<b>M</b> onoclonal <b>A</b> ntibody
<b>MBD</b>	<b>M</b> ethyl-CpG <b>B</b> inding <b>D</b> omain
<b>Mdm2</b>	<b>M</b> ouse <b>d</b> ouble <b>m</b> inute <b>2</b> homolog
<b>MeCP2</b>	<b>M</b> ethyl-CpG-binding <b>P</b> rotein <b>2</b>
<b>MgCl<sub>2</sub></b>	<b>M</b> agnesium <b>C</b> hloride
<b>MOPS</b>	3-( <b>N</b> - <b>m</b> orpholino) <b>p</b> ropanesulfonic acid
<b>MREs</b>	<b>M</b> icro <b>R</b> NA <b>r</b> esponse <b>e</b> lements
<b>MSDS</b>	<b>M</b> aterial <b>S</b> afety <b>D</b> ata <b>S</b> heet
<b>MW</b>	<b>M</b> olecular <b>W</b> eight
<b>NaOAc</b>	<b>N</b> atrium / <b>S</b> odium <b>A</b> cetate
<b>NaCl</b>	<b>N</b> atrium <b>C</b> hlorum / <b>S</b> odium <b>C</b> hloride
<b>NaHCO<sub>3</sub></b>	<b>N</b> atrium / <b>S</b> odium bicarbonate [ <b>S</b> odium hydrogen carbonate]
<b>NaOH</b>	<b>N</b> atrium / <b>S</b> odium <b>H</b> ydroxide
<b>Na<sub>2</sub>HPO<sub>4</sub></b>	<b>D</b> isodium phosphate [ <b>S</b> odium hydrogen phosphate]
<b>NC</b>	<b>N</b> itrocellulose
<b>NCBI</b>	The National <b>C</b> enter for <b>B</b> iotechnology <b>I</b> nformation
<b>NER</b>	<b>N</b> ucleotide <b>E</b> xcision <b>R</b> epair
<b>NP40</b>	<b>N</b> onyl <b>p</b> henoxypolyethoxylethanol (Detergent)
<b>Np95</b>	<b>N</b> uclear <b>P</b> rotein of <b>95</b> kDa
<b>OD<sub>WL</sub></b>	<b>O</b> ptical <b>D</b> ensity (at specific <b>W</b> avelength, <i>e.g.</i> , 600 nm)

<b>ON</b>	<b>Overnight</b>
<b>ORF</b>	<b>Open Reading Frame</b>
<b>O<sub>2</sub></b>	<b>Oxygen</b>
<b>pAb</b>	<b>Polyclonal Antibody</b>
<b>PAGE</b>	<b>Polyacrylamide Gel Electrophoresis</b>
<b>PBS</b>	<b>Phosphate Buffer Saline</b>
<b>PCR</b>	<b>Polymerase Chain Reaction</b>
<b>PEG</b>	<b>Polyethylene glycol</b>
<b>PLB</b>	<b>Protein Lysis / Loading / Laemmli Buffer</b>
<b>pH</b>	<b>Power of hydrogen / potential for hydrogen (Acidity scale)</b>
<b>PHD</b>	<b>Plant Homeo Domain</b>
<b>pI</b>	<b>Protein Isoelectric Point</b>
<b>PMSF</b>	<b>Phenylmethylsulfonyl fluoride</b>
<b>Pol III</b>	<b>RNA polymerase III</b>
<b>PPE</b>	<b>Personal protective equipment</b>
<b>pRB2</b>	<b>Proline rich protein BstNI subfamily 2</b>
<b>PTEN</b>	<b>Phosphatase and tensin homolog</b>
<b>PVDF</b>	<b>Polyvinylidene fluoride</b>
<b>p130</b>	<b>Protein 130 (Retinoblastoma-like protein 2)</b>
<b>qPCR</b>	<b>Quantitative PCR (Real time PCR)</b>
<b>RACE-PASS</b>	<b>Rescue Alarm Contain Extinguish - Pull Aim Squeeze Sweep</b>
<b>rcf</b>	<b>Relative centrifugal field (g.)</b>
<b>RING</b>	<b>Really Interesting New Gene Domain</b>
<b>RIPA</b>	<b>Radioimmunoprecipitation assay (Lysis buffer)</b>
<b>RNA</b>	<b>Ribonucleic acid</b>
<b>ROS</b>	<b>Reactive Oxygen Species</b>

<b>RT-PCR</b>	<b>Retro-transcription PCR</b>
<b>RT°</b>	<b>Room Temperature degree</b>
<b>rpm</b>	<b>Revolutions per minute</b>
<b>SAM</b>	<b>S-Adenosyl Methionine</b>
<b>SDS</b>	<b>Sodium dodecyl sulfate (Detergent)</b>
<b>shRNA</b>	<b>Short hairpin RNA</b>
<b>SI</b>	<b>International System of Units</b>
<b>siRNA</b>	<b>Small interfering RNA</b>
<b>SNPs</b>	<b>Single-nucleotide polymorphisms</b>
<b>SRA</b>	<b>Set and Ring Associated domain</b>
<b>SUMOs</b>	<b>Small Ubiquitin Like Modifiers</b>
<b>SWI/SNF</b>	<b>SWItch/Sucrose Non-Fermentable</b>
<b>T</b>	<b>Thymine</b>
<b>TDG</b>	<b>Thymine DNA Glycosylases</b>
<b>TEMED</b>	<b>N,N,N',N'-Tetra-methyl-ethylene-diamine</b>
<b>TET</b>	<b>Ten-Eleven Translocation</b>
<b>TFs</b>	<b>Transcription Factors</b>
<b>TGF</b>	<b>Transforming growth factor</b>
<b>Tip60</b>	<b>Tat interactive protein 60</b>
<b>TQ</b>	<b>Thymoquinone</b>
<b>TSGs</b>	<b>Tumor Suppressor Genes</b>
<b>TTD</b>	<b>Tandem Tudor Domain</b>
<b>TW20</b>	<b>TWEEN 20 / Polysorbate 20 (Detergent)</b>
<b>TX100</b>	<b>Triton X-100 (Detergent)</b>
<b>U</b>	<b>Uracil</b>

<b>Ub</b>	<b>Ubiquitin</b>
<b>UBL</b>	<b>Ubiquitin-like Domain</b>
<b>UHRF1</b>	<b>Ubiquitin-like containing plant Homeo-domain and RING Finger domain 1</b>
<b>USP7</b>	<b>Ubiquitin-Specific Peptidase 7</b>
<b>UTR</b>	<b>Untranslated Region</b>
<b>WB</b>	<b>Western Blotting</b>
<b>WT</b>	<b>Wild Type (+ / +)</b>
<b>5caC</b>	<b>5-carboxylCytosine</b>
<b>5fC</b>	<b>5-formylCytosine</b>
<b>5hmC</b>	<b>5-hydroxymethylCytosine</b>
<b>5mC</b>	<b>5-methyl-Cytosine</b>
<b>ΦNX</b>	<b>Phoenix</b> , a cell line derived from HEK cells
<b>(- / - WT)</b>	<b>Knocked-out</b> protein and restored with a tag
<b>ΔN-UHRF1</b>	<b>Delta</b> : means <u>deletion</u> of the <b>N-terminus</b> of <b>UHRF1</b>

<b>Latin Abb. / Terms</b>	<b>Full Form and Meaning</b>
<b>Agonist-Antagonist</b>	<b>Agōnista means:</b> (Competitor / Contributor / Activator / as a substrate) – <b>Antagōnista means:</b> (Blocker / Inhibitor)
<b>Analog-Paralog</b>	<b>Analog means:</b> (Similar / Comparable) <b>Paralog means:</b> (Parallel)
<b>Cis-trans</b>	<b>Citra means:</b> (Same side / Together with) <b>Trans means:</b> (Opposite side / Shift / Switch over)
<b>Cistron</b>	<b>means:</b> (Alternative term of “Gene”)
<b>et al.</b>	et alii <b>or</b> et alia <b>or</b> et alibi <b>means:</b> (and others <b>or</b> and co-workers)
<b>e.g.,</b>	exempli gratia <b>means:</b> (For example,)
<b>etc.</b>	et cetera <b>means:</b> (and the rest <b>or</b> and so forth)
<b>i.e.</b>	id est <b>means:</b> (that is, <b>or</b> which is, <b>or</b> which means that,)
<b>in vitro</b>	<b>means:</b> (within the glass)

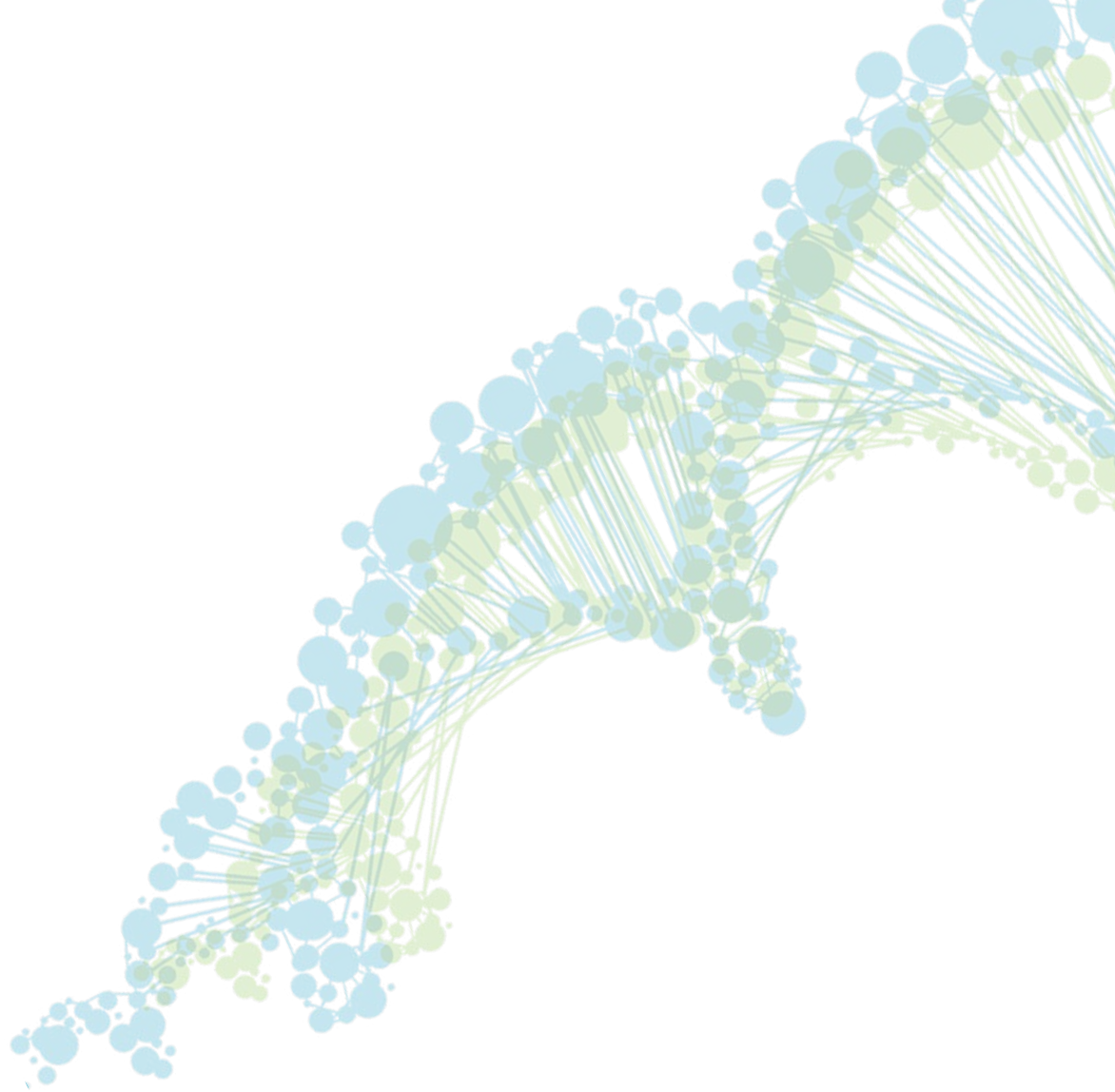
- in vivo***                      **means:** (within the living)
- in silico***                      **means:** (performed on computer **or** via computer simulation)
- per cent. (%)**                      per centum **means:** (for each one hundred)

Prefix / Suffix	Meaning	Example
<b>Anti- / Ant-</b>	Against	Antibody / Antigen / Antagonist
<b>Auto-</b>	Self	Auto-polyubiquitination
<b>Bi- / Di-</b>	Twice / Two / Double	Bicistronic / Di-methylation
<b>Co-</b>	Together	Co-factor / Co-repressor
<b>Cryo-</b>	Icy cold / Frost	Cryotube
<b>Epi-</b>	Above / Upon / Upper	Epigenetics
<b>Hemi-</b>	Half	Hemi-methylated DNA
<b>Iso-</b>	Equal	Isotonic / Isoelectric
<b>Mono-</b>	One / Alone / Single	Mono-ubiquitination
<b>Neo-</b>	New	Neo-angiogenesis
<b>Oligo-</b>	Few	Oligonucleotides
<b>Onc-</b>	Tumor / Cancerous	Oncogene / Onco-lncRNA
<b>Poly- / Multi-</b>	Many / Much / More	Poly-ubiquitination / Multicellular
<b>Pre-</b>	Precursor / Previous	Pre-mRNAs
<b>Pro-</b>	Leads to	Proapoptotic Proteins
<b>Proto-</b>	Changeable to / Primitive to be	Protooncogene
<b>Pseudo-</b>	False / Fake	Pseudogene
<b>Retro-</b>	Backward	Retro-transcription / Retrovirus
<b>Semi-</b>	Half / Partly	Semipermeable

<b>Sub-</b>	Under / Beneath / Below	Subunit
<b>Tri-</b>	Three / Triple	Tri-methylation
<b>Ultra-</b>	Extreme / Supreme / Above	Ultrasonic / Ultracentrifugation

Symbols	Meaning
$\alpha$	Alpha
$\beta$	Beta
$\gamma$	Gamma
$\lambda$	Lambda
	from Greek alphabets, used in scientific purposes
<b>A</b>	Ampere (SI electric current unit)
<b>atm</b>	Standard <b>atmosphere</b> (pressure unit, equal 101325 <b>Pa</b> )
<b>cd</b>	<b>Candela</b> (SI Luminous intensity unit)
<b>dB</b>	<b>Decibel</b> (Sound noise unit)
<b>eV</b>	Electron volt (Photon energy unit)
<b>g</b>	<b>Gram</b> (SI mass unit) (1 g ÷ 453.6 = 0.0022 lbs.)
<b>k</b>	<b>Kilo</b> (SI prefix factor of 10 <sup>3</sup> )
<b>lb.</b>	<b>Libra</b> "scales" <b>Pound</b> (US Mass unit)
<b>L</b>	<b>Liter</b> (SI Volume unit)
$\mu$	<b>Micro</b> (SI prefix factor of 10 <sup>-6</sup> )
<b>m</b>	<b>Milli</b> (SI prefix factor of 10 <sup>-3</sup> ) <u>or</u> <b>Meter</b> (SI length unit)
<b>Hz</b>	<b>Hertz</b> (SI Frequency unit)
<b>M</b>	<b>Molar</b> : mol/L (SI Concentration unit)
<b>m</b>	<b>Molal</b> : mol/kg
<b>n</b>	<b>Nano</b> (SI prefix factor of 10 <sup>-9</sup> ) <u>or</u> <b>No. of moles</b> (in the Molarity low)

<b>N<sub>A</sub></b>	Number of Avogadro (6.022 x10 <sup>23</sup> of atoms or molecules = 1 mole)
<b>Pa</b>	Pascal (SI Pressure unit)
<b>s</b>	Second (SI Time unit)
<b>IU</b>	International Unit (a unit of substance amount gives biological effect)
<b>V</b>	Volt (SI electric potential unit) <u>or</u> Volume (in the Molarity law)
<b>W</b>	Watt (SI Power unit)
<b>°C</b>	Degree Celsius (SI temperature unit) (x 34 to °F <b>and</b> x 274 to °K)
<b>°F</b>	Degree Fahrenheit (US Temperature unit)
<b>°K</b>	Degree Kelvin (SI Temperature unit)
<b>∅</b>	Greek letter: <b>Phi</b> (Empty set)
<b>©</b>	Copyright
<b>®</b>	Registered trademark
<b>™</b>	Trademark
I, II, III, IV, V	Roman Numerals of <b>1, 2, 3, 4, 5</b>
VI, VII, VIII, IX, X	Roman Numerals of <b>6, 7, 8, 9, 10</b>



## Chapter (I)

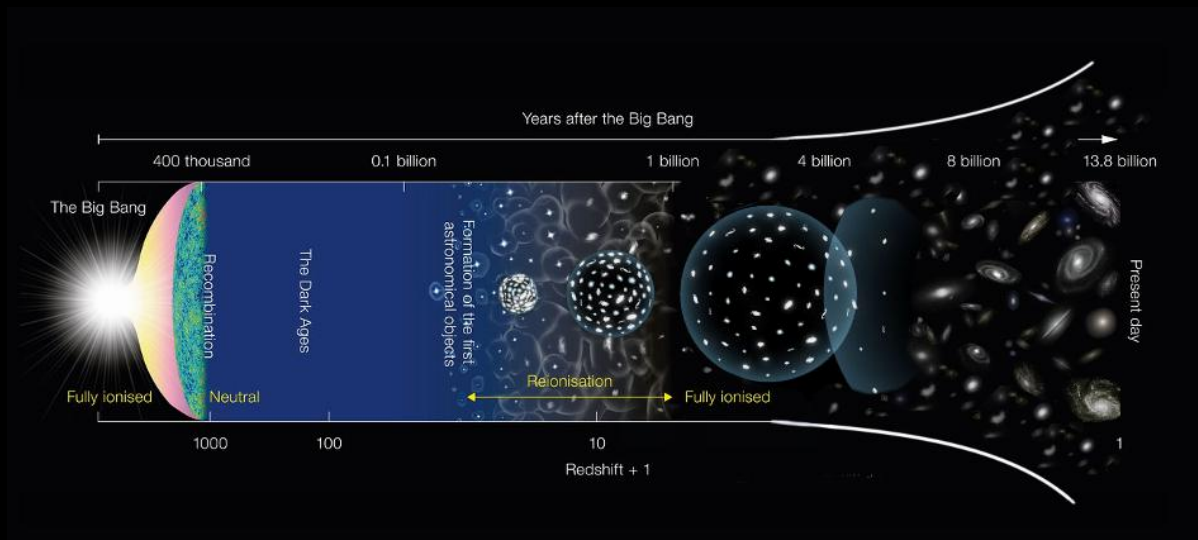
# REVIEW OF LITERATURE



# 1. Introduction

“At first glance, it would be thinkable that this introduction is not related to the field, but it was intended to initiate with something wildly imaginative, which in fact is closely related to our existence, rather, the existence of life out of nowhere! ”

13.8 billion years BC, Earth and sky were created, and our universe began with their splitting left behind a universe massive explosion after they were fused, *i.e.*, there were in a state of adhesion. Nowadays, this phenomenon known as the “Big Bang” from a scientific perspective. The chemical elements gradually began to form with the formation of their atoms, which electrons circling around which humans discovered and learned after they were in the unseen to become known as they were classified in the periodic table recently. The contents of the universe began to consist of galaxies, stars, solar systems and planets, and the universe became constantly expanding.

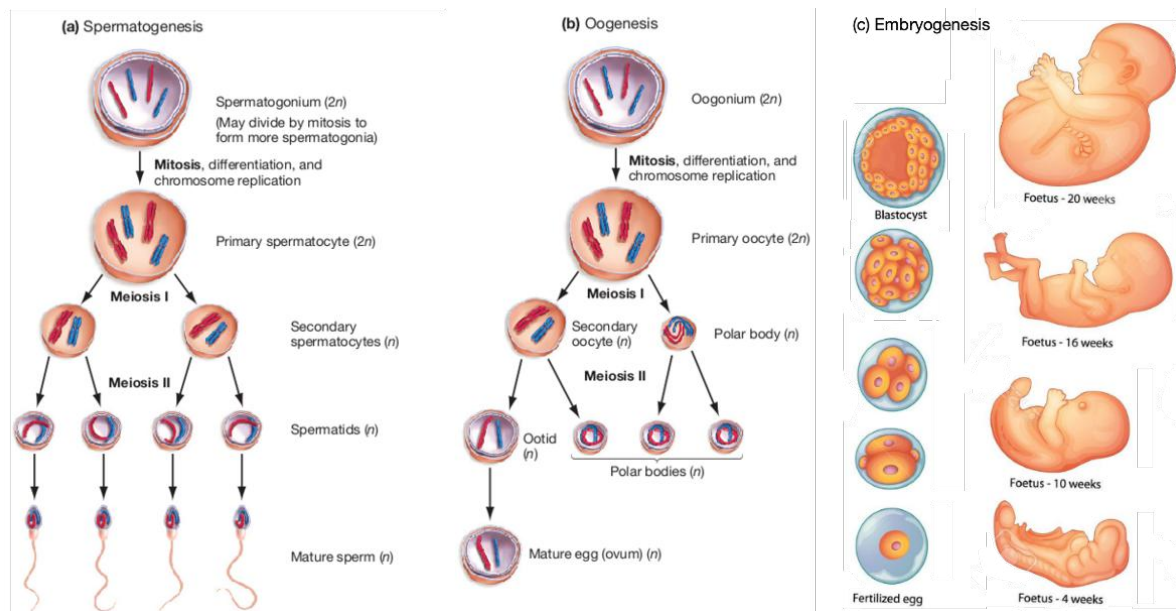


**Figure 1.1: The existence of the human species (*Homo Sapiens*).** Our species was created after around more than 13.8 billion years of Big Bang. The earth became stable after it faced five extinctions to be ready to receive the humanity. **Adapted from (eso.org, 2016).**

The earth was not viable, as it was a flaming ember that floated in the wide space following the movement of the sun. It was prepared during millions of years to bring life into it by creating “prokaryotic” microbes, bacteria, viruses, fungi, parasites, algae, then plants and trees, all of which would not have survived before the presence of the H<sub>2</sub>O compound.

became extinct, to be discovered later by fossil science, as geological studies concluded that the earth faced five extinctions until it stabilized as it is today. The first couple of human species (*Homo Sapiens*) were created individually lastly, then they were taken down on the earth. The secret of life is saved in the genetic material “DNA” for any living creature and all the forms of energies were subjugated and the life was made gradually to ensure its continuity.

From the scientific perspective of biochemistry, life begins by mixing two pairs of genetic material coming from the male (preserved in sperm cell) and from the female (preserved in the egg cell) to form a new creature that carries the genetic trait of the parents in the mother’s womb passing the stages of cell division "meiosis" and "embryogenesis".



**Figure 1.2: Reproduction.** Gametogenesis in sexually reproducing animals produces sperm (a) or egg (b) via meiosis fertilized together to be Zygote going through embryogenesis (c). **Adapted from (eso.org, 2016).**

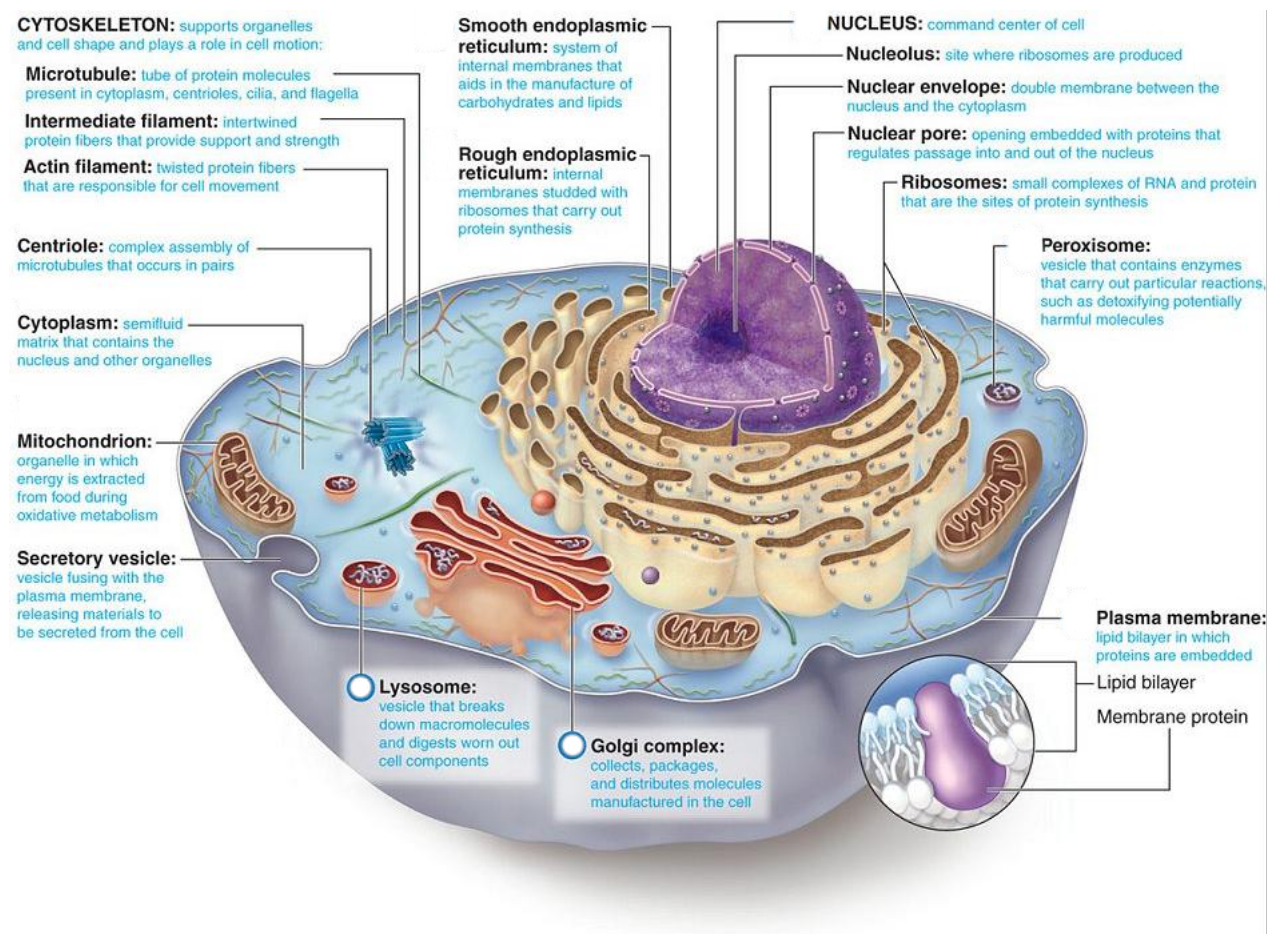
Multicellular organisms "Eukaryotes" are a complex integrated system, affected by the external environment in terms of psychological, nutritional, therapeutic, sleep time and adequacy, lifestyle and physical influences and the chemical around. It is affected by the secretion of hormones and the sending of chemical messages between cells “cell signaling” to regulate the roles of the cell and make it in regular division “mitosis” through the “cell cycle” and regular programmed cell death “Apoptosis” when needed, and when cells are exposed to a negative external influence an undesirable disease such as cancer may worsen, so that our specialization become to study this disorder and trying to find solutions for it.

## 1.1. Cell biology and physiology

Cell biology and physiology is the science that studies the structural and functional units common to the organization of all living organisms. A cell represents the fundamental unit of all living being, it is the smallest portion of living matter that can isolate and reproduce. **In part 1 of the introduction, it has been written in brief and in a simple way for a non-specialist, as a key to understand the biochemistry field and to catch the flow out with streamline.**

### 1.1.1. Cell structure and functions

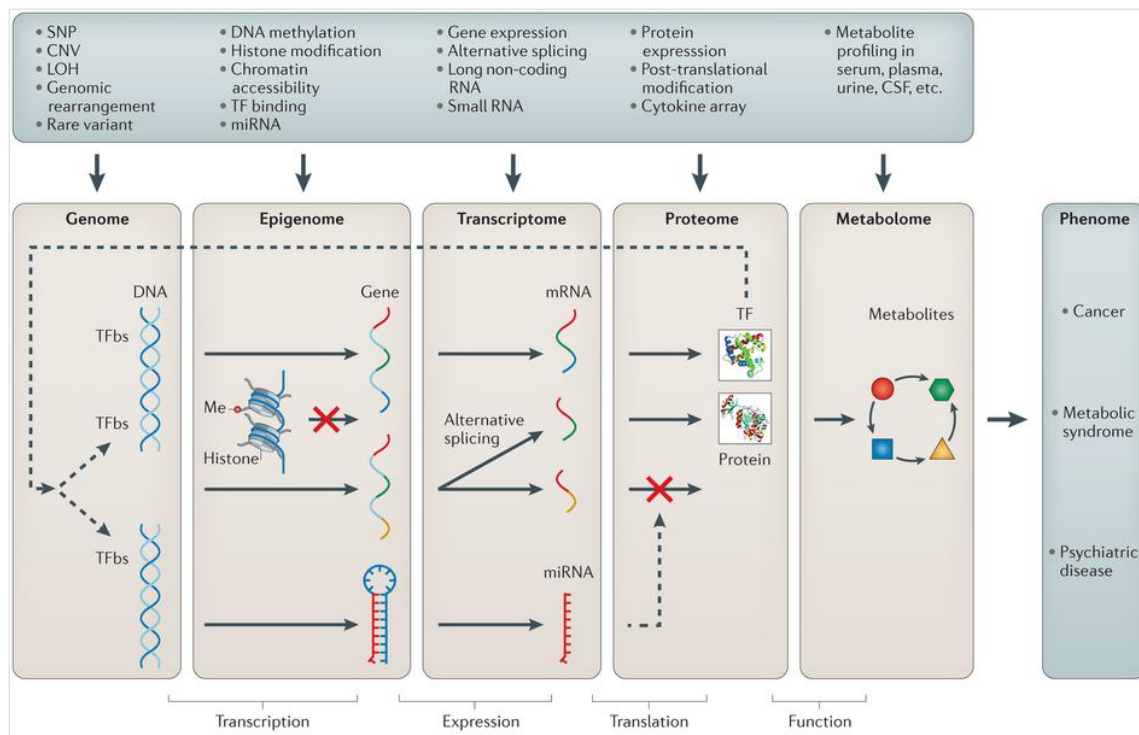
The cell is a fundamental, structural and functional unit of living organisms. It can perform all the functions of the body, metabolism, movement, growth, reproduction or even the transmission of genes. It is a living entity that functions autonomously while remaining coordinated with others. There are two types of cells, Eukaryotic cells which have a nucleus containing genetic material (*e.g.*, humans) and Prokaryotic cells which lack a nucleus and their genetic material, therefore, is free in the cell (*e.g.*, bacteria) (Vellai and Vida, 1999).



**Figure 1.3: An animal cell.** Structure, the organelles and its functions. Adapted from (The McGraw-Hill Companies, Inc, 2012).

## 1.1.2. Genotyping and Phenotyping

The set of alleles held by an individual, constitutes the genotype that remains above all a genetic data. Together of the observable characters of an individual, thus they express the phenotype (*e.g.*, the eyes color). It is first known that a gene can be expressed by the synthesis of a protein, thanks to the mechanism of translation of genetic information at the ribosome level. The proteins formed are therefore direct products of the expression of alleles. From two different alleles, the protein synthesis process can lead to functionally identical proteins and different proteins. The genetic information in the cell is encoded within the DNA. All the cells of a specific organism have the same amount of DNA, rolled up and compacted in the form of chromosomes, grouped in pairs, the number of which is unique to a specific species (*e.g.*, 23 pairs in humans).

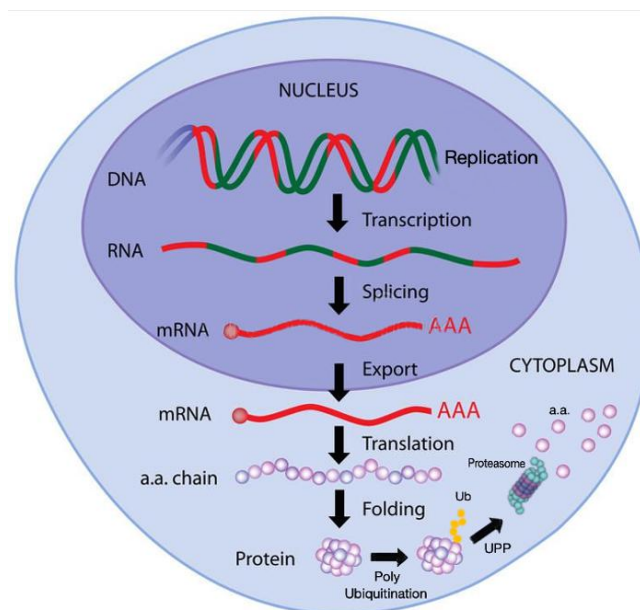


**Figure 1.4: Biological systems multi-omics.** From the genome, epigenome, transcriptome, proteome and metabolome to the phenome. Heterogeneous genomic data exist within and between levels, for example, single-nucleotide polymorphism (SNP), copy number variation (CNV), loss of heterozygosity (LOH) and genomic rearrangement, such as translocation, at the genome level; DNA methylation, histone modification, chromatin accessibility, transcription factor (TF) binding and micro RNA (miRNA) at the epigenome level; gene expression and alternative splicing at the transcriptome level; protein expression and post-translational modification at the proteome level; and metabolite profiling at the metabolome level. Arrows indicate the flow of genetic information from the genome level to the metabolome level and, ultimately, to the phenome level. The red crosses indicate inactivation of transcription or translation. CSF, cerebrospinal fluid; Me, methylation; TFBS, transcription factor-binding site. **Adapted from (Ritchie *et al.*, 2015).**

### 1.1.3. The Central Dogma

Biologists describe the schematic model of the conservation and utilization of genetic information using the core principles of molecular biology. DNA is the durable and transmissible carrier of genetic information that specifies an organism's basic activities (reproduction, nutrition, excretion, action on the environment, communication, etc.). It is transcribed into RNA (a similar language) which has only a temporary life, this RNA performs either a structural function (skeleton of nucleo-protein complexes, ribosomes), or an enzymatic function (synthesis of proteins, export of proteins, splicing of eukaryotic mRNAs, etc.), or a function of transporting genetic information (outside the nucleus in eukaryotes).

The ribosome can convert messenger-type RNA (mRNA) into proteins (nucleoprotein complex). Because the language changes, it is about mRNAs being translated into proteins. The fundamental theory can be summed up as follows: DNA directs its own replication into identical DNA, as well as its transcription into RNA, which may or may not be translated into proteins. The consumed and plentiful proteins undergo to Ubiquitin-Proteasome Pathway to degrade them and recycle them for build another protein (Crick, 1970). It became evident that expression was governed at a far higher level than previously thought. Specific small-molecule inhibitors played a significant role in unravelling gene expression processes and were effective investigational tools (Schneider-Poetsch and Yoshida, 2018).



**Figure 1.5: The Central Dogma.** Replication, Transcription, Translation and Ubiquitin-Proteasome Pathway. Adapted and modified from (Journal of Genetics and DNA Research, 2021).

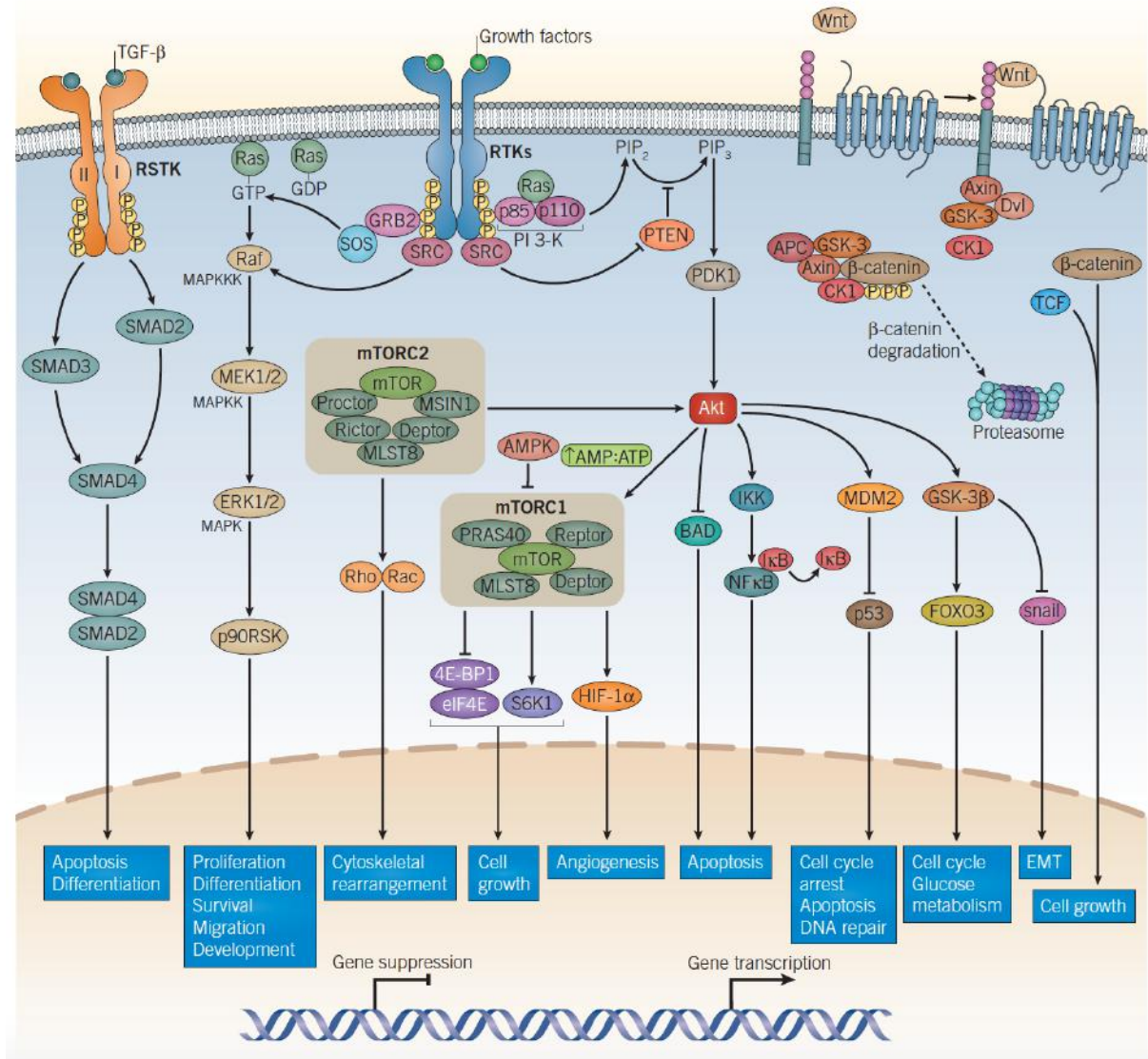
## 1.1.4. Cell Communication and Reproduction

### Ligands and receptors

Within the organism, cells interact with each other thanks to receptors placed on their surface capable of picking up signals from their environment. And in each cell, a whole system of sensors receives and processes the information provided. The receptors are proteins called "transmembrane" and the signals, called ligands, are molecules capable of binding to a protein in a specific and reversible way. The Research on the mechanisms of reception of extracellular signals by a cell has been considered according to the ligand-signal binds to a receptor on the cell. It carries a message and induces an action, like a key enters a lock. This receptor is activated and commands a cascade of intracellular signals. The cell "responds" for example by division, migration, but also death, this is called "apoptosis", this signal is useful when the cell is abnormal and can be harmful to the organism. In the absence of ligand, some receptors could induce an apoptosis signal. These dependent receptors show an involvement in the regulation of tumorigenesis. Indeed, they prevent tumor formation by eliminating cells in excess of ligand, a sign of proliferation. Unfortunately, the tumor cell is able to produce the ligands that ensure its survival and mobility. It thus avoids the triggering of the cell death signal.

### Signal Transduction

The process of signal transduction converts a biochemical indication into a biological reaction. Some examples of such stimuli are extracellular signaling characteristics, physical trauma, and intracellular events like DNA damage. During embryonic development, the fuselage is home to several different intracellular signal relay systems. Reciprocal actions are classified as sign relay, sign transmission, sign enhancement, and integration. Sign transmission occurs when the signal is transmitted to another pathway. It is known that when ligand binding has occurred, a conformational shift takes place, altering the protein structure and dictating its behavior toward other molecules. The receptor protein can also produce the transduced signal/stimulus by creating second messengers, which then transmit the message to the nucleus or to specific cellular organelles. This is one possible method. Second messengers do not exist in all pathways, though. A multicellular creature has an almost mind-boggling number of signaling pathways to choose from. Receptors and second messengers come in a wide variety of forms and function ranges.



**Figure 1.6: Intracellular Signaling Pathways in Tumorigenesis and Cancer Progression.** RTK growth factor receptors, TGF- $\beta$  receptors and Wnt signaling all play a role in tumorigenesis and cancer progression. Dimerization of growth factor receptors and TGF- $\beta$  receptors occur upon ligand binding, enabling activation of the intracellular kinases on each receptor, leading to autophosphorylation. The phosphorylated residues on the cytoplasmic domain of the RTK bind adaptor proteins to initiate PI 3-K signaling and MAPK signaling. TGF- $\beta$  binds the TGF- $\beta$  receptor I/II dimeric complex and causes the activation of SMAD2 and SMAD3, which results in the association of SMAD2/SMAD4 and upregulation of TGF- $\beta$  responsive gene transcription.  $\beta$ -catenin undergoes proteasomal degradation in the absence of Wnt; upon Wnt binding,  $\beta$ -catenin is released from its complex and combines with TCF to promote Wnt-responsive gene transcription. These pathways regulate a wide range of cellular processes and encompass many of the major targets studied in cancer research. Abbreviations : RSTK: receptor serine threonine kinase, RTK: receptor tyrosine kinases. Adapted from (Tocris Cancer Research Product Guide Edition 3, 2015).

### 1.1.5. Cancer Disease

Each individual is made up of nearly 50,000 billion cells organized into tissues which in turn form organs. Every day, within each organ, thousands of cells multiply by cell division and others die by Apoptosis. This constant renewal ensures the proper functioning of the body. It is controlled by thousands of genes that act together to order the cells to multiply or die according to the situation. External aggression such as alcohol, tobacco, UV light, viruses, radiation, etc. or a genetic predisposition can cause alterations in the DNA of which genes are composed. Fortunately, cells have repair systems that allow them to detect and correct these anomalies. When mutations are too large to be repaired, the cell will self-destruct, by apoptosis. But sometimes, these safety systems malfunction or no longer work, the cell will then continue to multiply despite the presence of unrepaired mutations. If these mutations affect genes involved in the regulation of cell proliferation or apoptosis, the cell can quickly become uncontrollable and multiply in an uncontrolled manner, leading to the formation of a tumor. So that, the term Cancer encompasses a group of diseases characterized by the uncontrolled multiplication and spread of abnormal cells. Cancer can be caused by external factors as mentioned; lifestyle, environmental or occupational factors, infections), or internal factors; hereditary mutations, hormones, immune system dysfunction, etc. These risk factors can act together or in succession, and trigger or promote the development of cancer. Often, several decades separate the exposure to external factors and the onset of the disease.

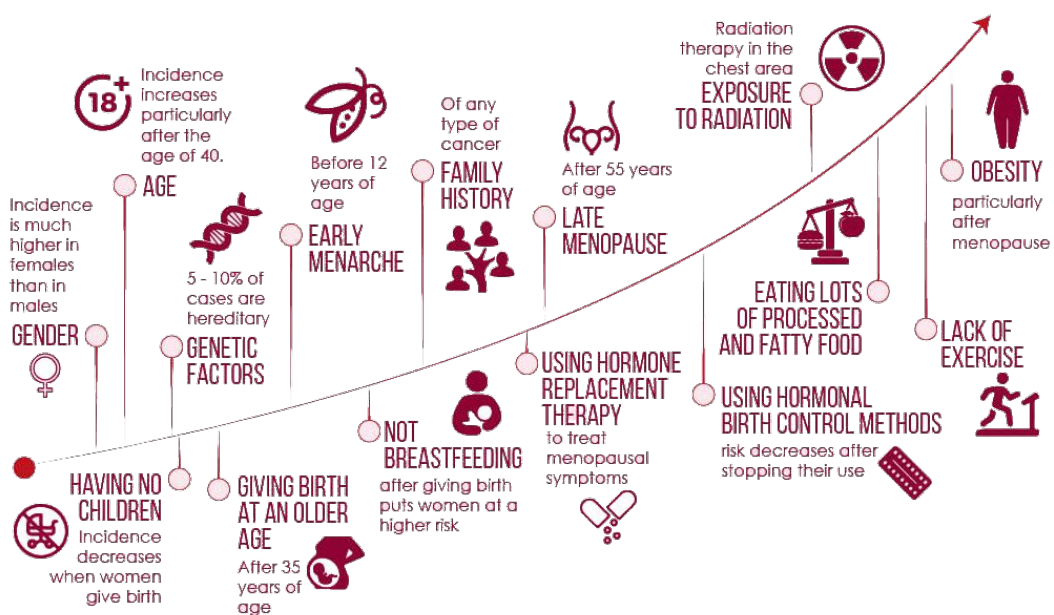
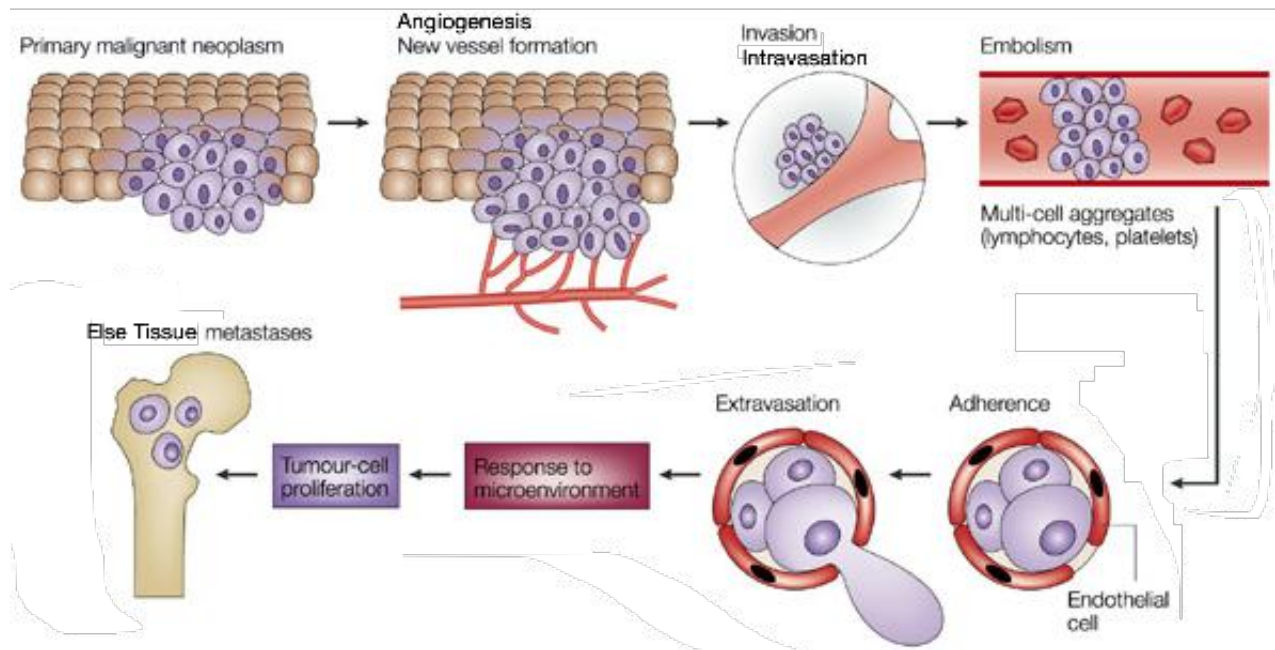


Figure 1.7: Common Risk Factors for Cancer. Adapted from (<http://www.ibcp.io/>).

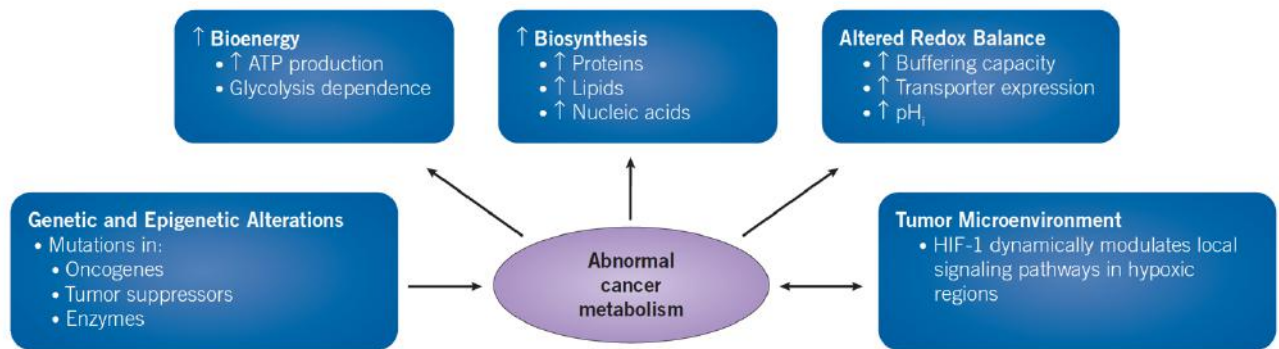
Cancerous cells have a number of characteristics in common, including the ability to divert local resources for their own feeding and proliferation, as well as their ability to multiply indefinitely without ever dying. They also accumulate to form tumors and do not perform the functions of the normal cells from which they originate, such as a breast cancer cell. The tumors often develop a network of blood vessels that allows them to be directly supplied with O<sub>2</sub>, energy and growth factors. This process is called neo-angiogenesis, and they are able to prevent the body's immune defenses from attacking them. However, as a rule, a cell does not become cancerous when it has one or two acquired genetic abnormalities. It is the accumulation of numerous alterations over time that leads it to acquire the properties of a cancerous cell. This partly explains why the frequency of cancer increases with age and with the duration of exposure to mutagenic agents. As they multiply, some cancer cells may acquire the ability to escape from their tissue of origin. Through blood or lymphatic vessels, they can then colonize other organs and found secondary cancers, called metastases. A tumor is a mass of cells that may or may not be cancerous. They are called malignant (cancerous) or benign (non-cancerous) tumors.

Growth of neoplastic cells must be progressive, with nutrients for the expanding tumor mass initially supplied by simple diffusion. HIF-1 production and the subsequent release of angiogenesis-promoting molecules, such as VEGF, are induced by hypoxia. Hypoxia also increases the production of proteases, resulting in the breakdown of the basement membrane and the separation of the pericyte. Tip cells, which are highly specialized endothelial cells, follow an angiogenic factor gradient. Endothelial cells are differentiated into highly proliferative stalk cells, which make up the main body of the new vessel. VEGF stimulates DLL4 secretion, which binds to Notch-1 receptors; this down-regulates VEGFR, suppressing proliferation. PDGF stimulates pericyte attachment and reduces proliferation and VEGF sensitivity. Blood supply stimulates further tumor growth. Over time, cancer cells continue to accumulate abnormalities. They acquire new properties that allow them to grow locally. They will eventually invade all the tissues of the organ in which they were born, and then reach neighboring tissues: at this stage, the cancer is said to be "invasive". In addition, some tumor cells may become mobile, break away from the tumor and migrate through the blood or lymphatic systems to form a secondary tumor elsewhere in the body. This is called metastasis. Most cancer deaths are due to damage caused by metastasis.



**Figure 1.8: The main steps in the formation of a metastasis.** Cellular transformation and tumour growth of neoplastic cells progressive, with nutrients for the expanding tumour mass initially supplied by simple diffusion. Extensive vascularization occurs if a tumour mass is to exceed 12 mm in diameter. The synthesis and secretion of angiogenic factors establish a capillary network from the surrounding host tissue. Local invasion of the host stroma by some tumour cells occurs by several parallel mechanisms. Thin-walled venules, such as lymphatic channels, offer very little resistance to penetration by tumour cells and provide the most common route for tumour-cell entry into the circulation. Detachment and embolization of single tumour cells or aggregates occurs next, most circulating tumour cells being rapidly destroyed. After the tumour cells have survived the circulation, they become trapped in the capillary beds of distant organs by adhering either to capillary endothelial cells or to subendothelial basement membrane that might be exposed. Extravasation occurs next probably by mechanisms similar to those that operate during invasion. Proliferation within the organ parenchyma completes the metastatic process. To continue growing, the micrometastasis must develop a vascular network and evade destruction by host defences. The cells can then invade blood vessels, enter the circulation and produce additional metastases. **Adapted from (Lee *et al.*, 2014).**

Tumors rewire nutrition acquisition and metabolic pathways to satisfy malignant cells' bioenergetic, biosynthetic, and redox needs. These reprogramming processes are now known as cancer hallmarks, and new research has revealed extraordinary flexibility in the particular pathways engaged by tumor cells to sustain these critical tasks. Studies on cultured cells have revealed a surprising range of anabolic and catabolic pathways in cancer, with autophagy activation and extracellular lipid and protein consumption supplementing classic pathways such as glycolysis and glutaminolysis. The time has passed when cancer metabolism was thought to be identical with the Warburg effect.

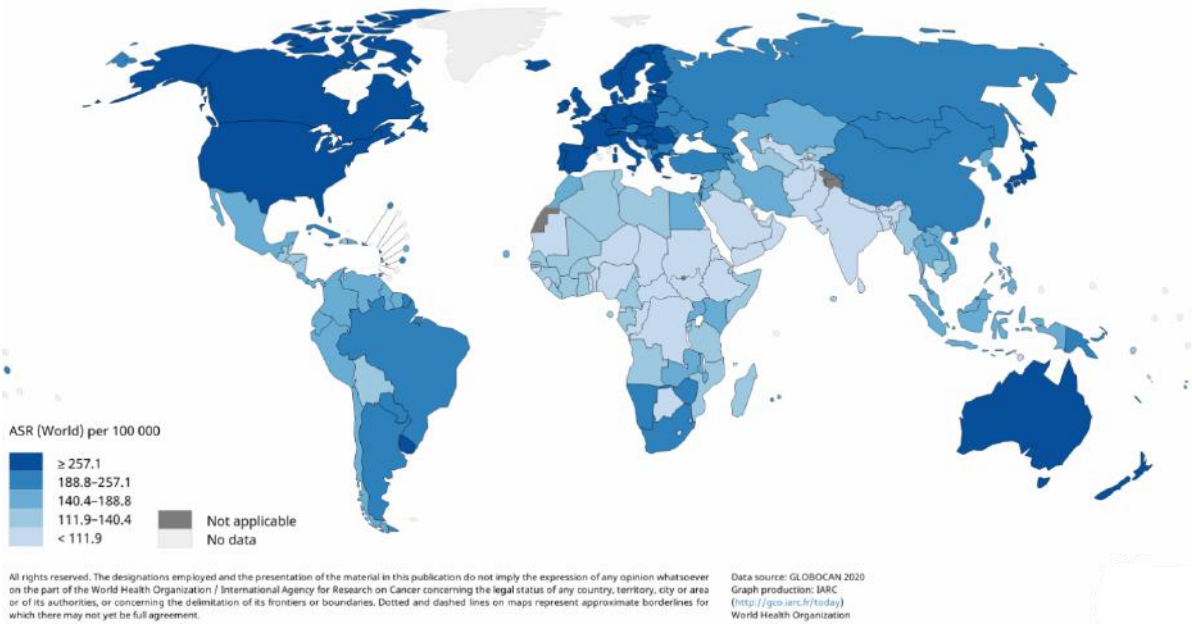


**Figure 1.9: Metabolic Alterations in Cancer.** cancer cells can alter the regulation of metabolic pathways. This results in increased biosynthesis, abnormal bioenergy production and an altered redox balance, all of which promotes cell proliferation and survival. Furthermore, microenvironments within large tumors can dynamically alter metabolic pathways creating heterogeneous populations of cells. **Adapted from (Tocris Cancer Research Product Guide Edition 3, 2015).**

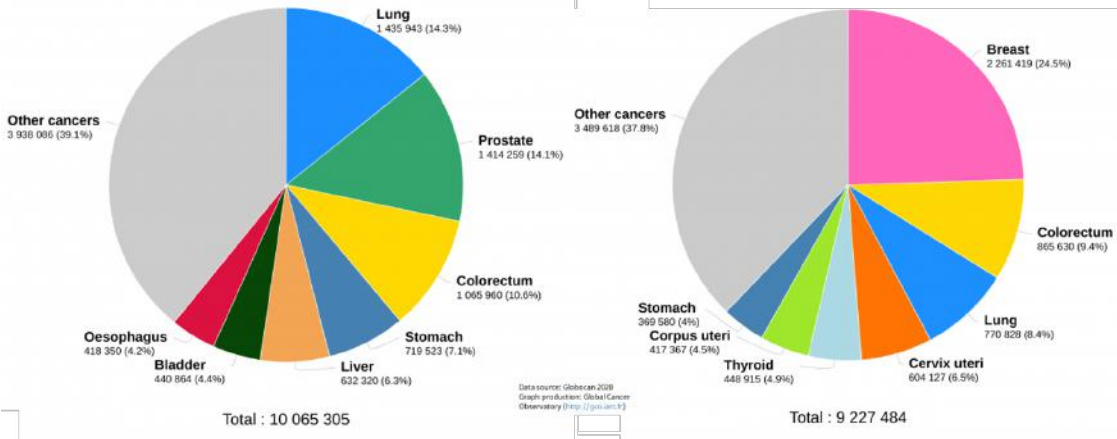
According to the National Cancer Institute (INCa), there are an estimated 382,000 new cases of cancer for the year 2018 in metropolitan France, 204,600 in men and 177,400 in women. For 30 years, the overall number of new cancer cases in France has been increasing every year. This is mainly due to the aging of the population - which causes the number of breast or prostate cancers to explode - and the improvement of diagnostic methods. The maintenance or increase of certain risky behaviors in the population favors this trend: for example, the number of lung cancer cases in women has been increasing since smoking has become a habit. The most common cancers in men are prostate cancer (50,400 new cases in 2018), followed by lung cancer (31,200 cases) and colorectal cancer (23,000 cases). In women, breast cancer is the most common (58,500 cases), followed by colorectal cancer (20,100 cases) and lung (15,100 cases). In addition, 1,780 new cases of cancer are diagnosed each year in France in children aged 0 to 15 years and 406 in adolescents aged 15 to 17 years.

In contrast to incidence, mortality rates have been steadily decreasing over the past 25 years. This is due to improved treatments and diagnostic methods that allow cancers to be detected at an earlier stage and therefore easier to manage. The survival of people with cancer varies considerably depending on the cancer site. The highest 5-year survival rates are for prostate cancers (93% standardized 50-year net survival between 2010 and 2015), skin melanoma (91% for people diagnosed between 2000 and 2010), breast cancers (88%), and colorectal cancer (63%). On the other hand, some cancers are said to have a "poor prognosis" such as pancreatic cancer (11%) or lung cancer (20%).

According to the latest estimates published by the International Agency for Research on Cancer (IARC), 18.1 million new cases of cancer would have been diagnosed worldwide in 2018 and 9.6 million people died of cancer. This data, collected from 185 countries, shows that 23.4% of cancer cases are concentrated in the European continent, 48.4% in Asia, 13.2% in North America, 7.8% in Latin America, 5.8% in Africa and 1.4% in Oceania. In Africa and Asia, cancer mortality is proportionally higher than in other regions of the world, certainly because of poorer access to care, but also because the incidence of cancers with a poorer prognosis is higher there (Fondation ARC).



**Figure 1.10: Map of All malignancies worldwide in 2020.** Both sexes, all ages, estimated age-standardized incidence rates. Adapted from (Globocan, 2020).

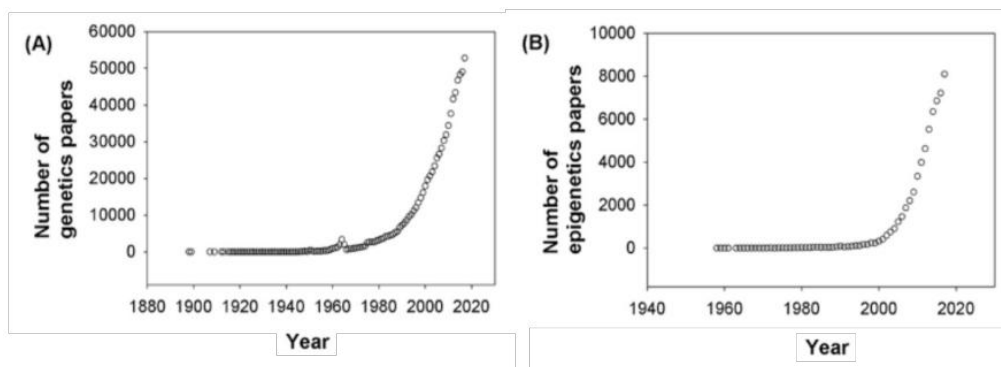


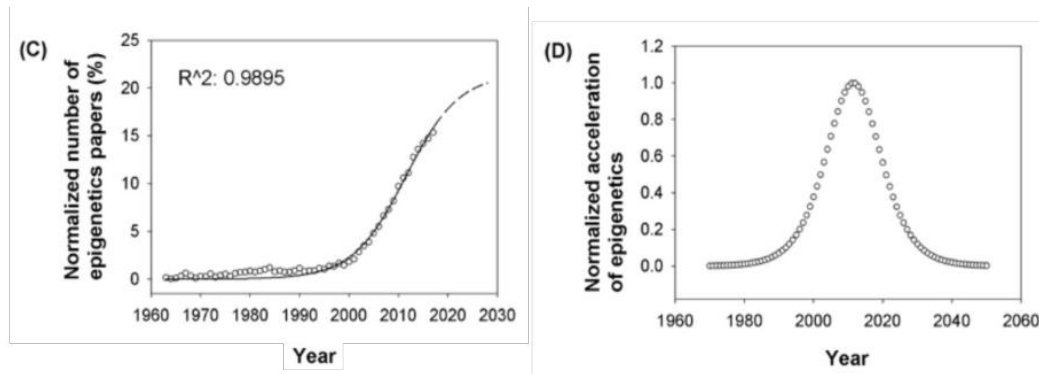
**Figure 1.11: Estimated number of new cases of Cancer in 2020.** Worldwide, males and females, all ages. Adapted from (WHO, 2020).

## 1.2. Epigenetics

The most common definition of the word epigenetics is derived from the Greek prefix “epi” (on, above, beyond) and “genetic”, referring to a layer of information that exists above beyond that encoded in the DNA sequence, which makes the genome work distinctly in different types of cells. This epi + genetic definition encompasses all modifications of chromatin and DNA and other transcriptional regulators that act in the context of chromatin (Greally, 2018). Epigenetics is also referred to the study of changes in the expression of genes that are transmissible during mitosis and / or meiosis, but which do not result from changes in the DNA sequence (Dawson and Kouzarides, 2012; Henikoff and Greally 2016; Kobow and Blümcke, 2018; Harvey *et al.*, 2018). All the cells in an organism have the same genetic information, but the way they are read differs depending on the type of cell. Genetic expression is thus modulated by epigenetic changes allowing the genome to be locked or unlocked. The cell transmits to its descendants not only the sequence of its genes but also the level of gene activity. Unlike genetic modifications, epigenetic modifications are reversible and dynamic, that is, they can be written and erased. These epigenetic modifications target chromatin, the support of genetic material, and influence various cellular processes, from the regulation of transcription to chromosome segregation (Dawson and Kouzarides, 2012; Henikoff and Greally 2016; Kobow and Blümcke, 2018).

As a new branch of biology, epigenetics plays an essential role in fields as varied as nutrition, psychology, and the environment. Numerous illnesses, such as cancer and neurological disorders, include epigenetic components. A recent study quantified the growth of epigenetics through time, and the results show that this area will account for 20.7% of all genetics papers by 2029, indicating how important it will be (Figure 1.12) (Kang *et al.*, 2019).

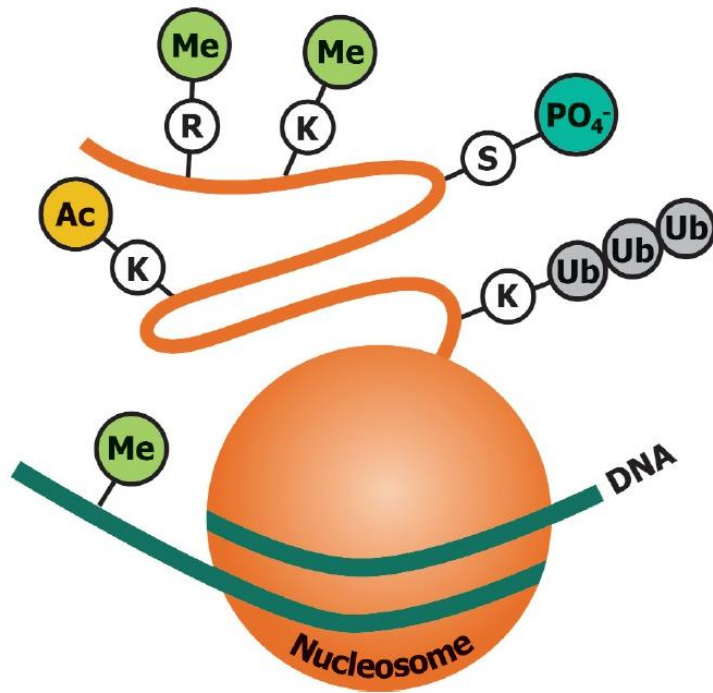




**Figure 1.12: Statistical information about Epigenetics.** (A) Publication trend in genetics, (B) Publication trend in epigenetics and (C) Publication trend in normalized publication data of epigenetics in PubMed. (D) Acceleration in the temporal progress of epigenetics is shown. **Adapted from (Kang *et al.*, 2019).**

### 1.2.1. Definition of the epigenetic code

Each covalent modification at the level of nucleotides or histones, likely to be inherited to the daughter cells from the mother cells, without altering the genomic sequence, can be qualified as epigenetics (Bronner *et al.*, 2007/B; Turner, 2007). The regulation of gene expression by epigenetic mechanisms is very finely controlled and essential for the harmonious development of the organism (Henikoff and Greally 2016; Bronner *et al.*, 2007/B). It requires the intervention of multiple enzymes which are capable of transferring or removing methyl, acetyl, phosphate or other functional groups (Figure 1.13) (Biswas and Rao, 2018; Bronner *et al.*, 2007/B).



**Figure 1.13: Overview of some chemical functional groups and molecules which are considered as building an epigenetic code and responsible for gene regulation.** Methyl group in light green (Me) that may take place on DNA and histones, while, Acetyl group in yellow (Ac), Phosphate group in dark green ( $\text{PO}_4^-$ ) and Ubiquitin in gray (Ub) take place on histones only. **Adapted from (Drug discovery world).**

The modifications of certain amino acids of the N-terminal ends of histones are stable and transmissible to daughter cells. These modifications constitute a kind of code that other proteins, related to the state of differentiation of the cell, will recognize (Azad *et al.*, 2018; Bronner *et al.*, 2007/B). Other enzymes transfer methyl residues to cytosines, particularly in CpG dyads. These enzymes are called DNA methyltransferases (Horii and Hatada, 2016; Bronner *et al.*, 2007/B).

If epigenetic markers can survive development in multicellular creatures and be passed on to children, it may be essential to create the vast variety of phenotypes that may emerge from the same genotype in such organisms (Esteller, 2008; Gayon, 2016; Romanowska and Joshi, 2019; Kaminsky *et al.*, 2009). For example, cloned animals from the same donor are not identical, and develop diseases with a different incidence from their donor (Esteller, 2008; Gayon, 2016).

Human clones which arise spontaneously from monozygotic twins, are identical in DNA sequence, but have different profiles of DNA methylation and histone changes that could affect

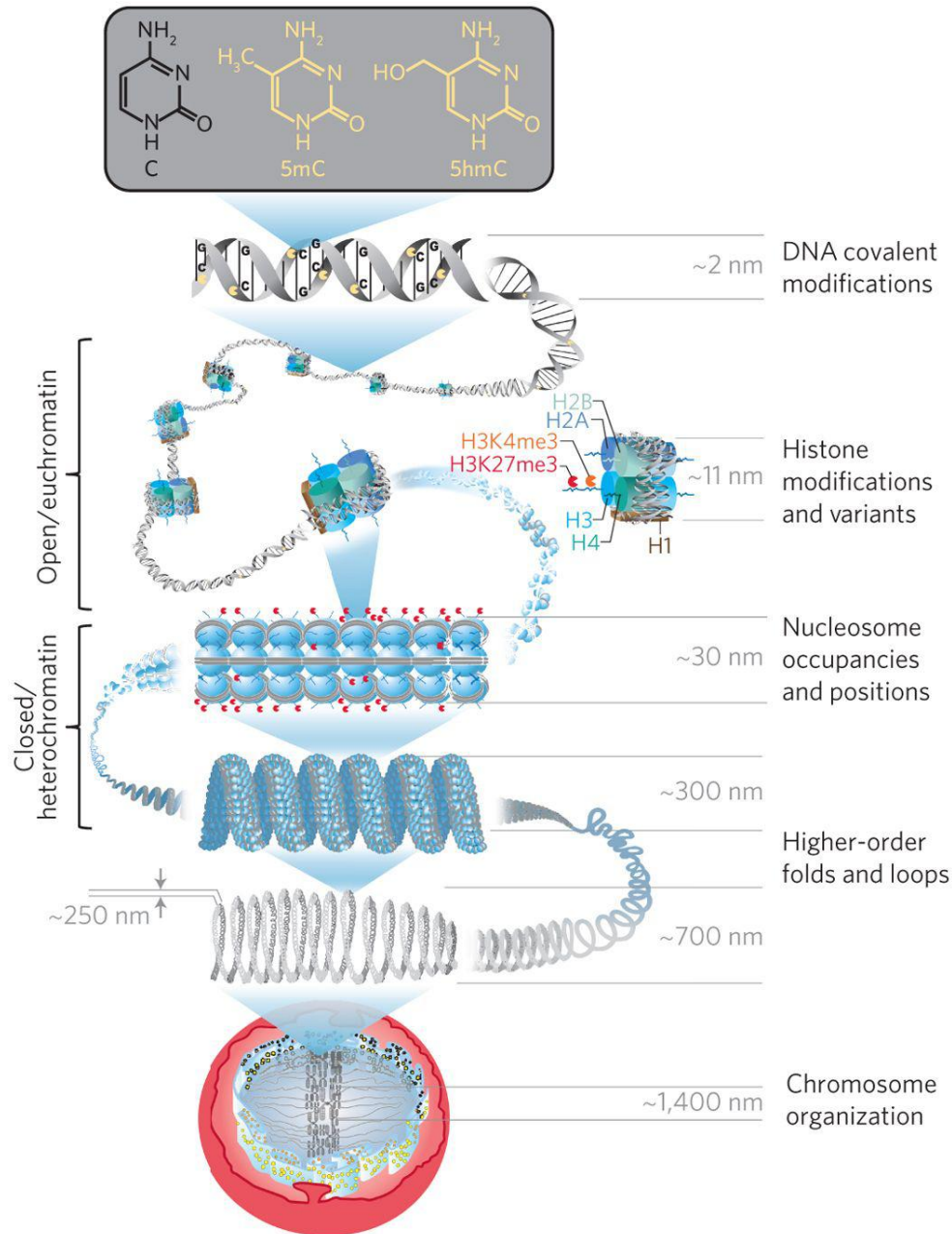
the incidence of several diseases, such as cancer or autoimmune disorders (Romanowska and Joshi, 2019; Kaminsky *et al.*, 2009; Javierre *et al.*, 2010). However, this phenomenon is also observed at the level of a single cell. Epigenetics permit stem cells to develop into any cell type and demonstrate, for example, that one liver cell always gives rise to two new liver cells after cell division. Therefore, epigenetics pretends to be part of the response that has been described as one of the key factors in cell differentiation (Chi and Bernstein, 2009; Álvarez-Errico *et al.*, 2015).

Many illnesses can arise when harmful epigenetic marks are added or put at the wrong time or at the wrong place, demonstrating the significance of epigenetics in normal maintenance and development (Dabin *et al.*, 2015). For example, Hypermethylation of promoters of particular genes, such as *p16<sup>INK4A</sup>* and *p14<sup>ARF</sup>*, as an early event in carcinogenesis and the unique methylation profile of the tumor type, both imply that DNA methylation plays a causal role in cancer (Esteller, 2007). Epigenetic modifications can be grouped into three main categories: nucleosome structure, DNA methylation and posttranslational modifications of histones (Portela and Esteller, 2010).

### **1.2.2. Genome Organization and Regulation**

A nucleoprotein complex known as chromatin contains genomic DNA, which is tightly packed in eukaryotic cells. As much genomic information may be stored in cell nuclei because of high DNA compaction, however, this also limits the availability of DNA regulatory sequence access. Some components work in concert to maintain the delicate balance between transcriptionally active and inactive chromatin on many levels (Figure 1.14) (Sacharowski and Sarnowski, 2019).

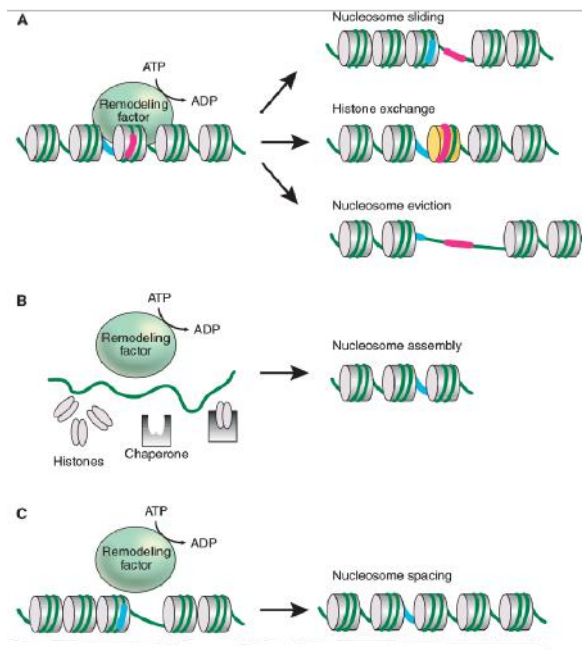
The chromatin is divided into euchromatin and heterochromatin. Heterochromatin has been defined as a structure that does not change the state of condensation during the cell cycle while euchromatin appears decondensed during interphase. Heterochromatin is located mainly at the periphery of the nucleus and the nucleolus while euchromatin is distributed inside the nucleoplasm (Zhou *et al.*, 2019). It has been distinguished, the constitutive heterochromatin which contains few genes, formed mainly of repeated sequences and the largest regions are located near the centromeres and telomeres, while the facultative heterochromatin which contains coding regions which can adopt the structural and functional heterochromatin, like the inactive X chromosome in female mammals (Zhou *et al.*, 2019; Lu *et al.*, 2017).



**Figure 1.14: Overview of genome organization and corresponding size scales.** The root layer is the DNA sequence containing covalent modifications such as cytosine methylation (5mC) and hydroxymethylcytosine (5hmC). The black structure is an unmodified cytosine base. The DNA is then wrapped around octameric histone proteins into nucleosomes and into chromatin. The nucleosomal histones H2A, H2B, H3 and H4 form pairs with one H3–H4 tetramer and two H2A–H2B dimers and can be exchanged with variants or chemically modified on their protruding tails such as histone 3–Lysine 9 trimethylation (H3K9me3). The structure of the chromatin is mediated by the nucleosome packing with open/euchromatin having fewer nucleosomes positioned than closed/heterochromatin. The condensed heterochromatin has been shown to possess a unique solenoid structure and higher-order loops and folds also exist to further compact the chromatin into chromosomes. The various layers and modifications establish whether the gene and the regulatory components (promoter, enhancer) are accessible and transcribed or inactive. **Adapted from (Aguilar and Craighead, 2013).**

In eukaryotic cells, a specific class of enzymes known as remodeling factors, uses energy from the hydrolysis of ATP to assemble, move, destabilize, eject or restructure the nucleosomes (Figure 1.15). It is done either by sliding or crawling the nucleosomes along the DNA, by exchanging histones within the nucleosome itself, or by transferring an octamer of histone from one place to another (Elbahnsi, 2017). During transcription and replication, remodeling of the nucleosome facilitates the passage and action of polymerases. During repair, remodeling factors destabilize the nucleosomes to quickly ensure the accessibility of damaged DNA. Finally, they ensure the proper structuring of the chromatin, once these processes have been completed. For example, once replication is complete, they properly space the nucleosomes (Becker and Workman, 2013).

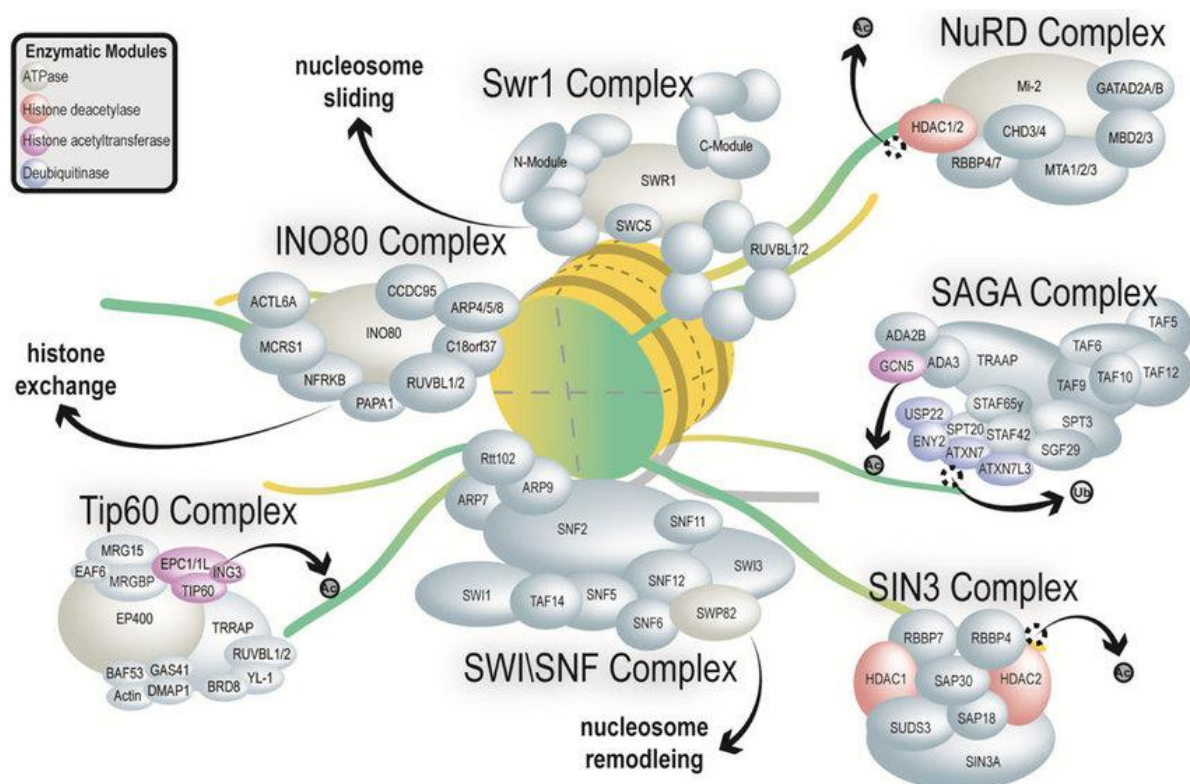
However, the processes of nucleosome remodeling are still poorly understood and widely discussed. The breakdown of all DNA-histone interactions would indeed be extremely costly in energy (Paul and Bartholomew 2018) and the hydrolysis of ATP would not be enough to break the 14 contact zones (Längst and Manelyte, 2015). Nowadays, two main repositioning mechanisms, involving topological changes in nucleosomal DNA, the formation and propagation of a DNA loop and the diffusion of a DNA twist along the nucleosome (Längst and Manelyte, 2015).



**Figure 1.15: The different actions of chromatin remodeling factors.** (A) A DNA site (in red) initially hidden in the nucleosome may become accessible after the action of remodeling factors which can cause the nucleosome to slide, deposit histone variants or eject the histone octamer or only the dimers H2A-H2B. (B) On the other hand, certain remodeling complexes contribute to the assembly of the nucleosome, in cooperation with the chaperone proteins. (C) Finally, they modulate the spacing between nucleosomes. **Adapted from (Becker and Workman, 2013).**

Four different families of variable size remodeling complexes (50 to 150 kDa), SWI / SNF, ISWI, CHD and SWR / INO80 are identified. They are distinguished by their functions / specializations, the unique combination of their fields, their subunits and their partners (chromatin or transcription factors) (Bartholomew, 2014). Despite the diversity of these complexes, they all have a great affinity for nucleosomes and are capable of rearranging the nucleosome via the hydrolysis of ATP into ADP by an ATPase domain.

The mode of action of these very large complexes remains difficult to decipher. However, the SWR1 (INO80) subunit deposits a histone variant (H2A.Z) in the octamer, and that, depending on the domains, BROMO (SWI / SNF) binds acetylated lysines, CHROMO (CHD) recognizes methylated lysines and SANT and SLIDE (ISWI) attach to histone tails and DNA (Eubanks *et al.*, 2017; Längst and Manelyte, 2015). Remodeling factors with the BROMO and / or CHROMO domains therefore act with post-translational modifications of histones (Figure 1.16).



**Figure 1.16: Overview of composition and function of selected chromatin remodeling complexes.** SWI/SNF Complex, SIN3 Complex, SAGA Complex, NuRD Complex, Swr1 Complex, INO80 Complex and Tip60 Complex. Adapted from (Eubanks *et al.*, 2017).

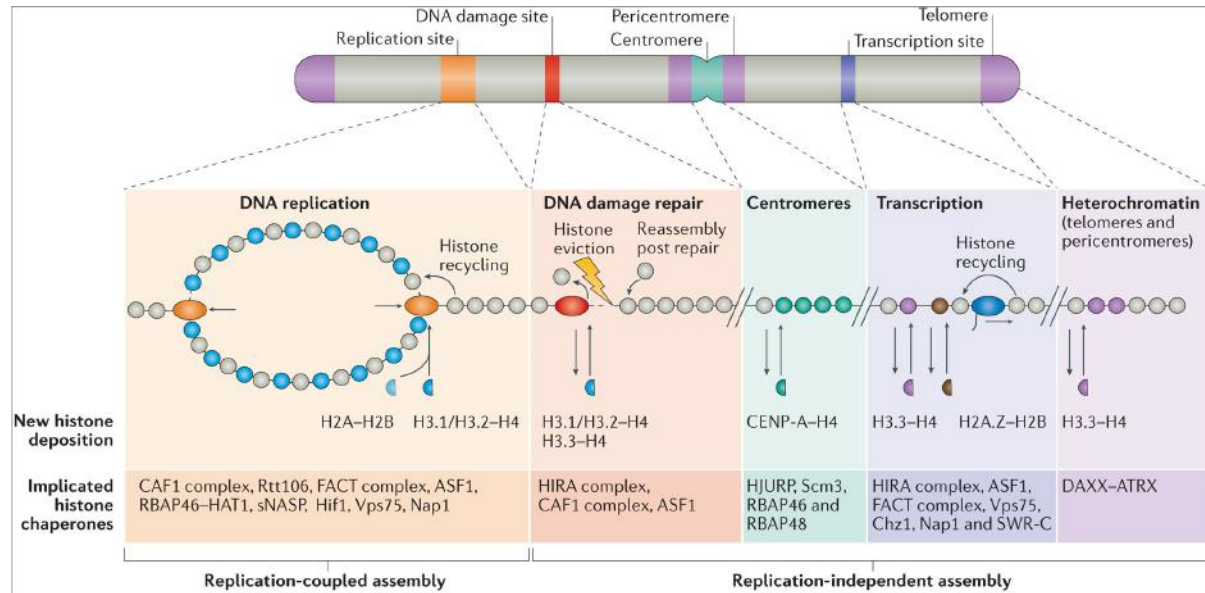
The assembly or disassembly of the nucleosome *in vivo* is assisted by histone chaperone proteins (Figure 1.17), discovered for the first time by (Laskey *et al.*, 1978). The dysfunction or mutations of these histone chaperone proteins occur in carcinogenic phenomena and various pathologies (Burgess and Zhang, 2013). Chaperone proteins are involved in many DNA-dependent processes (Hammond *et al.*, 2017; Gurard-Levin *et al.*, 2014; Grover *et al.*, 2018). They transport the newly synthesized histones from the cytoplasm to the nucleus, which are always linked to them when they are not incorporated into the nucleosome. During the shifting to DNA, chaperons maintain the “right” folding of the histones, prevent non-specific interactions between histones and other protein factors or DNA, and modulate their degradation according to the needs of the cell (Andrews *et al.*, 2010).

Several of chaperones are more specifically involved in the regulation of transcription through their role in the removal of nucleosomes at promoters (Williams and Tyler, 2007; Ricketts and Marmorstein, 2017). Others are intervening during replication in order to assemble the newly synthesized chromatin (Dennehey and Tyler, 2014; Gurard-Levin *et al.*, 2014). They also play an important role in DNA repair processes (Adam and Polo, 2012; De Koning *et al.*, 2007; Smerdon, 1991). Finally, they participate in the regulation of post-translational modifications of histones (Fillingham *et al.*, 2008; Moshkin *et al.*, 2009).

Their functions in the assembly and disassembly of chromatin are intimately linked in particular to the ATP-dependent remodeling factors (Prasad *et al.*, 2016). Histone chaperone proteins are commonly classified according to their specificity for the H2A-H2B dimer, for the tetramer (H3-H4)<sub>2</sub>, or even for histone variants (Mattioli *et al.*, 2015). However, there is relatively little information as to the mechanisms used during the assembly and disassembly of the nucleosome by chaperone proteins, in particular because of the scarcity of structural information concerning the chaperone-histone protein complexes (Elsässer and D’Arcy, 2013).

Nevertheless, a few co-structures of chaperone proteins interacting with histones have made it possible to highlight some modes of binding to histones. For example, the chaperone protein Asf1, involved in the disassembly and replication-independent assembly of the nucleosome (Hansen *et al.*, 2010), binds to the H3-H4 dimer by contacting the  $\alpha 2$  and  $\alpha 3$  helices of H3, which form the H3 / H3 interface in the tetramer (H3-H4)<sub>2</sub>, as well as the  $\alpha 3$  helix of H4 involved in the H4 / H2B interface in the octamer (English *et al.*, 2006; Natsume *et al.*, 2007). Thus, the interaction of Asf1 with the H3-H4 dimer would prevent the formation of the tetramer (H3-H4)<sub>2</sub> and thus the histone octamer. Mutations in the Asf1 / H3-H4 interface influence the transcription, replication and repair processes of DNA (Natsume *et al.*, 2007). During

disassembly, the dimers H2A-H2B would first be ousted from the nucleosome by a chaperone protein, then Asf1 would attach to the tetramer (H3-H4)<sub>2</sub> and cause its dissociation (English *et al.*, 2006).

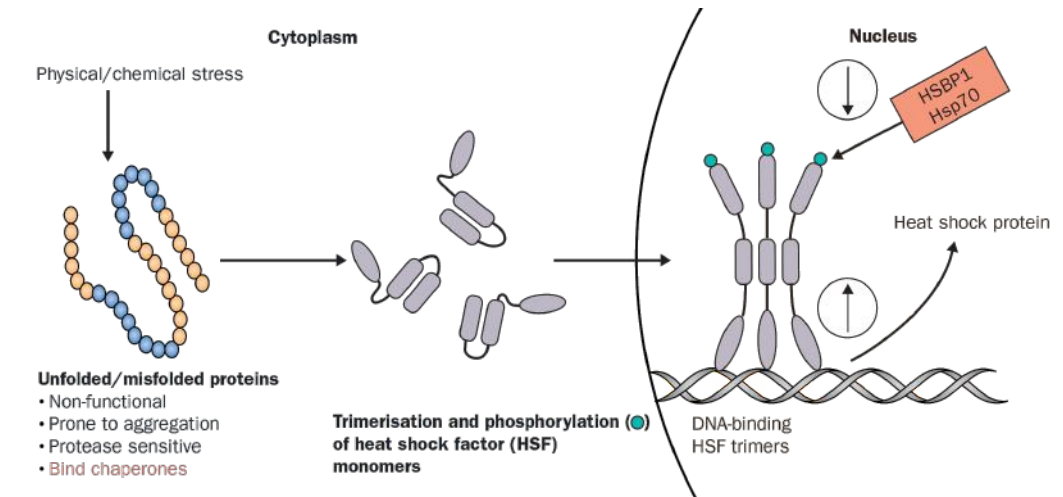


**Figure 1.17: Overview of histone deposition mechanisms and implicated chaperones.** Newly synthesized histones are incorporated into chromatin via globally and locally acting mechanisms. A network of specialized histone chaperones controls histone delivery and deposition. The figure provides an overview of replication-coupled and replication-independent pathways that require the incorporation of newly synthesized canonical histones and replacement variants, together with parental histone recycling. **Adapted from (Hammond *et al.*, 2017).**

Stressed cells generate heat shock proteins (HSPs), a class of chaperone proteins. Though initially linked to thermal shock, HSP expression has been found in various forms of cellular stress, including exposure to cold, UV radiation, and the healing or remodeling of wounds or tissue. Several members of this group serve as molecular chaperones by stabilizing nascent proteins like histones to guarantee proper three-dimensional folding or by assisting in the folding of proteins that have been exposed to cellular stress. This higher level of expression is the result of well controlled transcriptional activation. The Heat Shock Factor (HSF) transcription factor induces significant increases in heat shock protein synthesis, which is a critical part of the heat shock response. From bacteria to humans, HSF may be present in nearly every living entity (Figure 1.18) (Jacob *et al.*, 2017; Pockley, 2003; Beere, 2004).

The molecular weight of heat shock proteins determines the protein's nomenclature. families of heat shock proteins with molecular masses of 60, 70, and 90 kDa each, respectively. It possesses properties of both a heat shock protein and a ubiquitin protein, which identifies

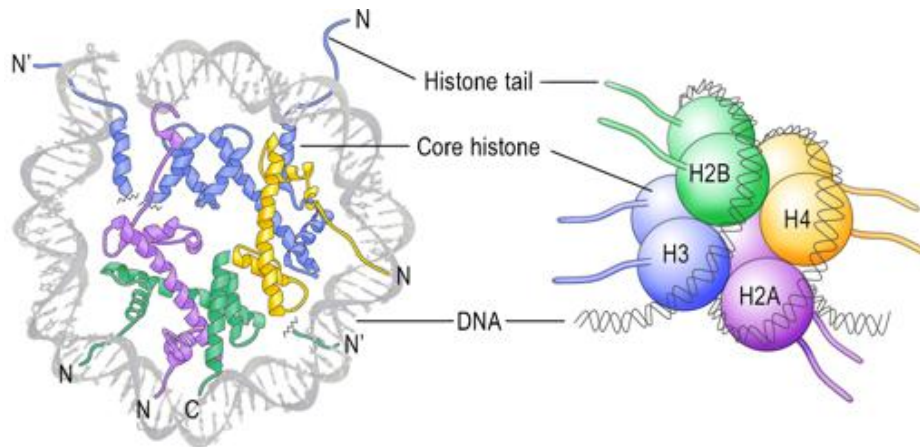
proteins and sends them to breakdown pathways in the cell (Pockley, 2003). Hsp-mediated control of apoptotic pathways is likely a fundamental protective mechanism that reduces the susceptibility of cells to harmful events in order to prevent cells from engaging in apoptosis, which would otherwise be unavoidable (Beere, 2004).



**Figure 1.18: Induction and regulation of heat shock protein expression.** Physical or chemical stress induces production of unfolded or misfolded proteins. Heat shock factor monomers in the cytoplasm form trimers, are phosphorylated, and translocate into the nucleus. HSF homotrimers bind to heat shock protein gene promoter regions, leading to induction of Hsp gene transcription. Hsp70 gene transcription is downregulated by interaction of Hsp70 or HSBP1 with the HSF trimers. **Adapted from (Pockley, 2003).**

The basic unit of chromatin is called the nucleosome, which is made up of DNA and histones (Figure 1.19) (Zhou *et al.*, 2019). It is the first level of DNA compaction in the nucleus. This structure is then regularly repeated to form the nucleofilament which can itself adopt more compact levels of organization, the highest level of condensation being reached within the metaphasic chromosome (Zhou *et al.*, 2019; Cutter and Hayes, 2015).

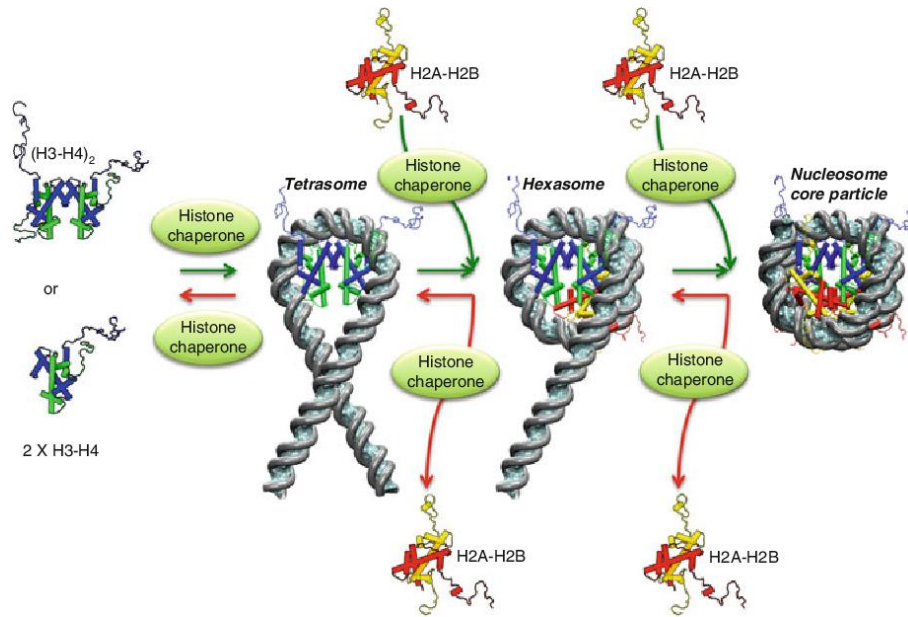
The nucleosome consists of an octamer of histones H3, H4, H2A and H2B, each present in the form of dimers, which are small basic proteins very conserved during evolution (Figure 1.19) (Cutter and Hayes, 2015; Zhou *et al.*, 2019; Bronner *et al.*, 2007/B; Deplus, 2005). The most conserved region of these histones is their central structured domain composed of the "histone fold motif" which comprises three helices separated by two loops (Hauer and Gasser, 2017; Nacev *et al.*, 2019). In contrast, the N-terminal ends of these histones are more variable and lack a secondary structure.



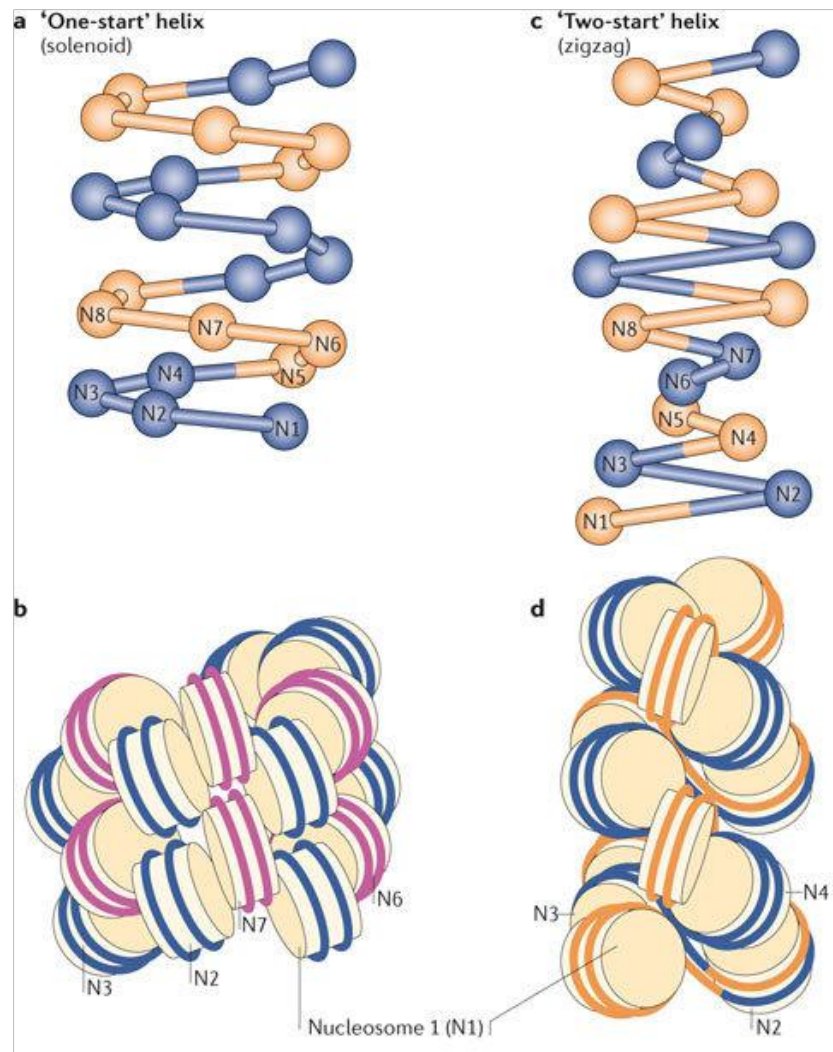
**Figure 1.19: Overview of the core nucleosome structure.** (Left) View of the nucleosome down the DNA superhelix axis showing one half of the nucleosome structure; reproduced with permission from. (Right) Schematic representation of the four-nucleosome core histones, H2A, H2B, H3 and H4. Adapted from (Gräff and Mansuy, 2008).

These ends are particularly rich in Lysine and Arginine residues and therefore they are very basic (Zhou *et al.*, 2019; Bronner *et al.*, 2007/B). They are a target of numerous post-translational modifications that can affect their charges, and also the accessibility to DNA and protein / protein interactions with the nucleosome (Cutter and Hayes, 2015; Zhou *et al.*, 2019; Bronner *et al.*, 2007/B; Deplus, 2005). The assembly of DNA into chromatin comprises several stages which begin with the formation of its fundamental unit, the nucleosome, and end with higher levels of organization in specific domains in the nucleus (McGinty and Tan, 2015). The first step involves the establishment, on DNA, of a tetramer of newly synthesized histones (H3-H4), duplicated, forming the sub-nucleosomal particle, in which two H2A-H2B dimers are added.

The whole constitutes “The Core” nucleosomal particle made up of 146 base pairs of DNA wrapped around the octamer of histones (Cutter and Hayes, 2015; Bronner *et al.*, 2007/B; McGinty and Tan, 2015). This "Core" particle and the binding DNA form the nucleosome, that fixed by linker Histone H1 in association with a linker DNA (38-53 bp long) which mediates two nucleosome cores. The newly synthesized histones are specifically modified (*e.g.*, Acetylation). The next step is a maturation step requiring the presence of ATP, during which the nucleosomes are regularly spaced and form the nucleofilament (McGinty and Tan, 2015). During this step, the newly incorporated histones are deacetylated (McGinty and Tan, 2015).



**Figure 1.20: The main stages of chromatin assembly.** The assembly begins with the establishment of a tetramer  $(H3-H4)_2$  of newly synthesized histones, to which are added two dimers H2A H2B to form the nucleosomal particle "The Core". The newly synthesized histones are specifically modified; the most conserved modification is the acetylation of histone H4 on Lysines 5 and 12 ( $H3-H4$ ). The maturation step requires the presence of ATP in order to establish a regular spacing of the nucleosomes and the newly incorporated histones are deacetylated. The incorporation of inter-nucleosomal histones is accompanied by the folding of the nucleofilament. Finally, several successive folds lead to higher levels of organization in specific areas in the nucleus. **Adapted from (Dennehey and Tyler, 2014).**

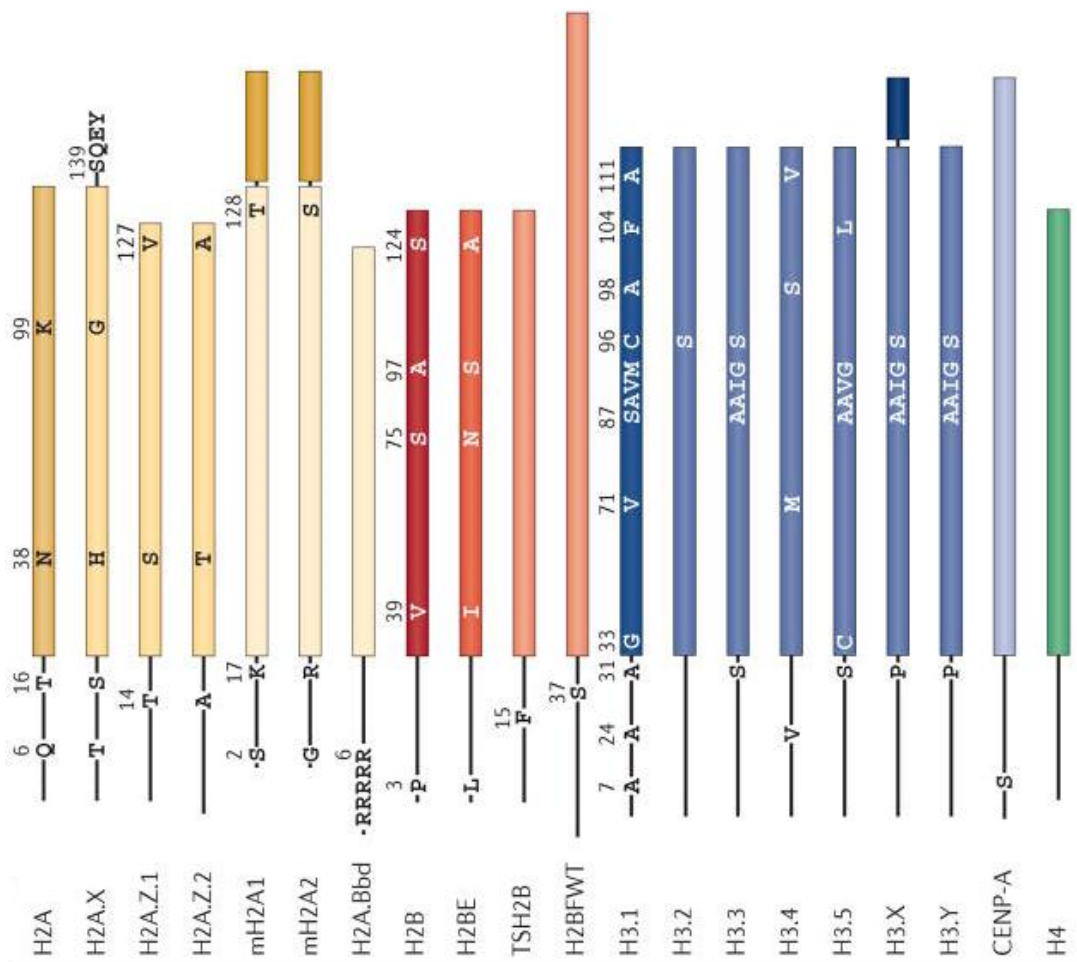


**Figure 1.21: Two models for chromatin secondary structure.** (a) The solenoid model is characterized by interactions between consecutive nucleosomes ( $n, n + 1$ ; a,b), (c) whereas the zigzag model implies interactions between alternate nucleosomes ( $n, n + 2$ ; c,d). The alternative nucleosomes are numbered from N1 to N8. In the solenoid model proposed by Rhodes and colleagues, the 30 nm chromatin fiber is an interdigitated one-start helix in which a nucleosome in the fiber interacts with its fifth and sixth neighbor nucleosomes. Alternative helical gyres are colored blue and purple (b). In the zigzag model, the chromatin fiber is a two-start helix in which nucleosomes are arranged in a zigzag manner such that a nucleosome in the fiber binds to the second neighbor nucleosome. Alternative nucleosome pairs are colored blue and orange (d). The two models also differ in the trajectory and degree of bending of the DNA that connects two nucleosomes (linker DNA). **Adapted from (Luger *et al.*, 2012).**

Compared to their conventional counterparts, histone variants that aren't canonical (non-allelic) differ by one or a few amino acid substitutions from the canonical (Figure 1.21). These histone variations impact chromatin remodeling and post-translational modifications to histones in different ways, depending on their expression, localisation, and species-distribution patterns (Talbert and Henikoff, 2017; Biterge and Schneider, 2014).

Multiple activities, including as transcription, chromosomal segregation and DNA repair, need eukaryotic core histones, which have diversified into numerous paralogues or variations. When the cell cycle is in the S phase, canonical histones are expressed, whereas replication is not required for histone variations. It's common to find many copies of canonical histone genes scattered over a chromosome, whereas histone variants tend to have single copies of their genes.

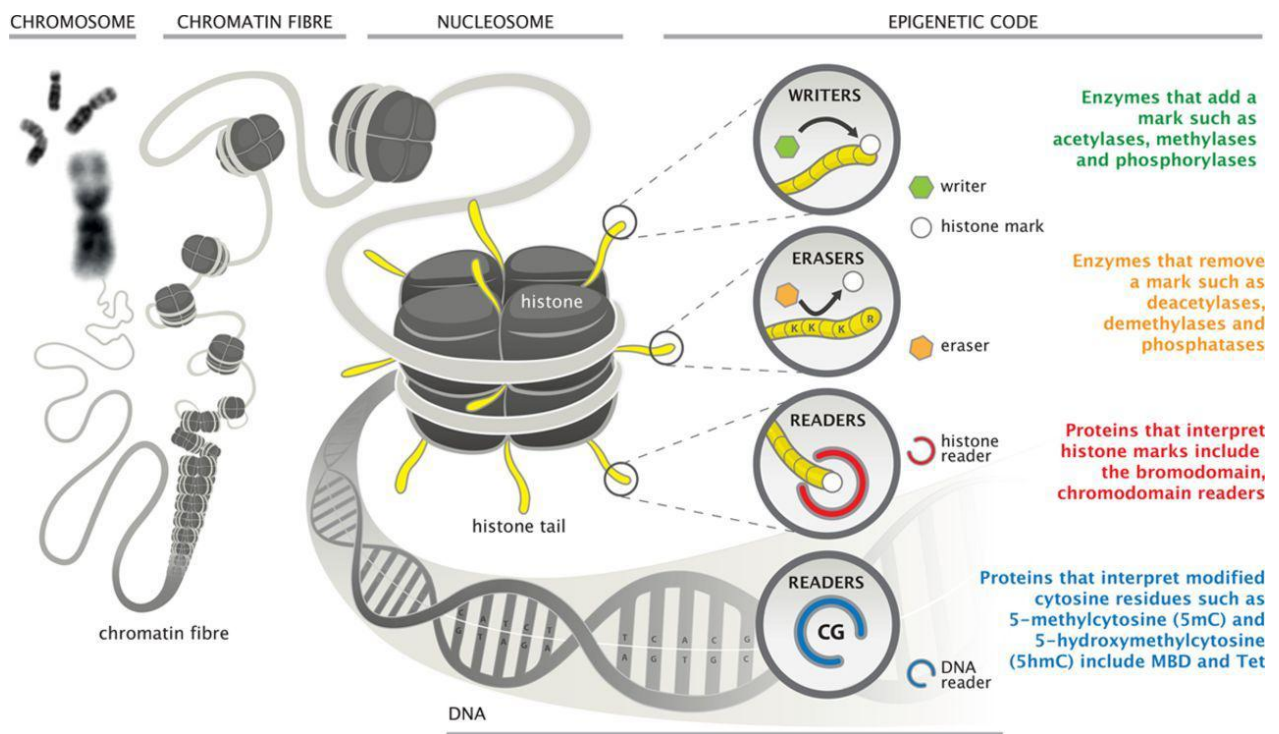
A growing body of evidence shows that many histone variations play important roles in organism development, with functional connections between variants and the delicate control. (Talbert and Henikoff, 2017; Biterge and Schneider, 2014; Hamiche and Shuaib, 2013).



**Figure 1.22: Human core and linker histone variants.** Variants of the core histones H2A (yellow), H2B (red), H3 (blue) and H4 (green) are shown. Unstructured amino-terminal tails are shown as black lines. Specific amino acid residues are depicted at key differences among variants of a common histone protein family. Different shades of color are used to indicate protein sequences that are highly divergent between canonical histones (which are listed first) and their variants. **Adapted from (Maze et al., 2014).**

### 1.2.3. Epigenetic Mechanisms

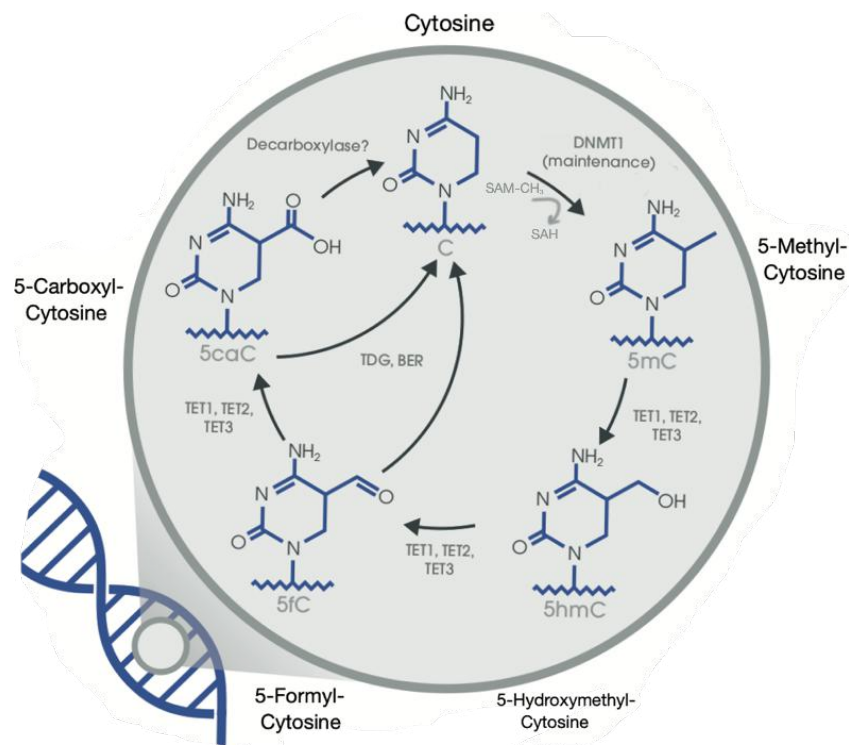
DNA methylation, histone modifications, histone variants, which are regulated by a combination of enzymes that have Reading/Recruiting, Writing and Erasing functions and non-coding RNA (ncRNA) activity represent the major mechanisms of epigenetic regulation in humans (Figure 1.23) (Zaccara *et al.*, 2019; Hyun *et al.*, 2017; Akhade *et al.*, 2017; Skvortsova *et al.*, 2018).



**Figure 1.23: Overview of epigenetic mechanisms.** Chromatin regulates gene structure and function. DNA is packaged into a 30-nm macromolecular structure consisting of the chromatin fiber. Together with post-translational modifications (PTM) of histone residues, chromatin regulates the functions involving transcription, repair, replication, and condensation. The nucleosome at 11 nm is comprised of  $\approx 147$  bp of DNA comprising an octamer of 2 copies of each of the 4 core histone proteins: H2A, H2B, H3, and H4. The histone tail is subject to immense interpretation by writing enzymes that add PTM shown such as histone methyltransferase. Histone tails are also subject to erasing enzymes that specifically remove these modifications and interpreted by reader proteins that identify histone tail modifications. Cytosine residues of the DNA duplex are subject to 5-methylcytosine (5mC) and 5-hydroxymethylcytosine (5hmC) modifications interpreted by methyl-CpG binding domain (MBD) and ten-eleven translocation (TET) enzyme. Methylation-mediated gene suppression events involve targeted MBD recruitment whereas TET proteins are implicated in active DNA demethylation and regulation of gene expression. **Adapted from (Keating *et al.*, 2016).**

### 1.2.4. DNA methylation / demethylation and regulation of gene expression

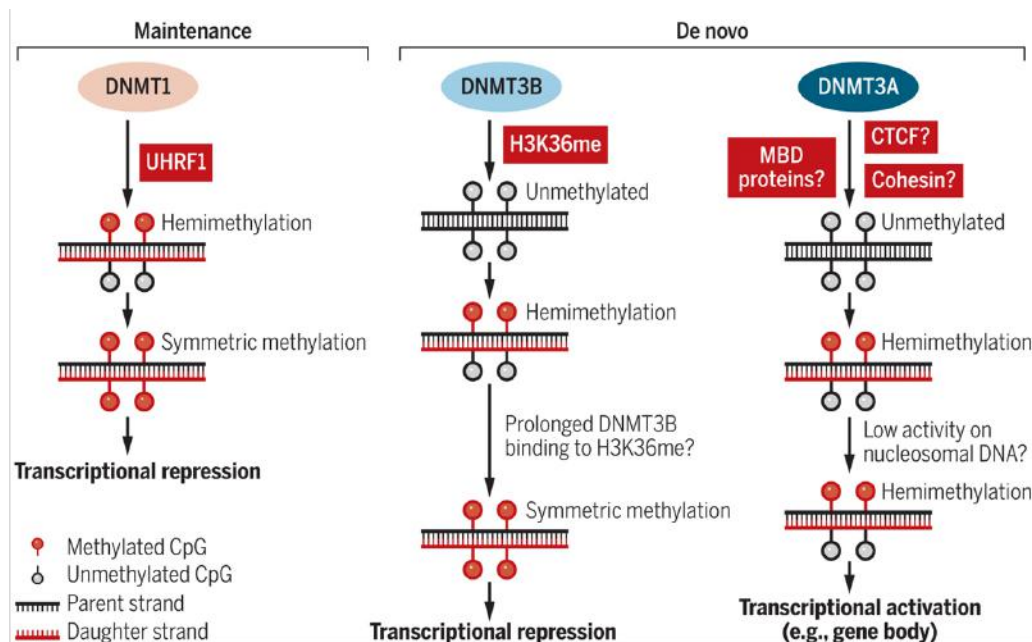
DNA methylation in eukaryotic cells occurs only on the basis of cytosines (Figure 1.24) and is associated with repressed chromatin and therefore with inhibition of gene expression (Rasmussen and Helin, 2016). DNA methylation in eukaryotes has been proposed to have evolved from RNA methylation in eukaryotes (Yang *et al.*, 2018).



**Figure 1.24: Overview of DNA methylation on Carbon 5 of Cytosine.** Ten-eleven translocation methylcytosine dioxygenase (TET) enzymes oxidizes the 5-methylcytosine (5mC), to 5-Hydroxymethylcytosine (5hmC) to 5-Formylcytosine (5fC) to 5-Carboxylcytosine (5caC), while, Thymine DNA glycosylase (TDG) and Base excision repair (BER) are involved in the DNA repair pathways. The question mark indicates the potential activity of DNA demethylases. **Adapted and modified from (Abcam, 2017).**

DNA methylation is catalyzed by a family of DNA methyltransferases (DNMTs) which transfers the methyl group of the donor "S-adenosyl methionine" (SAM) to the 5<sup>th</sup> position of the cytosine ring (Figure 1.24). Five DNA methyltransferases have been identified: DNMT1, DNMT2, DNMT3a, DNMT3b and DNMT3L. These enzymes exhibit different functions and catalyze different substrates. However, the variability of DNMTs is wider among the different species (Lyko, 2018; Tajima *et al.*, 2016; Tomkuvienė *et al.*, 2016). DNMTs have variable expressions during the cell cycle, embryogenesis and depend on the differentiation as

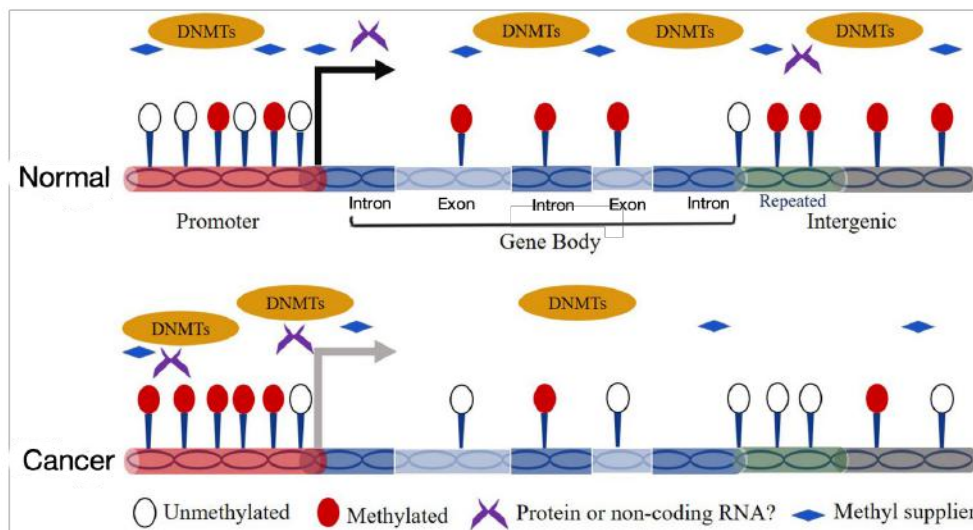
well as the disease state. For example, DNMT1o is only expressed during the first stage after fertilization and then DNMT1 take its place, which has a shorter sequence. Two major activities could mainly be distinguished: maintenance methylation and "de novo" methylation (Figure 1.25) (Bronner *et al.*, 2011; Lyko, 2018).



**Figure 1.25: Overview of the fate of hemimethylated DNA.** After DNA replication, hemimethylated CpGs are converted to symmetrical methylation by DNMT1. *De novo* symmetric methylation by DNMT3B is possibly mediated by H3K36me binding. DNMT3A maintains hemimethylated DNA at specific loci, potentially marked by CTCF cohesin and MBD proteins. **Adapted from (Sharif and Koseki, 2018).**

Methylation of cytosine in mammals is the epigenetic change that occurs on the palindromic CpG dinucleotides on both strands of unique DNA sequences and repetitive elements such as Transposable elements, Retrotransposons, Long terminal repeats (LTR), Long interspersed nuclear elements (LINEs), and Short interspersed nuclear elements (SINEs) (Papin *et al.*, 2017). The CpGs sites are regularly distributed in the genome. There are in around 60 percent of human gene promoters in which they are organized as CpG, and they are typically unmethylated in normal cells, however some of them (~6%) are methylated in a tissue manner at the beginning of development or in differentiated tissues (Straussman *et al.*, 2009). These CpG are mainly found in the 5' regions of several genes in the vicinity of the transcription initiation site. The distribution profile of methylated CpG islets varies from one cell type to another (Sun *et al.*, 2010).

Hypermethylation of CpG is a frequent event in carcinogenesis when it concerns the promoters of tumor suppressor genes (Kulis and Esteller, 2010). Most DNA methylations in specific tissues have been shown to occur in "shores", which are regions of low CpG density found in the upstream of transcription initiation (> 2 kb). which are involved in cell differentiation (Doi *et al.*, 2009; Ji *et al.*, 2010).



**Figure 1.26: A model of DNA methylations patterns in Normal and Cancer status.** Bivalent chromatin domains are more likely to have hypermethylated areas in cancer disease compared with normal status. **Adapted and modified from (Xiao *et al.*, 2019).**

DNA methylation is linked to a so-called "silent" transcription state of genes (Bogdanović and Liste, 2017). Methylation of cytosines prevents the association of transcription factors with the targeted DNA sequence, while methylated CpGs interact with the methyl-CpG Binding Domain proteins (MBD) binding proteins with subsequent recruitment of co-repressors to repress transcription (Bronner *et al.*, 2011; Du *et al.*, 2015). DNMTs are capable of repressing gene expression by recruiting MBDs to methylated CpG which interact with histone deacetylases, where locally, a compact chromatin structure is generated (Rasmussen and Helin, 2016; Du *et al.*, 2015; Bronner *et al.*, 2011). The MBD family includes MeCP2, MBD1-MBD4 as well as Kaiso (Ginder and Williams, 2018) and potentially UHRF1 (Hopfner *et al.*, 2000; Unoki *et al.*, 2004; Jeanblanc *et al.*, 2005; Achour *et al.*, 2008). For example, MBD2 has specific targets and its presence on these targets is essential for gene repression (Hainer *et al.*, 2016).

During differentiation, cells evolve from the totipotency stage through pluripotency stages to reach a well differentiated state. During this progression, they acquire specific properties reflecting a precise expression profile. This requires changes in the distribution of DNA methylation which will subsequently be transmitted to daughter cells, ensuring the sustainability of the differentiated state. DNA methylation therefore participates in controlling the expression of specific tissue genes. In addition, most DNA methylations in specific tissues have been shown to appear to occur in CpG islands (CGI), and these methylations are sufficient to discriminate between different tissues (Doi *et al.*, 2009; Ji *et al.*, 2010).

In addition to regulating gene transcription, DNA methylation has other functions as well. The repetitive elements include a significant amount of methylated CpG. DNA methylation is required to maintain chromosomal stability by preventing "parasite" sequences from reactivating and causing chromosomal instability (Esteller, 2007). DNA methylation is involved in certain more specific stages of development such as the inactivation of the X chromosome and the establishment of the parental genomic imprint. The genomic fingerprint is the process by which only the paternal or maternal allele is expressed. DNA methylation is critical for the genomic imprint, as hypermethylation of one of the two paternal alleles results in monoallelic expression (Elhamamsy, 2017).

Increasing evidence suggests that foods involved in methyl group metabolism may have substantial effects on epigenetics, according to recent advancements in knowledge of dietary impacts. Nutritional intakes high in methionine and folates (choline, methionine) can affect DNA methylation, which can modify gene expression all the way through pregnancy and childbirth (Andreescu *et al.*, 2018). Defective epigenetic regulation is implicated in the development of a number of human disorders, including Rett syndrome. Early life nutrition has been linked to adult health problems, and some of these may be due to epigenetic alterations (Andreescu *et al.*, 2018).

Demethylation of DNA at gene promoter is linked to transcriptional activation and gene expression. There are two mechanisms of DNA demethylation occurs passively, spontaneously, in the absence of methylation of newly synthesized DNA strands during several replication rounds or actively mediated by multiple enzymes and pathways. Methylated cytosine bases may be removed through cytosine deamination followed by removal of thymine from T/G mismatch, then followed by insertion of unmethylated cytosine using base excision repair (BER) machinery. 5-methylcytosine (5mC) may also be modified by oxidation of the methyl group respectively to be 5-Hydroxymethylcytosine (5hmC) oxidized by Ten-eleven translocation

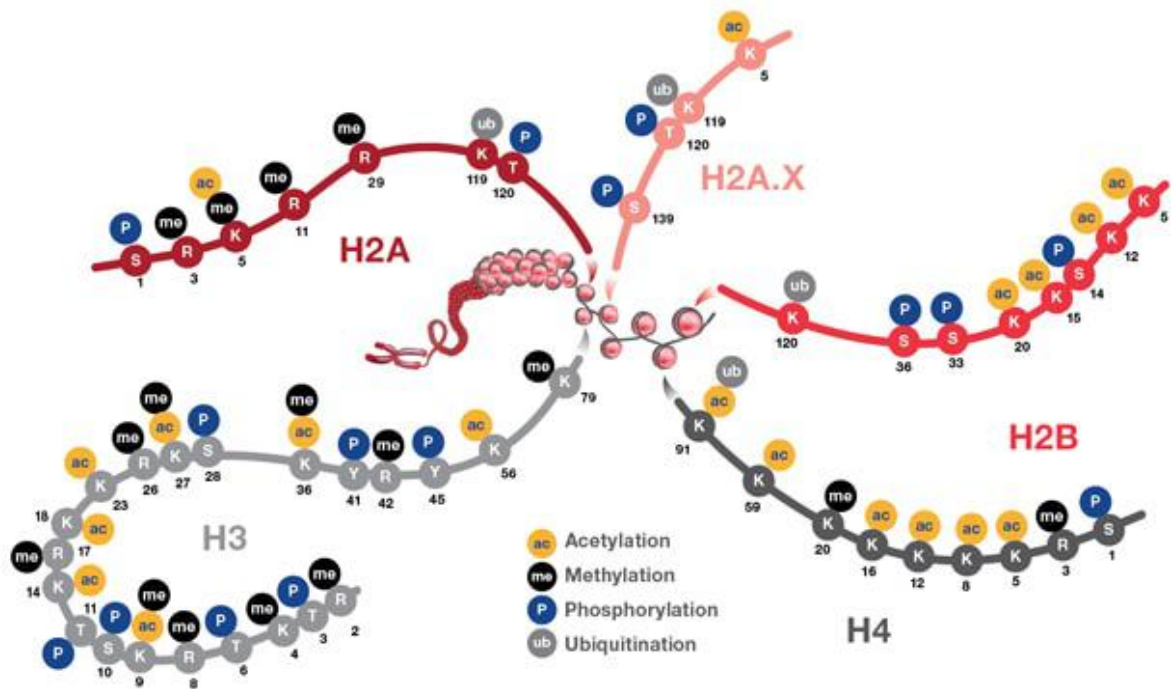
methylcytosine dioxygenase (TET) enzymes to 5-Formylcytosine (5fC), and 5-Carboxylcytosine (5caC).

### 1.2.5. Post-translational modifications of histones

Unlike DNA methylation, which leads to gene repression, changes in histones have more diverse and reversible effects on transcription. Histones are small proteins (11 to 22 kDa) that regulate the formation of chromatin (Bannister and Kouzarides, 2011; Bronner *et al.*, 2011). Histones have a flexible N-terminal tail and a spherical C-terminal end. The "histone code" concept is based on Lysine residues' ability to reside in one of three methylated forms (mono-, di-, and trimethylation) by interacting with other modifications like acetylation, ubiquitination, and phosphorylation (Figure 1.27) (Bannister and Kouzarides; Bronner *et al.*, 2011).

The common nomenclature for histone modifications initiates by the name of the histone (for example, H3), then, the letter abbreviation of amino acids (for example K for Lysine) and the position amino acids in the protein and the type of modification (Me: methyl, P: phosphate, Ac: acetyl, Ub: ubiquitin) So H3K9me3 designates the trimethylation of the new residue (Lysine) from the start (for example, N- terminal) of the H3 protein.

The high levels of acetylation and trimethylation of H3K4 and H3K36 and H3K79 seen in euchromatin define these post-translational modifications. Heterochromatin, on the other hand, has low amounts of acetylation and high levels of methylation in H3K9, H3K27, and H4K20 (Aguilar and Craighead, 2013). It was shown that the levels of histone changes are predictive of gene expression (Portela and Esteller, 2010). Active transcribed genes are characterized by elevated levels of H3K4me3, H3K27ac, H2BK5ac and H4K20me1 in the promoter and H3K79me1 and H4K20me1 along the gene body (Karlic *et al.*, 2010; Portela and Esteller, 2010). There are at least 150 modifications of known histones (Figure 1.27), some of which do not meet the definition of the epigenetic code since epigenetic modifications are supposed to be transmitted to the offspring in cells or in an organism (Bronner *et al.*, 2011; Stillman, 2018).



**Figure 1.27: The major / most documented post-translational modifications of histones.** Nucleosomes are represented by red spheres wrapped by DNA (shown in gray). Also depicted are the positions of PTMs located on the histone proteins H2A (and H2A.X), H2B, H3, and H4. These PTMs impact gene expression by altering chromatin structure and recruiting histone modifiers. PTM events mediate diverse biological functions such as transcriptional activation and inactivation, chromosome packaging, and DNA damage and repair processes. **Adapted from (Thermo Fisher Scientific, 2020).**

There is 51 distinct “chromatin states” based on the enrichment of specific combinations of histone modifications (Portela and Esteller, 2010). Separate biological roles are proposed for these different states of chromatin. An interesting case concerning modifications of the cohabiting histones is found in embryonic stem cells in “bivalent domains”, when the active mark H3K4me3 is in the presence of the repressive mark H3K27me3 at the level of promoters of genes important for development. These “bivalent domains” allow embryonic stem cells to activate gene expression rapidly during various development processes (Hall *et al.*, 2018; Matsumura *et al.*, 2015).

An interesting example of the interaction between histone modifications and DNA methylation is the relationship between DNMT3L and H3K4. DNMT3L interacts specifically with H3 histone terminations, inducing *de novo* methylation of DNA by recruitment of DNMT3a, but this interaction is strongly inhibited by H3K4me. In addition, histone methyltransferases and demethylases can also modify the stability of DNMTs, thereby

regulating DNA methylation levels (Du *et al.*, 2010; Bronner, 2011). On the other hand, DNA methylation can also drive changes in histones. For example, DNA methylation regulates H3K9 methylation through the recruitment of MeCP2 (Kinde *et al.*, 2016).

Nucleosomes are an obstacle for transcription which blocks the access of activators and transcription factors to their sites on DNA, at the same time, they inhibit the elongation of transcription by polymerases. The packaging of DNA in nucleosomes appears to affect all stages of transcription, as well as the regulation of gene expression (Portela and Esteller, 2010). In particular, the precise position of the nucleosomes in the sites of initiation of transcription has an important influence on the initiation of transcription. Thus, displacements of 30 bp nucleosomes from transcription initiation sites have been implicated in changes in the activity of RNA polymerase II (Portela and Esteller, 2010). The loss of a nucleosome directly upstream of the transcription initiation sites is strongly correlated with gene activation, while the occupation of the transcription initiation sites by a nucleosome is associated with gene repression (Iwafuchi-Doi *et al.*, 2016).

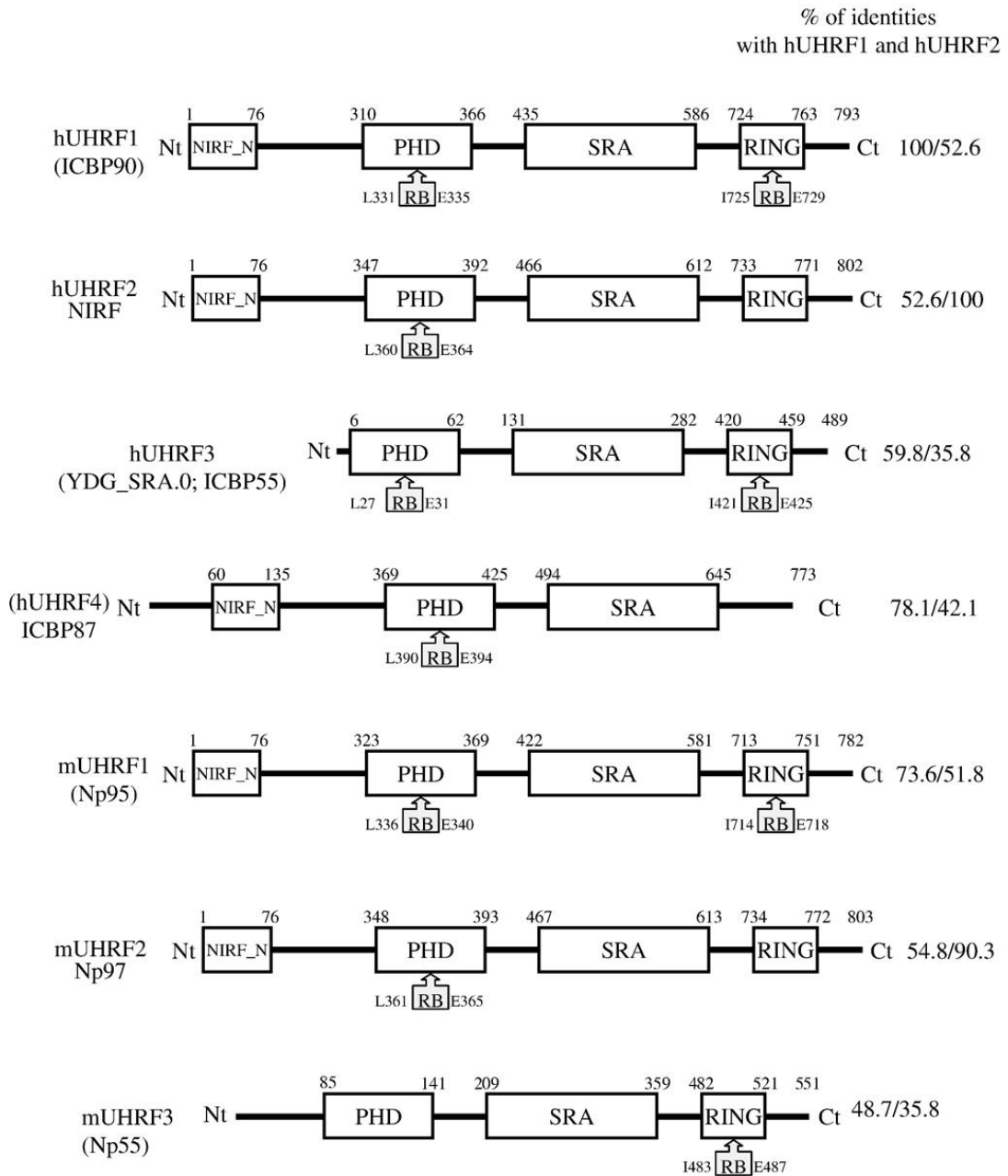
Histones have strong affinities for DNA via the electrostatic forces of amino acids (Lysines and Arginines) positively charged with histones and phosphate groups negatively charged with DNA. Consequently, any change in the charge of histones is likely to modify the affinity of DNA with histones and allow access to transcription factors (Gong and Miller, 2019). There are only a few proteins that are able to read histone post-translation modifications and at the same time a DNA modification and all belong to the UHRF1 family that is presented hereafter.

### **1.3. The UHRF subfamily of RING-finger type E3 ubiquitin ligases**

The UHRF family corresponds to a subfamily of the RING (Really Interesting New Gene) E3 ubiquitin ligases family.

#### **1.3.1. The UHRF Members**

The alignments of the primary structure of seven proteins made it possible to determine the percentages of homology between the different members of the family (Figure 1.28): hUHRF1 (ICBP90) (Hopfner *et al.*, 2000), hUHRF4 (ICBP87), mUHRF1 (Np95) (Fujimori *et al.*, 1998), hUHRF3 (ICBP55), mUHRF3 (Np55), hUHRF2 (NIRF, NP95 / ICBP90 Ring Finger) (Mori *et al.*, 2002), mUHRF2 (NP97, mouse NIRF) (GenBank accession number BAB68317).



**Figure 1.28: The UHRF family.** The structure of hUHRF1 (ICBP90), hUHRF4 (ICBP87), mUHRF1 (Np95), hUHRF3 (ICBP55), mUHRF3 (Np55), hUHRF2 (NIRF) and mUHRF2 (Np97). The sequences were obtained by GenBank (National Center for Biotechnology Information). The accession numbers are AF129507, EAW58743, EAW96409, Q8VDF2, AF274047, XP\_993132, for hUHRF1, hUHRF2, hUHRF3, mUHRF1, mUHRF2 and mUHRF3, respectively. HHRF4 was found in AceView (National Center for Biotechnology Information). The numbers correspond to the positions of the amino acids. Retinoblastoma protein (RB) binding sites are indicated by boxes. The values indicate the percentages of identity with UHRF1 and UHRF2, respectively. The TTD domain is not shown because it was discovered later. **Adapted from (Bronner *et al.*, 2007).**

Mouse NIRF (mUHRF2) shows 54.8% identity with hUHRF1. Human and mouse NIRF share 90.3% identity, while the homology between hUHRF1 and mUHRF1 (Np95) is only 73.6% (Figure 1.28). HUHRF1 and hUHRF2 show 78.1% and 42.1% identity with hUHRF4 (ICBP87), respectively. hUHRF1 and hUHRF2 (human NIRF) show 59.8% and 35.8% identity with hUHRF3 (ICBP55), respectively, and 48.7% and 35.8% with mUHRF3, respectively. These similarities suggest that NIRF and hUHRF1 are derived from two common ancestral genes (Bronner *et al.*, 2007/A).

Note that SIN259 (Similar to ICBP90 and NIRF) a 259 amino acid protein similar to hUHRF1 (GenBank accession number XM\_066969), two *Arabidopsis thaliana* proteins 1 and 2 (GenBank accession numbers AAG29238 and NP\_176778, respectively) and an *Oryza sativa* protein (GenBank accession number AAG03103) were considered to be of the UHRF1 family (Mousli *et al.*, 2003). These proteins have a very weak identity with hUHRF1 and hUHRF2 (NIRF). For example, hUHRF1 and NIRF show 21.4% and 18.3% identity with protein 1 from *A. thaliana*, respectively. Protein of *O. sativa* has 19.2% identity with hUHRF1 and 17.7% identity with human NIRF. The protein of *O. Sativa* does not have the ubiquitin-like domain or the PHD Finger domain. The second protein of *A. thaliana* shows 24% and 19% identity with hUHRF1 and NIRF, respectively, and has a PHD domain and a RING Finger domain as well as an SRA domain but not in the same order as that found in hUHRF1, thus raising the question of its belonging to this family (Mousli *et al.*, 2003, Bronner *et al.*, 2007/A).

Since then, six members of the ORTH / VIM family of *Arabidopsis thaliana* genes, which play a role in DNA methylation *in vivo*, have been identified to code proteins each containing a PHD, two RING domains, and one SRA domain. ORTH like-1 then codes for a protein with a single RING domain and an SRA domain (Kraft *et al.*, 2008).

### 1.3.2. Ubiquitin like with PHD and Ring Finger domains 1 (UHRF1)

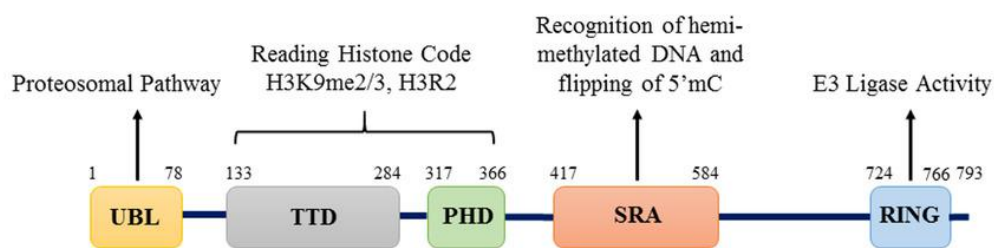
The first gene identified in this family was *UHRF1* originally called icbp90 for "Inverted CCAAT box Binding Protein of 90 kDa" (Hopfner *et al.*, 2000). its first property to be demonstrated was to modulate the expression of the topoisomerase II $\alpha$  gene (Hopfner *et al.*, 2000.). Furthermore, protein kinase 2 (CK2) is an important regulator of the transcriptional activity of UHRF1 (Bronner *et al.*, 2004) while the cAMP signaling pathway via Protein kinase A (PKA) enhances topoisomerase II $\alpha$  expression through UHRF1 phosphorylation (Trotzler *et al.*, 2004) which is at least partly induced by the blocking of the ERK1/2 signal pathway (Fang *et al.*, 2009).

From a structural point of view, the ICBP90 protein has an "ubiquitin-like" domain, two nuclear localization sites two TTD domains (Tandem Tudor Domain), two zinc finger domains (PHD and RING finger), as well as SRA domain "Set and Ring Associated domain" (Figure 1.29) (Hopfner *et al.*, 2000; Mousli *et al.*, 2003; Bronner *et al.*, 2007/A; Bronner *et al.*, 2009; Nady *et al.*, 2011). From this structure, the international nomenclature (HUGO committee) gave the name of "UHRF" to this family, for Ubiquitin-like containing PHD and Ring Finger domain. UHRF1 is therefore coded by the *UHRF1* gene, while *UHRF2* is coding for NIRF (Np95 / ICBP90 Ring Finger). This family contains 4 members in humans (Figure 1.29) (Bronner *et al.*, 2007/A).

The *UHRF1* gene has been located on the chromosomal region 19 p13.3 (Hopfner *et al.*, 2001). This gene covers a portion of genomic DNA of at least 53 kb (GenBank accession number: AF129507) (Unoki *et al.*, 2008).

### 1.3.3. Structural domains of UHRF1

From the N-terminal end towards the C-terminal end, it has been successively noted the presence of five domains that are very conserved during evolution (Figure 1.29): an UBL domain or an “ubiquitin-like” domain, the TTD domains “Cryptic Tandem Tudor Domains”, the PHD domain “plant Homeo domain” a zinc finger domain of type C4HC3, an SRA domain for “Set and Ring Finger Associated Domain”, and finally a zinc finger domain of type C3HC4 called RING finger domain for “Really Interesting New Gene” (Figure 1.29).



**Figure 1.29: The structure of UHRF1.** The structure of UHRF1 reveals the presence of five functional areas. From the NH<sub>2</sub> terminal end to the COOH terminal end: a UBL domain or an “ubiquitin-like” domain, the TTD domains “Cryptic Tandem Tudor Domains”, a zinc finger domain of type C4HC3 or the PHD domain “Plant-Homeo domain”, a “SRA” type domain for Set and Ring Finger Associated Domain, and finally a zinc finger domain of C3HC4 type or RING finger domain for “Really Interesting New Gene”. Adapted from (Ashraf *et al.*, 2017/B).

#### 1.3.3.1. Ubiquitin-like domain (UBL domain)

The ubiquitin-like motifs, which its structure is 35% identical to that of ubiquitin, consist of 45 to 80 highly conserved amino acids from protozoa to vertebrates. They are involved in many cellular processes such as the degradation of proteins carried out by the proteasome 26S, the repair of DNA, the maintenance of the chromatin structure, or even the regulation of gene expression (Cappadocia and Lima, 2018; DaRosa *et al.*, 2018). The significance of the UBL domain, on the other hand, is less known, and it may be involved in protein-protein interactions. The ubiquitin-like domain (UBL) of PLIC-1 "Protein Linking IAP to the Cytoskeleton" was shown to be capable of binding the "Ubiquitin-Interacting Motif (UIM)" of proteasomal subunit S5a and to be involved in trafficking to aggresomes (Heir *et al.*, 2006). We might be imagining that the NIRF-N domain of UHRF1 could be involved in its transport to aggresomes. A relationship between the ubiquitination of H2B and the methylation of H2 through proteasomal proteins in yeast has been described (Cole *et al.*, 2015). Monoubiquitination of histones H2B is required for two activating events, *i.e.*, methylation

of H3K4 and methylation of H3K79. The proteasomal ATPases Rpt4 and Rpt6 have been shown that they work to connect these two modifications of histones (Cole *et al.*, 2015). It has been found that the recruitment of the proteasomal subunit to chromatin depends on the ubiquitination of H2B and that a mutation in the proteasomal subunits Rpt4 and Rpt6 disrupts the methylation of H3 on K4 and K79 but leaves the ubiquitination of intact H2B (Cole *et al.*, 2015). In addition, (Citterio *et al.*, 2004) have suggested that the ubiquitination of histones by UHRF1 is a key regulatory mechanism to control gene expression. It can be imagined that the UHRF1 recruits the proteasome at the sites where the monoubiquitinated histones should be eliminated and degraded (Bronner *et al.*, 2007/A).

### **1.3.3.2. Tandem Tudor domains (TTD domains)**

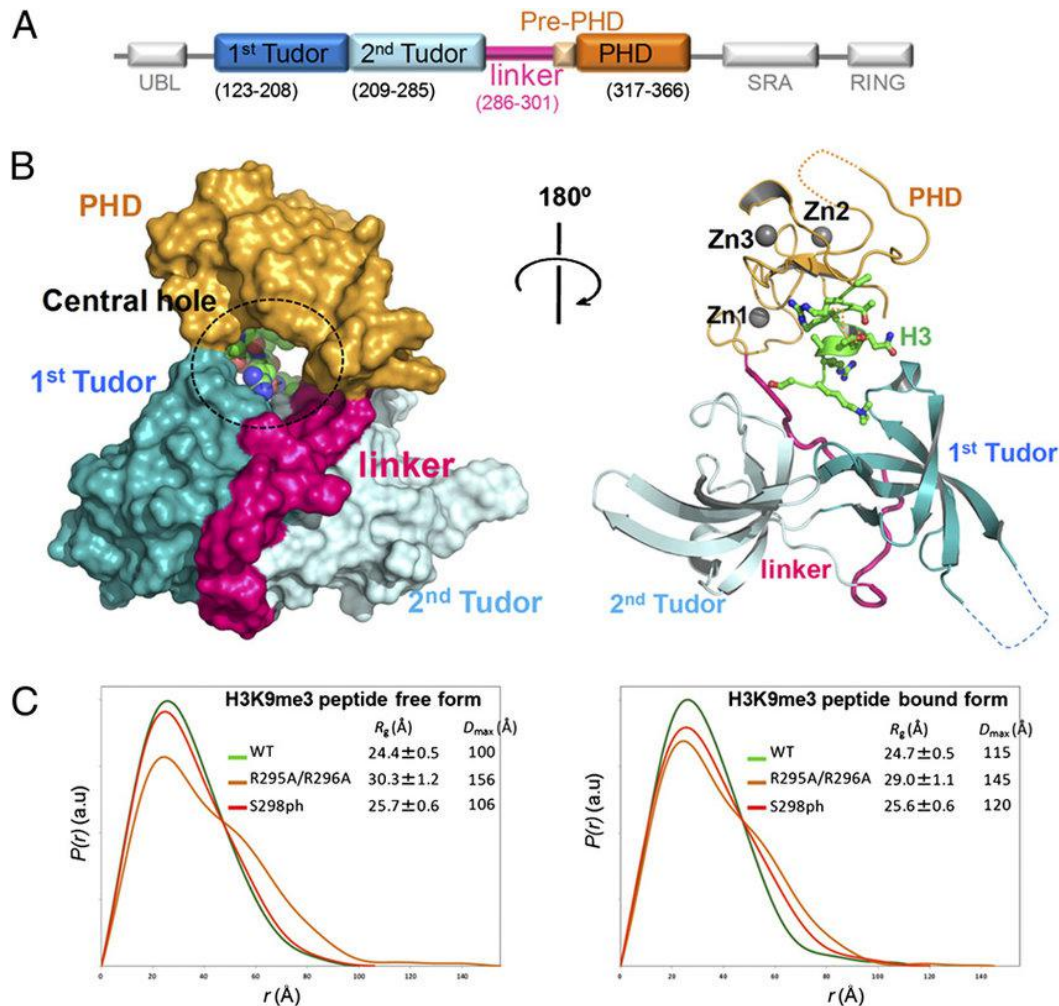
The Tudor domains belong to the SH3 super family (Dai *et al.*, 2018). SH3 domains are often modulator proteins which have a very important functional versatility from signal transmission to binding to nucleic acids (Dai *et al.*, 2018). The TTD domains correspond to a motif of 50 amino acids conserved with 10 repeats in the various proteins associated with RNA (Bauer *et al.*, 2019; Li *et al.*, 2018). Their structure is characterized by five strands of  $\beta$  motif and four connection loops. A large variation in the sequence, length and flexibility of the first three loops is responsible for the functional specificity of SH3-like domains (Dai *et al.*, 2018). However, the fourth loop has a very conserved structure and plays a very important role in the stability of the structure of these SH3 proteins. The 3D structure of the TTD domains of UHRF1 was first shown by Hashimoto *et al.*, (2009). The closest structural alignment was between TTD1 (residues 126-206) of UHRF1 and the N-terminal domain of TTD of 53BP1 (p53-Binding Protein). In general, functional similarities reside in structural similarities. There are two motifs corresponding to a TTD domain in the structure of 53BP1. The TTD domain of SMN (Survival of Motor Neuron) and 53BP1 is capable of binding to dimethylated Arginines of a sequence rich in Arginine-Glycine. The TTD domains of 53BP1 are capable of recognizing the dimethylated Lysine 382 of p53 (p53K382me2) following DNA damage, an interaction which stabilizes p53 (Kachirskaia *et al.*, 2008). The mammalian 53BP1 and its orthologs Rad9 and Crb2 / Rhp9 in yeast recognize double stranded DNA breaks via the TTD domain which is capable of interacting with methylated histones (Huyen *et al.*, 2004) K20 of histone H4 (Huyen *et al.*, 2004; Schotta *et al.*, 2008). Interestingly, (Nady *et al.*, 2011) Have shown that the TTD domain of UHRF1 is capable of interacting with histone H3K9me3 and with unmodified

histone H3K4 in the same peptide. The affinity deficient UHRF1 for H3K9me3 shows altered locations in heterochromatin and fails to maintain repression of a target gene, *p16<sup>INK4A</sup>* (Nady *et al.*, 2011). Rad9, which is involved in DNA repair in *S. cerevisiae*, recognizes via its TTD exclusively the methylated K79 of histone H3 (Grenon *et al.*, 2007); while Crb2 / Rhp9 (DNA repair protein) in *Schizosaccharomyces pombe* exclusively recognizes the methylated K20 of histone H4 via its TTD. These interactions of the TTD domain and the BRCT domain (Carboxyl-Terminal domain of the BRCA1 protein) of Rad9 with chromatin cooperate to stop the cell cycle in G1 phase (Hammett *et al.*, 2007). However, the UHRF1 is involved in the G1 / S transition (Jeanblanc *et al.*, 2005), this could be explained via its TTD. It could be imagined that the TTD of UHRF1 trimethylates the H3K9 near the promoter of the tumor suppressor gene *p16<sup>INK4A</sup>*. Trimethylation of H3K9 is believed to promote deacetylation of H3K9 by HDAC1 and methylation of DNA by DNMT1. These events are responsible for the repression of the *p16<sup>INK4A</sup>* gene which in turn is involved in the inhibition of the binding of cyclin D to Cdk 4 or Cdk 6 which is involved in G1 phase progression. Therefore, UHRF1 TTD promotes the entry of S-phase cells by repressing the expression of the *p16<sup>INK4A</sup>* gene. Other proteins also have the TTD domain like the heterochromatin HP1 which is able to bind to the methylated histone H3.

### 1.3.3.3. Plant-Homeo Domain (PHD domain)

This domain is a highly specialized domain for binding to methylated lysines, which has been found in several proteins that regulate gene expression. Indeed, publications describe how the PHD Finger is able to read part of the histone code (Pena *et al.*, 2006; Wysocka *et al.*, 2006). The PHD Finger could stimulate the activation or repression of a gene via the interaction with trimethylated H3K4, which is the universal modification for the activation of gene expression (Mellor, 2006). The PHD domain has a lower affinity for dimethylated K4 than for trimethylated K4, indicating that the PHD domain can distinguish between minor chemical changes, which is essential for reading the epigenetic code. In addition, mouse UHRF1 (mUHRF1) has been shown to be involved in the formation of pericentromeric heterochromatin via its PHD domain (Papait *et al.*, 2007). Karagianni *et al.*, 2008) have shown that the UHRF1 is capable of interacting with H3K9me3 via its PHD domain, suggesting that the UHRF1 assumes a link between the methylation of histones via its PHD domain and the methylation of DNA via its SRA domain, known to be capable of interacting with hemi-methylated DNA and with DNMT1 (Unoki *et al.*, 2004; Avvakumov *et al.*, 2008;

Achour *et al.*, 2008). The UHRF1-H3K9me3 interaction has been proposed to promote the ubiquitination of chromatin (Karagianni *et al.*, 2008). This event could be a signal to recruit other actors of the epigenetic code such as methyltransferases and deacetylases which promotes the formation of heterochromatin (Karagianni *et al.*, 2008).



**Figure 1.30: Structure of TTD-PHD of UHRF1 in complex with H3-K9me3.** (A) Diagram of UHRF1 domains. (B) Structure of TTD-PHD bound to H3-K9me3. (Left and Right) Surface model (Left) and illustration model (Right) of TTD-PHD. Each region of TTD-PHD is colored according to the diagram in A. Histone H3 is shown as a green sphere; zinc ions are shown as gray spheres. (C) SAXS analyses are shown for wild-type TTD-PHD (green), TTD-PHD R295A/R296A (orange), and TTD-PHD S298ph (red). Adapted from (Arita *et al.*, 2012).

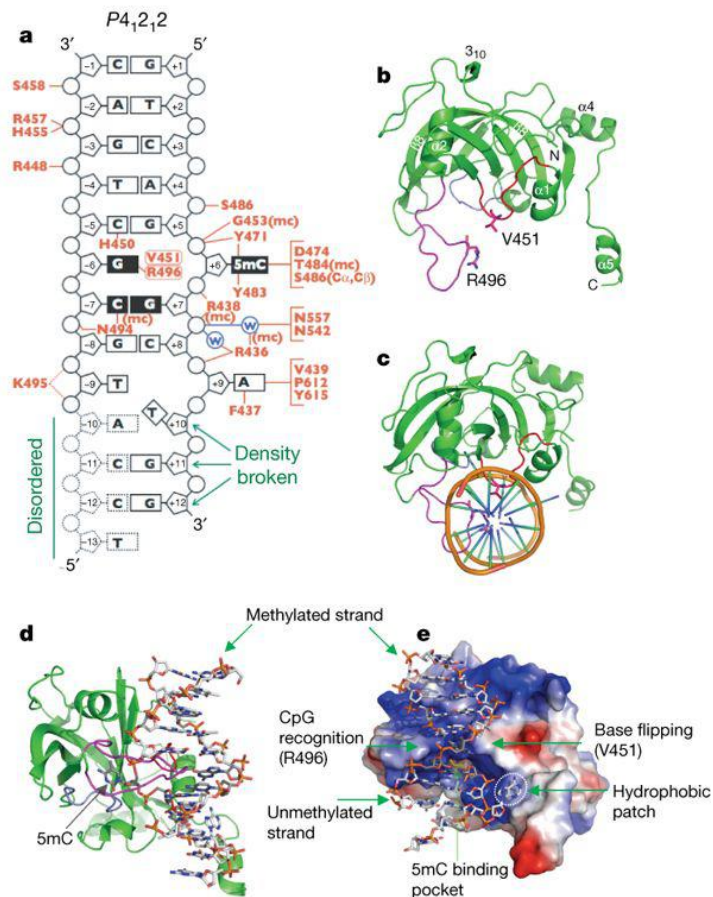
#### 1.3.3.4. Set and Ring Finger Associated domain (SRA domain)

The SRA domain is a domain composed of 170 amino acids characterized by the conservation of 13 Glycine residues and a motif of VRVVRG. So far, the SRA domain has only been found in the UHRF family regarding vertebrates. It was founded that the UHRF1 was able

to interact with the deacetylase HDAC1 through its SRA domain as well as with the methylated CpG islets (Unoki *et al.*, 2004) present at the promoter level of certain tumor suppressor genes such as *RBI*, *p14<sup>ARF</sup>* and *p16<sup>INK4A</sup>* (Unoki *et al.*, 2004). The SRA domain interacts with human DNMT1 (Achour *et al.*, 2008). DNMT1 and HDAC1 have been founded in the same macromolecular complex as Suv39H1, a histone methyltransferase. This suggests that UHRF1 and Suv39H1 may also be in the same complex.

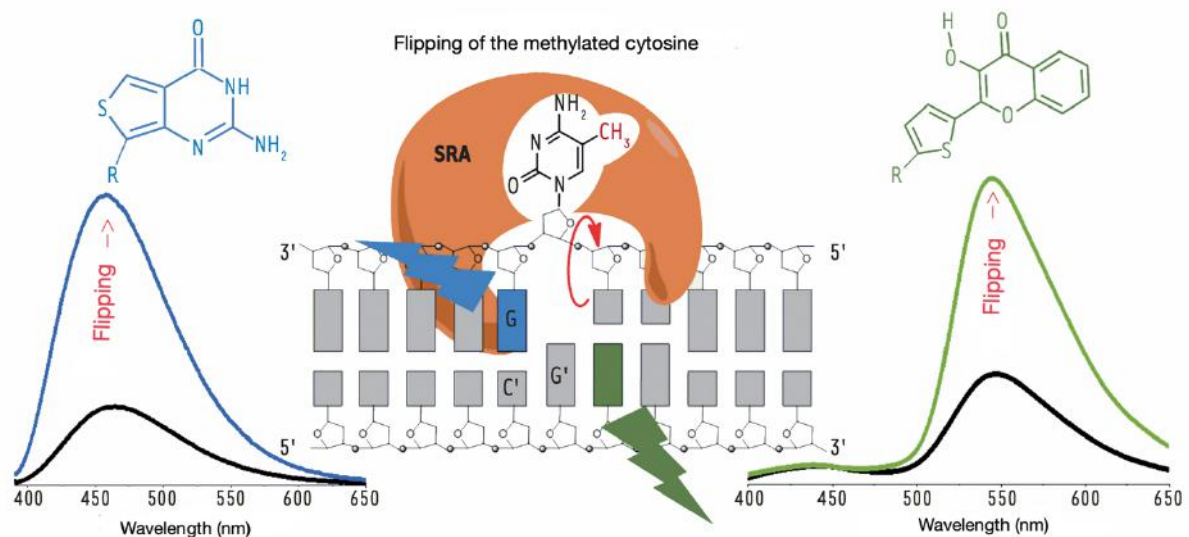
The SRA domain is also involved in the mechanisms of interaction with H3 histones as has been demonstrated for the mouse UHRF1 (Citterio *et al.*, 2004). The specific binding of UHRF1 with trimethylated H3K9 (H3K9me3) depends on two functional domains, the PHD domain which defines the binding specificity and the SRA domain which promotes the activity of this binding of (UHRF1-H3K9me3) (Karagianni *et al.*, 2008). It has been suggested that UHRF1, through the SRA domain, performs some of the functions of histone methyltransferases in plants (Bronner *et al.*, 2007/A). The UHRF1 SRA domain could be like a "bridge" between DNA methylation and the histone code, a fundamental property in the transmission of the epigenetic code (Bronner *et al.*, 2007/A). (Hashimoto *et al.*, 2008) have shown that the SRA domain of mUHRF1 flip the 5-methylcytosine outside the DNA helix. The methylcytosine base at the hemi-methylated site is flipped out of the DNA helix in the SRA-DNA complex and fits tightly into a protein pocket on the concave surface (Bronner *et al.*, 2019; Zaayer *et al.*, 2019; Bronner *et al.*, 2017A). Avvakumov *et al.*, (2008) have shown that the SRA domain of hUHRF1 flips the 5-methylcytosine outside the DNA helix and that the timely replacement of Gly448 with aspartic acid produces a mutated protein which has significantly lower affinity for hemi-methylated DNA. Also, Arg 491 and Asn 489 from the SRA domain of UHRF1 have been shown to play central roles in specificity and affinity for the 5-mCpG sequence (Avvakumov *et al.*, 2008).

To understand the dynamics of the flipping of methylated cytosines under the effect of the SRA domain of the protein UHRF1 which recognizes hemi-methylated DNA, two very innovative fluorescent analogs of nucleosides, 2-thienyl-3-hydroxychromone (3HCnt) which capable of replacing all the nucleobases in DNA and thienoguanosine (<sup>th</sup>G) which perfectly replaces guanine, were investigated (Bronner *et al.*, 2017; Kilin *et al.*, 2017). A modest difference was observed in the affinity of SRA for methylated cytosines on both strands and methylated cytosine duplexes which means the SRA domain does not need to discriminate between them supporting that the UHRF1 leaves DNA "Labeled with 2-Aminopurine" before the catalytic methylation step (Greiner *et al.*, 2015).



**Figure 1.31: Structure of SRA–DNA complex.** a, Summary of the SRA–DNA interactions; mc, main-chain-atom-mediated contacts; W, H<sub>2</sub>O mediated hydrogen bonds. Black boxes represent CpG recognition sequence and K495-associated dotted lines represent weak hydrogen bonds. b, The side chains of V451 of the base flipping loop and R496 of the CpG recognition loop are in direct van der Waals contact. c, The two loops—CpG recognition and base flipping—penetrate into the DNA helix from opposite directions. d, The 5mC flips out and binds in a cage-like pocket. e, The surface charge at neutral pH is displayed as blue for positive (20 kBT), red for negative (220 kBT), and white for neutral, where kB is the Boltzmann’s constant and T is the temperature. **Adapted from (Hashimoto *et al.*, 2008).**

By incorporating 3HCnt or <sup>th</sup>G at selected positions of a hemi-methylated DNA, it has been showed by fluorescence spectroscopy that it was possible to follow in a sensitive and faithful manner the flipping of the methylated cytosines, induced by the SRA domain of the protein UHRF1. Indeed, the SRA domain induces a strong increase in the fluorescence of these two probes, indicating the very high sensitivity of these fluorescent analogs of nucleosides to minor structural changes accompanying the flipping of the bases. This slow kinetics disappears when the SRA domain is replaced by a mutant motif incapable of inducing base flipping (Bronner *et al.*, 2017; Kilin *et al.*, 2017).



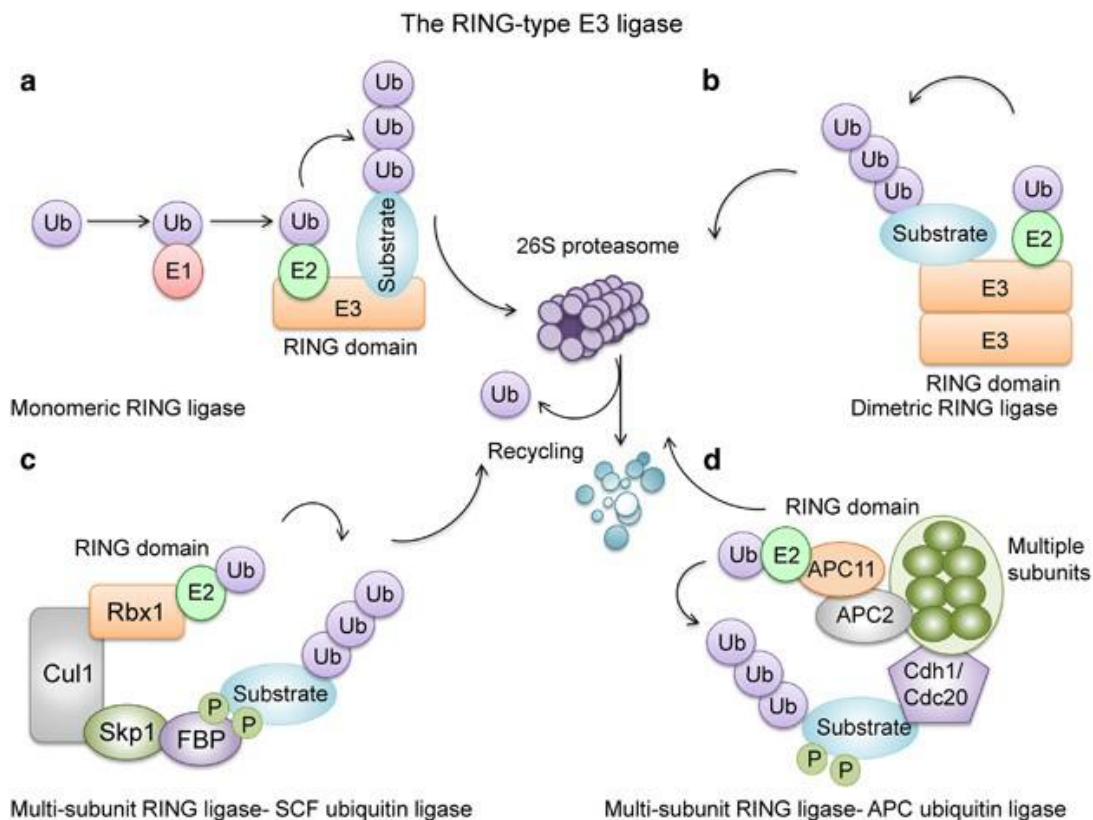
**Figure 1.32: Fluorescence monitoring of the flipping of methylated cytosine by the SRA domain of the protein UHRF1.** DNA is labeled with a fluorescent nucleoside analog: thienoguanosine (thG, shown in blue) or 2-thienyl-3-hydroxychromone (3HCnt, shown in green). At the mCpG site, the SRA domain flip the methylated cytosine, which will stabilize the binding of this domain to the hemimethylated DNA and allow the recruitment of the DNMT1 protein. The flipping of the methylated cytosine outside the DNA helix results in a sharp increase in the fluorescence of thG or 3HCnt. **Adapted from (Bronner *et al.*, 2017; Kilin *et al.*, 2017).**

### 1.3.3.5. Really Interesting New Gene Finger domain (RING Finger domain)

The RING finger domain has E3 ubiquitin ligase activity. In human cells, UHRF1 has been demonstrated to ubiquitinate histone H3 at lysine 18 (H3K18ub) (Qin *et al.*, 2015) and at lysine 23 (H3K23ub) utilizing the cell-free method of *Xenopus* egg extracts (Nishiyama *et al.*, 2013). Both findings indicate that UHRF1-dependent histone H3 ubiquitination is needed for DNA methylation maintenance, implying that the H3 ubiquitination mark(s) supplies DNMT1 with a binding site(s) (Qin *et al.*, 2015; Nishiyama *et al.*, 2013; Tollefsbol, 2017). Zinc coordination is essential to preserve the structural integrity of the RING domain, and it has been demonstrated that E3 ligase activity is impossible without it. Cysteine 724 and histidine 741 are residues in the UHRF1 RING motif that appear to be crucial for zinc binding and ligase activity, according to the RING domain consensus sequence (Freemont, 2000). Next, in chapter 4, the Ubiquitination by UHRF1 RING domain topic will be discussed in detail.

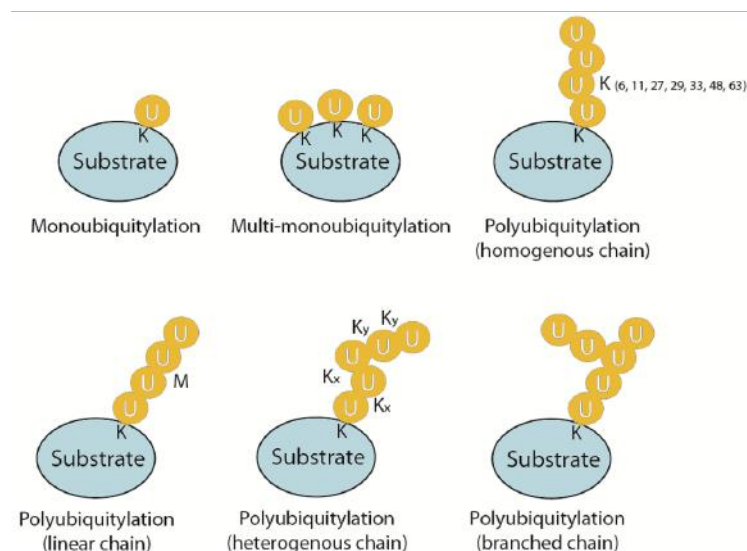
## 1.4. Ubiquitination Activity of UHRF1 RING domain

Ubiquitination is one of the post-transcriptional modifications in which a polypeptide of 76 amino acids is conjugated by its carboxylic end (C-terminal) to the lysines of proteins which are intended for degradation via the proteasome or for regulatory functions. A conserved enzyme cascade (E1-E2-E3) is involved in ubiquitination. Monomeric, homodimeric/heterodimeric, and multisubunit RING E3 ligases are the three types of RING E3 ligases. It is likely that the histones are the substrates for the members of the UHRF family. In fact, UHRF1 has been shown to ubiquitinates histones, *in vitro* and *in vivo*, with a clear preference for histone H3 (Citterio *et al.*, 2004). Putative substrates for mUHRF1 ubiquitination activity have recently been discovered. *In vitro*, mUHRF1 ubiquitinated all four nucleosomal core histones, histone H3, histone H2A, histone H2B, and histone H4 (Jenkins *et al.*, 2005). But histones could not be the only substrates for UHRF members since non-histone proteins have been identified to be ubiquitinated by hUHRF1 (Motnenko *et al.*, 2018; Liu *et al.*, 2017; Mori *et al.*, 2002). For example, UHRF1 ubiquitinates DNMT1 through its E3 ligase activity leading DNMT1 to the proteasome to be degraded (Du *et al.*, 2010).



**Figure 1.33. The ubiquitin–proteasome system and the structures of RING-type E3 ligases.** RING-type E3 ligases are classified into monomeric RING ligases (a), dimeric RING ligases (b) and multisubunit RING ligases, which includes SCF (c) and anaphase-promoting complex/cyclosome (APC/C) type ubiquitin ligases (d). Ubiquitylation of proteins is achieved through an enzymatic cascade involving ubiquitin-activating enzyme (E1), ubiquitin-conjugating enzyme (E2) and ubiquitin-ligating enzyme (E3). E3 enzymes provide platforms for binding E2 enzymes and specific substrates, thereby coordinating ubiquitylation of the selected substrate (a, b). Substrates of SCF and APC/C ubiquitin ligases must be modified by phosphorylation before they can bind to E3 and be subjected to ubiquitination (c, d). **Adapted from (Liu *et al.*, 2018).**

Monoubiquitylation, Multi-monoubiquitylation, or Polyubiquitylation using ubiquitin are a variety of ways where the substrates can be ubiquitinated (Figure 1.34) (Moreno and Gambus, 2015). The addition of ubiquitin or a ubiquitin chain to a substrate alters the substrate's overall three-dimensional structure, affecting its activity, location, and destiny. Each sort of chain has its own three-dimensional structure, which results in a different signal and consequence for the substrate. Two of the most well-studied types of ubiquitylation are the modification at K48 and K11 linked chains, which target proteins for proteasomal degradation and the modification at K63 linked chains, which play a vital role in DNA damage response (DDR) signaling. Through the activity of de-ubiquitylating enzymes, ubiquitin can be removed from the substrate or altered by de-ubiquitinases (DUBs). As a result, ubiquitylation as a posttranslational alteration is extremely adaptable and versatile.



**Figure 1.34. Types of ubiquitylation on substrate.** Mono-, Multi-mono- and Polyubiquitylation is presented. Different types of polyubiquitin chains: linked through specific but the same lysine throughout the chain (homogenous chains), linked through N-terminal methionine (linear chains), linked through alternative Lysines (heterogenous chains) and chains with one of the chain's ubiquitins modified by two further Ubiquitins linked through different lysines (branched chains). **Adapted from (Moreno and Gambus, 2015).**

### 1.4.1. Mono-Ubiquitination by UHRF1

UHRF1 controls targeted histone H3 ubiquitination, which is required for DNMT1 binding to freshly replicated chromatin and subsequent DNA methylation maintenance (Foster *et al.*, 2018; Mishima *et al.*, 2020). In fact, UHRF1 and DNMT1 have been shown to co-precipitate with USP7 (Ubiquitin-Specific Peptidase 7, also known as HAUSP for Herpes virus – Associated Ubiquitin Specific Protease), a de-ubiquitination enzyme. Overexpression of UHRF1 and USP7 results in opposite changes to the state of ubiquitination and stability of DNMT1 suggesting that UHRF1 and USP7 regulate the stability of DNMT1 by balancing the ubiquitination of DNMT1 (Qin *et al.*, 2011; Bronner, 2011). Furthermore, the role of Tip60 (Histone acetyltransferase) is to acetylate DNMT1 in order to be subsequently ubiquitinated by UHRF1. In contrast, the role of HDAC1 and USP7 is to protect DNMT1 from degradation (Du *et al.*, 2010; Bronner, 2011). UHRF1-mediated dual mono-ubiquitylation of histone H3 (H3Ub2) on lysine residues 14, 18, and 23 has been shown to have a role in the RFTS-dependent recruitment of DNMT1 and its enzymatic activation, guaranteeing high fidelity of DNA maintenance methylation, according to Nishiyama *et al.*, 2020. Accordingly, it has been shown that the dual mono-ubiquitylation of PAF15 (PAF15Ub2) is a molecular signature linking DNMT1 recruitment with DNA replication (Nishiyama *et al.*, 2020). UHRF1 is unable to bind with BRCA1 and ubiquitinate RIF1 in human cells when S674A phosphorylation is compromised, while maintaining its epigenetic function in DNA methylation and mono-ubiquitination of H3 (Zhang *et al.*, 2016). These findings imply that UHRF1's two roles are intertwined but have distinct characteristics; the two capacities may work together in the replication process, since genome integrity must be conserved before the right DNA methylation pattern can be spread. Both UHRF1 and UHRF2 have been discovered to be required for FANCD2 recruitment to ICLs and subsequent monoubiquitination by the FA core complex. UHRF1 and UHRF2 are recruited to ICLs in cells in separate ways. Normal FANCD2 recruitment and monoubiquitination, on the other hand, need the recruitment of both proteins (Motnenko *et al.*, 2018).

### 1.4.2. Poly-Ubiquitination by UHRF1

Poly-Ubiquitination of protein lysines are intended for degradation via the proteasome. Separate forms of polyubiquitin chains: homogeneous chains, linear chains, heterogenous

chains, and chains containing one ubiquitin modified by two additional ubiquitins connected through different lysines (branched chains) (Moreno and Gambus, 2015). UHRF1-dependent polyubiquitylation of histone H3 on lysine 23 (H3K23nUb) may serve as a platform for DNMT1 to bind hemimethylated DNA behind the replication fork and fully methylate it, according to previous research (Nishiyama *et al.*, 2013). UHRF1 is a ubiquitin ligase with an SRA domain that can bind hemimethylated DNA and has also been found to interact with PCNA (Tauber and Fischle, 2015; Sharif and Koseki, 2011). UHRF1 is brought to the replicating fork by these two contacts, where it ubiquitylates Histone H3, which is then preferentially bound by DNMT1. Surprisingly, the polyubiquitylated form of H3 could only be identified when Dnmt1 activity was inhibited owing to a negative feedback loop (after DNA is methylated, H3K23nUb is deubiquitylated) (Nishiyama *et al.*, 2013; Vaughan *et al.*, 2018).

### **1.4.3. Auto-Ubiquitination of UHRF1**

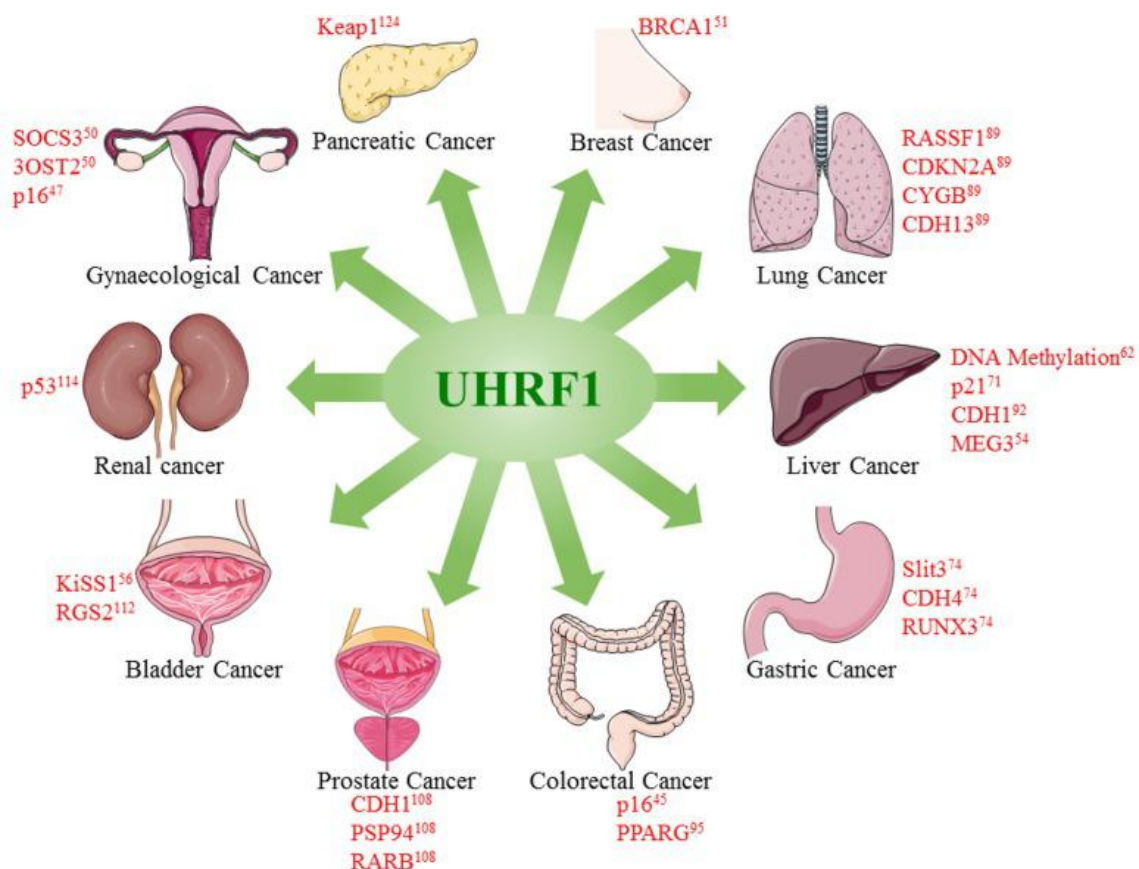
Members of the UHRF family, like several ligases comprising a RING Finger domain (Ibrahim *et al.*, 2018; Marsh and Dickson, 2019; Sun, 2020), have an *in vitro* self-ubiquitination activity (Motnenko *et al.*, 2018; Liu *et al.*, 2017; Mori *et al.*, 2002; Citterio *et al.*, 2004; Jenkins *et al.*, 2005). As part of the UHRF1 and DNMT1 complexes, USP7 is involved in both the deubiquitination process as well as proteasome-mediated degradation. UHRF1 and DNMT1 are both degraded via the RING domain of UHRF1 by poly-autoubiquitination, which in turn leads to apoptosis when USP7 is knocked out of the equation (Ibrahim *et al.*, 2018). Our laboratory was first to show that the auto-ubiquitination also occurs *in vivo* in the cell under the action of the anti-cancer drug thymoquinone (Ibrahim *et al.*, 2018). However, the role of this self-ubiquitination remains unknown.

## **1.5. Roles and functional mechanisms of UHRF1**

### **1.5.1. Expression of UHRF1 in cancer and during the cell cycle**

UHRF1 (ICBP90 and NP95) is overexpressed in several cancer lines including breast cancer (Hopfner *et al.*, 2000; Mousli *et al.*, 2003; Unoki *et al.*, 2004; Jenkins *et al.*, 2005; Zhang *et al.*, 2018; Ashraf *et al.*, 2017/B), cervical lesions (Lorenzato *et al.*, 2005), rhabdomyosarcoma, pancreatic adenocarcinoma, prostate cancer, gliomas, bladder, lung cancer (Unoki *et al.*, 2009; Unoki *et al.*, 2010) and Hepatocellular Carcinoma (Hasan *et*

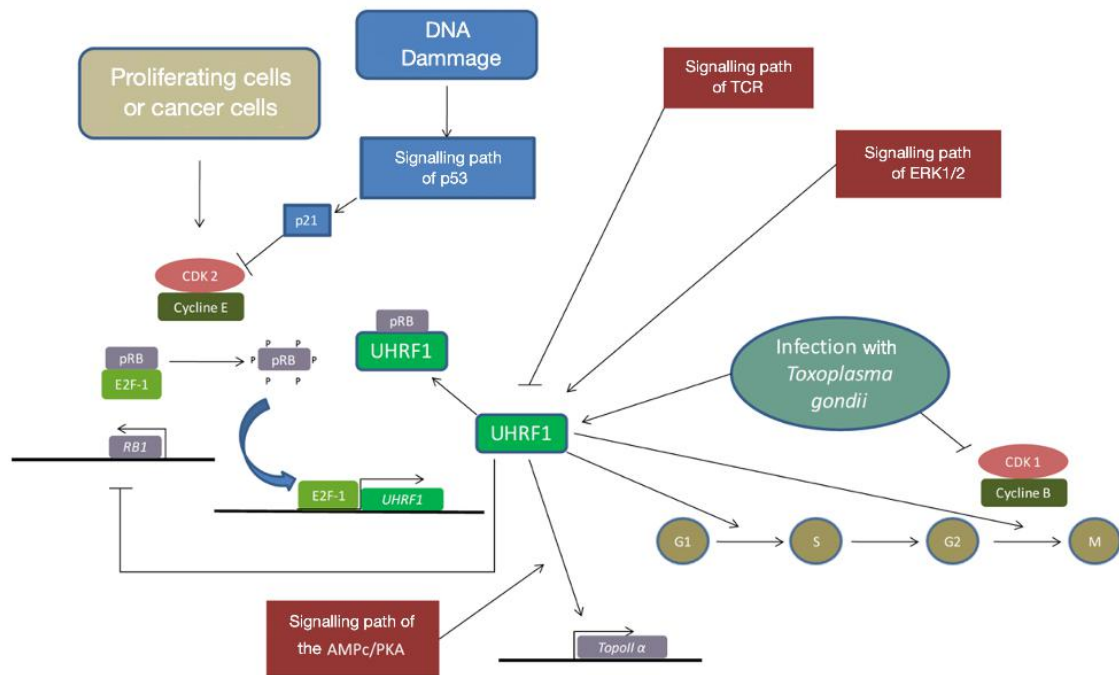
*al.*, 2019). The anti-UHRF1 antibody has been shown to mark cancer cells in cervical lesions with marker properties of cancer aggressiveness (Lorenzato *et al.*, 2005). A publication highlighted the qualities of UHRF1 as a cancer marker in adenomas of the pancreas compared to chronic pancreatitis or normal pancreatic tissue (Mudbhary and Sadler, 2011). The analysis of the expression of UHRF1 would be useful in the diagnosis of adenocarcinomas of the pancreas. Thus, UHRF1 could play a role in deregulating the expression of genes which are well known to play a primordial role in carcinogenesis such as the *topoisomerase IIa* gene (Bronner *et al.*, 2002; Hopfner *et al.*, 2000 and 2002), *RBI* (Jeanblanc *et al.*, 2005), *p16<sup>INK4A</sup>* (Alhosin *et al.*, 2016; Achour *et al.*, 2008), *p14<sup>ARF</sup>* *p53*, *p73* (Alhosin *et al.*, 2016; Alhosin *et al.*, 2010) and *RARβ* (Unoki *et al.*, 2004). Many other genes were shown to be regulated by UHRF1 in cancer cells (Figure 1.35). However, UHRF1 could also suppress the expression of tumor suppressor genes under physiological (non-cancerous) conditions mainly during the G1 / S transition, for example during the proliferation of human pulmonary fibroblasts and immortalized smooth muscle cells (SMC1- HVT) (Jeanblanc *et al.*, 2005, Achour *et al.*, 2008).



**Figure 1.35: Overexpression of UHRF1 promotes tumorigenesis in different cancers.** UHRF1 overexpression leads to epigenetic abnormalities including DNA methylation and downregulation of tumor suppressor genes or lncRNAs. **Adapted from (Ashraf *et al.*, 2017/B).**

The expression of UHRF1 is variable depending on the tissue nature. UHRF1 is not expressed in highly differentiated tissues (central nervous system, peripheral leukocytes) while in proliferative tissues (adult thymus and fetal), its expression is particularly high (Hopfner *et al.*, 2000). Within non-cancer cells, UHRF1 exhibits two expression peaks during G1 / S and G2 / M transitions in the cell cycle (Mousli *et al.*, 2003; Jeanblanc *et al.*, 2005). On the level of cancer lines, on the contrary, the expression of UHRF1 is both constant and high, which suggests an active participation of UHRF1 in the mechanisms linked to cell proliferation and its deregulation could be involved in the onset of tumorigenesis. Regarding the regulation of the expression of UHRF1, the mitogenic signaling pathways stimulate the expression of cyclin D and allows the formation and activation of cyclin-cdk complexes catalyzing the successive phosphorylation of the tumor suppressor pRB (Figure 1.36). When pRB is hyper-phosphorylated it becomes inactive and dissociates from the transcription factor E2F1 which can henceforth activate the expression of genes involved in cell proliferation including UHRF1 (Figure 1.36).

Arima *et al.*, 2004 have shown that UHRF1 is suppressed after activation of the p53-p21 pathway. Also, the expression of UHRF1 has been shown to increase under the influence of E2F1 (Mousli *et al.*, 2003), and it has been confirmed that the overexpression of UHRF1 is caused by the fixation of E2F1 on intron 1 of the *UHRF1* gene (Unoki *et al.*, 2004) (Figure 1.36). It was demonstrated that T cell receptor (TCR) signaling pathways regulate *UHRF1* gene expression through pRb/E2F complex, thus propose that the UHRF1 down-regulation is a key event in G1 arrest preceding T cell death (Abbadly *et al.*, 2005). UHRF1 positively regulates the expression of *Topoisomerase II $\alpha$*  (Bronner *et al.*, 2002; Hopfner *et al.*, 2000) and negatively, with the help of DNMT1 and HDAC1, the expression of tumor suppressor genes such as *p16<sup>INK4A</sup>*, *RB1*, *p14<sup>ARF</sup>* and *RAR $\beta$*  (Unoki *et al.*, 2004). Numerous works in the literature have shown that UHRF1 behaves as an oncogene and as an anti-apoptotic factor (Bronner *et al.*, 2004; Choudhry *et al.*, 2018; Zhang *et al.*, 2018; Kong *et al.*, 2019). Interestingly, the downregulation of UHRF1 is associated with the upregulation of various pro-apoptotic genes including *CASP3*, *TNF- $\alpha$* , *CASP7*, and *CDKN1A (p21)*.

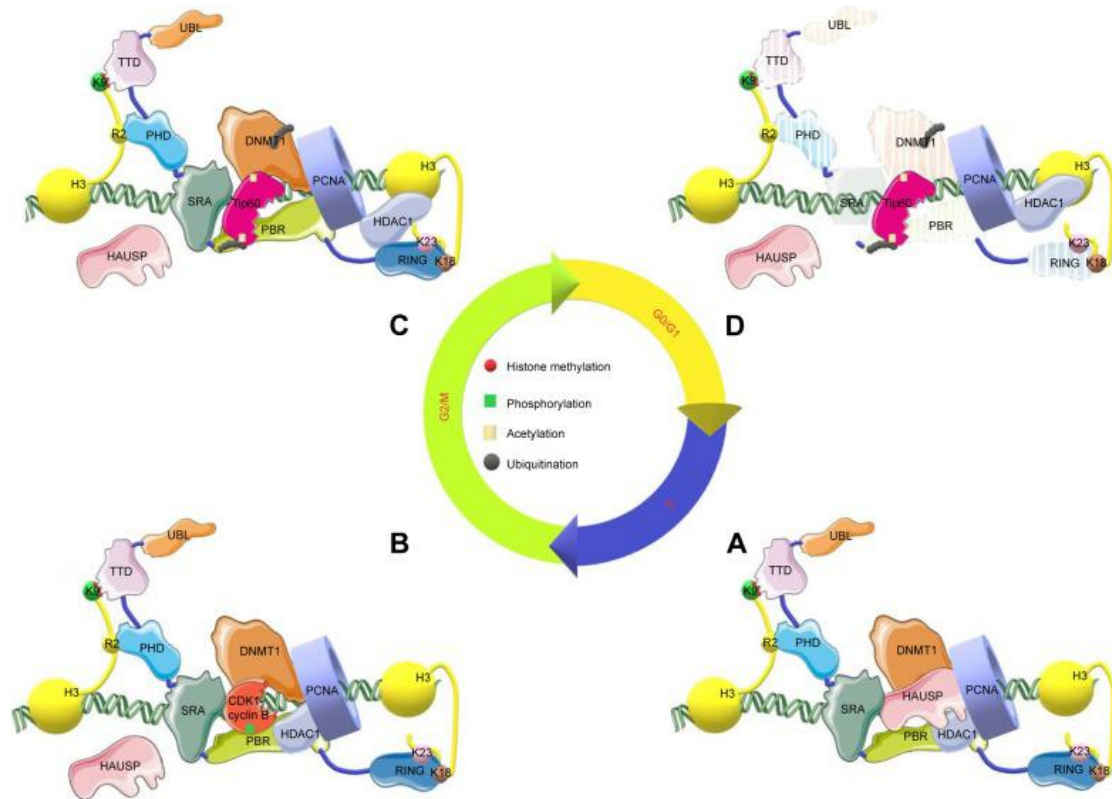


**Figure 1.36: Implication of the protein UHRF1 in different biological mechanisms.** Implication of UHRF1 in the regulation of the cell cycle during cell proliferation, DNA damage or infection by the parasite *Toxoplasma gondii*. Adapted from (Lallous N., 2010).

## 1.5.2 The UHRF1 complex

The macromolecular complex may function as follows (Figure 1.37): Respectively, after protein synthesis, DNMT1 and UHRF1 assume a closed conformation and an auto-inhibitory state. The UHRF1 complex binds to replication foci during DNA replication. Firstly, the UHRF1 conformation changes from a closed form to an open one because of that the SRA domain interacts to hmDNA, and phosphorylation of S651 by PI5P causes TTD alleviation from PBR. Secondly, in the open state, UHRF1 binds to the H3K9me2/3 mimic LIG1 as well as the H3K9me3e mimic LIG1; in addition, UHRF1 also binds to the H3R2 through the PHD domain. The third point is that the RING domain of UHRF1 ubiquitinates H3K18 and/or H3K23, which then binds the RFTS domain of DNMT1. When bound to the SRA domain or UBL of UHRF1, the RFTS domain of DNMT1 relieves the self-inhibitory activity of the SRA domain or UBL of UHRF1. The HDAC1 and USP7 can inhibit the Tip60-mediated deacetylation and ubiquitination of UHRF1 and DNMT1 when Tip60 levels are low. In addition to deubiquitinating histone H3, USP7 is also capable of recruiting DNMT1, through its RFTS domain, to ensure a reliable inheritance of DNA methylation patterns. When DNA replication is accomplished and methylation inheritance is established at the beginning of G2

phase, UHRF1 and DNMT1 are degraded. When phosphorylated at S652 by CDK1-cyclin B, and then ubiquitinated, UHRF1 dislocates from the UHRF1/DNMT1 complex.

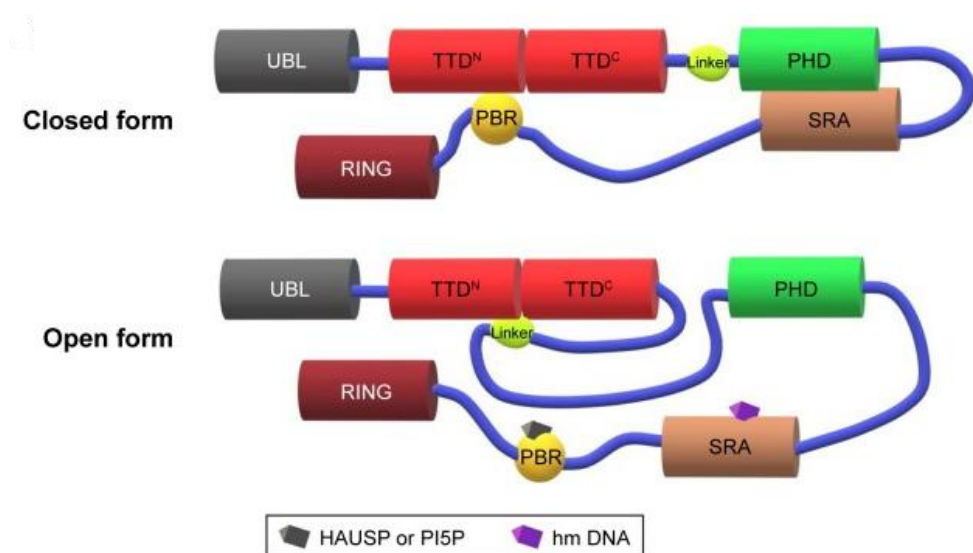


**Figure 1.37: Working model for dynamic regulation of UHRF1 macromolecular complex during cell cycle.** (A) UHRF1 macromolecular complex, which includes UHRF1, becomes localized in the open state when S phase commences, and additional members of ECREM are brought into replication forks. (B) The phosphorylation of HAUSP due to CDK1-cyclin B activation at the beginning of the G2 phase is required for the dissociation of HAUSP from the rest of the complex during G2 phase. (C) HAUSP and HDAC1 release results in Tip60 acetylation and ubiquitination of UHRF1 and DNMT1, which enables further HAUSP and HDAC1 secretion during G2-M phase. (D) In order to proceed normally in the cell cycle, UHRF1 and DNMT1 are ubiquitinated and degraded through the ubiquitination-mediated protein degradation pathway. **Adapted from (Xue *et al.*, 2019).**

A polybasic region (PBR) in the C-terminus of UHRF1 is reported to attach to the TTD and prevent it from recognizing H3K9me3 when it is not bound to chromatin (Gao *et al.*, 2018). In contrast to this, the SRA domain binds to the PHD domain and prevents the recognition of unmethylated histone H3 at residue R2 (H3R2), while UHRF1 impairs intramolecular interactions and switches to an open state, allowing TTD-PHD to recognize H3K9me3 and SRA-PBR to either recognize or recruit DNMT1 for an accurate methylation heredity upon binding to hmDNA by the SRA domain (Figure 1.37).

In the absence of chromatin, an  $\alpha$ -polybasic region in the C-terminus binds to the TTD and inhibits its recognition of H3K9me3 (Gao *et al.*, 2018), this occurs via the SRA domain, which binds to the PHD domain, thereby facilitating SRA-PBR binding to either hmDNA or to recruit DNMT1 for an accurate methylation process (Figure 1.37). Additionally, the PBR (through phosphorylation of S651) can interact with the UHRF1 heterochromatin localization complex, and together, they regulate the H3K9 methylation status as well as ensuring the crosstalk between H3K9 methylation and DNA methylation. This suggests that the linker region acts as a functional switch of UHRF1, regulating numerous regulatory processes, including as DNA methylation, transcriptional repression, and cell cycle progression (Xue *et al.*, 2019).

H3K9 methylation binding of UHRF1 does not ensure DNA methylation maintenance by itself, because it has been shown that only a 10% loss of DNA methylation occur in diverse tissues following ablation of the connection between H3K9me2/3 and UHRF1 in mammals. EZH2 plays a function in H3K27 methylation, which silences genes in cancer cells. G9a/GLP, UHRF1, and LIG1 (nonhistone mammalian DNA ligase 1) are all capable of being methylated, in this case at K126, and then attract the UHRF1 protein to replication foci, as it has been shown in previous cases involving the presence of H3K9-like methylation mimics (Xue *et al.*, 2019).

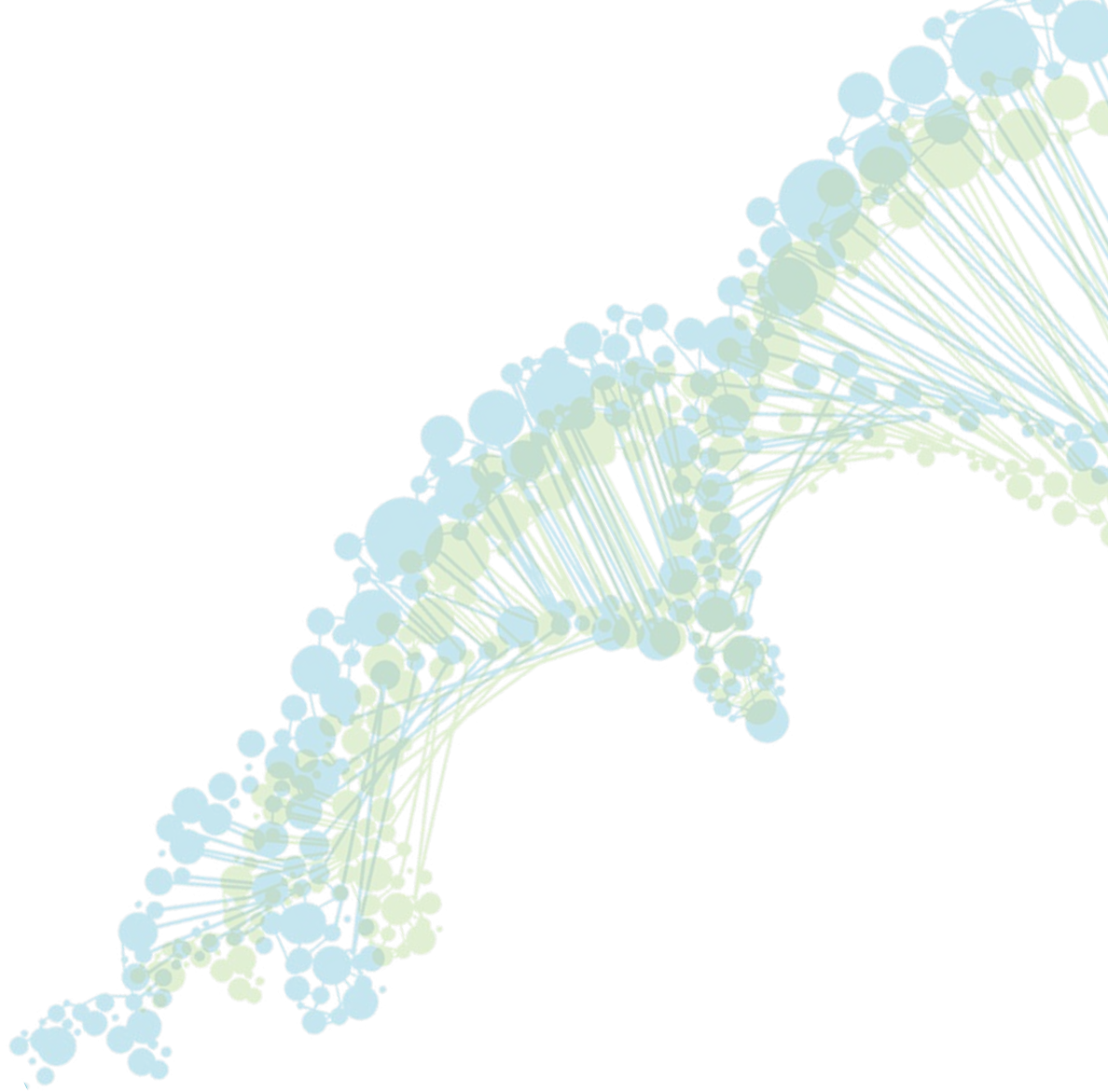


**Figure 1.38: Changes in the conformation of UHRF1 from close state to open state mediated by hmDNA. Adapted from (Xue *et al.*, 2019).**

### 1.5.3 Pharmacological regulation of UHRF1

Epigallocatechin gallate (EGCG) has been shown to inhibit the synthesis of UHRF1 and lower DNMT1 expression, therefore increasing the expression of tumor suppressor genes. Additionally, it was shown that down-regulating tumor suppressor genes, such as *p16<sup>INK4A</sup>*, requires UHRF1 base flipping. Caffeine, one of the EGCG components, appears to be an important pharmacological tool that down-regulates the production of endogenous UHRF1, which allows us to carry out overexpression experiments on the various domain of UHRF1 to see how the various domains regulate tumor suppressor gene expression (Achour *et al.*, 2013). The findings of Sharif *et al.*, 2011 indicated that the polyphenol-rich Aronia melanocarpa Juice effectively and selectively induced programmed cell death of T cell-derived lymphoblastic leukemia cells. The anticancer activity is critically dependent on the intracellular formation of ROS (Reactive Oxygen Species) involving superoxide anions and hydrogen peroxide, which, in turn, regulate the G2/M cell cycle transition and apoptosis (Sharif *et al.*, 2012). Furthermore, it has been shown the involvement of the Phosphodiesterase 1A (PDE1A) in the anti-proliferative effects (Abusnina *et al.*, 2011/B) of Curcumin and suggested a potential role for PDE1A inhibition as a new strategy to prevent and treat hyperproliferative disorders including cancer by regulation of p73 and UHRF1 expressions (Abusnina *et al.*, 2011/B). It has been also proposed a new molecular mechanism by which Curcumin present in food might act to prevent cancer occurrence and participate in epigenetic control of gene expression (Abusnina *et al.*, 2011/A). It has been found that the G extract of *Limoniastrum guyonianum* (an aqueous gall extract) activates the apoptosis pathway by inhibiting DNA methylation, resulting in a lower global DNA methylation level. This is likely due to the down-regulation of the epigenetic integrator UHRF1 and its main partner DNMT1. When combined with the G extract, the *p16<sup>INK4A</sup>* tumor suppressor gene is re-expressed in the HeLa cell line, arresting cell cycle progression and slowing cell proliferation at the G2/M phase (Krifa *et al.*, 2013).

Natural compounds such as Thymoquinone (TQ), Red wine polyphenols (RWPs) and potentially others are triggering a series of events that involve cell cycle arrest, apoptosis and inhibition of angiogenesis, all under the control of UHRF1 (Alhosin *et al.*, 2011; Walter *et al.*, 2010; Sharif *et al.*, 2010 and Sharif *et al.*, 2011). Of note, TQ so far is the sole natural compound that able to induce the poly-ubiquitination of UHRF1. Recently, our team demonstrated that the poly-ubiquitination of UHRF1 is regulated by Tip60 (Ahmad *et al.*, 2021). One of the objectives of my thesis is to investigate the role of this poly-ubiquitination which we consider is outside of the proteasomal pathway.



## Chapter (II)

# OBJECTIVS OF RESEARCH



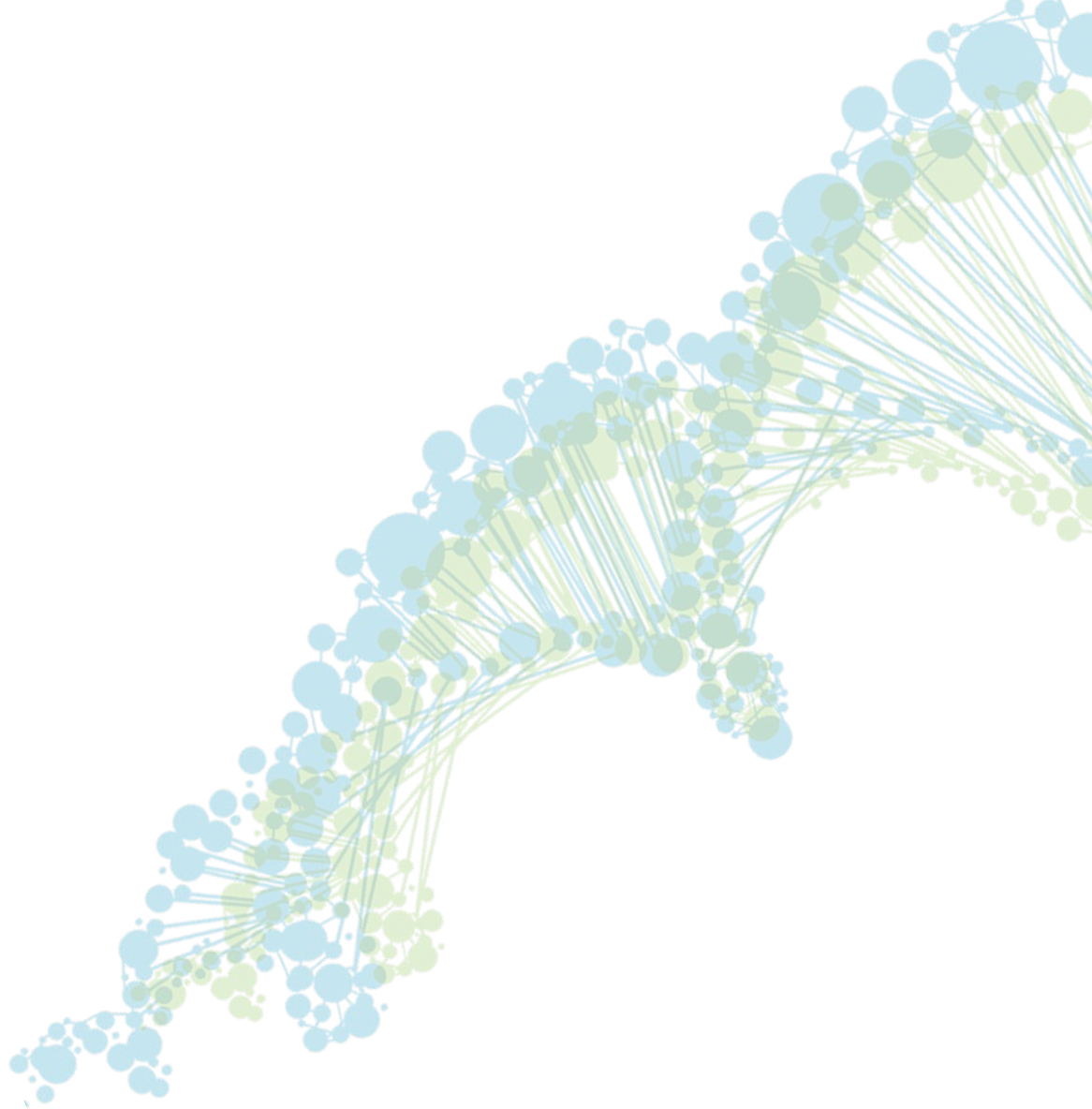
## 2. Purposes of Study

The role importance of UHRF1 is represented in the performing of epigenetic functions in the normal state of cells unless abnormal dysfunction occurs by overexpression leading to undesirable post-transcriptional and post-translational modifications that causing cancer. One of the main functions of the RING-finger type E3 ubiquitin ligase, UHRF1 protein, showed in its an enzymatic activity by its RING domain, which is very important in streamline a variety of biological process by ligating the ubiquitin to other proteins for regulating or leading to proteasomal pathway. A unique phenomenon has been observed related to the RING domain which is Auto-polyubiquitination of UHRF1 when the cell line treated with an anticancer drug, Thymoquinone (TQ) in between a several other drugs which are missing this feature, interestingly.

Thus, the main purpose of this project was to understand the importance, role, and regulation of UHRF1 ubiquitination in the cancer cells and Part of the objectives was to study the Reactive Oxygen Species (ROS) that produced by the anticancer drug, TQ, and which involved in the DNA damage and leading to ubiquitination of the oncogene, UHRF1.

It was aimed to characterize the anticancer activity of the tannin extract from the bark of maritime pine and investigate whether the UHRF1/DNMT1 tandem could be a central target to explain the re-expression of tumor suppressor genes such as TP73. Also, it was desired to study the effect of polyphenolic compounds and lanosterol based compound present in this bark on the proliferation of cancer cells at the G2/M phase of the cell cycle and to determine the MPTE treatment effect on the p73 tumor suppressor gene and the apoptotic pathway in HeLa cells, the levels of epigenetic proteins like UHRF1 and DNMT1 involved in the maintenance of DNA methylation and a global hypomethylation of the treated cells.

Part of this project was to figure out the reality behind the locus related to UHRF1 exists in the Chromosome 12, proposed as UHRF3 by (Bronner *et al.*, 2007), if it is expressing a truncated heterodimer protein that is essential for ubiquitination mechanism or it is a functional pseudogene transcript that regulates the parental UHRF1 protein.



## Chapter (III)

# SCIENTIFIC OUTPUT



## Notification

Before doing any practical experiments, the work was done with applying the safety procedure “in terms of **Safety First**” by following the COVID-19 safety measures, respecting colleagues to provides a healthy psychologically environment, wearing the personal protective equipment (PPE) to protect myself and colleagues from the samples and to protect the samples from possible contaminations, respecting the Safety signs, reading MSDS sheets of chemicals, knowing the places of Emergency Tools, being ready for chemical spill emergency response plan, First aid, BLS and RACE-PASS plan.



### **3.1 Article (I)**

**Maritime pine tannin extracts from bark exhibit anticancer properties by targeting the epigenetic UHRF1/DNMT1 tandem leading to re-expression of p73**

**PMID: [34897340](#)**

## Article (I) Summary

Cancer is one of the leading causes of mortality in the world today. Even though nature has shown itself to be the finest source of anticancer medications, the holy grail has yet to be identified since significant side effects and relapses diminish quality of life while undergoing treatment and after. Natural plant chemicals are being extensively studied for this purpose, and numerous natural-derived medications have gained clinical usage. Some of the most potent anticancer medicines, such as vincristine, vinblastine, docetaxel, and paclitaxel, originate from the plant kingdom and are now used in clinical trials to treat a wide range of tumors. These anti-cancer medications interrupt the cell cycle and induce apoptosis in order to slow the growth of malignancies. In the beginning, all of these pharmaceuticals were evaluated as extracts, and only after that were they further purified.

Polyphenolic compounds found in maritime pine bark are widely used as herbal supplements across the world. The goal of this investigation was to see if maritime pine tannin extract (MPTE) might be used as an anticancer treatment and to figure out how it works. MPTE, which contains procyanidin oligomers and lanostane type terpenoids, inhibits cancer cell growth by halting the cell cycle in the G2/M phase, according to our findings. Concentration-dependent induction of cell death by MPTE was seen in human cancer cell lines (HeLa and U2OS), with increased caspase 3 activation and PARP cleavage and decreased expression of the anti-apoptotic protein Bcl-2. Human non-cancerous fibroblasts are less responsive to MPTE, which suggests that it selectively targets cancer cells. P73 expression in p53-deficient cancer cells was increased by MPTE, which had a pro-oxidant function in cancer cells. UHRF1 and DNMT1 mediators of the DNA methylation machinery were also downregulated, and the global methylation levels in HeLa cells were lowered as a result of this treatment.

MPTE decreased HeLa cell growth by causing cell cycle arrest in the G2/M phase and activation of the mitochondrial apoptotic pathway via ROS, as was shown and described in this article. As a result of the downregulation of the UHRF1/DNMT1 tandem and the reduction in genome global methylation, the production of H<sub>2</sub>O<sub>2</sub> plays a crucial role in the rise in the expression of the tumor suppressor gene TP73. Maritime pine tannin extract can have a positive function in cancer treatment and should be further studied by the pharmaceutical sector, according to our research results.

Cite this: *Food Funct.*, 2022, **13**, 316

## Tannin extract from maritime pine bark exhibits anticancer properties by targeting the epigenetic UHRF1/DNMT1 tandem leading to the re-expression of *TP73*†

Waseem Ashraf,<sup>‡a,f</sup> Tanveer Ahmad,<sup>‡a</sup> Naif A. R. Almalki,<sup>b</sup> Mounira Krifa,<sup>a,c</sup> Liliyana Zaayer,<sup>a</sup> Antonio Pizzi,<sup>d</sup> Christian D. Muller,<sup>‡e</sup> Ali Hamiche,<sup>b</sup> Yves Mély,<sup>‡a</sup> Christian Bronner<sup>§b</sup> and Marc Mousli<sup>‡a</sup>\*

Maritime pine bark is a rich source of polyphenolic compounds and is commonly employed as a herbal supplement worldwide. This study was designed to check the potential of maritime pine tannin extract (MPTE) in anticancer therapy and to determine the underlying mechanism of action. Our results showed that MPTE, containing procyanidin oligomers and lanostane type terpenoids, has an inhibitory effect on cancer cell proliferation through cell cycle arrest in the G2/M phase. Treatment with MPTE also induced apoptosis in a concentration-dependent manner in human cancer cell lines (HeLa and U2OS), as evidenced by the enhanced activation of caspase 3 and the cleavage of PARP along with the downregulation of the antiapoptotic protein Bcl-2. Interestingly, human non-cancerous fibroblasts are much less sensitive to MPTE, suggesting that it preferentially targets cancer cells. MPTE played a pro-oxidant role in cancer cells and promoted the expression of the p73 tumor suppressor gene in p53-deficient cells. It also down-regulated the protooncogenic proteins UHRF1 and DNMT1, mediators of the DNA methylation machinery, and reduced the global methylation levels in HeLa cells. Overall, our results show that maritime pine tannin extract can play a favorable role in cancer treatment, and can be further explored by the pharmaceutical industry.

Received 12th May 2021.  
Accepted 1st November 2021

DOI: 10.1039/d1fo01484f

rsc.li/food-function

### 1. Introduction

Cancer related diseases are among the major causes of death around the world. Though modern therapies have improved patient care and therapeutic outcomes, the majority of tumors are still untreatable.<sup>1,2</sup> Chemotherapy is one of the most widely used treatments to cure cancer, although one of its fre-

quently encountered disadvantages is cancer recurrence associated with drug resistance. Nature has demonstrated that it is the best source of anticancer drugs, but the grail has not yet been discovered as severe side effects and relapses undermine quality of life during and after treatment.<sup>3</sup> Naturally occurring compounds from plants are being thoroughly explored for this purpose and many drugs of natural origin have entered clinical use.<sup>4</sup> Indeed, some of the most effective anticancer drugs such as vincristine, vinblastine, docetaxel, paclitaxel are derivatives of the plant kingdom and are in clinical use today for treating diverse types of cancers.<sup>5</sup> Treatment with these anticancer drugs inhibits the proliferation of tumors by halting cell cycle and inducing apoptosis.<sup>6,7</sup> All these drugs were first tested as an extract and later purified.

The *Pinus pinaster* tree (synonym *Pinus maritimus*, maritime pine) is well-known in traditional herbal medicine for its multiple biological activities. Maritime pine trees are commonly found in Mediterranean countries such as France, Italy, Spain and Portugal, and in some northern African countries including Tunisia, Algeria and Morocco.<sup>8</sup> Its bark is rich in polyphenolic compounds and is believed to have anti-inflammatory, antioxidant, antidiabetic, anticancer and antiallergic pro-

<sup>a</sup>Laboratory of Biomedicine and Pathologies, UMR 7021 CNRS, Université de Strasbourg, Faculté de Pharmacie, Illkirch, France. E-mail: marc.mousli@unistra.fr

<sup>b</sup>Department of Functional Genomics, Institut de Génétique et de Biologie Moléculaire et Cellulaire (IGBMC), INSERM U964 CNRS UMR 7104, Université de Strasbourg, Equipe labellisée Ligue contre le Cancer, Illkirch, France

<sup>c</sup>Unit of Bioactive and Natural Substances and Biotechnology UR17ES49, Faculty of Dental Medicine, University of Monastir, Monastir, Tunisia

<sup>d</sup>ENSTIB/LERMAB, Epinal, France

<sup>e</sup>Institut Pluridisciplinaire Hubert Curien, UMR 7178 CNRS Université de Strasbourg, Illkirch, France

<sup>f</sup>Department of Pharmacology, Faculty of Pharmacy, Bahauddin Zakariya University, Multan, Pakistan

†Electronic supplementary information (ESI) available. See DOI: 10.1039/d1fo01484f

‡Equal first authors.

§These authors are equal senior authors.

erties.<sup>9</sup> The dry extract from the bark is available commercially (Pycnogenol®) and is commonly indicated for multiple diseases including asthma, allergies, skin diseases, diabetes, osteoarthritis, erectile dysfunction and venous disease.<sup>10</sup> The polyphenolic constituents of this extract are divided into monomers or condensed (procyanidin) flavonoids. Monomers are generally catechin, epicatechin, epigallocatechin and epicatechin gallate along with small proportions of fisetinidin and taxifolin while the procyanidins are polymers of the flavan-3-ol units of (+)-catechin or epicatechin of various lengths.<sup>8,11,12</sup> Similar constituents are also present in the barks of other *Pinus* species including *Pinus massoniana*, *Pinus strobus* and *Pinus radiata* which are native to Southeast Asia (particularly southern China), North America and New Zealand, respectively.<sup>13–15</sup> *Pinus massoniana* bark extract (PMBE), *Pinus strobus* bark extract and *Pinus radiata* bark extract (PRE also called Enzogenol) are also well known to possess cardio-cerebrovascular protective, and antitumor, anti-inflammatory and antimicrobial properties.<sup>13,15–17</sup> Besides polyphenolic compounds, carbohydrates, terpenoids and some other phytochemical compounds have also been identified in the bark of *Pinus* trees.<sup>18–20</sup>

The anticancer activities of the French maritime pine bark have been outlined in a few studies as due to its polyphenolic content. It induces apoptosis in breast cancer cells, and leukemic and fibrosarcoma cells and also prevents the oncogenic transformation of ovarian cells on exposure to carcinogenic talc.<sup>21–24</sup> Treatment with bark extract also lowers the incidence of side effects related to anticancer therapy.<sup>25</sup> Despite the beneficial role of maritime pine bark in cancer suggested by these studies, the pathways involved in this beneficial effect remain elusive. The UHRF1/DNMT1 tandem is known to play an important role in the transmission of the cancer signature from a mother cell to the daughter cells.<sup>26–28</sup> One of these signatures includes the silencing of the tumor suppressor genes.<sup>27–30</sup>

Here, we characterized the anticancer activity of the tannin extract from the bark of maritime pine and investigated whether the UHRF1/DNMT1 tandem could be a central target to explain the re-expression of tumor suppressor genes such as *TP73*. The polyphenolic compounds and lanosterol based compound present in this bark inhibit the proliferation of cancer cells by inducing arrest in the G2/M phase of the cell cycle. MPTE treatment also activates the p73 tumor suppressor gene and the apoptotic pathway in HeLa cells. This extract also downregulates the levels of epigenetic proteins like UHRF1 and DNMT1 involved in the maintenance of DNA methylation, ultimately leading to a global hypomethylation of the treated cells.

## 2. Materials and methods

### 2.1. Maritime pine tannin extract preparation

Maritime pine (*Pinus maritimus*) bark was obtained from “Les Landes”, a region located in the southwest of France. It was dried initially and crushed mildly to obtain coarse chips of bark which were later completely dried till a constant weight

was obtained. Tannins were extracted from the dried ground bark by completely immersing it in 2% sodium bisulphite and 0.5% sodium bicarbonate water solution with continuous stirring in an industrial reactor (Biolandes, France). The final solution was spray-dried to obtain tannins in the form of a dark reddish-brown powder which was later used for studies.

### 2.2. Chemical characterization

The extract was analyzed by NMR spectroscopy and HPLC/MS techniques for chemical characterization. For NMR spectroscopy, the extract solutions were prepared using DMSO-*d*<sub>6</sub> and D<sub>2</sub>O as solvents and measured on a Bruker 500 MHz NMR spectrometer equipped with a BBO 5 mm probe head with a Z-gradient. The extract was also analyzed using an Agilent 6520 mass spectrometer coupled with an Agilent 1200 series HPLC equipped with a Zorbax C18-SB column. The system was run using acetonitrile + 0.05% formic acid/H<sub>2</sub>O + 0.05% formic acid with a linear gradient. The analysis was run both in the ESI positive and negative modes of ionization.

### 2.3. Cell culture and MPTE treatment

HeLa cells (ATCC, CCL-2), U2OS and human fibroblasts were cultured in DMEM (Dulbecco's Modified Eagle's Medium) supplemented with 10% FBS (fetal bovine serum), in addition to penicillin (100 U ml<sup>-1</sup>) and streptomycin (100 U ml<sup>-1</sup>) (Invitrogen). Cells were maintained at 37 °C in a humid atmosphere with a continuous supply of CO<sub>2</sub> maintained at 5%.<sup>31–33</sup> The MPTE solution was always freshly prepared for the treatment of cells. 10 mg of the extract powder was first mixed with 50 µL of DMSO by sonication, and then this solution was diluted in 10 mL of preheated DMEM by brief vortexing to obtain a concentration of 1 mg mL<sup>-1</sup>. The extract solution was then sterilized by passing through Millex-GP, 0.22 µm syringe filters (Merck-Millipore) and diluted to the required concentrations with additional DMEM. The prepared solutions of the desired concentration were then added to seeded cells while the controls were incubated with fresh medium, without the addition of the extract.

### 2.4. Antibodies and chemicals

Different antibodies used in this study include mouse monoclonal anti-PARP (BD Biosciences Pharmingen), rabbit polyclonal anti-caspase3 (Cell Signaling), mouse monoclonal anti-UHRF1 engineered as described previously,<sup>34</sup> mouse monoclonal anti-DNMT1 (Proteogenix France), mouse monoclonal anti-BCL-2 (Merck-Millipore), mouse monoclonal anti-GAPDH (Merck-Millipore), polyclonal anti-mouse (Promega) and polyclonal anti-rabbit (Promega) antibodies.

### 2.5. Cellular proliferation test

The effect of MPTE treatment on cellular proliferation was evaluated by using the colorimetric MTT assay. In this assay, viable cells are identified by their ability to reduce the tetrazolium dye MTT 3-(4,5-dimethylthiazol-2-yl)-2,5-diphenyltetrazolium bromide to form insoluble purple colored formazan crystals. These crystals are later dissolved in DMSO and quanti-

fied by measuring light absorption at 570 nm. Cells were seeded in a 96 well plate at a density of  $5 \times 10^3$  cells per well and incubated with different concentrations of the MPTE extract. For negative controls, the medium was replaced with fresh medium without MPTE. After 24 h of treatment, the medium was replaced with 100  $\mu$ L of the MTT (5 mg/10 mL) containing medium in each well and incubated for further 4 h. The formazan crystals formed after incubation with MTT were then dissolved in 100  $\mu$ L of DMSO and the absorption at 570 nm was determined by using a Xenius plate reader. The percentages of viable cells in the treated samples were calculated with reference to untreated samples. The inhibition of proliferation was expressed as  $IC_{50}$ , which is the concentration required to reduce the absorbance of the treated cells by 50% with reference to the control (untreated cells). The average  $IC_{50}$  values were statistically determined from the dose-response curves obtained using the Origin software (version 8.6).

### 2.6. Cell cycle and apoptosis analysis

For cell cycle analysis, HeLa cells were seeded in 6-well plates at a density of  $10^5$  cells per well and were treated with 75, 150 and 300  $\mu$ g  $mL^{-1}$  of MPTE along with the control samples. After 24 h of treatment, the cells were washed with PBS and mildly trypsinized. The collected cells were then fixed in the BD CellFIX (BD Biosciences) reagent and further incubated with the FxCycle™ PI/RNase staining solution (Thermo Fisher Scientific) for 20 min before analysis using the Guava 12HT capillary cytometer with the easyCyte™ software (Merck-Millipore). Fractions of cells in different phases of the cell cycle were quantified by using the InCyte Software for Guava® (Merck-Millipore). For apoptosis analysis, cells were seeded and treated as mentioned above. Cells were collected and incubated with PI and annexin V-FITC™ (Miltenyi Biotec) for 20 min to label cells undergoing apoptosis. Cells were then analyzed using the Guava capillary cytometer. The percentage of cells in different phases of apoptosis was obtained by using the easyCyte™ software (Merck-Millipore).

### 2.7. Analysis of reactive oxygen species (ROS) production

HeLa cells were seeded and treated in 6-well plates, as described in the previous section. ROS production was determined by flow cytometry using dihydroethidium (DHE) staining. Cells were incubated with 10  $\mu$ M of DHE for 30 min at 37 °C before collection and analyzed using the Guava 12HT cytometer (Merck-Millipore). PEG-catalase (Sigma-Aldrich) and *N*-acetylcysteine (NAC, Sigma-Aldrich) were added 1 h before MPTE.

### 2.8. Western blotting

HeLa cells were seeded in a 6-well plate and treated with 75, 150 and 300  $\mu$ g  $mL^{-1}$  of MPTE for 24 h, as described earlier. After treatment, the cells were collected by trypsinization and incubated with lysis buffer, 10 mM Tris-HCl pH 7.5, 150 mM NaCl, 1 mM EDTA and 1% NP40 supplemented with protease inhibitors (complete mini EDTA free protease inhibitor cocktail tablets, Roche, Germany), for 30 min on ice. Forty (40)  $\mu$ g

of the total protein lysate from each sample was resolved on 10% SDS-PAGE and transferred onto PVDF membranes. The membranes were blocked for 1 h with 3% blotting-grade blocker (Bio-Rad) in TBST buffer before incubating them overnight with primary antibodies at 4 °C. The membranes were then washed with TBST three times and incubated with secondary antibodies for 1 h at room temperature. After washing the membranes with TBST, they were imaged with the chemiluminescent ECL system (Clarity™ ECL western blotting substrate, Biorad, 170-5060) using the ImageQuant™ LAS 4000 system (GE Healthcare). Images were quantified using Image Studio Lite (LiCore Biosciences, USA).

### 2.9. Global methylation assay

For the global methylation assay, HeLa cells were seeded in six well plates and treated as described above. DNA was extracted from the treated and non-treated samples by using the QIAamp® DNA Kit (Qiagen). 200  $\mu$ g of the purified DNA from each sample was then analyzed for global methylation levels by using Sigma's Imprint® methylated DNA quantification kit (Sigma-Aldrich), according to the manufacturer's protocol.

### 2.10. Statistical analysis

All experiments were repeated three times and the results between groups were statistically compared by one-way ANOVA with the *post-hoc* Tukey test using the GraphPad-Prism (version 5.04) and Origin (version 8.6) software.

## 3. Results

### 3.1. Chemical characterization of MPTE

Maritime pine tannin extract from the bark of pine trees has been well-characterized previously by MALDI-TOF and  $^{13}C$  NMR techniques, which are useful techniques for the identification of polyflavonoid tannin compounds and their oligomers. MPTE was reported to contain procyanidin oligomers formed by catechin/epicatechin, epigallocatechin and epicatechin gallate monomers (with up to 20 to 21 repeating units) as well as small amounts of fisetinidine and carbohydrates.<sup>11</sup> However, MALDI-MS is not suitable to detect masses smaller than  $m/z$  500 because of the interference of the matrix peaks. Therefore, we also aimed to identify compounds with smaller masses through NMR spectroscopy and HPLC/MS techniques.

The NMR analysis of MPTE solutions in  $D_2O$  and  $DMSO-d_6$  revealed very complex spectra, indicating the presence of several compounds in the extract. In the  $D_2O$  based solution, the chemical shifts are compatible with carbohydrate compounds (presence of many peaks in the 3–4 ppm range compatible with CH(OH) protons), while in the  $DMSO$  based MPTE solution, the presence of signals at a higher frequency can be in line with the presence of procyanidins, as already reported in maritime pine.<sup>11</sup> For the HPLC/MS analysis, the extract was solubilized at 1 mg  $mL^{-1}$  in  $H_2O/DMSO$  95 : 5, which created a blind spot for very polar compounds such as catechins or sugars. While no compound could be detected in the ESI+

modus with significant intensity, two co-eluting compounds ( $m/z$  457.4 and  $m/z$  385.3) could be detected in the ESI–modus, at a retention time  $t_R = 10.458$  min (ESI Table 1 and Fig. 1†).

The selective fragmentation of the  $m/z$  457 peak led to the formation of the [ $m/z$  385 :  $m/z$  367] product couple. Increasing the fragmentation voltage stepwise led to the complete disappearance of the parent peak, and the increase of the [ $m/z$  385 :  $m/z$  367] and [ $m/z$  313 :  $m/z$  295] parent peaks derivative peaks. A possible explanation for the difference of 18 within each pair is provided by the loss of  $H_2O$ , such that these compounds probably contain at least 2 hydroxyl groups. This also tends to indicate that the two ESI-detected compounds probably share the same core motif (ESI Fig. 2†).

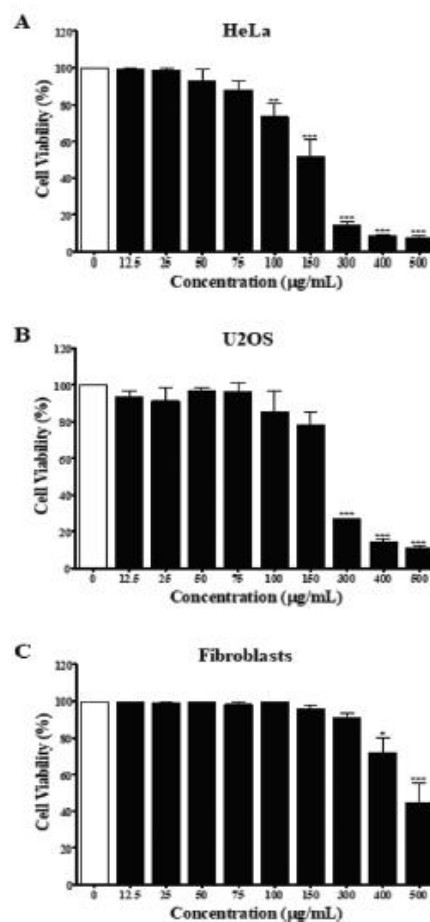
A search in the Dictionary of Natural Products within the *Pinus* genre shows only one hit for an exact mass between 458 and 459: the lanost-9(11)-ene-3,24,25-triol, with the chemical formula  $C_{30}H_{50}O_3$ .

### 3.2. Effect of maritime pine tannin extract (MPTE) on cell proliferation

First, the MPTE effect on cellular proliferation was determined by MTT assay on different cell lines including the cervical cancer HeLa cells, osteosarcoma U2OS cells, and normal fibroblast cells. Cells were treated with 12.5, 25, 50, 75, 100, 150, 300, 400 and 500  $\mu\text{g mL}^{-1}$  of the extract for 24 h and the inhibitory effect was determined by comparing the number of viable cells with the untreated cells. The results of the MTT assay showed that MPTE inhibited cell proliferation in a dose dependent manner (Fig. 1). The  $IC_{50}$  values were graphically determined for each cell line, and it was observed that MPTE reduced the proliferation of HeLa and U2OS cells at a relatively low concentration (Fig. 1A and B) as compared to normal fibroblast cells (Fig. 1C). The  $IC_{50}$  values of the HeLa and U2OS cells were  $150 \pm 20 \mu\text{g mL}^{-1}$  and  $220 \pm 10 \mu\text{g mL}^{-1}$ , respectively. For normal fibroblast cells, the  $IC_{50}$  value was  $490 \pm 30 \mu\text{g mL}^{-1}$ , showing the selective response of MPTE towards cancer cells, which prompted us to analyze the mechanism of action of MPTE in HeLa cells.

### 3.3. MPTE induces cell cycle arrest in the G2/M phase

In order to further explore the inhibitory effect of MPTE on cell proliferation, we analyzed the effect of 75, 150 and 300  $\mu\text{g mL}^{-1}$  of MPTE on different phases of the cell cycle. Cytometric analysis revealed that treatment with MPTE for 24 h reduced the cell population in the G0/G1 phase while the population in the G2/M phase was increased in a dose dependent manner (Fig. 2). Indeed, the cell fraction in the G0/G1 phase was reduced from 57% in control cells to 30% and 27% in cells treated with 150 and 300  $\mu\text{g mL}^{-1}$  of MPTE, respectively. Conversely, the cell population in the G2/M phase increased from 18% in control cells to 38% and 34% in HeLa cells treated with 150 and 300  $\mu\text{g mL}^{-1}$  of MPTE, respectively. This shows that MPTE inhibits the proliferation of cells by inducing cell cycle arrest at the G2/M phase.

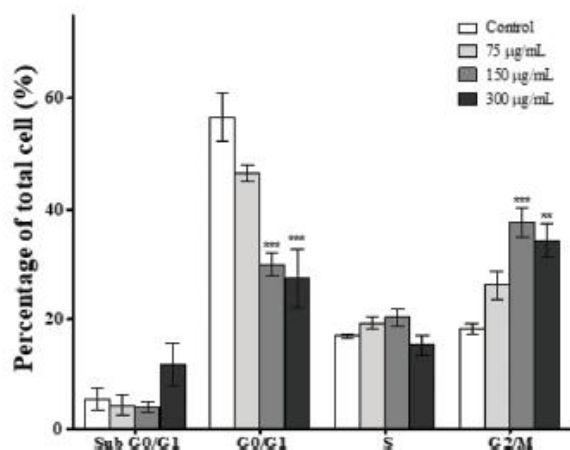


**Fig. 1** Inhibition of cell proliferation by MPTE. HeLa (A), U2OS (B) and fibroblast cells (C) were treated with MPTE for 24 h and the inhibition of proliferation was determined by colorimetric MTT assay. Values are represented as a percentage of the control, *i.e.*, in the absence of MPTE. Values are means  $\pm$  SEM of three independent experiments. Statistical significance is represented as \* $P < 0.05$ , \*\* $P < 0.01$ , and \*\*\* $P < 0.001$  versus control.

### 3.4. MPTE treatment induces apoptosis in cells

The induction of apoptosis by MPTE treatment was investigated by cytometry using annexin-FITC and propidium iodide labelling. Treatment with MPTE decreased the number of viable cells and induced apoptosis in HeLa cells in a concentration dependent manner (Fig. 3A). Indeed, viable cells were reduced from 92% in control cells to 76%, 48% and 27% in cells treated with 75, 150 and 300  $\mu\text{g mL}^{-1}$  of MPTE, respectively. In parallel, early apoptotic cells were increased from 1.8% in control to 8%, 8.7% and 5.2% in cells treated with 75, 150 and 300  $\mu\text{g mL}^{-1}$  of MPTE, respectively (Fig. 3A). The percentage of late apoptotic cells and necrotic cells also increased significantly with 150 and 300  $\mu\text{g mL}^{-1}$  of MPTE, showing the ability of this extract to induce apoptosis (Fig. 3A).

We confirmed the induction of apoptosis by analysing the activation of caspase 3 and the cleavage of PARP as well as Bcl-2 downregulation in MPTE treated cells (Fig. 3B). Western

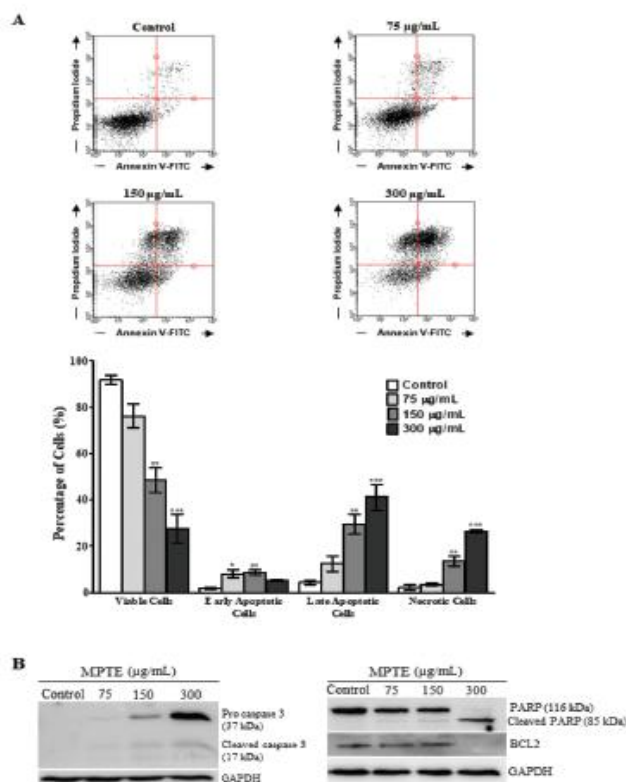


**Fig. 2** Cell cycle arrest induced by MPTE treatment. HeLa cells were treated with the indicated concentrations of MPTE for 24 h and the distribution of cells in different phases of the cell cycle was determined by cytometric analysis. The cellular distribution in each phase was represented in terms of percentage relative to the total cell number. Values are expressed as means  $\pm$  SEM of three independent experiments. Statistical significance is represented as \* $P < 0.05$ , \*\* $P < 0.01$ , and \*\*\* $P < 0.001$  versus control.

blotting analysis revealed the activation of caspase 3 from its precursor protein after the cells were treated with  $\geq 150 \mu\text{g mL}^{-1}$  of MPTE. PARP cleavage was also observed in response to MPTE treatment and became more prominent at a higher concentration of MPTE. Finally, Bcl-2 levels were found to decrease with MPTE treatment. These results confirmed the induction of apoptosis in response to MPTE treatment.

### 3.5. MPTE treatment induces ROS generation

In order to further determine the mechanism of apoptosis, we checked by cytometric analysis the levels of the reactive oxygen species (ROS) generated in cells treated with MPTE by using dihydroethidium (DHE) staining. DHE gets oxidized inside cells upon exposure to ROS and changes to 2-hydroxyethidium or ethidium which gets incorporated into the DNA and fluorescently labels the cells. The cytometric analysis of HeLa cells treated with MPTE for 24 h revealed significant production of ROS when they were incubated with the highest concentrations of MPTE (Fig. 4A and B). Indeed, the ROS levels increased by 1.5 and 2 fold upon 24 h treatment with 150 and 300  $\mu\text{g mL}^{-1}$  of MPTE, respectively, as compared to the controls (Fig. 4B). The cell granularity is usually increased with ROS generation and is often considered as an indicator of senescence or apoptosis.<sup>35</sup> Side scatter plots revealed that cell granularity increased after 24 h of treatment with 150 and 300  $\mu\text{g mL}^{-1}$  of MPTE, in a pattern similar to the increase in ROS levels, suggesting that the high ROS levels caused by MPTE treatment induce apoptosis in these cells (Fig. 4C and D). The generation of the ROS induced by 75  $\mu\text{g mL}^{-1}$  and 150  $\mu\text{g mL}^{-1}$  of MPTE, assessed by determining DHE-positive cells, was significantly inhibited by the antioxidants NAC and PEG-catalase (Fig. 5A and B). However, at 300  $\mu\text{g mL}^{-1}$  of MPTE, the inhibition was



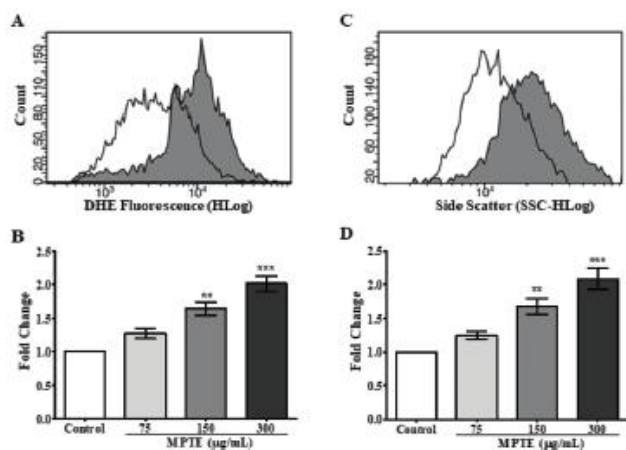
**Fig. 3** Apoptosis induced by MPTE treatment in HeLa cells. (A) HeLa cells were incubated with the indicated concentrations of MPTE for 24 h. Viable cells along with fraction of cells undergoing apoptosis were determined by annexin V-FITC and PI labelling through cytometry. Values are expressed as means  $\pm$  SEM of three independent experiments. Statistical significance is represented as \* $P < 0.05$ , \*\* $P < 0.01$ , and \*\*\* $P < 0.001$  versus control. (B) Western blotting showing the cleavage of procaspase 3 and PARP along with the downregulation of the Bcl-2 protein in MPTE-treated HeLa cells.

not evidenced, probably because the generated ROS concentrations became too high over a period of 24 h. These results suggest that the formation of  $\text{H}_2\text{O}_2$  plays a fundamental role in conferring an anticancer activity to MPTE.

### 3.6. MPTE treatment upregulates p73 and downregulates UHRF1 and DNMT1 in HeLa cells

Previously, it has been reported that naturally occurring polyphenolic compounds inhibit cell proliferation and activate apoptosis in p53-deficient cancer cells by inducing the expression of the analogue p73.<sup>36,37</sup> To check this effect as a possible mechanism for the induction of cell cycle arrest and apoptosis, we evaluated the effect of MPTE treatment on the expression of p73 in these cells. HeLa cells were treated with 75, 150 and 300  $\mu\text{g mL}^{-1}$  MPTE for 24 h. Western blotting data of the proteins isolated from these cells revealed that MPTE treatment induced the upregulation of p73 in HeLa cells (Fig. 6A and B). The increase in p73 expression was found to be the highest with 300  $\mu\text{g mL}^{-1}$  of MPTE which led to a five-fold upregulation in p73 levels as compared to controls (Fig. 6B).

## Food &amp; Function



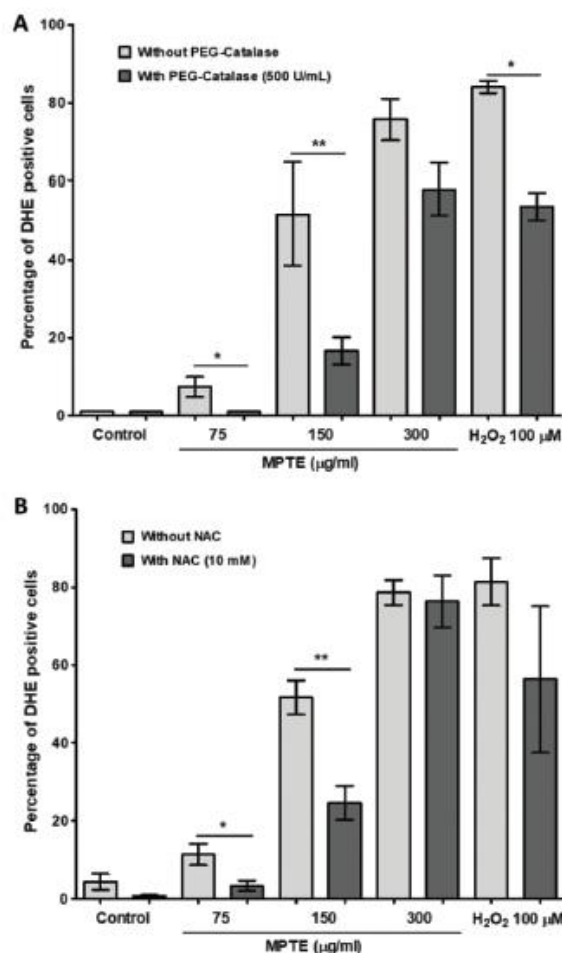
**Fig. 4** Effect of MPTE treatment on ROS levels and granularity in treated cells. (A) Cytochrome showing DHE labelling in the control (represented by a white area under the graph) and MPTE-treated cells ( $300 \mu\text{g mL}^{-1}$ , represented by a gray area under the graph). (B) Bar graph showing the fold change in DHE fluorescence by MPTE treatment at different concentrations compared to the control. (C) Cytochrome showing side scatter in the control (represented by a white area under the graph) and MPTE-treated cells ( $300 \mu\text{g mL}^{-1}$ , represented by a gray area under the graph). (D) Bar graph showing fold change in the side scatter by MPTE treatment at different concentrations with respect to the control. Values were obtained from three independent experiments and analyzed by one-way ANOVA with the *post-hoc* Tukey test ( $*P < 0.05$ ,  $**P < 0.01$ ,  $***P < 0.001$ ).

In our previous studies, we have shown that p73 is under the regulation of the UHRF1/DNMT1 tandem.<sup>36,37</sup> Thus, we hypothesized that the MPTE-induced up-regulation of p73 could be the result of the down-regulation of the UHRF1/DNMT1 tandem. Therefore, we also analyzed the levels of these epigenetic proteins after MPTE exposure to cells and observed a clear down-regulation of UHRF1 and DNMT1 in a dose dependent manner (Fig. 6A, C and D). Treatment with  $300 \mu\text{g mL}^{-1}$  of MPTE induced more than 60% decrease in UHRF1 and DNMT1 levels as compared to controls (Fig. 6C and D).

Since UHRF1 and DNMT1 are primarily involved in the maintenance of the DNA methylation pattern during the replication, we also checked the effect of MPTE treatment on the global DNA methylation level in cells by using the Imprint@ methylated DNA quantification assay. After treatment with different concentrations of MPTE for 24 h, our data indicated a decrease in the global methylation levels (Fig. 6E). For MPTE concentrations of  $150 \mu\text{g mL}^{-1}$  and  $300 \mu\text{g mL}^{-1}$ , the global methylation levels were, respectively, 25% and 33% less than those in the control samples.

## 4. Discussion

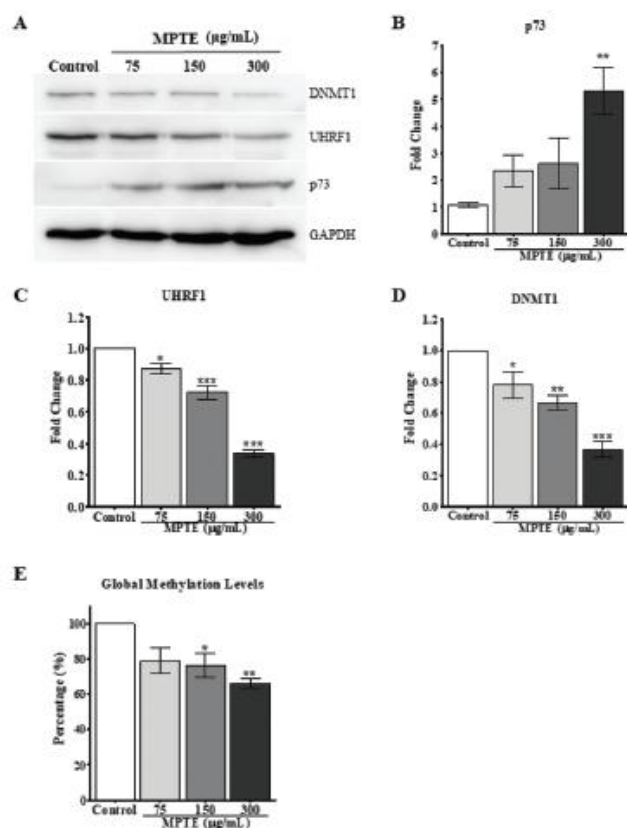
Many studies have shown a beneficial role of polyphenolic plant products in the prevention and cure of cancers. Such products are now being thoroughly explored for their possible application in the treatment of tumors by identifying their active ingredi-



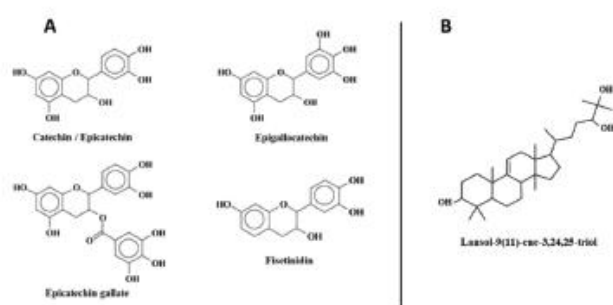
**Fig. 5** Effect of PEG-catalase (A) and alpha NAC (B) on ROS production induced by MPTE. PEG-catalase ( $500 \text{ U mL}^{-1}$ ) and NAC ( $10 \text{ mM}$ ) were added 1 h prior to MPTE incubation and analysis of ROS production was performed 24 h later, as described in "Materials and Methods". Values were obtained from three independent experiments and were analyzed by one-way ANOVA with the *post-hoc* Tukey test ( $*P < 0.05$ ,  $**P < 0.01$ ,  $***P < 0.001$ ).

ents and their possible mechanism of action.<sup>38,39</sup> Maritime pine bark has been previously reported to induce differentiation and apoptosis in cancer cells.<sup>21–24</sup> The aim of this study was to investigate the underlying mechanism by drawing attention to the epigenetic actors, considering that differentiation and apoptosis are regulated by epigenetic mechanisms such as DNA methylation. We focused on the DNMT1/UHRF1 tandem as it is responsible for DNA methylation maintenance and DNA methylation pattern inheritance.<sup>28</sup>

MPTE has been well characterized chemically. MALDI-TOF and <sup>13</sup>C NMR analysis of this extract revealed that it contains a mixture of condensed tannins (procyanidins) made up of varying subunits of catechin, epicatechin, epigallocatechin, epicatechin gallate and fisetinidin monomers (Fig. 7A).<sup>11</sup> Our HPLC/MS analysis also revealed the presence of lanost-9(11)-ene-3,24,25-triol from the terpenoid class of compounds (Fig. 7B).



**Fig. 6** MPTE upregulates p73 along with the downregulation of UHRF1 and DNMT1. (A) Western blotting analysis of proteins isolated from HeLa cells treated with 75, 150 and 300  $\mu\text{g mL}^{-1}$  MPTE for 24 h along with the untreated cells. (B) Effect of MPTE treatment on p73 levels versus controls. (C) Effect of MPTE treatment on UHRF1 levels with respect to controls. (D) Effect of MPTE treatment on DNMT1 levels versus controls. (E) Effect of MPTE treatment on global methylation levels. Values are obtained from three independent experiments and were analyzed by one-way ANOVA with the *post-hoc* Tukey test (\* $P < 0.05$ , \*\* $P < 0.01$ , \*\*\* $P < 0.001$ ).



**Fig. 7** Major phytochemicals in maritime pine tannin extract.

The different physiological properties of maritime pine bark extract such as antioxidant, anti-inflammatory, antidiabetic and cardioprotective effects have been attributed to the presence of these polyphenolic compounds.<sup>9,10</sup> Other pine bark extracts such as the *Pinus massoniana* bark extract, *Pinus*

*strobus* bark extract and *Pinus radiata* bark extract are also rich in procyanidins and possess similar bioactivities.<sup>13,17</sup> These compounds are also present in different combinations in green tea leaves and their anticancer properties have been shown in different studies.<sup>37,40</sup> It is also observed that these compounds work better in combination with a plant product rather than individually, because in combination, they are effective at a lower dose and cause less toxicity.<sup>41</sup> In MPTE, we also observed the presence of lanosterol based terpenoids which have been previously observed in *Pinus monticola* and *Pinus luchuensis*.<sup>18,19</sup>

Here, we observed that treatment with MPTE inhibited the proliferation of cervical cancer HeLa and osteosarcoma U2OS cell lines at a low concentration compared to primary fibroblasts, showing a specific response towards cancer cells. The inhibition of proliferation under MPTE treatment also resulted in the accumulation of cells in the G2/M phase, which is commonly seen with anticancer compounds.<sup>42–44</sup> MPTE induced apoptosis in HeLa cells, as indicated by flow cytometry analysis using annexin V and PI labelling. Western blotting results confirmed the induction of apoptosis by showing the activation of caspase 3 and the cleavage of PARP in a dose dependent manner in MPTE treated cells. The levels of the pro-survival protein Bcl-2 which is necessary for the maintenance of the integrity of the mitochondrial membrane were also decreased during treatment with MPTE. The loss of Bcl-2 results in the release of cytochrome c and thus leads to apoptosis.

Similar results have been observed in cervical, hepatoma, sarcoma and lung cancer cells by treatment with *P. massoniana* bark extract (PMBE) which also contains B-type procyanidin as the major constituent.<sup>45–50</sup> The treatment of cancer cells with PMBE reduced the migration of tumor cells and induced apoptosis by the downregulation of the Bcl-2 protein.<sup>45,48</sup> Similar effects were also observed with *P. radiata* bark extract, which contains a high amount of polyphenolic compounds such as quercetin, dihydroquercetin, catechin, epicatechin, taxifolin and other procyanidin oligomers and polymers.<sup>13,15</sup> This extract also induces apoptosis in lymphoma cells when used in combination with aquamin and green tea extract in a dose-dependent manner by increasing caspase 3 activity.<sup>51</sup>

In a similar manner, a number of polyphenolic compounds, *e.g.* (–) epigallocatechin gallate, butein and curcumin, have been shown to induce apoptosis in a variety of cancer cells by activating caspase 3 and PARP cleavage along with the downregulation of the Bcl-2 protein.<sup>4,52–55</sup> Along with polyphenolic compounds, lanosterol derived compounds are also well known for their potential to exert cytotoxic effects and induce apoptosis. These compounds can potentiate the effect of tumor suppressor proteins and activate the BAX protein for apoptosis in cancer cells.<sup>56,57</sup>

In contrast to the previously reported antioxidant activity of MPTE,<sup>9</sup> we observed a pro-oxidant role of MPTE in cancer cells, which was evidenced by a dose dependent increase in ROS staining which was sensitive to the antioxidants PEG-catalase and *N*-acetylcysteine. These results show that  $\text{H}_2\text{O}_2$  is an important factor in mediating the anti-cancer activity of MPTE

as has been reported, for instance, for white grape pomace extract.<sup>58</sup> Furthermore, it suggests that superoxide dismutase is involved in mediating such an effect as this enzyme is responsible for the generation of H<sub>2</sub>O<sub>2</sub> from superoxide anions, themselves scavenged in the presence of NAC. This explains the subsequent cascade of events, *i.e.* DNA damage and cell apoptosis.<sup>59,60</sup>

In agreement with our study, polyphenol-rich extracts from tea leaves, grapes, fruits and berries have also been reported to induce ROS production and apoptosis in cancer cells despite their predominantly antioxidant effects in normal cells.<sup>61</sup> Polyphenols can act both as an antioxidant and a pro-oxidant depending on the nature of cells. In normal cells, polyphenolic compounds protect the cellular material from oxidative stress because of their antioxidant activity. In cancer cells, they behave as pro-oxidant compounds and kill the cells as a result of the high pH and the increased level of redox active transient metals.<sup>61,62</sup> This specific targeting of cancer cells makes the polyphenolic compounds interesting candidates for anticancer therapy. Increased ROS levels are also associated with increased granularity in cell-induced senescence, indicating early signs of apoptosis.<sup>35,63</sup> Similar results have also been observed with Pinostrobin, a flavonoid from *Pinus strobus* which induces apoptosis in HeLa cells by excessive ROS production.<sup>64</sup>

Interestingly, MPTE treatment was observed to induce the expression of the tumor suppressor protein p73 in p53-deficient HeLa cells. Previously, it has been reported that ROS production can activate p73 expression in HeLa cells and induce their apoptosis through a mitochondrial activation of caspases 9 and 3.<sup>65</sup> The activation of p73 and apoptosis induced by a p73-dependent mechanism have also been observed in a number of plant products including thymoquinone, epigallocatechin-3-gallate and polyphenolic extracts from grapes and berries added to p53-deficient cancer cells.<sup>30,36,37,58,61,66–68</sup>

Earlier, we have reported in several studies that p53 and p73 also negatively regulate the epigenetic mediator UHRF1 in cancer cells.<sup>36,37</sup> In this study, we also observed the downregulation of UHRF1 along with the upregulation of p73 upon MPTE treatment in HeLa cells, in line with the previous data. UHRF1 is mostly found upregulated in cancers, where it promotes cell oncogenesis by facilitating their passage through the cell cycle.<sup>69</sup> Elevated levels of UHRF1 directly interfere with the function of the tumor suppressor genes (TSGs) and downregulate a variety of TSGs through their promoter hypermethylation. UHRF1 upregulation also makes cancer cells resistive to anticancer therapy by facilitating DNA damage repair, highlighting its potential as a target for anticancer therapy.<sup>27,69</sup> Therefore, the knockdown of UHRF1 by siRNA or other plant products such as EGCG, thymoquinone or polyphenolic extracts induced apoptosis in cancer cells and improved the response of resistive tumor cells to anticancer therapy.<sup>27,36,37</sup>

In our current study, we observed a MPTE-induced downregulation of UHRF1 and blockade of cells in the G2/M phase, in agreement with a previous finding where UHRF1 depletion

resulted in a cell cycle arrest in the G2/M phase.<sup>70</sup> MPTE also downregulated the expression of DNMT1. The downregulation of both DNMT1 and UHRF1 contributed to recovery of the expression of TSGs from a silenced state.<sup>27,71</sup> This re-expression likely results from a global genome hypomethylation. In our case, the downregulation of UHRF1 and DNMT1 was followed by global hypomethylation after treatment with MPTE. In agreement with our observations, catechol-containing dietary polyphenols have been previously described to interfere with the DNA methylation process.<sup>72</sup>

## 5. Conclusions

In conclusion, we reported here that MPTE inhibited the proliferation of HeLa cells by inducing cell cycle arrest in the G2/M phase along with a ROS mediated activation of the mitochondrial apoptotic pathway. It is concluded that the formation of H<sub>2</sub>O<sub>2</sub> plays a major role in the increase of the expression of the tumor suppressor gene *TP73* as a result of the downregulation of the UHRF1/DNMT1 tandem and a reduced genome global methylation.

## Author contributions

C. B. and M. M. conceived the project. W. A., T. A., N. A. R. A., C. D. M., M. K., A. P., A. H. and L. Z. performed the experiments. Data were curated by W. A. and T. A. The original draft was written by W. A., T. A., Y. M., C. B. and M. M. Funding acquisition was done by M. M. and Y. M. All authors were involved in the proofreading of the manuscript.

## Conflicts of interest

The authors declare no conflict of interest.

## Acknowledgements

The authors thank Dr Delphine Garnier from the technical platform PACSI of the Faculty of Pharmacy for performing the NMR spectroscopy and HPLC/MS analysis of the PMTE. Funding: This research was supported by ANR (SMFLUONA, ANR-17-CE11-0036-01). W. A. and T. A. were supported by fellowships from the Higher Education Commission (HEC), Pakistan. Y. M. is grateful to the Institut Universitaire de France (IUF) for support and providing additional time to be dedicated to research.

## References

- 1 J. Ferlay, I. Soerjomataram, R. Dikshit, S. Eser, C. Mathers, M. Rebelo, D. M. Parkin, D. Forman and F. Bray, Cancer Incidence and Mortality Worldwide: Sources, Methods and

- Major Patterns in GLOBOCAN 2012, *Int. J. Cancer*, 2015, 136, E359–E386.
- H. Gali-Muhtasib, R. Hmadi, M. Kareh, R. Tohme and N. Darwiche, Cell Death Mechanisms of Plant-Derived Anticancer Drugs: Beyond Apoptosis, *Apoptosis*, 2015, 20, 1531–1562.
  - A. Rayan, J. Raiyn and M. Falah, Nature Is the Best Source of Anticancer Drugs: Indexing Natural Products for Their Anticancer Bioactivity, *PLoS One*, 2017, 12, e0187925.
  - J. Wang, Y. Pan, J. Hu, Q. Ma, Y. Xu, Y. Zhang, F. Zhang and Y. Liu, Tea Polyphenols Induce S Phase Arrest and Apoptosis in Gallbladder Cancer Cells, *Rev. Bras. Pesqui. Med. Biol.*, 2018, 51, e6891.
  - M. Greenwell and P. K. S. M. Rahman, Medicinal Plants: Their Use in Anticancer Treatment, *Int. J. Pharma Sci. Res.*, 2015, 6, 4103–4112.
  - J. Iqbal, B. A. Abbasi, T. Mahmood, S. Kanwal, B. Ali, S. A. Shah and A. T. Khalil, Plant-Derived Anticancer Agents: A Green Anticancer Approach, *Asian Pac. J. Trop. Biomed.*, 2017, 7, 1129–1150.
  - S. Xie and J. Zhou, Harnessing Plant Biodiversity for the Discovery of Novel Anticancer Drugs Targeting Microtubules, *Front. Plant Sci.*, 2017, 8, 1–8.
  - L. Chupin, A. Pizzi, B. Charrier, C. Motillon and F. Charrier-El Bouhtoury, Characterisation of Maritime Pine (*Pinus Pinaster*) Bark Tannins Extracted under Different Conditions by Spectroscopic Methods, FTIR and HPLC, *Ind. Crops Prod.*, 2013, 49, 897–903.
  - L. Packer, G. Rimbach and F. Virgili, Antioxidant Activity and Biologic Properties of a Procyanidin-Rich Extract from Pine (*Pinus Maritima*) Bark, Pycnogenol, *Free Radicals Biol. Med.*, 1999, 27, 704–724.
  - P. J. Rohdewald, Update on the Clinical Pharmacology of Pycnogenol(R), *Med. Res. Arch.*, 2015, 3, 1–11.
  - P. Navarrete, A. Pizzi, H. Pasch, K. Rode and L. Delmotte, MALDI-TOF and <sup>13</sup>C NMR Characterization of Maritime Pine Industrial Tannin Extract, *Ind. Crops Prod.*, 2010, 32, 105–110.
  - M. de la Luz Cádiz-Gurrea, S. Fernández-Arroyo and A. Segura-Carretero, Pine Bark and Green Tea Concentrated Extracts: Antioxidant Activity and Comprehensive Characterization of Bioactive Compounds by HPLC-ESI-QTOF-MS, *Int. J. Mol. Sci.*, 2014, 15, 20382–20402.
  - Y.-Y. Li, J. Feng, X.-L. Zhang and Y.-Yu. Cui, Pine bark extracts: nutraceutical, pharmacological, and toxicological evaluation, *J. Pharmacol. Exp. Ther.*, 2015, 353, 9–16.
  - A. Theadom, S. Mahon, S. Barker-Collo, K. McPherson, E. Rush, A. C. Vandal and V. L. Feigin, Enzogenol for cognitive functioning in traumatic brain injury: a pilot placebo-controlled RCT, *Eur. J. Neurol.*, 2013, 20, 1135–1144.
  - T. Ghaffari, J.-H. Hong, S. Asnaashari, S. Farajnia, A. Delazar, H. Hamishehkar and K. H. Kim, Natural Phytochemicals Derived from Gymnosperms in the Prevention and Treatment of Cancers, *Int. J. Mol. Sci.*, 2021, 22, 6636–6652.
  - Y. Cui, H. Xie and J. Wang, Potential biomedical properties of *Pinus massoniana* bark extract, *Phytother. Res.*, 2005, 19, 34–38.
  - Y. Yazaki, Utilization of Flavonoid Compounds from Bark and Wood: A Review, *Nat. Prod. Commun.*, 2015, 10, 1934578X1501000333.
  - D. M. Fradinho, C. P. Neto, D. Evtuguin, F. C. Jorge, M. A. Irle, M. H. Gil and J. Pedrosa de Jesus, Chemical characterisation of bark and of alkaline bark extracts from maritime pine grown in Portugal, *Ind. Crops Prod.*, 2002, 16, 23–32.
  - A. H. Conner, B. A. Nagasampagi and J. W. Rowe, Terpenoid and other extractives of western white pine bark, *Phytochemistry*, 1980, 19, 1121–1131.
  - J. L. C. Sousa, P. A. B. Ramos, C. S. R. Freire, A. M. S. Silva and A. J. D. Silvestre, Chemical Composition of Lipophilic Bark Extracts from *Pinus pinaster* and *Pinus pinea* Cultivated in Portugal, *Appl. Sci.*, 2018, 8, 1–11.
  - H. T. Huynh and R. W. Teel, Selective Induction of Apoptosis in Human Mammary Cancer Cells (MCF-7) by Pycnogenol, *Anticancer Res.*, 2000, 20, 2417–2420.
  - W. W. Huang, J. S. Yang, C. F. Lin, W. J. Ho and M. R. Lee, Pycnogenol Induces Differentiation and Apoptosis in Human Promyeloid Leukemia HL-60 Cells, *Leuk. Res.*, 2005, 29, 685–692.
  - A. R. Buz'Zard and B. H. S. Lau, Pycnogenol Reduces Talc-Induced Neoplastic Transformation in Human Ovarian Cell Cultures, *Phytother. Res.*, 2007, 21, 579–586.
  - K. Harati, P. Slodnik, A. M. Chromik, B. Behr, O. Goertz, T. Hirsch, N. Kapalschinski, L. Klein-Hitpass, J. Kolbenschlag, W. Uhl, M. Lehnhardt and A. Daigeler, Pro-apoptotic Effects of Pycnogenol on HT1080 Human Fibrosarcoma Cells, *Int. J. Oncol.*, 2015, 46, 1629–1636.
  - G. Belcaro, M. R. Cesarone, D. Genovesi, A. Ledda, G. Vinciguerra, A. Ricci, L. Pellegrini, G. Gizzi, E. Ippolito and M. Dugall, Pycnogenol May Alleviate Adverse Effects in Oncologic Treatment, *Panminerva Med.*, 2008, 50, 227–234.
  - C. Bronner, G. Fuhrmann, F. L. Chédin, M. Macaluso and S. Dhe-Paganon, UHRF1 Links the Histone Code and DNA Methylation to Ensure Faithful Epigenetic Memory Inheritance, *Genet. Epigenet.*, 2010, 2009, 29–36.
  - C. Bronner, M. Krifa and M. Mousli, Increasing Role of UHRF1 in the Reading and Inheritance of the Epigenetic Code as Well as in Tumorigenesis, *Biochem. Pharmacol.*, 2013, 86, 1643–1649.
  - C. Bronner, M. Alhosin, A. Hamiche and M. Mousli, Coordinated Dialogue between UHRF1 and DNMT1 to Ensure Faithful Inheritance of Methylated DNA Patterns, *Genes*, 2019, 10, 65.
  - M. Alhosin, T. Sharif, M. Mousli, N. Etienne-Selloum, G. Fuhrmann, V. B. Schini-Kerth and C. Bronner, Down-Regulation of UHRF1, Associated with Re-Expression of Tumor Suppressor Genes, Is a Common Feature of Natural Compounds Exhibiting Anti-Cancer Properties, *J. Exp. Clin. Cancer Res.*, 2011, 30, 1–10.
  - M. Alhosin, Z. Omran, M. A. Zamzami, A. L. Al-Malki, H. Choudhry, M. Mousli and C. Bronner, Signalling

- Pathways in UHRF1-Dependent Regulation of Tumor Suppressor Genes in Cancer, *J. Exp. Clin. Cancer Res.*, 2016, 35, 1–11.
- 31 Y. Amrani, C. Magnier, J. Enouf, F. Wuytack and C. Bronner, Role of Ca<sup>2+</sup> Pools Controlled by Sarco-Endoplasmic Reticulum Ca(2+)-ATPase 2 Isoform, *Br. J. Pharmacol.*, 1995, 115, 1204–1210.
  - 32 Y. Amrani, R. A. J. Panettieri, N. Frossard and C. Bronner, Activation of the TNF Alpha-P55 Receptor Induces Myocyte Proliferation and Modulates Agonist-Evoked Calcium Transients in Cultured Human Tracheal Smooth Muscle Cells, *Am. J. Respir. Cell Mol. Biol.*, 1996, 15, 55–63.
  - 33 L. Zaayter, M. Mori, T. Ahmad, W. Ashraf, C. Boudier, V. Kilin, K. Gavvala, L. Richert, S. Eiler, M. Ruff, M. Botta, C. Bronner, M. Mousli and Y. Mély, A Molecular Tool Targeting the Base-Flipping Activity of Human UHRF1, *Chem. – Eur. J.*, 2019, 25, 13363–13375.
  - 34 R. Hopfner, M. Mousli, J. M. Jeltsch, A. Voulgaris, Y. Lutz, C. Marin, J. P. Bellocq, P. Oudet and C. Bronner, ICBP90, a Novel Human CCAAT Binding Protein, Involved in the Regulation of Topoisomerase II alpha Expression, *Cancer Res.*, 2000, 60, 121–128.
  - 35 K. Gosselin, E. Deruy, S. Martien, C. Vercaemer, F. Bouali, T. Dujardin, C. Slomianny, L. Houel-Renault, F. Chelli, Y. De Launoit and C. Abbadie, Senescent Keratinocytes Die by Autophagic Programmed Cell Death, *Am. J. Pathol.*, 2009, 174, 423–435.
  - 36 M. Alhosin, A. Abusnina, M. Achour, T. Sharif, C. Muller, J. Peluso, T. Chataigneau, C. Lugnier, V. B. Schini-Kerth, C. Bronner and G. Fuhrmann, Induction of Apoptosis by Thymoquinone in Lymphoblastic Leukemia Jurkat Cells Is Mediated by a P73-Dependent Pathway Which Targets the Epigenetic Integrator UHRF1, *Biochem. Pharmacol.*, 2010, 79, 1251–1260.
  - 37 M. Achour, M. Mousli, M. Alhosin, A. Ibrahim, J. Peluso, C. D. Muller, V. B. Schini-Kerth, A. Hamiche, S. Dhe-Paganon and C. Bronner, Epigallocatechin-3-Gallate up-Regulates Tumor Suppressor Gene Expression via a Reactive Oxygen Species-Dependent down-Regulation of UHRF1, *Biochem. Biophys. Res. Commun.*, 2013, 430, 208–212.
  - 38 M. Asensi, A. Ortega, S. Mena, F. Feddi and J. M. Estrela, Natural Polyphenols in Cancer Therapy, *Crit. Rev. Clin. Lab. Sci.*, 2011, 48, 197–216.
  - 39 Y. Zhou, J. Zheng, Y. Li, D.-P. Xu, S. Li, Y.-M. Chen and H.-B. Li, Natural Polyphenols for Prevention and Treatment of Cancer, *Nutrients*, 2016, 8, 1–35.
  - 40 C. S. Yang and H. Wang, Cancer Preventive Activities of Tea Catechins, *Molecules*, 2016, 21, 1–19.
  - 41 A. M. Bode and Z. Dong, Epigallocatechin 3-Gallate and Green Tea Catechins: United They Work, Divided They Fail, *Cancer Prev. Res.*, 2009, 2, 514–517.
  - 42 S. Senese, Y. C. Lo, D. Huang, T. A. Zangle, A. A. Gholkar, L. Robert, B. Homet, A. Ribas, M. K. Summers, M. A. Teitell, R. Damoiseaux and J. Z. Torres, Chemical Dissection of the Cell Cycle: Probes for Cell Biology and Anti-Cancer Drug Development, *Cell Death Dis.*, 2014, 5, e1462.
  - 43 H.-M. Shan, Y. Shi and J. Quan, Identification of Green Tea Catechins as Potent Inhibitors of the Polo-Box Domain of Polo-like Kinase 1, *ChemMedChem*, 2015, 10, 158–163.
  - 44 K. Takanashi, M. Suda, K. Matsumoto, C. Ishihara, K. Toda, K. Kawaguchi, S. Senga, N. Kobayashi, M. Ichikawa, M. Katoh, Y. Hattori, S. Kawahara, K. Umezawa, H. Fujii and H. Makabe, Epicatechin Oligomers Longer than Trimers Have Anti-Cancer Activities, but Not the Catechin Counterparts, *Sci. Rep.*, 2017, 7, 7791.
  - 45 Y.-Y. Cui, H. Xie, K.-B. Qi, Y.-M. He and J.-F. Wang, Effects of *Pinus massoniana* bark extract on cell proliferation and apoptosis of human hepatoma BEL-7402 cells, *World J. Gastroenterol.*, 2005, 11, 5277–5282.
  - 46 J.-H. Zhang, D.-R. Feng, H.-L. Ma, B. Liu, H.-B. Wang, H. Xie, R.-D. Li and J.-F. Wang, Antitumor Effects of *Pinus massoniana* Bark Extract in Murine Sarcoma S180 Both *in Vitro* and *in Vivo*, *Am. J. Chin. Med.*, 2012, 40, 861–875.
  - 47 H. Ma, B. Liu, D. Feng, H. Xie, R. Li, Y. Yuchi, H. Wang and J. Wang, *Pinus massoniana* bark extract selectively induces apoptosis in human hepatoma cells, possibly through caspase-dependent pathways, *Int. J. Mol. Med.*, 2010, 25, 751–759.
  - 48 D.-C. Wu, S. Li, D.-Q. Yang and Y.-Y. Cui, Effects of *Pinus massoniana* bark extract on the adhesion and migration capabilities of HeLa cells, *Fitoterapia*, 2011, 82, 1202–1205.
  - 49 J. Liu, J. Bai, G. Jiang, X. Li, J. Wang, D. Wu, L. Owusu, E. Zhang and W. Li, Anti-Tumor Effect of *Pinus massoniana* Bark Proanthocyanidins on Ovarian Cancer through Induction of Cell Apoptosis and Inhibition of Cell Migration, *PLoS One*, 2015, 10, e0142157.
  - 50 P. Mao, E. Zhang, Y. Chen, L. Liu, D. Rong, Q. Liu and W. Li, *Pinus massoniana* bark extract inhibits migration of the lung cancer A549 cell line, *Oncol. Lett.*, 2017, 13, 1019–1023.
  - 51 Y. C. O'Callaghan, E. Drummond, D. M. O'Gorman and N. M. O'Brien, Antioxidant and pro-apoptotic effects of marine-derived, multi-mineral aquamin supplemented with a pine bark extract, Enzogenol, and a green tea extract, Sunphenon, *J. Med. Food*, 2013, 16, 920–926.
  - 52 B. Halder, U. Bhattacharya, S. Mukhopadhyay and A. K. Giri, Molecular Mechanism of Black Tea Polyphenols Induced Apoptosis in Human Skin Cancer Cells: Involvement of Bax Translocation and Mitochondria Mediated Death Cascade, *Carcinogenesis*, 2008, 29, 129–138.
  - 53 Y.-H. Chen, C.-W. Yeh, H.-C. Lo, S.-L. Su, Y.-C. Hseu and L.-S. Hsu, Generation of Reactive Oxygen Species Mediates Butein-Induced Apoptosis in Neuroblastoma Cells, *Oncol. Rep.*, 2012, 27, 1233–1237.
  - 54 J. Wang, Y. Xie, Y. Feng, L. Zhang, X. Huang, X. Shen and X. Luo, (-)-Epigallocatechingallate Induces Apoptosis in B Lymphoma Cells via Caspase-Dependent Pathway and Bcl-2 Family Protein Modulation, *Int. J. Oncol.*, 2015, 46, 1507–1515.

- 55 L. Zhu, M. B. Han, Y. Gao, H. Wang, L. Dai, Y. Wen and L. X. Na, Curcumin Triggers Apoptosis via Upregulation of Bax/Bcl-2 Ratio and Caspase Activation in SW872 Human Adipocytes, *Mol. Med. Rep.*, 2015, 12, 1151–1156.
- 56 J.-L. Ríos, I. Andújar, M.-C. Recio and R.-M. Giner, Lanostanoids from Fungi: A Group of Potential Anticancer Compounds, *J. Nat. Prod.*, 2012, 75, 2016–2044.
- 57 D. Darwati, A. Tsamrotul, T. Herlina, T. Mayanti, N. Nurlelasari, K. Haikal and U. Supratman, Triterpenoids from The Bark of *Garcinia porecta* and their Cytotoxic Activity against MCF7 Breast Cancer Lines, *ALCHEMY J. Penelit. Kim.*, 2019, 15, 1–9.
- 58 A. J. León-González, M. J. Jara-Palacios, M. Abbas, F. J. Heredia and V. B. Schini-Kerth, Role of Epigenetic Regulation on the Induction of Apoptosis in Jurkat Leukemia Cells by White Grape Pomace Rich in Phenolic Compounds, *Food Funct.*, 2017, 8, 4062–4069.
- 59 L. Qi, X.-C. Wu and D.-Q. Zheng, Hydrogen peroxide, a potent inducer of global genomic instability, *Curr. Genet.*, 2019, 65, 913–917.
- 60 J. N. Cogley, N. V. Margaritelis, J. P. Morton, G. L. Close, M. G. Nikolaidis and J. K. Malone, The basic chemistry of exercise-induced DNA oxidation: oxidative damage, redox signaling, and their interplay, *Front. Physiol.*, 2015, 6, 182–182.
- 61 A. J. León-González, C. Auger and V. B. Schini-Kerth, Pro-Oxidant Activity of Polyphenols and Its Implication on Cancer Chemoprevention and Chemotherapy, *Biochem. Pharmacol.*, 2015, 98, 371–380.
- 62 S. Eghbaliferiz and M. Iranshahi, Prooxidant Activity of Polyphenols, Flavonoids, Anthocyanins and Carotenoids: Updated Review of Mechanisms and Catalyzing Metals, *Phytother. Res.*, 2016, 30, 1379–1391.
- 63 G. V. Raghuram, N. Pathak, D. Jain, H. Panwar, H. Pandey, S. K. Jain and P. K. Mishra, Molecular Mechanisms of Isocyanate Induced Oncogenic Transformation in Ovarian Epithelial Cells, *Reprod. Toxicol.*, 2010, 30, 377–386.
- 64 X. Sun, X. Liu and S. Chen, The Pharmacokinetics, Tissue Distribution, Metabolism, and Excretion of Pinostrobin in Rats: Ultra-High-Performance Liquid Chromatography Coupled With Linear Trap Quadrupole Orbitrap Mass Spectrometry Studies, *Front. Pharmacol.*, 2020, 11, 574638–574638.
- 65 M. Singh, H. Sharma and N. Singh, Hydrogen Peroxide Induces Apoptosis in HeLa Cells through Mitochondrial Pathway, *Mitochondrion*, 2007, 7, 367–373.
- 66 A. Abusnina, T. Keravis, I. Yougbaré, C. Bronner and C. Lugnier, Anti-Proliferative Effect of Curcumin on Melanoma Cells Is Mediated by PDE1A Inhibition That Regulates the Epigenetic Integrator UHRF1, *Mol. Nutr. Food Res.*, 2011, 55, 1677–1689.
- 67 T. Sharif, M. Alhosin, C. Auger, C. Minker, J.-H. Kim, N. Etienne-Selloum, P. Bories, H. Gronemeyer, A. Lobstein, C. Bronner, G. Fuhrmann and V. B. Schini-Kerth, Aronia Melanocarpa Juice Induces a Redox-Sensitive P73-Related Caspase 3-Dependent Apoptosis in Human Leukemia Cells, *PLoS One*, 2012, 7, e32526.
- 68 A. Ibrahim, M. Alhosin, C. Papin, K. Ouararhni, Z. Omran, M. A. Zamzami, A. L. Al-Malki, H. Choudhry, Y. Mély, A. Hamiche, M. Mousli and C. Bronner, Thymoquinone Challenges UHRF1 to Commit Auto-Ubiquitination: A Key Event for Apoptosis Induction in Cancer Cells, *Oncotarget*, 2018, 9, 28599–28616.
- 69 W. Ashraf, A. Ibrahim, M. Alhosin, L. Zaayter, K. Ouararhni, C. Papin, T. Ahmad, A. Hamiche, Y. Mély, C. Bronner and M. Mousli, The Epigenetic Integrator UHRF1: On the Road to Become a Universal Biomarker for Cancer, *Oncotarget*, 2017, 8, 51946–51962.
- 70 A. L. Tien, S. Senbanerjee, A. Kulkarni, R. Mudbhary, B. Goudreau, S. Ganesan, K. C. Sadler and C. Ukomadu, UHRF1 Depletion Causes a G2/M Arrest, Activation of DNA Damage Response and Apoptosis, *Biochem. J.*, 2011, 435, 175–185.
- 71 M. Unoki, Current and Potential Anticancer Drugs Targeting Members of the UHRF1 Complex Including Epigenetic Modifiers, *Recent Pat. Anticancer Drug Discovery*, 2011, 6, 116–130.
- 72 B. Stefanska, H. Karlic, F. Varga, K. Fabianowska-Majewska and A. Haslberger, Epigenetic Mechanisms in Anti-Cancer Actions of Bioactive Food Components—the Implications in Cancer Prevention, *Br. J. Pharmacol.*, 2012, 167, 279–297.

# Supplementary Data

**Maritime pine tannin extract from bark exhibits anticancer properties by targeting the epigenetic UHRF1/DNMT1 tandem leading to re-expression of *TP73*.**

**Waseem Ashraf<sup>1,#</sup>, Tanveer Ahmad<sup>1,#</sup>, Naif A. R. Almalki<sup>2</sup>, Mounira Krifa<sup>1,3</sup>, Liliyana Zaayer<sup>1</sup>, Antonio Pizzi<sup>4</sup>, Christian D. Muller<sup>5</sup>, Ali Hamiche<sup>2</sup>, Yves Mély<sup>1</sup>, Christian Bronner<sup>2,§</sup>, Marc Mousli<sup>1,§,\*</sup>**

<sup>1</sup>Laboratory of Bioimaging and Pathologies, UMR 7021 CNRS, Université de Strasbourg, Faculté de Pharmacie, Illkirch France

<sup>2</sup>Department of functional Genomics, Institut de Génétique et de Biologie Moléculaire et Cellulaire (IGBMC), INSERM U1258, CNRS UMR 7104, Université de Strasbourg, Illkirch-France

<sup>3</sup>Division of Pharmacognosy and Molecular Biology, Faculty of Pharmacy at Monastir, Monastir, Tunisia

<sup>4</sup>ENSTIB/LERMAB, Epinal, France

<sup>5</sup>Institut Pluridisciplinaire Hubert Curien, UMR 7178 CNRS Université de Strasbourg, Illkirch, France

# Equal first authors

§ **these authors are equal senior authors**

\*Correspondence: [marc.mousli@unistra.fr](mailto:marc.mousli@unistra.fr)

ORCID: 0000-0001-9759-6864

Laboratory of Bioimaging and Pathologies UMR 7021 CNRS,  
Faculté de Pharmacie, 74, Route du Rhin, 67401 Illkirch  
Cedex, France

## SUPPLEMENTARY INFORMATION

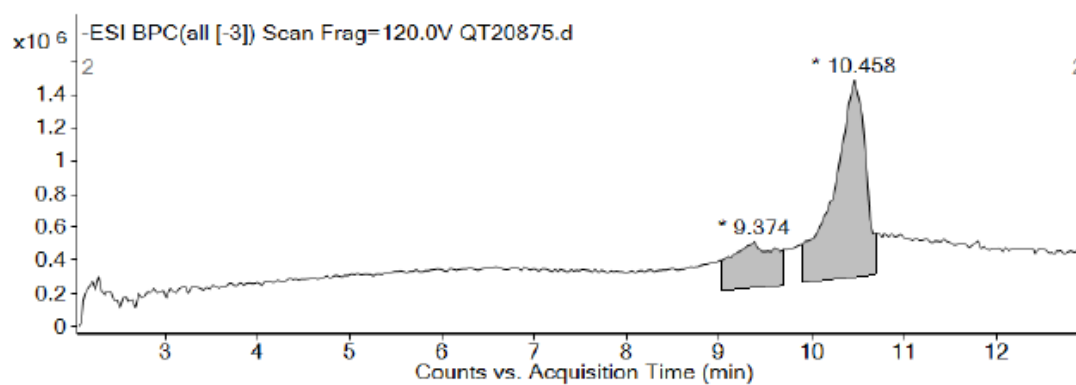
### Supplementary Table 1

Supplementary Table 1. Compound detected in MPTE extract by HPLC/MS analysis.

Peak	Start	RT	End	Mol. Mass	Tentative Identification	B.Peak m/z
1	9.891	10.458	10.692	458.3782	Lanost-9(11)-ene-3,24,25-triol	457.37

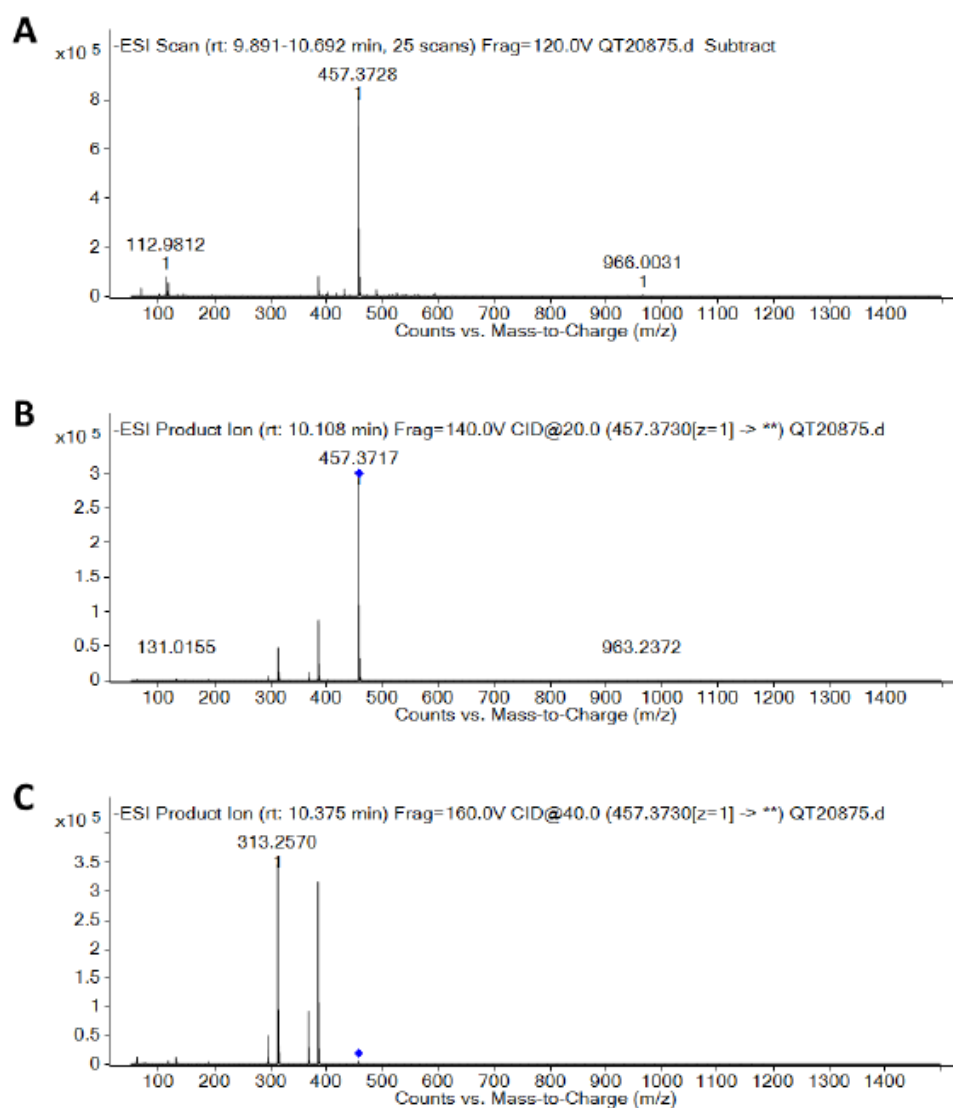
B.peak; base peak; Mol. Mass: molecular mass; RT: retention time

### Supplementary Figure 1



**Supplementary Figure 1.** HPLC/MS Base peak chromatogram of Maritime Pine Tannin Extract (MPTE) in negative mode of ionization.

## Supplementary Figure 2



**Supplementary Figure 2.** Mass spectra of Maritime Pine Tannin Extract (MPTE). A. Mass spectrum of peak with retention time 9.891 to 10.692. B. Mass spectrum of peak 457.37 at fragmentation voltage 140 Volts. C. Mass spectrum of peak 457.37 at fragmentation voltage 160 Volts.

### **3.2 Manuscript (I)**

#### **Role and regulation of UHRF1 auto-ubiquitination induced by Thymoquinone**

## Manuscript (I) Summary

As an E3-ligase, UHRF1 mediates the attachment of several ubiquitin molecules to target proteins, which is known as poly-ubiquitination. This process controls protein degradation as well as cell cycle progression, DNA repair and transcription. The term "mono-ubiquitination" refers to the use of E3 ligases to bind a single ubiquitin molecule. UHRF1 can catalyze both, *i.e.*, poly-ubiquitination and mono-ubiquitination. The E3 activity of a mouse UHRF1 (Np95) ubiquitin ligase was shown to be selective for histone H3 via the RING domain. It was also shown that UHRF1 ubiquitinates H3K23, which serves as a signal for the recruitment of DNMT1 to the replication fork, so tying DNA methylation maintenance to replication. However, poly-ubiquitination that results from auto-ubiquitination appears to have a different function in the proteosomal degradation process. We have found that UHRF1 is poly-ubiquitinated in a way dependent on the enzymatic activity of its RING domain in the presence of thymoquinone (TQ). Although this poly-ubiquitination was obliterated, it did not prevent UHRF1 degradation, suggesting a separate role for UHRF1 poly-ubiquitination from simple degradation. UHRF1 has been found to catalyze the K63-linked poly-ubiquitination of RIF1 (Replication Timing Regulatory Factor 1), which decreases the interaction between RIF1 and 53BP1 and promotes RIF1 detachment from double strand breaks. As a result, RIF1's blockage of BRCA1 foci is lifted, allowing HR to take place in the S phase. UHRF1 appears to be a crucial BRCA1 effector that promotes HR, according to these findings.

The 26S proteasome degrades proteins modified by K48-linked polyubiquitin chains, whereas K63-linked polyubiquitin chains have a role in endocytosis, DNA repair, and protein kinase activation instead. A primary goal of this work is to determine if UHRF1 auto-ubiquitination catalyzes the formation of auto K63-linked polyubiquitin chains or K8-linked polyubiquitin chains. We also wanted to figure out how UHRF1's auto-ubiquitination is regulated in order to uncover new information about the role of this process.

Thymoquinone (TQ) has been shown to polyubiquitinate UHRF1 by auto-ubiquitination exclusively in cancer cells. Recently, we have discovered that the Tat-60-interacting protein, 60 kDa (Tip60), controls UHRF1 auto-ubiquitination via disrupting the UHRF1-HAUSP (herpesvirus-specific protease) complex. UHRF1 auto-ubiquitination may play a role other than the traditional proteosomal-dependent degradation pathway, according to a variety of evidence we have collected. We found that the UHRF1-RING mutation reduced poly-ubiquitination of UHRF1 but did not affect its degradation.

The goal of this research was to figure out what role UHRF1's poly-ubiquitination plays. Unlike other natural products, TQ induces UHRF1 auto-ubiquitination, which is mediated by reactive oxygen species, as we discovered. It is possible to demonstrate that Tip60 is a mediator of TQ-induced auto-ubiquitination. It is well known that the glucocorticoid receptor (GR) is a nuclear receptor cofactor, thus we wanted to see if it may influence the ubiquitination of UHRF1. The auto-ubiquitination of UHRF1 was unaffected by GR activation with dexamethasone. The down-regulation of GR by TQ and its poly-ubiquitination by UHRF1, on the other hand, was observed to be controlled by UHRF1. Poly-ubiquitination of UHRF1 did not increase *p16<sup>INK4A</sup>* expression. Despite the fact that UHRF1 was not poly ubiquitinated, it was entirely eliminated. This shows that re-expression of tumor suppressor genes requires the entire removal of UHRF1, including the poly-ubiquitinated form. FLAG-HA-tagged UHRF1 was subjected to mass spectroscopy analysis, which demonstrated that TQ treatment altered the identity of UHRF1 partners in a significant way, and that auto-ubiquitination of UHRF1 may be responsible for these alterations. DNA repair genes like Ku70 and ku80 make up a significant portion of these partners, suggesting that poly-ubiquitination of UHRF1 may be involved in the process of DNA repair.

Here, we concluded that Poly-ubiquitination of UHRF1 is implicated in DNA repair processes by recruiting the machinery involved in DNA repair. UHRF1 has a molecular weight (MW) that we estimate to be far above 300kDa thanks to poly-ubiquitination. At least 25 ubiquitin molecules have been linked to UHRF1 at this point. There are at least four ubiquitin molecules connected together by isopeptide bonds between the C terminus of one ubiquitin and lysine 48 (K48) of the next in the standard targeting signal for protein degradation. This study suggests that UHRF1's high level of ubiquitination has a function in DNA repair beyond simple degradation. It's not for *p16<sup>INK4A</sup>* expression to be boosted when UHRF1 is poly-ubiquitinated. Indeed, a cell's initial response to a DNA attack is to try to repair it. In order to do this, UHRF1 will be poly-ubiquitinated, which will activate the DNA repair machinery without affecting the expression of tumor suppressor genes or activating the apoptosis pathway. It is possible to see a rise in UHRF1 expression in the first few minutes of TQ administration in agreement with this notion. It's also possible that the caspase pathway might play a role in the destruction of poly-ubiquitinated UHRF1 when a cancer cell decides that the DNA damage is too great to repair, such under the action of TQ after a few hours. Finally, it's worth noting that as more UHRF1 a cancer cell has, as more likely it is to repair DNA damage, and therefore to maintain silenced tumor suppressor genes, and therefore become resistant to anti-cancer therapy.

## Role and regulation of UHRF1 auto-ubiquitination induced by Thymoquinone.

Naif A. R. Almalki<sup>1,2</sup>, Abdulkhaleg Ibrahim<sup>1</sup>, Mahmoud Alhosin<sup>2</sup>, Jamal S. M. Sabir<sup>3</sup>, Yves Mély<sup>4</sup>, Ali Hamiche<sup>1</sup>, Marc Mousli<sup>4,§</sup>, Christian Bronner<sup>1,§,\*</sup>

Received 00th January 20xx,  
Accepted 00th January 20xx

DOI: 10.1039/x0xx00000x

DNA methylation is one of the most important epigenetic marks involved in many physiologic cellular processes and pathologies as well. The transmission of DNA methylation patterns from a mother to the daughter cells is ensured during mitosis through the action of the Ubiquitin-like, containing PHD and RING domains, 1/DNA methyltransferase 1 (UHRF1/DNMT1) tandem. UHRF1 is involved in the silencing of a huge number of tumor suppressor genes via mechanisms that remains largely to be deciphered. In the present study, we were interested in the role and regulation of UHRF1 poly-ubiquitination induced by thymoquinone a natural anti-cancer drug, known to enhance or re-activate the expression of tumor suppressor genes. We found that the auto-ubiquitination of UHRF1, induced by TQ, is induced by reactive oxygen species, and acts as a result of DNA damage. We could demonstrate that the poly-ubiquitinated form of UHRF1 is still able to silence the tumor suppressor gene *p16<sup>INK4A</sup>*. This suggests that it is the complete disappearance of UHRF1 including the poly-ubiquitinated version that is required for re-expression of tumor suppressor genes. We could show that UHRF1 poly-ubiquitination is not involved in its degradation. We could further show that TQ induced auto-ubiquitination is mediated via the activity of Tip60. As this latter is known as a nuclear receptor co-factor, we investigated if the glucocorticoid receptor (GR) might be involved in the regulation of UHRF1 ubiquitination. Activation of the GR, with dexamethasone, did not influence auto-ubiquitination of UHRF1. In contrast, we could observe that UHRF1 controls expression of GR and that TQ induced the down-regulation of this latter as well as its poly-ubiquitination. Mass-spectroscopy analysis of FLAG-HA-tagged UHRF1 identified UHRF1 partners involved in DNA repair and that TQ increased their association with UHRF1, suggesting that poly-ubiquitination of UHRF1 is involved in DNA repair process.

### 1. Introduction

Cancer DNA methylation is one of the most important epigenetic marks involved in many physiologic cellular processes such as gene expression, genomic stability, parental genomic imprinting, chromatin structure, cell fate and transgenerational environmental adaptation (1-6). Maintenance of DNA methylation patterns is indispensable for cell proliferation and cell phenotype integrity. However, DNA methylation alteration is also involved in many physiopathological mechanisms occurring in several diseases, if not all. In mammalian cells, DNA methylation predominantly

occurs at cytosine C5 in the context of CpG dinucleotides. In contrast to plants, 5mC in mammals covers most of the genome with exceptions in CpG islands. The 5mC patterns are established during early embryogenesis thanks to the activities of *de novo* DNA methyltransferases DNMT3A and DNMT3B (7-10). In differentiated cells, DNA methylation is symmetric outside of repetitive elements, *i.e.*, occurs on both DNA strands; this represents the basis for mitotic duplication. About 7% of all CpGs are within CpG islands (CGIs), a majority of which are unmethylated (11). Most 5mCs are found in repetitive sequences, gene bodies, and intergenic regions (12-14). In contrast, to DNA methylation patterns of repetitive elements, the duplication of symmetric DNA methylation is now well-known. Indeed, this duplication is ensured by the Ubiquitin-like, containing PHD and RING domains, 1/DNA methyltransferase 1 (UHRF1/DNMT1) tandem (15-18). Indeed, during DNA replication an intermediary state, *i.e.*, hemi-methylated DNA, is generated and this state is recognized by the SRA domain of UHRF1 allowing this latter to recruit DNMT1 in order to methylate the newly synthesized DNA strand (15-20).

Interestingly, UHRF1, controls a high number of tumor suppressor genes, via DNA methylation regulation. Among

<sup>1</sup>Department of Functional Genomics, Institut de Génétique et de Biologie Moléculaire et Cellulaire (IGBMC), INSERM U1258, CNRS UMR 7104, Université de Strasbourg, Equipe labellisée Ligue contre le Cancer, Illkirch, France

<sup>2</sup>Department of Biochemistry, King Abdulaziz University, Jeddah, Saudi Arabia.

<sup>3</sup>Department of Biological Sciences, King Abdulaziz University, Jeddah, Saudi Arabia

<sup>4</sup>Laboratory of Bioimaging and Pathologies, UMR 7021 CNRS, Université de Strasbourg, Faculté de Pharmacie, Illkirch, France

§ these authors are equal senior authors

\*Correspondence: [bronner@iqbmc.fr](mailto:bronner@iqbmc.fr)

Institut de Génétique et de Biologie Moléculaire et Cellulaire (IGBMC), INSERM U1258, CNRS UMR 7104, Université de Strasbourg, Illkirch-France

these genes, we can find *RB1* (21), *p16<sup>INK4A</sup>* (22-26), *p73* (27), *CDH13* and *SHP1* (28), *SOCS3* and *3OST2* (29), *BRCA1* (30), *CDX2*, *CDKN2A*, *RUNX3*, *FOXO4*, *PPARG* and *PML* (31, 32), *MEG3* (33), *14-3-3 $\sigma$*  (34) and *PTEN* (35). However, the role of UHRF1 is probably not restricted to regulation of DNA methylation considering its composition in terms of structural domains (36). Beside the ubiquitin-like domain (UBL), the tandem tudor domain (TTD), the plant homeodomain (PHD) and the SRA domain, the Really Interesting New Domain (RING domain) is a structural domain of UHRF1 that deserves much attention (15,19,37-44). Indeed, it is the sole domain of UHRF1 exhibiting enzymatic activity and by this way represents an interesting target for the development of new drug bearing anti-cancer activities.

UHRF1, thus belongs to the E3 ligases family which mediate the attachment of several ubiquitin molecules, termed polyubiquitination, to target proteins, thereby regulating protein degradation, cell cycle progression, DNA repair and transcription. E3 ligases can also catalyze the attachment of a single molecule of ubiquitin molecule, termed mono-ubiquitination. UHRF1 can catalyze both, *i.e.*, poly-ubiquitination and mono-ubiquitination. Accordingly, it has been demonstrated that mouse UHRF1 (Np95), via its RING domain, has specific E3 ubiquitin ligase activity for histone H3 (43 ;44). Furthermore, it was shown that UHRF1 ubiquitinates histone H3 on lysine 23, which is a signal for the recruitment of DNMT1 to the replication fork and thus couples maintenance DNA methylation and replication (41 ;45). Poly-ubiquitination is largely considered as a signal for proteasomal degradation (46; 47) but seems to have distinct role when arising from auto-ubiquitination. In support of this, we have observed that in the presence of thymoquinone (TQ), UHRF1 is poly-ubiquitinated in a manner dependent of the enzymatic activity of its RING domain (47). However, abolishing this poly-ubiquitination did not prevent UHRF1 degradation, suggesting a distinct role of UHRF1 poly-ubiquitination from simple degradation. Interestingly, it has been shown that UHRF1, catalyzes K63-linked polyubiquitination of RIF1 (Replication Timing Regulatory Factor 1), decreasing the interaction between RIF1 and 53BP1 and promoting RIF1 dissociation from double strand breaks sites (48). Consequently, the blockade of BRCA1 foci by RIF1 is released and homologous recombination (HR) occurs in S phase. These results suggest that UHRF1 is a critical effector of BRCA1 that promotes HR.

Proteins modified by K48-linked polyubiquitin chains are degraded by the 26S proteasome (49), whereas K63-linked polyubiquitin chains have functions in endocytosis, DNA repair, and activation of protein kinases (50). So far it is not known whether auto-ubiquitination of UHRF1 catalyzes auto K63-linked polyubiquitin chains or K48-linked polyubiquitin chains, which is one of the aims of the present study. The other goal of our study was to decipher the regulation of the auto-ubiquitination of UHRF1 in order to identify new leads for the role of the role of this auto-ubiquitination.

Poly-ubiquitination of UHRF1 via auto-ubiquitination has so far only been described in cancer cells in the presence of the anti-cancer drug thymoquinone (TQ) (47-51) or when Tip60 is overexpressed (52). Indeed, we have shown that the auto-ubiquitination of UHRF1 is under the control of Tat interactive protein, 60 kDa (Tip60) through the disruption of the UHRF1-HAUSP (herpesvirus-associated ubiquitin-specific protease) complex (52). A number of arguments allowed us to suggest that the auto-ubiquitination of UHRF1 exerts a role outside of the conventional proteasomal-dependent degradation pathway (47-51). Among these arguments, we observed that UHRF1-RING mutation abolished poly-ubiquitination of UHRF1 but not its degradation (47).

The present study was, therefore, undertaken in order to decipher the role of the poly-ubiquitination of UHRF1. We found that the auto-ubiquitination of UHRF1, induced by TQ, is induced by reactive oxygen species, and acts as a result of DNA damage. We could demonstrate that the poly-ubiquitinated form of UHRF1 is still able to silence the tumor suppressor gene *p16<sup>INK4A</sup>*. This suggests that it is the complete disappearance of UHRF1 including the poly-ubiquitinated version that is required for re-expression of tumor suppressor genes. We could further show that TQ induced auto-ubiquitination is mediated via the activity of Tip60. As this latter is known as a nuclear receptor co-factor (53), we investigated if the glucocorticoid receptor (GR) might be involved in the regulation of UHRF1 ubiquitination. Activation of the GR, with dexamethasone, did not influence auto-ubiquitination of UHRF1. In contrast, we could observe that UHRF1 controls expression of GR and that TQ induced the down-regulation of this latter as well as its poly-ubiquitination. Mass-spectroscopy analysis of FLAG-HA-tagged UHRF1 identified UHRF1 partners involved in DNA repair and that TQ increased their association with UHRF1, suggesting that poly-ubiquitination of UHRF1 is involved in DNA repair process.

## 2. Materials and methods

### 2.1. Cell lines and Culture

HeLa cells (ATCC<sup>®</sup> CCL-2), Jurkat cells (ATCC<sup>®</sup> TIB-152™), HEK-293T (ATCC<sup>®</sup> CRL-3216™) and mouse embryonic fibroblasts (MEF) were obtained and cultured in DMEM (Dulbecco's Modified Eagle's Medium) and RPMI, respectively as described elsewhere (52-55). DMEM without Phenol Red was used for the FACS experiment.

### 2.2. Chemicals and Antibodies

Thymoquinone, a natural phytochemical compound extracted from black seeds of the plant *Nigella sativa*, MnTMPyP, a cell-permeable used as superoxide dismutase (SOD) mimetic and doxorubicin hydrochloride were purchased from Sigma-Aldrich<sup>®</sup>. Maritime pine (*Pinus maritimus*) bark was obtained as described elsewhere (56). Hydrogen peroxide H<sub>2</sub>O<sub>2</sub>, used as a ROS positive control, dexamethasone, a glucocorticoid

(GCC) agonist, N-Acetyl-L-cysteine (NAC) and catalase-polyethylene glycol (PEG-Catalase) were obtained from Sigma-Aldrich®. Dihydroethidium (DHE) was obtained from Invitrogen™. Ethidium Bromide 1% (EUROMEDEX, EU0070).

Mouse monoclonal anti-UHRF1 was engineered as described previously (57). Mouse monoclonal anti-p16<sup>INK4A</sup> (sc-56330, SCBT, Inc.), mouse polyclonal anti-GR (3249, IGBMC), mouse monoclonal anti-GAPDH (ab8245, abcam), mouse monoclonal anti- $\beta$  Actin (ab8226, abcam), mouse monoclonal anti-Ku70 (sc-17789, SCBT, Inc.), rabbit polyclonal anti-Ku80 (sc-9034, SCBT, Inc.), rabbit polyclonal anti-VDAC (4866S, Cell Signaling Tech.®), anti-Histone H3 (H3-3E1, IGBMC), rabbit polyclonal and anti-K48-linkage polyUb. (4289, Cell Signaling Tech.®) were used as indicated by the manufacturers.

HRP conjugated goat anti-mouse antibody IgG (Jackson ImmunoResearch, 115-035-003), HRP conjugated goat anti-rabbit antibody IgG (Jackson ImmunoResearch, 111-035-003) and HRP conjugated goat anti-rat antibody IgG (Jackson ImmunoResearch, 112-035-003) were also used according to the recommendations of the manufacturers.

### 2.3. Cellular analysis of reactive oxygen species (ROS) production test

HeLa cells were seeded and treated in 6-well plates as described in previous section. ROS production was determined by flow cytometry using dihydroethidium (DHE) staining. Cells were incubated with 10  $\mu$ M of DHE for 30 min at 37°C before harvesting and analysis on a BD FACSCelesta™ (BD biosciences). PEG-catalase (Sigma-Aldrich®) and N-acetylcysteine (NAC, Sigma-Aldrich®) were added 1h before TQ.

### 2.4 Assessment of DNA damage

TQ induced DNA damage was evaluated using natural single cell gel electrophoresis (Comet) assay. Following treatment with TQ for 24 hours, the extent of total DNA damage was evaluated as described previously (58) with some modifications. Cells were harvested and resuspended in Hank's Balanced Salt Solution (Sigma-Aldrich®, USA) with 10% DMSO and 0.5 M EDTA. After centrifugation, the cell pellets were then resuspended in 0.7% low melting agarose at 37°C (Conda, Spain), and layered on to comet slides (Trevigen, USA). The cells were then lysed in lysis solution containing 2.5 M NaCl, 100 mM pH 8.0 EDTA, 10 mM Tris-HCL, 1% N-laurylsarcosine, 0.5% Triton -X and 10% DMSO at 4°C for one hour. Denaturation was carried out for 40 minutes, in chilled electrophoresis buffer (pH 8.3). Electrophoresis was subsequently carried out for one hour (at 18 V). Slides were immersed in neutralization buffer (500 Mm Tris-HCL, pH 7.4), dehydrated, dried and stained with Ethidium bromide dye (Trevigen) and scored with Comet Analysis Software (Metasystems, Germany). The images were captured using Zeiss Axioplan 2 imaging fluorescence microscope (Carl Zeiss, Germany) equipped with triple band filter. Fifty comets per sample were randomly selected and analyzed. The extent of DNA damage was expressed as tail moment, which

corresponded to the fraction of the DNA in the tail of the comet.

### 2.5. Western blot

HeLa cells were seeded in a 6-well plate and treated with 50, 100 and 200  $\mu$ g/mL of TQ for 24 h, as described earlier. After treatment, cells were collected by trypsinization and incubated with lysis buffer 10 mM Tris-HCl pH 7.5, 150 mM NaCl, 1 mM EDTA and 1% NP40 supplemented with protease inhibitors (complete mini EDTA free protease inhibitor cocktail tablets, Roche Germany) for 30 min on ice. Forty (40)  $\mu$ g of total protein lysate from each sample was resolved on 10% SDS-PAGE and transferred onto PVDF membranes. Membranes were blocked for 1 h with 3% blotting-grade blocker (Bio-Rad) in TBST buffer before incubating them overnight with primary antibodies at 4°C. Membranes were then washed with TBST for three times and incubated with secondary antibodies for 1 h at room temperature. After washing the membranes with TBST, membranes were imaged with the chemiluminescent ECL system (Clarity™ ECL western blotting substrate, Biorad, 170-5060) on ImageQuant™ LAS 4000 system (GE Healthcare). Images were quantified using the Image Studio Lite (LiCore Biosciences, USA).

### 2.6. Cell line with FLAG-HA tagged UHRF1

The coding sequence of UHRF1 was subcloned into the XhoI-NotI sites of the pOZ-N retroviral vector to produce UHRF1 protein fused with N-terminal Flag- and HA-epitope tags (e-UHRF1). e-UHRF1 was stably expressed in HeLa cells by retroviral transduction as described elsewhere (59). UHRF1 nuclear complex was purified from these cells by double immunoaffinity as described hereafter. Cells were lysed in hypotonic buffer (10 mM Tris-HCl at pH 7.65, 1.5 mM MgCl<sub>2</sub>, 10 mM KCl) and disrupted by Dounce homogenizer. This extract was then centrifuged at 4°C to separate the cytosolic fraction from the pellet. The nuclear-soluble fraction was obtained by incubation of the pellet in high-salt buffer (to get a final NaCl concentration of 300 mM). Tagged UHRF1 was then immunoprecipitated with anti-Flag M2-agarose (Sigma-Aldrich®), eluted with Flag peptide (0.5 mg/mL), further affinity-purified with anti-HA antibody-conjugated agarose (Sigma-Aldrich®), and eluted with HA peptide (1 mg/mL). The HA and Flag peptides were first buffered with 50 mM Tris-Cl (pH 8.5), then diluted to 4 mg/mL in TGEN 150 buffer (20 mM Tris at pH 7.65, 150 mM NaCl, 3 mM MgCl<sub>2</sub>, 0.1 mM EDTA, 10% glycerol, 0.01% NP40), and stored at -20° C until use. Between each step, beads were washed in TGEN 150 buffer. Complexes were resolved by SDS-PAGE and stained using the Silver Quest kit (Invitrogen). Identification of proteins was carried out by Taplin Biological Mass Spectrometry Facility (Harvard Medical School, Boston, MA).

### 2.7. Knocking down of UHRF1 based on RNA interference (RNAi)

For knock-down (KD) UHRF1 by shRNA, Oligonucleotides sequence strands containing Side part, Sense Strand, Loop, Anti-Sense Strand and other Side part (Up: 5'-CCGG ATG TGG

GAT GAG ACG GAA TTG CTCGAG CAA TTC CGT CTC ATC CCACA TTTTGTG-3') and (Down: 5'-AATCAAAAA ATG TGG GAT GAG ACG GAA TTG CTCGAG CAA TTC CGT CTC ATC CCA CAT-3') which represents the sequence coding for shRNA of UHRF1 mRNA flanked with restriction site of AgeI and EcoRI were designed. They were integrated into an expression vector (pLKO.1) which contains selective marker Blastidicine S sequence. HEK 293T cells were grown in 6-well plates to 50% confluency. The chemical kit of Effectene Transfection Reagent 4 x 1 was utilized to initialize the cells for transfection. The two reagents mixture (A and B) were prepared as shown in the tables below. The protocol was followed according to manufacturer's recommendations. The produced Lentivirus were transferred into 25 cm<sup>3</sup> culture flask containing 30% confluency of targeted HeLa cells allowing delivery the sequence and production of small hairpin RNA (shRNA) to knock-down (KD) the targeted UHRF1 mRNA. The targeted cells were transferred into two 75 cm<sup>2</sup> culture flasks and allowed to proliferate until full confluency then they were selected by Blastidicine S antibiotic treatment.

## 2.8. Statistical Analysis

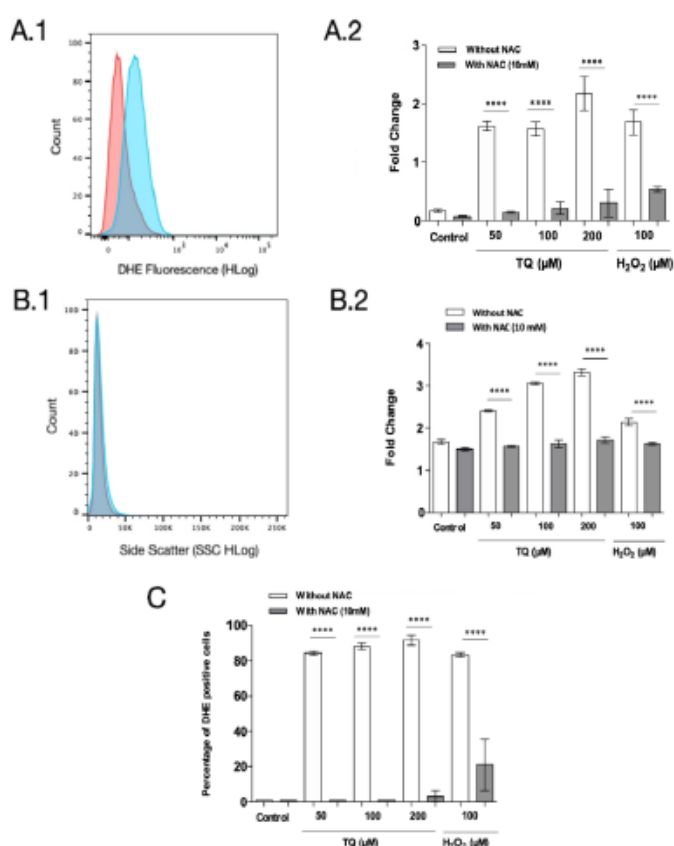
All experiments were repeated three times and results between groups were statistically compared by one-way ANOVA with post-hoc Tukey test using GraphPad-Prism (version 5.04) and Origin (version 8.6) software.

## 3. Results

### 3.1. Effect of Hydroxy peroxide, doxorubicin and thymoquinone on UHRF1 expression and ubiquitination.

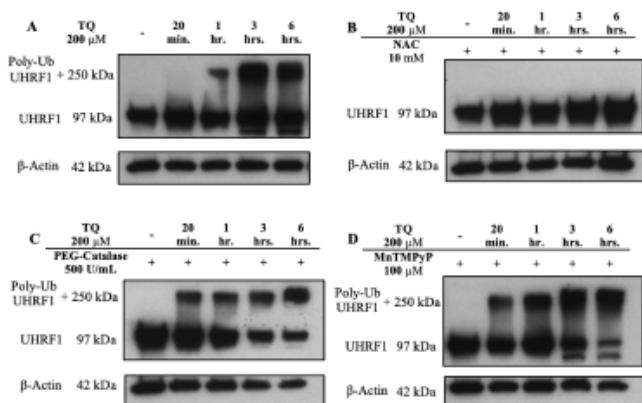
As a first step of deciphering, the role of UHRF1 ubiquitination, we aimed to investigate its regulatory pathway. Figure 1 shows the effect of TQ on the induction of reactive oxygen species (ROS). Treatment of HeLa cells with different concentrations of TQ (50, 100 and 200  $\mu$ M) induced ROS that was sensitive to 10 mM N-acetylcystein (NAC) added one hour before TQ (Fig. 1) but not to PEG-catalase (Fig. S1). These results show that TQ induces the generation of ROS different from H<sub>2</sub>O<sub>2</sub> considering that PEG-catalase, a scavenger of H<sub>2</sub>O<sub>2</sub>, was inefficient in reducing the DHE fluorescence of labelled cells. Interestingly, we observed that NAC at 10mM inhibited the time-dependent poly-ubiquitination of UHRF1 (Fig. 2.B) compared to control, *i.e.*, in the absence of NAC (Fig. 2.A). In contrast PEG-catalase was completely unable to prevent it (Fig. 2.C) as it was the case in the presence of the superoxide dismutase mimic MnTMPyP (Fig. 2.D) confirming that the generation of H<sub>2</sub>O<sub>2</sub> is not involved in the mechanism of action of TQ in contrast, for instance, to epigallo-catechin gallate (EGCG) (24). This is in accordance, with the fact that it is only TQ that is inducing the poly-ubiquitination of UHRF1 since EGCG (24), H<sub>2</sub>O<sub>2</sub> and doxorubicin were inefficient in doing this during the first six hours (Fig. S2) although these drugs induced down-regulation of UHRF1 after 24 hours (Figs. S3 and S4). The same type of

reasoning can be applied to MPTE which has the capacity of down-regulating UHRF1 without poly-ubiquitination (Fig. S5). NAC (Fig. S6).



**Fig. 1** Inhibition NAC significantly reduce ROS levels in HeLa cells treated with TQ. A.1, Cytogram showing DHE labeling in control (represented by red area under graph) and TQ treated cells at concentration of 200  $\mu$ M pretreated 1 hr. with NAC at concentration of 10 mM (represented by blue area under graph). A.2, Histogram showing fold change in DHE labeling by treatment of TQ at different concentration combined with NAC in comparison to TQ treatment as a control. B.1, Cytogram showing side scatter in control (represented by red area under graph) and TQ treated cells at concentration of 200  $\mu$ M pretreated 1 hr. with NAC at concentration of 10 mM (represented by blue area under graph). B.2, Histogram showing fold change of side scatter by treatment of TQ at different concentration combined with NAC in comparison to TQ treatment as a control. C. Histogram showing the percentage of DHE positive cells to DHE by treatment of TQ at different concentration combined with NAC in comparison to TQ treatment as a control. Values indicated are from three independent experiments and were analyzed by one-way ANOVA with post-hoc Tukey test. (\*  $P < 0.05$ , \*\*  $P < 0.01$ , \*\*\*  $P < 0.001$ ).

Thus, our results suggest that it is the breaks occurring on DNA that are responsible for the UHRF1 poly-ubiquitination. However, the DNA breaks induced by ROS following TQ treatment, are different from that induced by EGCG and MPTE, *i.e.*, different from H<sub>2</sub>O<sub>2</sub>. These DNA breaks also are different from that induced by doxorubicin.



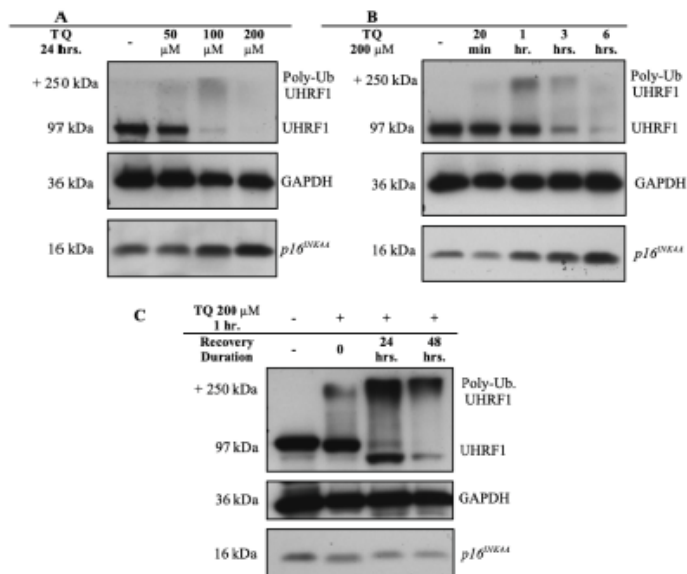
**Fig. 2** Time course effect of TQ on UHRF1 expression in the presence of ROS inhibitors. HeLa cells were pretreated with SOD mimic (MnTMPyP) at 100  $\mu$ M, NAC at 10 nM or PEG-Catalase at 500 U/ml for 1 hr. before adding TQ at 200  $\mu$ M for 20 min. up to 6 hrs. Western blot was then performed using anti-UHRF1 antibody.

Poly-ubiquitination is usually associated with proteasomal degradation (46, 47). However, recent evidence suggests that poly-ubiquitination may exert different roles. Accordingly, we have previously shown that disruption the RING domain of UHRF1, bearing the auto-ubiquitination activity, did not affect the degradation of UHRF1 but only the poly-ubiquitination of UHRF1 (47). TQ has been reported as a proteasomal inhibitor (63). Consequently, we treated HeLa cells only for one hour with TQ (then removed from the medium) and followed UHRF1 expression for further 24 hours or 48 hours, we observed that the poly-ubiquitinated form of UHRF1 was stable (Fig. 3.C), and thus suggest that poly-ubiquitination is not a signal for proteasomal degradation of UHRF1, otherwise we would not be able to detect the ubiquitinated form of UHRF1 after 48 hours. This result also suggests that the presence of TQ is required for the disappearance of the ubiquitinated form of UHRF1.

### 3.2. Effect of TQ and its removal on UHRF1 poly-ubiquitination and $p16^{INK4A}$ expression

Figure 3 shows the effect of TQ on UHRF1 expression, ubiquitination of this latter and on  $p16^{INK4A}$  expression. A pre-treatment with TQ for 24 hours led to a dose-dependent inhibition of UHRF1 expression accompanied with a concomitant increase of  $p16^{INK4A}$  expression (Fig. 3.A). A complete disappearance of UHRF1 was observed for 200  $\mu$ M of TQ. A pre-treatment of six hours. with TQ at 200  $\mu$ M was sufficient to observe a nearly maximal inhibition of UHRF1 expression in its non-ubiquitinated form and poly-ubiquitinated form as well (Fig. 3.B).

Treatment for one hour with 200  $\mu$ M of TQ, followed by removal of this latter, induced a poly-ubiquitination of UHRF1 which was still observed after 24 hours and 48 hours. Of note,  $p16^{INK4A}$  was not increased showing that poly-ubiquitinated UHRF1 can still exert its silencing role towards tumor suppressor genes such as  $p16^{INK4A}$ .



**Fig. 3** Dose effect for 24 hrs. (A) and time course effect (B) of TQ on HeLa cells. Cells were treated with TQ gradient concentrations for 24 hrs. and 200  $\mu$ M was selected for time course treatment for 20 min up to 6 hrs. and the expression of UHRF1 was investigated using a monoclonal anti-UHRF1 and  $p16^{INK4A}$ . Effect of TQ on UHRF1 expression after 1 hr. treatment and recovery duration (C). HeLa cells were treated with TQ at 200  $\mu$ M for 1 hr. and two groups were recovered for 24 hrs. and 48 hrs. Western blot was then performed using anti-UHRF1 antibody.

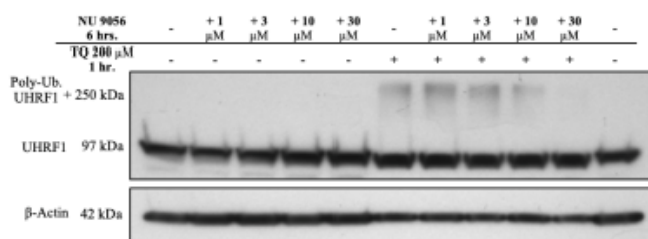
### 3.3. Effect of NU9056, an inhibitor of Tip60 enzymatic activity on UHRF1 ubiquitination

The tumor suppressor Tip60 is a histone acetyltransferase involved in transcriptional control and DNA double-strand break repair. Tip60 binds to the heterochromatic histone mark H3K9me3, an epigenetic mark read by UHRF1 (37, 64-67), triggering acetylation and activation of DNA double-strand break repair factors (68, 69). Tip60 belongs to the same macro-molecular complex than UHRF1 and is targeted by this latter as regulator of its expression (70-74). Recently, we have shown that poly-ubiquitination of UHRF1, due to auto-ubiquitination, is under the control of Tip60 through the disruption of USP7/UHRF1 complex (52). Accordingly, we hypothesized that Tip60 may be mediating the poly-ubiquitination. For this we used, NU9056 a well-known inhibitor of Tip60 enzymatic activity. Figure 4 shows a dose-dependent inhibition of TQ-induced UHRF1 ubiquitination starting at 10  $\mu$ M of NU9056 and a complete disappearing at 30  $\mu$ M. These results show that the poly-ubiquitination of UHRF1 induced by TQ is mediated via the activity of Tip60.

### 3.4. Effect of TQ and UHRF1 modulation on GR and $p16^{INK4A}$ expressions

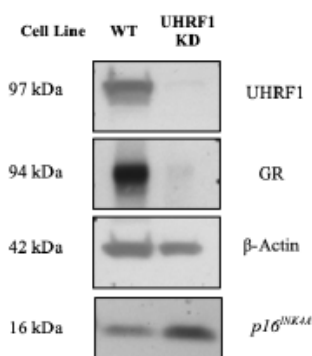
Tip60 is a co-regulator of nuclear receptor (53). We have recently reported that the glucocorticoid receptor (GR) belongs to the same-macromolecular complex than UHRF1 (75). We recently proposed that UHRF1 regulates the sensitivity to dexamethasone and thus participates in the glucocorticoid resistance (75). As a matter of fact, we hypothesized that GR may mediate a putative regulatory role on UHRF1 poly-ubiquitination. The physiological relevance is

that GR regulates apoptosis and UHRF1 is a pro-apoptotic factor (19, 15, 76). Unfortunately, the activation of the GR with dexamethasone did not allow us to show any significant variation of poly-ubiquitination of UHRF1 as well as any effect of its sub-cellular localization (Fig. S7).



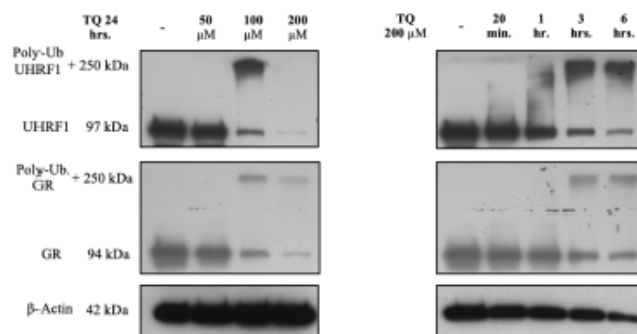
**Fig. 4** Effect of TQ on UHRF1 expression in the presence of the Tip60 inhibitor (NU 9056). HeLa cells were pretreated with Tip60 inhibitor (NU 9056) at different concentrations for 6 hrs. before adding TQ at 200  $\mu$ M for 1 hr. Western blot was then performed using anti-UHRF1 antibody.

In contrast, we found that the GR is controlled by UHRF1 since knocking-down UHRF1 leads to down-regulation of GR accompanied with an increase of *p16<sup>INK4A</sup>* expression (Fig. 5). Treatment with TQ in UHRF1 knocked-down cells did not induce any smear or bands above UHRF1 (Fig. S8) showing that the poly-ubiquitinated form is coming from expression of the *UHRF1* gene.



**Fig. 5** Effect of UHRF1 and Glucocorticoids receptor (GR) expression after knocking down of UHRF1 by shRNA. The plasmid (pLKO.1) that contain the shRNA sequence for knocking down UHRF1 and the plasmids that contains of Phage-like Lentivirus particles were transferred to HEK 293T. Western blot was then performed using anti-UHRF1, anti- $\beta$  actin, anti-GR and anti-p16<sup>INK4A</sup> antibodies.

Figure 6 shows that TQ induced a down-regulation of GR is accompanied by a poly-ubiquitination, which was found to be dose-dependent and time-dependent. Interestingly, ubiquitination of UHRF1 largely precedes that of GR since that of UHRF1 can already be seen after 20min while that of GR significantly appears only after three hours. Considering that the GR belongs to the same macro-molecular complex we do not exclude that the poly-ubiquitination of GR might be under the control of UHRF1. We found that the poly-ubiquitination of GR is due to K48-linked chain (Fig. S9). Interestingly, we found that UHRF1 poly-ubiquitination is not related to K48-linked polyubiquitin chains (Fig. S9) further supporting that poly-ubiquitination of UHRF1 is not involved in proteasomal degradation, but rather in other cellular processes, DNA repair, cell cycle and gene expression regulation.



**Fig. 6** Dose-effect curve and time course effect of TQ on UHRF1 and Glucocorticoid receptor (GR) expressions. HeLa cells were treated with gradient concentration of TQ then the concentration of 200  $\mu$ M was chosen for time course treatment from 20 min. up to 6 hrs. Western blot was then performed using anti-UHRF1 and anti-GR antibodies.

### 3.5. Analysis of UHRF1 complex content in terms of DNA repair machinery

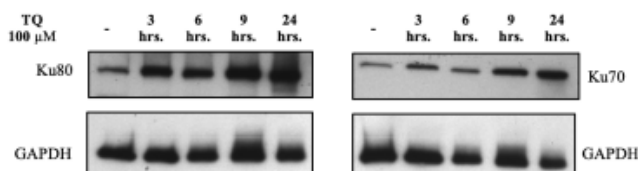
To disentangle the mechanism underlying the role of UHRF1 poly-ubiquitination, we aimed to purify the UHRF1 complex in HeLa cells treated or not with TQ. Table 1 shows that some interesting partners were identified among which some are involved in DNA repair. Indeed, TQ treatment induced increased association of PRKDC (DNA-PK) and of Ku70 and Ku80 as well. This increase is highly significant even when normalized with UHRF1 peptides. At least a 3-fold increase of these partners was observed, suggesting that TQ by inducing ROS challenge UHRF1 to recruit the DNA repair machinery. This is consistent with a recent study in which it was shown that stimulated microgravity induced ROS, DNA damage and activation of Ku70/80 and DNA-PK-mediated apoptotic cell death (77).

**Table 1: Mass spectrometry data of some proteins found in the soluble nuclear extract of epitope tagged UHRF1 in the absence or presence of 100  $\mu$ M of TQ.**

Entry	Protein	Peptide		%*
		Control	TQ-treated	
P78527_PRKDC_HUMAN	PRKDC (DNA-PK)	130	801	353
Q96T88_UHRF1_HUMAN	UHRF1 (ICBP90)	670	1170	100
P13010_XRCC5_HUMAN	XRCC5 (Ku80)	43	321	428
P12956_XRCC6_HUMAN	XRCC6 (Ku70)	51	257	288
P18858_DNL1_HUMAN	LIG1 (Ligase 1)	31	65	120

\* Percentage was calculated by normalizing vs UHRF1 change

Figure 7 shows the effect of TQ on the expression of Ku70 and Ku80. TQ induces a time-dependent and significant increase in the levels of both proteins already after three hours of treatment with 100  $\mu$ M of TQ. This suggests that the DNA damage induced by TQ result in an enhanced level of Ku70 and Ku80. This also suggests that the increase of the association of these two proteins to the UHRF1 complex is a result on an increased expression. It remains to determine whether Ku70 and/or Ku80 are under the control of UHRF1 in terms of expression regulation.



**Fig. 7** Time course effect of Thymoquinone (TQ) on HeLa cell lines. HeLa cells were treated with TQ 100  $\mu$ M for 3 hrs. up to 24 hrs. and the expression of Ku80 and Ku70 was investigated using a Polyclonal anti-Ku80 and monoclonal anti-Ku70 respectively.

#### 4. Discussion

UHRF1 is considered as an actor that promotes cancer progression and participates in the maintenance of immortality through the silencing of tumor gene suppressor silencing (15, 19, 37). Indeed, any biological event that induces a decrease in UHRF1 expression leads irreversibly to a re-expression of tumor suppressor genes. This is particularly true for the tumor suppressor genes *TP73* and *p16<sup>INK4A</sup>* in the presence of various natural compounds exhibiting anti-cancer activities (22, 25). Among these compounds, thymoquinone holds a special place in that it is the only one, so far, that is known to induce an auto-ubiquitination of UHRF1 before being degraded (48 and present study). Indeed,  $H_2O_2$ , MPTE and doxorubicin induced down-regulation of UHRF1 without poly-ubiquitination (present study). Furthermore, it seems that not all molecules of UHRF1 undergo auto-ubiquitination suggesting that only a small part of UHRF1 proteins is concerned and tagged with a specific role, *e.g.*, targeting and/or removing UHRF1 at specific loci. This also supports that poly-ubiquitination is not a prerequisite for UHRF1 degradation. This is consistent with our previous study, in which we demonstrated that TQ-induced UHRF1 down-regulation is mediated by the action of caspases. Therefore, why under the action of TQ the cells need a poly-ubiquitinated UHRF1? We hypothesized that considering this poly-ubiquitination is not involved in a degradation pathway, it might be involved in DNA repair process and or apoptosis activation pathway. Accordingly, UHRF1 has now been well-known as an anti-apoptotic actor (19, 20, 75, 76).

As a first approach, we looked at whether TQ is capable of generating ROS and causing DNA damage and tried to find a possible link with UHRF1 ubiquitination. We showed by comet assays that TQ induced DNA double strand breaks and the formation of ROS that are sensitive to the antioxidant NAC but not to PEG-catalase. Of note, only NAC prevented the auto-ubiquitination of UHRF1. Therefore, we suggest that the auto-ubiquitination of UHRF1 and the DNA damage, induced by TQ, is resulting from ROS that are different from  $H_2O_2$  and  $O_2^{\cdot-}$ , as well, considering that the superoxide dismutase mimic MnTMPyP was inefficient in preventing the UHRF1 poly-ubiquitination. Furthermore, we suggest that the DNA damage induced by TQ, via ROS, are different from that induced by doxorubicin and  $H_2O_2$ . The identification of the

type of ROS generated under the action of TQ will direct us to the type of DNA damage in question.

UHRF1 is well-known for its ability to silence or to down-regulate a huge number of tumor suppressor genes [for a review see (78) and the introduction section], we could identify an interesting experimental condition (one hour treatment with TQ followed by removal) in which non-ubiquitinated UHRF1 completely disappeared and only poly-ubiquitinated UHRF1 remained. Of note, in these conditions *p73* was still silenced and *p16<sup>INK4A</sup>* did not increase. These results show that UHRF1 still repressed tumor suppressor genes in spite of being poly-ubiquitinated. As a consequence, we suggest that poly-ubiquitination of UHRF1 does not alter the role of UHRF1, in terms of gene silencing in cancer cells, but possibly confers supplementary function to UHRF1. We confirmed this direction by showing that the poly-ubiquitination of UHRF1 is involving K63-linked chains, suggesting that UHRF1 auto-ubiquitination plays a role outside of the proteasomal degradation pathway, *e.g.*, cellular processes such as DNA repair, transcriptional gene regulation and so on. A role for auto-ubiquitination, outside of proteasomal degradation has been reported for several proteins such as for TRIM5 $\alpha$  is required for AP-1 activation (79) and TRAF6 (80).

Tip60 is one of the main partner of UHRF1 and is involved in the regulation of UHRF1 ubiquitination (52; 70; 71; 72; 73; 81) and is involved in DNA repair process (68). In the present study, we showed that the poly-ubiquitination of UHRF1 is dependent upon the activity of Tip60. Tip60 is negatively regulated by UHRF1 but here we show that one of its partners, *i.e.*, GR, is positively controlled. Mutation of Tip60 K430R increases DNA-PKcs phosphorylation and promotes NHEJ in S phase while blocking HR (82). Tip60 is involved in HR recombination. UHRF1 mediates K63-linked polyubiquitination of RIF1, and results in its dissociation from 53BP1 and DSBs thereby facilitating HR initiation (48). It was demonstrated that the interaction of Tip60 with DNA-PKcs is attenuated specifically in S phase, which facilitates HR pathway activation (82). In the present study, we identified DNA-PKs as a partner of UHRF1 complex.

Tip60 is a co-factor of nuclear receptors. We could observe that TQ also induced GR poly-ubiquitination but so far, we do not know whether it is involved in its degradation. An interesting direction would be to study the role of GR in the apoptotic effects of TQ and to see whether the down-regulation of GR is required for TQ to exert its effect. The results tend to be in favor of degradation considering that ubiquitination of GR is delayed vs that of UHRF1. Considering that GR favors apoptosis (83) in contrast to UHRF1, our results suggest that decreasing UHRF1 expression might render cancer cells insensitive to corticoid treatment under anticancer drugs such as TQ. Whatever the case maybe it appears that the activation of GR does not play a role in the regulation of UHRF1 poly-ubiquitination.

In the meantime, we are still digging into the DNA repair pathway given that we found Ku70, Ku80 and DNA-dependent protein kinase (DNA-PK) players in DNA repair, in the UHRF1 complex. Notably, we could show that TQ treatment increased the association of Ku70 and Ku80 to the UHRF1 complex (Table 1). DNA-PK is a serine/threonine-protein kinase that acts as a molecular sensor for DNA damage and is involved in DNA non-homologous end joining (NHEJ) required for double-strand break (DSB) repair and V(D)J recombination (84; 85; 86). DNA-PK is thought to act as the "sensor" for DNA double-stranded breaks (DSB), which are considered as the most deleterious type of DNA damage. We suggest that the poly-ubiquitination of UHRF1 induced by TQ plays a role in the recruitment of the DNA repair machinery such as Ku70 and Ku80. The recruitment of Ku70 and Ku80 is favored by an increase of the expression of these proteins. It still remains to show that the increase in Ku70 and Ku80 levels are mediated by UHRF1. It was suggested that auto-ubiquitination of UHRF1 might serve as a docking site for DNMT1 (87). DNMT1 has been shown to accumulate at DNA damage sites (88). We, thus, propose that the auto-ubiquitination of UHRF1 helps DNMT1 to be recruited at DNA damage site.

It was recently shown that ROS is an activator of the TRAF6 (TNF Receptor Associated Factor 6) auto-ubiquitination, resulting in AKT activation *in vitro* (80). Reducing the production of ROS suppressed TRAF6 auto-ubiquitination and regulated NF $\kappa$ B activation (80). It has been shown that PI3K/Akt signaling pathway is activated upon UHRF1 silencing (89) albeit the contrary was reported (90). *In vitro* and *in vivo* studies demonstrated that Tip60 suppressed growth and metastasis throughout the progression of CCA. The PI3K/AKT pathway was identified as a dominant signal of Tip60 and suggested that Tip60 regulated cancer cell proliferation and metastasis via PT3K-AKT pathway (91). Therefore, we suggest that TQ auto-ubiquitination of UHRF1 favors AKT signaling pathways and subsequent apoptosis.

## 5. Conclusions

In conclusion, we propose that poly-ubiquitination of UHRF1 is involved in DNA repair processes by recruiting DNA repair machinery. Our results, especially those related to the identification of the UHRF1 partners (Ku70/Ku80, DNA-PK), suggest that the poly-ubiquitination of UHRF1 induced by TQ, would rather be involved in NHEJ but those obtained with Tip60 would rather suggest to involve HR. We do not exclude that both pathways are involved as it has been reported for ROS generation in human promyelocytic leukemia cells (77). This makes sense considering that the poly-ubiquitination of UHRF1 is conferring to some versions of this latter a MW that we estimate highly above 300kDa. This means that at least 25 molecules of ubiquitin have been attached to UHRF1. The canonical targeting signal for protein degradation is a chain of at least four ubiquitin molecules linked to each other through isopeptide bonds between the C terminus of one ubiquitin

and lysine 48 (K48) of the next (92; 93). Therefore, high ubiquitination of UHRF1 is proposed here to play a role outside from simple degradation, hence a role in DNA repair. However, the poly-ubiquitination of UHRF1 is not sufficient to induce enhancement of *p16<sup>INK4A</sup>* expression. Indeed, the first defensive intention of a cell facing a DNA aggression, is to want to repair it. To do so, it will undergo a poly-ubiquitination of UHRF1 which will recruit the DNA repair machinery, without enhancing tumor suppressor gene expression and apoptotic pathway activation. In accordance with, we could often observe in the first minutes of TQ treatment a slight increase in UHRF1 expression which would support this hypothesis. However, when a cancer cell realizes that the DNA damage is too huge to be repaired like under the action of TQ, it destroys the poly-ubiquitinated UHRF1 by a pathway that remains to be discovered but which could involve the caspase pathway. Finally, it is noteworthy to suggest that as more a cancer cell contain UHRF1 as more it is prone to repair DNA damage, to silence tumor suppressor genes as well, and thus prone to be resistant to anti-cancer therapy. We propose also that the levels of UHRF1 expression might determine the sensitivity of a cancer type to corticoid treatment.

## Acknowledgments

N.A.R.A acknowledges the Saudi Arabian government represented in King Abdulaziz University (KAU) for the financial support.

## Keywords

Epigenetics, UHRF1, Tip60, GR, Dexamethasone, Thymoquinone, ROS, Polyubiquitination, DNA repair, Proteasomal degradation.

## Author Contributions

C.B. and M.M. conceived the project. N.A.R.A. and A.I. conducted all the experiments with the help of M.A., J.M.S.S. and A.H. under the supervision of A.H., M.M. and C.B.. CB and N.A.R.A wrote most of the manuscript with the help of A.H. and Y.M.

## Conflicts of interest

Authors declare no conflict of interest.

## Funding

This work was supported by grants from CNRS, INSERM, ANR "RAHMAN" number ANR-21-CE12-0017-01 (A.H), ANR "SIMOS" number ANR-21-CE11-0024-02 (A.H.), "SMFLUONA" number ANR-17-CE11-0036-01 (Y.M.) and La Ligue Nationale contre le Cancer, Equipe labellisée (A.H.). N.A.R.A acknowledges the Saudi Arabian government represented in King Abdulaziz University (KAU) for the financial support.

## References

1. Bogdanović O and Lister R: DNA methylation and the preservation of cell identity. *Curr Opin Genet Dev* 46: 9–14, 2017.

- 1 2. Kulis M and Esteller M: DNA methylation and cancer. *Adv Genet* 70: 27–56, 2010.
- 2 3. SanMiguel JM and Bartolomei MS: DNA methylation dynamics of genomic imprinting in mouse development. *Biol Reprod* 99: 252–262, 2018.
- 3 4. Minarovits J, Banati F, Szenthe K and Niller HH: Epigenetic Regulation. *Adv Exp Med Biol* 879: 1–25, 2016.
- 4 5. Sawai A and Dasen JS: De Novo DNA Methylation: Marking the Path from Stem Cell to Neural Fate. *Cell Stem Cell* 22: 469–471, 2018.
- 5 6. Cavalieri V and Spinelli G: Environmental epigenetics in zebrafish. *Epigenetics Chromatin* 10: 46, 2017.
- 6 7. Cedar H and Bergman Y: Linking DNA methylation and histone modification: patterns and paradigms. *Nat Rev Genet* 10: 295–304, 2009.
- 7 8. Hermann A, Gowher H and Jeltsch A: Biochemistry and biology of mammalian DNA methyltransferases. *Cell Mol Life Sci CMLS* 61: 2571–2587, 2004.
- 8 9. Jeltsch A: Molecular enzymology of mammalian DNA methyltransferases. *Curr Top Microbiol Immunol* 301: 203–225, 2006.
- 9 10. Jeltsch A and Jurkowska RZ: Allosteric control of mammalian DNA methyltransferases - a new regulatory paradigm. *Nucleic Acids Res* 44: 8556–8575, 2016.
- 10 11. Rollins RA, Haghghi F, Edwards JR, Das R, Zhang MQ, Ju J and Bestor TH: Large-scale structure of genomic methylation patterns. *Genome Res* 16: 157–163, 2006.
- 11 12. Felsenfeld G: A brief history of epigenetics. *Cold Spring Harb Perspect Biol* 6: a018200, 2014.
- 12 13. Law JA and Jacobsen SE: Establishing, maintaining and modifying DNA methylation patterns in plants and animals. *Nat Rev Genet* 11: 204–220, 2010.
- 13 14. Yang X, Han H, De Carvalho DD, Lay FD, Jones PA and Liang G: Gene body methylation can alter gene expression and is a therapeutic target in cancer. *Cancer Cell* 26: 577–590, 2014.
- 14 15. Bronner C, Alhosin M, Hamiche A and Mousli M: Coordinated Dialogue between UHRF1 and DNMT1 to Ensure Faithful Inheritance of Methylated DNA Patterns. *Genes* 10: E65, 2019.
- 15 16. Patnaik D, Estève P-O and Pradhan S: Targeting the SET and RING-associated (SRA) domain of ubiquitin-like, PHD and ring finger-containing 1 (UHRF1) for anti-cancer drug development. *Oncotarget* 9: 26243–26258, 2018.
- 16 17. Sidhu H and Capalash N: UHRF1: The key regulator of epigenetics and molecular target for cancer therapeutics. *Tumour Biol J Int Soc Oncodevelopmental Biol Med* 39: 1010428317692205, 2017.
- 17 18. Xie S and Qian C: The Growing Complexity of UHRF1-Mediated Maintenance DNA Methylation. *Genes* 9: E600, 2018.
- 18 19. Bronner C, Krifa M and Mousli M: Increasing role of UHRF1 in the reading and inheritance of the epigenetic code as well as in tumorigenesis. *Biochem Pharmacol* 86: 1643–1649, 2013.
- 19 20. Alhosin M, Sharif T, Mousli M, Etienne-Selloum N, Fuhrmann G, Schini-Kerth VB and Bronner C: Down-regulation of UHRF1, associated with re-expression of tumor suppressor genes, is a common feature of natural compounds exhibiting anti-cancer properties. *J Exp Clin Cancer Res* 30: 41, 2011.
- 20 21. Jeanblanc M, Mousli M, Hopfner R, *et al.*: The retinoblastoma gene and its product are targeted by ICBP90: a key mechanism in the G1/S transition during the cell cycle. *Oncogene* 24: 7337–7345, 2005.
- 21 22. Achour M, Jacq X, Rondé P, *et al.*: The interaction of the SRA domain of ICBP90 with a novel domain of DNMT1 is involved in the regulation of VEGF gene expression. *Oncogene* 27: 2187–2197, 2008.
- 22 23. Wang F, Yang Y-Z, Shi C-Z, *et al.*: UHRF1 promotes cell growth and metastasis through repression of p16(ink4a) in colorectal cancer. *Ann Surg Oncol* 19: 2753–2762, 2012.
- 23 24. Achour M, Mousli M, Alhosin M, *et al.*: Epigallocatechin-3-gallate up-regulates tumor suppressor gene expression via a reactive oxygen species-dependent down-regulation of UHRF1. *Biochem Biophys Res Commun* 430: 208–212, 2013.
- 24 25. Krifa M, Alhosin M, Muller CD, *et al.*: Limoniastrum guyonianum aqueous gall extract induces apoptosis in human cervical cancer cells involving p16 INK4A re-expression related to UHRF1 and DNMT1 down-regulation. *J Exp Clin Cancer Res* 32: 30, 2013.
- 25 26. Boukhari A, Alhosin M, Bronner C, *et al.*: CD47 activation-induced UHRF1 over-expression is associated with silencing of tumor suppressor gene p16INK4A in glioblastoma cells. *Anticancer Res* 35: 149–157, 2015.
- 26 27. Alhosin M, Abusnina A, Achour M, *et al.*: Induction of apoptosis by thymoquinone in lymphoblastic leukemia Jurkat cells is mediated by a p73-dependent pathway which targets the epigenetic integrator UHRF1. *Biochem Pharmacol* 79: 1251–1260, 2010.
- 27 28. Sheng Y, Wang H, Liu D, *et al.*: Methylation of tumor suppressor gene CDH13 and SHP1 promoters and their epigenetic regulation by the UHRF1/PRMT5 complex in endometrial carcinoma. *Gynecol Oncol* 140: 145–151, 2016.
- 28 29. Chen H, Zhang T, Sheng Y, Zhang C, Peng Y, Wang X and Zhang C: Methylation Profiling of Multiple Tumor Suppressor Genes in Hepatocellular Carcinoma and the Epigenetic Mechanism of 3OST2 Regulation. *J Cancer* 6: 740–749, 2015.
- 29 30. Jin W, Chen L, Chen Y, *et al.*: UHRF1 is associated with epigenetic silencing of BRCA1 in sporadic breast cancer. *Breast Cancer Res Treat* 123: 359–373, 2010.
- 30 31. Guan D, Factor D, Liu Y, Wang Z and Kao H-Y: The epigenetic regulator UHRF1 promotes ubiquitination-mediated degradation of the tumor-suppressor protein promyelocytic leukemia protein. *Oncogene* 34: 5206, 2015.
- 31 32. Zhou L, Shang Y, Jin Z, *et al.*: UHRF1 promotes proliferation of gastric cancer via mediating tumor suppressor gene hypermethylation. *Cancer Biol Ther* 16: 1241–1251, 2015.
- 32 33. Zhuo H, Tang J, Lin Z, *et al.*: The aberrant expression of MEG3 regulated by UHRF1 predicts the prognosis of hepatocellular carcinoma. *Mol Carcinog* 55: 209–219, 2016.
- 33 34. Qin L, Dong Z and Zhang J-T: Reversible epigenetic regulation of 14-3-3 $\sigma$  expression in acquired gemcitabine resistance by uhrf1 and DNA methyltransferase 1. *Mol Pharmacol* 86: 561–569, 2014.
- 34 35. Oh YM, Mahar M, Ewan EE, Leahy KM, Zhao G and Cavalli V: Epigenetic regulator UHRF1 inactivates REST and growth suppressor gene expression via DNA methylation to promote axon regeneration. *Proc Natl Acad Sci U S A* 115: E12417–E12426, 2018.
- 35 36. Vaughan RM, Kupai A, Foley CA, *et al.*: The histone and non-histone methyllysine reader activities of the UHRF1 tandem Tudor domain are dispensable for the propagation of aberrant DNA methylation patterning in cancer cells. *Epigenetics Chromatin* 13: 44, 2020.
- 36 37. Bronner C, Fuhrmann G, Chédin FL, Macaluso M and Dhe-Paganon S: UHRF1 Links the Histone code and DNA Methylation to ensure Faithful Epigenetic Memory Inheritance. *Genet Epigenetics* 2009: 29–36, 2010.
- 37 38. Mancini M, Magnani E, Macchi F and Bonapace IM: The multi-functionality of UHRF1: epigenome maintenance and preservation of genome integrity. *Nucleic Acids Res* 49: 6053–6068, 2021.
- 38 39. Foster BM, Stolz P, Mulholland CB, Montoya A, Kramer H, Bultmann S and Bartke T: Critical Role of the UBL Domain in Stimulating the E3 Ubiquitin Ligase Activity of UHRF1 toward Chromatin. *Mol Cell* 72: 739-752.e9, 2018.

- 39 40. Karg E, Smets M, Ryan J, *et al.*: Ubiquitome Analysis Reveals PCNA-Associated Factor 15 (PAF15) as a Specific Ubiquitination Target of UHRF1 in Embryonic Stem Cells. *J Mol Biol* 429: 3814–3824, 2017.
- 40 41. Harrison JS, Cornett EM, Goldfarb D, *et al.*: Hemimethylated DNA regulates DNA methylation inheritance through allosteric activation of H3 ubiquitylation by UHRF1. *eLife* 5: e17101, 2016.
- 41 42. Ma J, Peng J, Mo R, *et al.*: Ubiquitin E3 ligase UHRF1 regulates p53 ubiquitination and p53-dependent cell apoptosis in clear cell Renal Cell Carcinoma. *Biochem Biophys Res Commun* 464: 147–153, 2015.
- 42 43. Jenkins Y, Markovtsov V, Lang W, *et al.*: Critical role of the ubiquitin ligase activity of UHRF1, a nuclear RING finger protein, in tumor cell growth. *Mol Biol Cell* 16: 5621–5629, 2005.
- 43 44. Citterio E, Papait R, Nicassio F, *et al.*: Np95 is a histone-binding protein endowed with ubiquitin ligase activity. *Mol Cell Biol* 24: 2526–2535, 2004.
- 44 45. Nishiyama A, Yamaguchi L, Sharif J, *et al.*: Uhrf1-dependent H3K23 ubiquitylation couples maintenance DNA methylation and replication. *Nature* 502: 249–253, 2013.
- 45 46. Varshavsky A: The Ubiquitin System, Autophagy, and Regulated Protein Degradation. *Annu Rev Biochem* 86: 123–128, 2017.
- 46 47. Ibrahim A, Alhosin M, Papin C, *et al.*: Thymoquinone challenges UHRF1 to commit auto-ubiquitination: a key event for apoptosis induction in cancer cells. *Oncotarget* 9: 28599–28611, 2018.
- 47 48. Zhang H, Liu H, Chen Y, *et al.*: A cell cycle-dependent BRCA1-UHRF1 cascade regulates DNA double-strand break repair pathway choice. *Nat Commun* 7: 10201, 2016.
- 48 49. Wilkinson KD, Tashayev VL, O'Connor LB, Larsen CN, Kasperek E and Pickart CM: Metabolism of the polyubiquitin degradation signal: structure, mechanism, and role of isopeptidase T. *Biochemistry* 34: 14535–14546, 1995.
- 49 50. Deng L, Wang C, Spencer E, *et al.*: Activation of the IκappaB kinase complex by TRAF6 requires a dimeric ubiquitin-conjugating enzyme complex and a unique polyubiquitin chain. *Cell* 103: 351–361, 2000.
- 50 51. Abdullah O, Omran Z, Hosawi S, Hamiche A, Bronner C and Alhosin M: Thymoquinone Is a Multitarget Single Epidrug That Inhibits the UHRF1 Protein Complex. *Genes* 12: 622, 2021.
- 51 52. Ahmad T, Ashraf W, Ibrahim A, *et al.*: TIP60 governs the auto-ubiquitination of UHRF1 through USP7 dissociation from the UHRF1/USP7 complex. *Int J Oncol* 59: 89, 2021.
- 52 53. Jaiswal B and Gupta A: Modulation of Nuclear Receptor Function by Chromatin Modifying Factor TIP60. *Endocrinology* 159: 2199–2215, 2018.
- 53 54. Ibrahim A, Papin C, Mohideen-Abdul K, *et al.*: MeCP2 is a microsatellite binding protein that protects CA repeats from nucleosome invasion. *Science* 372: eabd5581, 2021.
- 54 55. Zaayter L, Mori M, Ahmad T, *et al.*: A Molecular Tool Targeting the Base-Flipping Activity of Human UHRF1. *Chem Weinh Bergstr Ger* 25: 13363–13375, 2019.
- 55 56. Ashraf W, Ahmad T, Almalki NAR, *et al.*: Tannin extract from maritime pine bark exhibits anticancer properties by targeting the epigenetic UHRF1/DNMT1 tandem leading to the re-expression of TP73. *Food Funct*, 2021.
- 56 57. Hopfner R, Mousli M, Jeltsch JM, *et al.*: ICBP90, a novel human CCAAT binding protein, involved in the regulation of topoisomerase IIα expression. *Cancer Res* 60: 121–128, 2000.
- 57 58. Erikel E, Yuzbasioglu D and Unal F: Genotoxic and antigenotoxic potential of amygdalin on isolated human lymphocytes by the comet assay. *J Food Biochem*: e13436, 2020.
- 58 59. Ouararhni K, Hadj-Slimane R, Ait-Si-Ali S, *et al.*: The histone variant mH2A1.1 interferes with transcription by down-regulating PARP-1 enzymatic activity. *Genes Dev* 20: 3324–3336, 2006.
- 59 60. Ross WE and Bradley MO: DNA double-stranded breaks in mammalian cells after exposure to intercalating agents. *Biochim Biophys Acta* 654: 129–134, 1981.
- 60 61. Cantoni O and Giacomoni P: The role of DNA damage in the cytotoxic response to hydrogen peroxide/histidine. *Gen Pharmacol* 29: 513–516, 1997.
- 61 62. Gurung RL, Lim SN, Khaw AK, *et al.*: Thymoquinone induces telomere shortening, DNA damage and apoptosis in human glioblastoma cells. *PLoS One* 5: e12124, 2010.
- 62 63. Cecarini V, Quassinti L, Di Blasio A, *et al.*: Effects of thymoquinone on isolated and cellular proteasomes. *FEBS J* 277: 2128–2141, 2010.
- 63 64. Nady N, Lemak A, Walker JR, *et al.*: Recognition of multivalent histone states associated with heterochromatin by UHRF1 protein. *J Biol Chem* 286: 24300–24311, 2011.
- 64 65. Gao L, Tan X-F, Zhang S, Wu T, Zhang Z-M, Ai H-W and Song J: An Intramolecular Interaction of UHRF1 Reveals Dual Control for Its Histone Association. *Struct Lond Engl* 1993 26: 304–311.e3, 2018.
- 65 66. Houliston RS, Lemak A, Iqbal A, *et al.*: Conformational dynamics of the TTD-PHD histone reader module of the UHRF1 epigenetic regulator reveals multiple histone-binding states, allosteric regulation, and druggability. *J Biol Chem* 292: 20947–20959, 2017.
- 66 67. Cheng J, Yang Y, Fang J, *et al.*: Structural insight into coordinated recognition of trimethylated histone H3 lysine 9 (H3K9me3) by the plant homeodomain (PHD) and tandem tudor domain (TTD) of UHRF1 (ubiquitin-like, containing PHD and RING finger domains, 1) protein. *J Biol Chem* 288: 1329–1339, 2013.
- 67 68. Mir US, Bhat A, Mushtaq A, Pandita S, Altaf M and Pandita TK: Role of histone acetyltransferases MOF and Tip60 in genome stability. *DNA Repair* 107: 103205, 2021.
- 68 69. Ghobashi AH and Kamel MA: Tip60: updates. *J Appl Genet* 59: 161–168, 2018.
- 69 70. Achour M, Fuhrmann G, Alhosin M, *et al.*: UHRF1 recruits the histone acetyltransferase Tip60 and controls its expression and activity. *Biochem Biophys Res Commun* 390: 523–528, 2009.
- 70 71. Du Z, Song J, Wang Y, *et al.*: DNMT1 stability is regulated by proteins coordinating deubiquitination and acetylation-driven ubiquitination. *Sci Signal* 3: ra80, 2010.
- 71 72. Ashraf W, Bronner C, Zaayter L, *et al.*: Interaction of the epigenetic integrator UHRF1 with the MYST domain of TIP60 inside the cell. *J Exp Clin Cancer Res* CR 36: 188, 2017.
- 72 73. Dai C, Shi D and Gu W: Negative regulation of the acetyltransferase TIP60-p53 interplay by UHRF1 (ubiquitin-like with PHD and RING finger domains 1). *J Biol Chem* 288: 19581–19592, 2013.
- 73 74. Bronner C: Control of DNMT1 abundance in epigenetic inheritance by acetylation, ubiquitylation, and the histone code. *Sci Signal* 4: pe3, 2011.
- 74 75. Yao J, Leng L, Fu W, Li J, Bronner C and Bucala R: ICBP90 Regulates MIF Expression, Glucocorticoid Sensitivity, and Apoptosis at the MIF Immune Susceptibility Locus. *Arthritis Rheumatol Hoboken NJ* 73: 1931–1942, 2021.
- 75 76. Alhosin M, Omran Z, Zamzami MA, Al-Malki AL, Choudhry H, Mousli M and Bronner C: Signalling pathways in UHRF1-dependent regulation of tumor suppressor genes in cancer. *J Exp Clin Cancer Res* CR 35: 174, 2016.
- 76 77. Singh R, Rajput M and Singh RP: Simulated microgravity triggers DNA damage and mitochondria-mediated apoptosis through ROS generation in human promyelocytic leukemic cells. *Mitochondrion* 61: 114–124, 2021.

- 77 78. Ashraf W, Ibrahim A, Alhosin M, *et al.*: The epigenetic integrator UHRF1: on the road to become a universal biomarker for cancer. *Oncotarget* 8: 51946–51962, 2017.
- 78 79. Na L, Tang Y-D, Wang C, Liu C and Wang X: Rhesus monkey TRIM5 $\alpha$  protein SPRY domain contributes to AP-1 activation. *J Biol Chem* 293: 2661–2674, 2018.
- 79 80. Wang Z, Zhang Y-H, Guo C, *et al.*: Tetrathiomolybdate Treatment Leads to the Suppression of Inflammatory Responses through the TRAF6/NF $\kappa$ B Pathway in LPS-Stimulated BV-2 Microglia. *Front Aging Neurosci* 10: 9, 2018.
- 80 81. Shamma A, Suzuki M, Hayashi N, *et al.*: ATM mediates pRB function to control DNMT1 protein stability and DNA methylation. *Mol Cell Biol* 33: 3113–3124, 2013.
- 81 82. Gao S-S, Guan H, Yan S, *et al.*: TIP60 K430 SUMOylation attenuates its interaction with DNA-PKcs in S-phase cells: Facilitating homologous recombination and emerging target for cancer therapy. *Sci Adv* 6: eaba7822, 2020.
- 82 83. Schmidt S, Rainer J, Ploner C, Presul E, Riml S and Kofler R: Glucocorticoid-induced apoptosis and glucocorticoid resistance: molecular mechanisms and clinical relevance. *Cell Death Differ* 11 Suppl 1: S45–55, 2004.
- 83 84. Ma Y, Pannicke U, Schwarz K and Lieber MR: Hairpin opening and overhang processing by an Artemis/DNA-dependent protein kinase complex in nonhomologous end joining and V(D)J recombination. *Cell* 108: 781–794, 2002.
- 84 85. Soubeyrand S, Pope L, Pakuts B and Haché RJG: Threonines 2638/2647 in DNA-PK are essential for cellular resistance to ionizing radiation. *Cancer Res* 63: 1198–1201, 2003.
- 85 86. Wechsler T, Chen BPC, Harper R, *et al.*: DNA-PKcs function regulated specifically by protein phosphatase 5. *Proc Natl Acad Sci U S A* 101: 1247–1252, 2004.
- 86 87. Vaughan RM, Dickson BM, Whelihan MF, *et al.*: Chromatin structure and its chemical modifications regulate the ubiquitin ligase substrate selectivity of UHRF1. *Proc Natl Acad Sci U S A* 115: 8775–8780, 2018.
- 87 88. Mortusewicz O, Schermelleh L, Walter J, Cardoso MC and Leonhardt H: Recruitment of DNA methyltransferase I to DNA repair sites. *Proc Natl Acad Sci U S A* 102: 8905–8909, 2005.
- 88 89. Liu Y, Liang G, Zhou T and Liu Z: Silencing UHRF1 Inhibits Cell Proliferation and Promotes Cell Apoptosis in Retinoblastoma Via the PI3K/Akt Signalling Pathway. *Pathol Oncol Res POR* 26: 1079–1088, 2020.
- 89 90. Chen X, Zhou Y-L, Liang S-Y, Shi Y-C, Lin S and Shu M-Q: Overexpression of UHRF1 promoted the proliferation of vascular smooth cells via the regulation of Geminin protein levels. *Biosci Rep* 39: BSR20181341, 2019.
- 90 91. Zhang Y, Ji G, Han S, *et al.*: Tip60 Suppresses Cholangiocarcinoma Proliferation and Metastasis via PI3k-AKT. *Cell Physiol Biochem Int J Exp Cell Physiol Biochem Pharmacol* 50: 612–628, 2018.
- 91 92. Thrower JS, Hoffman L, Rechsteiner M and Pickart CM: Recognition of the polyubiquitin proteolytic signal. *EMBO J* 19: 94–102, 2000.
- 92 93. Chau V, Tobias JW, Bachmair A, Marriott D, Ecker DJ, Gonda DK and Varshavsky A: A multiubiquitin chain is confined to specific lysine in a targeted short-lived protein. *Science* 243: 1576–1583, 1989.

# **Supplementary Data**

## **Role and regulation of UHRF1 auto-ubiquitination induced by thymoquinone**

**Naif A. R. Almalki<sup>1,2</sup>, Abdulkhaleg Ibrahim<sup>1</sup>, Mahmoud Alhosin<sup>2</sup>, Yves Mély<sup>3</sup>, Ali Hamiche<sup>1</sup>, Marc Mousli<sup>3</sup> §, Christian Bronner<sup>1</sup>, §, \***

<sup>1</sup>Department of functional Genomics, Institut de Génétique et de Biologie Moléculaire et Cellulaire (IGBMC), INSERM U1258, CNRS UMR 7104, Université de Strasbourg, Equipe labellisée Ligue contre le Cancer, Illkirch-France

<sup>2</sup>Department of Biochemistry, King Abdulaziz University, Jeddah. Saudi Arabia.

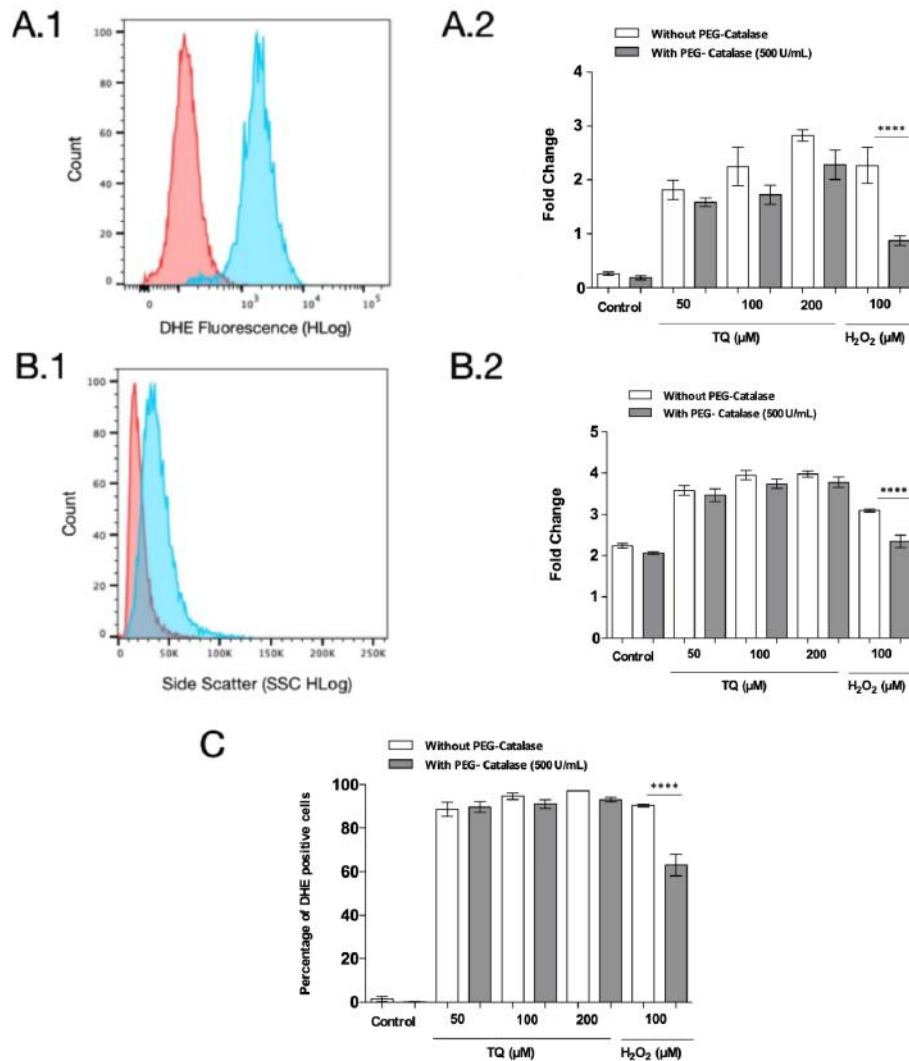
<sup>3</sup>Laboratory of Bioimaging and Pathologies, UMR 7021 CNRS, Université de Strasbourg, Faculté de Pharmacie, Illkirch France

**§ these authors are equal senior authors**

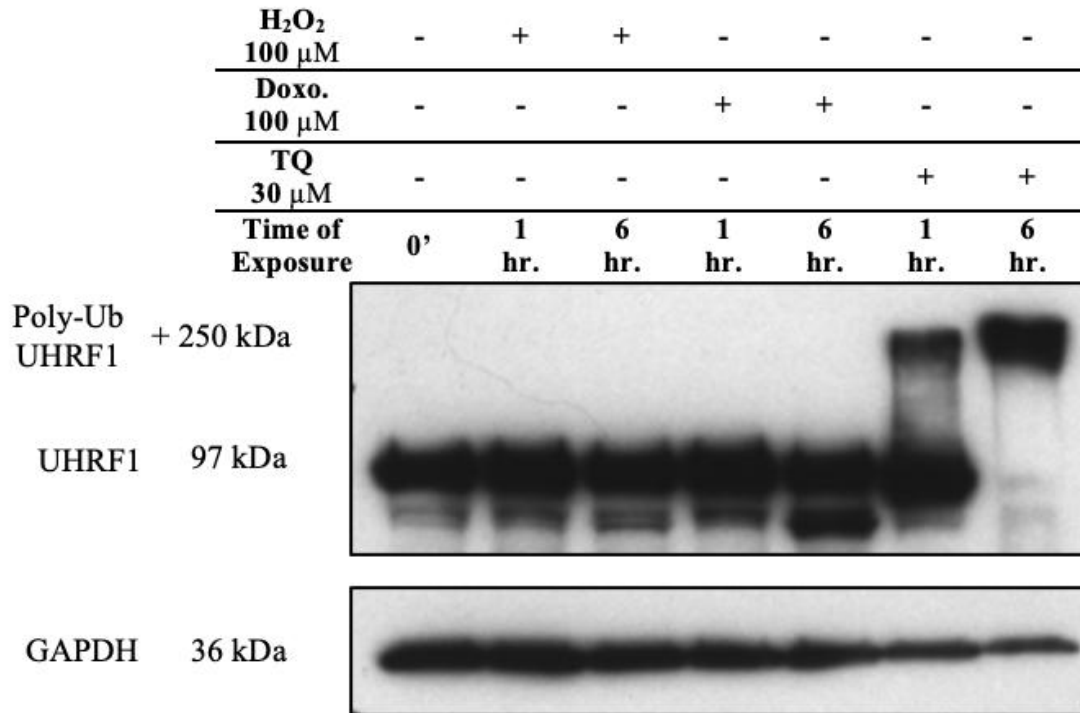
\*Correspondence : [bronnerc@igbmc.fr](mailto:bronnerc@igbmc.fr)

Institut de Génétique et de Biologie Moléculaire et Cellulaire (IGBMC), INSERM U1258, CNRS UMR 7104, Université de Strasbourg, Illkirch-France

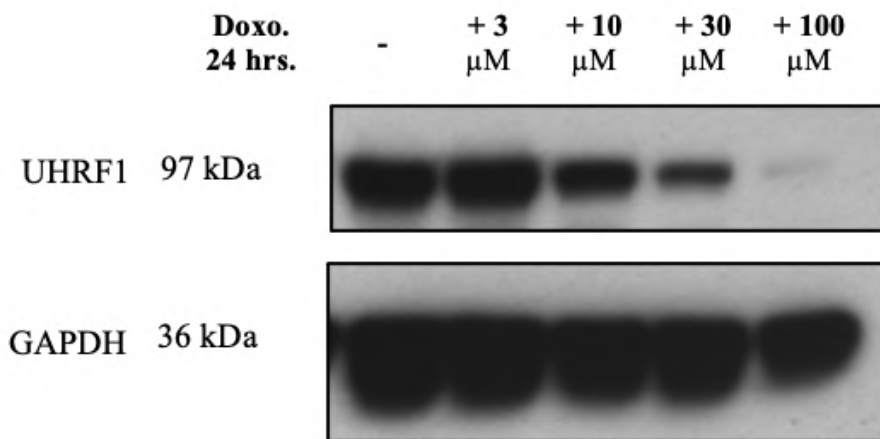
## SUPPLEMENTARY DATA



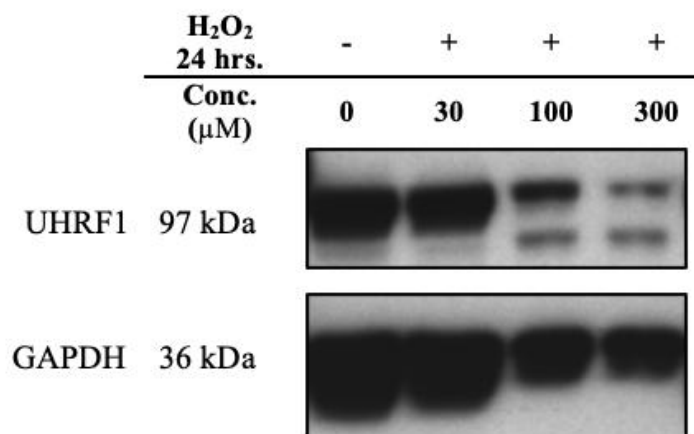
**Figure S1:** PEG-Catalase slightly reduce ROS levels in HeLa cells treated with TQ. A.1, Cytogram showing DHE labeling in control (represented by red area under graph) and TQ treated cells at concentration of 200  $\mu\text{M}$  pretreated 1 hr. with PEG-Catalase at concentration of 500 U/mL (represented by blue area under graph). A.2, Histogram showing fold change in DHE labeling by treatment of TQ at different concentration combined with PEG-Catalase in comparison to TQ treatment as a control. B.1, Cytogram showing side scatter in control (represented by red area under graph) and TQ treated cells at concentration of 200  $\mu\text{M}$  pretreated 1 hr. with PEG-Catalase at concentration of 500 U/mL (represented by blue area under graph). B.2, Histogram showing fold change of side scatter by treatment of TQ at different concentration combined with PEG-Catalase in comparison to TQ treatment as a control. C. Histogram showing the percentage of DHE positive cells to DHE by treatment of TQ at different concentration combined with PEG-Catalase in comparison to TQ treatment as a control. Values indicated are from three independent experiments and were analyzed by one-way ANOVA with post-hoc Tukey test. (\*  $P < 0.05$ , \*\*  $P < 0.01$ , \*\*\*  $P < 0.001$ ).



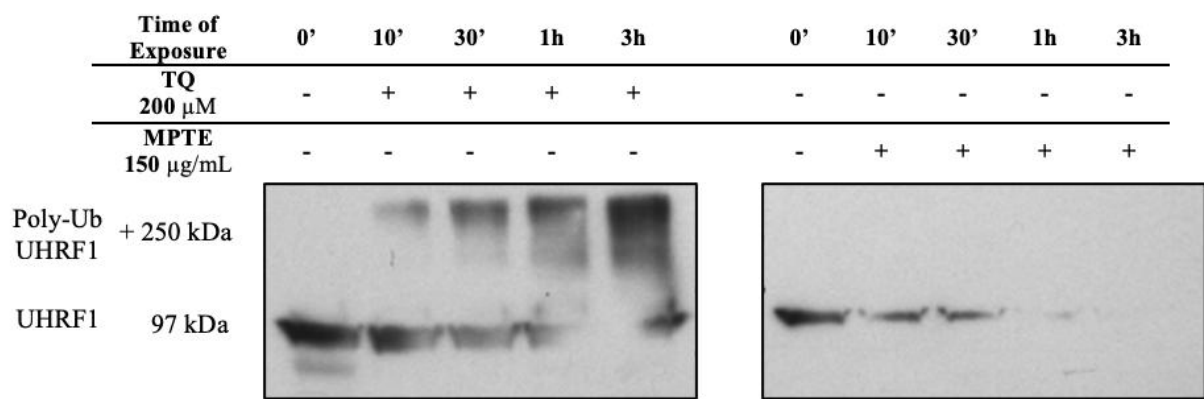
**Figure S2:** Time course effect of Hydrogen peroxide (H<sub>2</sub>O<sub>2</sub>) Doxorubicin (Doxo) and Thymoquinone (TQ) on UHRF1. Time course (1 hr. and 6 hrs.) of 100 μM H<sub>2</sub>O<sub>2</sub> and 100 μM Doxo. showing no ubiquitination effect while 30 μM TQ showing an ubiquitination on UHRF1 in Jurkat cells.



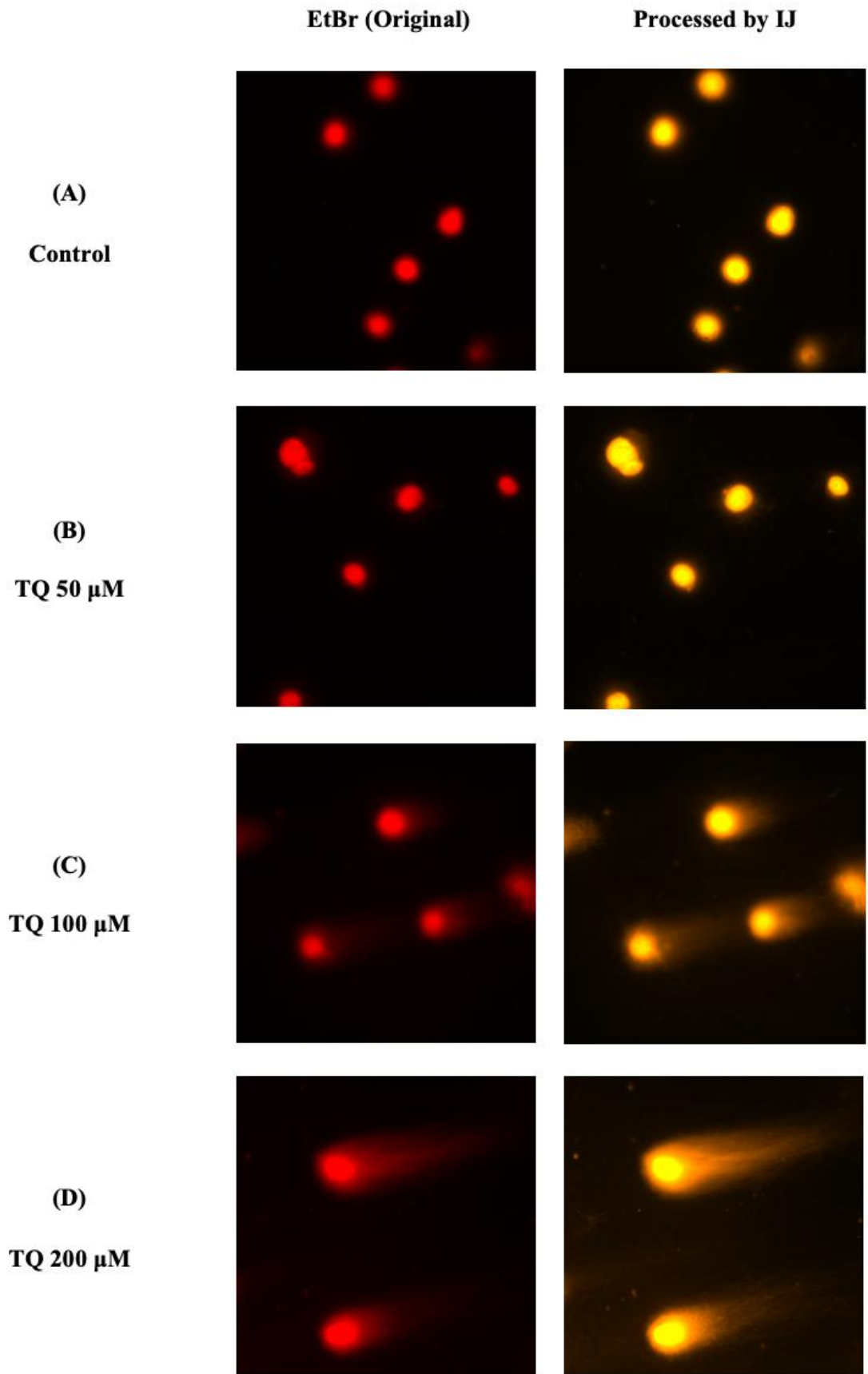
**Figure S3:** Effect of Doxorubicin (Doxo) on UHRF1 expression in Jurkat cell lines. Jurkat cells were treated with various concentrations of Doxo for 24 hrs. and the expression of UHRF1 was investigated using a monoclonal anti-UHRF1 antibody.



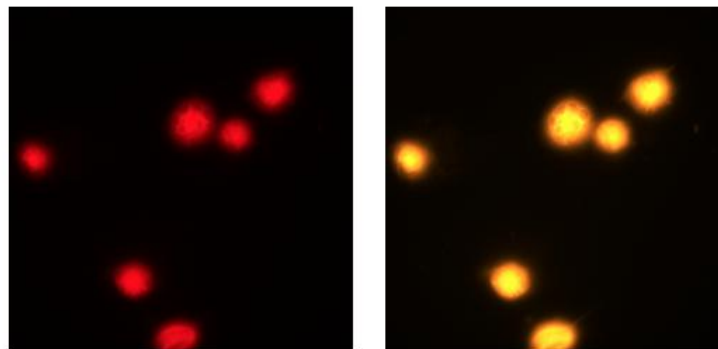
**Figure S4:** Effect of Hydrogen peroxide (H<sub>2</sub>O<sub>2</sub>) on UHRF1 expression in Jurkat cell lines. Jurkat cells were treated with various concentrations of H<sub>2</sub>O<sub>2</sub> for 24 hrs. and the expression of UHRF1 was investigated using a monoclonal anti-UHRF1 antibody.



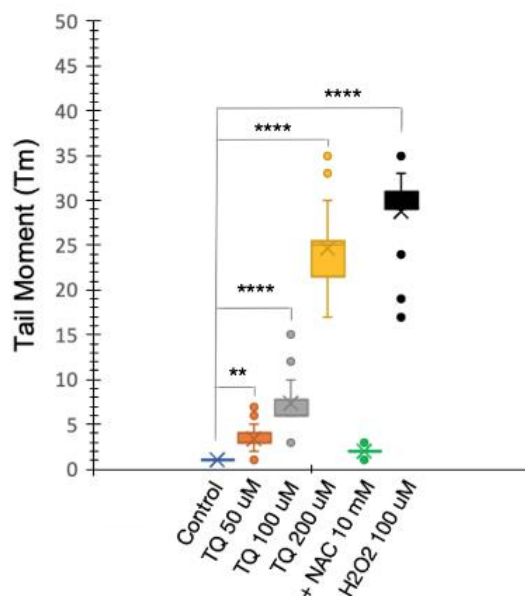
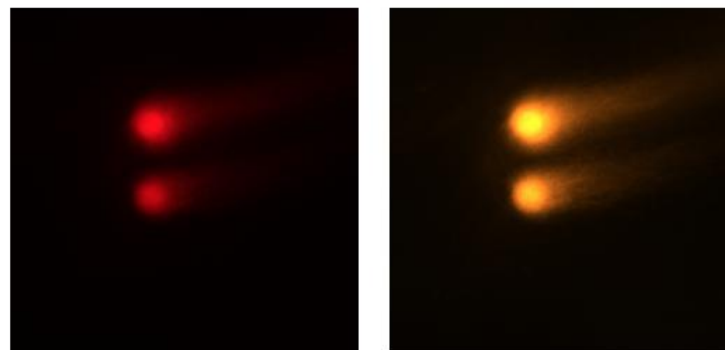
**Figure S5:** Effect of TQ and MPTE on UHRF1 expression. HeLa cells were treated with TQ at 200  $\mu$ M and MPTE at 150mg/mL for different times (10min, 30min, 1hr and 3hr).



(E)  
TQ 200  $\mu$ M + NAC 10 mM



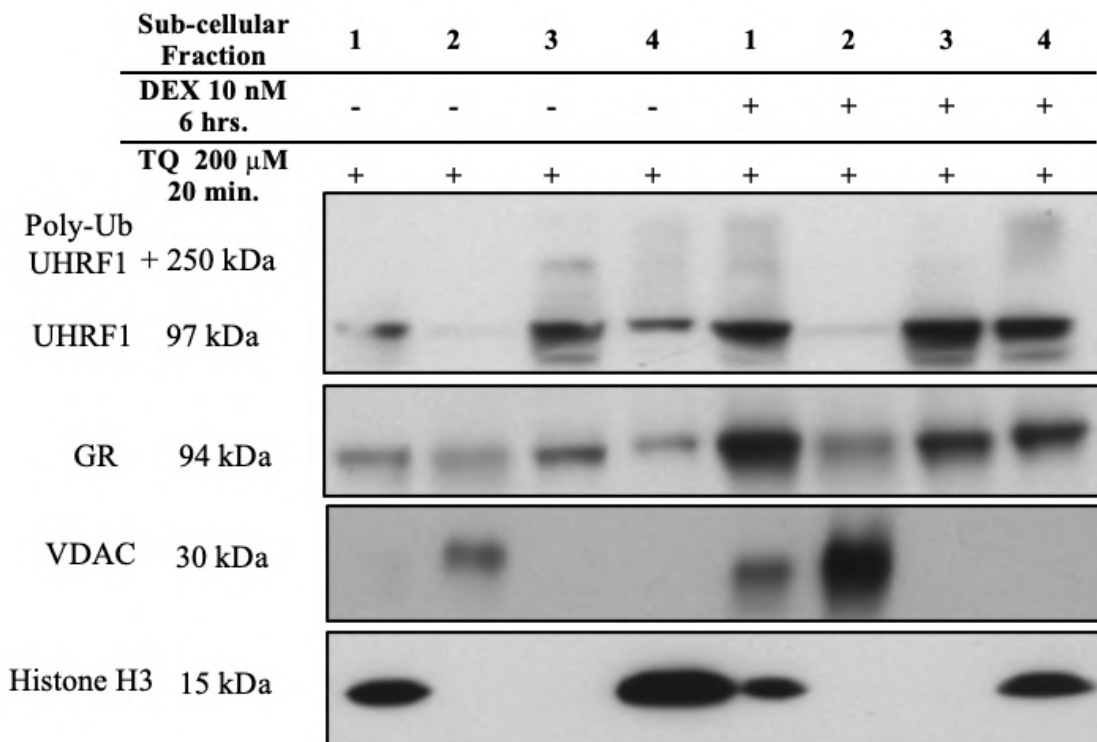
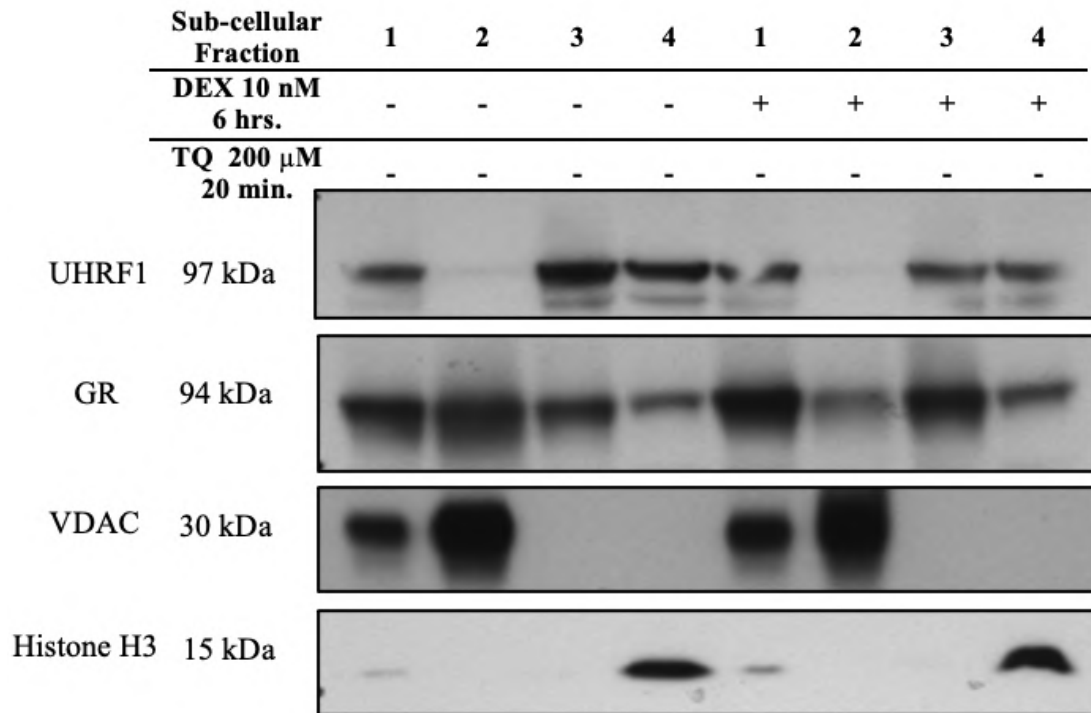
(F)  
H<sub>2</sub>O<sub>2</sub> 100  $\mu$ M



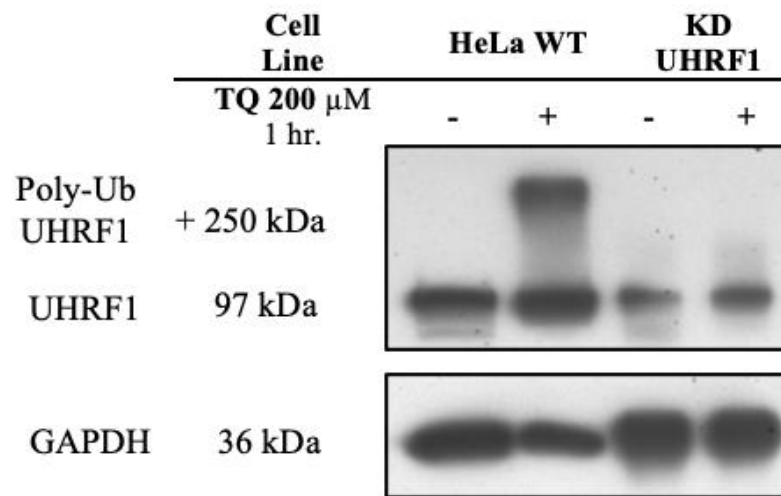
**Figure S6:** Comet Assay of HeLa cells, treated for 1 hour with TQ with concentration of 200  $\mu$ M. Comet images of the HeLa cells stained with Ethidium Bromide and observed under fluorescent microscope; Evaluation of Thymoquinone (TQ) DNA damage by comet assay. DNA damage is calculated as the DNA tail area/whole DNA area (%) and the comet tail length (from the center of DNA head to the end of the DNA tail) in HeLa cells. The bigger the DNA tail area (%) or the longer the DNA tail length, the more significant the damage. (A) Control, the DNA is intact without a DNA tail, (B) TQ, 50  $\mu$ M, (C) TQ, 100  $\mu$ M, (D) TQ, 200  $\mu$ M. (E) TQ, 200  $\mu$ M + NAC 10 mM. (F) Positive control, H<sub>2</sub>O<sub>2</sub>, 100  $\mu$ M; magnification 250x B) Comet Assay data quantitation by specialized ImageJ software. This parameter essentially represents the product of the percentage of total DNA in the tail and the distance between the centers of the mass of head and tail regions [Olive moment = (tail mean-head mean) x % of DNA in the tail]. Values indicated are from three independent experiments and were analyzed by one-way ANOVA with post-hoc Tukey test. (\* P < 0.05, \*\* P < 0.01, \*\*\* P < 0.001, \*\*\*\* P < 0.0001).

**Table S1:** Comparison of degree of DNA damage after TQ treatment using the comet assay in HeLa cells.

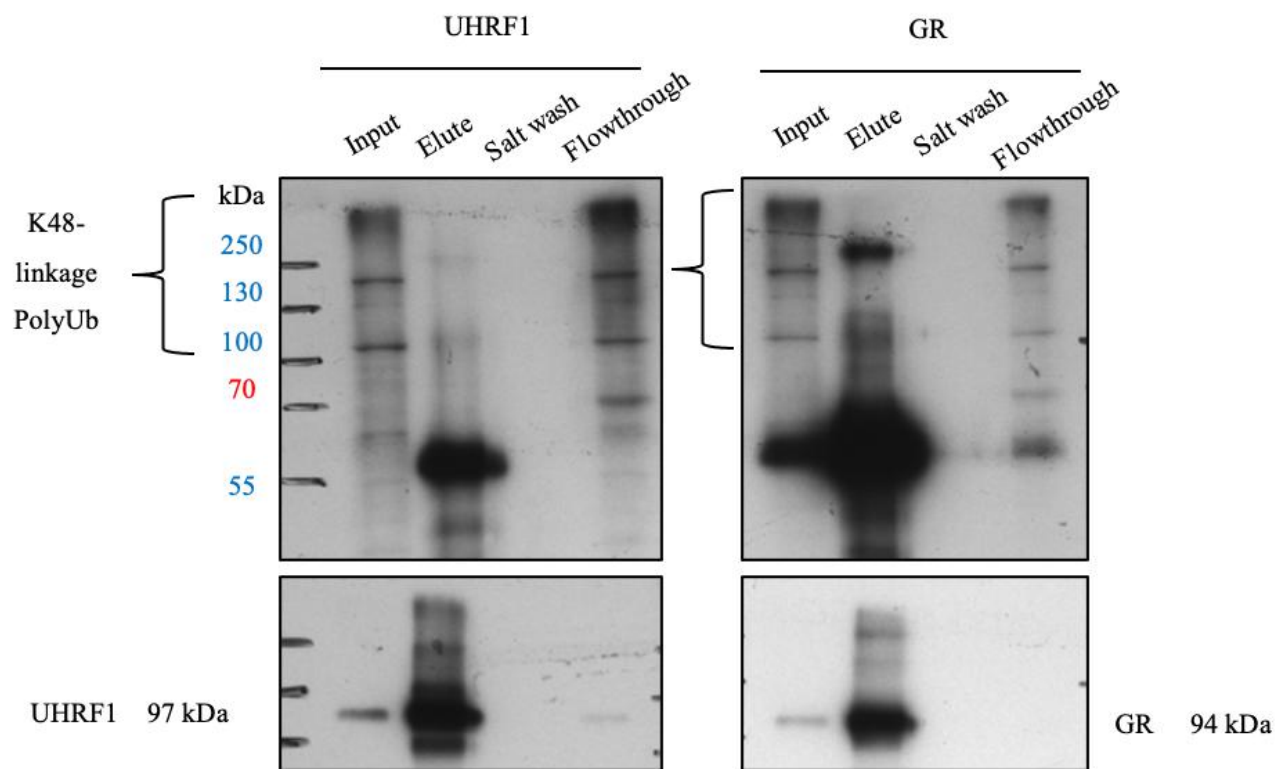
<b>Sample</b>	<b>Tail area/total area (%)</b>	<b>DNA tail length (b)</b>	<b>Tail moment (Tm)</b>
Control	5	3 ± 0.3	1
TQ (50 µM)	16	7 ± 1	3
TQ (100 µM)	63	33 ± 4	6
TQ (200 µM)	81	97 ± 2	25
TQ (200 µM) + NAC 10 mM	12	3 ± 0.2	2
H <sub>2</sub> O <sub>2</sub> (100 µM)	80	117 ± 7	35



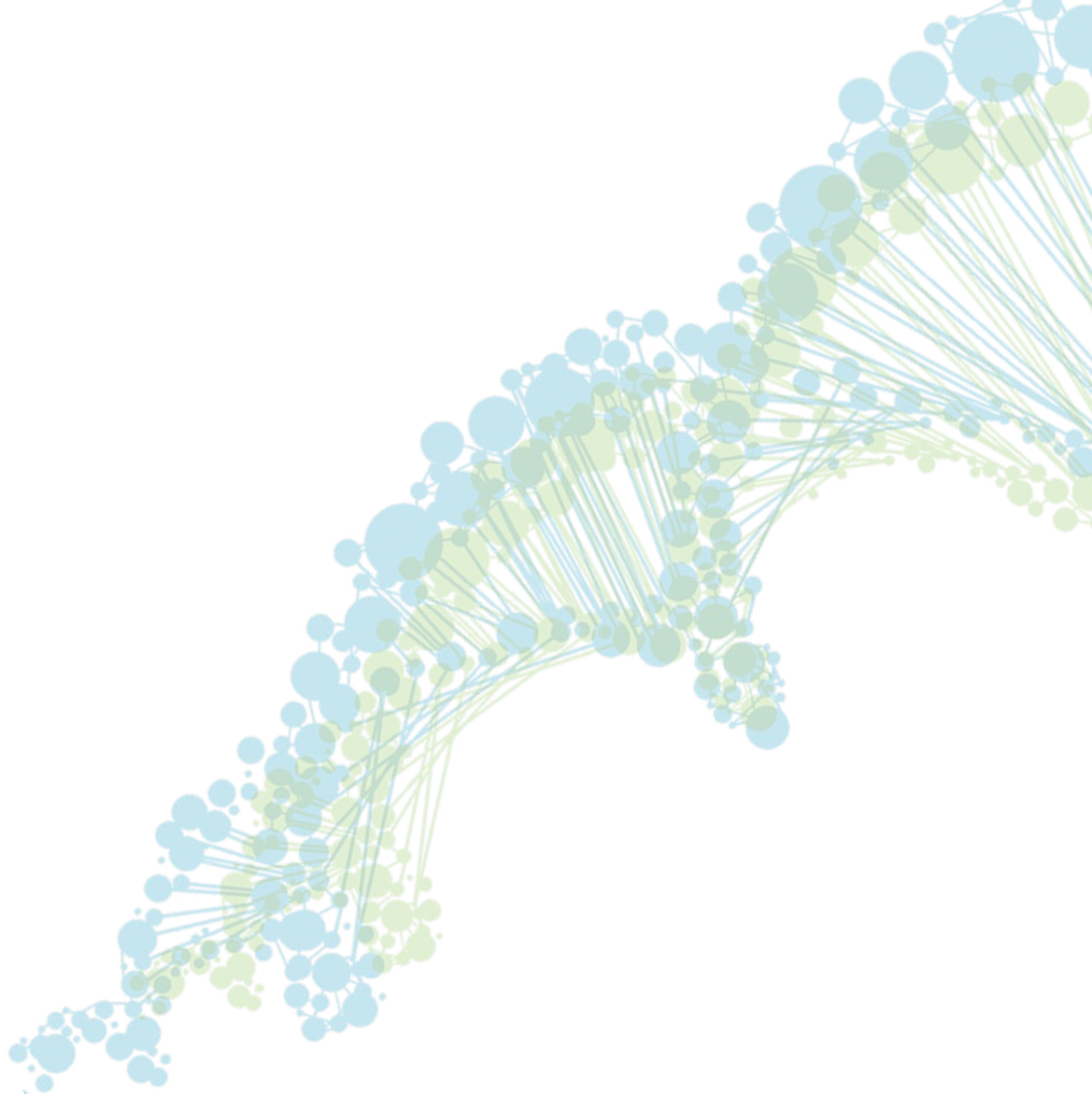
**Figure S7:** Effect of TQ on UHRF1 and Glucocorticoid receptor (GR) expressions in the presence of the Dexamethasone (DEX). HeLa cells were pretreated with DEX at 10 nM for 6 hrs. before adding TQ at 200  $\mu$ M for 20 min. Western blot was then performed using the antibodies of anti-UHRF1, anti-GR, anti-H3 as a nucleoplasmic marker and anti-VDAC as a cytoplasmic marked on the Input (1) and the fractions of cytoplasmic (2), Soluble Nucleoplasmic (3) and Insoluble Nucleoplasmic (4).



**Figure S8:** Effect of Thymoquinone (TQ) on WT and Knocked-down HeLa cell lines. WT and Knocked-down HeLa cells were treated with TQ for 1 hr. at 200  $\mu$ M for determine the Ubiquitination. and the expression of UHRF1 was investigated using a monoclonal anti-UHRF1.



**Figure S9:** Effect of Thymoquinone (TQ) on WT HeLa cell lines. Two groups of WT HeLa cells were treated with TQ for 1 hr. at 200  $\mu$ M for determine a specific Ubiquitination. The specific Ubiquitination linked to lysin K48 was investigated using a polyclonal anti-K48-linkage specific polyubiquitination antibody after UHRF1 and GR pulling down by immunoprecipitation (IP) technique using protein A and protein G Sepharose beads.



## Chapter (IV)

# GENERAL DISCUSSION



## 4. Discussion of Results

### 4.1. MPTE exhibit anticancer properties by targeting the epigenetic UHRF1/DNMT1 tandem

Polyphenolic plant products have been demonstrated to have a positive impact on cancer prevention and treatment in several studies. As a result, the active components and mechanisms of action of these medicines are currently being intensively investigated for potential applicability as a cancer therapy (Asensi *et al.*, 2011; Zhou *et al.*, 2016). Maritime pine bark has been previously reported to induce differentiation and apoptosis in cancer cells (Huynh and Teel, 2000; Huang *et al.*, 2005; Buz'Zard and Lau, 2007; Harati *et al.*, 2015). Because epigenetic processes such as DNA methylation are thought to govern differentiation and apoptosis, this work focused on epigenetic actors as a means of investigating the underlying mechanism. Due of its importance in maintaining DNA methylation and passing on DNA methylation patterns, it has been concentrated on the DNMT1/UHRF1 tandem (Bronner *et al.*, 2019).

Multiple physiological benefits of maritime pine bark extract have been linked to polyphenolic components, including antioxidant and anti-inflammatory activities as well as diabetic- and heart-protective effects (Packer *et al.*, 1999; Rohdewald, 2015). Other pine bark extracts, such those from *Pinus massoniana*, *Pinus strobus*, and *Pinus radiata*, are likewise high in procyanidins and have similar bioactivities to those of the aforementioned ones (Li *et al.*, 2015; Yazaki, 2015). Anticancer effects have been demonstrated in many studies using various combinations of these chemicals found in green tea leaves (Achour *et al.*, 2013; Yang and Wang, 2016). Compounds like this operate better when combined with a plant product than when used alone, because the combined dose is more effective and the toxicity is reduced (Bode and Dong, 2009). In MPTE, we also observed the presence of lanoste based terpenoids which have been previously observed in *Pinus monticola* and *Pinus luchuensis* (Fradinho *et al.*, 2002; Conner *et al.*, 1980). A low concentration of MPTE was found to have an inhibitory effect on the growth of cervical cancer HeLa and osteosarcoma U2OS cell lines, which is unique to cancer cells. The increase of cells in the G2/M phase, an usual occurrence with anticancer agents, was also observed with MPTE therapy (Senese *et al.*, 2014; Shan *et al.*, 2015; Takanashi *et al.*, 2017). Annexin V and PI fluorescence analyses showed that MPTE caused apoptosis in HeLa cells, as demonstrated by flow cytometry. It was confirmed by Western blotting that caspase 3 was activated and PARP was cleaved in MPTE-treated cells in a dosage dependent manner. Treatment with MPTE also lowered the levels of the pro-survival protein Bcl-2, which

is essential for the integrity of the mitochondrial membrane. Apoptosis occurs when cytochrome c is released as a result of Bcl-2 depletion.

In contrast to the previously reported antioxidant activity of MPTE (Packer *et al.*, 1999) A dose-dependent rise in ROS staining was found, which was responsive to the antioxidants PEG-catalase and N-acetylcysteine in cancer cells. MPTE's anti-cancer effect is mediated in part by H<sub>2</sub>O<sub>2</sub>, according to these findings, as has been previously documented for white grape pomace extract (León-González *et al.*, 2017). A further explanation is that MPTE-induced production of H<sub>2</sub>O<sub>2</sub> by superoxide dismutase may be involved in mediating this action. Superoxide anions are scavenged by this enzyme when it is present. This explains the ensuing chain of events, including DNA damage and cell death (Qi *et al.*, 2019; Copley *et al.*, 2015).

Despite their primarily antioxidant effects in normal cells, polyphenol-rich extracts from tea leaves, grapes, fruits, and berries have been shown to increase ROS generation and death in cancer cells, which is in line with our findings (León-González *et al.*, 2015). According to cellular phenotype, polyphenols can act as either antioxidants or a pro-oxidants. Polyphenolic substances have antioxidant action in normal cells, which protects cellular material from oxidative damage. Because of the elevated pH and higher levels of redox active transitory metals in cancer cells, they function as pro-oxidant chemicals and cause cell death (León-González *et al.*, 2015; Eghbaliferiz and Iranshahi, 2016). Anticancer treatment might benefit from the polyphenolic chemicals' ability to specifically target cancer cells. Apoptosis-related changes in granularity are connected with elevated levels of ROS, which may be an early indicator of cell death (Gosselin *et al.*, 2009; Raghuram *et al.*, 2010). Pinostrobin, a flavonoid from *Pinus strobus*, has similarly been shown to promote apoptosis in HeLa cells by causing excessive ROS generation (Sun *et al.*, 2020). In p53-deficient HeLa cells, MPTE treatment induced the production of the tumor suppressor protein p73, which is known to limit tumor growth (Ashraf *et al.*, 2022). Excessive ROS in HeLa cells has previously been shown to trigger apoptosis via the mitochondrial activation of caspases 9 and 3 (Singh *et al.*, 2007). Thymoquinone, epigallocatechin-3-gallate, and polyphenolic extracts from grapes and berries have all been shown to activate p73 and promote cell death in p53-deficient cancer cells (Alhosin *et al.*, 2016; Alhosin *et al.*, 2010; Achour *et al.*, 2013; León-González *et al.*, 2017; León-González *et al.*, 2015; Abusnina *et al.*, 2011; Sharif *et al.*, 2012; Ibrahim *et al.*, 2018).

UHRF1 downregulation and cell cycle arrest in the G2/M phase were seen in our current investigation, in keeping with a prior discovery that UHRF1 depletion resulted in a G2/M phase cell cycle arrest (Tien *et al.*, 2011). DNMT1 expression was likewise reduced by MPTE. TSGs

were able to recovery after being silenced due to the downregulation of DNMT1 and UHRF1 (Bronner *et al.*, 2013; Unoki, 2011). An overall decrease in DNA methylation may be to blame for this re-expression. UHRF1 and DNMT1 downregulation was followed by global hypomethylation in our instance after treatment with MPTE. Catechol-containing polyphenols in dietary have been shown to interfere with DNA methylation, which is in line with our findings (Stefanska *et al.*, 2012).

#### **4.2. Auto-ubiquitination has a regulatory role on the UHRF1 induced by thymoquinone (TQ)**

In the context of cancer growth and immortality, UHRF1 is seen as a key player in suppressing tumor suppressor silence (Bronner *et al.*, 2010; Bronner *et al.*, 2013; Bronner *et al.*, 2019). The re-expression of tumor suppressor genes is irreversible when UHRF1 expression is reduced by any biological event. *TP73* and *p16<sup>INK4A</sup>* tumor suppressor genes are highly sensitive to anti-cancer activity of several natural substances (Achour *et al.*, 2008; Alhosin *et al.*, 2013). Since no other substance has been shown to cause UHRF1 auto-ubiquitination before degradation, thymoquinone stands out as a particularly interesting case study (Ibrahim *et al.*, 2018). Indeed, H<sub>2</sub>O<sub>2</sub>, MPTE, and doxorubicin all reduced UHRF1 without requiring poly-ubiquitination as shown in the present study. Furthermore, it seems that not all molecules of UHRF1 undergo auto-ubiquitination suggesting that only a small part of UHRF1 proteins are concerned tagged with a specific role, *e.g.*, targeting and/or removing UHRF1 at specific loci. This also supports that poly-ubiquitination is not a prerequisite for UHRF1 degradation. Caspases have previously been shown to have a role in TQ-induced UHRF1 down-regulation, as observed in this work. Therefore, it must investigate the reason that cells require a poly-ubiquitinated UHRF1 under the influence of TQ. A potential role in DNA repair and/or apoptosis activation might be played by poly-ubiquitination, which does not appear to be part of the degradation pathway. Because of this, UHRF1 is now well recognized as a player in the anti-apoptotic actor (Bronner *et al.*, 2013; Alhosin *et al.*, 2011; Alhosin *et al.*, 2016; Yao *et al.*, 2021).

As a preliminary step, it has been investigated whether or not TQ may generate ROS and damage DNA and looking for a possible connection to the ubiquitination of UHRF1. Comet assay proved that the TQ causes DNA double strand breaks and the generation of ROS has been found to be responsive to NAC but not to PEG-catalase, as demonstrated by the western blotting

technique. Noteworthy, the auto-ubiquitination of UHRF1 was blocked exclusively by NAC. Because the superoxide dismutase mimic MnTMPyP was ineffective in inhibiting the poly-ubiquitination of UHRF1 and the DNA damage produced by TQ, we conclude that ROS other than H<sub>2</sub>O<sub>2</sub> and O<sup>2•-</sup> are responsible for the auto-ubiquitination of UHRF1 and the DNA damage generated by TQ. As a result, we hypothesize that TQ-induced DNA damage by ROS is distinct from that caused by doxorubicin, H<sub>2</sub>O<sub>2</sub>. It will be possible to determine the specific type of DNA damage caused by TQ by identifying the ROS that are created throughout the reaction.

We were able to uncover an unusual experimental condition in which non-ubiquitinated UHRF1 entirely vanished and only poly-ubiquitinated UHRF1 remained after a one-hour treatment with TQ followed by removal of the drug and analysis after 24 hours and 48 hours. There was still no rise in the expression of *p16<sup>INK4A</sup>* under these conditions. UHRF1 inhibited tumor suppressor genes while being polyubiquitinated. Consequently, we conclude that poly-ubiquitination of UHRF1 does not affect the role of UHRF1 in terms of gene silencing in cancer cells but may add a secondary function. By demonstrating that UHRF1 is poly-ubiquitinated with non K48-linked chains, we infer that UHRF1 auto-ubiquitination plays a function in activities outside of the proteasomal degradation pathway, such as DNA repair, transcriptional gene control, and other possible function. A role for auto-ubiquitination, outside of proteasomal degradation has been reported for several proteins such as for TRIM5 $\alpha$  is required for AP-1 activation (Na *et al.*, 2018) and TRAF6 (Wang *et al.*, 2018).

Tip60 is considered one of its most important partners (Ahmad *et al.*, 2021; Ashraf *et al.*, 2017; Dai *et al.*, 2013; Du *et al.*, 2010; Achour *et al.*, 2009; Shamma *et al.*, 2013) and indeed is involved in DNA repair process (Mir *et al.*, 2021). UHRF1 poly-ubiquitination was found to be reliant on Tip60 activity in our study. As Tip60 is a co-factor of nuclear receptor, GR poly-ubiquitination was observed to be induced by TQ, although its degradation pathway is not yet known. However, we propose that, since we observed K48-linked ubiquitin chains of the GR following TQ treatment, GR is degraded via the proteasomal pathway upon the effect of TQ and UHRF1 poly-ubiquitination. The involvement of GR in the apoptotic actions induced by TQ and GR down-regulation is essential for TQ to exert its impact might be studied as an intriguing path. According to our data, ubiquitination of GR is delayed compared to that of UHRF1. In light of the fact that GR promotes apoptosis (Schmidt *et al.*, 2004), we suggest that a decrease in the expression of UHRF1 could make cancer cells resistant to corticoid therapy under anti-cancer medicines like TQ. Whatever the reason, it doesn't appear that GR activation is influencing UHRF1 poly-ubiquitination in any way. It remains to investigate whether UHRF1

auto-ubiquitination is required to poly-ubiquitinate GR and thus being involved in its degradation before its own degradation.

We have investigated the pathways of DNA repair activated upon TQ treatment and UHRF1 poly-ubiquitination. We identified ku70, ku80, and DNA-PK players in the UHRF1 complex, which are involved in DNA repair. Our results showed that TQ treatment boosted Ku70 and Ku80's association to the UHRF1 complex, which is particularly noteworthy. Serine/threonine-protein kinase DNA-PK serves as a molecular sensor for DNA damage and is engaged in DNA non-homologous end joining (NHEJ), which is necessary for DSB repair and V(D)J recombination (Ma *et al.*, 2002; Soubeyrand *et al.*, 2003; Wechsler *et al.*, 2004). DNA-PK is supposed to be the "sensor" for DSBs, which are regarded to be the most detrimental kind of DNA damage. We hypothesize that TQ-induced poly-ubiquitination of UHRF1 aids in the engagement of DNA repair machinery like Ku70 and Ku80.

TRAF6 (TNF Receptor Associated Factor 6) auto-ubiquitination is activated by ROS, leading in AKT activation *in vitro*, according to current research (Wang *et al.*, 2018). TRAF6 auto-ubiquitination was reduced, and NF- $\kappa$ B activation was modulated by reducing ROS generation (Wang *et al.*, 2018). It has been shown that PI3K/Akt signaling pathway is activated upon UHRF1 silencing (Liu *et al.*, 2020) albeit the contrary was reported (Chen *et al.*, 2019). To date, Tip60 has been shown to have a significant impact on the advancement of cholangiocarcinoma in both *in vitro* and *in vivo* studies (Zhang *et al.*, 2018). It was shown that Tip60 regulates cholangiocarcinoma cell proliferation and metastasis via the PI3K-AKT pathway, which was identified as a major signal of Tip60 (Zhang *et al.*, 2018). according to the findings presented in this study, UHRF1 auto-ubiquitination induced by TQ, simulating silence, promotes AKT signaling pathways and subsequent apoptosis.

To boost the results obtained regarding the exact type of poly-ubiquitination as a perspective, we further plan to examine the K63-linkage specific poly-ubiquitination to discover the pathway of UHRF1 auto-polyubiquitination implicated after TQ treatment that is suggested to be involved in the DNA repair process and/or apoptosis activation pathway. Furthermore, it is favorable to determine the tumor suppressor gene p73 beside *p16<sup>INK4A</sup>* in the UHRF1 knocked down cells line to prove that the UHRF1 is governing TSGs expression as it has been observed previously.

### 4.3 UHRF1 as a prognostic factor and a potential therapeutic target

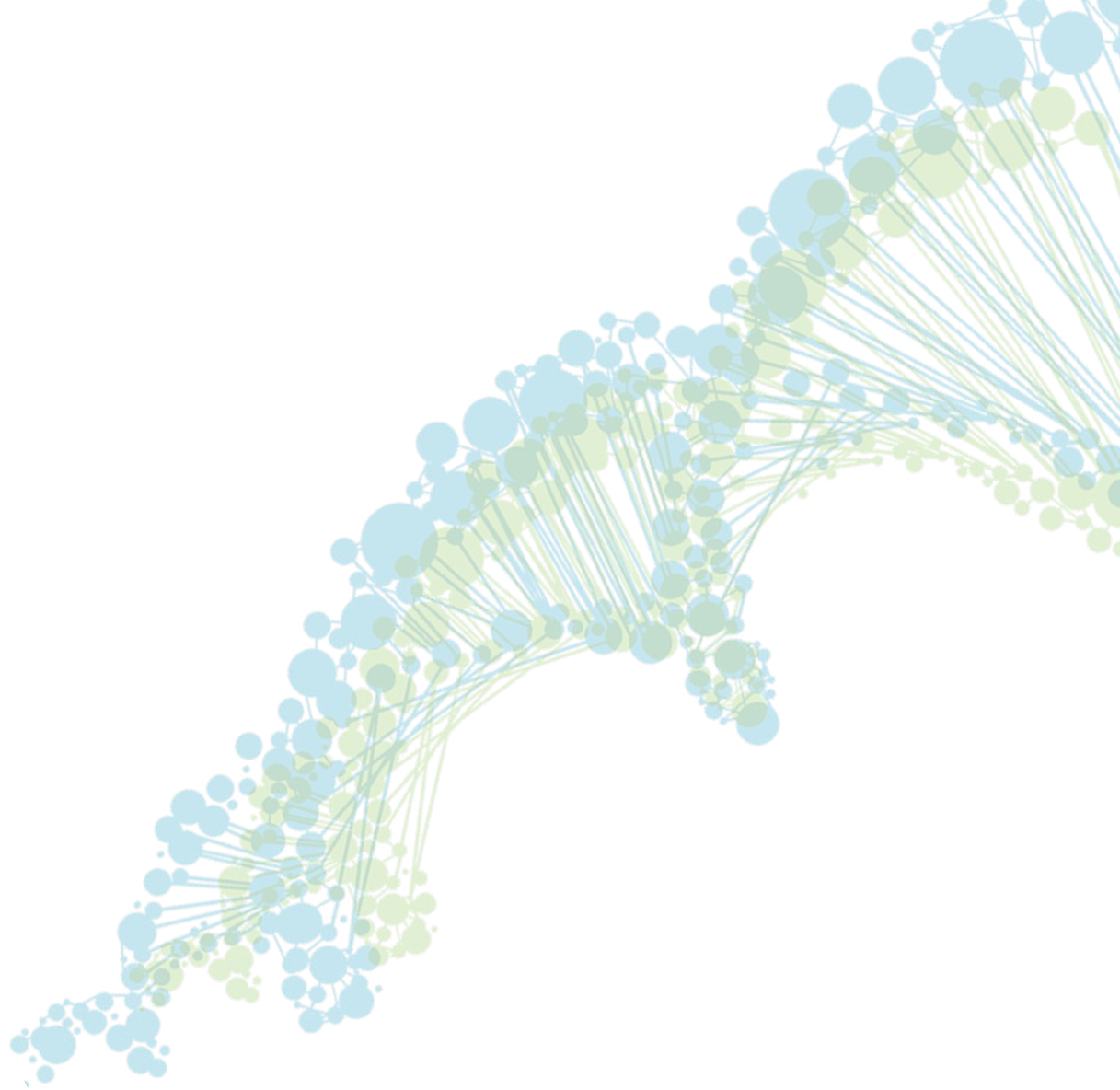
Inhibition of UHRF1 expression has been shown to prevent entry of S-phase cells, thereby causing the cell cycle to stop (Ashraf *et al.*, 2017/B; Arima *et al.*, 2004; Unoki *et al.*, 2004; Jenkins *et al.*, 2005). On the other hand, the overexpression of UHRF1 is capable of countering the inhibition of cell contact in human pulmonary fibroblasts (Hopfner *et al.*, 2002).

E3 ligases, including UHRF1, are overexpressed in several human cancers and their inhibition induces the arrest of the cell cycle and / or apoptosis in cancer cells (Bronner *et al.*, 2013; Sun, 2003; Chen *et al.*, 2006). The *UHRF1* gene fragment that acts as a dominant negative to UHRF1 was identified after a cDNA library in A549 cells was screened for genes that inhibit cell growth (Jenkins *et al.*, 2005). It is interesting to note that the overexpression of UHRF1, the RING Finger of which is mutated and for which it therefore lacks ligase activity, sensitizes cells to treatments with several chemotherapeutic agents, such as etoposide, cisplatinium, hydroxyurea and taxol (Jenkins *et al.*, 2005). Deletion of the UBL domain conferred cell protection (increased cell survival) in the presence of etoposide (Jenkins *et al.*, 2005). By decreasing the expression of UHRF1, greater sensitivity for hydroxyurea has been obtained in cancer cells resistant to this anti-cancer (Un *et al.*, 2006). It has been suggested that modulating the expression of UHRF1 could be an interesting strategy for reversing the resistance to cytotoxicity of hydroxyurea (Un *et al.*, 2006). The increase in chemosensitivity could result from an increase in the expression of tumor suppressor genes that trigger apoptotic signaling pathways (Bronner *et al.*, 2007/A).

It would be interesting to find a specific inhibitor of UHRF1 that would inhibit the proliferation of tumor cells without hindering UHRF1 from playing its role in genomic stability in non-cancer cells. One possibility is to inhibit the E3 ligase activity of the RING Finger which, to our knowledge, is not involved in replication and in genomic stability while allowing the SRA domain to recruit HDAC1 and DNMT1 to deacetylate the histones in pericentromeric heterochromatin (Bronner *et al.*, 2013; Bronner *et al.*, 2019; Zaayter *et al.*, 2019). Interesting to note is that the SRA domain of UHRF1 is emerging as a great candidate to treat malignancies that are characterized by overexpression of UHRF1 and hypermethylation of DNA. Small molecules SRA domain of UHRF1 binders would be valuable additions to a molecular toolkit that is focused on elucidating the molecular basis of cancer epigenetics, cell signaling pathways, and may prove to be important drug discovery leads as well (Patnaik *et al.*, 2018).

There are several anticancer medicines that target UHRF1, such as the uracil derivative NSC232003133, which is the only one that targets UHRF1's SRA domain. When administered to the MDF-7 and HeLa cell lines, shikonin causes the downregulation of UHRF1 and DNMT1 (Xue *et al.*, 2019). In addition, hinokitiol, dihydroartemisinin, epigallocatechin-3-gallate, emodin, mTOR inhibitor torin-2, luteolin, ERK1/2 pathway inhibitor PD98059, LY294002, AG490, Hsp90 inhibitor 17-AAG or 17-dimethylamino-ethylamino-17 demeth-oxyge-ldanamycin, anisomycin, and curcumin have been reported to be used in various types of cancers (Xue *et al.*, 2019).

Cell permeable and selective UHRF1 inhibitors may be developed using compound NSC232003 as a lead molecule. Chemical tools that block UHRF1's interactions with DNA will make it easier to investigate the many functions this complex protein may play in numerous biochemical processes and give insight on its role in disease pathology, allowing UHRF1 to be further established as a viable therapeutic target (Myrianthopoulos *et al.*, 2016).



## Chapter (V)

# CONCLUSION & PERSPECTIVES

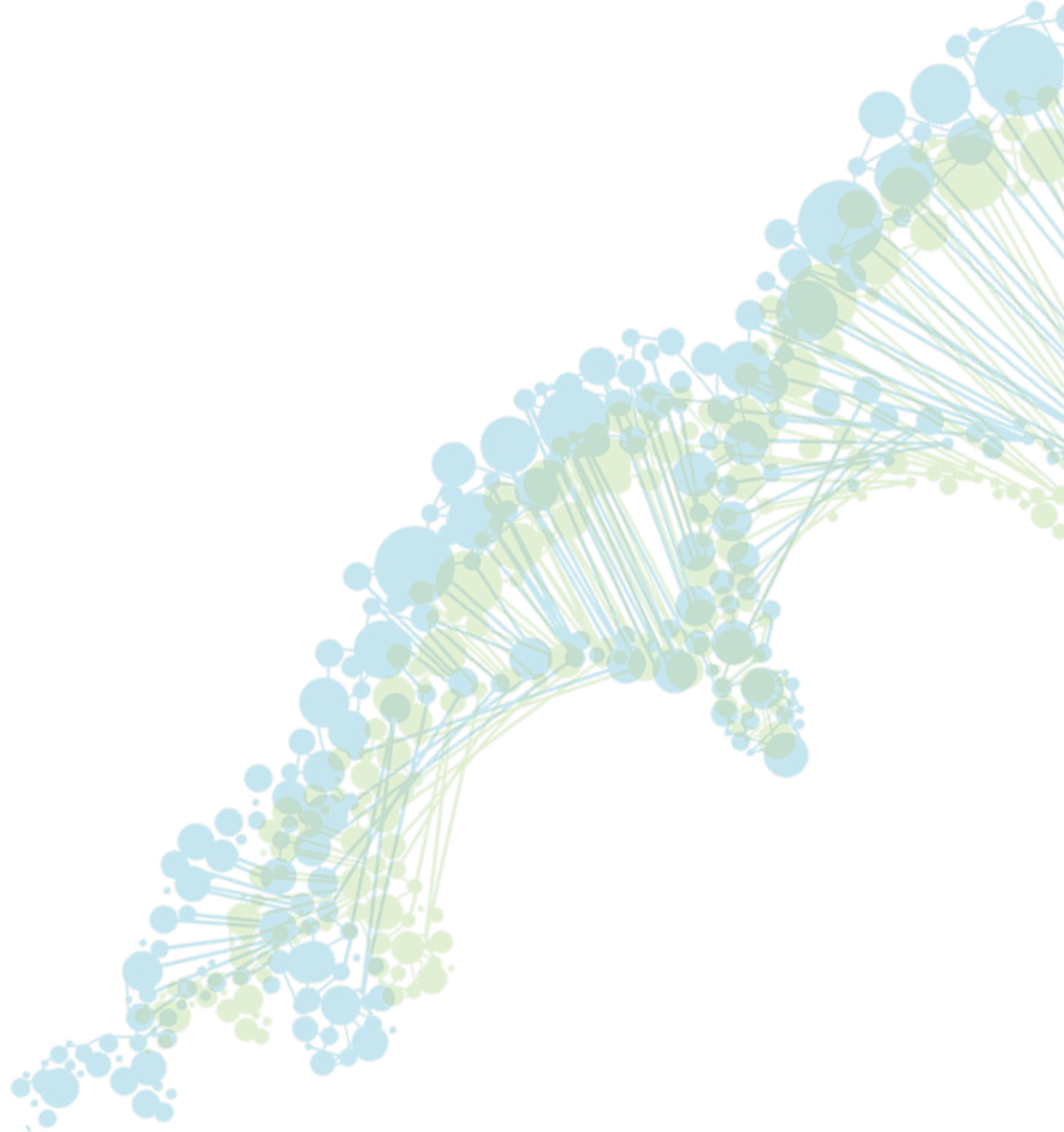


## 5. Conclusion and Perspectives

It was interesting to conduct experiments and research to understand the role of the UHRF1 and its regulation and to try to reduce its levels in cancer cells by treating with chemical compounds extracted from natural plants. Poly-ubiquitination is one of the biological processes that targets proteins into proteasomal degradation. It was uniquely found that the UHRF1 protein auto-poly-ubiquitinated after treatment with thymoquinone (TQ) extracted from black seed oil extracted from the black caraway plant (*Nigella sativa*), which led to its fading and the establishment of apoptosis by cancer cells. The results demonstrated that thymoquinone activates reactive oxygen species (ROS), which in turn damages the DNA and leads to compliance with the auto-polyubiquitination process. ROS-dependent poly-ubiquitination as inferred. The type of ubiquitin multiple labeling was also determined by the use of an antibody (anti-K48 linkage specific poly-ubiquitination) that specifically binds to the label-conjugated amino acid lysine 48, which indicated the proteasomal pathway.

We hypothesize that UHRF1 poly-ubiquitination is engaged in DNA repair processes by engaging DNA repair machinery. UHRF1 poly-ubiquitination caused by TQ is more likely to be implicated in NHJE than in HR, according to our data, particularly those linked to the identification of the UHRF1 partners (Ku70/Ku80, DNA-PK). We can't rule out the possibility that ROS production, like in human promyelocytic leukemia cells, involves both pathways. Poly-ubiquitinated UHRF1 has a molecular weight (MW) that we estimate to be far above 300kDa. Therefore, to our opinion, at least 25 ubiquitin molecules have been linked to UHRF1 at this point. It's hard for us to imagine that a cell would devote so much energy to attaching 25 molecules of ubiquitin (tripling the MW of UHRF1) just to induce a degradation of its target. Ubiquitin chains of at least four molecules, connected by isopeptide bonds between the C terminus of one ubiquitin and lysine 48 (K48) of the next, are considered to constitute the typical targeting signal for protein degradation. We were unable to show that UHRF1 is poly-ubiquitinated through K48-linked chains, further supporting that poly-ubiquitination of UHRF1 is not involved in its degradation. It is hypothesized here that UHRF1's high ubiquitination has a role beyond simple degradation, and hence a part in DNA repair. It is, however, not sufficient to increase *p16<sup>INK4A</sup>* expression via poly-ubiquitination of UHRF1. Indeed, a cell's initial response to a DNA aggression is to try to repair it. In order to do this, UHRF1 will be poly-ubiquitinated, which will activate the DNA repair machinery without affecting the expression of tumor suppressor genes or activating the apoptosis pathway. In accordance with, we could often observe in the first minutes of TQ treatment a slight increase in UHRF1 expression which

would support this hypothesis. It's possible that the caspase pathway might play a role in the destruction of poly-ubiquitinated UHRF1 when a cancer cell decides that the DNA damage is too great to repair, such under the action of TQ. Further evidence suggests that cancer cells with higher UHRF1 levels are more likely to repair DNA damage and silence tumor suppressor genes. This makes them more resistant to anti-cancer therapy and hence more likely to spread. According to our hypothesis, a cancer's susceptibility to corticoid treatment might be influenced by the amount of UHRF1 protein expressed. Consequently, it will be interesting to investigate whether such mechanism is unique to cancer cells, *i.e.*, to check in non-cancerous cells whether poly-ubiquitination of UHRF1 is able or not to keep the TSGs in a silenced state. We started this study to provide answers as to the role of UHRF1 ubiquitination. We are convinced that we have discovered interesting avenues to improve the knowledge of UHRF1 functions in cancer cells. However, as our study progressed, we found that each result raised more questions than answers, but that is the basis of the research.



## Chapter (VI)

# BIBLIOGRAPHY REFERENCES



## 6. Bibliography References

### 6.1. Publications, Articles and Books

The citation style which applied in this project was according to **American Psychological Association (APA)** style, which represents the following arrangement:

Author last name, Author First Initial. Author Second Initial. (Publication Year) Title of article. Title of Journal. Volume (Issue; if issue numbered): from page № – to page №.

#### A

Abbadly AQ., Bronner C, Bathami K, Muller CD, Jeanblanc M, Mathieu E, Klein JP, Candolfi E, Mousli M. (2005) TCR pathway involves ICBP90 gene down-regulation via E2F binding sites. *Biochem Pharmacol.* 70(4):570-9.

Abusnina A., Alhosin M, Keravis T, Muller CD, Fuhrmann G, Bronner C, Lugnier C. (2011/A) Down-regulation of cyclic nucleotide phosphodiesterase PDE1A is the key event of p73 and UHRF1 deregulation in thymoquinone-induced acute lymphoblastic leukemia cell apoptosis. *Cell Signal.* 23(1):152-60.

Abusnina A., Keravis T, Yougbaré I, Bronner C, Lugnier C. (2011/B) Anti-proliferative effect of curcumin on melanoma cells is mediated by PDE1A inhibition that regulates the epigenetic integrator UHRF1. *Mol Nutr Food Res.* 55(11):1677-89.

Achour M. (2011). Rôle de UHRF1 et de ses partenaires dans la régulation épigénétique des gènes suppresseurs de tumeur. PhD thesis, Supervised by Bronner C., Strasbourg University, Biophotonics and Pharmacology Laboratory, CNRS\_UMR 7213.

Achour M., Fuhrmann G, Alhosin M, Rondé P, Chataigneau T, Mousli M, Schini-Kerth VB, Bronner C. (2009) UHRF1 recruits the histone acetyltransferase Tip60 and controls its expression and activity. *Biochem Biophys Res Commun.* 390(3):523-8.

Achour M., Jacq X, Rondé P, Alhosin M, Charlot C, Chataigneau T, Jeanblanc M, Macaluso M, Giordano A, Hughes AD, Schini-Kerth VB, Bronner C. (2008) The interaction of the SRA domain of ICBP90 with a novel domain of DNMT1 is involved in the regulation of VEGF gene expression. *Oncogene.* 27(15):2187-97.

Achour M., Mousli M., Alhosin M., Ibrahim A, Peluso J, Muller CD, Schini-Kerth VB., Hamiche A., Dhe-Paganon S. and Bronner C. (2013) Epigallocatechin-3-gallate up-regulates tumor suppressor gene expression via a reactive oxygen species-dependent down-regulation of UHRF1. *Biochem Biophys Res Commun.* 430(1):208-12.

Adam, S., and Polo, S.E. (2012). Chromatin dynamics during nucleotide excision repair: histones on the move. *Int. J. Mol. Sci.* 13, 11895–11911.

Aguilar, C., Craighead, H. Micro- and nanoscale devices for the investigation of epigenetics and chromatin dynamics (2013). *Nature Nanotech* 8, 709–718.

Ahmad, T., Ashraf, W., Ibrahim, A., Zaayter, L., Muller, C. D., Hamiche, A., Mély, Y., Bronner, C., and Mousli, M. (2021). TIP60 governs the auto-ubiquitination of UHRF1 through USP7 dissociation from the UHRF1/USP7 complex. *International journal of oncology*, 59(5), 89.

Akhade VS., Pal D. and Kanduri C. (2017) Long Noncoding RNA: Genome Organization and Mechanism of Action. *Adv Exp Med Biol.* 1008:47-74.

Alhosin M., Abusnina A, Achour M, Sharif T, Muller C, Peluso J, Chataigneau T, Lugnier C, Schini-Kerth VB, Bronner C, Fuhrmann G. (2010) Induction of apoptosis by thymoquinone in lymphoblastic leukemia Jurkat cells is mediated by a p73-dependent pathway which targets the epigenetic integrator UHRF1. *Biochem Pharmacol.* 79(9):1251-60.

Alhosin, M., Omran, Z., Zamzami, M. A., Al-Malki, A. L., Choudhry, H., Mousli, M., and Bronner, C. (2016). Signalling pathways in UHRF1-dependent regulation of tumor suppressor genes in cancer. *Journal of experimental and clinical cancer research : CR*, 35(1), 174.

Alhosin, M., Sharif, T., Mousli, M., Etienne-Selloum, N., Fuhrmann, G., Schini-Kerth, V. B., and Bronner, C. (2011). Down-regulation of UHRF1, associated with re-expression of tumor suppressor genes, is a common feature of natural compounds exhibiting anti-cancer properties. *Journal of experimental and clinical cancer research : CR*, 30(1), 41.

Allah (610-632) Surah Al-Isra. *The Holy Quran.* 17:85(15), 282-293.

Álvarez-Errico D., Vento-Tormo R., Sieweke M. and Ballestar E. (2015) Epigenetic control of myeloid cell differentiation, identity and function. *Nat Rev Immunol.* 15(1):7-17.

Andreescu N., Puiu M. and Niculescu M. (2018) Effects of Dietary Nutrients on Epigenetic Changes in Cancer. *Methods Mol Biol.* 1856:121-139.

Andrews, A.J., Chen, X., Zevin, A., Stargell, L.A., and Luger, K. (2010). The Histone Chaperone Nap1 Promotes Nucleosome Assembly by Eliminating Nonnucleosomal Histone DNA Interactions. *Mol. Cell* 37, 834–842.

Arima Y., Hirota T, Bronner C, Mousli M, Fujiwara T, Niwa S, Ishikawa H, Saya H. (2004) Down-regulation of nuclear protein ICBP90 by p53/p21Cip1/WAF1-dependent DNA-damage checkpoint signals contributes to cell cycle arrest at G1/S transition. *Genes Cells.* 9(2):131-42.

Arita, K., Isogai, S., Oda, T., Unoki, M., Sugita, K., Sekiyama, N., Kuwata, K., Hamamoto, R., Tochio, H., Sato, M., Ariyoshi, M., and Shirakawa, M. (2012). Recognition of modification status on a histone H3 tail by linked histone reader modules of the epigenetic regulator UHRF1. *Proceedings of the National Academy of Sciences of the United States of America*, 109(32), 12950–12955.

Ashraf, W., Ahmad, T., Almalki N. A. R., Krifa, M., Zaafter, L., Pizzi, A., Muller, C. D., Hamiche, A., Mély, Y., Bronner, C., and Mousli, M. (2022). Tannin extract from maritime pine bark exhibits anticancer properties by targeting the epigenetic UHRF1/DNMT1 tandem leading to the re-expression of TP73. *Food & function*, 13(1), 316–326.

Ashraf, W., Bronner, C., Zaafter, L., Ahmad, T., Richert, L., Alhosin, M., Ibrahim, A., Hamiche, A., Mely, Y., and Mousli, M. (2017/A). Interaction of the epigenetic integrator UHRF1 with the MYST domain of TIP60 inside the cell. *Journal of experimental and clinical cancer research: CR*, 36(1), 188.

Ashraf, W., Ibrahim, A., Alhosin, M., Zaafter, L., Ouararhni, K., Papin, C., Ahmad, T., Hamiche, A., Mély, Y., Bronner, C., and Mousli, M. (2017/B). The epigenetic integrator UHRF1: on the road to become a universal biomarker for cancer. *Oncotarget*, 8(31), 51946–51962.

Asensi, M., Ortega, A., Mena, S., Feddi, F., and Estrela, J. M. (2011). Natural polyphenols in cancer therapy. *Critical Reviews in Clinical Laboratory Sciences*, 48(5–6), 197–216.

Avvakumov GV., Walker JR, Xue S, Li Y, Duan S, Bronner C, Arrowsmith CH, Dhe-Paganon S. (2008) Nature. Structural basis for recognition of hemi-methylated DNA by the SRA domain of human UHRF1. 455(7214):822-5.

Azad GK., Swagatika S., Kumawat M., Kumawat R. and Tomar RS. (2018) Modifying Chromatin by Histone Tail Clipping. J Mol Biol. 430(18 Pt B):3051-3067.

## B

Bannister, A. J., and Kouzarides, T. (2011). Regulation of chromatin by histone modifications. Cell research, 21(3), 381–395.

Bartholomew, B. (2014). Regulating the chromatin landscape: structural and mechanistic perspectives. Annu. Rev. Biochem. 83, 671–696.

Bauer KM., Dicoivitsky R., Pellegrini M., Zhaxybayeva O. and Ragusa MJ. (2019) The structure of a highly-conserved picocyanobacterial protein reveals a Tudor domain with an RNA-binding function. J Biol Chem. 294(39):14333-14344.

Becker, P. B., and Workman, J. L. (2013). Nucleosome remodeling and epigenetics. Cold Spring Harbor perspectives in biology, 5(9), a017905.

Beere HM. (2004) "The stress of dying": the role of heat shock proteins in the regulation of apoptosis. J Cell Sci. 117(Pt 13):2641-51.

Biswas S., Rao CM. (2018) Epigenetic tools (The Writers, The Readers and The Erasers) and their implications in cancer therapy. Eur J Pharmacol. 837:8-24.

Biterge B. and Schneider R. (2014) Histone variants: key players of chromatin. Cell Tissue Res. 356(3):457-66.

Bivehed, E., and Hellman, B. (2020). Flash-comet assay. MethodsX, 7, 101161.

Bode, A. M., and Dong, Z. (2009). Epigallocatechin 3-gallate and green tea catechins: United they work, divided they fail. Cancer Prevention Research (Philadelphia, Pa.), 2(6), 514–517.

Bogdanović O and Lister R. (2017) DNA methylation and the preservation of cell identity. Curr Opin Genet Dev. 46:9-14.

Boukhari A., Alhosin M., Bronner C., Sagini K., Truchot C., Sick E., Schini-Kerth VB., André P., Mély Y., Mousli M., Gies JP. (2015) CD47 activation-induced UHRF1 over-expression is associated with silencing of tumor suppressor gene *p16<sup>INK4A</sup>* in glioblastoma cells. Anticancer Res. 35(1):149-57.

Bronner C. (2011) Control of DNMT1 abundance in epigenetic inheritance by acetylation, ubiquitylation, and the histone code. Sci Signal. 2011 Jan 25;4(157):pe3.

Bronner C., Achour M, Arima Y, Chataigneau T, Saya H, Schini-Kerth VB. (2007/A) The UHRF family: oncogenes that are drugable targets for cancer therapy in the near future?. Pharmacol Ther. 115(3):419-34.

Bronner C, Achour M, Chataigneau T and Schini-Kerth VB. (2011) "Epigenetic control of gene transcription - Chapter 5" (Epigenetics and Gene Transcription. Section III). Cancer Epigenetics:

Biomolecular Therapeutic in Human Cancer (Editors: Giordano A. and Macaluso M.), by Wiley-Blackwell Health Sciences. 57-99

Bronner, C., Alhosin, M., Hamiche, A., and Mousli, M. (2019). Coordinated Dialogue between UHRF1 and DNMT1 to Ensure Faithful Inheritance of Methylated DNA Patterns. *Genes*, 10(1), 65.

Bronner C, Chataigneau T, Schini-Kerth VB, Landry Y. (2007/B). The "Epigenetic Code Replication Machinery", ECREM: a promising drugable target of the epigenetic cell memory. *Curr Med Chem* 14: 2629-2641.

Bronner, C., Fuhrmann, G., Chédin, F. L., Macaluso, M., and Dhe-Paganon, S. (2010). UHRF1 Links the Histone code and DNA Methylation to ensure Faithful Epigenetic Memory Inheritance. *Genetics and epigenetics*, 2009(2), 29–36.

Bronner C. and Hamiche A. (2012) Cancer cell death and selection: unexpected putative roles for pRb2/p130, BORIS and CTCF in endoplasmic stress response maintained by the T-antigen. *Cell Cycle*. 11(11):2052.

Bronner C., Hopfner R. and Mousli M. (2002) Transcriptional regulation of the human topoisomerase IIalpha gene. *Anticancer Res.* 22(2A):605-12.

Bronner C., Krifa M., Mousli M. (2013) Increasing role of UHRF1 in the reading and inheritance of the epigenetic code as well as in tumorogenesis. *Biochem Pharmacol.* 86(12):1643-9.

Bronner C., Mousli M., Burger A., Mély Y. (2017) La première étape de la transmission d'un caractère épigénétique suivie par fluorescence. *Med Sci (Paris)* 33 : 717–719.

Bronner C., Trotzier MA, Filhol O, Cochet C, Rochette-Egly C, Schöller-Guinard M, Klein JP, Mousli M. (2004) The antiapoptotic protein ICBP90 is a target for protein kinase 2. *Ann N Y Acad Sci.* 1030:355-60.

Brou, C., Chaudhary, S., Davidson, I., Lutz, Y., Wu, J., Egly, J. M., Tora, L., and Chambon, P. (1993). Distinct TFIID complexes mediate the effect of different transcriptional activators. *The EMBO journal*, 12(2), 489–499.

Brunet J., Pfaff AW, Abidi A, Unoki M, Nakamura Y, Guinard M, Klein JP, Candolfi E, Mousli M. (2008) *Toxoplasma gondii* exploits UHRF1 and induces host cell cycle arrest at G2 to enable its proliferation. *Cell Microbiol.* 10(4):908-20.

Burgess, R.J., and Zhang, Z. (2013). Histone chaperones in nucleosome assembly and human disease. *Nat. Struct. Mol. Biol.* 20, 14–22.

Buz'Zard, A. R., and Lau, B. H. S. (2007). Pycnogenol reduces talc-induced neoplastic transformation in human ovarian cell cultures. *Phytotherapy Research: PTR*, 21(6), 579–586.

## C

Cappadocia, L., and Lima, C. D. (2018). Ubiquitin-like Protein Conjugation: Structures, Chemistry, and Mechanism. *Chemical reviews*, 118(3), 889–918.

Cito L., Indovina P, Forte IM, Pentimalli F, Di Marzo D, Somma P, Barone D, Penon A, Penon D, Ceccherini E, Micheli P, Saragoni L, Di Domenico M, Feola A, Roviello F, Mattioli E, Giordano

GG. and Giordano A. (2015) pRb2/p130 localizes to the cytoplasm in diffuse gastric cancer. *J Cell Physiol.* 230(4):802-5.

Chen C, Seth AK, Aplin AE. (2006). Genetic and expression aberrations of E3 ubiquitin ligases in human breast cancer. *Mol Cancer Res* 4: 695–707.

Chen, X., Zhou, Y.-L., Liang, S.-Y., Shi, Y.-C., Lin, S., and Shu, M.-Q. (2019). Overexpression of UHRF1 promoted the proliferation of vascular smooth cells via the regulation of Geminin protein levels. *Bioscience Reports*, 39(2), BSR20181341.

Chi AS, Bernstein BE. (2009). Developmental biology. Pluripotent chromatin state. *Science* 323, 220–221.

Choudhry, H., Zamzami, M. A., Omran, Z., Wu, W., Mousli, M., Bronner, C., and Alhosin, M. (2018). Targeting microRNA/UHRF1 pathways as a novel strategy for cancer therapy. *Oncology letters*, 15(1), 3–10.

Citterio E, Papait R, Nicassio F, Vecchi M, Gomiero P, Mantovani R, Di Fiore PP, Bonapace IM. (2004). Np95 is a histone-binding protein endowed with ubiquitin ligase activity. *Mol Cell Biol* 24: 2526-2535.

Cobley, J. N., Margaritelis, N. V., Morton, J. P., Close, G. L., Nikolaidis, M. G., and Malone, J. K. (2015). The basic chemistry of exercise-induced DNA oxidation: Oxidative damage, redox signaling, and their interplay. *Frontiers in Physiology*, 6, 182.

Cole AJ, Clifton-Bligh R. and Marsh DJ. (2015) Histone H2B monoubiquitination: roles to play in human malignancy. *Endocr Relat Cancer.* 22(1):T19-33.

Conner, A. H., Nagasampagi, B. A., and Rowe, J. W. (1980). Terpenoid and other extractives of western white pine bark. *Phytochemistry*, 19(6), 1121–1131.

Crick F. Central dogma of molecular biology. *Nature.* (1970) 8;227(5258):561-3.

Cutter, A. R., and Hayes, J. J. (2015). A brief review of nucleosome structure. *FEBS letters*, 589(20 Pt A), 2914–2922.

## D

Dabin, J., Fortuny, A., and Polo, S. E. (2016). Epigenome Maintenance in Response to DNA Damage. *Molecular cell*, 62(5), 712–727.

Dai, C., Shi, D., and Gu, W. (2013). Negative regulation of the acetyltransferase TIP60-p53 interplay by UHRF1 (ubiquitin-like with PHD and RING finger domains 1). *The Journal of Biological Chemistry*, 288(27), 19581–19592.

Dai, Y., Zhang, A., Shan, S., Gong, Z. and Zhou, Z. (2018). Structural basis for recognition of 53BP1 tandem Tudor domain by TIRR. *Nature communications*, 9(1), 2123.

DaRosa, P. A., Harrison, J. S., Zelter, A., Davis, T. N., Brzovic, P., Kuhlman, B. and Klevit, R. E. (2018). A Bifunctional Role for the UHRF1 UBL Domain in the Control of Hemi-methylated DNA-Dependent Histone Ubiquitylation. *Molecular cell*, 72(4), 753–765.e6.

Dawson MA and Kouzarides T. (2012) Cancer Epigenetics: From Mechanism to Therapy. *Cell*, 150(1), 12–27.

De Koning, L., Corpet, A., Haber, J.E., and Almouzni, G. (2007). Histone chaperones: an escort network regulating histone traffic. *Nat. Struct. Mol. Biol.* 14, 997–1007.

Dennehey, B.K., and Tyler, J. (2014). Histone Chaperones in the Assembly and Disassembly of Chromatin. In *Fundamentals of Chromatin*, J.L. Workman, and S.M. Abmayr, eds. (New York, NY: Springer New York), pp. 29–67.

Doi A, Park IH, Wen B, Murakami P, Aryee MJ, Irizarry R, Herb B, Acosta CL, Rho J, Loewer S, Miller J, Schlaeger T, Daley GQ, Feinberg AP. (2009). Differential methylation of tissue- and cancer-specific CpG island shores distinguishes human induced pluripotent stem cells, embryonic stem cells and fibroblasts. *Nat Genet* 41: 1350–1353.

Du Q., Luu PL., Storzaker C. and Clark SJ. (2015) Methyl-CpG-binding domain proteins: readers of the epigenome. *Epigenomics*. 7(6):1051-73.

Du Z, Song J, Wang Y, Zhao Y, Guda K, Yang S, Kao HY, Xu Y, Willis J, Markowitz SD, Sedwick D, Ewing RM and Wang Z. (2010). DNMT1 stability is regulated by proteins coordinating deubiquitination and acetylation-driven ubiquitination. *Sci Signal* 3: 1-10.

---

## E

---

Eghbaliferiz, S., and Iranshahi, M. (2016). Prooxidant Activity of Polyphenols, Flavonoids, Anthocyanins and Carotenoids: Updated Review of Mechanisms and Catalyzing Metals. *Phytotherapy Research: PTR*, 30(9), 1379–1391.

Elbahnsi A. (2017). Dynamique et stabilité du nucléosome. PhD thesis, Supervised by Hartmann B. and Oguey C., Paris-Saclay University, ENS, CNRS.

Elhamamsy A. R. (2017). Role of DNA methylation in imprinting disorders: an updated review. *Journal of assisted reproduction and genetics*, 34(5), 549–562.

Elsässer, S.J., and D’Arcy, S. (2013). Towards a mechanism for histone chaperones. *Biochim. Biophys. Acta* 1819, 211– 221.

English, C.M., Adkins, M.W., Carson, J.J., Churchill, M.E.A., and Tyler, J.K. (2006). Structural Basis for the Histone Chaperone Activity of Asf1. *Cell* 127, 495–508.

Esteller M. (2007). Cancer epigenomics: DNA methylomes and histone-modification maps. *Nat Rev Genet* 8: 286–298.

Esteller M. (2008). Epigenetics in evolution and disease. *Lancet* 372: S90–S96.

Eubanks, C. G., Dayebgadoh, G., Liu, X., and Washburn, M. P. (2017). Unravelling the biology of chromatin in health and cancer using proteomic approaches. *Expert review of proteomics*, 14(10), 905–915.

## F

Fang Z., Xing F, Bronner C, Teng Z, Guo Z. (2009) ICBP90 mediates the ERK1/2 signaling to regulate the proliferation of Jurkat T cells. *Cell Immunol.* 257(1-2):80-7.

Fillingham, J., Recht, J., Silva, A.C., Suter, B., Emili, A., Stagljar, I., Krogan, N.J., Allis, C.D., Keogh, M.-C., and Greenblatt, J.F. (2008). Chaperone control of the activity and specificity of the histone H3 acetyltransferase Rtt109. *Mol. Cell. Biol.* 28, 4342–4353.

Foster, B. M., Stolz, P., Mulholland, C. B., Montoya, A., Kramer, H., Bultmann, S., and Bartke, T. (2018). Critical Role of the UBL Domain in Stimulating the E3 Ubiquitin Ligase Activity of UHRF1 toward Chromatin. *Molecular cell*, 72(4), 739–752.e9.

Fradinho, D. M., Neto, C. P., Evtuguin, D., Jorge, F. C., Irlle, M. A., Gil, M. H., and Pedrosa de Jesus, J. (2002). Chemical characterisation of bark and of alkaline bark extracts from maritime pine grown in Portugal. *Industrial Crops and Products*, 16(1), 23–32.

Freemont P. S. (2000). RING for destruction?. *Current biology : CB*, 10(2), R84–R87.

Fujimori A, Matsuda Y, Takemoto Y, Hashimoto Y, Kubo E, Araki R, Fukumura R, Mita K, Tatsumi K. and Muto M. (1998). Cloning and mapping of Np95 gene which encodes a novel nuclear protein associated with cell proliferation. *Mamm Genome* 12: 1032–1035.

## G

Galadari, S., Rahman, A., Pallichankandy, S., and Thayyullathil, F. (2017). Reactive oxygen species and cancer paradox: To promote or to suppress?. *Free radical biology and medicine*, 104, 144–164.

Gao, S.-S., Guan, H., Yan, S., Hu, S., Song, M., Guo, Z.-P., Xie, D.-F., Liu, Y., Liu, X., Zhang, S., and Zhou, P.-K. (2020). TIP60 K430 SUMOylation attenuates its interaction with DNA-PKcs in S-phase cells: Facilitating homologous recombination and emerging target for cancer therapy. *Science Advances*, 6(28), eaba7822.

Gao, L., Tan, X. F., Zhang, S., Wu, T., Zhang, Z. M., Ai, H. W. and Song, J. (2018). An Intramolecular Interaction of UHRF1 Reveals Dual Control for Its Histone Association. *Structure* (London, England: 1993), 26(2), 304–311.e3.

Gayon J. (2016) From Mendel to epigenetics: History of genetics. *C R Biol.* 339(7-8):225-30.

Ginder, G. D., and Williams, D. C., Jr (2018). Readers of DNA methylation, the MBD family as potential therapeutic targets. *Pharmacology and therapeutics*, 184, 98–111.

Gong, F., and Miller, K. M. (2019). Histone methylation and the DNA damage response. *Mutation research*, 780, 37–47.

Gosselin, K., Deruy, E., Martien, S., Vercamer, C., Bouali, F., Dujardin, T., Slomianny, C., Houel-Renault, L., Chelli, F., De Launoit, Y., and Abbadie, C. (2009). Senescent keratinocytes die by autophagic programmed cell death. *The American Journal of Pathology*, 174(2), 423–435.

Gräff J. and Mansuy I. (2008) Epigenetic codes in cognition and behaviour. *Behavioural Brain Research*. 192(1), 70-87

Gray TA., Hernandez L., Carey AH., Schaldach MA, Smithwick MJ, Rus K, Marshall Graves JA, Stewart CL. and Nicholls RD. (2000) The ancient source of a distinct gene family encoding proteins featuring RING and C3H zinc-finger motifs with abundant expression in developing brain and nervous system. *Genomics*. 66: 76–86.

Greally, J. (2018) A user's guide to the ambiguous word 'epigenetics'. *Nat Rev Mol Cell Biol*. 19; 207–208.

Greiner VJ., Kovalenko L., Humbert N., Richert L., Birck C., Ruff M., Zaporozhets OA., Dhe-Paganon S., Bronner C., Mély Y. (2015) Site-Selective Monitoring of the Interaction of the SRA Domain of UHRF1 with Target DNA Sequences Labeled with 2-Aminopurine. *Biochemistry*. 54(39):6012-20.

Grenon M, Costelloe T, Jimeno S, O'Shaughnessy A, Fitzgerald J, Zgheib O, Degerth L, Lowndes NF. (2007). Docking onto chromatin via the *Saccharomyces cerevisiae* Rad9 Tudor domain. *Yeast* 24: 105-119.

Grover P., Asa JS. and Campos EI. (2018) H3-H4 Histone Chaperone Pathways. *Annu Rev Genet*. 52:109-130.

Gurard-Levin, Z.A., Quivy, J.-P., and Almouzni, G. (2014). Histone Chaperones: Assisting Histone Traffic and Nucleosome Dynamics. *Annu. Rev. Biochem.* 83, 487–517.

---

## H

---

Hainer, S. J., McCannell, K. N., Yu, J., Ee, L. S., Zhu, L. J., Rando, O. J., and Fazio, T. G. (2016). DNA methylation directs genomic localization of Mbd2 and Mbd3 in embryonic stem cells. *eLife*, 5, e21964.

Hall, A. W., Battenhouse, A. M., Shivram, H., Morris, A. R., Cowperthwaite, M. C., Shpak, M., and Iyer, V. R. (2018). Bivalent Chromatin Domains in Glioblastoma Reveal a Subtype-Specific Signature of Glioma Stem Cells. *Cancer research*, 78(10), 2463–2474.

Hamiche A, Shuaib M. (2013) Chaperoning the histone H3 family. *Biochim Biophys Acta*. 1819(3-4):230-237.

Hammet A, Magill C, Heierhorst J, Jackson SP. (2007). Rad9 BRCT domain interaction with phosphorylated H2AX regulates the G1 checkpoint in budding yeast. *EMBO Rep* 8: 851-857.

Hammond, C. M., Strømme, C. B., Huang, H., Patel, D. J., and Groth, A. (2017). Histone chaperone networks shaping chromatin function. *Nature reviews. Molecular cell biology*, 18(3), 141–158.

Hansen, J.C., Nyborg, J.K., Luger, K., and Stargell, L.A. (2010). Histone Chaperones, Histone Acetylation, and the Fluidity of the Chromogenome. *J. Cell. Physiol*. 224, 289–299.

Harati, K., Slodnik, P., Chromik, A. M., Behr, B., Goertz, O., Hirsch, T., Kapalschinski, N., Klein-Hitpass, L., Kolbenschlager, J., Uhl, W., Lehnhardt, M., and Daigeler, A. (2015). Pro-apoptotic effects of pycnogenol on HT1080 human fibrosarcoma cells. *International Journal of Oncology*, 46(4), 1629–1636.

Harrison, J. S., Cornett, E. M., Goldfarb, D., DaRosa, P. A., Li, Z. M., Yan, F., Dickson, B. M., Guo, A. H., Cantu, D. V., Kaustov, L., Brown, P. J., Arrowsmith, C. H., Erie, D. A., Major, M. B.,

Klevit, R. E., Krajewski, K., Kuhlman, B., Strahl, B. D., and Rothbart, S. B. (2016). Hemi-methylated DNA regulates DNA methylation inheritance through allosteric activation of H3 ubiquitylation by UHRF1. *eLife*, 5, e17101.

Harvey, Z. H., Chen, Y., and Jarosz, D. F. (2018). Protein-Based Inheritance: Epigenetics beyond the Chromosome. *Molecular cell*, 69(2), 195–202.

Hasan, M. N., Razvi, S. S., Choudhry, H., Hassan, M. A., Moselhy, S. S., Kumosani, T. A., Zamzami, M. A., Abualnaja, K. O., Halwani, M. A., Al-Malki, A. L., Ragoussis, J., Wu, W., Bronner, C., Asami, T., and Alhosin, M. (2019) Gene Ontology and Expression Studies of Strigolactone Analogues on a Hepatocellular Carcinoma Cell Line. *Analytical cellular pathology (Amsterdam)*, 2019, 1598182.

Hashimoto, H., Horton, J. R., Zhang, X., Bostick, M., Jacobsen, S. E., and Cheng, X. (2008) The SRA domain of UHRF1 flips 5-methylcytosine out of the DNA helix. *Nature* 455, 826–829.

Hashimoto H, Horton JR, Zhang X. and Cheng X. (2009). UHRF1, a modular multi-domain protein, regulates replication-coupled crosstalk between DNA methylation and histone modifications. *Epigenetics* 4: 8-14.

Hassan YI. and Zempleni J. (2008) A novel, enigmatic histone modification: biotinylation of histones by holocarboxylase synthetase. *Nutr Rev.* 2008 Dec;66(12):721-5.

Hauer, M. H., and Gasser, S. M. (2017). Chromatin and nucleosome dynamics in DNA damage and repair. *Genes and development*, 31(22), 2204–2221.

Henikoff S., Grealley JM. (2016) Epigenetics, cellular memory and gene regulation. *Curr Biol.* 26(14):R644-8.

Heir R, Ablasou C, Dumontier E, Elliott M, Fagotto-Kaufmann C. and Bedford FK. (2006). The UBL domain of PLIC-1 regulates aggresome formation. *EMBO Rep* 7: 1252–1258.

Hirotsune S., Yoshida N., Chen A., Garrett L., Sugiyama F., Takahashi S., Yagami K., Wynshaw-Boris A. and Yoshiki A. (2003) An expressed pseudogene regulates the messenger-RNA stability of its homologous coding gene. *Nature.* 423: 91–6.

Hopfner R., Mousli M, Garnier JM, Redon R, du Manoir S, Chatton B, Ghyselinck N, Oudet P, Bronner C. (2001) Genomic structure and chromosomal mapping of the gene coding for ICBP90, a protein involved in the regulation of the topoisomerase IIalpha gene expression. *Gene.* 266(1-2):15-23.

Hopfner R., Mousli M, Jeltsch JM, Voulgaris A, Lutz Y, Marin C, Bellocq JP, Oudet P, Bronner C. (2000) ICBP90, a novel human CCAAT binding protein, involved in the regulation of topoisomerase IIalpha expression. *Cancer Res.* 60(1):121-8.

Hopfner R., Mousli M, Oudet P, Bronner C. (2002) Overexpression of ICBP90, a novel CCAAT-binding protein, overcomes cell contact inhibition by forcing topoisomerase II alpha expression. *Anticancer Res.* 22(6A):3165-70.

Horii, T., and Hatada, I. (2016). Regulation of CpG methylation by DNMT and Tet in pluripotent stem cells. *The Journal of reproduction and development*, 62(4), 331–335.

Huang, W. W., Yang, J. S., Lin, C. F., Ho, W. J., and Lee, M. R. (2005). Pycnogenol induces differentiation and apoptosis in human promyeloid leukemia HL-60 cells. *Leukemia Research*, 29(6), 685–692.

Huyen Y, Zgheib O, Ditullio RA Jr, Gorgoulis VG, Zacharatos P, Petty TJ, Sheston EA, Mellert HS, Stavridi ES, and Halazonetis TD. (2004). Methylated lysine 79 of histone H3 targets 53BP1 to DNA double-strand breaks. *Nature* 432: 406-411.

Huynh, H. T., and Teel, R. W. (2000). Selective induction of apoptosis in human mammary cancer cells (MCF-7) by pycnogenol. *Anticancer Research*, 20(4), 2417–2420.

Hyun, K., Jeon, J., Park, K., and Kim, J. (2017). Writing, erasing and reading histone lysine methylations. *Experimental and molecular medicine*, 49(4), e324.

## I

Ibrahim, A., Alhosin, M., Papin, C., Ouarrhni, K., Omran, Z., Zamzami, M. A., Al-Malki, A. L., Choudhry, H., Mély, Y., Hamiche, A., Mousli, M., and Bronner, C. (2018). Thymoquinone challenges UHRF1 to commit auto-ubiquitination: a key event for apoptosis induction in cancer cells. *Oncotarget*, 9(47), 28599–28611.

Iwafuchi-Doi, M., Donahue, G., Kakumanu, A., Watts, J. A., Mahony, S., Pugh, B. F., Lee, D., Kaestner, K. H., and Zaret, K. S. (2016). The Pioneer Transcription Factor FoxA Maintains an Accessible Nucleosome Configuration at Enhancers for Tissue-Specific Gene Activation. *Molecular cell*, 62(1), 79–91.

## J

Jacob, P., Hirt, H., and Bendahmane, A. (2017). The heat-shock protein/chaperone network and multiple stress resistance. *Plant biotechnology journal*, 15(4), 405–414.

Javierre BM, Fernandez AF, Richter J, Al-Shahrour F, Martin-Subero JI, Rodriguez-Ubreva J, Berdasco M, Fraga MF, O'Hanlon TP, Rider LG, Jacinto FV, Lopez-Longo FJ, Dopazo J, Forn M, Peinado MA, Carreno L, Sawalha AH, Harley JB, Siebert R, Esteller M, Miller FW, Ballestar E. (2010). Changes in the pattern of DNA methylation associate with twin discordance in systemic lupus erythematosus. *Genome Res* 20: 170-179.

Jeanblanc M., Mousli M, Hopfner R, Bathami K, Martinet N, Abbady AQ, Siffert JC, Mathieu E, Muller CD, Bronner C. (2005) The retinoblastoma gene and its product are targeted by ICBP90: a key mechanism in the G1/S transition during the cell cycle. *Oncogene*. 24(49):7337-45.

Jenkins Y, Markovtsov V, Lang W, Sharma P, Pearsall D, Warner J, Franci C, Huang B, Huang J, Yam GC, Vistan JP, Pali E, Vialard J, Janicot M, Lorens JB, Payan DG, Hitoshi Y. (2005). Critical role of the ubiquitin ligase activity of UHRF1, a nuclear RING finger protein, in tumor cell growth. *Mol Biol Cell* 16: 5621–5629.

Ji H, Ehrlich LI, Seita J, Murakami P, Doi A, Lindau P, Lee H, Aryee MJ, Irizarry RA, Kim K, Derrick JR, Matthew AI, Thomas S, Holger K, Lena H, George QD, Irving LW, Andrew PF. (2010). Comprehensive methylome map of lineage commitment from haematopoietic progenitors. *Nature* 467: 338–342.

## K

Kachirskaja I, Shi X, Yamaguchi H, Tanoue K, Wen H, Wang EW, Appella E. and Gozani O. (2008). Role for 53BP1 Tudor domain recognition of p53 dimethylated at lysine 382 in DNA damage signaling. *J Biol Chem* 283: 34660- 34666.

Kaminsky ZA, Tang T, Wang SC, Ptak C, Oh GH, Wong AH, Feldcamp LA, Virtanen C, Halfvarson J, Tysk C. (2009). DNA methylation profiles in monozygotic and dizygotic twins. *Nat Genet* 41: 240–245.

Kang, J., Daines, J. R., Warren, A. N., and Cowan, M. L. (2019). Epigenetics for the 21<sup>st</sup>-Century Biology Student. *Journal of microbiology and biology education*, 20(3), 20.3.56.

Karagianni P, Amazit L, Qin J, Wong J. (2008). ICBP90, a novel methyl K9 H3 binding protein linking protein ubiquitination with heterochromatin formation. *Mol Cell Biol* 28: 705 717.

Karlic R, Chung HR, Lasserre J, Vlahovicek K, Vingron M. (2010). Histone modification levels are predictive for gene expression. *Proc Natl Acad Sci USA* 107: 2926–2931.

Keating S.T., Plutzky J., and El-Osta A. (2016) Epigenetic Changes in Diabetes and Cardiovascular Risk. *Circulation Research*. 118(11):1706–1722

Kilin, V., Gavvala, K., Barthes, N. P., Michel, B. Y., Shin, D., Boudier, C., Mauffret, O., Yashchuk, V., Mousli, M., Ruff, M., Granger, F., Eiler, S., Bronner, C., Tor, Y., Burger, A., and Mély, Y. (2017). Dynamics of Methylated Cytosine Flipping by UHRF1. *Journal of the American Chemical Society*, 139(6), 2520–2528.

Kinde, B., Wu, D. Y., Greenberg, M. E., and Gabel, H. W. (2016). DNA methylation in the gene body influences MeCP2-mediated gene repression. *Proceedings of the National Academy of Sciences of the United States of America*, 113(52), 15114–15119.

Kobow K. and Blümcke I. (2018) Epigenetics in epilepsy. *Neuroscience Letters*. 667; 40-46.

Kong, X., Chen, J., Xie, W., Brown, S. M., Cai, Y., Wu, K., Fan, D., Nie, Y., Yegnasubramanian, S., Tiedemann, R. L., Tao, Y., Chiu Yen, R. W., Topper, M. J., Zahnnow, C. A., Easwaran, H., Rothbart, S. B., Xia, L., and Baylin, S. B. (2019). Defining UHRF1 Domains that Support Maintenance of Human Colon Cancer DNA Methylation and Oncogenic Properties. *Cancer cell*, 35(4), 633–648.e7.

Kraft E., Bostick M., Jacobsen SE. and Callis J. (2008). ORTH/VIM proteins that regulate DNA methylation are functional ubiquitin E3 ligases. *Plant J* 56: 704–715.

Krifa, M., Alhosin, M., Muller, C. D., Gies, J. P., Chekir-Ghedira, L., Ghedira, K., Mély, Y., Bronner, C., and Mousli, M. (2013). *Limoniastrum guyonianum* aqueous gall extract induces apoptosis in human cervical cancer cells involving *p16<sup>INK4A</sup>* re-expression related to UHRF1 and DNMT1 down-regulation. *Journal of experimental and clinical cancer research: CR*, 32(1), 30.

Krifa M., Leloup L, Ghedira K, Mousli M, Chekir-Ghedira L. (2014) Luteolin induces apoptosis in BE colorectal cancer cells by downregulating calpain, UHRF1, and DNMT1 expressions. *Nutr Cancer*. 66(7):1220-7.

Kulis M. and Esteller M. (2010) DNA methylation and cancer. *Adv Genet*. 70:27-56.

## L

- Labie D. (2003) L'évolution d'un pseudogène vers un rôle fonctionnel. *Med Sci.* 19 : 1066–1067
- Lallous N. (2010). Etude structurale et fonctionnelle des modules de reconnaissance des marques épigénétiques dans la protéine humaine UHRF1. PhD thesis, Supervised by Samama J., Strasbourg University, Institut de Génétique et de Biologie Moléculaire et Cellulaire (IGBMC).
- Längst, G., and Manelyte, L. (2015). Chromatin Remodelers: From Function to Dysfunction. *Genes* 6, 299–324.
- Laskey, R.A., Honda, B.M., Mills, A.D., and Finch, J.T. (1978). Nucleosomes are assembled by an acidic protein which binds histones and transfers them to DNA. *Nature* 275, 416–420.
- Lee JT. (2003) Complicity of gene and pseudogene. *Nature.* 423: 26–8.
- Lee, S. K., Dawson, J., Lee, J. A., Osman, G., Levitin, M. O., Guzel, R. M., and Djamgoz, M. B. (2014). Management of cancer pain: 1. Wider implications of orthodox analgesics. *International journal of general medicine*, 7, 49–58.
- León-González, A. J., Auger, C., and Schini-Kerth, V. B. (2015). Pro-oxidant activity of polyphenols and its implication on cancer chemoprevention and chemotherapy. *Biochemical Pharmacology*, 98(3), 371–380.
- León-González, A. J., Jara-Palacios, M. J., Abbas, M., Heredia, F. J., and Schini-Kerth, V. B. (2017). Role of epigenetic regulation on the induction of apoptosis in Jurkat leukemia cells by white grape pomace rich in phenolic compounds. *Food and Function*, 8(11), 4062–4069.
- Li, Y.-Y., Feng, J., Zhang, X.-L., and Cui, Y.-Y. (2015). Pine bark extracts: Nutraceutical, pharmacological, and toxicological evaluation. *The Journal of Pharmacology and Experimental Therapeutics*, 353(1), 9–16.
- Li, T., Wang, L., Du, Y., Xie, S., Yang, X., Lian, F., Zhou, Z., and Qian, C. (2018). Structural and mechanistic insights into UHRF1-mediated DNMT1 activation in the maintenance DNA methylation. *Nucleic acids research*, 46(6), 3218–3231.
- Li, C. L., Yang, W. Z., Shi, Z. and Yuan, H. S. (2018). Tudor staphylococcal nuclease is a structure-specific ribonuclease that degrades RNA at unstructured regions during microRNA decay. *RNA (New York, N.Y.)*, 24(5), 739–748.
- Liu, Y., Liang, G., Zhou, T., and Liu, Z. (2020). Silencing UHRF1 Inhibits Cell Proliferation and Promotes Cell Apoptosis in Retinoblastoma Via the PI3K/Akt Signalling Pathway. *Pathology Oncology Research: POR*, 26(2), 1079–1088.
- Liu, L., Wong, C. C., Gong, B., and Yu, J. (2018). Functional significance and therapeutic implication of ring-type E3 ligases in colorectal cancer. *Oncogene*, 37(2), 148–159.
- Liu, Y., Zhang, B., Meng, X., Korn, M. J., Parent, J. M., Lu, L. Y., and Yu, X. (2017). UHRF2 regulates local 5-methylcytosine and suppresses spontaneous seizures. *Epigenetics*, 12(7), 551–560.
- Lorenzato M., Caudroy S, Bronner C, Evrard G, Simon M, Durlach A, Birembaut P, Clavel C. (2005) Cell cycle and/or proliferation markers: what is the best method to discriminate cervical high-grade lesions?. *Hum Pathol.* 36(10):1101-7.

Lu, Z., Carter, A. C., and Chang, H. Y. (2017). Mechanistic insights in X-chromosome inactivation. *Philosophical transactions of the Royal Society of London. Series B, Biological sciences*, 372(1733), 20160356.

Luger, K., Dechassa, M. L., and Tremethick, D. J. (2012). New insights into nucleosome and chromatin structure: an ordered state or a disordered affair?. *Nature reviews. Molecular cell biology*, 13(7), 436–447.

Lyko F. (2018) The DNA methyltransferase family: a versatile toolkit for epigenetic regulation. *Nat Rev Genet.* 19(2):81-92.

## M

Ma, Y., Pannicke, U., Schwarz, K., and Lieber, M. R. (2002). Hairpin opening and overhang processing by an Artemis/DNA-dependent protein kinase complex in nonhomologous end joining and V(D)J recombination. *Cell*, 108(6), 781–794.

Marsh, D. J., and Dickson, K. A. (2019). Writing Histone Monoubiquitination in Human Malignancy-The Role of RING Finger E3 Ubiquitin Ligases. *Genes*, 10(1), 67.

Matsumura Y., Nakaki R., Inagaki T., Yoshida A., Kano Y., Kimura H., Tanaka T., Tsutsumi S., Nakao M., Doi T., Fukami K., Osborne TF., Kodama T., Aburatani H. and Sakai J. (2015) H3K4/H3K9me3 Bivalent Chromatin Domains Targeted by Lineage-Specific DNA Methylation Pauses Adipocyte Differentiation. *Mol Cell.* 60(4):584-96.

Mattiroli, F., D’Arcy, S., and Luger, K. (2015). The right place at the right time: chaperoning core histone variants. *EMBO Rep.* 16, 1454–1466.

Maze, I., Noh, K. M., Soshnev, A. A., and Allis, C. D. (2014). Every amino acid matters: essential contributions of histone variants to mammalian development and disease. *Nature reviews. Genetics*, 15(4), 259–271.

McGinty, R. K., and Tan, S. (2015). Nucleosome structure and function. *Chemical reviews*, 115(6), 2255–2273.

Mellor J. (2006). It takes a PHD to read the histone code. *Cell* 126: 22-24.

Mir, U. S., Bhat, A., Mushtaq, A., Pandita, S., Altaf, M., and Pandita, T. K. (2021). Role of histone acetyltransferases MOF and Tip60 in genome stability. *DNA Repair*, 107, 103205.

Mishima, Y., Brueckner, L., Takahashi, S., Kawakami, T., Otani, J., Shinohara, A., Takeshita, K., Garvilles, R. G., Watanabe, M., Sakai, N., Takeshima, H., Nachtgael, C., Nishiyama, A., Nakanishi, M., Arita, K., Nakashima, K., Hojo, H., and Suetake, I. (2020). Enhanced processivity of Dnmt1 by monoubiquitinated histone H3. *Genes to cells : devoted to molecular and cellular mechanisms*, 25(1), 22–32.

Moreno, S. P., and Gambus, A. (2015). Regulation of Unperturbed DNA Replication by Ubiquitylation. *Genes*, 6(3), 451–468.

Mori T, Li Y, Hata H, Ono K, Kochi H. (2002). NIRF, a novel RING finger protein, is involved in cell-cycle regulation. *Biochem Biophys Res Commun* 296: 530–536.

Moshkin, Y.M., Kan, T.W., Goodfellow, H., Bezstarosti, K., Maeda, R.K., Pilyugin, M., Karch, F., Bray, S.J., Demmers, J.A.A., and Verrijzer, C.P. (2009). Histone Chaperones ASF1 and NAP1 Differentially Modulate Removal of Active Histone Marks by LID-RPD3 Complexes during NOTCH Silencing. *Mol. Cell* 35, 782–793.

Motnenko, A., Liang, C. C., Yang, D., Lopez-Martinez, D., Yoshikawa, Y., Zhan, B., Ward, K. E., Tian, J., Haas, W., Spingardi, P., Kessler, B. M., Kriaucionis, S., Gygi, S. P., and Cohn, M. A. (2018). Identification of UHRF2 as a novel DNA interstrand crosslink sensor protein. *PLoS genetics*, 14(10), e1007643.

Mousli, M., Hopfner, R., Abbady, A. Q., Monté, D., Jeanblanc, M., Oudet, P., Louis, B., and Bronner, C. (2003). ICBP90 belongs to a new family of proteins with an expression that is deregulated in cancer cells. *British journal of cancer*, 89(1), 120–127.

Mudbhary, R., and Sadler, K. C. (2011). Epigenetics, development, and cancer: zebrafish make their mark. *Birth defects research. Part C, Embryo today: reviews*, 93(2), 194–203.

Myrianthopoulos V., Cartron PF., Liutkevičiūtė Z., Klimašauskas S., Matulis D., Bronner C., Martinet N., Mikros E. (2016) Tandem virtual screening targeting the SRA domain of UHRF1 identifies a novel chemical tool modulating DNA methylation. *Eur J Med Chem*. 114:390-6.

---

## N

---

Na, L., Tang, Y.-D., Wang, C., Liu, C., and Wang, X. (2018). Rhesus monkey TRIM5 $\alpha$  protein SPRY domain contributes to AP-1 activation. *The Journal of Biological Chemistry*, 293(8), 2661–2674.

Nady, N., Lemak, A., Walker, J. R., Avvakumov, G. V., Kareta, M. S., Achour, M., Xue, S., Duan, S., Allali-Hassani, A., Zuo, X., Wang, Y. X., Bronner, C., Chédin, F., Arrowsmith, C. H., and Dhe-Paganon, S. (2011). Recognition of multivalent histone states associated with heterochromatin by UHRF1 protein. *The Journal of biological chemistry*, 286(27), 24300–24311.

Nacey, B. A., Feng, L., Bagert, J. D., Lemiesz, A. E., Gao, J., Soshnev, A. A., Kundra, R., Schultz, N., Muir, T. W., and Allis, C. D. (2019). The expanding landscape of 'oncohistone' mutations in human cancers. *Nature*, 567(7749), 473–478.

Natsume, R., Eitoku, M., Akai, Y., Sano, N., Horikoshi, M., and Senda, T. (2007). Structure and function of the histone chaperone CIA/ASF1 complexed with histones H3 and H4. *Nature* 446, 338–341.

Nishiyama, A., Mulholland, C. B., Bultmann, S., Kori, S., Endo, A., Saeki, Y., Qin, W., Trummer, C., Chiba, Y., Yokoyama, H., Kumamoto, S., Kawakami, T., Hojo, H., Nagae, G., Aburatani, H., Tanaka, K., Arita, K., Leonhardt, H., and Nakanishi, M. (2020). Two distinct modes of DNMT1 recruitment ensure stable maintenance DNA methylation. *Nature communications*, 11(1), 1222.

Nishiyama, A., Yamaguchi, L., Sharif, J., Johmura, Y., Kawamura, T., Nakanishi, K., Shimamura, S., Arita, K., Kodama, T., Ishikawa, F., Koseki, H., and Nakanishi, M. (2013). Uhrf1-dependent H3K23 ubiquitylation couples maintenance DNA methylation and replication. *Nature*, 502(7470), 249–253.

## P

Packer, L., Rimbach, G., and Virgili, F. (1999). Antioxidant activity and biologic properties of a procyanidin-rich extract from pine (*Pinus maritima*) bark, pycnogenol. *Free Radical Biology and Medicine*, 27(5–6), 704–724.

Papin, C., Ibrahim, A., Gras, S. L., Velt, A., Stoll, I., Jost, B., Menoni, H., Bronner, C., Dimitrov, S., and Hamiche, A. (2017). Combinatorial DNA methylation codes at repetitive elements. *Genome research*, 27(6), 934–946.

Papait R, Pistore C, Negri D, Pecoraro D, Cantarini L, Bonapace IM. (2007). Np95 is implicated in pericentromeric heterochromatin replication and in major satellite silencing. *Mol Biol Cell* 18: 1098–1106.

Patnaik D., Estève, P. O. and Pradhan, S. (2018). Targeting the SET and RING-associated (SRA) domain of ubiquitin-like, PHD and ring finger-containing 1 (UHRF1) for anti-cancer drug development. *Oncotarget*, 9(40), 26243–26258.

Paul S., Bartholomew B. (2018) Regulation of ATP-dependent chromatin remodelers: accelerators/brakes, anchors and sensors. *Biochem Soc Trans.* 46(6):1423-1430.

Pena PV, Davrazou F, Shi X, Walter KL, Verkhusha VV, Gozani O, Zhao R, Kutateladze TG. (2006). Molecular mechanism of histone H3K4me3 recognition by plant homeodomain of ING2. *Nature* 442: 100-103.

Pockley AG. (2003) Heat shock proteins as regulators of the immune response. *Lancet*. 362(9382):469-76.

Portela A. and Esteller M. (2010) Epigenetic modifications and human disease. *Nat Biotechnol.* 28(10):1057-68.

Prasad, R., D'Arcy, S., Hada, A., Luger, K., and Bartholomew, B. (2016). Coordinated Action of Nap1 and RSC in Di-sassembly of Tandem Nucleosomes. *Mol. Cell. Biol.* 36, 2262–2271.

## Q

Qadi, S. A., Hassan, M. A., Sheikh, R. A., Baothman, O. A., Zamzami, M. A., Choudhry, H., Al-Malki, A. L., Albukhari, A., and Alhosin, M. (2019). Thymoquinone-Induced Reactivation of Tumor Suppressor Genes in Cancer Cells Involves Epigenetic Mechanisms. *Epigenetics insights*, 12, 2516865719839011.

Qi, L., Wu, X.-C., and Zheng, D.-Q. (2019). Hydrogen peroxide, a potent inducer of global genomic instability. *Current Genetics*, 65(4), 913–917.

Qin W, Leonhardt H. and Spada F. (2011). Usp7 and Uhrf1 control ubiquitination and stability of the maintenance DNA methyltransferase DNMT1. *J Cell Biochem* 112: 439-444.

Qin, W., Wolf, P., Liu, N., Link, S., Smets, M., La Mastra, F., Forné, I., Pichler, G., Hörl, D., Fellingner, K., Spada, F., Bonapace, I. M., Imhof, A., Harz, H., and Leonhardt, H. (2015). DNA methylation requires a DNMT1 ubiquitin interacting motif (UIM) and histone ubiquitination. *Cell research*, 25(8), 911–929.

## R

Raghuram, G. V., Pathak, N., Jain, D., Panwar, H., Pandey, H., Jain, S. K., and Mishra, P. K. (2010). Molecular mechanisms of isocyanate induced oncogenic transformation in ovarian epithelial cells. *Reproductive Toxicology* (Elmsford, N.Y.), 30(3), 377–386.

Rasmussen, K. D., and Helin, K. (2016). Role of TET enzymes in DNA methylation, development, and cancer. *Genes and development*, 30(7), 733–750.

Ricketts, M. D., and Marmorstein, R. (2017). A Molecular Prospective for HIRA Complex Assembly and H3.3-Specific Histone Chaperone Function. *Journal of molecular biology*, 429(13), 1924–1933.

Ritchie MD., Holzinger ER., Li R., Pendergrass SA. and Kim D. (2015) Methods of integrating data to uncover genotype–phenotype interactions. *Nat Rev Genet* 16, 85–97.

Rohdewald, P. J. (2015). Update on the Clinical Pharmacology of Pycnogenol(R). *Medical Research Archives*, 3, 1–11.

Romanowska, J., and Joshi, A. (2019). From Genotype to Phenotype: Through Chromatin. *Genes*, 10(2), 76.

Root, D. E., Hacohen, N., Hahn, W. C., Lander, E. S., and Sabatini, D. M. (2006). Genome-scale loss-of-function screening with a lentiviral RNAi library. *Nature methods*, 3(9), 715–719.

## S

Sacharowski SP. and Sarnowski TJ. (2019) [Mechanisms controlling chromatin structure]. *Postepy Biochem.* 65(1):9-20.

Schmidt, S., Rainer, J., Ploner, C., Presul, E., Riml, S., and Kofler, R. (2004). Glucocorticoid-induced apoptosis and glucocorticoid resistance: Molecular mechanisms and clinical relevance. *Cell Death and Differentiation*, 11 Suppl 1, S45-55.

Schneider-Poetsch T. and Yoshida M. (2018) Along the Central Dogma-Controlling Gene Expression with Small Molecules. *Annu Rev Biochem.* 20;87:391-420.

Schotta G, Sengupta R, Kubicek S, Malin S, Kauer M, Callén E, Celeste A, Pagani M, Opravil S, De La Rosa-Velazquez IA, Espejo A, Bedford MT, Nussenzweig A, Busslinger M. and Jenuwein T. (2008). A chromatin-wide transition to H4K20 monomethylation impairs genome integrity and programmed DNA rearrangements in the mouse. *Genes Dev* 22: 2048–2061.

Senese, S., Lo, Y. C., Huang, D., Zangle, T. A., Gholkar, A. A., Robert, L., Homet, B., Ribas, A., Summers, M. K., Teitell, M. A., Damoiseaux, R., and Torres, J. Z. (2014). Chemical dissection of the cell cycle: Probes for cell biology and anti-cancer drug development. *Cell Death and Disease*, 5, e1462.

Shamma, A., Suzuki, M., Hayashi, N., Kobayashi, M., Sasaki, N., Nishiuchi, T., Doki, Y., Okamoto, T., Kohno, S., Muranaka, H., Kitajima, S., Yamamoto, K.-I., and Takahashi, C. (2013). ATM mediates pRB function to control DNMT1 protein stability and DNA methylation. *Molecular and Cellular Biology*, 33(16), 3113–3124.

Shan, H.-M., Shi, Y., and Quan, J. (2015). Identification of green tea catechins as potent inhibitors of the polo-box domain of polo-like kinase 1. *ChemMedChem*, 10(1), 158–163.

Sharif, J., and Koseki H. (2018). Hemimethylation: DNA's lasting odd couple: Stably inherited DNA hemimethylation regulates chromatin interaction and transcription. *Science*, 359(6380), 1102–1103.

Sharif, T., Alhosin, M., Auger, C., Minker, C., Kim, J. H., Etienne-Selloum, N., Bories, P., Gronemeyer, H., Lobstein, A., Bronner, C., Fuhrmann, G., and Schini-Kerth, V. B. (2012). Aronia melanocarpa juice induces a redox-sensitive p73-related caspase 3-dependent apoptosis in human leukemia cells. *PloS one*, 7(3), e32526.

Sharif T., Auger C, Alhosin M, Ebel C, Achour M, Etienne-Selloum N, Fuhrmann G, Bronner C, Schini-Kerth VB. (2010) Red wine polyphenols cause growth inhibition and apoptosis in acute lymphoblastic leukaemia cells by inducing a redox-sensitive up-regulation of p73 and down-regulation of UHRF1. *Eur J Cancer*. 46(5):983-94.

Sharif T., Auger C, Bronner C, Alhosin M, Klein T, Etienne-Selloum N, Schini-Kerth VB, Fuhrmann G. (2011) Selective proapoptotic activity of polyphenols from red wine on teratocarcinoma cell, a model of cancer stem-like cell. *Invest New Drugs*. 29(2):239-47.

Sharif, J., and Koseki, H. (2011). Recruitment of Dnmt1 roles of the SRA protein Np95 (Uhrf1) and other factors. *Progress in molecular biology and translational science*, 101, 289–310.

Singh, M., Sharma, H., and Singh, N. (2007). Hydrogen peroxide induces apoptosis in HeLa cells through mitochondrial pathway. *Mitochondrion*, 7(6), 367–373.

Skvortsova K., Iovino N., Bogdanović O. (2018) Functions and mechanisms of epigenetic inheritance in animals. *Nat Rev Mol Cell Biol*. 19(12):774-790.

Smerdon, M.J. (1991). DNA repair and the role of chromatin structure. *Curr. Opin. Cell Biol*. 3, 422–428.

Soubeyrand, S., Pope, L., Pakuts, B., and Haché, R. J. G. (2003). Threonines 2638/2647 in DNA-PK are essential for cellular resistance to ionizing radiation. *Cancer Research*, 63(6), 1198–1201.

Stefanska, B., Karlic, H., Varga, F., Fabianowska-Majewska, K., and Haslberger, A. (2012). Epigenetic mechanisms in anti-cancer actions of bioactive food components—The implications in cancer prevention. *British Journal of Pharmacology*, 167(2), 279–297.

Stillman B. (2018) Histone Modifications: Insights into Their Influence on Gene Expression. *Cell*. 175(1):6-9.

Straussman R, Nejman D, Roberts D, Steinfeld I, Blum B, Benvenisty N, Simon I, Yakhini Z, Cedar H. (2009). Developmental programming of CpG island methylation profiles in the human genome. *Nat Struct Mol Biol* 16: 564–571.

Studzinski G. P. (1999) *Cell Growth, Differentiation and Senescence: A Practical Approach*, 1<sup>st</sup> edition, Oxford University Press.

Sun, X., Liu, X., and Chen, S. (2020). The Pharmacokinetics, Tissue Distribution, Metabolism, and Excretion of Pinostrobin in Rats: Ultra-High-Performance Liquid Chromatography Coupled With Linear Trap Quadrupole Orbitrap Mass Spectrometry Studies. *Frontiers in Pharmacology*, 11, 574638.

Sun, Y. (2003). Targeting E3 ubiquitin ligases for cancer therapy. *Cancer Biol Ther* 2 : 623–629.

Sun Y. (2020) Cullin-RING Ligases and Protein Neddylation. *Adv Exp Med Biol.* 1217:1-8.

Sun YV, Turner ST, Smith JA, Hammond PI, Lazarus A, Van De Rostyne JL, Cunningham JM, Kardia SL. (2010). Comparison of the DNA methylation profiles of human peripheral blood cells and transformed B-lymphocytes. *Hum Genet* 127:651-658.

---

## T

---

Tajima S., Suetake I., Takeshita K., Nakagawa A., Kimura H. (2016) Domain Structure of the DNMT1, DNMT3a, and DNMT3b DNA Methyltransferases. *Adv Exp Med Biol.* 945:63-86.

Takanashi, K., Suda, M., Matsumoto, K., Ishihara, C., Toda, K., Kawaguchi, K., Senga, S., Kobayashi, N., Ichikawa, M., Katoh, M., Hattori, Y., Kawahara, S.-I., Umezawa, K., Fujii, H., and Makabe, H. (2017). Epicatechin oligomers longer than trimers have anti-cancer activities, but not the catechin counterparts. *Scientific Reports*, 7(1), 7791.

Talbert, P. and Henikoff, S. (2017) Histone variants on the move: substrates for chromatin dynamics. *Nat Rev Mol Cell Biol.* 18, 115–126.

Tauber, M., and Fischle, W. (2015). Conserved linker regions and their regulation determine multiple chromatin-binding modes of UHRF1. *Nucleus (Austin, Tex.)*, 6(2), 123–132.

Tien, A. L., Senbanerjee, S., Kulkarni, A., Mudbhary, R., Goudreau, B., Ganesan, S., Sadler, K. C., and Ukomadu, C. (2011). UHRF1 depletion causes a G2/M arrest, activation of DNA damage response and apoptosis. *The Biochemical Journal*, 435(1), 175–185.

Tollefsbol T. (2017) *Handbook of Epigenetics: The New Molecular and Medical Genetics*. 2<sup>nd</sup> Edition. Academic Press - Elsevier Inc.©. 2:11-24

Tomkuvienė M., Kriukienė E. and Klimašauskas S. (2016) DNA Labeling Using DNA Methyltransferases. *Adv Exp Med Biol.* 945:511-535.

Trotzler MA., Bronner C, Bathami K, Mathieu E, Abbady AQ, Jeanblanc M, Muller CD, Rochette-Egly C, Mousli M. (2004) Phosphorylation of ICBP90 by protein kinase A enhances topoisomerase IIalpha expression. *Biochem Biophys Res Commun.* 319(2):590-5.

Turner BM. (2007). Defining an epigenetic code. *Nature Cell Biol* 9: 2-6.

---

## U

---

Un F., Qi C, Prosser M, Wang N, Zhou B, Bronner C, Yen Y. (2006) Modulating ICBP90 to suppress human ribonucleotide reductase M2 induction restores sensitivity to hydroxyurea cytotoxicity. *Anticancer Res.* 26(4B):2761-7.

Unoki, M. (2011). Current and potential anticancer drugs targeting members of the UHRF1 complex including epigenetic modifiers. *Recent Patents on Anti-Cancer Drug Discovery*, 6(1), 116–130.

Unoki M., Bronner C, Mousli M. (2008) A concern regarding the current confusion with the human homolog of mouse Np95, ICBP90/UHRF1. *Radiat Res.* 169(2):240-4.

Unoki M., Brunet J, Mousli M. (2009) Drug discovery targeting epigenetic codes: the great potential of UHRF1, which links DNA methylation and histone modifications, as a drug target in cancers and toxoplasmosis. *Biochem Pharmacol.* 78(10):1279-88.

Unoki M, Daigo Y, Koinuma J, Tsuchiya E, Hamamoto R, Nakamura Y. (2010). UHRF1 is a novel diagnostic marker of lung cancer. *Br J Cancer* 103: 217–222.

Unoki M, Nishidate T, Nakamura Y. (2004). ICBP90, an E2F1 target, recruits HDAC1 and binds to methyl-CpG through its SRA domain. *Oncogene* 23: 7601-7610.

---

## V

Vandemoortele, G., Eyckerman, S., and Gevaert, K. (2019). Pick a Tag and Explore the Functions of Your Pet Protein. *Trends in biotechnology*, 37(10), 1078–1090.

Vaughan, R. M., Dickson, B. M., Whelihan, M. F., Johnstone, A. L., Cornett, E. M., Cheek, M. A., Ausherman, C. A., Cowles, M. W., Sun, Z. W., and Rothbart, S. B. (2018). Chromatin structure and its chemical modifications regulate the ubiquitin ligase substrate selectivity of UHRF1. *Proceedings of the National Academy of Sciences of the United States of America*, 115(35), 8775–8780.

Vellai, T., and Vida, G. (1999). The origin of eukaryotes: the difference between prokaryotic and eukaryotic cells. *Proceedings. Biological sciences*, 266(1428), 1571–1577.

---

## W

Walter A., Etienne-Selloum N, Brasse D, Khallouf H, Bronner C, Rio MC, Beretz A, Schini-Kerth VB. (2010) Intake of grape-derived polyphenols reduces C26 tumor growth by inhibiting angiogenesis and inducing apoptosis. *FASEB J.* 24(9):3360-9.

Wang, Z., Zhang, Y.-H., Guo, C., Gao, H.-L., Zhong, M.-L., Huang, T.-T., Liu, N.-N., Guo, R.-F., Lan, T., Zhang, W., Wang, Z.-Y., and Zhao, P. (2018). Tetrathiomolybdate Treatment Leads to the Suppression of Inflammatory Responses through the TRAF6/NFκB Pathway in LPS-Stimulated BV-2 Microglia. *Frontiers in Aging Neuroscience*, 10, 9.

Wechsler, T., Chen, B. P. C., Harper, R., Morotomi-Yano, K., Huang, B. C. B., Meek, K., Cleaver, J. E., Chen, D. J., and Wabl, M. (2004). DNA-PKcs function regulated specifically by protein phosphatase 5. *Proceedings of the National Academy of Sciences of the United States of America*, 101(5), 1247–1252.

Williams, S.K., and Tyler, J.K. (2007). Transcriptional regulation by chromatin disassembly and reassembly. *Curr. Opin. Genet. Dev.* 17, 88–93.

Wysocka J, Swigut T, Xiao H, Milne TA, Kwon SY, Landry J, Kauer M, Tackett AJ, Chait BT, Badenhorst P, Wu C, Allis CD. (2006). A PHD Finger of NURF couples histone H3 lysine 4 trimethylation with chromatin remodelling. *Nature* 442: 86-90.

---

## X

Xiao, F. H., Wang, H. T., and Kong, Q. P. (2019). Dynamic DNA Methylation During Aging: A "Prophet" of Age-Related Outcomes. *Frontiers in genetics*, 10, 107.

## Y

Yang, C. S., and Wang, H. (2016). Cancer Preventive Activities of Tea Catechins. *Molecules* (Basel, Switzerland), 21(12), E1679.

Yang Y., Chen YS., Sun BF. and Yang YG. (2018) [RNA methylation: regulations and mechanisms]. *Yi Chuan*. 40(11):964-976.

Yao, J., Leng, L., Fu, W., Li, J., Bronner, C., and Bucala, R. (2021). ICBP90 Regulates MIF Expression, Glucocorticoid Sensitivity, and Apoptosis at the MIF Immune Susceptibility Locus. *Arthritis and rheumatology* (Hoboken, N.J.), 10.1002/art.41753. Advance online publication.

Yazaki, Y. (2015). Utilization of flavonoid compounds from bark and wood: A review. *Natural Product Communications*, 10(3), 513–520.

## Z

Zaayter L., Mori M., Ahmad T., Ashraf W., Boudier C., Kilin V., Gavvala K., Richert L., Eiler S., Ruff M., Botta M., Bronner C., Mousli M., Mély Y., (2019) A Molecular Tool Targeting the Base-Flipping Activity of Human UHRF1. *Chem. Eur. J.*, 25, 13363.

Zaccara S., Ries RJ. and Jaffrey SR. (2019) Reading, writing and erasing mRNA methylation. *Nat Rev Mol Cell Biol*. 20(10):608-624.

Zhang, H., Liu, H., Chen, Y., Yang, X., Wang, P., Liu, T., Deng, M., Qin, B., Correia, C., Lee, S., Kim, J., Sparks, M., Nair, A. A., Evans, D. L., Kalari, K. R., Zhang, P., Wang, L., You, Z., Kaufmann, S. H., Lou, Z., and Pei, H. (2016). A cell cycle-dependent BRCA1-UHRF1 cascade regulates DNA double-strand break repair pathway choice. *Nature communications*, 7, 10201.

Zhang, Q., Qiao, L., Wang, X., Ding, C., and Chen, J. J. (2018). UHRF1 epigenetically down-regulates UbcH8 to inhibit apoptosis in cervical cancer cells. *Cell cycle* (Georgetown, Tex.), 17(3), 300–308.

Zhang, Y., Ji, G., Han, S., Shao, Z., Lu, Z., Huo, L., Zhang, J., Yang, R., Feng, Q., Shen, H., Wang, H., and Li, X. (2018). Tip60 Suppresses Cholangiocarcinoma Proliferation and Metastasis via PI3k-AKT. *Cellular Physiology and Biochemistry: International Journal of Experimental Cellular Physiology, Biochemistry, and Pharmacology*, 50(2), 612–628.

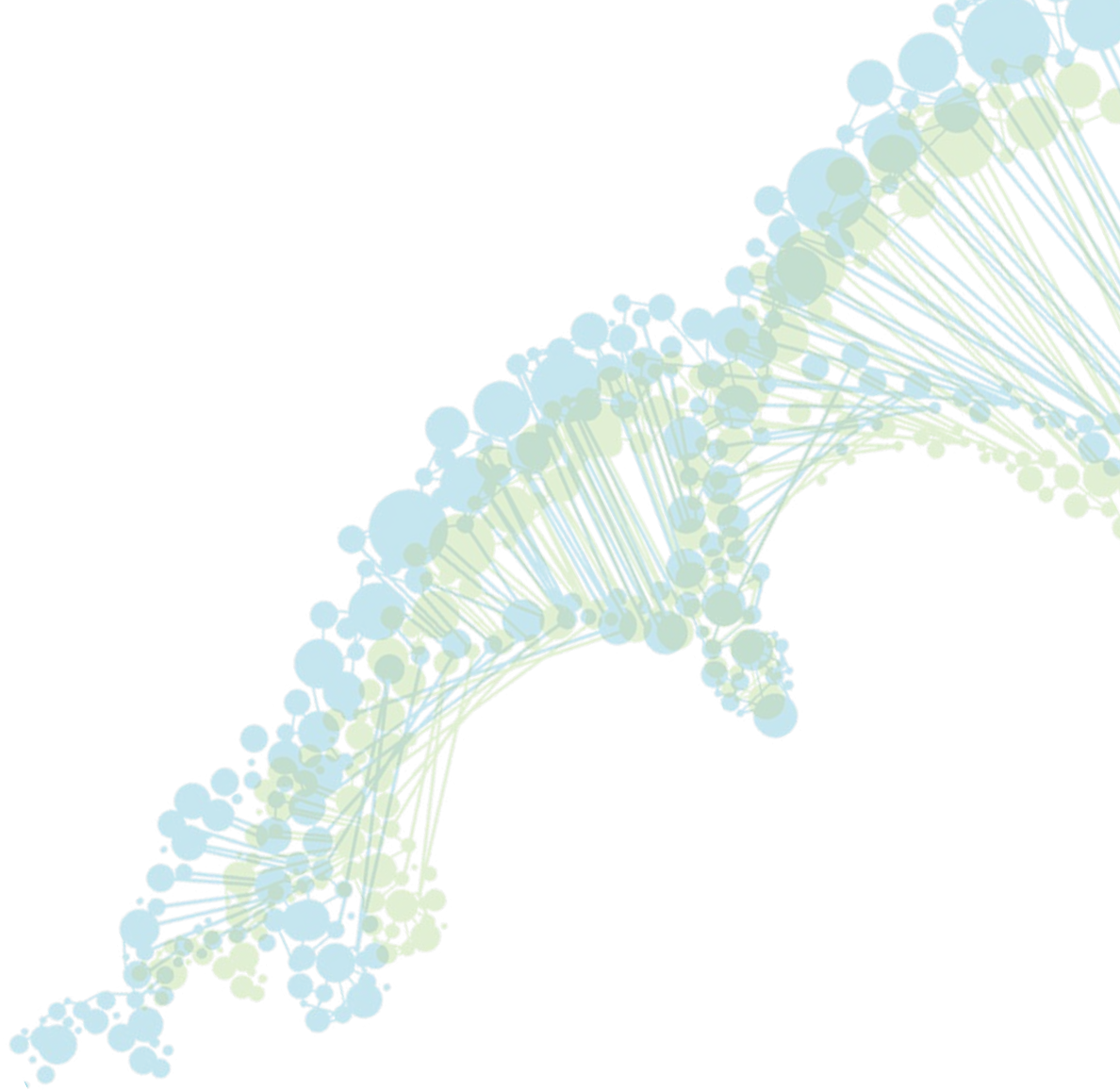
Zhao, J., Chen, X., Song, G., Zhang, J., Liu, H., and Liu, X. (2017). Uhrf1 controls the self-renewal versus differentiation of hematopoietic stem cells by epigenetically regulating the cell-division modes. *Proceedings of the National Academy of Sciences of the United States of America*, 114(2), E142–E151.

Zhou, K., Gaullier, G. and Luger, K. (2019) Nucleosome structure and dynamics are coming of age. *Nat Struct Mol Biol* 26, 3–13.

Zhou, Y., Zheng, J., Li, Y., Xu, D.-P., Li, S., Chen, Y.-M., and Li, H.-B. (2016). Natural Polyphenols for Prevention and Treatment of Cancer. *Nutrients*, 8(8), E515.

## 6.2. Websites Links

- University of Strasbourg UNISTRA (<https://www.unistra.fr/>)
- Doctoral School ED-414 (<http://ed.vie-sante.unistra.fr/>)
- IGBMC (<http://www.igbmc.fr/>)
- Saudi Digital Library SDL (<https://sdl.edu.sa/>)
- National Center for Biotechnology Information NCBI (<https://www.ncbi.nlm.nih.gov/>)
- PubMed engine (<https://www.ncbi.nlm.nih.gov/pubmed/>)
- Basic Local Alignment Search Tool BLAST (<https://blast.ncbi.nlm.nih.gov/Blast.cgi>)
- Ensemble genome browser (<https://www.ensembl.org/>)
- MultAlin – Sequence alignment tool (<http://multalin.toulouse.inra.fr/multalin/>)
- Eurofins Genomics (<https://www.eurofinsgenomics.eu/>)
- Sigma-Aldrich® “Merck” (<https://www.sigmaaldrich.com/>)
- Thermo Fisher Scientific (<https://www.thermofisher.com/>)
- Abcam (<https://www.abcam.com/>)
- abm (<https://www.abmgood.com/>)
- Protein data bank (<https://www.rcsb.org/>)
- Expasy – Protein parameter and characteristics tool (<https://web.expasy.org/protparam/>)
- NEB – Interactive tool (<https://international.neb.com/>)
- GenScript – gRNA design tool (<https://www.genscript.com/gRNA-design-tool.html>)
- Research Gate (<https://www.researchgate.net/>)
- EMBL (<https://www.embl.de/>)
- Drug Discovery World (<https://www.ddw-online.com/>)
- Learn genetics (<https://learn.genetics.utah.edu/>)



# SUPPLEMENTARY APPENDIX



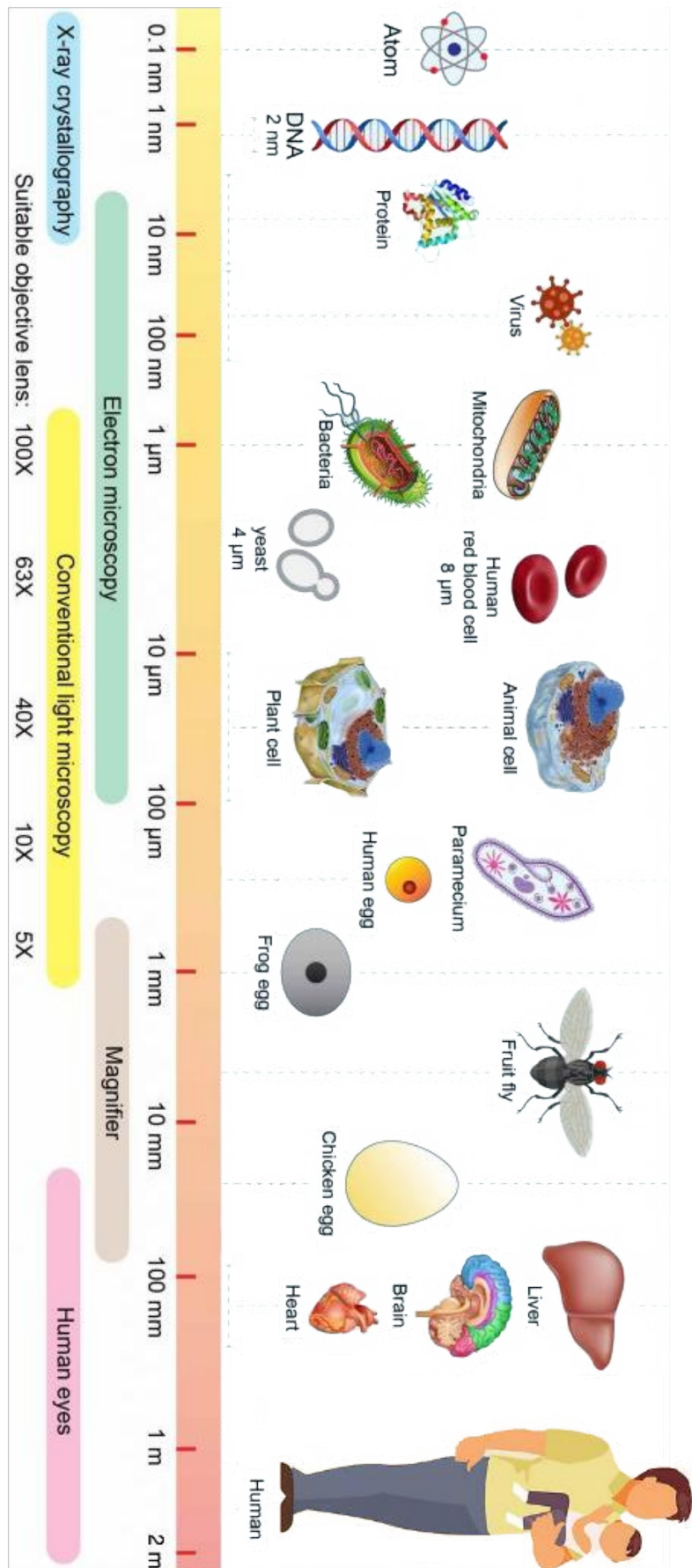


Figure S.1. Level of organization (Scale from nm to m)

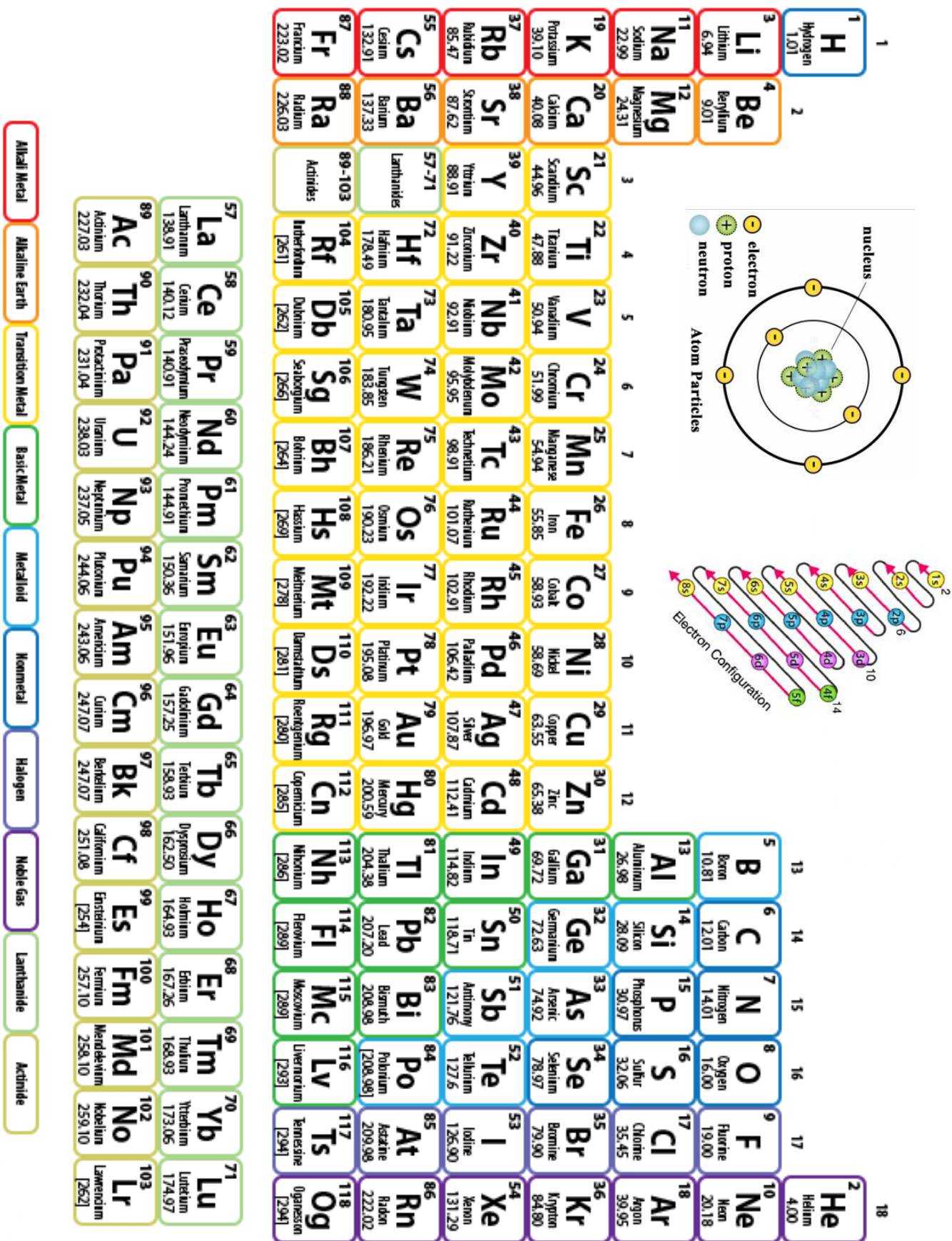


Figure S.2. Periodic Table of The Elements

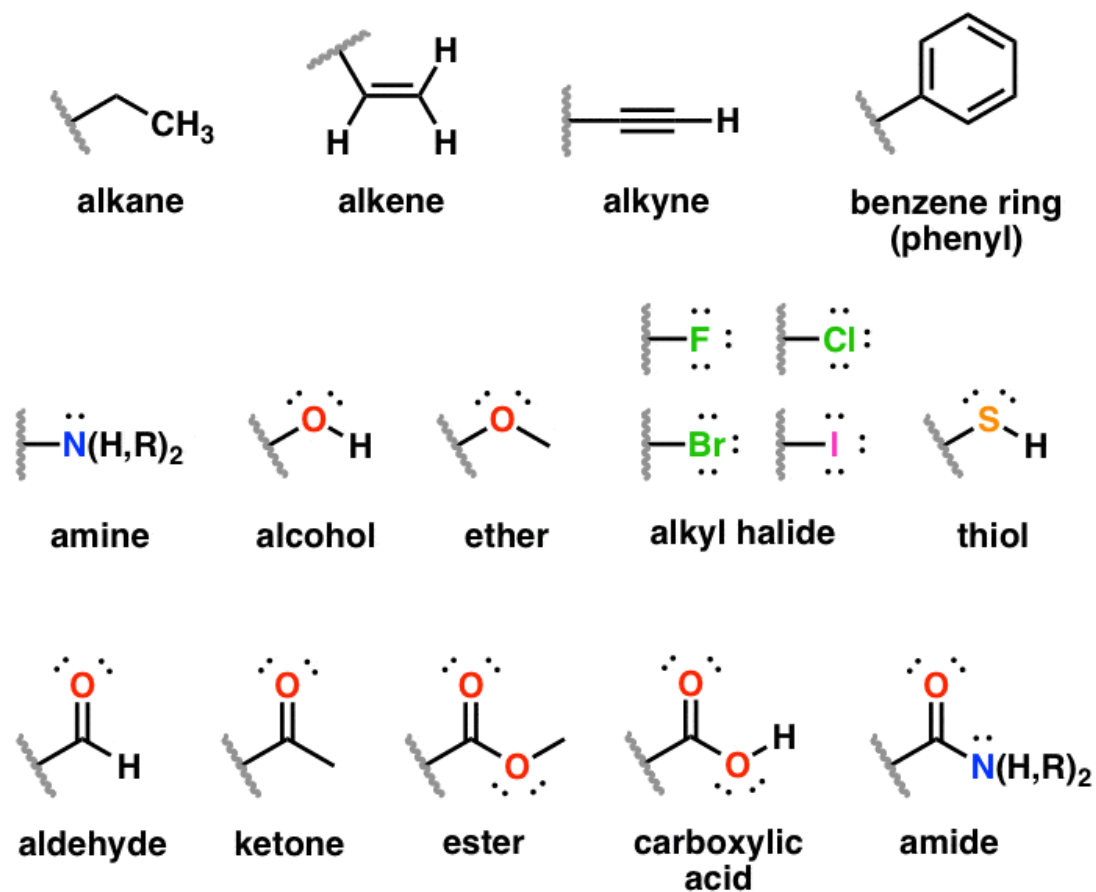


Figure S.3A. Functional Groups (The main players)

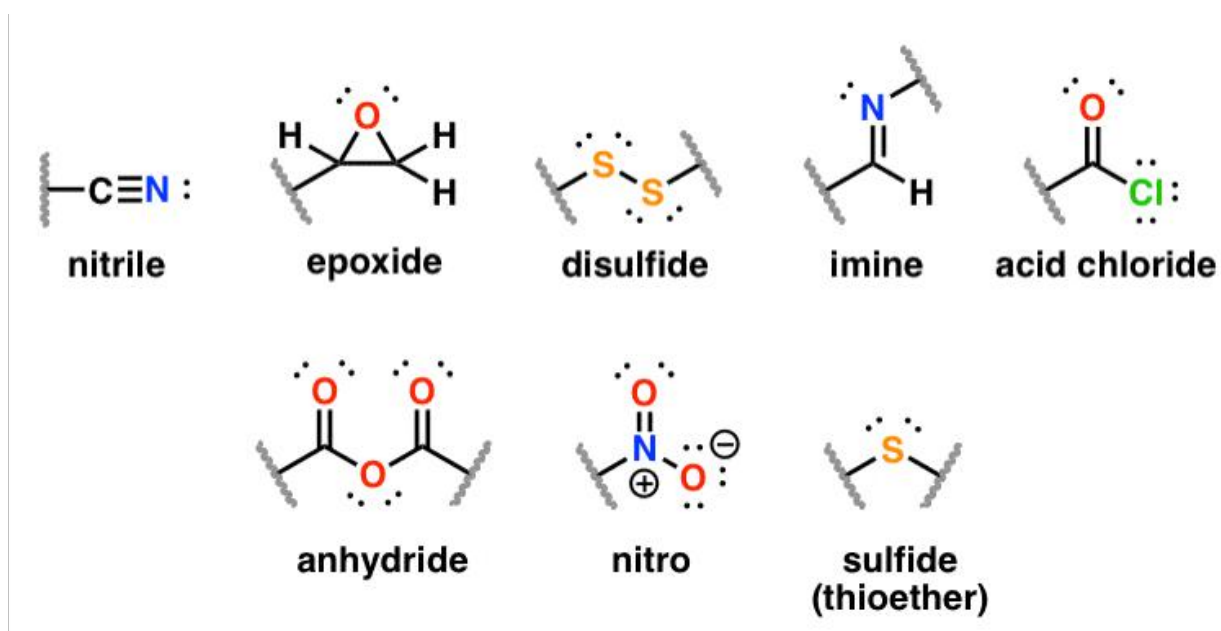


Figure S.3B. Functional Groups (Supporting actors)

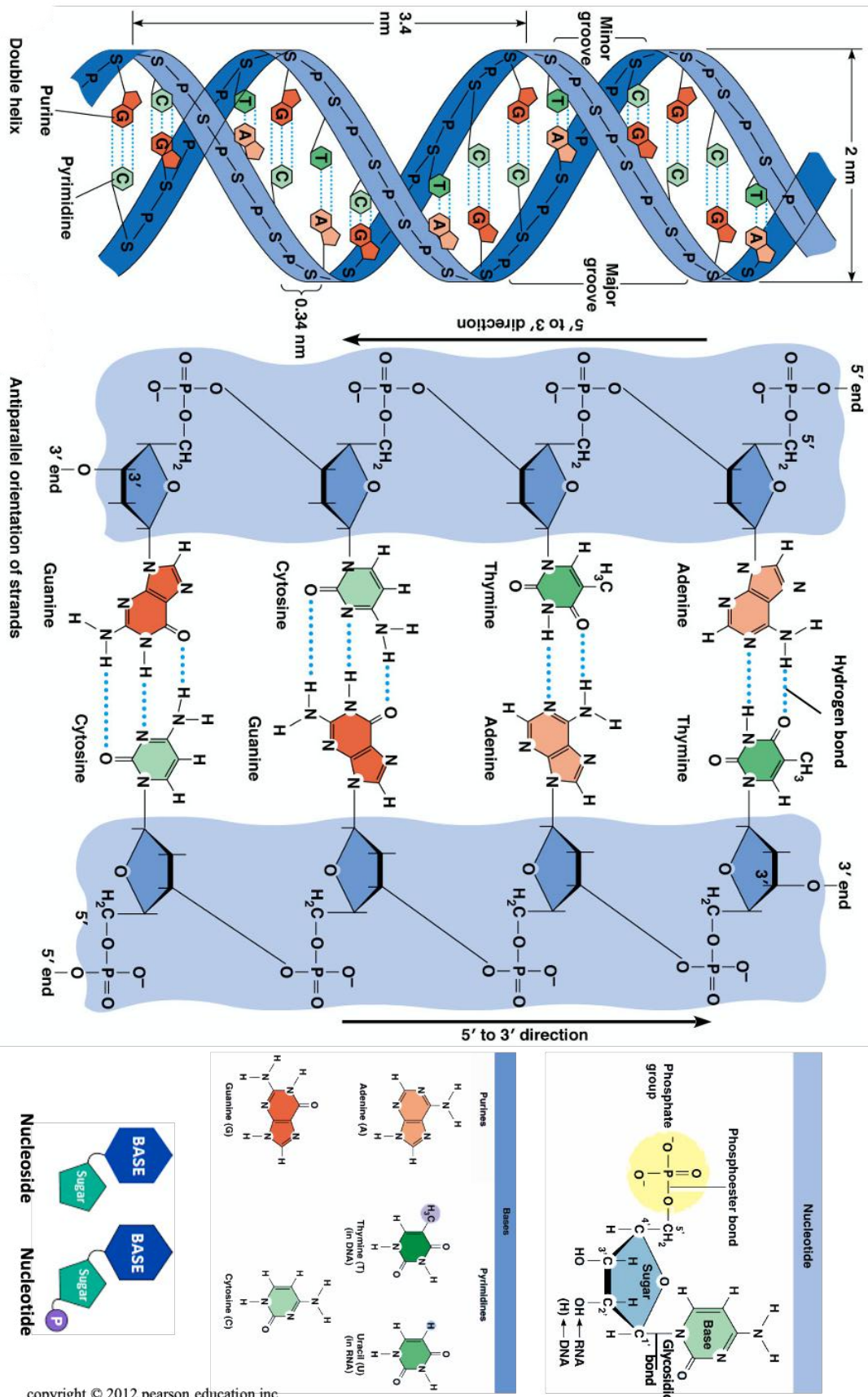
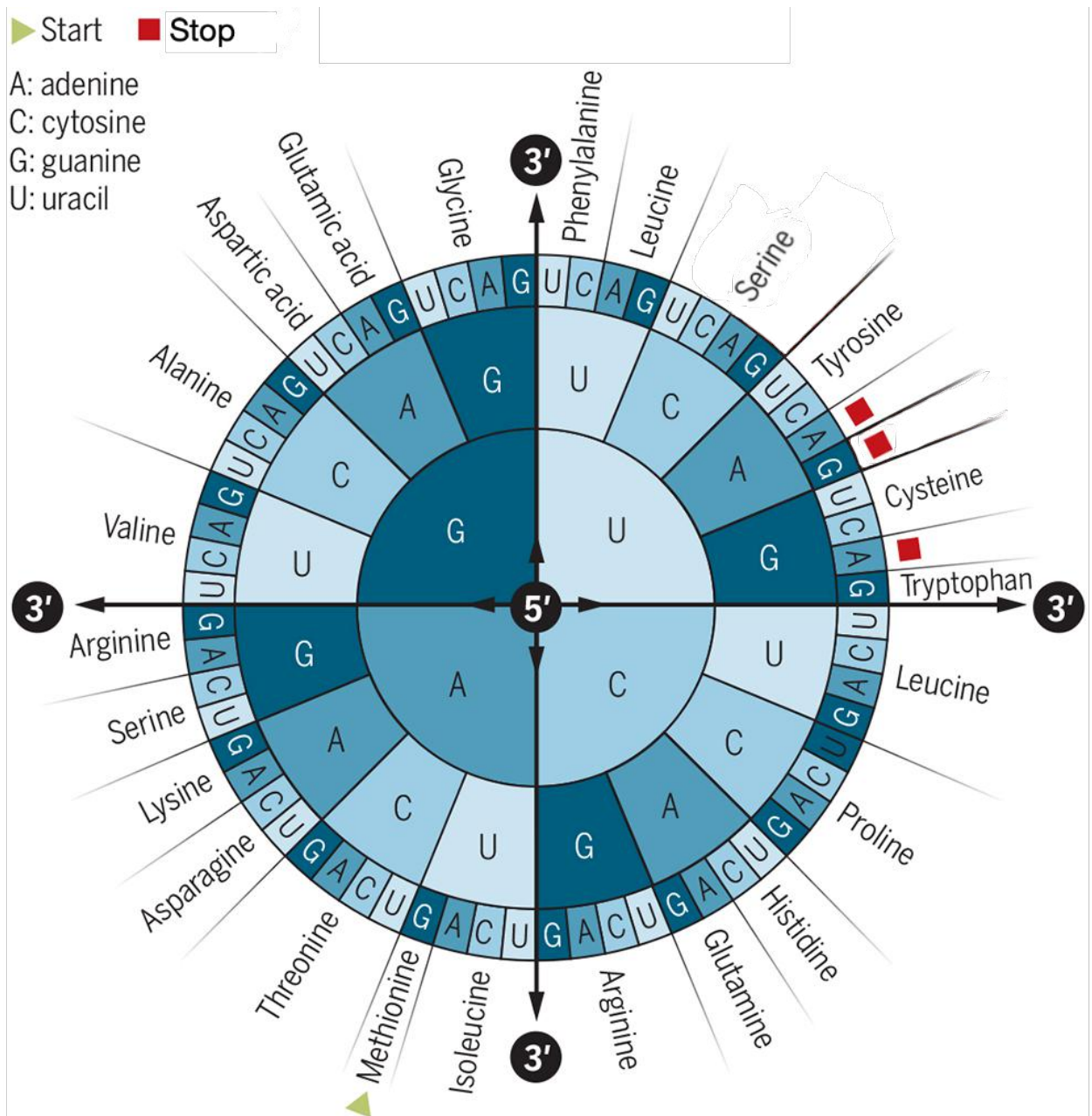


Figure S.4. Chemical Structure of DNA



**Figure S.5. Genetic Code**

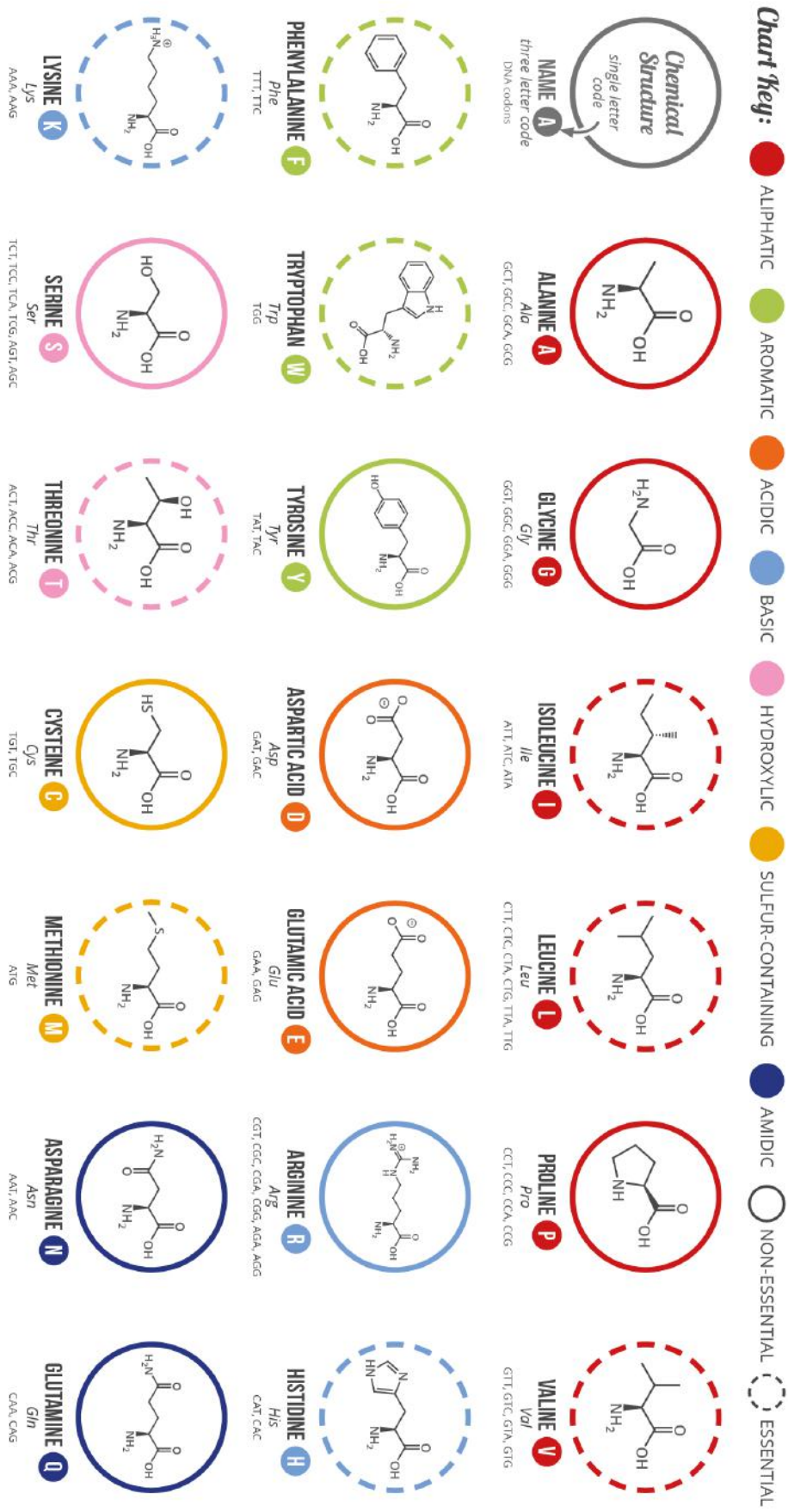


Figure S.6. Amino Acids Structures and Characteristics

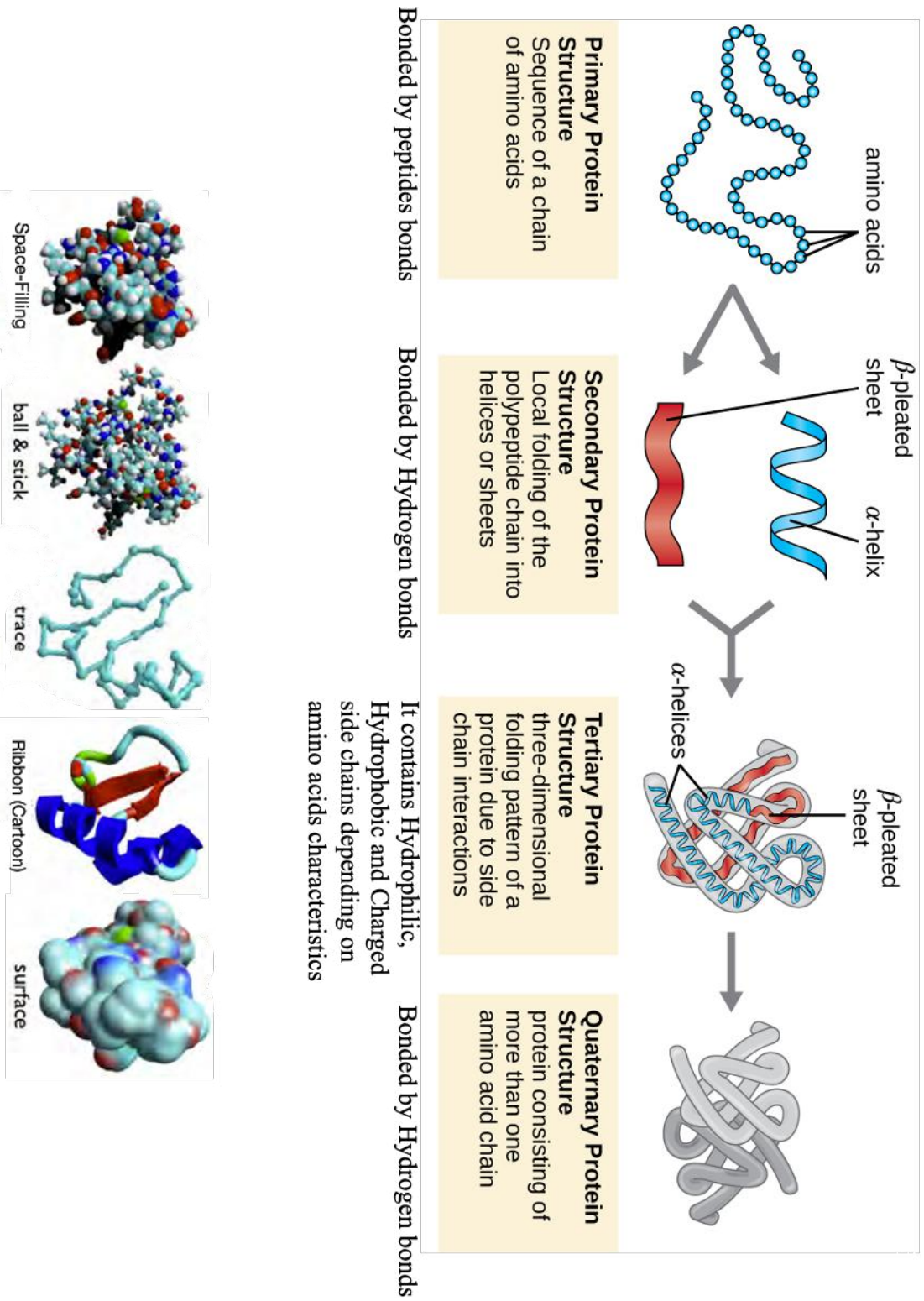


Figure S.7. Protein Structure Levels and Representation Diagrams

Figure S.8.

RCSB **PDB** Molecular Machinery: A Tour of the Protein Data Bank

PROTEIN DATA BANK  
rcsb.org

Cells build many complex molecular machines that perform the biological jobs needed for life. Some of these machines are molecular sensors that cut food into digestible pieces. Others then use these pieces to build new molecules when cells grow or tissues need to be repaired. Some molecular machines form part of beams that support cilia, and others are motors that use energy to crawl along these beams. Some recognize attacks and mobilize defenses against infection. Researchers around the world are studying these molecules at the atomic level. These 3D structures are freely available at the Protein Data Bank (PDB), the central storehouse of biomolecular structures. A few examples from the ~100,000 structures held in the PDB are shown here at a magnification of about 3,500,000 times, with each atom represented as a small sphere. The enormous range of molecular sizes is illustrated here, from the water molecule (H<sub>2</sub>O) with only three atoms (shown at the left) to the thousand-slabbed virus with hundreds of thousands of atoms.

**Digestive Enzymes: breaking food into small nutrient molecules**

- 1. Amylase
- 2. Pepsinogen
- 3. Pepsin
- 4. Invertase
- 5. Lipase
- 6. Trypsin
- 7. Chondroitinase
- 8. Bifidobacterium

**Blood Plasma Proteins: transporting nutrients and defending against injury**

- 9. Factor D
- 10. Thrombin
- 11. Serum Albumin
- 12. Serum Albumin
- 13. Albumin
- 14. Bifidobacterium

**Viruses and Antibodies: engaging in constant battle in the bloodstream**

- 15. Coxsackievirus
- 16. Herpesvirus
- 17. Epstein-Barr Virus
- 18. Herpesvirus
- 19. Herpesvirus
- 20. Herpesvirus
- 21. Herpesvirus
- 22. Herpesvirus
- 23. Herpesvirus
- 24. Herpesvirus
- 25. Herpesvirus
- 26. Herpesvirus
- 27. Herpesvirus
- 28. Herpesvirus
- 29. Herpesvirus
- 30. Herpesvirus
- 31. Herpesvirus
- 32. Herpesvirus
- 33. Herpesvirus
- 34. Herpesvirus
- 35. Herpesvirus
- 36. Herpesvirus
- 37. Herpesvirus
- 38. Herpesvirus
- 39. Herpesvirus
- 40. Herpesvirus
- 41. Herpesvirus
- 42. Herpesvirus
- 43. Herpesvirus
- 44. Herpesvirus
- 45. Herpesvirus
- 46. Herpesvirus
- 47. Herpesvirus
- 48. Herpesvirus
- 49. Herpesvirus
- 50. Herpesvirus
- 51. Herpesvirus
- 52. Herpesvirus
- 53. Herpesvirus
- 54. Herpesvirus
- 55. Herpesvirus
- 56. Herpesvirus
- 57. Herpesvirus
- 58. Herpesvirus
- 59. Herpesvirus
- 60. Herpesvirus
- 61. Herpesvirus
- 62. Herpesvirus
- 63. Herpesvirus
- 64. Herpesvirus
- 65. Herpesvirus
- 66. Herpesvirus
- 67. Herpesvirus
- 68. Herpesvirus
- 69. Herpesvirus
- 70. Herpesvirus
- 71. Herpesvirus
- 72. Herpesvirus
- 73. Herpesvirus
- 74. Herpesvirus
- 75. Herpesvirus
- 76. Herpesvirus
- 77. Herpesvirus
- 78. Herpesvirus
- 79. Herpesvirus
- 80. Herpesvirus
- 81. Herpesvirus
- 82. Herpesvirus
- 83. Herpesvirus
- 84. Herpesvirus
- 85. Herpesvirus
- 86. Herpesvirus
- 87. Herpesvirus
- 88. Herpesvirus
- 89. Herpesvirus
- 90. Herpesvirus
- 91. Herpesvirus
- 92. Herpesvirus
- 93. Herpesvirus
- 94. Herpesvirus
- 95. Herpesvirus
- 96. Herpesvirus
- 97. Herpesvirus
- 98. Herpesvirus
- 99. Herpesvirus
- 100. Herpesvirus

**Channels, Pumps and Receptors: getting back and forth across the membrane**

- 11. Sodium Channel
- 12. Sodium Channel
- 13. Sodium Channel
- 14. Sodium Channel
- 15. Sodium Channel
- 16. Sodium Channel
- 17. Sodium Channel
- 18. Sodium Channel
- 19. Sodium Channel
- 20. Sodium Channel
- 21. Sodium Channel
- 22. Sodium Channel
- 23. Sodium Channel
- 24. Sodium Channel
- 25. Sodium Channel
- 26. Sodium Channel
- 27. Sodium Channel
- 28. Sodium Channel
- 29. Sodium Channel
- 30. Sodium Channel
- 31. Sodium Channel
- 32. Sodium Channel
- 33. Sodium Channel
- 34. Sodium Channel
- 35. Sodium Channel
- 36. Sodium Channel
- 37. Sodium Channel
- 38. Sodium Channel
- 39. Sodium Channel
- 40. Sodium Channel
- 41. Sodium Channel
- 42. Sodium Channel
- 43. Sodium Channel
- 44. Sodium Channel
- 45. Sodium Channel
- 46. Sodium Channel
- 47. Sodium Channel
- 48. Sodium Channel
- 49. Sodium Channel
- 50. Sodium Channel
- 51. Sodium Channel
- 52. Sodium Channel
- 53. Sodium Channel
- 54. Sodium Channel
- 55. Sodium Channel
- 56. Sodium Channel
- 57. Sodium Channel
- 58. Sodium Channel
- 59. Sodium Channel
- 60. Sodium Channel
- 61. Sodium Channel
- 62. Sodium Channel
- 63. Sodium Channel
- 64. Sodium Channel
- 65. Sodium Channel
- 66. Sodium Channel
- 67. Sodium Channel
- 68. Sodium Channel
- 69. Sodium Channel
- 70. Sodium Channel
- 71. Sodium Channel
- 72. Sodium Channel
- 73. Sodium Channel
- 74. Sodium Channel
- 75. Sodium Channel
- 76. Sodium Channel
- 77. Sodium Channel
- 78. Sodium Channel
- 79. Sodium Channel
- 80. Sodium Channel
- 81. Sodium Channel
- 82. Sodium Channel
- 83. Sodium Channel
- 84. Sodium Channel
- 85. Sodium Channel
- 86. Sodium Channel
- 87. Sodium Channel
- 88. Sodium Channel
- 89. Sodium Channel
- 90. Sodium Channel
- 91. Sodium Channel
- 92. Sodium Channel
- 93. Sodium Channel
- 94. Sodium Channel
- 95. Sodium Channel
- 96. Sodium Channel
- 97. Sodium Channel
- 98. Sodium Channel
- 99. Sodium Channel
- 100. Sodium Channel

**Hormones: carrying molecular messages through blood**

- 1. Insulin
- 2. Glucagon
- 3. Somatostatin
- 4. Calcitonin
- 5. Parathyroid hormone
- 6. Growth hormone
- 7. Prolactin
- 8. Oxytocin
- 9. Vasopressin
- 10. Angiotensin
- 11. Aldosterone
- 12. Testosterone
- 13. Estrone
- 14. Estradiol
- 15. Progesterone
- 16. Cortisol
- 17. Thyroxine
- 18. Triiodothyronine
- 19. Calcitriol
- 20. Vitamin D
- 21. Vitamin K
- 22. Vitamin E
- 23. Vitamin C
- 24. Vitamin B12
- 25. Vitamin B6
- 26. Vitamin B1
- 27. Vitamin B2
- 28. Vitamin B3
- 29. Vitamin B5
- 30. Vitamin B7
- 31. Vitamin B9
- 32. Vitamin B10
- 33. Vitamin B11
- 34. Vitamin B12
- 35. Vitamin B13
- 36. Vitamin B14
- 37. Vitamin B15
- 38. Vitamin B16
- 39. Vitamin B17
- 40. Vitamin B18
- 41. Vitamin B19
- 42. Vitamin B20
- 43. Vitamin B21
- 44. Vitamin B22
- 45. Vitamin B23
- 46. Vitamin B24
- 47. Vitamin B25
- 48. Vitamin B26
- 49. Vitamin B27
- 50. Vitamin B28
- 51. Vitamin B29
- 52. Vitamin B30
- 53. Vitamin B31
- 54. Vitamin B32
- 55. Vitamin B33
- 56. Vitamin B34
- 57. Vitamin B35
- 58. Vitamin B36
- 59. Vitamin B37
- 60. Vitamin B38
- 61. Vitamin B39
- 62. Vitamin B40
- 63. Vitamin B41
- 64. Vitamin B42
- 65. Vitamin B43
- 66. Vitamin B44
- 67. Vitamin B45
- 68. Vitamin B46
- 69. Vitamin B47
- 70. Vitamin B48
- 71. Vitamin B49
- 72. Vitamin B50
- 73. Vitamin B51
- 74. Vitamin B52
- 75. Vitamin B53
- 76. Vitamin B54
- 77. Vitamin B55
- 78. Vitamin B56
- 79. Vitamin B57
- 80. Vitamin B58
- 81. Vitamin B59
- 82. Vitamin B60
- 83. Vitamin B61
- 84. Vitamin B62
- 85. Vitamin B63
- 86. Vitamin B64
- 87. Vitamin B65
- 88. Vitamin B66
- 89. Vitamin B67
- 90. Vitamin B68
- 91. Vitamin B69
- 92. Vitamin B70
- 93. Vitamin B71
- 94. Vitamin B72
- 95. Vitamin B73
- 96. Vitamin B74
- 97. Vitamin B75
- 98. Vitamin B76
- 99. Vitamin B77
- 100. Vitamin B78

**Photosynthesis: harvesting energy from the sun**

- 1. Photosystem II
- 2. Photosystem I
- 3. Photosystem II
- 4. Photosystem I
- 5. Photosystem II
- 6. Photosystem I
- 7. Photosystem II
- 8. Photosystem I
- 9. Photosystem II
- 10. Photosystem I
- 11. Photosystem II
- 12. Photosystem I
- 13. Photosystem II
- 14. Photosystem I
- 15. Photosystem II
- 16. Photosystem I
- 17. Photosystem II
- 18. Photosystem I
- 19. Photosystem II
- 20. Photosystem I
- 21. Photosystem II
- 22. Photosystem I
- 23. Photosystem II
- 24. Photosystem I
- 25. Photosystem II
- 26. Photosystem I
- 27. Photosystem II
- 28. Photosystem I
- 29. Photosystem II
- 30. Photosystem I
- 31. Photosystem II
- 32. Photosystem I
- 33. Photosystem II
- 34. Photosystem I
- 35. Photosystem II
- 36. Photosystem I
- 37. Photosystem II
- 38. Photosystem I
- 39. Photosystem II
- 40. Photosystem I
- 41. Photosystem II
- 42. Photosystem I
- 43. Photosystem II
- 44. Photosystem I
- 45. Photosystem II
- 46. Photosystem I
- 47. Photosystem II
- 48. Photosystem I
- 49. Photosystem II
- 50. Photosystem I
- 51. Photosystem II
- 52. Photosystem I
- 53. Photosystem II
- 54. Photosystem I
- 55. Photosystem II
- 56. Photosystem I
- 57. Photosystem II
- 58. Photosystem I
- 59. Photosystem II
- 60. Photosystem I
- 61. Photosystem II
- 62. Photosystem I
- 63. Photosystem II
- 64. Photosystem I
- 65. Photosystem II
- 66. Photosystem I
- 67. Photosystem II
- 68. Photosystem I
- 69. Photosystem II
- 70. Photosystem I
- 71. Photosystem II
- 72. Photosystem I
- 73. Photosystem II
- 74. Photosystem I
- 75. Photosystem II
- 76. Photosystem I
- 77. Photosystem II
- 78. Photosystem I
- 79. Photosystem II
- 80. Photosystem I
- 81. Photosystem II
- 82. Photosystem I
- 83. Photosystem II
- 84. Photosystem I
- 85. Photosystem II
- 86. Photosystem I
- 87. Photosystem II
- 88. Photosystem I
- 89. Photosystem II
- 90. Photosystem I
- 91. Photosystem II
- 92. Photosystem I
- 93. Photosystem II
- 94. Photosystem I
- 95. Photosystem II
- 96. Photosystem I
- 97. Photosystem II
- 98. Photosystem I
- 99. Photosystem II
- 100. Photosystem I

**Enzymes: cutting and joining the molecules of life**

- 1. DNA Polymerase
- 2. RNA Polymerase
- 3. DNA Polymerase
- 4. RNA Polymerase
- 5. DNA Polymerase
- 6. RNA Polymerase
- 7. DNA Polymerase
- 8. RNA Polymerase
- 9. DNA Polymerase
- 10. RNA Polymerase
- 11. DNA Polymerase
- 12. RNA Polymerase
- 13. DNA Polymerase
- 14. RNA Polymerase
- 15. DNA Polymerase
- 16. RNA Polymerase
- 17. DNA Polymerase
- 18. RNA Polymerase
- 19. DNA Polymerase
- 20. RNA Polymerase
- 21. DNA Polymerase
- 22. RNA Polymerase
- 23. DNA Polymerase
- 24. RNA Polymerase
- 25. DNA Polymerase
- 26. RNA Polymerase
- 27. DNA Polymerase
- 28. RNA Polymerase
- 29. DNA Polymerase
- 30. RNA Polymerase
- 31. DNA Polymerase
- 32. RNA Polymerase
- 33. DNA Polymerase
- 34. RNA Polymerase
- 35. DNA Polymerase
- 36. RNA Polymerase
- 37. DNA Polymerase
- 38. RNA Polymerase
- 39. DNA Polymerase
- 40. RNA Polymerase
- 41. DNA Polymerase
- 42. RNA Polymerase
- 43. DNA Polymerase
- 44. RNA Polymerase
- 45. DNA Polymerase
- 46. RNA Polymerase
- 47. DNA Polymerase
- 48. RNA Polymerase
- 49. DNA Polymerase
- 50. RNA Polymerase
- 51. DNA Polymerase
- 52. RNA Polymerase
- 53. DNA Polymerase
- 54. RNA Polymerase
- 55. DNA Polymerase
- 56. RNA Polymerase
- 57. DNA Polymerase
- 58. RNA Polymerase
- 59. DNA Polymerase
- 60. RNA Polymerase
- 61. DNA Polymerase
- 62. RNA Polymerase
- 63. DNA Polymerase
- 64. RNA Polymerase
- 65. DNA Polymerase
- 66. RNA Polymerase
- 67. DNA Polymerase
- 68. RNA Polymerase
- 69. DNA Polymerase
- 70. RNA Polymerase
- 71. DNA Polymerase
- 72. RNA Polymerase
- 73. DNA Polymerase
- 74. RNA Polymerase
- 75. DNA Polymerase
- 76. RNA Polymerase
- 77. DNA Polymerase
- 78. RNA Polymerase
- 79. DNA Polymerase
- 80. RNA Polymerase
- 81. DNA Polymerase
- 82. RNA Polymerase
- 83. DNA Polymerase
- 84. RNA Polymerase
- 85. DNA Polymerase
- 86. RNA Polymerase
- 87. DNA Polymerase
- 88. RNA Polymerase
- 89. DNA Polymerase
- 90. RNA Polymerase
- 91. DNA Polymerase
- 92. RNA Polymerase
- 93. DNA Polymerase
- 94. RNA Polymerase
- 95. DNA Polymerase
- 96. RNA Polymerase
- 97. DNA Polymerase
- 98. RNA Polymerase
- 99. DNA Polymerase
- 100. RNA Polymerase

**Storage: containing nutrients for future consumption**

- 1. Hemoglobin
- 2. Myoglobin
- 3. Ferritin
- 4. Ferritin
- 5. Ferritin
- 6. Ferritin
- 7. Ferritin
- 8. Ferritin
- 9. Ferritin
- 10. Ferritin
- 11. Ferritin
- 12. Ferritin
- 13. Ferritin
- 14. Ferritin
- 15. Ferritin
- 16. Ferritin
- 17. Ferritin
- 18. Ferritin
- 19. Ferritin
- 20. Ferritin
- 21. Ferritin
- 22. Ferritin
- 23. Ferritin
- 24. Ferritin
- 25. Ferritin
- 26. Ferritin
- 27. Ferritin
- 28. Ferritin
- 29. Ferritin
- 30. Ferritin
- 31. Ferritin
- 32. Ferritin
- 33. Ferritin
- 34. Ferritin
- 35. Ferritin
- 36. Ferritin
- 37. Ferritin
- 38. Ferritin
- 39. Ferritin
- 40. Ferritin
- 41. Ferritin
- 42. Ferritin
- 43. Ferritin
- 44. Ferritin
- 45. Ferritin
- 46. Ferritin
- 47. Ferritin
- 48. Ferritin
- 49. Ferritin
- 50. Ferritin
- 51. Ferritin
- 52. Ferritin
- 53. Ferritin
- 54. Ferritin
- 55. Ferritin
- 56. Ferritin
- 57. Ferritin
- 58. Ferritin
- 59. Ferritin
- 60. Ferritin
- 61. Ferritin
- 62. Ferritin
- 63. Ferritin
- 64. Ferritin
- 65. Ferritin
- 66. Ferritin
- 67. Ferritin
- 68. Ferritin
- 69. Ferritin
- 70. Ferritin
- 71. Ferritin
- 72. Ferritin
- 73. Ferritin
- 74. Ferritin
- 75. Ferritin
- 76. Ferritin
- 77. Ferritin
- 78. Ferritin
- 79. Ferritin
- 80. Ferritin
- 81. Ferritin
- 82. Ferritin
- 83. Ferritin
- 84. Ferritin
- 85. Ferritin
- 86. Ferritin
- 87. Ferritin
- 88. Ferritin
- 89. Ferritin
- 90. Ferritin
- 91. Ferritin
- 92. Ferritin
- 93. Ferritin
- 94. Ferritin
- 95. Ferritin
- 96. Ferritin
- 97. Ferritin
- 98. Ferritin
- 99. Ferritin
- 100. Ferritin

**Infrastructure: supporting and moving cells**

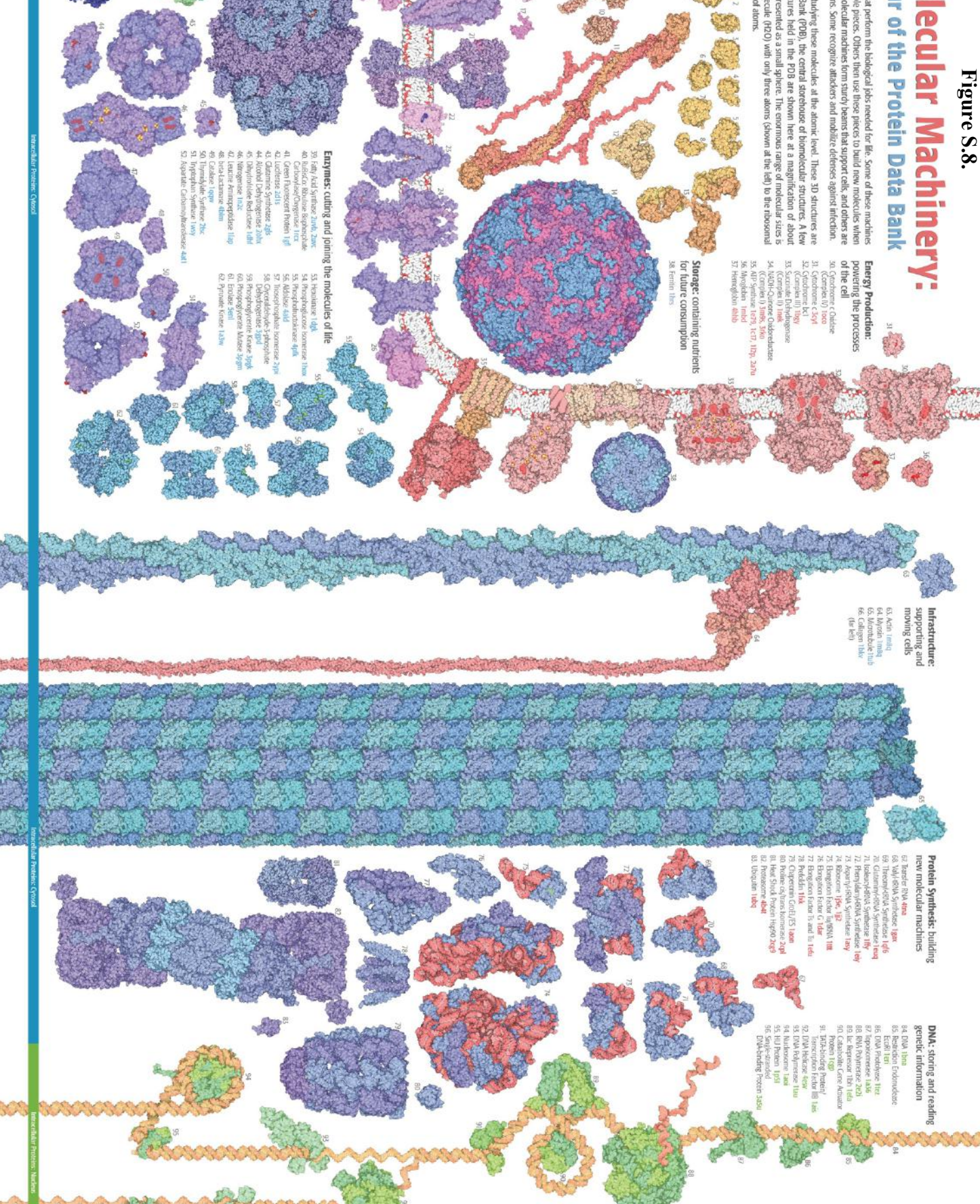
- 1. Actin
- 2. Myosin
- 3. Tubulin
- 4. Spectrin
- 5. Ankyrin
- 6. Clathrin
- 7. Caveolin
- 8. F-Actin
- 9. Myosin II
- 10. Myosin I
- 11. Tubulin
- 12. Spectrin
- 13. Ankyrin
- 14. Clathrin
- 15. Caveolin
- 16. F-Actin
- 17. Myosin II
- 18. Myosin I
- 19. Tubulin
- 20. Spectrin
- 21. Ankyrin
- 22. Clathrin
- 23. Caveolin
- 24. F-Actin
- 25. Myosin II
- 26. Myosin I
- 27. Tubulin
- 28. Spectrin
- 29. Ankyrin
- 30. Clathrin
- 31. Caveolin
- 32. F-Actin
- 33. Myosin II
- 34. Myosin I
- 35. Tubulin
- 36. Spectrin
- 37. Ankyrin
- 38. Clathrin
- 39. Caveolin
- 40. F-Actin
- 41. Myosin II
- 42. Myosin I
- 43. Tubulin
- 44. Spectrin
- 45. Ankyrin
- 46. Clathrin
- 47. Caveolin
- 48. F-Actin
- 49. Myosin II
- 50. Myosin I
- 51. Tubulin
- 52. Spectrin
- 53. Ankyrin
- 54. Clathrin
- 55. Caveolin
- 56. F-Actin
- 57. Myosin II
- 58. Myosin I
- 59. Tubulin
- 60. Spectrin
- 61. Ankyrin
- 62. Clathrin
- 63. Caveolin
- 64. F-Actin
- 65. Myosin II
- 66. Myosin I
- 67. Tubulin
- 68. Spectrin
- 69. Ankyrin
- 70. Clathrin
- 71. Caveolin
- 72. F-Actin
- 73. Myosin II
- 74. Myosin I
- 75. Tubulin
- 76. Spectrin
- 77. Ankyrin
- 78. Clathrin
- 79. Caveolin
- 80. F-Actin
- 81. Myosin II
- 82. Myosin I
- 83. Tubulin
- 84. Spectrin
- 85. Ankyrin
- 86. Clathrin
- 87. Caveolin
- 88. F-Actin
- 89. Myosin II
- 90. Myosin I
- 91. Tubulin
- 92. Spectrin
- 93. Ankyrin
- 94. Clathrin
- 95. Caveolin
- 96. F-Actin
- 97. Myosin II
- 98. Myosin I
- 99. Tubulin
- 100. Spectrin

**Protein Synthesis: building new molecular machines**

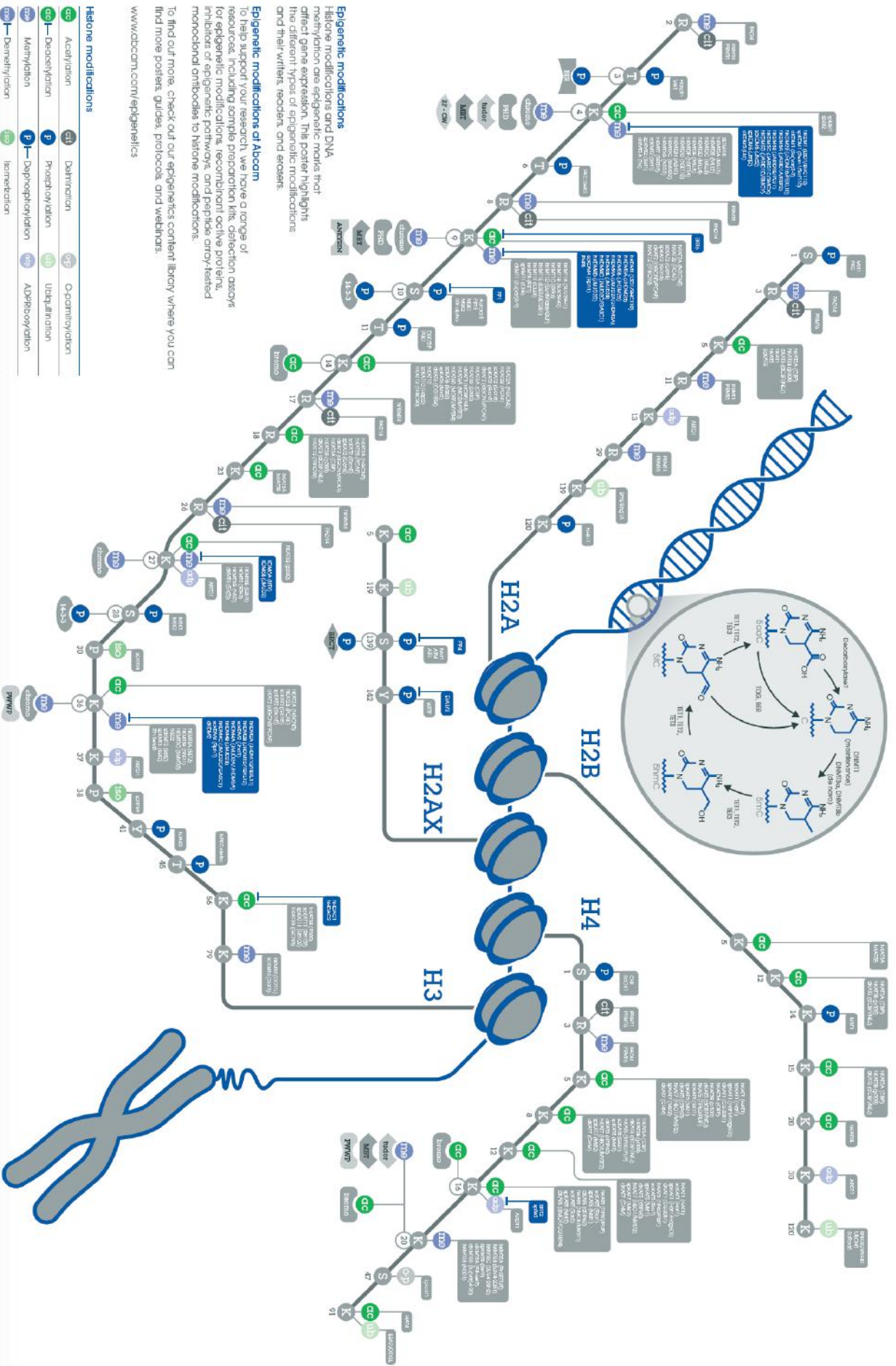
- 1. Ribosome
- 2. Ribosome
- 3. Ribosome
- 4. Ribosome
- 5. Ribosome
- 6. Ribosome
- 7. Ribosome
- 8. Ribosome
- 9. Ribosome
- 10. Ribosome
- 11. Ribosome
- 12. Ribosome
- 13. Ribosome
- 14. Ribosome
- 15. Ribosome
- 16. Ribosome
- 17. Ribosome
- 18. Ribosome
- 19. Ribosome
- 20. Ribosome
- 21. Ribosome
- 22. Ribosome
- 23. Ribosome
- 24. Ribosome
- 25. Ribosome
- 26. Ribosome
- 27. Ribosome
- 28. Ribosome
- 29. Ribosome
- 30. Ribosome
- 31. Ribosome
- 32. Ribosome
- 33. Ribosome
- 34. Ribosome
- 35. Ribosome
- 36. Ribosome
- 37. Ribosome
- 38. Ribosome
- 39. Ribosome
- 40. Ribosome
- 41. Ribosome
- 42. Ribosome
- 43. Ribosome
- 44. Ribosome
- 45. Ribosome
- 46. Ribosome
- 47. Ribosome
- 48. Ribosome
- 49. Ribosome
- 50. Ribosome
- 51. Ribosome
- 52. Ribosome
- 53. Ribosome
- 54. Ribosome
- 55. Ribosome
- 56. Ribosome
- 57. Ribosome
- 58. Ribosome
- 59. Ribosome
- 60. Ribosome
- 61. Ribosome
- 62. Ribosome
- 63. Ribosome
- 64. Ribosome
- 65. Ribosome
- 66. Ribosome
- 67. Ribosome
- 68. Ribosome
- 69. Ribosome
- 70. Ribosome
- 71. Ribosome
- 72. Ribosome
- 73. Ribosome
- 74. Ribosome
- 75. Ribosome
- 76. Ribosome
- 77. Ribosome
- 78. Ribosome
- 79. Ribosome
- 80. Ribosome
- 81. Ribosome
- 82. Ribosome
- 83. Ribosome
- 84. Ribosome
- 85. Ribosome
- 86. Ribosome
- 87. Ribosome
- 88. Ribosome
- 89. Ribosome
- 90. Ribosome
- 91. Ribosome
- 92. Ribosome
- 93. Ribosome
- 94. Ribosome
- 95. Ribosome
- 96. Ribosome
- 97. Ribosome
- 98. Ribosome
- 99. Ribosome
- 100. Ribosome

**DNA: storing and reading genetic information**

- 1. DNA
- 2. DNA
- 3. DNA
- 4. DNA
- 5. DNA
- 6. DNA
- 7. DNA
- 8. DNA
- 9. DNA
- 10. DNA
- 11. DNA
- 12. DNA
- 13. DNA
- 14. DNA
- 15. DNA
- 16. DNA
- 17. DNA
- 18. DNA
- 19. DNA
- 20. DNA
- 21. DNA
- 22. DNA
- 23. DNA
- 24. DNA
- 25. DNA
- 26. DNA
- 27. DNA
- 28. DNA
- 29. DNA
- 30. DNA
- 31. DNA
- 32. DNA
- 33. DNA
- 34. DNA
- 35. DNA
- 36. DNA
- 37. DNA
- 38. DNA
- 39. DNA
- 40. DNA
- 41. DNA
- 42. DNA
- 43. DNA
- 44. DNA
- 45. DNA
- 46. DNA
- 47. DNA
- 48. DNA
- 49. DNA
- 50. DNA
- 51. DNA
- 52. DNA
- 53. DNA
- 54. DNA
- 55. DNA
- 56. DNA
- 57. DNA
- 58. DNA
- 59. DNA
- 60. DNA
- 61. DNA
- 62. DNA
- 63. DNA
- 64. DNA
- 65. DNA
- 66. DNA
- 67. DNA
- 68. DNA
- 69. DNA
- 70. DNA
- 71. DNA
- 72. DNA
- 73. DNA
- 74. DNA
- 75. DNA
- 76. DNA
- 77. DNA
- 78. DNA
- 79. DNA
- 80. DNA
- 81. DNA
- 82. DNA
- 83. DNA
- 84. DNA
- 85. DNA
- 86. DNA
- 87. DNA
- 88. DNA
- 89. DNA
- 90. DNA
- 91. DNA
- 92. DNA
- 93. DNA
- 94. DNA
- 95. DNA
- 96. DNA
- 97. DNA
- 98. DNA
- 99. DNA
- 100. DNA



**Figure S.9.**  
Epigenetic Modifications



**Epigenetic modifications**  
Histone modifications and DNA methylation are epigenetic marks that affect gene expression. The poster highlights the different types of epigenetic modifications and their writers, readers, and erasers.

**Epigenetic modifications at Abcam**  
To help support your research, we have a range of resources, including sample preparation kits, detection assays for epigenetic modifications, recombinant active proteins, inhibitors of epigenetic pathways, and peptide array-tested monoclonal antibodies to histone modifications.

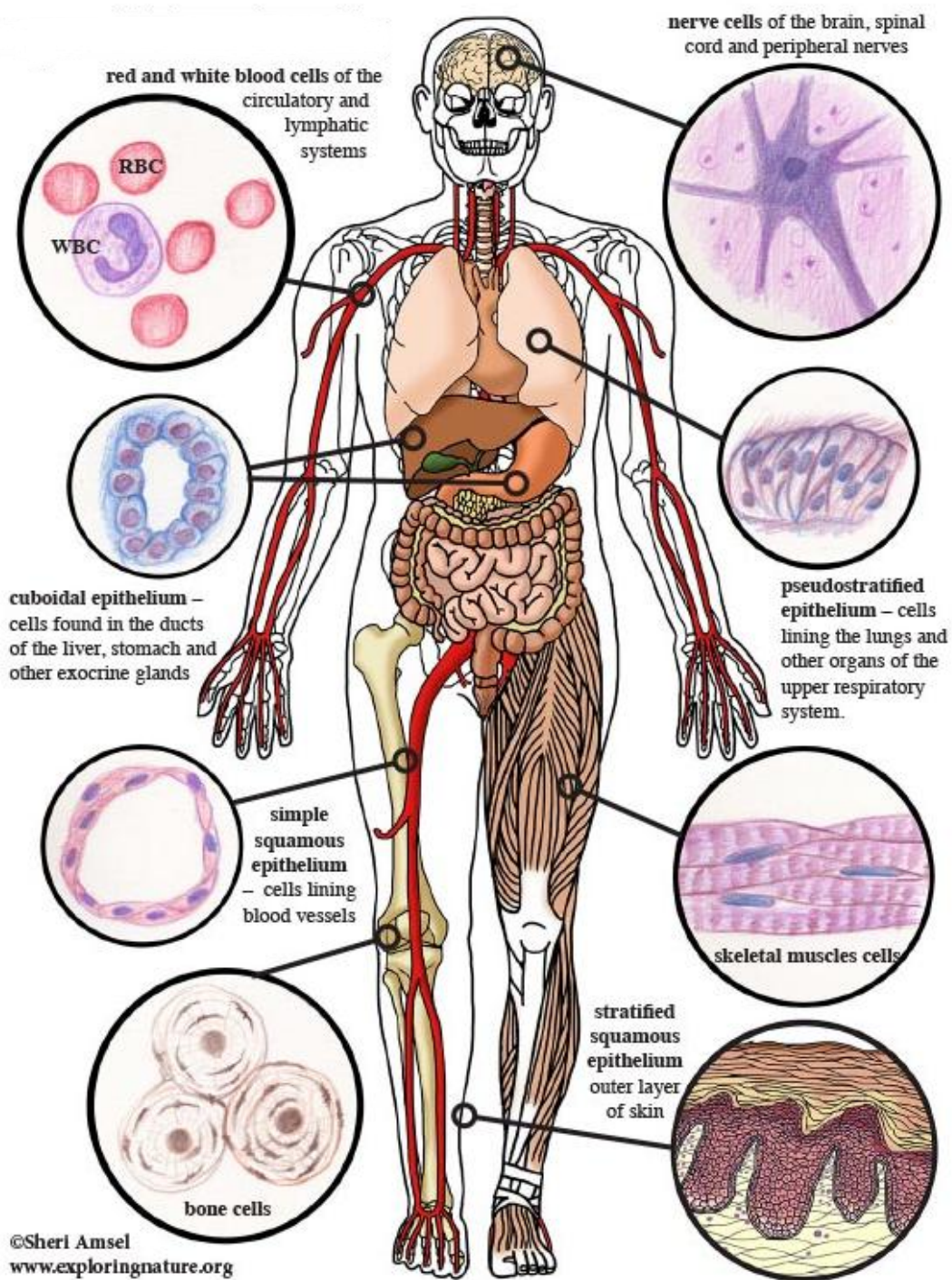
To find out more, check out our epigenetics content library where you can find more posters, guides, protocols and webinars.  
[www.abcam.com/epigenetics](http://www.abcam.com/epigenetics)

**Histone modifications**

Acetylation	acH	Deamination	deP	O-glycosylation	ogP
Demethylation	dm	Hydroxylation	hoH	Ubiquitination	ubP
Methylation	meP	Demethylase	dmP	ADP-ribosylation	adP
Demethylation	dmP	Hydroxylation	hoP		

**Histone modifications binding proteins**

Protein	Abcam ID	Protein	Abcam ID
CHD1	105066w/2	BRG1	105066w/3
14-3-3σ	105066w/2	BRG1	105066w/3
14-3-3β	105066w/2	BRG1	105066w/3
14-3-3γ	105066w/2	BRG1	105066w/3
14-3-3δ	105066w/2	BRG1	105066w/3
14-3-3ε	105066w/2	BRG1	105066w/3
14-3-3ζ	105066w/2	BRG1	105066w/3
14-3-3η	105066w/2	BRG1	105066w/3
14-3-3θ	105066w/2	BRG1	105066w/3
14-3-3ι	105066w/2	BRG1	105066w/3
14-3-3κ	105066w/2	BRG1	105066w/3
14-3-3λ	105066w/2	BRG1	105066w/3
14-3-3μ	105066w/2	BRG1	105066w/3
14-3-3ν	105066w/2	BRG1	105066w/3
14-3-3ξ	105066w/2	BRG1	105066w/3
14-3-3π	105066w/2	BRG1	105066w/3
14-3-3σ	105066w/2	BRG1	105066w/3
14-3-3τ	105066w/2	BRG1	105066w/3
14-3-3υ	105066w/2	BRG1	105066w/3
14-3-3φ	105066w/2	BRG1	105066w/3
14-3-3χ	105066w/2	BRG1	105066w/3
14-3-3ψ	105066w/2	BRG1	105066w/3
14-3-3ω	105066w/2	BRG1	105066w/3
14-3-3	105066w/2	BRG1	105066w/3



**Figure S.10. Human body systems and the main cell lines**

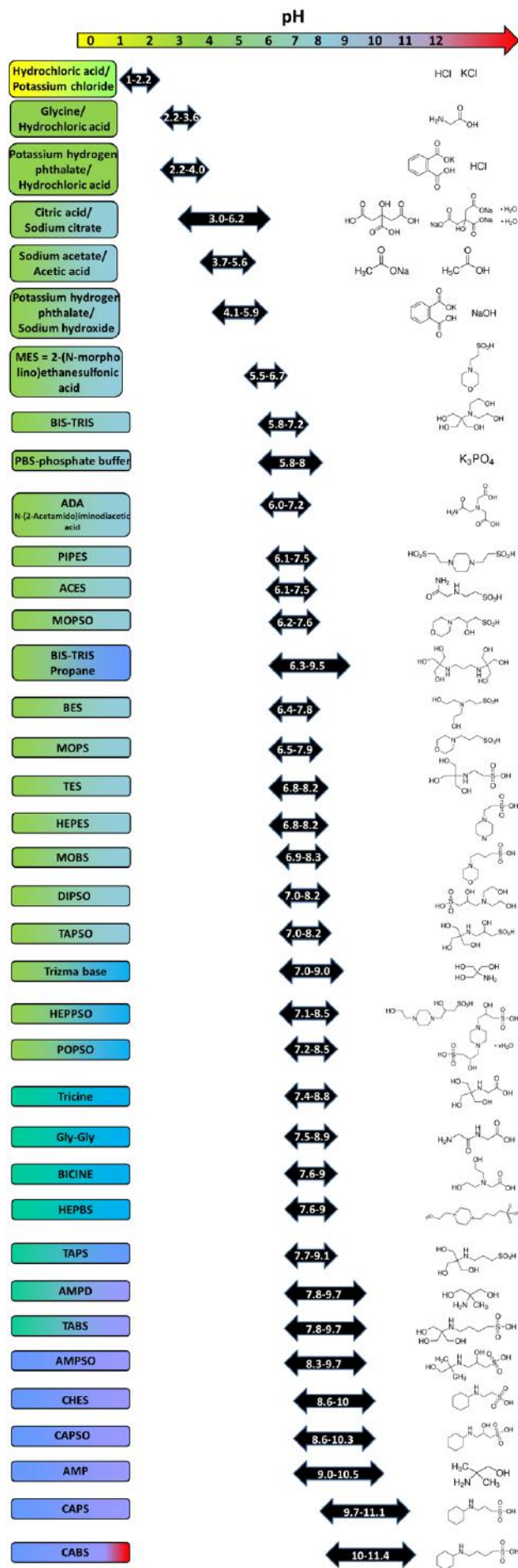
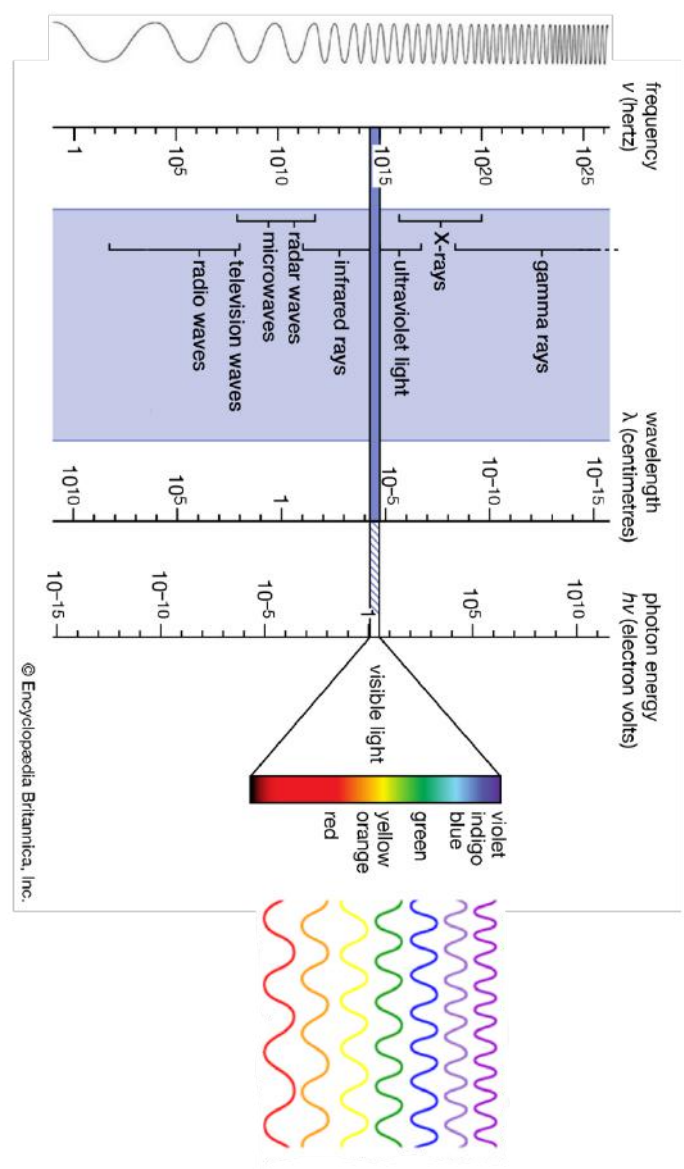
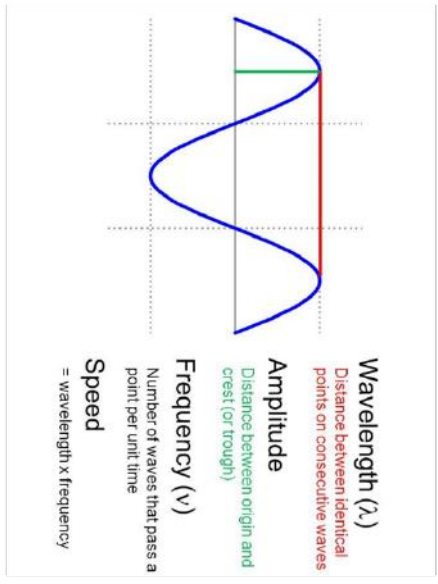


Figure S.11. The main selected biological buffers with their rang of pH



**Figure S.12. The Electromagnetic spectrum (Wavelengths of some applications and their Frequencies)**

## The Main Biochemical Equations

The Molarity equation

$$M = \frac{n}{V}$$

$$M = \frac{g}{MW \times V}$$

$$M = \frac{MW \times g \times V(\text{mL})}{1000 \text{ mL}}$$

The Number (Atoms / Molecules) from [Number of Avogadro ( $N_A$ ):  $6.022 \times 10^{23}$ ]

$$\text{Atoms or Molecules} = N_A \times n$$

Calculation of Molarity of molecule dissolved in  $H_2O$  as (w/w) [Density ( $\rho$ ):  $1.11 \text{ kg/m}^3$ ]

$$\% \times \rho = (x) \quad > \quad (x) \times 10 = (m)g/kg \quad > \quad (m)/MW = M$$

Transfer Percentage unit to Molarity unit (% to M)

$$M = \frac{\% \times 10}{MW}$$

Transfer Molarity unit to Percentage unit (M to %)

$$\% = \frac{M \times MW}{10}$$

Transfer Micromolar unit to Micrograms per milliliters unit ( $\mu\text{M}$  to  $\mu\text{g/mL}$ )

$$\mu\text{M} = \frac{(\mu\text{g/mL}) \times 1000}{MW}$$

Transfer Micrograms per milliliters unit to Micromolar unit ( $\mu\text{g/mL}$  to  $\mu\text{M}$ )

$$(\mu\text{g/mL}) = \frac{\mu\text{M}}{1000} \times MW$$

The Dilution equation [C: Concentration, V: Volume, 1: Stock, 2: Working solution]

$$C1 \times V1 = C2 \times V2$$

Transfer the Centrifuge speed unit (rpm) to (rcf / g.) [r: Radius of centrifuge in mm]

$$\text{rcf (g.)} = \left( \frac{\text{rpm}}{1,000} \right)^2 \times r \times 1.118 \Rightarrow \text{rpm} = \sqrt{\frac{\text{rcf (g.)}}{r \times 1.118}} \times 1,000$$



**SUMMARY IN FRENCH**  
**RESUME EN FRANÇAIS**



## Introduction

UHRF1 (Ubiquitin-like, containing PHD and RING finger domains, 1) est une protéine nucléaire classée dans la sous-famille des ubiquitines ligases E3 de type doigt de zinc, qui a la capacité d'ubiquitiner d'autres protéines grâce à son domaine Really Interesting New Gene (domaine RING), mais également capable de s'auto-ubiquitiner par ce même domaine. Le rôle de UHRF1 est de réguler la méthylation de l'ADN, grâce à deux propriétés essentielles qui sont de pouvoir déceler la présence d'ADN hémi-méthylé (ADN méthylé sur un seul brin) et d'être capable de dialoguer à l'aide de différents domaines structuraux avec la DNMT1, enzyme essentielle pour la méthylation de maintenance de l'ADN (Unoki *et al.*, 2004 ; Achour *et al.*, 2008). UHRF1 est également capable de lire les modifications post-traductionnelles des histones notamment la méthylation de la Lysine 9 de l'histone H3 à des fins de régulation de la structure chromatinienne et donc de l'expression des gènes. Ces deux propriétés sont fondamentales pour la transmission du code épigénétique d'une cellule mère aux cellules filles. C'est ainsi qu'une cellule différenciée conserve son phénotype durant les mitoses successives. Malheureusement par ce biais, les cellules cancéreuses conservent également leur phénotype parmi lequel, on trouve la répression des gènes suppresseurs de tumeurs. Notre laboratoire a pu montrer que UHRF1 est surexprimée dans la plupart des cancers et que celle-ci était responsable de la répression de gènes suppresseurs de tumeurs tels que *p73* ou *p16<sup>INK4A</sup>* (Achour *et al.*, 2008 ; Alhosin *et al.*, 2016 ; Alhosin *et al.*, 2010). De nombreux travaux de la littérature ont montré que UHRF1 se comportait comme un oncogène et comme un acteur anti-apoptotique (Bronner *et al.*, 2004 ; Choudhry *et al.*, 2018 ; Zhang *et al.*, 2018 ; Kong *et al.*, 2019). Ainsi, une inhibition de l'expression ou une augmentation du catabolisme de UHRF1 pourrait avoir des vertus anti-cancéreuses et représenterait une stratégie anti-cancéreuse très intéressante. Dans notre équipe, nous nous intéressons à l'ubiquitination de UHRF1, notamment quel est son rôle dans son catabolisme, comment est-elle induite et comment est-elle régulée.

L'ubiquitination (ou ubiquitylation) désigne la modification post-traductionnelle du groupe  $\epsilon$ -amino d'un résidu lysine par la fixation covalente d'un (mono-ubiquitination) pour la régulation ou de plusieurs (poly-ubiquitination) monomères d'ubiquitine. Dans la plupart des cas, cette poly-ubiquitination joue un rôle primordial dans la dégradation de la protéine cible. Néanmoins, d'autres rôles ont été rapportés avec notamment un détachement de la protéine de la chromatine ou encore une interaction avec le nucléole dans un but de protection.

## Résultats

Dans un premier temps nous avons construit 2 lignées cellulaires « taggées » FLAG-HA du côté N-terminal et C-terminal dans le but de déterminer d'une part les partenaires et/ou cibles de UHRF1 et d'autre part les voies empruntées par UHRF1 dans sa dégradation. UHRF1, étiquetée FLAG-HA en N-terminal et en C-terminal, a été précisément caractérisée et prévue pour être transfectée dans une lignée cellulaire HeLa. Pour cela, des amorces spécifiques sens et anti-sens ont été conçues pour amplifier l'ADNc codant pour l'UHRF1. Cet ADNc a été cloné dans un vecteur (pOZ-N et pOZ-C) afin d'obtenir UHRF1 incluant un FLAG-HA-tag. Le vecteur en plus contient l'ADNc pour IL2RA (CD25) permettant la sélection des cellules transfectées avec succès. Les cellules Phoenix-ECO ont été cultivées dans des plaques à 6 puits jusqu'à 50% de confluence. Les cellules HeLa-XLP positives, c'est à dire transfectées avec succès, ont été sélectionnées à l'aide de billes magnétiques. Les Dynabeads CD25 se lient à l'IL2R $\alpha$  exprimé à la surface des cellules positives, et la sélection a été réalisée à l'aide d'un support magnétique. Par immunocytochimie, nous avons constaté que UHRF1 taggée en N-ter ou en C-ter, se localise uniquement dans le noyau, montrant ainsi que UHRF1 est fonctionnelle du point de la localisation subcellulaire. La poursuite des investigations va consister à purifier les complexes UHRF1 ubiquitinée ou non et à les analyser par spectrométrie de masse (MS) afin d'orienter nos recherches vers des pistes intéressantes pour cerner le rôle de l'ubiquitination de UHRF1.

Pour induire rapidement l'ubiquitination de UHRF1, nous utilisons la Thymoquinone (TQ), composé majeur de l'huile de cumin noir. En effet, à notre connaissance, la TQ est la seule substance capable d'induire l'ubiquitination de UHRF1, ce qui en fait un outil tout à fait original et précieux pour notre recherche. En effet, nous n'avons pas observé de poly-ubiquitination de UHRF1 lorsqu'on traite les cellules par H<sub>2</sub>O<sub>2</sub> ou par la doxorubicine, également connus pour induire des dommages à l'ADN. Cette poly-ubiquitination résulterait principalement de l'activité endogène dépendante du RING finger de UHRF1. Dans le présent travail, nous avons pu montrer que la TQ induit très rapidement une poly-ubiquitination de UHRF1. D'une manière hautement intéressante, UHRF1 commence à disparaître lorsque l'ubiquitination de UHRF1 n'est plus visible. On pourrait donc penser que la poly-ubiquitination est impliquée dans la dégradation de UHRF1. Cependant, il apparaît que ce n'est pas aussi simple et vrai.

En effet, de manière intéressante, nous avons observé dans les lignées cellulaires où UHRF1 est taggée en N-ter qu'il n'y avait pas d'ubiquitination en appliquant l'anticorps anti-

HA, ce qui peut conduire à penser que l'UHRF1 marqué par Flag-HA N-terminal empêche UHRF1 de s'auto-ubiquitiner en raison d'un repliement de la protéine en présence de la séquence Flag-HA qui encombrerait le domaine RING et donc son activité E3-ligase (ubiquitination). Néanmoins, en l'absence d'ubiquitination, UHRF1 est encore dégradé, ce qui suggère que UHRF1 n'emprunterait pas la voie protéosomale pour sa dégradation. D'autre part, l'UHRF1 étiqueté Flag-HA C-terminal n'a pas d'effet sur l'auto-ubiquitination. D'autre part, la présence de la séquence Flag-HA dans la partie C-terminale n'altère pas le repliement de la protéine, ce qui permet au domaine RING de reconnaître le domaine Ubiquitin-like et de l'ubiquitiner. La dégradation de l'UHRF1 peut emprunter de nombreuses voies, notamment la voie protéasomique de l'ubiquitine et d'autres voies alternatives. Une analyse subcellulaire nous a permis de montrer que cette poly-ubiquitination engendre une dissociation de UHRF1 de la chromatine. Il reste encore à trouver les conséquences de cette dissociation si elle est destinée à favoriser sa séquestration à des fins de protection. Cette dissociation pourrait aussi permettre à UHRF1 de devenir une cible pour une voie de dégradation qui reste encore à être identifiée. Comme évoqué précédemment, nous attendons beaucoup de l'analyse des complexes UHRF1, traité ou non par la TQ, pour orienter notre recherche et découvrir des pistes d'intérêt pour notre domaine de recherche.

Nous avons également observé que l'état de confluence des cellules influençait directement l'efficacité de la Thymoquinone à induire l'ubiquitination de UHRF1. En effet, plus les cellules sont confluentes moins, la TQ induisait d'ubiquitination. Ce résultat nous a permis de suggérer que lorsque les cellules prolifèrent moins, la TQ induisait moins de dommages à l'ADN donc moins d'ubiquitination de UHRF1.

Nous avons observé que la Tat Interacting Protein of 60kDa (Tip60), une acétylase connue pour jouer un rôle dans les dommages à l'ADN, est capable d'inhiber la poly-ubiquitination de UHRF1. De cette manière, Tip60 jouerait un rôle dans la réparation de l'ADN en maintenant l'intégrité de l'épigénome par le biais d'un empêchement de la dissociation de UHRF1 de la chromatine. Ce résultat très intéressant devra être renforcé en montrant par exemple que l'acétylation de UHRF1 par Tip60 est responsable de l'auto-ubiquitination. Nous envisageons également de mener à bien des expériences de surexpression de Tip60 afin de voir s'il y a une régulation positive de l'ubiquitination de UHRF1 sous l'effet de la TQ. Identifier les sites d'acétylation par Tip60 de UHRF1 impliqués dans la régulation de l'ubiquitination, est envisagée à plus long terme.

## **Conclusion et perspectives**

Notre étude a montré que la Thymoquinone exerce 2 effets différents sur UHRF1 dont la finalité semble être différente. Le premier est une poly-ubiquitination relativement rapide suivie d'une inhibition de son expression. Nous suggérons que le premier événement, ne semble pas être impliquée dans le second, puisqu'en l'absence d'auto-ubiquitination, il y a toujours dégradation de UHRF1. Au contraire, nous suggérons que la poly-ubiquitination pourrait être impliquée dans la réparation de l'ADN mais lorsque les dommages sont trop importants il y a activation de l'apoptose via une dégradation de UHRF1. Nous souhaitons compléter les résultats en analysant le mécanisme d'action de TQ pour comprendre quel est le signal induit par la TQ contribuant à l'induction de la poly-ubiquitination de UHRF1. Nous pensons que la poly-ubiquitination de UHRF1 est susceptible de jouer un rôle complexe considérant que cette modification post-traductionnelle conduit à plus qu'un triplement de sa masse moléculaire.

Grade de Directeur de Thèse (BRONNER Christian)

PR	Professeur des universités
ém.	Émérite
MC	Maître de conférences
DR	Directeur de recherche
CR	Chargé de recherche
HDR	Habilité à diriger des recherches

## École Doctorale Inscrit

ED 101 – Droit, sciences politique et histoire (Sciences juridiques)

ED 182 – Physique et chimie physique

ED 221 – Augustin Cournot

ED 222 – Sciences chimiques

ED 269 – Mathématiques, sciences de l'information et de l'ingénieur

ED 270 – Théologie et sciences religieuses

ED 413 – Sciences de la terre, de l'univers et de l'environnement

**ED 414 – Sciences de la vie et de la santé**

ED 519 – École doctorale des sciences humaines et sociales. Perspectives européennes

ED 520 – École doctorale des humanités

Department of IGBMC – CNRS UMR 7104 - Inserm U 1258 - UM 41

Development and stem cells  
Integrated structural Biology  
Functional genomics and cancer  
Translational medicine and neurogenetics

Research area of interest

Chromatin and Epigenetic Regulation  
In between 13 areas of interest

Team of research

Ali HAMICHE Team  
Out of 13 teams of the department / 52 teams of the IGBMC





University of Strasbourg (Unistra)  
Doctoral School of Life and Health Sciences (ED 414)  
Institute of Genetics and Molecular and Cellular Biology (IGBMC)

Thesis submitted for obtaining the degree of

**DOCTOR OF PHILOSOPHY (PhD)**

## **Role and Regulation of UHRF1 Ubiquitination in Cancer Cells**

Presented by

**Naif Abdullah R. ALMALKI (21803439)**

**Discipline:** Molecular and Cellular Biochemistry

**Specialization:** Molecular and cellular aspects of biology

**Date of Public Defense: March 1<sup>st</sup>, 2022**

• **THE JURY MEMBERS**

Dr. Christian BRONNER

Pr. Philippe BOUCHER

Dr. Hugues de ROCQUIGNY

Pr. Jean-Luc BUEB

• **THE REPRESENTATION**

**Thesis Supervisor**

**Internal Examiner**

**External Rapporteur**

**External Rapporteur**

---

Dr. Ali HAMICHE

**Invited Member**

Dr. Marc MOUSLI

**Invited Member**

Dr. Mahmoud ALHOSIN

**Invited Member**



## نايف بن عبدالله بن رده المالكي

### دور وتنظيم توسيم الـ(UHRF1) باليوبيكويتين في الخلايا السرطانية

#### الملخص العربي العام

بروتين الـ(UHRF1) المختصر في الإنجليزية من (Ubiquitin-like, containing PHD and RING finger domains, 1) هو أحد البروتينات النووية ذات خمس نطاقات (UBL, TTD, PHD, SRA, RING) والمصنف تحت العائلة الفرعية للانزيمات الثالثة اللاحة لليوبيكويتين (E3 ubiquitin ligase) فضلاً لنطاق الـ(RING) الذي يقوم بهذا الدور. لدى بروتين الـ(UHRF1) العديد من الوظائف الحيوية داخل نواة الخلية ومن أهمها صيانة شريط الحمض النووي (DNA) أثناء عملية الاستنساخ (Replication) وذلك بالكشف عن المناطق المطلوب توسيمها بمركب الميثايل ( $CH_3$ ) بواسطة نطاق الـ(SRA) ومن ثم تجنيد إنزيم الـ(DNMT1) لعمل التوسيم بالميثايل. يعتبر بروتين الـ(UHRF1) من البروتينات المؤدية للورم (Oncogene) نظراً لفرط التعبير المحتمل لها الذي يؤدي إلى قمع البروتينات الكابتة للورم (TSG) مما يسبب تكاثر خلوي غير متحكم به وهروب من عملية الموت الخلوي المبرمج (Apoptosis) ناتجاً عنه مرض السرطان (Cancer). ومن هذا المنطلق كان من الجدير بالاهتمام القيام بعمل التجارب والأبحاث لفهم دور هذا البروتين وتنظيمه ومحاولة تقليص مستوياته في الخلايا السرطانية بالمعالجة بالمركبات الكيميائية المستخلصة من النباتات الطبيعية. التوسيم العديدي لليوبيكويتين (Polyubiquitination) هي أحد العمليات الحيوية التي تعنى بإقحام البروتينات الغير ضرورية أو المعيبة أو المستهدفة علاجياً في عملية التكسير البروتوزومي (Proteasomal degradation)، حيث وجد بشكل فريد أن بروتين الـ(UHRF1) يحصل له عملية التوسيم العديدي لليوبيكويتين ذاتياً (Auto-polyubiquitination) بعد المعالجة بمادة الثايموكينون (Thymoquinone) المستخلصة من زيت الحبة السوداء المستخرجة من نبتة الكراوية السوداء (*Nigella sativa*) مما أدى إلى تلاشيها وقيام الخلايا السرطانية بعملية الـ(Apoptosis). وأثبتت النتائج بأن الثايموكينون يقوم بتنشيط أنواع الاكسجين التفاعلية (ROS) التي بدورها تقوم بتخريب الحمض النووي (DNA) المثبتة بتجربة المذنب (Comet assay) في غياب إنزيمات المقاومة للـ(ROS) المحتملة في الخلايا السرطانية مما يؤدي إلى الانصياع إلى عملية الـ(Auto-polyubiquitination) المعتمدة على الـ(ROS) كما تم استنتاجه. وقد تم أيضاً تحديد نوع التوسيم العديدي لليوبيكويتين من خلال استخدام جسم مضاد الذي يرتبط خصيصاً مع الحمض الأميني اللاليسين رقم (K-48) المقترن بالتوسيم، وهو ما يحدد مسار التكسير البروتوزومي و(K-63) المقترن بالتوسيم، وهو ما يحدد مسار أنوار تنظيمية. ومن جانب آخر، أوجدت النتائج تكسر بروتين الـ(UHRF1) بعد معالجة الخلايا السرطانية بمستخلص التانين من لحاء الصنوبر البحري (MPTE) الغنية بمركبات عديدة الفينول (Polyphenols) والتي حالت دون تكاثر خلايا هيل (HeLa cells) عن طريق تحفيز إيقاف دورة الخلية في طور (G2/M) جنباً إلى جنب مع تنشيط أنواع الاكسجين التفاعلية (ROS) بواسطة مسار موت الخلايا المبرمج للميتوكوندريا. ولقد استنتج أن تكوين مركب بيروكسيد الهيدروجين ( $H_2O_2$ ) يلعب دوراً رئيسياً في زيادة التعبير عن جين كابت الورم (TP73) نتيجة لتقليل تنظيم (UHRF1 / DNMT1) إضافة إلى انخفاض التوسيم العام بالميثايل للجينوم. وعلى صعيد آخر، تم عمل تجارب للكشف عن احتمالية وجود بروتين الـ(UHRF3) والذي قد تم افتراض وجوده في ورقة علمية سابقة، حيث يوجد في الكروموسوم رقم 12 تسلسل جيني شبيه بأجزاء بروتين الـ(UHRF1) خاصة نطاق الـ(SRA) الذي يظهر كبروتين مستقل وبنفس حجم التسلسل الجيني بتقنية الـ(Western Blot). بتطبيق تقنية الاقصاء (Knock out) للجين المحتمل (UHRF3) اظهرت النتيجة عدم استجابة بروتين الـ(UHRF1) لعملية الـ(Auto-polyubiquitination) بعد المعالجة بالثايموكينون مما يضع احتمالية وجود البروتين (UHRF3) بالفعل وأنه يعمل كشريك لبروتين الـ(UHRF1) في عمليات تنظيم التوسيم باليوبيكويتين، هذا ما يفتح المجال لدراسات تعمقية مستقبلاً في الكشف عن بروتينات تشكل وحدات بروتينية ثنائية مغايرة (Heterodimer) شريكة لانزيمات الـ(E3 ubiquitin ligase) عموماً، خصوصاً بعد ملاحظة عدة جينات أخرى شبيهة في تسلسلها الجيني لانزيمات الـ(E3 ubiquitin ligase) الأم الأخرى أو ربما تكون جينات منظمة للبروتينات الأم لتشكل وحدات بروتينية ثنائية مماثلة (Homodimer). وكتوصيات لعمل تجارب مستقبلية يمكن دراسة تسلسل الحمض النووي (RNA) في الخلايا التي تم اقصاء جين الـ(UHRF3) منها، وبتطبيق تقنية الـ(Western Blot) باستخدام الهلام الأساس (Native gel) الغير محتوي على مادة الـ(SDS) يمكن التأكد من وجود معقد محتمل (UHRF1/UHRF3 complex). وبتطبيق تقنية اقحام وسم داخلي (Knock-in an endogenous tag) يمكن التأكد من وجود البروتين بالترسيب المناعي (Immunoprecipitation). كما يمكن عمل مقارنة مع الخلايا الطبيعية من حيث وفرة الانزيمات المقاومة للـ(ROS) والكشف عن الخلايا الإيجابية لصبغة الـ(DHE) الناشئة من تنشيط الـ(ROS) إضافة إلى تطبيق تجربة المذنب على الخلايا الطبيعية.



**Naif A. R. ALMALKI**

## **Role and Regulation of UHRF1 Ubiquitination in Cancer Cells**

### **Resume en Francisc**

La méthylation de l'ADN est l'une des marques épigénétiques les plus importantes, impliquée dans de nombreux processus cellulaires physiologiques ainsi que dans des pathologies. La transmission des profils de méthylation de l'ADN de la mère aux cellules filles est assurée au cours de la mitose par l'action du tandem (UHRF1/DNMT1). UHRF1 est impliqué dans l'extinction d'un très grand nombre de gènes suppresseurs de tumeurs par des mécanismes qui restent largement à décrypter. Dans la présente étude, nous nous sommes intéressés au rôle et à la régulation de la poly-ubiquitination d'UHRF1 induite par la thymoquinone, un médicament anticancéreux naturel, connu pour augmenter ou réactiver l'expression des gènes suppresseurs de tumeurs. Nous avons découvert que l'auto-ubiquitination de l'UHRF1, induite par la TQ, est provoquée par des espèces réactives de l'oxygène, et agit suite à des dommages à l'ADN. Nous avons pu démontrer que la forme poly-ubiquitinylée de UHRF1 est encore capable de réduire au silence le gène suppresseur de tumeur *p16<sup>INK4A</sup>*. Cela suggère que c'est la disparition complète de UHRF1, y compris la version poly-ubiquitinylée, qui est nécessaire à la réexpression des gènes suppresseurs de tumeurs. Nous avons pu montrer que la poly-ubiquitination de UHRF1 n'est pas impliquée dans sa dégradation. Nous avons également pu montrer que l'auto-ubiquitination induite par la TQ est médiée par l'activité de Tip60. Ce dernier étant connu comme un cofacteur des récepteurs nucléaires, nous avons cherché à savoir si le récepteur des glucocorticoïdes (GR) pouvait être impliqué dans la régulation de l'ubiquitination de UHRF1. L'activation du GR, avec la dexaméthasone, n'a pas influencé l'auto-ubiquitination de l'UHRF1. En revanche, nous avons pu observer que l'UHRF1 contrôle l'expression du GR et que la TQ a induit la down-régulation de ce dernier ainsi que sa poly-ubiquitination. L'analyse par spectroscopie de masse de l'UHRF1 étiqueté FLAG-HA a permis d'identifier des partenaires de l'UHRF1 impliqués dans la réparation de l'ADN et que la TQ augmentait leur association avec l'UHRF1, suggérant que la poly-ubiquitination de l'UHRF1 est impliquée dans le processus de réparation de l'ADN.

### **Abstract in English**

DNA methylation is one of the most important epigenetic marks involved in many physiologic cellular processes and pathologies as well. The transmission of DNA methylation patterns from a mother to the daughter cells is ensured during mitosis through the action of the Ubiquitin-like, containing PHD and RING domains, 1/DNA methyltransferase 1 (UHRF1/DNMT1) tandem. UHRF1 is involved in the silencing of a huge number of tumor suppressor genes via mechanisms that remains largely to be deciphered. In the present study, we were interested in the role and regulation of UHRF1 poly-ubiquitination induced by thymoquinone a natural anti-cancer drug, known to enhance or re-activate the expression of tumor suppressor genes. We found that the auto-ubiquitination of UHRF1, induced by TQ, is induced by reactive oxygen species, and acts as a result of DNA damage. We could demonstrate that the poly-ubiquitinated form of UHRF1 is still able to silence the tumor suppressor gene *p16<sup>INK4A</sup>*. This suggests that it is the complete disappearance of UHRF1 including the poly-ubiquitinated version that is required for re-expression of tumor suppressor genes. We could show that UHRF1 poly-ubiquitination is not involved in its degradation. We could further show that TQ induced auto-ubiquitination is mediated via the activity of Tip60. As this latter is known as a nuclear receptor co-factor, we investigated if the glucocorticoid receptor (GR) might be involved in the regulation of UHRF1 ubiquitination. Activation of the GR, with dexamethasone, did not influence auto-ubiquitination of UHRF1. In contrast, we could observe that UHRF1 controls expression of GR and that TQ induced the down-regulation of this latter as well as its poly-ubiquitination. Mass-spectroscopy analysis of FLAG-HA-tagged UHRF1 identified UHRF1 partners involved in DNA repair and that TQ increased their association with UHRF1, suggesting that poly-ubiquitination of UHRF1 is involved in DNA repair process.