



HAL
open science

Behavioural approach to larval dispersal in marine systems

Jean-Olivier Irisson

► **To cite this version:**

Jean-Olivier Irisson. Behavioural approach to larval dispersal in marine systems. Sciences du Vivant [q-bio]. Ecole pratique des hautes études - EPHE PARIS, 2008. Français. NNT : . tel-00344625

HAL Id: tel-00344625

<https://theses.hal.science/tel-00344625v1>

Submitted on 5 Dec 2008

HAL is a multi-disciplinary open access archive for the deposit and dissemination of scientific research documents, whether they are published or not. The documents may come from teaching and research institutions in France or abroad, or from public or private research centers.

L'archive ouverte pluridisciplinaire **HAL**, est destinée au dépôt et à la diffusion de documents scientifiques de niveau recherche, publiés ou non, émanant des établissements d'enseignement et de recherche français ou étrangers, des laboratoires publics ou privés.



École Pratique des Hautes Études

École doctorale Systèmes Intégrés, Environnement et Biodiversité
Thèse pour l'obtention du grade de docteur
Spécialité: Écologie

Approche comportementale de la dispersion larvaire en milieu marin

Jean-Olivier Irisson



Dirigé par **Serge Planes**

en collaboration avec **Claire Paris**

Soutenue le 3 Juillet 2008

Jury

| | |
|------------------------|----------------------|
| Philippe Koubbi | Rapporteur |
| Michel de Lara | Président |
| Claire Paris | Co-directrice |
| Serge Planes | Directeur |
| Pierre Pépin | Rapporteur |
| Éric Thiébaud | Examineur |

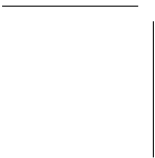

À mon étoile.

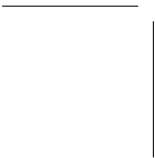

École doctorale de l'École Pratique des Hautes Études
mention *Systèmes Intégrés, Environnement et Biodiversité*

Thèse pour l'obtention du grade de docteur en Écologie

Approche comportementale de la dispersion larvaire en milieu marin

Jean-Olivier IRISSON

sous la direction de

Serge PLANES

Biologie et Écologie Tropicale et Méditerranéenne
UMR 5244 CNRS EPHE UPVD
Université de Perpignan, 66860 Perpignan

en collaboration avec

Claire PARIS

Rosenstiel School of Marine and Atmospheric Science
University of Miami, Division of Applied marine Physics
4600 Rickenbacker Causeway, Miami, Florida 33149-1098

Soutenue le 3 Juillet 2008

Devant un jury composé de (par ordre alphabétique)

| | |
|-----------------|---------------|
| Philippe KOUUBI | Rapporteur |
| Michel DE LARA | Président |
| Claire PARIS | Co-directrice |
| Pierre PEPIN | Rapporteur |
| Serge PLANES | Directeur |
| Éric THIÉBAUT | Examineur |

Résumé La plupart des organismes marins démersaux présentent une phase larvaire pélagique avant le recrutement dans la population adulte. Cet épisode pélagique est souvent la seule opportunité de dispersion au cours du cycle de vie. De ce fait, il structure les connexions entre populations, qui régissent la dynamique et la composition génétique des métapopulations benthiques. Cependant, ces "larves" ne sont pas de simples ébauches des adultes, dispersées au gré des courants en attendant leur métamorphose. Ce sont des organismes souvent très spécifiquement adaptés à leur milieu. Dans cette thèse nous nous sommes efforcés d'évaluer l'impact du comportement des larves lors de la phase pélagique. Nous nous sommes focalisés sur les larves de poissons (coralliens plus spécifiquement) dont les capacités sensorielles et motrices sont particulièrement élevées. Des approches expérimentales ont été développées afin de quantifier leur orientation et leur nage *in situ*. Grâce à une observation synchrone des caractéristiques physiques du milieu et de la distribution des larves lors d'une campagne océanographique, nous avons tenté de caractériser leur distribution en trois dimensions dans le milieu pélagique, afin de comprendre les interactions physico-biologiques déterminant le recrutement. Enfin, une approche de modélisation novatrice, faisant appel à des concepts de minimisation des coûts et de maximisation des bénéfices habituellement utilisés en économie ou en théorie de l'approvisionnement optimal, a permis d'intégrer le comportement des larves aux modèles Lagrangiens de dispersion.

Mot-clés comportement, larves de poisson, auto-recrutement, distribution spatiale, orientation, trajectoires, optimisation

École Pratique des Hautes Études
mention *Integrated Systems, Environment and Biodiversity*

PhD thesis in Ecology

Behavioural approach to larval dispersal in marine systems

Jean-Olivier IRISSON

under the supervision of

Serge PLANES

Biologie et Écologie Tropicale et Méditerranéenne
UMR 5244 CNRS EPHE UPVD
Université de Perpignan, 66860 Perpignan

in collaboration with

Claire PARIS

Rosenstiel School of Marine and Atmospheric Science
University of Miami, Division of Applied marine Physics
4600 Rickenbacker Causeway, Miami, Florida 33149-1098

Defended on July, 3rd 2008

The jury comprised (in alphabetical order)

| | |
|-----------------|-------------------|
| Philippe KOUUBI | Reviewer |
| Michel DE LARA | President |
| Claire PARIS | Associate advisor |
| Pierre PEPIN | Reviewer |
| Serge PLANES | Advisor |
| Éric THIÉBAUT | Examiner |

Abstract Most demersal marine organisms have a bipartite life history and larvae are pelagic before recruiting in the adult population. This pelagic episode is often the sole opportunity for dispersal in the life of these organisms. Therefore, it structures the connections between populations, which, in turn, determine demographic dynamics and genetic composition of benthic metapopulations. Nevertheless, these “larvae” are not just drafts of the adults, dispersed by oceanic currents before their metamorphosis. They are very specialised organisms, often tightly adapted to their environment. In this doctoral research, we strove to evaluate the impact of larval behaviour during the pelagic interval. We focused on fish larvae (particularly coral-reef fishes) which sensory and swimming capabilities are particularly high. Experimental approaches were developed to quantify larval orientation and swimming *in situ*. During an oceanographic campaign, synchronous observations of physical properties of sea water and of the distribution of larvae enabled to characterise their distribution in three dimensions within the pelagic environment and to understand physical-biological interactions determining recruitment. Finally, a novel modelling framework, drawing from cost minimisation and benefit maximisation techniques traditionally used in economics or optimal foraging models, allowed to integrate larval behaviour in Lagrangian models of larval dispersal.

Keywords behaviour, fish larvae, self-recruitment, spatial distribution, orientation, trajectories, optimisation

Table des matières

| | |
|---|-------------|
| Table des matières | ix |
| Liste des figures | xiii |
| Liste des tableaux | xvii |
| I Introduction | 1 |
| I.1 Les modifications de la relation stock-recrutement | 3 |
| I.1.1 Régulation des populations de poissons | 3 |
| I.1.2 Dynamique des abondances larvaires | 5 |
| I.2 Un aperçu de l'écologie des métapopulations | 6 |
| I.2.1 Qu'est-ce qu'une métapopulation ? | 6 |
| I.2.2 Effets du fonctionnement en métapopulation | 7 |
| I.2.3 Importance de l'auto-recrutement | 9 |
| I.3 La connectivité des populations marines | 11 |
| I.3.1 Particularités des métapopulations marines | 11 |
| I.3.2 Mesures de connectivité | 12 |
| I.3.3 Échelles de connectivité | 13 |
| I.4 Les concepts de l'écologie comportementale | 14 |
| I.4.1 Explications du comportement | 16 |
| I.4.2 Prédire le comportement | 17 |
| I.5 La biologie des larves de poissons coralliens | 20 |
| I.5.1 Écologie des récifs coralliens | 20 |
| I.5.2 Larves des poissons coralliens | 22 |
| I.6 Résumé et présentation du travail | 23 |
| 1 The importance of behaviour in models of fish early-life history | 25 |
| 1.1 Introduction | 26 |
| 1.2 General questions on behavioural traits | 27 |
| 1.2.1 Mean vs. mean+variance vs. maximum | 27 |
| 1.2.2 Ontogeny of behaviour | 28 |
| 1.2.3 Taxonomic resolution of behaviour | 28 |
| 1.3 Vertical position | 30 |
| 1.3.1 Potential influences | 30 |
| 1.3.2 When to include this behaviour? | 30 |

| | | |
|----------|---|-----------|
| 1.3.3 | Simple modelling tests | 31 |
| 1.3.4 | How to get the relevant data? | 31 |
| 1.3.5 | Suggested implementation | 32 |
| 1.4 | Horizontal swimming | 33 |
| 1.4.1 | Potential influences | 33 |
| 1.4.2 | When to include this behaviour? | 33 |
| 1.4.3 | Simple modelling tests | 34 |
| 1.4.4 | How to get the relevant data? | 34 |
| 1.4.5 | Suggested implementation | 35 |
| 1.5 | Orientation | 36 |
| 1.5.1 | Potential influences | 36 |
| 1.5.2 | Simple modelling tests | 36 |
| 1.5.3 | How to get the relevant data? | 36 |
| 1.5.4 | Suggested implementation | 38 |
| 1.6 | Foraging | 39 |
| 1.6.1 | Potential influences | 39 |
| 1.6.2 | When to include this behaviour? | 40 |
| 1.6.3 | How to get the relevant data? | 40 |
| 1.7 | Predator avoidance | 41 |
| 1.7.1 | Potential influences | 41 |
| 1.7.2 | When to implement this behaviour? | 41 |
| 1.8 | Schooling | 41 |
| 1.8.1 | Potential influences | 41 |
| 1.8.2 | Simple modelling tests | 42 |
| 1.8.3 | How to get the relevant data? | 42 |
| 1.8.4 | Suggested implementation | 42 |
| 1.9 | Choice of settlement habitat | 43 |
| 1.9.1 | Potential influences | 43 |
| 1.9.2 | When to include this behaviour? | 44 |
| 1.9.3 | How to get the relevant data? | 44 |
| 1.9.4 | Suggested implementation | 44 |
| 1.10 | Conclusions | 46 |
| 2 | Detection and quantification of marine larvae orientation in the pelagic environment | 47 |
| 2.1 | Introduction | 47 |
| 2.2 | Materials and Procedures | 49 |
| 2.2.1 | Materials | 49 |
| 2.2.2 | Procedures | 50 |
| 2.3 | Assessment | 54 |
| 2.4 | Discussion | 57 |
| 2.A | Acknowledgments | 60 |
| 3 | <i>In situ</i> observation of settlement behaviour in larvae of coral reef fishes at night | 61 |
| 3.1 | Introduction | 61 |
| 3.2 | Methods | 62 |

| | | |
|----------|--|------------|
| 3.3 | Results | 63 |
| 3.4 | Discussion | 65 |
| 3.5 | Conclusion | 66 |
| 3.A | Acknowledgements | 67 |
| 4 | Biophysical correlates in the spatial distribution of coral reef fish larvae around an isolated atoll | 69 |
| 4.1 | Introduction | 69 |
| 4.2 | Methods | 71 |
| 4.2.1 | Sampling scheme | 71 |
| 4.2.2 | Treatment of samples and data | 73 |
| 4.2.3 | Statistical analysis | 74 |
| 4.3 | Results | 76 |
| 4.3.1 | Highly variable physical environment | 76 |
| 4.3.2 | Patchy distribution of fish larvae | 79 |
| 4.3.3 | Intrinsic biological variability | 80 |
| 4.3.4 | Spatial correlates in the physical environment | 82 |
| 4.4 | Discussion | 87 |
| 4.A | Acknowledgements | 91 |
| 5 | Ontogenetic vertical “migration” in fish larvae: description and consequences for dispersal | 93 |
| 5.1 | Introduction | 93 |
| 5.2 | The statistical analysis of vertical distributions | 95 |
| 5.2.1 | Direct comparison of distributions | 96 |
| 5.2.2 | Comparison of distribution descriptors: the depth centre of mass | 97 |
| 5.3 | Methods | 100 |
| 5.3.1 | Sampling protocol and data treatment | 100 |
| 5.3.2 | Statistical analysis | 101 |
| 5.3.3 | Model of the influence of ontogenetic vertical migration | 103 |
| 5.4 | Results | 104 |
| 5.4.1 | Factors affecting vertical distribution | 104 |
| 5.4.2 | Diel-vertical migration and other physical correlates | 106 |
| 5.4.3 | Ontogenetic shifts in vertical distribution | 107 |
| 5.4.4 | Influence of ontogenetic shifts on advection | 107 |
| 5.5 | Discussion | 111 |
| 5.5.1 | Vertical distribution | 111 |
| 5.5.2 | Influence on advection | 113 |
| 5.A | Acknowledgements | 114 |
| 6 | Oceanography vs. behaviour: a modelling approach | 115 |
| 6.1 | Introduction | 115 |
| 6.2 | A general modelling framework for larval behaviour | 119 |
| 6.2.1 | Model description | 119 |
| 6.2.2 | Stochastic dynamic programming equation | 123 |

| | | |
|----------|---|------------|
| 6.2.3 | Example trajectories | 125 |
| 6.3 | The balance between feeding and predation: comparison of life history strategies | 126 |
| 6.3.1 | Plankton and predators in a 3D current field . . . | 126 |
| 6.3.2 | More elaborate larval dynamics and stochastic model | 128 |
| 6.3.3 | Comparison between contrasting biological parameters | 130 |
| 6.3.4 | Resulting optimal trajectories and decisions | 132 |
| 6.3.5 | Discussion | 136 |
| 6.4 | The relative influence of oriented swimming and passive advection in a dynamic flow field | 137 |
| 6.4.1 | Advection in a dynamic current field | 137 |
| 6.4.2 | Continuous and quantitative description of swimming behaviour | 142 |
| 6.4.3 | Complete optimisation model | 148 |
| 6.4.4 | Large impact of swimming | 150 |
| 6.4.5 | Effect of temperature | 154 |
| 6.4.6 | Discussion | 158 |
| 6.5 | General discussion | 160 |
| 6.5.1 | Why optimal strategies? | 160 |
| 6.5.2 | Why self-recruitment? | 163 |
| 6.5.3 | Model validation | 166 |
| 6.5.4 | Consequences of larval behaviour on connectivity | 166 |
| 6.A | Choice of the last two optimal decisions | 168 |
| 6.B | Acknowledgements | 169 |
| C | Conclusion | 171 |
| C.1 | Principaux résultats | 171 |
| C.2 | Intérêts et limites des modèles numériques | 174 |
| C.2.1 | Quand et pourquoi utiliser des modèles? | 174 |
| C.2.2 | Quels modèles pour la phase larvaire des organismes marins? | 176 |
| C.3 | Pistes de recherche | 179 |
| A | Undescribed Chaetodontidae | 183 |
| | Bibliographie | 187 |
| | Remerciements | 209 |

Liste des figures

| | | |
|------|--|----|
| I.1 | Page de garde de la publication de Hjort, 1914 | 1 |
| I.2 | Cycle de vie des poissons démersaux | 3 |
| I.3 | Densité dépendance à l'installation pour <i>Dascyllus trimaculatus</i> | 5 |
| I.4 | Schéma d'une métapopulation | 7 |
| I.5 | Dispersion et dispersion natale | 11 |
| I.6 | Noyau de dispersion et échelles spatio-temporelles pertinentes pour les questions écologiques et génétiques | 14 |
| I.7 | Échelles spatio-temporelles des processus influençant et influencés par la connectivité | 15 |
| I.8 | Prédiction du chargement optimal chez l'Étourneau | 18 |
| I.9 | Photographies aériennes de la Grande Barrière de Corail | 21 |
| I.10 | Vitesses de nage et capacité sensorielles chez 11 taxa marins | 22 |
| 1.1 | Comparison of trait values for the whole population and for successful recruits | 27 |
| 1.2 | Larval behaviours hierarchy, by importance for early life history models | 46 |
| 2.1 | 3D representation of the OWNFOR device | 49 |
| 2.2 | Flowchart of the video analysis process | 52 |
| 2.3 | Video frame captured by the OWNFOR device, before and after video processing | 53 |
| 2.4 | Two characteristic trajectories of the OWNFOR device | 55 |
| 2.5 | Trajectory in the aquarium before and after correction by compass readings | 55 |
| 2.6 | Comparison between a passive trajectory and possible ranges of active trajectories of a pomacentrid in the Gulf Stream | 59 |
| 3.1 | Number of species per vertical position for each settlement zone | 63 |
| 4.1 | Tetiaroa situation map and sampling stations | 71 |
| 4.2 | Sampling plan at one station | 72 |
| 4.3 | Wind field for the four rotations | 77 |
| 4.4 | Interpolated surface flow field for the four rotations | 78 |
| 4.5 | Interpolated pycnocline depth for the four rotations | 79 |

| | | |
|------|---|-----|
| 4.6 | Distribution of coral reef fish larvae for each rotation | 81 |
| 4.7 | Regression tree of concentration of coral reef fish larvae against taxonomic, ontogenetic, and physical factors | 82 |
| 4.8 | Distribution of the normalised concentrations of the five most abundant reef fish families during the four rotations | 83 |
| 4.9 | Principal Component Analysis of the concentrations of the ten most abundant reef fish families and various physical factors | 84 |
| 4.10 | Concentration of reef fish larvae plotted over mean intensity of current speed | 85 |
| 4.11 | Comparison of larval fishes abundance and residuals of Generalised Linear Models | 87 |
| 5.1 | Demonstration of the bias in z_{cm} calculation when using concentration instead of standardised abundance | 97 |
| 5.2 | Regression tree of the z_{cm} against taxonomic, physical, and ontogenetic factors | 105 |
| 5.3 | Z_{cm} s of the ten most abundant reef fish families | 105 |
| 5.4 | Violin plot of z_{cm} s by family and ontogenetic stage for eight common reef fish families | 108 |
| 5.5 | Violin plot of z_{cm} s for the global community at three ontogenetic stages | 109 |
| 5.6 | Z_{cm} in function of mean relative size | 109 |
| 5.7 | Trajectories of vertically migrating particles around a circular island | 110 |
| 6.1 | State space representation of transitions in a simplified model | 121 |
| 6.2 | Transition matrices for the simplest parameterisation of the one-dimensional model | 122 |
| 6.3 | Two examples of optimal trajectories | 126 |
| 6.4 | Snapshot of SYMPHONIE's output | 127 |
| 6.5 | Swimming decisions available in the refined model | 128 |
| 6.6 | Comparison of optimal trajectories of a larva of type Acanthuridae and a larva of type Pomacentridae | 133 |
| 6.7 | Schematic comparison of trajectories starting on the downstream side of the island for Acanthuridae and Pomacentridae | 134 |
| 6.8 | Linear regression of recruitment rate against the island-mass factor | 135 |
| 6.9 | Bathymetry of the circular island and the promontory models | 138 |
| 6.10 | Daily snapshots of surface flow in the island model | 140 |
| 6.11 | Daily snapshots of surface flow in the promontory model | 141 |
| 6.12 | Development of critical speed throughout the larval period and effect of temperature | 144 |
| 6.13 | Decrease of larval duration with increasing temperature | 145 |
| 6.14 | Possible explanation of the sudden increase in swimming endurance during ontogeny | 147 |

| | | |
|------|---|-----|
| 6.15 | Comparison of ten passive and active trajectories of <i>Pomacentrus amboinensis</i> in the island case | 151 |
| 6.16 | Comparison of five passive and active trajectories of temperate larvae in the promontory case | 152 |
| 6.17 | Detail of trajectories of <i>P. amboinensis</i> in the island and promontory configurations: swimming speeds and 3D representations | 153 |
| 6.18 | Optimal swimming speeds of <i>P. amboinensis</i> larvae through time during ontogeny | 154 |
| 6.19 | Comparison between trajectories of temperate larvae around the island in present conditions and after a 2°C increase . . . | 156 |
| 6.20 | Comparison between trajectories of <i>P. amboinensis</i> in the present situation and after a 2°C increase, in the promontory case | 157 |
| C.1 | Abondance des Loups et des Orignaux sur l'Île Royale . . . | 178 |
| A.1 | Side view of specimen 1 of the "longhorn" Chaetodon . . . | 184 |
| A.2 | Top view of specimen 1 of the "longhorn" Chaetodon . . . | 184 |
| A.3 | Face view of specimen 1 of the "longhorn" Chaetodon . . . | 185 |
| A.4 | Side view of specimen 1 of the "longhorn" Chaetodon . . . | 185 |
| A.5 | Side view of specimen 2 of the "longhorn" Chaetodon . . . | 186 |

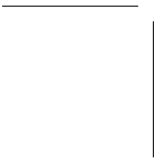

Liste des tableaux

| | | |
|-----|---|-----|
| 1.1 | Potential orientation cues for coral reef fishes | 37 |
| 2.1 | Position, bearings and directionality statistics for 18 assessed larvae | 56 |
| 3.1 | Swimming behaviour and settlement sites of 27 species observed at Moorea Island and comparison with literature data | 64 |
| 4.1 | Abundances of the ten most abundant families of coral reef fishes | 81 |
| 5.1 | Statistics for the difference in z_{cm} s of different ontogenetic stages of eight abundant families of coral reef fishes | 108 |
| 6.1 | Parameters of the biological model for <i>Pomacentrus amboinensis</i> and a cold temperate fish larva | 149 |
| 6.2 | Comparison of the mean percentages of success along passive and active trajectories | 150 |
| 6.3 | Effect of the a 2°C increase in water temperature on the model's output for active larvae | 155 |
| A.1 | Morphometric measurements and meristic counts for the "longhorn" Chaetodon | 186 |

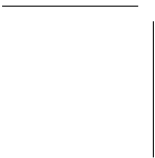

Chapitre I

Introduction

L'origine de l'intérêt scientifique pour la phase larvaire des poissons est probablement à chercher dans cette publication colossale de Johan Hjort en 1914 :

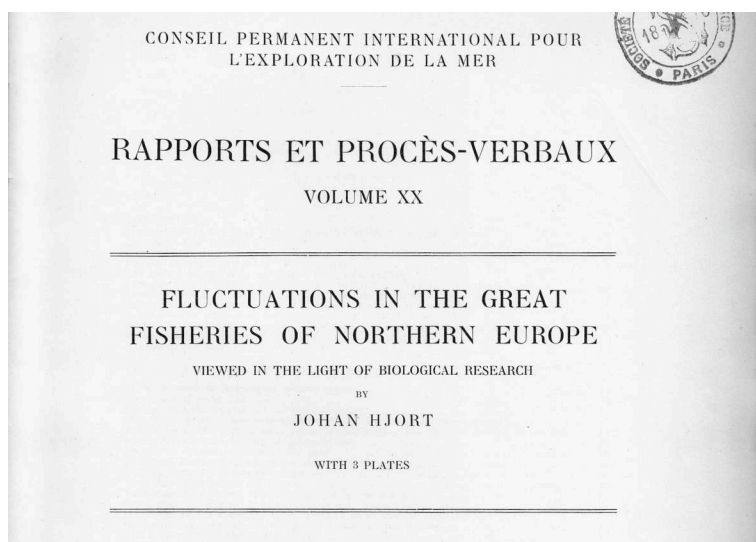

Figure I.1 Page de garde de la publication de Hjort¹ dans les Rapports et Procès Verbaux des Réunions de l'ICES.

Les stocks de Morue et de Hareng des mers nordiques varient énormément : alors que certaines années les tonnages débarqués sont massifs, les années suivantes sont maigres, jusqu'à ce que, de façon imprévisible, le poisson "revienne". Le gouvernement norvégien mandate Hjort pour expliquer ces variations. Entre 1900 et 1913 il amasse quantité de données sur les fluctuations des stocks et, surtout, calcule les abondances relatives des différentes classes d'âge d'individus pêchés grâce à une nouvelle méthode (basée sur l'étude des écailles et des os

Les stocks halieutiques fluctuent

plutôt que sur la longueur du poisson). Hjort observe que l'âge moyen des individus augmente d'année en année et que, bien souvent, la majorité des poissons pêchés vient d'une seule cohorte (i.e. sont du même âge). Un seul événement de recrutement^a semble déterminer l'état des stocks sur plusieurs années successives. L'explication des variations dans les stocks est donc à chercher dans les causes des variations du recrutement.

La survie des larves
détermine le stock

Le cycle de vie de la plupart des organismes marins démersaux (notamment de la Morue et du Hareng) est divisé en une phase larvaire pélagique et une phase adulte benthique (Figure I.2). Pour recruter, les larves doivent donc trouver un site d'alevinage propice sur le plateau continental, habituellement une zone peu profonde et proche de la côte. Ce changement de mode de vie et cette contrainte spatiale différencient les poissons démersaux de poissons complètement pélagiques (Thons, Marlins, etc.) pour lesquels le développement est plus continu et qui peuvent "recruter" dans l'océan. Dans le cas de poissons démersaux, Hjort observe que le nombre ou la condition physique des individus reproducteurs (donc le nombre d'œufs produits) n'est pas corrélé au nombre d'individus recrutant. Ainsi, il semble que ce soient les événements ayant lieu lors de la phase de vagabondage océanique qui déterminent l'occurrence ou l'absence d'un événement de recrutement extraordinaire et pas le stock (l'abondance) des adultes. À une échelle suffisamment faible (infra-kilométrique) il est même probable que la quasi-totalité des recrues proviennent d'ailleurs que de la zone d'intérêt², déconnectant ainsi l'afflux de larves de la reproduction locale.

C'est avec ces phrases (italiques sic.) qu'il y a presque un siècle, Hjort résumait son travail, éveillant ainsi l'intérêt scientifique pour la phase larvaire :

The rich year classes thus appear to make their presence felt when still quite young; in other words, the numerical value of a year class is apparently determined at a very early stage, and continues in approximately the same relation to that of other year classes throughout the life of the individuals ...

... it is difficult to avoid the conclusion that the actual quantity of eggs spawned is *not* a factor in itself sufficient to determine the numerical value of a year class ...

This again leads us to the question, at which stage of development the most critical period is to be sought. Nothing is known with certainty as to this; such data as are available, however, appear to indicate *the very earliest larval and young fry stages* as most important.

^aLe recrutement au sens halieutique est l'entrée des jeunes individus dans les stocks de pêche, c'est-à-dire le moment où ils atteignent une taille suffisante pour être pris dans les filets. Le recrutement au sens biologique correspond à l'adoption, par les larves, d'un mode de vie proche de celui des adultes. Il s'accompagne souvent de la métamorphose. Hjort utilise le mot dans ses deux sens, en fonction du contexte.

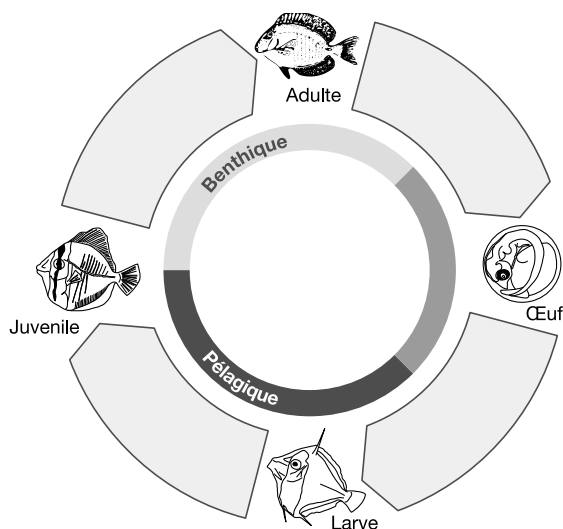

Figure I.2 Cycle de vie de la plupart des poissons démersaux : les adultes produisent des œufs qui peuvent être pélagiques ou benthiques ; ces œufs éclosent et donnent des larves qui, elles, sont pélagiques ; ces larves adoptent enfin le mode de vie adulte (i.e. elles recrutent). Il n'existe que peu d'espèces faisant exception et présentant une phase larvaire benthique.

Les communautés de poissons peuvent donc être vues comme des entités alimentées par un flux variable de larves, dont l'abondance n'est pas uniquement déterminée par le nombre initial d'œufs produits. Dans ces conditions, deux questions se posent : comment la densité des populations est-elle régulée face à ce flux aléatoire ? Quels sont les facteurs qui déterminent l'abondance des recrues ?

I.1 Les modifications de la relation stock-recrutement

I.1.1 Régulation des populations de poissons

Comme Hjort le remarque, les abondances relatives des différentes cohortes sont stables dans le temps, après le recrutement. Si le taux de mortalité est similaire à chaque âge et qu'il ne dépend pas de l'abondance de chaque cohorte, cela signifie que la régulation s'opère plus tôt dans le cycle de vie. Deux théories s'opposent initialement à propos de quand, précisément, l'abondance de chaque cohorte est déterminée.

Les communautés côtières étant en général des assemblages de haute richesse spécifique, il est initialement admis que chaque espèce a une niche écologique très spécialisée et que l'abondance de chacune d'elles est limitée par la disponibilité de son habitat ou de la source de nourriture qui lui est spécifique^{3,4}. Une limitation par les ressources se traduit par une mortalité *densité-dépendante* : quand l'afflux de larves s'approche

Mortalité
densité-dépendante
des juvéniles

du nombre maximal de juvéniles que l'habitat peut héberger (sa *capacité portante*), la compétition augmente et, avec elle, la mortalité. En particulier, les premiers stades benthiques, pré-recrutement, subissent une mortalité importante⁵ qui est souvent dépendante de la densité des individus de la même cohorte et/ou des adultes⁶. Ce mécanisme pourrait réguler la densité des communautés de poissons à long terme, même si l'alimentation en larves est variable. S'il s'applique, ces communautés devraient être stables dans le temps, tant que l'environnement ne change pas.

Limitation par le recrutement

Cependant, ce mécanisme n'explique pas les variations d'abondance que Hjort observe sur des stades plus âgés, après l'épisode initial de forte mortalité. Il n'explique pas non plus que les patrons de distribution observés à l'arrivée de larves de Poissons Demoiselles sur un récif corallien, avant l'épisode de forte mortalité, se retrouvent dans la distribution des sub-adultes, après cet épisode. C'est ce qui conduit Doherty⁷ à proposer l'hypothèse d'une *limitation par le recrutement*, même dans le cas des communautés de poissons coralliens, pourtant très riches est donc propices à l'explication énoncée ci-dessus. Cette hypothèse suppose que le nombre de larves arrivant sur un récif est toujours inférieur à sa capacité portante, qu'il détermine l'abondance future des recrues et que, comme l'habitat n'est jamais saturé, la mortalité des premiers stades benthiques est densité-indépendante. Selon cette hypothèse, la mortalité des premiers stades larvaires pélagiques — "*the very earliest larval and young fry stages*" pour Hjort — déterminerait à elle seule l'abondance future de la cohorte.

Unification : la "détermination" par le recrutement

Ces deux hypothèses se sont longtemps affrontées tant elles paraissent en tous points opposées : pour la première, l'abondance des larves est saturante et la mortalité des premiers stades benthiques est densité-dépendante ; pour la seconde, les larves ne saturent jamais l'habitat et la mortalité juvénile est densité-indépendante. Qui plus est, les observations de terrain sont contradictoires et peuvent corroborer les deux hypothèses : la mortalité durant la phase d'installation sur un substrat benthique est souvent indépendante de la densité la cohorte qui s'installe, par contre la mortalité post-installation est souvent densité-dépendante⁶. Doherty² unifie finalement ces différentes observations en explicitant les nuances de sa théorie de la limitation par le recrutement, en général mal comprises par ses opposants. Tout d'abord, au moment de l'installation, la densité-dépendance ne se fait sentir qu'au dessus d'un certain seuil dans l'afflux de larves et elle ne serait prépondérante que lors de l'arrivée d'agrégats de larves particulièrement denses (Figure I.3). Ceci expliquerait que l'installation puisse être densité-dépendante à certains lieux et moments et densité-indépendante à d'autres⁶. La distribution spatiale des larves installées est ensuite quelque peu lissée au cours du temps, ce qui suggère une mortalité spatialement hétérogène et probablement densité-dépendante, mais les patrons d'installation restent visibles⁸ et déterminent en partie la structure des communautés benthiques. Cette théorie d'une *détermination*

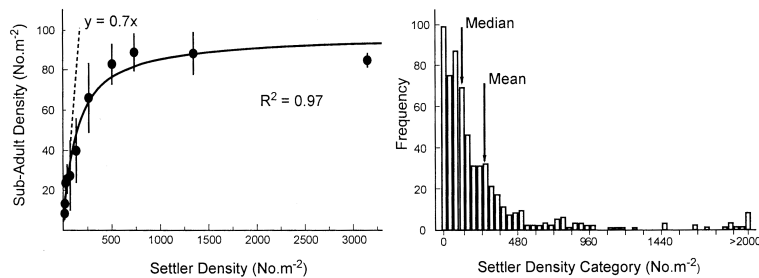

Figure I.3 Gauche : relation entre la densité des larves colonisant le récif (settler density) et la densité des sub-adultes (sub-adult density) pour *Dascyllus trimaculatus* sur 180 jours. Pour des densités faibles de larves, la courbe est bien approximée par la droite en pointillés, qui représente un scénario de mortalité densité-indépendante. Droite : Histogramme des densités de larves colonisant le récif. Dans 58% des cas, les densités sont en dessous du seuil ou la densité-dépendance se fait sentir. D'après Schmitt et al.¹⁰, reproduit par Doherty².

par recrutement⁹ assouplit celle du recrutement limitant et clôt un débat très largement lexical. En réalité, les populations fluctuent entre une borne minimale (l'extinction) et une borne maximale (la saturation du milieu) et la part relative de la densité-dépendance augmente quand les effectifs s'approchent de la saturation, alors que celle de la limitation par le recrutement augmente quand les effectifs sont faibles.

I.1.2 Dynamique des abondances larvaires

Dans tous les cas, la quantité de larves de poissons arrivant sur les lieux d'installation détermine, au moins en partie, l'abondance future de la cohorte. Mais ceci avait déjà été remarqué par Hjort, alors qu'avons nous appris depuis un siècle ? Tout d'abord, la phase larvaire a été reconnue aussi importante pour la plupart des organismes démersaux que pour les poissons (voir par exemple la revue de Levin¹¹, principalement focalisée sur les animaux invertébrés). Ensuite, plusieurs hypothèses ont été examinées quant à l'explication des fluctuations dans l'abondance des larves.

La première hypothèse a été émise par Hjort lui-même avant d'être détaillée par de nombreux travaux, notamment ceux de Cushing¹². Il suppose que lors de la période larvaire, certaines phases sont critiques et que, notamment, la survie des larves au moment de leur première prise de nourriture dépend étroitement de l'abondance de leurs proies planctoniques. Les périodes de "bloom" planctonique varient d'année en année alors que la période de reproduction des adultes est plus constante. Une survie importante des larves serait associée à une synchronie entre les processus de ponte et d'enrichissement planctonique au printemps, alors que, lorsque les deux phénomènes sont désynchronisés, les larves subissent une mortalité massive. C'est l'hypothèse du "mismatch". Outre la synchronie temporelle entre la multiplication du

La synchronie spatio-temporelle des larves et de leurs proies détermine leur survie

plancton et l'éclosion larves de poissons, de nombreux phénomènes peuvent modifier localement les conditions d'alimentation des larves, compliquant ainsi la relation de "match-mismatch" au niveau spatial. La stratification de la colonne d'eau entraîne par exemple la concentration de plancton dans des couches horizontales fines¹³, qui sont des lieux d'alimentation particulièrement profitables. À plus petite échelle, la turbulence favorise la rencontre entre les larves et leurs proies¹⁴. À méso-échelle, les fronts se formant entre deux masses d'eau aux propriétés thermohalines différentes créent des zones de production primaire élevée¹⁵ qui sont propices à la survie des larves. Néanmoins, ces zones riches en proies sont bien souvent aussi riches en prédateurs¹⁶. Un compromis est donc nécessaire entre la nécessité de trouver des proies et le risque d'en devenir une. Ce risque de prédation, initialement non considéré par Hjort, a depuis été reconnu comme une source potentielle de variabilité au niveau de la survie des larves¹⁷.

Les courants déterminent en partie les voies de dispersion

Les phénomènes physiques influencent également directement le recrutement car ils sont, en partie au moins, responsables de l'advection des larves : ils les rapprochent ou les éloignent des sites favorables au recrutement. En particulier, les structures océanographiques se développant près des côtes (tourbillons, fronts, etc.) ont probablement une influence sur la rétention des larves¹⁸. Ceci se reflète d'ailleurs largement dans les premiers modèles de dispersion larvaire lors de la phase océanique, qui ne traitent les larves que comme des particules, souvent passives, déplacées par les courants¹⁹⁻²².

L'influence relative des différents facteurs physiques et biologiques est encore mal appréhendée car tous sont difficiles à observer²³. Les interactions physico-biologiques sont d'autre part compliquées par le comportement des adultes qui, par le choix du site de reproduction, influencent les conditions initiales de la dispersion²⁴ et par le comportement des larves qui, rapidement, ne sont plus passives²⁵.

Quoi qu'il en soit, depuis Hjort, la majorité des travaux confirment que la période larvaire est critique pour les populations d'organismes marins démersaux. Qui plus est, à l'état adulte, ces organismes sont très largement sédentaires et forment des peuplements fortement structurés spatialement. Aux questions de renouvellement des stocks, qui focalisent les études halieutiques, sont donc venues se rajouter, depuis une dizaine d'années, des questions écologiques concernant les niveaux de connexion entre les populations.

I.2 Un aperçu de l'écologie des métapopulations

I.2.1 Qu'est-ce qu'une métapopulation ?

Chaque sous-population peut s'éteindre

La distribution spatiale des populations peut avoir un effet important sur leur fonctionnement. La première formalisation efficace de la dynamique d'un réseau de populations discrètes dans l'espace est due à Levins^{26,27}. Il utilise le premier le terme *métapopulation* pour désigner le système

qu'il modélise : un ensemble de nombreuses populations se reproduisant indépendamment les unes des autres et ayant chacune une probabilité substantielle de s'éteindre.

Néanmoins, cette approche *métapopulationnelle* a été généralisée par la suite pour embrasser tous les phénomènes où l'espace est discret et où les processus écologiques ont lieu à deux échelles : l'échelle locale et l'échelle de la métapopulation²⁸. Cette définition plus large comprend donc également les échanges démographiques entre des populations sources et des populations puits, sans qu'il y ait nécessairement extinction.

Finalement, il est possible de parler de métapopulation dès qu'il existe des échanges entre des populations se reproduisant localement, de façon indépendante²⁸. Ces populations sont appelées *dèmes* et l'ensemble des dèmes forme la *métapopulation* (Figure I.4).

Des relations
source-puits
sans extinction

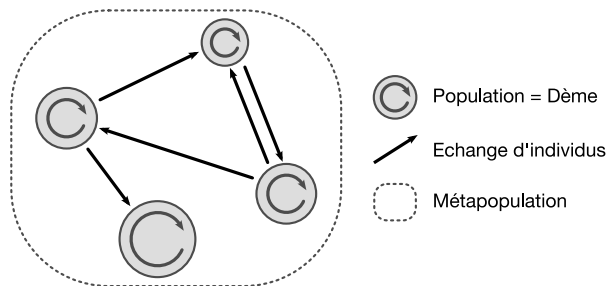

Figure I.4 Représentation schématique du concept de métapopulation. Chaque dème est indépendant pour la reproduction mais des échanges sont possibles entre les dèmes au sein de la métapopulation.

I.2.2 Effets du fonctionnement en métapopulation

Étant donné que le concept de métapopulation est né dans un cadre théorique, il est naturel d'essayer de décrire ses propriétés par le biais de modèles. Considérons la dynamique d'une population isolée représentée par la fonction logistique

$$\frac{dn}{dt} = rn\left(1 - \frac{n}{K}\right) \quad (\text{I.1})$$

où n est l'abondance, t le temps, r le taux de croissance intrinsèque (représentant la natalité et la mortalité densité indépendante) et K la capacité portante. Dans la métapopulation la plus simple comprenant deux populations ne différant que par leur capacité portante (i.e. des individus aux propriétés identiques répartis dans deux localités différentes), ce modèle devient

$$\begin{cases} \frac{dn_1}{dt} = rn_1\left(1 - \frac{n_1}{K_1}\right) - mn_1 + mn_2 \\ \frac{dn_2}{dt} = rn_2\left(1 - \frac{n_2}{K_2}\right) - mn_2 + mn_1 \end{cases} \quad (\text{I.2})$$

où m est le taux de migration. Dans le cas sans migration (équation I.1), l'équilibre est $n = 0$ ou $n = K$. L'analogie dans le cas de deux populations non-éteintes est $N = K_1 + K_2$ (N est l'abondance globale dans la métapopulation). L'équilibre avec migration est donné par

$$\begin{cases} rn_1^* \left(1 - \frac{n_1^*}{K_1}\right) - mn_1^* + mn_2^* = 0 \\ rn_2^* \left(1 - \frac{n_2^*}{K_2}\right) - mn_2^* + mn_1^* = 0 \end{cases} \quad (\text{I.3})$$

Afin de comprendre quelle est l'influence du terme de migration, considérons le cas limite où $m \rightarrow \infty$. Soustraire les équations (I.3) donne, à l'équilibre

$$\frac{1}{m} \left[rn_1^*(m) \left(1 - \frac{n_1^*(m)}{K_1}\right) + rn_2^*(m) \left(1 - \frac{n_2^*(m)}{K_2}\right) \right] = 2(n_1^*(m) - n_2^*(m)) \quad (\text{I.4})$$

La quantité à gauche de l'équation tend vers zéro quand $m \rightarrow \infty$ car $0 \leq n_i^*(m) \leq K_i$ donc

$$\lim_{m \rightarrow \infty} [n_1^*(m) - n_2^*(m)] = 0 \quad (\text{I.5})$$

Additionner les deux équations (I.3) en tenant compte du fait que $n_1^* = n_2^* = n^*$ lorsque $m \rightarrow \infty$ donne

$$\begin{aligned} rn_1^* \left(1 - \frac{n_1^*}{K_1}\right) + rn_2^* \left(1 - \frac{n_2^*}{K_2}\right) &= 0 \\ rn^* \left(1 - \frac{n^*}{K_1}\right) &= -rn^* \left(1 - \frac{n^*}{K_2}\right) \\ n^* &= \frac{2K_1K_2}{K_1 + K_2} \end{aligned} \quad (\text{I.6})$$

Ce qui nous permet de comparer les équilibres de la métapopulation sans migration ($K_1 + K_2$) et avec migration ($2n^*$)

$$\begin{aligned} K_1 + K_2 - 2n^* &= K_1 + K_2 - 2 \frac{2K_1K_2}{K_1 + K_2} \\ &= \frac{(K_1 - K_2)^2}{K_1 + K_2} > 0 \end{aligned} \quad (\text{I.7})$$

Les échanges d'individus influencent la dynamique des métapopulations

Le fait que cette quantité soit toujours positive signifie que l'abondance totale est plus faible lorsque les deux populations sont reliées par la migration que lorsqu'elles sont indépendantes, si $K_1 \neq K_2$. Par exemple, avec $K_1 > K_2$, les individus se déplacent davantage de la population 1 vers la population 2 que dans le sens opposé et, à l'équilibre, la population 1 n'est donc pas saturée. Ce modèle simple permet de souligner que les échanges entre les dèmes modifient la dynamique de chacun d'eux mais influencent également la dynamique globale de la métapopulation. Ce "tout" est différent de la somme de ses "parties" et il est donc important de considérer les interactions entre les populations.

Le fait qu'une population puisse se maintenir sur un site défavorable à sa survie ($r < 1$) grâce à un apport suffisant de migrants (mn_2 grand) est un autre exemple particulièrement frappant de l'influence des échanges d'individus sur la dynamique des populations. Dans le cas des métapopulations avec extinction et re-colonisation, d'autres situations sont caractéristiques de la dynamique particulière des populations connectées. Il est par exemple possible d'expliquer le maintien de deux espèces en compétition, par leur occurrence alternée au sein de chacune des populations, fournissant ainsi une alternative à la théorie un peu limitante de l'exclusion compétitive. À l'inverse, un taux d'extinction trop élevé par rapport au taux de re-colonisation peut conduire à une situation dans laquelle la métapopulation dans son ensemble s'éteint alors qu'il existe encore des habitats favorables.

Les individus qui se déplacent entre les populations sont autant d'ensembles de gènes et ces échanges génétiques ont, eux aussi, des conséquences. Du fait des extinctions locales et de la stochasticité de la reproduction dans chacune des populations, la taille effective d'une métapopulation est probablement plus faible que celle d'une population panmictique contenant le même nombre total d'individus²⁹. Ce plus faible effectif efficace augmente la dérive génétique, facilite la fixation des allèles bénéfiques et l'élimination des allèles délétères, diminuant ainsi la variabilité génétique. De plus, au sein de chaque dème, la sélection favorise une adaptation aux conditions locales, rapide car les effectifs sont divisés, ce qui diminue globalement la capacité à conquérir de nouveaux milieux²⁸. Enfin, la dispersion a un effet rétro-actif sur sa propre évolution. En effet, en considérant que la propension à la migration est codée génétiquement, dans une population à fort pourcentage de migrants, le taux de migration aura tendance à baisser car les individus les plus enclins à migrer seront partis. Ceci a pour effet de stabiliser le taux de migration à long terme^{28,29}.

Échanges d'individus,
échanges de gènes

I.2.3 Importance de l'auto-recrutement

Un effet principal du fonctionnement en métapopulation est de modifier la dynamique des abondances dans les populations. Dans le cas de populations isolées, il existe une condition de persistance simple à exprimer mathématiquement et à appréhender biologiquement. Pour une population structurée en âge dont la dynamique est décrite par une matrice de Leslie, cette condition est que la valeur propre principale de la matrice de Leslie soit supérieure ou égale à un. La généralisation de cette condition en termes biologiques est que chaque individu, au cours de sa vie, donne en moyenne au moins un descendant. La dynamique d'une population structurée spatialement avec des échanges entre les sous-populations (i.e. une métapopulation) peut être représentée sous la forme d'une matrice ayant les mêmes propriétés que les matrices de Leslie. La condition mathématique de la persistance d'une métapopulation est donc la même. Cependant cette condition n'a pas de traduction

Persistance des
populations
isolées : taux de
reproduction ≥ 1

biologique simple. Hastings & Botsford³⁰ proposent une autre condition de persistance, détaillée ci-après, qui, elle, a une interprétation biologique.

Considérons un ensemble de populations à générations non chevauchantes (le résultat peut être généralisé à des populations avec survie adulte). Sa dynamique est représentée par

$$N_{t+1} = CN_t \quad (\text{I.8})$$

où N_t est le vecteur des abondances au temps t . C est une matrice dont chaque élément c_{ij} représente la contribution de la population j à l'effectif de la population i . Les termes de la forme c_{ii} représentent donc l'auto-recrutement. Quand il existe un $c_{ii} \geq 1$, alors cette population est auto-suffisante et la métapopulation dans son ensemble est trivialement persistante (il restera toujours au moins la population auto-suffisante). Qui plus est, dans ce cas, certaines autres populations puits peuvent être maintenues. Hastings & Botsford³⁰ s'intéressent au cas non trivial où tous les c_{ii} sont strictement inférieurs à un (i.e. toutes les populations sont localement des puits) et cherchent une condition de persistance pour la métapopulation dans son ensemble.

Armsworth³¹ avait déjà utilisé un raisonnement par l'absurde prouvant que, pour que la métapopulation persiste, il faut qu'il existe, pour chaque population, au moins un chemin de connexion fermé, la reliant à elle-même. C'est-à-dire, par exemple, que la population 1 émette des individus qui recrutent dans la population 2 et que la population 2, à son tour, émette des individus qui recrutent en 1. Hastings & Botsford³⁰ arrivent au même résultat de façon algébrique en utilisant les propriétés de la matrice

$$Q = C - I \quad (\text{I.9})$$

où I est la matrice identité, i.e. les éléments de Q sont

$$q_{ij} = \begin{cases} c_{ij} & \text{quand } i \neq j, \\ c_{ij} - 1 & \text{quand } i = j. \end{cases} \quad (\text{I.10})$$

Les éléments $|q_{ii}|$ représentent donc le "manque à gagner" en auto-recrutement ($1 - c_{ij}$) pour chacune des populations, lequel doit être compensé par les apports extérieurs pour que la population soit persistante. Dans le cas simple de deux populations, la condition de persistance pour la métapopulation dans son ensemble s'écrit finalement

$$\frac{q_{12}q_{21}}{|q_{11}q_{22}|} > 1 \quad (\text{I.11})$$

C'est à dire que les apports indirects ($q_{12}q_{21}$) doivent être supérieurs au manque à gagner global en auto-recrutement ($|q_{11}q_{22}|$). Il est intéressant de remarquer que les seuls apports qui contribuent à la persistance de la population sont ces chemins de connexion fermés et que les flux unidirectionnels n'ont aucun effet. Par exemple, dans le cas de trois populations, $q_{12}q_{23}q_{31}$ intervient alors que $q_{12}q_{23}q_{32}$ (réseau qui ne retourne pas vers 1) n'a pas de rôle dans la persistance de la métapopulation.

Ces deux raisonnements soulignent le fait que l'auto-recrutement est primordial dans la persistance des métapopulations :

- d'abord l'existence d'une population auto-suffisante garantit le maintien de la population dans son ensemble et permet la persistance de puits ;
- ensuite, dans le cas où toutes les populations sont des puits, c'est l'importance du manque à gagner en auto-recrutement qui détermine la condition de persistance de la métapopulation.

Qui plus est, cette condition met l'accent sur les connections locales, même ténues³⁰, qui ont davantage de probabilité de former des circuits fermés que les connections à longue distance.

L'auto-recrutement favorise le maintien du réseau populationnel

I.3 La connectivité des populations marines

I.3.1 Particularités des métapopulations marines

Les métapopulations les plus étudiées en milieu terrestre correspondent à des populations d'animaux vivant dans des habitats fractionnés et dont les adultes se déplacent régulièrement de patch en patch (papillons, fourmis, oiseaux, etc. voir les exemples dans Hanski²⁸ et Clobert et al.³²). Chez les organismes marins démersaux, le stade mobile et potentiellement dispersant est réduit aux larves, c'est à dire à la phase pré-reproductive. Ce phénomène de *dispersion natale* (sensu Clobert et al.³²) existe évidemment chez les animaux terrestres, mais il est plus systématique chez les Angiospermes par exemple, pour lesquelles la dispersion à moyenne et longue distance à partir d'un parent donné est assurée par un seul stade : la graine. Deux structures d'échanges entre les dèmes peuvent ainsi être distinguées (Figure I.5) et diffèrent notamment au niveau des causes de la dispersion. Dans le cas de la dispersion natale, elles impliquent davantage les effets maternels³³ et moins les effets du milieu³⁴.

Dispersion limitée à la phase larvaire

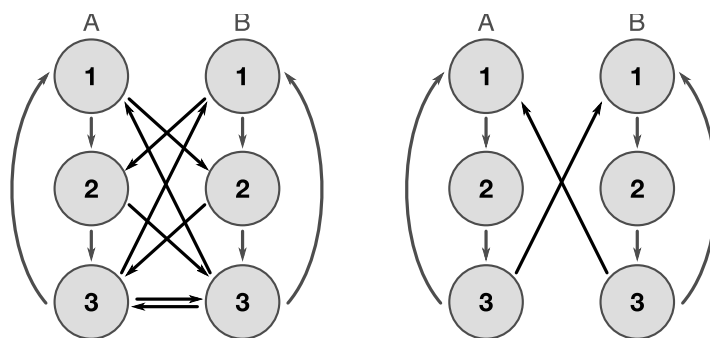

Figure I.5 Réseaux de dispersion (flèches noires) entre deux populations (A et B) structurées en trois classes d'âge (1, 2 et 3). Cas général (à gauche) comparé avec les connections possibles lorsque la dispersion est réduite à la dispersion natale (à droite).

Le milieu lui-même est en mouvement

La dispersion des graines offre un autre parallèle avec la dispersion en milieu marin, dans le cas de l'anémochorie ; en cela que le milieu lui-même est en mouvement et participe au déplacement des particules. Cette vision a conduit à penser que les directions de dispersion des larves marines peuvent être déduites de la direction moyenne des courants²². Ce paradigme réducteur à différents points de vue a rapidement été nuancé³⁵ mais il n'en reste pas moins que les courants marins participent aux mouvements des larves des organismes démersaux. Une description fine du milieu est donc nécessaire pour étudier leurs déplacements.

L'écosystème pélagique est très structuré

En temps que créatures terrestres n'effectuant que de brèves incursions océaniques, cantonnées à la surface le plus souvent, le milieu pélagique dans lequel se dispersent les larves nous apparaît comme une vaste étendue uniforme. En réalité, la salinité peut varier sur quelques centimètres en surface après de fortes précipitations ou sur quelques kilomètres entre l'embouchure d'un fleuve et les eaux marines environnantes. La production primaire au large des côtes du Chili et du Pérou, par exemple, varie de façon saisonnière du fait des changements de luminosité et de température, comme partout ailleurs. Mais elle fluctue également à l'échelle de la décade car elle est favorisée par un fort upwelling qui est modifié par les phénomènes El Niño. L'océan est donc un milieu très hétérogène et la structuration des propriétés physiques (température, salinité, turbidité, etc.), de la production primaire et de la biomasse se fait sentir à différentes échelles spatiales (des centimètres à plusieurs centaines de kilomètres) et temporelles (des minutes aux années)³⁶. L'échelle à laquelle est posée la question du mouvement des larves et des connexions entre les populations détermine quelles structures et quels phénomènes seront primordiaux. Néanmoins, tous les niveaux, depuis la micro-turbulence¹⁴ jusqu'au changement climatique³⁷, peuvent avoir un impact pendant la phase larvaire.

I.3.2 Mesures de connectivité

Les populations marines étaient considérées largement ouvertes

La compréhension de la dynamique des populations marines passe par la mesure de la *connectivité*, c'est-à-dire de l'échange d'individus entre les dèmes³⁸. Traditionnellement la connectivité a été estimée à partir d'hypothèses sur le transport de particules par les courants³⁹, évaluée par l'analyse de fréquences alléliques⁴⁰ ou inférée indirectement de la distribution des espèces. Ces mesures ont toutes suggéré une connectivité élevée, sur de larges échelles spatiales (bassins océaniques entiers¹¹).

La connectivité est en fait plus restreinte

À l'heure actuelle, l'analyse de régions hypervariables de l'ADN ou l'analyse de parenté révèlent une structuration génétique à très petite échelle^{41,42}. De rares analyses de marquage-recapture suggèrent un pourcentage non négligeable d'autorecrutement^{41,43,44}. Enfin, des modèles bio-physiques plus réalistes montrent que la connectivité était auparavant surestimée⁴⁵. Toutes ces approches permettent de favoriser

l'hypothèse d'une dispersion plus restreinte (kilomètres à centaine de kilomètres).

I.3.3 Échelles de connectivité

Au delà des échelles spatio-temporelles discutées ci-dessus, il existe une différence fondamentale entre deux types de connectivité^{38,46}. La définition considérée implicitement jusqu'à présent correspond à la *connectivité écologique*, qui s'intéresse seulement aux échanges d'individus en nombre suffisant pour avoir un impact sur la dynamique des populations locales. Ce concept est né de l'importance des échanges entre les dèmes pour la démographie de ceux-ci, déjà évoquée dans la partie I.2.2. Cependant, au même endroit, il a été mis en valeur que les mouvements d'individus sont également des mouvements de gènes. Apparaît alors la *connectivité génétique*, qui correspond aux échanges affectant la structure génétique des populations. Dans ce cas, des échanges rares et faibles (un individu par génération par exemple) suffisent à maintenir l'homogénéité génétique entre deux populations. De plus, les effets de l'isolement génétique se font sentir à plus long terme que ceux de l'isolement démographique.

Connectivité écologique
ou génétique

Les échelles de dispersion sont souvent représentées sous la forme d'un *noyau de dispersion* (dispersal kernel), c'est-à-dire de la densité de probabilité des distances de dispersion à partir d'une source. Sous cette forme, il est aisé de visualiser en quoi la différence du seuil pertinent pour chaque approche induit une différence d'échelle spatiale, et donc temporelle (Figure I.6). Les échelles spatio-temporelles à considérer dans le cas de la connectivité génétique sont beaucoup plus grandes que celles à considérer dans le cas de la connectivité écologique.

Ce changement d'échelle s'accompagne d'un changement de processus. En effet, les phénomènes environnementaux, océanographiques ou biologiques, ayant un rôle au niveau écologique jouent sur des distances de l'ordre de la dizaine de kilomètres et des durées allant de quelques jours à quelques mois (la durée de la phase larvaire). Les processus importants au niveau génétique ou évolutif sont ceux qui se déroulent à l'échelle de la génération et donc potentiellement aussi à bien plus large échelle spatiale⁴⁷. La Figure I.7 mets en parallèle les processus océanographiques et les phénomènes biologiques sur lesquels ils jouent, à chaque échelle.

Échelles et processus

Enfin, une dichotomie apparaît également au niveau opérationnel, entre deux façons de mesurer la connectivité. L'approche la plus commune consiste à estimer la quantité de larves partant d'un site et arrivant dans un autre. La période pertinente pour l'étude de la connectivité correspond donc uniquement à la phase pélagique, depuis la libération des oeufs ou des larves dans le plancton jusqu'à l'installation des larves sur un substrat benthique. Cependant, comme nous l'avons vu en I.1.1, les premiers stades benthiques des poissons subissent une mortalité très élevée (plus de 60% en une nuit⁵) qui peut complètement changer les pa-

Connectivité et
connectivité efficace

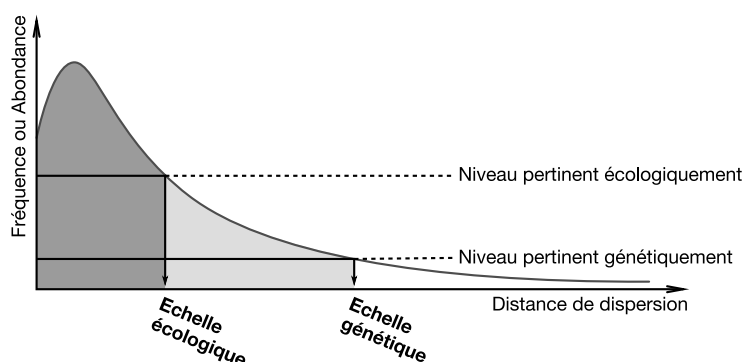

Figure I.6 Schématisation d'un noyau de dispersion unidimensionnel typique. La hauteur de la courbe représente la fréquence d'occurrence de chaque distance de dispersion, ou le nombre d'individus dispersant sur cette distance. La dispersion à courte distance est prédominante mais il existe quelques cas de dispersion à longue distance dans la queue de la distribution. Lorsque l'intérêt est porté aux phénomènes démographiques, les connections pertinentes sont celles qui sont fréquentes et/ou qui impliquent un grand nombre d'individus. Ce sont donc en général des connections à courte distance. Au contraire, de faibles niveaux de connections, et donc de longues distances, sont pertinentes en génétique des populations ou en évolution.

trons de distribution observés à l'arrivée des futures recrues. De plus, les événements ayant lieu durant la phase larvaire influencent la condition physique des larves à l'installation qui, à son tour, détermine en partie leur survie future, à l'état de juvéniles : les larves en meilleure condition survivent mieux que les autres⁴⁸⁻⁵⁰. Les conséquences de la vie larvaire se font donc sentir même après l'installation. Ceci conduit à définir la *connectivité efficace* qui correspond à l'échange d'individus qui survivent et se reproduisent dans leur population d'installation (traduction de la *reproductive connectivity* de Pineda et al.²³) et fait écho au concept de taille efficace en génétique des populations. Cette définition est plus pertinente à la fois au niveau écologique et évolutif car les individus arrivant sur un site d'installation pour y mourir immédiatement n'ont évidemment qu'un rôle très limité dans la dynamique de l'écosystème. Elle a été formulée explicitement de façon à appuyer l'importance des processus post-installation, dans un contexte où la majorité des observations et des modèles se limitent à la phase larvaire *sensu stricto*.

I.4 Les concepts de l'écologie comportementale

Les stades qui participent à la connectivité en milieu marin sont les stades larvaires, mais ces larves n'en restent pas moins des animaux, capables de se mouvoir et de réagir à leur environnement. Ceci est particulièrement vrai dans le cas des poissons²⁵ (voir partie I.5). L'étude du comportement des animaux en milieu sous-marin se heurte à des

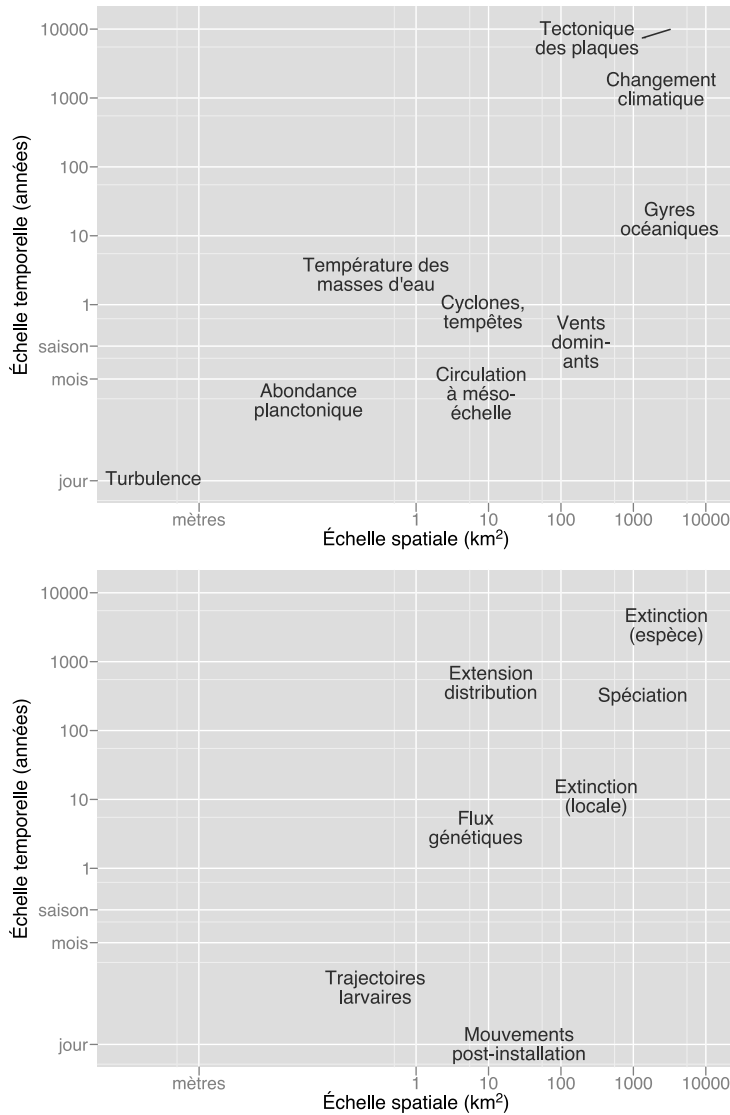

Figure I.7 Échelles spatiales et temporelles des processus environnementaux pouvant influencer la connectivité (haut) et des processus biologiques qu'ils influencent et sur lesquels il faut se focaliser pour étudier la connectivité (bas). Chaque zone ombrée recouvre les échelles pertinentes pour le processus désigné. Les zones claires contourées sont les processus plus pertinents en terme de connectivité écologique alors que les zones sombres sans contour sont les processus plus pertinents au niveau génétique. Cette dichotomie est à nuancer pour les processus intermédiaires (vents et tempêtes par exemple). Toutes les échelles sont logarithmiques.

obstacles techniques qui expliquent son retard par rapport au milieu terrestre. En effet, l'avènement de techniques permettant l'observation directe et autonome de la vie sous-marine est récent (1940-1950 pour le scaphandre de plongée, 1950-1960 pour les sous-marins à vocation scientifique). Même aujourd'hui, ces observations sont réduites dans le temps et dans l'espace par les contraintes de pression, de respiration et de visibilité dans l'eau. Enfin, l'observation des stades larvaires est encore compliquée par leur dilution dans de grands espaces océaniques, leur petite taille et leur fragilité. Or l'éthologie, c'est-à-dire l'étude biologique du comportement⁵¹, est basée en grande partie sur l'observation. Il semble donc intéressant de se pencher sur les avancées de la discipline en milieu terrestre afin d'accélérer la compréhension du comportement des animaux sous-marins, en transférant les concepts d'un milieu à l'autre.

I.4.1 Explications du comportement

Causation,
survival value,
ontogeny, evolution

Face à la diversité des approches dans l'éthologie naissante, Tinbergen⁵¹ proposa quatre types d'explication aux comportements animaux, quatre moyens de répondre à la question "Pourquoi?" en éthologie. Bien que leur présentation soit théorique, considérons leurs significations dans le cadre d'un exemple : pourquoi les passereaux émettent-ils des chants complexes au printemps ?

1. Les passereaux chantent car la photopériode augmente. L'aspect mécanique de ce comportement est que les passereaux chantent parce que de l'air passe dans leur gorge et fait vibrer des membranes qui émettent alors un son, modulable selon la fréquence des vibrations. Ces deux réponses ont trait à la cause immédiate qui explique leur comportement : *causation* pour Tinbergen.
2. Les passereaux chantent pour attirer des partenaires sexuels et leur chant complexe est spécifique à chaque espèce, permettant ainsi le rapprochement d'individus inter-féconds. Il s'agit de la fonction de leur comportement, de sa cause en terme de valeur sélective (*survival value*).
3. Les passereaux chantent parce que, au cours de leur vie embryonnaire, des membranes souples (les *membrana tympaniformis*) sont apparues dans leur syrinx et qu'ils ont ensuite appris, grâce à leurs parents, à les faire vibrer d'une certaine manière pour émettre un chant caractéristique. Le développement (*ontogeny*) explique ainsi le comportement observé actuellement.
4. Les passereaux émettent des chants complexes parce que leurs ancêtres émettaient des sons simples et que, au cours du temps, les individus émettant des sons plus complexes ont été avantagés et que les génotypes associés ont envahi les populations. Il s'agit là de décrire et d'expliquer l'*évolution* qui a mené au comportement actuel.

Aucune de ces quatre explications n'est plus vraie ou plus correcte qu'une autre. Il s'agit de quatre points de vue différents sur une même question. Alors que les études de physiologie (explorant les causes proximales, mécaniques du comportement — explications 1 et parfois 3 de Tinbergen) et d'écologie du comportement (s'intéressant aux causes distales, évolutives des comportements — explications 2 et 4 de Tinbergen) avaient tendance à s'opposer, Tinbergen prône leur rassemblement sous une même étiquette éthologique. Depuis, la frontière entre la neuro-physiologie, les sciences cognitives et l'écologie est devenue plus floue, et d'autant plus intéressante.

Les explications ne sont pas exclusives

I.4.2 Prédire le comportement

Au delà de la description, l'éthologie moderne tente de faire des prédictions quantitatives des comportements animaux. En suivant les explications 2 et 4 de Tinbergen (valeur sélective et évolution) il est naturel de penser que les comportements observés sont adaptés à l'environnement dans lequel ils ont évolué, et qu'ils maximisent une mesure de valeur sélective⁵². L'application la plus aboutie de ce raisonnement est la théorie de l'approvisionnement optimal (*optimal foraging*)⁵³. L'étude d'un exemple permet d'en comprendre le principe.

La théorie de l'approvisionnement optimal

Les Étourneaux doivent quitter leur nid pour aller chercher au sol de quoi nourrir leurs jeunes (insectes, vers, etc.). Lors d'un épisode de recherche de nourriture, ils sont de moins en moins efficaces au fur et à mesure que le temps passe : les animaux qu'ils chassent ont eu le temps de s'enfuir, ils font tomber de leur bec des proies déjà capturées en essayant d'en attraper une nouvelle, etc. Ainsi la courbe du nombre de proies capturées en fonction du temps est concave et atteint un maximum de huit proies par événement de recherche (Figure I.8). La question est : quelle stratégie de recherche de nourriture permet de maximiser l'énergie récupérée par rapport à l'énergie dépensée ? La beauté de cet exemple est que sa solution est géométrique. L'énergie dépensée est proportionnelle au temps passé en dehors du nid (a sur la Figure I.8). L'énergie récupérée est proportionnelle au nombre de proies capturées (b sur la Figure I.8). Il s'agit donc de trouver le couple (a, b) qui satisfait

Maximiser le bénéfice énergétique par rapport au coût d'exploitation

$$\operatorname{argmax}_{a,b} \left(\frac{b}{a} \right) \tag{I.12}$$

Or, par construction de la droite définissant l'angle α et parce que la fonction tangente est strictement croissante sur $[0, \pi/2]$, cela équivaut à

$$\operatorname{argmax}_{\alpha} (\tan(\alpha)) = \max_{\alpha} (\alpha) \tag{I.13}$$

Pour une durée de trajet donnée, il faut donc trouver la droite partant de ce point qui maximise α . Il s'agit de la tangente à la courbe du quadrant de droite et elle correspond à un chargement de sept proies (Figure I.8). En effet, comme le montrent les deux courbes plus claires,

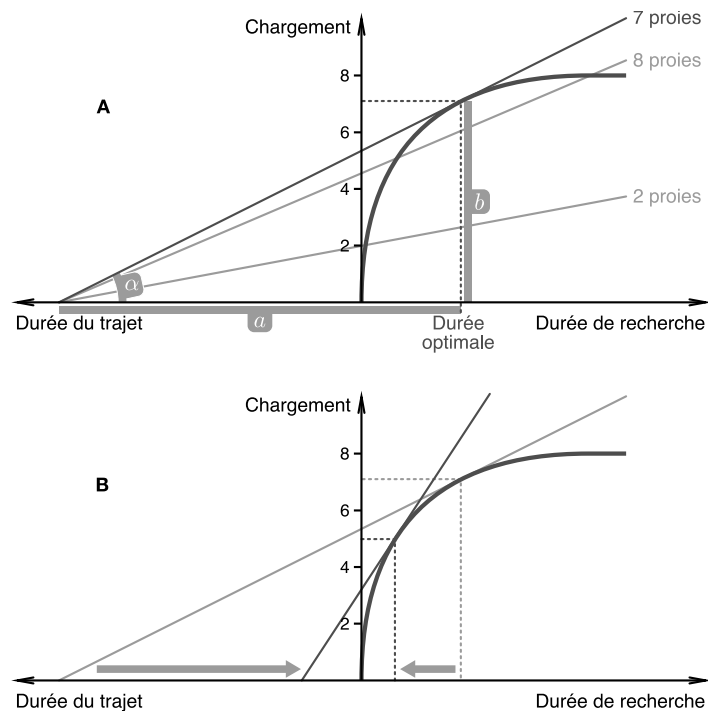

Figure I.8 Prédiction géométrique du chargement optimal chez l'Étourneau. La portion droite des graphiques représente le nombre de proies chargées dans le bec en fonction du temps de recherche. À gauche, un autre axe horizontal, orienté à l'opposé du temps de recherche, correspond au temps de trajet entre le nid et l'aire de recherche de nourriture. Le temps total (i.e. l'énergie totale) dépensé(e) pour la recherche de nourriture est la somme des valeurs sur ces deux axes. **A** : Calcul du chargement optimal et du temps de recherche associé. **B** : Pour un temps de trajet plus court, le chargement optimal est plus faible.

des chargements plus important (huit proies) ou plus faible (deux proies) entraînent un moins bon rapport entre énergie acquise et énergie dépensée (i.e. un angle α plus faible). Pour une durée de trajet plus courte, le chargement optimal est plus faible (Figure I.8, B). Ce modèle en apparence très simple prédit en fait bien les chargements observés chez les Étourneaux dans la nature⁵⁴.

La valeur sélective :
 "monnaie unique"
 de l'évolution

L'efficacité de ces modèles tient au fait qu'ils sont basés sur une "monnaie unique" : l'énergie. Les apports et les pertes énergétiques sont mesurables, et ce avec les mêmes unités. Cependant, le principe de cette théorie (maximiser le rapport bénéfice sur coût) peut être étendu à toute sorte de comportements dès lors qu'une monnaie unique peut être identifiée. La quantité qui a un sens au niveau évolutif est la valeur sélective et les modèles d'écologie comportementale sont donc souvent des modèles d'optimisation de la valeur sélective⁵². Les mesures de valeur sélective diffèrent (nombre total de descendants,

taux de croissance d'un mutant dans une population à l'équilibre, taux de reproduction d'un allèle, etc.) et les méthodes d'optimisation également (programmation dynamique et maximisation, théorie des jeux et recherche de stratégies évolutivement stables) mais ces modèles suivent tous un canevas identique⁵². Il est illustré ci-dessous dans le cas des Étourneaux

- *identifier la décision comportementale à laquelle l'animal est confronté.* La durée de trajet des Étourneaux est incompressible, le choix porte donc sur la durée passée à chercher de la nourriture
- *déterminer quel estimateur de la valeur sélective est approprié pour ce problème.* Une bonne approximation de la valeur sélective est le nombre total de descendants produits par un individu. Mais il est difficile de relier cette mesure à un seul événement de recherche de nourriture. Par contre la survie des jeunes dépend directement de l'énergie fournie par les proies rapportées par les parents. À son tour, l'investissement énergétique des parents dans la recherche de nourriture se fait au détriment d'autres activités, comme le nettoyage du nid ou la reproduction. Le rapport énergétique associé à chaque sortie en vue de rechercher de la nourriture peut finalement être exprimé en terme de valeur sélective.
- *quantifier les rapports bénéfice/coût des différentes options comportementales.* Les différentes décisions correspondent aux différentes durées de recherche et le rapport bénéfice/coût est défini par la courbe du quadrant droit de la Figure I.8.
- *faire une prédiction quantitative* (et tester cette prédiction de façon expérimentale si possible). Le raisonnement géométrique permet de prédire une charge optimale, qui est comparée aux chargements observés dans la nature.

La généralité de ce canevas théorique permet par exemple d'utiliser un modèle exactement identique à celui présenté ici pour la taille de chargement chez les Étourneaux afin de prédire le temps de copulation des Drosophiles. Pour les mâles, après une période de recherche d'une femelle, il existe une relation concave entre le temps de copulation et la proportion d'oeufs fécondés. Le modèle géométrique permet de prédire un temps optimal de copulation de 41 min, seulement 3 min plus long que le temps moyen observé. Outre leur efficacité et leur versatilité en écologie, les modèles de comportement optimal ont profité du partage d'outils mathématiques avec les modèles économiques : la *valeur marginale* a ainsi une définition écologique proche de son sens économique, les stratégies évolutivement stables ne sont autres que des équilibres de Nash en économie. Comme c'est souvent le cas, le croisement de deux disciplines a donné naissance à de nouvelles théories dans chacune d'elles.

Un système de modélisation puissant et versatile

I.5 La biologie des larves de poissons coralliens

I.5.1 Écologie des récifs coralliens

Les récifs sont agrégés au sein d'un milieu très oligotrophe

Les récifs coralliens sont construits par les coraux hermatypiques, entre 30° de latitude Nord et 30° de latitude Sud environ³⁶. La majorité d'entre eux se développent en eaux peu profondes et façonnent ainsi les côtes tropicales. Au sein de cette bande tropicale, ils sont présents sur les îles océaniques, qu'ils gardent émergées sous forme d'atolls même après subduction de l'île originelle. L'habitat qu'ils forment ainsi n'est présent que ponctuellement, au sein d'un milieu pélagique très pauvre en nutriments, où la production primaire est faible. Même au niveau des côtes continentales où les récifs couvrent parfois des superficies importantes (comme la Grande Barrière de Corail australienne par exemple), ils forment un habitat très structuré² (Figure I.9). Qui plus est, la communauté corallienne détermine en partie la communauté benthique qui lui est associée et crée ainsi une structure plus fine, à l'échelle d'un récif, en fonction de la distribution spatiale des espèces et des morphologies de corail. Cette agrégation de l'habitat et de la productivité primaire, au sein d'un milieu très pauvre, induit un fonctionnement en métapopulation avec des communautés localement très abondantes et reliées entre elles par le biais de la dispersion larvaire.

Les récifs coralliens ne sont pas stables à courte échéance

L'estimation de l'âge de certains récifs (e.g. 50 millions d'années pour Enewetak Atoll³⁶) a donné le sentiment de leur immuabilité. Cependant, à l'échelle des temps écologiques, de nombreux événements peuvent perturber la stabilité apparente des récifs coralliens. Les cyclones, blanchissements massifs ou invasions de prédateurs (*Acanthaster planci*) peuvent en quelques jours décimer un récif. En quelques années, la modification des apports terrigènes, notamment du fait des activités humaines sur le littoral, peut conduire à l'enfouissement de récifs vieux de plusieurs siècles. Ensuite, après une attaque massive d'*Acanthaster planci* à Guam par exemple, la couverture corallienne revient à son état d'origine en une dizaine d'années⁵⁵, bien que la structure des communautés soit changée et la croissance globale du récif ralentie. Sur des distances kilométriques et à l'échelle de quelques années, les récifs peuvent donc être vus comme des métapopulations au sens de Levins : avec extinctions et re-colonisations.

Du fait de la forte agrégation de l'habitat au niveau spatial, de la dynamique potentiellement instable de l'écosystème, mais aussi de la richesse biologique et donc potentiellement de la richesse des stratégies écologiques, l'écosystème corallien semble être un formidable laboratoire pour l'étude de la dynamique des métapopulations. Qui plus est, les menaces qui pèsent sur ces milieux (sur-développement des populations humaines sur les côtes, réchauffement climatique, etc.) soulèvent des problèmes qui, pour la plupart, nécessitent la prise en compte des liens entre les populations, tant ceux-ci font partie intégrante

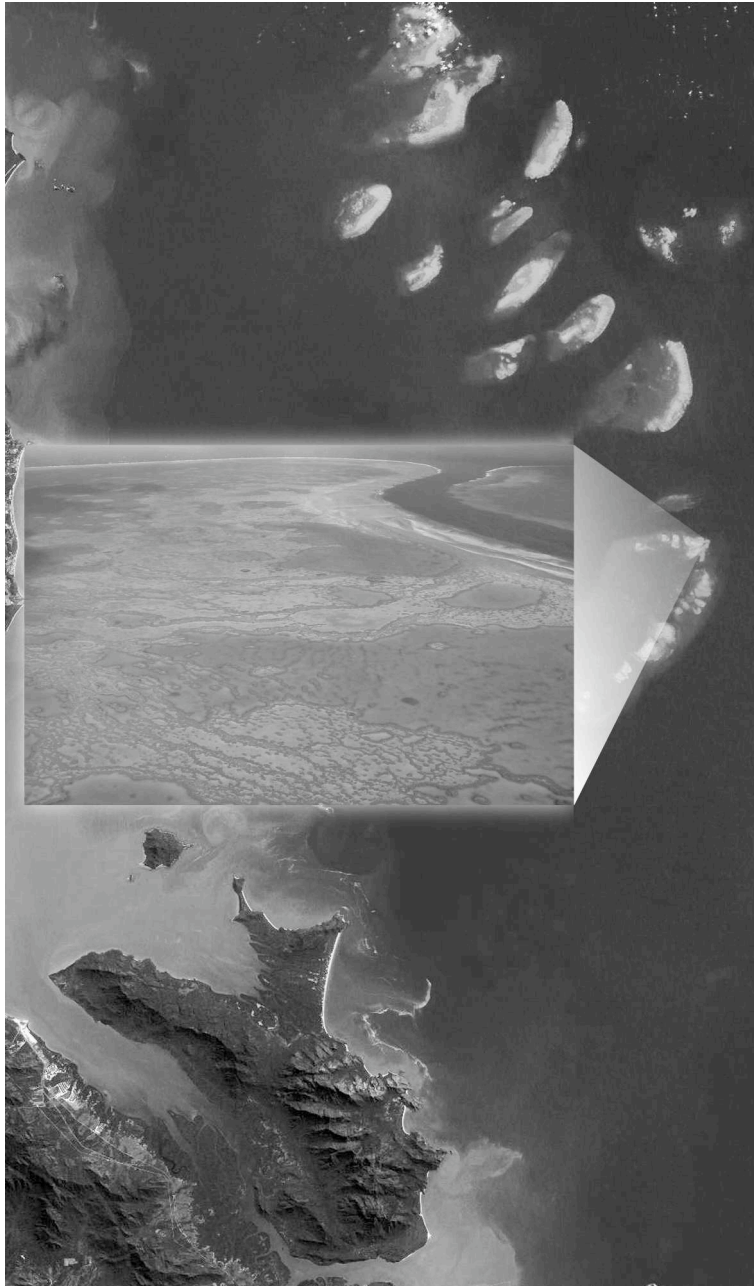

Figure I.9 Photographies aériennes de la Grande Barrière de Corail en Australie, à deux échelles. À chacune de ces échelles, l'habitat récifal est agrégé. (Photographies : NASA)

du fonctionnement de l'écosystème (par exemple, la mise en place de réseaux de réserves côtières ou la détection d'éventuelles zones refuge).

I.5.2 Larves des poissons coralliens

Les larves de poissons coralliens nagent vite et longtemps ...

Par rapport aux larves d'autres organismes marins, les larves de poissons sont extraordinairement mobiles et ont des capacités sensorielles particulièrement développées (Figure I.10). La plupart d'entre elles doivent donc être considérées comme du necton plutôt que comme du plancton : elles sont capables de se mouvoir rapidement et sur des dizaines de kilomètres²⁵. Par ailleurs, il existe de grandes variations aux niveaux taxonomique et géographique. Les stades avancés des larves de Gadiformes ou de Pleuronectiformes nagent à des vitesses de l'ordre de 1 à 2 cm.s⁻¹ alors que les stades équivalents chez les Perciformes atteignent en général 10 cm.s⁻¹²⁵. Au sein des Perciformes, les espèces tempérées présentent des vitesses soutenables maximales de l'ordre de 10 à 15 cm.s⁻¹⁵⁶ alors que les espèces tropicales atteignent en moyenne 35 cm.s⁻¹⁵⁷ (voir aussi Figure I.10). À titre de comparaison, la vitesse de nage 35 cm.s⁻¹ atteinte par une larve de 1 cm de long correspondrait, pour un homme, à l'allure impressionnante de 215 km.h⁻¹ ! Certaines de ces larves peuvent nager à 60 cm.s⁻¹ pendant plusieurs minutes, ou à 13 cm.s⁻¹ (équivalent à 83 km.h⁻¹) de façon continue pendant plusieurs jours, tout en s'alimentant et en continuant à grandir normalement²⁵.

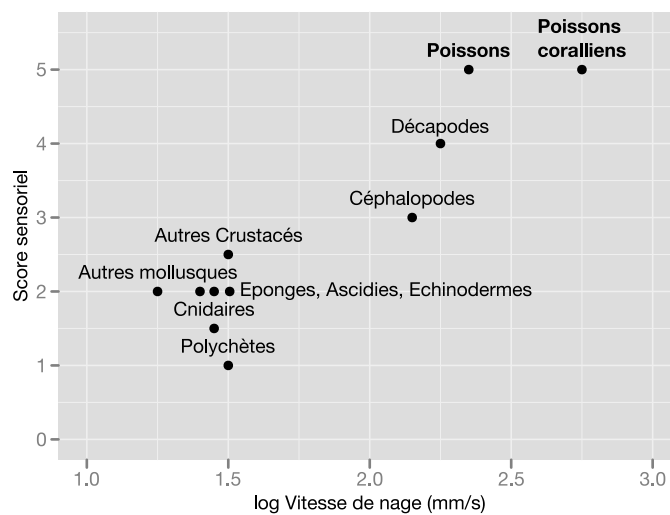

Figure I.10 Relation entre la vitesse de nage (échelle logarithmique) et les capacités sensorielles chez 11 taxa marins (reproduit et augmenté d'après Kingsford et al.⁵⁸). Les sens participant à la notation sont : l'audition, la vision (avec ou sans formation d'une image), l'olfaction, la sensibilité magnétique et électrique. Un score de 1 est donné pour un sens connu chez la larve, 0,5 pour un sens connu chez l'adulte mais pas chez la larve.

De plus, les larves de poissons semblent capables de s'orienter dans le milieu pélagique (bien que tous les mécanismes ne soient pas encore connus)²⁵ et leur nage n'est donc pas aléatoire. De ce fait, leur impact sur le résultat de la dispersion est augmenté et n'est pas correctement représenté comme une simple augmentation de la diffusion des particules à partir d'un site source, comme cela est traditionnellement considéré⁵⁹.

... et se déplacent de façon orientée

Le développement des capacités natatoires suggère que les larves de Perciformes, particulièrement en milieu corallien, sont capables de modifier leurs trajectoires de dispersion, au moins lors de la seconde moitié d'une période larvaire allant de quelques jours à quelques semaines⁶⁰. Ces animaux semblent donc être un bon modèle pour l'étude de l'impact du comportement larvaire lors de la phase pélagique. De façon générale, pour les poissons, mais probablement aussi pour les Décapodes et les Céphalopodes, négliger le mouvement des larves par rapport au mouvement des courants n'est plus une hypothèse acceptable²⁵. À la fin de la période larvaire, ce sont les courants qui pourraient presque devenir négligeables face aux vitesses de déplacement potentielles des larves.

I.6 Résumé et présentation du travail

La période larvaire est omniprésente chez les organismes marins démersaux et semble être un déterminant principal du niveau des stocks et des échanges entre populations. Une approche métapopulationnelle met en valeur l'importance de ces échanges pour la dynamique, la structure génétique et l'évolution des populations interconnectées. Qui plus est, au sein d'un tel réseau, l'auto-alimentation de chacune des populations est un facteur important de la viabilité du réseau tout entier. Cette approche spatialisée et dynamique est nécessaire si nous voulons comprendre le fonctionnement des écosystèmes marins littoraux et participer, en tant que scientifiques, à la conservation et à la gestion des richesses naturelles qu'ils contiennent. En ces temps de changement climatique global et d'explosion de la population sur les côtes de tous les continents, il est urgent d'arriver à comprendre le présent pour tenter de gérer l'avenir.

Dans le cadre de la connectivité écologique, qui est particulièrement sensible en milieu corallien, il semble que le comportement des larves ait le potentiel de façonner les patrons de dispersion et les niveaux d'auto-recrutement. Ceci est particulièrement flagrant pour les poissons, qui présentent à la fois la capacité de nager et la capacité de s'orienter pour des durées de plusieurs jours à plusieurs semaines. Cependant, l'impact réalisé de ce potentiel n'est pas encore connu car la transposition des concepts de l'éthologie, développés en milieu terrestre, est à l'heure actuelle rare en milieu sous-marin.

L'objectif de cette thèse est d'étudier l'influence du comportement des larves marines, de poissons en particulier, sur leurs trajectoires océaniques et les conséquences sur leur distribution et sur la connectivité entre les populations. Le premier chapitre présente une synthèse des connaissances sur le comportement des larves de poissons, détaille leur impact potentiel et suggère des techniques et des critères pour leur intégration au sein de modèles numériques de la phase larvaire. Le second et le troisième chapitres présentent des données sur le comportement des larves *in situ*. Une nouvelle technique permettant de quantifier l'orientation des larves est présentée dans le chapitre 2. Le chapitre 3 examine le comportement de nage des larves lors de la transition critique entre la vie pélagique et la vie benthique. Les chapitres 4 et 5 décrivent la distribution des larves de poissons coralliens autour d'un atoll isolé du Pacifique. L'objectif est de comprendre quels facteurs physiques et biologiques déterminent les positions et les trajectoires des larves lors de leur phase pélagique. Enfin le chapitre 6 propose une approche de modélisation reposant sur la théorie du comportement optimal, qui permet d'intégrer le comportement larvaire de façon explicite aux modèles bio-physiques de la phase pélagique, afin d'examiner l'impact que celui-ci peut avoir sur les trajectoires de dispersion et, en particulier, l'intensité de l'auto-recrutement.

Chapter 1

The importance of behaviour in models of fish early-life history

J.-O. Irisson, J. M. Leis, C. Paris, H. Browman
Manual of Recommended Practices for Modelling Physical-Biological
Interactions in Fish Early-Life History
ICES Cooperative Research Reports

Following the *Workshop on advancements in modelling physical-biological interactions in fish early-life history (recommended practices and future directions)* held in Nantes in 2006, the participants were invited to write a collaborative document which objectives were to

... summarise appropriate methods for modelling physical-biological interactions during the early life of fish, recommend modelling techniques in the context of specific applications, and identify knowledge gaps.

according to E. North, A. Gallego, and P. Petitgas, the editors. The manual contains three sections on modelling practices in the fields of Hydrodynamic models, Particle tracking, and Biological processes. Each one presents the state of the art in the field, proposes what the minimum acceptable model should contain, and gives advice regarding model elaboration and research needs. Then three applications of these modelling practices are presented, regarding Adaptive sampling, Connectivity and Recruitment prediction. Each application involves modelling practices from the three fields previously identified and details how model complexity should be constructed depending on the question at hand.

After two years of work involving almost 30 people, the manual will be published as an ICES Cooperative Research Report. This chapter is a slightly modified version of the "Larval behaviour" part in the "Biological processes" section.

1.1 Introduction

Fish larvae do “behave” Behaviour refers to the actions or reactions of organisms, usually in relation to the environment. Fish larvae display such actions or reactions, and it is increasingly obvious that their behavioural capabilities have the potential to greatly influence dispersal outcomes, as explained in section I.5.2 (and see review by Leis²⁵). Recent research has shown that fish larvae have behavioural capabilities in areas of swimming, orientation and sensory abilities that were unknown and unexpected just 10 years ago. Thus, the simplifying assumption of passive advection of particles that has been the basis for many biophysical models in the past is no longer justified⁵⁹. Behaviour as a possibly important factor that can influence the outcomes of such models must be considered as a real alternative. This requires an understanding of the behaviour of the larvae, something that is frequently lacking.

Larval behaviour can become overwhelmingly complex because individuals acquire behavioural capabilities as they develop. Nevertheless, a “good” model does not need to be exhaustive; instead it should only include behaviours that are sufficient to reproduce observed patterns and/or mechanisms relevant to the scope of the study. Sensitivity analyses wherein different behaviours are added to the model to assess their influence on outcomes can aid in determining which behaviours to incorporate.

In this chapter we will consider vertical positioning, horizontal swimming, orientation, foraging, predator avoidance, schooling, and settlement. All these behaviours can potentially influence the outcome of the larval phase and may need to be considered when designing a model of the early life history of fishes. The following sections provide clues on whether it is worth implementing each behaviour depending on the *a priori* knowledge of the system and the other processes already included in the model. All sections loosely follow the same structure: first we outline how the behaviour in question can affect the processes a model seeks to address, hence why it is potentially important to include it in a model; then we examine which biological or environmental conditions make the behaviour particularly consequential, which should help determine *a priori* when to actually include it; we also propose simple tests to examine its influence in the model with as little modification as possible; after that we give insights on how to get relevant data regarding the behaviour in question, and point to appropriate literature references; finally, we suggest full implementations of this behaviour in a model.

Sensitivity analysis to the inclusion of behaviour is mandatory

We further encourage modellers to test the relative influence of physical conditions and behaviour for their particular model/species/area of interest. Sensitivity analysis to behaviour-related parameters, as well as comparison of predictions to empirical data, should be done routinely after each behaviour is implemented. Such *a posteriori* tests are the only means of assessing the influence of modelled behaviour with

certainty. The following sections are intended to help the reader to answer the question: what are the priorities in the implementation of larval behaviour?

1.2 General questions on behavioural traits

1.2.1 Mean vs. mean+variance vs. maximum

All behavioural traits are variable in essence: swimming speeds and vertical position change among individuals, sensitivity to environmental cues for orientation vary, as do response to these cues, etc. Therefore, the description of behaviour has to be probabilistic to account for these variations. Behavioural studies, whether they are experimental or done in the field, allow an estimate of population traits. The question is then which population descriptors are most relevant for a model of the early life history of fishes?

In such models, we are mostly interested in the individuals that survive the larval phase and recruit successfully. If most larvae succeeded, the behavioural traits of the survivors and of the whole population would have similar means (Figure 1.1). Hence, including mean population traits in models would be appropriate to predict recruitment. But very few larvae survive the larval phase⁶¹. The few that do probably succeed because their traits are different from the others and well-suited for the circumstances they encountered within the heterogeneous pelagic environment⁶². For example, there is now evidence from several systems and species that the fastest growing individual larvae are the ones most likely to survive, and the same may apply to behavioural performance (Figure 1.1).

Variations and maxima of behavioural traits must be considered

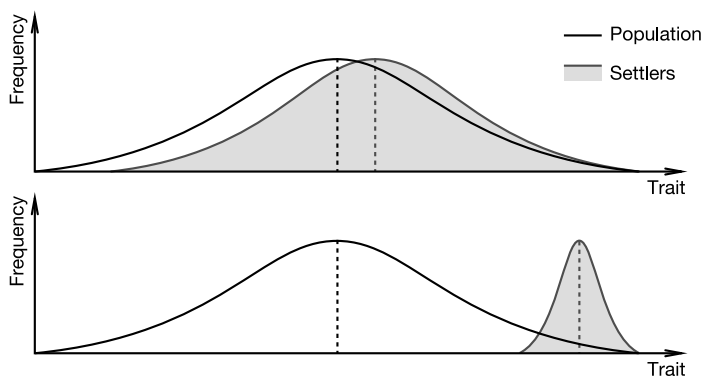

Figure 1.1 Frequency distribution of trait values (e.g. swimming speed) for the whole population (empty curve) and for settlers (shaded curves), when most larvae recruit or when recruitment is not dependent on the trait (upper panel), and when only a small proportion of the population recruits (e.g. the best swimmers, lower panel). Behaviours worth including into models are the second kind, hence the mean of the population is not a good descriptor.

Using mean population performance in models is not appropriate when only a small portion of the performance distribution may constitute the survivors. Therefore, variance around the mean has to be derived from observations⁶³ or estimated from published accounts and incorporated into the model to provide a realistic range of individual results. Such a probabilistic approach can be accomplished through individual based models where traits of individual particles can be assigned following a probability density function. In addition, maximum values should also be considered because successful recruits may be the very few “best” individuals of each cohort (Figure 1.1).

1.2.2 Ontogeny of behaviour

Just like morphology, behaviour develops during the pelagic larval stage from essentially planktonic at its start to nektonic at its end, and the passive portion of it is likely to be short. In addition to ontogenetic changes in behavioural *ability* (e.g. swimming speed), there are frequently ontogenetic changes in the *use* of those abilities (e.g. age-related changes in depth or in swimming direction). The methods for modelling behaviour need to be adjusted according to the state of knowledge of physical-biological interactions that result in larval growth. Indeed, most studies indicate that size (or stage of development) is a better predictor of behavioural ability than is age⁶⁴.

Ontogeny of behaviour is best described by size

- When growth is explicitly included in the model, behaviour can be formulated as a function of size. In addition, as mentioned above, this relation should not be deterministic and should not consider only the mean value for the population; associated variation should be included. In this case, as larvae are subjected to differential growth, in a model with spatially heterogeneous resources for example, they will display differential performance for a given behaviour.
- When larval growth is not resolved in the model or when not enough information is available to predict a continuous relationship between size and behavioural performance, either age or developmental milestones can be used to model behaviours, possibly in a simplified, step-wise manner. Age and ontogenetic stages can be expressed by a dimensionless metric such as an developmental age⁶⁵ or ontogenetic index⁶⁴.

1.2.3 Taxonomic resolution of behaviour

Ideally, the behaviour of larvae of the species to be modelled should be incorporated into the model. Nevertheless, it is important to know the degree to which the behaviour of a particular species can be generalised to other taxa, because it is unlikely that we will ever have even partial information on the behaviour of all fish species. At present, the amount

of information available on any particular behaviour is limited to relatively few species, and to only a portion of the larval stage (usually older larvae). When deciding if behavioural information from species A can justifiably be used in a model for species B, two things must be considered at the outset: the evolutionary closeness of the two species and the similarity of the environment in which the species live.

The vast diversity of teleost fish species — approximately 27000 species in 448 families divided among 40 Orders⁶⁶ — means that some species are very distantly related, with evolutionary histories that have been separate for tens of millions of years. Particularly among Orders, there is no reason to assume that behaviours will be similar. Within mammals, for example, no one would assume that the behaviour of a Tiger (Order Carnivora) would be similar to that of Dugong (Order Sirenia), just as no one should assume that the behaviour of a Plaice larva (Order Pleuronectiformes) would be similar to that of a Herring larva (Order Clupeiformes). As a general rule, in the absence of other information, the closer two species are related, the more justifiable it should be to assume they have equivalent behaviour. The use of well-corroborated phylogenies that encompass the species under consideration is essential in assessing the closeness of relationships, but for many fish taxa such phylogenies do not exist. Even this general rule should be applied cautiously, because there are many examples of larvae of confamilials with different behaviours. For example, larvae of some pomacentrid species are found in midwater, whereas those of other species prefer the top few centimetres of the water column⁶⁷. At this point in our knowledge of the behaviour of fish larvae, it is difficult to make any defensible statement about how closely related two species must be before it is justified to assume the behaviour of their larvae is similar. An analysis of behaviour of fish larvae in the context of phylogeny to help establish if relatedness provides a sound basis for inferring behaviour would be most useful.

Cross-Order
generalisations
do not make sense

It is unlikely that, even within a family, the larvae of a species that is pelagic as an adult will behave similarly to the larvae of a species that lives on a coral reef, or in an estuary. Therefore, if it is not possible to obtain behavioural data on the species of interest, the species supplying the behavioural data should at least live in the same habitat as the species of interest, both in the adult and larval stages. Echoing the comment above, an analysis of behaviour of fish larvae to determine to what extent habitat similarity provides a sound basis for inferring behaviour would be very valuable.

Adult lifestyle influences
larval behaviour

Overall, the use of behavioural data from a distantly related species that lives in a different habitat should be avoided at all cost. Finally, there are indications that swimming speed can be predicted from the morphology of the larvae⁶⁸. Therefore, the use of swimming data from species with similar larval morphology might be appropriate.

1.3 Vertical position

1.3.1 Potential influences

Vertical heterogeneity
in physical variables

Any vertical heterogeneity in the current field will interact with the vertical distribution of larvae to indirectly influence their dispersal, as demonstrated by modelling^{69,70} and empirical⁷¹ studies. And of course, many things in addition to current velocity vary vertically in the ocean (temperature, light, food concentrations, etc.). Temperature influences pelagic phase duration⁷², development rates⁷³, and swimming speed²⁵. Food resources are often greater near the thermocline and fish larvae may accumulate at these depths⁷⁴⁻⁷⁶. Conversely, they might use diel vertical migration to avoid predation near the surface⁷⁷. Larvae may use sun angle or sound for orientation, so the vertical position of a larva relative to the surface (sun angle detection) or the thermocline (hearing) may influence its ability to detect these cues and orient. Overall, the vertical position of larvae can therefore influence their feeding success, predation risk, growth, swimming ability, and ability to detect sensory cues, all of which can influence their trajectories⁷⁸. Of all behaviours, vertical positioning is the most widely recognised as being influential and the one most often incorporated into biophysical models.

The unknown effect
of boundary layers

Furthermore, in coastal waters, larvae may occupy the epibenthic boundary layer, where current velocity can differ substantially from that in the water column. Unfortunately, information on the occurrence of fish larvae in such epibenthic locations is limited because it is very hard to sample, especially in deep water or where the bottom is very irregular or hard. Occupancy of the boundary layer not only places the larvae in a different current regime, but it may also shift their food regime and expose them to increased risk of predation from benthic predators. Given the important effect boundary layers potentially have, further investigation is suited.

1.3.2 When to include this behaviour?

Vertical behaviour
should always
be included

Current velocity, hydrography (e.g. salinity, temperature), and fluorometry profiles (or their modelled equivalents) over the spatial scale and depth range where larval fishes occur are required in order to evaluate the degree of vertical shear in the current, the temperature gradient, and the depth of chlorophyll maximum. Clearly, if substantial heterogeneity in the velocity field is detected, vertical distribution of larvae must be included in a model. Some models integrate water movement over the surface Ekman Layer, while, in this layer, water velocity often differs with depth. This means that larvae at different depths within the Ekman Layer will be subject to different current speeds and directions, and the model should reflect this and avoid averaging over depth. If some modelled features (such as survival or growth) explicitly depend on food availability or temperature and these are not homogeneous on the

depth range of interest, vertical position must be included. Finally, if sensory cues are known to be used by larvae for orientation and are also affected by the vertical structure of the water column, this structure must be included.

1.3.3 Simple modelling tests

When a 3D oceanographic model is available, the influence of vertical migration can be assessed by comparing the fate of particles constrained to the top and bottom layers within the species' depth range. When 3D oceanographic models are computationally unfeasible, then 2D models are often employed. If the model simulates horizontal (e.g. cross shelf) and vertical (e.g. depth) dimensions, then the influence of vertical position could be tested in a manner similar to that used for 3D models. If the model dimensions do not include the vertical, then there is no simple test for the potential influence of vertical migration in the model. If a strong vertical current shear is observed in the field and larvae are observed to migrate through it, then the use of a 3D model is recommended.

1.3.4 How to get the relevant data?

Vertical distribution is probably the behaviour about which we have the most information. It has been explored primarily with towed nets, performing stratified sampling of the water column. This requires multi-sample nets, preferably the Multi Opening and Closing Net and Environmental Sampling System (MOCNESS), or repeated single-net (e.g. Bongo net) sampling of the same area at different depths. To resolve diel vertical migration, a few stations should be sampled over several 24-h cycles. Similar information can be obtained from pump samples, but pumps suffer from significant avoidance, particularly when sampling larger larval stages. Acoustic methods can also provide useful information on vertical distribution, but suffer from difficulties in actually identifying the species whose vertical distribution they portray. Finally, *in situ* observations of larvae by divers⁶⁷ can provide detailed information on vertical distribution and changes therein by individual larvae that are caught, typically with light traps, and subsequently released. This approach can only be used in the day time, for larvae > 5 mm, and is limited by diver safety considerations to relatively shallow depths.

Stratified sampling provides the concentrations of larvae caught within specific depth intervals. This information can be summarised using statistical descriptors such as the depth centre of mass of the larval patch, its variance, the total depth range in which larvae are caught. An alternative to a depth centre of mass portrayal of vertical distribution is the computation of a depth-frequency distribution. Depth bins, usually determined by the vertical resolution of the sampling design, are established and the mean percentage (and associated variance)

Stratified sampling and
direct observation ...

of the larval population in the sampled water column is calculated for each bin. This offers some advantages over the centre mass in terms of detail but is less robust to deviation from the sampling plan (e.g. different depth intervals between stations) and more difficult to transfer to a model.

In addition, these descriptive statistics should be discussed dynamically in time and ontogeny. For example, the differences between day and night conditions or between several ontogenetic stages should be investigated and, if present, described.

... bring different and complementary information

Finally, the movement of individuals, and not only the distribution of the population mean, is important. A simple example highlights this fact²⁵:

Imagine a stratified system with a flow of x in an upper layer equal, but opposite, to that in a lower layer, and with the larvae equally distributed vertically between the two layers. If there is no movement by individual larvae between layers, at the end of time t the larvae in the upper layer will be advected a horizontal distance of $2xt$ relative to those in the lower layer. If movement of larvae between layers is constant and individuals spend an equal amount of time in each layer, then the larvae in the two layers will not become horizontally separated at all.

This information can be obtained by *in situ* observations of larvae over time to determine their individual vertical movements⁶⁷ or by the use of specialised sampling equipment that can determine the upward and downward movement of individuals rather than vertical shifts of population means⁷⁹.

1.3.5 Suggested implementation

Vertical distribution can be introduced in a 3D model as a parameter referring to a user controlled function or as an emergent property of the model, resulting from other processes being modelled explicitly.

Vertical distribution described by parameters

A straightforward implementation is to initialise the model with different numbers of particles in each depth stratum, or to weight the results of dispersal in each depth layer, using numbers, or weights, which respect the observed vertical distribution of larvae. This is valid only if the structure of larval patches is constant throughout the larval phase. If not, at each time step, particles can be moved between depths using a random process that fits the probability density function appropriate to the current age or size of the larva as observed in the field⁷⁰.

Vertical distribution emerging from other processes

If vertical distribution is to be modelled as an emergent property of the system, processes that cause vertical structure must be explicitly represented. For heterogeneity of the current field to be exploited, vertical swimming with some sort of criteria to choose depth should be modelled^{78,80}. For food or temperature heterogeneity to be exploited,

growth and/or survival should be modelled explicitly (see appropriate sections in this manual). From those, deriving vertical swimming decisions which maximise growth rate or survival is probably meaningful for fish larvae (see references above).

1.4 Horizontal swimming

1.4.1 Potential influences

Horizontal swimming of larvae partially disconnects them from the current field⁸¹. As a result, trajectories including horizontal swimming can diverge significantly from purely passive Lagrangian trajectories and can result in significantly different dispersal outcomes. Random swimming increases the amount of search area covered by larvae in a manner similar to increasing diffusion, and hence can increase the dispersal kernel, improve survival or settlement probability, by chance alone. oriented swimming, on the other hand, has the potential to affect larval trajectories more directly and is discussed in the next section.

In addition to resulting in different dispersal outcomes in terms of settlement position, these differences in the trajectories could also influence growth, condition and survival by passing into or out of food and/or predator rich areas.

Swimming affects trajectories, most effectively when oriented

1.4.2 When to include this behaviour?

The question can be rephrased as: how great must swimming performance be before it can significantly influence trajectories? Heuristic models inform us that speeds of 1-5 cm s⁻¹ can strongly influence dispersal outcomes⁸². Leis²⁵ provides some field data or model examples of the effect of oriented swimming which concur:

A vertical swimming speed >5 cm.s⁻¹ was considered necessary 'to overcome vertical mixing' in a tidal channel (Smith & Stoner 1993). Near Georges Bank, on-bank swimming by larvae of 0.3-1.0 cm s⁻¹ 'would substantially enhance shoalward displacement', and result in modelled distributions consistent with field observations (Werner et al. 1993). On the Newfoundland shelf, directed horizontal swimming of 1-3 cm s⁻¹ by Cod larvae was considered able to 'greatly increase their retention on the shelf (and on banks, too)' (Pepin & Helbig 1997). In a numerical model of the Florida coast, simulated larvae that swam at only 1 cm s⁻¹ had settlement 36 to 300% greater than passive larvae, whereas larvae that swam at 10 cm s⁻¹ had settlement rates 'many times' greater (Porch 1998). In a numerical model of an Australian coral reef, a swimming speed of 10 cm s⁻¹ by simulated settlement-stage larvae resulted in a duplication

Modest swimming speeds (~ 1-5 cm s⁻¹) are enough

of measured distributions of larvae that was impossible to achieve with passively drifting model larvae (Wolanski et al. 1997).

1.4.3 Simple modelling tests

Testing for the importance of un-oriented swimming can be achieved by increasing the variance of the random walk/flight in the Lagrangian tracking scheme. This is especially efficient for swimming speeds that are small compared to ambient current velocities (e.g. one or more orders of magnitude smaller).

If orientation behaviour is not known, testing extreme oriented swimming scenarios can give insights on the extent to which swimming can influence trajectories. Such scenarios can include adding a movement at full speed, perpendicular or parallel to current direction at each time step; testing full speed movement relative to whatever cues may exist (e.g. toward the recruitment location); etc. If these tests lead to the conclusion that oriented swimming could make a large difference (which it will in most cases), then information on orientation is needed. Please see section on orientation below.

1.4.4 How to get the relevant data?

Many measures of swimming speed ...

Information on horizontal swimming is becoming more widely available, but most of it concerns tropical species. In addition, several methods have been used to estimate swimming speeds of fish larvae (and recently reviewed²⁵). These are (from high to low): burst speed, which measures the speed at which larvae flee in response to a stimulus; critical speed (U_{crit}), which measures the speed of a flow against which larvae can maintain their position in swimming channels⁸⁸; maximum sustainable swimming speed, which measures the speed that can be maintained in a swimming channel over 24 hours⁸⁹; *in situ* speed, in which scuba-divers follow larvae in the sea and measure their speed⁹⁰; and routine speed, which measures swimming speeds of undisturbed larvae in laboratory containers⁹¹. These techniques do not actually measure the same thing and the speed estimates they provide differ. Therefore they are not equally suitable for use in dispersal models and care must be taken to ensure that the type of swimming speed measure is adequate to the purpose.

... not all are appropriate

Routine speed has the advantage of being a measure of swimming speed undisturbed by divers or any overt forcing by the investigator, but it carries the disadvantage of being measured in artificial laboratory conditions. *In situ* speed has the clear advantage of being measured in the sea, but with the unknown influence of the observing divers. U_{crit} is most relevant for comparisons of relative performance, but it is not a performance measure that can be directly included in dispersal models as it is almost certainly faster than larvae actually swim in the

sea. The least appropriate measure is burst speed (the highest speed of which a fish is capable), because it can only be maintained over very short periods of time (typically $< 20 \text{ s}^{92}$) and is considered to be fuelled anaerobically. Despite these clear limitations burst speed has been used for modelling purpose⁹³.

If swimming speeds are to be included as-is in a model of the early-life history of fishes, *in situ* speed is the best existing measure of how fast larvae actually swim in the sea. On the other hand, if maximum potential swimming speeds are needed, rather than observed cruising speeds, the maximum sustainable swimming speed of Fisher & Wilson⁸⁹ is a well suited measure. It has to be noted that maximum sustainable swimming speed was equal to about one-half of U_{crit} and similar to values of *in situ* speed of settlement-stage larvae for the nine species for which all speeds were measured.

In addition, using a constant mean or maximum swimming speed is justifiable only if the larvae are considered never to be fatigued (food supplied *ad lib.* and no muscular fatigue). In most cases the relationship between swimming speed and time swum should be estimated. This results in shaping the relation between swimming speed and endurance, which is theoretically cubic^{89,94}. Furthermore, feeding is known to enhance endurance to the point that it may be virtually open-ended for some species (in which case the constant approximation is valid). Nevertheless, significant swimming endurance may not develop until relatively late in ontogeny²⁵.

If no information about swimming speed is available, some mechanistic rules or regression models can be used to compute maximum swimming speed (using relative speeds⁹⁵), swimming endurance⁹⁴ or development of swimming abilities⁶⁰. Please note that these rules have all been examined in a tropical context and that, given that temperature has a great influence on swimming speed and energetics, it may be misleading to assume that they will apply in cold water.

In situ speed and U_{crit} are useful values

Swimming speed must be coupled with endurance

1.4.5 Suggested implementation

Lagrangian stochastic models can be used to incorporate horizontal swimming. The governing equations of a commonly used stochastic transport model are

$$dx = [u(x) + u'] dt + du' \cdot dt \quad (1.1)$$

$$du' = \left[\frac{-u'}{T_L} + a(x, u') \right] dt + b(x) \cdot dW(t) \quad (1.2)$$

where, in (1.1), x is the vector of coordinates, $u(x)$ is the velocity, u' is the turbulent velocity, and dt is the time step. In (1.2), the first term represents a fading memory for velocity fluctuations, which enhances the correlation of particles with the flow. The function a , the drift correction term, is zero when turbulence is stationary and homogeneous⁹⁶. The second term represents random forcing where dW is a random increment

Swimming as part of random motion

from a Wiener process (i.e. continuous-time Gaussian stochastic process) with zero mean and variance dt . The function b , the tensor amplitude, multiplies the random increment (sensu Berloff & McWilliams⁹⁷). Thus, b can describe larval swimming with random or oriented motion as seen in Codling et al.⁸². Caution is advised in situations where the decorrelation time scale (T_L) of passive particles (the one dictated by the velocity field) differs from that of active larvae (which somehow decorrelate from the flow). In addition, once swimming speed becomes non-negligible with respect to current speed ($>5-10 \text{ cm.s}^{-1}$), turbulence becomes negligible with respect to swimming speed and it makes little sense to include a random walk at this point.

Additive displacement vectors

A different approach is to simply add deterministic swimming velocities to the current field and advect particles considering that

$$\vec{u} = \vec{u}_{\text{flow}} + \vec{u}_{\text{swimming}}$$

with the rest of the model kept identical (i.e. with or without diffusion).

Yet another alternative is to include swimming behaviour only implicitly during the end of the larval pelagic phase by assuming that a larva can actively recruit once found at a determined distance from the nursery habitat⁹⁸.

1.5 Orientation

1.5.1 Potential influences

Orientation occurs but the cues are mostly unknown

As mentioned above, random horizontal swimming can already change the outcome of the larval phase. But the impact of swimming is of course greater if larvae are able to orient toward areas of greater food supply or toward settlement sites. All examples in the quote from Leis²⁵ assume directed motion and show that small swimming speeds can have a large influence if the movement is oriented. *In situ* observations suggest that such orientation abilities exist even if the associated environmental cues are not always known⁹⁰. Current knowledge related to each potential cue (which concerns mainly coral reef fishes) is summarised in Table 1.1.

1.5.2 Simple modelling tests

Orientation can be added gradually, starting from a very simple set of behavioural rules, then testing the impact of each step of the implementation. There is no easy way however to test its impact without implementing it somehow.

1.5.3 How to get the relevant data?

Information on orientation of fish larvae is limited to relatively few studies (see review by Leis²⁵), so the opportunity to obtain information from the literature is limited.

Table 1.1 Potential orientation cues for coral reef fishes

| Cue | Influence |
|-----------------|---|
| Vision | Visual acuity in surface layers (where light is abundant) is 12-30 m for late stage. Allows choice of settlement site. Can mediate schooling. Kingsford et al. (2002); Lara (2001) |
| Hearing | Detection of coastal areas using reef associated choruses, or breaking waves at distances of kms, but probably not at 10s of kms. Kingsford et al. (2002); Leis & Lockett (2005); Montgomery et al. (2006) |
| Olfaction | Land associated chemicals could guide larvae toward the coast. At a smaller spatial scale, settling individuals can detect conspecifics or habitats using chemical signals. Kingsford et al. (2002); Sweatman (1988); Atema et al. (2002) |
| Lateral line | Is associated with behavioural responses such as prey detection, obstacle or predator avoidance, and schooling. Only affects movement over short distances. Fuiman (1994); Alexandre & Ghysen (1999) |
| Magnetic sense | Could be used for navigation. Sensitivity to electromagnetic fields has been demonstrated in white shark, salmon, tuna, and eel but not in larval stages of marine fishes. Kingsford et al. (2002); Klimley et al. (1992); Nishi et al. (2004) |
| Sun angle | Could be used as a compass. Existence suggested by observations but not demonstrated in larval fish. Leis & Carson-Ewart (2003) |
| Polarised light | Could be used for navigation but never demonstrated in the larval stage. Hawryshyn (2000) |

In situ studies are required to test whether larvae orient

The first step is to detect whether fishes orient or not. Such information can be provided by field studies involving the release of larvae followed by divers^{90,109–111}, or *in situ* orientation chambers¹¹².

Information about cues and detection thresholds is scarce

The second step involves testing experimentally the ability of larvae to detect environmental cues^{100,102,103,113–116}. The potential for detecting a cue can be demonstrated in the laboratory by testing the preference of larvae toward a given environmental signal for example (e.g. coastal vs. oceanic water, reef sounds vs. random sound). Which cue is actually used *in situ* is currently unknown, due to the lack of experimental means of testing cues separately in the pelagic environment.

The last step would be to describe thresholds for detection. This directly relates to the spatial scale over which cues can be detected and used for orientation. Knowledge in this regard is currently mostly lacking and is difficult to obtain, yet this is essential information for incorporation into models.

1.5.4 Suggested implementation

Orientation as a parameter or an emergent property

The implementation of orientation is closely associated with that of swimming (both horizontal and vertical): orientation is simply a choice among the set of possible swimming vectors. Once again, two approaches can be taken: (1) behavioural rules in response to the environment can be defined *a priori*, based on observations and experimental work; (2) these behavioural rules can emerge from the model by defining the set of possible swimming vectors, a biologically sensible “goal” for larvae (e.g. settlement), and letting an algorithm choose the suite of decisions to achieve this goal (see Irsson et al.¹¹⁷ for an example of the use of stochastic dynamic programming to solve such an optimisation problem).

In both cases, orientation is a function which associates a swimming decision to the current state of a particle, such as

$$f : \text{state} \times \text{time} \times \text{environment} \rightarrow \text{swimming}(\text{speed}, \text{direction})$$

The amount of detail in the orientation behaviour is determined by what is incorporated in each of the left hand side variables. In the most simple model, when orientation is observed but the clues are unknown, orientation depends only on the position of larvae and on time. When responses to sensory clues are involved, the environment can include temperature, food, predators, current fields, land associated chemical concentrations, sun orientation, etc. If some kind of energy budget is present, the state of larvae can also encompass energetic reserves. This formalisation is therefore very scalable.

1.6 Foraging

1.6.1 Potential influences

Behaviours associated with prey search and foraging are unlikely to strongly and directly influence the trajectories of dispersing larvae. Indeed, for most of the larval period, these behaviours will occur on a relatively small spatial scale. Nonetheless, if these behaviours motivate larvae to undertake vertical migration in their search for food, for example, such repositioning could indirectly influence pelagic trajectories, as indicated previously.

Foraging movements are small

Food is typically limiting for fish larvae, at least with respect to it being less than they would require to achieve maximal growth rates. Growth rate in turn influences swimming speed, survival probability, and pelagic larval duration, which are key processes in the early-life history models of fish. However, the efficiency of foraging will probably have little influence early on for most larvae (except inasmuch as they conserve energy and delay the “point of no return”), but perhaps more as they approach the juvenile period.

Food is limiting for growth

Turbulence and predator-prey interactions in the plankton

Substantial effort has been applied in attempts to demonstrate that microscale turbulence can significantly increase the feeding rate of planktonic predators (reviewed in Dower et al.¹¹⁸). This effort has been driven by the theoretically-derived conclusion that microscale turbulence increases the encounter rate between planktonic predators and their prey. The original theory assumed that the geometry of the water volume searched for prey by a predator is spherical¹⁴. More recent theoretical formulations assume a forward-projecting hemispherical perceptual volume^{118,119}. However, for all planktonic taxa for which such information exists, the geometry of the perceptual field is neither a sphere nor a hemisphere^{119,120}. The manner in which a non-symmetrical perceptual field might affect the conclusions of turbulence encounter theory was recently examined by Lewis¹²⁰ for cruise searching copepods. He concludes that, under turbulent conditions, the optimal swimming strategy (associated with prey search) for predators with non-symmetrical perceptual fields differs radically from what is otherwise predicted. Analogous work on larvae of Atlantic Cod (*Gadus morhua*) produced a similar result: the advantage of turbulence is greatly reduced when the perceptual space is represented with a more realistic geometry¹¹⁹. Because virtually all models of predator-prey interactions in the plankton have, at their heart, a parameter for the distance at which prey can be located, this demonstrates how empirical knowledge of the perceptual abilities of marine organisms is essential. Without such information, we risk making large errors in prediction, which can lead to misleading and/or incorrect conclusions.

Larval perceptual volume is not spherical ...

... and affects models of foraging interactions

Operational prey abundance and the myth of prey choice by small zooplanktivores

Larvae do not have the opportunity to choose between prey

The abundance of prey that could be consumed by small zooplanktivores most often ranges between 0 and 100 l⁻¹. The volume of water contained in the visual perceptual field (VPF) of a 6 to 10 mm fish larva is approximately 0.8 to 1.0 ml^{119,121}. Thus, at an absolute prey abundance (AA) of 100 l⁻¹, only 0.08 to 0.1 prey items would be within the VPF at any given instant. From the perceptual perspective of the larva, the number of prey per VPF is the operational measure of prey availability. Thus, AA would have to be > 2000 l⁻¹ in order for larvae to have the choice between more than one prey (prey aggregations at thin boundary layers may be this dense¹²²). These VA numbers illustrate that small zooplanktivores — for example, carnivorous copepods or fish larvae — will only rarely have an opportunity to actively choose from amongst several simultaneously available prey items. Although it is possible that these predators make choices from amongst prey encountered sequentially, under anything but the highest of prey abundances they must eat whatever and whenever they can, or risk starvation.

Most feeding models are not parameterised correctly

Numerical models that attempt to define feeding rate, prey choice or prey selectivity in small zooplanktivores all use AA as an input variable, while the perceptual prey abundance is in fact three orders of magnitude less than AA. This represents another example of the need to accurately characterise the perceptual abilities of these organisms in order to realistically parameterise such models.

1.6.2 When to include this behaviour?

There is little need for a detailed component on foraging

While a “condition” factor for the larva may be needed in some models where growth or swimming speed are dependent on condition, there is probably no need for a detailed subcomponent on foraging. This can be considered as secondary.

For a model that is designed to predict larval trajectories (and not growth or recruitment abundance), there would only be a need to incorporate prey search and foraging if there was evidence that these were the primary motivators for relatively local changes in vertical and/or horizontal position that might move them into different water masses. There is very little evidence to support this in the literature.

1.6.3 How to get the relevant data?

Current data is inappropriate to describe prey fields

The temporal and spatial scales over which fish larvae can perceive their prey are orders of magnitude smaller than the scales over which their prey fields are surveyed. Therefore, when modelling the encounter rates of fish larvae and their prey, there is a discontinuity between the data available to characterise the prey fields and the operational prey field (what the larva can actually perceive). Two things are required to bridge this gap: (1) sampling of prey fields at smaller temporal and spatial

intervals that are more closely aligned with the perceptual abilities of the larvae; (2) empirical characterisation of the perceptual fields of fish larvae on different prey, under different conditions (light, turbulence), and at different sizes.

1.7 Predator avoidance

1.7.1 Potential influences

Traditional aquatic food webs place plankton at the base of the food chain, often with fishes as top predators. However, during ontogeny, fishes go through a phase as an important (albeit transient) member of the plankton. At this small size, fish larvae are subject to predation by other plankters: carnivorous copepods such as *Paraeuchaeta norvegica*, chaetognaths, gelatinous zooplankton, other ichthyoplankton, etc.

Early fish larvae are predated upon ...

As early larvae, fishes have only a limited capability to perceive and escape from predators. In contrast, many adult invertebrates, and/or older larval or juvenile fishes, are formidable predators against which early-stage fish larvae would have virtually no chance. There are almost no empirical observations of such interactions (although see Yen & Okubo¹²³, Browman et al.¹²⁴). For more swimming capable larvae, the probability of escape is highly dependent on the type of predator. For example, if an aggregation of gelatinous zooplankton sweeps through a population of larvae, high mortality could result.

... and have little chance to avoid it

As with foraging, predator avoidance occurs on a relatively small spatial scale and is therefore not likely to influence dispersal trajectories, except through indirect influences via vertical or horizontal repositioning in different water masses.

1.7.2 When to implement this behaviour?

There is currently no data available to parameterise larvae-predators interactions. In addition, for a model that is designed to predict larval trajectories (and not mortality or recruitment abundance), predator avoidance would only need to be incorporated if there were evidence that these movements result in displacement into different water masses.

Knowledge is lacking

1.8 Schooling

1.8.1 Potential influences

Field observations, net sampling, and acoustic trace indicate that some fish larvae undergo a near-bottom schooling phase prior to recruitment^{125,126}. The size of these larvae may be intermediate between the sizes of larvae collected in plankton tows and of metamorphosed juveniles collected from the benthos¹²⁵. Rearing experiments also demonstrated that schooling is developed early during ontogeny among pelagic

Fish larvae school prior to settlement

species¹²⁷. Although schooling is mediated primarily by visual cues starting aggregation, formation of the lateral line canals appears to improve coordination of school members for parallel orientation⁶⁴.

Effects on patchiness,
orientation, and survival

Potter & Chitre¹²⁸ used simple numerical experiments implementing the “many wrongs” principle¹²⁹ to demonstrate that schooling can enhance the location of reefs by sounds, ultimately affecting the choice of settlement and changing the end point of individual trajectories. This principle states that individual errors in locating the source of information (sound here) cancel out in the school resulting in a better emerging orientation for the school as a whole. Schooling is also a strategy to avoid predation, and may ultimately affect survival and simulated levels of recruitment. Therefore, schooling can become important when modelling recruitment to specific nursery areas, as well as for testing hypotheses on orientation and sensory capabilities of larvae. Schooling will also alter the patchiness in the distribution of pelagic larvae, which has implications for sampling, predation, feeding and patterns of settlement.

1.8.2 Simple modelling tests

As this behaviour may change spatial patterns of settlement, the rule of thumb is to verify that the model grid-scale can resolve those spatial differences. The extent of the spatial differences (with and without schooling) can be estimated as the distance travelled by larvae at the mean velocity of the flow field near the settlement area from the onset of schooling to settlement.

In addition, schooling may enhance the sensibility and precision in orientation. Therefore, in a model with orientation implemented as a response to environmental cues, one can artificially increase the sensory sensitivity of larvae and check if this has an influence on both survival rates (ability to find suitable recruitment habitat before the end of the pelagic phase) and spatial patterns of settlement.

1.8.3 How to get the relevant data?

Very little is known
regarding schooling
in larval fish

Unfortunately, there is little published information on schooling behaviour in fish larvae. Data can be obtained through rearing experiments¹²⁷, direct *in situ* observations^{125,130}, and acoustic measurements combined with net tows¹²⁶. Development of optical and acoustic technologies will provide new information on larval behaviour. Observations should aim at elucidating the timing of the onset of schooling behaviour because it would be crucial to its incorporation in models.

1.8.4 Suggested implementation

Schooling based on
swimming rules

Implementation of schooling is similar to that of orientation, in that one needs to follow a set of rules for individual particles. The maintenance of

coherent schools is usually coded as a bias in the swimming direction of each particle toward the barycentre of the locations of its neighbours¹²⁸. However, schooling can also be based on the influence of a single neighbour at any one time by a decision algorithm¹³¹.

The occurrence and influence of schooling may also be related to a taxis behaviour common among all larvae, where swimming direction and speed depend on the location and intensity of a cue source (sound, chemicals). As the cue decreases in intensity, each swimming particle takes a more random step. For examples on modelling various fishes aggregation behaviours in a Lagrangian context, see Flierl et al.¹³².

1.9 Choice of settlement habitat

1.9.1 Potential influences

In most species of demersal fishes, settlement-stage (i.e. competent) larvae have particular habitat requirements and will not just settle anywhere. In addition, up to 30% of larvae may discard a seemingly appropriate habitat for no obvious reason^{133,134}. Similarly, some species will settle only or primarily at certain times, for example at night and/or during new moons¹⁵⁶. Hence, settlement behaviour can influence both the endpoints and the length of dispersal trajectories.

Selectivity about where and when to settle

Meso-scale selectivity of settlement location has been shown in a variety of species. For example, larvae of some reef fishes will not settle on either leeward or windward portions of a coral reef but only within lagoons¹³⁵, and other species settle only into sheltered seagrass beds, often in estuaries. At smaller scales, larvae may select particular microhabitats upon which to settle. For example, among pomacentrids, anemone fishes (*Amphiprion*) only settle to particular species of anemones^{109,113}, and *Dischistodus spp* only settle into sand patches on coral reefs¹³⁴.

Interaction with benthic resident fishes can strongly influence the distribution of settlement. Obviously, predation by benthic residents will prevent settlement. Both schools of planktivorous fishes hovering off a reef edge and aggressive approaches by other resident fishes (even herbivores) can cause a larva to swim back out to sea rather than settle¹³⁴. This will at least influence the distribution of settlement and may also influence its magnitude if the larvae driven back to sea are unable to subsequently locate settlement habitat.

Benthic interactions also shape settlement patterns

Several interacting sensory cues are probably involved in the selection of settlement sites⁵⁸. Unlike some invertebrates, no "settlement stimulating compound" has been identified for marine demersal fishes¹³⁶, but different studies have identified vision, olfaction (including detection of salinity) and audition as important factors^{25,101}. There is probably a continuum of cues involved in moving from open water to settlement sites, and just where pelagic orientation ends and settlement behaviour

begins is not clear. Therefore, we do not treat these separately here, but refer the reader to the section on orientation.

1.9.2 When to include this behaviour?

Often sub-grid scale The degree to which settlement behaviour is relevant to a given model depends on the spatial scale over which the behaviour operates and on the grid size of the model. If the settlement processes are sub-grid scale, which they often will be, they may have implications for the numbers of larvae that survive settlement, but they will not influence the spatial pattern of settlement at the scale of the model.

1.9.3 How to get the relevant data?

A posteriori inferences are misleading Unfortunately, there is no broad review of settlement behaviour in marine, demersal fishes, although there is substantial literature on the subject. Some field studies make inferences about settlement behaviour based on the spatial and temporal distribution of recruits, often weeks or even months following settlement. Such studies should be treated cautiously for several reasons. Mortality rates of settling and newly settled larvae are extremely high⁵ and in many cases have been shown to be density dependent¹³⁷. Therefore the distribution of recruits can differ markedly from that of settlers. Secondly, a number of species settle in one place or habitat and then move to another over a period of days to months^{138,139}, so the distribution of recruits, even seemingly recently settled ones, may differ substantially from that of settling fishes.

Direct observation of settlement is possible Well-designed field observations of and experiments involving settlement behaviour provide the most reliable information. These include measuring what settles onto artificial habitat¹³⁵, use of video¹⁴⁰ or other remote sensing equipment to watch natural settlement onto unaltered habitat, complex multifactorial designs¹⁴¹, and divers directly observing the behaviour of larvae released in different habitats¹³⁴. Published examples can be found of all of these, although the range of species covered is narrow. It may frequently be possible to conduct similar experiments or observations on the species of interest, and examination of published work in this area is recommended to assist in their design. It might be tempting to use recently settled individuals for these experiments or observations, but given the extent and rapidity with which metamorphosis and alterations in behaviour take place upon settlement, there is little assurance that recently settled juveniles will behave with any similarity to settling larvae⁸⁸.

1.9.4 Suggested implementation

How to treat arrival at the wrong time? Where there is evidence of temporal factors in settlement, a decision about whether the model larvae can remain near the settlement habitat if they arrive at the “wrong” time will be needed. For example, consider

larvae arriving off a reef during the daytime when they only settle at night. Would these larvae simply continue on, past suitable habitat, or would they sense the presence of the habitat and behave in a way that keeps them in the vicinity until nightfall? There is little direct information on this sort of behaviour, although circumstantial evidence indicates that larvae do accumulate in the vicinity of settlement habitat to wait for the appropriate time¹⁴². This circumstantial evidence does not, however, help to decide over what periods of time such accumulation might take place. Information on the swimming, orientation or sensory abilities of the species of interest can be used to eliminate from consideration accumulation that is beyond the capabilities of the larvae.

When habitat quality is known to influence settlement probability, it should be represented in the model, either explicitly when the fineness of the grid permits, or through parameterisation in each grid cell (e.g. description of the percentage of each habitat type in the cell). Settlement probability should be deduced from this habitat map. Caution is advised regarding how this probability is computed. One could be tempted to use settlement patterns observed *a posteriori* to compute a spatial probability of settlement. While this would be likely to enhance the result of the model when compared to observations, it does not rely on a mechanistic understanding of the process, hence has no predictive value. Instead, settlement experiments should be done in all habitat types and probabilities should be derived from those.

Spatial probability
of settlement

1.10 Conclusions

Information is often lacking

All seven behaviours considered here — vertical and horizontal swimming, orientation, foraging, predators avoidance, schooling, selectivity in settlement — have the potential to influence the outcome of the pelagic larval phase, through modifications of dispersal trajectories, survival probability, and growth. For most behaviours, information is still cruelly lacking, hampering precise estimation of their impact and making their introduction in models particularly sensible. In addition, the importance of any particular behaviour depends on the species/location of interest and on the question the model is designed to address. We tried to provide enough information in each section to help the reader to choose which to include. Given current knowledge and assuming a general interest in predicting where and how many larvae settle, we propose a hierachisation of their impact in Figure 1.2. Once again this should really be considered as a general rule, and adapted to each modelling scenario.

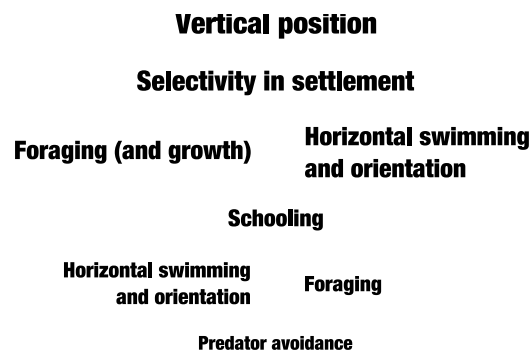

Figure 1.2 Tentative hierarchy of larval behaviours, ordered by decreasing importance. When two behaviours are placed on the same level, the one on the left should be preferred for slow swimming, temperate larvae, for which growth is critical, while the one of the right should be preferred for faster swimming larvae, usually tropical ones.

Swimming should be tackled

Many models now consider the importance of vertical position; and those which do not should be regarded with caution. In cases where settlement opportunity is very localised, settlement locations are also represented⁴⁵. The dynamics of larval growth has been well studied in temperate environments and several modelling frameworks exist. Therefore, the next step in many cases is to incorporate swimming by fish larvae, whether it occurs on large spatial scales (oriented swimming) or finer ones (schooling).

Chapter 2

Detection and quantification of marine larvae orientation in the pelagic environment

J.-O. Irisson, C. Guigand, C. Paris
Submitted to *Limnology & Oceanography: Methods*

2.1 Introduction

The previous chapter highlighted that many behaviours of larval fishes are potentially important but still very poorly described. In fact, most information concerns coral reef fishes in their late larval stage. It also pointed out the inclusion of oriented swimming as the natural next step for models of the early-life of history of fish. Indeed, if larvae swim randomly, their movement would only add noise around the passive drifting trajectories. In contrast, modelling studies have shown that oriented horizontal swimming greatly influences dispersal outcomes⁸⁷. Modelling experiments also suggested that the nature of the orientation cue influences larval trajectories and that the sensory threshold is the key factor determining the supply rate of larvae onto the reef^{82,143}. Therefore, to understand the dynamics of the pelagic phase, it is critical to be able to measure the orientation of larvae throughout ontogeny and gain further insight in the cues involved in this behaviour.

Orientation behaviour and related cues have been studied using three methods: *in situ* visual observations by scuba divers⁹⁰, *in situ* fixed experiments using light traps or patch reefs where cues are manipulated^{144,145}, and laboratory observations in choice chambers^{103,112,115}. These methods have shown that fish larvae orient and that cues such as sound and chemical plumes originating from reefs can be detected and might be used for navigation. These findings were consistent among the studies and were the subject of recent reviews^{25,58,101,146}. However,

Orientation is little known but important

Three study methods exist

the scope of these results is limited due to methodological constraints, as detailed hereafter.

Divers observation
does not allow to
investigate cues

Following larvae on scuba allows for observation of their natural swimming behaviours, both horizontally and vertically, in an open environment with apparently insignificant influence by the presence of divers. However, scuba diving restricts the duration and depth of the observations as well as the size of the study specimen, particularly when visibility is reduced. Therefore, this method has only been used for day-time observations of the late, pre-settlement stages of coral reef fishes in clear coastal waters. In addition, this method is impractical for manipulating and inferring the cues potentially used for orientation.

Experimental methods
are limited to
near-reef orientation

Alternatively, the experimental methods have provided direct evidence that sound¹¹⁵ or chemical¹⁰³ cues influence the orientation of reef fishes. Because these studies rely on the use of some kind of fixed device toward which larvae are attracted, they operate in shallow water habitats and/or on late stage larvae. They are designed to identify the cues involved during settlement and not for investigating large-scale navigation during the pelagic phase of reef fishes.

In summary, the existing methods provide valuable information on the orientation of late-stage larvae relative to a limited set of coastal water cues. However, fish are known to develop swimming capacities early²⁵; hence, orientation of young individuals is potentially influential to the connectivity between adult populations. The behaviour of younger larvae in the pelagic environment is still completely unknown and may involve other cues, such as magnetic or electric fields, sun position, swell and waves¹⁴⁶. Current methods are not appropriate to tackle these questions.

Studying orientation
cues *in situ* and
throughout ontogeny

Here, we present a device aimed at assessing the orientation of all larval stages directly in the pelagic environment, while conserving some control over environmental cues. Larvae embedded in oceanic waters have no apparent frame of reference for detecting the direction of the current¹⁴⁶. Therefore the device is designed to drift with the current, and contains a circular behavioural arena in which a larva is filmed. The larva used for the experiment is thus exposed to sensory cues as a free larva would. Its trajectory is extracted from the movie recording and analysed through circular statistics to detect orientation behaviour. Simplicity, extendibility, and ease of use were major foci during the design of this instrument, while avoiding limitations in detecting and measuring orientation behaviour and manipulating proximal cues. We describe the observation methodology and present a proof of concept using data collected with late stage reef larvae.

2.2 Materials and Procedures

2.2.1 Materials

The OWNFOR (Orientation With No Frame Of Reference) apparatus is built upon a hollow cylindrical frame (130.8 cm height, 45.7 cm diameter) made of four aluminium bars and three aluminium rings (1.25 cm thick) welded together (Figure 2.1). Eight smaller bars, to which four strong nylon fabric sheets (130.8 cm \times 29.20 cm) are secured, protrude diametrically outward from the cylinder and should lock the apparatus in the surrounding water mass. The bottom of the frame holds a cylindrical arena (12 cm height, 38 cm diameter) made of two round pieces of transparent acrylic (1.25 cm thick), secured by transparent plastic bolts. The bolts are placed outside of the arena so that the specimen cannot seek refuge behind them. The periphery of the arena is closed by 300 μ m Nytex® mesh attached with Velcro® bands. The arena is entirely symmetrical to minimise visual reference for the larvae enclosed within.

At the top of the frame, an Ikelite Underwater Systems housing contains a Sony Handycam DCR-PC350® camcorder aimed down at the arena, a diving compass, and a white reference mark over a black plastic disc. This DV camera has very good low-light performance and all filming is done in available light. Frames measure 720 \times 576 pixels

A symmetric cylindrical frame ...

... drifting with the current

Record larval trajectories on video ...

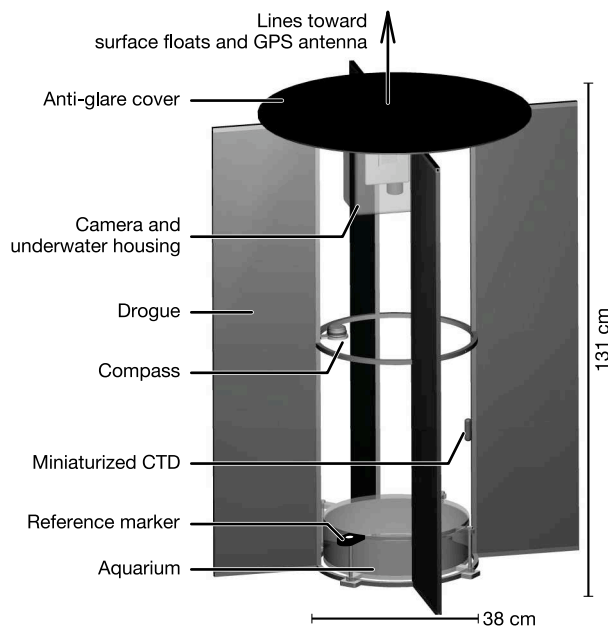

Figure 2.1 3D representation of the observation apparatus

and cover a region 45 cm wide (i.e. a 600 μm pixel resolution). The video data is recorded on 80 min Mini DV tapes in SP mode. The compass records the orientation of the arena and the white marker provides a fixed reference point on the arena relative to the camera. Both are used for data calibration. Finally, an opaque plastic disc tops the frame to avoid glare from the sea's surface on the arena.

... together with
physical data

The submerged part of the OWNFOR device is attached to a set of three stainless steel bridles that connect to a 3 mm diameter line leading to the surface. This line first runs through a small float, then forms a loose buckle tied with a bungee cord, and finally attaches to a larger surface float, sold as an inflatable spherical fender. The line length can be adjusted prior to deployment in order to run experiments at different depths. The use of the sub-surface float and of the bungee cord attenuates the effect of waves on the OWNFOR apparatus below. A custom made spar-type float is attached to the surface float and houses a Global Positioning System (GPS) antenna interfaced with a GPS data logger (Geostats Inc.). The position of the device is recorded every 30 s. In addition, a mini Conductivity Temperature Density (CTD) logger from Starr-Oddi Inc. is attached to the frame and records environmental variables (temperature, salinity, and depth) every 30 seconds.

After deployment, the video data is retrieved and stored on the hard drive of a computer. Analysis of such data only requires a large enough storage space to hold the videos and 1 Gb of memory to allow all the video frames to be loaded at once. The video analysis relies on software programs that are most easily installed on a Unix-like operating system. The assessment data presented here was processed on a PowerMacintosh running Mac OS 10.4 and on an HP Proliant running Debian GNU/Linux 3.0 and Fedora Core Linux 7.0.

2.2.2 Procedures

Deployment

Reduced crew and
easy deployment

The OWNFOR device's size and shape allow deployment and recovery from a small boat using only two persons. The surface float is deployed downstream from the boat and the line is slowly paid out. The frame is lowered on its side alongside the vessel. While one person holds the frame half submerged the other places one larva inside the area. Once the specimen is inside the arena the frame is slowly released. As it sinks sideways the air escapes from the arena through the mesh. The frame slowly reaches its final depth as tension in the line causes it to align vertically in the water column. After 3-5 minutes the apparatus is stable within the current and is allowed to drift for a period of 20 minutes. The boat briefly motors a few hundred meters downstream from the surface float and the engine is shut off for the remainder of the experiment. After the experiment the surface float is approached from upstream in order to pull the instrument aboard. The specimen is retrieved from

the arena and preserved in 75% Ethanol. The video camera batteries and remaining time on the tape are checked before starting a new experiment.

Data analysis

Typical evidence for orientation preference is directionality in the swimming bearings⁹⁰. However, in an enclosed circular arena, a larva is restricted by the boundary, and its orientation behaviour may take two forms: (1) the larva may swim toward a preferred direction, as it would do in the open environment, then touch the boundary and swim in a non-oriented manner around the arena before heading toward its preferred direction again, in which case its average swimming *direction* is indicative of orientation; (2) the larva may be less active and simply stay in the region of the arena corresponding to its preferred bearing, in which case its *positions* are indicative of orientation. To capture and statistically quantify these behaviours a good representation of the trajectory of the larva is necessary.

Raw video recordings of larval positions are corrupted by several factors: *in situ* images are often noisy; unexpected events may occur during the recording (e.g. adult fish swimming around the arena disturbing the study specimen); the camera usually vibrates slightly with respect to the arena; and the whole device rotates on itself (*ca.* 360° per 20 min). Therefore, a series of processing steps are performed to mitigate these factors and yield accurate estimates of larval trajectories from video data: sub-sampling and enhancing of video data, acquisition and calibration of trajectories, and appropriate statistical analysis (Figure 2.2). This whole process is achieved using a set of customised open source software.

The raw video data comes encoded as a 30 images per second movie. The position of the specimen is detected manually (see below) with a mean imprecision of 1.7 mm. Manual detection on all frames would be laborious and error prone because 1.7 mm represents half the displacement of a larva swimming at 10 cm s⁻¹ during 1/30 s. Instead, the video is resampled by keeping only 1 frame each 30 frames (i.e. one image per second). However, when the trajectory curves during a 1 s interval, it is estimated as a straight line. The scenario leading to the largest resampling error would be a larva swimming in small circles around the centre of the arena (the smaller the circles, the larger the angular speed and error). The theoretical case of a larva swimming regularly in a 15 cm diameter circle suggests that a 1 s resampling period is virtually error free near mean cruising speeds (5 cm s⁻¹²⁵⁸), and induces little relative error at higher speeds (10% at 20 cm s⁻¹).

To minimise anomalous data, the video is analysed only once the device drifts at the selected depth and the boat engine is turned off. Video frames are denoised using the high quality denoise filter of MPlayer¹⁴⁷ and the contrast and luminosity are enhanced manually

Orientation shows through positions or bearings

Raw video data is corrupted

Video sub-sampling

Video enhancements and conversion

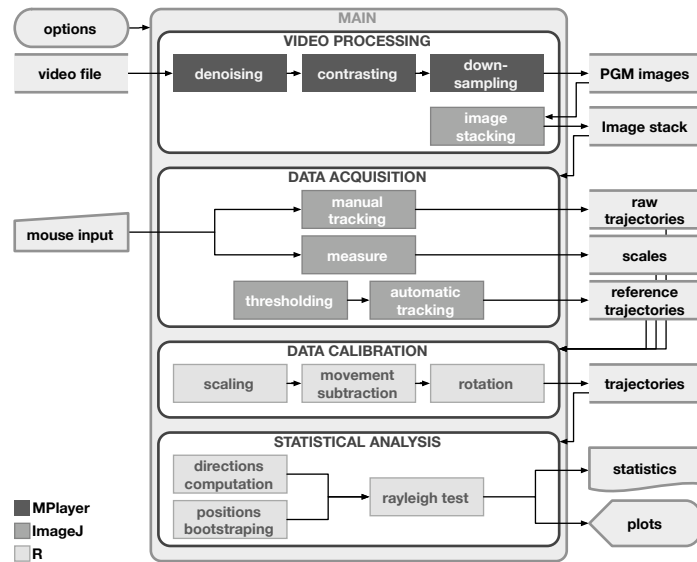

Figure 2.2 Flowchart of the video analysis process. Input is on the left, output on the right. Action boxes are coloured according to the external software on which they depend. The complete software environment used for the analysis is open-sourced and documented. <http://rsmas.miami.edu/personal/cparis/ownfor/>

to facilitate the detection of the larva (Figure 2.3). Individual frames are then exported as Portable Grey Map (PGM) images and stacked in a single Tagged Image File Format (TIFF) image sequence. Finally, the grey shades are normalised throughout the stack to dampen the variations in the lighting conditions: the brightest point of each image is scaled to white and the darkest to black.

Data acquisition The position of the larva is recorded on each frame of the stack by clicking on it within a graphical user interface provided by the software ImageJ¹⁴⁸. When other organisms such as larger fishes are visible in the frame, the position of the larva is simply discarded in the current, preceding, and following frames. This process outputs raw coordinates of the larva in pixel units, relative to the bottom left corner of the image, which need to be calibrated.

Data calibration The centre and diameter of the arena are recorded on the first image and provide both the scale and frame of reference for the raw coordinates. However, this frame of reference is still relative to the arena, which may vibrate relative to the camera and rotate on itself; we are interested in the orientation of larvae in an absolute cardinal reference. To obtain this, the position of the white reference mark is automatically detected on every frame and its movement is subtracted from larva's coordinates to suppress the vibration of the arena relative to the camera. The detection is performed with a custom version of the

automatic tracking plugin of ImageJ which outputs coordinates that are further manipulated in R¹⁴⁹. Then, magnetic north, which appears as a white triangle on the compass' dark background, is also automatically detected and corrected with the same procedure. Next, the compass bearings are computed and subtracted from the positions of the larva represented in polar coordinates relative to the centre of the arena. At this point, north is consistent and the trajectories are available in real-world coordinates (centimetres).

Circular statistics treat data as independent unit vectors pointing toward recorded angles¹⁵⁰. The sum of these vectors gives information on directionality in the dataset. If angles are uniformly distributed, all vectors cancel out and their sum vector is short. Conversely, if some vectors point in the same direction, the sum vector length is $\gg 0$. This technique removes noise and extracts the information we are interested in. Therefore, we reduce our data to bearings of vectors between the centre of the arena and the position of the larva (discarding the length of such vectors) or swimming directions (discarding swimming speed). The sum vector is tested for significant directionality for each larva with Rayleigh's test. However, while swimming directions are independent (lags ≥ 1 s shows auto-correlation $< 10\%$), positions are not. A bootstrap-like technique is then used, resampling randomly 5% of the position data. Rayleigh's test is computed on the subset of independent data and the process is repeated 1000 times. Directionality in the dataset is assumed

Statistical analysis
of trajectories
as circular data

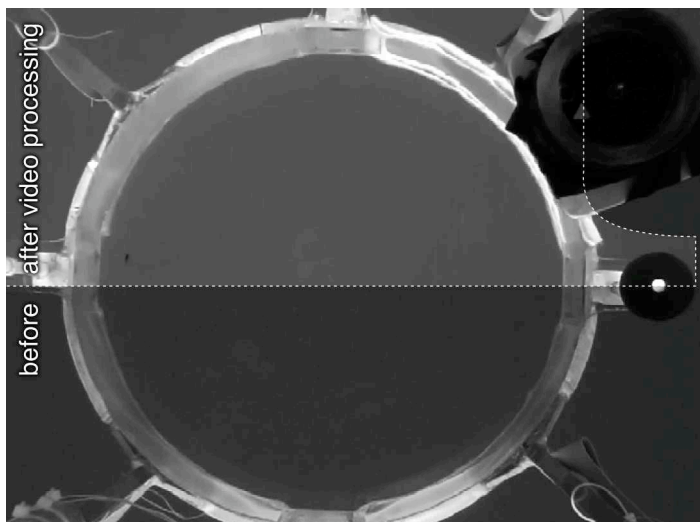

Figure 2.3 A typical video frame before and after video processing. In the centre is the circular arena, with the larva (dark mark) on its left side and the white reference mark on the right side. Still on the right side, but 60 cm above the arena is the diving compass. Video processing removes background irregularities (some frames have more noise but more intense filtering achieves the same quality) and enhances contrast.

if > 95% of the 1000 sum vectors are significant and point toward a similar bearing. Using this technique, angles are treated as independent records, regardless of their sequence or frequency. This allows to freely skip frames on which the larva is disturbed or undetectable, with little impact on the data. All analyses are performed using the *circular* package available for R¹⁵¹.

2.3 Assessment

Drag must be absent and non-random movement must be detected

To be considered successful, the OWNFOR method must meet two criteria. First, the device needs to be locked in the water mass and drift without drag. This is necessary to ensure that larvae experience environmental conditions similar to those of free larvae, having no frame of reference for the direction of the current in which they are embedded. Second, the system must be able to capture non-random movement of larvae and differentiate orientation behaviour from artefacts potentially caused by the enclosure.

The system was tested off Key Largo and Miami (Florida, USA) during six days of calm weather (wind speed < 5 kt, wave height < 1 m) in the summer of 2005 and spring of 2006. Settlement-stage larvae were captured at night, near the reef margin, with light traps retrieved at dawn, on the day of the experiments¹⁵². The device was deployed in water with a depth > 60 m and drogued at *ca.* 20 m below the surface.

The device was locked in the current

In all deployments the system drifted northward or north-eastward with the Florida Current, generally following the isobaths (Figure 2.4). Mean drifting speeds were 0.56 m s⁻¹ off Key Largo and 1.12 m s⁻¹ off Miami, well in agreement with the rapid surface-current speeds measured in those locations at similar distances from the reef edge¹⁵³. Further corroborating the device's effectiveness as a drogue, there was little to no displacement of planktonic particles between the camera and the arena.

Directionality was detected in larval positions

Out of the 18 fish larvae observed, 16 showed significant directionality in their positions and none showed significant directionality in their swimming bearings (Table 2.1). The absence of directionality in the swimming direction was to be expected for such late-stage larvae, because of the relatively small size of the arena. The cruising speed of late-stage larvae is fast enough (10-15 cm s⁻¹²⁵) to force them to turn very often and lead to vectors in almost every direction, though four larvae showed bi-directional swimming patterns. As such, orientation was detected through the positions of the larvae rather than in their swimming directions.

Real orientation can be discerned from artefacts

Although the arena is symmetrical, it is critical to verify that the concentration of positions is not an artefact caused by preference for a feature of the arena. Such behaviours can be discerned from true orientation when correcting for the rotation of the device. When a larva artefactually follows a feature of the arena, its positions aggregate

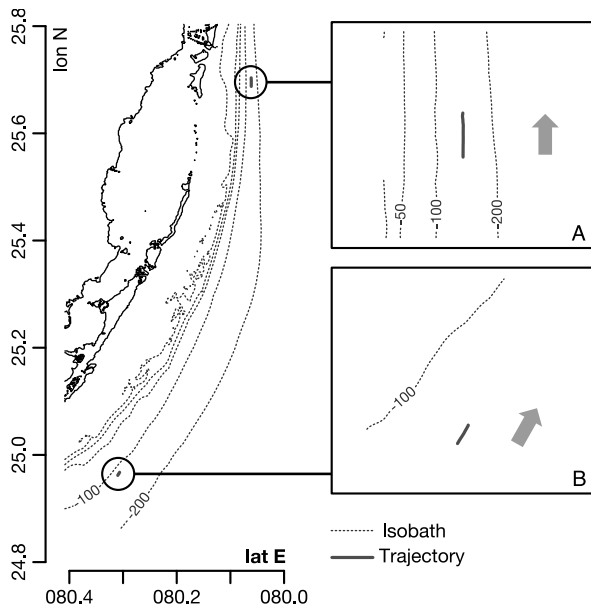

Figure 2.4 Two characteristic trajectories of the OWNFOR device: the system drifted along the isobaths entrained by the current (global situation on the left, details on and drifting directions the right: A – off Miami, B – off Key Largo).

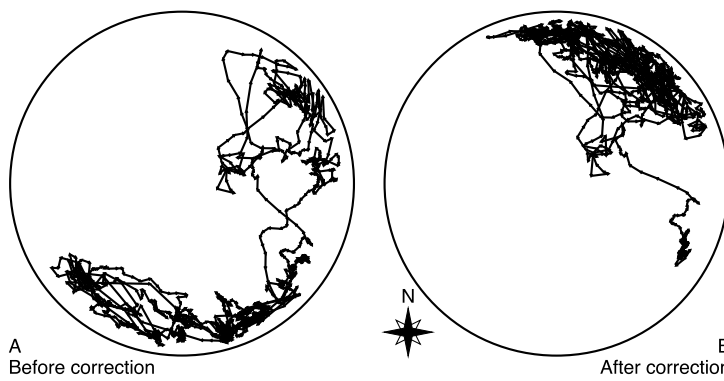

Figure 2.5 Recorded trajectory of a damselfish (*Pomacentridae*) larva plotted before (A) and after (B) correction by compass readings. Only B is in a cardinal reference.

Table 2.1 For each larva ($n = 18$) mean position bearing (mean of the significant sum vectors among the 1000 computed during the bootstrap procedure) and mean direction bearing are reported. The directionality of positions is quantified by the proportion of the 1000 tests which were significant (directionality if $\% > 95$). When directionality is detected, three criteria are used to determine whether it is real orientation or not (see second to last paragraph of the 2.3 section; + for orientation: all criteria met, - for artefact: no criterion met, n/a: criteria do not concord). The directionality in directions is quantified by the p -value of Rayleigh's test.

| Family | pos. bearing | % | orient. | dir. bearing | p |
|---------------|--------------|--------|---------|--------------|------|
| Apogonidae | 279.5 | 97.40 | + | 274 | 0.65 |
| Apogonidae | 218.4 | 96.90 | + | 168.7 | 0.99 |
| Balistidae | 293 | 96.30 | - | 36.8 | 0.18 |
| Monacanthidae | 189.9 | 100.00 | n/a | 145 | 0.26 |
| Pomacentridae | 64.8 | 100.00 | + | 26.8 | 0.66 |
| Pomacentridae | 32.9 | 100.00 | + | 325.1 | 0.60 |
| Pomacentridae | 19 | 100.00 | + | 222.6 | 0.76 |
| Pomacentridae | 199.1 | 100.00 | n/a | 130.1 | 0.42 |
| Pomacentridae | 82.7 | 99.90 | n/a | 112.5 | 0.80 |
| Pomacentridae | 263.6 | 100.00 | n/a | 178.5 | 0.12 |
| Pomacentridae | 54 | 99.70 | - | 8.5 | 0.81 |
| Pomacentridae | 38.1 | 72.80 | | 302.6 | 0.31 |
| Pomacentridae | 332 | 100.00 | n/a | 319.2 | 0.92 |
| Pomacentridae | 181.7 | 11.40 | | 193.4 | 0.94 |
| Pomacentridae | 226.2 | 100.00 | + | 180.3 | 0.90 |
| Pomacentridae | 80.1 | 100.00 | + | 70.5 | 0.74 |
| Pomacentridae | 82.6 | 100.00 | + | 195.9 | 0.17 |
| Pomacentridae | 61.8 | 100.00 | n/a | 357.5 | 0.66 |

around this point when related to the device itself but are scattered on all sides of the arena when observed in a cardinal reference, due to the rotation of the device. Conversely, when a larva has preference for a course rather than for a feature of the arena, its trajectory is more coherent after correction by compass readings than before (Figure 2.5). Thus, series of comparisons before and after correction are carried out. The concentration of positions indicates true orientation if three criteria are met: (1) the proportion of significant sum vectors of the bootstrap procedure is larger after correction, (2) the circular dispersion of those significant vectors is smaller, and (3) the mean circular dispersion of position angles is reduced. For half the specimens, these three criteria were all met, illustrating that these larvae oriented despite the enclosure. Alternatively, only two larvae had preference for a section of the arena. For the rest of the larvae, only two of the three criteria were met because the amount rotation of the drifting system was not enough. Orientation was unequivocally detectable (i.e. all three criteria were met) when the apparatus rotated.

In summary, the OWNFOR system drifted correctly, remained embedded within its surrounding water mass, and late-stage larvae of various coral reef fish species displayed orientation through their positions in the arena. More experiments are necessary before we can relate

our results to the literature. However, our goal to provide a means of observing orientation in pelagic fish larvae was met. Furthermore, the design of the device made it easy to build and to deploy at any depth for any period of time. The use of free, open source software further reduced the cost, and tailoring the programs to our use made them more efficient and transparent than other software solutions.

2.4 Discussion

The OWNFOR system is a hybrid between conventional laboratory experiments and free, *in situ* methods. Indeed, *in situ* observations are performed in an environment that can be controlled by the observer to some extent. As revealed in our work, the enclosure causes swimming bearings of fast moving larvae to be uniformly distributed in all directions. Yet, this does not prevent the detection of orientation through the positions of the larvae. Additionally, this is likely to be less of a problem for younger larvae or other taxa that are less-capable swimmers. The enclosure also limits the vertical movement of larvae. In consequence, vertical swimming behaviour and cues that would trigger a response by vertical positioning, such as light intensity, water density, or concentration of chlorophyll^{65,98} cannot be investigated with this device. Its purpose is to explore the horizontal (i.e. cardinal) orientation of larvae. In addition, to test for effects of vertical position on cardinal orientation, the system can be deployed at various depths where navigational capabilities can be tested and related to environmental data recorded along with the trajectories. Finally, when the intensity of the cue is very low, the searching animal detects it sporadically and its search path is likely to display some frequent ‘casting’ or ‘zigzagging’ events in the quest for information¹⁵⁴. Such cases are likely to arise for chemical cues far downstream of reefs. Because the device’s movement, rather than the larva itself, determines the large-scale trajectory of the larva, our system is inappropriate to detect these types of behaviour. However, before we can track individual larvae *in situ* for long periods of time and without direct human observation, these cases are likely to remain unexplored.

The proof-of-concept trials presented here show that larvae orient in the arena and that, similarly with the method of Leis et al.⁹⁰, their orientation can be detected *in situ*. The immediate advantages of the OWNFOR device are to (1) limit human presence, (2) increase the spatiotemporal scales of the observations (e.g. further offshore, deeper in the water column, at night using far red lighting), and (3) observe larvae at earlier stages and throughout ontogeny. However, the full potential of this system resides in the fact that it enables testing of the influence of individual cues on orientation behaviour directly *in situ*. For example, larvae can easily be isolated from ambient chemicals in a hermetically closed arena, made of acoustically clear plastic film so

The method focuses on horizontal, cardinal orientation

Allows a larger scope of *in situ* observations ...

... and investigation of orientation cues

that it still lets sound through. High frequency sound can be reduced to inaudible levels using two nested arenas isolated by a layer of air. A polarising acrylic filter placed over the chamber can change the polarisation of light. Eventually, even the magnetic information could be altered using a solenoid coil placed around the arena (K. Lohmann, pers. comm.).

Permits to study
younger larval stages

Compared to the experimental methods used on the reef or in the laboratory (manipulated light traps¹⁴⁴ or patch reefs¹⁴⁵, and choice chambers^{103,112,115}), this device greatly broadens the scope of the experiment. It makes it possible to study early stage as well as competent larvae within pelagic waters—their natural environment—instead of restricting the study to settlement-stage larvae near the reef.

Previous experimental methods only investigated the possibility for young larvae to detect a particular cue, without any information about whether it was actually used for orientation. In contrast, *in situ* methods showed that larvae orient, but only allow speculation regarding the cues involved. The OWNFOR method could bring together those two types of results and allow for an *in situ* investigation the influence of environmental cues in the orientation behaviour of all larval stages. Great efforts have been directed toward modelling larval trajectories and incorporating larval behaviour in dispersal models¹⁵⁵. The preliminary observations made in this study help to emphasise the potential role of orientation in shaping dispersal trajectories. Given observed current conditions and swimming bearings, larvae could deviate from passive trajectories by several hundred meters in as little as 15 minutes, even under the strong flow speeds in the Gulf Stream (Figure 2.6). The success and effectiveness of this new device in investigating both orientation and related cues opens new possibilities for such models and for the understanding of larval ecology in general.

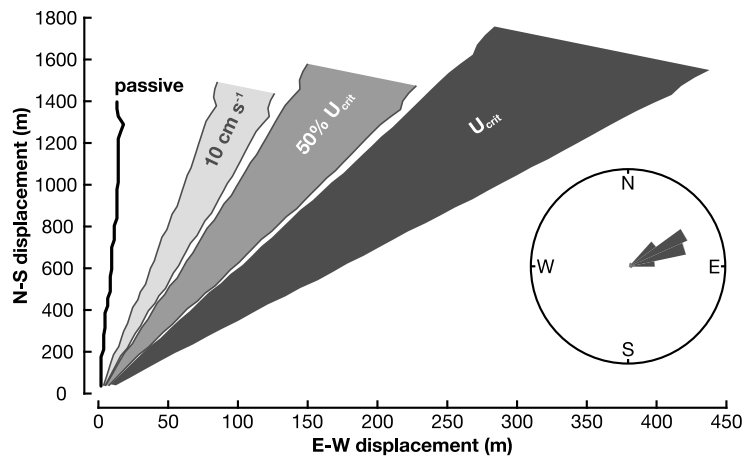

Figure 2.6 Comparison between passive trajectory of the device (thick line) and ranges of possible active trajectories under different swimming speeds, for the 15 min of the experiment. In all cases the range of swimming bearings is the one observed in the device (see included rose diagram). Three speeds are considered: *in situ* speed (10 cm s^{-1}), half U_{crit} which is a measure of sustained swimming speed, and $U_{\text{crit}} = 37.5 \text{ cm s}^{-1}$ which is measure of maximum performance for shorter time periods. In as little as 15 min, larvae would deviate up to 400 m from the passive trajectory.

2.A Acknowledgments

We would like to thank E. D'Alessandro and J. Llopiz for field assistance; S. Sponaugle for boat time; J. Serafy for the video camera; T. Rankin for sharing light trap catches; R. Fisher, S. Planes, S. Sponaugle, S. Simpson, R. Cowen, J. Leis, E. d'Alessandro, K. Huebert, and J. Llopiz for useful comments; Bellamare LLC for engineering drawings; MPlayer, ImageJ, and R groups for their work and online support. Funding was provided by the NSF SGER #0512167 to C. Paris.

Chapter 3

In situ observation of settlement behaviour in larvae of coral reef fishes at night

J.-O. Irisson and D. Lecchini
Journal of Fish Biology 72, 2707-2713 (2008)

3.1 Introduction

The process of “settlement” is the crucial hinge between two phases in the life history of demersal organisms: larvae migrate from the pelagic realm to benthic habitats (as described by Figure I.2 in the introduction). Numerous studies have examined the patterns of habitat use in settling marine larvae and many coral reef fish species are known to be very selective about where they settle^{2,25}. As explained in section 1.9, this choice directly participates in shaping connectivity patterns (or the lack thereof, when suitable habitat is not found). In addition, the settlement period sustains a huge mortality which can quickly and deeply alter said patterns (see section I.3.3). The interactions between habitat choice and mortality seem particularly sensible because larvae not able to find an appropriate shelter risk immediate predation. However a lack of understanding remains about the proximate behavioural mechanisms which lead to habitat choice during settlement (e.g. responses to cues, swimming abilities). Such behavioural processes are probably very important because settling fish larvae, in particular coral reef ones, have efficient sensory systems and swim actively²⁵.

The swimming behaviour of late stage fish larvae (speed and/or orientation) has been investigated in swimming chambers⁸⁸ or observed *in situ*⁹⁰. However, none of these studies report direct observation of wild specimens. Instead, they used reared larvae or late-stage larvae captured in light traps and subsequently released into the ocean or experimental device. In addition, while many species are known to settle

Settlement is critical ...

... and habitat selection directly participates in its outcome

The behaviour of settling larvae has never been observed directly

in greater numbers at night¹⁵⁶, only one study examines the behaviour of fish larvae *in situ* at night, and its observations are confined to the latest parts of the settlement process¹⁵⁷. The present study reports the vertical positioning and swimming activity of fish larvae observed *in situ*, throughout the settlement phase, on their first night in the lagoon. Relationships are then drawn between their behaviour and their settlement patterns.

3.2 Methods

The study was conducted on Moorea Island, French Polynesia (17°30' S, 149°5' W), where larvae enter the lagoon by “surfing” above the reef crest at night, predominantly around new moons¹⁵⁶. Larvae were followed at night, during two-hour periods three times a week (Sundays, Tuesdays, and Thursdays) in July, August and December 2001 and January 2002. Observation times were shifted within the 20:00-05:00 window to avoid the brightest moonlight, and no observations were carried out around full moon.

Following larvae at night

An observer positioned behind the reef crest and equipped with a submersible light waited for larvae crossing the crest. When a larva was spotted, it was followed for at least two minutes or until it settled onto the reef. If the larva was lost before two minutes of tracking, it was discarded. Because Moorea lagoon is mostly shallow (depth < 3m), tracking was performed on snorkel. During observations, larvae were identified to the lowest possible taxonomic level and their swimming activity (active or passive) and vertical position in the water column (surface, middle, or bottom) were recorded. Moorea's lagoon was partitioned into 14 zones, from reef crest to shore (see Lecchini¹⁵⁸ for a detailed definition), and when a larva was followed until it settled, its settlement zone was also recorded.

Recording behaviour

Active swimming was defined as conspicuous body undulation and/or fin movements. Passive larvae were either drifting in the current, usually positioned head down, 45 degrees from the horizontal, with little to no fin movement, or they were lying on the substrate. Larvae that were passive, actually moved over the reef because the water flows from the reef crest to the coast. Vertical position was defined as “surface” for the 30 cm below the surface, “bottom” for the 30 cm above the substrate, and “middle” for the water column in between. When a larva displayed multiple behaviours during a single observation, only the most common was recorded (e.g. a larva passive 10% of the time and active for the remaining 90% would have been recorded as active). This approach was adopted because all observed larvae displayed very consistent behaviour. For example, en route to their settlement habitat, active larvae swam constantly except for very brief stops, whereas passive larvae did not swim at all except possibly at the end of their ingress into the lagoon.

3.3 Results

A total of 534 larvae belonging to 27 species from 14 families were successfully followed (Table 3.1). No intra-species variability was observed within the qualitative framework used: all larvae in each of the 27 species displayed similar swimming activity and depth. Thus, species and not individuals were considered for further analyses to avoid over-representing more frequently observed species. At the family level, only Pomacentridae displayed species-specific traits even though several families with more than one species were observed (Table 3.1).

Active swimming was the most common swimming behaviour, observed in 20 of 27 species (74%). The vertical positions ratio was 11:10:6 for surface, midwater, and bottom, which suggests bottom avoidance. Statistical tests failed to reveal a significant relationship between swimming activity and vertical position (Fisher's exact test, $p = 0.87$). For example, all Acanthuridae, Lutjanidae and Mullidae were active, but most Acanthuridae swam near the surface while all Lutjanidae and Mullidae swam at midwater.

Settlement sites could be determined for only 18 of the 534 larvae of this study. However, in most cases (14 out of 18) they were in agreement with a concurrent study which used a different technique (capture-mark-recapture) to determine the settlement sites of 229 other specimen¹⁵⁸. Therefore, settlement habitat data of those 229 larvae were used to compare against the swimming behaviour of larvae in the present study. Both studies were conducted at the same time and location, on specimens of similar age, and used the same nomenclature (14 reef zones).

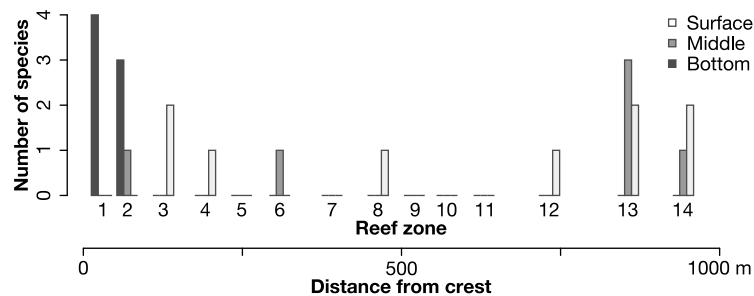

Figure 3.1 Number of species per vertical position for each settlement zone. Zones are numbered from reef crest (1) to shore (14).

No significant relationship between swimming activity and settlement site was detected (Fisher's exact test, $p = 0.35$). In contrast, the relationship between vertical position and settlement site was significant (Pearson's randomised χ^2 test, $p = 0.0064$; Fisher's exact test, $p = 0.0058$). Indeed, species that swam near the bottom settled closer to the lagoon entrance (Figure 3.1). For example, *Stegastes nigricans* (Lacepède, 1802) swam near the bottom and settled on the reef crest, while *Chromis viridis*

Very consistent
behaviour

Relation between
vertical position and
settlement location

Table 3.1 *Swimming behaviour*: For each species, the table presents the number of larvae followed (n), their swimming activity (active, passive) and depth (surface, middle, bottom). *Settlement site*: For seven species in this study, data on the settlement site of n' larvae were recorded and compared with those determined by a concurrent capture-mark-recapture study that defines the nomenclature: settlement zones are numbered from reef crest (1) to shore (14). When the same species was observed in several zones, n' contains the number of settlers in each zone respectively.

| Family <i>Species</i> | SWIMMING BEHAVIOUR | | | SETTLEMENT SITE | | |
|---------------------------------|--------------------|----------|---------|-----------------|------|-------------------|
| | n | Activity | Depth | n' | Zone | Zone ^a |
| Acanthuridae | | | | | | |
| <i>Acanthurus lineatus</i> | 15 | active | surface | | | |
| <i>Acanthurus nigricauda</i> | 55 | active | surface | | | 13 |
| <i>Acanthurus triostegus</i> | 58 | active | surface | 2 | 14 | 14 |
| <i>Ctenochaetus striatus</i> | 40 | active | surface | 2,1 | 4,8 | 4,8 |
| <i>Naso unicornis</i> | 20 | active | middle | | | |
| <i>Zebrasoma veliferum</i> | 10 | active | surface | | | |
| Apogonidae | | | | | | |
| <i>Apogon exostigma</i> | 36 | active | bottom | 5 | 1 | 1 |
| <i>Apogon franeatus</i> | 15 | active | bottom | | | 1 |
| <i>Apogon novemfasciatus</i> | 10 | active | bottom | | | 1 |
| Aulostomidae | | | | | | |
| <i>Aulostomus chinensis</i> | 10 | passive | middle | | | |
| Balistidae | | | | | | |
| <i>Rhinecanthus aculeatus</i> | 5 | passive | surface | | | 14 |
| Belonidae | | | | | | |
| <i>Platybelone sp.</i> | 20 | active | surface | | | |
| Chaetodontidae | | | | | | |
| <i>Chaetodon lunula</i> | 3 | passive | surface | | | |
| Holocentridae | | | | | | |
| <i>Myripristis adusta</i> | 1 | passive | middle | | | 6 |
| Lutjanidae | | | | | | |
| <i>Lutjanus fulvoiflamma</i> | 13 | active | middle | 2 | 6 | 13 |
| <i>Lutjanus fulvus</i> | 9 | active | middle | | | 13 |
| Mullidae | | | | | | |
| <i>Mulloidis flavolineatus</i> | 10 | active | middle | 2 | 6 | 14 |
| <i>Parupeneus barberinus</i> | 15 | active | middle | | | |
| Muraenidae | | | | | | |
| <i>Gymnothorax spp.</i> | 16 | active | middle | | | 2 |
| Pomacanthidae | | | | | | |
| <i>Centropyge flavissimus</i> | 17 | active | surface | | | 3 |
| Pomacentridae | | | | | | |
| <i>Chromis viridis</i> | 8 | passive | surface | 2 | 12 | 12,13 |
| <i>Chrysiptera leucopoma</i> | 45 | active | surface | | | 3 |
| <i>Stegastes albifasciatus</i> | 24 | active | middle | | | 13 |
| <i>Stegastes nigricans</i> | 37 | active | bottom | 2 | 2 | 1,2,(4) |
| Scorpaenidae | | | | | | |
| <i>Scorpaenodes guamensis</i> | 4 | passive | bottom | | | 2 |
| <i>Scorpaenodes parvipinnis</i> | 3 | passive | bottom | | | 2 |
| Synodontidae | | | | | | |
| <i>Synodus binotatus</i> | 5 | active | middle | | | |

^aData reproduced from Lecchini¹⁵⁸

(Cuvier, 1830) swam closer to the surface and settled on the fringing reef, farther from the crest. This result is particularly interesting because it suggests species-specific decisions about when to leave the water column and search the bottom for a suitable habitat.

3.4 Discussion

Because no information was available on the behaviour of settling reef fish larvae, a bold approach was chosen to collect a large amount of data: observing larvae using a submersible light. However, the potential artefacts caused by the introduction of visible light at night must be discussed before interpreting the results.

As a first step, larvae conspicuously affected by light (e.g. staying close to the light source or fleeing the light beam) were not recorded. These reactions to light were highly species-specific (i.e. for each species, almost all individuals were affected or none seemed affected). Hence, no individuals of the species eventually presented here were discarded and the results for them are not affected. Many animals freeze when exposed to light at night and such behaviours would have been recorded as passive in our study. Though this potential artefact cannot be ruled out, our results hold even when passive individuals are discarded (i.e. the relationship between vertical position and settlement location is still significant). Followed larvae were more visible to predators because they were illuminated, yet we rarely observed predation attempts. When we did, we usually lost the larva because it was eaten or burst away to avoid the predator. Their behaviour was therefore assessed only before the encounter of predators, when larvae were not yet affected.

Light did not induce a conspicuous bias

Coral reef fish larvae settle in successive peaks, as larval patches reach the reef¹⁵⁶. Hence, when a larva was followed, several individuals from the same patch were likely swimming around or had settled hours to minutes before. When we were able to follow a larva until it settled, we repeatedly observed conspecifics that colonised the reef on the same night near the settlement site of the tracked specimen (characteristic morphological traits are often displayed during the night of settlement). We also showed that settlement sites observed in our study and those determined by Lecchini¹⁵⁸ using a completely different method (capture-mark-recapture) were similar. This suggested that tracked larvae exhibited natural, unbiased behaviour and settled into their usual habitat.

Undisturbed larvae showed similar settlement locations

Overall, following fish larvae at night using a visible light probably introduced some artefacts. However, other observation methods used to assess the behaviour of fish larvae also did^{88,90}. Yet, they yielded results important for our understanding of the late larval phase of coral reef fishes.

In the present study, most larvae (74% of species recorded) swam actively which confirms that their behaviour is an important factor of

the settlement process. Bottom avoidance could be interpreted as a way to avoid predation by benthic predators, in particular opportunistic species. As predation is particularly high during the night of settlement (mortality estimated at 61%⁵), any predation avoidance mechanism would be favoured by natural selection. Eventually, larvae swimming close to the bottom were shown to settle earlier than surface- and midwater-dwelling larvae. The first part of the relationship is well exemplified by apogonids, which quickly and actively descended toward the bottom immediately upon lagoon entry. They swam for a while among coral rubble and finally settled among these debris. A simple explanation would be that larvae swimming on the bottom settled earlier simply because they encountered a potential habitat earlier. On the other hand, surface- and midwater-dwelling larvae could have descended to settle at any time during their ingress into the lagoon. Yet, most swam directly to areas 13 and 14, very close to the shore, which suggests that they searched for particular conditions met only in these areas. Two hypotheses can be proposed to explain the inverse relationship between swimming depth and settlement location: either larvae search for a specific settlement habitat and consequently adapt their vertical position, or vertical position is predetermined in a species-specific way and larvae obey a “first-encounter first-stop” model. The latter scenario is observed for many marine invertebrate larvae, even active ones, which appear to settle on first encountered substrate and only afterward may desert unfavourable environments¹⁵⁹. On the other hand, Doherty et al.¹⁶⁰ and Leis & Carson-Ewart¹³⁴ demonstrated the existence of predefined habitats and of habitat selection prior to settlement for pomacentrids. The data reported here do not allow to decide between those two hypotheses. Nevertheless, previous observations of settling fishes during daytime revealed larvae discarding seemingly appropriate habitat¹³⁴. Furthermore, fish larvae are perfectly capable of discerning between habitats even without light¹⁶¹. Hence, the first hypothesis, of habitat selection and appropriate behavioural response to achieve this choice, may be favoured at this point.

Habitat choice or
“first-encounter
first-stop”?

3.5 Conclusion

To conclude, observing larvae *in situ* with a submersible light may introduce some artefacts, but this simple method yielded completely novel data on the behaviour of wild coral reef fishes during their night of settlement. This approach highlighted very marked and species-specific behaviours in the late larval stage of coral reef fishes, which seem associated with active habitat selection by these organisms. While the large scale vertical distribution of larvae in the ocean (from surface to tens or hundred of meters) has been shown to be very important in shaping their dispersal patterns^{69,71}, vertical distribution also reveals itself as a behavioural response on a much finer scale here.

3.A Acknowledgements

The authors are grateful to the staff of the CRIOBE for field assistance, and to C. B. Paris, D. E. Richardson, M. J. Hauff, and two anonymous referees for their comments on the manuscript. This research was supported in part by the École Normale Supérieure and grants from CRISP (Coral Reef Initiative for the South Pacific), ANR (ANR-06-JCJC-0012-01) and MOM (06 PF 15).

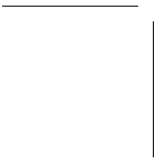

Chapter 4

Biophysical correlates in the spatial distribution of coral reef fish larvae around an isolated atoll

J.-O. Irisson, C. Paris, R. Crech'riou, S. Planes
Manuscript in preparation

4.1 Introduction

Demersal organisms spend the largest part of their lives as adults associated with the substrate, so the adult phase is probably the most relevant both ecologically and economically. Therefore, scientists and managers are usually most interested in recruitment (the *outcome* of the pelagic phase) which determines adults dynamics, rather than in the pelagic phase *itself*. However, to understand and somehow predict this outcome, interest must inevitably shift to the processes governing the distribution and trajectories of larvae within the oceanic realm.

As highlighted in section I.3.1, the open ocean is a highly structured environment, despite its apparent uniformity. Physical variables such as temperature, salinity or nutrient richness are heterogeneous at all scales³⁶. This results in heterogeneity in the primary production and, in turn, in the distribution of planktonic and higher level consumers. The distribution of fish larvae is no exception and is known to be patchy. The dimension of such patches has been measured to range from 1-2 km¹⁶² to 5-6 km^{71,163} on the mesoscale. Meter-scale patchiness may also occur, in the form of schools of larvae for example.

Despite the mesoscale patchiness, some areas can be recognised as supporting higher abundances of larval fishes on average. For example, fish larvae are particularly abundant at the edge of cyclonic eddies¹⁶⁴, inside which water is rich in nutrients and plankton production is higher (but see Williams & English¹⁶³). Similarly, oceanic islands, that disrupt the flow and increase primary production, usually support higher levels

Fish larvae occur in patches

Some locations support higher biomass

of planktonic life in their vicinity¹⁶⁵. Fish larvae were found to be most abundant on the windward side of islands¹³⁰, or in their lee, at depth⁷⁴. Both locations are retentive areas due to reduced current speeds. Eventually, in temperate or cold waters, temperature was found to be a primary driver of the abundance of fish eggs and larvae^{166,167}. In places where the growing season is short, there is probably a large advantage in staying where the water is warmer because growth strongly increases with temperature⁷². Temperature may also be important in tropical waters because it modulates growth and size at settlement which, in turn, influence juvenile mortality^{48,170,171}. However, the proximal causes for these higher abundances are still largely unresolved. Are larvae more abundant where temperature is high because they die more in cold water, because they are spawned in warm water and stay there, or because they actively aggregate in warm regions? Similarly, is physical retention enough to explain the high abundance of larvae in the windward or leeward sides of islands and in eddies, or is an active retention mechanism also involved?

The proximal causes for accumulation are not yet untangled

Larval ecology-specific spatial patterns

Part of the answer may come from the fact that the distributions of ecologically different species are dissimilar. For example, species with demersal eggs are usually more abundant close to shore^{162,168} while species with pelagic eggs are either uniformly distributed or more abundant offshore¹⁶⁸. An explanation would be that larvae hatching from demersal eggs are already able to swim and use this ability to actively enhance retention. In contrast, pelagic eggs are advected away from their source, at least until they hatch. These differences have led to define "assemblages" of fish species (or more often families) that are characteristic of certain habitats such as embayments, nearshore waters, neritic waters^a, etc.¹⁶⁹. The consistency of such assemblages among locations highlights the importance of the biology of each species, and leads to favour the hypothesis that larval fishes concentrations at open sea are, at least partially, behaviourally driven.

In this study we investigate the spatial correlations between larval fishes abundance and physical variables (flow field, temperature, salinity, etc.), sampled synchronously, on the scale of several kilometres, around a small isolated atoll in the South-Pacific. We seek to understand the factors driving the distribution of coral reef fish larvae, in this location. In particular, we question the existence of the nearshore-offshore and windward-leeward patterns in the case of a rather small atoll with no large scale shielding effect on wind. We also investigate the correlations between hydrographic variables, such as temperature, and larval abundance. Ultimately, the goal is to formulate hypotheses regarding the causes of these spatial patterns and the relative influence of biology vs. physics, by investigating the relative effects of taxonomic vs. hydrographic variables.

^aThe neritic habitat is the shallow part of the sea, near a coast and overlying the continental shelf.

4.2 Methods

4.2.1 Sampling scheme

Thirty-six stations were repeatedly sampled around the atoll of Tetiaroa (149.55°W, 17°S – Figure 4.1, right) from May 10th to May 27th 2006, aboard the N. O. Alis. Tetiaroa was chosen because it is relatively close to a port, yet quite isolated in regard of the surface currents in the region. Indeed, trade winds blow from the Southeast, entraining water in the surface, mixed, layer toward the Northwest and West, through Ekman transport. Tetiaroa is 55 km straight North of Tahiti, the nearest land upstream is a small active volcano (Mehetia, 2.3 km²) 190 km away. Beyond that, it is just open sea for 400 km upstream, to the East and South-East (Figure 4.1, left). The possibilities for exogenous supply of larvae therefore seem limited.

An isolated atoll

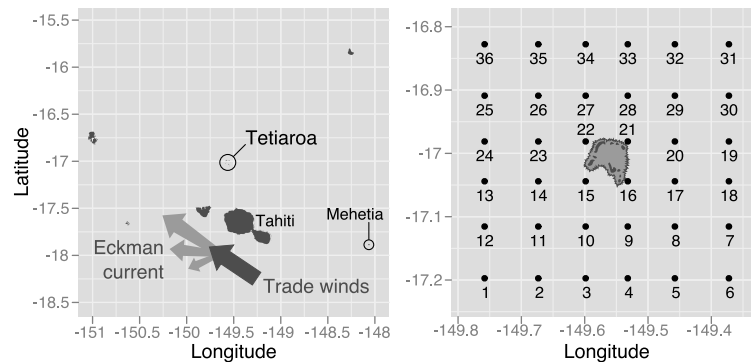

Figure 4.1 Left: situation of Tetiaroa in the Society archipelago. Right: close up on Tetiaroa (7 km across) and sampling stations. Stations are sampled in order, from 1 to 36, in less than 3 days.

To describe the large scale distribution of larvae, the stations were placed on a large, coarse grid around the atoll. The distance between the atoll coastline and the farthest stations was 25 km. The smallest distance between stations was 8 km, which is larger than commonly observed patch sizes^{71,162,163} and should have allowed to sample individual larval patches independently (Figure 4.1, right). In addition, because the atoll is approximately 7 km across in all directions, the scale of the hydrodynamical structures it may induce (e.g. eddies) is also of the order of the grid size. Hence, at each station, the physical structures sampled were also probably quite different.

Large scale sampling

At each station physical and biological data were sampled simultaneously. A 4 m² opening, 800 μm mesh, Multiple Opening-Closing Net and Environmental Sampling System (MOCNESS) allowed stratified sampling of the planktonic fauna. Net 0 was lowered at 9-12 m min⁻¹ from surface down to the maximum depth, then nets 1-4 were towed back up and opened sequentially, at 25 m intervals (Figure 4.2). The

Synchronous biological and physical data

maximum depth of sampling was not kept constant between stations to improve vertical resolution (see chapter 5 for details). The MOCNESS was towed at about 1.5 knot. The speed of hauling by the winch varied within $3\text{--}5.5\text{ m min}^{-1}$ and was adjusted to keep the angle of the net close to 45° , which is optimal for fishing. During the tow, net angle, volume filtered, Conductivity-Temperature-Depth (CTD) and fluorescence data were sent to the ship every 4 seconds through the device's cable. At the end of the tow, the nets were rinsed with sea water, the sample of net 0 was preserved in 90% ethanol (for genetic identification, not detailed here), and samples collected in nets 1-4 were preserved in a solution of 4% buffered formaldehyde and sea water. Following the MOCNESS tow, a 330 μm Bongo net, of $0.28 \times 2\text{ m}^2$ circular opening, was hauled from surface to 100 m (depth was estimated from cable angle and length). The volume filtered was recorded with General Oceanics flow-meters. The samples were also preserved in formalin. At the end of the Bongo tow, the ship was stopped, a 300 kHz Acoustic Doppler Current Profiler (ADCP) was lowered on its side and measured the local flow every 18 s for 4 min, from 6 m down to 100 m depth on approximately 24 layers (4 m interval). Finally, a second round of Bongo sampling was conducted, down to 50 m in order to get a sense of the stratification of the lower trophic planktonic community. The whole process lasted approximately one hour for each station. During this time, the Differential Global Positioning System (DGPS) of the ship provided meter-accurate position at 1 s intervals (hence speed) and meteorological sensors provided wind speed and direction at 30 s intervals.

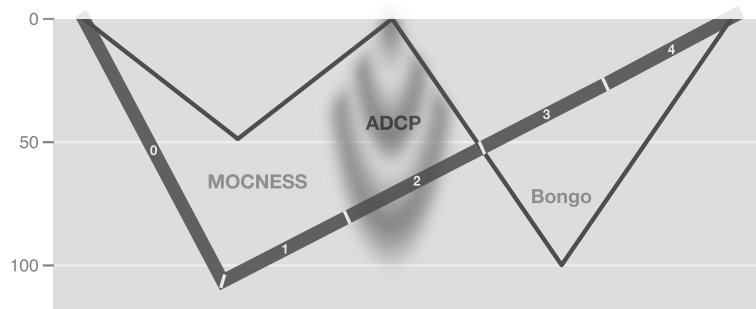

Figure 4.2 Description of the sampling scheme at one station. The MOCNESS sampled mostly ichthyoplankton and large zooplankton in a stratified manner (net 0 was open during descent and nets 1 to 4 were successively opened when going back up), and collected physical data along the way. The Bongo nets sampled the finer fraction of plankton which contains potential prey for fish larvae. The ADCP measured the instantaneous current field. The maximum depth of MOCNESS tows was varied between stations (represented here in different shades) to increase vertical resolution (see chapter 5).

Repeated 24/7 sampling

The grid was sampled continuously, day and night, and the 36 stations were completed in 68 h (2.8 days) on average. After the ship was repositioned in station 1, a new sampling “rotation” was started.

Three rotations were completed in a row and a fourth one was done after a 4 days break.

4.2.2 Treatment of samples and data

In the laboratory, fish larvae were sorted out of the MOCNESS samples and reef fishes were identified to the lowest possible taxonomic level, under a stereomicroscope. Larvae were identified using various books¹⁷²⁻¹⁷⁵ and articles. When in doubt, the specimen was photographed and pictures were commented by several experts in the field, through an online photography database^b. When clear morphological characteristics were discernible but that it was still impossible to relate the specimen to a single genus, larvae were catalogued in morphological groups within a family. The ontogenetic stage of each individual was classified as pre-flexion (notochord completely straight), flexion (notochord bent but caudal fin not yet fully formed), post-flexion (notochord flexed at ca. 90° and caudal fin fully formed). A few Bongo samples were processed through a ZOOSCAN¹⁷⁶ for broad taxonomic identification and detection of size classes. This data is still being processed at the Scripps Institution of Oceanography, San Diego, and will not be used here.

Visual identification
of fish larvae

Outliers in CTD profiles near the surface (0-50 m) were filtered out using techniques based on the median absolute deviation¹⁷⁷. Then, each portion was linearly interpolated on a 1 m resolution vertical coordinate. Finally, the profile for each station was computed as the mean between the descending and ascending portions of the MOCNESS tows to better represent the mean conditions at the sampling station. To detect the depth of the thermo-, halo-, and pycnocline the profiles were first approximated by a smoothing spline. Then, a 15 m tall moving window was used to compute the standard deviation of the value of interest from surface to bottom. The middle points of the windows in which the standard deviation of the temperature, salinity or density were maximal were taken as the depths of the thermocline, halocline, and pycnocline respectively. The fluorometry maxima (a proxy for the chlorophyll maxima) were identified on smoothed fluorometry profiles and their depths were recorded.

CTD and ADCP data
need to be cleaned
and interpolated

ADCP measurements are highly variable inherently and particularly with the setting we used. In addition, the ship drifted during the measurement and its movement needed to be suppressed from the speeds measured. To avoid outlying values, the start and end time bins were discarded and the intermediate values were filtered following the method of Paris et al.¹⁷⁸. ADCP measurements were taken at 18 s intervals. Ship drift was computed within 22 s intervals centred on each ADCP measurement, to smooth instantaneous variability. Drift distance was computed from start and end DGPS positions assuming

^b<http://cbetm.univ-perp.fr/larvae/>. The database is now open for consultation and the pictures and comments are placed under a Creative Commons Attribution-Share Alike 3.0 Licence.

the displacement occurred along a straight line (which appears as a safe assumption for a 22 s drift). Then, the drift vector was suppressed from the velocity measured. Finally, instantaneous measurements were averaged over the 4 min of recording. As the apparatus tended to drop some data at depth, in each depth layer the mean was computed only when more than four individual measurements were available. This mean speed is used in the following.

Objective analysis
of the flow to reveal
its large scale direction

Finally, to resolve the general direction of the flow field, CTD and ADCP data were jointly interpolated through multivariate optimal statistical interpolation (also called “objective analysis”)¹⁷⁸. Dynamic height was computed from CTD data, with a reference layer at 90 m. This depth was sampled at all stations. At 90 m, the range of variation in dynamic height between stations was small, around 0.3 dyn cm for all rotations. In addition, deeper CTD records did not reveal any noteworthy decline. Hence, 90 m was chosen as reference. CTD and ADCP data were assessed independently and showed good agreement. Guided by this agreement and previous studies^{178–180}, the cross-correlation parameter between the stream function and the geostrophic stream function was set to 0.95, the divergence to total variance ratio to 0.05, and the noise-to-signal ratio to 0.1. A critical parameter for the analysis is the characteristic scale of the correlation function. Given the size of the grid (ca. 10 km) there was no point in trying to resolve the structures possibly generated by the atoll (size ca. 7–14 km) which are too small. The characteristic scale was set to 25 km, which satisfied the requirement of being at least twice the grid size and erased small scale variability to reveal the global direction of the flow. The final interpolation grid had square grid cells with 4 km sides and four layers corresponding to the average depths of each of the four ascending MOCNESS nets (12.5, 37.5, 62.5, and 87.5 m).

4.2.3 Statistical analysis

For spatial analysis, the vertical dimension was not considered so, at each station, the catches for nets 1–4 were pooled together. As the sampling effort is not the same at all stations, abundances were divided by volumes filtered to convert them to concentrations. When it was more appropriate to deal explicitly with counts, concentrations were multiplied by a constant volume, hence providing abundances which did not suffer from bias in sampling effort, called “standardised” abundances. Data was then analysed along two frameworks.

Explicitly spatial
comparisons

Spatial distributions of different families or ontogenetic stages were compared two by two with Syrjala’s non-parametric test¹⁸¹. The method tests for a difference between the distributions of two populations and proceeds as follows. Consider a rectangle containing all K sampling points, of coordinates (x_k, y_k) , $k = 1, \dots, K$. Divide the abundances (d) of each population (subscripted i) by their total abundance, so that the

test really focuses on whether the biomass is *distributed* differently in the two populations rather than on their relative abundances.

$$\gamma_i(x_k, y_k) = \frac{d_i(x_k, y_k)}{\sum_{k=1}^K d_i(x_k, y_k)} \quad (4.1)$$

Compute the cumulative distribution (Γ) of each of the two populations at every point, i.e. the sum of the normalised abundances (γ) at all points below the focus point, in the current coordinate system.

$$\Gamma_i(x_k, y_k) = \sum_{\forall x \leq x_k, \forall y \leq y_k} \gamma(x, y) \quad (4.2)$$

Compute the sum over all points of the squared differences between the two cumulative distribution functions (an equivalent to the Cramér-von-Mises statistic).

$$\psi = \sum_{k=1}^K [\Gamma_1(x_k, y_k) - \Gamma_2(x_k, y_k)]^2 \quad (4.3)$$

And average this value over the four possible origins of the coordinate system (i.e. the four corners of the rectangle, subscripted c).

$$\psi_c = \sum_{k=1}^K [\Gamma_1(x_{c,k}, y_{c,k}) - \Gamma_2(x_{c,k}, y_{c,k})]^2 \quad (4.4)$$

$$\psi = \frac{1}{4} \sum_{c=1}^4 \psi_c \quad (4.5)$$

Given these definitions, the statistic ψ is large when the difference between the cumulative distributions of the two populations (in the statistical sense, i.e. groups) are large. Its value is tested for significance with a randomisation procedure whereby some abundances are permuted between the two populations and the statistic is re-computed. The p-value is the percentage of permutations which lead to a statistic greater than or equal to the one observed. Often, the computation of all permutations is too resource intensive to be feasible and only a random subset of those is computed to approximate the p-value. This procedure was not available in any peer-reviewed statistical package. Therefore, equations (4.1) to (4.5) as well as the randomisation procedure were coded in R. The code was submitted to R's spatial statistics Special Interest Group for review and no error was reported (but it is impossible to know how many people reviewed the code). Syrjala's test was complemented by another test for spatial association, performed with the dedicated method of the software Spatial Analysis by Distance IndicEs¹⁸² (SADIE). This method proceeds by computing spatial indices of similarity between points for each population and then compares the indices maps of the two populations. Eventually, the significance of the

agreement or dissimilarity between the two is assessed, taking spatial autocorrelation (i.e. the fact that two neighbouring points are more likely to have similar properties) into account (following the method of Dutilleul et al.¹⁸³).

Non-explicitly spatial
regressions

Even if we are interested in the spatial distribution of fish larvae, what we are looking for ultimately are correlations with explanatory factors (e.g. are larvae more abundant where temperature is higher?). These correlations do not need to be explicitly spatial. Therefore, such co-variations between the abundance of larvae and environmental factors were first examined with Principal Component Analysis (PCA) and regression trees, considering each station as an independent data point. PCA allows to examine several families in parallel in a multivariate procedure. Regression trees hierarchise explanatory factors and allow to use discrete and continuous explanatory variables together. The variables tested to explain larval fishes abundance were taxonomic (family), ontogenetic (flexion stage), temporal (rotation, time of day), geographic (latitude, longitude, location with respect to the island, i.e. windward, leeward), and hydrographic (depth of thermo-, halo-, pycnoclines, and of the fluorometry maximum, temperature, salinity, density, and fluorometry in the mixed layer — above the clines —, mean current speed in the same layer). For correlated explanatory variables (such as the depths of clines) each factor was assessed independently and only the most explanatory one was kept in the final analysis. Besides these general, exploratory analyses, some specific relationships between larval fishes abundance and various physical factors were tested using Generalised Linear Models (GLM) with a quasi-Poisson error distribution family (which is appropriate for data expressed as counts). Eventually, a multiple regression model, with the same error distribution, was built to summarise the global picture. As a first step, all physical but non-geographic variables were introduced in the model and it was reduced to (1) keep only the most informative variable among each set of correlated variables (e.g. one of the clines only), taking in account the effect of interactions, (2) keep only significant factors. In a second step, geographic variables (e.g. location) were added to investigate whether some spatial trends remain and were not explained by spatially varying physical variables.

All analyses were performed in R, with the additional packages `FactoMineR` (PCA), `mvpart` (trees), `akima` and `fields` (spatial interpolation).

4.3 Results

4.3.1 Highly variable physical environment

Wind regime shift

The wind is usually quite steady in the region and this should have allowed to repeatedly study the same location under equivalent physical conditions. However the regime shift between trade winds and Northerly

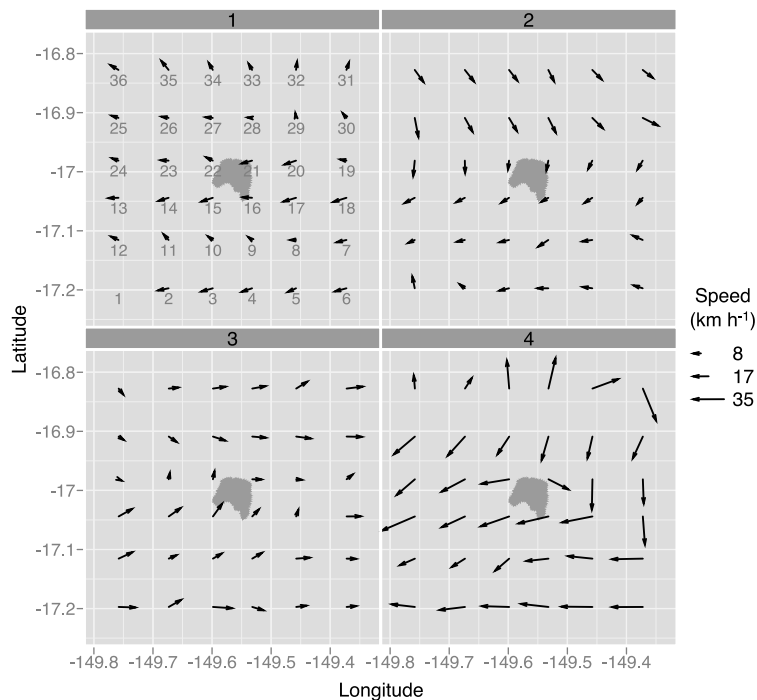

Figure 4.3 Mean of instantaneous wind recordings (every 30 s) during the sampling period (ca. 1 hour) at each station, for the four rotations. Wind was weakly blowing from the East in rotation 1. In rotations 2 and 3 the direction regularly shifted in time. Wind speeds reached storm levels (instantaneous peaks at 70 km h^{-1}) with high variability during rotation 4.

winds, which occurs once a year, started earlier than usual in 2006 and lasted from the end of the first rotation to the end of the cruise. Therefore, for most of the cruise, the wind was highly variable in both direction and speed (Figure 4.3). During rotation 2 for example, a 180° reversal in wind direction was noticeable: the origin of the wind gradually shifted from the Southeast in station 1 to the Northwest in station 36, in counter-clockwise direction.

As a consequence of the wind regime shift, the current was also very variable. While the objective analysis smoothed small scale variations, by considering geostrophic flow and using a large correlation distance, the variations between rotations are still conspicuous (Figure 4.4). Globally, water flowed from the South-East to the North-West in rotations 1, 2, and 4, but with considerable local variations. In rotation 3, even the large scale picture was different. The flow was globally oriented from the West to the East with a returning current in the North-Western corner of our sampling grid.

Because wind conditions changed so radically even during a single rotation, great caution is in order when interpreting the results of the

Which induces variable surface flow ...

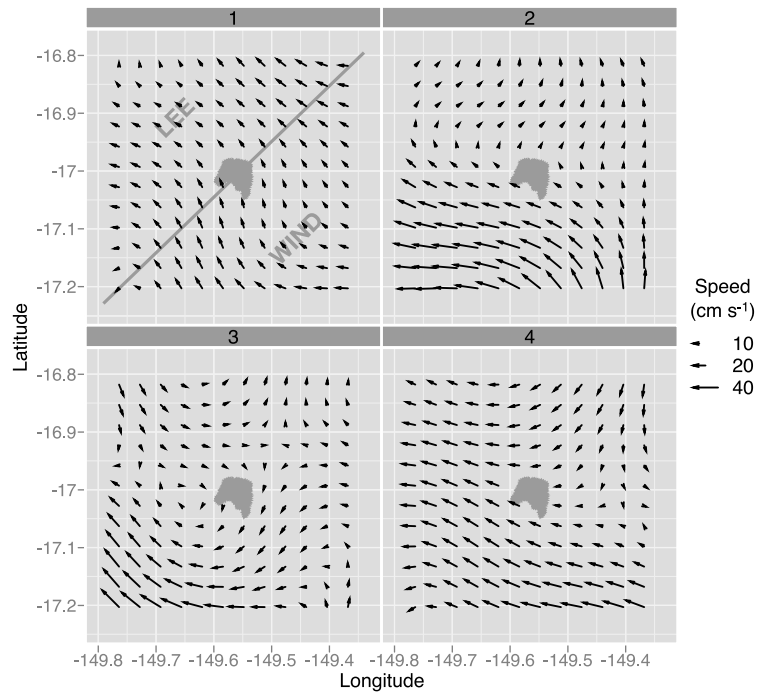

Figure 4.4 Flow field interpolated through objective analysis in the surface layer (12.5 m), for the four rotations. In deeper layers, the structure of the flow was essentially the same but speeds were slower (mean speed equals 20 cm s^{-1} at the surface, and 12 cm s^{-1} at 100 m).

objective analysis and when dealing with currents overall. Indeed, as any spatial interpolation routine, objective analysis supposes the original observations to be simultaneous. This is never true but the assumption can be relaxed when conditions are stationary and sampling is relatively synoptic. Here conditions were clearly not stationary during the 2.8 days of each rotation. Thus, the interpolated flow field should only be used to identify global directions and close to order-of-magnitude changes in speed. Nonetheless, two ADCP-only surveys with more points (70 and 50), sampled in less time (24 and 17 h respectively) after rotation 3 revealed the same general picture. By being more synoptic, some of the confounding effects were eliminated and the similarity of results confirms that, if small scale features cannot be trusted, the general flow can.

... and a moving bottom
for the mixed layer

Eventually, the changes in the dynamics of the surface mixed layer were reflected in its lower boundary: the thermocline, halocline and hence pycnocline depths were also highly variable in time (Figure 4.5). The association of larval fishes — and of their prey — with these structures is still unclear^{74,77}. However, variations in the depth of the clines are presumably indicative of the presence of eddies (which either

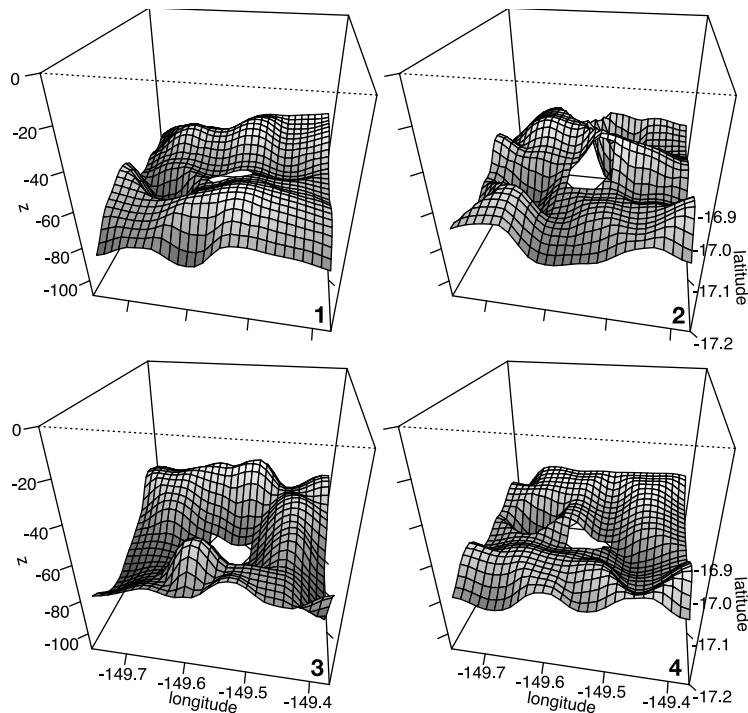

Figure 4.5 Perspective view of the pycnocline for the four rotations (interpolated by cubic splines). While the cline is globally always around 70 m, local holes and bumps largely differ from one rotation to another

“pump” water up or push it down). Cyclonic eddies may locally enrich the water in nutrients through upwelling, while anticyclonic ones may trap terrigenous products. In both cases, they are good candidates to test for correlations with the abundance of larval fish.

4.3.2 Patchy distribution of fish larvae

Of the 576 MOCNESS samples, 572 could be used. The mean volume filtered per sample was 1056 m^3 (Standard Deviation = 302 m^3). They contained an estimate of 47,800 fish larvae, comprised of at least 94 families (pelagic or deep specimen were not all sorted). Epi- and mesopelagic species dominated the samples with more than twice as many pelagic larvae than coral reef fish larvae. The two most abundant orders were the Clupeiformes (mostly Engraulidae) and the Myctophiformes. 10,794 coral reef fish larvae were identified and the most common, by far, were Acanthuridae (Table 4.1). The relative abundances of coastal vs. oceanic taxa are comparable to those observed around another isolated atoll in the tropical North-Pacific⁷⁴ or in the Florida Keys¹⁸⁴. Compared to the Keys, Bregmacerotidae were notably less prominent and Acanthuridae were particularly abundant. Among these > 10,000 coral reef fish larvae,

Over 10,000 coral reef fish larvae, mostly pre-flexion

3,624 were measured and the median body length was 3.5 mm; 10% and 90% quantiles were 2.47 mm and 6.3 mm. The small size of captured larvae and the fact that pre-flexion stages largely dominated the samples in most families (see Table 4.1) probably indicate avoidance of the net by larger, older, hence more behaviourally capable larvae. In addition the early ontogenetic stage limited most identifications to family level. Indeed, given the important biodiversity in the region, fin rays and spines counts are often required to identify genera and they are not fully developed in pre-flexion and flexion stage larvae. Therefore, all following analyses were performed at family level.

Very patchy distribution

The spatial distribution of coral reef fish larvae was very uneven (Figure 4.6). Two regions of high abundance were present: in the Northwest during rotation 1 and in the Southwest during rotation 2. Rich stations were in general associated with extraordinary abundance of pre-flexion Acanthuridae. Those few stations explain the overall dominance of this family. When discarded, the first 5 families had similar total abundances (650-800). Rotations 3 and 4 were overall less structured and samples were thinner (the difference in concentrations between rotations is highly significant – Kruskal-Wallis, $\chi^2 = 44.05$, $df = 3$, $p < 10^{-8}$)

Family and ontogenetic stage drive overall concentrations

A global regression tree highlights only two factors for the explanation of the overall abundance of reef fishes: family and ontogenetic stage (Figure 4.7). In other words, the role of other factors (geographic, hydrographic, etc.) was negligible compared to the combined influence of taxonomy and ontogeny. The primary driving factor was family, acknowledging the fact that Acanthuridae were most abundant. Then, in the only other significant split, pre-flexion Acanthuridae were separated from flexion and post-flexion ones which were less abundant (Figure 4.7; this split also occurred in most other families when Acanthuridae were excluded from the analysis). These two simple splits explain 13% of the variability in abundance (residual error cross-validated by permutations = 0.869). Therefore, it is necessary to assess the influence of those two biological factors before getting to biophysical correlations.

4.3.3 Intrinsic biological variability

Families are distributed differently

As taxonomy is such a large determinant of abundance, and the ecology of different species of fish has been shown to determine aspects of the distribution of their larvae^{162,168}, it is natural to first investigate the spatial distribution of the different families. The distribution of the concentrations of the five most abundant reef fish families (Figure 4.8) reveals that Acanthuridae, Holocentridae, and Lutjanidae were concentrated in the areas of high overall abundance (Northwest quadrant in rotation 1 and Southwest quadrant in rotation 2). Labridae and Scariidae seem more evenly distributed even if they were also abundant in these regions. Syrjala's tests and SADIE analysis failed to reveal any significant dissociation between those families. However, the SADIE association indexes show higher association within the Acanthuridae-

Table 4.1 Abundances of the ten most abundant families of coral reef fishes. Both total abundance and abundance per ontogenetic stage are reported. The most abundant stage is bolded. NA means Non-Available ontogenetic stage (usually larvae with a damaged tail).

| Family | Total | Pre-flexion | Flexion | Post-flexion | NA |
|---------------|-------|-------------|------------|--------------|----|
| Acanthuridae | 2907 | 2543 | 261 | 81 | 22 |
| Labridae | 826 | 30 | 151 | 643 | 2 |
| Holocentridae | 756 | 662 | 48 | 43 | 3 |
| Lutjanidae | 654 | 466 | 136 | 42 | 10 |
| Scaridae | 624 | 19 | 30 | 573 | 2 |
| Pomacentridae | 541 | 119 | 281 | 137 | 4 |
| Apogonidae | 506 | 78 | 201 | 226 | 1 |
| Serranidae | 442 | 246 | 117 | 75 | 4 |
| Lethrinidae | 428 | 312 | 94 | 19 | 3 |
| Gobiidae | 337 | 1 | 6 | 329 | 1 |

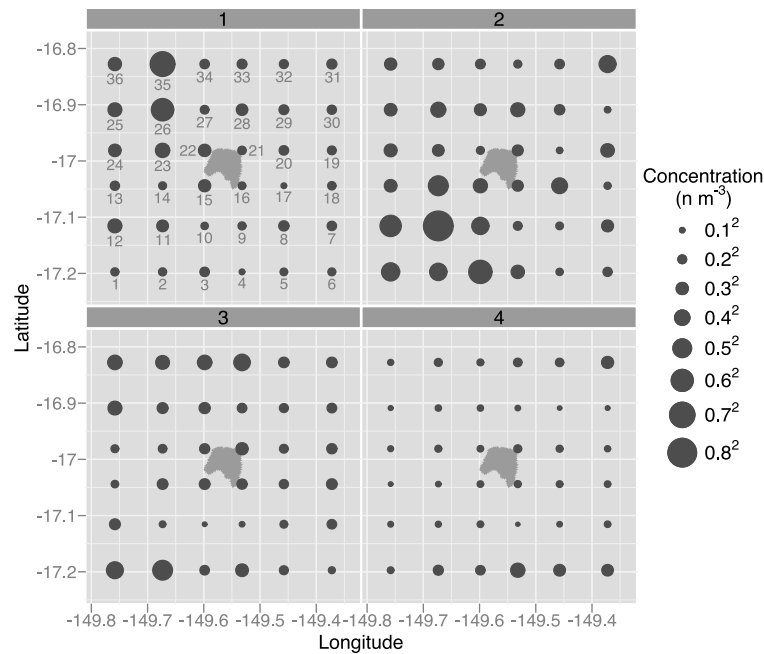

Figure 4.6 Distribution of coral reef fish larvae for each rotation. The areas of the dots are proportional to concentration.

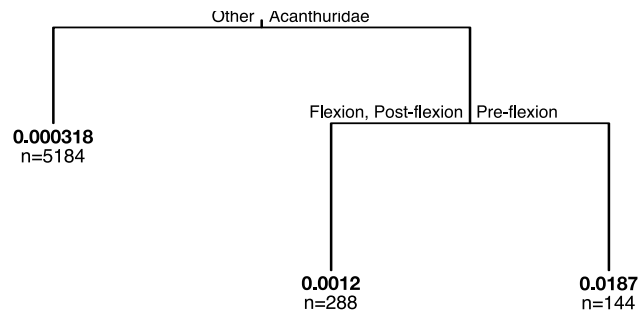

Figure 4.7 Univariate regression tree assessing the influence of taxonomic, ontogenetic, and physical (time of day, temperature, cline depths, etc.) factors on the concentration of coral reef fish larvae. Branches separate groups of observations most different from one another. The tree hierarchises explanatory variables: the first ones have more influence. The length of branches are proportional to the variance explained by each split. The numbers at the tip of branches are the mean number of larvae per m^3 and the number of observations in the group defined by preceding splits (e.g. pre-flexion Acanthuridae for the right-most branch).

Holocentridae-Lutjanidae group than among other combinations. For example the association index between Acanthuridae and Holocentridae is 0.68 (and shows significant association between those families: Dutilleul adjusted probability $< 10^{-4}$) while it is only 0.11 between Acanthuridae and Labridae.

Ontogenetic stages are distributed similarly

Early and late stage larvae of each of these families may be distributed closer to shore than mid-aged larvae, because early larvae are probably not very far from their point of origin and late stage larvae must approach shore to recruit. However, within the age range captured here, Syrjala's test failed to reveal any difference in the spatial distribution of pre-flexion, flexion and post-flexion larvae. In fact, SADIE analysis even showed significant *association* between the distributions of all stages. This was true when abundances of all families were pooled together or when each of the five families above was assessed individually (association indexes and Dutilleul adjusted probability for the pooled case were: pre-flexion vs. flexion, $X = 0.73$, $p < 0.0001$; flexion vs. post-flexion, $X = 0.56$, $p = 0.002$; pre-flexion vs. post-flexion, $X = 0.39$, $p = 0.01$). While early ontogenetic stages were more abundant than later stages, the horizontal distribution of each and all families did not appear to vary ontogenetically.

4.3.4 Spatial correlates in the physical environment

Exploratory analysis

Weak effect of current speed and longitude

Beyond spatial differences between families or ontogenetic stages, we were most interested in determining whether some physical factors influence the distribution of the overall coral reef fish larvae community.

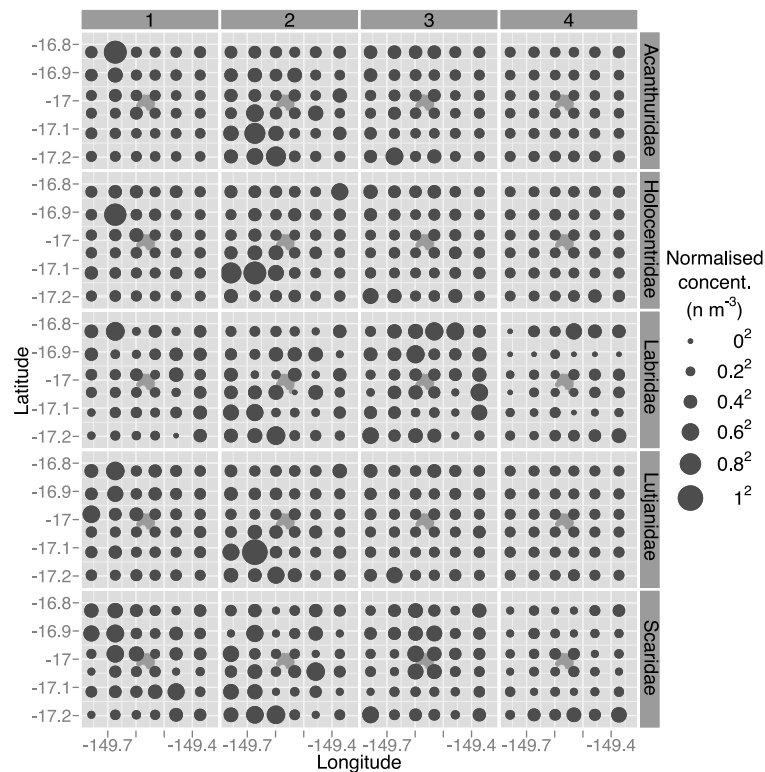

Figure 4.8 Distribution of the concentrations of the five most abundant reef fish families for the four rotations. Concentrations were normalised between 0 and 1 for each family to avoid being confounded by their relative abundances and be more representative of what Syrjala's and SADIE methods test. The areas of dots are proportional to normalised concentration.

A PCA reveals that concentrations of the ten most common coral reef fish families were positively associated with high current speeds (particularly the Serranidae) and negatively associated with longitude, meaning that concentrations were higher in the Western side (Figure 4.9). The result was similar when the total abundance of larvae was used, rather than split by families. But overall, the PCA mostly shows that these factors explain very little of the variations in abundance: the explanatory power of the primary axis is low and the effects of longitude and current speed projected on this axis are even weaker.

A regression tree analysis similar to the one described in section 4.3.2 (page 82) was conducted, but this time with concentrations of larvae normalised by family and ontogenetic stage. The normalisation discards, for a time, the effects of taxonomy and ontogeny and allows access to the underlying spatial variability. A multivariate approach, as in the PCA above, could have achieved the same purpose but would have been less powerful (all stations where at least one family was not

Confirmed effect
of current speed

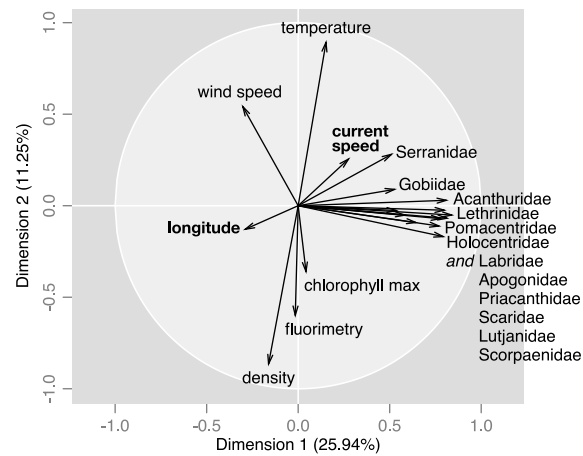

Figure 4.9 Principal Component Analysis of the concentrations of the ten most abundant reef fish families and various physical factors: depth of the chlorophyll maximum and of the halo-, thermo- and pycnoclines, mean salinity, temperature, density and fluorimetry above the clines, current and wind speed, latitude and longitude). Only factors with noteworthy projections are plotted.

captured would have been discarded). The regression tree only revealed current speed as influential, with more larvae where current speed was high. However, here also, the explanatory power was low (residual error = 0.85 but residual cross-validated error = 1.35, meaning that, in many permutations, the split occurred differently, thus is not robust). In addition, time of day was close to being influential too. Larvae were indeed captured in greater numbers at night than during the day (Wilcoxon rank sum test, $p = 0.0001$). However this was probably simply related to higher net avoidance during daytime.

Single factor regressions

The exploratory analysis revealed that, beyond intrinsic taxonomic and ontogenetic variations, two factors seem to influence the density of the larval reef fish community around Tetiaroa: longitude and current speed. But both effects were weak and need more thorough investigation.

Current speed explains
7.6% of variance

Current speed was highlighted by both exploratory methods. For each rotation considered independently, Figure 4.10 also suggests that current is usually fast in regions of high concentration. However, larval concentrations are very low in rotation 4 compared to the others, while current is faster almost everywhere. Overall, a GLM regression of standardised larval abundances against current speed shows that its effect is significant ($p = 0.00325$), but only explains 7.6% of the variance.

More larvae to the
West of the atoll

The effect of longitude, highlighted in the PCA, is significant whether it is tested as a comparison between abundances to the East and to the West of the atoll (Wilcoxon rank sum test, $W = 3190$, $p = 0.017$) or as a

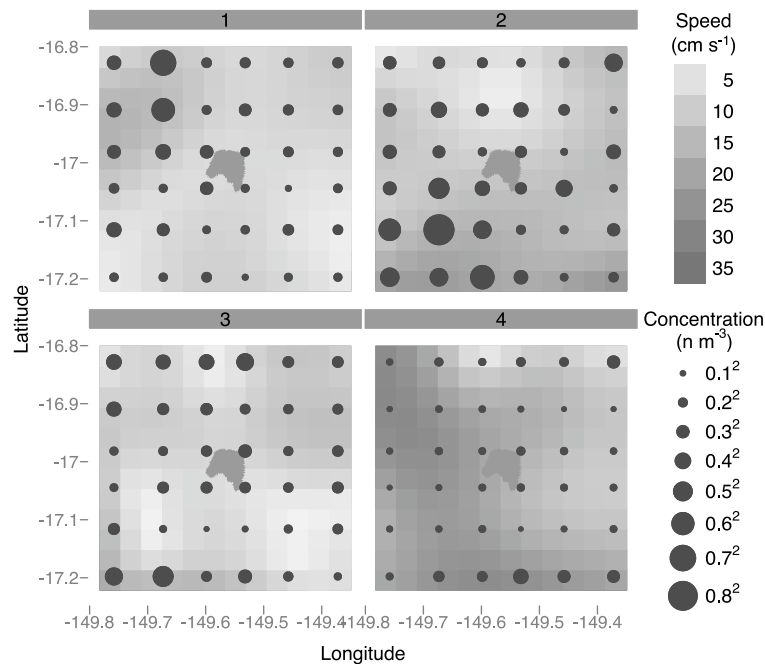

Figure 4.10 Concentration of reef fish larvae (as in Figure 4.6) plotted over the mean intensity of current speed within 0-90 m, as determined by the objective analysis (see Figure 4.4 for a representation of speeds, in the surface layer only).

continuous variable in a GLM ($p = 0.001$, variance explained = 9.5%). These results are related to the two regions of high abundances which are both to the West of the atoll (Figure 4.6 or 4.4). Assuming that the general direction of the flow is from the South-East to the North-West, as deduced from the objective analysis, the opposite diagonal, passing through stations 1, 11, 15, 21, 29 and 31, separates windward stations from leeward stations (see Figures 4.1 and 4.4). Among these three groups (windward, leeward, and middle), the abundances are not significantly different (Kruskal-Wallis $\chi^2 = 4.16$, $df = 2$, $p = 0.13$). When groups were restricted to strictly wind- and leeward stations, closer to the island, the difference became significant (Wilcoxon rank sum test, $W = 278$, $p = 0.035$). But the effect is still weaker than the longitudinal gradient and may actually just be a by-product (leeward stations are, on average, more westerly than windward ones).

Distance from shore was shown to influence the abundance of fish larvae. Larvae of species with demersal eggs were more abundant close to shore while larvae hatching from pelagic eggs peaked farther away from shore^{162,168}. However, at the scale of this study (from 500 m to 25 km away from the reef), distance from shore was *never* significantly influencing the abundance of larvae, whether it was tested on the total abundance or for specific groups (e.g. Gobiidae or Pomacentridae

Distance from shore
has no influence

which lay demersal eggs, Apogonidae which brood them, or various combinations of such taxa).

Temperature in the mixed layer neither
Similarly, while larvae of cold water fishes were shown to be more abundant in regions of warmer temperature¹⁶⁶, temperature in the mixed layer (i.e. above the thermocline) had no significant influence in this tropical environment. Mean salinity in the same layer was closer to significance (GLM, $p = 0.07$) but had little explanatory power anyway (3.6% of variance).

Faint effect of eddies
Eventually, while eddies could not be directly detected, their possible role was assessed through regressions of the standardised abundance of larvae against the depth of clines or against mean fluorometry in the mixed layer. No regression was significant except for a very mild relationship between abundance and the depth of the halocline (GLM, $p = 0.04$, variance explained = 4.6%). Larvae were more abundant where the halocline was deeper, i.e. possibly in anti-cyclonic eddies.

General model

Current speed + salinity + depth of halocline
Finally, a global GLM was built to assess the influence of all spatially varying environmental factors on standardised abundance^c. While the model itself was not spatially explicit, the explanatory variables were. Hence, some of the variance explained by the model was spatial. First all physical but non-geographical variables were considered: current speed, depth of clines and chlorophyll maximum, mean salinity, temperature, or fluorometry above the clines. The minimal suitable model highlights a positive correlation of larval fishes abundance with current speed ($p = 0.005$), the depth of the halocline ($p = 0.0007$), and a negative one with salinity in the mixed layer ($p = 0.0005$). No interactions were significant. All three significant factors were already highlighted in individual regressions beforehand and their combined effect is still significant, which means that they explain different portions of the variance. To evaluate the spatial footprint of this model, the distribution of residuals was compared to the original distribution of standardised abundance (second and first rows in Figure 4.11 respectively). The high concentrations in the North- and South-West during rotation 1 and 2, which are the only clearly recognisable structure in the data, are reduced a little in the residuals, particularly in the case of rotation 2.

+ longitude or location
As a second step, spatially explicit factors such as longitude, latitude, distance from the atoll and windward or leeward location were introduced atop previous model. After a similar reduction process, either location ($p < 10^{-6}$) or longitude ($p < 10^{-5}$) could be kept, with longitude being a little more explanatory. Once again, these factors were already found to have an effect in previous individual regressions. Their effect is still present here and no other factor appears through interactions,

^cAs a reminder, standardised abundance is computed by multiplying observed concentration by a constant volume. It is different from normalised abundance which is scaled between zero and one within a group of observations (for each family for example).

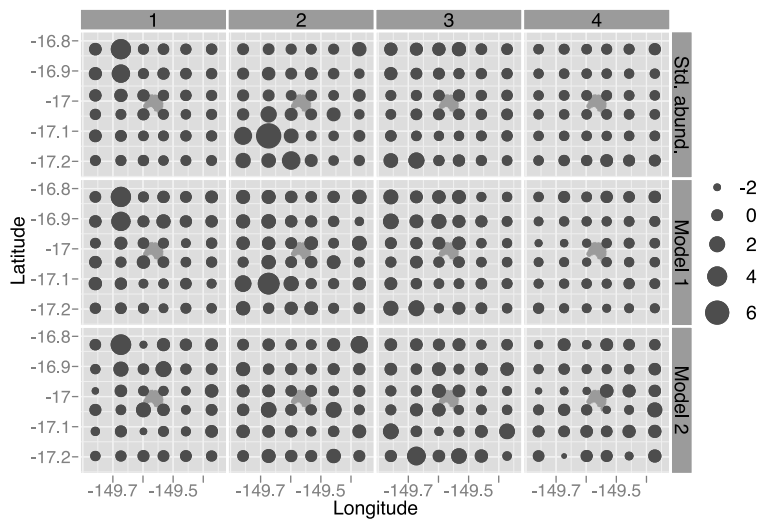

Figure 4.11 Comparison of standardised abundance (first line), residuals of the first model (second line), and residuals of the second model (third line), for the four rotations. All values were centred and reduced so that their absolute value does not confound the comparison (focus is on the spatial *distribution* here).

which confirms that they explain yet another form of the variance and that they are the only spatial factors to consider for this dataset. The third line of Figure 4.11 presents residuals of the model with longitude included. Compared with the first model (second line), the area of high concentration in rotation 2 is well explained and, overall, the distribution of residuals is more random and chaotic. The increased randomness indicates that longitude explained some of the remaining spatial structure, and that there was indeed something special about being to the West rather than to the East of Tetiaroa.

4.4 Discussion

The most conspicuous pattern in the distribution of coral reef fish larvae around Tetiaroa was the high abundances in the Northwest during rotation 1 and in the Southwest during rotation 2. They did not seem to be caused by a bias in sampling efficiency between day and night because during rotation 2 for example, stations 1, 2, and 12 were sampled at night, stations 3, 10 were sampled during the day, station 11 was sampled at dusk and all held high concentrations of reef fishes (Figure 4.6). Given the size of the grid (10 km) and the size of larval patches previously observed (1-6 km^{71,162,163}), these regions with several rich stations could be interpreted as regions where patches are more concentrated and/or frequent rather than as belonging to one

Two regions where larval patches are frequent

large patch. However, without continuous sampling between them it is impossible to be positive about the interpretation.

Usual correlations
were absent

Several factors classically recognised to structure larval assemblages were apparently not influential around Tetiaroa. Distance from shore, for example, was never a satisfactory explanation for larval distribution patterns. This may be explained by the small size of Tetiaroa, which makes it less likely to retain particles in its lee than Johnson Atoll (130 km²)¹⁶⁹, Hawaii¹⁶⁸ or New-Zealand¹⁶² islands where patterns of nearshore accumulation were originally described. Similarly, temperature is important in cold-temperate waters¹⁶⁶ and could have been relevant here given the importance of growth even in tropical regions^{48,50,170}. But temperature in the mixed layer was never significantly explaining the abundance of larvae. In these tropical waters, the mean temperature was high (26.4°C) and the range of variation was small (SD = 0.9°C). Within such limits, temperature was probably not critical to growth as it is in colder environments, and other requirements were likely to take precedence in shaping the distribution of fish larvae.

Localised correlation
between current speed
and abundance ...

Several analyses highlighted that larvae were more abundant where current speed was high. A first nuance to this result is that current speeds were computed by an interpolation routine which assumes simultaneous measurements as input, while current speeds and CTD data were measured over three days, in a very unsteady environment. Hence, the absolute value of current speeds should not be relied upon too much. The result is further confounded by high current speeds but low captures during rotation 4. This apparent contradiction may be explained by low capture efficiency because of difficult weather conditions. Wind and waves reached high levels (up to 70 km h⁻¹ for wind and several metres for waves) and hauling a 800 kg net at constant pace and angle in these conditions was challenging. In fact, the only situation in which the correlation was quite obvious was for the South-South-Western portion of the domain during rotation 2. Current speed was clearly higher than in the North (by nearly an order of magnitude, see Figure 4.4) and abundance was also very high in the South-Western quadrant (Figures 4.6 and 4.10). In addition, this feature was explained in part by a statistical model containing current speed as a factor (Model 1 in Figure 4.11).

... which may be
artificial or denote
non-isolation

There is no physical mechanism explaining the accumulation of particles in jets. On the contrary particles rather accumulate at fronts or in other regions of *reduced* flow¹⁵. A possible explanation would be behaviour of breeding adults, or of the larvae themselves, toward fast moving currents which enhance advection away from the atoll, an area of high predation risk¹⁸⁵. However, the current in question was already over 10 km away from shore and larvae captured there were not the earliest stages. An alternative explanation would be higher capturability of fish larvae in these conditions. Indeed, the net was always towed against the wind, hence somewhat against the current. In a fast moving current, the larvae were brought faster into the net, with less opportunity to escape.

But the most likely explanation is that water in the Southern part of the sampling region during rotation 2 corresponds to the intrusion of a large eddy shed by Tahiti and transported by surface flow; hereby suggesting that Tetiaroa was not as isolated as it appeared. Indeed the current pattern in the South-South-Western region is compatible with the upper portion of a counter-clockwise rotating eddy (i.e. anti-cyclonic, as Tetiaroa is in the Southern hemisphere; see Figure 4.4). The pycnocline is generally deeper in the South which is also compatible with an anti-cyclonic structure. It presents a low point in stations 2 and 3, about where the centre of the presumed eddy would be (see upper right graph in Figure 4.5). This hypothesis would explain the greater abundances because anti-cyclonic eddies are retentive structures and because waters coming from Tahiti, a large high-island with sizeable reef areas, are probably richer than those coming from Tetiaroa. It would also account for the larger current speeds because water would have been accelerated at the periphery of the eddy compared to the ambient flow.

Longitude was the second most important factor identified, separating rich stations to the West of the atoll from poorer stations to the East. This difference was not caused by different water conditions to the West or to the East because those were also captured by other explanatory variables which proved to never be significant. The position of these stations was really what set them apart. An analogous spatial factor identified in previous studies would be the windward or leeward enrichment compared to the background concentrations^{74,130}. Given the North-Western direction of the flow during rotations 1 and 2, an accumulation of larvae in the North-West near the surface and in the South-West at depth would be compatible with Ekman transport and leeward accumulation. However, this was not the case and maximum abundances occurred at shallow depths (ca. 25 m) in both locations. The aforesaid hypothesis of a contamination by water originating from Tahiti would conciliate these observations. If the high concentrations during rotation 2 are caused by the presence of the eddy, it only leaves the North-Western zone in rotation 1 to be explained. And this one is compatible with leeward accumulation (and is, in fact, explained equally well by longitude or by location, as mentioned in the section General model, page 86).

Overall, the main conclusion is really that, despite a rather intensive and complete sampling scheme, there is not much to be gathered from environmental variables in order to predict the distribution of coral reef fish larvae. The patchiness of larvae in the ocean causes variations of large amplitude in abundance (from zero to over a hundred larvae of the same species in a single net). They may have confounded statistical analysis and prevented the detection of correlations. However stations with very high abundance are an integral part of data, and cannot be considered as outliers. In addition, the same analyses were performed on square-rooted standardised abundance (a classic transformation for

Foreign water intrusion and leeward accumulation

Non-important physical correlates or low statistical power?

count data which reduces variance) and results were similar. An other possibility is that large taxonomic or ontogenetic differences, in raw abundance and/or in responses to the environment, prevented the elucidation of underlying physical correlations at community level. However, analyses on normalised abundance or multivariate approaches were not more successful. In addition, the same analyses were performed on individual families, which were the lowest taxonomic division at which larvae were numerous enough to avoid loss of power due to small sample size. In the case of Acanthuridae, Holocentridae, and Pomacentridae they did not lead to better results (as glimpsed here in the case of distance from shore – see page 86). Eventually, biophysical interactions may take place at a different scale. For example, accumulation of larvae in small (< 10 km) eddies or fronts was not discernible here: several sampling points within a 10 km interval would have been required. If such “high-frequency” variations were also “high-amplitude”, they would have prevented the detection of larger scale correlations.

Correlation with plankton abundance is not likely either

Another source of correlation not investigated here yet is the distribution of smaller sized plankton. Fish larvae may be where their prey are. The finer meshed Bongo samples should allow the investigation of this hypothesis. As of now, however, no relationship was detected between larval concentrations and mean fluorometry (\sim chlorophyll concentration \sim phytoplankton abundance) in the mixed layer. In addition, one would expect the distribution of plankton to be correlated to some of the physical variables tested here (e.g. distance from the atoll according to the island mass effect¹⁶⁵). Therefore, nothing leads to think that the abundance of larval fishes will be highly correlated to that of their planktonic prey.

Similar early life history means similar distribution ...

One very clear result, however, is that, although abundances and distributions of several common coral reef fishes families were sometimes very different, families with similar early life history were distributed similarly. For example, Acanthuridae and Holocentridae both have pelagic eggs, fast swimming larvae²⁵ with many spiny body extensions recognised as adaptations to pelagic life¹⁷⁴, pelagic duration of the order of months^{186,187} prolonged by a facultative pelagic juvenile stage, and their spatial distributions were significantly similar (Figure 4.8). Labridae and Scaridae have quite comparable larval morphologies, with few obvious adaptations to pelagic life¹⁷⁴, and, in both families, many species recruit as larvae not yet metamorphosed and burrow themselves in the sand on the reef for a few days before entering the juvenile habitat. Here again, their larval distribution were more alike than when compared to other families. Pomacentridae, which lay demersal eggs and are mid-capable swimmers, presented yet another pattern of distribution. Not all comparisons denoted association or dissociation strong enough to be significant but all spatial association indexes were higher between ecologically close families. Longer term sampling, focused on a few contrasting taxa, should help confirm these tendencies by eliminating local and small temporal scale variations.

This evidence and the lack of correlation with physical variables, except for a possible accumulation in the atoll's lee or in eddies, suggest that larval distribution was determined by the combined effects of advection by currents, spawning time (because it determines which currents the larvae will be subjected to), and family-specific swimming strategies interacting with the current. Indeed larvae did not seem to position themselves in areas of specific hydrographic or feeding conditions, so their swimming was probably more related to the interaction with, and exploitation of, flow structures. And at least some larvae probably swam because some Pomacentridae larvae, for example, were found more than 20 km away from the nearest shore (while species with demersal eggs were thought to stay close to shore^{162,168}). If those larvae were to recruit, Tetiaroa was the nearest opportunity, and it would demand some significant swimming to get there.

... and this is a behaviourally driven process

In a nutshell, no strong biophysical correlates could actually be detected between the overall distribution of coral reef fish larvae and hydrographic factors such as temperature, phytoplankton richness, or local current speed. No general "law" regarding the spatial position of larval aggregations was obvious either (close or far from shore, on the windward or leeward side of land masses, etc.). This lack of evidence could be caused by the limitations of currently available sampling methods which do not resolve both metre and kilometre scale structures at once. Such limitations will only be overcome by instruments allowing both high frequency and large scale sampling, such as towed video recording systems¹⁸⁸. Alternatively, the spatial distribution could be the result, seemingly random and probably chaotic, of advection by currents together with behaviour by fish larvae. The only way to predict the distribution of larvae in such a situation is probably that used in Paris & Cowen⁷¹: small temporal and spatial scale modelling with immediate feedback from observations. Only by progressing in small time steps is it possible to resolve such non-linear interactions between behaviour and currents. While the advances in physical oceanography are promising, predicting larval advection accurately will remain impossible until we gain, at least, a clear understanding of the behaviour of fish larvae throughout ontogeny.

4.A Acknowledgements

The authors are grateful to the captain and crew of the N. O. Alis who showed unwearied enthusiasm and ingenuity, to the rest of the scientific crew (C. Guigand, L. Carassou, D. Lecchini, P. Ung), to R. K. Cowen for accepting to lend his equipment and let go some of his best crew members for a month, to P. Torres for his help with the sorting of MOCNESS samples, to A. Fukui, D. Johnson, J. M. Leis, M. J. Miller, D. Richardson, and A. Suntsov for their advice on the identification of fish larvae, and to the staff of the CRIOBE, in Moorea, for pre- and post-

fieldwork support. Funding for this work came from the ACI MOOREA, the Agence Nationale de la Recherche (ANR, project Bioaqua), the Délégation à la Recherche du Haut Commissariat de la République en Polynésie and the DIREN of French Polynesia.

Chapter 5

Ontogenetic vertical “migration” in fish larvae: description and consequences for dispersal

J.-O. Irisson, C. Paris, R. K. Cowen, S. Planes
Manuscript in preparation

5.1 Introduction

Rhythm is put in the oceans by the regular migration of organisms between depth and surface. Within the mixed layer, fish larvae are no exception and vertical migration is their most studied behaviour (chapter 1, page 30). Fish larvae migrate vertically at two temporal scales: they accompany the rest of the plankton in its diel, or sub-diel (e.g. tidal), migration, and their mean preferred depth also seems to change as they develop^{71,189,190}.

Vertical migration is universal

The vertical distribution of fish larvae was found to correlate with many environmental factors, such as light intensity^{65,191–193} or the depth of clines (pycnocline¹⁹², but not thermocline^{75,77}). In most cases, these correlations relate to movements at small temporal scale (diel or sub-diel) and result from a balance between eating and being eaten. Indeed, it may be profitable to accumulate near the surface or near the clines because food is more abundant there^{191,192}. On the other hand, predation risk is also higher near the surface than at depth. This is the most common explanation of why so many organisms stay hidden at depth during daytime and only go up to feed at night, when obscurity keeps them safe from some of the predators¹⁹⁴. Downward ontogenetic vertical migration may also be a longer term manifestation of this trade-off¹⁸⁹. For example, as fish larvae develop, their visual system improves and they become capable of feeding in dimmer light environments⁶⁵. Therefore, the point

To eat or to be eaten

where there is enough light to feed but not too much to be seen by predators becomes deeper and deeper in the course of ontogeny. Finally, temperature also varies vertically and may affect this trade-off, because of its influence on metabolic rates⁷²: fishes staying deeper in the water column live in colder environments, have lower metabolic rates hence need to find less food but also grow more slowly.

Vertical shifts cause horizontal movement

Apart from influencing the probability to find food, these vertical movements also affect how larvae are advected by currents. Indeed, a shear is often noticeable between fast surface velocities and moderate flow at depth, because of wind stress at the surface and/or bottom friction at depth. Actually, most hydrographic variables (i.e. current speed but also temperature, salinity, etc.) vary faster vertically than horizontally. Therefore, moving vertically may have dramatic consequences, even on horizontal advection. For example, in Chesapeake Bay, vertical diffusion influences the result of an advection model more than horizontal diffusion does¹⁹⁵. And, indeed, vertical swimming by oyster larvae greatly modifies their dispersal routes¹⁹⁶. On coasts featuring strong tides, synchronisation of vertical migration with tides is a very efficient means of transport, either inshore or offshore^{197,198}. Ontogenetic vertical migration may also favour retention, as models suggest either on a large scale (Georges Bank⁸⁴) or around a smaller island (Barbados⁷¹). Finally, more theoretical works suggest that exploiting vertical shear is an efficient strategy to reach a settlement site, especially for larvae not capable of swimming against the flow¹⁹⁹.

Vertical distribution vs. vertical migration

Most of the data on vertical distribution comes from stratified sampling by towed plankton nets^{71,74,130,200-203}. An alternative for late stage larvae are stratum-specific light traps²⁰⁴, but their limited scope restricts their use. To understand the results of these methods correctly, it is important to bear in mind that they describe the vertical *distribution* of fish larvae and do not give direct information on their vertical *migration* behaviour. If individuals move around but that the overall distribution of the population stays the same, the range of vertical movement of each larva would be greater than what is inferred from the distribution⁷⁹. At the other limit, an ontogenetic shift in distribution toward depth could be the result of selective mortality in the surface without any movement by larvae. Therefore caution is advised when interpreting distribution data and trying to infer the movement of individuals, or even patches, from it.

In this study we seek to detect and quantify ontogenetic shifts in the vertical distribution of coral reef fish larvae, and to estimate their impact on the advection of larvae by currents. We use repeated, large scale, vertically stratified sampling to capture the vertical distribution of the population of fish larvae around an oceanic island. Eventually, an oceanographic model, calibrated by observations on the study site, is used to advect larvae in a realistic, dynamic flow field and compare the trajectories of passive and vertically migrating ones. Furthermore, given the prevalence of depth stratified data and the disparateness of

its approaches in the literature, we start by presenting a clear statistical framework for the analysis of such data, and only then detail the methods used in this particular study.

5.2 The statistical analysis of vertical distributions

As mentioned before, most data regarding the vertical distribution of ichthyoplankton comes from stratified sampling with fine-mesh nets. For example, Multiple Opening Closing Nets and Environmental Sampling Systems (MOCNESS) allow simultaneous sampling of plankton and hydrographic data. The separation of biological samples from different strata in several nets and the depth profile of the two are controlled from onboard the ship (as presented in previous chapter, page 71). Before that, mechanical systems such as Tucker trawls were used to achieve the same purpose. Smaller planktonic organisms are also surveyed this way but, for those, other techniques, such as the Video Plankton Recorder²⁰⁵, allow finer resolution. Similar techniques may become available for ichthyoplankton in the near future¹⁸⁸, but taxonomic identification will probably be more difficult than on preserved samples and sampled volumes will be lower than with large opening nets. Therefore, stratified sampling is likely to remain important in the investigation of the vertical distribution of larval fish, if only as a reference.

The statistically relevant peculiarities of stratified ichthyoplankton data are:

- The data are “counts” and zeros and low counts are frequent because the mean density of fish larvae in the ocean is very low.
- Ichthyoplankton is patchy and captures are therefore highly variable, with a few very dense samples over a background of low numbers.
- The distribution is physically bounded at the surface and also limited at depth (physically by the bottom and/or practically by the maximum depth of sampling)
- At each sampling point, which is usually meant to describe a set of physical conditions or a particular location of interest, not one, but several biological samples are collected, raising the question of what one *statistical* sample is.

Focus is here on ichthyoplankton but these characteristics still hold for other planktonic organisms, except that most other taxa, but late stage decapods, are probably be more abundant.

The fact that several biological samples are collected in one point separates two approaches of the data. On one hand, each sampling point can be considered as a complete estimation of the population distribution, and comparing places, species, or environmental conditions means comparing distributions. On the other hand, each point can be

Characteristics of vertically stratified samples

summarised by one value and its variations are then analysed with more usual statistical tools.

5.2.1 Direct comparison of distributions

Distribution tests are sensitive to patchiness

Two sets of binned data, such as the number of organisms in each bin of two vertically stratified plankton samples, can be compared with the Kolmogorov-Smirnov test. This statistic (D) is based on the maximum difference between the cumulative distribution functions of the two samples. The significance of the difference can be tested by randomisation: the two samples are pooled together, two new samples are created randomly, the maximum difference between their cumulative distribution functions is computed, the whole process is repeated and the p-value is estimated as the percentage of randomised samples for which D was greater than the one observed. Solow et al.²⁰⁶ present a caricatural example of the effect of patchiness in such a procedure. Suppose extreme patchiness: organisms aggregate around the first individual present in each sample, to the point that only one depth bin is occupied. If the bins are different from one sample to another, $D_{\text{obs}} = 1$. Now the randomisation procedure recreates samples where *two* depths bins are occupied, by mixing the two original samples. Therefore, it will always produce values of $D < 1$, and, by not taking in account the aggregation behaviour, will incorrectly assess the significance of D . This extreme situation exemplifies why Kolmogorov-Smirnov test should not be used for organisms whose distribution is patchy (i.e. probably for all planktonic organisms). Solow et al.²⁰⁶ provide a modification of the test to compare two vertical distributions with patchiness.

A modification for replicated samples

The modified test only compares two samples, which is probably relevant only when they contain a representative quantity of organisms in each depth bin (Solow et al.²⁰⁶ are dealing with hundreds to thousands of individual at each station). In ichthyoplankton studies, replicated samples with low captures at each station are more common. Pooling the replicates together in two groups, to reduce the analysis to the case of Solow et al.²⁰⁶, would lead to loose the information regarding variability and patchiness that the replication provides. Fortunately the same authors²⁰⁷ use the work of Paul & Banerjee²⁰⁸ to provide a solid framework to compare vertical plankton distributions in several groups (e.g. sets of conditions, groups of locations), with replication in each one^a.

Using distributions restricts the statistical toolbox

An important benefit of dealing directly with distributions is that it allows the detection of changes in spread (i.e. variance) with no change in location (i.e. mean). However, to be powerful, they require a good description of the distribution, hence many depths bins, which makes the practical work very tedious. In addition, the same depths bins must be used at each station, which can be challenging in the field. Finally, it

^aR functions implementing statistics and tests from Solow et al.²⁰⁶ and Paul & Banerjee²⁰⁸ are available on demand.

restricts the statistical array of tools to comparisons between locations or times, while those may differ by more than one factor. By doing so, it impedes the ability to de-intricate factors varying simultaneously and to dissect the variance between those.

An alternative to using complete distributions is to summarise the distribution by a single descriptor and to study this random variable with usual statistical tools.

5.2.2 Comparison of distribution descriptors: the depth centre of mass

Definition and application of the z_{cm}

Each station takes a sample in a 3D larval patch so a natural descriptor is the barycentre of the patch, also called the depth centre of mass (z_{cm}). It is simply the mean of the depths sampled by each net, weighted by the proportion of larvae captured in those nets.

The barycentre of patches as a summary

$$z_{cm} = \bar{z}_w = \frac{\sum_i a_i z_i}{\sum_i a_i} \quad (5.1)$$

where z_i is the mean of the depth range sampled by net i and a_i is a measure of the abundance of larvae in net i . This measure must be standardised by sampling effort because the volume sampled usually varies between nets. However using concentrations (i.e. just dividing raw abundance by volume sampled) is error prone, as explained in Figure 5.1.

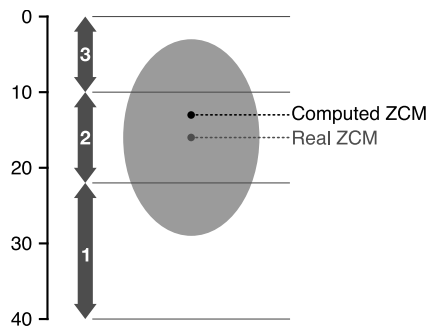

Figure 5.1 A patch of larvae spread across three layers (1, 2 and 3). Assuming uniform distribution in the patch and homogenous sampling effort, for simplicity, it can be remarked visually that the number of larvae is the same in nets 1 and 3. Yet the concentration is higher in net 3 because the volume is smaller. Computing the z_{cm} as a mean weighted by concentrations would be biased toward net 3.

Therefore, *standardised abundance* must be used instead, as defined by

$$a_i = a_i^{std} = \frac{a_i^{raw}}{v_i} \cdot h_i \cdot 1 \quad (5.2)$$

where the subscript i denotes the net, a_i^{raw} is the raw abundance, v is the volume sampled in m^3 (a/v is the concentration), h is the depth

range sampled by each net, in meters, and 1 is a dimensionalisation constant in m^2 .

z_{cm} allows the use of standard techniques

Using the z_{cm} as a summary for vertical distributions in further analyses is appropriate because its definition stems from the patchiness of the data and it is not overly sensible to large variations in captures. Indeed, nets with large captures influence the computation of the z_{cm} itself, but, after that, this particular z_{cm} is not given more weight than $z_{\text{cm}s}$ computed at other stations, where captures are lower. Indeed, a station with important captures only represents *one* observation of *one* larval patch; a dense patch certainly, but still only one. Having a unique numerical descriptor for each observation makes it possible to use all the standard statistical tools. The last characteristic of stratified data that should be acknowledged is the fact that $z_{\text{cm}s}$ are bounded at the surface and possibly at depth. Therefore the distribution of $z_{\text{cm}s}$ is likely to be non-normal. The gamma distribution, which is bounded at zero, may be used for parametric approaches.

Varying depth bins increases resolution

The z_{cm} is computed from means of the depth ranges sampled by each net (z_i). For example, all organisms sampled by a net from 100 m to 50 m depth are treated as if they have been captured at 75 m. If those depth ranges are the same at each station, which, to our knowledge, is the case in all studies where the bottom was not limiting or was uniform, then the $z_{\text{cm}s}$ are computed as means of the same numbers. The result is therefore biased toward those numbers. Furthermore, if certain organisms are concentrated within a thin layer that is always completely sampled by one net, their depth will always be estimated as the mean of this particular net, which is likely to be different from their actual depth. In the example above, organisms located between 95 m and 85 m would systematically be shifted to 75 m. These limitations disappear if the depths intervals are randomised, or at least varied, between stations. Such a sampling strategy prevents the use of the techniques based on distributions (section 5.2.1) and complicates the comparison of two given stations, because depths bins are not the same. However, with enough replicates, it enhances the vertical resolution in a z_{cm} approach.

Dispersion around the mean

Descriptive statistics that accompany the computation of the mean can be used to depict the spread of the patch. The formula for the variance is²⁰⁹

$$s^2 = \frac{\sum (x_i - \bar{x})^2}{n - 1} \quad (5.3)$$

where x_i are the observations, \bar{x} is the mean, and n is the sample size.

Weighted variance

With the weights added, and in particular for the z_{cm} , it becomes

$$s_w^2 = \frac{\sum a_i (z_i - \bar{z}_w)^2}{(n' - 1) (\sum a_i / n')} \quad (5.4)$$

where n' is the number of non-zero values of a_i (i.e. the number of nets with catches; nets with no catches have a weight of zero). It is easy to check that if all a_i are equal and non-null, equation (5.4) becomes equation (5.3). All other descriptors, such as standard deviation or quantiles, can be computed from weighted variance.

Brodeur & Ruge²¹⁰ used the z_{cm} to describe the vertical description of ichthyoplankton in Alaska, but their formula for the standard deviation erroneously added a square factor to the weights compared to equation (5.4). While their formula also reduces to (5.3) in the case of equal weights, it emphasises nets in which abundances are high. As those are generally closer to the z_{cm} , it diminishes variance. An alternative equation for the weighted variance, often used in software packages, is

$$s_w^2 = \frac{\sum a_i (z_i - \bar{z}_w)^2}{\sum a_i - 1} \quad (5.5)$$

which conceptually corresponds to considering weights as "repeats", hence the number of observations is the sum of weights ($n' \leftrightarrow \sum_i a_i$). When the weights are normalised (i.e. their mean is made equal to one) equations (5.4) and (5.5) are equivalent.

Definitions of weighted variance differ

Confidence of the mean and hypothesis testing

While the z_{cm} is an efficient way to summarise vertical distributions for further analyses, it can also be used by itself, and two z_{cm} s may be compared. Testing hypothesis on means involves a measure of the confidence in the value of those means (i.e. the standard deviation of the mean, also called standard error). However, there is no analytical equivalent to the standard error for weighted data. Gatz & Smith²¹¹ discuss the validity of several estimates of the weighted standard error by comparing them to a bootstrap method. The best suited is an approximate ratio variance by Cochran²¹²

No analytical definition of the weighted standard error

$$se_w^2 = \frac{n'}{(n' - 1)(\sum a_i)^2} \left[\sum (a_i z_i - \bar{a} \bar{z}_w)^2 - 2\bar{z}_w \sum (a_i - \bar{a})(a_i z_i - \bar{a} \bar{z}_w) + \bar{z}_w^2 \sum (a_i - \bar{a})^2 \right]. \quad (5.6)$$

The weighted standard error allows to compute weighted confidence intervals, perform weighted t-tests, and everything that would normally be available for non weighted data.

The problem of unequal variances

Dealing with z_{cm} s means dealing with non-normal data, hence using non-parametric tests. It is common belief that the popular Wilcoxon-Mann-Whitney test, and its multi-sample extension, the Kruskal-Wallis test, do not require the variances to be equal, because they are non-parametric. This is wrong^{213,214}. As, under the null hypothesis, the two

Non-parametric tests require homogeneity of variances

samples are supposed to be drawn from the same (statistical) population, these tests assume equal shape and equal spread in the two samples. When this assumption is violated, the α -error risk (i.e. the risk of rejecting the null hypothesis when it is true) increases when the largest variance is in the more numerous sample (which is usually the case).

Variances are often not equal between planktonic samples

Unfortunately, differences in variance are quite common in vertical samples of plankton. For example, while many larval fishes are grouped around a preferred depth during the day, they are more spread out at night^{130,191,200,215}. How to test for vertical migration (i.e. difference in location = median) when the distribution changes (i.e. there is a difference in spread = variance)? This problem, known as the Behrens-Fisher problem, can be solved using robust rank procedures (described by Fligner & Policello²¹⁶). Neuhäuser²¹⁴ and Kasuya²¹³ advise the use of the Fligner-Policello test as an all purpose replacement for the Wilcoxon-Mann-Whitney test when variances are not equal. In fact, the Fligner-Policello test may not be appropriate for most situations in which the Wilcoxon-Mann-Whitney test is used in ecology, that is: to test for a difference in location. Indeed, in this situation, it assumes symmetric distributions²¹⁷, which is often what leads to reject the normality hypothesis in the first place. Hence there is no clear solution to the Behrens-Fisher problem in the case of non-normal populations: either accept an increased α -error risk or assume a symmetric distribution.

5.3 Methods

In this study, we chose to use a z_{cm} approach because it does not restrict the array of statistical tools available and allows to de-intricate different possible causes of variance. The data collection was already presented in previous chapter (page 71). It is only briefly repeated here, and the details specific to the vertical aspect are highlighted.

5.3.1 Sampling protocol and data treatment

Synchronous biophysical sampling

Thirty-six stations were sampled four times, around the clock, for three weeks, in the vicinity of the atoll of Tetiaroa, French Polynesia (see Figure 4.1, page 71). Each of the four sampling rotations lasted three days. At each station, ichthyoplankton samples were collected in a depth stratified manner using a MOCNESS. The instrument synchronously collected CTD and fluorescence data. Two finer meshed Bongo tows down to 100 m and 50 m respectively should have allowed an approximate stratified view of the lower trophic planktonic community, but these samples are still being processed. Finally an ADCP recorded instantaneous currents in the middle of the profile for 4 min, from surface to 100 m depth, in 4 m bins.

Randomised depth bins increase vertical resolution

To increase vertical resolution, the depths bins sampled by the MOCNESS were shifted on a four stations cycle. At the first station of the cycle, a new net was opened (and the previous one was closed) at 105,

80, 55, 30 m (Figure 4.2, page 72). At the next station, depths were shifted up 5 m: 100, 75, 50, 25 m, and again on the third and fourth stations. However, on the fourth, the last net fished from 20 m to the surface, and not from 15 m to the surface, because the volume sampled was too low to be representative otherwise. The maximum depth sampled was 105 m because most coral reef fish larvae are concentrated in the first 100 m²⁰¹ (the thermocline was around 70 m and most larvae are above or near the thermocline). In the family Acanthuridae, some post-flexion larval stages spend some time deeper, around 200-300 m²¹⁸, but these are exceptions and sampling such depths would have lowered resolution too much in the first hundred meters, that appear to be the most important. Each rotation, station 1 was set to a different state in this four possibilities cycle, to avoid sampling the same stations always at the same depths.

ADCP and CTD profiles were filtered to eliminate outliers. ADCP data was corrected for ship drift and averaged on the four minutes of recording. Depth of thermo-, halo- and pycnocline, as well as depth of the chlorophyll maximum were extracted from CTD and fluorometry profiles. Fish larvae were sorted out of the MOCNESS samples and coral reef fish larvae were identified to the lowest possible taxonomic level. Given the small size and early ontogenetic stage of most larvae, this meant family for all of them and genus for some. When clear morphological characteristics were available but that genus could not be determined, larvae were classified in morphological groups within families. The ontogenetic stage of coral reef fish larvae was also classified in pre-flexion, flexion, and post-flexion stages. Among the 10,794 coral reef fish larvae captured, 3,624 were measured to the nearest tenth of mm using the micrometer scale of a stereomicroscope.

5.3.2 Statistical analysis

Stations were placed ca. 10 km apart specifically to sample discrete larval patches (which range from 1 to 6 km in size^{71,162,163}). Therefore, each station was considered as an independent measurement of the vertical distribution of one larval fishes patch. In this study, focus is not on describing the dynamics of single patches but rather on studying the overall vertical distribution of the population. The varying depth bins in the vertical sampling scheme were expressly designed to improve the resolution in a z_{cm} analysis. One z_{cm} was computed per station, using equation (5.1) applied to the abundances of the whole community or of certain groups (divided taxonomically, ontogenetically, etc.) depending on the question at hand. Stations where only one net had captures were discarded, because computing a mean from only one value does not make sense. The resulting data (one z_{cm} per station) was then treated as any numerical data, simply taking in account non-normality and bounds in the distribution.

Sampling optimised
for a z_{cm} analysis

Before exploring the differences between the distribution of ontogenetic stages, one must make sure that other sources of variability are not obscuring the potential effect of ontogeny. For example, post-flexion larvae may be always a few meters lower in the water column than pre-flexion larvae, but if both pre- and post-flexion larvae are within 0-20 m when the thermocline is at 30 m and within 20-50 m when it is at 60 m, testing for a global difference in location through a rank test such as the Wilcoxon-Mann-Whitney test will show nothing. One solution is to work with the *difference* in z_{cm} at each station, rather than with the z_{cm} themselves. Another possibility, which gives additional information on the system, is to identify the other sources of variability and eliminate them before testing the effect of ontogeny.

Situate ontogeny among other factors

Successive regression trees were constructed to hierarchise the factors influencing the distribution of z_{cm} s, and situate ontogeny among those. The explanatory variables considered in addition to ontogeny were taxonomic (family), temporal (time of day), geographic (latitude, longitude, location with respect to the atoll, i.e. windward, leeward), and hydrographic (depth of thermo-, halo-, pycnoclines, and of the fluorometry maximum, mean current speed in the surface layer). When several factors were correlated (e.g. depth of thermo- and pycnocline) they were tested independently and only the most explanatory was kept in the final tree. For discrete explanatory variables, the effect of influential factors was investigated by comparing z_{cm} s between groups (by taxon, by ontogenetic stage, etc.) using non-parametric tests for differences in medians (Wilcoxon-Mann-Whitney and Kruskal-Wallis). Homogeneity in variances was tested using the Fligner-Killeen test. When variances were different between groups, the choice was made to still use the same tests but to lower the significance level to 0.01, to account for the higher risk of α -error (distributions were clearly non-symmetric, preventing the use of robust rank procedures, as mentioned in the section "The problem of unequal variances", page 99). The effect of continuous explanatory variables was estimated by regression using Generalised Linear Models with a gamma distribution of errors.

Regression between size and depth

Over 3000 larvae were measured and their size was used as a proxy for development. Indeed larvae usually reach a particular ontogenetic level at a given size rather than at a given age⁶⁴. They allowed to test whether there was a continuous change in vertical distribution during ontogeny (i.e. along with increasing sizes) through a regression analysis. Of course size varies greatly among different fish taxa. Therefore, sizes were normalised per taxon, i.e. for each of the lowest taxonomic units identified, the size of the smallest fish captured was set to zero while the size of the largest fish was scaled to one. While the ranges of ontogenetic stages captured probably differed between taxa (i.e. size = 1 did not correspond to the same point in development for all taxa), this brought sizes on a more homogenous scale. Relative size and depth of capture could then be compared. However, because of the patchiness in the distribution of larvae, two larvae of the same taxon captured at the

same station were likely to belong to the same patch, hence to have similar depths and sizes. Therefore, relative sizes were averaged per station and these mean relative sizes were associated with the z_{cm} at the station. In the worst case scenario of a convergence zone where several patches of all development stages occur, this would just erase the signal. Eventually, the regression between mean relative size and z_{cm} was carried out, with a Generalised Linear Model featuring gamma errors to account for the bounded distribution of z_{cm} s.

All analyses were performed in R, with the additional package `mvpart` for regression trees.

5.3.3 Model of the influence of ontogenetic vertical migration

To estimate the impact of ontogenetic shifts in vertical distribution on horizontal drift, the trajectories of vertically migrating larvae were compared to those of passive particles in a numerical model. The model parameters were intended to approach the observed situation.

First, the patterns of vertical distribution observed through the z_{cm} approach described above were used to parameterise ontogenetic vertical migration in the model. The Probability Density Function (PDF) of the centres of mass was estimated, using kernel density estimation, for pre-flexion, flexion and post-flexion larvae of several families and for the whole community. It provided a conservative estimate of the range of ontogenetic vertical migration because the PDFs were computed for the centres of mass and not directly from the concentrations of larvae in each net. Computing PDFs from larval concentrations would have meant pooling all data together, hence considering that abundances in two nets of the same station were independent observations, which they obviously were not. The mean age of pre-flexion, flexion, and post-flexion larvae of these taxa was roughly estimated from sizes, assuming linear growth between hatching and settlement sizes found in the literature. A eight days time window centred on flexion was used in the simulations because enough information was available for all taxa during this period. To describe the distribution throughout these eight days, the three PDFs (for pre-flexion, flexion, and post-flexion larvae) were progressively “morphed” into one another by linear interpolation. In the model, at each time step, the particles were moved vertically by a random process which ensured that the PDF for this time step was respected. In addition, larvae could be forced to follow smooth vertical trajectories: a larva that went down already was more likely to continue going down than to suddenly rush to the surface while an other surface dwelling larvae suddenly dove at depth. Those larvae displayed a real vertical “migration”, as opposed to erratic movements within the depth window defined by the PDF in the default case.

Ideally, the 3D current field used to advect larvae should have been the one measured around Tetiaroa. However, as the previous chapter underlined, the resolution of this observed field was too low to resolve

Respect observed
vertical distributions

Use an oceanographic
model to advect particles

eddies and fine scale vertical variations in the flow. In addition, the large variations in weather conditions made it impossible to get a continuous picture of the current throughout eight consecutive days. Therefore, the Regional Ocean Modeling System (ROMS) was used to simulate the flow around a cylindrical deep-ocean island, similar to, but larger than, Tetiaroa (20 km diameter). The configuration was modified from Dong et al.²¹⁹. The incoming flow featured a vertical shear that was parameterised according to ADCP measurements in the presumed upstream region of Tetiaroa: 20 cm s⁻¹ near the surface, 12 cm s⁻¹ at 100 m, with a sigmoid decline. The simulation grid had dimensions 200 × 100 km × 500 m, with an horizontal resolution of 500 m, and 20 evenly spaced layers, which allowed to resolve mesoscale eddies shed by the island.

Advection scheme Particles advection was performed off-line, with custom Fortran code. The grid was restricted to the inner 150 × 80 km and the current field was interpolated on a 250 m regular mesh through 4th order polynomial interpolation. In the vertical direction, only the first 100 m were used, and divided in 5 layers. Simulated pre-flexion larvae were simultaneously released at 100 points within a 5 km radius around the island, at a depth of 25 m (the depth of maximum occurrence of pre-flexion larvae in most families), on three occasions, contrasting in terms of flow conditions. Larvae were advected using a first order forward scheme, with a 1.30 h time step. While the advection scheme did not allow all fine scale features of the flow to affect trajectories, the same scheme was used for passive and vertically migrating larvae. So it did not bias the comparison which was the primary focus of the simulations here.

5.4 Results

5.4.1 Factors affecting vertical distribution

Predominant effect of taxonomy An univariate regression tree was built to hierarchise the effect of taxonomy, physical variables, and ontogeny on the location of the z_{cm} , computed per family and per stage, at each station. The first splits, robust after cross-validation, show a strong effect of taxonomy (Figure 5.2). Some families, such as Lutjanidae, Lethrinidae, and Holocentridae, were systematically higher in the water column than others (Figure 5.3). These two splits alone account for 23% of the variability (residual cross validated error = 0.77). This result is confirmed by a very significant difference between per-family z_{cm} s (Kruskal-Wallis, $\chi^2 = 211.43$, $df = 9$, $p < 10^{-16}$) which leaves no doubt, even though variances are different (Fligner-Killeen, $\chi^2 = 29.7$, $df = 9$, $p = 0.0005$).

Circumstantial differences for sub-family taxa Some differences between the distributions of sub-family taxonomic groups are significant. For example, within the Serranidae, Epinephelini were higher in the water column than Grammistini (Fligner-Killeen, $\chi^2 = 1.1$, $df = 1$, $p = 0.3$; Wilcoxon, $W = 5$, $p = 0.002$). There is also a

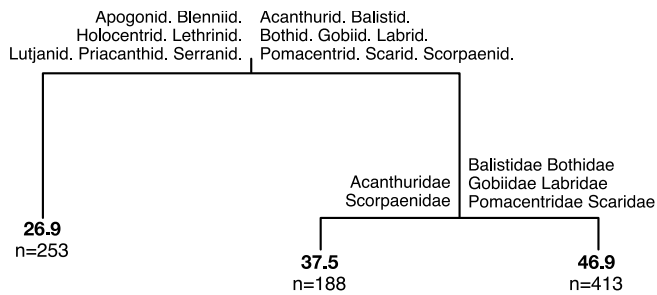

Figure 5.2 Univariate regression tree of the z_{cm} (computed by station, family and stage) against taxonomic (family), physical (depth of the thermocline, of the fluorimetry maximum, time of day, geographic location), and ontogenetic (flexion advancement stage) factors. Splits separate groups of observations most different from one another. The tree hierarchises explanatory variables: the first ones have more influence. The length of branches is proportional to the variance explained by each split. The numbers at the tip of branches are the mean z_{cm} in the group defined by preceding splits and the number of observations in this group.

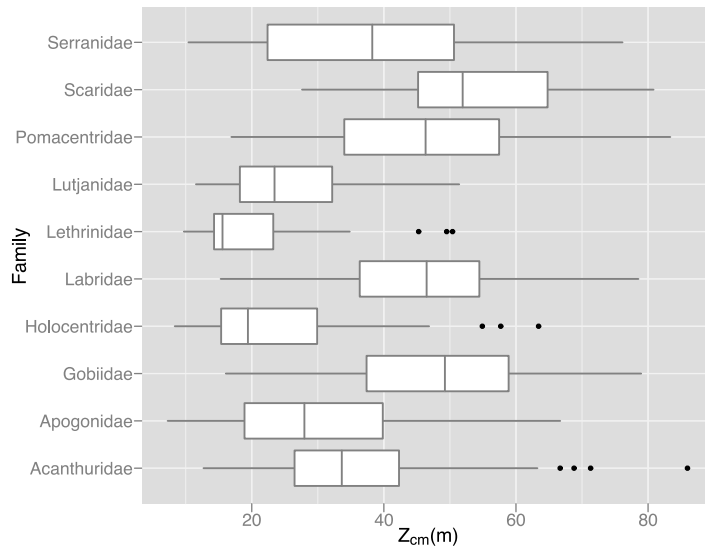

Figure 5.3 “Box-and-whisker” plot of the distribution of z_{cm} for the ten most abundant reef fish families. The bar in the middle is the median, the box represents the inter-quartile range, the bars display the range of observations, excluding potential outliers, represented as dots.

difference among the five identified genera and morphological groups of Acanthuridae (Fligner-Killeen, $\chi^2 = 16.24$, $df = 4$, $p = 0.002$; Kruskal-Wallis, $\chi^2 = 83.43$, $df = 4$, $p < 10^{-16}$). However, the number of larvae involved in these comparisons was of course lower than at family level, and results could be confounded by non-taxonomic factors, such as ontogeny. For example, most Grammistini were post-flexion while most Epinephelini were pre-flexion. By contrast, when dealing with groupings by family, the coverage for factors other than taxonomy was better because the number of larvae in each group were higher.

Ontogeny appears in the residual variance

After normalisation of the influence of family, a new tree highlights an effect of ontogenetic stage, whereby pre-flexion and flexion larvae were higher in the water column than post-flexion ones. This effect is the only one resisting cross validation and accounts for 7% of the variance in this new dataset (with the taxonomic effect normalised). Underneath the effect of ontogeny some geographic (location with respect to the atoll) as well as hydrographic (thermocline depth, current speed) factors appear, but both are less robust.

From these results, it is obvious that further analyses should first be conducted per family.

5.4.2 Diel-vertical migration and other physical correlates

Correlation with thermocline depth

The influence of geographic location mentioned above was probably caused by differences in physical conditions between these locations. Indeed, a GLM, with a gamma error distribution, reveals an effect of thermocline depth on z_{cm} for some families, whereby deeper z_{cm} s were associated with deeper thermoclines in Lethrinidae ($p = 0.0005$) and Gobiidae ($p = 0.023$), and with shallower thermoclines in Bleniidae ($p = 0.031$). The slopes are all around 0.5: a 40 m variation in thermocline was accompanied by a mean shift of 20 m in z_{cm} .

No clear diel vertical migration

Because of its prevalence in the literature, the existence of a diel vertical migration was tested for each family. Plots reveal a tendency for upward movement at night in all families but the difference in z_{cm} between day and night is only significant for Serranidae (Fligner-Killeen, $\chi^2 = 1.1$, $df = 1$, $p = 0.3$; Wilcoxon, $W = 480$, $p = 0.02$). Late stage larvae are more mobile, hence more likely to migrate on a daily basis, but the result is similar when the comparisons are restricted to post-flexion larvae. In addition, while coral reef fish larvae were found to be more diffused at night, when observed in the first 20 m of the water column^{130,200,215}, no difference in spread is evident here, on a 0-100 m scale. All tests of difference in variances are indeed not significant (Fligner-Killeen, $p > 0.1$ for the ten most abundant reef fish families).

5.4.3 Ontogenetic shifts in vertical distribution

As taxonomic differences in z_{cm} were prominent, the effect of ontogeny was first tested within each family. Among the ten most abundant families (see Table 4.1, page 81), only eight had enough catches in different ontogenetic stages to warrant further analysis (Gobiidae and Scaridae were excluded because almost all z_{cm} s were for post-flexion larvae).

For all families, Figure 5.4 reveals a vertical spread of z_{cm} s during ontogeny. The centres of mass of patches of post-flexion larvae were detected throughout the water column, while pre-flexion larvae were usually more localised. However, when tested as a difference in variance, this spread is never significant (though very close to significance for Apogonidae – see Table 5.1). The location (i.e. median) of the centres of mass, on the other hand, is significantly different between stages for four families: Acanthuridae, Holocentridae, Labridae, and Serranidae (Table 5.1). All these families display a clear downward ontogenetic shift in vertical distribution, as highlighted in Table 5.1 and Figure 5.4. For families in which enough genera were identified (Acanthuridae, Lutjanidae, and Pomacentridae), the behaviour in each genus seemed remarkably consistent with the tendencies displayed at family level. However, at this level, the number of z_{cm} per group was often low and the tests were not conclusive.

More interestingly, it seems that, in all cases where a shift in distribution is significant, it occurred in the same direction: from surface toward deep water. This effect was already suggested by the second regression tree, once z_{cm} s were normalised by family (see section 5.4.1). This leads to suspect a global ontogenetic trend, beyond taxonomic differences. And indeed, at community-level, the ontogenetic shift toward depth is very significant (Kruskal-Wallis, $\chi^2 = 111.4$, $df = 2$, $p < 10^{-15}$; variances were homogenous: Fligner-Killeen, $\chi^2 = 4.2$, $df = 2$, $p = 0.12$). All stages were distributed differently from one another (Wilcoxon, with Holm's correction for multiple testing: pre-flex, $p < 10^{-5}$; flex-post, $p < 10^{-8}$; pre-post, $p < 10^{-15}$), and post-flexion larvae were on average 25 m lower in the water column than pre-flexion stages (Figure 5.5).

Similarly, the regression between mean relative size (a proxy for the advancement of development) and z_{cm} , computed at the level of the whole community, is very significant (GLM with gamma errors, $p = 0.0023$) and explains 16.3% of the variance in z_{cm} s. As shown in Figure 5.6, z_{cm} s were deeper at stations where larvae were larger on average.

Vertical spread and downward shift during ontogeny

Strong difference perceptible at community-level

Larger larvae were deeper

5.4.4 Influence of ontogenetic shifts on advection

Particles displaying the vertical distribution of larvae of Acanthuridae, Serranidae, Labridae (Figure 5.4), and of the total community (Figure 5.5) were advected in the current field generated by ROMS. These families

Vertical migration reduces drift distances by very little ...

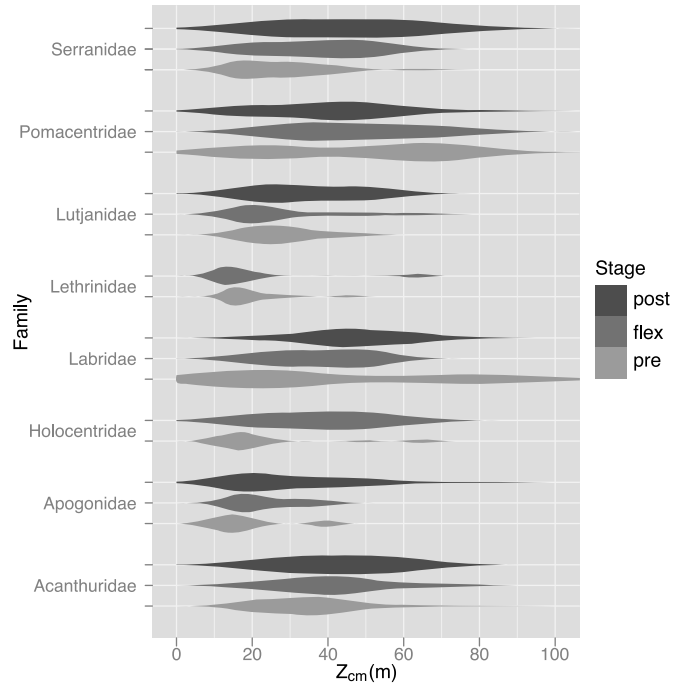

Figure 5.4 “Violin” plot of the distribution of z_{cm} by family and ontogenetic stage. Each shape represents the probability density function of z_{cm} s, estimated via kernel density at 512 points in the domain 0-100 m. Basically, z_{cm} s were more likely to be where the shapes are wide. The probability density was not estimated for post-flexion larvae in Lethrinidae and Holocentridae because catches were too low.

Table 5.1 Tests for differences in variances (Fligner-Killeen) and medians (Kruskal-Wallis) for the z_{cm} s of different ontogenetic stages of eight abundant families of coral reef fishes. For Lethrinidae and Holocentridae, only pre-flexion and flexion stages are used. For each test, both the test statistic and the p-value are reported (values are bolded in significant tests, and italicised for close to significant ones). In the last three columns are the z_{cm} medians (in m) for each family and stage.

| Family | Fligner | Kruskal | z_{cm} | | |
|---------------|--------------------|---------------------|--------------|------|------|
| | $\chi^2 - p$ | $\chi^2 - p$ | pre | flex | post |
| Serranidae | 5.07 – 0.08 | 7.86 – 0.02 | 29 < 36 < 45 | | |
| Pomacentridae | 4.02 – 0.13 | 2.63 – 0.27 | 58 | 46 | 41 |
| Lutjanidae | 1.16 – 0.56 | 2.16 – 0.34 | 27 | 22 | 31 |
| Lethrinidae | 2.66 – 0.26 | 3.12 – 0.21 | 17 | 14 | |
| Labridae | 0.63 – 0.73 | 7.91 – 0.019 | 26 < 38 < 47 | | |
| Holocentridae | 3.12 – 0.21 | 6.10 – 0.047 | 17 < 40 | | |
| Apogonidae | 6.07 – <i>0.05</i> | 5.88 – <i>0.053</i> | 15 | 20 | 24 |
| Acanthuridae | 1.38 – 0.5 | 6.44 – 0.04 | 35 < 41 < 43 | | |

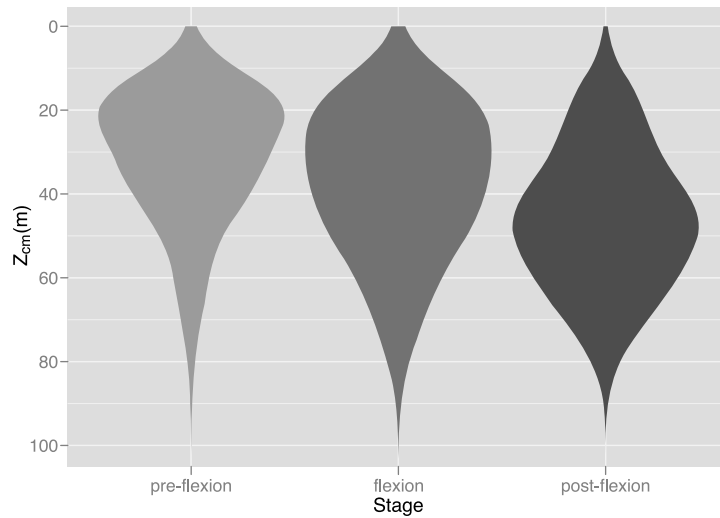

Figure 5.5 Violin plot of the vertical distribution of z_{cm} computed for the global community (all families) at three ontogenetic stages.

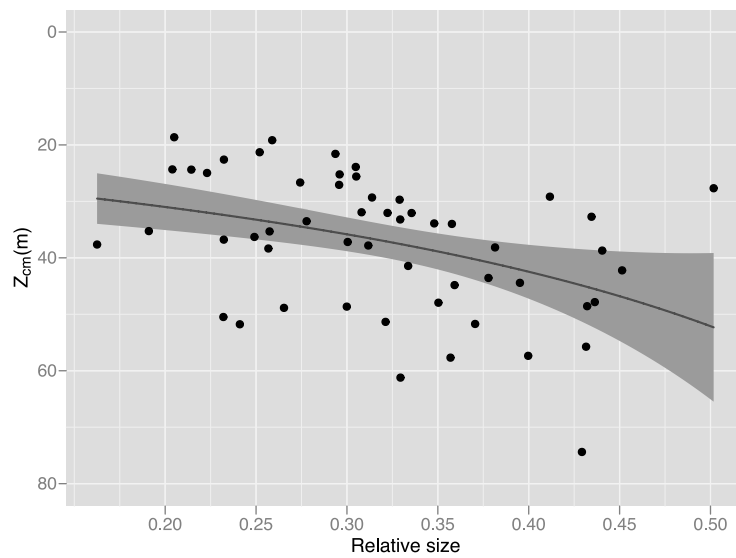

Figure 5.6 z_{cm} per station for the global coral reef fish community in function of mean relative size of larvae at the corresponding station. Dots are data points (i.e. stations), the solid line is the fit from a GLM model with a gamma error distribution and the shaded area is the 95% confidence interval around the fit.

were chosen because an ontogenetic shift was significant and larvae were abundant enough to estimate the probability density function of z_{cm} s in the three ontogenetic stages. After a larva was released, the straight-line distance between its starting point and current position was computed at each time step. These distances were compared to determine whether shifts in vertical distribution facilitate or impede drift. After six days, passive particles were on average 80 km away from their point of origin (past this point, some particles reached the domain boundaries and biased the estimation of drift distance). In all cases, vertical migration reduced the mean drift distance, albeit by very little: 2.3 km for Acanthuridae, 3.3 km for Serranidae, 4.7 km for Labridae, and 3.6 km for a vertical movement corresponding to that of the global coral reef fish community. These differences were even smaller when particles were allowed to move randomly within the depth range defined by the PDF, i.e. not enforcing smooth vertical migration.

... but induces some rare retention events

Passive particles were all advected away more or less at the same pace. They were only slowed down by their entrapment in transient eddies. By contrast, some migrating particles were brought at depth, behind the island, in areas where retention was much higher. As shown in Figure 5.7, some particles were actually retained within 10 km of the island for the whole eight days. For those few, the drift trajectory was very different from that of passive particles.

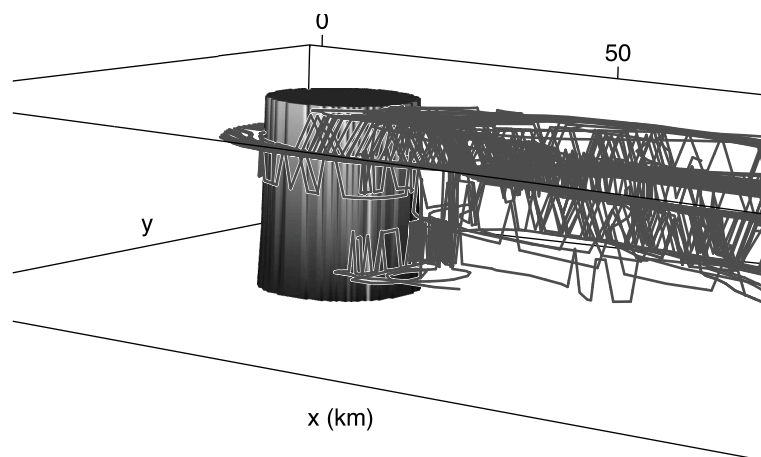

Figure 5.7 Trajectories of vertically migrating particles advected around an isolated deep oceanic island for eight days. The island was 20 km in diameter. Particles were constrained in the upper 100 m. Most particles were advected away but a few were retained at depth, behind the island.

5.5 Discussion

5.5.1 Vertical distribution

The Z_{cm} analysis first highlighted that different families had contrasting vertical distributions and that it was the main force structuring the vertical assemblages of coral reef fish larvae. The only documented hypothesis regarding these taxonomic differences is that they could be caused by taxonomic variations in the minimum intensity of light required to feed⁶⁵. However, based on those requirements alone, Apogonidae should be deeper in the water column than Pomacentridae for example, because their light sensitivity is higher. Yet, the opposite was observed here (Figure 5.3). Furthermore, Apogonidae were on average slightly older than Pomacentridae (pre-flexion, flexion, post-flexion ratios in Apogonidae: 15% 40% 45%, and Pomacentridae: 22% 52% 26%) so they should have been even deeper because visual sensitivity increases with age. The opposite position observed here is therefore not confounded by ontogeny. Light intensity may not be as prominent as it was supposed to be in shaping the vertical patterns of distribution in those families. Although there is currently no published information regarding the diet of coral reef fish larvae, all species are probably quite specific in their preferences (J. Llopiz, unpublished) and not likely to eat the same prey. If those prey are distributed differently, fish larvae would probably accumulate where their prey are abundant. Finally, not all species have the same swimming abilities or larval duration, and these various ecological strategies may also show through their vertical placements, because it affects dispersal trajectories^{71,84,196}.

Large taxonomic variability

Analyses were mostly inconclusive when conducted at taxonomic levels under family. Probably because larvae were difficult to identify to these levels, hence the sample sizes were small. Only more extensive sampling or other identification techniques (such as genetic barcoding²²⁰) would have allowed to overcome this limitation. When these analyses were possible, however, they highlighted possible intra-family differences (in Acanthuridae and Serranidae). Such differences are to be expected because other behavioural characteristics, such as swimming speed, are known to be species-specific²²¹.

Possible intra-family differences

Beyond these taxonomic differences, physical factors usually observed to influence vertical positioning (depth of clines, time of day) had little influence here. The absence of significance in diel vertical migration is particularly intriguing given its prevalence in the literature^{36,194}. Of course, the sampling strategy was not designed to capture daily migration of a specific group of individuals — it would have been more appropriate to sample repeatedly a single patch throughout one or several days. So the results here may be obscured by inter-patch variability. Furthermore, diel vertical migration was often described for late stage larvae or juvenile fishes^{210,215} and may only occur in larvae older than those caught here. Yet, it was not detected more clearly in

Not strong evidence for diel vertical migration

post-flexion larvae than in the total population. In this dataset, diel vertical migration seems to be reduced to tendencies for upward movement at night.

Ontogenetic migration
behaviour ...

Finally, young larvae were found to be on average higher in the water column than old ones, either in the total community (25 m shift) or in some abundant families (Acanthuridae, Holocentridae, Labridae, Serranidae). The fact that population-level ontogenetic shifts are significant despite inter-patch variability underlines the importance of this process. However, a possible source of artefacts in these result would be differential mortality. First, within a family, if two species are distributed differently and that one suffers higher mortality, the patterns at family level would change through time, without this being related to ontogenetic vertical migration. But ontogenetic shifts, when significant, were very consistent across families and even at the level of the entire community. So it seems very unlikely that they were all confounded in the same way by lower level differences. Second, if larvae suffer higher predation in the surface layer (because predators are more abundant or larvae more visible for example¹⁹⁴), the relative abundance of deep-dwelling larvae would increase and distributions would give the false impression of a vertical migration. However, some families, such as Apogonidae, were still very abundant in the surface layers after flexion. In fact, in most families, some post-flexion larvae were present in the surface layer. The only change compared to pre-flexion larvae is that they were also abundant at depth. So the downward ontogenetic trend seems to be intricate with a spread in the vertical distribution: while pre-flexion occurred more often at shallow depths, post-flexion larvae occupied most of the water column (Figure 5.4). Moreover, the spread is detected here in the distribution of the centres of mass of patches. It may be even more noticeable if the distribution of the population as a whole can be finely described. The increase in maximum depth of occurrence of larval patches could explain at least part of the downward shift in the median z_{cm} . Finally, this spread suggests that young larvae are somehow restricted to shallow depths while older larvae are less constrained, but it does not imply that post-flexion larvae have a particular preference for depth. As mentioned in the introduction, the diminution, during ontogeny, of the minimal light intensity required to feed may explain such a spread⁶⁵.

... or consequence of
a vertical spread?

Explains
some differences
among families

Without inferring its cause, the downward ontogenetic shift in distribution would explain some of the differences between families because the ontogenetic compositions of catches were different. For example, Lethrinidae and Holocentridae appear to be restricted to the top of the water column (Figure 5.3) and most larvae of these families were pre-flexion and flexion stages. On the opposite, Gobiidae and Scaridae were the two deepest families and were both dominated by post-flexion larvae. Given the range of the spread in other families, however, such strong concentrations at depth or near the surface are probably also the

expression of different biological requirements and ecological strategies of the different taxa.

Beyond taxonomic differences, the vertical spread and downward shift seem to be widespread, and clearly show at community level (Figure 5.5). They may represent a common strategy to increase self-recruitment because downward movement should increase retention^{71,84}.

5.5.2 Influence on advection

When particles with the vertical distributions observed here were input into a realistic flow field interacting with topography, their average dispersion was not very different from that of vertically immobile particles. This mild effect is surprising given the body of literature indicating otherwise^{24,71,84,197}. The effect would probably have been more conspicuous if the advection experiment had been conducted on a longer time scale and represented vertical shifts of greater amplitude. Indeed, a large difference may exist between particles starting in the neuston (eggs, very young larvae) and the pre-flexion larvae of the model which were released at 25 m depth already. For example, a numerical model showed that shallow ontogenetic vertical migration had little influence on particles trajectories and connectivity patterns, while deeper migration was influential⁷⁰. In fact, in the configuration used here, positively buoyant particles restricted to the surface layer showed differences > 15 km compared to vertically migrating ones. In addition, most post-flexion larvae captured here were still quite young and, if the downward trend continues, the rate of divergence between passive and migrating particles should increase in time. In this study, the choice was made to avoid possibly misleading extrapolations by restricting the experiment to the period around flexion, when field information concerning the distributions was available.

However, even with this restricted span of vertical variability and in a weakly stratified current, the effect of vertical migration was very sensible for a few trajectories. They may seem anecdotal, but only one on 10^5 larvae finally recruits⁶¹ and it may well be that the important cases are the exceptions, rather than the mean. The fact that *no* passive particles were retained, while *some* vertically migrating ones were, could make the difference between *no* recruitment and *enough* recruitment.

Even when retention was effective, the numerical experiment conducted here suggests that it was not strong enough for larvae to self-recruit based on vertical migration alone. After eight days, even particles initially retained were advected away from the island. In situations where there is no strong backward flow at depth (as there could be in estuaries and tidal channels^{197,198}, or around particular topographic structures^{71,202}) horizontal swimming is probably also required to self-recruit. In fact, it may be critical for a target as small as a Tetiaroa. Indeed, the island in the model was 20 km in diameter while Tetiaroa is only 7 km wide. In Tetiaroa, retention through vertical migration would be

Vertical shifts in distribution may have more influence

The importance of "exceptions"

Indirect influence on horizontal swimming

even weaker and without horizontal movement, self-recruitment would likely be impossible. Furthermore, swimming endurance is inversely correlated with swimming speed, in a non linear manner (swimming fast is proportionally more demanding energetically than swimming at moderate speeds)⁹⁴. Therefore, vertical migration indirectly influences the possibility for sustained swimming, by placing larvae in an environment where the flow is weaker. Overall, the effects of vertical and horizontal swimming may be inextricable, in a way that no single behaviour has a large influence but the combination of both is critical.

Downward migration and vertical spread have different consequences

This reasoning, however, is based on the assumption that ontogenetic shifts correspond to ontogenetic *migration*, i.e. that larvae move down and spend more time at depth when they are older. Most models representing ontogenetic vertical migration make the same assumption^{80,84,196}. As already pointed out, the spread in vertical distributions occurring along with ontogeny would rather suggest that post-flexion larvae are simply less constrained in their vertical movements. Retention in the model was even lower when larvae were allowed to move randomly within the depth range determined by their probability density function. Such vertical movements would require an even finer synchronisation between different larval behaviours. For example, swimming would be effective when larvae are at depth but may become a waste of energy near the surface because endurance is low at high swimming speeds⁹⁴; meanwhile, foraging efficiency varies in the opposite direction (i.e. increases near the surface).

The distribution/migration confusion highlights how little is currently known about the behaviour of larvae, and how important its details can be for the outcome of the larval phase. The spread and shift in vertical distribution, however, can already be trusted as solid observations. The consistency in the direction of the shifts across families and at community level should encourage their inclusion in models. Still, estimating their influence may no be straightforward. Indeed, in environments that are not heavily stratified, vertical migration would probably not affect mean advection in any obvious way. Nevertheless, it might explain the very few trajectories that eventually determine effective connectivity patterns. This raises the question of how to treat rare events in a probabilistic approach that, in this case, clouds our judgement by focusing on the mean.

5.A Acknowledgements

The people and funding agencies involved in this study are similar to those mentioned in chapter 4, and we acknowledge their participation and advice once again. In addition, we thank K. Huebert for insightful discussions.

Chapter 6

Oceanography vs. behaviour: a modelling approach

J.-O. Irisson, L. Cherubin, A. LeVan, M. de Lara, S. Planes
Portions published in
Journal of Theoretical Biology **227**, 205–218 (2004)

6.1 Introduction

The outcome of the larval phase is determined by physical-biological interactions, such as the co-occurrence of plankton blooms and hatching of fish larvae, or the advection of larvae into suitable nursery habitat (see I.1.2, page 5). However, high resolution sampling of both physical and biological data that would permit to investigate those interactions is difficult, as the two previous chapters underlined. On the other hand, oceanographic models steadily improved through the last two decades, thanks to better understanding of mesoscale processes and increased computational abilities²²². These models form the basis for a flourishing field of biophysical numerical representations of the early life history of fishes. In a recent review²²², such models were found to serve three purposes: explain observed patterns of recruitment, infer the importance of a given process through sensitivity analysis, or generate testable hypotheses about an unknown portion of the larval stage (e.g. backward-predict the location of spawning areas from the locations of observed recruitment sites). These three kinds of models allow to study the pelagic portion of the life history indirectly; yet, the more useful to understand the governing processes of the larval phase, and least common unfortunately, are the two latter sorts.

Early life-history models of marine organisms are mainly concerned with the advection of larvae by currents: the computation of Lagrangian trajectories. While accurate prediction of such trajectories is a challenge in itself, chapter 1 showed that the challenge does not end there and that incorporating some sort of larval behaviour is mandatory in most

Biophysical models are tools to explain, infer, and generate hypotheses

Including behaviour in large scale models is mandatory

situations. For example, chapter 5 demonstrated that ontogenetic vertical migration occurs frequently in coral reef fish larvae, and may influence retention. Actually, even the first model of the early-life history of fish included vertical migration²¹. Since then, evidence has accumulated, highlighting the great swimming and orientation capabilities of fish larvae²⁵ and the large extent to which they can impact trajectories^{70,143,199}. Progress has also been made in small scale modelling of feeding and how vertical position is adapted in consequence^{223,224}. But the examples of large scale integration of such models are still rare^{78,80}.

Vertical and horizontal swimming are indivisible

Similarly to how vertical diffusion may have a greater impact on horizontal displacement than horizontal diffusion (because of vertical shear in the flow¹⁹⁵), vertical swimming may impact dispersal trajectories more than horizontal swimming, because it matters even at very low swimming speeds (as low as $< 1 \text{ cm s}^{-1}$ ¹⁹⁶). However, chapter 5 suggested that these two components of swimming should be investigated together, because vertical swimming may place larvae in weak flow environments where the impact of horizontal displacement increases. Furthermore, from a biological point of view, no such distinction exists between “vertical” or “horizontal” swimming: larvae are only faced with a continuum of possible displacements.

Interactions with currents, prey, and predators

Two sets of biophysical interactions govern swimming behaviour. First swimming interacts with advection by currents, the constraint being to reach a suitable recruitment area by the end of the larval phase. Second, swimming requires energy and there is often a trade-off between feeding and being fed upon, because food rich areas are usually also predators rich¹⁶.

Mesoscale features disrupt mean flow ...

Many mesoscale oceanographic features may contribute to the first set of interactions. Vortices concentrate or eject particles depending on whether they are anti-cyclonic or cyclonic²²⁵. Up- and down-welling flows are respectively accompanied by offshore and inshore currents at the surface, which deviate particles from the mean along-shore flow^{226,227}. Fronts, slicks, or other linear features concentrate particles^{15,228}. Tidal and estuarine circulation are characterised by a strong vertical shear^{197,198}. All these processes affect particles' trajectories, making them diverge from the mean flow. An energetically efficient swimming strategy would exploit the heterogeneities of the currents¹⁹⁹, and such behaviours are probably central because a small displacement at some point can lead to strongly diverging trajectories. Thus, the development of swimming abilities and of orientation in larvae governs their interactions with the currents. While orientation at the end of the larval phase has been observed for coral reef fishes²⁵ (see chapters 1 and 2), its development is unknown except for a few exceptions^{190,229}. Similarly, swimming speed and endurance have been studied at the end of the larval phase (for coral reef fishes in particular²⁵) but their ontogeny is less known. When ontogenetic data is available, it usually describes the development of speed or endurance with size and not with age^{25,56,60,190,230}. For these relationships to be used in models, however,

... and interact with larval swimming abilities as they develop

a good description of the growth curve of larvae in the pelagic environment is needed; and is seldom available^{72,231,232}. Most information is obtained through allometry from otolith growth^{170,233}, a method not yet fully validated and which is likely to be imprecise, or through rearing methods which probably underestimate growth rates in the ocean²²⁹.

Prey-predator interactions in the plankton are the prime driving force for ubiquitous behaviours such as diel vertical migration and are likely to shape other behaviours of planktonic animals. While they may look like pure biological interactions rather than physical-biological ones, the primary production levels are, in fact, driven by the physics of the ocean. First, upwelling (whether coastal or through cyclonic eddies) brings nutrients to the euphotic layer, hence enhances primary production. In addition, slicks and fronts aggregate zooplankton — to the point that Haeckel named them “zoocurrents”¹⁵. The physically-driven enrichment of low trophic levels in these areas attracts higher level consumers, all the way up to top predators such as tunas^{15,16}. From the point of view of fish larvae, these locations are therefore profitable and dangerous at the same time. This trade-off is likely to influence the direction and speed of swimming. First, orienting toward areas rich in prey may not always be a good choice. In addition, swimming fast is very expensive energetically⁹⁴ and because energy acquisition is associated with high predation, fast swimming speeds may be avoided.

Therefore, in models of the early life history of fishes, behaviour should be represented as tightly coupled to the environment, in particular to currents, food, and predators.

The efficient harvest of spatially heterogeneous food has been conceptualised in terrestrial ecosystems under the theory of *optimal foraging*⁵³ (see section I.4.2, page 17). However, little of this literature has been transferred to fishes²³⁴, not to mention fish larvae. The generalised theory of optimal behaviour states that if the environment is stable at the generation level (offspring experience conditions similar to those experienced by their parents), if a behaviour is heritable, if this behaviour is variable, and if these variations impact the fitness of the individuals, then behaviour is under natural selection and will tend toward those variations that provide better fitness^{52,54}. Even if coastal regions can be quite perturbed, the overall system is stable at the generation level: coasts do not move, the trade-off between staying near shore and dispersing away in the ocean exists at each generation, and the oceanic features governing advection and retention function in the same way (while their strength or location may vary from year to year). It is therefore likely that some behaviours would emerge as “better adapted” in this environment. Larval behavioural variables, such as swimming speed or feeding efficiency, have never been proved to be heritable. However, swimming speed is very species specific²³⁵ and differences between species persist across ecosystems²²¹. Therefore, swimming speed, at least, is likely to have a genetic basis. Within species, inter-individual variation is observed in all quantitative aspects of larval behaviour.

Trade-off between eating and being eaten

Optimisation models allow to predict behaviour

Fitness during the larval phase is survival (and growth)

For example the swimming endurance of some individuals may be more than twice the mean of the population²³⁶. Finally, all sections of chapter 1 highlighted how the different aspects of larval behaviour could influence the outcome of the pelagic stage: oriented swimming may enhance retention in food rich areas and facilitate recruitment to suitable nursery zones, efficient foraging would increase growth (because food is limiting), schooling would affect swimming, feeding, avoidance of predators, and enhance recruitment. Surviving the larval phase is a pre-requisite for future reproduction, and fitness can therefore be summarised in term of survival, or recruitment success. Given the very low recruitment rates observed in fishes (around 10^{-5} ^{45,61}), selective pressure is likely to be strong during the pelagic phase, so that any variation in these behaviours which enhances survival would be strongly favoured. In addition, faster growth increases the probability to survive the larval phase^{237,238} and to persist once installed^{48,50,170}. Therefore selective pressure on energy intake and energetic efficiency is also probably intense. Overall, the behaviour of marine larvae, and of larval fishes in particular, can be viewed, studied, and predicted through the prism of the theory of optimal behaviour, thus providing a means to avoid the “simplifying assumption”^{22,25} of passive transport.

Self-recruitment is essential to metapopulations dynamics

In marine metapopulations connected by larval dispersal, self-recruitment was initially thought to be uncommon and local populations were expected to be replenished largely by larvae originating from elsewhere^{22,239}. However, as detailed in section I.2.3 (page 9), self-recruitment is in fact essential to metapopulations dynamics. First, one self-sustaining population may be sufficient to maintain many other sink populations. Second, the shortfalls in self-recruitment of all local populations multiply in the persistence condition of the whole metapopulation³⁰. And indeed, self-recruitment was found to be higher than expected in marine populations (between 20 and 60%^{43,44,240}). Larval behaviour was often evoked to explain such high proportions of retention^{24,57}. Nowadays, the paradigm has shifted from early ideas of open populations to current conceptions of restricted dispersal^{241,242}. Therefore, it seems important to examine the behavioural processes that favour or impede self-recruitment.

This chapter presents a framework for the inclusion of behaviour in models of the early life history of fish, and two applications. Rather than trying to implement the very few known facts about larval swimming, orientation, and feeding as behavioural rules in the model, the rules emerge from the interactions with the environment through the application of optimal behaviour theory with biologically sensible constraints. Within the three categories of early life history models²²², the purpose of this modelling framework is clearly inferential, possibly hypothesis generating, but not explanatory or descriptive. First the framework is presented through a very simplified model, then two complete models are constructed along its guidelines. The first is used to investigate the trade-off between predation and feeding in two species with contrasting

early life histories. The second focuses on a detailed description of swimming and, by comparing passive and active trajectories, seeks to evaluate the relative influence of advection and swimming. In addition, it examines the effect of increased behavioural abilities due to a temperature increase within a global warming scenario.

6.2 A general modelling framework for larval behaviour

In the classical framework of stochastic optimal control^{243,244}, a stochastic dynamic model describes the evolution of the state, decisions (or *controls*) influence the dynamics, and an optimisation quantity (*gain*) is chosen. A *strategy* (which generates a sequence of controls) is optimal if it maximises the mean value of the gain. In this section, we present a simple model intended to help in understanding the use of stochastic optimal control to predict behavioural decisions of fish larvae. It features a highly simplified portrayal of the state and environment of fish larvae (i.e. one-dimensional ocean, binary decisions for larvae) in order to detail Markov chain modelling and its control.

A stochastic optimal control model

6.2.1 Model description

Time

Time is measured in discrete units until a fixed finite horizon. In reality, the pelagic larval duration is often variable around a given mean for each species^{245,246}. Some Acanthuridae, for example, are capable of delaying metamorphosis, hence retarding their recruitment on coral reefs²⁴⁷. Nevertheless, we only consider the mean here, for mathematical simplicity. In this simple model, the time step is 6 hours and the time horizon is 2 months (240 time steps).

Discrete time

State

The state of the system is entirely characterised by the state of the larva, comprised of its energy resources and position. The computation of an energy budget is necessary to obtain biologically sensible strategies. For example, if the energy resources of larvae were not limited, they would be able to swim at their maximum speed eternally without having to rest or eat. Energy resources (θ) are represented as a scalar. When $\theta = 0$, the larva is dead. The position (x) is restricted to a one dimensional vector (distance from the coast). When $x = 0$, the larva is nearshore, in a nursery area, and can recruit.

Larvae characterised by their positions and energy resources

Environment

Environmental variables such as predation pressure, food availability and current velocity are involved in the dynamical evolution of positions and energy resources of larvae. They are described as functions of state

Survival, feeding, and advection affect the state

and time, giving either a real number (current speed) or a probability (to survive or to eat) at each time step. In this simple model, predation pressure, food availability and currents are uniform on the whole space. Survival probability equals the constant p . Food is considered sufficient and the probability to eat is one. Currents are taking the larva away from the coast by a quantity $\Delta x^0 > 0$ at each time step.

Controlled dynamics

Foraging or swimming At each time step, the larva must resolve a trade-off between two types of behaviour: foraging (decision $d = 0$) or directional swimming (decision $d = 1$)^a. Each behaviour has consequences on its future state, as described below and in Figure 6.1.

Foraging Either the larva dies, or it survives with probability p , increases its energy by a fixed quantity $\Delta\theta^0$, and is taken away by the current on a distance Δx^0 .

$$(\theta_{t+1}, x_{t+1}) = \begin{cases} (0, x_t) & \rightarrow 1-p \\ (\mathcal{S}_0^{\theta_{\max}}(\theta_t + \Delta\theta^0), \mathcal{S}_0^{x_{\max}}(x_t + \Delta x^0)) & \rightarrow p \end{cases}$$

where “ \rightarrow ” means “with probability” and indices denote a function of time (i.e. $\theta_t = \theta(t)$ and $x_t = x(t)$). The \mathcal{S} function (saturation) ensures that position and energy stay bounded, and is defined by

$$\mathcal{S}_{\xi_{\min}}^{\xi_{\max}}(\xi) = \begin{cases} \xi_{\max} & \text{if } \xi > \xi_{\max} \\ \xi & \text{if } \xi \in [\xi_{\min}, \xi_{\max}] \\ \xi_{\min} & \text{if } \xi < \xi_{\min} \end{cases}$$

Directional swimming Either the larva dies, or it survives with probability p , swims toward the coast, against the current, and travels a distance Δx^1 . It consumes $\Delta\theta^1$ units of energy doing so.

$$(\theta_{t+1}, x_{t+1}) = \begin{cases} (0, x_t) & \rightarrow 1-p \\ (\mathcal{S}_0^{\theta_{\max}}(\theta_t - \Delta\theta^1), \mathcal{S}_0^{x_{\max}}(x_t - \Delta x^1)) & \rightarrow p \end{cases}$$

A controlled Markov chain ...

These probabilities are used to build the transition matrices which characterise the Markov chain (Figure 6.2). An element $\mathcal{M}(i, j)$ of such matrices is the probability of transition between the initial state i and the final state j . As the Markov chain is *controlled*, a different transition matrix is associated with each decision (i.e. control) of the larva.

The simplest meaningful transition matrices for this model are presented in Figure 6.2. State is defined by three energy levels and four

^aIn stochastic optimal control, controls (i.e. decisions) are commonly noted using the letter u . To avoid confusion with the zonal (West-East) component of current in a three dimensional flow, which is the u component of a (u, v, w) vector field, decisions are noted d here.

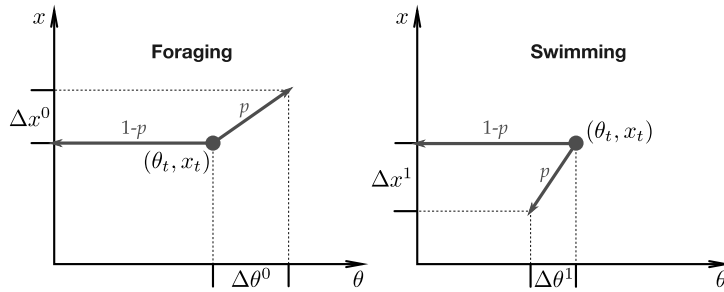

Figure 6.1 State space representation of the transitions. θ is the amount of energy reserves, x is the position. The arrows represent the transitions from the initial state (θ_t, x_t) and the probability associated with each transition is written above the arrow. The left panel represents the transition when the larva is foraging ($d = 0$), the right one when the larva is swimming ($d = 1$)

distances from the coast. When the larva forages, it moves away with the current on one distance unit but gains one energy unit (matrix \mathcal{M}^0); when it swims, its distance from the coast is reduced by one unit but one energy unit is expended (matrix \mathcal{M}^1). Let us detail how these matrices are constructed in a few relevant cases.

First, a dead larva (initial energy equals zero) remains dead (final energy is zero), at the same position, whatever the decision. Thus the identity matrix is placed at the upper left corner of each matrix. Now, consider case A, in Figure 6.2. The larva's initial state is (energy = 1, position = 1) and its decision is to forage ($d = 0$). Either it dies, with probability $1 - p$, or it survives with probability p . Only these two probabilities are non-null, and need to be placed on line A. When the larva dies, its energy becomes zero and it remains at the same position (position = 1); thus we place $1 - p$. When it survives, it forages and its energy increases to 2, but it is shifted away from the coast by one unit (position becomes 2); thus we place p . Then, consider the same initial state but the alternative decision: swimming ($d = 1$). That is case B. When the larva dies, nothing changes. When survives, it swims, loses one energy unit (energy becomes zero) and comes closer to the coast (position becomes zero). Eventually, let us consider a two-step scenario. The larva starts from case A. It survives with probability p . Its state is now (energy = 2, position = 2), i.e. case C. Either it dies and its state becomes (energy = 0, position = 2) with probability $1 - p$; or it survives and swims toward the coast: its state becomes (energy = 1, position = 1) with probability p .

... with only two possible transitions per initial state

Optimisation criteria

Within this modelling framework, we are only concerned with *successful* trajectories: larvae that return to where they were spawned at the last time step (i.e. the only possibility for recruitment here). In the simplest

Maximising survival probability ...

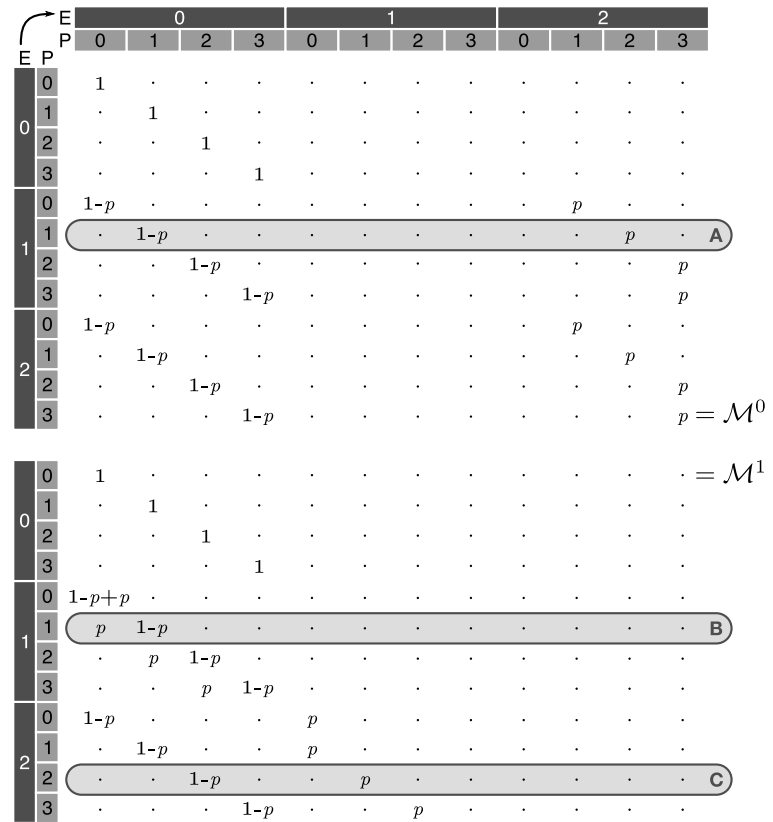

Figure 6.2 Transition matrices for the simplest parameterisation of the one-dimensional model. \mathcal{M}^0 is the matrix associated with foraging (top), and \mathcal{M}^1 is the matrix associated with swimming (bottom). In each case, lines are initial states, columns are final states, and elements of the matrix are transition probabilities (zeros are displayed as dots for clarity). States are indexed by energy reserves (E) and position (P)

scenario, interest is in strategies which maximise the probability of recruitment. The number of self-recruiting trajectories is potentially infinite, so maximising self-recruitment probability means selecting the strategies, hence trajectories along which *survival* is maximal. In other words, as self-recruitment is a prerequisite, the quantity optimised along recruiting trajectories (the *gain*) is, in fact, survival. As the introduction highlighted, this criterion is meaningful in terms of natural selection. However, more complex criteria can be specified, such as probability of return with maximum energy, with a given energy level, etc. The gain is then defined in terms of instantaneous gain (gain at each time step) and final gain (gain at the last time step).

... and energy resources
at recruitment

In this simple model, we focus on trajectories which optimise the probability of recruiting with maximum energy. This translates into zero

instantaneous gains (there are no gains or costs along the trajectories as long as they satisfy the given criterion at the last time step), which are thus defined by the function

$$L(\theta, x, d, t) = 0 \quad \forall \theta, x, d, t \quad (6.1)$$

and a final gain equal to the amount of energy reserves of a larva when it reaches the nursery ($x = 0$), and zero elsewhere

$$\Phi(\theta, x, T) = \theta \cdot \mathbf{1}_{\{x=0\}} \quad (6.2)$$

The function $\mathbf{1}_{\{x=0\}}$ equals one when the condition is satisfied ($x = 0$), zero otherwise.

Eventually, from any initial point in time ($t = t_i$) and state (θ_{t_i}, x_{t_i}) , the optimisation problem can be written as the value function

$$\begin{aligned} V(\theta_{t_i}, x_{t_i}, t_i) &= \max_{d_{t_i}, \dots, d_{T-1}} \mathbb{E} \left(\sum_{\tau=t_i}^{T-1} L(\theta_\tau, x_\tau, d_\tau, \tau) + \Phi(\theta_T, x_T, T) \right) \\ &= \max_{d_{t_i}, \dots, d_{T-1}} \mathbb{E} (\theta_T \cdot \mathbf{1}_{\{x_T=0\}}) \end{aligned} \quad (6.3)$$

meaning that, over all possible future decisions (d_{t_i}, \dots, d_{T-1}), the final energy (θ_T) is maximised but only if the larva reaches the nursery (i.e. only if $x_T = 0$).

6.2.2 Stochastic dynamic programming equation

Backward induction of decisions

Now that the evolution of the state is described (by transition matrices) and that an optimisation criterion is specified (maximise energy resources at recruitment), optimal strategies have to be found. Optimal strategies are functions of state and time which give a sequence of optimal decisions ($d_0^\#, \dots, d_{T-1}^\#$) for each state. They are computed by means of the stochastic dynamic programming equation (or Bellman's equation)^{243,244} which is the backward induction

Computation of the value function from the final gain

$$\left\{ \begin{array}{l} V(\theta, x, T) = \theta \cdot \mathbf{1}_{\{x=0\}} \\ V(\theta, x, t) = \max \left(\begin{array}{l} (1-p)V(0, x, t+1) + \\ pV(\theta + \Delta\theta^0, x + \Delta x^0, t+1), \\ (1-p)V(0, x, t+1) + \\ pV(\theta - \Delta\theta^1, x - \Delta x^1, t+1) \end{array} \right) \\ d^\#(\theta, x, t) \in \operatorname{argmax} \left(\begin{array}{l} (1-p)V(0, x, t+1) + \\ pV(\theta + \Delta\theta^0, x + \Delta x^0, t+1), \\ (1-p)V(0, x, t+1) + \\ pV(\theta - \Delta\theta^1, x - \Delta x^1, t+1) \end{array} \right) \end{array} \right. \quad (6.4)$$

where $V(\theta, x, T)$ is the final gain and the first argument (i.e. the first two lines) of the max and argmax functions is the mean gain associated

with foraging, while the second argument (i.e. the last two lines) is the mean gain associated with directional swimming. Note that time indices were omitted for clarity. These equations compute Bellman’s value function (V) backward in time, from the final gain, $V(\theta, x, T)$, which is known. They also give associated optimal decisions $d^\#(\theta, x, t)$ in feedback form (i.e. as functions of state and time).

Furthermore, at $t = 0$ and using equation (6.3) we can remark that

$$V(\theta_0, x_0, 0) = \max_{d_0, \dots, d_{T-1}} \mathbb{E}(\theta_T \cdot \mathbf{1}_{\{x_T=0\}}) \tag{6.5}$$

Self-recruitment rate without running trajectories Which means that the gain at starting time provides direct access to the probability of recruitment (the expectation of $\mathbf{1}_{\{x_T=0\}}$). Once the value function (V) is computed until time $t = 0$, the optimal self-recruitment rate is known, without having to actually run trajectories.

Special case simplification In the case of our simple model, these equations can be simplified. Indeed, when a larva is dead, it remains at the same state (energy = 0, position = x) with probability one (see Figure 6.2). Hence, for any t , $V(0, x, t) = V(0, x, t + 1) = \dots = V(0, x, T)$. From the definition of final gain in equation (6.2), we have $V(0, x, T) = 0$ for any x . So, overall, $V(0, x, t) = 0$ for any t and any x , and equation (6.4) simplifies itself into the induction

$$\begin{cases} V(\theta, x, T) = \theta \cdot \mathbf{1}_{\{x=0\}} \\ V(\theta, x, t) = \max \left(\begin{array}{l} pV(\theta + \Delta\theta^0, x + \Delta x^0, t + 1), \\ pV(\theta - \Delta\theta^1, x - \Delta x^1, t + 1) \end{array} \right) \\ d^\#(\theta, x, t) \in \operatorname{argmax} \left(\begin{array}{l} pV(\theta + \Delta\theta^0, x + \Delta x^0, t + 1), \\ pV(\theta - \Delta\theta^1, x - \Delta x^1, t + 1) \end{array} \right) \end{cases} \tag{6.6}$$

This backward equation is solved using the software Scilab²⁴⁸ (see next paragraph). However, the last two optimal decisions can easily be inferred as they are quite intuitive. The last optimal decision, at time $T - 1$, should be to swim if the nursery is reachable. Otherwise, there is no difference between swimming and foraging: the nursery will never be reached anyway. At time step $T - 2$, if the coast is very far (beyond two times the larva’s swimming capacity in one time step) there is no preferred choice for the same reason: it cannot be reached at $t = T$. If the coast is at twice the distance that a larva can swim in one time step, the optimal choice should be to swim so that the nursery becomes reachable at time $T - 1$. If the coast is very close, the decision of the larva should be to eat, increasing its energy resources, and then swim at time $T - 1$ to reach the nursery; this way, energy resources are maximised. The reader can find mathematical justifications of these conclusions in the appendix “Choice of the last two optimal decisions”, page 168.

Numerical solution

Given the description of the evolution of the state through transition matrices (Figure 6.2), solving the backward computation of gain and decisions (equation 6.4) is a matter of manipulating matrices. The final gain is a vector indexed by state. In the simple case presented in Figure 6.2, it is a column vector of length 12. Now, computing the value function (i.e. the optimal gain) at time $T - 1$ is a three step process:

Multiply transition matrices and gain, backward in time

1. Fill the matrices describing the transition probabilities from all states at $t = T - 1$ to all other states at $t = T$, for the two decisions. These probabilities come from the description of the dynamical system (advection by currents, energy consumption, etc.) and this process has been detailed for three examples on page 121.
2. Multiply each matrix by the final gain vector. For each initial state, this means multiplying the gain associated with every reachable final state by the probability to reach it and then summing all those products. These sums are therefore the mean gain at $T - 1$, for each state and each decision.
3. For each state, compare the gain values in the two mean gain vectors (one for each decision), choose the maximum, and record to which decision it corresponds. This gives optimal mean gain and optimal decisions.

To compute the value function at $t = T - 2$, repeat these steps with the optimal mean gain at $t = T - 1$ instead of the final gain. And similarly until $t = 0$.

6.2.3 Example trajectories

Given the description of the environment and the characteristics of the larva, optimal strategies (giving sequences of optimal decisions) and optimal trajectories (state trajectories for which the sequence of decisions is optimal) can be computed. There is no finite number of optimal trajectories. Indeed, in this version of the model, stochasticity is introduced by random survival.

Two characteristic examples of optimal trajectories are presented in Figure 6.3. As remarked for the last two decisions, the behaviour of larvae is very intuitive. When it survives (left plot), the larva forages and lets itself be taken away by currents until it reaches its maximum energy resources. Then, it alternates swimming and foraging in order to keep energy close to its maximum at final time. In the right plot, the behaviour begins the same way but the larva dies at time step 25. We can conclude from the results of this simple model that the algorithm used to simulate larval behaviour and to solve the optimisation problem is correct.

Predictable and sensible decisions: the problem is solved correctly

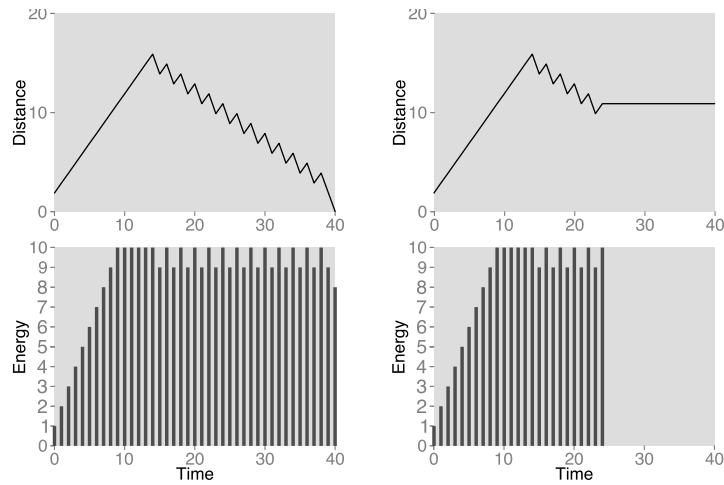

Figure 6.3 Two examples of optimal trajectories. On the left, the larva survives and recruits successfully nearshore ($x_T = 0$). On the right, the larva dies before reaching the shore. The upper plots are the trajectories. The lower panels show energy resources. Notice that, even for the trajectories, abscissa represents time and not a component of position (position is one-dimensional).

6.3 The balance between feeding and predation: comparison of life history strategies

Now that the quality of the algorithm has been checked, the aim of more elaborate versions of the model is to approach a biologically relevant description of the pelagic larval episode of fishes. In this first refinement, we focus on introducing three dimensional prey and predators distributions around an deep-ocean tropical island. Literature data allows to choose nominal size order values for the parameters used in simulations, yet they are not intended to represent a precise field situation. Rather, the aim of this model is to infer the relative influence of different variables (probability to feed, to be predated upon, etc.), varying within biologically sensible ranges.

6.3.1 Plankton and predators in a 3D current field

Three dimensional island

An isolated tropical, deep-ocean island is represented in three dimensions as a cylinder of 7 km diameter, rising from a horizontal sea bottom. The island is both the spawning point and the only recruitment possibility for larvae. All quantities are discrete, including space. The domain is $100 \text{ km} \times 50 \text{ km}$, and the water column is 100 m high. The horizontal mesh size is 720 m and the vertical coordinate is divided in four depth levels. As we will explain later, the value of the mesh of this model is determined by other parameters and is not a direct choice of the user.

Water around isolated tropical islands is driven by a quite steady and uniform flow, possibly disrupted locally by winds and tides²⁴⁹. In this current field, islands induce perturbations in their lee, such as eddies²²⁵ or complex backward jets at depth²⁰². Here currents are simulated with SYMPHONIE^{250,251}, a three dimensional, σ -coordinate, finite difference oceanographic model. A steady flow of 10 cm s^{-1} is injected at the eastern boundary of the domain and the model simulates the structures created by the island. Only a snapshot of SYMPHONIE's output (Figure 6.4), with little turbulence, is used as input for the total duration of the biological run. While this static view may seem oversimplified, it allows to focus on the trade-off between predation and feeding, which is the purpose of this model. Finally, we decide arbitrarily that the incoming velocity (10 cm s^{-1}) corresponds to a movement of three space units during one time step. The time step is 6 h ($6 \cdot 3600$ seconds), so the space unit is $6 \cdot 3600 \cdot 10 / 3 = 72\,000 \text{ cm}$ or 720 m.

Steady flow

Deep ocean islands can be compared to oases in a desert of oligotrophic waters. Nearshore waters sustain high primary production due to terrigenous input and/or upwelling of deep, nutrient-rich water²⁵². Moreover, the current regime described above tends to create a plume of enriched water in the lee of the island. Consequently, fish densities are often higher in the vicinity of an island than in distant oceanic water¹⁵. This phenomenon is known as the "island mass effect"^{165,253}. Therefore, in the model, predation pressure and plankton abundance are described as varying discretely, in three concentric areas. These zones are centred on the island and elongated in a direction and to an extent determined by the current field (Figure 6.4). The spatial averages of survival and feeding probabilities are always constant, but an *island-effect factor* (f) determines how concentrated food and predators are

The island mass effect concentrates predators and plankton

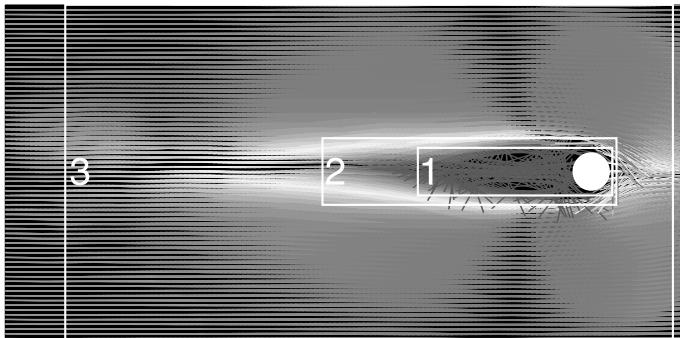

Figure 6.4 Snapshot of SYMPHONIE's output used to advect larvae in the biological run. Warmer colours mean faster current to the West. The water enters the eastern boundary at 10 cm s^{-1} . Behind the island, a region of reduced flow forms. Two accelerated jets are present on both sides of the topography. The white outlines are regions defined for the island mass effect (1: region where returning flow may occur, 2: region of reduced flow, 3: biological domain).

Diel vertical migration of prey

around the island. When $f = 1$, probabilities are homogeneous on the whole domain. Daily mortality probability is set to 0.22 which is the mean observed for temperate perciform fishes²³². It is probably a low estimate for tropical ones because mortality increases with temperature between ecosystems⁷². Feeding probability per 6 h time step is equal to an arbitrary value of 0.5 (i.e. the null hypothesis that larvae have one in two chance of feeding when they try to). When $f = 1.4$, feeding probability is approximately 1 close to the island, 0.7 in the mid-field area, 0.45 in the far field; and survival probability varies inversely: low in the near-field, and close to one in the far-field. To evaluate the impact of the repartition of prey and predators, f values equal to 1, 1.1, 1.2, and 1.4 are compared. Finally, zooplankton completes a daily vertical migration and is abundant in the bottom water layer during the day and in the top layer at night. Therefore, the availability of prey also depends on the depth and time of day. In the model, larva surrounded by abundant plankton is one and a half time more likely to succeed when foraging than a larva in the vicinity of low plankton densities.

6.3.2 More elaborate larval dynamics and stochastic model

More behavioural possibilities and stochasticity

As space is three dimensional, behavioural possibilities increase. Seven decisions are available: swimming northward, southward, eastward, westward, toward the bottom, toward the surface, or foraging (Figure 6.5). Fish larvae have been observed to eat “on the run”²⁵⁴. So, in the model, when larvae forage, they also swim. Nevertheless, their movement is assumed random as it is determined by wherever their planktonic prey are.

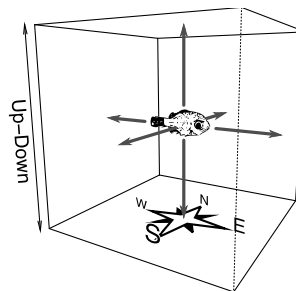

Figure 6.5 Swimming decisions available in this refined model: 6 possible directions.

The state comprises energy and position

The state of larvae still consists of their energy resources and position (which is now a vector with three components). The optimisation framework used here implies that these theoretical larvae are aware of their state, in particular of their position with respect to the island, at all time. As underlined in chapter 1 and 2, sensory abilities of larvae have only been investigated at the end of the larval phase⁵⁸. At

this stage, larvae are capable of orienting toward or away from reefs²⁵ and even to recognise the chemical signature of their reef of origin⁴². Swimming abilities of fish larvae were shown to develop much earlier than what was expected⁶⁰ and it might be the same for sensory abilities. Early-stage larvae may also be able to locate islands and reef. Fishes of the genus *Amphiprion*, for example, are known to be sensible to sound at the embryo stage already²⁵⁵. This model focuses on the behavioural response of larvae and this is the reason for such emphasis on their sensory abilities. Furthermore, this modelling framework is intended to identify optimal pelagic trajectories, not to describe precisely the behaviour of each and every dispersing larva. This point will be fully discussed in section 6.5.

This model is focused on self-recruitment and final gain equals one for every non-dead larva arriving to the island at the given time horizon. Otherwise final gain equals zero. Instantaneous gains still equal zero. Thus, the optimisation problem can be written as

Optimising survival

$$\max_{d_0, \dots, d_{T-1}} \mathbb{E}(\mathbf{1}_{\{x_T \in \text{isl.} \cap \theta_T > 0\}}) = \max_{d_0, \dots, d_{T-1}} \mathbb{P}(x_T \in \text{isl.} \cap \theta_T > 0) \quad (6.7)$$

The criterion maximised is therefore the probability of recruitment ($\mathbb{P}_{x_T \in \text{isl.} \cap \theta_T > 0}$). As demonstrated in the section “Optimisation criteria”, page 121, when focus is on successful (i.e. recruiting) trajectories, this criterion means in fact optimising (i.e. maximising) *survival* probability. Furthermore, by equation (6.5), the maximal probability to reach the island is given by $V(\theta_0, x_0, y_0, z_0, 0)$ where V is the value function. This provides direct access to the optimal self-recruitment rate once the value function is computed, without having to run trajectories and deduce it *a posteriori*.

Note – Computer memory and speed Dynamic programming requires lots of physical memory when the state dimension grows. This phenomenon is known as the “curse of dimensionality”^{243,244}. In addition, optimal decisions are often non-continuous in nature (such as swimming vs. foraging here). When they are continuous, their distribution is not: if the optimal decision at $x = 1$ is to swim Northward and the optimal decision at $x = 2$ is to swim Eastward, the optimal decision at $x = 1.5$ is not necessarily to swim North-Eastward. Thus, the curse cannot be escaped by computing decisions on a coarse grid and interpolating them afterward. As the state becomes more detailed (e.g. spatial resolution increases), the size of transition matrices, which describe the transition from one state to all the others (Figure 6.2), increases by a square factor. For example, with a $100 \times 100 \times 3$ space and 6 energy levels, the state has dimension 180000. Stored as float numbers, a $180,000^2$ matrix takes 130 MB of memory. In the elaborate model, there are seven of them to be filled and kept in memory at once, to compute optimal decisions at every time step, as explained in the section “Numerical solution”, page 125.

The curse of dimensionality

Transition matrices are sparse One solution in Scilab is to use linked C routines for the filling of matrices, and to store them as *sparse matrices*. Sparse matrices take advantage of the fact that transition matrices contain mostly zeros (only two final states are reachable from any initial state) and store only the positions and values of non-zero probabilities. The progress in computation time is impressive: from a whole day to two seconds for a $20 \times 20 \times 2 \times 6$ state space. This is the solution used here.

Another solution, however, is to forget about the matrix aspect of the calculation altogether, bluntly loop over all states, for each one compute all possible outcomes for all decisions, and compute and store the maximum mean gain and the associated optimal decision before moving on to the next state. While very inefficient in an interpreted language such as Scilab, which is slow at loops and only fast at vectorised operations, this can be a viable solution in a compiled language where vectorisation and parallelisation of loops are efficient (such as C or Fortran). When the state and number of decisions grow too much, it can become the only solution.

6.3.3 Comparison between contrasting biological parameters

Reproductive strategies in fishes Reef fish larvae present very different behavioural characteristics depending, in part, on the species' reproductive strategy²⁵⁶.

1. Eggs can be directly dispersed in the water, thus advected as passive particles; then larvae hatch in the ocean. The eggs are usually small and numerous which mean larvae are small and little developed at hatching.
2. Eggs can be demersal (i.e. laid on the substrate, within the reef). Parents care for the eggs until they hatch. Then larvae disperse into the ocean but are usually larger and have greater swimming and sensory abilities than larvae hatching from pelagic eggs.
3. The larval phase is completed entirely inside a lagoon (rare).

Compare Acanthuridae and Pomacentridae which differ in ...
 ... their pelagic duration ... To investigate how these contrasting behavioural abilities affect dispersal patterns, two theoretical larvae with different early life histories are compared, namely an Acanthuridae with pelagic eggs and a Pomacentridae with demersal eggs. The families first differ in the duration of their larval stage: around 50 days for Acanthuridae²⁵⁷ and from 14 to 35 days among Pomacentridae²⁴⁶. Pelagic larval periods of 50 and 20 days are chosen as examples. Acanthuridae disperse eggs that are completely passive. After approximately 24 h, larvae hatch and develop four days before the first food intake. Afterward, their swimming abilities improve substantially, and late-stage Acanthuridae larvae have been shown to be very good swimmers²³⁶. By contrast, Pomacentridae species whose eggs are demersal disperse larvae that are active right from the start of the pelagic period. Their swimming abilities improve brutally around the middle of the pelagic phase⁶⁰ but stay below those

of Acanthuridae²³⁶. Therefore, the larval phase is divided into three time periods, to account for the changes in swimming abilities. The limits of those three periods are defined approximately at ontogenetic shifts: end of yolk sac period and end of flexion. Swimming speed values are estimated from published records^{60,236,258}. Most studies measured critical swimming speed (maximal speed of a current against which a larva can maintain its position). These speeds are probably greater than actual swimming speeds in the field²⁵⁸. Therefore, we choose lower swimming speeds for both species in each time period, while retaining the difference observed between them: 0, 13, and 36 cm s⁻¹ for the Acanthuridae and 3, 10, and 20 cm s⁻¹ for the Pomacentridae.

During the first period, larvae extract energy from their yolk sac reserves, hence do not need to forage. In the model, their energy resources are constant and maximal. Afterward, they lose one energy unit per time step. As they have a maximum resource of five units they can only swim four time steps (24 h) before food is required. Coral reef fish larvae can swim for longer periods of time before starving (up to 194 h for Acanthuridae for example)²³⁶. Nevertheless, in the field, larvae are likely to avoid starvation and keep their energy resources level as high as they can. Furthermore, most studies about the swimming endurance of reef fish larvae focus on the time that a larva can swim against a current before starving or being completely exhausted, without any consideration about maintaining growth rate or integrity of metabolic pathways. However, the daily food intake of fish larvae needed to maintain their growth rate is high (50% of body weight per day is a general mean²³²), especially for fast-growing, warm-water fish larvae²³². Therefore, fish larvae should eat often, probably on a daily basis, during dispersal.

... and their swimming abilities

Energy intake is limiting in fish larvae

Finally, the parameters for this more elaborate model can be summarised along the guidelines set by the modelling framework.

Time 6 hours time step; horizon of 50 days for Acanthuridae and 20 days for Pomacentridae

State Energy reserves (five levels, one consumed per 6 h of swimming) and three-dimensional position in a 100 km × 50 km × 100 m domain of 720 m horizontal mesh size and 50 m vertical mesh size.

Environment Spatially explicit survival and feeding probabilities; concentration around the island is described by factor f ; $f = 1$ means homogenous repartition; as f increases, the island effect is stronger and food as well as predators are more concentrated near shore; $f = 1, 1.1, 1.2$ and 1.4 are tested. Static current field with incoming flow speed of 10 cm s⁻¹.

Controlled dynamics Seven decisions: swimming north, south, east, west, up, down and losing one energy unit, or foraging and filling energy reserves when successful. Swimming speeds increase in three steps:

| | Acanthuridae | Pomacentridae |
|-----------------|------------------------------|------------------------------|
| Steps duration | 5, 25, 20 days | 3, 10, 7 days |
| Swimming speeds | 0, 13, 36 cm s ⁻¹ | 3, 10, 20 cm s ⁻¹ |

Optimisation criterion Reach the island at final time, with energy > 0 (i.e. maximise survival during the pelagic phase)

6.3.4 Resulting optimal trajectories and decisions

Comparison between families

Avoiding predation,
following plankton

In this more elaborate model, uncertainty is introduced in several ways: feeding and surviving are stochastic events and the direction of swimming when foraging is also random. Optimal trajectories are therefore not unique. Only one characteristic example of successful trajectory is presented for each type of larva in Figure 6.6. Common features can be identified in the two trajectories presented. At the beginning of dispersal, larvae do not need to feed because their energy resources come from their yolk sacs. Their only requirement is therefore to survive. As a consequence, the optimal trajectories of Pomacentridae (which can swim) go out from the high predation zone, enhancing survival probability (Figure 6.6, column 2, lines 1 and 4). Then, as death by predation is negligible in zone 3, the priority of larvae becomes food acquisition. Indeed, energy resources begin to vary during time step 2. During this period, trajectories are characterised by vertical movements which are related to the vertical migration of plankton: when the larva needs to feed, it moves to the high plankton density layer, hence maximising its probability to find food (Figure 6.6, second line in both columns). Finally, when swimming abilities are well developed (after flexion, during time step 3), larvae return to the island. As larvae come closer to the island, predation risk increases. Therefore optimal trajectories are those reaching the island sideways (North or South in our geometry) in order to pass through the thinner portions of the high predation areas and to maximise survival (Figure 6.6, lines 3 and 4 in both columns). We conclude that, as in the first, simple, case, this modelling framework gives sensible and biologically interpretable trajectories.

Pomacentridae remain
closer to the island

One main difference between these optimal trajectories is that Pomacentridae stay closer to the island than Acanthuridae (this is very noticeable in the two-dimensional plots of Figure 6.6). The difference is probably related to the pelagic eggs, longer pelagic phase, and greater swimming abilities of Acanthuridae: they are entrained farther away

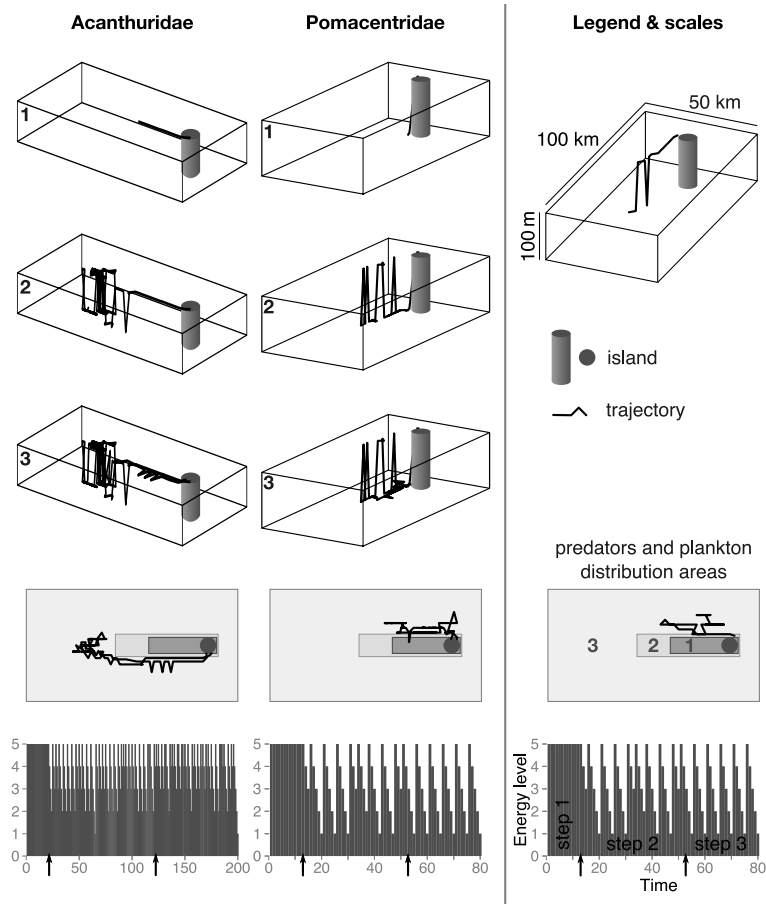

Figure 6.6 Comparison of a characteristic example of optimal trajectory for a larva of type Acanthuridae (left) and a larva of type Pomacentridae (centre), with an island-effect factor of 1.2. In each column, the first three plots are a three-dimensional representations of the trajectories until the end of the first, second and third time steps. The fourth plot is a two-dimensional representation of the complete trajectory overlaid on the three regions of differential abundance of predators and plankton. The bottom plot depicts the evolution of the energy resources through time. The rightmost column displays legends.

from the island, for a longer time, and are still capable of swimming back to the island to recruit.

Initial mortality impacts
self-recruitment rate

The absolute value of the optimal self-recruitment rate is probably not realistic here. Indeed, the parameters used in the model are size order values and do not represent a precise field situation. In particular, while the space-averaged mortality rate is deduced from the literature (and equals 22% per day), the rest of the probabilities have to be inferred. Nevertheless, we can notice that the recruitment rate is two orders of magnitude lower in Acanthuridae ($\sim 10^{-4}$) than in Pomacentridae ($\sim 10^{-2}$). Note that the difference is probably compensated at the juvenile stage because juvenile mortality is size dependant^{48,50,170} and Acanthuridae recruit at larger sizes than Pomacentridae. Once again, the difference in recruitment rate is probably related to the greater duration of the pelagic phase in Acanthuridae, which exposes them longer to predation. However, this may also be related to their incapacity to swim during the early part of dispersal. Indeed, all Acanthuridae trajectories beginning in the lee of the island are entrained through the predator-rich zones (zones 1 and 2) by the current and this results in high mortality. As sketched in Figure 6.7, this is not true for Pomacentridae, which use their rudimentary swimming abilities combined with predominant currents to avoid these high predation zones, hence diminishing their early mortality rate.

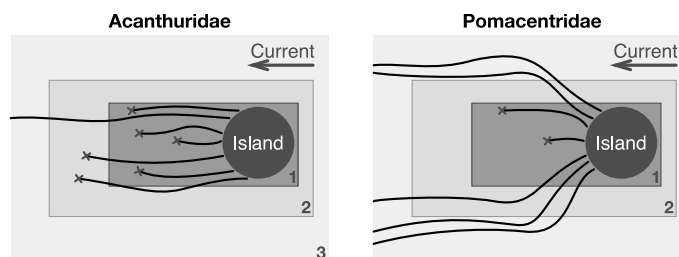

Figure 6.7 Schematic comparison of the beginning of trajectories starting on the downstream side of the island for Acanthuridae (left) and Pomacentridae (right). The shading in the three zones is proportional to the amount of predators and plankton. Acanthuridae cannot swim at the beginning of the pelagic phase and are only driven by the current field. This keeps them mostly in the predator-rich areas and many die (crosses). By contrast, Pomacentridae can swim and flee these areas.

Sensitivity to the strength of the island mass effect

Stronger island mass
effect leads to lower
recruitment rate

As we just showed, predation and feeding drive the decisions and trajectories of larvae. Due to their contrasting early life history, the two types of larvae considered here may be influenced by the island mass effect in different ways. The sensitivity of recruitment rate to values of f , the island mass factor (i.e. to the concentration of predators and plankton around the island) is tested. Once again, the absolute values of

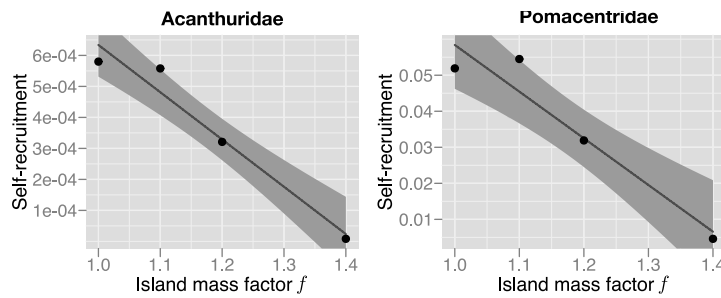

Figure 6.8 Linear regression of the recruitment rate against the island-mass factor for the two larval types (Acanthuridae: left; Pomacentridae: right). Regression lines as well as 95% confidence intervals are drawn. Larger values of f mean more aggregation of plankton and predators around the island.

the optimal recruitment rate are probably not realistic, but the variations of these values are still meaningful and can be studied in a sensitivity analysis. In both cases, an increased concentration of predators and plankton around the island leads to lower recruitment (Figure 6.8). Notwithstanding the low number of points, the linear regressions are significant: $p = 0.022$, $R^2 = 0.96$ for Acanthuridae, $p = 0.041$, $R^2 = 0.92$ for Pomacentridae.

This effect has two explanations. First, Figure 6.7 highlighted that predation on the early stages has probably a large influence on the recruitment rate: it participates in a two orders of magnitude difference between Acanthuridae and Pomacentridae. When the island-mass factor increases, predation close to the island is more frequent. In consequence, a larger proportion of Acanthuridae larvae die early and recruitment rate diminishes. This explanation is supported by the difference between larvae starting on the downstream side of the island (i.e. spending a lot of time in zone 1) and larvae starting on the upstream side of the island (i.e. spending little time in zone 1, because the flow ejects them on the sides of the island). Indeed, as the island-mass factor increases, the difference between those two regions widens: the recruitment rate of larvae starting on the downstream side drops quickly while it only decreases slowly for larvae starting on the upstream side. Then, along trajectories which avoid predation (either those starting on the upstream side or Pomacentridae swimming away from zone 1), the problem becomes food availability. When food is concentrated around the island it is relatively scarcer in zone 3 and more larvae die from starvation. Overall, an higher concentration of resources and predators around the island has a noticeable adverse effect on self-recruitment rate, and its precise quantification through further studies would be valuable.

The effect is mainly explained by predation

6.3.5 Discussion

| | |
|---|---|
| Species with demersal eggs are more abundant near shore | The differences in behaviour of our two theoretical larval types, implied by their reproductive strategies, have important consequences on their optimal pelagic trajectories. The differences observed qualitatively fit the few observations of fish larvae densities around tropical islands ^{130,259} . Indeed, species with demersal eggs are more abundant in the vicinity of the island, on the downwind side. This is interpreted as retention. On the contrary, species with pelagic eggs are found mainly on the windward side of the island. In that case, they are supposed to come from an upstream reef and not to be retained there. In our case, recruitment on another reef is not possible. Nevertheless, Pomacentridae larvae (demersal eggs) are retained closer to their natal island than Acanthuridae (pelagic eggs). This underlines the fact that some behavioural variables may be crucial in determining dispersal trajectories and recruitment rate. |
| Important effect of predation | Of the two environmental variables which interact with behaviour here (distribution of prey and of predators), the influence of predation seems to be the most important. It is the prime determinant of a two orders of magnitude difference in optimal self-recruitment rate between Acanthuridae and Pomacentridae, and explains the decrease in self-recruitment when the island-mass factor increases. Early feeding was initially thought to be key in temperate systems. It led to the definition of the critical period by Hjort ¹ , of the match-mismatch by Cushing ¹² , and to many developments of those hypotheses since. In tropical systems, where feeding requirements are high (larvae have to feed daily in the model, even at the end of the larval stage when they are observed to sustain much longer periods of food deprivation in laboratory experiments ²³⁶) and with a conservative estimate of predation rate (the estimate used here is a mean for perciform fishes, mostly temperate ones ²³² , while mortality is likely to be higher in warmer waters ⁷²) it seems that early predation is more important. In fact, a similar balance between death by starvation or predation was also considered to explain the variations in the abundance of Cod on Georges Bank ²⁶⁰ . In addition, the relative influence of early stage predation vs. late stage predation may be even greater because predation is size dependent and young, small individuals are more vulnerable ^{237,238} . |
| Vertical migration may be less flagrant | The primary effect of feeding is the oscillation between surface and bottom, in the quest for high plankton densities. However, most fish larvae are probably visual feeders and require light to feed ²⁶¹ and no restriction on feeding based on the time of day was introduced in the model. Therefore such oscillations may be restricted to dawn and dusk periods, when light is still present and plankton already migrates. To resolve such movements however, the time step of the model should be decreased enough to capture up and down movements during those two periods (probably down to an hour). On the other hand, predation may also participate in the vertical movement of fish larvae, because it |

is expected to be higher in the surface during the day. But this effect is currently difficult to parameterise sensibly given how little information is available regarding predation on larval fish.

Eventually, in this static flow regime, optimal trajectories tend to follow the exterior contours of the region of slow flow and of the zones of high predation behind the island. This result also fits with the observation that larval fish densities are often high at the edge of eddies¹⁶⁴. The accumulation is probably driven by a compromise between the three factors considered here: advection, predation, and feeding. Indeed, inside eddies advection is reduced, feeding is favoured due to higher concentrations of plankton¹⁶⁴ but predators are also more numerous. Outside eddies the abundances are inverted. This is represented in the model by fitting zones 1, 2, and 3 to the current field determined by SYMPHONIE. As a result, staying at the limit between these areas is optimal probably because it limits advection and predation while not impeding feeding too much. A more continuous description of the prey and predator field would be interesting to evaluate this trade off more clearly. Unfortunately the distribution of predators is likely to be difficult to know with such precision. Similarly, the extent to which this feature is robust in a more dynamic flow field looks like a very promising perspective for such models.

Accumulation at
the edge of eddies

6.4 The relative influence of oriented swimming and passive advection in a dynamic flow field

In this second refinement of the model, focus is on the interaction of swimming behaviour and currents. A more dynamic view of the current field is introduced and the description of swimming is refined, to study how optimal strategies would exploit fine scale patterns in the flow. Both the ontogeny and the energetics of swimming are described in a continuous manner. The objective is to compare passive and active trajectories in two complex and dynamic flow conditions and, from those, to infer the influence of swimming. In addition, because temperature has an effect on all metabolic rates, it impacts swimming speed²⁶² and the pace of development³⁷. So the effect of a temperature change on the interaction between currents and swimming is also examined, within a range compatible with a climate change scenario.

6.4.1 Advection in a dynamic current field

Stratified flow in two environments

The current field is provided by the Regional Ocean Modeling System (ROMS) which is a free-surface, hydrostatic, primitive equation, 3D ocean model. It uses stretched, terrain-following coordinates in the vertical (σ -coordinate) and orthogonal curvilinear coordinates in the horizontal^{263,264}. The ROMS is configured for two case studies in which

Two case studies
in the ROMS

the current has to be vertically sheared, and horizontally uniform. The former is meant to reproduce vertical shear observed in the field and is an important feature of the model in relation to the vertical swimming behaviour of larvae¹⁹⁶ (see also previous chapter). The latter is requested to prevent anomalous behaviour of larvae that would seek low speed areas near the boundaries for example. The two configurations consisted of (1) an isolated cylindrical island surrounded by a uniform eastward current and (2) a promontory on the southern side of a channel embedded in an eastward current (Figure 6.9), both of which represent idealised versions of common coastal features.

Initialisation of a channel with a uniform geostrophic flow

To initialise such current field, the zonal flow is defined by a density gradient both meridional and vertical. Details of the formulas used for the definition of the flow are given in Dong et al.²¹⁹. Therefore, the flow is geostrophic and the entire model domain is initialised with the same flow. For both cases the model domain is a zonal channel (200×100 km) and the horizontal resolution is 500 m. The model is discretised with 20 layers vertically. In case (1), the flow is maintained constant at the four domain boundaries using relaxation toward the initial flow

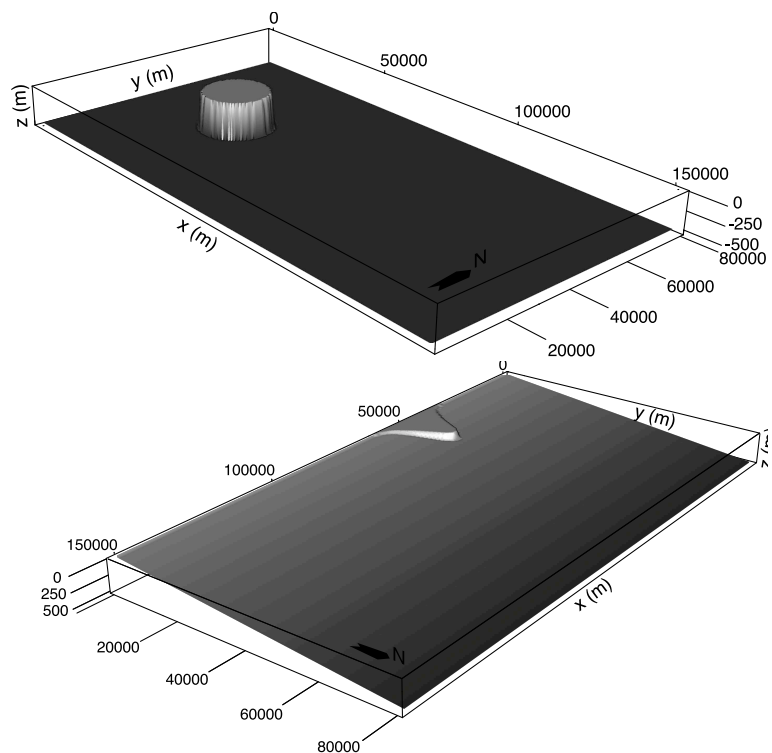

Figure 6.9 Bathymetry of the two model systems: circular island at the top, promontory at the bottom. Distances are in metres and distances in the vertical dimension are exaggerated twenty times. Shading is proportional to depth.

and density fields as well as radiation boundary conditions of type specified and Orlansky. The former constrains the field to be equal to the initial field at the boundary and the latter allows perturbation to leave the domain. In case (2) the same boundary conditions are applied at three of the boundaries, whereas the southern boundary is treated as a wall. The solid boundary around the island and along the southern wall has a zero-normal and no-slip flow implemented through a standard land-mask algorithm²⁶⁵. The surface momentum, heat flux, and freshwater flux are set to zero. The bottom stress applied is linearly proportional to the horizontal bottom velocity with a friction coefficient of $2.0 \cdot 10^{-4} \text{ m s}^{-1}$.

In configuration (1), the centre of the island is located one-fourth of the domain away from the upstream boundary and in the middle of the meridional range. The island diameter is 20 km, and the water depth is 500 m, well below the incoming shear and stratification layers (Figure 6.9, top). The current is maximum at the surface (20 cm s^{-1}) and null at the bottom. Flow regimes consist of the formation of an anticyclonic and a cyclonic eddy respectively north and south of the island (Figure 6.10). Once the wake eddies are well formed, mutual advection among them governs their motion, along with downstream advection by the mean wake flow. A return flow is present in the lee of the island. Vertically, the eddy decreases quickly with depth, just like the incoming current. However, the peak of the returning flow in the wake is located at the depth of 100 m, the top of the stratification.

Vortex street in the wake of a deep-ocean island

In case (2), the promontory is gaussian-like, 16.5 km wide, extruding from a linear sloping bottom. Depth at the southern boundary is 20 m and decreases to 500 m at the northern boundary (Figure 6.9, bottom). The vertical shear in the current is identical to the island case (current speed = 20 cm s^{-1} at the surface, zero at the bottom, and 12 cm s^{-1} at 100 m). The promontory creates a jet at its tip and a region of reduced or even returning flow behind it. This generates a meridional shear in the lee of the cape that contributes to the formation of anticyclonic eddies that are carried in the wake of the promontory (Figure 6.11). In the shallow water region, east of the promontory near the southern boundary, current speed is also reduced within the depth range of interest for the advection of larvae (0-100 m, see Figure 6.11).

Anticyclonic eddies shed by a promontory

Simple advection scheme and its justification

The grid of the biological model is regular in all directions, including the vertical, the mesh size is 500 m in the horizontal and 25 m in the vertical, and the dimensions are $150 \text{ km} \times 80 \text{ km} \times 100 \text{ m}$. Hence, before advecting particles, the speed field is cropped to the dimensions of the biological model and interpolated from the $500 \text{ m} \times 500 \text{ m}$ and σ -coordinate Arakawa-C grid of the ROMS to the $500 \text{ m} \times 500 \text{ m} \times 25 \text{ m}$ regular biological grid using 4th order polynomial interpolation with special masking conditions for the topography (the speeds around

Interpolate current field

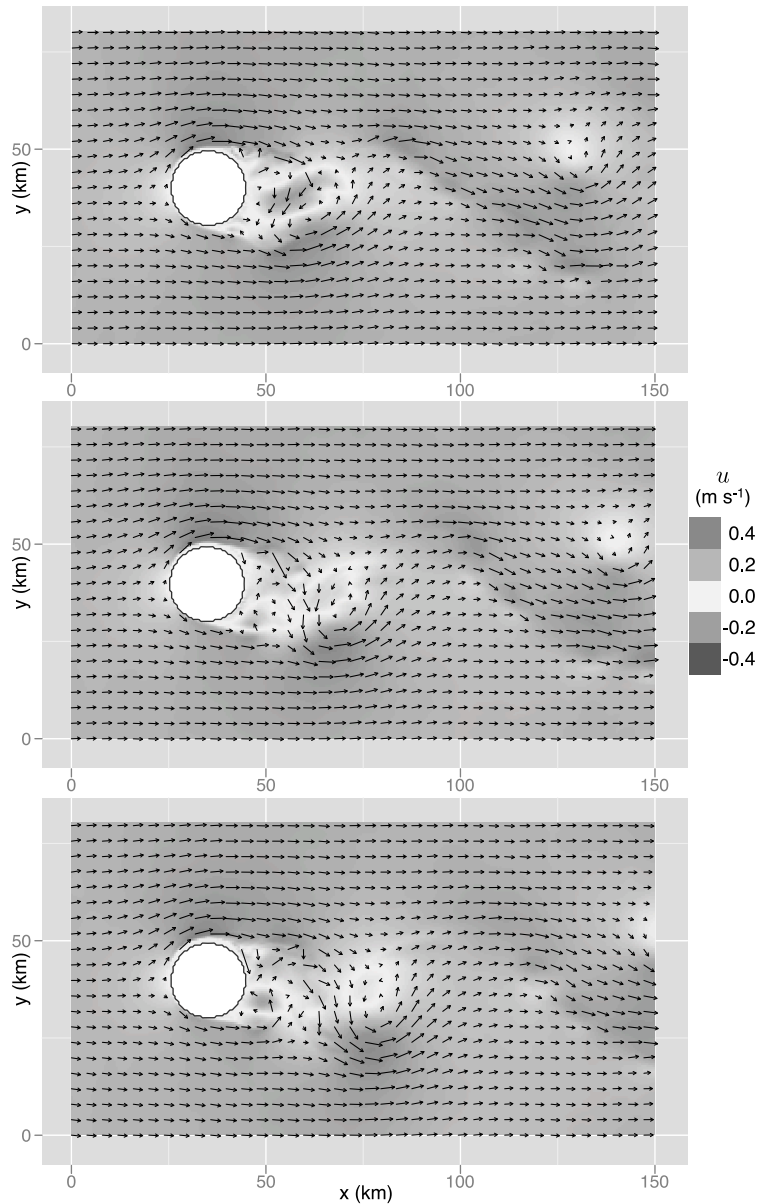

Figure 6.10 Three successive daily snapshots of the surface flow field simulated by the ROMS, interpolated and cropped to the biological domain, in the island case. The zonal speed component (u) is mapped to a colour scale. Arrows indicate the horizontal component of the flow ($\vec{u} \cdot \vec{v}$). During these three days, a cyclonic eddy detaches from the south of the island, while a new region of weak flow forms in its lee. An older eddy is advected away in the wake and almost leaves the domain on day three. The flow field at 100 m depth is very similar in structure to the surface one but the range of speeds is reduced from $[-0.12, 0.38]$ to $[-0.12, 0.28]$ m s^{-1}

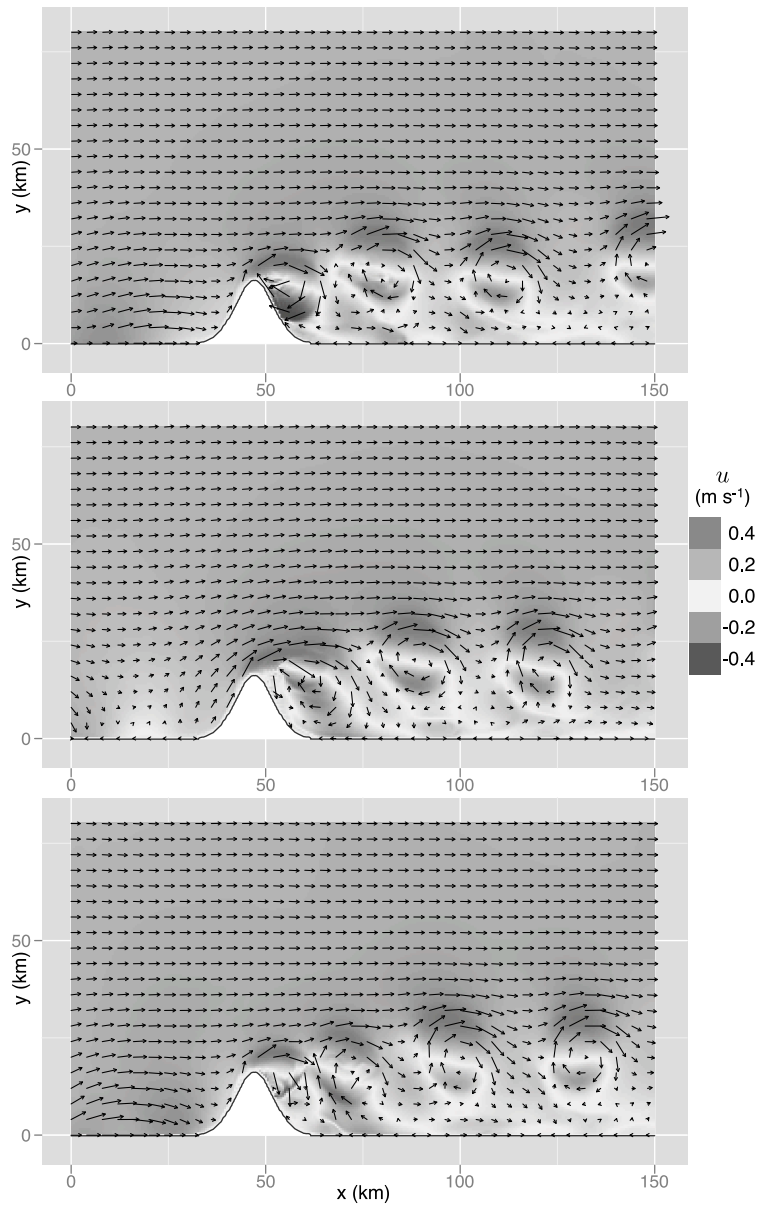

Figure 6.11 Equivalent of Figure 6.10 in the promontory case. Three anticyclonic eddies are already well formed and a fourth one detaches from the cape on day two. All of them are progressively advected away in the wake while a new eddy forms on day three. In the lee of the promontory, between the southern boundary and the vortex street, the flow is weak and mainly shoreward at the surface (note the length and direction of the arrows).

the steep topography of the island or the promontory would otherwise be smoothed). The time step of the biological model is 3 hours and the output of the ROMS is stored at the same frequency so no temporal interpolation is needed.

Simple Euler-forward advection is appropriate

Larvae are released all around the island and the promontory, 1 km away from the 10 m isobath. The spawning strategy of adults may influence where larvae are released and how they are initially advected. For example, some tropical marine fishes were observed to spawn near the surface when tides entrain eggs toward the open ocean¹⁸⁵. While potentially important, these behaviours are very location-specific and require fine scale representations of the topography and currents near the coast. This model focuses on general mesoscale features and the configuration used in the ROMS does not resolve fine scale structures, so we are only interested in what happens once the first moments of dispersal are over, 1 km away from shore. From there on, particles are advected using a simple Euler forward scheme with a 3 h time step. Particles are active in this model and de-correlate from the flow at a rate very different from that of passive particles. Therefore elaborate Lagrangian advection methods, which feature a fading memory of currents in a random flight scheme or parameterised diffusion in a random walk one for example, cannot be used (see section 1.4.5, page 35). Finer advection schemes (e.g. Runge-Kutta) or shorter time steps could be used, but end positions would still have to be brought back to grid nodes. Indeed, the optimisation is performed at those points only, and optimal decisions cannot be interpolated (see Note – Computer memory and speed, page 129).

6.4.2 Continuous and quantitative description of swimming behaviour

In this model, at each time step, larvae can choose between several swimming speeds, oriented toward twenty-five different directions homogeneously distributed in space. In addition, instead of a three step progress, as in section 6.3, the development of swimming speed is described in a continuous fashion. To model swimming continuously in time, the ontogeny of maximum sustainable swimming speed and of swimming endurance (i.e. of the energetics of swimming) have to be described. Unfortunately, there are still very few observations of those variables throughout the larval phase.

Development of swimming abilities and temperature effects

Continuous, almost linear, development of swimming speed

During ontogeny, maximum swimming speed increases because of allometry: even with a constant speed in body length per second (bl s^{-1}), the actual speed in cm s^{-1} increases as larvae grow. However, on top of that, fin and muscle develop and the speed in bl s^{-1} actually increases during larval life⁹⁵. A handful of studies^{56,57,60} described the evolution

of critical speed (U_{crit})²⁶⁶ with age and size. They found size to be a better predictor of speed than age. Yet, when age was expressed in terms of developmental age (i.e. days since hatching/larval duration) and when speed was normalised per species (speed equals zero at hatching and one at settlement), a unique $\log_{10}(\text{age}) \cdot \log_{10}(\text{speed})$ relationship held for all ten perciform species studied by Fisher⁵⁷

$$\frac{\log_{10}(U - U_{\text{hatch}})}{\log_{10}(U_{\text{settlement}} - U_{\text{hatch}})} = \frac{\log_{10}(A)}{\log_{10}(A_{\text{settlement}})} \quad (6.8)$$

where A is age in days post-hatch (so $A_{\text{settlement}}$ is what is commonly measured as pelagic larval duration from otoliths: number of daily increments between hatching and settlement marks), and U is U_{crit} in cm s^{-1} (U_{hatch} is speed at hatching, and $U_{\text{settlement}}$ is speed at settlement). In a more useful form, this equation provides speed in function of age post-hatch

$$U = U_{\text{hatch}} + 10^{\frac{\log_{10}(A)}{\log_{10}(A_{\text{settlement}})}} \log_{10}(U_{\text{settlement}} - U_{\text{hatch}}) \quad (6.9)$$

It requires U_{crit} and age at settlement, values of which can be found in the literature, and U_{crit} at hatching, which is more scarcely reported. Given the ranges of variation and units of age and speed (days and cm s^{-1} respectively), this is approximately equivalent to a linear relationship, as depicted by the solid curve in Figure 6.12.

To measure critical swimming speed, larvae are made to swim in a flume inside which current speed is increased every few minutes. Therefore, it measures “forced” swimming and probably overestimates speeds at which larvae would swim when not constrained. Actually, U_{crit} was found to be approximately five times the speed at which larvae were observed to swim freely in a large tank (routine speed)⁹¹, and twice the speed they go *in situ*²⁵. The development of *in situ* speed with size has also been described in at least two studies^{190,229}. Yet, in this model, larvae are given the possibility to choose between several swimming speeds. So, what we really need is the maximum *potential* speed larvae could attain, discarding burst speed (burst speed is fuelled anaerobically and is only relevant to behaviours such as escape from predators⁹²). And U_{crit} is precisely that: a measure of potential speed^{25,92}.

Critical speed is the right measure of potential speed

The direct effect of temperature on swimming speed is twofold: first water temperature affects muscle efficiency because fishes are ectotherms; second, water viscosity increases when temperature drops, which could slow larvae down²⁵. These two effects explain in part why tropical fish larvae are in general much better swimmers than temperate ones²⁵ (section I.5.2, page 22). Finally, temperature also affects development, and larvae develop faster — hence acquire swimming abilities faster — in warmer waters^{37,267}. In a brilliant meta-analysis, O'Connor et al.³⁷ derived a single relationship between temperature and pelagic larval duration (PLD – i.e. the duration of ontogeny), that is valid for an extremely wide range of marine taxa (crustaceans, Annelids, fishes,

Temperature affects the metabolism, physics, and development of swimming

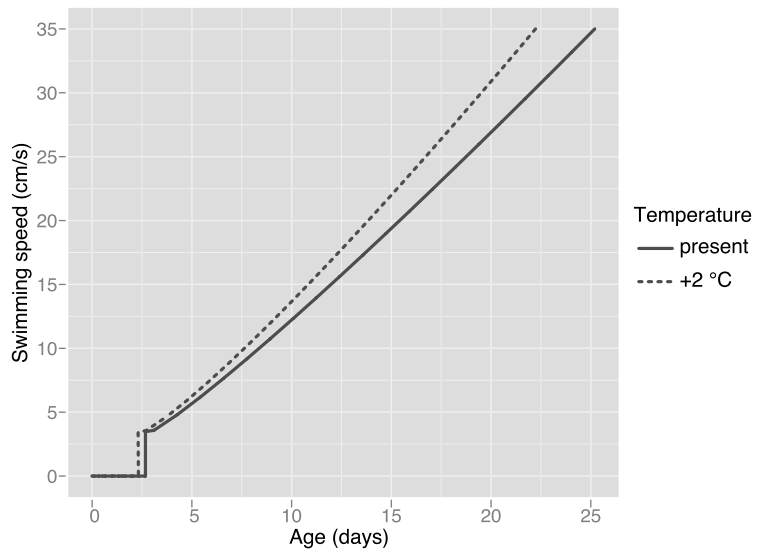

Figure 6.12 Development of critical speed throughout the larval period and effect of temperature. Speed is zero before hatching. When larvae hatch (around 2.5 days here), the development of maximum U_{crit} is deduced from Fisher⁵⁷ (solid curve). The effect of a 2°C increase in water temperature on the pelagic larval duration is computed from O'Connor et al.³⁷ and ontogeny of swimming speed is re-calculated. In warmer temperatures, the pelagic stage is shorter and swimming abilities develop faster (dashed curve).

Exponential decrease of PLD when temperature increases

etc.). They attributed the wide applicability of this relationship to the universal effect of temperature on metabolism. In all taxa, PLD decreases exponentially with temperature

$$\ln(PLD) = \beta_0 + \beta_1 \ln(T/T_c) + \beta_2 (\ln(T/T_c))^2 \quad (6.10)$$

where β_0 is a species-specific constant, β_1 and β_2 are constants valid for all species: $\beta_1 = -1.368$ and $\beta_2 = -0.283$, and $T_c = 15^\circ\text{C}$ (Figure 6.13). Dividing by T_c is equivalent to subtracting $\ln(T_c)$ to each observation on a log scale and is a form of centring, to improve the fit. For any species, β_0 can be calculated by substituting the species' PLD and the water temperature in the environment where PLD was measured in equation (6.10). Once the relationship is calibrated, it allows to predict the variations of PLD in response to changes in temperature.

Faster development of swimming abilities after a 2°C increase

In our model, the effect of a 2°C increase in water temperature is simulated. 2°C corresponds to the estimated mean variation expected in most climate change scenarios over the next century (A. Clement and C. Paris, pers. comm.). A 3°C difference in rearing temperature was found to decrease critical swimming speed of 7 days old *Amphiprion melanopus* larvae from 17 cm s⁻¹ to 12 cm s⁻¹, because larvae reared at the lower temperature were smaller and less advanced in ontogeny²⁶². However, the same 3°C difference in the temperature of the water in

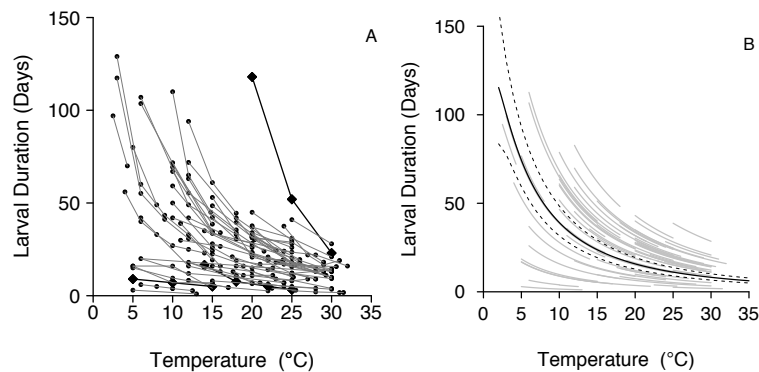

Figure 6.13 Decrease of larval duration with increasing temperature; observations for 72 species (A, left) and model (B, right). Thick lines with diamonds in plot A are species identified as outliers in the subsequent analysis. Light lines in plot B are the models for individual species. The dark solid line is the grand mean model with 95% confidence interval (dotted lines). Reproduced with permission from O'Connor et al.³⁷.

which larvae were set to swim had no significant influence on their critical speed. So, within a few degrees, the only noticeable effect of temperature on swimming is through muscle development and growth. Therefore, in the model, the only effect of temperature is on PLD. For a tropical fish with $PLD = 25$ d, the relationship predicts a decrease of 3 d. The PLD of a temperate fish decreases more, because of the convexity of the curve, from 27 d to 21.7 d. From the reduced PLD, the development of swimming speed is re-computed with equation (6.9) and, as a consequence, at any given age, U_{crit} of larvae developing in warmer waters is higher than U_{crit} of larvae developing at present-day rate (Figure 6.12).

Different view of the energy budget

In addition to setting maximum speeds, the time larvae can sustain such speeds also needs to be bounded for swimming strategies to be biologically sensible (section 6.2.1, page 119). Measures of swimming endurance involve setting larvae to swim in flumes of constant speed and timing how long they are able to maintain their position against the current²³⁶. As noticed before, this technique measures the maximum *potential* of larvae because it disregards any concern about maintaining growth. Such studies reveal that, even unfed, coral reef²³⁶ and temperate rocky shore²⁶⁸ fish larvae can swim continuously for several days and cover tenths of kilometres. In the same setting, when larvae are fed, their swimming endurance increases to the point that the experiment must sometimes be stopped before the fish is exhausted²⁶⁹. In such cases, the oldest individuals even grow at a rate comparable to control, non-swimming, larvae²⁷⁰. Similarly to swimming speed, in this new

Extraordinary
swimming endurance

model, we are interested in the *potential* endurance of fish larvae and, apparently, in may be infinite in some species. Hence, simply limiting time swum is not meaningful and the energetic cost of each swimming action must be represented instead.

Energy expense
proportional to the cube
of swimming speed

Fisher & Bellwood⁹⁴ measured time swum against different current speeds and found that swimming endurance of late stage coral reef fish larvae decreases with roughly the cube of swimming speed. The fitted relationship for *Amphiprion melanopus* was

$$\log_{10}(\text{time swum}) = -2.95 \cdot \log_{10}(\text{swimming speed}) + 3.39 \quad (6.11)$$

This relationship agrees with the theoretical expectation that muscular energy expenditure should be proportional to the cube of swimming speed ($3 \sim 2.95$ here)²⁷¹, which was also highlighted in other studies dealing with swimming by larval fishes^{199,272}. It provides a quantitative estimate of the energetic cost of each swimming decision (i.e. each swimming speed). However, while the slope in equation (6.11) is of general value, the intercept (= 3.39) is species-specific. Therefore, as for PLD and temperature, the relationship needs to be calibrated for the species of interest. The measures of unfed endurance of late stage larvae at 13.5 cm s^{-1} , the most widespread in the literature since Stobutzki & Bellwood²³⁶, provide a point of calibration for equation (6.11).

Validity of the
cubic relationship
throughout ontogeny?

This cubic relationship was demonstrated in late stage larvae only and the development of swimming endurance was only tackled by two studies to date^{56,60}. Fisher et al.⁶⁰ set larvae of three coral reef fish species of different ages to swim against a flume of speed 11 bl s^{-1} (11 body lengths per second). Clark et al.⁵⁶ set larvae of four temperate reef fishes of different sizes to swim against a 10 cm s^{-1} flow in the same type of setting (speed was reduced to 2 cm s^{-1} or 8 cm s^{-1} for the youngest stages). In both cases, swimming endurance was low at hatching (< 1 h) and stayed negligible until, for some species, it rose suddenly at about 0.8 developmental age (= age/PLD)⁶⁰ or two thirds of the larval life⁵⁶, after notochord flexion was completed. Both studies have agreed that endurance increases non-linearly in time, suggesting that sustained swimming is very costly for young larvae and much less for older ones. Yet, Fisher & Bellwood⁹⁴ remarked that significant swimming endurance appeared only when critical speed of larvae increased beyond *twice* the experimental speed. So another interpretation of their results is the following (Figure 6.14). Due to muscular and fin development on top of growth, critical speed increases more than linearly with size. In other words, the same relative experimental speed of 11 bl s^{-1} may represent 80% of U_{crit} for a young larva but only 40% of U_{crit} for an older one. Let us assume that half U_{crit} acts indeed as a threshold. While experimental speed is $> 50\% U_{\text{crit}}$, swimming would be very costly because of the cubic factor in the relationship between energy expenditure and swimming speed. After experimental speed becomes $< 50\% U_{\text{crit}}$, swimming would become viable. Past this point, endurance would increase abruptly because U_{crit} increases more than linearly, so

Apparently non-linear
diminution of swimming
cost through time

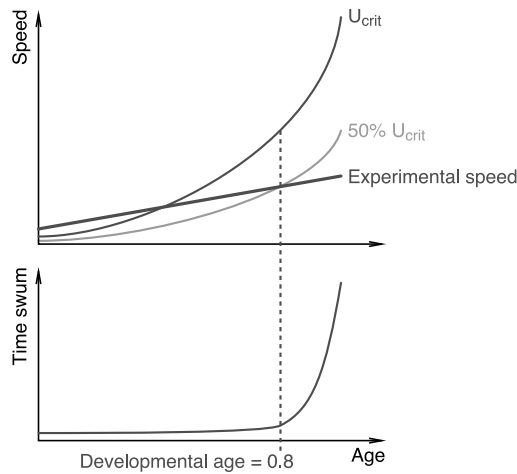

Figure 6.14 Possible explanation of the sudden increase in swimming endurance during ontogeny. Experimental speed increases because it is linearly proportional to fish size. U_{crit} increases because of both allometry and muscle and fin development. Until experimental speed is $< 50\% U_{crit}$, the energetic cost is too high for swimming to be sustained. After that it decreases quickly. Note that the curvature of U_{crit} is exaggerated for clarity purposes.

experimental speed becomes relatively smaller and swimming becomes cheaper. This decrease would be further multiplied by the cubic factor. Overall, the null hypothesis assuming that the same cubic relationship is valid throughout ontogeny would be enough to explain the apparent non-linearity of the result. There is no need to invoke higher energetic cost for young than for old larvae.

To confirm whether the cost of sustained swimming is identical for young and old larvae, their endurance should be measured in currents speeds equal to a *constant fraction* of U_{crit} , 50% for example, throughout the larval phase. Unfortunately this has yet to be done. So the null hypothesis of identical energetic cost throughout ontogeny (i.e. cost always proportional to the cube of swimming speed, where swimming speed is expressed as a relative to U_{crit}) is assumed to be true in this model, because it would explain the results of the two studies above and because it is based on low level muscular energetics principles which hold some generality.

Practically, in the model, energy is no longer part of the state of the larva. Instead, the cost of swimming is incorporated as a negative *immediate* gain (i.e. an immediate *cost*) proportional to the cube of swimming speed. The value of the cost is deduced using equation (6.11). First, the intercept is calibrated for the species of interest using swimming endurance of late larval stages at 13.5 cm s^{-1} . Then, for each swimming decision, the time swum at this particular speed before exhaustion is computed. This time is assumed to bring the total gain to zero, which

Null hypothesis based on cubic energetic cost is as explanatory

Implicit energetic balance and immediate swimming costs

makes swimming for such duration infinitely expensive energetically. The actual immediate cost for this time step is computed as

$$\text{total gain} \cdot \frac{\text{time step duration}}{\text{time before exhaustion}}$$

This provides an estimate that is conservative for two reasons. First, mean relationships are used in the calibration, while best performers could have significantly higher endurance²³⁶. Second, immediate costs accumulate through time and no “recovery” (through feeding, for example) is made possible, because no quantitative information is available about it.

6.4.3 Complete optimisation model

Optimisation criterion

Recruitment window Focus is still on self-recruitment so, as in the previous model, the final gain equals one for every larva recruiting back to the island or to the promontory at final time, zero otherwise. But, to account for the elasticity in the duration of the larval period, the gain is maintained equal to one during a time window prior to the time horizon. Larvae are assumed to recruit during this time window, so advection is not performed in those locations either.

Reach recruitment zones while minimising energy allocated to swimming The optimisation criterion is still to reach the recruitment location at final time, but immediate costs are now non-null and proportional to swimming speed so its biological interpretation changes: in this model, we are interested in successful trajectories along which energy consumption is lowest. As pointed out in the introduction, maximising energetic efficiency during the larval phase makes sense from a biological and evolutionary point of view. Indeed, there is a trade-off between energy allocated to swimming and energy allocated to growth. And survival both during^{237,238} and after^{48,50,170} the larval phase is size dependent. So energetic efficiency ultimately affects survival and, as a consequence, is under strong selective pressure given the high mortality during the larval phase⁶¹.

Choice of numerical parameters

Two species, from two environments Two fish species with contrasting swimming abilities are modelled to study the influence of swimming behaviour in different situations. In addition, because the relative effect of a temperature change on PLD is much larger in cold than in warm water (Figure 6.13), one of those species is tropical while the other is temperate. All necessary parameters (PLD, temperature of estimation of the PLD, U_{crit} at hatching, U_{crit} at settlement, time swum at 13.5 cm s^{-1} for settlement-stage larvae, reproductive biology i.e. demersal or pelagic eggs) were available for *Pomacentrus amboinensis*, a tropical damselfish^{57,95,186,235}. No single temperate species could be identified as a good candidate so parameters

were derived from family means (in Leis²⁵ and references therein). *P. amboinensis* is meant to represent the case of larvae with high swimming abilities (it swims early and fast), while the temperate species would represent the case of weak swimming larvae in general.

Table 6.1 Numerical values used to parameterise the biological model and compare the tropical *Pomacentrus amboinensis* to a cold temperate fish larva.

| | <i>P. amboinensis</i> | Cold temperate |
|---|-----------------------|---------------------|
| PLD (d) | 20-25 | 4 as egg then 20-23 |
| Temperature (°C) | 28 | 10 |
| U_{hatch} (cm s ⁻¹) | 3.5 | 0.5 |
| $U_{\text{settlement}}$ (cm s ⁻¹) | 35 | 5 |
| Endurance at settlement (h) | 46.33 | 15 |

To summarise previous information, the parameters of the model are presented along the guidelines of the modelling framework.

Time 3 h time step; maximum horizon fixed by maximum observed PLD (Table 6.1); recruitment window prior to maximum horizon; development pace modulated by temperature (equation 6.10)

State Three-dimensional position in a 150 km × 80 km × 100 m domain, of 500 m horizontal mesh size and 25 m vertical mesh size

Environment Dynamic, vertically sheared current field computed by the ROMS; incoming flow speed of 20 cm s⁻¹ at the surface, 12 cm s⁻¹ at the bottom; two bottom topography configurations corresponding to an isolated oceanic island or a promontory along a coast; eddy shedding regime in both cases; no spatially heterogeneous survival or feeding probabilities

Controlled dynamics Continuous increase of maximum potential speed after hatching (equation 6.9) for two types of species (Table 6.1); many swimming decisions at each time step: from one (not swimming) to several multiples of 25 (swim at different swimming speeds toward 25 possible directions); discretisation in each direction done based on the smallest speed that would cause a displacement of one grid unit; no explicit feeding; energy consumed in each swimming event is proportional to the cube of swimming speed relative to U_{crit} (equation 6.11)

Optimisation criterion Reach the island at final time, spending as little energy in swimming as possible

Note – Another solution to the curse of dimensionality In this new version of the model, both the state dimension and the number of

Loops instead of
matrix computation

controls increase significantly: from $140 \cdot 170 \cdot 3 \cdot 6 = 176,400$ to $300 \cdot 160 \cdot 5 = 240,000$ for the state and from seven to hundreds for controls. On the other hand, stochasticity sources are removed: there is no explicit energy budget anymore, so no feeding, and survival is not represented (i.e. is considered homogenous spatially). So the use of transition matrices is inappropriate because they would be very large but only one final state would be reachable from any given initial state and decision. Therefore, gain is computed at each state inside a loop, and transition matrices are never built. The loop is coded in Fortran 90 and compile time vectorisation (using Intel Fortran Compiler) as well as local parallelisation (through OpenMP) accelerate the process. The extraction/interpolation of current speeds and computation of optimal decisions takes between one and two hours for the set of parameters specified above, on a cluster node with four 2.33 GHz double core CPUs. Both optimal decision and end points after advection are stored in a NetCDF file, so the advection does not have to be done again for the forward computation of trajectories. Computing trajectories is therefore virtually instantaneous and can be done in an interpreted language (R in this case).

6.4.4 Large impact of swimming

Swimming
greatly enhances
self-recruitment

First, the impact of swimming is assessed by comparing trajectories of passive and active larvae in the same situation (identical release sites and date, same PLD). Figures 6.15 and 6.16 highlight the tremendous impact of swimming, even for slow swimming larvae, in both configurations used here. When larvae are treated as passive particles, most of them are advected away from their release location. In the island case, passive retention in regions of weak flow is almost never sufficient to retain particles for the whole larval phase. In the promontory case, where backward flow is more stable behind the cape, a small percentage of larvae can be passively retained and self-recruit. These are just five or ten trajectories, in one flow situation, but they are representative of the overall magnitude of the impact of swimming. The effect is estimated quantitatively by computing the percentage of recruiting (i.e. self-recruiting) larvae starting from the promontory or the island at three release dates (Table 6.2). In all cases, self-recruitment is quasi-impossible for passive particles but swimming shifts the regime to a situation where most larvae can self-recruit.

Table 6.2 Mean percentage of successful trajectories for the coral reef fish *P. amboinensis* and a temperate fish, in the island and promontory configurations.

| | CORAL-REEF | | TEMPERATE | |
|------------|------------|--------|-----------|--------|
| | passive | active | passive | active |
| Island | 0 | 95 | 0 | 45 |
| Promontory | 2 | 95 | 1 | 72 |

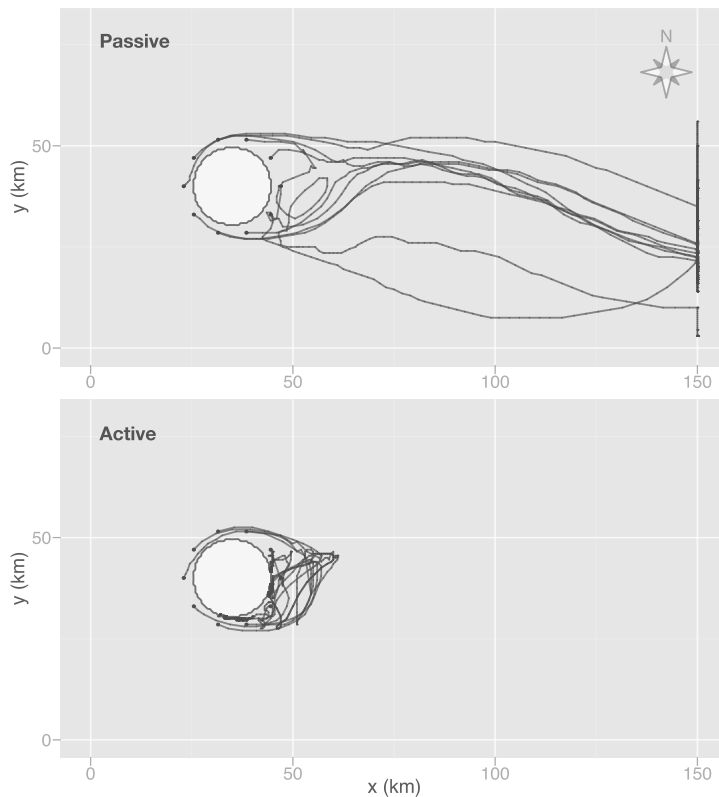

Figure 6.15 Comparison of ten passive (top) and active (bottom) trajectories of *P. amboinensis* in the island case, viewed in two dimensions from above. The circle is the island. The light rectangle is the simulation domain. Only one of the ten passive larvae is briefly retained by eddies behind the island but eventually all ten are advected away and none recruits. By contrast, when larvae are active, all ten recruit.

When observing optimal trajectories and decisions in more detail (Figure 6.17) it appears that very little swimming is in fact required to achieve such a large self-recruitment rate. In the island configuration (Figure 6.17, top-left), larvae starting in the upstream region swim initially toward the island, hence avoid being ejected away by the two strong jets on the sides of the topography. Once in the lee of the island, the retentive structures are quite weak and occasional swimming is necessary to maintain their position inside regions of low flow. Particularly at the end of the larval phase, swimming is necessary to finally reach the island. In the promontory configuration, a few swimming bouts at the beginning of the larval phase are enough to ensure retention in the area of weak or returning flow behind the cape (Figure 6.17, bottom-left).

Little swimming
is necessary

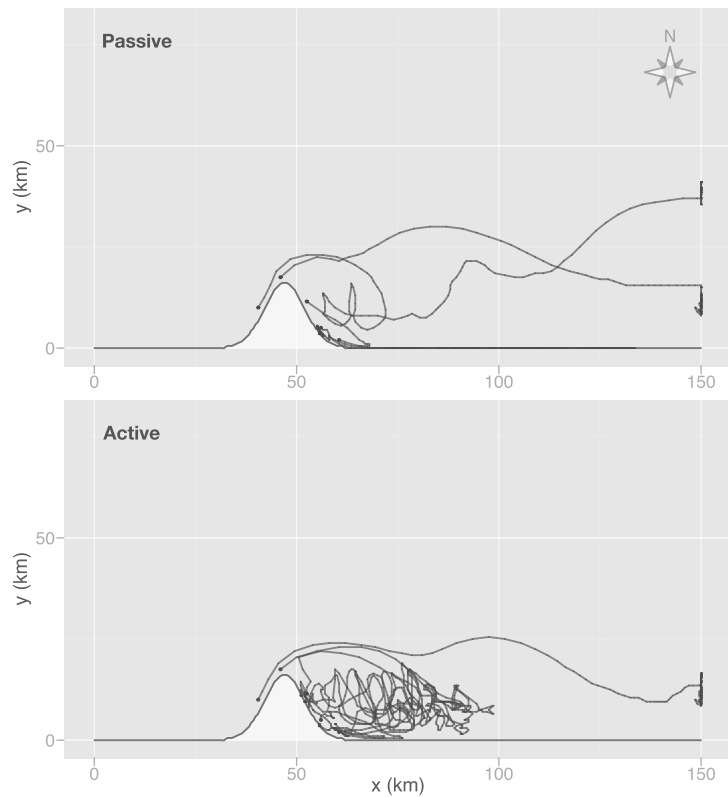

Figure 6.16 Comparison of five passive (top) and active (bottom) trajectories of temperate larvae in the promontory case. The gaussian-like shape is the promontory. When larvae are passive, the first two are entrained away from the promontory, the next two are retained for a time but eventually transported away along the coast, and the last one is flushed on shore and away from the promontory by South-Eastward surface currents. When larvae are active, only the first one is still unable to reach the promontory; all four others recruit there.

Vertical movements
facilitate horizontal
swimming

High retention with so little swimming is achieved by the exploitation of the horizontal structure of the flow, as described above, but also of vertical stratification. Indeed, currents are weaker at depth (12 cm s^{-1} at 100 m in the incoming flow, instead of 20 cm s^{-1} at the surface) and an efficient way to avoid advection is to move down, from surface to deeper layers. The distances in the vertical are much smaller than in the horizontal and low swimming speeds are enough to reach large depths (0.9 cm s^{-1} allows to move from surface to 100 m in a single three hours time step). As shown in the right panels of Figure 6.17 for *P. amboinensis*, optimal strategies feature such downward movement, in areas of strong surface flow such as the tip of the promontory in particular. Then, at depth, the horizontal swimming decisions allow to move from one current regime (e.g. eastward jet) to the other (e.g. westward returning

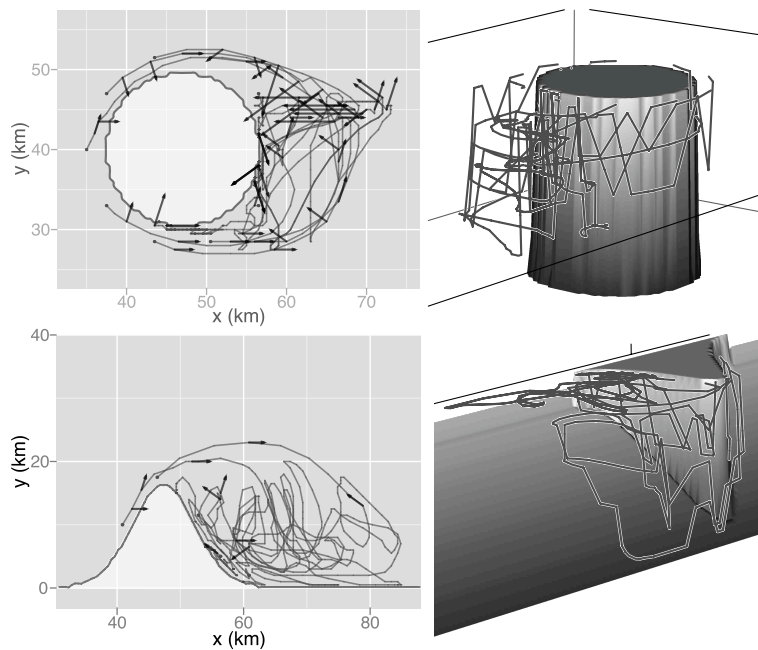

Figure 6.17 Detail of ten optimal trajectories of *P. amboinensis* in the island case (top) and five in the promontory case (bottom). Panels on the left present swimming speeds (black arrows) along 2D views of the trajectories. Most swimming occurs early on and places larvae in retentive areas afterward. In the island case physical retention is weaker so more swimming is necessary to stay in the lee of the topography. Right panels hold 3D representations of the trajectories which highlight that they exploit the stratification of the current and the topography. For example, at the tip of the cape, where a powerful surface jet occurs, the optimal strategy is to move down, where the flow is weaker. Eventually all trajectories reach areas of reduced surface flow, behind the promontory or the island. Once retained there, little swimming (hence little energy expenditure) is necessary to finally recruit. The depth range represented is 0-110 m (the bottom is not represented at locations where it is > 110 m deep).

flow). Overall, optimal strategies exploit the heterogeneities of the flow through the interaction of vertical *and* horizontal movements.

Finally, comparing optimal swimming decisions to potentially available decisions for *P. amboinensis* (Figure 6.18) highlights that larvae seldom swim at their maximum swimming speed. In fact, most optimal decisions are to “not swim”, which makes sense because swimming is energetically costly. When they do swim, the mean speed of larvae is about 2 cm s^{-1} . The situation for the temperate larva, not presented here, is similar. Overall, swimming, and particularly swimming at speeds close to the maximum, is only common early in the larval phase, even though swimming abilities are weak at this stage. Therefore, the model suggests that it is more energetically efficient for larvae to swim early on, even at very low speeds, to reach retentive areas and finally self-recruit,

The importance of swimming early

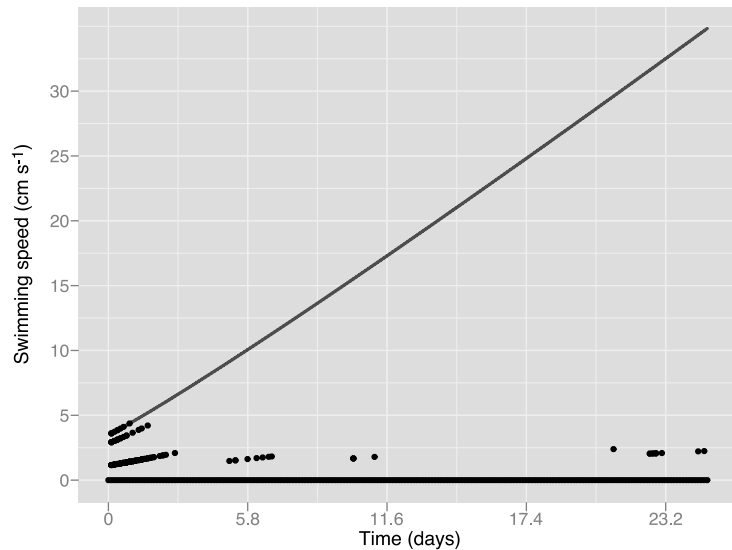

Figure 6.18 Swimming speeds of *P. amboinensis* larvae through time, along 100 optimal trajectories in each of the two environments. Maximum potential speed (curve) is compared to speed decisions actually chosen along the trajectories (dots). Most of the time, larvae do not swim (zero speeds are present during the whole larval phase). When they do, their speed is often much less than the maximum. Most swimming, in particular fast swimming events, occurs early in the larval phase.

than to first be advected away passively and take advantage of their increased swimming abilities to later return to the recruitment area.

6.4.5 Effect of temperature

Increased
recruitment success

The impact of swimming should be reinforced in warmer water, because swimming abilities develop faster (Figure 6.12, page 144). To investigate this hypothesis, the same type of comparison between optimal trajectories is performed. Table 6.3 summarises the effect of a 2°C temperature increase in all configurations. While the percentage of successful (i.e. recruiting) trajectories is constant for *P. amboinensis* (whose swimming abilities are already sufficient to exploit the heterogeneities of the flow), the larvae of the cold-temperate species are more successful after the 2°C increase. Figure 6.19 compares some trajectories of the cold temperate species in present conditions and after a 2°C increase. In current situation, most larvae are advected away from the island, first as passive eggs, then as weak swimming larvae. After a 2°C increase, the egg phase is shorter, swimming abilities develop faster, and some young larvae are able to swim down in the lee of the island. This allows them to be retained there for the remainder of the pelagic phase. Here again,

Table 6.3 Effect of the a 2°C increase in water temperature on the Pelagic Larval Duration, percentage of successful (i.e. self-recruiting) trajectories, recruitment rate, and mean distance from the starting location along the trajectory, for the coral reef fish *P. amboinensis* and a temperate fish, in the island and promontory (Prom.) environments. The reduction of PLD is computed after O'Connor et al.³⁷.

| | | CORAL-REEF | | TEMPERATE | |
|--------|------------------------------------|------------|-------------|-----------|-------------|
| | | present | +2°C | present | +2°C |
| | PLD (d) | 25 | 22.1 | 27 | 21.7 |
| Island | success (%) | 95 | 95 | 45 | 48 |
| | recruitment rate × 10 ³ | 1.9 | 2.2 | 0.092 | 0.28 |
| | mean dist (km) | 17.1 | 18.5 | 18.1 | 20.1 |
| Prom. | success (%) | 95 | 95 | 72 | 75 |
| | recruitment rate × 10 ³ | 1.9 | 2.2 | 0.15 | 0.44 |
| | mean dist (km) | 16.5 | 22.4 | 43.5 | 33.1 |

swimming early and swimming down seem to be key to enhancing self-recruitment.

The rate of self-recruitment is estimated as PLD multiplied by daily mortality rate and success percentage (Table 6.3). The daily mortality rates are 0.22 for the perciform coral-reef fish, and 0.27 for the temperate fish (which would correspond to a gadiform species or to a measure of the mean between gadiform, pleuronectiform, and perciform temperate fishes)²³² and were adjusted for temperature after the 2°C increase (mortality rates increase with temperature)^{72,273}. For *P. amboinensis* the increase in recruitment rate is due to the shorter PLD that reduces the exposure of larvae to pelagic mortality. For the temperate larvae, however, the increase in recruitment rate is proportionally larger, both because the reduction in PLD is larger (5.3 d instead of 2.9 d – note the convexity of the curve in Figure 6.13, page 145) and because the mean percentage of success increases. In all cases, recruitment varies between roughly 10⁻³ and 10⁻⁵.

Eventually, as self-recruitment is higher, one may assume that larvae are retained more and stay closer to their release points on average. The mean radial distance between the release point and positions at each time step along the trajectory is computed for the successful trajectories among a hundred runs in each configuration. As Table 6.3 highlights, the expected result is only observed for the temperate species in the promontory configuration. In all other cases, the mean distance is actually *larger* after the 2°C increase. This surprising result has two explanations. First, in present situation, some larvae may rapidly be entrained too far to self-recruit. After a 2°C increase, their swimming abilities develop faster and, following the same initial trajectories, larvae may now be able to make it back to the island (or promontory) to recruit. The optimisation routine is only concerned with successful trajectories

Higher self-recruitment but increased distance from release point

Increased maximum distance

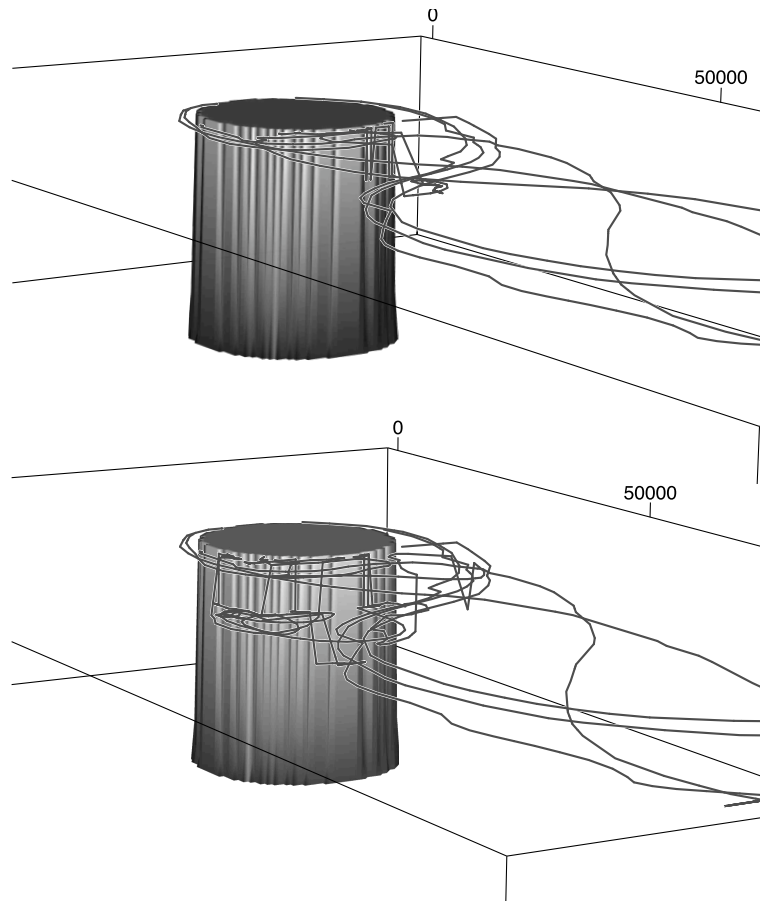

Figure 6.19 Comparison between five optimal trajectories of temperate, slow swimming larvae, around the island, in present conditions (top) and after a two degree increase in water temperature (bottom). The faster development of swimming speeds in warmer waters allows more larvae to be retained in the lee of the island, by swimming down initially. The depth range represented here is 0-110 m.

and those initial dispersal routes are therefore ignored in the present temperature situation while they become available after the 2°C increase. And some of them are optimal, hence chosen. In those trajectories, the maximum distance from the release point is greater than along all others, thereby increasing the mean distance at the population level. In addition, a closer look at the promontory case for example (Figure 6.20), shows that, for some trajectories, the maximum distance from the release point does not change, yet the shapes of optimal trajectories change within this range. In particular, some larvae spend more time far from the release site after the 2°C increase (inset in Figure 6.20). This increases the mean distance from the release point along such trajectories. Both effects (increased maximum distance in some trajectories and increased mean distance in others) contribute to the unexpected result that mean distance from the release point at population level is larger after a 2°C increase in temperature, even though self-recruitment rate is higher.

Constant maximum
but increased mean

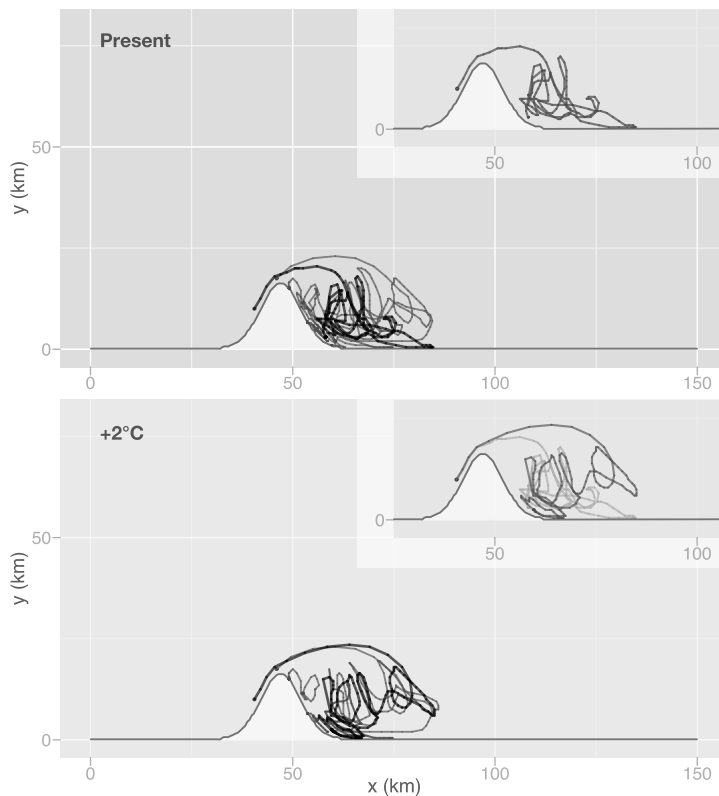

Figure 6.20 Comparison between five trajectories of *P. amboinensis* in the present situation (top) and after a 2°C increase in water temperature (bottom), in the promontory case. In the climate change scenario, larvae spend more time farther down in the lee of the promontory than in present conditions. One trajectory is highlighted in the main figure and presented alone in the insert to highlight this fact more clearly.

6.4.6 Discussion

One important result of this study is the tremendous difference between active and passive trajectories, even with very low swimming speeds. The combined effect of downward movements to avoid surface advection and horizontal movements to move between water masses enhances self-recruitment in this model. The second important finding is that early swimming decisions, even though they would appear expensive energetically, seem to be key in determining the fate of larvae. As a consequence, conditions which enhance swimming abilities, in particular early on, (such as an increase in temperature) result in increased self-recruitment rate for larvae displaying optimal strategies. Surprisingly, this is not accompanied by greater retention of larvae around recruitment areas, but by an increase in the distance roamed by particles from their release point.

The difference between active vs. passive larvae may be milder but is probably real

A nuance to the difference between passive and active trajectories is that the rough advection scheme we use here is probably not capturing the full potential for passive retention. With a finer time step, particles would follow streamlines more closely and may be retained more inside eddies for example. Similarly, the inclusion of diffusion would increase the probability to encounter a retentive area from any release point. Yet, both those effects would also be relevant for active trajectories. In addition, it is not likely that an increase in self-recruitment rate from 0% to 95% could be achieved purely passively, only because of the inclusion of those two refinements. Therefore, the difference observed here strongly advocates for the inclusion of swimming in all early life history models of fish, or of other organisms whose swimming speeds may be as low as a few centimetres per second.

Low swimming speeds matter

Indeed, the environments considered here are not those where swimming would be expected to make a large difference: stratification is not particularly strong (no returning flow at depth, only a slow down) and current speeds are rather high (up to 60 cm s^{-1} at the surface). Nevertheless, mean swimming speeds of 2 cm s^{-1} are sufficient to completely shift the system from nearly no self-recruitment to return rates of 95% in the case of the Pomacentridae. Furthermore, the temperate larvae were very weak swimmers (maximum swimming speed of 5 cm s^{-1} at the end of the larval phase) and still achieved self-recruitment rates over 40%. Both results suggest that weakly swimming organisms could have an impact on their dispersal, provided that their swimming is oriented and exploits the heterogeneities in the current field.

Early swimming may be more constrained ...

Early swimming may, however, be favoured intrinsically in this model. First, because no energy budget is explicitly represented, no recovery after swimming is allowed. As a consequence, strategies that result in as little swimming as possible during the whole larval life are favoured. This translated in much swimming early on at, or close to, the maximum speed, and less later in larval life, often at only a fraction of maximum speed. With recovery, it might have been better to space swimming

decisions more evenly in time. In addition, the recovery capacity of older larvae would probably be higher than that of younger stages. Therefore, swimming at maximum speed may become optimal at the end of the larval phase. Second, the relationship defining the energetic cost of swimming was identical for young and old larvae. The reasoning behind this null-hypothesis is detailed on page 146. Yet, the eventuality that swimming would be relatively more costly for young stages than for old ones — as the authors initially suggested — has to be considered. With a similar criterion of minimum energy expenditure, this should result in less swimming at the beginning of larval life. Third, early larvae may not have the sensory abilities to detect even local cues and orient in consequence. Though there is evidence that even clownfish embryos can detect sound waves in the range of those produced by coral reef communities²⁵⁵, knowledge is currently lacking in this area. Nevertheless, the two energetic constraints can be discussed. Even if early swimming is frequently observed among optimal trajectories (Figure 6.18), it does not mean that all larvae swim repeatedly for the first days after hatching. On the contrary, swimming decisions along any single optimal trajectory are quite sparse (Figure 6.17). In addition, if some larvae swim at, or close to, their maximum U_{crit} , many also swim at speeds equivalent to only a fraction of it (Figure 6.18). Therefore, there is room for more constraints on early swimming speed and endurance before these optimal strategies become impossible energetically. Furthermore, taxa which differ in early life history (i.e. demersal vs. pelagic eggs) are usually distributed differently in space^{130,162,168,274} (see also chapter 4). This supports the hypothesis that events occurring early in the larval phase have a large influence on its outcome⁷¹ — though it might be confounded by systematic differences during the rest of the pelagic interval: species with demersal eggs are usually only passable swimmers while species with pelagic eggs are, on average, very good swimmers by the end of the larval phase²⁵. Anyhow, it was already pointed out that energy not invested in swimming is available for growth, and that larval growth is particularly important for survival^{48,50,170,237,238}. So a strategy minimising overall energetic expenditure, such as early swimming here, should at least be regarded as a selective advantage, if anything else.

Finally, the importance of early swimming decisions is highlighted by the differences between the tropical and temperate larvae considered here. The temperate species has very weak swimming abilities, even late in larval life ($U_{crit} < 5 \text{ cm s}^{-1}$), and, in addition, has pelagic eggs. As a consequence, in the model, temperate larvae are initially advected passively by currents and are not capable of coming back to the recruitment zone if they are entrained too far away. This explains, in part, why tropical larvae achieve self-recruitment rates of 95% and temperate larvae only 40 to 70%, and makes early retention particularly important for the latter. A natural development of this study would be to investigate the case of tropical taxa with pelagic eggs, which are passive at first, have longer pelagic lives, but are very capable

... but is probably an evolutionary optimum

swimmers by the time of settlement (Acanthuridae, $U_{\text{crit}} \sim 55 \text{ cm s}^{-1}$; Holocentridae, $U_{\text{crit}} \sim 80 \text{ cm s}^{-1}$)^{25,221}. Swimming at only a fraction of the maximum U_{crit} (hence spending little energy in swimming), late in larval life, would be enough to overcome many currents. Together with the exploitation of flow heterogeneities, late swimming probably allows those taxa to achieve recruitment rates similar to those of demersal spawners. The first field evidence of this kind indeed reveals that self-recruitment rates are similar (and $\sim 60\%$) for a clownfish with demersal eggs and a larval duration of 8 d and a butterfly fish with pelagic eggs and a larval duration of 50 d⁴⁴. The literature regarding the trade-off between the size and the number of eggs is vast and old, thus many hypotheses exist regarding the drivers of this trade-off: quality of offspring²⁷⁵, investment of parents²⁷⁶, success of fertilisation²⁷⁷, etc. In the context of larval dispersal and population connectivity, the two strategies consisting in (1) laying few, large, demersal eggs, giving birth to larvae which develop quickly and have average behavioural abilities throughout the pelagic phase or (2) spawning many, small, pelagic eggs from which larvae hatch with weak behavioural abilities but develop longer and achieve tremendous swimming speeds at the end of the pelagic phase, may be two different means to achieve the same end: self-recruit.

6.5 General discussion

To summarise the hypotheses and characteristics of these models, consider that they predict what larvae *should do* if they were to *maximise self-recruitment*. So, before discussing the predictions of the models, two central questions must be addressed: Why should larvae do anything special (and why is it relevant to look at optimal strategies in particular)? Why focus on self-recruitment (and do the predictions have any value outside the context of isolated islands)?

6.5.1 Why optimal strategies?

Optimal control is new in larval dispersal models

The use of optimal control in models of larval dispersal is new. To our knowledge, the only other studies that have used this framework are Armsworth¹⁹⁹ and Fiksen et al.⁷⁸. The former focused only on the end of the pelagic phase, in the vicinity of a coral reef, and used optimal control to find trajectories that minimise energy expenditure or transit time to reach the reef. The latter built on similar work on copepods²⁷⁸ or daphnia²⁷⁹, and used dynamic optimisation to predict the vertical distribution of Cod (*Gadus morhua*) larvae. The computation was then included as a component in a larger model of the entire pelagic interval. Our study is the first to provide such an extensive description of larval behaviour, computed from the whole environment, on large temporal and spatial scales, hence widening the scope of this modelling framework. The authors of the contributions cited above advocated for

such integration of behavioural ecology and physical oceanography in models of larval fish dispersal⁸⁰, or of fish in general²³⁴, through the use of optimal control in particular. Indeed, this approach allows to model larval behaviour as it should be: a dynamic response to the environment. Behaviour emerges from the interaction of individuals with their environment, rather than being determined *a priori*. Its fineness is therefore only bounded by the complexity of the description of said environment. This ensures broad application and great flexibility of such models, as knowledge of the pelagic ecosystem progresses. We shall, however, discuss the hypotheses of these models in more details.

The first justification for the use of *optimisation* models forms the basis of the theory of optimal behaviour. As stated in the Introduction (section I.4.2, page 17) and earlier in this chapter (page 117): as soon as a behaviour is heritable, occurs in an environment stable at the generation level, is variable, and its variations result in differential fitness, it is under selection. And natural selection will favour those forms that provide greater fitness^{52,54}. All four conditions are satisfied during the early life history of fishes. During this pre-reproductive phase, fitness can be reduced to survival, both during and immediately after the larval phase. This is the justification for optimisation criteria such as maximising survival along successful trajectories (section 6.3), or minimising energy expenditure (because energy participates to growth and growth in turn affects survival^{48,50,170,237,238} – section 6.4). While most larvae do *not* always respond optimally to their environment, the optimal behaviour theory states that they will tend to. Furthermore, this model should not be viewed as a description of the behaviour of each and every larva during its pelagic stage. Instead it aims at evaluating an upper bound to the influence of larval behaviour, in a context in which modellers have been looking at the lower bound most of the time (either passive particles, vertical migration only, or very simplified rules of behaviour^{84,86,87,143}). Moreover, this upper bound is made quite conservative regarding the behavioural abilities of fish larvae (swimming, energy reserves) by the choice of mean parameters for swimming speed and high energetic requirements. Due to the scarcity of information available throughout the larval phase, this safe approach is necessary but behaviour by fish larvae may have an even greater impact.

Even if natural selection tends to optimise behaviours, it selects within the limits of what is energetically, ontogenetically, and mechanically possible. In this modelling framework, our theoretical larvae “know” their environment and all its future states, in a probabilistic sense (e.g. they “know” the distribution of the predation *probability*, not its realisation). Do larvae have the sensory abilities to detect predators, plankton, and direction of currents on a large spatial scale, and to predict their evolution in time? Probably not. But this is not what our modelling hypothesis implies. Consider the downward movement at the tip of the cape in Figure 6.17 for example. Larvae in the field probably

Natural selection tends to optimise behaviours

Optimal control reasons on the distal causes of behaviour

do not move downward *to* avoid fast current at the surface, or even less *to* eventually reach an area of reduced flow behind the cape. However, larvae which display downward vertical migration in response to a proxy cue (such as light, small scale turbulence or small scale vertical shear) would be more likely to eventually reach the area behind the cape, hence increase their probability to recruit, and would spend less energy doing so than non-migrating larvae. Such behaviour would therefore be selected for and its frequency would increase in the population. The juxtaposition of an accelerated jet and of reduced flow, in particular in the interaction with topography, is a common mechanism for the formation of eddies, so the behavioural strategy selected in such an environment holds some generality. To put in another way, optimal control does not infer anything about proximal cues of behaviour, but rather reasons on its distal, evolutionary, causes. Both explanations are valid and non contradictory. They are just two of the four possible explanations of behaviour in Tinbergen's sense⁵¹. Now, are larvae able to detect light, or small scale turbulence? Yes, they do^{65,191}. Late stage fish larvae, tropical ones in particular, have well developed sensory organs which allow them to perceive dissolved chemicals and recognise the water of their natal reef¹⁰³, orient to reefs thanks to the sound choruses of reef inhabitants¹⁴⁵, sense and escape from their predators⁶⁴, and may even orient cardinally thanks to sun angle¹⁰⁷ or polarised light¹⁰⁸ (see chapter 1 section 1.5 for details). They would therefore be fully capable of detecting proxy cues which could mediate the optimal behaviours predicted by the model. As already highlighted, a remaining issue is the ontogeny of those sensory abilities. Morphologically, sensory organs are well developed at least by the middle of larval development²⁸⁰. However, the stage at which they are actually functional is unknown. For some, it could be as early as the embryonic stage²⁵⁵.

Fish larvae can detect proxy cues mediating those behaviours

Mortality during the larval phase filters bad strategies out

Be that as it may, even if larval behaviours were not heritable or were ontogenetically constrained to the point that they would not be under natural selection, strategies and trajectories which maximise survival during the larval phase would still be interesting. Indeed, let us assume the extreme scenario of larvae all taking random decisions. Many larvae die before recruitment⁶¹. By tautology, the few that survive have, on average, taken decisions that were good for their survival. These are precisely the decisions computed by the model when the criterion is to optimise survival (or survival related traits, such as energy expenditure and growth). From this point of view, the large mortality occurring during the pelagic interval can be considered as a *filter* that lets only the best strategies through. Trajectories induced by optimal strategies are therefore related to real trajectories of successful fish larvae.

6.5.2 Why self-recruitment?

Relevance of self-recruitment in models

In these models, we only focus on recruitment back to the natal region. In the island configuration of the last model for example, if a second island was introduced downstream and that final gain was set to one at both locations, then it is easy to guess that all optimal trajectories would go from the upstream to the downstream island, because it would be the energetically cheapest route to recruitment⁶⁹. Yet, we would learn very little from the behavioural mechanisms involved in such trajectories: they would be different if the island was downstream and to the left for example, or downstream and to the right. The trajectories and underlying strategies would be highly specific to the spatial configuration of the system and, as such, would be difficult to justify from an evolutionary point of view. By contrast, downward vertical migration for example, will almost always enhance retention, whether around an island or along a coast^{71,202}. The behaviours involved in retention, and ultimately self-recruitment, appear consistent between organisms and locations²⁴. Because of that, they are subjected to long term evolution and can be explained in terms of fitness and phylogeny, along Tinbergen's view⁵¹, a requirement for the theory of optimal behaviour. The opposite of retentive mechanisms would be behaviours enhancing advection, albeit *in no particular direction*. Indeed, it is difficult to think of mechanisms that would explain the long term evolution of behaviours such as "enhance advection to the west only" (because it just happens that there is a recruitment opportunity there). So this modelling framework does not apply without modification to situations with many recruitment targets. It would require to specify additional hypotheses regarding how much intrinsic value self-recruitment has compared to allo-recruitment, or to modify the optimisation method to include only partial information about the environment, hence changing the focus from distal causes of behaviour to proximal ones. This was not the purpose of this work.

Sponaugle et al.²⁴ list many processes potentially affecting self-recruitment, from adult spawning behaviour, to larval swimming and orientation, to coastal complexity and flow characteristics. Most of the paper consists in the discussion of isolated examples illustrating each potential effect. By interconnecting larval behaviour and environment description closely, the modelling framework presented here allows to integrate those effects together, and we discuss the relative influence of some mechanisms here. Currently, only a mechanistic modelling approach allows such quantitative comparisons.

Relevance of self-recruitment strategies for connectivity

It is increasingly obvious that self-recruitment, or at least limited dispersal, is more common than it was initially thought to be in marine populations^{41,43,44,240-242,281,282}. The very few direct field estimates of

Optimal allo-recruiting strategies have no evolutionary justification

Allo-recruitment induces hypotheses outside our scope

Modelling allows to integrate self-recruitment causes together

Self-recruitment is frequent even in a connectivity context

self-recruitment available for marine fishes are 20–60%⁴³, 50%²⁴⁰, 60–81%²⁸¹, 40%⁴¹, and 60%⁴⁴. These numbers are very different of what was predicted under scenarios of mostly passive advection^{4,19,22,84} and are probably explained by active larval retention²⁸³. So, even in situations where recruitment to other locations was possible, about half of the recruits were larvae which actively sought self-recruitment. For those at least, the predictions of the models presented here apply. The remaining question is whether all larvae seek self-recruitment and some fail, or whether only a portion of the population displays such behaviours. This requires to investigate the distal (i.e. evolutionary) causes of dispersal vs. self-recruitment during the pelagic phase.

Larval phase ≠
dispersive larval phase

In this respect, the early confusion between the existence of a complex life cycle (with pelagic larvae) and the occurrence of dispersal is still misleading today. Pelagic larvae were initially assumed to be *for* dispersal and large scale dispersal was considered as pervasive as the larval stage itself^{22,284}. In consequence, the discussions of the evolutionary causes of both phenomenon were tangled²⁸⁵. In fact, most explanations invoked for the existence of a pelagic larval phase do not require dispersal. For example, oceanic larvae could be a means of exploiting food sources non-attainable by adults, hence reducing competition and better harvesting the environment²⁸⁶. This argument applies equally to dispersing or self-recruiting pelagic larvae. Besides, some evolutionary processes could push organisms toward producing more and more eggs, necessarily small and pelagic, hence preventing a reversion to big, demersal eggs which may lead to brooding of larvae in the parental habitat (as in e.g. *Acanthochromis polyacanthus*)²⁸⁵. Here also, this would select for a pelagic phase but not necessarily a dispersive one. The most common explanation is that larvae in the ocean avoid predation in shore habitats, which is probably very high¹⁸⁵. Once again, there is no need to specifically invoke dispersal here, a pelagic phase is sufficient. Eventually, the only explanation specific to a *dispersive* larval stage is to be sought at the level of the species, or at least of the population: populations which only self-recruit are more likely to become extinct after a local catastrophe. In the long run, only populations which disperse would persist.

Species-level
justifications
are irrelevant

A first limitation of this explanation is that theoretical work on the dynamics of metapopulations has long been demonstrating that a substantial rate of self-recruitment is necessary for metapopulations to be maintained^{30,31,287}. Two justifications have been presented in detail in the Introduction (section I.2.3, page 9): the persistence of metapopulations depends on the shortfall in self-recruitment and on closed exchange pathways between populations^{30,31}. So, at population/species level, dispersal may help on evolutionary time scales but self-recruitment is better in the short term, on ecological time scales. A more profound issue with this argument is that natural selection does not operate at the level of the species, but at the level of the *individual* (or of the gene). A convincing example is the hypertrophy of secondary sexual characters,

such as the tail of the Peacock. At the level of the species, the energy allocated to producing tails and parading would be more efficiently used in producing more offspring. However, Peacocks which displayed larger tails had more individual reproductive success than the others, so the frequency of the character increased. In general, if a particular behaviour/trait is advantageous for individuals, it will be selected for, no matter how deleterious it is for the species. There is evidence that such characters may even lead to the species' own extinction (also called evolutionary suicide)^{288,289}. A less academic example would be us, human beings, who are probably the only species conscious of its existence as such and who still exploit our environment individually, in a way that may well lead to our extinction in the near evolutionary future. Regarding dispersal during the larval phase, this means that, unless there are advantages at the level of the individual which compensate the risk of losing progeny in an hazardous dispersive stage, dispersal will not persist solely "because it is good for the species".

The evolutionary causes of dispersal must be sought at the level of the individual. In the, mostly terrestrial, literature³² some processes are classically recognised to favour dispersal: local environment variability at the scale of the life of the parent, which makes it better, for the parent and for the offspring, to spread the risk by dispersing at each reproductive event; high percentage of local inbreeding; and strong parasitism or competition pressure in the habitat of the parents. Few have been investigated to explain natal dispersal in marine systems and we only risk conjectures here. The Introduction (section I.5.1, page 20) highlighted that even coral reefs, which were considered very stable, are in fact subject to catastrophes. The remaining question is whether these perturbations are frequent enough to make systematic dispersal advantageous. According to Bonhomme & Planes²⁸⁵, they are not. Inbreeding depression is little considered in fishes except in an aquaculture context²⁹⁰. Finally, given the small space available for demersal species (compared to pelagic ones for example) and the densities observed in favourable environments such as rocky shores or coral reefs, parasitism and competition are likely to be strong, albeit everywhere. On the other hand, for each individual, the parental habitat is of demonstrably sufficient quality for reproduction. This should favour self-recruitment; as should the potential for local adaptation²⁹¹. As already highlighted, the fact that two species with very different early life histories (demersal eggs and short PLD vs. pelagic eggs and long PLD) achieve the same 60% rate of self-recruitment⁴⁴ suggests that there are some forces which favour this behaviour. Finally, from a mechanistic point of view, large scale orientation toward a known point of origin can be explained (through imprinting^{103,255} and/or solar or magnetic compass calibration¹⁴⁶) but orientation toward a hypothetical other habitat cannot²⁹².

In a nutshell, marine organisms may present a larval stage for reasons other than dispersal, still not fully understood. Most larvae probably enhance retention actively (otherwise they would take the risk to roam

Individual-level selective forces are required

Classic causes of dispersal seem absent

Arguments for self-recruitment exist

the ocean at random) and such behaviour would be advantageous selectively. As a consequence self-recruitment and reduced dispersal should be high; and they are. Thus, long distance dispersal may only be regarded as a side effect of having a larval phase, rather than as a cause for it. Regarding our models, this means that swimming decisions maximising self-recruitment also make sense in a connectivity context.

6.5.3 Model validation

Distribution patterns agree with observations

After justifying the hypotheses of optimal behaviour and focus on self-recruitment *a priori*, we evaluate their performance when implemented in a model. As already noted, in the model, Pomacentridae are distributed closer to shore than the other species, which have pelagic eggs. This qualitatively agrees with observations near coral-reefs^{168,259,293}. Similarly, fish larvae are observed to accumulate in the lee of emerged land^{74,130,215,259} or at the edge of eddies¹⁶⁴ and these are also features of the model.

Vertical swimming found in real-world data

Besides larval trajectories, that are the focus of all early life history models, our model also predicts behavioural strategies. One feature highlighted by the second model is that swimming downward, particularly in areas or intense surface flow, is an effective means of retention, or at least places larvae in environments where other behaviours make retention possible. This also agrees with the observations that ontogenetic downward migration increase retention^{71,84} (see also chapter 5).

Model predictions

Nevertheless, data allowing validation of such models is still very scarce and we have to resort to predictions about what should be observed. Because not all larvae behave optimally, young larvae are expected to be distributed differently from what the model predicts (all strategies would still be present at this stage, including non-optimal ones). The agreement between model and observations should progressively increase for older larvae, as mortality filters out the bad strategies. Yet, these models are more about processes than about the resulting patterns, so it would be more interesting to focus on decisions than on trajectories. Currently information regarding swimming decisions is virtually absent, except for the latest larval stages²⁵. Hence the occurrence of early swimming, or its shoreward orientation in the island case for example (Figure 6.17), cannot be checked. New observational devices should prove useful in that respect (chapter 2).

6.5.4 Consequences of larval behaviour on connectivity

Events early in larval life determine retention

Models help to get a mechanical understanding of processes. Here, the processes that increase self-recruitment can be identified and their consequences in terms of population connectivity, inferred. First, mortality by predation early in larval life seems key in determining the magnitude of self-recruitment, in particular in environments where resources are very concentrated near shore. In addition, early swimming is the most

energetically efficient strategy to favour retention in two common coastal environments. Therefore, Hjort's "critical period"¹ hypothesis, which supposes that early food intake is crucial for the survival of fish larvae, may indeed be limiting recruitment, albeit for reasons different from what he initially proposed. As a consequence, species laying demersal eggs and species spawning pelagic eggs, which begin larval life in very different conditions, differ greatly in their initial dispersal pathways. Dispersal trajectories for these two types of species are therefore expected to be very different when behaviour is considered, to an extent that exceeds the effect of other differences (in pelagic larval duration, in settlement stage swimming capacity, etc.).

Behaviour has been frequently evoked in modelling studies to explain why natural populations show finer structure (indicating smaller dispersal distances) compared to the results of models^{19,294}. In such models, including even limited behavioural abilities usually improves the predictions^{70,84}. In the meantime, most studies regarding behavioural abilities of fish larvae^{57,60,88,90,94,295} inevitably conclude with sentences such as "behaviour by reef fish larvae could have a much greater impact on modifying larval dispersal than previously thought"⁹⁴. And by "modifying" authors usually suggest "reduce". Finally, after the question of larval behaviour has, in part, raised the debate among ecologists interested in the connectivity between populations^{22,35}, all recent connectivity-related reviews mention it as a potentially major process^{11,38,59,155,296}. Our results suggest that oriented swimming by marine larvae, even at speeds as low as a few cm s^{-1} , improves greatly their ability to self-recruit. The effect of increased behavioural abilities on connectivity would not be straightforward, however, because they would apparently be accompanied by longer distances travelled from the spawning locations. This study brings the first quantitative evidence that, when coupled with the environment, larval behaviour can indeed be a major force in shaping dispersal trajectories.

Larval behaviour
reduces dispersal

6.A Choice of the last two optimal decisions

In the simple model presented in section 6.2 (page 119 and following) it is possible to describe analytically the choice of the last two decisions. It helps in understanding how the optimisation algorithm works.

Last optimal decision $d^\#(\theta, x, T - 1)$

The value function is

$$\begin{aligned} V(\theta, x, T - 1) &= p \cdot \max_d \left(\begin{array}{c} \underbrace{V(\theta + \Delta\theta^0, x + \Delta x^0, T)}_{\text{Foraging, } d = 0} \\ \underbrace{V(\theta - \Delta\theta^1, x - \Delta x^1, T)}_{\text{Swimming, } d = 1} \end{array} \right) \\ &= p \cdot \max \left(\begin{array}{c} (\theta + \Delta\theta^0) \cdot \mathbf{1}_{\{x + \Delta x^0 = 0\}} \\ (\theta - \Delta\theta^1) \cdot \mathbf{1}_{\{x - \Delta x^1 = 0\}} \end{array} \right) \end{aligned}$$

Now, $x + \Delta x^0 \neq 0$ because $x \geq 0$ and $\Delta x^0 > 0$. Thus

$$\begin{cases} V(\theta, x, T - 1) = p \cdot (\theta - \Delta\theta^1) \cdot \mathbf{1}_{\{x - \Delta x^1 = 0\}} \\ d^\#(\theta, x, T - 1) = 1 \end{cases}$$

Therefore, the optimal decision at time $T - 1$ is swimming if $x - \Delta x^1 = 0$. It means that the larva will swim if it can reach the reef by choosing swimming. But, if x is not equal to Δx^1 (it cannot reach the island), V equals zero for any decision. In this case it does not have any favourite decision for its last choice.

Before the last optimal decision $u^\#(\theta, x, T - 2)$ Assuming the last decision was swimming ($d^\#(\theta, x, T - 1) = 1$), the value function at $T - 2$ is

$$\begin{aligned} V(\theta, x, T - 2) &= p \cdot \max_d \left(\begin{array}{c} \underbrace{V(\theta + \Delta\theta^0, x + \Delta x^0, T - 1)}_{\text{Foraging, } d = 0} \\ \underbrace{V(\theta - \Delta\theta^1, x - \Delta x^1, T - 1)}_{\text{Swimming, } d = 1} \end{array} \right) \\ &= p \cdot \max \left(\begin{array}{c} (\theta + \Delta\theta^0 - \Delta\theta^1) \cdot \mathbf{1}_{\{x + \Delta x^0 = \Delta x^1\}} \\ (\theta - 2\Delta\theta^1) \cdot \mathbf{1}_{\{x - \Delta x^1 = \Delta x^1\}} \end{array} \right) \end{aligned}$$

As we cannot have at the same time $x + \Delta x^0 = \Delta x^1$ and $x - \Delta x^1 = \Delta x^1$, it comes that:

$$\begin{aligned} V(\theta, x, T - 2) &= p \cdot \left((\theta + \Delta\theta^0 - \Delta\theta^1) \cdot \mathbf{1}_{\{x + \Delta x^0 = \Delta x^1\}} \right. \\ &\quad \left. + (\theta - 2\Delta\theta^1) \cdot \mathbf{1}_{\{x - \Delta x^1 = \Delta x^1\}} \right) \end{aligned}$$

Therefore:

- If $x = \Delta x^1 - \Delta x^0$, then $d^\#(\theta, x, T - 2) = 0$, the larva chooses to forage. When the larva chooses to eat at time $T - 2$, it optimises its energy resources value and is taken away from the reef by Δx^0 . So, at time $T - 1$, it will be at the correct distance to come back to the reef (i.e. Δx^1).
- If $x = 2\Delta x^1$, then $d^\#(\theta, x, T - 2) = 1$, the larva decides to swim. Here again, this choice is natural as swimming brings the larva to a distance Δx^1 from the reef. It will only have to swim once more at last time step to reach it.

The explicit calculation of $V(\theta, x, t)$ becomes more and more complex as one goes backward in time. A computer code is developed in Scilab to find numerically all optimal decisions. Still, we have noted that solving Bellman's equation gives very intuitive results at time $T - 1$ and $T - 2$.

6.B Acknowledgements

The authors are thankful to J-P. Chancelier, from the CERMICS, for his help in coding the model in Scilab and to A. Lo-Yat, M. S. Pratchett, D. J. Gibson and two anonymous referees for their comments on the manuscript submitted to the Journal of Theoretical Biology. Regarding further development of the model, the authors are grateful to P. Marsaleix for its help in adapting SYMPHONIE to the configuration used here, and most indebted to C. Dong for sharing his ROMS configuration. This work was accomplished with financial support from the French ministry of research (ACI MOOREA, quantitative ecology).

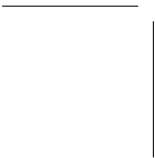

Chapitre C

Conclusion

C.1 Principaux résultats

La synthèse de la littérature, présentée dans le chapitre 1, a tenté d'isoler plusieurs traits comportementaux potentiellement importants lors de la phase larvaire des poissons démersaux. La nage, verticale et horizontale, particulièrement lorsqu'elle est orientée, serait une force majeure modifiant les trajectoires de dispersion dans le milieu pélagique. Les comportements de recherche de nourriture et d'évitement des prédateurs auraient, semble-t-il, une influence à plus petite échelle spatiale, mais joueraient directement sur la survie des larves. La nage en banc pourrait à la fois modifier les interactions de prédation, d'acquisition de nourriture et augmenter la capacité d'orientation des individus. Enfin, étant donné que les larves s'installent dans des habitats très spécifiques, les prédictions basées uniquement sur les points d'arrivée de trajectoires océaniques, sans se soucier de la disponibilité d'un habitat approprié à cet endroit, pourraient s'avérer insuffisantes. Au cours de ce travail nous nous sommes efforcés d'apporter des informations, quantitatives quand cela était possible, concernant ces différents comportements.

La mesure de l'orientation cardinale *in situ* de larves suggère que les écarts entre les positions de particules passives et de larves nageant de façon orientée peuvent aller jusqu'à 400 m en 15 min seulement, pour un Pomacentridae dérivant dans le Gulf Stream. La détection et la quantification de l'orientation des larves, *in situ* et à tout âge lors de la phase larvaire, semble donc une priorité. L'appareil présenté dans le chapitre 2 a permis de déterminer sans équivoque que 8 des 18 larves de poissons coralliens testées s'orientaient très nettement dans une direction cardinale. Ce système semble donc un moyen prometteur de quantifier l'orientation des larves.

L'observation des larves au moment même de leur installation, décrite dans le chapitre 3 était inédite jusqu'alors. Elle a révélé des comportements de nage qualitativement très conservés au sein de chaque espèce. Ces comportements suggèrent d'autre part que les larves cherchent un

Un moyen de détecter
l'orientation *in situ*

Comportement adapté
à l'habitat d'installation

habitat bien spécifique au moment de leur installation et adaptent leur nage à la localisation de cet habitat : leur localisation verticale dans les quelques mètres d'eau au dessus du récif dépend de la distance qu'elles parcourent sur le récif avant de s'installer.

Un environnement
pélagique très
dynamique ...

Les conditions de vent et de courant, la température et la salinité dans la couche mélangée de surface, ainsi que la profondeur de cette couche se sont révélées extrêmement variables autour d'un petit atoll du Pacifique Sud. L'amplitude des variations va jusqu'à un ordre de magnitude en moins de trois jours, sur des distances inférieures à 40 km. L'environnement pélagique dans lequel évoluent les larves est donc particulièrement dynamique. En son sein, la distribution spatiale des agrégats de larves n'est pas aisément corrélée à des variables environnementales. Les variables physiques et spatiales telles que la vitesse du courant, la température de l'eau ou la localisation par rapport à l'atoll n'expliquent jamais plus de 10% de la variance des abondances larvaires. Ces abondances sont, en fait, extraordinairement variables dans le temps et dans l'espace : les captures vont du simple au centuple entre deux prélèvements effectués à 10 km et 1 h d'intervalle. Au niveau taxonomique, les abondances relatives des familles les plus communes sont elles aussi très différentes. En revanche, les familles présentant une biologie larvaire proche (œufs pélagiques ou démersaux, durée de la phase pélagique, etc.) sont distribuées de façon similaire. En milieu tropical, il semble donc probable que la distribution spatiale des larves soit le résultat, chaotique en apparence, de l'interaction entre la dynamique des courants marins, la biologie reproductive des adultes et le comportement des larves, spécifiques à chaque taxon.

... qui déplace des
agrégats de larves aux
propriétés spécifiques
à chaque taxon

Au cours de l'ontogénie,
étalement vertical
et déplacement en
profondeur ...

La distribution verticale des larves de poissons coralliens est, elle aussi, très spécifique à chaque famille, révélant probablement des stratégies de dispersion ou des exigences écologiques différentes. Au cours de l'ontogénie, la distribution verticale de nombreuses familles a tendance à s'étaler entre la surface et 100 m de profondeur. Pour certaines, cet étalement s'accompagne d'un déplacement des centres de masse des agrégats larvaires en profondeur, de 25 m en moyenne. Le résultat le plus important de cette étude est que ces résultats ont une validité générale : au niveau de la communauté entière, les larves aux stades développement les plus avancés ou les larves les plus grosses sont plus en profondeur que les larves plus jeunes ou plus petites. Ces résultats sont probablement à mettre en relation avec le développement des capacités sensorielles des larves, qui leur ouvre l'accès à de plus grandes profondeurs. Cependant, ces résultats concernent la distribution de la population et cette description ne permet pas de remonter aux mouvements de migration individuels. En faisant l'hypothèse d'une migration verticale régulière au cours de l'ontogénie (qui aurait le plus fort impact sur l'advection) et dans des conditions courantologiques qui ne sont pas marquées par un fort cisaillement vertical, l'impact du déplacement en profondeur sur les distances de dérive horizontale des larves est faible. Néanmoins, il suffit à expliquer quelques

événements rares de rétention qui peuvent être déterminants pour l'auto-recrutement. Quoi qu'il en soit, la migration verticale facilite également les mouvements horizontaux. Ses effets sur l'advection et la nage sont donc synergiques.

L'introduction de la nage dans les modèles de la phase larvaire par le biais de la théorie du comportement optimal est justifiée par l'importante mortalité survenant lors de la phase larvaire, qui agit à la fois comme une force de sélection naturelle et comme un filtre sur les phénotypes (i.e. stratégies comportementales) restants. Son application dans les cas de l'auto-recrutement requiert peu d'hypothèses fondamentales et le comportement émerge uniquement de l'interaction avec l'environnement. Dans un modèle incluant les prédateurs et les proies des larves de poisson de façon spatialement explicite (chapitre 6, partie 6.3), il semble que la concentration des prédateurs autour des côtes soit le déterminant principal de l'intensité de l'auto-recrutement, particulièrement pour les espèces à œufs pélagiques. Une forte concentration des ressources et des prédateurs près des côtes a pour conséquence un plus faible taux de recrutement. D'autre part, les compromis nécessaires entre la rétention à proximité du point de départ, l'acquisition de nourriture et le risque de devenir une proie conduit les larves à s'accumuler à la limite extérieure de la zone d'influence d'une île océanique, en aval de celle-ci. Enfin, les espèces à œufs pélagiques semblent s'éloigner davantage du point d'émission des œufs dans l'océan et recrutent moins que les espèces à œufs démersaux. Dans un modèle où les courants et le développement des capacités natatoires des larves sont décrits de façon plus dynamique (chapitre 6, partie 6.4), la nage, même à des vitesses de l'ordre du $\text{cm}\cdot\text{s}^{-1}$, change complètement les trajectoires par rapport à un scénario d'advection purement passive. Pour des larves passives, dans les quatre scénarii considérés ici (déplacement autour d'une île ou d'un promontoire de larves ayant des capacités natatoires bonnes ou limitées), l'auto-recrutement est quasi-impossible. Cependant, quelques actions de nage bien orientées, suffisent à faire basculer le système vers régime dans lequel l'auto-recrutement est dominant (40 à 95%). D'autre part, le modèle montre qu'il est plus efficace au niveau énergétique de nager tôt afin d'atteindre des zones de rétention physique, plutôt que de nager tard, bien que des vitesses de nage élevées soit alors accessibles. Enfin, la nage a un impact particulièrement important quand elle exploite l'hétérogénéité du courant. Le modèle suggère que, pour optimiser l'auto-recrutement, les larves évitent d'être entraînées loin de leur site de recrutement (en particulier en descendant dans la colonne d'eau, vers des courants ralentis) et s'agrègent de façon active dans les zones de rétention en aval de structures topographiques. Étant donné que la nage favorise l'auto-recrutement, suite à une augmentation de la température des océans de 2°C (qui entraînerait un développement plus rapide des capacités natatoires des larves), l'auto-recrutement serait, lui aussi, augmenté. Cependant, dans le même temps, les distances parcourues dans l'océan depuis les zones de frai augmenteraient. L'effet

... qui expliquent de rares événements de rétention

La prédation des stades jeunes limite largement le taux de recrutement

La nage orientée au début de la vie larvaire est déterminante pour la suite des trajectoires

Une nage efficace exploite l'hétérogénéité des courants

global sur la connectivité entre les populations adultes n'est donc pas trivial.

C.2 Intérêts et limites des modèles numériques

C.2.1 Quand et pourquoi utiliser des modèles ?

Notre difficulté à
appréhender les
interactions

Notre faculté de raisonnement est en général mise à mal dès que nous cessons de voir les choses en termes purement additifs et soustractifs et que nous essayons d'appréhender des interactions. Considérons, par exemple, un événement de la vie courante impliquant un raisonnement souvent purement additif : faire des courses dans un supermarché. Le processus est régi par des lois simples : chaque élément a une propriété (un prix) et ces propriétés sont additives (plus il y a de marchandises dans le caddie, plus le prix est élevé). Ce type de raisonnement est tellement naturel qu'après une période d'observation, nous sommes en général capable de prédire à peu près combien coûtera un caddie donné, sans explicitement faire le calcul. Considérons alors le cas de promotions : acheter un produit réduit le prix d'un autre produit (il existe une interaction entre les deux produits, qui modifie leurs propriétés). Tant que les changements restent simples et localisés (3 pour 2, 15% de réduction, etc.) nous arrivons à prédire leur effet sur le prix final. Imaginons maintenant une grande surface où acheter un litre de jus d'orange donne droit à 0.5 euros de réduction sur un kilo de viande bovine — origine France certifiée — et que la viande de bœuf donne à son tour droit à un produit gratuit dans le rayon "Entretien du jardin", mais augmente également le prix de la viande de porc, par un facteur différent selon l'heure de la journée ... nous serions rapidement dépassés. Pourtant, cette situation ne correspondrait qu'à un écosystème très simplifié, avec quelques relations de coopération (les promotions) et d'exploitation (les augmentations de prix) régies par des facteurs extrinsèques (l'heure de la journée). Tout comme les grandes surfaces ont recours à des caisses enregistreuses, il est utile de recourir à une représentation mathématique dans laquelle les propriétés de chacun des constituants sont paramétrées et les interactions (qui, prises individuellement, sont simples) sont représentées, afin de comprendre le comportement du réseau d'interactions à partir de l'observation des résultats.

Propension à rendre les
modèles plus "réalistes"

Notre faiblesse face aux interactions et aux processus dit *non-linéaires* qu'elles engendrent, explique pourquoi les modèles mathématiques sont des outils prisés dans les domaines de la biologie où les interactions sont dominantes : les réseaux neuronaux, l'expression génétique, les voies métaboliques, le fonctionnement des écosystèmes, etc. Elle explique également notre tendance à vouloir rendre ces modèles toujours plus "réalistes", en y intégrant le maximum de processus, car les interactions entre tous ces processus seraient très difficiles à aborder autrement. Mais il convient alors de s'interroger sur les hypothèses et

les approximations qui accompagnent la complexification des modèles. Qui plus est, il existe une différence fondamentale entre un modèle de pêche²⁹⁷, par exemple, et le modèle de taille optimale de chargement chez l'Étourneau⁵⁴, présenté en Introduction (page 18). Rendre chacun de ces modèles plus "réaliste" n'a pas le même intérêt.

Dans le premier cas, les modèles de dynamique des stocks halieutiques ont pour objectif de guider des politiques d'exploitation²⁹⁷. Ils participent, par exemple, à la définition des quotas de pêche par l'Union Européenne (en théorie du moins). L'objectif de ces modèles est donc d'obtenir des données numériques précises sur les abondances, à partir d'estimations de terrain, et de prédire leur évolution dans le futur. Ce sont des modèles principalement *descriptifs*. Dans ce cadre, tout nouveau processus qui rendrait le modèle plus proche de la réalité semble bienvenu. Cependant, les estimations des paramètres sur lesquels ces modèles sont basés sont imparfaites, et les incertitudes ont des effets multiplicatifs dans les prédictions du modèle. Par exemple, la comparaison de quatre modèles structurés en âge, de complexité croissante, représentant la dynamique d'une population de Marmottes, révèle que la variance dans l'estimation de la densité, ou des taux d'émergence après l'hiver, augmente avec la complexité du modèle²⁹⁸. Qui plus est, le modèle le plus simple s'avère suffisant pour prédire l'abondance moyenne de la population à l'équilibre. Les raffinements successifs (sous division en groupes, spatialisation, ajout de comportements sociaux) ne sont nécessaires que pour prédire les dynamiques d'atteinte de cet équilibre, et au prix d'une incertitude accrue quant à l'état final. De même, en écologie marine, une analyse de la littérature concernant les modèles écosystémiques révèle que les modèles les plus complexes prédisent en général *moins* bien la réalité que des modèles représentant les relations trophiques avec un niveau de détail moyen²⁹⁹. Enfin, même si les techniques d'assimilation de séries temporelles de données permettent l'affinement de l'estimation des paramètres^{300,301}, elles sont en général aveugles aux processus décrits par le modèle. Il en résulte des modèles bien calibrés pour décrire le comportement du système dans la gamme des variations passées et actuelles, mais au pouvoir prédictif faible dans le cas de changements plus drastiques ou plus globaux dans l'avenir (changement climatique par exemple). Même dans le cas de modèles à visée descriptive, il n'est donc pas toujours évident que complexifier un modèle l'améliore.

Le modèle de taille de chargement optimal chez les Étourneaux n'a un intérêt opérationnel que très limité : il ne guidera probablement jamais une politique de conservation ou d'exploitation de cet oiseau. Son objectif n'est pas de décrire mais de *comprendre* le comportement, et surtout de généraliser les processus observés. Et, en effet, il semble que maximiser le rapport bénéfice/coût, lorsqu'il existe une relation concave entre l'énergie dépensée et le bénéfice reçu, ait une portée générale, puisqu'exactement le même raisonnement permet de prédire très efficacement le temps de copulation chez la Drosophile. Lorsque

L'incertitude sur
les paramètres ...

... rend les modèles
complexes moins
performants

Les modèles aident
à la compréhension
quand ils sont simples

l'intérêt est porté aux processus, le but de l'exercice de modélisation devient de trouver le modèle *minimal* qui décrit le système, afin d'aider à sa compréhension. L'ajout de nouveaux composants est donc intrinsèquement indésirable.

C.2.2 Quels modèles pour la phase larvaire des organismes marins ?

Les modèles actuels sont principalement descriptifs

Les modèles de la phase larvaire des poissons ne font pas exception à cette dichotomie²²² et il existe des modèles tentant de décrire et de prédire les distributions larvaires alors que d'autres, comme ceux présentés dans le chapitre 6, ont pour objectif d'inférer l'importance relative de différents processus. Les modèles descriptifs sont, de loin, les plus nombreux²²². La plupart sont, au minimum, des modèles Lagrangiens d'advection de particules basés sur des modèles généraux de circulation des masses d'eaux (Global Circulation Models, ou GCMs). Seulement un tiers d'entre eux inclut une description du bilan énergétique des larves (alimentation, croissance, etc.). Quarante pour cent incluent une forme de comportement des larves et, dans l'immense majorité des cas, il s'agit uniquement d'une migration verticale. Certains processus, tels que la nage orientée ou l'advection à petite échelle à la sortie des zones de frai, sont très nettement sous représentés, alors qu'ils sont potentiellement importants²²² (chapitre 1). Avant de prôner la complexification, qui peut parfois se révéler néfaste comme nous venons de le voir, il convient de s'interroger sur ce que veulent décrire et prédire ces modèles.

Ils visent à prédire de façon quantitative le recrutement ...

... dans un environnement incertain ...

L'objectif explicite de nombreux modèles descriptifs de la phase larvaire des organismes marins, et non plus seulement des poissons, est de prédire de façon *quantitative* le taux de recrutement en un point, ou le taux d'échanges entre localités. Ces taux dépendent, au moins, du transport par les courants marins qui est décrit par le biais de modèles océanographiques. Or ces GCMs sont très proches des modèles météorologiques : la circulation des masses d'air et des masses d'eau est régie par les mêmes lois de dynamiques des fluides. Au vu de la précision avec laquelle les modèles météorologiques prédisent, ne serait-ce que qualitativement, le temps qu'il fera sous 7 jours et au niveau régional, il est facile de réaliser que les modèles océaniques sont forcément imparfaits. Même si les échelles de temps sont plus longues pour les écoulements d'eau, les prédictions des modèles océanographiques à l'échelle de la vie larvaire (plusieurs semaines voire plusieurs mois, à une résolution kilométrique) sont incertaines⁴⁷. Qui plus est, ce champ de courant n'est que le point de départ de simulations Lagrangiennes. Pour continuer le parallèle avec les modèles météorologiques, cela signifie qu'au delà de prédire la direction du vent au dessus de Paris, il faut prédire comment va se déplacer un avion en papier entraîné par le vent. Il est probable que le destin de cet avion sera très différent selon qu'il est lancé depuis le haut de la tour Eiffel où le pied de la tour Montparnasse.

Cet exemple, caricatural certes, met néanmoins en valeur le fait que, même si le champ moyen de courant est bien connu, l'advection de particules est très sensible aux variations locales, et notamment aux conditions initiales de dispersion⁴⁷, qui sont pour l'instant très mal résolues par les GCMs¹⁵⁵. Jusqu'ici, seuls des processus complètement déterministes ont été considérés : les mouvements des courants et l'advection des particules sont régis par des lois physiques. Cependant, leur description dans les modèles repose souvent sur des approximations probabilistes, pour représenter les phénomènes ayant lieu à une échelle plus faible que celle de la grille de simulation. Les modèles de résolution trop faible (maille > 3 km) peuvent donc faire des erreurs de prédiction substantielles du fait de ces approximations³⁰². Mais oublions même cela et considérons que les développements techniques futurs permettront de bien représenter ces processus. Il reste toujours une source inhérente de stochasticité : les "particules" simulées dans ces modèles sont des être vivants. Elles ne sont pas inertes. Elles ont donc des propriétés (de mouvement, de taille, de flottaison, etc.) qui ne sont pas régies par des lois déterministes. Certaines de ces propriétés, comme leur distribution verticale par exemple, peuvent complètement changer leurs trajectoires d'advection^{70,83,84,198} (chapitre 6). Enfin, étant donné la faible proportion de larves qui recrutent finalement, il est possible, et à vrai dire probable²⁵, que les recrues aient des propriétés différentes de la moyenne de la population. Décrire la stochasticité des processus biologiques de façon classique, c'est-à-dire par le biais d'un taux de variation autour d'une moyenne, serait donc insuffisant.

En résumé, les modèles de la phase larvaire des organismes marins traitent de phénomènes probabilistes (et potentiellement de leurs exceptions plutôt que de leur moyenne), aux dynamiques non linéaires et très sensibles aux conditions initiales, et tentent de faire des prédictions à long terme en se basant sur une description de l'environnement imparfaite. Je pense donc que, dans ces conditions, les modèles de la phase larvaire *ne peuvent pas, et ne pourront jamais, donner des prédictions quantitatives fiables du taux de recrutement*. Est-ce à dire que tous les modèles sont inutiles, et que le chapitre 6 de ce travail, au moins, est bon à jeter ? Évidemment non, du moins je l'espère.

Tout d'abord, même si les modèles océanographiques sont imparfaits et si les modèles biologiques probabilistes ne sont qu'approximatifs, ils ne sont pas non plus complètement déraisonnables. Ainsi, il est probable que ces modèles soient assez solides pour donner des indices de confiance sur des prédictions qualitatives, par exemple : "Cette année le taux de recrutement a 80% de chances d'être élevé", ou : "... plus élevé que l'année dernière", ou encore : "Placer une réserve marine à cet endroit permettra, en moyenne, de protéger davantage de sources de larves que de la placer ailleurs". De telles prédictions qualitatives seraient déjà très utiles à la gestion des peuplements. Ces indices de confiance et la solidité des prédictions ne pourront être évalués qu'après

... où l'advection est non-linéaire ...

... et où les particules ont des propriétés stochastiques propres

Leur résultat ne peut pas être quantitatif

Des indices de confiance et des prédictions qualitatives peuvent suffire

La différence entre la réalité et les modèles aide à la compréhension des processus

analyse de leur sensibilité aux variations de différents paramètres du modèle.

Enfin, les modèles ne sont pas informatifs uniquement lorsqu'ils prédisent correctement les observations. Par exemple, l'équilibre de Hardy-Weinberg n'est probablement jamais exactement respecté dans les populations naturelles. Cependant, sa formulation permet de partir d'une hypothèse nulle, générée par des mécanismes bien identifiés, et de n'avoir à expliquer que la *différence* entre cette hypothèse nulle et la réalité. De même, le modèle de Lotka et Volterra prédit des oscillations régulières dans les systèmes proies-prédateurs et a changé la façon d'aborder leur étude. Par exemple, les populations de Loup et d'Orignal de l'Île Royale du Lac Supérieur semblent varier de concert (Figure C.1). Cependant, leurs oscillations sont loin d'être aussi régulières que celles prédites par la théorie de Lotka-Volterra. Il apparaît qu'en plus des oscillations, l'abondance des Loups est régulée intrinsèquement de façon densité dépendante car ils forment des groupes très structurés. Qui plus est, la différence temporelle entre les pics d'abondance des Orignaux et des Loups dépend de la structure d'âge de la population d'Orignal, car les Loups capturent plus facilement les Orignaux jeunes ou très âgés³⁰³. Sans l'hypothèse nulle d'une oscillation commune entre proies et prédateurs, ces deux dynamiques plus fines auraient été beaucoup plus difficiles, voire impossibles, à établir. Enfin, dans le domaine qui concerne plus directement ce travail, les premiers modèles de la phase larvaire, qui ne tenaient pas compte du comportement des larves, ont permis de suggérer son importance pour expliquer la différence entre leurs prédictions et les observations^{19,294}. De même, la réduction des différences entre les résultats du modèle et les observations lorsque la migration verticale était intégrée a souligné l'importance de ce comportement^{70,84}.

Des hypothèses explicites pour des modèles simples et robustes

Ainsi les modèles, et particulièrement les approches centrées sur les processus (nage, recherche de nourriture, choix de l'habitat, interaction avec les courants, etc.), ont tout à fait leur place dans l'étude de la phase larvaire des organismes marins. La récente synthèse de cette littérature

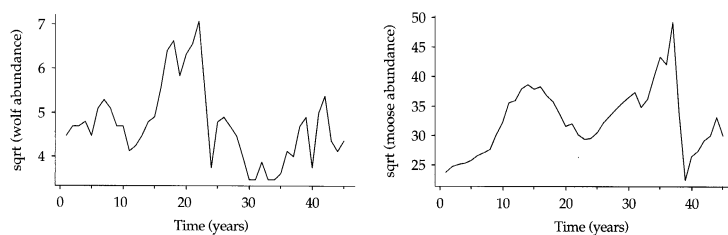

Figure C.1 Série temporelle de l'abondance des Loups (gauche) et des Orignaux (droite) sur l'Île Royale, Lac Supérieur. Les deux populations présentent de grossières oscillations désynchronisées (l'abondance des Loups augmente quelques années après celle des Orignaux). Tiré de Bonsall & Hassell³⁰³.

remarque également un déplacement du centre d'intérêt depuis les premiers modèles descriptifs vers des modèles plus déductifs, générant des hypothèses^{222,304}. Au vu de la discussion précédente, il est possible de suggérer des guides pour la construction et l'interprétation de ces modèles. En premier lieu, la complexité ne doit pas être considérée comme une marque de réalisme ou de performance. Lorsque l'intérêt est porté à un processus en particulier, il est préférable de représenter un scénario simple dans le modèle, quitte à discuter ensuite ses limites et ses prédictions dans des cas plus complexes, plutôt que d'intégrer toute la complexité au modèle. Certains processus de la phase larvaire des poissons ont bénéficié d'approches élégantes de ce type : la dispersion loin du site d'origine²⁸⁶, la nage et l'orientation lors de l'approche du site d'installation^{82,143,199}, l'évolution de la phase larvaire en réponse à la structure de l'habitat³⁰⁵ et à la prédation sur le site d'origine³⁰⁶, ou encore l'orientation lors de la nage en banc³⁰⁷. D'autre part, tous les paramètres numériques utilisés dans un modèle sont autant d'hypothèses informulées sur le processus étudié. Quand cela est possible, il semble donc intéressant de réduire le nombre paramètres, par exemple en décrivant leurs variations spatiales ou temporelles par des fonctions. Procéder ainsi oblige à rendre explicites les hypothèses sur les variations des paramètres et, même si celles-ci sont approximatives, elles ont le mérite d'être visibles, modifiables et discutables. Évidemment, les meilleures estimations possibles doivent être utilisées pour ces paramètres. Ces estimations sont une opportunité d'interaction entre les modèles et les travaux de terrain ou expérimentaux. Ces derniers fournissent des données numériques et, en retour, les modèles peuvent suggérer quels paramètres il est le plus urgent de mieux estimer (e.g. le taux de mortalité par prédation, le coût énergétique de la nage, etc.) ou même directement guider des campagnes d'échantillonnage ajusté (*adaptive sampling*). Enfin, l'analyse des résultats d'un modèle dans différentes situations est nécessaire afin d'attester de leur robustesse. Cette analyse de sensibilité est le point clef du développement et de l'interprétation des modèles numériques et ne doit jamais être négligée.

C.3 Pistes de recherche

Le chapitre 4 a souligné que la distribution spatiale des larves était probablement le fruit de processus à diverses échelles, y compris des échelles plus faibles que celles auxquelles les techniques d'échantillonnage actuelles permettent d'accéder. D'autre part, il a été impossible de déterminer si plusieurs échantillons de forte densité correspondaient à plusieurs observations d'un seul agrégat de larves ou à plusieurs agrégats indépendants. Ceci limite l'interprétation que nous pouvons faire de ces observations et met en valeur la difficulté d'étudier des processus spatiaux à partir d'observations ponctuelles. Il semble donc nécessaire de développer des méthodes d'observation des larves et de

Des outils d'observation plus synoptiques

leur environnement qui permettent un échantillonnage à la fois précis, continu et rapide, afin d'observer les distributions à l'échelle métrique et de déployer le système de façon synoptique sur une grande surface, à l'échelle kilométrique⁴⁷. Un système basé sur l'observation vidéo des larves *in situ* et leur identification automatique, proche du Video Plankton Recorder, devrait permettre des avancées dans ce domaine¹⁸⁸.

Mieux décrire la dispersion initiale

Si les phénomènes biologiques au début de la phase larvaire sont importants (chapitre 6), les phénomènes océanographiques le sont probablement aussi. Comme cela a déjà été remarqué plus haut, les modèles d'advection sont très sensibles aux conditions locales, notamment aux conditions initiales^{47,155}. Celles-ci sont pour l'instant mal prédites par les modèles océanographiques, du fait des limites imposées sur leur résolution par les moyens de calcul³⁰⁸. L'accroissement exponentiel des capacités matérielles de calcul, selon la "loi" de Moore³⁰⁹, ainsi que le développement de modèles fins, emboîtés dans les grilles plus larges, devraient permettre de mieux les représenter dans le futur³⁰⁸.

Les modèles permettent d'identifier les lacunes dans la littérature

L'effort de modélisation du comportement des larves permet, outre ses résultats intrinsèques, une analyse critique des données quantitatives présentes dans la littérature. Par exemple, alors que les articles s'intéressant aux capacités natatoires des larves se comptent par dizaines, il n'a été possible de rassembler les paramètres nécessaires au modèle de nage que pour une seule espèce : *Pomacentrus amboinensis*. Pourtant le nombre de paramètres a été réduit par l'utilisation de régressions décrivant leur évolution temporelle. Le modèle nécessitait seulement : la durée des portions de la phase pélagique passées en tant qu'œuf (pour les espèces à œufs pélagiques) et en tant que larve, les vitesses critiques à l'éclosion et à l'installation, et l'endurance de larves en âge de s'installer nageant à 13.5 cm s⁻¹. Comparé à certains modèles de dispersion de la Morue ou de la Sole, qui nécessitent une trentaine de paramètres uniquement pour décrire la croissance³¹⁰, c'est peu ; mais déjà trop. La plupart des études concernant le comportement des larves de poisson portent sur les stades avancés des larves de poissons coralliens, en particuliers perciformes²⁵. Dans ces conditions, il n'est pas étonnant que le paramètre dont la disponibilité était limitante pour le modèle du chapitre 6 ait été la vitesse de nage à l'éclosion. Il semble nécessaire d'élargir le champ taxonomique, ontogénique et écosystémique de l'étude du comportement.

Décrire les capacités natatoires des larves jeunes et de poissons tempérés

Un objectif pressant serait d'obtenir des données sur l'endurance des larves de poissons tempérés, en particulier non-perciformes. Ces groupes n'ont pas été considérés jusqu'à présent, car l'opinion commune était que leurs capacités de nage étaient de toute façon négligeables face aux courants qu'ils subissent. Plusieurs résultats suggèrent maintenant que des vitesses faibles peuvent faire la différence¹⁹⁶ (chapitre 6). De plus, les modèles présentés ici suggèrent que la nage aux premiers stades après éclosion est primordiale pour l'auto-recrutement. Ce résultat est néanmoins conditionné par l'endurance et les capacités sensorielles des larves à ces stades, qui sont encore mal connues. Un second objectif

serait donc d'obtenir des données similaires à celles qui sont maintenant disponibles pour les stades avancés des poissons coralliens, mais tout au long de l'ontogénie, ou au moins pour les stades les plus jeunes.

Enfin, bien que les modèles complexes ne soient pas un objectif à atteindre, ils ne faut pas non plus que la simplicité de notre représentation de la phase larvaire résulte de l'absence d'information. Au contraire, il faut qu'elle soit construite par une simplification raisonnée des processus, qui commence par négliger ceux qui ont le moins d'impact. Pour ce faire, il faut connaître l'ensemble des phénomènes impliqués et estimer leur importance, par exemple dans des analyses de sensibilité. Des processus notablement absents des modèles actuels, souvent du fait d'un manque d'information, sont la nage orientée des larves et la prédation²²². Les observations directes de l'orientation des larves sont ponctuelles et ne permettent en général pas de remonter aux causes proximales du comportement^{90,133,134,311}. Nous espérons que le dispositif décrit dans le chapitre 2 permettra d'apporter des informations sur le processus d'orientation. En ce qui concerne la prédation, les estimations de taux de mortalité des larves sont rares et parfois dans une littérature difficile d'accès^{72,273,312-317}. Tant que la distribution et le comportement de recherche de nourriture des prédateurs ne seront pas connues, il sera probablement difficile d'aller plus loin que des taux moyens et spatialement uniformes de mortalité journalière. Cette lacune est d'autant plus regrettable que tous les modèles tenant compte de la mortalité s'accordent pour dire qu'elle a un effet primordial^{70,86,305} (chapitre 6).

Estimer *in situ* les capacités d'orientation des larves et les taux de mortalité



Les différentes approches utilisées dans ce travail ont contribué à montrer que les organismes translucides, de quelques millimètres de long, que sont les larves de poissons sont probablement capables de s'orienter dans l'océan. Elles nagent et interagissent avec les courants, influençant ainsi leur distribution spatiale et, même modestes, ces capacités natatoires ont le potentiel de complètement modifier leurs trajectoires océaniques. Ces résultats impliquent que le comportement des larves de tous les poissons (tropicaux comme tempérés), mais probablement aussi des larves de Décapodes et de Céphalopodes (Figure I.10, page 22), a des conséquences pour la connectivité entre les populations³⁸ et le renouvellement des stocks¹. Il est probable que l'approvisionnement en recrues des populations marines côtières soit en grande partie local et que, en conséquence, celles-ci soient plus structurées que ne le supposent leurs politiques de gestion actuelles.

Comme tout comportement, le déplacement des larves est une réponse motrice à un stimulus sensoriel. Les dix dernières années ont amené leur lot d'étonnement, et même d'incrédulité, face à la découverte des capacités motrices extraordinaires des larves de poissons²⁵. De même, il est probable que nous ne fassions qu'effleurer leurs capacités sensorielles à l'heure actuelle. Le développement des recherches tentant d'expliquer comment les larves sont capables de retourner précisément à leur lieu de naissance après un épisode pélagique de plusieurs semaines^{41,42} promet d'être plein de surprises.

Appendix A

Undescribed Chaetodontidae

Two specimen of a quite odd looking larva were captured on two different occasions during the cruise around Tetiaroa, at several days interval (see chapter 4 for details regarding sampling strategy). Both are advanced stages and were identified as Chaetodontids due to the bony head plates characteristic of the tholichthys stage of this family. They are otherwise characterised by particularly long supra-ocular ridges, horn-like, which protrude forward. In other species where those ridges are extended, they are rather oriented perpendicular to the body, or backward. Such “longhorn” specimen were already captured in French Polynesia, around the atoll of Mururoa in 1977. A technical report of the ORSTOM³¹⁸ contains a picture of at least four specimen, but they were erroneously identified as *Heniochus sp.* and were not described. Those specimen are nowhere to be found today.

Both specimen were photographed still alive, straight out of the nets, onboard the ship. These pictures of somewhat low quality allow to see their real colours (Figures A.1 and A.4). Several months after being fixed in formalin, high quality photographs were taken by David G. Johnson in the National Museum of Natural History, Washington (Figure A.2, A.3, and A.5). Both specimen are now stored in 90% ethanol.

Morphometric measurements were performed on high resolution side-view photographs, with the software ImageJ. Meristic counts were performed on fixed specimen and on the same photographs (Table A.1).

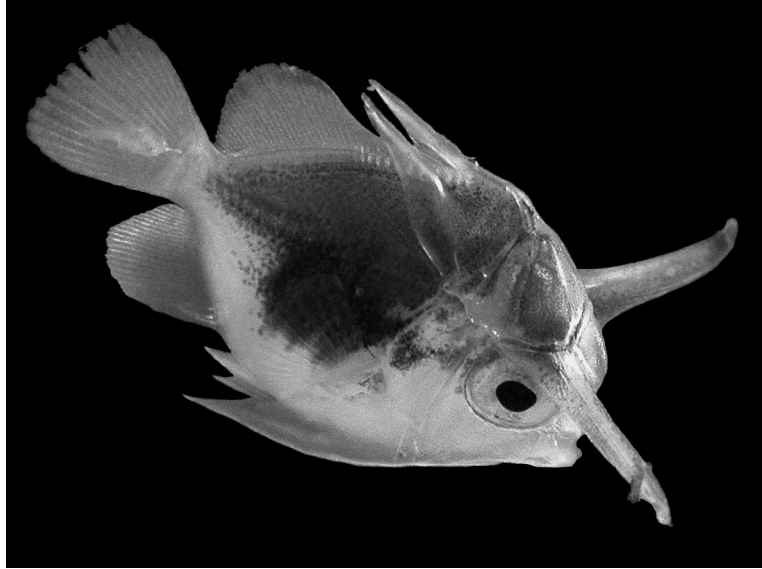

Figure A.1 Side view of specimen 1, still alive. The dorsal and opercular portions of the body are covered in pigment, and the top half is generally brightly coloured in rose/red. The green colour of the eye is probably artifactual here (caused by reflection or irisation). The rose-mass on the caudal fin is a chalinus larval stage of a parasite of the family Caligidae (M. Vignon, pers. comm.).



Figure A.2 High definition top view of specimen 1. Note the length of the forward-projecting supra-ocular spines. The parasite is fixed on the right side of caudal fin.



Figure A.3 High definition face view of specimen 1. The length of supra-ocular spines is, once again, very noticeable.



Figure A.4 Side view of specimen 1, alive. In this picture, it is more evident that the dorsal pigment (which appeared black or brown in previous picture) was in fact reflective and coloured in a bright electric blue. The rose colour of the head is apparent though the head bones.

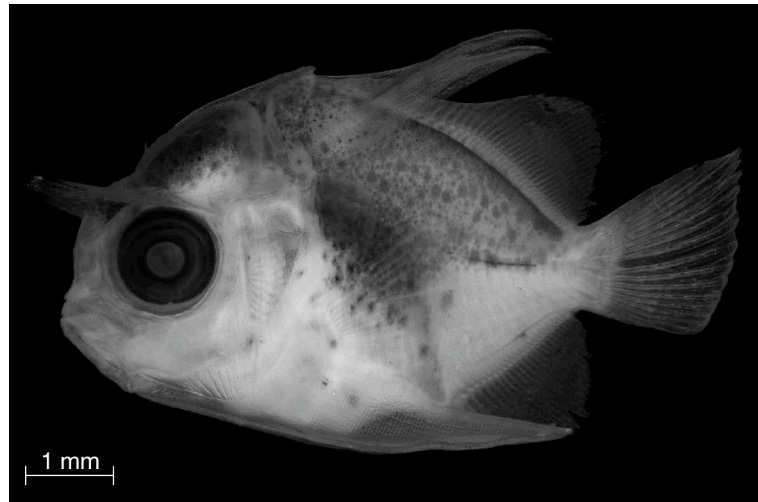

Figure A.5 High definition side view of specimen 2. The notochord is not completely flexed yet and the larva is smaller.

Table A.1 Morphometric measurements and meristic counts for the two specimens. Lengths are in mm. Meristic counts follow conventions of Leis & Carson-Ewart¹⁷⁴.

| Ontogenetic stage | Specimen 1 | Specimen 2 |
|-------------------------|--------------|----------------|
| | post flexion | end of flexion |
| Body length | 9.66 | 6.38 |
| Body depth | 7.21 | 4.06 |
| Pre-anal length | 7.74 | 4.46 |
| Vent to anal-fin length | ? | 0 |
| Pre dorsal-fin length | 5.71 | 3.19 |
| Head length | 5.05 | 3.07 |
| Eye diameter | 1.65 | 1.13 |
| Snout length | 1.33 | 0.67 |
| Dorsal fin | | >IV, 18 |
| Anal fin | | III, 21 |
| Caudal fin | | 17 |
| Pelvic fins | | ? |
| Pectoral fins | | 14 |

Bibliographie

- [1] Hjort J. Fluctuations in the great fisheries of northern Europe viewed in the light of biological research. *Rapports et Procès-Verbaux des Réunions du Conseil International Permanent pour l'Exploration de la Mer* **20**, 1–228 (1914).
- [2] Doherty PJ. Variable replenishment and the dynamics of reef fish populations. In *Coral Reef Fishes : Dynamics and Diversity in a Complex Ecosystem*, Sale PF, ed., Academic Press, San Diego, California, USA, chap. 15, 327–355 (2002).
- [3] Ehrlich PR. The population biology of coral reef fishes. *Annual Review of Ecology and Systematics* **6**, 211–247 (1975).
- [4] Sale PF. The ecology of fishes on coral reefs. *Oceanography and Marine Biology : an Annual Review* **18**, 376–421 (1980).
- [5] Doherty PJ, Dufour V, Galzin R, Hixon MA, Meekan MG, Planes S. High mortality during settlement is a population bottleneck for a tropical surgeonfish. *Ecology* **85**, 2422–2428 (2004).
- [6] Hixon MA, Webster MS. Density dependance in reef fish populations. In *Coral Reef Fishes : Dynamics and Diversity in a Complex Ecosystem*, Sale PF, ed., Academic Press, San Diego, California, USA, chap. 15, 327–355 (2002).
- [7] Doherty PJ. Coral reef fishes : Recruitment-limited assemblages ? In *Proceedings of the 4th International Coral Reef Symposium*, Gomez ED, Birkeland CE, Buddemeier RW, Johannes RE, Marsh J, Tsuda RT, eds., Marine Sciences Center, University of the Philippines, vol. 2, 465–470 (1981).
- [8] Doherty PJ, Fowler T. An empirical test of recruitment limitation in a coral reef fish. *Science* **263**, 935–939 (1994).
- [9] Forrester GE. Factors influencing the juvenile demography of a coral reef fish. *Ecology* **71**, 1666–1681 (1990).
- [10] Schmitt RJ, Holbrook SJ, Osenberg CW. Quantifying the effects of multiple processes on local abundance : a cohort approach for open populations. *Ecology Letters* **2**, 294–303 (1999).
- [11] Levin LA. Recent progress in understanding larval dispersal : new directions and digressions. *Integrative and Comparative Biology* **46**, 282–297 (2006).

- [12] Cushing DH. *Recruitment and parent stock in fishes*. University of Washington Press, Seattle (1973).
- [13] Lasker R. The role of a stable ocean in larval fish survival and subsequent recruitment. In *Marine Fish Larvae, Morphology, Ecology, and Relation to Fisheries*, Lasker R, ed., University of Washington Press, Seattle, 33–77 (1981).
- [14] Rothschild BJ, Osborn TR. Small-scale turbulence and planktonic contact rates. *Journal of Plankton Research* **10**, 465–474 (1988).
- [15] Wolanski E, Hamner WM. Topographically controlled fronts in the ocean and their biological influence. *Science* **241**, 177–181 (1988).
- [16] Fiedler PC, Bernard HJ. Tuna aggregation and feeding near fronts observed in satellite imagery. *Continental Shelf Research* **7**, 871–881 (1987).
- [17] Govoni JJ. Fisheries oceanography and the ecology of early life histories of fishes : a perspective over fifty years. *Scientia Marina* **69** (2005).
- [18] Lobel PS, Robinson AR. Reef fishes at sea : Ocean currents and the advection of larvae. In *The Ecology of Deep and Shallow Coral Reefs, Symposium Series for Underwater Research*, Reaka ML, ed., NOAA's Undersea Research Program, Rockville, MD, vol. 1, 29–38 (1983).
- [19] Dight IJ, James MK, Bode L. Models of larval dispersal within the central Great Barrier Reef : Patterns of connectivity and their implications for species distributions. In *Proceedings of the 6th International Coral Reef Symposium*, Choat JH, Barnes D, Borowitzka MA, Coll JC, Davies PJ, Flood P, Hatcher BG, Hopley D, Hutchings PA, Kinsey D, Orme GR, Pichon M, Sale PF, Sammarco P, Wallace CC, Wilkinson C, Wolanski E, Bellwood O, eds., 6th International Coral Reef Symposium Executive Comitee, vol. 3, 217–224 (1988).
- [20] Black KP. The relationship of reef hydrodynamics to variations in numbers of planktonic larvae on and around coral reefs. In *Proceedings of the 6th International Coral Reef Symposium*, Choat JH, Barnes D, Borowitzka MA, Coll JC, Davies PJ, Flood P, Hatcher BG, Hopley D, Hutchings PA, Kinsey D, Orme GR, Pichon M, Sale PF, Sammarco P, Wallace CC, Wilkinson C, Wolanski E, Bellwood O, eds., 6th International Coral Reef Symposium Executive Comitee, vol. 2, 125–130 (1988).
- [21] Bartsch J, Brander K, Heath M, Munk P, Richardson K, Svendsen E. Modelling the advection of herring larvae in the North Sea. *Nature* **340**, 632–636 (1989).
- [22] Roberts CM. Connectivity and management of Caribbean coral reefs. *Science* **278**, 1454–1457 (1997).
- [23] Pineda J, Hare JA, Sponaugle S. Larval transport and dispersal in the coastal ocean and consequences for population connectivity. *Oceanography* **20**, 22–39 (2007).

- [24] Sponaugle S, Cowen RK, Shanks A, Morgan SG, Leis JM, Pineda J, Boehlert GW, Kingsford MJ, Lindeman KC, Grimes C, Munro JL. Predicting self-recruitment in marine populations : Biophysical correlates and mechanisms. *Bulletin of Marine Science* **70**, 341–375 (2002).
- [25] Leis JM. Are larvae of demersal fishes plankton or nekton ? *Advances in Marine Biology* **51**, 57–141 (2006).
- [26] Levins R. Some demographic and genetic consequences of environmental heterogeneity for biological control. *Bulletin of the Entomological Society of America* **15**, 237–240 (1969).
- [27] Levins R. Extinction. In *Some Mathematical Questions in Biology*, Gerstenhaber M, ed., American Mathematical Society, Providence, Rhode Island, USA, 75–107 (1970).
- [28] Hanski I. *Metapopulation ecology*. Oxford University Press (1999).
- [29] Whitlock MC. Dispersal and the genetic properties of metapopulations. In *Dispersal*, Clobert J, Danchin E, Dhondt AA, Nichols JD, eds., Oxford University Press, 273–282 (2001).
- [30] Hastings A, Botsford LW. Persistence of spatial populations depends on returning home. *Proceedings of the National Academy of Sciences of the United States of America* **103**, 6067–6072 (2006).
- [31] Armsworth PR. Recruitment limitation, population regulation, and larval connectivity in reef fish metapopulations. *Ecology* **83**, 1092–1104 (2002).
- [32] Clobert J, Danchin E, Dhondt AA, Nichols JD. *Dispersal*. Oxford University Press (2001).
- [33] Massot M, Clobert J. Influence of maternal food availability on offspring dispersal. *Behavioral Ecology and Sociobiology* **37**, 413–418 (1995).
- [34] Weisser WW, McCoy KD, Boulinier T. Parasitism and predation as causes of dispersal. In *Dispersal*, Clobert J, Danchin E, Dhondt AA, Nichols JD, eds., Oxford University Press, 180–190 (2001).
- [35] Bellwood DR, Leis JM, Stobutzki IC, Sale PF, Roberts CM. Fishery and reef management. *Science* **279**, 2021–2023 (1998).
- [36] Kaiser MJ, Attrill MJ, Jennings S, Thomas DN, Barnes DKA, Brierley AS, Polunin NVC, Raffaelli DG, Williams PJIB. *Marine ecology : Processes systems and impacts*. Oxford University Press (2005).
- [37] O'Connor MI, Bruno JF, Gaines SD, Halpern BS, Lester SE, Kinlan BP, Weiss JM. Temperature control of larval dispersal and the implications for marine ecology, evolution, and conservation. *Proceedings of the National Academy of Sciences of the United States of America* **104**, 1266 (2007).
- [38] Cowen RK, Gawarkiewicz G, Pineda J, Thorrold SR, Werner FE. Population connectivity in marine systems : An overview. *Oceanography* **20**, 14–21 (2007).

- [39] Johnson MW. The correlation of water movements and dispersal of pelagic larval stages of certain littoral animals, especially the sand crab, *Emerita*. *Journal of Marine Research* **2**, 236–245 (1939).
- [40] Planes S. Biogeography and larval dispersal inferred from population genetic analysis. In *Coral Reef Fishes : Dynamics and Diversity in a Complex Ecosystem*, Sale PF, ed., Academic Press, chap. 9, 201–220 (2002).
- [41] Jones GP, Planes S, Thorrold SR. Coral reef fish larvae settle close to home. *Current Biology* **15**, 1314–1318 (2005).
- [42] Gerlach G, Atema J, Kingsford MJ, Black KP, Miller-Sims V. Smelling home can prevent dispersal of reef fish larvae. *Proceedings of the National Academy of Sciences of the United States of America* **104**, 858–863 (2007).
- [43] Jones GP, Milicich MJ, Emslie MJ, Lunow C. Self-recruitment in a coral reef fish population. *Nature* **402**, 802–804 (1999).
- [44] Almany GR, Berumen ML, Thorrold SR, Planes S, Jones GP. Local replenishment of coral reef fish populations in a marine reserve. *Science* **316**, 742–744 (2007).
- [45] Cowen RK, Paris CB, Srinivan A. Scaling of connectivity in marine populations. *Science* **311**, 522–527 (2006).
- [46] Moilanen A, Hanski I. On the use of connectivity measures in spatial ecology. *Oikos* **95**, 147–151 (2001).
- [47] Gawarkiewicz G, Monismith S, Largier J. Observing larval transport processes affecting population connectivity : Progress and challenges. *Oceanography* **20**, 40–53 (2007).
- [48] Shima JS, Findlay AM. Pelagic larval growth rate impacts benthic settlement and survival of a temperate reef fish. *Marine Ecology Progress Series* **235**, 303–309 (2002).
- [49] Vigliola L, Meekan MG. Size at hatching and planktonic growth determine post-settlement survivorship of a coral reef fish. *Oecologia* **131**, 89–93 (2002).
- [50] Sponaugle S, Grorud-Colvert K. Environmental variability, early life-history traits, and survival of new coral reef fish recruits. *Integrative and Comparative Biology* **46**, 623–633 (2006).
- [51] Tinbergen N. On aims and methods of Ethology. *Zeitschrift für Tierpsychologie* **20**, 410–433 (1963).
- [52] MacNamara JM, Houston AI, Collins EJ. Optimality models in behavioral biology. *SIAM Review* **43**, 413–466 (2001).
- [53] MacArthur RH, Pianka ER. On optimal use of a patchy environment. *The American Naturalist* **100**, 603–609 (1966).
- [54] Krebs JR, Davies NB. *An introduction to behavioural ecology*. Blackwell Publishing, 3rd edn. (1993).
- [55] Colgan MW. Coral reef recovery on Guam (Micronesia) after catastrophic predation by *Acanthaster planci*. *Ecology* **68**, 1592–1605 (1987).

- [56] Clark DL, Leis JM, Hay AC, Trnski T. Swimming ontogeny of larvae of four temperate marine fishes. *Marine Ecology Progress Series* **292**, 287–300 (2005).
- [57] Fisher R. Swimming speeds of larval coral reef fishes : impacts on self-recruitment and dispersal. *Marine Ecology Progress Series* **285**, 223–232 (2005).
- [58] Kingsford MJ, Leis JM, Shanks A, Lindeman KC, Morgan SG, Pineda J. Sensory environments, larval abilities and local self-recruitment. *Bulletin of Marine Science* **70**, 309–340 (2002).
- [59] Leis JM. Behaviour as input for modelling dispersal of fish larvae : behaviour, biogeography, hydrodynamics, ontogeny, physiology and phylogeny meet hydrography. *Marine Ecology Progress Series* **347**, 185–193 (2007).
- [60] Fisher R, Bellwood DR, Job SD. Development of swimming abilities in reef fish larvae. *Marine Ecology Progress Series* **202**, 163–173 (2000).
- [61] Doherty PJ. Diel, lunar and seasonal rhythms in the reproduction of two tropical damselfishes : *Pomacentrus flavicauda* and *P. wardi*. *Marine Biology* **75**, 215–224 (1983).
- [62] Fuiman LA, Cowan JH Jr. Behavior and recruitment success in fish larvae : Repeatability and covariation of survival skills. *Ecology* **84**, 53–67 (2003).
- [63] Browman HI, St-Pierre JF, Skiftesvik AB, Racca RG. Behaviour of Atlantic cod (*Gadus morhua*) larvae : an attempt to link maternal condition with larval quality. In *The Big Fish Bang. Proceedings of the 26th Annual Larval Fish Conference*, Browman HI, Skiftesvik AB, eds., Institute of Marine Research, Bergen, Norway, 71–96 (2003).
- [64] Fuiman LA. The interplay of ontogeny and scaling in the interactions of fish larvae and their predators. *Journal of Fish Biology* **45**, 55–79 (1994).
- [65] Job SD, Bellwood DR. Light sensitivity in larval fishes : Implications for vertical zonation in the pelagic zone. *Limnology and Oceanography* **45**, 362–371 (2000).
- [66] Nelson JS. *Fishes of the World*. Wiley, Hoboken, NJ, 4th edn. (2006).
- [67] Leis JM. Vertical distribution behaviour and its spatial variation in late-stage larvae of coral reef fishes during the day. *Marine and Freshwater Behaviour and Physiology* **37**, 65–68 (2004).
- [68] Fisher R, Hogan JD. Morphological predictors of swimming speed : a case study of pre-settlement juvenile coral reef fishes. *Journal of Experimental Biology* **210**, 2436 (2007).
- [69] Armsworth PR, James MK, Bode L. When to press on or turn back : dispersal strategies for reef fish larvae. *The American Naturalist* **157**, 434–450 (2001).
- [70] Paris CB, Chérubin LM, Cowen RK. Surfing, spinning, or diving from reef to reef : effects on population connectivity. *Marine Ecology Progress Series* **347**, 285–300 (2007).

- [71] Paris CB, Cowen RK. Direct evidence of a biophysical retention mechanism for coral reef fish larvae. *Limnology and Oceanography* **49**, 1964–1979 (2004).
- [72] Houde ED. Comparative growth, mortality, and energetics of marine fish larvae : Temperature and implied latitudinal effects. *Fisheries Bulletin* **87**, 471–495 (1989).
- [73] Otterlei E, Nyhammer G, Folkvord A, Stefansson SO. Temperature and size dependent growth of larval and juvenile cod (*Gadus morhua* L.) – a comparative study between Norwegian coastal cod and Northeast Arctic cod. *Canadian Journal of Fisheries and Aquatic Sciences* **56**, 2099–2111 (1999).
- [74] Boehlert GW, Watson W, Sun LC. Horizontal and vertical distributions of larval fishes around an isolated oceanic island in the tropical Pacific. *Deep Sea Research Part I : Oceanographic Research Papers* **39**, 436–466 (1992).
- [75] Gray CA. Do thermoclines explain the vertical distributions of larval fishes in the dynamic coastal waters of south-eastern Australia? *Australian Journal of Marine and Freshwater Research* **47**, 183–190 (1996).
- [76] Rissik D, Suthers IM. Enhanced feeding by pelagic juvenile myctophid fishes within a region of island-induced flow disturbance in the Coral Sea. *Marine Ecology Progress Series* **203**, 263–273 (2000).
- [77] Gray CA, Kingsford MJ. Variability in thermocline depth and strength, and the relationships with vertical distributions of fish larvae and mesozooplankton in dynamic coastal waters. *Marine Ecology Progress Series* **247**, 221–224 (2003).
- [78] Fiksen Ø, Jørgensen C, Kristiansen T, Vikebø F, Huse G. Linking behavioural ecology and oceanography : larval behaviour determines growth, mortality and dispersal. *Marine Ecology Progress Series* **347**, 195–205 (2007).
- [79] Pearre S. Problems of detection and interpretation of vertical migration. *Journal of Plankton Research* **1**, 29–44 (1979).
- [80] Vikebø F, Jørgensen C, Kristiansen T, Fiksen Ø. Drift, growth, and survival of larval Northeast Arctic cod with simple rules of behaviour. *Marine Ecology Progress Series* **347**, 207–219 (2007).
- [81] Brickman D, Marteinsdottir G, Taylor L. Formulation and application of an efficient optimized biophysical model. *Marine Ecology Progress Series* **347**, 275–284 (2007).
- [82] Codling EA, Hill NA, Pitchford JW, Simpson SD. Random walk models for the movement and recruitment of reef fish larvae. *Marine Ecology Progress Series* **279**, 215–224 (2004).
- [83] Smith NP, Stoner AW. Computer simulation of larval transport through tidal channels : Role of vertical migration. *Estuarine, Coastal and Shelf Science* **37**, 43–58 (1993).
- [84] Werner FE, Page FH, Lynch DR, Loder JW, Lough RG, Perry RI, Greeberg DA, Sinclair NM. Influences of mean advection and simple behavior on the distribution of cod and haddock early life stages on Georges Bank. *Fisheries Oceanography* **2**, 43–64 (1993).

- [85] Pepin P, Helbig JA. Distribution and drift of Atlantic cod (*Gadus morhua*) eggs and larvae on the northeast Newfoundland Shelf. *Canadian Journal of Fisheries and Aquatic Sciences* **54**, 670–685 (1997).
- [86] Porch CE. A numerical study of larval fish retention along the southeast Florida coast. *Ecological Modelling* **109**, 35–59 (1998).
- [87] Wolanski E, Doherty PJ, Carleton J. Directional swimming of fish larvae determines connectivity of fish populations on the Great Barrier Reef. *Naturwissenschaften* **84**, 262–268 (1997).
- [88] Stobutzki IC, Bellwood DR. An analysis of the sustained swimming abilities of pre- and post-settlement coral reef fishes. *Journal of Experimental Marine Biology and Ecology* **175**, 275–286 (1994).
- [89] Fisher R, Wilson SK. Maximum sustainable swimming speeds of late-stage larvae of nine species of reef fishes. *Journal of Experimental Marine Biology and Ecology* **312**, 171–186 (2004).
- [90] Leis JM, Sweatman HPA, Reader SE. What the pelagic stages of coral reef fishes are doing out in blue water : daytime field observations of larval behavioural capabilities. *Australian Journal of Marine and Freshwater Research* **47**, 401–411 (1996).
- [91] Fisher R, Bellwood DR. Undisturbed swimming behaviour and nocturnal activity of coral reef fish larvae. *Marine Ecology Progress Series* **263**, 177–188 (2003).
- [92] Plaut I. Critical swimming speed : its ecological relevance. *Comparative Biochemistry and Physiology, Part A Physiology* **131**, 41–50 (2001).
- [93] Bradbury IR, Snelgrove PVR, Pepin P. Passive and active behavioural contributions to patchiness and spatial pattern during the early life history of marine fishes. *Marine Ecology Progress Series* **257**, 233–245 (2003).
- [94] Fisher R, Bellwood DR. The influence of swimming speed on sustained swimming performance of late-stage reef fish larvae. *Marine Biology* **140**, 801–807 (2002).
- [95] Bellwood DR, Fisher R. Relative swimming speeds in fish larvae. *Marine Ecology Progress Series* **211**, 299–303 (2001).
- [96] Veneziani M, Griffa A, Reynolds AM, Mariano AJ. Oceanic turbulence and stochastic models from subsurface lagrangian data for the Northwest Atlantic Ocean. *Journal of Physical Oceanography* **34**, 1884–1906 (2004).
- [97] Berloff PS, McWilliams JC. Material transport in oceanic gyres. Part II : Hierarchy of stochastic models. *Journal of Physical Oceanography* **32**, 797–830 (2002).
- [98] Cowen RK, Sponaugle S, Paris CB, Fortuna JL, Lwiza KMM, Dorsey S. Impact of North Brazil Current rings on local circulation and coral reef fish recruitment to Barbados, West Indies. In *Interhemispheric Water Exchange*, Goni G, ed., Elsevier Oceanographic Series, chap. 17, 443–462 (2003).

- [99] Lara MR. Morphology of the eye and visual acuities in the settlement-intervals of some Coral Reef Fishes (Labridae, Scaridae). *Environmental Biology of Fishes* **62**, 365–378 (2001).
- [100] Leis JM, Lockett MM. Localization of reef sounds by settlement-stage larvae of coral-reef fishes (Pomacentridae). *Bulletin of Marine Science* **76**, 715–724 (2005).
- [101] Montgomery JC, Jeffs A, Simpson SD, Meekan MG, Tindle C. Sound as an orientation cue for the pelagic larvae of reef fishes and decapod crustaceans. *Advances in Marine Biology* **51**, 143–239 (2006).
- [102] Sweatman HPA. Field evidence that settling coral reef fish larvae detect resident fishes using dissolved chemical cues. *Journal of Experimental Marine Biology and Ecology* **124**, 163–174 (1988).
- [103] Atema J, Kingsford MJ, Gerlach G. Larval reef fish could use odour for detection, retention and orientation to reefs. *Marine Ecology Progress Series* **241**, 151–160 (2002).
- [104] Alexandre D, Ghysen A. Somatotopy of the lateral line projection in larval zebrafish. *Proceedings of the National Academy of Sciences of the United States of America* **96**, 7558–7562 (1999).
- [105] Klimley AP, Anderson SD, Pyle P, Henderson R. Spatiotemporal patterns of white shark (*Carcharodon carcharias*) predation at the South Farallon Islands, California. *Copeia* **1992**, 680–690 (1992).
- [106] Nishi T, Kawamura G, Matsumoto K. Magnetic sense in the Japanese eel, *Anguilla japonica*, as determined by conditioning and electrocardiography. *Journal of Experimental Biology* **207**, 2965–2970 (2004).
- [107] Leis JM, Carson-Ewart BM. Orientation of pelagic larvae of coral-reef fishes in the ocean. *Marine Ecology Progress Series* **252**, 239–253 (2003).
- [108] Hawryshyn CW. Ultraviolet polarization vision in fishes : possible mechanisms for coding e-vector. *Philosophical Transactions : Biological Sciences* **355**, 1187–1190 (2000).
- [109] Elliott JK, Elliott JM, Mariscal RN. Host selection, location, and association behaviors of anemonefishes in field settlement experiments. *Marine Biology* **122**, 377–389 (1995).
- [110] Trnski T. Behaviour of settlement-stage larvae of fishes with an estuarine juvenile phase : *in situ* observations in a warm-temperate estuary. *Marine Ecology Progress Series* **242**, 205–214 (2002).
- [111] Hindell JS, Jenkins GP, Moran SM, Keough MJ. Swimming ability and behaviour of post-larvae of a temperate marine fish re-entrained in the pelagic environment. *Oecologia* **135**, 158–166 (2003).
- [112] Stobutzki IC, Bellwood DR. Nocturnal orientation to reefs by late pelagic stage coral reef fish. *Coral Reefs* **17**, 103–110 (1998).

- [113] Arvedlund M, McCormick MI, Fautin D, Bildsøe M. The anemonefish *Amphiprion melanopus* (Bleeker) (Pisces : Pomacentridae) : a study of host detection and possible imprinting. *Marine Ecology Progress Series* **188**, 207–218 (1999).
- [114] Tolimieri N, Haine O, Montgomery J, Jeffs A. Ambient sound as a navigational cue for larval reef fish. *Bioacoustics* **12**, 214–217 (2002).
- [115] Tolimieri N, Haine O, Jeffs A, McCauley R, Montgomery J. Directional orientation of pomacentrid larvae to ambient reef sound. *Coral Reefs* **23**, 184–191 (2004).
- [116] Wright KJ, Higgs DM, Belanger AJ, Leis JM. Auditory and olfactory abilities of pre-settlement larvae and post-settlement juveniles of a coral reef damselfish (Pisces : Pomacentridae). *Marine Biology* **147**, 1425–1434 (2005).
- [117] Irisson JO, Levan A, De Lara M, Planes S. Strategies and trajectories of coral reef fish larvae optimizing self-recruitment. *Journal of Theoretical Biology* **227**, 205–218 (2004).
- [118] Dower JF, Miller TJ, Leggett WC. The role of microscale turbulence in the feeding ecology of larval fish. *Advances in Marine Biology* **31**, 169–220 (1997).
- [119] Galbraith PS, Browman HI, Racca RG, Skiftesvik AB, Saint-Pierre JF. Effect of turbulence on the energetics of foraging in Atlantic cod (*Gadus morhua*) larvae. *Marine Ecology Progress Series* **281**, 241–257 (2004).
- [120] Lewis D. Planktonic encounter rates in homogeneous isotropic turbulence : the case of predators with limited fields of sensory perception. *Journal of Theoretical Biology* **222**, 73–97 (2003).
- [121] Browman HI, Skiftesvik AB. Effects of turbulence on the predation cycle of fish larvae : Comments on some of the issues. *Marine Ecology Progress Series* **139**, 309–312 (1996).
- [122] Gallagher SM, Yamazaki H, Davis CS. Contribution of fine-scale vertical structure and swimming behavior to formation of plankton layers on Georges Bank. *Marine Ecology Progress Series* **267**, 27–43 (2004).
- [123] Yen J, Okubo A. Particle and prey detection by mechanoreceptive copepods : a mathematical analysis. *Hydrobiologia* **480**, 165–173 (2002).
- [124] Browman HI, Yen J, St-Pierre JF, Kuhn P. Predatory behaviour of the carnivorous copepod *Euchaeta norvegica*, and escape responses of their prey (larval Atlantic cod, *Gadus morhua*). *Marine Ecology Progress Series* (in prep).
- [125] Breitburg DL. Demersal schooling prior to settlement by larvae of the naked goby. *Environmental Biology of Fishes* **26**, 97–103 (1989).
- [126] Nelson L, Reynal L, Rambally J, Punnet S, Oxenford H, Fanning P. Fish and invertebrate identified during the Lesser Antilles Pelagic Ecosystem (LAPE) project April 26 to May 9, 2004. In *Proceedings of the 59th Annual Meeting of the Gulf & Caribbean Fisheries Institute, Belize City, Gulf & Caribbean Fisheries Institute* (2006).

- [127] Masuda R, Shoji J, Nakayama S, Tanaka M. Development of schooling behavior in Spanish mackerel *Scomberomorus niphonius* during early ontogeny. *Fisheries Science* **69**, 772 (2003).
- [128] Potter JR, Chitre M. Do fish fry use emergent behaviour in schools to find coral reefs by sound? Abstract OS54E-02. *EOS Transactions, AGU, Ocean Science Meeting Supplement* **87** (2006).
- [129] Simons AM. Many wrongs : the advantage of group navigation. *Trends in Ecology and Evolution* **19**, 453–455 (2004).
- [130] Leis JM. Vertical and horizontal distribution of fish larvae near coral reefs at Lizard Island, Great Barrier Reef. *Marine Biology* **90**, 505–516 (1986).
- [131] Huth A, Wissel C. The simulation of the movement of fish schools. *Journal of Theoretical Biology* **156**, 365–385 (1992).
- [132] Flierl G, Grünbaum D, Levins S, Olson D. From individuals to aggregations : The interplay between behavior and physics. *Journal of Theoretical Biology* **196**, 397–454 (1999).
- [133] Leis JM, Carson-Ewart BM. *In situ* swimming and settlement behaviour of larvae of an Indo-Pacific coral-reef fish, the coral trout *Plectropomus leopardus* (Pisces : Serranidae). *Marine Biology* **134**, 51–64 (1999).
- [134] Leis JM, Carson-Ewart BM. *In situ* settlement behaviour of damselfish (Pomacentridae) larvae. *Journal of Fish Biology* **61**, 325–346 (2002).
- [135] Leis JM, McCormick MI. The biology, behavior, and ecology of the pelagic larval stage of coral reef fishes. In *Coral Reef Fishes : Dynamics and Diversity in a Complex Ecosystem*, Sale PF, ed., Academic Press, USA, chap. 8, 171–198 (2002).
- [136] Hadfield MG. The DP Wilson Lecture. Research on settlement and metamorphosis of marine invertebrate larvae past, present and future. *Biofouling* **12**, 9–29 (1998).
- [137] Schmitt RJ, Holbrook SJ. Mortality of juvenile damselfish : Implications for assessing processes that determine abundance. *Ecology* **80**, 35–50 (1999).
- [138] McCormick MI, Makey LJ. Post-settlement transition in coral reef fishes : Overlooked complexity in niche shifts. *Marine Ecology Progress Series* **153**, 247–257 (1997).
- [139] Nagelkerken I, Van Der Velde G. Connectivity between coastal habitats of two oceanic Caribbean Islands as inferred from ontogenetic shifts by coral reef fishes. *Gulf and Caribbean Research* **14**, 43–59 (2003).
- [140] Holbrook SJ, Schmitt RJ. *In situ* nocturnal observations of reef fishes using infrared video. In *Proceedings of the 5th Indo-Pacific Fish Conference, Nouméa*, Séret B, Sire JY, eds., Société Française d'Ichtyologie & Institut de Recherche pour le Développement, Paris, 805–812 (1997).
- [141] Almany GR. Priority effects in coral reef fish communities of the Great Barrier Reef. *Ecology* **85**, 2872–2880 (2004).

- [142] Doherty PJ, McIlwain J. Monitoring larval fluxes through the surf zones of Australian coral reefs. *Marine and Freshwater Research* **47**, 383–390 (1996).
- [143] Armsworth PR. Modelling the swimming response of late stage larval reef fish to different stimuli. *Marine Ecology Progress Series* **195**, 231–247 (2000).
- [144] Tolimieri N, Jeffs A, Montgomery JC. Ambient sound as a cue for navigation by the pelagic larvae of reef fishes. *Marine Ecology Progress Series* **207**, 219–224 (2000).
- [145] Simpson SD, Meekan M, Montgomery J, McCauley R, Jeffs A. Homeward sound. *Science* **308**, 221 (2005).
- [146] Montgomery JC, Tolimieri N, Haine OS. Active habitat selection by pre-settlement reef fishes. *Fish and Fisheries* **2**, 261–277 (2001).
- [147] MPlayer Development Team. Árpád Gereöffy's discourse : introduction of video player software MPlayer. Online reference (2002). <http://www.mplayerhq.hu/homepage/design7/konf2002-arpi.html>.
- [148] Rasband WS. *ImageJ*. U. S. National Institutes of Health, Bethesda, Maryland, USA (1997–2005). <http://rsb.info.nih.gov/ij/>.
- [149] R Development Core Team. *R : a language and environment for statistical computing*. R Foundation for Statistical Computing, Vienna, Austria (2005). <http://www.R-project.org>.
- [150] Batschelet E. *Circular statistics in biology*. Academic Press, London (1981).
- [151] Agostinelli C. Package `circular` 0.3-8 : Circular Statistics. Online reference (2007-08-15). <http://cran.r-project.org/src/contrib/Descriptions/circular.html>.
- [152] Sponaugle S, Pinkard DR. Lunar cyclic population replenishment of a coral reef fish : shifting patterns following oceanic events. *Marine Ecology Progress Series* **267**, 267–280 (2004).
- [153] Lee TN, Rooth C, Williams E, McGowan M, Szmant AF, Clarke ME. Influence of Florida Current, gyres and wind-driven circulation on transport of larvae and recruitment in the Florida Keys coral reefs. *Continental Shelf Research* **12**, 971–1002 (1992).
- [154] Vergassola M, Villermaux E, Shraiman BI. 'Infotaxis' as a strategy for searching without gradients. *Nature* **445**, 406–409 (2007).
- [155] Werner FE, Cowen RK, Paris CB. Coupled biological and physical models : Present capabilities and necessary developments for future studies of population connectivity. *Oceanography* **20**, 54–69 (2007).
- [156] Dufour V, Galzin R. Colonization patterns of reef fish larvae to the lagoon at Moorea Island, French Polynesia. *Marine Ecology Progress Series* **102**, 143–152 (1993).

- [157] Holbrook SJ, Schmitt RJ. Settlement patterns and processes in a coral reef damselfish : *in situ* nocturnal observation using infrared video. In *Proceedings of the 8th International Coral Reef Symposium*, Lessios HA, Macintyre IG, eds., Smithsonian Tropical Research Institute, Balboa, Republic of Panama, vol. 2, 1143–1148 (1996).
- [158] Lecchini D. Spatial and behavioural patterns of reef habitat settlement by fish larvae. *Marine Ecology Progress Series* **301**, 247–252 (2005).
- [159] Abelson A, Denny M. Settlement of marine organisms in flow. *Annual Review of Ecology and Systematics* **28**, 317–339 (1997).
- [160] Doherty PJ, Kingsford MJ, Booth D, Carleton JH. Habitat selection before settlement by *Pomacentrus coelestis*. *Australian Journal of Marine and Freshwater Research* **47**, 391–399 (1996).
- [161] Danilowicz BS. Choice of coral species by naive and field-caught damselfish. *Copeia* **1996**, 735–739 (1996).
- [162] Kingsford MJ, Choat JH. Horizontal distribution patterns of presettlement reef fish : are they influenced by the proximity of reefs? *Marine Biology* **101**, 285–297 (1989).
- [163] Williams DM, English S. Distribution of fish larvae around a coral reef : direct detection of a meso-scale, multi-specific patch. *Continental Shelf Research* **12**, 923–937 (1992).
- [164] Lobel PS. Transport and entrapment of fish larvae by ocean mesoscale eddies and current in Hawaiian waters. *Deep Sea Research Part I : Oceanographic Research Papers* **33**, 483–500 (1986).
- [165] Doty MS, Oguri M. The island mass effect. *ICES Journal of Marine Science : Journal du Conseil* **22**, 33–37 (1956).
- [166] Laprise R, Pepin P. Factors influencing the spatio-temporal occurrence of fish eggs and larvae in a northern, physically dynamic coastal environment. *Marine Ecology Progress Series* **122**, 73–92 (1995).
- [167] Kideys AE, Gordina AD, Bingel F, Niermann U. The effect of environmental conditions on the distribution of eggs and larvae of anchovy (*Engraulis encrasicolus* L.) in the Black Sea. *ICES Journal of Marine Science : Journal du Conseil* **56**, 58–64 (1999).
- [168] Leis JM, Miller JM. Offshore distributional patterns of Hawaiian fish larvae. *Marine Biology* **36**, 359–367 (1976).
- [169] Boehlert GW, Mundy BC. Ichthyoplankton assemblages at seamounts and oceanic islands. *Bulletin of Marine Science* **53**, 336–361 (1993).
- [170] Bergenius MAJ, Meekan MG, Robertson R, McCormick MI. Larval growth predicts the recruitment success of a coral reef fish. *Oecologia* **131**, 521–525 (2002).
- [171] Sponaugle S, Grorud-Colvert K, Pinkard D. Temperature-mediated variation in early life history traits and recruitment success of the coral reef fish *Thalassoma bifasciatum* in the Florida Keys. *Marine Ecology Progress Series* **308**, 1–15 (2006).

- [172] Moser HG, Richards WJ, Cohen DM, Fahay MP, Kendall AWJ, Richardson SL. *Ontogeny and systematics of fishes : based on an international symposium dedicated to the memory of Elbert Halvor Ahlstrom*. American Society of Ichthyologists and Herpetologists, New-York (1984).
- [173] Moser HG. *The early stages of fishes in the california current region – CALCOFI Atlas*, vol. 33. Allen Press (1996).
- [174] Leis JM, Carson-Ewart BM. *The larvae of Indo-Pacific coastal fishes : An identification guide to marine fish larvae*. Fauna Malesiana Handbook (2004).
- [175] Miller MJ, Tsukamoto K. *An introduction to Leptocephali biology and identification*. Ocean Research Institute, The University of Tokyo, Tokyo (2004).
- [176] Grosjean P, Picheral M, Warembourg C, Gorsky G. Enumeration, measurement, and identification of net zooplankton samples using the ZOOSCAN digital imaging system. *ICES Journal of Marine Science : Journal du Conseil* **61**, 518–525 (2004).
- [177] Davies L, Gather U. The Identification of Multiple Outliers. *Journal of the American Statistical Association* **88**, 782–792 (1993).
- [178] Paris CB, Cowen RK, Lwiza KMM, Wang DP, Olson DB. Multivariate objective analysis of the coastal circulation of Barbados, West Indies : implication for larval transport. *Deep Sea Research Part I : Oceanographic Research Papers* **49**, 1363–1386 (2002).
- [179] Pinot JM, Tintore J, Gomis D. Multivariate analysis of the surface circulation in the Balearic Sea. *Progress In Oceanography* **36**, 343–344 (1995).
- [180] Gomis D, Ruiz S, Pedder MA. Diagnostic analysis of the 3D ageostrophic circulation from a multivariate spatial interpolation of CTD and ADCP data. *Deep Sea Research Part I : Oceanographic Research Papers* **48**, 269–295 (2001).
- [181] Syrjala SE. A statistical test for a difference between the spatial distributions of two populations. *Ecology* **77**, 75–80 (1996).
- [182] Winder L, Alexander C, Holland JM, Woolley C, Perry JN. Modelling the dynamic spatio-temporal response of predators to transient prey patches in the field. *Ecology Letters* **4**, 568–576. (2001).
- [183] Dutilleul P, Clifford P, Richardson S, Hemon D. Modifying the t Test for Assessing the Correlation Between Two Spatial Processes. *Biometrics* **49**, 305–314 (1993).
- [184] Limouzy-Paris C, McGowan MF, Richards WJ, Umaran JP, Cha SS. Diversity of fish larvae in the Florida Keys : Results from SEFCAR. *Bulletin of Marine Science* **54** (1994).
- [185] Johannes RE. Reproductive strategies of coastal marine fishes in the tropics. *Environmental Biology of Fishes* **3**, 65–84 (1978).
- [186] Brothers EB, Williams DM, Sale PF. Length of larval life in twelve families of fishes at One Tree Lagoon, Great Barrier Reef, Australia. *Marine Biology* **76**, 319–324 (1983).

- [187] Bowen B, Bass A, Muss A, Carlin J, Robertson D. Phylogeography of two Atlantic squirrelfishes (Family Holocentridae) : exploring links between pelagic larval duration and population connectivity. *Marine Biology* **149**, 899–913 (2006).
- [188] Cowen RK, Guigand CM. *In situ* ichthyoplankton imaging system (ISIS) : system design and preliminary results. *Limnology and Oceanography : Methods* **6**, 126–132 (2008).
- [189] Fortier L, Harris RP. Optimal foraging and density-dependent competition in marine fish larvae. *Marine Ecology Progress Series* **51**, 19–33 (1989).
- [190] Leis JM, Hay AC, Trnski T. *In situ* ontogeny of behaviour in pelagic larvae of three temperate, marine, demersal fishes. *Marine Biology* **148**, 655–669 (2005).
- [191] Heath MR, Henderson EW, Baird DL. Vertical distribution of herring larvae in relation to physical mixing and illumination. *Marine Ecology Progress Series* **47**, 211–228 (1988).
- [192] Munk P, Kjørboe T, Christensen V. Vertical migrations of herring, *Clupea harengus*, larvae in relation to light and prey distribution. *Environmental Biology of Fishes* **26**, 87–96 (1989).
- [193] Olla BL, Davis MW. Effects of physical factors on the vertical distribution of larval walleye pollock *Theragra chalcogramma* under controlled laboratory conditions. *Marine Ecology Progress Series* **63**, 105–112 (1990).
- [194] Lampert W. The adaptive significance of diel vertical migration of zooplankton. *Functional Ecology* **3**, 21–27 (1989).
- [195] North E, Schlag Z, Li M, Zhong L, Hannah C. Parameterizing biophysical particle-tracking models : recommendations and implications for dispersal of planktonic organisms. (in prep).
- [196] North EW, Schlag Z, Hood RR, Li M, Zhong L, Gross T, Kennedy VS. Vertical swimming behavior influences the dispersal of simulated oyster larvae in a coupled particle-tracking and hydrodynamic model of Chesapeake Bay. *Marine Ecology Progress Series* (in press).
- [197] Forward RB, Tankersley RA. Selective tidal-stream transport of marine animals. *Oceanography and Marine Biology : an Annual Review* **39**, 305–353 (2001).
- [198] Sentchev A, Korotenko K. Modelling distribution of flounder larvae in the eastern English Channel : sensitivity to physical forcing and biological behaviour. *Marine Ecology Progress Series* **347**, 233–245 (2007).
- [199] Armsworth PR. Directed motion in the sea : Efficient swimming by reef fish larvae. *Journal of Theoretical Biology* **210**, 81–91 (2001).
- [200] Leis JM. Vertical distribution of fish larvae in the Great Barrier Reef Lagoon, Australia. *Marine Biology* **109**, 157–166 (1991).

- [201] Cha SS, McGowan MF, Richards WJ. Vertical distribution of fish larvae off the Florida Keys, 26 May – 5 June 1989. *Bulletin of Marine Science* **54**, 828–842 (1994).
- [202] Cowen RK, Castro LR. Relation of coral reef fish larval distributions to island scale circulation around Barbados, West Indies. *Bulletin of Marine Science* **54**, 228–244 (1994).
- [203] Hendriks I, Wilson D, Meekan MG. Vertical distributions of late stage larval fishes in the nearshore waters of the San Blas Archipelago, Caribbean Panama. *Coral Reefs* **20**, 77–84 (2001).
- [204] Fisher R, Bellwood DR. A light trap design for stratum-specific sampling of reef fish larvae. *Journal of Experimental Marine Biology and Ecology* **269**, 27–37 (2002).
- [205] Davis CS, Gallager SM, Solow AR. Microaggregations of oceanic plankton observed by towed video microscopy. *Science* **257**, 230–232 (1992).
- [206] Solow AR, Bollens SM, Beet A. Comparing two vertical plankton distributions. *Limnology and Oceanography* **45**, 506–509 (2000).
- [207] Beet A, Solow AR, Bollens SM. Comparing vertical plankton profiles with replication. *Marine Ecology Progress Series* **262**, 285–287 (2003).
- [208] Paul SR, Banerjee T. Analysis of two-way layout of count data involving multiple counts in each cell. *Journal of the American Statistical Association* **93**, 1419–1420 (1998).
- [209] Zar JH. *Biostatistical analysis*. Prentice Hall, 4th edn. (1999).
- [210] Brodeur RD, Rugen WC. Diel vertical distribution of ichthyoplankton in the northern Gulf of Alaska. *Fishery Bulletin* **92**, 223–235 (1994).
- [211] Gatz DF, Smith L. The standard error of a weighted mean concentration—I. Bootstrapping vs other methods. *Atmospheric Environment* **29**, 1185–1193 (1995).
- [212] Cochran WG. *Sampling Techniques*. Wiley, New York, 3rd edn. (1977).
- [213] Kasuya E. Mann-Whitney U test when variances are unequal. *Animal Behaviour* **61**, 1247–1249 (2001).
- [214] Neuhäuser M. Two-sample tests when variances are unequal. *Animal Behaviour* **63**, 823–825 (2002).
- [215] Leis JM. Larval fish assemblages near Indo-Pacific coral reefs. *Bulletin of Marine Science* **53**, 362–392 (1993).
- [216] Fligner MA, Policello GEI. Robust Rank Procedures for the Behrens-Fisher Problem. *Journal of the American Statistical Association* **76**, 162–168 (1981).
- [217] Zumbo BD, Coulombe D. Investigation of the robust rank-order test for non-normal populations with unequal variances : The case of reaction time. *Canadian Journal of Experimental Psychology* **51**, 139–149 (1997).

- [218] Oxenford HA, Fanning P, Cowen RK. Swimming deep : new evidence of Acanthurid larval dispersal at depth in the eastern Caribbean. In *Proceedings of the 59th Annual Meeting of the Gulf & Caribbean Fisheries Institute, Belize City*, Gulf & Caribbean Fisheries Institute (2006).
- [219] Dong CC, McWilliams JC, Shchepetkin AF. Island wakes in deep water. *Journal of Physical Oceanography* **37**, 962 – 981 (2007).
- [220] Kochzius M, Nölte N, Weber H, Silkenbeumer N, Hjörleifsdóttir S, Hreggvidsson GO, Marteinsson V, Kappel K, Planes S, Tinti F, Magoulas A, Garcia Vazquez E, Turan C, Hervet C, Campo Falgueras D, Antoniou A, Landi M, Blohm D. DNA microarrays for identifying fishes. *Marine Biotechnology* **10**, 207–217 (2008).
- [221] Fisher R, Leis JM, Clark D, Wilson SKK. Critical swimming speeds of late-stage coral reef fish larvae : variation within species, among species and between locations. *Marine Biology* **147**, 1201–1212 (2005).
- [222] Miller TJ. Contribution of individual-based coupled physical–biological models to understanding recruitment in marine fish populations. *Marine Ecology Progress Series* **347**, 127–138 (2007).
- [223] Rosland R, Giske J. A dynamic optimization model of the diel vertical distribution of a pelagic planktivorous fish. *Progress in Oceanography* **34**, 1–43 (1994).
- [224] Fiksen Ø, MacKenzie BR. Process-based models of feeding and prey selection in larval fish. *Marine Ecology Progress Series* **243**, 151–164 (2002).
- [225] Wolanski E, Asaeda T, Tanaka A, Deleersnijder E. Three-dimensional island wakes in the field, laboratory experiments and numerical models. *Continental Shelf Research* **16**, 1437–1452 (1996).
- [226] Parada C, Van Der Lingen CD, Mullon C, Penven P. Modelling the effect of buoyancy on the transport of anchovy (*Engraulis capensis*) eggs from spawning to nursery grounds in the southern Benguela : An IBM approach. *Fisheries Oceanography* **12**, 170–184 (2003).
- [227] Penven P, Echevin V, Pasapera J, Colas F, Tam J. Average circulation, seasonal cycle, and mesoscale dynamics of the Peru Current System : A modeling approach. *Journal of Geophysical Research C : Oceans* **110**, 1–21 (2005).
- [228] Kingsford MJ. Linear oceanographic features : A focus for research on recruitment processes. *Australian Journal of Ecology* **15** (1990).
- [229] Leis JM, Hay AC, Clark DL. Behavioral ontogeny in larvae and early juveniles of the giant trevally (*Caranx ignobilis*) (Pisces : Carangidae). *Fishery Bulletin* **104**, 401–414 (2006).
- [230] Leis JM, Matthew M Lockett ACH, Chen JP, Fang LS. Ontogeny of swimming speed in larvae of pelagic-spawning, tropical, marine fishes. *Marine Ecology Progress Series* **349**, 257–269 (2007).

- [231] Houde ED, Schekter RC. Growth rates, rations and cohort consumption of marine fish larvae in relation to prey concentrations. *Rapports et Procès-Verbaux des Réunions du Conseil International Permanent pour l'Exploration de la Mer* **178**, 441–453 (1981).
- [232] Houde ED, Zastrow CE. Ecosystem- and taxon-specific dynamic and energetics properties of larval fish assemblages. *Bulletin of Marine Science* **53**, 290–335 (1993).
- [233] Meekan M, Carleton J, McKinnon A, Flynn K, Furnas M. What determines the growth of tropical reef fish larvae in the plankton : Food or temperature ? *Marine Ecology Progress Series* **256**, 193–204 (2003).
- [234] Giske J, Huse G, Fiksen Ø. Modelling spatial dynamics of fish. *Reviews in Fish Biology and Fisheries* **8**, 57–91 (1998).
- [235] Stobutzki IC. Interspecific variation in sustained swimming ability of late pelagic stage reef fish from two families (Pomacentridae and Chaetodontidae). *Coral Reefs* **17**, 111–119 (1998).
- [236] Stobutzki IC, Bellwood DR. Sustained swimming abilities of the late pelagic stages of coral reef fishes. *Marine Ecology Progress Series* **149**, 35–41 (1997).
- [237] Cowan JH Jr, Houde ED. Size-dependent predation on marine fish larvae by Ctenophores, Scyphomedusae, and Planktivorous fish. *Fisheries Oceanography* **1**, 113–126 (1992).
- [238] Cowan JH Jr, Houde ED, Rose KA. Size-dependent vulnerability of marine fish larvae to predation : an individual-based numerical experiment. *ICES Journal of Marine Science : Journal du Conseil* **53**, 23–37 (1996).
- [239] Williams DM, Wolanski E, Andrews JC. Transport mechanisms and the potential movement of planktonic larvae in the central region of the Great Barrier Reef. *Coral Reefs* **3**, 229–236 (1984).
- [240] Swearer SE, Caselle JE, Lea DW, Warner RR. Larval retention and recruitment in an island population of a coral-reef fish. *Nature* **402**, 799–802 (1999).
- [241] Cowen RK, Lwiza KMM, Sponaugle S, Paris CB, Olson DB. Connectivity of marine populations : open or closed ? *Science* **287**, 857–860 (2000).
- [242] Mora C, Sale PF. Are populations of coral reef fishes open or closed ? *Trends in Ecology and Evolution* **17**, 422–428 (2002).
- [243] Puterman ML. *Markov decision processes*. Wiley, New-York (1994).
- [244] Bertsekas DP. *Dynamic programming and optimal control*, vol. 1–2. Athena Scientific, Belmont, Massachusetts, 2nd edn. (2000).
- [245] Victor BC. Duration of the planktonic larval stage of one hundred species of Pacific and Atlantic wrasses (family Labridae). *Marine Biology* **90**, 317–326 (1986).

- [246] Wellington GM, Victor BC. Planktonic larval duration of one hundred species of Pacific and Atlantic damselfishes (Pomacentridae). *Marine Biology* **101**, 557–567 (1989).
- [247] McCormick MI. Delayed metamorphosis of a tropical reef fish (*Acanthurus triostegus*) : A field experiment. *Marine Ecology Progress Series* **176**, 25–38 (1999).
- [248] Chancelier JP, Delebecque F, Gomez C, Goursat M, Nikoukhah R, Steer S. *Introduction à Scilab*. Springer-Verlag, Paris (2004). <http://www.scilab.org/>.
- [249] Rougerie F, Rancher J. The Polynesian South Ocean : Features and circulation. *Marine Pollution Bulletin* **29**, 14–25 (1994).
- [250] Marsaleix P, Auclair F, Estournel C. Considerations on open boundary conditions for regional and coastal ocean models. *Journal of Atmospheric and Oceanic Technology* **23**, 1604–1613 (2006).
- [251] Marsaleix P, Auclair F, Floor JW, Herrmann MJ, Estournel C, Pairaud I, Ulses C. Energy conservation issues in sigma-coordinate free-surface ocean models. *Ocean Modelling* **20**, 61–89 (2008).
- [252] Rougerie F, Wauthy B. Atoll-oasis functioning and the endo-upwelling concept. *Oceanologica Acta* **9**, 133–148 (1986).
- [253] Jones EC. Evidence of island mass effect upon the standing crop of zooplankton near the Marquesas Islands, Central Pacific. *ICES Journal of Marine Science : Journal du Conseil* **27**, 223–231 (1962).
- [254] Leis JM, Carson-Ewart BM. Complex behaviour by coral-reef fish larvae in open-water and near-reef pelagic environments. *Environmental Biology of Fishes* **53**, 259–266 (1998).
- [255] Simpson SD, Yan HY, Wittenrich ML, Meekan MG. Response of embryonic coral reef fishes (Pomacentridae : *Amphiprion* spp.) to noise. *Marine Ecology Progress Series* **287**, 201–208 (2005).
- [256] Thresher RE. *Reproduction in reef fishes*. T.F.H. Publications (1984).
- [257] Lo Yat AL. *Variabilité temporelle de la colonisation par les larves de poissons de l'atoll de Rangiroa (Tuamotu, Polynésie Française) et utilisation de l'outil otolith de ces larves*. Ph.D. thesis, Université de Polynésie Française et Ecole Pratique des Hautes Etudes (2002).
- [258] Leis JM, Carson-Ewart BM. *In situ* swimming speeds of the late pelagic larvae of some Indo-Pacific coral-reef fishes. *Marine Ecology Progress Series* **159**, 165–174 (1997).
- [259] Leis JM, Goldman B. Composition and distribution of larval fish assemblages in the Great Barrier Reef Lagoon, near Lizard Island, Australia. *Australian Journal of Marine and Freshwater Research* **38**, 211–223 (1987).
- [260] Sissenwine MP. Why do fish populations vary ? In *Exploitation of Marine Communities*, May RM, ed., Springer-Verlag, Berlin, Heidelberg, New-York, Tokyo, 59–94 (1984).

- [261] Blaxter JHS. Visual thresholds and spectral sensitivity of herring larvae. *Journal of Experimental Biology* **48**, 39–53 (1968).
- [262] Green BS, Fisher R. Temperature influences swimming speed, growth and larval duration in coral reef fish larvae. *Journal of Experimental Marine Biology and Ecology* **299**, 115–132 (2004).
- [263] Marchesiello P, McWilliams JC, Shchepetkin AF. Equilibrium structure and dynamics of the California Current System. *Journal of Physical Oceanography* **33**, 753–783 (2003).
- [264] Shchepetkin AF, McWilliams JC. The regional oceanic modeling system (ROMS) : a split-explicit, free-surface, topography-following-coordinate oceanic model. *Ocean Modelling* **9**, 347–404 (2005).
- [265] Shchepetkin AF, O'Brien JJ. A physically consistent formulation of lateral friction in shallow-water equation ocean models. *Monthly Weather Review* **124**, 1285–1300 (1996).
- [266] Brett JR. The respiratory metabolism and swimming performance of young sockeye salmon. *Journal of the Fisheries Research Board of Canada* **21**, 1183–1226 (1964).
- [267] Gillooly JF, Charnov EL, West GB, Savage VM, Brown JH. Effects of size and temperature on developmental time. *Nature* **417**, 70–73 (2002).
- [268] Dudley B, Tolimieri N, Montgomery J. Swimming ability of the larvae of some reef fishes from New Zealand waters. *Marine and Freshwater Research* **51**, 783–787 (2000).
- [269] Fisher R, Bellwood DR. Effects of feeding on the sustained swimming abilities of late-stage larval *Amphiprion melanopus*. *Coral Reefs* **20**, 151–154 (2001).
- [270] Leis JM, Clark DL. Feeding greatly enhances swimming endurance of settlement-stage reef-fish larvae of damselfishes (Pomacentridae). *Ichthyological Research* **52**, 185–188 (2005).
- [271] Schmidt-Nielsen K. *Scaling : Why is animal size so important?* Cambridge University Press, 1st edn. (1984).
- [272] William F, Beamish H. Swimming metabolism and temperature in juvenile walleye, *Stizostedion vitreum vitreum*. *Environmental Biology of Fishes* **27**, 309–314 (1990).
- [273] Houde ED. Effects of temperature and delayed feeding on growth and survival of larvae of three species of subtropical marine fishes. *Marine Biology* **26**, 271–285 (1974).
- [274] Leis JM. Nearshore distributional gradients of larval fish (15 taxa) and planktonic crustaceans (6 Taxa) in Hawaii. *Marine Biology* **72**, 89–97 (1982).
- [275] Smith CC, Fretwell SD. The optimal balance between size and number of offspring. *The American Naturalist* **108**, 499–506 (1974).

- [276] Sargent RC, Taylor PD, Gross MR. Parental care and the evolution of egg size in fishes. *The American Naturalist* **129**, 32–46 (1987).
- [277] Levitan DR. The importance of sperm limitation to the evolution of egg size in marine invertebrates. *The American Naturalist* **141**, 517–536 (1993).
- [278] Fiksen Ø, Giske J. Vertical distribution and population dynamics of copepods by dynamic optimization. *ICES Journal of Marine Science : Journal du Conseil* **52**, 483–503 (1995).
- [279] Fiksen Ø. Allocation patterns and diel vertical migration : Modeling the optimal daphnia. *Ecology* **78**, 1446–1456 (1997).
- [280] Myrberg AA Jr, Fuiman LA. The sensory world of coral reef fishes. In *Coral Reef Fishes : Dynamics and Diversity in a Complex Ecosystem*, Sale PF, ed., Academic Press, USA, chap. 6, 123–148 (2002).
- [281] Thorrold SR, Latkoczy C, Swart PK, Jones CM. Natal homing in a marine fish metapopulation. *Science* **291**, 297–299 (2001).
- [282] Swearer SE, Shima JS, Hellberg ME, Thorrold SR, Jones GP, Robertson DR, Morgan SG, Selkoe KA, Ruiz GM, Warner RR. Evidence of self-recruitment in demersal marine populations. *Bulletin of Marine Science* **70**, 251–271 (2002).
- [283] Todd CD, Lamberta WJ, Thorpec JP. The genetic structure of intertidal populations of two species of nudibranch molluscs with planktotrophic and pelagic lecithotrophic larval stages : are pelagic larvae “for” dispersal? *Journal of Experimental Marine Biology and Ecology* **228**, 1–28 (1998).
- [284] Sale PF. Reef fish communities : Open nonequilibrium systems. In *The Ecology of Fishes on Coral Reefs*, Academic Press, San Diego, California, USA, 564–598 (1991).
- [285] Bonhomme F, Planes S. Some evolutionary arguments about what maintains the pelagic interval in reef fishes. *Environmental Biology of Fishes* **59**, 365–383 (2000).
- [286] Doherty PJ, Williams DM, Sale PF. The adaptive significance of larval dispersal in coral reef fishes. *Environmental Biology of Fishes* **12**, 81–90 (1985).
- [287] Metz JAJ, Jong TJ, Klinkhamer PGL. What are the advantages of dispersing ; a paper by Kuno explained and extended. *Oecologia* **57**, 166–169 (1983).
- [288] Matsuda H, Abrams PA. Runaway evolution to self-extinction under asymmetrical competition. *Evolution* **48**, 1764–1772 (1994).
- [289] Rankin DJ, Lopez-Sepulcre A. Can adaptation lead to extinction? *Oikos* **111**, 616–619 (2005).
- [290] Kincaid H. Inbreeding in fish populations used for aquaculture. *Aquaculture* **33**, 5–227 (1983).
- [291] Conover DO, Clarke LM, Munch SB, Wagner GN. Spatial and temporal scales of adaptive divergence in marine fishes and the implications for conservation. *Journal of Fish Biology* **69**, 21–47 (2006).

- [292] Alerstam T. Conflicting evidence about long-distance animal navigation. *Science* **313**, 791–794 (2006).
- [293] Leis JM, Goldman B. A preliminary distributional study of fish larvae near a ribbon coral reef in the Great Barrier Reef. *Coral Reefs* **2**, 197–203 (1984).
- [294] Danilowicz BS, Sale PF. Modelling settlement in open populations of reef fishes. *Ecological Modelling* **121**, 261–276 (1999).
- [295] Stobutzki IC. Energetic cost of sustained swimming in the late pelagic stages of reef fishes. *Marine Ecology Progress Series* **152**, 249–259 (1997).
- [296] Woodson CB, McManus MA. Foraging behavior can influence dispersal of marine organisms. *Limnology and Oceanography* **52**, 2701–2709 (2007).
- [297] Beddington JR, Kirkwood GP. Fisheries. In *Theoretical Ecology : Principles and Applications*, May RM, McLean A, eds., Oxford University Press, New York, chap. 11, 148–157 (2007).
- [298] Stephens PA, Frey-roos F, Arnold W, Sutherland WJ. Model complexity and population predictions. The alpine marmot as a case study. *Journal of Animal Ecology* **71**, 343–361 (2002).
- [299] Fulton EA, Smith ADM, Johnson CR. Effect of complexity on marine ecosystem models. *Marine Ecology Progress Series* **253**, 1–16 (2003).
- [300] Spitz YH, Moisan JR, Abbott MR, Richman JG. Data assimilation and a pelagic ecosystem model : parameterization using time series observations. *Journal of Marine Systems* **16**, 51–68 (1998).
- [301] Ussif AA, Sandal L, Steinshamn S. Assimilation of time series data into a dynamic bioeconomic fisheries model : An application to the North East Arctic Cod stock. *Journal of Bioeconomics* **7**, 179–195 (2005).
- [302] Helbig JA, Pepin P. The effects of short space and time scale current variability on the predictability of passive ichthyoplankton distributions : an analysis based on HF radar observations. *Fisheries Oceanography* **11**, 175–188 (2002).
- [303] Bonsall MB, Hassell MP. Predator-prey interactions. In *Theoretical Ecology : Principles and Applications*, May RM, McLean A, eds., Oxford University Press, New York, chap. 5, 46–61 (2007).
- [304] Hannah CG. Future directions in modelling physical-biological interactions. *Marine Ecology Progress Series* **347**, 301–306 (2007).
- [305] Dytham C. How landscapes affect the evolution of dispersal behaviour in reef fishes : results from an individual-based model. *Journal of Fish Biology* **63**, 213–225 (2003).
- [306] Dytham C, Simpson SD. Elevated mortality of fish larvae on coral reefs drives the evolution of larval movement patterns. *Marine Ecology Progress Series* **346**, 255–264 (2007).
- [307] Codling EA, Pitchford JW, Simpson SD. Group navigation and the “many-wrongs principle” in models of animal movement. *Ecology* **88**, 1864–1870 (2007).

- [308] Greenberg DA, Dupont F, Lyard FH, Lynch DR, Werner FE. Resolution issues in numerical models of oceanic and coastal circulation. *Continental Shelf Research* **27**, 1317–1343 (2007).
- [309] Moore GE. Cramming more components onto integrated circuits. *Electronics* **38**, 114–117 (1965).
- [310] van der Molen J, Rogers SI, Ellis JR, Fox CJ, McCloghrie P. Dispersal patterns of the eggs and larvae of spring-spawning fish in the Irish Sea, UK. *Journal of Sea Research* **58**, 313–330 (2007).
- [311] Leis JM, Carson-Ewart BM. Behaviour of pelagic larvae of four coral-reef fish species in the ocean and an atoll lagoon. *Coral Reefs* **19**, 247–257 (2000).
- [312] O’Connell CP, Raymond LP. The effect of food density on survival and growth of early post yolk-sac larvae of the northern anchovy (*Engraulis mordax* Girard) in the laboratory. *Journal of Experimental Marine Biology and Ecology* **5**, 187–197 (1970).
- [313] Lough RG, Bolz GR, Pennington MR, Grosslein MD. Abundance and mortality estimates for sea herring (*Clupea harengus* L.) larvae spawned in the Georges Bank–Nantucket Shoals area, 1971–1978 seasons, in relation to spawning stock and recruitment. Tech. Rep. 80/IX/129 (Revised), NAFO SCR (1980).
- [314] Hunter JR. Behavior and survival of northern anchovy *Engraulis mordax* larvae. Tech. rep., California cooperative oceanic fisheries investigations (1981).
- [315] Fortier L, Leggett WC. A drift study of larval fish survival. *Marine Ecology Progress Series* **25**, 245–257 (1985).
- [316] Houde ED, Zastrow CE. Ecosystem-specific and taxa-specific growth, mortality and energetics relationships of teleost larvae. In *ICES Council Meeting Papers*, ICES, Copenhagen, Denmark, 1–30 (1991).
- [317] Paris CB. *Transport dynamics and survival of the pelagic larval stages of a coral reef fish, the bicolor damselfish, *Stegastes partitus* (Poey)*. Ph.D. thesis, State University of New York at Stony Brook, New-York (2001).
- [318] Bourret P, Binet D, Hoffschir C, Rivalon J, Velayoudon H. Evaluation de “l’effet d’île” d’un atoll : plancton et micronecton au large de Mururoa (Tuamotus). Tech. rep., Centre ORSTOM, Noumea (1979).

Remerciements

Ce travail n'aurait pas été possible sans l'aide et le soutien de nombreuses personnes. Certaines ont déjà été remerciées de façon formelle à la fin de plusieurs chapitres. J'espère parvenir à les remercier toutes de façon plus personnelle ici, dans un ordre plus ou moins aléatoire.

Mes premiers remerciements vont à **Serge Planes** pour avoir initié et soutenu le projet qui a d'abord mené à mon DEA, puis à cette thèse. Merci de m'avoir encadré et de m'avoir fourni tout ce qui était nécessaire à la réussite de mon travail au long de ces quatre années. Merci de m'avoir toujours accueilli avec le sourire alors que, bien souvent, mon arrivée dans votre bureau était accompagnée d'une question épineuse ou d'une demande de financement. Merci de m'avoir permis de participer à de nombreux congrès et collaborations au cours de ma thèse, qui ont enrichi ce travail, mes idées et le cercle de mes connaissances. Merci, enfin, d'avoir mené à bien l'organisation de la mission scientifique à Tetiaroa malgré l'épreuve personnelle que vous viviez à ce moment là. Ces circonstances me font regretter encore plus amèrement de n'avoir pu partager ce moment fort, scientifiquement et humainement, avec vous. J'espère que ce n'est que partie remise.

Merci ensuite à **Claire Paris** d'avoir collaboré à la direction de cette thèse depuis mon séjour à Miami en 2005. Merci de m'avoir appris beaucoup sur les modèles Lagrangiens, d'avoir éveillé mon intérêt pour l'analyse de la distribution verticale des larves, l'analyse objective et tant d'autres choses. Merci d'avoir participé à la réussite de la campagne de Tetiaroa et de nous avoir fait partager ton émerveillement devant les petits bijoux de larves que nous récoltions. Merci de m'avoir permis d'assister au WKAMF meeting à tes côtés ; il s'est révélé primordial pour le reste de ma thèse. Ton enthousiasme et ton accueil (à Miami et sur le projet OWNFOR) m'ont motivé et inspiré. Je me réjouis déjà de continuer à travailler avec toi lors d'un post-doctorat que j'espère productif.

Merci enfin à **Michel de Lara** d'avoir été à l'origine de la rencontre entre les mathématiques et la biologie pour ce projet. C'est notamment votre intérêt pour les écosystèmes tropicaux qui est à l'origine de l'ACI MOOREA (si bien nommée !) et de ce travail. Merci d'avoir initié mon esprit de biologiste au contrôle optimal, d'autant plus que cela a demandé du temps. Merci d'avoir posé des bases mathématiques

solides pour ces modèles et de m'avoir éclairé sur ce que peut dire ou ne peut pas dire un modèle numérique. Merci, enfin, pour votre simplicité et votre efficacité.

Cette thèse a été réalisée au Centre de Biologie et d'Écologie Tropicale et Méditerranéenne, au sein de l'UMR 8046 (devenue 5244) et plus particulièrement de l'équipe "Récifs Coralliens". Je remercie **René Galzin** et **André Théron** de m'y avoir accueilli. Merci en particulier à René Galzin d'avoir répondu à une avalanche d'e-mails de ma part en 2001, lors de ma licence, par une offre de stage plutôt que par le refus systématique qu'aurait pu mériter mon insistance. C'est de ce premier contact qu'a découlé tout le reste.

Merci à **Philippe Koubbi** et **Pierre Pepin** d'avoir accepté d'être rapporteurs de ce manuscrit, ainsi qu'à **Éric Thiébaud** d'avoir accepté de le juger. Je suis flatté que ce travail ait éveillé votre curiosité et j'espère que la lecture de ces pages s'est avérée intéressante. Je vous remercie par avance de vos commentaires, qui amélioreront leur contenu.

C'est grâce à la collaboration de nombreuses personnes que j'ai pu apprendre et ré-utiliser diverses techniques, afin d'aborder la question du comportement des larves durant leur phase océanique sous différents angles.

*My deepest thanks go to **Robert Cowen** for hosting me in his team in RSMAS, University of Miami. These six weeks were among the most scientifically profitable of my whole PhD thanks, in part, to insightful discussions with the students there: **David Richardson**, **Joel Llopiz**, **Klaus Huebert** and **Jonathan Kool**. The collaboration of **Robert Cowen** was also key in the success of the oceanographic campaign in Tetiaroa. Thank you for accepting to lend the invaluable MOCNESS net and let go some of your best crew members on this cruise with us, for a month. Many thanks also to **Zulema Garraffo** who has made my stay at her place very enjoyable, in addition to her very didactic help on MICOM.*

La campagne océanographique sur le navire Alis n'aurait pas été aussi efficace et agréable sans le professionnalisme et l'enthousiasme du capitaine et des marins de ce navire. Merci beaucoup au capitaine **Hervé le Houarnot**, et à **Robert Zamora**, son second, pour leur navigation irréprochable et leur patience face à nos changements de stratégie d'échantillonnage ; à **Frank "Boubou"**, chef mécano, **Renaud** et **Pierrick**, son équipe, pour avoir facilité notre travail par leur savoir-faire ; à **Féfé**, le bosco, et à **Fred**, lieutenant, pour leur habileté à la manette du treuil ; à **Jacques** et **Nicolas**, les cuistots, pour nous avoir régales durant les trois semaines à bord ; et enfin à **Kesiano**, **Guy** et **Steeve**, l'équipe de matelots, pour leur aide de tous les instants sur le pont, pour avoir compensé la faiblesse de nos petits biceps blanchâtres de métropolitains de bureau par leur force herculéenne, et pour avoir rythmé la vie à bord au son de morceaux wallisiens, futuniens et kanaks.

Cette campagne n'aurait pas non plus été possible sans l'aide d'une équipe scientifique compétente et motivée (pour passer 12 heures par

jour à relever des filets il faut l'être!). Merci à **Pascal Ung**. Tu as fait preuve d'une énergie et d'une ingéniosité sans pareilles. Merci aussi d'avoir des cousins dans tout Papeete, prêts à ouvrir leur magasin d'accastillage un dimanche pour sauver notre départ. L'équipe du CRIOBE se trouvera, j'en suis sûr, très enrichie par ta présence. Merci à **David Lecchini** d'avoir accepté de prendre la place de Serge au pied levé et d'avoir relayé les informations entre l'équipe scientifique et l'équipage durant cette campagne. Merci à **Laure Carassou** de nous avoir rejoint et d'avoir remplacé Claire pour la fin de la campagne. J'espère que tu n'en garderas pas un trop mauvais souvenir malgré les conditions de mer difficiles. Merci également à **Yannick Chancerelle** qui, avec Pascal, a fait du CRIOBE une base arrière solide pour cette mission. Merci à **Gaël Simon** d'avoir conçu et réalisé le bras de déploiement de l'ADCP ainsi que plusieurs petites améliorations du labo de tri de larves. *Finally, many thanks to Kate Hanson for her help on the sorting of the fine zooplankton of Bongo nets. I hope that this collaboration will continue and be fruitful in the coming months.*

Des remerciements spéciaux vont à **Romain Crec'hriou**. En plus d'avoir été un très bon ami au labo, un partenaire de parties de contrées endiablées et d'autres soirées sympas, tu m'as beaucoup aidé pour la préparation et l'accomplissement de cette mission, ainsi que pour le tri et l'identification de ces quelques milliers de larves. Merci de m'avoir formé et d'avoir persévéré face à un travail de tri assez gargantuesque. Je garderai finalement un très bon souvenir de ce samedi de marathon-tri sur lequel nous avons conclu la rotation 4 (ainsi que de la pizza tartiflette qui a suivi évidemment!). Bonne chance pour la suite au pays des Kiwis.

Un autre merci un peu spécial va à **Cédric Guigand**. Sur le projet OWNFOR comme lors de la campagne de Tetiaroa, tu as prouvé que l'esprit de McGyver n'est pas mort. Merci mille fois de nous avoir formé à l'utilisation du MOCNESS (j'espère que nous aurons tous notre certificat officiel), d'avoir travaillé d'arrache-pied durant toute la campagne, à t'en rendre presque malade, et d'avoir même été jusqu'à risquer ta vie (au sens propre!) lors de l'utilisation de ce filet. Merci aussi pour ces quelques jours magiques, quand "Le temps s'immobilise, Aux Marquises". J'en garderai un souvenir impérissable, alimenté par tes magnifiques photos.

Sorting and identifying all these fish larvae was made possible by the help and encouragements of many brilliant taxonomists around the world. I am grateful to Andrey Suntsov, Claire Paris, Jeffrey Leis, David Johnson, David Richardson, Michael Miller and Atsushi Fukui for the reprints they sent me and for their thoughtful advice on the numerous pictures of larval fishes they kindly agreed to look at. Thanks also to William Richards for sending me a copy of the 760 pages of the invaluable but out of print, "Ontogeny & Systematics of Fishes". I hope that the taxonomic database which resulted from this collaboration will prove useful in the future. It certainly was for me. Un grand merci va également à **Pierre Torres**, pour son aide efficace dans le

tri des larves de poisson et l'analyse de données ichthyoplanctoniques, lors de son stage de master. La note qui a récompensé ce stage est méritée par l'intelligence de ta discussion, pourtant écrite très rapidement après un stage chargé en travail de paillasse. J'espère que mon Stakhanovisme (selon tes propres termes) t'aura influencé sans t'aliéner.

Enfin, l'analyse des données de Tetiaroa a été facilitée par l'aide de **Joachim Claudet**, **Erwan Roussel** et **Marion Jarraya** dans l'application de diverses techniques statistiques. Merci de m'avoir initié au monde merveilleux des MRT, GLM et autres ACP. Vos approches différentes et complémentaires m'ont permis d'acquérir une vision globale et solide de ces données.

L'utilisation de modèles océanographiques est le fruit de collaborations avec **Patrick Marsaleix** du laboratoire d'aérodynamique de Toulouse, pour le modèle SYMPHONIE, et de **Zulema Garaffo**, **Changming "Charles" Dong** et surtout **Laurent Chérubin**, de l'Université de Miami (RSMAS) et de l'UCLA, pour MICOM puis ROMS. L'adaptation de ces modèles à mon cas d'étude s'est révélée plus ardue que prévue et je remercie en particulier Laurent de ne pas s'être découragé même après deux ans d'échanges transatlantiques qui se sont finalement soldés par un échec et l'abandon de MICOM. Ils m'auront au moins permis de me familiariser, à ton contact, avec le vocabulaire et les techniques de l'océanographie physique. J'espère que le modèle actuel et son utilisation récompenseront tes efforts. Merci aussi pour ton aide sur ce manuscrit et pour ta bonne humeur.

Le cadre de modélisation par contrôle optimal a été élaboré pour cette étude par **Michel de Lara** que je remercie encore une fois ici. Les premiers modèles (1D et version initiale de la version 3D) ont été conçus et codés par **Anselme LeVan** avec l'aide de **Jean-Philippe Chancellier** en Scilab. Je remercie également Jean-Philippe Chancellier d'avoir poursuivi son aide à mes côtés pour mes premières versions en Scilab.

Les ordinateurs et les méthodes informatiques ont, à l'heure actuelle, une place centrale dans la recherche scientifique. Au grand désespoir de certains et certaines, qui se reconnaîtront, ceci est particulièrement vrai pour moi, qui ai tendance à passer beaucoup (trop ?) de temps face à mon écran. Qui plus est, en sciences, où la reproductibilité des résultats devrait être une condition obligatoire à la publication et où la collaboration entre chercheurs est la meilleure voie d'innovation, je pense que les logiciels libres devraient être utilisés en priorité, car ils facilitent ces deux aspects. C'est à ce principe que j'ai adhéré durant ma thèse et je tiens à remercier ici les équipes qui, dans leur temps libre et bénévolement, développent les logiciels qui m'ont permis de mener à bien ma recherche scientifique : **MPlayer** et **ImageJ** pour l'analyse d'images, **Scilab** et **R** pour les simulations et l'analyse de données, **Subversion** et **git** pour la gestion du code informatique de mes programmes, différentes moutures du système **GNU/Linux** qui ont fait tourner les

serveurs de calcul, **ΛT_EX** et **BibDesk** pour l'écriture d'articles, de ce manuscrit et la recherche bibliographique, et **Inkscape** pour l'édition des figures. Au delà des logiciels, les discussions sur les listes de diffusion de ImageJ, MPlayer et R, ainsi que sur les newsgroups `comp.text.tex` et `comp.lang.fortran` m'ont fait progresser rapidement au niveau technique mais aussi scientifique. Un merci particulier à l'équipe d'**Inkscape** qui m'a très amicalement intégré en tant que développeur de la version Mac OS X de ce fabuleux logiciel. Merci également à **Hadley Wickham**, le développeur de `ggplot` et `reshape` (deux modules de R qui m'ont immensément facilité la vie) d'avoir toujours rapidement répondu à mes questions et intégré certaines de mes suggestions à `ggplot`.

*Computers and informatics now play a central role in scientific research, and particularly for me, given the time I spend in front of a computer screen. In this field, I think that open source software should be preferred over other alternatives, because it eases reproducibility of results, which should be mandatory for the publication of scientific work, and facilitates collaborative work, from which most innovative research springs. I adhered to this principle during my PhD work and thank here the people who, in their spare time and voluntarily, develop the software which allowed me to pursue my scientific endeavours: **MPlayer** and **ImageJ** for image analysis, **Scilab** and **R** for simulations and data analysis, **Subversion** and **git** for the management of my source code, various versions of the **GNU/Linux** operating system which powered the computation servers, **ΛT_EX** and **BibDesk** for the edition of papers, this manuscript and for bibliographic research, and **Inkscape** for the edition of figures. Besides software, the mailing lists for MPlayer, ImageJ and R and the newsgroups `comp.text.tex` and `comp.lang.fortran` also helped me to progress in my research, both technically and scientifically. Special thanks go to Inkscape's team who cordially accepted me as a new developer for the OS X port of this wonderful software. I also thank **Hadley Wickham**, the developer of `ggplot` and `reshape` (two R packages which facilitated my work tremendously) for promptly answering my numerous questions and integrating some of my suggestions into `ggplot`.*

Enfin, sans avoir participé directement à la recherche scientifique qui est la base de cette thèse, de nombreuses personnes ont aidé à son accomplissement.

Je tiens à remercier **Régis Ferrière** et **Marc-André Selosse** de m'avoir proposé des enseignements à l'ENS et en préparation à l'agrégation à l'Université de Montpellier, qui m'ont permis de m'intéresser de façon didactique à des sujets souvent proches de mon travail de recherche. Merci également à MAS de m'avoir soutenu lors de petits épisodes de découragement. Merci enfin à **Olivier Verneau** de m'avoir affecté aux enseignements de licence pluridisciplinaire à Perpignan, plutôt qu'aux habituels TPs et TDs, et aux étudiants des trois promotions de cette licence que j'ai suivis. Ces enseignements m'ont permis de rester en contact avec la réalité des connaissances biologiques d'étudiants non-spécialistes.

Évidemment, tout le personnel du Centre de Biologie et d'Écologie Tropicale et Méditerranéenne de Perpignan a créé l'environnement de travail dans lequel il a été agréable de travailler durant ces quatre ans. Merci en particulier à **Raymonde Lecomte** pour l'organisation des séminaires et la gestion de la bibliothèque, à **Bruno Delessale** pour ses conseils et son aide matérielle face aux loupes binoculaires, à **Jean-Luc Maspimby** pour l'administration des serveurs de calcul et à **Jocelyne Blanc** pour son infatigable application à régler les problèmes comptables et administratifs. Merci aussi à tous les étudiants, ingénieurs, chercheurs, etc. qui ont formé le groupe à géométrie variable des copains-du-labo : Joachim, Rita, Romain, Aurore, Lucie, Bastien, Erwan, Vanouch, Élisabeth, François, Olivier, Mehdi, Muriel, Philippe, Loïc, Suzie, Mathias, Anne, Jérémy, Jérémie, Pablo, Johann et tous les autres. Merci pour l'ambiance agréable qui a entouré ces années perpignanaïses.

Merci aussi aux "amis-d'avant", de Marseille ou des diverses prépas, qui m'ont permis de m'échapper du monde de la recherche pour quelques moments de repos. Ces jours de l'an, mariages, retours à Marseille ou retrouvailles sans avoir vraiment besoin de raison m'ont équilibré ... et fourni un bon prétexte pour me plaindre de l'état de la recherche et de l'avancement de ma thèse ! Une mention particulière va à Lorène pour s'être proposée spontanément et avoir relu ce travail.

Merci aussi à la famille d'Estelle de m'avoir accueilli si naturellement à St Brice, Crisolles ou ailleurs, pour des week-ends et vacances avec elle, me permettant de changer d'air. Merci en particulier à Anne-Marie d'avoir repris sa casquette de professeur de français afin de corriger mes fautes d'orthographe (sachant que toutes celles qui pourraient rester sont évidemment celles que je me suis empressé de rajouter lors des révisions suivantes du texte).

Merci à ma famille, qui m'a toujours soutenu et encouragé vers l'excellence, au cours de mes études et de cette thèse. Je suis assez fier, rétrospectivement, de ce que votre soutien à tous m'a permis d'accomplir jusqu'à maintenant, et conscient de vous le devoir. Quant à cette thèse, j'espère que le résultat vaudra le temps passé loin de Marseille et expliquera la rareté de mes coups de fil. Elle marque en tout cas la fin plutôt floue d'une longue période étudiante et me fait finalement rejoindre Estelle et Antoine dans la "vie active", en bon dernier ... comme d'habitude !

Enfin, merci à Estelle d'avoir donné aux quatre dernières années de ma vie un goût unique. Merci de ta patience face à mon emploi du temps qui te laissait moins de place que je ne l'aurais voulu. Merci d'avoir fait l'effort de me suivre depuis Paris jusqu'à Perpignan, te séparant ainsi de ta famille. Merci de poursuivre cet effort lors de mon départ pour un post-doc outre-Atlantique. Merci d'être là pour moi. Merci d'être toi.

Document typeset by L^AT_EX — 19th September 2008

Approche comportementale de la dispersion larvaire en milieu marin

La plupart des organismes marins démersaux présentent une phase larvaire pélagique avant le recrutement dans la population adulte. Cet épisode pélagique est souvent la seule opportunité de dispersion au cours du cycle de vie. De ce fait, il structure les connections entre populations qui régissent la dynamique et la composition génétique des métapopulations benthiques. Cependant, ces "larves" ne sont pas de simples ébauches des adultes, dispersées au gré des courants en attendant leur métamorphose. Ce sont des organismes souvent très spécifiquement adaptés à leur milieu. Dans cette thèse nous nous sommes efforcés d'évaluer l'impact du comportement des larves lors de la phase pélagique. Nous nous sommes focalisés sur les larves de poissons (coralliens plus spécifiquement) dont les capacités sensorielles et motrices sont particulièrement élevées. Des approches expérimentales ont été développées afin de quantifier leur orientation et leur nage *in situ*. Grâce à une observation synchrone des caractéristiques physiques du milieu et de la distribution des larves lors d'une campagne océanographique, nous avons tenté de caractériser leur distribution en trois dimensions dans le milieu pélagique, afin de comprendre les interactions physico-biologiques déterminant le recrutement. Enfin, une approche de modélisation novatrice, faisant appel à des concepts de minimisation des coûts et de maximisation des bénéfices habituellement utilisés en économie ou en théorie de l'approvisionnement optimal, a permis d'intégrer le comportement des larves aux modèles Lagrangiens de dispersion.



Behavioural approach to larval dispersal in marine systems

Most demersal marine organisms have a bipartite life history and larvae are pelagic before recruiting in the adult population. This pelagic episode is often the sole opportunity for dispersal in the life of these organisms. Therefore, it structures the connections between populations, which, in turn, determine demographic dynamics and genetic composition of benthic metapopulations. Nevertheless, these "larvae" are not just drafts of the adults, dispersed by oceanic currents before their metamorphosis. They are very specialised organisms, often tightly adapted to their environment. In this doctoral research, we strove to evaluate the impact of larval behaviour during the pelagic interval. We focused on fish larvae (particularly coral-reef fishes) which sensory and swimming capabilities are particularly high. Experimental approaches were developed to quantify larval orientation and swimming *in situ*. During an oceanographic campaign, synchronous observations of physical properties of sea water and of the distribution of larvae enabled to characterise their distribution in three dimensions within the pelagic environment and to understand physical-biological interactions determining recruitment. Finally, a novel modelling framework, drawing from cost minimisation and benefit maximisation techniques traditionally used in economics or optimal foraging models, allowed to integrate larval behaviour in Lagrangian models of larval dispersal.