



HAL
open science

Chemins confinés dans un quadrant

Kilian Raschel

► **To cite this version:**

Kilian Raschel. Chemins confinés dans un quadrant. Mathematics [math]. Université Pierre et Marie Curie - Paris VI, 2010. English. NNT: . tel-00539964

HAL Id: tel-00539964

<https://theses.hal.science/tel-00539964>

Submitted on 25 Nov 2010

HAL is a multi-disciplinary open access archive for the deposit and dissemination of scientific research documents, whether they are published or not. The documents may come from teaching and research institutions in France or abroad, or from public or private research centers.

L'archive ouverte pluridisciplinaire **HAL**, est destinée au dépôt et à la diffusion de documents scientifiques de niveau recherche, publiés ou non, émanant des établissements d'enseignement et de recherche français ou étrangers, des laboratoires publics ou privés.

École Doctorale de Paris Centre

THÈSE DE DOCTORAT

Discipline : Mathématiques

présentée par

Kilian RASCHEL

Chemins confinés dans un quadrant

dirigée par Irina KURKOVA

Soutenue le 24 novembre 2010 devant le jury composé de :

M. Philippe BIANE	Université de Marne la Vallée	examineur
M. Philippe BOUGEROL	Université Pierre et Marie Curie	examineur
M. Nathanaël ENRIQUEZ	Université Paris Nanterre	examineur
M. Guy FAYOLLE	INRIA Paris Rocquencourt	examineur
M. Philippe FLAJOLET	INRIA Paris Rocquencourt	rapporteur
M. Wolfgang KÖNIG	WIAS Berlin	rapporteur
M ^{me} Irina KURKOVA	Université Pierre et Marie Curie	directrice
M. Marc PEIGNÉ	Université de Tours	examineur

Remerciements

Mes remerciements s'adressent tout naturellement d'abord à ma directrice de thèse, Irina Kurkova. Je souhaite la remercier pour son accompagnement constant, son soutien sans faille et ses encouragements permanents. Son expérience, ainsi que la générosité avec laquelle elle m'a fait profiter de ses qualités scientifiques, ont été pour moi une immense chance ; cette thèse lui doit beaucoup.

J'exprime ma profonde gratitude à Philippe Flajolet et Wolfgang König pour le temps consacré à rapporter cette thèse, pour leurs appréciations encourageantes et inspiratrices, ainsi que pour leur accueil chaleureux durant des visites à l'INRIA Paris-Rocquencourt et au WIAS Berlin.

Je suis extrêmement reconnaissant à Philippe Biane, Philippe Bougerol, Nathanaël Enriquez, Guy Fayolle et Marc Peigné d'avoir accepté de faire partie de mon jury. Je remercie d'abord Philippe Biane pour l'intérêt qu'il a porté envers mon travail ainsi que pour les discussions enrichissantes dont j'ai eu le plaisir de bénéficier. Je suis très redevable à Philippe Bougerol pour sa bienveillance et pour avoir inspiré l'étude de chacune des deux parties de ma thèse. Je suis aussi reconnaissant à Nathanaël Enriquez de sa disponibilité et de l'intérêt qu'il a manifesté à l'égard des méthodes d'analyse utilisées dans ma thèse. Je remercie également Guy Fayolle pour nos discussions si agréables autour du "petit livre jaune" ainsi que pour notre collaboration fructueuse. J'exprime enfin ma gratitude à Marc Peigné pour sa bienveillance et son accompagnement, depuis maintenant plus de sept ans.

Les deux années passées à l'Université de Tours ont été déterminantes dans ma volonté de poursuivre l'étude des mathématiques. Aussi je remercie tous les enseignants-chercheurs que j'ai eu la chance et le plaisir de croiser durant cette période, et tout particulièrement Marie-Françoise Bidaut-Véron pour ses encouragements et l'intérêt qu'elle m'a témoigné.

Tout au long de mes années de thèse, j'ai été particulièrement sensible au fait que des enseignants-chercheurs prennent le temps de parler de mathématiques avec moi – si inexpérimenté ! –, et parfois même me proposent des collaborations, ou encore m'invitent quelques jours dans leur université. Aussi en sais-je profondément gré à Ivo Adan, Nils Berglund, Alin Bostan, Onno Boxma, Frédéric Chyzak, Rodolphe Garbit, Barbara Gentz, Irina Ignatiouk-Robert, Pauline Lafitte-Godillon, Johan van Leeuwen, Thomas Simon, Chi Tran et Wolfgang Woess.

Je mesure la chance d'avoir effectué ma thèse au sein du Laboratoire de Probabilités et de Modèles Aléatoires, et je remercie chaleureusement tous ses membres pour leur accueil et leur accompagnement pendant ma thèse. Ces trois années se sont déroulées dans l'ambiance joyeuse régnante au sein des doctorants, et j'adresse mes amitiés à Abass, Alexander, Assane, Clément, David, Dominique, Elie, Emmanuel, Eric, Fernando, François C., François S., Gilles, Guanying, Joachim, Joseph, Manon, Mathieu, Nicolaos, Noufel, Pascal, Raoul, Sophie D., Sophie L., Stavros, Thanh Mai, Thomas et Vincent.

Je suis également reconnaissant à Aurélie et Mathieu pour leur amitié et leur accueil si chaleureux lors de mes séjours à Paris. Je salue aussi amicalement Ludovic et Benjamin, mes anciens colocataires, pour les deux années agréables passées au Pré ; je remercie ce même Benjamin pour les discussions variées que j'ai eu le plaisir de partager avec lui.

Enfin, je tiens à remercier sincèrement ma famille, d'abord pour leur présence et leurs encouragements, aussi pour leur grande aide en allemand et en anglais, enfin pour avoir rendu le choix d'un doctorat si naturel.

En tout dernier lieu, je remercie Gaëlle pour sa présence toujours rassurante, enrichissante et porteuse d'espoirs, au-delà de ces trois années de thèse.

Résumé et mots clés

Résumé : Les thèmes abordés dans le cadre de la thèse “Chemins confinés dans un quadrant” se concentrent autour des marches à petits sauts (c’est-à-dire aux huit plus proches voisins) confinées dans un quart de plan.

Tout d’abord, nous considérons le problème combinatoire consistant à compter les chemins du plan qui, se déplaçant selon un ensemble fixé de sauts, restent dans un quadrant. Nous nous focalisons sur les questions suivantes :

- expliciter la série génératrice des nombres de chemins partant de l’origine et se terminant en un certain point en un temps fixé ;
- analyser la façon dont cette fonction dépend de l’ensemble de sauts, et en particulier étudier sa nature (rationnelle, algébrique, (non) holonome).

Ensuite, nous examinons le problème probabiliste des marches aléatoires à valeurs dans un quadrant, homogènes à l’intérieur et tuées au bord. Nous nous intéressons alors aux questions suivantes :

- expliciter les probabilités d’absorption en un certain point du bord en un temps fixé, et en particulier les probabilités d’absorption en un certain site du bord ;
- trouver l’asymptotique de ces probabilités ;
- expliciter les probabilités que le processus se trouve en un certain point intérieur au quadrant en un temps fixé, et les fonctions de Green ;
- calculer l’asymptotique précise de ces fonctions de Green le long de toutes les trajectoires ;
- obtenir toutes les fonctions harmoniques positives ou nulles ainsi que la compactification de Martin ;
- analyser le temps d’absorption sur les axes, et notamment l’asymptotique de sa queue de distribution.

Les méthodes que nous utilisons pour répondre aux questions ci-dessus font appel à l’analyse complexe.

Mots clés : Marches aléatoires tuées ; Fonctions de Green ; Probabilités d’absorption ; Frontière de Martin ; Énumération des marches du plan ; Séries génératrices ; Algébricité ; Holonomie ; Problèmes frontière ; Surfaces de Riemann ; Uniformisation ; Représentations conformes

Abstract and keywords

Abstract : The PhD thesis “Paths confined to a quadrant” deals with two different aspects of the walks with small steps (i.e. to the eight nearest neighbors) that are confined to a quarter plane.

First, we study the combinatorics of counting the planar walks which, while moving according to a given step set, remain in a quadrant. We then concentrate on the following problems :

- to make explicit the generating function of the numbers of such trajectories ;
- to analyse the fashion in which that series depends on the step set, and in particular its nature (rational, algebraic, (non-)holonomic).

Second, we study the random walks with values in a quadrant, which are taken homogeneous inside and killed at the boundary. For these processes, we are interested in the following probabilistic problems :

- to make explicit the absorption probabilities at a fixed time in a certain site of the boundary, and in particular the absorption probabilities in some point of the boundary ;
- to find the asymptotic behavior of these probabilities ;
- to make explicit the probabilities that the process, at a fixed time, is in a certain site belonging to the interior of the quadrant, and in particular the Green functions ;
- to compute the precise asymptotics of these Green functions along all trajectories ;
- to obtain all non-negative harmonic functions, as well as the Martin compactification ;
- to analyse the hitting time of the axes, and in particular evaluating its asymptotic tail distribution.

The methods that we use in order to solve these problems are partially based on complex analysis.

Keywords : Killed random walks ; Green functions ; Absorption probabilities ; Martin boundary ; Enumeration of the planar walks ; Generating functions ; Algebraicity ; Holonomy ; Boundary value problems ; Riemann surfaces ; Uniformization ; Conformal mappings

Table des matières

I	Introduction	11
1	Approche analytique	14
1.1	Principe de l'approche	14
1.2	Problèmes de Riemann-Carleman et collage conforme	18
1.3	Calcul des asymptotiques	21
2	Énumération des chemins	23
3	Marches tuées	30
3.1	Résultats explicites	35
3.2	Asymptotique des fonctions de Green et des probabilités d'absorption dans le cas d'un drift non nul	37
3.3	Asymptotique des fonctions de Green et des probabilités d'absorption dans le cas d'un drift nul	39
3.4	Asymptotique de la queue de distribution du temps d'atteinte d'un des axes	43
4	Correspondance des principaux résultats de l'introduction	46
5	Perspectives	47
6	Notations	47
II	Énumération des chemins	49
A	Gessel's walk	51
A.1	Introduction and main results	51
A.2	Study of the conformal gluing functions	60
A.2.1	Uniformization	60
A.2.2	Implicit expression and global properties of the CGF	62
A.2.3	Proof of Theorem A.7	63
A.3	Holomorphic continuation of the generating functions	65
B	Counting walks in a quadrant, a unified way	69
B.1	Introduction and main results	69
B.2	Holomorphic continuation of the generating functions	75
B.2.1	Proof of Theorem B.8	76
B.2.2	Proof of Theorem B.4	77
B.3	Uniformization	79
B.4	Conformal gluing functions	82
B.4.1	Finding all suitable conformal gluing functions	82
B.4.2	Case of an infinite group	84

B.4.3	Case of a finite group	86
B.4.4	Concluding remarks	91
III	Marches tuées	93
C	Killed random walks with non-zero drift	95
C.1	Introduction	95
C.2	Analytic approach	99
C.2.1	The fundamental functional equation	99
C.2.2	The Riemann surface $\{(x, y) \in (\mathbb{C} \cup \{\infty\})^2 : K(x, y) = 0\}$	99
C.2.3	Galois automorphisms and meromorphic continuation	101
C.2.4	About the probability of absorption	103
C.3	Explicit expression of the absorption probabilities	106
C.3.1	Riemann boundary value problem with shift	106
C.3.2	Study of the integral representations of the generating functions	107
C.4	Asymptotic of the Green functions	109
C.4.1	First case : $\gamma \in]0, \pi/2[$	110
C.4.2	Second case : $\gamma = 0, \pi/2$	113
C.5	Fine properties of the conformal gluing functions	120
C.6	Asymptotic of the absorption probabilities	123
D	Killed random walks related to $SU(3)$	131
D.1	Introduction and main results	131
D.2	Explicit expression of the Green functions	135
D.3	Asymptotic of the Green functions	140
D.4	Interlude	144
E	Killed random walks related to $Sp(4)$	149
E.1	Introduction	149
E.2	Analytic approach	154
E.2.1	A functional equation	154
E.2.2	Uniformization and meromorphic continuation	155
E.3	Harmonic functions	159
E.4	Asymptotic of the Green functions	162
E.4.1	Statement of the results	162
E.4.2	Proofs	163
E.5	Absorption probabilities	168
E.5.1	Asymptotic of the absorption probabilities, <i>a first method</i>	168
E.5.2	Integral representation of the generating functions	168
E.5.3	Asymptotic of the absorption probabilities, <i>a second method</i>	170
F	Hitting time of the boundary	173
F.1	Distribution of the hitting times of both axes and of the origin	173
F.2	Case of a group of order 4 for all z	175
F.2.1	A change of variable <i>via</i> the Chebyshev polynomials	176
F.2.2	The gambler ruin	177
F.2.3	Drift zero	178

F.2.4	Non-zero drift	180
F.2.5	Generalization of Subsection F.2.3	183
F.3	Case of a group of order 6 for all z	185
F.3.1	The voter model	186
F.3.2	Exact distribution of the hitting times of both axes	188
F.3.3	Asymptotic tail distribution of the hitting times	189
F.4	Case of a group of order 8 for all z and extensions	193

Première partie

Introduction

Les thèmes que nous aborderons dans le cadre de cette thèse se concentreront autour des marches à petits sauts confinées dans un quart de plan. Nous étudierons deux aspects de ces processus, en donnant, dans chacune des Parties II et III, un sens différent à la notion de confinement.

Tout d'abord, dans la Partie II, nous considérerons les chemins du quadrant \mathbb{Z}_+^2

- * se déplaçant selon le même ensemble de sauts \mathcal{S} en tout point intérieur au quadrant,
- * suivant $\mathcal{S} \cap (\mathbb{Z} \times \mathbb{Z}_+)$ (resp. $\mathcal{S} \cap (\mathbb{Z}_+ \times \mathbb{Z})$, $\mathcal{S} \cap (\mathbb{Z}_+ \times \mathbb{Z}_+)$) sur le bord horizontal (resp. sur le bord vertical, en l'origine) du quart de plan \mathbb{Z}_+^2 ,
- * à petits sauts, *i.e.* $\mathcal{S} \subset \{-1, 0, 1\}^2 \setminus \{0, 0\}$.

Il y a manifestement 2^8 modèles, mais quelques-uns sont triviaux, tandis que certains s'obtiennent par symétrie à partir d'autres ; M. Bousquet-Mélou et M. Mishna montrent dans [BMM09] qu'il existe en réalité 79 problèmes intrinsèquement différents à étudier. Pour ces 79 ensembles de sauts \mathcal{S} , nous nous focaliserons sur les questions suivantes :

- (1) expliciter la fonction génératrice (de trois variables) du nombre de chemins partant de l'origine et se terminant en un certain point de \mathbb{Z}_+^2 en un temps fixé,
- (2) analyser la façon dont cette fonction génératrice dépend de \mathcal{S} , et, en particulier, étudier sa nature (rationnelle, algébrique, holonome, non holonome).

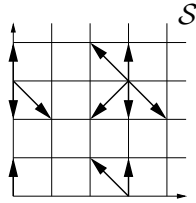

FIGURE 1 – Exemple de marches considérées dans la Partie II

Ensuite, dans la Partie III, particulièrement motivés par les travaux [Bia91, Bia92a, Bia92b, Bia92c] de P. Biane, [IR08, IRL09, IR09a, IR09b] de I. Ignatiouk-Robert *et al.* et [EK08, KS09] de W. König *et al.*, nous analyserons les marches aléatoires $(X(k), Y(k))_{k \in \mathbb{Z}_+}$ à valeurs dans le quart de plan \mathbb{Z}_+^2

- * homogènes à l'intérieur du quadrant \mathbb{Z}_+^2 , *i.e.* les probabilités de transition $p_{i,j} = \mathbb{P}[(X(k+1), Y(k+1)) = (X(k), Y(k)) + (i, j) \mid X(k) \neq 0, Y(k) \neq 0]$ ne dépendront pas de $(X(k), Y(k))$,
- * faisant des petits sauts à l'intérieur du quadrant, *i.e.* les $p_{i,j}$ ci-dessus seront nulles dès que $|i| > 1$ ou $|j| > 1$,
- * tuées au bord de \mathbb{Z}_+^2 , *i.e.* sur $(\mathbb{Z}_+^* \times \{0\}) \cup \{(0, 0)\} \cup (\{0\} \times \mathbb{Z}_+^*)$.

Pour ces processus, nous nous intéresserons aux problèmes suivants :

- (3) expliciter la fonction génératrice (de deux variables) des probabilités d'absorption en un certain point du bord en un temps fixé, et, en particulier, celle (d'une variable) des probabilités d'absorption en un certain site du bord,
- (4) trouver la forme explicite et l'asymptotique des probabilités ci-dessus,
- (5) expliciter la fonction génératrice (de trois variables) des probabilités que le processus se trouve en un certain point de l'intérieur du quadrant en un temps fixé, et, en particulier, la fonction génératrice (de deux variables) des fonctions de Green,

- (6) calculer l'asymptotique précise des fonctions de Green le long de toutes les trajectoires,
- (7) obtenir toutes les fonctions harmoniques positives ou nulles, ainsi que la compactification de Martin,
- (8) analyser le temps d'atteinte des axes, et, en particulier, évaluer l'asymptotique de sa queue de distribution.

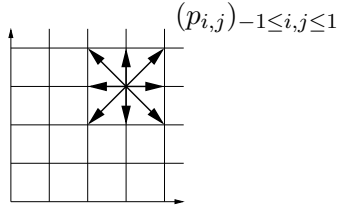

FIGURE 2 – Marches aléatoires analysées dans la Partie III

Les thèmes des deux branches de cette thèse sont certes indépendants, mais leur analyse s'avérera posséder un point commun essentiel : les fonctions génératrices des quantités qui nous intéresseront, comme le nombre de chemins dans la Partie II, puis les probabilités d'absorption et les fonctions de Green dans la Partie III, vérifient une certaine équation fonctionnelle qui sera notre point de départ.

C'est cet aspect analytique que nous allons présenter en premier lieu, dans la Section 1 de cette introduction. Par la suite, nous motiverons et énoncerons de façon détaillée nos contributions à l'analyse de l'énumération des chemins et à l'étude des marches tuées, dans les Sections 2 et 3 respectivement.

1 Approche analytique

1.1 Principe de l'approche

L'approche pionnière pour résoudre des problèmes liés aux marches dans un quadrant *via* l'utilisation d'une équation fonctionnelle et de l'analyse complexe a été proposée par V. Malyshev dans les années 1970, alors afin d'étudier les probabilités stationnaires pour des marches aléatoires ergodiques, homogènes à l'intérieur du quadrant et réfléchies sur le bord, voir [Mal72]. Dans cet article, V. Malyshev a obtenu leur fonction génératrice en termes de séries et de produits infinis, définis sur le recouvrement universel d'une certaine surface de Riemann naturellement associée à la marche aléatoire. Pour des questions semblables, G. Fayolle et R. Iasnogorodski ont, peu de temps après, présenté dans [FI79] une approche plus intrinsèque au plan complexe, utilisant notamment des problèmes frontière. Plus récemment, le livre [FIM99] des trois auteurs précédemment mentionnés a résumé et proposé de nouvelles voies pour le calcul de ces fonctions génératrices.

Malheureusement, ces méthodes ne donnent pas directement d'information sur le comportement quantitatif des probabilités stationnaires. C'est pourquoi V. Malyshev a suggéré de façon indépendante, dans [Mal73], une approche pour calculer l'asymptotique de ces probabilités. Cette dernière a été notamment développée par I. Kurkova et V. Malyshev dans [KM98] pour le calcul de l'asymptotique des fonctions de Green et de la frontière de Martin de processus transients et réfléchis sur le bord du quadrant, puis adaptée par

I. Kurkova et Y. Suhov dans [KS03] à l'étude de certaines marches aléatoires non homogènes à l'intérieur du quadrant.

Avant de décrire précisément les deux aspects de cette approche, nous allons nous intéresser à son analogue élémentaire de dimension un, à travers l'exemple de la ruine du joueur. Notons donc $(X(k))_{k \in \mathbb{Z}_+}$ la marche aléatoire aux plus proches voisins sur \mathbb{Z}_+ , avec probabilités p_1 de croître et $p_{-1} = 1 - p_1$ de décroître, absorbée en 0 et partant d'un certain état initial i_0 . Aussi, posons q_{i_0} pour la probabilité de ruine et $Q_{i_0}(x) = \sum_{i \geq 1} \sum_{k \geq 1} \mathbb{P}_{i_0}[X(k) = i]x^{i-1}$ pour la série génératrice des fonctions de Green. Il est très facile de montrer que ces dernières vérifient l'équation

$$x[p_1x + p_{-1}x^{-1} - 1]Q_{i_0}(x) = q_{i_0} - x^{i_0}. \quad (1)$$

Grâce à (1), trouver explicitement les fonctions de Green est équivalent à obtenir q_{i_0} . Pour ce faire, remarquons qu'évaluer (1) en un point \hat{x} annulant le noyau $x[p_1x + p_{-1}x^{-1} - 1]$ et appartenant au domaine de définition de Q_{i_0} conduit à $q_{i_0} = \hat{x}^{i_0}$ – le seul \hat{x} possible étant ici $[1 - (1 - 4p_1p_{-1})^{1/2}]/[2p_1]$.

Pour obtenir alors l'asymptotique des fonctions de Green, il suffit de constater que (1) conduit aisément à connaître le comportement de Q_{i_0} au voisinage de son unique singularité – à savoir $[1 + (1 - 4p_1p_{-1})^{1/2}]/[2p_1]$ – et permet donc de conclure.

Dans le cas de la dimension deux, l'équation fonctionnelle analysée dans [FIM99] peut être présentée de façon générique comme

$$K(x, y)Q(x, y) = k(x, y)q(x) + \tilde{k}(x, y)\tilde{q}(y) + k_0(x, y)q_0, \quad (2)$$

où $Q(x, y) = \sum_{i, j \geq 1} Q_{i, j}x^{i-1}y^{j-1}$, $q(x) = \sum_{i \geq 1} Q_{i, 0}x^{i-1}$, $\tilde{q}(y) = \sum_{j \geq 1} Q_{0, j}y^{j-1}$ et $q_0 = Q_{0, 0}$ sont inconnues, tandis que $K(x, y) = xy[\sum_{i, j} p_{i, j}x^i y^j - 1]$, $k(x, y) = x[\sum_{i, j} p'_{i, j}x^i y^j - 1]$, $\tilde{k}(x, y) = y[\sum_{i, j} p''_{i, j}x^i y^j - 1]$ et $k_0(x, y) = \sum_{i, j} p^0_{i, j}x^i y^j - 1$ sont des polynômes connus.

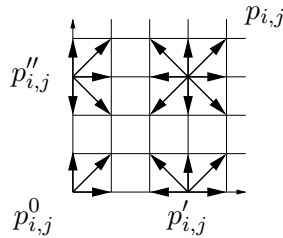

FIGURE 3 – Marches aléatoires étudiées dans [FIM99]

Ci-dessus, les $p_{i, j}$ (resp. $p'_{i, j}$, $p''_{i, j}$, $p^0_{i, j}$) désignent donc les probabilités de transition des marches aléatoires à l'intérieur (resp. sur l'axe horizontal, sur l'axe vertical, en l'origine) du quadrant, et les $Q_{i, j}$ sont les probabilités stationnaires des processus – supposés ergodiques dans [FIM99]. Par ailleurs, les marches sont supposées ne faire, à l'intérieur du quart de plan, que des petits sauts : cela signifie que si $|i| > 1$ ou $|j| > 1$, alors $p_{i, j} = 0$. Ceci entraîne en particulier que K est un polynôme du second degré au plus en chacune des variables x, y . Enfin, il est important de noter que Q, q, \tilde{q} étant des fonctions génératrices de probabilités, le domaine de validité de (2) est *a priori* égal à $\mathcal{D}^2 = \{(x, y) \in \mathbb{C}^2 : |x| < 1, |y| < 1\}$.

Si la série Q est cherchée explicitement, alors, grâce à (2), il suffit de déterminer les fonctions q, \tilde{q} et la constante q_0 . À cet égard, l'idée issue de la dimension un et consistant à

utiliser les zéros du noyau K est la bonne. En effet, cet ensemble des zéros du noyau, qui ne contenait que deux points dans le cas de la dimension un, est maintenant, selon les valeurs des paramètres $p_{i,j}$, une surface de Riemann de genre 0 ou 1, autrement dit une sphère ou un tore. Utilisant la richesse de cet ensemble ainsi que la dépendance q, \tilde{q} en une seule des deux variables x, y , les auteurs de [FIM99] montrent que q, \tilde{q} vérifient des problèmes frontière de type Riemann-Carleman, à partir desquels ils déduisent des expressions explicites de ces deux séries, puis de q_0 par normalisation.

En ce qui concerne maintenant le comportement quantitatif des coefficients $Q_{i,j}$ de Q , V. Malyshev avait noté que l'équation (2) permet de les représenter comme des intégrales doubles de Cauchy, avec au dénominateur de l'intégrand la fonction $K(x, y)x^i y^j$. Les exposants i, j allant tendre vers l'infini, il était par conséquent naturel, dans le but de calculer l'asymptotique de $Q_{i,j}$, d'adapter à deux paramètres i, j la méthode du col. C'est précisément ce qu'a proposé V. Malyshev dans [Mal73], utilisant d'abord le théorème des résidus pour ramener les $Q_{i,j}$ à des intégrales simples, puis le théorème de Cauchy afin de bouger le contour jusqu'au point du col.

Dans la première situation décrite ci-dessus, les courbes sur lesquelles q, \tilde{q} vérifient les problèmes frontière peuvent tout à fait être extérieures à \mathcal{D} , *i.e.* au domaine de définition de q, \tilde{q} ; dans la deuxième, le point du col peut également ne pas appartenir à \mathcal{D} . Pour ces deux raisons, il convient de commencer par prolonger q, \tilde{q} au-delà de \mathcal{D} , jusqu'à ces courbes et points. À cette fin, une procédure originale de prolongement est introduite dans [FIM99] : basée sur l'équation (2), elle utilise de façon cruciale le fait que q, \tilde{q} ne dépendent que d'une des deux variables x, y , ainsi que la surface donnée par les zéros du noyau $\{(x, y) \in \mathbb{C}^2 : \sum_{i,j} p_{i,j} x^i y^j - 1 = 0\}$ et ses automorphismes associés dits "de Galois" (déjà considérés dans [Mal71])

$$\xi(x, y) = \left(x, \frac{\sum_i p_{i,-1} x^i \frac{1}{y}}{\sum_i p_{i,+1} x^i y} \right), \quad \eta(x, y) = \left(\frac{\sum_j p_{-1,j} y^j \frac{1}{x}}{\sum_j p_{+1,j} y^j x}, y \right), \quad (3)$$

et elle conduit à un prolongement des fonctions q, \tilde{q} à tout le plan complexe. Une autre conséquence de ce prolongement est que l'identité (2) elle-même peut être étendue à un domaine contenant strictement \mathcal{D}^2 .

Nous reviendrons en détail sur ces transformations ξ, η laissant invariante la fonction $\sum_{i,j} p_{i,j} x^i y^j$ ainsi que sur le prolongement des fonctions q, \tilde{q} , à la fois dans les Sous-sections 1.2-1.3 et dans les Sections 2-3.

Les étapes principales de l'approche analytique introduite dans [FIM99] étant rappelées, nous souhaitons maintenant mettre en évidence deux différences notables entre les équations fonctionnelles qui y sont considérées et celles que nous nous apprêtons à rencontrer et étudier dans cette thèse.

D'une part, les processus auxquels nous allons nous intéresser ici seront tels que les fonctions connues k, \tilde{k}, k_0 ne dépendront pas des deux variables x, y mais k_0 sera constant et k (resp. \tilde{k}) dépendra uniquement de x (resp. y). Cela entraînera des simplifications tout à fait profitables, notamment lors de la résolution explicite des problèmes frontière.

D'autre part, nous introduirons ici une nouvelle variable dans l'équation fonctionnelle (2) puisqu'en plus de [FIM99], nous considérerons la variable "du temps" z . Cela nous permettra en effet d'élargir le spectre de notre étude, et de répondre, par exemple, à des questions liées au nombre d'étapes pour l'énumération des marches ou au temps d'atteinte du bord pour les marches tuées. Cela sera, en revanche, une source constante de difficultés

techniques supplémentaires : il s'agira notamment d'étendre la procédure de prolongement des fonctions q, \tilde{q} à toutes les valeurs de z , ou encore d'étudier la dépendance vis à vis de z du groupe de Galois engendré par les automorphismes (3).

Grâce à (2) et en accord avec les deux remarques faites ci-dessus, il est possible de présenter ainsi les équations fonctionnelles que nous considérerons dans cette thèse :

$$K(x, y, z)Q(x, y, z) = k(x, z)q(x, z) + \tilde{k}(y, z)\tilde{q}(y, z) + k_0(z)q_0(z) + \kappa(x, y, z), \quad (4)$$

Q, q, \tilde{q}, q_0 étant inconnues et $K, k, \tilde{k}, k_0, \kappa$ connues – la présence de κ ci-dessus est certes une différence formelle avec (2) mais ne compliquera en rien l'analyse.

En nous appuyant sur les notations prises au tout début de cette introduction, nous définissons à présent en détail ce que seront les fonctions inconnues et connues dans (4), pour chacun des modèles des Sections 2 et 3.

Dans la Section 2, si \mathcal{S} désigne l'espace des sauts admissibles, posant

$$q_{\mathbb{Z}_+^2}(i, j, k) = |\{\text{trajectoires se mouvant selon } \mathcal{S}, \text{ confinées dans } \mathbb{Z}_+^2, \\ \text{partant de } (0, 0) \text{ et se terminant en } (i, j) \text{ au temps } k \text{ exactement}\}|,$$

les séries génératrices Q, q, \tilde{q}, q_0 seront égales à

$$Q(x, y, z) = \sum_{i, j, k \geq 0} q_{\mathbb{Z}_+^2}(i, j, k) x^i y^j z^k,$$

$q(x, z) = Q(x, 0, z)$, $\tilde{q}(y, z) = Q(0, y, z)$ et $q_0(z) = Q(0, 0, z)$. Quant aux fonctions connues, elles vaudront

$$K(x, y, z) = xyz \left[\sum_{(i, j) \in \mathcal{S}} x^i y^j - 1/z \right],$$

$k(x, z) = K(x, 0, z)$, $\tilde{k}(y, z) = K(0, y, z)$, $k_0(z) = K(0, 0, z)$ et $\kappa(x, y, z) = -xy$. Nous supposons que $\mathcal{S} \subset \{-1, 0, 1\}^2 \setminus \{0, 0\}$, voir la Figure 1, ce qui en particulier entraînera que K sera un polynôme du second degré au plus en chacune des variables x, y .

Dans la Section 3, notant (i_0, j_0) la position initiale du processus $(X(k), Y(k))_{k \in \mathbb{Z}_+}$,

$$Q(x, y, z) = \sum_{i, j \geq 1, k \geq 0} \mathbb{P}_{(i_0, j_0)}[(X(k), Y(k)) = (i, j)] x^{i-1} y^{j-1} z^k$$

sera la série génératrice des fonctions de Green à l'intérieur du quadrant, tandis que q, \tilde{q}, q_0 seront celles des probabilités d'absorption, et plus précisément, posant, pour i ou/et j nul,

$$h_{i, j, k}^{i_0, j_0} = \mathbb{P}_{(i_0, j_0)}[(X, Y) \text{ est tué au point } (i, j) \text{ au temps } k \text{ exactement}],$$

les séries q, \tilde{q}, q_0 vaudront

$$q(x, z) = \sum_{i \geq 1, k \geq 0} h_{i, 0, k}^{i_0, j_0} x^{i-1} z^k, \quad \tilde{q}(y, z) = \sum_{j \geq 1, k \geq 0} h_{0, j, k}^{i_0, j_0} y^{j-1} z^k, \quad q_0(z) = \sum_{k \geq 0} h_{0, 0, k}^{i_0, j_0} z^k.$$

Quant aux fonctions connues, elles seront égales à

$$K(x, y, z) = xyz \left[\sum_{i, j} p_{i, j} x^i y^j - 1/z \right], \quad k(x, z) = \tilde{k}(y, z) = k_0(z) = 1, \quad \kappa(x, y, z) = -x^{i_0} y^{j_0},$$

les $p_{i,j}$ ci-dessus désignant les probabilités de transition à l'intérieur du quadrant. Elles seront supposées nulles si $|i| > 1$ ou $|j| > 1$, voir la Figure 2; le noyau K sera donc, ici aussi, un polynôme du second degré au plus en chacune des deux variables x, y .

Nous allons maintenant, dans la Sous-section 1.2, montrer que les fonctions inconnues q, \tilde{q} satisfaisant à l'équation fonctionnelle (4) vérifient des problèmes frontière, nous en déduirons alors leurs expressions explicites. Nous nous pencherons ensuite, dans la Sous-section 1.3, sur différentes méthodes pour calculer l'asymptotique des coefficients de ces séries génératrices désormais explicites.

1.2 Problèmes de Riemann-Carleman et collage conforme

Tout au long de la Sous-section 1.2 et des suivantes, nous supposons que K est un polynôme du second degré exactement en chacune des variables x, y – cette hypothèse sera naturellement vérifiée dans les Parties II et III.

Réduction de l'analyse à un problème frontière Si $X_0(y, z)$ et $X_1(y, z)$ désignent les deux solutions en x de $K(x, y, z) = 0$, alors pour $i \in \{0, 1\}$ et sous réserve que l'identité (4) soit vérifiée en $(X_i(y, z), y)$, l'égalité

$$0 = k(X_i(y, z), z)q(X_i(y, z), z) + \tilde{k}(y, z)\tilde{q}(y, z) + k_0(z)q_0(z) + \kappa(X_i(y, z), y, z) \quad (5)$$

a lieu. Faire ensuite la différence des deux équations (5) correspondant à $i \in \{0, 1\}$ conduit formellement à

$$k(X_0(y, z), z)q(X_0(y, z), z) - k(X_1(y, z), z)q(X_1(y, z), z) = \kappa(X_0(y, z), y, z) - \kappa(X_1(y, z), y, z). \quad (6)$$

Avant de poursuivre, il convient de se pencher plus en détail sur les fonctions algébriques X_0, X_1 . Un calcul simple nous fait remarquer que leur expression analytique comporte la racine carrée d'un polynôme de degré trois ou quatre, à racines réelles et distinctes; pour cette raison, X_0, X_1 sont méromorphes sur un plan complexe coupé du type $\mathbb{C} \setminus ([y_1(z), y_2(z)] \cup [y_3(z), y_4(z)])$, les $y_i(z)$ étant les racines du polynôme susmentionné. X_0, X_1 ne sont bien sûr pas définies sur les segments $[y_1(z), y_2(z)]$ et $[y_3(z), y_4(z)]$ mais admettent, pour y tendant vers l'un d'eux en restant dans un des demi-plans inférieur ou supérieur, des limites complexes conjuguées l'une de l'autre.

Faisant tendre ainsi y vers $[y_1(z), y_2(z)]$ ou $[y_3(z), y_4(z)]$ et posant $t = X_0(y, z)$, nous trouvons que la fonction q vérifie formellement la condition

$$k(t, z)q(t, z) - k(\bar{t}, z)q(\bar{t}, z) = \kappa(t, X_0^{-1}(t, z), z) - \kappa(\bar{t}, X_0^{-1}(t, z), z) \quad (7)$$

pour $t \in X([y_1(z), y_2(z)], z)$ ou $t \in X([y_3(z), y_4(z)], z)$, courbes manifestement symétriques par rapport à l'axe réel. (7) est appelée une condition au bord de type Riemann-Carleman.

Pour résumer, sous réserve que l'équation (4) soit vérifiée en $(X_i(y, z), y)$ pour $i \in \{0, 1\}$ et $y \in [y_1(z), y_2(z)]$ ou/et $y \in [y_3(z), y_4(z)]$, nous obtenons une ou deux conditions au bord (7).

Il sera montré dans les Sections 2-3 qu'un des segments ci-dessus, disons $[y_1(z), y_2(z)]$, appartient au disque unité \mathcal{D} , tandis que l'autre, $[y_3(z), y_4(z)]$, y est extérieur.

Avec cette notation, le prolongement holomorphe des fonctions q, \tilde{q} que nous construirons sera tel que l'identité (4) pourra être étendue à un domaine contenant $\{(X_i(y, z), y), i \in \{0, 1\}\}$ pour $y \in [y_1(z), y_2(z)]$, mais pas pour $y \in [y_3(z), y_4(z)]$.

Ainsi nous obtiendrons le problème frontière de Riemann-Carleman suivant : *trouver une fonction q holomorphe à l'intérieur du domaine borné par la courbe $X([y_1(z), y_2(z)], z)$ et vérifiant sur cette dernière la condition au bord (7).*

Par symétrie, il existe bien sûr un analogue de ce problème pour la fonction \tilde{q} .

Réussir le prolongement des fonctions q, \tilde{q} est donc doublement crucial : il permet d'une part d'étendre leur domaine de définition jusqu'aux courbes sur lesquelles elles vérifient la condition au bord (7), et d'autre part également de déterminer la classe de fonctions dans laquelle il convient de les chercher.

L'extension de cette étape de l'approche analytique à toutes les valeurs de z n'est pas une conséquence directe du livre [FIM99], et cette généralisation à laquelle nous parviendrons dans les Sections 2-3 sera, à cet égard, une des contributions de cette thèse.

Résolution du problème frontière Nous nous concentrons maintenant sur la façon d'obtenir des expressions explicites de q, \tilde{q} à partir des problèmes frontière de Riemann-Carleman décrits et obtenus ci-dessus.

Le raisonnement usuel, voir [Gak66], consiste à ramener ces problèmes frontière à d'autres, pour lesquels la résolution explicite est particulièrement agréable, à savoir les problèmes de type Riemann-Hilbert, *i.e.* avec une condition au bord sur un segment.

Pour réaliser la transformation de l'un en l'autre, il s'agit donc de trouver une fonction qui "colle" la partie supérieure de $X([y_1(z), y_2(z)], z)$ à sa partie inférieure en un segment, et plus précisément une "conformal gluing function" (CGF) pour l'ensemble délimité par $X([y_1(z), y_2(z)], z)$, au sens suivant, voir [Gak66] ou [Lit00].

Définition 1. Soit $\mathcal{C} \subset \mathbb{C} \cup \{\infty\}$ un ensemble ouvert, simplement connexe, symétrique par rapport à l'axe réel et différent de \emptyset, \mathbb{C} et $\mathbb{C} \cup \{\infty\}$. w est dite une CGF pour l'ensemble \mathcal{C} si w est une application méromorphe dans \mathcal{C} , par ailleurs conforme de \mathcal{C} vers le plan complexe privé d'un segment, et si en outre pour tout t sur le bord de \mathcal{C} , $w(t) = w(\bar{t})$.

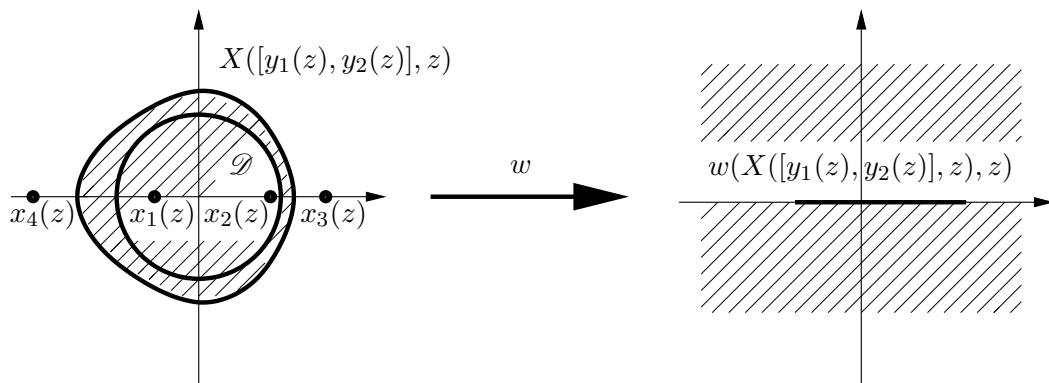

FIGURE 4 – Collage conforme de l'ensemble $X([y_1(z), y_2(z)], z)$

La théorie générale de ces fonctions prédit leur existence – mais en revanche aucune expression explicite – pour tout ensemble ayant un bord suffisamment régulier, voir par exemple [Gak66].

Cela étant, grâce à l'utilisation d'une CGF, le problème frontière avec condition au bord (7) devient de type Riemann-Hilbert, et, par la même, immédiatement résoluble en termes d'intégrales de Cauchy, voir [Gak66].

Pour rendre l'expression de q, \tilde{q} ainsi déterminée complètement explicite, il reste donc à trouver explicitement une CGF.

C'est un résultat auquel parviennent les auteurs de [FIM99] dans le cadre de l'équation fonctionnelle (2), grâce au raisonnement suivant : ils commencent par plonger la courbe dont ils cherchent une CGF dans l'ensemble $\mathcal{K}_1 = \{(x, y) \in \mathbb{C}^2 : \sum_{i,j} p_{i,j} x^i y^j - 1 = 0\}$; ils uniformisent ensuite la surface \mathcal{K}_1 , avec des fonctions rationnelles si son genre est 0 ou elliptiques de Weierstrass si le genre est 1 ; ils montrent alors que sur cette nouvelle surface, la courbe est transformée en un ensemble particulièrement simple (typiquement un segment), pour lequel il est facile de trouver explicitement une CGF ; ils projettent enfin la CGF ainsi trouvée pour revenir au plan complexe et en obtiennent finalement une pour la courbe initiale.

Le collage conforme est un aspect de l'approche analytique que nous développerons tout particulièrement dans cette thèse, et ce pour les deux raisons ci-après.

Premièrement, parce que trouver des CGF pour les courbes rencontrées dans les problèmes des Sections 2-3 permet, concrètement, de compléter l'explicitation des expressions de q, \tilde{q} obtenues grâce aux problèmes frontière.

Deuxièmement, parce que le collage conforme est une notion intrinsèque : les CGF ne dépendent en effet que du noyau K et sont donc les mêmes pour une classe d'équations fonctionnelles (et donc de processus) bien plus large que (4) – par exemple, celle obtenue de (4) en conservant le même noyau K mais en autorisant les fonctions k, \tilde{k}, k_0 à dépendre des trois variables x, y, z (ce qui, du point de vue des processus, correspond à permettre des comportements beaucoup plus généraux sur les frontières).

Concernant les résultats existants, nous avons déjà noté, plus haut, qu'un procédé pour construire une CGF est présenté dans [FIM99] ; en revanche, aucune propriété de cette fonction – le fait qu'elle soit effectivement une CGF mis à part – n'y est démontrée. C'est pourquoi nous prouverons ici les faits suivants.

Tout d'abord, nous étendrons la méthode de [FIM99] consistant à trouver explicitement une CGF pour $z = 1$ à des valeurs de z générales, ce qui nécessitera de construire une uniformisation de $\mathcal{K}_z = \{(x, y) \in \mathbb{C}^2 : K(x, y, z) = 0\}$, et non pas seulement de \mathcal{K}_1 .

Ensuite, nous montrerons que la construction de [FIM99] est potentiellement complète, au sens suivant : leur méthode conduit à disposer d'une CGF arbitraire ; pour les obtenir *toutes*, il convient alors d'utiliser des résultats généraux sur le collage conforme ou sur les opérateurs de Fredholm. Ici, nous prouverons que leur construction d'une CGF peut en fait se généraliser, et nous trouverons ainsi, de manière élémentaire et directement, *toutes* les CGF.

Enfin, nous étudierons et caractériserons les propriétés globales de ces CGF. En fait, la forme explicite des CGF obtenue abruptement après l'analyse met en jeu plusieurs fonctions elliptiques de Weierstrass, associées à des périodes différentes, et ne fait en particulier pas clairement apparaître la dépendance aux paramètres (c'est-à-dire à \mathcal{S} dans la Section 2 et aux $p_{i,j}$ dans la Section 3), question pourtant tout à fait naturelle. En utilisant la théorie des transformations des fonctions elliptiques, voir par exemple [HC44], nous montrerons que les propriétés globales des CGF sont considérablement liées à la finitude du groupe engendré par les automorphismes de Galois (3), et plus précisément, nous démontrerons le résultat suivant : pour z fixé, si le groupe d'automorphismes est fini (resp. infini) alors toute

CGF est algébrique (resp. non holonome) – rappelons qu’une fonction est dite holonome si elle est solution d’une équation linéaire à coefficients polynomiaux, ce qui est le cas, par exemple, des fonctions algébriques, voir [FS09]. Nous prouverons aussi que le signe de la covariance peut s’avérer déterminant quant à la nature de ces fonctions.

Ces résultats seront précisés dans les Sections 2-3 : nous expliciterons, le cas échéant, le degré d’algébricité des CGF, nous montrerons également que si le groupe engendré par (3) est fini pour tout z , alors la CGF est algébrique en tant que fonction bivariée, enfin nous donnerons de nombreux exemples explicites, ainsi que la méthode générale de simplification des expressions abruptes.

En conclusion, les Sous-sections 1.1-1.2 conduisent à disposer de représentations intégrales complètement explicites pour les fonctions q, \tilde{q} , également pour q_0 en évaluant (4) en tout point annulant le noyau et appartenant au domaine de validité de (4), et finalement aussi pour Q en utilisant de nouveau (4).

1.3 Calcul des asymptotiques

Les résultats explicites précédents, très satisfaisants par certains côtés, sont pourtant loin de conduire directement à l’asymptotique des coefficients des séries Q, q, \tilde{q}, q_0 .

Concernant la partie combinatoire de cette thèse (Partie II), nous expliquerons dans la Section 2 qu’il sera naturel de se focaliser davantage sur l’obtention d’expressions explicites plutôt que sur le calcul d’asymptotiques. En revanche, nous montrerons dans la Section 3 qu’il sera tout à fait pertinent de s’intéresser à des comportements quantitatifs dans la situation probabiliste des marches tuées (Partie III).

Nous allons donc ici présenter les méthodes asymptotiques et les développements que nous en avons fait sur les deux exemples suivants, issus de la future Section 3 : avec les notations du tout début de cette introduction, nous considérerons d’abord les fonctions de Green $G_{i,j}^{i_0,j_0} = \sum_{k \geq 0} \mathbb{P}_{(i_0,j_0)}[(X(k), Y(k)) = (i, j)]$, dont la série génératrice est égale à $Q(x, y, 1)$, puis les probabilités d’atteinte des bords $\mathbb{P}_{(i_0,j_0)}[(X, Y) \text{ atteint l'axe horizontal (resp. vertical) au temps } k \text{ exactement}]$, dont la série génératrice vaut $q(1, z)$ (resp. $\tilde{q}(1, z)$).

Asymptotique des fonctions de Green Dans ce paragraphe, la variable z sera égale constamment à 1, et pour cette raison, nous l’omettrons dans les notations – par exemple, nous écrirons $\kappa(x, y)$ à la place de $\kappa(x, y, 1)$.

Il s’agit donc ici d’obtenir l’asymptotique, lorsque $i + j \rightarrow \infty$ selon $j/i \rightarrow \tan(\gamma)$, $\gamma \in [0, \pi/2]$, des coefficients $G_{i,j}^{i_0,j_0}$ de Q vérifiant (4). Pour cela, suivant [Mal73] et [KM98], nous utilisons d’abord les formules de Cauchy dans (4), ce qui nous permet d’écrire ces coefficients comme des intégrales doubles, puis nous appliquons le théorème des résidus à l’infini : nous obtenons alors que $-2\pi i G_{i,j}^{i_0,j_0}$ est égal à

$$\int_{\{|x|=1-\epsilon\}} \frac{k(x)q(x)}{[\partial_y K(x, Y_1(x))]x^i Y_1(x)^j} dx + \int_{\{|y|=1-\epsilon\}} \frac{\tilde{k}(y)\tilde{q}(y) + k_0 q_0 + \kappa(X_1(y), y)}{[\partial_x K(X_1(y), y)]X_1(y)^i y^j} dy, \quad (8)$$

où $\epsilon > 0$ est petit. Rappelons (voir la Sous-section 1.2) que X_0, X_1 sont les racines en x de $K(x, y)$; de même, Y_0, Y_1 ci-dessus désignent les racines en y du noyau. Elles sont définies de manière non ambiguë grâce à la remarque suivante : une application du principe du maximum conduit à noter que nécessairement $|X_0| \leq |X_1|$ ou $|X_1| \leq |X_0|$, et que de même $|Y_0| \leq |Y_1|$ ou $|Y_1| \leq |Y_0|$, nous les fixons donc en choisissant $|X_0| \leq |X_1|$ et $|Y_0| \leq |Y_1|$.

Les exposants i, j étant destinés à tendre vers l'infini, il est par conséquent naturel, afin d'obtenir l'asymptotique de (8), de souhaiter adapter la méthode du col – initialement prévue pour un seul paramètre. Cette idée s'avèrera être fructueuse, mais sa réalisation tout à fait différente selon que le drift est nul, ou non.

Supposons donc d'abord que le drift est non nul. Dans ce cas, le point du col s'avèrera dépendre de γ .

Pour $\gamma \in]0, \pi/2[$, nous généraliserons directement au cas des marches aux huit plus proches voisins les travaux [Mal73] et [KM98] réalisés dans le cadre des marches simples – c'est-à-dire ayant des sauts aux quatre plus proches voisins seulement.

Lorsque $\gamma = 0$ et $\gamma = \pi/2$, le point du col coïncidera avec une singularité algébrique de X ou Y et l'analyse, nettement plus délicate, n'a pas été faite dans les travaux antérieurs ; pour la mener à bien, nous aurons recours à une méthode plus sophistiquée, utilisant notamment les chemins de plus grande descente.

Faisons maintenant l'hypothèse que le drift est nul. Dans ce cas, le point du col sera égal à 1 pour tout γ , et la situation paraît *a priori* favorable. En réalité, ce point 1 sera très problématique : d'un côté, parce que le dénominateur de chacun des intégrands de (8) aura un pôle en 1 (ce sera, en fait, une conséquence de la nullité du drift), d'un autre côté, car les deux numérateurs auront également une singularité en 1, de type logarithmique (cela nous sera révélé par les expressions explicites de q, \tilde{q} que nous obtiendrons des Sous-sections 1.1-1.2). Pour avoir l'espoir de conclure, il conviendra donc de chercher à considérer ensemble les deux membres de (8) et d'étudier alors l'asymptotique.

Pour réaliser cette idée, nous utiliserons une uniformisation de la surface \mathcal{K}_1 , c'est-à-dire que nous trouverons deux fonctions $x(s)$ et $y(s)$ – en l'occurrence des fractions rationnelles – telles que $\mathcal{K}_1 = \{(x(s), y(s)) : s \in \mathbb{C} \cup \{\infty\}\}$. Partant de (8), nous obtiendrons alors que

$$G_{i,j}^{i_0,j_0} = \frac{1}{2\pi i} \int_{\Gamma} \frac{k(x(s))q(x(s)) + \tilde{k}(y(s))\tilde{q}(y(s)) + k_0q_0 + \kappa(x(s), y(s))}{[\partial_y K(x(s), y(s))]x(s)^i y(s)^j} \partial_s x(s) ds, \quad (9)$$

où Γ est un certain contour – le fait d'avoir ce même contour Γ pour les deux termes de (8) sera hautement non trivial et requerra, en plus de l'utilisation du théorème de Cauchy, une connaissance fine des propriétés analytiques des intégrands de (8).

Il s'agira alors d'étudier précisément le comportement de l'intégrand de (9) au voisinage du contour Γ et tout particulièrement près du point du col, *i.e.* près du point correspondant à $(x, y) = (1, 1)$. Ce travail se révélera de nature très technique, et nous apparaîtra hors de portée dans le cas général. Il y aura cependant une classe de processus pour laquelle nous pourrions analyser cette quantité, à savoir les marches telles que le prolongement conduira à une forme fermée et explicite de $k(x)q(x) + \tilde{k}(y)\tilde{q}(y) + k_0q_0 + \kappa(x, y)$ pour $(x, y) \in \mathcal{K}_1$, ou de manière équivalente du numérateur de (9). Dans la Section 3, nous décrirons en détail la classe de marches couverte par l'hypothèse ci-dessus et nous montrerons qu'elle est agréablement importante, à la fois par le nombre et par le caractère des processus qu'elle renferme (nous prouverons notamment que pour tout entier $p \geq 2$, elle contient au moins un processus admettant un groupe engendré par (3) d'ordre exactement $2p$).

Étendre l'analyse asymptotique de (9) à toutes les marches aléatoires aux huit plus proches voisins à drift nul est un enjeu très stimulant (qui conduirait par exemple à répondre au problème ouvert qu'est la description de la compactification de Martin de ces processus) et est un point que nous souhaitons vivement développer dans les années futures.

Asymptotique de la queue de distribution du temps d'atteinte d'un des axes
 Nous nous tournons maintenant vers la dépendance des séries Q, q, \tilde{q}, q_0 en la variable z , que nous réintroduisons donc ici. Nous allons nous concentrer sur l'exemple de $q(1, z)$, qui sera, dans la Partie III, la série génératrice des probabilités d'atteindre le bord horizontal en un certain temps pour les marches tuées, voir le tout début de la Sous-section 1.3.

En premier lieu, rappelons que les Sous-sections 1.1-1.2 conduisent à disposer d'une expression explicite de $q(1, z)$. Une façon naturelle et usuelle d'aborder alors le calcul de l'asymptotique des coefficients de cette fonction d'une variable est la recherche et l'étude de ses singularités, dans l'esprit de [Jun31], [Pól74] ou [FO90] – et ici il suffira en fait de se focaliser sur le point 1.

Le comportement de $q(1, z)$ au voisinage du point 1 nous apparaîtra d'une profonde complexité, la variable z apparaissant en effet dans la courbe d'intégration ou encore dans les périodes des différentes fonctions elliptiques de Weierstrass qui composent les CGF – à titre de comparaison, la dépendance de $q(x, z)$ en x est nettement plus simple : c'est celle d'une intégrale de Cauchy évaluée, certes, en une CGF.

Dans cette thèse, nous nous focaliserons donc sur l'analyse de $q(1, z)$ dans les quelques cas particuliers pour lesquels il nous sera possible de surmonter ces difficultés, à savoir certaines marches disposant d'un groupe engendré par (3) fini pour tout z .

Cette notion de groupe ne dépendant pas de z , qui peut à première vue paraître une nécessité calculatoire, s'avère en réalité être tout à fait pertinente ; elle a notamment été considérée (en substance, voir Proposition 13 page 36) dans les travaux de combinatoire [BMM09].

À titre d'exemple, l'hypothèse ci-dessus sera vérifiée par les 19 marches qui, dans la classification de [BMM09], disposent d'un groupe fini et d'une covariance négative ou nulle ; comme cas particuliers, nous pouvons citer les marches aléatoires dans les chambres de Weyl des duaux de $SU(2) \times SU(2)$, $SU(3)$ et $Sp(4)$, voir la Figure 12 page 39, ainsi que le processus pouvant s'interpréter comme le passage de quatre à deux blocs dans le célèbre modèle du votant, voir la Figure 14 page 45.

Nous avons à présent terminé la description des différentes facettes de l'approche analytique utilisée et développée dans cette thèse, et nous souhaitons maintenant, dans les Sections 2 et 3, présenter nos résultats combinatoires et probabilistes.

2 Énumération des chemins

Le premier thème abordé dans le cadre de cette thèse sera l'énumération des marches se déplaçant sur un réseau plan, qui est un sujet à la fois classique et célèbre en combinatoire.

Pour un ensemble borné de sauts $\mathcal{S} \subset \mathbb{Z}^2$ donné, il est question de compter le nombre de chemins $q_{\mathcal{U}}(i, j, k)$ se mouvant selon \mathcal{S} , partant d'un point fixé et arrivant en un certain point (i, j) en un temps donné $k \geq 0$, tout en étant éventuellement confinés dans une région $\mathcal{U} \subset \mathbb{Z}^2$. Il s'agit alors, d'une part, de résoudre ce modèle, c'est-à-dire d'explicitier la série génératrice $\sum_{(i,j) \in \mathcal{U}, k \geq 0} q_{\mathcal{U}}(i, j, k) x^i y^j z^k$ qui lui est associée, et d'autre part, de décrire la nature (rationnelle, algébrique, holonome, non holonome) de cette fonction.

Ainsi, si aucune restriction sur les chemins n'est imposée (*i.e.* $\mathcal{U} = \mathbb{Z}^2$), il est facile d'explicitier la série génératrice ci-dessus qui s'avère être une fraction rationnelle.

Autre exemple, si les trajectoires sont supposées rester dans un demi-plan \mathcal{U} , alors la série peut également être explicitée et se révèle algébrique, voir par exemple [BMP03].

Il est ensuite naturel de considérer les marches confinées dans une intersection de deux demi-plans, comme le quart de plan $\mathcal{U} = \mathbb{Z}_+^2$. La situation semble d'emblée plus riche et plus diverse : certaines marches sont telles que leur série génératrice est algébrique, c'est le cas de la marche associée à $\mathcal{S} = \{(-1, 0), (1, 1), (0, -1)\}$ et partant de $(0, 0)$, voir [FH84] et [Ges86], d'autres admettent une série génératrice qui n'est pas même holonome, comme le montre l'exemple de la marche attachée à $\mathcal{S} = \{(-1, 2), (2, -1)\}$ et partant de $(1, 1)$, voir [BMP03]. Cette pluralité fait qu'il paraît très intéressant de se concentrer sur ces marches restant dans un quart de plan.

C'est ainsi que M. Bousquet-Mélou et M. Mishna ont récemment entrepris, dans [BMM09], l'étude systématique des marches confinées dans \mathbb{Z}_+^2 , partant de l'origine et ayant des petits sauts. Rappelons-nous (voir le tout début de l'introduction) que cela signifie que \mathcal{S} est inclus dans l'ensemble à huit éléments $\{-1, 0, 1\}^2 \setminus \{(0, 0)\}$, et souvenons-nous aussi que sur le bord horizontal $\mathbb{Z}_+^* \times \{0\}$ (resp. sur le bord vertical $\{0\} \times \mathbb{Z}_+^*$, en l'origine $(0, 0)$), les pas de la marche ont alors lieu selon $\mathcal{S} \cap (\mathbb{Z} \times \mathbb{Z}_+)$ (resp. $\mathcal{S} \cap (\mathbb{Z}_+ \times \mathbb{Z})$, $\mathcal{S} \cap (\mathbb{Z}_+ \times \mathbb{Z}_+)$).

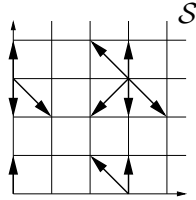

FIGURE 5 – Exemple de marche à petits sauts confinée dans \mathbb{Z}_+^2

Il y a au total 2^8 tels modèles, mais, comme déjà relevé, quelques-uns sont triviaux et certains s'obtiennent par symétrie à partir d'autres : il existe en fait 79 problèmes intrinsèquement différents à étudier, voir [BMM09].

Un point de départ commun pour l'analyse de ces 79 marches est le suivant : désignant, comme dans la Sous-section 1.1, le nombre de chemins confinés dans \mathbb{Z}_+^2 , partant de $(0, 0)$ et se terminant en (i, j) en temps k par $q_{\mathbb{Z}_+^2}(i, j, k)$, leur série génératrice

$$Q(x, y, z) = \sum_{i, j, k \geq 0} q_{\mathbb{Z}_+^2}(i, j, k) x^i y^j z^k \quad (10)$$

vérifie l'identité

$$xyz \left[\sum_{(i, j) \in \mathcal{S}} x^i y^j - 1/z \right] Q(x, y, z) = c(x, z)Q(x, 0, z) + \tilde{c}(y, z)Q(0, y, z) - z\delta Q(0, 0, z) - xy, \quad (11)$$

où nous notons $c(x, z) = zx \sum_{(i, -1) \in \mathcal{S}} x^i$, $\tilde{c}(y, z) = zy \sum_{(-1, j) \in \mathcal{S}} y^j$ et $\delta = 1$ si $(-1, -1) \in \mathcal{S}$, $\delta = 0$ sinon. L'équation fonctionnelle (11), qui est démontrée dans [BMM09], est bien celle présentée dans la Sous-section 1.1 : effectivement, si $K(x, y, z) = xyz \left[\sum_{(i, j) \in \mathcal{S}} x^i y^j - 1/z \right]$, alors $c(x, z) = K(x, 0, z)$, $\tilde{c}(y, z) = K(0, y, z)$ et $\delta = K(0, 0, z)$. Par ailleurs, si n désigne le cardinal de \mathcal{S} , alors l'identité (11) est valide au moins sur $\{|x| \leq 1, |y| \leq 1, |z| < 1/n\}$, puisque, bien sûr, $q_{\mathbb{Z}_+^2}(i, j, k) \leq n^k$.

Pour résoudre tous les modèles, c'est-à-dire dans le but d'expliciter $Q(x, y, z)$ pour chacun des 79 problèmes, il suffit donc de résoudre l'équation fonctionnelle (11).

M. Bousquet-Mélou et M. Mishna ont alors remarqué qu’une idée-clé pour l’analyse de (11) est l’utilisation du groupe engendré par (3). Il convient tout de suite de noter que le sens donné à ce groupe sera ici légèrement différent que celui utilisé précédemment : en effet, dans les Sections 1 et 3, de même que dans [Mal71] et [FIM99], il est considéré comme un groupe d’automorphismes de l’ensemble \mathcal{X}_1 des zéros du noyau, tandis qu’ici, il sera défini comme un groupe de transformations birationnelles de $\mathbb{C}(x, y)^2$ – en particulier, la propriété de finitude devient plus contraignante. Ces différentes appréhensions de la notion du groupe seront d’ailleurs commentées autour de la Proposition 13 page 36.

Cela étant, ce groupe (au sens des transformations birationnelles, donc) est étudié en détail dans [BMM09] pour chacune des 79 marches : il est fini dans 23 cas (et alors de cardinal 4, 6 ou 8) et est infini dans les 56 autres.

En ce qui concerne les 23 marches ayant un groupe fini, les réponses aux deux questions qui nous intéressent, à savoir l’obtention d’une expression explicite de la série génératrice (10) et la description de sa nature, ont été trouvées très récemment.

En effet, dans l’important article [BMM09], 22 de ces 23 modèles sont résolus : la série (10) est explicitée et s’avère être holonome, même algébrique dans 3 cas.

La 23ème modèle, qui correspond aux sauts $\mathcal{S} = \{(-1, -1), (-1, 0), (1, 1), (1, 0)\}$, est aujourd’hui communément appelée “marche de Gessel”, en raison de la conjecture que I. Gessel énonça en 2001, à propos de la validité supposée de la formule $q(0, 0, 2k) = 16^k [(5/6)_k (1/2)_k] / [(2)_k (5/3)_k]$, où $(a)_k = a(a+1) \cdots (a+k-1)$. La “conjecture de Gessel” demeurant sans preuve, l’intérêt manifesté par la communauté combinatoricienne à son égard – et plus globalement à l’attention de la marche de Gessel – n’a cessé de grandir depuis 2001, jusqu’à devenir particulièrement aigu tout au long des années 2008-2010.

Ainsi, en 2009, M. Kauers, C. Koutschan et D. Zeilberger offrent enfin, dans [KKZ09], une preuve (par ordinateur) de cette fameuse conjecture. Une kyriade d’autres approches de la conjecture de Gessel et plus généralement de remarques autour de la marche homonyme entoure ce résultat : voir, dans cette perspective, [PW08], [Ayy09], [Pin09]. Enfin, A. Bostan et M. Kauers donnent dans [BK09] une preuve assistée par ordinateur du fait que la série (10) associée à la marche de Gessel est algébrique. De plus, ils en explicitent des polynômes minimaux, utilisant pour cela un système de calcul formel puissant de l’INRIA (Institut National de Recherche en Informatique et Automatique).

En automne 2009, I. Kurkova et moi remarquons qu’en dépit de ce vif intérêt, ce modèle n’est toujours pas résolu, c’est-à-dire que la série (10) n’est pas encore explicitée. C’est pour cette raison que nous déposons sur arXiv, en décembre 2009, le preprint [KR09a] donnant une expression explicite de la série (10) pour la marche de Gessel, utilisant pour cela les méthodes analytiques (en particulier, sans aide d’ordinateur) décrites dans la Section 1. Peu de temps après, nous apprenons que de son côté, M. van Hoeij a également, durant l’automne 2009, cherché et obtenu une expression par radicaux de la série (10) (utilisant à cette fin les polynômes minimaux donnés dans [BK09] avec aide d’ordinateur, voir l’appendice de [BK09]), mais, à cette époque, il n’a pas encore rendu public ce résultat.

Ainsi, avec [BMM09] et [KR09a], les 23 modèles associés à un groupe fini deviennent résolus sans aide informatique. Par ailleurs, dans le travail en préparation [BCK⁺10], A. Bostan *et al.* obtiennent des représentations intégrales de (10) pour ces mêmes 23 marches, par une méthode partiellement algorithmique, basée sur le télescopage créatif et sur la résolution des équations différentielles du second ordre en termes de fonctions hypergéométriques.

D'un autre côté, seulement 2 des 56 modèles ayant un groupe infini ont été résolus : pour les marches associées à $\mathcal{S} = \{(-1, 1), (1, 1), (1, -1)\}$ et $\mathcal{S} = \{(-1, 1), (0, 1), (1, -1)\}$ dessinées à gauche sur la Figure 6 ci-dessous, M. Mishna a, dans [MR09], explicité la série (10) et a montré qu'elle était, dans les deux cas, non holonome.

C'est dans ce contexte très stimulant que s'inscrivent les contributions de cette thèse à l'énumération des chemins.

Notre premier article, résolvant la marche de Gessel [KR09a] et cité plus haut, est à notre connaissance une des premières exportations à un autre domaine que les probabilités de l'approche analytique de [FIM99]. Il pose ainsi les bases de l'utilisation de ces méthodes dans le contexte d'énumération des marches à petits sauts confinées dans un quart de plan.

La difficulté des détails techniques s'est, quant à elle, essentiellement focalisée sur le calcul de la CGF, que nous avons explicitée et dont nous avons montré qu'elle était algébrique en tant que fonction bivariable.

À la fois pour contextualiser et pour élargir ce résultat, il était alors naturel de souhaiter généraliser cette analyse à toutes les 79 marches. C'est ce que nous avons fait dans [Ras10a], en introduisant une approche unifiée pour la résolution explicite de tous les 79 problèmes.

La portée de ce dernier travail [Ras10a] est double : d'une part, il conduit à disposer, pour la première fois, d'une expression explicite de la série (10) pour 54 des 56 marches associées à un groupe infini, et d'autre part, en fournissant une expression explicite du même type pour les 79 marches, il permet de faire ressortir clairement la façon dont la série (10) dépend des paramètres – nous serons davantage précis à ce propos dans le Théorème 5.

Nous allons maintenant décrire précisément nos contributions. Dans ce qui suit, nous adoptons les notations suivantes : $xyz \left[\sum_{(i,j) \in \mathcal{S}} x^i y^j - 1/z \right] = \tilde{a}(y, z)x^2 + \tilde{b}(y, z)x + \tilde{c}(y, z) = a(x, z)y^2 + b(x, z)y + c(x, z)$, où $\tilde{c}(y, z), c(x, z)$ sont les polynômes définis au-dessous de (11), $\tilde{a}(y, z) = zy \sum_{(+1,j) \in \mathcal{S}} y^j$, $\tilde{b}(y, z) = -1 + zy \sum_{(0,j) \in \mathcal{S}} y^j$, $a(x, z) = zx \sum_{(i,+1) \in \mathcal{S}} x^i$ et $b(x, z) = -1 + zx \sum_{(i,0) \in \mathcal{S}} x^i$. Posons également $\tilde{d}(y, z) = \tilde{b}(y, z)^2 - 4\tilde{a}(y, z)\tilde{c}(y, z)$ ainsi que $d(x, z) = b(x, z)^2 - 4a(x, z)c(x, z)$. En particulier, les racines du noyau considérées dans la Section 1 prennent les expressions $X_0(y, z) = [-\tilde{b}(y, z) + \tilde{d}(y, z)^{1/2}]/[2\tilde{a}(y, z)]$, $X_1(y, z) = [-\tilde{b}(y, z) - \tilde{d}(y, z)^{1/2}]/[2\tilde{a}(y, z)]$, $Y_0(x, z) = [-b(x, z) + d(x, z)^{1/2}]/[2a(x, z)]$ et $Y_1(x, z) = [-b(x, z) - d(x, z)^{1/2}]/[2a(x, z)]$.

Pour les 5 processus de la Figure 6 ci-dessous, il s'avère que l'approche de la Section 1 ne fonctionne pas, car les courbes associées aux problèmes frontière (7) deviennent dégénérées en des points. Ces 5 marches disposent de la propriété commune qu'aucune des transitions $(0, -1), (-1, -1), (-1, 0)$ n'appartient à \mathcal{S} , elles sont dites "singulières".

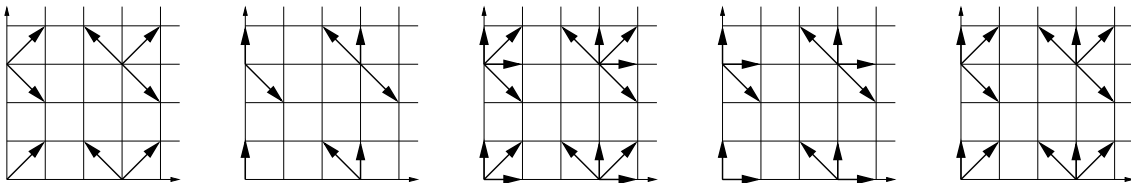

FIGURE 6 – Les 5 marches singulières dans la classification de [BMM09]

Deux de ces processus sont ceux qu'a étudiés M. Mishna dans [MR09] ; nous généraliserons son approche aux 5 marches singulières et nous obtiendrons le résultat ci-après – où $f^{\circ k}$ désigne $f \circ \dots \circ f$ avec k occurrences de f .

Théorème 2. *Pour les 5 marches singulières de la Figure 6,*

$$Q(x, 0, z) = \frac{1}{zx^2} \sum_{k \geq 0} Y_0 \circ (X_0 \circ Y_0)^{\circ k}(x, z) [(X_0 \circ Y_0)^{\circ k}(x, z) - (X_0 \circ Y_0)^{\circ(k+1)}(x, z)].$$

$Q(0, y, z)$ est obtenu de l'égalité ci-dessus en remplaçant X_0 (resp. Y_0) par Y_0 (resp. X_0). De plus, $Q(0, 0, z) = 0$ et $Q(x, y, z)$ est alors explicitée grâce à (11).

Ces résultats étant donnés, nous souhaitons maintenant nous intéresser à la situation plus riche des marches non singulières. Elles sont telles que pour tout $z \in]0, 1/n[$, \tilde{d} (resp. d) a trois ou quatre racines, que nous appelons $y_k(z)$ (resp. $x_k(z)$). Fixons-les en notant que $|y_1(z)| < y_2(z) < 1 < y_3(z) < |y_4(z)|$ (resp. $|x_1(z)| < x_2(z) < 1 < x_3(z) < |x_4(z)|$). Aussi, posons $\mathcal{G}Y([x_1(z), x_2(z)], z)$ (resp. $\mathcal{G}X([y_1(z), y_2(z)], z)$) pour la composante connexe de $\mathbb{C} \setminus Y([x_1(z), x_2(z)], z)$ (resp. $\mathbb{C} \setminus X([y_1(z), y_2(z)], z)$) contenant $y_1(z)$ (resp. $x_1(z)$).

Théorème 3. *Supposons que la marche soit non singulière.*

La fonction $c(x, z)Q(x, 0, z) - c(0, z)Q(0, 0, z)$ admet, pour $x \in \mathcal{G}X([y_1(z), y_2(z)], z)$ et $z \in]0, 1/n[$, l'expression suivante :

$$c(x, z)Q(x, 0, z) - c(0, z)Q(0, 0, z) = xY_0(x, z) + \frac{1}{\pi} \int_{x_1(z)}^{x_2(z)} \frac{t[-d(t, z)]^{1/2}}{2a(t, z)} \left[\frac{\partial_t w(t, z)}{w(t, z) - w(x, z)} - \frac{\partial_t w(t, z)}{w(t, z) - w(0, z)} \right] dt,$$

w étant une CGF (voir la Définition 1) pour l'ensemble $\mathcal{G}X([y_1(z), y_2(z)], z)$.

La fonction $\tilde{c}(y, z)Q(0, y, z) - \tilde{c}(0, z)Q(0, 0, z)$ admet, pour $y \in \mathcal{G}Y([x_1(z), x_2(z)], z)$ et $z \in]0, 1/n[$, l'expression suivante :

$$\tilde{c}(y, z)Q(0, y, z) - \tilde{c}(0, z)Q(0, 0, z) = X_0(y, z)y + \frac{1}{\pi} \int_{y_1(z)}^{y_2(z)} \frac{t[-\tilde{d}(t, z)]^{1/2}}{2\tilde{a}(t, z)} \left[\frac{\partial_t \tilde{w}(t, z)}{\tilde{w}(t, z) - \tilde{w}(y, z)} - \frac{\partial_t \tilde{w}(t, z)}{\tilde{w}(t, z) - \tilde{w}(0, z)} \right] dt,$$

\tilde{w} étant une CGF pour $\mathcal{G}Y([x_1(z), x_2(z)], z)$.

La formulation de $Q(0, 0, z)$ dépend de la valeur de $c(0, z) = \tilde{c}(0, z) \in \{0, z\}$ comme suit.

Supposons tout d'abord que $c(0, z) = \tilde{c}(0, z) = z$, ou de manière équivalente que $\delta = 1$ dans (11). Grâce à (11), nous obtenons que pour tout x, y, z vérifiant $\sum_{(i,j) \in \mathcal{S}} x^i y^j - 1/z = 0$, $|x| \leq 1$, $|y| \leq 1$ et $z \in]0, 1/n[$:

$$zQ(0, 0, z) = xy - [c(x, z)Q(x, 0, z) - c(0, z)Q(0, 0, z)] - [\tilde{c}(y, z)Q(0, y, z) - \tilde{c}(0, z)Q(0, 0, z)].$$

Supposons maintenant que $c(0, z) = \tilde{c}(0, z) = 0$, ou de manière équivalente que $\delta = 0$ dans (11). Alors la fonction $Q(0, 0, z)$ est égale à la limite, lorsque x tend vers 0, de

$$\frac{1}{c(x, z)} \left(xY_0(x, z) + \frac{1}{\pi} \int_{x_1(z)}^{x_2(z)} \frac{t[-d(t, z)]^{1/2}}{2a(t, z)} \left[\frac{\partial_t w(t, z)}{w(t, z) - w(x, z)} - \frac{\partial_t w(t, z)}{w(t, z) - w(0, z)} \right] dt \right).$$

La fonction $Q(x, y, z)$ a alors l'expression explicite obtenue en injectant dans (11) les représentations intégrales de $Q(x, 0, z)$, $Q(0, y, z)$ et $Q(0, 0, z)$ trouvées juste ci-dessus.

Ainsi, pour que les fonctions $Q(x, 0, z)$, $Q(0, y, z)$, $Q(0, 0, z)$ et $Q(x, y, z)$ soient complètement connues, il reste à expliciter des CGF pour les ensembles $\mathcal{G}X([y_1(z), y_2(z)], z)$ et $\mathcal{G}Y([x_1(z), x_2(z)], z)$.

Le résultat suivant répond précisément à cet objectif, en donnant, pour toutes les 74 marches non singulières, l'expression explicite d'une CGF pour chacun des ensembles $\mathcal{G}X([y_1(z), y_2(z)], z)$ et $\mathcal{G}Y([x_1(z), x_2(z)], z)$; malheureusement, nous ne pourrions l'énoncer dans son intégralité que dans la Partie II.

Théorème 4. *Les fonctions w et \tilde{w} explicitement définies en (B.11) de la Partie II sont des CGF pour les ensembles $\mathcal{G}X([y_1(z), y_2(z)], z)$ et $\mathcal{G}Y([x_1(z), x_2(z)], z)$ respectivement.*

Dans la Partie II, nous verrons que la forme explicite des CGF w et \tilde{w} du Théorème 4 associe plusieurs fonctions elliptiques de Weierstrass, liées à des périodes différentes, et ne fait en particulier pas clairement apparaître la dépendance à l'ensemble de sauts \mathcal{S} . C'est pourquoi nous prouverons le résultat ci-dessous.

Théorème 5. *Si le groupe de la marche engendré par (3) est fini (resp. infini) au sens des transformations birationnelles, alors toute CGF pour les ensembles $\mathcal{G}X([y_1(z), y_2(z)], z)$ et $\mathcal{G}Y([x_1(z), x_2(z)], z)$ est algébrique (resp. non holonome) en tant que fonction bivariée. De plus, dans le cas d'un groupe fini, si la covariance $\sum_{(i,j) \in \mathcal{S}} ij$ est négative ou nulle (resp. positive) alors toute CGF est rationnelle (resp. algébrique non rationnelle).*

Nous explicitons maintenant, sous forme simplifiée, une CGF pour chacune des 23 marches disposant d'un groupe fini.

Proposition 6. *Pour les 16 marches ayant un groupe d'ordre 4, les fonctions $[(t/x_4(z) - 1)(t - x_1(z))]/[(t - x_2(z))(t - x_3(z))]$ et $[(t/y_4(z) - 1)(t - y_1(z))]/[(t - y_2(z))(t - y_3(z))]$ sont des CGF pour les ensembles $\mathcal{G}X([y_1(z), y_2(z)], z)$ et $\mathcal{G}Y([x_1(z), x_2(z)], z)$ respectivement.*



FIGURE 7 – 2 exemples parmi les 16 marches ayant un groupe d'ordre 4

Proposition 7. *Pour les 2 marches de la Figure 8, les fonctions suivantes sont des CGF pour les ensembles $\mathcal{G}X([y_1(z), y_2(z)], z)$ et $\mathcal{G}Y([x_1(z), x_2(z)], z)$ respectivement :*

$$\frac{u(t)}{(t - x_2(z))(t - 1/x_2(z)^{1/2})^2}, \quad \frac{\tilde{u}(t)}{(t - y_2(z))(t - 1/y_2(z)^{1/2})^2},$$

avec $u(t) = t^2$ et $\tilde{u}(t) = t$ (resp. $u(t) = \tilde{u}(t) = t(t + 1)$) pour la marche à gauche (resp. à droite) sur la Figure 8.

Les deux marches de la Figure 8 ci-dessous, très célèbres, apparaîtront de façon naturelle dans la Partie III : celle de gauche s'interprétera, en effet, comme (la duale d') une marche dans la chambre de Weyl du dual de $SU(3)$, tandis que celle de droite interviendra dans l'étude du modèle du votant, voir les Figures 12 et 14 pages 39 et 45 respectivement.



FIGURE 8 – Les 2 marches ayant un groupe d'ordre 6 et une covariance négative

Proposition 8. *Pour les 3 marches de la Figure 9, il existe des fonctions algébriques (explicitées dans le Chapitre B) $\alpha(z), \beta(z), \delta(z), \gamma(z)$ telles qu'une CGF pour l'ensemble $\mathcal{GX}([y_1(z), y_2(z)], z) = \mathcal{GY}([x_1(z), x_2(z)], z)$ est donnée par l'unique fonction ayant un pôle en $x_2(z)$ et par ailleurs solution de*

$$w^2 + \left[\alpha(z) + \frac{\beta(z)u(t)}{(t - x_2(z))(t - 1/x_2(z))^{1/2}} \right] w + \left[\delta(z) + \frac{\gamma(z)u(t)}{(t - x_2(z))(t - 1/x_2(z))^{1/2}} \right] = 0,$$

avec $u(t) = t^2$ (resp. $u(t) = t$, $u(t) = t(t+1)$) pour la marche à gauche (resp. au milieu, à droite) sur la Figure 9.

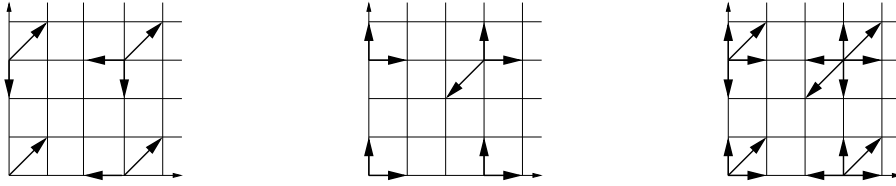

FIGURE 9 – Les 3 marches ayant un groupe d'ordre 6 et une covariance positive

Les marches de la Figure 9 revêtent une importance historique particulière : celle de gauche, souvent nommée “de Flatto” ou “de Kreweras”, voir [FH84] ou [Ges86], est en effet la première des 79 pour laquelle il fut prouvé que la série génératrice trivariée est algébrique.

Proposition 9. *Pour la marche à gauche sur la Figure 10, les fonctions suivantes sont des CGF pour les ensembles $\mathcal{GX}([y_1(z), y_2(z)], z)$ et $\mathcal{GY}([x_1(z), x_2(z)], z)$ respectivement :*

$$\frac{t^2}{(t - x_2(z))(t - 1)^2(t - x_3(z))}, \quad \frac{t(t+1)^2}{(t - x_2(z))^2(t - x_3(z))^2}.$$

Proposition 10. *Considérons la marche à droite sur la Figure 10. Posons $G_2(z) = (4/27)(1 + 224z^2 + 256z^4)$, $G_3(z) = (8/729)(1 + 16z^2)(1 - 24z + 16z^2)(1 + 24z + 16z^2)$, $K(z)$ pour l'unique solution positive de $K^4 - G_2(z)K^2/2 - G_3(z)K - G_2(z)^2/48 = 0$ - si nous définissons $r_k(z) = [G_2(z) - \exp(2ki\pi/3)(G_2(z)^3 - 27G_3(z)^2)^{1/3}]/3$, nous avons $K(z) = [-r_0(z)^{1/2} + r_1(z)^{1/2} + r_2(z)^{1/2}]/2$ - et*

$$F(t, z) = \frac{1 - 24z + 16z^2}{3} - \frac{4(1 - 4z)^2}{z} \frac{t^2}{(t - x_2(z))(t - 1)^2(t - x_3(z))},$$

$$\tilde{F}(t, z) = \frac{1 - 24z + 16z^2}{3} + \frac{4(1 - 4z)^2}{z} \frac{t(t+1)^2}{[(t - x_2(z))(t - x_3(z))]^2}.$$

Une CGF pour l'ensemble $\mathcal{GX}([y_1(z), y_2(z)], z)$ est alors donnée par l'unique fonction ayant un pôle en $x_2(z)$ et par ailleurs solution de

$$w^3 - w^2 [F(t, z) + 2K(z)] + w [2K(z)F(t, z) + K(z)^2/3 + G_2(z)/2] - [K(z)^2 F(t, z) + 19G_2(z)K(z)/18 + G_3(z) - 46K(z)^3/27] = 0. \quad (12)$$

De même, une CGF pour l'ensemble $\mathcal{GY}([x_1(z), x_2(z)], z)$ est donnée par l'unique fonction ayant un pôle en $x_3(z)$ et solution de l'équation obtenue de (12) en remplaçant F par \tilde{F} .



FIGURE 10 – Les 2 marches ayant un groupe d'ordre 8

Nous avons déjà commenté de façon approfondie le statut si particulier de la marche de Gessel, à droite ci-dessus. Notons que la marche représentée à gauche sur la Figure 10 (souvent appelée “de Gouyou-Beauchamps”) est également fameuse : elle possède des connexions avec de multiples objets combinatoires, comme avec, par exemple, les “non-crossing matchings”, voir [CDD⁺07].

3 Marches tuées

L'enthousiasme de la communauté probabiliste à l'endroit des processus stochastiques confinés dans des cônes de \mathbb{Z}^d date au moins d'un demi-siècle et de l'article [Dys62]. C'est en effet dans ce travail qu'en étudiant le fameux “gaussian unitary ensemble”, F. Dyson observa que la famille des valeurs propres de ce processus matriciel est égale, en distribution, à un ensemble de particules browniennes conditionnées à ne jamais avoir de collision les unes avec les autres. Suivirent alors quelques décennies plus silencieuses, puis un net regain d'intérêt dans les années 1990. Depuis lors, d'importantes classes de processus confinés dans des cônes de \mathbb{Z}^d sont analysées, comme, par exemple, les “non-colliding random walks”, également appelées “vicious walkers” ou encore “non-intersecting paths”. Ce sont les processus $Z = (Z_1(k), \dots, Z_d(k))_{k \in \mathbb{Z}_+}$ composés de d marches aléatoires i.i.d. et conditionnés, en outre, à ne jamais quitter la chambre de Weyl $\mathcal{W} = \{z \in \mathbb{R}^d : z_1 < \dots < z_d\}$. Les processus $(Z_2(k) - Z_1(k), \dots, Z_d(k) - Z_{d-1}(k))_{k \in \mathbb{Z}_+}$ formés des distances entre ces marches aléatoires s'avèrent décrire le comportement des valeurs propres d'intéressants processus matriciels, dans cette perspective, voir [Bru91, HW96, Gra99, KO01, KT04], et apparaissent également dans l'analyse du “corner-growth model”, voir [Joh00, Joh02]. Par ailleurs, de multiples connexions entre ces processus, les matrices aléatoires et les files d'attente en tandem sont mises en évidence dans [O'C03c], tandis que [Kön05] propose une vue d'ensemble de ce domaine, à travers le prisme des polynômes orthogonaux.

Une façon naturelle et usuelle de construire des processus conditionnés à rester dans une chambre de Weyl consiste à utiliser une transformation de Doob. C'est précisément l'objet de l'article [EK08] pour les processus Z décrits plus haut. P. Eichelsbacher et W. König y trouvent une fonction h positive, harmonique et nulle au bord de la chambre de Weyl \mathcal{W} ; il

est alors clair que le h -processus de Z est bien confiné dans \mathscr{W} – par h -processus de Z nous entendons le processus Z^h défini par $\mathbb{P}_u[Z^h(k) \in dv] = \mathbb{P}_u[Z(k) \in dv, \tau_{\mathscr{W}} > k]h(v)/h(u)$, où $\tau_{\mathscr{W}} = \inf\{p > 0 : Z(p) \notin \mathscr{W}\}$. En outre, les auteurs de [EK08] prouvent que Z^h coïncide, en distribution, avec la limite, lorsque $p \rightarrow \infty$, du processus Z conditionné par $[\tau_{\mathscr{W}} > p]$, ce qui est loin de prévaloir en général. Afin d’obtenir ce dernier résultat, ils démontrent que l’asymptotique de la queue de distribution du temps d’atteinte $\tau_{\mathscr{W}}$ admet la forme $\mathbb{P}_u[\tau_{\mathscr{W}} > p] \sim_{p \rightarrow \infty} Ch(u)/p^\alpha$, pour certaines constantes C et α . En effet, il leur suffit alors d’utiliser cet équivalent dans l’identité suivante, obtenue grâce à la propriété de Markov de Z :

$$\mathbb{P}_u[Z(k) \in dv | \tau_{\mathscr{W}} > p] = \mathbb{P}_u[Z(k) \in dv, \tau_{\mathscr{W}} > k] \frac{\mathbb{P}_v[\tau_{\mathscr{W}} > p - k]}{\mathbb{P}_u[\tau_{\mathscr{W}} > p]}.$$

Cela suggère, plus globalement, de s’intéresser à l’asymptotique de la queue de distribution du temps de sortie de cônes, pour des processus généraux de \mathbb{Z}^d .

À ce propos, outre les résultats du travail [EK08], par ailleurs étendus dans [KS09] à des chambres de Weyl d’autres types, citons les articles [DO05] et [DM09], où des problèmes semblables sont étudiés dans le cadre des processus associés à des groupes de réflexion finis.

Mentionnons également les travaux très généraux [Var99] et [Var00] de N. Varopoulos. Ce dernier y considère des marches aléatoires de \mathbb{Z}^d homogènes et non corrélées, et montre alors que pour tout cône Ω (suffisamment régulier et contenant l’état initial de la marche), il existe une constante α , universelle pour chaque cône Ω , telle que la queue de distribution $\mathbb{P}[\tau_\Omega > p]$ du temps d’atteinte τ_Ω du bord du cône Ω est bornée, de part et d’autre, par une quantité de la forme C/p^α . Néanmoins, ces différentes constantes C ne peuvent être précisées par cette approche.

Un tout autre domaine où des processus confinés dans des cônes de \mathbb{Z}^d apparaissent est celui des marches quantiques – généralisations non commutatives des marches aléatoires classiques, voir *e.g.* [Bia08]. D’une manière remarquable, il s’avère possible d’obtenir des processus classiques à partir des quantiques, par restriction de ces derniers à des espaces commutatifs ; ce traitement *ad hoc* des processus classiques peut d’ailleurs se révéler tout à fait fructueux. C’est ainsi que dans [Bia91], en étudiant une marche quantique sur l’algèbre de von Neumann de $SU(n)$, P. Biane obtient deux processus classiques, par restriction au tore maximal puis au centre du dual de $SU(n)$. P. Biane prouve alors que le premier des deux processus n’est rien d’autre qu’une marche aléatoire homogène aux plus proches voisins sur le tore maximal du dual de $SU(n)$, tandis que le deuxième est le h -processus du premier préalablement tué au bord de la chambre de Weyl, au moyen d’une certaine fonction harmonique h positive à l’intérieur de la chambre de Weyl associée et nulle à son bord. Par la suite, P. Biane généralise ces résultats, dans [Bia92c], au cas des groupes de Lie semi-simples et simplement connexes.

*

Dans les deux situations considérées ci-dessus, h est une fonction harmonique, positive à l’intérieur de la chambre de Weyl et nulle à son bord. Est-elle unique ? Sinon, quelle est la structure de l’ensemble de ces telles fonctions ? Les réponses à ces questions trouvent naturellement leur place dans la théorie de la frontière de Martin (appliquée aux processus sous-jacents tués au bord de la chambre de Weyl), dont nous esquissons ci-après les grandes lignes.

D’abord introduit pour le mouvement brownien par R. Martin en 1941 dans [Mar41], le concept de compactification de Martin a été ensuite étendu aux chaînes de Markov discrètes

par J. Doob et G. Hunt à la fin des années 1950, dans [Doo59] et [Hun60]. L'objet de cette théorie est à la fois de décrire le comportement asymptotique des chaînes de Markov et de caractériser toutes leurs fonctions (sur)harmoniques.

Pour une chaîne de Markov transiente définie sur un espace d'état E , la compactification de Martin est la plus petite compactification \hat{E} de E pour laquelle les noyaux de Martin $z \mapsto k_z^{z_0} = G_z^{z_0}/G_z^{z_1}$ se prolongent continûment – par $G_z^{z_0}$ nous désignons les fonctions de Green du processus, c'est-à-dire les nombres moyen de visites faites par le processus en z partant de z_0 , et par z_1 nous notons un état arbitraire de référence. $\hat{E} \setminus E$ est alors nommée la frontière de Martin. Aussi, il est clair que pour tout $\alpha \in \hat{E}$, $z_0 \mapsto k_\alpha^{z_0}$ est surharmonique ; $\partial_m E = \{\alpha \in \hat{E} \setminus E : z_0 \mapsto k_\alpha^{z_0} \text{ est harmonique minimale}\}$ est alors communément appelée la frontière de Martin minimale – rappelons qu'une fonction harmonique h est dite minimale si l'inégalité $0 \leq \tilde{h} \leq h$ avec \tilde{h} harmonique implique que \tilde{h} est proportionnelle à h . Avec ces notations, la théorie (voir *e.g.* [Dyn69]) affirme que toute fonction h surharmonique (resp. harmonique) peut s'écrire comme $h(z_0) = \int_{\hat{E}} k_z^{z_0} \mu(dz)$ (resp. $h(z_0) = \int_{\partial_m E} k_z^{z_0} \mu(dz)$), où μ est une certaine mesure finie, caractérisée de manière unique dans le second cas ci-dessus.

*

Dans ce contexte, le cas des marches aléatoires *homogènes* de \mathbb{Z}^d est, aujourd'hui, complètement traité. Tout d'abord, la frontière de Martin minimale est décrite dans [DSW60], grâce à la théorie de Choquet-Deny. De plus, si le drift est *non nul*, P. Ney et F. Spitzer obtiennent, dans le célèbre article [NS66], l'asymptotique des fonctions de Green, utilisant pour cela des changements exponentiels de mesure et le théorème limite central local ; cela donne, par conséquent, la réalisation concrète de la frontière de Martin. Par ailleurs, si le drift est *nul*, l'asymptotique des fonctions de Green est trouvée dans [Spi64] ; il s'ensuit que la compactification de Martin est alors la compactification d'Alexandrov.

*

En revanche, les résultats relatifs à la frontière de Martin pour les marches aléatoires *non homogènes* de \mathbb{Z}^d sont rares et plus récents. Dans toute la suite, nous nous concentrerons sur une sous-classe de ces processus non homogènes de \mathbb{Z}^d , à savoir les marches aléatoires tuées au bord de cônes de \mathbb{Z}^d . En effet, d'une part, ce sont des processus très étudiés (voir ainsi [Bia91, Bia92a, Bia92b, Bia92c] et [IR08, IRL09, IR09a, IR09b]), et, d'autre part, ils sont intimement liés aux processus Z décrits plus haut : les fonctions harmoniques des processus Z tués étant, par essence, nulles au bord, elles fournissent autant de possibilités pour conditionner les processus Z (tués ou non) à rester confinés à l'intérieur des cônes.

D'un côté, le cas des processus de \mathbb{Z}^d tués au bord d'un cône à l'intérieur duquel ils possèdent un drift *non nul* est, à l'heure actuelle, plutôt bien connu.

Ainsi, en étudiant des marches quantiques sur le dual des groupes de Lie compacts, P. Biane vient à considérer, dans [Bia92c], des marches aléatoires classiques ayant un drift non nul à l'intérieur de la chambre de Weyl et tuées à son bord – grâce au procédé de restriction déjà présenté. Résolvant alors une équation du type Choquet-Deny, il parvient à trouver la frontière de Martin minimale de ces processus.

Lorsque le groupe de Lie compact ci-dessus n'est autre que $SU(n)$, la compactification de Martin est décrite dans [Col04], grâce à l'obtention de l'asymptotique des noyaux de Green.

Par ailleurs, la frontière de Martin minimale des marches de \mathbb{Z}^d tuées au bord de \mathbb{Z}_+^d ayant une structure produit et un drift non nul à l'intérieur de \mathbb{Z}_+^d est décrite dans [PW92].

Enfin, d'importants travaux ayant trait à ces processus ont été réalisés récemment par I. Ignatiouk-Robert. En effet, en 2006, elle propose une approche novatrice pour l'analyse de la frontière de Martin des marches aléatoires à drift non nul et réfléchies au bord du demi-espace $\mathbb{Z}^{d-1} \times \mathbb{Z}_+$, combinant pour cela des méthodes issues de la théorie des grandes déviations à l'utilisation de résultats propres aux processus de Markov additifs, voir [IR09b]. Par la suite, cette approche est étendue avec succès, dans [IR08], à la description de la frontière de Martin des marches tuées au bord de $\mathbb{Z}^{d-1} \times \mathbb{Z}_+$. I. Ignatiouk-Robert et C. Loree la développent alors, dans [IRL09], à l'étude des marches tuées au bord du quart de plan \mathbb{Z}_+^2 , puis I. Ignatiouk-Robert la déploie enfin, dans [IR09a], à l'analyse des processus tués au bord de \mathbb{Z}_+^d . Notons toutefois que les différents travaux décrits dans ce paragraphe ne traitent pas de l'asymptotique des fonctions de Green, et que, par ailleurs, l'hypothèse faite sur la non nullité du drift γ est absolument essentielle.

D'un autre côté, un très petit nombre de résultats concernant les processus tués au bord de cônes de \mathbb{Z}^d à l'intérieur desquels ils disposent d'un drift *nul* existe aujourd'hui.

Le cas des marches produit de \mathbb{Z}^d à drift nul et tuées au bord de \mathbb{Z}_+^d est considéré dans [PW92] : la frontière de Martin minimale se compose alors d'un unique point.

Des exemples intéressants apparaissent une nouvelle fois dans le contexte des marches quantiques : ainsi, dans [Bia92c], P. Biane considère certains processus tués obtenus par restriction, et montre, grâce à la considération d'une équation du type Choquet-Deny, que s'ils possèdent un drift nul à l'intérieur de la chambre de Weyl, alors leur frontière de Martin minimale est réduite à un point.

C'est en particulier le cas de $SU(n)$, pour lequel P. Biane parvient à trouver, dans [Bia91], l'asymptotique des fonctions de Green le long de toutes les trajectoires, sauf celles tangentées au bord de la chambre de Weyl.

Pour un usage futur, notons que le processus juste ci-dessus correspond, pour $n = 3$, à celui dessiné au milieu de la Figure 12 (voir page 39), et que l'unique fonction harmonique sous-jacente trouvée dans [Bia91] est alors $(i_0, j_0) \mapsto i_0 j_0 (i_0 + j_0)$.

*

C'est dans ce contexte riche dépeint ci-dessus que s'inscrivent les contributions de cette thèse à l'étude des marches tuées. À propos, rappelons (voir le tout début de l'introduction) qu'elles concerneront l'ensemble \mathcal{P} des marches aléatoires $(X(k), Y(k))_{k \in \mathbb{Z}_+}$ du quart de plan \mathbb{Z}_+^2

- * homogènes à l'intérieur du quadrant \mathbb{Z}_+^2 , *i.e.* les probabilités de transition $p_{i,j} = \mathbb{P}[(X(k+1), Y(k+1)) = (X(k), Y(k)) + (i, j) \mid X(k) \neq 0, Y(k) \neq 0]$ ne dépendent pas de $(X(k), Y(k))$,

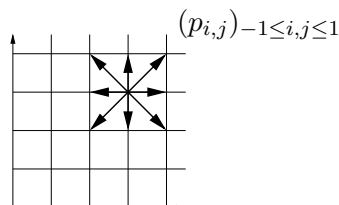

FIGURE 11 – Marches aléatoires \mathcal{P} analysées ci-après

- * faisant des petits sauts à l'intérieur du quadrant, *i.e.* les $p_{i,j}$ ci-dessus sont nulles dès que $|i| > 1$ ou $|j| > 1$,
- * non singulières, *i.e.* dans la liste $p_{1,1}, p_{1,0}, p_{1,-1}, p_{0,-1}, p_{-1,-1}, p_{-1,0}, p_{-1,1}, p_{0,1}$, il n'y a pas trois zéros consécutifs (cette hypothèse technique nous permet d'éviter l'étude des marches dégénérées),
- * tuées au bord de \mathbb{Z}_+^2 , *i.e.* sur $(\mathbb{Z}_+^* \times \{0\}) \cup \{(0,0)\} \cup (\{0\} \times \mathbb{Z}_+^*)$.

Pour les processus de cet ensemble \mathcal{P} , nous nous intéresserons essentiellement à leurs fonctions de Green et probabilités d'absorption $h_{i,j,k}^{i_0,j_0} = \mathbb{P}_{(i_0,j_0)}[(X,Y) \text{ est tué au point } (i,j) \text{ au temps } k \text{ exactement}]$, pour i ou/et j nul, souvent à travers leurs fonctions génératrices

$$Q^{i_0,j_0}(x,y,z) = \sum_{i,j \geq 1, k \geq 0} \mathbb{P}_{(i_0,j_0)}[(X(k), Y(k)) = (i,j)] x^{i-1} y^{j-1} z^k,$$

et

$$q^{i_0,j_0}(x,z) = \sum_{i \geq 1, k \geq 0} h_{i,0,k}^{i_0,j_0} x^{i-1} z^k, \quad \tilde{q}^{i_0,j_0}(y,z) = \sum_{j \geq 1, k \geq 0} h_{0,j,k}^{i_0,j_0} y^{j-1} z^k, \quad q_0^{i_0,j_0}(z) = \sum_{k \geq 0} h_{0,0,k}^{i_0,j_0} z^k.$$

Rappelons (voir l'identité (4) de la Section 1) qu'elles vérifient l'équation fonctionnelle

$$K(x,y,z)Q^{i_0,j_0}(x,y,z) = q^{i_0,j_0}(x,z) + \tilde{q}^{i_0,j_0}(y,z) + q_0^{i_0,j_0}(z) - x^{i_0}y^{j_0}. \quad (13)$$

Nous nous apprêtons maintenant à décrire en détail nos contributions, en quatre temps.

Tout d'abord, dans la Sous-section 3.1, nous donnerons des expressions explicites des fonctions génératrices $Q^{i_0,j_0}, q^{i_0,j_0}, \tilde{q}^{i_0,j_0}, q_0^{i_0,j_0}$ ci-dessus, et, par la même, des fonctions de Green, des probabilités d'absorption et de la distribution du temps d'atteinte de chacun des axes et de l'origine.

Ensuite, dans les Sous-sections 3.2-3.3, nous nous intéresserons à l'asymptotique des fonctions de Green et des probabilités d'absorption, dans le cas d'un drift d'abord non nul, puis nul. En particulier, nous formulerons alors nos conclusions concernant la frontière de Martin.

Enfin, dans la Sous-section 3.4, nous énoncerons et commenterons nos résultats asymptotiques relatifs au temps d'atteinte de chacun des axes et de l'origine.

*

Rappelons que $K(x,y,z) = xyz [\sum_{i,j} p_{i,j} x^i y^j - 1/z]$; par ailleurs, dans la suite, nous poserons

$$K(x,y,z) = \tilde{a}(y,z)x^2 + \tilde{b}(y,z)x + \tilde{c}(y,z) = a(x,z)y^2 + b(x,z)y + c(x,z),$$

ainsi que $d(x,z) = b(x,z)^2 - 4a(x,z)c(x,z)$ et $\tilde{d}(y,z) = \tilde{b}(y,z)^2 - 4\tilde{a}(y,z)\tilde{c}(y,z)$. Pour tout $z \in]0, 1[$, les polynômes d et \tilde{d} possèdent chacun trois ou quatre racines, que nous appelons les $x_k(z)$ et $y_k(z)$. Fixons-les en remarquant que $|x_1(z)| < x_2(z) < 1 < x_3(z) < |x_4(z)|$ et $|y_1(z)| < y_2(z) < 1 < y_3(z) < |y_4(z)|$. Finalement, les racines du noyau K considérées dans la Section 1 possèdent les expressions $X_0(y,z) = [-\tilde{b}(y,z) + \tilde{d}(y,z)^{1/2}]/[2\tilde{a}(y,z)]$, $X_1(y,z) = [-\tilde{b}(y,z) - \tilde{d}(y,z)^{1/2}]/[2\tilde{a}(y,z)]$, $Y_0(x,z) = [-b(x,z) + d(x,z)^{1/2}]/[2a(x,z)]$ et $Y_1(x,z) = [-b(x,z) - d(x,z)^{1/2}]/[2a(x,z)]$.

3.1 Résultats explicites

Du point de vue de l'approche analytique, la situation est semblable à celle de la Section 2 : grâce à l'équation fonctionnelle (13) et aux méthodes exposées dans la Section 1, des représentations intégrales explicites faisant intervenir des fonctions de conformal gluing (CGF) peuvent être obtenues pour les différentes séries génératrices recherchées. Notons, cependant, que la richesse analytique sera ici indéniablement supérieure à celle de la Section 2, les paramètres $p_{i,j}$ étant tels que nous considérons à présent une infinité de marches, et non pas seulement 79.

Théorème 11. *Les fonctions $q^{i_0, j_0}(x, z)$ et $\tilde{q}^{i_0, j_0}(y, z)$ de (13) admettent les représentations intégrales obtenues de celles de $c(x, z)Q(x, 0, z) - c(0, z)Q(0, 0, z)$ et $\tilde{c}(y, z)Q(0, y, z) - \tilde{c}(0, z)Q(0, 0, z)$ données dans le Théorème 3, après avoir remplacé $t/[2a(t, z)]$ et $t/[2\tilde{a}(t, z)]$ par $t^{i_0}\mu_{j_0}(t, z)$ et $t^{j_0}/\tilde{\mu}_{i_0}(t, z)$, où*

$$\begin{aligned}\mu_{j_0}(t, z) &= \frac{1}{[2a(t, z)]^{j_0}} \sum_{k=0}^{(j_0-1)/2} C_{j_0}^{2k+1} d(t, z)^k [-b(t, z)]^{j_0-(2k+1)}, \\ \tilde{\mu}_{i_0}(t, z) &= \frac{1}{[2\tilde{a}(t, z)]^{i_0}} \sum_{k=0}^{(i_0-1)/2} C_{i_0}^{2k+1} \tilde{d}(t, z)^k [-\tilde{b}(t, z)]^{i_0-(2k+1)}.\end{aligned}$$

Pour obtenir $q_0^{i_0, j_0}(z)$, il suffit alors d'évaluer (13) en tout triplet (x, y, z) vérifiant $|z| < 1$ et $(x, y) \in \mathcal{X}_z$; parvenir à une expression explicite de $Q^{i_0, j_0}(x, y, z)$ est ensuite immédiat à partir de (13).

Ainsi, les fonctions génératrices Q^{i_0, j_0} , q^{i_0, j_0} , \tilde{q}^{i_0, j_0} , $q_0^{i_0, j_0}$ sont désormais connues explicitement. Leurs coefficients le deviennent donc également; en particulier :

- * les coefficients de $Q^{i_0, j_0}(x, y, z)$, *i.e.* les probabilités de visite $\mathbb{P}_{(i_0, j_0)}[(X(k), Y(k)) = (i, j)]$, pour $i, j \geq 1$ et $k \geq 0$,
- * les coefficients de $Q^{i_0, j_0}(x, y, 1)$, en d'autres termes les fonctions de Green $G_{i,j}^{i_0, j_0} = \sum_{k \geq 0} \mathbb{P}_{(i_0, j_0)}[(X(k), Y(k)) = (i, j)]$, pour $i, j \geq 1$,
- * les coefficients de $q^{i_0, j_0}(x, z)$, $\tilde{q}^{i_0, j_0}(y, z)$ et $q_0^{i_0, j_0}(z)$, *c'est-à-dire* les différentes probabilités $\mathbb{P}_{(i_0, j_0)}[(X, Y)$ est tué au point (i, j) au temps $k]$, pour i ou/et j nul et $k \geq 0$,
- * les coefficients de $q^{i_0, j_0}(x, 1)$, $\tilde{q}^{i_0, j_0}(y, 1)$ et $q_0^{i_0, j_0}(1)$, *i.e.* les probabilités d'absorption en un certain site du bord, *c'est-à-dire* $\mathbb{P}_{(i_0, j_0)}[\exists k \geq 0 : (X(k), Y(k)) = (i, j)]$, pour i ou/et j nul,
- * les coefficients de $q^{i_0, j_0}(1, z)$, $\tilde{q}^{i_0, j_0}(1, z)$ et $q_0^{i_0, j_0}(z)$, donc la distribution du temps d'atteinte de l'axe horizontal (resp. de l'axe vertical, de l'origine), *i.e.* les quantités $\mathbb{P}_{(i_0, j_0)}[(X, Y)$ atteint l'axe horizontal (resp. l'axe vertical, l'origine) au temps $k]$.

Les coefficients ci-dessus, obtenus, par exemple, grâce aux formules de Cauchy, peuvent parfois être aussi écrits sous une forme particulièrement compacte; à titre d'illustration, mentionnons le résultat ci-après.

Proposition 12. *Pour les marches aléatoires telles que $p_{-1,0} + p_{0,1} + p_{1,0} + p_{0,-1} = 1$, l'égalité suivante a lieu :*

$$\begin{aligned}\mathbb{P}_{(i_0, j_0)}[\exists k \geq 0 : (X(k), Y(k)) = (i, 0)] &= \\ \frac{1}{\pi} \int_{x_3(1)}^{x_4(1)} t^{-i-1} [t^{i_0} - ([p_{-1,0}/p_{1,0}]/t)^{i_0}] \mu_{j_0}(t, 1) [-d(t, 1)]^{1/2} dt + r_i^{i_0, j_0},\end{aligned}$$

où $r_i^{i_0, j_0}$ désigne le coefficient d'ordre i du polynôme $xP_\infty[x^{i_0-1}Y_0(x, 1)^{j_0}]$, si $P_\infty[f]$ dénote la partie principale à l'infini de f . Remarquons que pour $i \geq [1 \vee (i_0 - j_0)]$, $r_i^{i_0, j_0} = 0$.

L'ingrédient principal de la preuve de la Proposition 12 est la rationalité d'ordre 2 de la CGF sous-jacente (rationalité obtenue en adaptant, pour $z = 1$ seulement, le Théorème 5). Cette dernière propriété n'est cependant pas le monopole des marches vérifiant $p_{-1,0} + p_{0,1} + p_{1,0} + p_{0,-1} = 1$, mais s'avère être partagée, plus généralement, par tous les processus disposant, pour $z = 1$ seulement, d'un groupe d'automorphismes de $\mathcal{K}_z = \{(x, y) \in \mathbb{C}^2 : K(x, y, z) = 0\}$ généré par (3) d'ordre 4.

La question de la description de la famille formée des marches possédant un groupe d'automorphismes de \mathcal{K}_1 d'ordre 4 se pose immédiatement : coïncide-t-elle avec celle, rencontrée dans la Section 2, des processus disposant d'un groupe d'ordre 4 au sens des transformations birationnelles ? Ou avec celle, évoquée dans la Sous-section 1.3, des processus ayant, pour tout $z \in]0, 1[$, un groupe d'automorphismes de \mathcal{K}_z généré par (3) d'ordre 4 ?

Proposition 13. *Le groupe engendré par (3) est d'ordre $2p$ au sens des transformations birationnelles si et seulement si, pour tout $z \in]0, 1[$, il est d'ordre $2p$ au sens des automorphismes de $\mathcal{K}_z = \{(x, y) \in \mathbb{C}^2 : K(x, y, z) = 0\}$.*

S'il n'y a donc pas de différence entre la notion du groupe engendré par (3) "au sens des transformations birationnelles" et celle "au sens des automorphismes de \mathcal{K}_z pour tout z ", il y en aura en revanche bien une entre la notion du groupe "au sens des automorphismes de \mathcal{K}_z pour tout z " et celle "au sens des automorphismes de \mathcal{K}_1 "; c'est là une grande richesse analytique de cette Section 3 – dans la Section 2, la question n'avait pas lieu d'être posée, puisque la classification des marches y était réalisée, *ipso facto*, grâce à la notion "au sens des transformations birationnelles".

Nous rencontrerons, dès la Sous-section 3.3, un nombre important d'exemples illustrant cette diversité, comme les familles de processus (15), (17) et (18) : certains de leurs éléments se révéleront posséder des groupes finis pour $z = 1$, mais infinis pour d'autres valeurs de z .

À propos des groupes finis pour $z = 1$, nous montrerons, dans la Partie III, le résultat ci-dessous. Ce dernier est une conséquence du fait que, pour de tels processus, la procédure de prolongement des fonctions q^{i_0, j_0} et \tilde{q}^{i_0, j_0} prend la forme d'un algorithme fini, permettant ainsi d'obtenir des formules fermées pour certaines quantités, comme, par exemple, pour $\mathbb{P}_{i_0, j_0}[(X, Y) \text{ est tué}]$.

Proposition 14. *Sous l'hypothèse que le groupe d'automorphismes $\langle \xi, \eta \rangle$ est fini pour $z = 1$ et sous réserve que la condition $\omega_2/\omega_3 \in \mathbb{Z}$ soit vérifiée (pour les définitions de ω_2 et ω_3 , nous reportons à l'équation (C.9) de la Partie III), la probabilité que le processus soit tué au bord vaut*

$$\mathbb{P}_{i_0, j_0}[(X, Y) \text{ est tué}] = 1 - \sum_{\rho \in \langle \xi, \eta \rangle} \text{sign}(\rho)\rho(1),$$

où $\text{sign}(\rho)$ désigne la signature de ρ , c'est-à-dire $(-1)^m$, si ρ peut s'écrire comme la composée de m automorphismes ξ et η .

Enfin, que le groupe soit fini ou infini, nous prouverons le résultat suivant, donnant la vitesse, lorsque l'état initial (i_0, j_0) s'éloigne du bord, à laquelle $\mathbb{P}_{i_0, j_0}[(X, Y) \text{ est tué}]$ tend vers 0.

Proposition 15. *La probabilité que le processus soit tué au bord vérifie la double inégalité $A/2 \leq \mathbb{P}_{i_0, j_0}[(X, Y) \text{ est tué}] \leq A$, où nous avons noté*

$$A = \left[\frac{p_{1,-1} + p_{0,-1} + p_{-1,-1}}{p_{1,1} + p_{0,1} + p_{-1,1}} \right]^{i_0} + \left[\frac{p_{-1,1} + p_{-1,0} + p_{-1,-1}}{p_{1,1} + p_{1,0} + p_{1,-1}} \right]^{j_0}.$$

3.2 Asymptotique des fonctions de Green et des probabilités d'absorption dans le cas d'un drift non nul

Tout au long de la Sous-section 3.2, nous supposons que le drift est positif, c'est-à-dire que $\sum_{i,j} i p_{i,j} > 0$ et $\sum_{i,j} j p_{i,j} > 0$.

Nos premiers résultats concernent l'asymptotique des fonctions de Green

$$G_{i,j}^{i_0, j_0} = \sum_{k \geq 0} \mathbb{P}_{(i_0, j_0)}[(X(k), Y(k)) = (i, j)] = \mathbb{E}_{(i_0, j_0)} \left[\sum_{k \geq 0} \mathbf{1}_{\{(X(k), Y(k)) = (i, j)\}} \right],$$

d'abord pour $\gamma \in]0, \pi/2[$ (Théorème 16), ensuite pour $\gamma = 0$ et $\gamma = \pi/2$ (Théorème 17).

Afin de les énoncer, soit $(u(\gamma), v(\gamma))$ l'unique solution de $\text{grad}(\phi(u, v))/|\text{grad}(\phi(u, v))| = (\cos(\gamma), \sin(\gamma))$ sur la courbe $\{(u, v) \in \mathbb{R}^2 : \phi(u, v) = \sum_{i,j} p_{i,j} \exp(iu) \exp(jv) = 1\}$, voir [Hen63]. Posons alors $s_x(\tan(\gamma)) = \exp(u(\gamma))$ et $s_y(\tan(\gamma)) = \exp(v(\gamma))$.

Théorème 16. *Pour les marches de \mathcal{P} possédant un drift positif, les fonctions de Green $G_{i,j}^{i_0, j_0}$ admettent l'asymptotique suivante, lorsque $i + j \rightarrow \infty$ et $j/i \rightarrow \tan(\gamma)$, $\gamma \in]0, \pi/2[$:*

$$C(\gamma) \frac{s_x(\tan(\gamma))^{i_0} s_y(\tan(\gamma))^{j_0} - q^{i_0, j_0}(s_x(\tan(\gamma)), 1) - \tilde{q}^{i_0, j_0}(s_y(\tan(\gamma)), 1) - q_0^{i_0, j_0}(1)}{i^{1/2} s_x(j/i)^i s_y(j/i)^j},$$

où $C(\gamma) > 0$ est une constante (explicitée dans la preuve).

Théorème 17. *Pour les marches de \mathcal{P} possédant un drift positif, les fonctions de Green admettent l'asymptotique suivante, lorsque $i + j \rightarrow \infty$ et $j/i \rightarrow \tan(\gamma)$, $\gamma = 0$:*

$$G_{i,j}^{i_0, j_0} \sim C_0 \frac{j j_0 s_x(0)^{i_0} s_y(0)^{j_0-1} - \partial_y \tilde{q}^{i_0, j_0}(s_y(0), 1)}{i^{1/2} s_x(j/i)^i s_y(j/i)^j},$$

où $C_0 > 0$ est une constante (explicitée dans la preuve).

L'asymptotique des fonctions de Green lorsque $i + j \rightarrow \infty$ et $j/i \rightarrow \tan(\gamma)$, $\gamma = \pi/2$ s'obtient alors par un changement adéquat des paramètres.

Faisons maintenant trois remarques autour des Théorèmes 16-17.

Premièrement, ils complètent doublement le travail [IRL09], où l'asymptotique des noyaux de Martin (c'est-à-dire des quotients de fonctions de Green $G_{i,j}^{i_0, j_0} / G_{i,j}^{1,1}$) est obtenue. D'abord, parce qu'ils donnent l'asymptotique des fonctions de Green elles-mêmes ; ensuite, car toutes les quantités apparaissant dans cette asymptotique sont ici obtenues explicitement (à ce propos, voir la Sous-section 3.1, voir aussi le Théorème 20 plus bas).

Deuxièmement, ils ont permis de donner une nouvelle preuve, seulement un mois après (voir [KR09b]) la parution sur arXiv de l'article [IRL09], du résultat ci-dessous.

Corollaire 18. *Pour les marches de \mathcal{P} ayant un drift positif, la compactification de Martin de \mathbb{Z}_+^2 est homéomorphe à la fermeture de $\{(x, y)/(1 + \|(x, y)\|) : (x, y) \in \mathbb{Z}_+^2\}$ dans \mathbb{R}^2 .*

Troisièmement, le Théorème 17 conduit à l'asymptotique des probabilités d'absorption $\mathbb{P}_{(i_0, j_0)}[\exists k \geq 0 : (X(k), Y(k)) = (i, 0)]$ et $\mathbb{P}_{(i_0, j_0)}[\exists k \geq 0 : (X(k), Y(k)) = (0, j)]$. En effet, ces quantités étant, pour $i_0, j_0 > 0$, reliées aux fonctions de Green via

$$\begin{aligned} \mathbb{P}_{(i_0, j_0)}[\exists k \geq 0 : (X(k), Y(k)) = (i, 0)] &= p_{1,-1}G_{i-1,1}^{i_0, j_0} + p_{0,-1}G_{i,1}^{i_0, j_0} + p_{-1,-1}G_{i+1,1}^{i_0, j_0}, \\ \mathbb{P}_{(i_0, j_0)}[\exists k \geq 0 : (X(k), Y(k)) = (0, j)] &= p_{-1,1}G_{1,j-1}^{i_0, j_0} + p_{-1,0}G_{1,j}^{i_0, j_0} + p_{-1,-1}G_{1,j+1}^{i_0, j_0}, \end{aligned} \quad (14)$$

leurs asymptotiques, lorsque i et j tendent vers l'infini, découlent de celle des fonctions de Green dans les cas limite $\gamma = 0$ et $\gamma = \pi/2$.

Corollaire 19. *Pour les marches de \mathcal{P} ayant un drift positif, les probabilités d'absorption admettent l'asymptotique suivante, lorsque $i \rightarrow \infty$:*

$$\mathbb{P}_{(i_0, j_0)}[\exists k \geq 0 : (X(k), Y(k)) = (i, 0)] \sim C_1 \frac{j_0 s_x(0)^{i_0} s_y(0)^{j_0-1} - \partial_y \tilde{q}^{i_0, j_0}(s_y(0), 1)}{i^{3/2} s_x(1/i)^i},$$

où $C_1 = [C_0/s_y(0)] \cdot [p_{1,-1}s_x(0) + p_{0,-1} + p_{-1,-1}/s_x(0)]$, C_0 étant la même constante que dans l'énoncé du Théorème 17.

L'asymptotique des probabilités d'absorption $\mathbb{P}_{(i_0, j_0)}[\exists k \geq 0 : (X(k), Y(k)) = (0, j)]$ lorsque $j \rightarrow \infty$ s'obtient alors par un changement adéquat des paramètres.

Grâce au Théorème 11 de la Sous-section 3.1, les différentes quantités apparaissant dans l'asymptotique des probabilités d'absorption sont explicites. Néanmoins, la façon dont elles dépendent des paramètres, notamment du groupe d'automorphismes $\langle \xi, \eta \rangle$, n'est pas transparente, et le reste de la Sous-section 3.2 est justement destiné à la description de cette dépendance.

Théorème 20. *La constante*

$$C_1 [j_0 s_x(0)^{i_0} s_y(0)^{j_0-1} - \partial_y \tilde{q}^{i_0, j_0}(s_y(0), 1)]$$

apparaissant dans le Corollaire 19 peut s'écrire comme $A_1^{i_0, j_0} + A_2^{i_0, j_0}$, avec $A_1^{i_0, j_0}$ et $A_2^{i_0, j_0}$ définis comme suit.

* Supposons d'abord que $p_{1,1} + p_{1,-1} + p_{-1,-1} + p_{-1,1} < 1$. Alors

$$\begin{aligned} A_1^{i_0, j_0} &= \frac{j_0 s_x(0)^{i_0}}{4} \left[\frac{-s_x(0) \partial_x d(s_x(0), 1)}{\pi a(s_x(0), 1) c(s_x(0), 1)} \left(\frac{c(s_x(0), 1)}{a(s_x(0), 1)} \right)^{j_0} \right]^{1/2}, \\ A_2^{i_0, j_0} &= C_2 \int_{x_1(1)}^{x_2(1)} \frac{\partial_t w(t, 1) t^{i_0} \mu_{j_0}(t, 1) [-d(t, 1)]^{1/2}}{[w(t, 1) - w(s_x(0), 1)]^2} dt, \end{aligned}$$

où $a(x, z), c(x, z), d(x, z), x_k(z)$ sont définis dans l'introduction de la Section 3, μ_{j_0} dans la Sous-section 3.1, w dans la Section 1 et où C_2 est une constante explicitée dans l'énoncé du Théorème C.24 de la Partie III.

Si en outre, avec les notations (C.9) de la Partie III,

** $\omega_2/\omega_3 \in 2\mathbb{Z} + 1$, alors $A_2^{i_0, j_0} = 0$,

** $\omega_2/\omega_3 \in 2\mathbb{Z}$, alors

$$A_2^{i_0, j_0} = -\frac{j_0 x_2(1)^{i_0}}{4\pi^{1/2}} \left[-\frac{x_3(1) \partial_x d(x_2(1), 1)}{a(x_2(1), 1) c(x_2(1), 1)} \frac{\text{res}[w, x_2(1)]}{\text{res}[w, x_3(1)]} \left(\frac{c(x_2(1), 1)}{a(x_2(1), 1)} \right)^{j_0} \right]^{1/2},$$

où, pour $k = 2$ et 3 , $\text{res}[w, x_k(1)]$ désigne le résidu de la fonction w au point $x_k(1)$ – nous verrons dans le Lemme C.26 de la Partie III que ces résidus sont, dans ce cas, non nuls.

* Supposons à présent que $p_{1,1} + p_{1,-1} + p_{-1,-1} + p_{-1,1} = 1$. Alors, avec les notations ci-dessus,

$$C_1 [j_0 s_x(0)^{i_0} s_y(0)^{j_0-1} - \partial_y \tilde{q}^{i_0, j_0}(s_y(0), 1)] = 2A_1^{i_0, j_0} + 2A_2^{i_0, j_0}.$$

3.3 Asymptotique des fonctions de Green et des probabilités d'absorption dans le cas d'un drift nul

Dans toute la Sous-section 3.3, nous supposons que le drift est nul, c'est-à-dire que $\sum_{i,j} i p_{i,j} = 0$ et $\sum_{i,j} j p_{i,j} = 0$.

Cette sous-section est composée de trois paragraphes, consacrés successivement aux énoncés des résultats concernant les familles de processus \mathcal{P}_p , $\mathcal{P}_{\alpha, \beta}$ et \mathcal{P}^n , voir (15), (17) et (18), que nous introduisons maintenant.

Les processus représentés sur la Figure 12 ci-dessous étant, *nolens, volens*, particulièrement importants (notamment car ils apparaissent dans le contexte des marches quantiques), nous souhaitons définir, pour chacun des trois, une famille (infinie) le contenant et vérifiant des propriétés du même type.

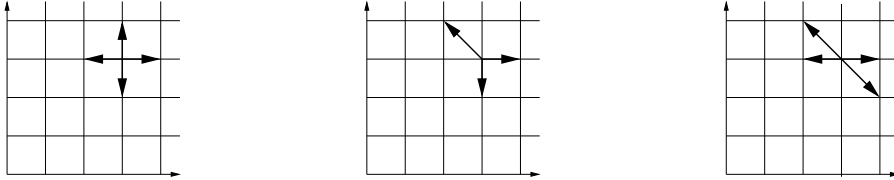

FIGURE 12 – Marches aléatoires dans les chambres de Weyl des duals de $SU(2) \times SU(2)$, $SU(3)$ et $Sp(4)$

* Premièrement, puisque la marche à gauche sur la Figure 12 possède, pour tout z , un groupe d'ordre 4, il semble naturel de la plonger dans

$$\mathcal{P}_p = \{\text{processus à drift nul de } \mathcal{P} : \text{pour } z = 1, \text{ le groupe (3) est d'ordre 4}\}. \quad (15)$$

Dans la Partie III, nous verrons qu'à l'intérieur de \mathcal{P}_p cohabitent des marches associées à des groupes d'ordre 4 pour tout z et d'autres liées à des groupes ayant un ordre 4 pour $z = 1$ seulement.

Par ailleurs, notons qu'il existe une toute autre description de \mathcal{P}_p , à savoir

$$\mathcal{P}_p = \{\text{processus à drift nul de } \mathcal{P} : (i_0, j_0) \mapsto i_0 j_0 \text{ est harmonique}\}. \quad (16)$$

Pour obtenir l'égalité (16), il est possible d'utiliser le critère suivant, prouvé dans [FIM99] : pour $z = 1$, une marche admet un groupe d'ordre 4 si et seulement si

$$\begin{vmatrix} p_{1,1} & p_{1,0} & p_{1,-1} \\ p_{0,1} & -1 & p_{0,-1} \\ p_{-1,1} & p_{-1,0} & p_{-1,-1} \end{vmatrix} = 0.$$

Il suffit alors de remarquer que d'autre part, un élément de \mathcal{P} à drift nul possède $(i_0, j_0) \mapsto i_0 j_0$ pour fonction harmonique si et seulement s'il vérifie l'égalité ci-dessus.

* Deuxièmement, remarquons que la marche au milieu de la Figure 12 dispose, pour tout z , d'un groupe d'ordre 6. Définir un analogue strict de (15) paraît toutefois difficile, car la description de l'ensemble

$$\{\text{processus à drift nul de } \mathcal{P} : \text{pour } z = 1, \text{ le groupe engendré par (3) est d'ordre 6}\}$$

nous paraît véritablement ardue. L'utilisation des fonctions harmoniques, comme en (16), est en revanche davantage envisageable, et nous définissons

$$\mathcal{P}_{\alpha,\beta} = \{\text{processus à drift nul de } \mathcal{P} : (i_0, j_0) \mapsto i_0 j_0 (i_0 + \alpha j_0 + \beta) \text{ est harmonique}\}. \quad (17)$$

Prendre $\alpha = 1$ et $\beta = 0$ ci-dessus conduit immédiatement à noter que la marche dessinée au milieu de la Figure 12 appartient, effectivement, à un $\mathcal{P}_{\alpha,\beta}$. Par ailleurs, nous constaterons que tous les éléments de cet ensemble ont un groupe d'ordre 6 pour $z = 1$ – et, parfois seulement, pour tout z .

* Troisièmement, observant que seules des marches associées à des groupes d'ordre 4, 6 ou 8 étaient jusqu'alors connues, nous introduisons maintenant, pour $n \geq 3$,

$$\mathcal{P}^n = \{\text{processus de } \mathcal{P} : p_{-1,0} = p_{1,0} = \sin(\pi/n)^2/2, p_{-1,1} = p_{1,-1} = \cos(\pi/n)^2/2\}. \quad (18)$$

Nous prouverons que ces processus admettent, pour $z = 1$, un groupe d'ordre $2n$. Pour d'autres valeurs de z , nous verrons qu'il est toujours infini – à l'exception de $n = 4$, cas correspondant précisément à la marche dessinée à droite sur la Figure 12.

Les processus \mathcal{P}_p (voir (15))

Théorème 21. *Supposons que le processus appartienne à \mathcal{P}_p . Alors les fonctions de Green admettent l'asymptotique suivante, lorsque $i + j \rightarrow \infty$ et $j/i \rightarrow \tan(\gamma)$, $\gamma \in [0, \pi/2]$:*

$$G_{i,j}^{i_0,j_0} \sim C i_0 j_0 \frac{ij}{[(p_{1,1} + p_{0,1} + p_{-1,1})i^2 + (p_{1,1} + p_{1,0} + p_{1,-1})j^2]^2},$$

où $C > 0$ est une constante.

Ci-dessus, si le processus de \mathcal{P}_p est celui représenté à gauche sur la Figure 12, alors l'asymptotique des fonctions de Green pour $\gamma \in]0, \pi/2[$ peut certainement être obtenue de [Bia91]. Quel que soit le processus de \mathcal{P}_p , le Théorème 21 pour $\gamma \in [0, \pi/2]$ est inédit – à notre connaissance.

Mentionnons maintenant deux conséquences du Théorème 21. La première concerne la frontière de Martin.

Corollaire 22. *La compactification de Martin des processus de \mathcal{P}_p est la compactification d’Alexandrov.*

Dans le cas du processus dessiné à gauche sur la Figure 12, ce résultat peut être déduit de [Bia92a]. Plus généralement, ce corollaire est une conséquence de [PW92] dans le cas particulier (strictement inclus dans \mathcal{P}_p) des marches aléatoires produit, c’est-à-dire des processus $pP + qQ + (1 - p - q)P \otimes Q$, où P et Q sont des marches aléatoires unidimensionnelles, ayant des sauts aux plus proches voisins, à drift nul et tuées en l’origine.

Une deuxième conséquence du Théorème 21 est relative aux probabilités d’absorption $\mathbb{P}_{(i_0, j_0)}[\exists k \geq 0 : (X(k), Y(k)) = (i, 0)]$ et $\mathbb{P}_{(i_0, j_0)}[\exists k \geq 0 : (X(k), Y(k)) = (0, j)]$. En effet, grâce aux identités (14), nous obtenons le résultat ci-après.

Corollaire 23. *Supposons que le processus appartienne à \mathcal{P}_p . Alors les probabilités d’absorption admettent l’asymptotique suivante, lorsque $i \rightarrow \infty$:*

$$\mathbb{P}_{(i_0, j_0)}[\exists k \geq 0 : (X(k), Y(k)) = (i, 0)] \sim C[(p_{1,-1} + p_{0,-1} + p_{-1,-1})/p_{0,1}^2]i_0j_0/i^3,$$

où C est la même constante que dans l’énoncé du Théorème 21.

Les probabilités $\mathbb{P}_{(i_0, j_0)}[\exists k \geq 0 : (X(k), Y(k)) = (0, j)]$ possèdent l’équivalent obtenu ci-dessus en remplaçant $(p_{1,-1} + p_{0,-1} + p_{-1,-1})/p_{0,1}^2$ par $(p_{-1,1} + p_{-1,0} + p_{-1,-1})/p_{1,0}^2$.

Les processus $\mathcal{P}_{\alpha, \beta}$ (voir (17)) Nous allons, à présent, énoncer des équivalents du Théorème 21 et des Corollaires 22-23 pour la famille $\mathcal{P}_{\alpha, \beta}$; mais auparavant, nous souhaitons introduire $\mathcal{P}_{\alpha, \beta}$ en détail.

Plus haut, nous avons noté que pour la marche tuée dessinée au milieu de la Figure 12, il est prouvé dans [Bia91] et [Bia92a] que $(i_0, j_0) \mapsto i_0j_0(i_0 + j_0)$ est l’unique fonction harmonique positive. Par des méthodes similaires, un résultat analogue pourrait certainement être obtenu pour la marche “duale”, c’est-à-dire pour le processus admettant les sauts de probabilités $p_{-1,0} = p_{0,1} = p_{1,-1} = 1/3$. En particulier, posant $\mathcal{P}_{p, \text{SU}(3)}$ pour

$$\{\text{processus de } \mathcal{P} : p_{0,-1} = p_{-1,1} = p_{1,0} = \mu, p_{-1,0} = p_{0,1} = p_{1,-1} = \nu, \mu + \nu = 1/3\},$$

i.e. pour l’ensemble formé des produits cartésiens d’une marche aléatoire sur la chambre de Weyl de $\text{SU}(3)$ avec sa duale, voir à gauche sur la Figure 13 ci-dessous, il provient de [PW92] que tout processus de $\mathcal{P}_{p, \text{SU}(3)}$ admet également une frontière de Martin minimale réduite à un point. L’unique fonction harmonique sous-jacente étant $(i_0, j_0) \mapsto i_0j_0(i_0 + j_0)$, il semble alors naturel de considérer la famille $\mathcal{P}_{1,0}$, voir (17) ; nous verrons dans le Chapitre D de la Partie III que l’inclusion $\mathcal{P}_{p, \text{SU}(3)} \subset \mathcal{P}_{1,0}$ est stricte.

Afin de considérer l’ensemble des marches de \mathcal{P} admettant un polynôme de degré trois, harmonique et positif dans \mathbb{Z}_+^2 , il est finalement naturel de définir $\mathcal{P}_{\alpha, \beta}$, cf. (17).

Sa description précise en termes des paramètres $p_{i,j}$ est plutôt volumineuse, mais facile à obtenir ; elle est donnée dans le Chapitre D. À ce sujet, notons ici simplement que si $\alpha > 2$ ou $\alpha < 1/2$, alors pour tout β , $\mathcal{P}_{\alpha, \beta} = \emptyset$; si $\alpha = 1/2$ ou $\alpha = 2$, alors pour tout $\beta \neq 0$, $\mathcal{P}_{\alpha, \beta} = \emptyset$, tandis que $\mathcal{P}_{\alpha, 0}$ est réduit à une marche ; et si $\alpha \in]1/2, 2[$ et $|\beta|$ est suffisamment petit, alors $\mathcal{P}_{\alpha, \beta}$ est un ensemble (non vide) à deux paramètres. À droite sur la Figure 13 ci-dessous, nous représentons l’exemple d’un processus appartenant à $\mathcal{P}_{\alpha, 0}$, quel que soit $\alpha \in [1/2, 2]$.



FIGURE 13 – À gauche, une marche typique de $\mathcal{P}_{p, \text{SU}(3)}$, avec $\mu + \nu = 1/3$. À droite, l'exemple d'une marche de $\mathcal{P}_{\alpha, 0}$, avec $\lambda = \alpha(\alpha - 1/2)/[2 - \alpha + 2\alpha^2]$, $\mu = (\alpha/2)/[2 - \alpha + 2\alpha^2]$ et $\nu = (1 - \alpha/2)/[2 - \alpha + 2\alpha^2]$

Théorème 24. *Supposons que le processus appartienne à $\mathcal{P}_{\alpha, \beta}$. Alors les fonctions de Green admettent l'asymptotique suivante, lorsque $i + j \rightarrow \infty$ et $j/i \rightarrow \tan(\gamma)$, $\gamma \in [0, \pi/2]$:*

$$G_{i,j}^{i_0, j_0} \sim C_{\alpha, \beta} i_0 j_0 (i_0 + \alpha j_0 + \beta) \frac{ij(i + \alpha j)}{[i^2 + \alpha ij + \alpha^2 j^2]^3},$$

où $C_{\alpha, \beta} > 0$ est une constante (explicitée dans le Chapitre D).

Dans le cas particulier de la marche aléatoire du milieu de la Figure 12, l'asymptotique ci-dessus est obtenue dans [Bia91], lorsque $\gamma \in]0, \pi/2[$.

Donnons maintenant deux conséquences du Théorème 24 ci-dessus.

Corollaire 25. *La compactification de Martin des processus de $\mathcal{P}_{\alpha, \beta}$ est la compactification d'Alexandrov.*

Corollaire 26. *Supposons que le processus appartienne à $\mathcal{P}_{\alpha, \beta}$. Alors les probabilités d'absorption admettent l'asymptotique suivante, lorsque $i \rightarrow \infty$:*

$$\mathbb{P}_{(i_0, j_0)}[\exists k \geq 0 : (X(k), Y(k)) = (i, 0)] \sim C_{\alpha, \beta} [p_{1, -1} + p_{0, -1} + p_{-1, -1}] i_0 j_0 (i_0 + \alpha j_0 + \beta) / i^4,$$

où $C_{\alpha, \beta}$ est la même constante que dans l'énoncé du Théorème 24.

Les probabilités $\mathbb{P}_{(i_0, j_0)}[\exists k \geq 0 : (X(k), Y(k)) = (0, j)]$ possèdent l'équivalent obtenu de ci-dessus en remplaçant $[p_{1, -1} + p_{0, -1} + p_{-1, -1}]$ par $[p_{-1, 1} + p_{-1, 0} + p_{-1, -1}] / \alpha^5$.

Les processus \mathcal{P}^n (voir (18)) Rappelons que quel que soit $n \geq 3$, les processus de \mathcal{P}^n admettent un groupe d'ordre $2n$: la famille $\cup_{n \geq 3} \mathcal{P}^n$ est donc représentative de l'ensemble des processus de \mathcal{P} à drift nul et associés à des groupes finis – et c'est, précisément, ce qui motive sa définition.

Théorème 27. *Supposons que le processus appartienne à \mathcal{P}^n . Alors les fonctions de Green admettent l'asymptotique suivante, lorsque $i + j \rightarrow \infty$ et $j/i \rightarrow \tan(\gamma)$, $\gamma \in [0, \pi/2]$:*

$$G_{i,j}^{i_0, j_0} \sim C_n f_n(i_0, j_0) \frac{\sin(n \arctan(\frac{j/i}{1+j/i} \tan(\pi/n)))}{[\cos(\pi/n)^2 (i^2 + 2ij) + j^2]^{n/2}},$$

où

- * $C_n > 0$ est une constante (explicitée dans le Chapitre E),
- * f_n est un polynôme de degré n , strictement positif (resp. nul) à l'intérieur (resp. au bord) de \mathbb{Z}_+^2 , harmonique pour les processus de \mathcal{P}^n et explicité dans le Chapitre E.

Ipso facto, la quantité $f_n(i_0, j_0)$ ci-dessus apparaît lors du calcul du développement au voisinage de $(x, y) = (1, 1)$ de $\sum_{\rho \in \langle \xi, \eta \rangle} \text{sign}(\rho) \rho(x^{i_0} y^{j_0})$ – ce qui évoque, à juste titre d’ailleurs, l’énoncé de la Proposition 14. En particulier, l’expression explicite de $f_n(i_0, j_0)$ est complexe, dans le cas générique $n \geq 3$, c’est pourquoi nous ne la donnerons dans sa généralité que dans le Chapitre E ; à titre d’exemple, mentionnons simplement ici

$$\begin{aligned} f_3(i_0, j_0) &= 24 \cdot 3^{1/2} \cdot i_0 j_0 (i_0 + 2j_0), \\ f_4(i_0, j_0) &= (256/3) \cdot i_0 j_0 (i_0 + 2j_0)(i_0 + j_0), \\ f_6(i_0, j_0) &= (288/5) 3^{1/2} \cdot i_0 j_0 (i_0 + 2j_0)(i_0 + j_0) \left((i_0 + 2j_0/3)(i_0 + 4j_0/3) + 10/9 \right). \end{aligned}$$

Donnons maintenant deux conséquences du Théorème 27 ci-dessus.

Corollaire 28. *La compactification de Martin des processus de \mathcal{P}^n est la compactification d’Alexandrov.*

Corollaire 29. *Supposons que le processus appartienne à \mathcal{P}^n . Alors les probabilités d’absorption admettent l’asymptotique suivante, lorsque $i \rightarrow \infty$:*

$$\mathbb{P}_{(i_0, j_0)}[\exists k \geq 0 : (X(k), Y(k)) = (i, 0)] \sim C_n f_n(i_0, j_0) n [\tan(\pi/n) / (\cos(\pi/n))^n] / i^{n+1},$$

où C_n est la même constante que dans l’énoncé du Théorème 27.

Les probabilités $\mathbb{P}_{(i_0, j_0)}[\exists k \geq 0 : (X(k), Y(k)) = (0, j)]$ possèdent l’équivalent obtenu de ci-dessus en remplaçant $\tan(\pi/n) / (\cos(\pi/n))^n$ par $\sin(2\pi/n)/2$.

3.4 Asymptotique de la queue de distribution du temps d’atteinte d’un des axes

Dans cette sous-section, nous allons nous concentrer sur les asymptotiques des queues de distribution des temps d’atteinte de l’axe horizontal et de l’axe vertical. À cet effet, rappelons que les lois exactes de ces temps d’atteinte sont connues, puisque

$$\begin{aligned} q^{i_0, j_0}(1, z) &= \sum_{k \geq 0} \sum_{i \geq 1} h_{i, 0, k}^{i_0, j_0} z^k = \sum_{k \geq 0} \mathbb{P}_{(i_0, j_0)}[(X, Y) \text{ atteint l’axe horizontal au temps } k] z^k, \\ \tilde{q}^{i_0, j_0}(1, z) &= \sum_{k \geq 0} \sum_{j \geq 1} h_{0, j, k}^{i_0, j_0} z^k = \sum_{k \geq 0} \mathbb{P}_{(i_0, j_0)}[(X, Y) \text{ atteint l’axe vertical au temps } k] z^k, \end{aligned}$$

ont été obtenues explicitement dans la Sous-section 3.1.

Notre premier résultat concerne les trois processus de la Figure 12 plus haut.

Théorème 30. *Supposons que le processus soit l’un des trois représentés sur la Figure 12. Notons alors, pour les processus de gauche à droite sur cette même figure, $h(i_0, j_0) = i_0 j_0$, $i_0 j_0 (i_0 + j_0)$ et $i_0 j_0 (i_0 + j_0)(i_0 + 2j_0)$, fonctions harmoniques correspondant à l’unique point de la frontière de Martin (voir les Corollaires 22, 25 et 28). L’asymptotique suivante a lieu lorsque $k \rightarrow \infty$:*

$$\mathbb{P}_{(i_0, j_0)}[(X, Y) \text{ atteint l’axe horizontal au temps } k] \sim C_{ah} \frac{h(i_0, j_0)}{k^{1+|\langle \xi, \eta \rangle|/4}}, \quad (19)$$

$C_{ah} > 0$ étant une constante dépendant du processus, par ailleurs explicitée dans le Chapitre F, et $|\langle \xi, \eta \rangle|$ le cardinal du groupe engendré par (3).

Une asymptotique similaire a lieu pour $\mathbb{P}_{(i_0, j_0)}[(X, Y) \text{ atteint l’axe vertical au temps } k]$,

- * après avoir remplacé C_{ah} par une autre constante $C_{av} > 0$,
- * en notant que pour le processus à droite sur la Figure 12, si i_0 et k n'ont pas la même parité, alors $\mathbb{P}_{(i_0, j_0)}[(X, Y) \text{ atteint l'axe vertical au temps } k] = 0$.

Signalons que pour la marche à droite sur la Figure 12, l'asymptotique de $\mathbb{P}_{(i_0, j_0)}[(X, Y) \text{ atteint le bord au temps } k] = \mathbb{P}_{(i_0, j_0)}[(X, Y) \text{ atteint l'axe horizontal au temps } k] + \mathbb{P}_{(i_0, j_0)}[(X, Y) \text{ atteint l'axe vertical au temps } k]$ peut vraisemblablement être aussi obtenue de [DO05], où la série génératrice de la distribution du temps d'atteinte du bord (pour le processus à temps continu sous-jacent) est explicitée.

Corollaire 31. *Posons, pour les processus de gauche à droite sur la Figure 12, $h(i_0, j_0) = i_0 j_0$, $i_0 j_0(i_0 + j_0)$ et $i_0 j_0(i_0 + j_0)(i_0 + 2j_0)$. Alors, pour ces trois processus (X, Y) , le h -processus au sens de Doob de (X, Y) coïncide, en distribution, avec la limite, lorsque $p \rightarrow \infty$, du processus (X, Y) conditionné par $[\tau > p]$, τ étant le temps d'atteinte du bord.*

*

Outre les trois processus représentés sur la Figure 12, nous nous intéresserons tout particulièrement, dans le Chapitre F, à celui dont les sauts sont dessinés sur la Figure 14 plus bas, et ce dans le but de compléter certains résultats de [BFMP01] et [MMVW08] relatifs au modèle du votant.

Par le modèle du votant, nous désignons un processus à temps continu sur $\{0, 1\}^{\mathbb{Z}}$, pouvant s'interpréter comme suit : initialement, en chaque site de \mathbb{Z} , il y a zéro ou une particule ; une particule apparaît (resp. disparaît) alors en un site libre (resp. occupé) selon une loi exponentielle de taux proportionnel au nombre de sites voisins où une particule est présente (resp. absente). Par ailleurs, l'état initial est supposé appartenir à l'ensemble des configurations ayant un nombre fini de sites libres (resp. occupés) à gauche (resp. à droite) de l'origine. Cela entraîne, en particulier, que le processus reste dans cet ensemble au cours de son évolution. Ainsi, à chaque instant, il y a un nombre fini de "01" (resp. "10"), *i.e.* de paires de sites $(x, x + 1)$ avec zéro (resp. une) particule en x et une (resp. zéro) en $x + 1$.

Quant au modèle à temps discret sous-jacent, la configuration \mathcal{C}_{n+1} au temps $n + 1$ s'obtient de \mathcal{C}_n en deux temps : il y a d'abord le choix, selon une loi uniforme, d'un "01" ou "10", puis vient son remplacement, avec probabilité 1/2, par un "00" ou "11".

Si l'état initial est la configuration d'Heaviside, c'est-à-dire la configuration formée d'uniquement deux blocs infinis de 1 et de 0, alors le processus en sera, à chaque instant, une translation. Cela suggère indubitablement de considérer la relation d'équivalence suivante : deux configurations sont dites équivalentes si elles sont des translations l'une de l'autre. Dans la suite, nous travaillerons sur l'espace quotient latent, dont tout élément peut donc être caractérisé par un nombre fini d'entiers positifs $(X_1, Y_1, \dots, X_N, Y_N)$:

$$\dots 111 \overbrace{0000}^{X_1} \overbrace{111}^{Y_1} \overbrace{000}^{X_2} \overbrace{11111}^{Y_2} \dots \overbrace{000}^{X_N} \overbrace{1111}^{Y_N} 000 \dots, \quad (20)$$

N étant le nombre de blocs finis de zéros (ou uns) et n_i (resp. m_i), $i \in \{1, \dots, N\}$ la taille du i ème bloc de zéros (resp. uns). Nous référons à [Lig85] pour une présentation approfondie du modèle du votant, et plus généralement pour une introduction aux "interacting particle systems".

En utilisant des fonctions de Lyapunov, les auteurs de [BFMP01] démontrent que si τ est le temps d'atteinte de la configuration d'Heaviside, alors $\mathbb{E}[\tau^{3/2-\epsilon}] < \infty$, pour tout

$\epsilon > 0$. Ensuite, dans le but de prouver que $\mathbb{E}[\tau^{3/2+\epsilon}] = \infty$, pour tout $\epsilon > 0$ (et tout état initial différent de la configuration d'Heaviside), ils remarquent qu'il suffit de le faire pour tout état initial vérifiant $N = 1$ dans (20). Ainsi, avec les notations de (20), ils considèrent le processus $(X_1, Y_1) = (X_1(k), Y_1(k))_{k \in \mathbb{Z}_+}$.

$$\dots \overbrace{111000000}^{X_1(k)} \overbrace{11111000}^{Y_1(k)} \dots$$

Le processus (X_1, Y_1) est une chaîne de Markov sur \mathbb{Z}_+^2

- * homogène à l'intérieur du quadrant, avec des probabilités de saut $p_{1,0} = p_{1,-1} = p_{0,-1} = p_{-1,0} = p_{-1,1} = p_{0,1} = 1/6$ (cf. la dynamique du processus à temps discret présentée plus haut),
- * absorbée au bord (puisque la configuration d'Heaviside est absorbante pour le modèle du votant).

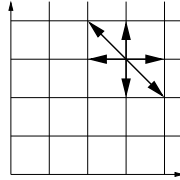

FIGURE 14 – Marche aléatoire apparaissant dans l'étude du passage de quatre à deux blocs pour le modèle du votant

Utilisant alors les résultats de [AIM96], qui concernent les moments des temps de passage pour des marches réfléchies au bord d'un quadrant, les auteurs de [BFMP01] prouvent que $\mathbb{E}_{(i_0, j_0)}[\tau^{3/2+\epsilon}] = \infty$, pour tout $\epsilon > 0$ et tout état initial (i_0, j_0) intérieur à \mathbb{Z}_+^2 , τ étant le temps d'atteinte du bord pour le processus (X_1, Y_1) .

Néanmoins, la question de la finitude de $\mathbb{E}_{(i_0, j_0)}[\tau^{3/2}]$ n'obtient pas de réponse des deux articles [BFMP01] et [MMVW08].

Dans ce contexte, la contribution de cette thèse est double. En effet, d'un côté, grâce à la Sous-section 3.1, les fonctions $q^{i_0, j_0}(1, z)$ et $\tilde{q}^{i_0, j_0}(1, z)$ sont explicitées; d'un autre côté, nous prouverons le résultat asymptotique ci-après.

Théorème 32. *Pour le processus de la Figure 14, lorsque $k \rightarrow \infty$:*

$$\mathbb{P}_{(i_0, j_0)}[(X_1, Y_1) \text{ atteint l'axe horizontal au temps } k] \sim \frac{9}{16} \left(\frac{3}{\pi}\right)^{1/2} \frac{i_0 j_0 (i_0 + j_0)}{k^{5/2}}.$$

Exactement la même asymptotique que ci-dessus a lieu pour $\mathbb{P}_{(i_0, j_0)}[(X_1, Y_1) \text{ atteint l'axe vertical au temps } k]$.

En particulier, il devient clair que $\mathbb{E}_{(i_0, j_0)}[\tau^{3/2}] = \infty$.

Par ailleurs, un analogue du Corollaire 31 pourrait clairement être énoncé.

Dans le Chapitre F de la Partie III, nous verrons que les Théorèmes 30-32 et le Corollaire 31 admettent une généralisation au cas de toute marche qui, d'une part, dispose d'un groupe fini pour tout z , et d'autre part, possède une CGF rationnelle – c'est le cas, par exemple,

de 19 des 23 marches associées à des groupes finis dans la classification de [BMM09]. Pour toutes ces marches, un résultat similaire au Théorème 30 pourrait ainsi être énoncé ; en outre, si le drift est nul, la fonction h de (19) correspond à l'unique élément de la frontière de Martin (alors réduite à un point), tandis que si le drift est non nul, h devient la fonction harmonique apparaissant dans l'asymptotique des fonctions de Green lorsque $j/i \rightarrow \tan(\gamma)$, pour γ égal à l'angle du drift.

4 Correspondance des principaux résultats de l'introduction

<i>Introduction</i>	<i>Page</i>	<i>Corps de la thèse</i>	<i>Page</i>
Théorème 2	27	Theorem B.2	73
Théorème 3	27	Theorems A.6 & B.5	56 & 74
Théorème 4	28	Subsection B.4.1	82
Théorème 5	28	Theorem B.7	75
Proposition 6	28	Proposition B.26	86
Proposition 7	28	Proposition B.27	87
Proposition 8	29	Proposition B.28	87
Proposition 9	29	Proposition B.29	87
Proposition 10	29	Theorem A.7	57
Théorème 11	35	Theorems C.13 & F.1	108 & 174
Proposition 12	35	Equations (D.25) & (F.25)	146 & 183
Proposition 13	36	Proposition B.18	81
Proposition 14	36	Corollary C.9	105
Proposition 15	37	Proposition C.10	105
Théorème 16	37	Theorem C.15	112
Théorème 17	37	Theorem C.18	114
Corollaire 18	38	Corollary C.19	114
Corollaire 19	38	Corollary C.23	123
Théorème 20	38	Theorem C.24	124
Théorème 21	40	Section D.4	144
Corollaire 22	41	Section D.4	144
Corollaire 23	41	Section D.4	144
Théorème 24	42	Theorem D.1	134
Corollaire 25	42	Corollary D.2	134
Corollaire 26	42	Corollary D.3	134
Théorème 27	42	Theorem E.10	162
Corollaire 28	43	Corollary E.12	162
Corollaire 29	43	Proposition E.13	168
Théorème 30	43	Propositions F.5, F.14 & F.23	183, 185 & 193
Corollaire 31	44	Corollaries F.6, F.15 & F.24	178, 185 & 194
Théorème 32	45	Proposition F.14	185

5 Perspectives

Terminons cette introduction par l'évocation de quelques points précis que nous souhaitons vivement développer dans les mois et années futures.

*

En ce qui concerne l'approche analytique de la Section 1, il nous semble que deux possibilités de généralisation émergent :

- * d'abord, dans l'esprit de [CB83] et [Coh92a], il est tout à fait normal d'envisager des sauts plus généraux que seuls ceux aux huit plus proches voisins ;
- * aussi, il est naturel de considérer le cas de la dimension supérieure.

Si le premier *item* ci-dessus paraît un objectif attingible à moyen ou long terme, la réalisation du deuxième nous semble encore plus ambitieuse.

*

Pour ce qui est de la Section 2, il nous paraît absolument important de développer les deux aspects suivants :

- * dans un premier temps, nous souhaitons vivement trouver la nature de la série génératrice trivariée pour *toutes* les 56 marches ayant un groupe infini, ce qui nous permettrait de répondre à une conjecture de M. Bousquet-Mélou et M. Mishna, voir [BMM09] ;
- * d'un tout autre point de vue, il paraît naturel d'envisager des légères modifications du modèle (comme l'introduction de chemins avec poids, ou la permission de comportements plus généraux sur les frontières, *etc.*), et de répondre alors aux mêmes questions (voir celles numérotées (1) et (2), au tout début de l'introduction).

*

Enfin, citons également deux points de la Section 3 qu'il nous semble crucial d'étendre :

- * premièrement, nous souhaitons trouver, pour *toutes* les marches à drift nul, la compactification de Martin (est-elle, systématiquement, la compactification d'Alexandrov ?) ;
- * deuxièmement, nous désirons obtenir l'asymptotique de la queue de distribution des temps d'atteinte pour *toutes* les marches à drift nul.

6 Notations

Ci-dessous, nous introduisons quelques notations que nous utiliserons dans cette thèse.

- * i désignera le nombre complexe usuel tel que $i^2 = -1$.
- * Nous noterons \bar{z} le nombre complexe conjugué de z .
- * Pour la dérivée d'une fonction f , nous emploierons indifféremment l'écriture " ∂f " ou " f' ".
- * \ln sera systématiquement la détermination principale du logarithme (voir [JS87]).
- * C_n^p représentera le coefficient binomial de p éléments parmi n .
- * $[x]$ désignera la partie entière du réel x .

Deuxième partie

Énumération des chemins

Chapitre A

Explicit expression of the counting generating function for Gessel's walk *

In this chapter, we consider the so-called Gessel's walk, that is the planar random walk that is confined to the first quadrant and that can move in unit steps to the West, North-East, East and South-West. For this walk, we make explicit the generating function of the number of paths starting at $(0,0)$ and ending at (i,j) in time k .

A.1 Introduction and main results

The enumeration of lattice walks is a classical problem in combinatorics. The one of Gessel's walk seems to puzzle the mathematical community already for several years [Ges86, PW08, KKZ09, Ayy09, Pin09, BK09]. This is a planar random walk that is confined to the first quadrant and that can move in the interior in unit steps to the West, North-East, East and South-West, see Picture A.1.

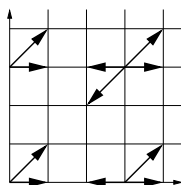

FIGURE A.1 – Gessel's walk

For $(i,j) \in \mathbb{Z}_+^2$ and $k \in \mathbb{Z}_+$, set

$$q(i,j,k) = |\{\text{walks confined in } \mathbb{Z}_+^2 \text{ starting at } (0,0) \text{ and ending at } (i,j) \text{ in time } k\}|.$$

I. Gessel conjectures around 2001 that $q(0,0,2k) = 16^k [(5/6)_k (1/2)_k] / [(2)_k (5/3)_k]$, where $(a)_k = a(a+1) \cdots (a+k-1)$. In 2009, M. Kauers, C. Koutschan and D. Zeilberger yield a remarkable although heavily computer-aided proof of this conjecture, see [KKZ09].

*. This work is a collaboration with I. Kurkova and is taken from the preprint [KR09a].

The articles [Ayy09, Pin09] give connections between Gessel's walk and other interesting models. Precisely, S. Ping in [Pin09] establishes a probabilistic model for Gessel's walk concerned with vicious walkers, and A. Ayyer interprets in [Ayy09] such walks as Dick words with two sets of letters and gives explicit formulas for a restricted class of these words. Nevertheless, both approaches are yet in some way of providing a "human" proof of Gessel's conjecture, but may certainly help for a better understanding of Gessel's walk.

M. Petkovsek and H. Wilf in [PW08] state some similar conjectures for the number of walks ending at other points – two of them have been proved, besides, by S. Ping in [Pin09]. In [PW08], M. Petkovsek and H. Wilf also obtain an infinite lower-triangular system of linear equations satisfied by the values of $q(i, 0, k)$ and $q(0, j, k) + q(0, j - 1, k)$, and they manage to express these values as determinants of lower Hessenberg matrices with unit superdiagonals whose non-zero entries are products of two binomial coefficients.

Finally, A. Bostan and M. Kauers in [BK09] show that the complete generating function for Gessel's walk

$$Q(x, y, z) = \sum_{i, j, k \geq 0} q(i, j, k) x^i y^j z^k$$

is algebraic and make explicit minimal polynomials for $Q(x, 0, z)$ and $Q(0, y, z)$. The proof of A. Bostan and M. Kauers given in [BK09] involves, among other tools, computer calculations using a powerful computer algebra system Magma, it requires immense computational effort.

Curiously, in spite of this vivid interest to Gessel's walk, the complete generating function $Q(x, y, z)$, or even $Q(0, y, z)$ or $Q(x, 0, z)$ have *not* yet been analyzed *without computer help* – up to our knowledge.

Furthermore, M. Bousquet-Mélou and M. Mishna in [BMM09] undertake recently the systematic analysis of the enumeration of the walks confined to the quarter plane \mathbb{Z}_+^2 starting from the origin and making steps at any point of \mathbb{Z}_+^2 from a given subset of $\{-1, 0, 1\}^2 \setminus \{(0, 0)\}$. There are 2^8 such models. Moreover they show that, after eliminating trivial models and those that are equivalent to models of walks confined to a half-plane and solved by known methods, it remains 79 inherently different problems to study. Following the idea of Book [FIM99], they associate with each model a group W of birational transformations (for details on this group, see Subsection A.2.1 below). This group is finite in 23 cases and infinite in the 56 other cases. Then, they are able to solve "mathematically" (*i.e.* to make explicit the function $Q(x, y, z)$ *without computer help*) 22 models associated with a finite group. The only case with finite group that remains unsolved is the model of Gessel's walk.

The aim of Chapter A is to solve Gessel's walk model, *i.e.* to represent in a closed form the generating function $Q(x, y, z)$ *without computer help*.

In addition of being not computer-aided, our method presents the advantage of being generalizable up to the case of all 2^8 walks described above with unit steps in the quarter plane \mathbb{Z}_+^2 and associated with a finite or infinite group – this extension will be the object of Chapter B.

Let us observe that for any $(i, j) \in \mathbb{Z}_+^2$ and $k \in \mathbb{Z}_+$, $q(i, j, k) \leq 4^k$, so that $Q(x, y, z)$ is holomorphic in $\{|x| < 1, |y| < 1, |z| < 1/4\}$ and continuous up to $\{|x| \leq 1, |y| \leq 1, |z| < 1/4\}$.

Our starting point is the functional equation already stated in [BMM09] and exploited

in [PW08], valid *a priori* on $\{|x| \leq 1, |y| \leq 1, |z| < 1/4\}$:

$$K(x, y, z)Q(x, y, z) = zQ(x, 0, z) + z(y+1)Q(0, y, z) - zQ(0, 0, z) - xy, \quad (\text{A.1})$$

where $K(x, y, z) = xyz[1/x + 1/(xy) + x + xy - 1/z]$.

Our method heavily relies on the profound analytic approach developed in [FIM99] by G. Fayolle, R. Iasnogorodski and V. Malyshev. Let us recall from Section 1 of Part I that in this book, the authors compute the generating functions of stationary probabilities for some ergodic random walks in a quarter plane. These random walks have four domains of spatial homogeneity, namely the interior $\{(i, j) : i > 0, j > 0\}$, the horizontal axis $\{(i, 0) : i > 0\}$, the vertical axis $\{(0, j) : j > 0\}$ and the origin $\{0, 0\}$; in the interior, the only possible non-zero transition probabilities are the eight jumps at distance one. They reduce the problem to the solution of the following functional equation on $\{|x| \leq 1, |y| \leq 1\}$,

$$K(x, y)Q(x, y) = k(x, y)q(x) + \tilde{k}(x, y)\tilde{q}(y) + k_0(x, y)q_0, \quad (\text{A.2})$$

with known polynomials $K(x, y)$, $k(x, y)$, $\tilde{k}(x, y)$, $k_0(x, y)$ and with functions $Q(x, y)$, $q(x)$, $\tilde{q}(y)$ unknown but holomorphic in unit discs, continuous up to the boundary.

First, they continue $q(x)$ and $\tilde{q}(y)$ meromorphically (with poles that can be identified) to the whole complex plane cut along some segment. This ingenious continuation procedure is the crucial step of Book [FIM99].

After that, they show that $q(x)$ and $\tilde{q}(y)$ verify a boundary value problem of Riemann-Carleman type, and they solve the latter by converting it into a boundary value problem of Riemann-Hilbert type.

Compared to (A.2), our equation (A.1) seems more difficult to analyze, as it involves a complementary parameter z . From the other point of view, the coefficients $k(x, y)$, $\tilde{k}(x, y)$ and $k_0(x, y)$ in front of the unknowns $zQ(x, 0, z)$, $z(y+1)Q(0, y, z)$ and $zQ(0, 0, z)$ are absent. This will allow us to continue $zQ(x, 0, z)$ and $z(y+1)Q(0, y, z)$ as holomorphic and not only meromorphic functions and, consequently, to simplify substantially the solutions.

In the sequel, we will suppose, for technical reasons, that z is fixed in $]0, 1/4[$.

We are now going to state the main results of Chapter A. To begin with, let us have a closer look to the kernel $K(x, y, z)$ that appears in (A.1) and let us take some notations.

The polynomial $K(x, y, z)$ can be written as $K(x, y, z) = \tilde{a}(y, z)x^2 + \tilde{b}(y, z)x + \tilde{c}(y, z) = a(x, z)y^2 + b(x, z)y + c(x, z)$, with $\tilde{a}(y, z) = zy(y+1)$, $\tilde{b}(y, z) = -y$, $\tilde{c}(y, z) = z(y+1)$ and $a(x, z) = zx^2$, $b(x, z) = zx^2 - x + z$, $c(x, z) = z$. Define also $\tilde{d}(y, z) = \tilde{b}(y, z)^2 - 4\tilde{a}(y, z)\tilde{c}(y, z)$ and $d(x, z) = b(x, z)^2 - 4a(x, z)c(x, z)$.

For any $z \in]0, 1/4[$, \tilde{d} has one root equal to zero as well as two real positive roots, that we denote by $y_2(z) < 1 < y_3(z)$. We have $y_2(z) = [1 - 8z^2 - (1 - 16z^2)^{1/2}]/[8z^2]$ and $y_3(z) = [1 - 8z^2 + (1 - 16z^2)^{1/2}]/[8z^2]$; we also note $y_1(z) = 0$ and $y_4(z) = \infty$.

Likewise, for all $z \in]0, 1/4[$, d has four real positive roots, that we denote by $x_1(z) < x_2(z) < 1 < x_3(z) < x_4(z)$. Their explicit expression is $x_1(z) = [1 + 2z - (1 + 4z)^{1/2}]/[2z]$, $x_2(z) = [1 - 2z - (1 - 4z)^{1/2}]/[2z]$, $x_3(z) = [1 - 2z + (1 - 4z)^{1/2}]/[2z]$ and $x_4(z) = [1 + 2z + (1 + 4z)^{1/2}]/[2z]$.

With these notations, we have $K(x, y, z) = 0$ if and only if $[\tilde{b}(y, z) + 2\tilde{a}(y, z)x]^2 = \tilde{d}(y, z)$ or $[b(x, z) + 2a(x, z)y]^2 = d(x, z)$. In particular, the algebraic functions $X(y, z)$ and $Y(x, z)$ defined by $K(X(y, z), y, z) = 0$ and $K(x, Y(x, z), z) = 0$ have two branches, meromorphic on respectively $\mathbb{C} \setminus ([y_1(z), y_2(z)] \cup [y_3(z), y_4(z)])$ and $\mathbb{C} \setminus ([x_1(z), x_2(z)] \cup [x_3(z), x_4(z)])$.

The following straightforward results give some properties of the two branches of these algebraic functions $X(y, z)$ and $Y(x, z)$.

Lemma A.1. *Call $X_0(y, z) = [-\tilde{b}(y, z) + \tilde{d}(y, z)^{1/2}]/[2\tilde{a}(y, z)]$ and $X_1(y, z) = [-\tilde{b}(y, z) - \tilde{d}(y, z)^{1/2}]/[2\tilde{a}(y, z)]$ the branches of $X(y, z)$. For all $y \in \mathbb{C}$, we have $|X_0(y, z)| \leq |X_1(y, z)|$.*

On $\mathbb{C} \setminus ([y_1(z), y_2(z)] \cup [y_3(z), y_4(z)])$, X_0 has a simple zero at -1 , no other zero and no pole; X_1 has a simple pole at -1 , no other pole and no zero. Finally, both X_0 and X_1 become infinite at $y_1(z) = 0$ and zero at $y_4(z) = \infty$.

Now we call $Y_0(x, z) = [-b(x, z) + d(x, z)^{1/2}]/[2a(x, z)]$ and $Y_1(x, z) = [-b(x, z) - d(x, z)^{1/2}]/[2a(x, z)]$ the branches of $Y(x, z)$. For all $x \in \mathbb{C}$, we have $|Y_0(x, z)| \leq |Y_1(x, z)|$.

On $\mathbb{C} \setminus ([x_1(z), x_2(z)] \cup [x_3(z), x_4(z)])$, Y_0 has a double zero at ∞ , no other zero and no pole; Y_1 has a double pole at 0 , no other pole and no zero.

Both $X_i(y, z)$, $i \in \{0, 1\}$ are not defined when y belongs to a branch cut, in other words for $y \in [y_1(z), y_2(z)] \cup [y_3(z), y_4(z)]$. However, the limits $X_i^\pm(y, z)$ defined by $X_i^+(y, z) = \lim X_i(\hat{y}, z)$ as $\hat{y} \rightarrow y$ from the *upper* side of the cut and $X_i^-(y, z) = \lim X_i(\hat{y}, z)$ as $\hat{y} \rightarrow y$ from the *lower* side of the cut are well defined. Since for y in a branch cut, $\tilde{d}(y, z) < 0$, these two quantities are complex conjugate the one from the other.

A similar remark holds for $Y_i(x, z)$, $i \in \{0, 1\}$ and $x \in [x_1(z), x_2(z)] \cup [x_3(z), x_4(z)]$.

In fact, for respectively $y \in [y_1(z), y_2(z)]$ and $x \in [x_1(z), x_2(z)]$, we have :

$$X_0^\pm(y, z) = \frac{-\tilde{b}(y, z) \mp i[-\tilde{d}(y, z)]^{1/2}}{2\tilde{a}(y, z)}, \quad Y_0^\pm(x, z) = \frac{-b(x, z) \mp i[-d(x, z)]^{1/2}}{2a(x, z)}, \quad (\text{A.3})$$

$X_1^\pm(y, z) = X_0^\mp(y, z)$ and $Y_1^\pm(x, z) = Y_0^\mp(x, z)$ – note that for Equation (A.3) to be true for respectively $y \in [y_3(z), y_4(z)]$ and $x \in [x_3(z), x_4(z)]$, we have to exchange $X_0^\pm(y, z)$ and $Y_0^\pm(x, z)$ in $X_0^\mp(y, z)$ and $Y_0^\mp(x, z)$ respectively.

Lemma A.2. *Consider $X([y_1(z), y_2(z)], z)$ and $Y([x_1(z), x_2(z)], z)$. (i) These two curves are symmetrical w.r.t. the real axis and not included in the unit disc. (ii) $X([y_1(z), y_2(z)], z)$ contains ∞ and $Y([x_1(z), x_2(z)], z)$ is closed. (iii) Both of them split the plane into two connected components, we call $\mathcal{G}X([y_1(z), y_2(z)], z)$ and $\mathcal{G}Y([x_1(z), x_2(z)], z)$ the connected components of $x_1(z)$ and $y_1(z)$. They verify $\mathcal{G}X([y_1(z), y_2(z)], z) \subset \mathbb{C} \setminus [x_3(z), x_4(z)]$ and $\mathcal{G}Y([x_1(z), x_2(z)], z) \subset \mathbb{C} \setminus [y_3(z), y_4(z)]$.*

Note that complete proofs, for $z = 1/4$, of Lemmas A.1 and A.2 can be found in Part 5.3 of [FIM99]. For other values of z , the details are essentially similar and thus we omit them.

These notations and properties of the kernel $K(x, y, z)$ are enough in order to state our results.

First of all, we would like to show that $zQ(x, 0, z)$ and $z(y+1)Q(0, y, z)$ verify some boundary value problems of Riemann-Carleman type.

But it turns out that the associated boundary conditions verified by $zQ(x, 0, z)$ and $z(y+1)Q(0, y, z)$ hold respectively on the curves $X([y_1(z), y_2(z)], z)$ and $Y([x_1(z), x_2(z)], z)$, which are *not* included in the unit disc, see Lemma A.2, and where therefore the functions $zQ(x, 0, z)$ and $z(y+1)Q(0, y, z)$ are *a priori* not defined. For this reason, first we need to continue the generating functions up to these curves. In fact, we are going to show the following result – the proof of which being the central subject of Section A.3.

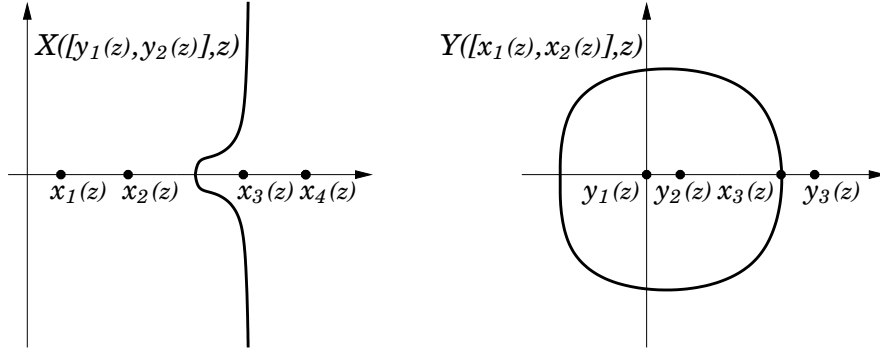
FIGURE A.2 – The curves $X([y_1(z), y_2(z)], z)$ and $Y([x_1(z), x_2(z)], z)$

Theorem A.3. *The functions $zQ(x, 0, z)$ and $z(y+1)Q(0, y, z)$ can be holomorphically continued from their unit disc up to $\mathbb{C} \setminus [x_3(z), x_4(z)]$ and $\mathbb{C} \setminus [y_3(z), y_4(z)]$ respectively. Furthermore, for any $y \in \mathbb{C} \setminus ([y_1(z), y_2(z)] \cup [y_3(z), y_4(z)])$,*

$$zQ(X_0(y, z), 0, z) + z(y+1)Q(0, y, z) - zQ(0, 0, z) - X_0(y, z)y = 0, \quad (\text{A.4})$$

and, for any $x \in \mathbb{C} \setminus ([x_1(z), x_2(z)] \cup [x_3(z), x_4(z)])$,

$$zQ(x, 0, z) + z(Y_0(x, z) + 1)Q(0, Y_0(x, z), z) - zQ(0, 0, z) - xY_0(x, z) = 0. \quad (\text{A.5})$$

Remark A.4. *For $y \in \{|y| \leq 1\}$ such that $|X_0(y, z)| \leq 1$, (A.4) follows immediately from (A.1). Likewise, for $x \in \{|x| \leq 1\}$ such that $|Y_0(x, z)| \leq 1$, (A.5) is a straightforward consequence of (A.1). The fact that equations (A.4) and (A.5) are verified not only for these values of y and x but actually on $\mathbb{C} \setminus ([y_1(z), y_2(z)] \cup [y_3(z), y_4(z)])$ and $\mathbb{C} \setminus ([x_1(z), x_2(z)] \cup [x_3(z), x_4(z)])$ respectively will be shown in Section A.3.*

Remark A.5. *In the proof of Theorem A.3, we will see that like $z(y+1)Q(0, y, z)$, $Q(0, y, z)$ can be holomorphically continued from the unit disc up to $\mathbb{C} \setminus [y_3(z), y_4(z)]$.*

Now we explain how to obtain the above mentioned boundary conditions verified by the functions $zQ(x, 0, z)$ and $z(y+1)Q(0, y, z)$.

Let $y \in [y_1(z), y_2(z)]$, and let \hat{y}^+ and \hat{y}^- be close to y , such that \hat{y}^+ is in the *upper* half-plane and \hat{y}^- in the *lower* half-plane. Then we have (A.4) for both \hat{y}^+ and \hat{y}^- . If now $\hat{y}^+ \rightarrow y$ and $\hat{y}^- \rightarrow y$, then we obtain $X_0(\hat{y}^+, z) \rightarrow X_0^+(y, z)$ and $X_0(\hat{y}^-, z) \rightarrow X_0^-(y, z) = X_1^+(y, z)$. So we have proved that for any $y \in [y_1(z), y_2(z)]$,

$$zQ(X_0^+(y, z), 0, z) + z(y+1)Q(0, y, z) - zQ(0, 0, z) - X_0^+(y, z)y = 0, \quad (\text{A.6})$$

$$zQ(X_1^+(y, z), 0, z) + z(y+1)Q(0, y, z) - zQ(0, 0, z) - X_1^+(y, z)y = 0. \quad (\text{A.7})$$

Subtracting (A.7) from (A.6), we obtain that for any $y \in [y_1(z), y_2(z)]$,

$$z[Q(X_0^+(y, z), 0, z) - Q(X_1^+(y, z), 0, z)] = X_0^+(y, z)y - X_1^+(y, z)y. \quad (\text{A.8})$$

Then, using the fact that for $i \in \{0, 1\}$, $y \in [y_1(z), y_2(z)]$ and $z \in]0, 1/4[$, $Y_0(X_i^\pm(y, z), z) = y$ – which can be proved by elementary considerations starting from Lemma A.1, or by the

use of the forthcoming Lemma A.16 –, we get the first part of (A.9) below :

$$\begin{aligned} \forall t \in X([y_1(z), y_2(z)], z) : \quad & z[Q(t, 0, z) - Q(\bar{t}, 0, z)] = tY_0(t, z) - \bar{t}Y_0(\bar{t}, z), \\ \forall t \in Y([x_1(z), x_2(z)], z) : \quad & z[(t+1)Q(0, t, z) - (\bar{t}+1)Q(0, \bar{t}, z)] = X_0(t, z)t - X_0(\bar{t}, z)\bar{t}. \end{aligned} \quad (\text{A.9})$$

Likewise, we could prove the second part of (A.9).

Note that as a consequence of (A.6) and (A.7), the equality (A.4) is, in some sense, also verified for $y \in [y_1(z), y_2(z)]$ – the same is true for (A.5) and $x \in [x_1(z), x_2(z)]$.

With Lemma A.2, Theorem A.3 and Equation (A.9), we obtain that $zQ(x, 0, z)$ and $z(y+1)Q(0, y, z)$ can be found among the functions holomorphic in $\mathcal{G}X([y_1(z), y_2(z)], z)$ and $\mathcal{G}Y([x_1(z), x_2(z)], z)$, continuous up to the boundary and verifying the boundary conditions (A.9).

Such problems are known as boundary value problems of Riemann-Carleman type. A standard way to solve them consists in converting them into boundary value problems of Riemann-Hilbert type by use of *conformal gluing functions* (CGF), in the sense of Definition 1 of Part I.

Let $w(t, z)$ and $\tilde{w}(t, z)$ be CGF for $\mathcal{G}X([y_1(z), y_2(z)], z)$ and $\mathcal{G}Y([x_1(z), x_2(z)], z)$ – the existence (but *no* explicit expression) of w and \tilde{w} is ensured by general results on conformal gluing. For a general account about boundary value problems and conformal gluing, we refer to [Lit00].

Transforming the boundary value problems of Riemann-Carleman type into boundary value problems of Riemann-Hilbert type thanks to w and \tilde{w} , solving them and working out the solutions, we will prove the following.

Theorem A.6. *The function $z[Q(x, 0, z) - Q(0, 0, z)]$ has the following explicit expression for $z \in]0, 1/4[$ and $x \in \mathbb{C} \setminus [x_3(z), x_4(z)]$:*

$$z[Q(x, 0, z) - Q(0, 0, z)] = xY_0(x, z) + \frac{1}{\pi} \int_{x_1(z)}^{x_2(z)} \frac{t[-d(t, z)]^{1/2}}{2a(t, z)} \left[\frac{\partial_t w(t, z)}{w(t, z) - w(x, z)} - \frac{\partial_t w(t, z)}{w(t, z) - w(0, z)} \right] dt,$$

w being a CGF for the set $\mathcal{G}X([y_1(z), y_2(z)], z)$.

The function $z[(y+1)Q(0, y, z) - Q(0, 0, z)]$ has the following explicit expression for $z \in]0, 1/4[$ and $y \in \mathbb{C} \setminus [y_3(z), y_4(z)]$:

$$z[(y+1)Q(0, y, z) - Q(0, 0, z)] = X_0(y, z)y + \frac{1}{\pi} \int_{y_1(z)}^{y_2(z)} \frac{t[-\tilde{d}(t, z)]^{1/2}}{2\tilde{a}(t, z)} \left[\frac{\partial_t \tilde{w}(t, z)}{\tilde{w}(t, z) - \tilde{w}(y, z)} - \frac{\partial_t \tilde{w}(t, z)}{\tilde{w}(t, z) - \tilde{w}(0, z)} \right] dt,$$

\tilde{w} being a CGF for the set $\mathcal{G}Y([x_1(z), x_2(z)], z)$.

The function $Q(0, 0, z)$ has the following explicit expression for $z \in]0, 1/4[$:

$$Q(0, 0, z) = -\frac{1}{\pi} \int_{y_1(z)}^{y_2(z)} \frac{t[-\tilde{d}(t, z)]^{1/2}}{2\tilde{a}(t, z)} \left[\frac{\partial_t \tilde{w}(t, z)}{\tilde{w}(t, z) - \tilde{w}(-1, z)} - \frac{\partial_t \tilde{w}(t, z)}{\tilde{w}(t, z) - \tilde{w}(0, z)} \right] dt,$$

\tilde{w} being a CGF for the set $\mathcal{G}Y([x_1(z), x_2(z)], z)$.

The function $Q(x, y, z)$ has the explicit expression obtained by using the ones of $Q(x, 0, z)$, $Q(0, y, z)$ and $Q(0, 0, z)$ in (A.1).

Above, all functions in the integrands are explicit, except for the CGF w and \tilde{w} . In [FIM99], suitable CGF are computed *implicitly* by means of the reciprocal of some known functions (see the formulas (A.23) and (A.24) below for the details). Starting from this representation, we are able to make *explicit* these functions for Gessel's walk.

In order to state the result, we need to define $G_2(z) = (4/27)(1 + 224z^2 + 256z^4)$, $G_3(z) = (8/729)(1 + 16z^2)(1 - 24z + 16z^2)(1 + 24z + 16z^2)$, $L(z)$ as the only positive root of $L^4 - G_2(z)L^2/2 - G_3(z)L - G_2(z)^2/48 = 0$ - noting $r_k(z) = [G_2(z) - \exp(2k\pi/3)(G_2(z)^3 - 27G_3(z)^2)^{1/3}]/3$, we have $L(z) = [-r_0(z)^{1/2} + r_1(z)^{1/2} + r_2(z)^{1/2}]/2$ - and

$$\begin{aligned} F(t, z) &= \frac{1 - 24z + 16z^2}{3} - \frac{4(1 - 4z)^2}{z} \frac{t^2}{(t - x_2(z))(t - 1)^2(t - x_3(z))}, \\ \tilde{F}(t, z) &= \frac{1 - 24z + 16z^2}{3} + \frac{4(1 - 4z)^2}{z} \frac{t(t + 1)^2}{[(t - x_2(z))(t - x_3(z))]^2}. \end{aligned} \quad (\text{A.10})$$

Theorem A.7. *A suitable CGF for the set $\mathcal{G}X([y_1(z), y_2(z)], z)$ is the only function having a pole at $x_2(z)$ and solution of*

$$\begin{aligned} w^3 - w^2[F(t, z) + 2L(z)] + w[2L(z)F(t, z) + L(z)^2/3 + G_2(z)/2] \\ - [L(z)^2F(t, z) + 19G_2(z)L(z)/18 + G_3(z) - 46L(z)^3/27] = 0. \end{aligned} \quad (\text{A.11})$$

Likewise, a suitable CGF for the set $\mathcal{G}Y([x_1(z), x_2(z)], z)$ is the only function having a pole at $x_3(z)$ and solution of the equation obtained from (A.11) by replacing F by \tilde{F} , see (A.10).

Let us now outline some facts around Theorems A.3, A.6 and A.7.

Remark A.8. *With Theorems A.6 and A.7, it is clear that the integral representations of $Q(x, 0, z)$ and $Q(0, y, z)$, initially given for $z \in]0, 1/4[$ admit holomorphic continuations for $|z| < 1/4$. In particular, Cauchy's formulas yield explicit expressions for the numbers of paths $q(i, j, k)$.*

In fact, the initial hypothesis " $z \in]0, 1/4[$ " is just technical, in the sense that it aims at ensuring that both polynomials d and \tilde{d} have three or four distinct and real roots, which is very convenient for a synthetic presentation of Sections A.2 and A.3.

Remark A.9. *Since (A.1) is valid at least on $\{|x| \leq 1, |y| \leq 1, |z| < 1/4\}$, then for any such (\hat{x}, \hat{y}, z) with $K(\hat{x}, \hat{y}, z) = 0$, the right hand side of (A.1) equals zero, so that*

$$z[Q(\hat{x}, 0, z) - Q(0, 0, z)] + z[(\hat{y} + 1)Q(0, \hat{y}, z) - Q(0, 0, z)] + zQ(0, 0, z) - \hat{x}\hat{y} = 0. \quad (\text{A.12})$$

We deduce that

$$zQ(0, 0, z) = -z[Q(\hat{x}, 0, z) - Q(0, 0, z)] - z[(\hat{y} + 1)Q(0, \hat{y}, z) - Q(0, 0, z)] + \hat{x}\hat{y}, \quad (\text{A.13})$$

with the functions in the square brackets in right hand side given by the first two formulas in Theorem A.6. For the explicit expression of $zQ(0, 0, z)$ given in Theorem A.6, we have chosen to substitute $(\hat{x}, \hat{y}, z) = (0, -1, z)$ in (A.13), which is such that $K(\hat{x}, \hat{y}, z) = 0$, since with Lemma A.1, we have $X_0(-1, z) = 0$. Moreover, we show in Theorem A.3 that for any $z \in]0, 1/4[$, the equation (A.12) is valid not only on $\{(x, y) \in \mathbb{C}^2 : K(x, y, z) = 0\} \cap \{|x| \leq 1, |y| \leq 1\}$ but in a much larger domain of the algebraic curve $\{(x, y) \in \mathbb{C}^2 : K(x, y, z) = 0\}$. Namely, if (\hat{x}, \hat{y}, z) is such that $z \in]0, 1/4[$, $\hat{x} \notin [x_3(z), x_4(z)]$ and $\hat{y} = Y_0(\hat{x}, z)$, or $\hat{y} \notin [y_3(z), y_4(z)]$ and $\hat{x} = X_0(\hat{y}, z)$, then (A.12) is still valid. Substituting any (\hat{x}, \hat{y}, z) from this domain into (A.12) yields $zQ(0, 0, z)$ as in (A.13).

Remark A.10. *With the analytical approach proposed here, it would be possible, without additional difficulty, to obtain explicitly the generating function of the number of walks beginning at an arbitrary initial state (i_0, j_0) and ending at (i, j) in time k . Indeed, the only significant difference is that the product xy in (A.1) would be then replaced by $x^{i_0+1}y^{j_0+1}$.*

Remark A.11. *In Theorem A.6, the functions $z[Q(x, 0, z) - Q(0, 0, z)]$ and $z[(y + 1)Q(0, y, z) - Q(0, 0, z)]$ are written as the sums of two functions which are not holomorphic near $[x_1(z), x_2(z)]$ and $[y_1(z), y_2(z)]$ respectively. However, the sum of these two functions is, of course, holomorphic near these segments, since they are included in the unit disc. By an application of the residue theorem as in Section C.6 of Chapter C (see particularly (C.54) and (C.59)), we could write both generating series as functions manifestly holomorphic near these segments and having in fact their singularities near respectively $[x_3(z), x_4(z)]$ and $[y_3(z), y_4(z)]$.*

The rest of Chapter A is organized as follows.

In Section A.2, we prove Theorem A.7. There the implicit representation of the CGF given in [FIM99] (and recalled here in Subsections A.2.1 and A.2.2) in a general setting is developed in Subsection A.2.3 to the case of Gessel's walk.

The proof of Theorem A.3 is postponed to the last Section A.3. The main idea of the holomorphic continuation procedure is borrowed again from [FIM99], we show how it works with the parameter $z \in]0, 1/4[$.

Finally, we give now the proof of Theorem A.6.

Proof of Theorem A.6. The proof is composed of two steps : the first one, inspired by [FIM99], will allow us to obtain integral representations of the functions $zQ(x, 0, z)$ and $z(y + 1)Q(0, y, z)$ on the curves $X([y_1(z), y_2(z)], z)$ and $Y([x_1(z), x_2(z)], z)$; the second one will consist in transforming these formulations into the integrals on real segments written in the statement of Theorem A.6, which are more convenient, notably from a calculations point of view.

Let us begin by solving the boundary value problems of Riemann-Carleman type with boundary conditions (A.9). The use of CGF allows us, as in [FIM99] or [Lit00], to transform them into boundary value problems of Riemann-Hilbert type. Following again [FIM99] or [Lit00], we solve them, and in this way, we obtain representations of the unknown functions $zQ(x, 0, z)$ and $z(y + 1)Q(0, y, z)$ as integrals along the curves $X([y_1(z), y_2(z)], z)$ and $Y([x_1(z), x_2(z)], z)$. Precisely, for $zQ(x, 0, z)$, we get that up to some additive function of z ,

$$zQ(x, 0, z) = \frac{1}{2\pi i} \int_{X([y_1(z), y_2(z)], z)} tY_0(t, z) \frac{\partial_t w(t, z)}{w(t, z) - w(x, z)} dt, \quad (\text{A.14})$$

where w is the CGF of $\mathcal{G}X([y_1(z), y_2(z)], z)$ we used for the transformation of the boundary value problems. Similarly, we could write an integral representation of $z(y + 1)Q(0, y, z)$, up to some additive function of z .

We are now going to transform the integral representation (A.14) of $zQ(x, 0, z)$. To begin with, let $C(\epsilon, z)$ be any contour such that

- (i) $C(\epsilon, z)$ is connected and contains ∞ ,
- (ii) $C(\epsilon, z) \subset (\mathcal{G}X([y_1(z), y_2(z)], z) \cup X([y_1(z), y_2(z)], z)) \setminus [x_1(z), x_2(z)]$,
- (iii) $\lim_{\epsilon \rightarrow 0} C(\epsilon, z) = X([y_1(z), y_2(z)], z) \cup S(z)$, where we have denoted by $S(z)$ the real segment $[x_1(z), X(y_2(z), z)]$ traversed from $X(y_2(z), z)$ to $x_1(z)$ along the lower edge of the slit and then back to $X(y_2(z), z)$ along the upper edge,

and let $\mathcal{G}C(\epsilon, z)$ be the connected component of 0 of $\mathbb{C} \setminus C(\epsilon, z)$.

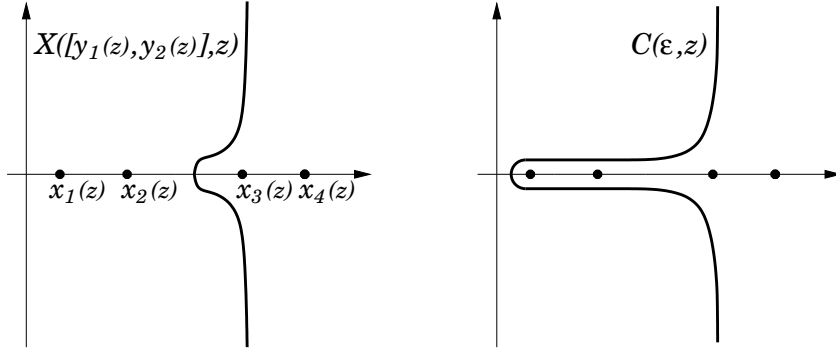

FIGURE A.3 – The curve $X([y_1(z), y_2(z)], z)$ and the new contour of integration $C(\epsilon, z)$

Now we apply the residue theorem to the integrand of (A.14) on the contour $C(\epsilon, z)$. Thanks to Lemma A.1 and the property (ii) of the contour $C(\epsilon, z)$, $tY_0(t, z)$ is, as a function of t , holomorphic in $\mathcal{G}C(\epsilon, z)$. Likewise, by using Definition 1 of Part I as well as the property (ii) above, we get that $\partial_t w(t, z)/(w(t, z) - w(x, z))$ is meromorphic on $\mathcal{G}C(\epsilon, z)$, with a unique pole at $t = x$. Therefore, we have :

$$\frac{1}{2\pi i} \int_{C(\epsilon, z)} tY_0(t, z) \frac{\partial_t w(t, z)}{w(t, z) - w(x, z)} dt = xY_0(x, z). \quad (\text{A.15})$$

Making then ϵ go to 0, using (A.14), (A.15) and the property (iii) of the contour, we obtain that, up to an additive function of z ,

$$zQ(x, 0, z) = xY_0(x, z) - \frac{1}{2\pi i} \int_{S(z)} tY_0(t, z) \frac{\partial_t w(t, z)}{w(t, z) - w(x, z)} dt. \quad (\text{A.16})$$

Since for any $x \in \mathcal{G}X([y_1(z), y_2(z)], z)$, the integrand in (A.16) is, as a function of t , holomorphic at any point of $]x_2(z), X(y_2(z), z)[$, we have

$$\int_{S(z)} tY_0(t, z) \frac{\partial_t w(t, z)}{w(t, z) - w(x, z)} dt = \int_{x_1(z)}^{x_2(z)} [tY_0^+(t, z) - tY_0^-(t, z)] \frac{\partial_t w(t, z)}{w(t, z) - w(x, z)} dt, \quad (\text{A.17})$$

so that with (A.3), we immediately obtain the expression of $z[Q(x, 0, z) - Q(0, 0, z)]$ stated in Theorem A.6, when $x \in \mathcal{G}X([y_1(z), y_2(z)], z)$.

Likewise, we could obtain, for $y \in \mathcal{G}Y([x_1(z), x_2(z)], z)$, the expression of $z[(y + 1)Q(0, y, z) - Q(0, 0, z)]$ written in Theorem A.6.

The formula for $Q(0, 0, z)$ has been already proved in Remark A.9.

In fact, the integral representations of $z[Q(x, 0, z) - Q(0, 0, z)]$ and $z[(y + 1)Q(0, y, z) - Q(0, 0, z)]$ hold not only on $\mathcal{G}X([y_1(z), y_2(z)], z)$ and $\mathcal{G}Y([x_1(z), x_2(z)], z)$ but actually on $\mathbb{C} \setminus [x_3(z), x_4(z)]$ and $\mathbb{C} \setminus [y_3(z), y_4(z)]$; we will show this fact in Proposition A.17, since the necessary tools will be naturally introduced in Subsections A.2.1 and A.2.2. \square

Note. In December 2009, just after the first version of the paper [KR09a] (that has led to the bulk of Chapter A) appeared on arXiv, we received an e-mail from M. van Hoeij, who

said us that he had, at the same time, found explicitly $Q(x, y, z)$ by computing an explicit solution to the minimal polynomials for $Q(x, 0, z)$ and $Q(0, y, z)$ given in [BK09] and by using (A.1) – this expression can be found in the appendix of [BK09]. As already said, the results of A. Bostan and M. Kauers in [BK09], and consequently also the ones of M. van Hoeij, require the use of a powerful computer algebra system. However, this computer-aided approach leads to another closed form of $Q(x, y, z)$ and gives a complementary interesting insight into Gessel's walk.

A.2 Study of the conformal gluing functions

Notation. For the sake of shortness, we drop, from now on, the dependence of the different quantities w.r.t. $z \in]0, 1/4[$.

The main subject of Section A.2 is to prove Theorem A.7. For this, we are going to define two functions, namely w and \tilde{w} , which thanks to Part 5.5 of [FIM99] are known to be suitable CGF for the sets $\mathcal{GX}([y_1, y_2])$ and $\mathcal{GY}([x_1, x_2])$, and we will show that these functions verify the conclusions of Theorem A.7.

The definitions of these CGF given in [FIM99] are recalled here in Subsection A.2.2, see particularly (A.23) and (A.24). They require to define some functions on a uniformization of the algebraic curve $\{(x, y) \in \mathbb{C}^2 : K(x, y, z) = 0\}$, so that we begin Section A.2 by studying an adequate uniformization of this curve – note that Subsection A.2.1 is also necessary for Section A.3, where we will prove Theorem A.3.

A.2.1 Uniformization

In what follows, we note \mathcal{K} the algebraic curve $\{(x, y) \in \mathbb{C}^2 : K(x, y, z) = 0\}$, K being defined in (A.1).

Proposition A.12. *For any $z \in]0, 1/4[$, \mathcal{K} is a Riemann surface of genus one.*

Proof. We have shown in Section A.1 that $K(x, y, z) = 0$ if and only if $[b(x) + 2a(x)y]^2 = d(x)$. But the Riemann surface of the square root of a polynomial which has four distinct roots of order one has genus one, see *e.g.* [JS87], therefore the genus of \mathcal{K} is also one. \square

With Proposition A.12, it is immediate that \mathcal{K} is isomorphic to some torus; in other words, there exists a two-dimensional lattice Ω such that \mathcal{K} is isomorphic to \mathbb{C}/Ω . Such a suitable lattice Ω (in fact the *only possible* lattice, up to a homothetic transformation) is made explicit in Parts 3.1 and 3.3 of [FIM99], namely $\omega_1\mathbb{Z} + \omega_2\mathbb{Z}$, where

$$\omega_1 = \imath \int_{x_1}^{x_2} \frac{dx}{[-d(x)]^{1/2}}, \quad \omega_2 = \int_{x_2}^{x_3} \frac{dx}{[d(x)]^{1/2}}. \quad (\text{A.18})$$

We are now going to give a uniformization of the surface \mathcal{K} , in other words, we are going to make explicit two functions $x(\omega), y(\omega)$ elliptic w.r.t. the lattice Ω such that $\mathcal{K} = \{(x(\omega), y(\omega)), \omega \in \mathbb{C}\}$ – and then also equal to $\{(x(\omega), y(\omega)), \omega \in \mathbb{C}/\Omega\}$. By using the same arguments as in Part 3.3 of [FIM99], we immediately obtain that we can take

$$x(\omega) = x_4 + \frac{d'(x_4)}{\wp(\omega) - d''(x_4)/6}, \quad y(\omega) = \frac{1}{2a(x(\omega))} \left[-b(x(\omega)) + \frac{d'(x_4)\wp'(\omega)}{2(\wp(\omega) - d''(x_4)/6)^2} \right], \quad (\text{A.19})$$

\wp being the Weierstrass elliptic function with periods ω_1, ω_2 .

By convenience, we consider, from now on, that the coordinates of the uniformization x and y are defined on \mathbb{C}/Ω rather than on \mathbb{C} .

It is well-known that \wp is characterized by its invariants g_2, g_3 through

$$\wp'(\omega)^2 = 4\wp(\omega)^3 - g_2\wp(\omega) - g_3. \quad (\text{A.20})$$

Lemma A.13. *The invariants g_2, g_3 of \wp are equal to :*

$$g_2 = (4/3)(1 - 16z^2 + 16z^4), \quad g_3 = -(8/27)(1 - 8z^2)(1 - 16z^2 - 8z^4).$$

Proof. It is well-known that $4\wp(\omega)^3 - g_2\wp(\omega) - g_3 = 4[\wp(\omega) - \wp(\omega_1/2)][\wp(\omega) - \wp([\omega_1 + \omega_2]/2)][\wp(\omega) - \wp(\omega_2/2)]$; in particular, the invariants can be calculated in terms of the values of \wp at the half-periods. But it is clear (and proved in Part 3.3 of [FIM99]) that setting $f(t) = d'(x_4)/(t - x_4) + d''(x_4)/6$, we have $\wp(\omega_1/2) = f(x_3)$, $\wp([\omega_1 + \omega_2]/2) = f(x_2)$ and $\wp(\omega_2/2) = f(x_1)$, so that Lemma A.13 follows from a direct calculation. \square

Now that the uniformization (A.19) is completely and explicitly defined, it is natural to be interested in the reciprocal images through it of the important cycles that are the branch cuts $[x_1, x_2]$, $[x_3, x_4]$, $[y_1, y_2]$ and $[y_3, y_4]$. For this, we need to define a new period, namely

$$\omega_3 = \int_{-\infty}^{x_1} \frac{dx}{[d(x)]^{1/2}}. \quad (\text{A.21})$$

We will importantly use the fact that $\omega_3 \in]0, \omega_2[$, which is proved in Part 3.3 of [FIM99].

Proposition A.14. *We have $x^{-1}([x_1, x_2]) = [0, \omega_1[+ \omega_2/2$ and $x^{-1}([x_3, x_4]) = [0, \omega_1[$, $y^{-1}([y_1, y_2]) = [0, \omega_1[+ [\omega_2 + \omega_3]/2$ and $y^{-1}([y_3, y_4]) = [0, \omega_1[+ \omega_3/2$.*

Proposition A.14 follows from repeating the arguments of Part 5.5 of [FIM99], and is illustrated on Picture A.4 below.

Now we define $S(x, y) = 1/x + 1/(xy) + x + xy$, the generating function of the jump probabilities of Gessel's walk, and we consider the following two birational transformations

$$\Psi(x, y) = (x, 1/(x^2y)), \quad \Phi(x, y) = (1/(xy), y).$$

They are such that $\Psi^2 = \Phi^2 = \text{id}$ and $S \circ \Psi = S \circ \Phi = S$. Then, as in [FIM99], we define the *group of the random walk* W as the group generated by Ψ and Φ . This is well known, see *e.g.* [BMM09], that W is of order eight for the process considered here; in other words, $\inf\{n > 0 : (\Phi \circ \Psi)^n = \text{id}\} = 4$.

If $(x, y) \in \mathbb{C}^2$ is such that $K(x, y, z) = 0$ and if Θ is any element of W , then obviously $K(\Theta(x, y), z) = 0$. This means that the group W can also be understood as a group of automorphisms of the algebraic curve \mathcal{K} .

It is also shown in Part 3.1 of [FIM99] that these automorphisms Ψ and Φ defined on \mathcal{K} become on \mathbb{C}/Ω the automorphisms ψ and ϕ with the following expressions :

$$\psi(\omega) = -\omega, \quad \phi(\omega) = -\omega + \omega_3. \quad (\text{A.22})$$

They are such that $\psi^2 = \phi^2 = \text{id}$, $x \circ \psi = x$, $y \circ \psi = 1/(x^2y)$, $x \circ \phi = 1/(xy)$ and $y \circ \phi = y$. A crucial fact is the following.

Proposition A.15. *For all $z \in]0, 1/4[$, we have $\omega_3 = 3\omega_2/4$.*

Proof. Since the group generated by Ψ and Φ is of order eight, so is the group generated by ψ and ϕ (this fact will be completely shown and generalized in the proof of Proposition B.18), in other words, $\inf\{n > 0 : (\phi \circ \psi)^n = \text{id}\} = 4$. With (A.22), this immediately implies that $4\omega_3$ is some point of the lattice Ω , contrary to ω_3 , $2\omega_3$ and $3\omega_3$. But we already know that $\omega_3 \in]0, \omega_2[$, so that two possibilities remain : either $\omega_3 = \omega_2/4$ or $\omega_3 = 3\omega_2/4$.

In addition, essentially because the covariance of Gessel's walk is positive, we can use the same arguments as in Section C.5 of Chapter C, and, in this way, we obtain that ω_3 is necessary larger than $\omega_2/2$, which entails Proposition A.15. \square

A.2.2 Implicit expression and global properties of the CGF

As said in Section A.1, the *existence* of CGF for the sets $\mathcal{G}X([y_1, y_2])$ and $\mathcal{G}Y([x_1, x_2])$ follows from general results on conformal gluing, see *e.g.* [Lit00]; actually finding *explicit expressions* for CGF is more problematic.

But by using the same analysis as in Part 5.5 of [FIM99], we obtain explicitly suitable CGF for these sets. Before writing the expression of these CGF, let us recall that \wp , and therefore also x , take each value of $\mathbb{C} \cup \{\infty\}$ twice on $[0, \omega_2] \times [0, \omega_1/\iota]$, but are one-to-one on $[0, \omega_2/2] \times [0, \omega_1/\iota]$. In particular, on this half-parallelogram, x admits a reciprocal function, that we denote by x^{-1} .

Then, with [FIM99], we state :

$$w(t) = \wp_{1,3}(x^{-1}(t) - [\omega_1 + \omega_2]/2), \quad (\text{A.23})$$

$\wp_{1,3}$ being the Weierstrass elliptic function with periods ω_1, ω_3 and x^{-1} the reciprocal function of the first coordinate of the uniformization (A.19); the periods $\omega_1, \omega_2, \omega_3$ are defined in (A.18) and (A.21).

In Section C.5 of Chapter C, we will study some properties of the function defined by (A.23); among other things, we will show that if $\omega_3 > \omega_2/2$ (which is actually the case here, see Proposition A.15), then the function (A.23) is in fact meromorphic on $\mathbb{C} \setminus [x_3, x_4]$ with a unique pole, of order one and at x_2 .

In order to find explicitly a CGF for the set $\mathcal{G}Y([x_1, x_2])$, we remark that

$$\tilde{w}(t) = w(X_0(t)) \quad (\text{A.24})$$

is suitable – this is a consequence of the facts that w is a CGF for $\mathcal{G}X([y_1, y_2])$ and that $X_0 : \mathcal{G}Y([x_1, x_2]) \setminus [y_1, y_2] \rightarrow \mathcal{G}X([y_1, y_2]) \setminus [x_1, x_2]$ is conformal, as stated in Lemma A.16 below.

More globally, \tilde{w} defined by (A.24) is meromorphic on $\mathbb{C} \setminus [y_3, y_4]$ and has there a unique pole, of order two and at $Y(x_2) = x_3$ – this is a consequence of some properties of w already mentioned and of the fact that $X_0(\mathbb{C}) \subset \mathbb{C} \setminus [x_3, x_4]$, see also Lemma A.16 (for the proof of the latter, we refer to Part 5.3 of [FIM99]).

Lemma A.16. $X_0 : \mathcal{G}Y([x_1, x_2]) \setminus [y_1, y_2] \rightarrow \mathcal{G}X([y_1, y_2]) \setminus [x_1, x_2]$ and $Y_0 : \mathcal{G}X([y_1, y_2]) \setminus [x_1, x_2] \rightarrow \mathcal{G}Y([x_1, x_2]) \setminus [y_1, y_2]$ are conformal and reciprocal the one from the other. In addition, $X_0(\mathbb{C}) \subset \mathbb{C} \setminus [x_3, x_4]$ and $Y_0(\mathbb{C}) \subset \mathbb{C} \setminus [y_3, y_4]$

Let us now complete the proof of Theorem A.6, by showing the following.

Proposition A.17. *The integral representations of $z[Q(x, 0, z) - Q(0, 0, z)]$ and $z[(y + 1)Q(0, y, z) - Q(0, 0, z)]$ given in Theorem A.6 hold not only on the sets $\mathcal{G}X([y_1, y_2])$ and $\mathcal{G}Y([x_1, x_2])$ but actually on $\mathbb{C} \setminus [x_3, x_4]$ and $\mathbb{C} \setminus [y_3, y_4]$.*

Proof. It is clear from their explicit expression that these integral representations can be continued from $\mathcal{G}X([y_1, y_2])$ and $\mathcal{G}Y([x_1, x_2])$ up to $\mathbb{C} \setminus ([x_3, x_4] \cup (w^{-1}(w([x_1, x_2])) \setminus [x_1, x_2]))$ and $\mathbb{C} \setminus ([y_3, y_4] \cup (\tilde{w}^{-1}(\tilde{w}([y_1, y_2])) \setminus [y_1, y_2]))$ respectively. In other words, in order to prove Proposition A.17, it is enough to show that $w^{-1}(w([x_1, x_2])) \setminus [x_1, x_2] = \emptyset$ and that $\tilde{w}^{-1}(\tilde{w}([y_1, y_2])) \setminus [y_1, y_2] = \emptyset$.

To begin with, we explain why $w^{-1}(w([x_1, x_2])) \setminus [x_1, x_2] = \emptyset$. By using the fact \wp is one-to-one on $[0, \omega_2/2[\times]0, \omega_1/\iota[$, we easily obtain that $x^{-1}(\mathbb{C}) = [0, \omega_2/2] \times [0, \omega_1/\iota[$. In particular, with Proposition A.15, we have $x^{-1}(\mathbb{C}) \subset]-\omega_3 + \omega_2/2, \omega_2/2] \times [0, \omega_1/\iota[$. But $\wp_{1,3}$ takes each value of $\mathbb{C} \cup \{\infty\}$ twice on the parallelogram $] -\omega_3 + \omega_2/2, \omega_2/2] \times [0, \omega_1/\iota[$, and with the proof of Lemma A.13, $\wp_{1,3}([-\omega_1/2, 0]) = \wp_{1,3}([0, \omega_1/2]) = w([x_1, x_2])$, so that we get $w^{-1}(w([x_1, x_2])) \setminus [x_1, x_2] = \emptyset$.

By using the same kind of arguments as above, as well as with (A.24), we obtain that $\tilde{w}^{-1}(\tilde{w}([y_1, y_2])) \setminus [y_1, y_2] = \emptyset$. \square

A.2.3 Proof of Theorem A.7

Proof. We are going here to note $\omega_4 = \omega_2/4$, and $\wp_{1,4}$ for the Weierstrass elliptic function with periods ω_1, ω_4 . Moreover, we recall that \wp and $\wp_{1,3}$ denote the Weierstrass elliptic functions with respective periods ω_1, ω_2 and $\omega_1, \omega_3 = 3\omega_2/4$.

To begin with, let us mention the following fact. Let $\check{\wp}$ be the Weierstrass elliptic function with periods noted $\hat{\omega}, \check{\omega}$ and let n be some positive integer. Then the Weierstrass elliptic function with periods $\hat{\omega}, \check{\omega}/n$ can be written in terms of $\check{\wp}$ as follows :

$$\check{\wp}(\omega) + \sum_{k=1}^{n-1} [\check{\wp}(\omega + k\check{\omega}/n) - \check{\wp}(k\check{\omega}/n)], \quad (\text{A.25})$$

see <http://functions.wolfram.com/EllipticFunctions/WeierstrassP/16/06/03/>.

Then, by using *e.g.* the addition theorem (A.26) for the Weierstrass elliptic function $\check{\wp}$ in (A.25) and next the identity (A.20), we obtain that *the Weierstrass elliptic function with periods $\hat{\omega}, \check{\omega}/n$ is a rational function of the Weierstrass elliptic function with periods $\hat{\omega}, \check{\omega}$.*

The proof of Theorem A.7 will then follow from applying this fact twice :

- (i) first, since $\omega_4 = \omega_2/4$, we will express $\wp_{1,4}$ as a rational function of \wp ,
- (ii) then, thanks to the identity $\omega_4 = \omega_3/3$, we will formulate $\wp_{1,4}$ as a rational function of $\wp_{1,3}$.

Before making explicit the rational transformations that appear with the points (i) and (ii), we explain how to conclude the proof of Theorem A.7.

An immediate consequence of (i) and (ii) is the possibility of writing $\wp_{1,3}$ as an algebraic function of \wp . In particular, it is clear from that and from the addition theorem (A.26) for \wp that the formula $w(t) = \wp_{1,3}(\wp^{-1}(f(t)) - [\omega_1 + \omega_2]/2)$, with $f(t) = d'(x_4)/(t - x_4) + d''(x_4)/6$ – which is the CGF under consideration, see (A.19) and (A.23) – defines an algebraic function of t .

Explicit expression of the rational function for (i). With (A.25), we can write

$$\wp_{1,4}(\omega) = \wp(\omega) + \wp(\omega + \omega_2/2) + \wp(\omega + \omega_2/4) + \wp(\omega + 3\omega_2/4) - \wp(\omega_2/2) - \wp(\omega_2/4) - \wp(3\omega_2/4).$$

Then, by using the addition theorem for \wp , namely the following formula, valid for all $\omega, \tilde{\omega}$ – which can be found *e.g.* in [Law89] –,

$$\wp(\omega + \tilde{\omega}) = -\wp(\omega) - \wp(\tilde{\omega}) + \frac{1}{4} \left[\frac{\wp'(\omega) - \wp'(\tilde{\omega})}{\wp(\omega) - \wp(\tilde{\omega})} \right]^2, \quad (\text{A.26})$$

as well as the equalities $\wp(\omega_2/4) = \wp(3\omega_2/4)$, $\wp'(\omega_2/4) = -\wp'(3\omega_2/4)$ and $\wp'(\omega_2/2) = 0$ – obtained from the facts that $\wp(\omega_2/2 + \omega)$ and $\wp'(\omega_2/2 + \omega)$ are respectively even and odd functions of ω –, we get

$$\wp_{1,4}(\omega) = -2\wp(\omega) + \frac{\wp'(\omega)^2 + \wp'(\omega_2/4)^2}{2[\wp(\omega) - \wp(\omega_2/4)]^2} + \frac{\wp'(\omega)^2}{4[\wp(\omega) - \wp(\omega_2/2)]^2} - \wp(\omega_2/2) - 2\wp(\omega_2/4). \quad (\text{A.27})$$

Now we recall from the proof of Lemma A.13 that $\wp(\omega_2/2) = f(x_1)$. In other words, for the right hand side of (A.27) to be completely explicit, it remains to find the expressions of $\wp(\omega_2/4)$ and $\wp'(\omega_2/4)$ in terms of z .

But starting from the known value of $\wp(\omega_2/2)$, it is easy to obtain the expression of $\wp(\omega_2/4)$, by using *e.g.* the formula below (a proof of which being given in [Law89]) :

$$\wp(\omega_2/4) = \wp(\omega_2/2) + [(\wp(\omega_2/2) - \wp(\omega_1/2))(\wp(\omega_2/2) - \wp([\omega_1 + \omega_2]/2))]^{1/2}. \quad (\text{A.28})$$

Then we use that $\wp(\omega_1/2) = f(x_3)$, $\wp([\omega_1 + \omega_2]/2) = f(x_2)$, $\wp(\omega_2/2) = f(x_1)$ and after simplification, we get $\wp(\omega_2/4) = (1 + 4z^2)/3$. As a consequence as well as with (A.20) and Lemma A.13, we obtain $\wp'(\omega_2/4)^2 = 64z^4$. Since \wp is decreasing on $]0, \omega_2/2[$, see [Law89], we have $\wp'(\omega_2/4) < 0$ and therefore $\wp'(\omega_2/4) = -8z^2$. In conclusion, the right hand side of (A.27) is completely and explicitly known.

In particular, evaluating (A.27) at $\omega = \wp^{-1}(f(t)) - [\omega_1 + \omega_2]/2$ and using again the addition formula (A.26) for \wp , we obtain that the right hand side of (A.27) is a rational function of t that can be explicitly obtained in terms of t and z ; after a substantial but elementary calculation, we get $\wp_{1,4}(\wp^{-1}(f(t)) - [\omega_1 + \omega_2]/2) = F(t)$, F being defined in (A.10).

Explicit expression of the rational function for (ii). Using the same arguments that have allowed us to obtain (A.27) from (A.25), we obtain that $\wp_{1,4}$ is the following rational function of $\wp_{1,3}$:

$$\wp_{1,4}(\omega) = -\wp_{1,3}(\omega) + \frac{\wp'_{1,3}(\omega)^2 + \wp'_{1,3}(\omega_3/3)^2}{2[\wp_{1,3}(\omega) - \wp_{1,3}(\omega_3/3)]^2} - 4\wp_{1,3}(\omega_3/3). \quad (\text{A.29})$$

By using then (A.29) and the equality $\wp'_{1,3}(\omega)^2 = 4\wp_{1,3}(\omega)^3 - g_{2,1,3}\wp_{1,3}(\omega) - g_{3,1,3}$, where $g_{2,1,3}, g_{3,1,3}$ are the invariants associated with $\wp_{1,3}$, we get that $\wp_{1,4}$ is a rational function of $\wp_{1,3}$; moreover, with Lemma A.18 as well as with the equality $\wp'_{1,3}(\omega_3/3)^2 = 4\wp_{1,3}(\omega_3/3)^3 - g_{2,1,3}\wp_{1,3}(\omega_3/3) - g_{3,1,3}$ and Lemma A.19, the coefficients of this rational function in terms of z become explicitly known.

Proof of (A.11). Now we remark that Lemmas A.18 and A.19 allow us to write (A.29) as

$$\begin{aligned} \wp_{1,3}(\omega)^3 - \wp_{1,3}(\omega)^2 [\wp_{1,4}(\omega) + 2L] + \wp_{1,3}(\omega) [2L\wp_{1,4}(\omega) + L^2/3 + G_2/2] \\ - [L^2\wp_{1,4}(\omega) + 19G_2L/18 + G_3 - 46L^3/27] = 0. \end{aligned}$$

In particular, evaluating this equality at $\omega = \wp^{-1}(f(t)) - [\omega_1 + \omega_2]/2$, using the fact already proved that $\wp_{1,4}(\wp^{-1}(f(t)) - [\omega_1 + \omega_2]/2) = F(t)$ as well as the definition (A.23) of w , we obtain (A.11).

End of the proof of Theorem A.7. If F is infinite at some point, then the equality (A.11) becomes $(w - L)^2 = 0$. In particular, at a such point at least two roots of (A.11) take finite values. In addition, by using the root-coefficient relationships, it is clear that at a point where F is infinite, at least one root of (A.11) is infinite.

This proves that at any point where F is infinite, there is one and only one root of (A.11) which is infinite.

In particular, since F is infinite at x_2 , see (A.10), and since w has a pole at x_2 , see Subsection A.2.2, w can be characterized as the only solution of (A.11) with a pole at x_2 .

Likewise, we could prove the corresponding fact for \tilde{w} . Theorem A.7 is proved. \square

Let G_2, G_3, L be the quantities defined in Section A.1 (just above the statement of Theorem A.7). The two following results have been used in the proof of Theorem A.7.

Lemma A.18. $\wp_{1,3}(\omega_3/3) = L$.

Lemma A.19. $g_{2,1,3}, g_{3,1,3}$, the invariants of $\wp_{1,3}$, have the following explicit expressions :

$$g_{2,1,3} = 40L^2/3 - G_2, \quad g_{3,1,3} = -280L^3/27 + 14LG_2/9 + G_3.$$

Proof of Lemmas A.18 and A.19. Start by expanding $\wp_{1,4}$ at 0 in two different ways.

Firstly, by using (A.27) and after simplification, we obtain

$$\wp_{1,4}(\omega) = \frac{1}{\omega^2} + [9G_2/20]\omega^2 - [27G_3/28]\omega^4 + O(\omega^6). \quad (\text{A.30})$$

Secondly, we can also use (A.29) in order to expand $\wp_{1,4}$ at 0, and after some calculation, we get

$$\wp_{1,4}(\omega) = \frac{1}{\omega^2} + [6L^2 - 9g_{2,1,3}/20]\omega^2 + [10L^3 - 3Lg_{2,1,3}/2 - 27g_{3,1,3}/28]\omega^4 + O(\omega^6). \quad (\text{A.31})$$

Lemma A.19 follows then immediately, by identifying the expansions (A.30) and (A.31).

As for Lemma A.18, it is actually be a consequence of Lemma A.19 and of the following result, proved *e.g.* in [Law89] : the quantity $M = \wp_{1,3}(\omega_3/3)$ is the only positive solution of the equation $M^4 - g_{2,1,3}M^2/2 - g_{3,1,3}M - g_{2,1,3}^2/48 = 0$. But thanks to Lemma A.19, we can replace $g_{2,1,3}, g_{3,1,3}$ by their expression in terms of G_2, G_3, M ; in this way, we obtain that M verifies the equation $M^4 - G_2M^2/2 - G_3M - G_2^2/48 = 0$. \square

A.3 Holomorphic continuation of the generating functions

In this part, we are going to prove Theorem A.3, in other words, we are going to show that $zQ(x, 0)$ and $z(y + 1)Q(0, y)$ can be holomorphically continued from their unit disc up to $\mathbb{C} \setminus [x_3, x_4]$ and $\mathbb{C} \setminus [y_3, y_4]$ respectively.

In fact, we are going to show that $Q(x, 0)$ and $Q(0, y)$ can be holomorphically continued up to $\mathbb{C} \setminus [x_3, x_4]$ and $\mathbb{C} \setminus [y_3, y_4]$ respectively, which is an equivalent assertion, as shown at the end of the proof of Theorem A.20.

For this, we are going to use the following procedure.

- (i) First of all, we will lift the functions $Q(x, 0)$ and $Q(0, y)$ up to \mathbb{C}/Ω by setting $q_x(\omega) = Q(x(\omega), 0)$ and $q_y(\omega) = Q(0, y(\omega))$. The functions q_x and q_y are *a priori* well defined on $x^{-1}(\{|x| \leq 1\})$ and $y^{-1}(\{|y| \leq 1\})$ respectively.
- (ii) Then, we will prove the following.

Theorem A.20. *q_x and q_y , initially well defined on $x^{-1}(\{|x| \leq 1\})$ and $y^{-1}(\{|y| \leq 1\})$ respectively, can be holomorphically continued up to the whole parallelogram \mathbb{C}/Ω cut along $[0, \omega_1[$ and $[0, \omega_1[+ \omega_3/2$ respectively. Moreover, these continuations verify*

$$\forall \omega \in \mathbb{C}/\Omega \setminus [0, \omega_1[: q_x(\omega) = q_x(\psi(\omega)), \quad \forall \omega \in \mathbb{C}/\Omega \setminus ([0, \omega_1[+ \omega_3/2) : q_y(\omega) = q_y(\phi(\omega)), \quad (\text{A.32})$$

and

$$\forall \omega \in]3\omega_2/8, \omega_2[\times [0, \omega_1/\iota[: zq_x(\omega) + z(y(\omega) + 1)q_y(\omega) - zQ(0, 0) - x(\omega)y(\omega) = 0. \quad (\text{A.33})$$

Remark A.21. *Both (A.4) and (A.5) are immediate consequences of (A.33).*

- (iii) Finally, we will set $Q(x, 0) = q_x(\omega)$ if $x(\omega) = x$ and $Q(0, y) = q_y(\omega)$ if $y(\omega) = y$. Thanks to (A.32) and Proposition A.14, these equalities define $Q(x, 0)$ and $Q(0, y)$ on respectively $\mathbb{C} \setminus [x_3, x_4]$ and $\mathbb{C} \setminus [y_3, y_4]$ not ambiguously, as holomorphic functions.

Item (i) and (iii) are straightforward. For the proof of (ii), it is useful first to find the location of the cycles $x^{-1}(\{|x| = 1\})$ and $y^{-1}(\{|y| = 1\})$ on \mathbb{C}/Ω , this is the subject of the following result, illustrated on Picture A.4 below.

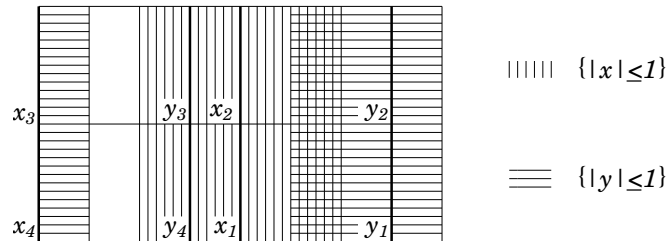

FIGURE A.4 – Location of the important cycles on the surface $[0, \omega_2[\times [0, \omega_1/\iota[$

Proposition A.22. *We have $x^{-1}(\{|x| = 1\}) = ([0, \omega_1[+ \omega_2/4) \cup ([0, \omega_1[+ 3\omega_2/4)$ and $y^{-1}(\{|y| = 1\}) = ([0, \omega_1[+ \omega_2/8) \cup ([0, \omega_1[+ 5\omega_2/8)$.*

Proof. The details are of course essentially the same for x and y , so that we are going to prove only the assertion concerning x . The proof is composed of three steps.

But first of all, let us note that because of the equality $x \circ \psi = x$, it is sufficient to prove that $x^{-1}(\{|x| = 1\}) \cap ([0, \omega_2/2[\times [0, \omega_1/\iota[) = [0, \omega_1[+ \omega_2/4$ – the advantage of this being that \wp , and therefore also x , are one-to-one in the half-parallelogram $[0, \omega_2/2[\times [0, \omega_1/\iota[$.

Firstly, we prove that $x(\omega_2/4 + \omega_1/2) = 1$. For this, we recall that $\wp(\omega_2/4) = (1 + 4z^2)/3$, $\wp'(\omega_2/4) = -8z^2$, $\wp(\omega_1/2) = f(x_3)$ and $\wp'(\omega_2/2) = 0$, see the proofs of Theorem A.7 and Lemma A.13. Then, with the addition theorem (A.26), we immediately obtain the explicit value of $\wp(\omega_2/4 + \omega_1/2)$. Finally, after a simple calculation and the use of (A.19), we get that $x(\omega_2/4 + \omega_1/2) = 1$.

Secondly, we show that $x^{-1}(\{|x| = 1\}) \cap ([0, \omega_2/2[\times [0, \omega_1/\iota[) \subset [0, \omega_1[+ \omega_2/4$. For this, let $\theta \in [0, 2\pi[$. With (A.19), we have $x(\omega) = \exp(i\theta)$ if and only if $\wp(\omega) = f(\exp(i\theta))$. Since $\omega \in [0, \omega_2/2] \times [0, \omega_1/\iota[$, we can use the well-known explicit expression of the reciprocal function of \wp , and with the first step we obtain :

$$\omega = \omega_2/4 + \omega_1/2 + \int_{f(1)}^{f(\exp(i\theta))} \frac{dt}{[4t^3 - g_2t - g_3]^{1/2}} = \omega_2/4 + \omega_1/2 + \frac{1}{2} \int_{\exp(i\theta)}^1 \frac{dx}{[d(x)]^{1/2}}, \quad (\text{A.34})$$

d being defined in Section A.1 and g_2, g_3 in Lemma A.13. Note that the second equality above is got with the same calculations as in Part 3.3 of [FIM99].

Now we remark that $d(x) = x^4 d(1/x)$. In particular, the change of variable $x \mapsto 1/x$ in the integral $\int_{\exp(i\theta)}^1 dx/[d(x)]^{1/2}$ yields

$$\int_{\exp(i\theta)}^1 \frac{dx}{[d(x)]^{1/2}} = - \int_{\exp(-i\theta)}^1 \frac{dx}{[d(x)]^{1/2}}.$$

As a consequence, this integral belongs to $i\mathbb{R}$.

In conclusion, with (A.34), we have shown that actually $x^{-1}(\{|x| = 1\}) \cap ([0, \omega_2/2[\times [0, \omega_1/\iota[) \subset [0, \omega_1[+ \omega_2/4$.

Thirdly, we prove that the inclusion above has to be an equality. Indeed, if it was not the case, the curve $x^{-1}(\{|x| = 1\}) \cap ([0, \omega_2/2[\times [0, \omega_1/\iota[)$ would be curve *not* closed, which is a manifest contradiction with the facts that $\{|x| = 1\}$ is closed and that x is meromorphic and one-to-one in the half-parallelogram $[0, \omega_2/2[\times [0, \omega_1/\iota[$. \square

Proof of Theorem A.20. The proof is composed of two steps. We are going first to define the continuations of q_x and q_y on the whole parallelogram \mathbb{C}/Ω appropriately cut, and then, we will verify that the functions so-constructed actually verify the conclusions of Theorem A.20.

- * We define $q_x(\omega)$ on $x^{-1}(\{|x| \leq 1\})$ by $Q(x(\omega), 0)$ and $q_y(\omega)$ on $y^{-1}(\{|y| \leq 1\})$ by $Q(0, y(\omega))$ – note that as a consequence of Proposition A.22, we have $x^{-1}(\{|x| \leq 1\}) = [\omega_2/4, 3\omega_2/4] \times [0, \omega_1/\iota[$ and $y^{-1}(\{|y| \leq 1\}) = [5\omega_2/8, 9\omega_2/8] \times [0, \omega_1/\iota[$.
- * Motivated by Equation (A.1), on $]3\omega_2/4, \omega_2[\times [0, \omega_1/\iota[\subset y^{-1}(\{|y| \leq 1\})$, we set $q_x(\omega) = -(y(\omega) + 1)q_y(\omega) + Q(0, 0) + x(\omega)y(\omega)/z$ and on $]3\omega_2/8, 5\omega_2/8] \times [0, \omega_1/\iota[\subset x^{-1}(\{|x| \leq 1\})$, we set $(y(\omega) + 1)q_y(\omega) = -q_x(\omega) + Q(0, 0) + x(\omega)y(\omega)/z$.
- * On $]0, \omega_2/4] \times [0, \omega_1/\iota[$, we define $q_x(\omega)$ by $q_x(\phi(\omega))$ – note that with (A.22), we have $\phi(]0, \omega_2/4] \times [0, \omega_1/\iota[) = [3\omega_2/4, \omega_2[\times [0, \omega_1/\iota[$. On $[\omega_2/8, 3\omega_2/8] \times [0, \omega_1/\iota[$, we define $q_y(\omega)$ by $q_y(\psi(\omega))$ – by using (A.22), we have $\psi([\omega_2/8, 3\omega_2/8] \times [0, \omega_1/\iota[) =]3\omega_2/8, 5\omega_2/8] \times [0, \omega_1/\iota[$.

The functions q_x and q_y are now well defined on the whole parallelogram \mathbb{C}/Ω cut along $[0, \omega_1[$ and $[0, \omega_1[+ \omega_3/2$ respectively.

Note that the definitions of q_x and q_y given in the first *item* above are quite natural. The one stated in the second *item* is also natural since on $x^{-1}(\{|x| \leq 1\}) \cap y^{-1}(\{|y| \leq 1\}) = [5\omega_2/8, 3\omega_2/4] \times [0, \omega_1/\iota[$, the equality $q_x(\omega) + (y(\omega) + 1)q_y(\omega) - Q(0, 0) - x(\omega)y(\omega)/z = 0$ holds, see (A.1). The definition set in the third *item* is to ensure that (A.32) is valid.

Let us now prove that the functions q_x and q_y so-continued verify the different assertions of Theorem A.20.

Note first that (A.33) is immediately true, by construction of the continuations.

We are now going to verify (A.32) for q_x .

By using the first *item* above as well as the equality $x \circ \psi = x$, (A.32) is obviously verified on $[\omega_2/4, 3\omega_2/4] \times [0, \omega_1/\iota[= \psi([\omega_2/4, 3\omega_2/4] \times [0, \omega_1/\iota[)$. Moreover, with the third *item*, (A.32) is verified for q_x on $]0, \omega_2/4[\times [0, \omega_1/\iota[$, and since $\psi^2 = \text{id}$, (A.32) is also true for q_x on $]3\omega_2/4, \omega_2[\times [0, \omega_1/\iota[$, and finally on the whole $\mathbb{C}/\Omega \setminus [0, \omega_1[$.

Likewise, we verify easily that (A.32) is valid for q_y on $\mathbb{C}/\Omega \setminus ([0, \omega_1[+ 3\omega_2/8)$.

It remains to prove that the continuations of q_x and q_y are holomorphic on \mathbb{C}/Ω cut along $[0, \omega_1[$ and $[0, \omega_1[+ 3\omega_2/8$ respectively.

We show first that they are *meromorphic* on their respective cut parallelogram. For q_x , the following cycles are *a priori* problematic : $[0, \omega_1[$, $[0, \omega_1[+ \omega_2/4$ and $[0, \omega_1[+ 3\omega_2/4$.

In an open neighborhood of $[0, \omega_1[+ 3\omega_2/4$, we have the identity $q_x(\omega) = -(y(\omega) + 1)q_y(\omega) + Q(0, 0) + x(\omega)y(\omega)/z$, so that q_x is in fact meromorphic in the neighborhood of the cycle $[0, \omega_1[+ 3\omega_2/4$. Since (A.32) holds, q_x is also meromorphic near $[0, \omega_1[+ \omega_2/4 = \psi([0, \omega_1[+ 3\omega_2/4)$, so that only $[0, \omega_1[$ *a priori* remains (and actually is) a singular cycle.

Similarly, we could show that q_y is meromorphic on $\mathbb{C}/\Omega \setminus ([0, \omega_1[+ 3\omega_2/8)$.

Let us now prove that these continuations are even *holomorphic* on their respective cut parallelogram.

q_x is obviously holomorphic on $] \omega_2/4, 3\omega_2/4[\times [0, \omega_1/\iota[$, since it is there defined through the power series $Q(x, 0)$.

On $]5\omega_2/8, \omega_2[\times [0, \omega_1/\iota[$, we have $q_x(\omega) = -(y(\omega) + 1)q_y(\omega) + Q(0, 0) + x(\omega)y(\omega)/z$, and all terms of the right hand side of this equality are holomorphic on this domain – at $7\omega_2/8$, x has a pole of order one and y has a zero of order two, see Lemma A.23 below, so that the product xy is holomorphic near $7\omega_2/8$.

On $]0, 3\omega_2/8[\times [0, \omega_1/\iota[$, we have $q_x = q_x \circ \psi$, so that q_x is holomorphic on this domain since it is on $\psi(]0, 3\omega_2/8[\times [0, \omega_1/\iota[) =]5\omega_2/8, \omega_2[\times [0, \omega_1/\iota[$.

Likewise, we could show that $(y + 1)q_y$ is holomorphic on $\mathbb{C}/\Omega \setminus ([0, \omega_1[+ \omega_3/2)$. This implies that q_y is holomorphic on the same set except at the points where $y + 1 = 0$. There are two possibilities in order to show that q_y is also holomorphic at the points where $y + 1 = 0$, namely $\omega_2/8$ and $5\omega_2/8$, in accordance with Lemma A.23.

First, we can use the fact that the generating function $Q(0, y)$ is bounded at -1 , see Section A.1, so that $q_y(\omega) = Q(0, y(\omega))$, being meromorphic and bounded near $\omega_2/8$ and $5\omega_2/8$, is actually holomorphic at these points.

We can also remark that with (A.33), $(y(5\omega_2/8) + 1)q_y(5\omega_2/8) = 0$, since with Lemma A.23, $x(5\omega_2/8) = 0$. Moreover, since $\phi(5\omega_2/8) = \omega_2/8$, $(y(\omega_2/8) + 1)q_y(\omega_2/8) = 0$. In other words, at $\omega = \omega_2/8$ and $\omega = 5\omega_2/8$, both holomorphic functions $(y + 1)q_y$ and $(y + 1)$ have a zero, the first one of order equal or larger than one, the second one of order exactly one ; it follows immediately that q_y is holomorphic at ω . \square

The following result, which has been used in the proof of Theorem A.20, follows easily from Lemma A.1 and from the fact that the Weierstrass elliptic function \wp takes on the parallelogram $]0, \omega_2[\times [0, \omega_1/\iota[$ each value of $\mathbb{C} \cup \{\infty\}$ twice.

Lemma A.23. *The only poles of x are at $\omega_2/8, 7\omega_2/8$ and its only zeros are at $3\omega_2/8, 5\omega_2/8$. The only pole of y (of order two) is at $3\omega_2/8$ and its only zero (also of order two) is at $7\omega_2/8$. The only zeros of $y + 1$ are at $\omega_2/8, 5\omega_2/8$.*

Chapitre B

Counting walks in a quarter plane, a unified approach *via* boundary value problems *

The aim of this chapter is to introduce a unified method for giving explicit integral representations of the trivariate generating function of the number of paths for walks with small steps confined in a quadrant. For a number of such walks, this yields for the first time an explicit expression of this counting function. Moreover, the nature of the integrand of the integral formulations obtained here is shown to be very directly dependent on the finiteness of a well-known and naturally attached group of birational transformations.

B.1 Introduction and main results

The enumeration of planar lattice walks is a classical topic in combinatorics. For a given set \mathcal{S} of steps, it is a matter of counting the number of paths with jumps in \mathcal{S} , starting and ending at some arbitrary points in a certain time and eventually restricted to some regions of the plane. A first natural question is then simply : how many such paths exist ? A second question concerns the nature of the associated generating function : is it rational, algebraic, holonomic (*i.e.* solution of a linear differential equation with polynomial coefficients) or non-holonomic ?

For instance, if no restriction on the paths is made, it is well-known and easy to make explicit the counting generating function which is rational. As an other example, if the walks are supposed to remain in a half-plane, then the generating function can also be made explicit and is algebraic, see *e.g.* [BMP03].

It is next natural to consider the walks confined in the intersection of two half-planes, as the quadrant \mathbb{Z}_+^2 . The situation seems then more multifarious : some walks admit an algebraic generating function, see *e.g.* [FH84] and [Ges86] for the walk with steps set $\mathcal{S} = \{(-1, 0), (1, 1), (0, -1)\}$ and starting at $(0, 0)$, while some others admit a counting function that is even not holonomic, see *e.g.* [BMP03] for the walk with steps set $\mathcal{S} = \{(-1, 2), (2, -1)\}$ and starting at $(1, 1)$. It appears therefore interesting to focus on these walks staying in \mathbb{Z}_+^2 .

This is how that very recently, M. Bousquet-Mélou and M. Mishna initiate in [BMM09]

*. The bulk of this work is taken from the preprint [Ras10a].

the systematic study of the walks confined in \mathbb{Z}_+^2 , starting at the origin and having small steps, which means that the set of admissible steps \mathcal{S} is included in $\{(i, j) : |i|, |j| \leq 1\} \setminus \{(0, 0)\}$.

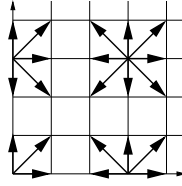

FIGURE B.1 – Walks with small steps confined in the quadrant \mathbb{Z}_+^2

There are obviously 2^8 such models. After eliminating the trivial models as well as the ones intrinsic to the half-plane and taking account of the fact that some models are obtained by symmetry starting from other ones, M. Bousquet-Mélou and M. Mishna show that it remains 79 inherently different problems to study – we will often refer to these 79 walks and to their tables stated in [BMM09].

A common starting point for the study of these 79 walks is the following : denoting by $q(i, j, k)$ the number of paths confined in \mathbb{Z}_+^2 , starting at $(0, 0)$ and ending at (i, j) in time k , their generating function

$$Q(x, y, z) = \sum_{i, j, k \geq 0} q(i, j, k) x^i y^j z^k \quad (\text{B.1})$$

verifies the functional equation (proved in [BMM09])

$$xyz \left[\sum_{(i, j) \in \mathcal{S}} x^i y^j - 1/z \right] Q(x, y, z) = c(x, z)Q(x, 0, z) + \tilde{c}(y, z)Q(0, y, z) - z\delta Q(0, 0, z) - xy, \quad (\text{B.2})$$

where we have noted $c(x, z) = zx \sum_{(i, -1) \in \mathcal{S}} x^i$, $\tilde{c}(y, z) = zy \sum_{(-1, j) \in \mathcal{S}} y^j$ and $\delta = 1$ if $(-1, -1) \in \mathcal{S}$, $\delta = 0$ otherwise. If $n = |\mathcal{S}|$ is the number of steps, then the equality (B.2) is valid at least on $\{|x| \leq 1, |y| \leq 1, |z| < 1/n\}$, since obviously $q(i, j, k) \leq n^k$.

In this way, for answering both questions stated at the very beginning of Chapter B, it is enough to solve (B.2) and to study the expression of (B.1) so-obtained.

It turns out that a key idea for examining Equation (B.2) is to consider some group, introduced in a probabilistic context in [FIM99] and called there *the group of the walk*. This is a group of birational transformations leaving invariant the steps generating function $\sum_{(i, j) \in \mathcal{S}} x^i y^j$, and more precisely this is the group $W = \langle \Psi, \Phi \rangle$ generated by

$$\Psi(x, y) = \left(x, \frac{\sum_{(i, -1) \in \mathcal{S}} x^i \frac{1}{y}}{\sum_{(i, +1) \in \mathcal{S}} x^i y} \right), \quad \Phi(x, y) = \left(\frac{\sum_{(-1, j) \in \mathcal{S}} y^j \frac{1}{x}}{\sum_{(+1, j) \in \mathcal{S}} y^j x}, y \right).$$

Obviously $\Psi \circ \Psi = \Phi \circ \Phi = \text{id}$ and W is a dihedral group – of order even and larger than four. In [BMM09] is calculated this order for each of the 79 cases : 23 walks admit a finite group (and then of order four, six or eight) and the 56 others have an infinite group.

For the 23 walks with a finite group, the answers to both questions (explicit expression and nature of the function (B.1)) in which we are interested have been given very recently. Indeed, in the important paper [BMM09] are solved successfully 22 of the 23 models

associated with a finite group : the series (B.1) is made explicit and is shown to be either algebraic or transcendental but holonomic. As for the 23th walk, known as Gessel’s walk, A. Bostan and M. Kauers have given in [BK09] a computer-aided proof of the fact that the function (B.1) is algebraic. And even more, using a powerful computer algebra system, they have made explicit minimal polynomials. Thanks to these polynomials, M. van Hoeij has then managed to express the function (B.1) by radicals, see the appendix of [BK09]. Before the latter result was public, we have given in [KR09a] an explicit integral representation of the generating function (B.1), without computer help. Moreover, in the work in preparation [BCK⁺10], A. Bostan *et al.* obtain integral representations of the function (B.1) for the 23 walks having a finite group, by using a mathematical and algorithmic method, based on creative telescoping and on the resolution of differential equations of order two in terms of hypergeometric functions.

On the other hand, only 2 cases of the 56 walks having an infinite group have been solved : in [MR09] M. Mishna has considered the walks with steps sets $\mathcal{S} = \{(-1, 1), (1, 1), (1, -1)\}$ and $\mathcal{S} = \{(-1, 1), (0, 1), (1, -1)\}$, see on the left of Picture B.2 below, has made explicit the series (B.1) and has shown that in both cases it is non-holonomic.

The aim of Chapter B is to introduce a unified approach giving an explicit expression of the generating function (B.1) for any of the 79 walks.

For 54 of the 56 walks with an infinite group, this result is new – up to our knowledge. Chapter B also gives rise, after Chapter A on Gessel’s walk, to write integral representations of the function (B.1) for the 22 other walks with a finite group. By the way, we will show that the finiteness of the group and the sign of the covariance of \mathcal{S} act very directly on the nature (rational, algebraic, holonomic, non-holonomic) of the functions in these integral representations.

The approach that we are going to use here is not the same according to the walks under consideration are, or not, singular – by singular we mean here that none of the steps $(0, -1), (-1, -1), (-1, 0)$ belongs to \mathcal{S} .

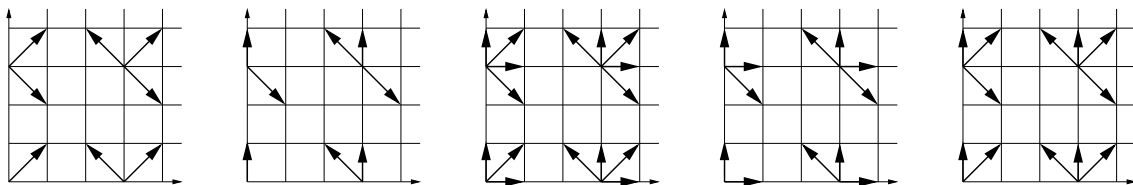

FIGURE B.2 – The five singular walks in the classification of [BMM09]

In order to achieve our aim for the non-singular walks – this concerns the 23 walks having a finite group and 51 of the 56 ones attached to an infinite group, see the tables stated in [BMM09] –, we are going here to generalize up to three variables x, y, z the profound analytic approach developed in [FIM99] by G. Fayolle, R. Iasnogorodski and V. Malyshev for two variables x, y , approach that we have presented Section 1 of Part I.

To summarize, starting from the functional equation (B.2), we will show that $c(x, z)Q(x, 0, z)$ and $\tilde{c}(y, z)Q(0, y, z)$ verify boundary value problems of Riemann-Carleman type; next, transforming them into boundary value problems of Riemann-Hilbert type by use of *conformal gluing functions* and solving these new problems, we will deduce the announced integral representation of (B.1).

Moreover, we will here study in-depth these conformal gluing functions, their analysis

being just sketched out in [FIM99]. The study of these functions, that will use a uniformization of the Riemann surface $\{(x, y) \in \mathbb{C}^2 : \sum_{(i,j) \in \mathcal{S}} x^i y^j - 1/z = 0\}$ given by the zeros of the kernel and fine properties of the Weierstrass elliptic functions, will imply that the finiteness of the group and the sign of the covariance of \mathcal{S} are decisive quantities for the study of these walks.

For the 5 singular walks, the curves associated with the boundary value problems above become degenerated into a point and the previous arguments will not work anymore. But more easily, and once again starting from (B.2), we will be able in this case to make explicit a series representation of the function (B.1) .

We are now going to state the main results of Chapter B. But first of all, let us have a close look to the kernel $xyz[\sum_{(i,j) \in \mathcal{S}} x^i y^j - 1/z]$ that appears in the functional equation (B.2), and let us take some notations.

This kernel can be written as

$$xyz \left[\sum_{(i,j) \in \mathcal{S}} x^i y^j - 1/z \right] = \tilde{a}(y, z)x^2 + \tilde{b}(y, z)x + \tilde{c}(y, z) = a(x, z)y^2 + b(x, z)y + c(x, z)$$

where

$$\begin{aligned} \tilde{a}(y, z) &= zy \sum_{(+1,j) \in \mathcal{S}} y^j, & \tilde{b}(y, z) &= -1 + zy \sum_{(0,j) \in \mathcal{S}} y^j, & \tilde{c}(y, z) &= zy \sum_{(-1,j) \in \mathcal{S}} y^j, \\ a(x, z) &= zx \sum_{(i,+1) \in \mathcal{S}} x^i, & b(x, z) &= -1 + zx \sum_{(i,0) \in \mathcal{S}} x^i, & c(x, z) &= zx \sum_{(i,-1) \in \mathcal{S}} x^i. \end{aligned}$$

Let us also define

$$\tilde{d}(y, z) = \tilde{b}(y, z)^2 - 4\tilde{a}(y, z)\tilde{c}(y, z), \quad d(x, z) = b(x, z)^2 - 4a(x, z)c(x, z).$$

If the walk is non-singular, then for any $z \in]0, 1/n[$, \tilde{d} (resp. d) has three or four roots, that we call the $y_k(z)$ (resp. the $x_k(z)$). They are such that $|y_1(z)| < y_2(z) < 1 < y_3(z) < |y_4(z)|$ (resp. $|x_1(z)| < x_2(z) < 1 < x_3(z) < |x_4(z)|$), as shown in Part 2.3 of [FIM99].

If the walk is singular, the roots above become $y_1(z) = y_2(z) = 0 < 1 < y_3(z) < |y_4(z)|$ (resp. $x_1(z) = x_2(z) = 0 < 1 < x_3(z) < |x_4(z)|$), see Part 6.1 of [FIM99].

The behavior of the branch points $y_k(z)$ and $x_k(z)$ is not so simple for $z \notin]0, 1/n[$ and for this reason, *we will suppose in the sequel that z is fixed in $]0, 1/n[$.*

Now we remark that the kernel equals zero if and only if $[\tilde{b}(y, z) + 2\tilde{a}(y, z)x]^2 = \tilde{d}(y, z)$ or $[b(x, z) + 2a(x, z)y]^2 = d(x, z)$. In particular, the algebraic functions $X(y, z)$ and $Y(x, z)$ defined by $\sum_{(i,j) \in \mathcal{S}} X(y, z)^i y^j - 1/z = 0$ and $\sum_{(i,j) \in \mathcal{S}} x^i Y(x, z)^j - 1/z = 0$ have two branches, meromorphic on the sets $\mathbb{C} \setminus ([y_1(z), y_2(z)] \cup [y_3(z), y_4(z)])$ and $\mathbb{C} \setminus ([x_1(z), x_2(z)] \cup [x_3(z), x_4(z)])$ (resp. $\mathbb{C} \setminus [y_3(z), y_4(z)]$ and $\mathbb{C} \setminus [x_3(z), x_4(z)]$) in the non-degenerate (resp. degenerate) case.

The following straightforward result (see Part 5.3 of [FIM99]) gives some properties and settles the notations for the two branches of the algebraic functions $X(y, z)$ and $Y(x, z)$.

Lemma B.1. *Call $X_0(y, z) = [-\tilde{b}(y, z) + \tilde{d}(y, z)^{1/2}]/[2\tilde{a}(y, z)]$ and $X_1(y, z) = [-\tilde{b}(y, z) - \tilde{d}(y, z)^{1/2}]/[2\tilde{a}(y, z)]$ the branches of $X(y, z)$. For all $y \in \mathbb{C}$ we have $|X_0(y, z)| \leq |X_1(y, z)|$.*

Now we call $Y_0(x, z) = [-b(x, z) + d(x, z)^{1/2}]/[2a(x, z)]$ and $Y_1(x, z) = [-b(x, z) - d(x, z)^{1/2}]/[2a(x, z)]$ the branches of $Y(x, z)$. For all $x \in \mathbb{C}$ we have $|Y_0(x, z)| \leq |Y_1(x, z)|$.

With these notations, we can state the result concerning the explicit expression of the function (B.1) for the 5 singular walks – see Picture B.2. Below, by f^{ok} we mean $f \circ \dots \circ f$ with k occurrences of f .

Theorem B.2. *Suppose that the walk is singular. Then the following series representation holds :*

$$Q(x, 0, z) = \frac{1}{zx^2} \sum_{k \geq 0} Y_0 \circ (X_0 \circ Y_0)^{\circ k}(x, z) [(X_0 \circ Y_0)^{\circ k}(x, z) - (X_0 \circ Y_0)^{\circ(k+1)}(x, z)].$$

$Q(0, y, z)$ is obtained from the equality above by replacing X_0 (resp. Y_0) by Y_0 (resp. X_0). Moreover, $Q(0, 0, z) = 0$ and the function $Q(x, y, z)$ is obtained with (B.2).

Theorem B.2 is shown in [MR09] for both steps sets $\mathcal{S} = \{(-1, 1), (1, 1), (1, -1)\}$ and $\mathcal{S} = \{(-1, 1), (0, 1), (1, -1)\}$; its proof for the three other singular walks is obtained in the same way and we omit it.

Let us now turn to the 74 non-singular walks. We are going to state that both functions $c(x, z)Q(x, 0, z)$ and $\tilde{c}(y, z)Q(0, y, z)$ verify a boundary value problem of Riemann-Carleman type, with boundary conditions on $X([y_1(z), y_2(z)], z)$ and $Y([x_1(z), x_2(z)], z)$, and thus we begin by recalling from Part 5.3 of [FIM99] some properties of these curves.

Lemma B.3. *Consider $X([y_1(z), y_2(z)], z)$ and $Y([x_1(z), x_2(z)], z)$. (i) These two curves are symmetrical w.r.t. the real axis. (ii) They are connected and closed in $\mathbb{C} \cup \{\infty\}$. (iii) They split the complex plane into two connected components; we call $\mathcal{G}X([y_1(z), y_2(z)], z)$ and $\mathcal{G}Y([x_1(z), x_2(z)], z)$ the connected components of $x_1(z)$ and $y_1(z)$ respectively. They verify $\mathcal{G}X([y_1(z), y_2(z)], z) \subset \mathbb{C} \setminus [x_3(z), x_4(z)]$ and $\mathcal{G}Y([x_1(z), x_2(z)], z) \subset \mathbb{C} \setminus [y_3(z), y_4(z)]$.*

Moreover, as illustrated by the example of Gessel's walk in Chapter A, these curves are possibly not included in the unit disc and, thus, the functions $c(x, z)Q(x, 0, z)$ and $\tilde{c}(y, z)Q(0, y, z)$ may *a priori* be not defined on them. For this reason, we need first to continue the generating functions up to these curves : this is exactly the object of the following result, the proof of which being the subject of Section B.2.

Theorem B.4. *The functions $c(x, z)Q(x, 0, z)$ and $\tilde{c}(y, z)Q(0, y, z)$ can be holomorphically continued from the open unit disc \mathcal{D} to $\mathbb{C} \setminus [x_3(z), x_4(z)]$ and $\mathbb{C} \setminus [y_3(z), y_4(z)]$ respectively.*

Now, exactly as in Section A.1 of Chapter A, we obtain that :

$$\begin{aligned} \forall t \in X([y_1(z), y_2(z)], z) & : c(t, z)Q(t, 0, z) - c(\bar{t}, z)Q(\bar{t}, 0, z) = tY_0(t, z) - \bar{t}Y_0(\bar{t}, z), \\ \forall t \in Y([x_1(z), x_2(z)], z) & : \tilde{c}(t, z)Q(0, t, z) - \tilde{c}(\bar{t}, z)Q(0, \bar{t}, z) = X_0(t, z)t - X_0(\bar{t}, z)\bar{t}. \end{aligned} \tag{B.3}$$

Therefore, using Theorem B.4, we get that $c(x, z)Q(x, 0, z)$ and $\tilde{c}(y, z)Q(0, y, z)$ can be found among the functions holomorphic in $\mathcal{G}X([y_1(z), y_2(z)], z)$ and $\mathcal{G}Y([x_1(z), x_2(z)], z)$ and verifying the conditions (B.3) on the boundary of the latter sets.

Such problems are known as boundary value problems of Riemann-Carleman type, see *e.g.* [FIM99]. A standard way to solve them consists in converting them into boundary value problems of Riemann-Hilbert type by use of conformal gluing functions (CGF), in the sense of Definition 1 of Part I.

It is worth recalling that the existence (but *no* explicit expression) of a CGF for a generic set is ensured by general results on conformal gluing, see *e.g.* Chapter 2 of [Lit00].

Transforming the boundary value problems of Riemann-Carleman type into boundary value problems of Riemann-Hilbert type thanks to a CGF, solving these new problems and working out the solutions, we get, as in Chapter A, the following.

Theorem B.5. *Suppose that the walk is one of the 74 non-singular walks.*

The function $c(x, z)Q(x, 0, z) - c(0, z)Q(0, 0, z)$ has the following explicit expression for $z \in]0, 1/n[$ and $x \in \mathcal{GX}([y_1(z), y_2(z)], z)$:

$$c(x, z)Q(x, 0, z) - c(0, z)Q(0, 0, z) = xY_0(x, z) + \frac{1}{\pi} \int_{x_1(z)}^{x_2(z)} \frac{t[-d(t, z)]^{1/2}}{2a(t, z)} \left[\frac{\partial_t w(t, z)}{w(t, z) - w(x, z)} - \frac{\partial_t w(t, z)}{w(t, z) - w(0, z)} \right] dt,$$

w being a CGF for $\mathcal{GX}([y_1(z), y_2(z)], z)$.

The function $\tilde{c}(y, z)Q(0, y, z) - \tilde{c}(0, z)Q(0, 0, z)$ has the following explicit expression for $z \in]0, 1/n[$ and $y \in \mathcal{GY}([x_1(z), x_2(z)], z)$:

$$\tilde{c}(y, z)Q(0, y, z) - \tilde{c}(0, z)Q(0, 0, z) = X_0(y, z)y + \frac{1}{\pi} \int_{y_1(z)}^{y_2(z)} \frac{t[-\tilde{d}(t, z)]^{1/2}}{2\tilde{a}(t, z)} \left[\frac{\partial_t \tilde{w}(t, z)}{\tilde{w}(t, z) - \tilde{w}(y, z)} - \frac{\partial_t \tilde{w}(t, z)}{\tilde{w}(t, z) - \tilde{w}(0, z)} \right] dt,$$

\tilde{w} being a CGF for $\mathcal{GY}([x_1(z), x_2(z)], z)$.

The explicit expression of $zQ(0, 0, z)$ depends on the value of $c(0, z) = \tilde{c}(0, z) \in \{0, z\}$.

Suppose first that $c(0, z) = \tilde{c}(0, z) = z$. Then $\delta = 1$ in (B.2) and with (B.2), we obtain that for any x, y, z verifying $\sum_{(i,j) \in \mathcal{S}} x^i y^j - 1/z = 0$ with $|x| \leq 1$, $|y| \leq 1$ and $z \in]0, 1/n[$:

$$zQ(0, 0, z) = xy - [c(x, z)Q(x, 0, z) - c(0, z)Q(0, 0, z)] - [\tilde{c}(y, z)Q(0, y, z) - \tilde{c}(0, z)Q(0, 0, z)].$$

Suppose now that $c(0, z) = \tilde{c}(0, z) = 0$, or equivalently that $\delta = 0$ in (B.2). Then the function $Q(0, 0, z)$ equals the limit at x goes to 0 of

$$\frac{1}{c(x, z)} \left(xY_0(x, z) + \frac{1}{\pi} \int_{x_1(z)}^{x_2(z)} \frac{t[-d(t, z)]^{1/2}}{2a(t, z)} \left[\frac{\partial_t w(t, z)}{w(t, z) - w(x, z)} - \frac{\partial_t w(t, z)}{w(t, z) - w(0, z)} \right] dt \right).$$

The function $Q(x, y, z)$ has the explicit expression obtained by putting in (B.2) the integral representations of $Q(x, 0, z)$, $Q(0, y, z)$ and $Q(0, 0, z)$ obtained just above.

As a consequence, for the generating functions $c(x, z)Q(x, 0, z) - c(0, z)Q(0, 0, z)$ and $\tilde{c}(y, z)Q(0, y, z) - \tilde{c}(0, z)Q(0, 0, z)$ to be completely explicit, it remains to find explicitly suitable CGF w and \tilde{w} for the sets $\mathcal{GX}([y_1(z), y_2(z)], z)$ and $\mathcal{GY}([x_1(z), x_2(z)], z)$.

In this perspective, let us first state the following fact – which unfortunately can be properly and completely written only in Section B.4.

Theorem B.6. *The functions w and \tilde{w} explicitly defined in (B.11) of Section B.4 are adequate CGF for the sets $\mathcal{GX}([y_1(z), y_2(z)], z)$ and $\mathcal{GY}([x_1(z), x_2(z)], z)$ respectively.*

Having a CGF w for some set \mathcal{C} , it is clear that any of its fractional linear transformations $[\alpha w + \beta]/[\gamma w + \delta]$ with $\alpha, \beta, \gamma, \delta \in \mathbb{C}$ such that $\alpha\gamma \neq 0$ is also a CGF for \mathcal{C} , see Definition 1 of Part I. They are actually the only ones – this can be deduced from page 39 in Chapter 2 of [Lit00].

In particular, once Theorem B.6 shown, we will have the explicit expression of *all* possible CGF, but the way in which they depend on the steps set \mathcal{S} is yet unclear. In fact, we have the following link – intrinsic, because independent of the choice of the CGF.

Theorem B.7. *If the group of the walk is finite (resp. infinite), then any CGF for the sets $\mathcal{GX}([y_1(z), y_2(z)], z)$ or $\mathcal{GY}([x_1(z), x_2(z)], z)$ is algebraic (resp. non-holonomic, and then, of course, non-algebraic). Moreover, in the case of a finite group, if in addition the covariance (i.e. the quantity $\sum_{(i,j) \in \mathcal{S}} ij$) is negative or zero (resp. positive), then any CGF is rational (resp. algebraic non-rational).*

Furthermore, in the case of a finite group, we will in Section B.4 considerably simplify the explicit expression of the CGF. In Propositions B.26, B.27 and B.29, we will consider the walks having a negative or zero covariance and we will then give the rational expression of the CGF; next, in Proposition B.28, we will concentrate on the walks having a positive covariance and we will then give minimal polynomials for the algebraic non-rational CGF.

Let us now note that Remarks A.8, A.10 and A.11 of Chapter A can be extended without problem to the walks of this chapter.

The rest of Chapter B is organized as follows.

First, in Section B.2, we prove Theorem B.4 and we comment on other continuation methods.

Next, Section B.3 is a technical and introductory part to Section B.4. We study closely the surface $\{(x, y) \in \mathbb{C}^2 : \sum_{(i,j) \in \mathcal{S}} x^i y^j - 1/z = 0\}$ and particularly we uniformize it.

Finally, in Section B.4, we are interested in conformal gluing. There, we prove Theorems B.6-B.7 and Propositions B.26-B.29.

B.2 Holomorphic continuation of the generating functions

Notation. For the sake of shortness, we drop, from now on, the dependence of the different quantities on $z \in]0, 1/n[$; it is implied that any statement in the sequel begins with “for any $z \in]0, 1/n[$ ”.

This part aims at proving Theorem B.4, in other words at showing that the generating functions $c(x)Q(x, 0)$ and $\tilde{c}(y)Q(0, y)$, already holomorphic in their open unit disc \mathcal{D} , can be holomorphically continued up to $\mathbb{C} \setminus [x_3, x_4]$ and $\mathbb{C} \setminus [y_3, y_4]$ respectively.

Before starting the proof of Theorem B.4, let us remark that the continuation given by Theorem B.8 below is sufficient for obtaining the main results of Chapter B, see Section B.1.

Theorem B.8. *The functions $c(x)Q(x, 0)$ and $\tilde{c}(y)Q(0, y)$ can be holomorphically continued from the open unit disc \mathcal{D} to $\mathcal{GX}([y_1, y_2]) \cup \mathcal{D}$ and $\mathcal{GY}([x_1, x_2]) \cup \mathcal{D}$ respectively.*

Section B.2 is then composed of two parts.

First, in Subsection B.2.1, we show Theorem B.8, which is a version of Theorem B.4 weaker but more elementary : weaker because Theorem B.8 yields a continuation of the generating functions up to $\mathcal{GX}([y_1, y_2]) \cup \mathcal{D}$ and $\mathcal{GY}([x_1, x_2]) \cup \mathcal{D}$ and not up to $\mathbb{C} \setminus [x_3, x_4]$ and $\mathbb{C} \setminus [y_3, y_4]$, as in Theorem B.4, but more elementary because this continuation is done directly on the complex plane, rather than on the Riemann surface given by a uniformization of $\{(x, y) \in \mathbb{C}^2 : \sum_{(i,j) \in \mathcal{S}} x^i y^j - 1/z = 0\}$, as for Theorem B.4.

Next, in Subsection B.2.2, we prove Theorem B.4.

B.2.1 Proof of Theorem B.8

First of all, we note that the location of the sets $\mathcal{G}X([y_1, y_2])$ and $\mathcal{G}Y([x_1, x_2])$ depends strongly on the steps set \mathcal{S} . In particular, it may happen that they are included in the unit disc – it is *e.g.* the case for both walks represented on Picture B.6, as it will be illustrated on Picture ?? –, in that case, Theorem B.8 is obvious. On the other hand, there exist actually walks for which these sets don't belong to the unit disc – it is *e.g.* the case of Gessel's walk, see Chapter A.

Proof of Theorem B.8. We are going to explain the procedure of continuation only for $c(x)Q(x, 0)$, we would continue $\tilde{c}(y)Q(0, y)$ similarly.

To begin with, let us note that evaluating (B.2) at any x, y in the unit disc \mathcal{D} such that $\sum_{(i,j) \in \mathcal{S}} x^i y^j - 1/z = 0$ leads to $c(x)Q(x, 0) + \tilde{c}(y)Q(0, y) - z\delta Q(0, 0) - xy = 0$. As a consequence, if $x \in \{x \in \mathbb{C} : |Y_0(x)| < 1\} \cap \mathcal{D}$, we obtain

$$c(x)Q(x, 0) + \tilde{c}(Y_0(x))Q(0, Y_0(x)) - z\delta Q(0, 0) - xY_0(x) = 0. \quad (\text{B.4})$$

Since $x \in \{x \in \mathbb{C} : |Y_0(x)| < 1\} \cap \mathcal{D}$ is non-empty, see (i) of Lemma B.9 below, both functions $c(x)Q(x, 0)$ and $\tilde{c}(Y_0(x))Q(0, Y_0(x))$ as well as the identity (B.4) can be extended up to the connected component of $\{x \in \mathbb{C} : |Y_0(x)| < 1\} \cup \mathcal{D}$ containing $\{x \in \mathbb{C} : |Y_0(x)| < 1\} \cap \mathcal{D}$, by analytic continuation.

Therefore, in order to prove Theorem B.8, it is enough to show that $\mathcal{G}X([y_1, y_2]) \cup \mathcal{D}$ is connected and included in $\{x \in \mathbb{C} : |Y_0(x)| < 1\} \cup \mathcal{D}$, since $\mathcal{G}X([y_1, y_2]) \cup \mathcal{D}$ has obviously a non-empty intersection with $\{x \in \mathbb{C} : |Y_0(x)| < 1\} \cap \mathcal{D}$. These facts are exactly the objects of (ii) and (iii) in Lemma B.9 below.

It remains thus only to prove that this continuation of $c(x)Q(x, 0)$ is holomorphic on $\mathcal{G}X([y_1, y_2]) \cup \mathcal{D}$.

On \mathcal{D} this is immediate, $c(x)Q(x, 0)$ being there defined by its power series.

On $(\mathcal{G}X([y_1, y_2]) \cup \mathcal{D}) \setminus \mathcal{D}$, it follows from (B.4) that the function $c(x)Q(x, 0)$ may have eventually the same singularities as Y_0 , namely the branch cuts $[x_1, x_2]$, $[x_3, x_4]$, and is holomorphic elsewhere. But these segments don't belong to $(\mathcal{G}X([y_1, y_2]) \cup \mathcal{D}) \setminus \mathcal{D}$: with Section B.1, we have that $[x_1, x_2]$ is included in \mathcal{D} and by Lemma B.3, we get that $[x_3, x_4]$ is exterior to $\mathcal{G}X([y_1, y_2])$.

The continuation of $c(x)Q(x, 0)$ is thus holomorphic on $\mathcal{G}X([y_1, y_2]) \cup \mathcal{D}$ and Theorem B.8 is proved. \square

Lemma B.9. (i) $\{x \in \mathbb{C} : |Y_0(x)| < 1\} \cap \mathcal{D}$ is non-empty. (ii) $\mathcal{G}X([y_1, y_2]) \cup \mathcal{D}$ is connected. (iii) $\mathcal{G}X([y_1, y_2]) \cup \mathcal{D}$ is included in $\{x \in \mathbb{C} : |Y_0(x)| < 1\} \cup \mathcal{D}$.

Proof. Note first that (i) is a straightforward consequence of Lemma B.10. (ii) is also clear: both sets $\mathcal{G}X([y_1, y_2])$ and \mathcal{D} are connected and the intersection $\mathcal{G}X([y_1, y_2]) \cap \mathcal{D}$ is non-empty, *e.g.* because x_1 belongs to both sets, so that the union $\mathcal{G}X([y_1, y_2]) \cup \mathcal{D}$ is connected. And now we show (iii).

Clearly, it is enough to prove that $(\mathcal{G}X([y_1, y_2]) \cup \mathcal{D}) \setminus \mathcal{D}$ is included in $\{x \in \mathbb{C} : |Y_0(x)| < 1\}$. This will follow from an application of the maximum modulus principle (see *e.g.* [JS87] for its precise statement) to the function Y_0 on $(\mathcal{G}X([y_1, y_2]) \cup \mathcal{D}) \setminus \mathcal{D}$.

First of all, let us note that Y_0 is analytic on the latter domain, since thanks to Section B.1, it is included in $\mathbb{C} \setminus ([x_1, x_2] \cup [x_3, x_4])$.

Next, we prove that $|Y_0| < 1$ on the boundary of the set $(\mathcal{G}X([y_1, y_2]) \cup \mathcal{D}) \setminus \mathcal{D}$, and for this it is enough to show that $|Y_0| < 1$ on $\{|x| = 1\} \cup X([y_1, y_2])$.

But by Lemma B.10, it is immediate that $|Y_0| < 1$ on $\{|x| = 1\}$, and by extending Lemma A.16 of Chapter A up to all the non-singular walks considered here, we get that $Y_0(X([y_1, y_2])) = [y_1, y_2]$, segment which is known to belong to the unit disc, thanks to Section B.1.

In this way, the maximum modulus principle directly entails that $|Y_0| < 1$ on the domain $(\mathcal{G}X([y_1, y_2]) \cup \mathcal{D}) \setminus \mathcal{D}$. \square

Lemma B.10. $Y_0(\{|x| = 1\}) \subset \{|y| < 1\}$.

Proof. To avoid any confusion – in this proof, we are going to use different values of z –, we reintroduce here the variable z . Let us first recall that Y_0 is one of the two solutions in y of $\sum_{(i,j) \in \mathcal{S}} x^i y^j - 1/z = 0$, and that if Y_1 denotes the other one, then we have $|Y_0| \leq |Y_1|$, see Lemma B.1.

We are going to prove Lemma B.10 first for $z = 1/n$, and we will deduce from this particular case the remaining cases $z \in]0, 1/n[$.

For $z = 1/n$, the equality $\sum_{(i,j) \in \mathcal{S}} x^i y^j - 1/z = 0$ can be written $\sum_{(i,j) \in \mathcal{S}} (1/n)x^i y^j = 1$; since $\sum_{(i,j) \in \mathcal{S}} (1/n) = 1$, we can apply Lemma 2.3.4 of [FIM99] and in this way, we directly obtain that $Y_0(\{|x| = 1\}, 1/n) \subset \{|y| \leq 1\}$.

Suppose now that $z \in]0, 1/n[$. In this case, it is *not* possible to have $\sum_{(i,j) \in \mathcal{S}} x^i y^j - 1/z = 0$ with $|x| = |y| = 1$: indeed, for $|x| = |y| = 1$ we have

$$\left| \sum_{(i,j) \in \mathcal{S}} x^i y^j \right| \leq \sum_{(i,j) \in \mathcal{S}} 1 = n < \frac{1}{z}.$$

As a consequence, $Y_0(\{|x| = 1\}, z) \cap \{|y| = 1\} = \emptyset$. By connectedness, this implies that either $Y_0(\{|x| = 1\}, z) \subset \{|y| < 1\}$ or $Y_0(\{|x| = 1\}, z) \subset \{|y| > 1\}$.

But once again with Lemma 2.3.4 of [FIM99], we get $Y_0(\{|x| = 1\}, 1/n) \cap \{|y| < 1\} \neq \emptyset$, so that by continuity, we obtain that for $z \in]0, 1/n[$, $Y_0(\{|x| = 1\}, z) \subset \{|y| < 1\}$. \square

B.2.2 Proof of Theorem B.4

First of all, let us prove the following result.

Lemma B.11. *Both $x^{-1}(\{|x| = 1\})$ and $y^{-1}(\{|y| = 1\})$ have two non-intersecting connected components homotopic to $[0, \omega_1[$.*

Proof. We recall from Section B.1 that the branch points x_k and y_k are such that $[x_1, x_2] \subset \{|x| < 1\}$, $[x_3, x_4] \subset \{|x| > 1\}$, $[y_1, y_2] \subset \{|y| < 1\}$ and $[y_3, y_4] \subset \{|y| > 1\}$. In particular, it is immediate that $x^{-1}(\{|x| = 1\})$ and $y^{-1}(\{|y| = 1\})$ have two connected components, respectively homotopic to $x^{-1}([x_1, x_2])$ and $y^{-1}([y_1, y_2])$ and therefore both homotopic to $[0, \omega_1[$. \square

Moreover, by the same kind of reasoning as in the proof of Lemma B.10, we could prove that (for all $z \in]0, 1/n[$) one connected component of $x^{-1}(\{|x| = 1\})$ (resp. $y^{-1}(\{|y| = 1\})$) belongs to $\{|y| < 1\}$ (resp. $\{|x| < 1\}$), we call it Γ_0 (resp. $\tilde{\Gamma}_0$), and the other to $\{|y| > 1\}$ (resp. $\{|x| > 1\}$), we call it Γ_1 (resp. $\tilde{\Gamma}_1$).

The rest of Subsection B.2.2 (that uses some notations of Section B.3) aims at proving Theorem B.4, *i.e.* at showing that $c(x)Q(x, 0)$ and $\tilde{c}(y)Q(0, y)$, already holomorphic in their unit disc, can be holomorphically continued up to $\mathbb{C} \setminus [x_3, x_4]$ and $\mathbb{C} \setminus [y_3, y_4]$ respectively. For this, we are going to use the following procedure, already introduced in Chapter A.

- (i) First, we will lift both functions $c(x)Q(x, 0)$ and $\tilde{c}(y)Q(0, y)$ up to \mathbb{C}/Ω by setting $r_x(\omega) = c(x(\omega))Q(x(\omega), 0)$ and $r_y(\omega) = \tilde{c}(y(\omega))Q(0, y(\omega))$. The functions r_x and r_y are *a priori* well defined on $\{\omega \in \mathbb{C}/\Omega : |x(\omega)| \leq 1\}$ and $\{\omega \in \mathbb{C}/\Omega : |y(\omega)| \leq 1\}$ respectively – for the sake of brevity, we will note $\{|x| \leq 1\}$ and $\{|y| \leq 1\}$ the latter sets.
- (ii) Then, we will prove the following.

Theorem B.12. *The functions r_x and r_y , initially well defined on respectively $\{|x| \leq 1\}$ and $\{|y| \leq 1\}$, can be holomorphically continued up to the whole parallelogram \mathbb{C}/Ω cut along respectively $[0, \omega_1[$ and $[0, \omega_1[+ \omega_3/2$. Moreover, these continuations verify*

$$\forall \omega \in \mathbb{C}/\Omega \setminus [0, \omega_1[: r_x(\omega) = r_x(\psi(\omega)), \quad \forall \omega \in \mathbb{C}/\Omega \setminus ([0, \omega_1[+ \omega_3/2) : r_y(\omega) = r_y(\phi(\omega)), \quad (\text{B.5})$$

ψ and ϕ being properly defined in (B.10) below.

- (iii) Finally, for $x, y \in \mathbb{C}$, we will set $c(x)Q(x, 0) = r_x(\omega)$ if $x(\omega) = x$ and $\tilde{c}(y)Q(0, y) = r_y(\omega)$ if $y(\omega) = y$. Thanks to (B.5) and Proposition B.16, these equalities define $c(x)Q(x, 0)$ on $\mathbb{C} \setminus [x_3, x_4]$ and $\tilde{c}(y)Q(0, y)$ on $\mathbb{C} \setminus [y_3, y_4]$ not ambiguously, as holomorphic functions.

Item (i) and (iii) above are straightforward, so that we are going to concentrate our attention on (ii).

Proof of Theorem B.12. In what follows, we note $D_1 =]0, \omega_3/2[\times [0, \omega_1/\iota[$, $D_2 =]\omega_3/2, \omega_2[\times [0, \omega_1/\iota[$ and $\Delta = \{|x| \leq 1\} \cup \{|y| \leq 1\}$. The procedure of continuation of the functions r_x and r_y is composed of the three following steps.

1. First, we continue r_x from $\{|x| \leq 1\}$ up to $\{|x| \leq 1\} \cup (\Delta \cap D_2)$ and r_y from $\{|y| \leq 1\}$ up to $\{|y| \leq 1\} \cup (\Delta \cap D_2)$.

For this, we recall that in respectively $\{|x| \leq 1\}$ and $\{|y| \leq 1\}$, r_x and r_y are already well defined, thanks to their power series. Moreover, in $\{|x| \leq 1\} \cap \{|y| \leq 1\}$, we have the equality $r_x + r_y - z\epsilon Q(0, 0) - xy = 0$, as consequence of (B.2).

So, in $\Delta \cap D_2 \cap \{|x| \geq 1\} \subset \{|y| \leq 1\}$ we define $r_x = xy + z\epsilon Q(0, 0) - r_y$ and in $\Delta \cap D_2 \cap \{|y| \geq 1\} \subset \{|x| \leq 1\}$ we set $r_y = xy + z\epsilon Q(0, 0) - r_x$.

2. Next, we continue r_x from $\{|x| \leq 1\} \cup (\Delta \cap D_2)$ up to $\{|x| \leq 1\} \cup D_2$ and r_y from $\{|y| \leq 1\} \cup (\Delta \cap D_2)$ up to $\{|y| \leq 1\} \cup D_2$.

If $\Delta \cap D_2 = D_2$ – as it is *e.g.* the case for Gessel’s walk, see Chapter A –, then Step 2 is already completed and we go directly to Step 3.

If $\Delta \cap D_2 \neq D_2$, then the continuation will be a consequence of the fact that *at least one* of the two following assertions holds.

- 2.1. There exists a non-empty strip S_x such that $S_x \cup \delta(S_x) \subset \{|x| \leq 1\} \cup (\Delta \cap D_2)$ on which $r_x \circ \delta = r_x + xy \circ \delta - xy \circ \psi$.
- 2.2. There exists a non-empty strip S_y such that $S_y \cup \delta(S_y) \subset \{|y| \leq 1\} \cup (\Delta \cap D_2)$ on which $r_y \circ \delta = r_y + xy \circ \psi - xy$.

We will show this in a few lines, but before we explain why this enables us to obtain the wished continuation of the functions r_x and r_y .

If 2.1 (resp. 2.2) holds, then by analytic continuation it allows us to continue r_x (resp. r_y) on $\delta^k(\{|x| \leq 1\} \cup (\Delta \cap D_2)) \cap D_2$ (resp. $\delta^k(\{|y| \leq 1\} \cup (\Delta \cap D_2)) \cap D_2$), first for $k = \pm 1$, then for $k = \pm 2$, *etc.* until the whole D_2 is covered.

If 2.1 and 2.2 hold, then r_x (resp. r_y) is continued up to $\{|x| \leq 1\} \cup D_2$ (resp. $\{|y| \leq 1\} \cup D_2$) and Step 2 is completed.

If only 2.1 (resp. 2.2) holds, then we continue r_y (resp. r_x) by using (11), as in Step 1 : we set $r_y = xy + z\epsilon Q(0,0) - r_x$ (resp. $r_x = xy + z\epsilon Q(0,0) - r_y$).

3. Finally, in $D_1 \cap \{|x| \geq 1\}$ we set $r_x = r_x \circ \psi$ and in $D_1 \cap \{|y| \geq 1\}$ we set $r_y = r_y \circ \phi$ – note that with Steps 1 and 2, r_x and r_y are actually already defined on respectively $\psi(D_1 \cap \{|x| \geq 1\})$ and $\phi(D_1 \cap \{|y| \geq 1\})$.

Theorem B.12 being a straightforward consequence of Steps 1, 2 and 3, it remains to show that at least one of 2.1 and 2.2 holds.

Let us first prove that if the domain $\{|x \circ \phi| \leq 1, |y| \leq 1\} \cap D_2 \cap \phi(D_2)$ is non-empty, then 2.1 is verified.

By using Step 1, we have for $\omega \in \{|y| \leq 1\} \cap D_2$ the equality $r_x(\omega) + r_y(\omega) - z\epsilon Q(0,0) - xy(\omega) = 0$. If moreover $\omega \in \phi(\{|y| \leq 1\} \cap D_2)$, we have $r_x(\phi(\omega)) + r_y(\omega) - z\epsilon Q(0,0) - xy(\phi(\omega)) = 0$ – we recall that if $\omega \in \{|y| \leq 1\}$, then $r_y(\phi(\omega)) = r_y(\omega)$. Suppose in addition that $\phi(\omega) \in \{|x| \leq 1\}$; in that case, $r_x(\phi(\omega)) = r_x(\psi(\phi(\omega)))$ and since $\psi \circ \phi = \delta^{-1}$ we obtain $r_x(\delta^{-1}(\omega)) + r_y(\omega) - z\epsilon Q(0,0) - xy(\phi(\omega)) = 0$. Therefore, by subtraction we get $r_x(\delta^{-1}(\omega)) = r_x(\omega) + xy(\phi(\omega)) - xy(\omega)$ on the domain $\{|x \circ \phi| \leq 1, |y| \leq 1\} \cap D_2 \cap \phi(D_2)$. In particular, 2.1 holds on $\delta^{-1}(\{|x \circ \phi| \leq 1, |y| \leq 1\} \cap D_2 \cap \phi(D_2))$.

Likewise, we could prove that if the domain $\{|y \circ \psi| \leq 1, |x| \leq 1\} \cap D_2 \cap \psi(D_2)$ is non-empty, then 2.2 holds.

Now we give some sufficient conditions for the domain $\{|x \circ \phi| \leq 1, |y| \leq 1\} \cap D_2 \cap \phi(D_2)$ (resp. $\{|y \circ \psi| \leq 1, |x| \leq 1\} \cap D_2 \cap \psi(D_2)$) to be non-empty. For this, we recall that we suppose $\Delta \cap D_2 \neq D_2$, otherwise Step 2 is not necessary; in particular, it is not possible that Δ contains both $[0, \omega_1[$ and $[0, \omega_1[+ \omega_3/2$.

Suppose first that Δ does not contain $[0, \omega_1[$. Then obviously a part of the contour $\tilde{\Gamma}_1$ belongs to $\{|x \circ \phi| \leq 1, |y| \leq 1\} \cap D_2 \cap \phi(D_2)$.

Suppose now that Δ does not contain $[0, \omega_1[+ \omega_3/2$. Then a part of the contour Γ_1 necessarily belongs to $\{|y \circ \psi| \leq 1, |x| \leq 1\} \cap D_2 \cap \psi(D_2)$. \square

B.3 Uniformization

This part is introductory to Section B.4 and consists in studying closely the set of zeros of the kernel, namely $\mathcal{K} = \{(x, y) \in \mathbb{C}^2 : \sum_{(i,j) \in \mathcal{S}} x^i y^j - 1/z = 0\}$.

Proposition B.13. *For any non-singular walk, \mathcal{K} is a Riemann surface of genus one.*

Proof. From Section B.1, $\sum_{(i,j) \in \mathcal{S}} x^i y^j - 1/z = 0$ if and only if $[b(x) + 2a(x)y]^2 = d(x)$. But the Riemann surface of the square root of a third or fourth degree polynomial with distinct roots has genus one, see e.g. [JS87], therefore the genus of \mathcal{K} is also one. \square

Remark B.14. *Note first that Proposition B.13 can't be extended to the singular walks. Indeed, it follows from Section B.1 that, for the singular walks, the polynomial d has a double root at 0 and two simple roots at $x_3 \neq x_4$, and it is well-known, see e.g. [JS87], that the Riemann surface of the square root of such a polynomial has genus zero.*

Note also that Proposition B.13, implicitly stated for $z \in]0, 1/n[$, can't be extended to $z = 0$ or $z = 1/n$ in the general case.

Indeed, for $z = 0$ we have $d(x) = x^2$ and the Riemann surface of the square root of this polynomial is a disjoint union of two spheres, see e.g. [JS87].

As for $z = 1/n$, it may happen that the genus of \mathcal{K} is still one as it may happen that it becomes zero. In fact, Parts 2.3 and 6.1 of [FIM99] entail that it equals one (resp. zero) if and only if not the two (resp. the two) equalities $\sum_{(i,j) \in \mathcal{S}} i = 0$ and $\sum_{(i,j) \in \mathcal{S}} j = 0$ hold.

With Proposition B.13, it is immediate that \mathcal{K} is isomorphic to some torus \mathbb{C}/Ω . A suitable lattice Ω (in fact the *only possible* lattice, up to a homothetic transformation) is made explicit in Parts 3.1 and 3.3 of [FIM99], namely $\Omega = \omega_1\mathbb{Z} + \omega_2\mathbb{Z}$, where

$$\omega_1 = \imath \int_{x_1}^{x_2} \frac{dx}{[-d(x)]^{1/2}}, \quad \omega_2 = \int_{x_2}^{x_3} \frac{dx}{[d(x)]^{1/2}}. \quad (\text{B.6})$$

By using the same arguments as in Part 3.3 of [FIM99], we immediately obtain that we have, in addition, the *uniformization* $\mathcal{K} = \{(x(\omega), y(\omega)), \omega \in \mathbb{C}/\Omega\}$, where

$$x(\omega) = F(\wp(\omega), \wp'(\omega)), \quad y(\omega) = G(\wp(\omega), \wp'(\omega)), \quad (\text{B.7})$$

with $F(p, p') = x_4 + d'(x_4)/(p - d''(x_4)/6)$, $G(p, p') = [-b(F(p, p')) + d'(x_4)p'/(2(\wp(\omega) - d''(x_4)/6)^2)]/[2a(F(p, p'))]$ if $x_4 \neq \infty$ and $F(p, p') = (6p - d''(0))/d'''(0)$, $G(p, p') = [-b(F(p, p')) - 3p'/d'''(0)]/[2a(F(p, p'))]$ if $x_4 = \infty$, \wp being the Weierstrass elliptic function with periods ω_1, ω_2 .

It is well-known, see *e.g.* [JS87], that \wp satisfies the differential equation

$$\wp'(\omega)^2 = 4[\wp(\omega) - \wp(\omega_1/2)][\wp(\omega) - \wp([\omega_1 + \omega_2]/2)][\wp(\omega) - \wp(\omega_2/2)]. \quad (\text{B.8})$$

Moreover, it is proved in Part 3.3 of [FIM99] that $\wp(\omega_1/2) = f(x_3)$, $\wp([\omega_1 + \omega_2]/2) = f(x_2)$ and $\wp(\omega_2/2) = f(x_1)$.

We are now going to be interested in the location on the parallelogram $[0, \omega_2[\times [0, \omega_1/\imath[$ of the reciprocal images through the uniformization of the important cycles that are the branch cuts $[x_1, x_2]$, $[x_3, x_4]$, $[y_1, y_2]$ and $[y_3, y_4]$. For this, we need to define a new period, namely

$$\omega_3 = \int_{X(y_1)}^{x_1} \frac{dx}{[d(x)]^{1/2}}. \quad (\text{B.9})$$

In Part 3.3 of [FIM99] is shown the following.

Lemma B.15. $\omega_3 \in]0, \omega_2[$.

By using then exactly the same analysis as in Part 5.5 of [FIM99], we get the following very nice result – one of the essential purposes of having introduced the uniformization (B.7).

Proposition B.16. $x^{-1}([x_1, x_2]) = [0, \omega_1[+ \omega_2/2$, $x^{-1}([x_3, x_4]) = [0, \omega_1[$, $y^{-1}([y_1, y_2]) = [0, \omega_1[+ (\omega_2 + \omega_3)/2$ and $y^{-1}([y_3, y_4]) = [0, \omega_1[+ \omega_3/2$.

Now we would like to study more accurately ω_3 . First, by use of the same arguments as the ones we will use in Section C.5 of Chapter C, we obtain the location of ω_3 w.r.t. $\omega_2/2$.

Proposition B.17. $\omega_3 < \omega_2/2$ (resp. $\omega_3 = \omega_2/2$, $\omega_3 > \omega_2/2$) if and only if the covariance (*i.e.* the quantity $\sum_{(i,j) \in \mathcal{S}} ij$) of the walk is negative (resp. zero, positive).

It could appear surprising to introduce here the covariance, in fact it will turn out that on its sign depends interestingly a lot of quantities – in this perspective, see Subsection B.4.4.

If the group $W = \langle \Psi, \Phi \rangle$ defined in Section B.1 is finite, we can precise Proposition B.17.

Proposition B.18. *For any $k \geq 2$, the group $W = \langle \Psi, \Phi \rangle$ has order $2k$ if and only if there exists an integer $q \in \{1, \dots, k-1\}$, independent of z and having no common divisor with k , such that for all $z \in]0, 1/n[$, $\omega_3 = (q/k)\omega_2$.*

In particular, since it is proved in [BMM09] that the group W takes only the orders 4, 6, 8 and ∞ , Propositions B.17-B.18 lead immediately to the following.

Corollary B.19. *The group $W = \langle \Psi, \Phi \rangle$ has order 4 if and only if for all $z \in]0, 1/n[$, $\omega_3 = \omega_2/2$. For $k \in \{3, 4\}$, it has order $2k$ and a negative (resp. positive) covariance if and only if for all $z \in]0, 1/n[$, $\omega_3 = \omega_2/k$ (resp. $\omega_3 = \omega_2 - \omega_2/k$).*

Before beginning the proof of Proposition B.18, we emphasize that the birational transformations Ψ and Φ can obviously be understood as automorphisms of \mathcal{K} , and we recall from Part 3.1 of [FIM99] that thanks to the uniformization (B.7), these automorphisms of \mathcal{K} become on \mathbb{C}/Ω the automorphisms ψ and ϕ with the following expressions :

$$\psi(\omega) = -\omega, \quad \phi(\omega) = -\omega + \omega_3. \quad (\text{B.10})$$

They are such that $\psi \circ \psi = \phi \circ \phi = \text{id}$, $x \circ \psi = x$, $y \circ \psi = [c(x)/a(x)]/y$, $x \circ \phi = [\tilde{c}(y)/\tilde{a}(y)]/x$ and $y \circ \phi = y$.

Proof of Proposition B.18. Let us begin by proving the converse sense of Proposition B.18 and for this let us, here again, reintroduce the variable z .

Suppose first that for *some* value $z \in]0, 1/n[$, $\omega_3/\omega_2 = q/k$, the integers q and k having no common divisor. This means that $\langle \psi, \phi \rangle$ is a finite group of order $2k$, see (B.10), which is equivalent to the fact $\langle \Psi, \Phi \rangle$ has order $2k$ on \mathcal{K} – but *a priori* not on \mathbb{C}^2 . This implies that for any $x \in \mathbb{C}$, the equalities $(\Phi \circ \Psi)^{\circ k}(x, Y_0(x, z)) = (x, Y_0(x, z))$ and $(\Phi \circ \Psi)^{\circ k}(x, Y_1(x, z)) = (x, Y_1(x, z))$ hold.

Suppose now that for *any* value $z \in]0, 1/n[$, ω_3/ω_2 is this same rational number q/k . In particular, for any fixed $x \in \mathbb{C}$ and all $z \in]0, 1/n[$, $(\Phi \circ \Psi)^{\circ k}(x, Y_0(x, z)) = (x, Y_0(x, z))$. In other words, for any fixed $x \in \mathbb{C}$ and any $y \in \{Y_0(x, z) : z \in]0, 1/n[\}$, $(\Phi \circ \Psi)^{\circ k}(x, y) = (x, y)$. Since the set $\{Y_0(x, z) : z \in]0, 1/n[\}$ is not isolated, by analytic continuation we obtain that for any $x \in \mathbb{C}$ and any $y \in \mathbb{C}$, $(\Phi \circ \Psi)^{\circ k}(x, y) = (x, y)$, in such a way that $\langle \Psi, \Phi \rangle$ is finite as a group of birational transformations, of order less than or equal to $2k$.

$\langle \Psi, \Phi \rangle$ is of order exactly $2k$ because $\langle \psi, \phi \rangle$ has order $2k$ and thus we can find some elements (x, y) of order exactly $2k$. This entails the converse sense of Proposition B.18.

Suppose now that $W = \langle \Psi, \Phi \rangle$ has order $2k$. The group $\langle \psi, \phi \rangle$ generated by ψ and ϕ is *a fortiori* finite, of order $2r(z) \leq 2k$, which means that $\inf\{p > 0 : (\phi \circ \psi)^{\circ p} = \text{id}\} = r(z)$. With (B.10), this immediately implies that $r(z)\omega_3$ is some point of the lattice $\omega_1\mathbb{Z} + \omega_2\mathbb{Z}$, contrary to $p\omega_3$ for $p \in \{1, \dots, r(z) - 1\}$. But with Lemma B.15, we have $\omega_3 \in]0, \omega_2[$, so that we get $r(z)\omega_3 = q(z)\omega_2$, where $q(z) \in \{1, \dots, r(z) - 1\}$ has no common divisor with $r(z)$.

Moreover, from (B.6) and (B.9), we know that $\omega_3/\omega_2 = q(z)/r(z)$ is a holomorphic function of z ; taking rational values it has to be constant, say $\omega_3/\omega_2 = q/r$. Finally, if r was strictly smaller than k , then with the first part of the proof we would obtain that $W = \langle \Psi, \Phi \rangle$ has also order $2r$, and not $2k$ as assumed, so that $r = k$ and Proposition B.18 is proved. \square

The location of the reciprocal images through (B.7) of $[x_1, x_2]$, $[x_3, x_4]$, $[y_1, y_2]$ and $[y_3, y_4]$ being known, let us give, in Picture ??, some examples of the parallelogram $[0, \omega_2[\times [0, \omega_1/\iota[$ – in addition of the one corresponding to Gessel’s walk, that can be found in Picture A.4 of Chapter A.

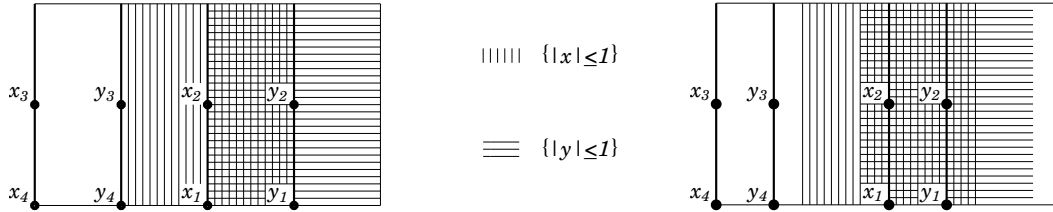

FIGURE B.3 – Examples of the parallelogram $[0, \omega_2[\times [0, \omega_1/\iota[$ with its important cycles, on the left for the first walk of Picture B.5 and on the right for the second walk of Picture B.6

Indeed, for the first walk of Picture B.5, the group has order four, see [BMM09], and with Corollary B.19, we get $\omega_3 = \omega_2/2$. In addition, it is quite rather to show that in this case, $X([y_1, y_2]) = X([y_3, y_4]) = Y([x_1, x_2]) = Y([x_3, x_4])$ is equal to the unit circle. In particular, we obtain that $x^{-1}(\{|x| = 1\}) = ([0, \omega_1[+ \omega_2/4) \cup ([0, \omega_1[+ 3\omega_2/4)$ and $y^{-1}(\{|y| = 1\}) = ([0, \omega_1[) \cup ([0, \omega_1[+ \omega_2/2)$.

Also, for the second walk of Picture B.6, the group has order six and the covariance is negative, hence with Corollary B.19, we get $\omega_3 = \omega_2/3$. Then, by using the same arguments as in the proof of Proposition A.22 of Chapter A, we obtain the location of the cycles $x^{-1}(\{|x| = 1\})$ and $y^{-1}(\{|y| = 1\})$ for this walk, namely $x^{-1}(\{|x| = 1\}) = ([0, \omega_1[+ \omega_2/4) \cup ([0, \omega_1[+ 3\omega_2/4)$ and $y^{-1}(\{|y| = 1\}) = ([0, \omega_1[+ 5\omega_2/12) \cup ([0, \omega_1[+ 11\omega_2/12)$.

B.4 Conformal gluing functions

The main subject of Section B.4 is to introduce and to study suitable CGF (see Definition 1 of Part I) of the sets $\mathcal{G}X([y_1, y_2])$ and $\mathcal{G}Y([x_1, x_2])$ for the 74 non-degenerate walks.

For this, we are first going to find explicitly, in Subsection B.4.1, all appropriate CGF for both sets above (essentially thanks to the uniformization studied in Section B.3) and in particular, we will prove Theorem B.6. Then we will remark that the behavior of these CGF is quite different according to the finiteness of the group W . This is why we will focus separately, in Subsections B.4.2 and B.4.3, on the walks having an infinite and next a finite group, and we will prove Theorem B.7 as well as Propositions B.26-B.29. Finally, in Subsection B.4.4, we will compare this classification of the 79 walks according to the nature of the CGF with the one according to the nature of the series (B.1), obtained from [BMM09] and [BK09].

B.4.1 Finding all suitable conformal gluing functions

In [FIM99] is found explicitly *one* CGF and *only* for $z = 1/n$, see (B.11) below. Let us begin here by generalizing this result and by finding the expressions of *all* possible CGF for the sets $X([y_1, y_2])$ and $Y([x_1, x_2])$ for *any* value of z , and for this, let us quote page 126

of [FIM99] : if we note $\hat{w} = w \circ x$ or $\hat{w} = w \circ y$, with x, y defined in (B.7), then the problem of finding a CGF w is equivalent to find a function \hat{w} meromorphic in $[\omega_2/2, (\omega_2 + \omega_3)/2] \times \mathbb{R}$, ω_1 periodic, with only one simple pole in the domain $[\omega_2/2, (\omega_2 + \omega_3)/2] \times [0, \omega_1/2]$ hatched on the left of Picture B.4 below, and satisfying to the next two conditions :

- (i) for all $\omega \in [-\omega_1/2, \omega_1/2]$, $\hat{w}([\omega_1 + \omega_2]/2 + \omega) = \hat{w}([\omega_1 + \omega_2]/2 - \omega)$,
- (ii) for all $\omega \in [-\omega_1/2, \omega_1/2]$, $\hat{w}([\omega_1 + \omega_2 + \omega_3]/2 + \omega) = \hat{w}([\omega_1 + \omega_2 + \omega_3]/2 - \omega)$.

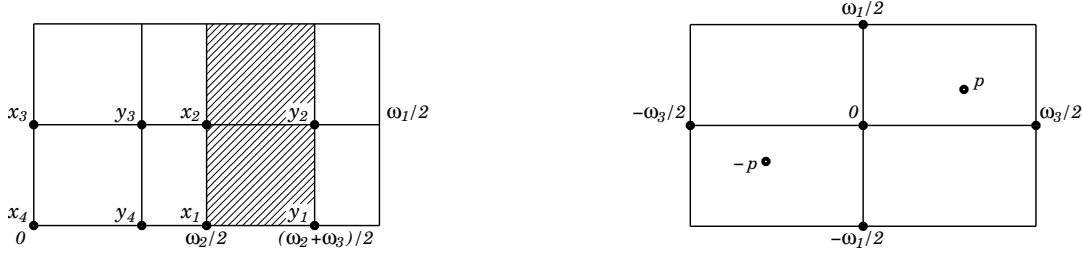

FIGURE B.4 – Domains of definition of \hat{w} (on the left) and \check{w} (on the right)

Setting $\check{w}(\omega) = \hat{w}([\omega_1 + \omega_2]/2 + \omega)$, the problem mentioned above obviously becomes to find a function \check{w} meromorphic in $[0, \omega_3/2] \times \mathbb{R}$, ω_1 periodic, with only one simple pole in the domain $[0, \omega_3/2] \times [-\omega_1/(2i), \omega_1/(2i)]$, and such that :

- (i') for all $\omega \in [-\omega_1/2, \omega_1/2]$, $\check{w}(\omega) = \check{w}(-\omega)$,
- (ii') for all $\omega \in [-\omega_1/2, \omega_1/2]$, $\check{w}(\omega_3/2 + \omega) = \check{w}(\omega_3/2 - \omega)$.

Now we remark that by analytic continuation, (i') allows us to continue \check{w} from $[0, \omega_3/2] \times \mathbb{R}$ up to $[-\omega_3/2, \omega_3/2] \times \mathbb{R}$, and next, also by analytic continuation, (ii') enables us to continue \check{w} as a ω_3 periodic function – since evaluating (ii') at $\omega_3/2 + \omega$ and using (i') leads to $\check{w}(\omega_3 + \omega) = \check{w}(\omega)$. Therefore, the problem of finding the CGF finally becomes : to find an even elliptic function \check{w} with periods ω_1, ω_3 and having only two simple poles at $\pm p$ (or one double pole at p if p and $-p$ are congruent modulo the lattice) in the parallelogram $[-\omega_3/2, \omega_3/2] \times [-\omega_1/(2i), \omega_1/(2i)]$ drawn on the right of Picture B.4 above.

A crucial fact for us is then the following – below, $\wp_{1,3}$ denotes the Weierstrass elliptic function with periods ω_1, ω_3 .

Lemma B.20. *Let $p \in [-\omega_3/2, \omega_3/2] \times [-\omega_1/(2i), \omega_1/(2i)]$.*

If $p = 0$, the only solutions of the problem above are the $\alpha + \beta\wp_{1,3}(\omega)$ for $\alpha, \beta \in \mathbb{C}$.

If $p \neq 0$, the only solutions are the $\alpha + \beta/[\wp_{1,3}(\omega) - \wp_{1,3}(p)]$ for $\alpha, \beta \in \mathbb{C}$.

Proof. It is well-known, see e.g. Theorem 3.11.1 and Theorem 3.13.1 of [JS87], that an even elliptic function with periods ω_1, ω_3 and having $2q$ poles in a period parallelogram is necessarily a rational transformation of order q of $\wp_{1,3}$. In our case, \check{w} , which has exactly two poles of order one or one pole of order two in $[-\omega_3/2, \omega_3/2] \times [-\omega_1/(2i), \omega_1/(2i)]$ is thus a fractional linear transformation (i.e., a rational transformation of order one) of $\wp_{1,3}$.

In particular, it is immediate that $p = 0$ yields $\check{w}(\omega) = \alpha + \beta\wp_{1,3}(\omega)$.

If $p \neq 0$, then $\wp_{1,3}(p) \neq \infty$ and we obtain $\check{w}(\omega) = [\alpha\wp_{1,3}(\omega) + \gamma]/[\wp_{1,3}(\omega) - \wp_{1,3}(p)]$. \square

Applying Lemma B.20 for $p = 0$, we get that

$$w(t) = \wp_{1,3}(x^{-1}(t) - [\omega_1 + \omega_2]/2), \quad \tilde{w}(t) = \wp_{1,3}(y^{-1}(t) - [\omega_1 + \omega_2]/2) \quad (\text{B.11})$$

are suitable CGF for the sets $\mathcal{G}X([y_1, y_2])$ and $\mathcal{G}Y([x_1, x_2])$, x^{-1} and y^{-1} denoting, in (B.11), the reciprocal functions of the coordinates of the uniformization (B.7). Theorem B.6 is thus proved.

Applying now Lemma B.20 for *any* value of p yields that the fractional linear transformations of (B.11) are the only possible CGF.

Remark B.21. *As said in Section B.1, it can be deduced from [Lit00] – by using general results on Fredholm integral equations – that two CGF for the same set are necessarily fractional linear transformations the one from the other.*

It is worth noting that in our case, we have recovered this fact by using only the properties of the Weierstrass elliptic functions written in Lemma B.20.

Remark B.22. *The functions w and \tilde{w} of (B.11) are related together through $\tilde{w} = w(X_0)$: indeed, (B.7) entails that $x(\omega) = X_0(y(\omega))$.*

Let us now concentrate on w and \tilde{w} defined by (B.11), and note first that in Section C.5 of Chapter C, we will prove their following global properties.

Proposition B.23. *The function w (resp. \tilde{w}) defined by (B.11) is meromorphic on $\mathbb{C} \setminus [x_3, x_4]$ (resp. $\mathbb{C} \setminus [y_3, y_4]$) and has there one simple pole, at x_2 (resp. $Y(x_2)$), and the lower integer part of $\omega_2/(2\omega_3)$ double poles at some points of the segment $]x_2, x_3[\cap (\mathbb{C} \setminus \mathcal{G}X([y_1, y_2]))$ (resp. $]y_2, y_3[\cap (\mathbb{C} \setminus \mathcal{G}Y([x_1, x_2]))$).*

Now we remark that with (B.7), it is immediate that $w(t) = \wp_{1,3}(\wp^{-1}(f(t)) - [\omega_1 + \omega_2]/2)$, with $f(t) = d''(x_4)/6 + d'(x_4)/(t - x_4)$ if $x_4 \neq \infty$ and $f(t) = d''(0)/6 + d'''(0)t/6$ if $x_4 = \infty$.

The CGF w is therefore equal to the Weierstrass elliptic function with periods ω_1, ω_3 evaluated at a translation of the reciprocal of the Weierstrass elliptic function with periods ω_1, ω_2 . It turns out that the theory of transformation of elliptic functions – the basic result of which being here recalled in Equation (A.25) of Chapter A – entails that this expression admits a very nice simplification if ω_3/ω_2 is rational.

But Proposition B.18 shows that the latter condition is related to the group $W = \langle \Psi, \Phi \rangle$ defined in Section B.1, since it states that ω_3/ω_2 is rational for all $z \in]0, 1/n[$ if and only if the group W is finite, so that we will consider separately the study of w and \tilde{w} according to the finiteness of this group.

First, in Subsection B.4.2, we will concentrate on the case of an *infinite* group of the walk, and we will show that w and \tilde{w} are then non-holonomic, which will prove the part of Theorem B.7 concerning the infinite group.

Then, in Subsection B.4.3, we will consider the case of a *finite* group. We will see that w and \tilde{w} are then algebraic, and we will complete the proof of Theorem B.7. Moreover, we will considerably simplify the explicit expressions of w and \tilde{w} given in (B.11) for all the 23 walks having a finite group : see Proposition B.26 (resp. B.27-B.28, B.29) for the walks associated with a group of order four (resp. six, eight).

It is worth noting that, even for $z = 1/n$, the forthcoming results of Subsections B.4.2-B.4.3 on an in-depth study of the CGF are new – up to the best of our knowledge.

B.4.2 Case of an infinite group

Remark B.24. *If the walk admits an infinite group, it may happen that ω_3/ω_2 is rational for some values of z , but ω_3/ω_2 has also to take non-rational values.*

Indeed, if ω_3/ω_2 was rational for all $z \in]0, 1/n[$, then ω_3/ω_2 would be a rational constant, since with (B.6) and (B.9), ω_3/ω_2 is a holomorphic function of z , and Proposition B.18 would then entail that the group is finite.

Let us now prove the part of Theorem B.7 concerning the group infinite, and more precisely, that for any $z \in]0, 1/n[$ such that ω_3/ω_2 is non-rational, the CGF w and \tilde{w} defined in (B.11) are non-holonomic.

Proof. The class of holonomic functions being closed under algebraic substitution, see *e.g.* [FS09], it is enough to prove that $v(t) = w(f^{-1}(t)) = \wp_{1,3}(\wp^{-1}(t) - [\omega_1 + \omega_2]/2)$ is non-holonomic, since on the one hand, f is rational and on the other hand, $\tilde{w} = w(X_0)$ with X_0 algebraic.

First, we are going to show that v is non-algebraic, and next, we will prove that if v is holonomic then it has to be algebraic, in such a way that v will be non-holonomic.

Suppose thus that v is algebraic, in other words assume that there exist polynomials a_0, \dots, a_q with $a_q \neq 0$ such that $\sum_{k=0}^q a_k(t)v(t)^k = 0$. By definition of v and since the Weierstrass elliptic function is non-algebraic, at least one of a_0, \dots, a_q is non-constant.

Evaluating now the last equality at $t = \wp(\omega + [\omega_1 + \omega_2]/2)$ and using the definition of v , we get $\sum_{k=0}^q a_k(\wp(\omega + [\omega_1 + \omega_2]/2))\wp_{1,3}(\omega)^k = 0$. Since $\wp(\omega + [\omega_1 + \omega_2]/2)$ is a rational transformation of $\wp(\omega)$, see *e.g.* the addition theorem (A.26) stated in Chapter A, the previous equality reads $P(\wp(\omega), \wp_{1,3}(\omega)) = 0$, where P is a polynomial non-constant w.r.t. the two variables.

Now we recall from *e.g.* [JS87] that \wp (resp. $\wp_{1,3}$) has poles at every point of the lattice $\omega_1\mathbb{Z} + \omega_2\mathbb{Z}$ (resp. $\omega_1\mathbb{Z} + \omega_3\mathbb{Z}$). Moreover, it is well-known that if ω_3/ω_2 is non-rational, then $\omega_2\mathbb{Z} + \omega_3\mathbb{Z}$ is dense in \mathbb{R} . In particular, if ω_3/ω_2 is non-rational, then the poles of $P(\wp(\omega), \wp_{1,3}(\omega))$ are non-isolated, which is a contradiction between the principle of analytic continuation and the fact that $P(\wp(\omega), \wp_{1,3}(\omega))$ is non-zero and meromorphic.

Suppose now that v is holonomic, *i.e.* that there are polynomials a_0, \dots, a_q with $a_q \neq 0$ such that $\sum_{k=0}^q a_k(t)v^{(k)}(t) = 0$, $v^{(k)}$ denoting the k th derivative of v , and let us show that in this case

$$\sum_{k=0}^q a_k(t)v^{(k)}(t) = U(t, v(t)) + V(t, v(t))v'(t), \quad (\text{B.12})$$

where the dependence of U and V w.r.t. the first (resp. second) variable is rational (resp. polynomial), and where at least U or V is non-zero. Before showing these facts, let us explain how they entail the algebraicity of v .

If V is identically zero, then U has to be non-zero. Moreover, since U is rational w.r.t. the first variable and since with (B.12) we have $U(t, v(t)) = 0$, U has to be non-constant w.r.t. the second variable and (B.12) immediately yields that v is then algebraic.

Suppose now that V is not identically zero. From (B.12) and the supposed holonomy of v , it follows that $U(t, v(t))^2 - V(t, v(t))^2v'(t)^2 = 0$. Also, noting g the derivative of \wp^{-1} (if g_2 and g_3 are the invariants of \wp we have $g(t) = [4t^3 - g_2t - g_3]^{-1/2}$), we obtain $v'(t)^2 = g(t)^2\wp'_{1,3}(\wp^{-1}(t) - [\omega_1 + \omega_2]/2)^2$. But if $g_{2,1,3}$ and $g_{3,1,3}$ are the invariants of $\wp_{1,3}$, we have $\wp'_{1,3}^2 = 4\wp_{1,3}^3 - g_{2,1,3}\wp_{1,3} - g_{3,1,3}$ and finally we get $U(t, v(t))^2 - V(t, v(t))^2g(t)^2[4v(t)^3 - g_{2,1,3}v(t) - g_{3,1,3}] = 0$. The latter quantity is rational in the first variable, since actually $g(t)^2$ is rational, and an odd degree polynomial in the second, in such a way that v is algebraic.

So it is enough to prove (B.12). For this we are going to show that for any k ,

$$v^{(k)}(t) = U_k(t, v(t)) + V_k(t, v(t))v'(t), \quad (\text{B.13})$$

where the dependence of U_k (resp. V_k) is rational w.r.t. the first variable and polynomial of degree exactly $\lfloor k/2 + 1 \rfloor$ (resp. $\lfloor (k-1)/2 \rfloor$) w.r.t. the second variable, $\lfloor \cdot \rfloor$ denoting the lower integer part. Equality (B.12) will be then an immediate consequence of (B.13). Indeed, if q is even, then by using (B.13) in (B.12), we obtain that the degree of U in the second variable is exactly $\lfloor q/2 + 1 \rfloor$ and U is thus obviously non-zero. Likewise, if q is odd, we get that the degree of V in the second variable is exactly $\lfloor (q-1)/2 \rfloor$ and is thus clearly non-zero if $q \geq 3$. If $q = 1$, then straightforwardly we make explicit $V_0 = 0$ and V_1 , and we immediately deduce that V is also non-zero.

Let us now show (B.13). For $k = 0$, this is obvious. As for $k \geq 1$, an easy calculation leads to

$$v^{(k)}(t) = \sum_{p=1}^k b_p(t) \wp_{1,3}^{(p)}(\wp^{-1}(t) - [\omega_1 + \omega_2]/2),$$

with $b_k = g(t)^k$, $b_{k-1}(t) = [k(k-1)/2]g'(t)g(t)^{k-2}$ and for $p \in \{2, \dots, k-1\}$, b_{k-p} is a polynomial in the variables $g(t), g'(t), \dots, g^{(p)}(t)$. Moreover, if p is even, then clearly b_p is rational whereas if p is odd, then b_p/g is rational. Next, by a repeated use of Lemma B.25 below and by using that $\wp'_{1,3}(\wp^{-1}(t) - [\omega_1 + \omega_2]/2) = v'(t)/g(t)$, we obtain

$$v^{(k)}(t) = \sum_{p \in \{1, \dots, k\} \text{ even}} b_p(t) p_{p/2}(v(t)) + v'(t) \sum_{p \in \{1, \dots, k\} \text{ odd}} [b_p(t)/g(t)] p'_{(p-1)/2}(v(t)).$$

With the values of b_k and b_{k-1} given above, this immediately yields (B.13), and therefore also (B.12), and finally the fact that v , w and \tilde{w} are non-holonomic. \square

Let us recall from [JS87] the following classical fact, that we have used in the last proof.

Lemma B.25. *For any integer $r \geq 0$ we have $\wp^{(2r)} = p_r(\wp)$, where $p_r(x)$ is a polynomial with dominant coefficient equal to $(2r+1)!x^{r+1}$.*

B.4.3 Case of a finite group

Thanks to Proposition B.18, we obtain that for the 23 walks having a finite group, ω_2/ω_3 is rational. Moreover, with [BMM09] and Corollary B.19, it is enough to consider the cases ω_2/ω_3 equal to 2, 3, 3/2, 4, 4/3. According to the classification of [BMM09], there are respectively 16, 2, 3, 1, 1 such walks.

Proposition B.26. *If the walk has a group of order four (i.e. if \mathcal{S} has a vertical symmetry, see [BMM09]), or equivalently if $\omega_2/\omega_3 = 2$, then w defined in (B.11) is an affine combination of $[(t/x_4 - 1)(t - x_1)]/[(t - x_2)(t - x_3)]$. Moreover, suitable and explicit CGF for the set $\mathcal{G}Y([x_1, x_2])$ are $w(X_0(t))$, or, more symmetrically, $[(t/y_4 - 1)(t - y_1)]/[(t - y_2)(t - y_3)]$.*



FIGURE B.5 – Two examples among the sixteen walks with a group of order four

Proposition B.27. *For both walks represented on Picture B.6 – the only ones with a group of order six and a negative covariance, or equivalently verifying $\omega_2/\omega_3 = 3 -$, w and \tilde{w} defined in (B.11) are affine combinations of respectively*

$$\frac{u(t)}{(t - x_2)(t - 1/x_2^{1/2})^2}, \quad \frac{\tilde{u}(t)}{(t - y_2)(t - 1/y_2^{1/2})^2},$$

with $u(t) = t^2$ and $\tilde{u}(t) = t$ (resp. $u(t) = \tilde{u}(t) = t(t + 1)$) for the walk on the left (resp. on the right) of Picture B.6.



FIGURE B.6 – The two walks with a group of order six and a negative covariance

Proposition B.28. *For the three walks represented on Picture B.7 – the only ones with a group of order six and a positive covariance, or equivalently verifying $\omega_2/\omega_3 = 3/2 -$, there exist $\alpha, \beta, \delta, \gamma$ which are algebraic w.r.t. z and made explicit in the proof, such that $w = \tilde{w}$ defined in (B.11) is the only solution with a pole at x_2 of*

$$w^2 + \left[\alpha + \beta \frac{u(t)}{(t - x_2)(t - 1/x_2^{1/2})^2} \right] w + \left[\delta + \gamma \frac{u(t)}{(t - x_2)(t - 1/x_2^{1/2})^2} \right] = 0,$$

with $u(t) = t^2$ (resp. $u(t) = t, u(t) = t(t + 1)$) for the walk on the left (resp. in the middle, on the right) of Picture B.7.

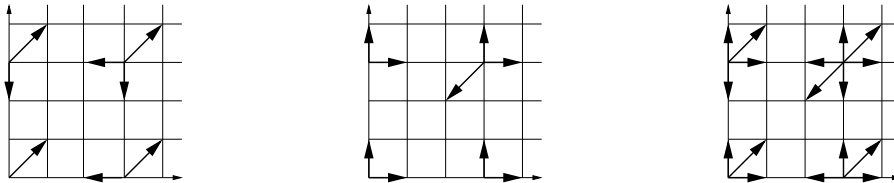

FIGURE B.7 – The three walks with a group of order six and a positive covariance

Proposition B.29. *For the walk represented on the left of Picture B.8 – the only one with a group of order eight and a negative covariance, or equivalently verifying $\omega_2/\omega_3 = 4 -$, w and \tilde{w} defined in (B.11) are affine combinations of respectively*

$$\frac{t^2}{(t - x_2)(t - 1)^2(t - x_3)}, \quad \frac{t(t + 1)^2}{(t - x_2)^2(t - x_3)^2}.$$

As for the walk on the right of Picture B.8 below, known as Gessel’s walk, the functions w and \tilde{w} have been found explicitly in Theorem A.7 of Chapter A.



FIGURE B.8 – The two walks with a group of order eight

Finite group of the walk and negative or zero covariance As a first enlightening example, let us consider the case of a covariance equal to zero – or equivalently the case $\omega_2/\omega_3 = 2$.

Proof of Proposition B.26. It will follow from the equality (peculiar to the case $\omega_2/\omega_3 = 2$)

$$\wp_{1,3}(\omega - [\omega_1 + \omega_2]/2) = -2f(x_1) + (f(x_2) - f(x_3))^2 \frac{\wp(\omega) - f(x_1)}{(\wp(\omega) - f(x_2))(\wp(\omega) - f(x_3))}. \quad (\text{B.14})$$

Indeed, if (B.14) holds, let us evaluate it at $\omega = \wp^{-1}(f(t))$: with (B.11), we obtain that there exist two constants K_1 and K_2 such that $w(t) = K_1 + K_2[f(t) - f(x_1)]/[(f(t) - f(x_2))(f(t) - f(x_3))]$. But by using the explicit expression of f , it is immediate that if $x_4 \neq \infty$, then $w(t) = K_1 + K_3[(t - x_1)(t - x_4)]/[(t - x_2)(t - x_3)]$ and if $x_4 = \infty$, then $w(t) = K_1 + K_4[t - x_1]/[(t - x_2)(t - x_3)]$, K_3 and K_4 being some non-zero constants. Therefore, for proving Proposition B.26, it is enough to show (B.14).

For this, start by applying Equation (A.25) for $p = 2$: we get $\wp_{1,3}(\omega - [\omega_1 + \omega_2]/2) = \wp(\omega - [\omega_1 + \omega_2]/2) + \wp(\omega - \omega_1/2) - \wp(\omega_2/2)$. Now, taking the usual notations $e_1 = \wp(\omega_1/2)$, $e_{1+2} = \wp([\omega_1 + \omega_2]/2)$ and $e_2 = \wp(\omega_2/2)$, we can state the two following particular cases of the addition formula (A.26) : $\wp(\omega - [\omega_1 + \omega_2]/2) = e_{1+2} + [(e_{1+2} - e_1)(e_{1+2} - e_2)]/[\wp(\omega) - e_{1+2}]$ and $\wp(\omega - \omega_1/2) = e_1 + [(e_1 - e_2)(e_1 - e_{1+2})]/[\wp(\omega) - e_1]$. In this way and after simplification, we obtain $\wp_{1,3}(\omega - [\omega_1 + \omega_2]/2) = e_1 - e_2 + e_{1+2} + (e_1 - e_{1+2})^2 [\wp(\omega) - e_2]/[(\wp(\omega) - e_1)(\wp(\omega) - e_{1+2})]$. Finally, by using the equalities $e_1 = f(x_3)$, $e_{1+2} = f(x_2)$ and $e_2 = f(x_1)$, see below (B.8), as well as $e_1 + e_{1+2} + e_2 = 0$, we immediately obtain (B.14). \square

Let us now consider the case of a negative covariance – or equivalently the situation where ω_2/ω_3 is equal to 3 or 4 –, and begin with the case $\omega_2/\omega_3 = 3$, which concerns the two walks of Picture B.6.

Proof of Proposition B.27. First of all, let us sketch the proof. First, we are going to show that there exist and we are going to make explicit two third degree polynomials A and B such that $\wp_{1,3}(\omega - [\omega_1 + \omega_2]/2) = A(\wp(\omega))/B(\wp(\omega))$. In particular, with (B.11), we will then obtain that $w(t) = A(f(t))/B(f(t))$. Next we will consider separately the two walks of Picture B.6.

- (i) For the walk on the left of Picture B.6 we have $x_4 = \infty$, and then $A(f(t))$ and $B(f(t))$ are also third degree polynomials, see the expression of f below (B.11). We will show that $B(f(t)) = (t - x_2)(t - 1/x_2^{1/2})^2$. In addition, if $r(t)$ denotes the rest of the euclidean division of $A(f(t))$ by $B(f(t))$, we will prove that $r(t) = (r''(0)/2)t^2$ with $r''(0) \neq 0$, in such a way that $w(t) = B(f(\infty))/A(f(\infty)) + (r''(0)/2)t^2/[(t - x_2)(t - 1/x_2^{1/2})^2]$.

- (ii) For the walk drawn on the right of Picture B.6 we have $x_4 \neq \infty$, and then $(t - x_4)^3 A(f(t))$ and $(t - x_4)^3 B(f(t))$ are third degree polynomials. We will show that $(t - x_4)^3 B(f(t)) = (t - x_2)(t - 1/x_2^{1/2})^2$. If $r(t)$ denotes the rest of the euclidean division of $(t - x_4)^3 A(f(t))$ by $(t - x_4)^3 B(f(t))$, then we will prove that $r(t) = (r''(0)/2)t(t + 1)$ with $r''(0) \neq 0$ so that $w(t) = B(f(\infty))/A(f(\infty)) + (r''(0)/2)t(t + 1)/[(t - x_2)(t - 1/x_2^{1/2})^2]$.

Finally, starting from the so-obtained explicit formulation of w and by using that $\tilde{w} = w(X_0)$, an elementary calculation will lead, for each walk, to the expression of \tilde{w} stated in Proposition B.27, this will conclude the proof.

So we begin by finding explicitly, for both walks of Picture B.6, two polynomials A and B of degree three such that $\wp_{1,3}(\omega - [\omega_1 + \omega_2]/2) = A(\wp(\omega))/B(\wp(\omega))$.

Applying Equation (A.25) with $p = 3$, we get that $\wp_{1,3}(\omega - [\omega_1 + \omega_2]/2) = \wp(\omega - [\omega_1 + \omega_2]/2) + \wp(\omega - \omega_1/2 - \omega_2/6) - \wp(\omega_2/3) + \wp(\omega - \omega_1/2 + \omega_2/6) - \wp(2\omega_2/3)$. Then, using the addition formula (A.26) for \wp and noting $K = e_{1+2} - 2\wp(\omega_2/3) - 2\wp(\omega_1/2 + \omega_2/6)$, we have that $\wp_{1,3}(\omega - [\omega_1 + \omega_2]/2)$ equals

$$\frac{(e_{1+2} - e_1)(e_{1+2} - e_2)}{\wp(\omega) - e_{1+2}} - 2\wp(\omega) + \frac{1}{2} \frac{\wp'(\omega)^2 + \wp'(\omega_1/2 + \omega_2/6)^2}{[\wp(\omega) - \wp(\omega_1/2 + \omega_2/6)]^2} + K. \quad (\text{B.15})$$

To obtain (B.15), we have used that $\wp(\omega_1/2 + \omega_2/6) = \wp(\omega_1/2 - \omega_2/6)$ and $\wp'(\omega_1/2 + \omega_2/6) = -\wp'(\omega_1/2 - \omega_2/6)$, got from the fact that $\wp(\omega_1/2 + \omega)$ and $\wp'(\omega_1/2 + \omega)$ are respectively even and odd functions of ω .

With both (B.8) and (B.15), it is now clear that $\wp_{1,3}(\omega - [\omega_1 + \omega_2]/2)$ can be written as $A(\wp(\omega))/B(\wp(\omega))$, moreover we can take $B(\wp(\omega)) = (\wp(\omega) - e_{1+2})(\wp(\omega) - \wp(\omega_1/2 + \omega_2/6))^2$.

Now we prove that $\wp(\omega_1/2 + \omega_2/6) = f(1/x_2^{1/2})$. For this, we are going to formulate $\wp(\omega_1/2 + \omega_2/6)$ w.r.t. z . Since $\wp(\omega_1/2 + \omega_2/6) = e_1 + [(e_1 - e_2)(e_1 - e_{1+2})]/[\wp(\omega_2/6) - e_1]$, it is enough to express $\wp(\omega_2/6)$ w.r.t. z . In order to do that, let us first find explicitly $\wp(\omega_2/3)$ and then use, for $\omega = \omega_2/3$, the fact that $\wp(\omega/2)$ equals (see *e.g.* [JS87])

$$\wp(\omega) + [(\wp(\omega) - e_1)(\wp(\omega) - e_2)]^{1/2} + [(\wp(\omega) - e_1)(\wp(\omega) - e_{1+2})]^{1/2} + [(\wp(\omega) - e_2)(\wp(\omega) - e_{1+2})]^{1/2}.$$

In other words, for all coefficients in (B.15) to be explicit w.r.t. the variable z , it is enough to find only $\wp(\omega_2/3)$ in terms of z .

And now we show that for both walks of Picture B.6, $\wp(\omega_2/3) = 1/3$. For this, we use the following fact, already recalled in Chapter A : the quantity $L = \wp(\omega_2/3)$ is the only positive root of $L^4 - g_2 L^2/2 - g_3 L - g_2^2/48$, $g_2 = -4[e_1 e_2 + e_1 e_{1+2} + e_2 e_{1+2}]$ and $g_3 = 4e_1 e_2 e_{1+2}$ being the invariants of \wp . By using the explicit expressions of g_2 and g_3 (we recall that e_1, e_2 and e_{1+2} are known explicitly w.r.t. z , see the proof of Proposition B.26), we easily show that $1/3$ is a root of the polynomial above, being positive, we get $\wp(\omega_2/3) = 1/3$.

Then, an elementary calculation leads to $\wp(\omega_1/2 + \omega_2/6) = f(1/x_2^{1/2})$. Next, with (B.8), we also obtain $\wp'(\omega_1/2 + \omega_2/6)$, and thus all coefficients in (B.15) are known in terms of z . In particular, this is also the case for the polynomials A and B . After a tedious but easy calculation, we obtain the facts claimed in (i) and (ii) above, and, thus, Proposition B.27. \square

Proposition B.29 – concerning $\omega_2/\omega_3 = 4$ – could be obtained by applying (A.25) for $p = 4$, the details would be essentially the same as above, so that we omit to write them.

Finite group of the walk and positive covariance The only such walks are the three ones of Picture B.7 as well as the one on the right of Picture B.8.

The latter, known as Gessel's walk, has already been considered in Chapter A : there, we have shown that the CGF w and \tilde{w} defined by (B.11) are algebraic (of degree three in t) and we have made explicit their minimal polynomials.

By using the same key idea as in Chapter A – namely, a double application of (A.25) –, we are going now to prove Proposition B.28, *i.e.* to show, for the three walks of Picture B.7, that w and \tilde{w} are algebraic (of degree two in t) and to find their minimal polynomials.

Proof of Proposition B.28. Let us, first of all, recall that for the three walks considered here, $\omega_2/\omega_3 = 3/2$, and define the auxiliary period $\omega_4 = \omega_2/3$.

First, with $\omega_4 = \omega_2/3$, thanks to Equation (A.25), we will be able to express $\wp_{1,4}$ as a rational function of \wp . Moreover, since $\omega_4 = \omega_3/2$, once again with (A.25), we will write $\wp_{1,4}$ as a rational function of $\wp_{1,3}$. As an immediate consequence, $\wp_{1,3}$ will be an algebraic function of \wp . Then, with (B.11) and the addition formula (A.26), we will obtain that the CGF w defines an algebraic function of t .

Rational expression of $\wp_{1,4}$ in terms of \wp . By using exactly the same arguments as in the proof of Proposition B.27, we obtain the three following facts : firstly, $\wp_{1,4}(\omega - [\omega_1 + \omega_2]/2)$ is equal to (B.15) ; secondly, $\wp(\omega_2/3) = 1/3$; and thirdly, the expression of all coefficients in (B.15) w.r.t. z is explicit. In this way, we obtain that there exist K_1 and K_2 which depend only on z and could be made explicit, such that

$$\wp_{1,4}(x^{-1}(t) - [\omega_1 + \omega_2]/2) = K_1 + \frac{K_2 u(t)}{(t - x_2)(t - 1/x_2^{1/2})^2}, \quad (\text{B.16})$$

with $u(t)$ as described in the statement of Proposition B.28.

Rational expression of $\wp_{1,4}$ in terms of $\wp_{1,3}$. Applying, as in the proof of Proposition B.26, Equation (A.25) for $p = 2$, we obtain that $\wp_{1,4}(\omega) = \wp_{1,3}(\omega) + \wp_{1,3}(\omega + \omega_3/2) - \wp_{1,3}(\omega_3/2)$. Noting $e_{1,1,3} = \wp_{1,3}(\omega_1/2)$, $e_{1+3,1,3} = \wp_{1,3}([\omega_1 + \omega_3]/2)$ and $e_{3,1,3} = \wp_{1,3}(\omega_3/2)$, we have $\wp_{1,3}(\omega + \omega_3/2) = e_{3,1,3} + [(e_{3,1,3} - e_{1,1,3})(e_{3,1,3} - e_{1+3,1,3})]/[\wp_{1,3}(\omega) - e_{3,1,3}]$. In particular, we immediately obtain that

$$\wp_{1,3}(\omega)^2 - [e_{3,1,3} + \wp_{1,4}(\omega)]\wp_{1,3}(\omega) + [(e_{3,1,3} - e_{1,1,3})(e_{3,1,3} - e_{1+3,1,3}) + e_{3,1,3}\wp_{1,4}(\omega)] = 0. \quad (\text{B.17})$$

Therefore, once the expressions of $e_{1,1,3}$, $e_{1+3,1,3}$ and $e_{3,1,3}$ will be known explicitly, Equations (B.11), (B.16) and (B.17) will immediately entail Proposition B.28.

It remains thus to find explicitly $e_{1,1,3}$, $e_{1+3,1,3}$ and $e_{3,1,3}$. This will be a consequence of the possibility of expanding $\wp_{1,4}$ in two different ways.

First, we have seen just above that

$$\wp_{1,4}(\omega) = \wp_{1,3}(\omega) + \frac{(e_{3,1,3} - e_{1,1,3})(e_{3,1,3} - e_{1+3,1,3})}{\wp_{1,3}(\omega) - e_{3,1,3}},$$

so that by using the expansion of $\wp_{1,3}$ at 0, namely $\wp_{1,3}(\omega) = 1/\omega^2 + g_{2,1,3}\omega^2/20 + g_{3,1,3}\omega^4/28 + O(\omega^6)$, $g_{2,1,3}$ and $g_{3,1,3}$ being the invariants of $\wp_{1,3}$, as well as the following straightforward equality $(e_{3,1,3} - e_{1,1,3})(e_{3,1,3} - e_{1+3,1,3}) = 3e_{3,1,3}^2 - g_{2,1,3}/4$, we get

$$\wp_{1,4}(\omega) = \frac{1}{\omega^2} + [3e_{3,1,3}^2 - g_{2,1,3}/5]\omega^2 + [g_{3,1,3} + 3e_{3,1,3}^3 - g_{2,1,3}e_{3,1,3}/4]\omega^4 + O(\omega^6). \quad (\text{B.18})$$

Second, by applying Equation (A.25) for $p = 3$, we obtain $\wp_{1,4}(\omega) = -\wp(\omega) + [\wp'(\omega)^2 + \wp'(\omega_2/3)^2]/[2(\wp(\omega) - \wp(\omega_2/3))] - 4\wp(\omega_2/3)$. Using that $\wp(\omega_2/3) = 1/3$ as well as (B.8) yield

$$\wp_{1,4}(\omega) = \frac{1}{\omega^2} + [2/3 - 9g_2/20]\omega^2 + [10/27 - g_2/2 - 27g_3/28]\omega^4 + O(\omega^6). \quad (\text{B.19})$$

By identifying the expansions (B.18) and (B.19), we obtain the expressions of $g_{2,1,3}$ and $g_{3,1,3}$ in terms of g_2 , g_3 and $e_{3,1,3}$.

In addition, $e_{3,1,3}$ is obviously a solution of $4e_{3,1,3}^3 - g_{2,1,3}e_{3,1,3} - g_{3,1,3} = 0$. If we use the expressions of $g_{2,1,3}$ and $g_{3,1,3}$ obtained just above, we obtain that $e_{3,1,3}^3 + [9g_2/16 - 5/6]e_{3,1,3} + [35/108 - 27g_3/32 - 7g_2/16] = 0$. We can solve this equation (we recall that g_2 and g_3 are known explicitly w.r.t. z) and in this way we get $e_{3,1,3}$. Next, we obtain $g_{2,1,3}$ and $g_{3,1,3}$, or, equivalently, $e_{1,1,3}$ and $e_{1+3,1,3}$. In particular, the expansion (B.17) is now completely known and Proposition B.28 is proved. \square

B.4.4 Concluding remarks

Some of the 23 walks associated with a finite group have been and are still the object of numerous studies, as illustrated by the recent and vivid interest in the famous Gessel's walk, see [KKZ09], [BK09] and [KR09a]. But other walks have also repeatedly caught the attention of the mathematical community, as Kreweras' walk (represented here on the left of Picture B.7), see [BMM09] and the references therein, as well as Gouyou-Beauchamps' walk (drawn on the left of Picture B.8), which, among others, has strong connections with the enumeration of non-crossing matchings, see [CDD⁺07].

However, certain questions concerning these walks – as the one of explaining some closed form expressions for quantities associated with them – are still open, see [BMM09]. We hope that Propositions B.26-B.29 and the results of Chapter A, which give simple explicit expressions of the CGF w and \tilde{w} for these 23 walks, and therefore, thanks to Theorem B.5, which yield an explicit expression of the trivariate generating function (B.1), with a different formulation from the one obtained in [BMM09] and [BK09], will lead to make progress in this perspective.

Another thing is that, although it is yet unclear how the nature of the CGF yields the nature of the generating function (B.1), we can make the following observation *a posteriori*. Subsections B.4.2-B.4.3 imply that we can split the 23 walks having a finite group into two families, according to the nature of the CGF : for the 19 walks with negative or zero covariance, the CGF is rational, see Propositions B.26, B.27 and B.29, whereas for the 4 walks with positive covariance, the CGF is algebraic non-rational : see Proposition B.28 and Chapter A.

It is interesting to remark that this classification – that clearly implies that the sign of the covariance is a notable and natural quantity, thanks to Proposition B.17 – is the same as the classification according to the nature of the series (B.1) : if the walk has negative or zero covariance, then the generating function is holonomic non-algebraic, see [BMM09], whereas if the walk has positive covariance, then (B.1) is algebraic, see [BMM09] and [BK09].

Troisième partie

Marches tuées

Chapitre C

Random walks in \mathbb{Z}_+^2 with non-zero drift absorbed at the axes *

Random walks in the quarter plane \mathbb{Z}_+^2 with non-zero jump probabilities at distance at most one, homogeneous and with non-zero drift in the interior of \mathbb{Z}_+^2 and absorbed when reaching the axes are studied. Absorption probabilities generating functions are explicitly obtained and the asymptotic of these probabilities along the axes is found. The asymptotic of the Green functions is computed along all different infinite paths of states, in particular along the ones approaching the axes.

C.1 Introduction

Random walks in cones of \mathbb{Z}^d conditioned in the sense of Doob h -transform never to reach the boundary nowadays arouse a lot of interest in the mathematical community as they appear in several distinct domains.

An important class of such walks is constituted by the so-called “non-colliding random walks”. These walks are the processes $(Z_1(k), \dots, Z_d(k))_{k \geq 0}$ composed of d independent and identically distributed random walks that never leave the Weyl chamber $\{z \in \mathbb{R}^d : z_1 < \dots < z_d\}$. The distances between these random walks $(Z_2(k) - Z_1(k), \dots, Z_d(k) - Z_{d-1}(k))_{k \geq 0}$ give a $d - 1$ -dimensional random process whose components are positive. These processes appear in the eigenvalues description of important matrix-valued stochastic processes, see [Dys62] for an old well-known result on the eigenvalues of the process version of the Gaussian Unitary Ensemble and *e.g.* [Bru91, HW96, Gra99, KO01, KT04]. They are found in the analysis of the corner-growth model, see [Joh00, Joh02]. Moreover, interesting connections between non-colliding random walks, random matrices and queues in tandem are the subject of [O’C03c]. Paper [EK08] reveals a rather general mechanism of the construction of a suitable h -transform for such processes.

But processes whose components are distances between independent random walks are not the only class of interest. In [KOR02], random walks with exchangeable increments and conditioned never to exit the Weyl chamber are considered. In [OY02], the authors study an other class of random walks, namely $(X_1(k), \dots, X_d(k))_{k \geq 0}$, where for $p \in \{1, \dots, d\}$, $X_p(k) = |\{0 \leq m \leq k : \xi_m = p\}|$, $(\xi_m)_{m \geq 0}$ being a sequence of independent and identically

*. This work is a collaboration with I. Kurkova and is to appear in the “Bulletin de la Société Mathématique de France” as [KR09b].

distributed random variables with common distribution on $\{1, \dots, d\}$, and they identify in law their conditional version with a certain path transformation. In both [O’C03a, O’C03b], N. O’Connell relates these objects to the Robinson-Schensted algorithm.

Another important area where stochastic processes in cones of \mathbb{Z}^d conditioned never to reach the boundary appear is the domain of the “quantum random walks”. In [Bia92b], P. Biane constructs a quantum Markov chain on the von Neumann algebra of $SU(d)$ and interprets the restriction of this quantum Markov chain to the algebra of a maximal torus of $SU(d)$ as a random walk on the lattice of integral forms on $SU(d)$ with respect to this maximal torus. He proves that the restriction of the quantum Markov chain to the center of the von Neumann algebra is a Markov chain on the same lattice obtained from the preceding by conditioning it in Doob’s sense to exit a Weyl chamber at infinity. In [Bia92c], P. Biane extends these results to the case of general semi-simple connected and simply connected compact Lie groups, the basic notion being that of the minuscule weight. The corresponding random walk on the weight lattice in the interior of the Weyl chamber can be obtained as follows : if $2n$ is the order of the associated Weyl group, one draws the vector corresponding to the minuscule weight and its $n - 1$ conjugates under the Weyl group, then one translates these vectors to each point of the weight lattice in the interior of the Weyl chamber and assigns to them equal probabilities of jumps, namely $1/n$.

For example, in the case of $SU(3)$, the Weyl chamber of the corresponding Lie algebra $\mathfrak{sl}_3(\mathbb{C})$ is the planar cone of angle $\pi/3$, that is to say the domain of \mathbb{R}_+^2 delimited on the one hand by the horizontal axis and on the other by the axis making an angle equal to $\pi/3$ with the horizontal axis. One gets a spatially homogeneous random walk in the interior of the weight lattice, as in the left hand side of Picture C.1, the arrows designing transition probabilities equal to $1/3$. In the cases of the Lie algebras $\mathfrak{sp}_4(\mathbb{C})$ or $\mathfrak{so}_5(\mathbb{C})$, the Weyl chamber is the planar cone of angle $\pi/4$, see the second figure of Picture C.1 for the transition probabilities. Both of these random walks can be, of course, thought as walks in the quarter plane \mathbb{Z}_+^2 with transition probabilities drawn in the third and fourth figures of Picture C.1.

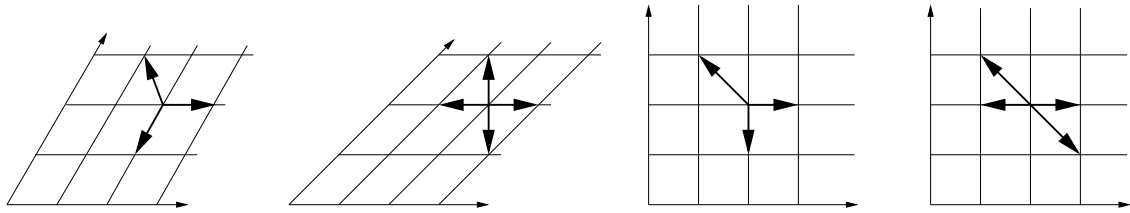

FIGURE C.1 – The walks on weight lattices of classical algebras (above, $\mathfrak{sl}_3(\mathbb{C})$ and $\mathfrak{sp}_4(\mathbb{C})$) can be viewed as random walks on \mathbb{Z}_+^d

P. Biane shows that the suitable Doob h -transform $h(i_0, j_0)$ for these random walks is the dimension of the underlying representation with highest weight $(i_0 - 1, j_0 - 1)$. In [Bia91], again thanks to algebraic methods, he computes the asymptotic of the Green functions for both walks (absorbed at the boundary) on the right of Picture C.1, as $i, j \rightarrow \infty$ and $j/i \rightarrow \tan(\gamma)$, for γ lying in $[\epsilon, \pi/2 - \epsilon]$ and $\epsilon > 0$. The asymptotic of the Green functions as $j/i \rightarrow 0$ or $j/i \rightarrow \infty$ could not be found by these techniques.

In [Bia92c], P. Biane also studies some extensions to random walks with drift : these are spatially homogeneous random walks in the same Weyl chambers, with the same non-zero jump probabilities as previously, but now these transition probabilities are admitted not to

be all equal to $1/n$, so that the mean drift vector may have non-zero coordinates. Due to Choquet-Deny theory, he finds in [Bia92c] all minimal non-negative harmonic functions for these random walks. Nevertheless, this approach seems not allow him to find the Martin compactification of these random walks, nor to compute the asymptotic of the Green functions along all different paths.

In [IR08], I. Ignatiouk-Robert obtains, under general assumptions and for all $d \geq 2$, the Martin compactification of some walks in the half-space $\mathbb{Z}^{d-1} \times \mathbb{Z}_+$ killed at the boundary. In this paper and in [IR09b], I. Ignatiouk-Robert proposes a new approach for the analysis of the Martin boundary, combining large deviations methods with the ratio-limit theorem for Markov-additive processes. I. Ignatiouk-Robert and C. Loree develop this original approach in a recent paper [IRL09] and apply it with success to the analysis of spatially homogeneous random walks in \mathbb{Z}_+^2 killed at the axes, under the hypotheses of an exponential decay of the jump probabilities and of a non-zero drift. In this way, they compute the Martin compactification for these random walks and therefore also their full Martin boundary. However, these methods seem not to be powerful for a more detailed study, as for the computation of the asymptotic of the Green functions or for the calculation of the absorption probabilities at different points on the axes. They also seem to be quite difficult to generalize to the case of the random walks with zero drift.

In Chapter C, we would like to study in detail the random walks $(X(k), Y(k))_{k \geq 0}$ in the quadrant \mathbb{Z}_+^2 with the following properties – below, let us denote the transition probabilities by $\mathbb{P}[(X(k+1), Y(k+1)) = (i_0 + i, j_0 + j) \mid (X(k), Y(k)) = (i_0, j_0)] = p_{(i_0, j_0), (i_0, j_0) + (i, j)}$.

(H1) *For all (i_0, j_0) such that $i_0, j_0 > 0$, $p_{(i_0, j_0), (i_0, j_0) + (i, j)}$ does not depend on (i_0, j_0) and can thus be denoted by $p_{i, j}$.*

(H2) *If $|i| > 1$ or $|j| > 1$, then $p_{i, j} = 0$.*

(H3) *The boundary $\{(0, 0)\} \cup \{(i, 0) : i \geq 1\} \cup \{(0, j) : j \geq 1\}$ is absorbing.*

(H4) *$\sum_{i, j} i p_{i, j} > 0$ and $\sum_{i, j} j p_{i, j} > 0$.*

(H5) *In the list $p_{1,1}, p_{1,0}, p_{1,-1}, p_{0,-1}, p_{-1,-1}, p_{-1,0}, p_{-1,1}, p_{0,-1}$, there are no three consecutive zeros.*

The last hypothesis (H5) is purely technical and avoids studying degenerated walks.

It is the book [FIM99] that gave us the main tool of analysis and has therefore inspired Chapter C. Let us recall from Section 1 of Part I that this book studies the random walks in \mathbb{Z}_+^2 under assumptions (H1)-(H2) but not (H3)-(H4) : the transition probabilities from the boundary to the interior of the quadrant are there non-zero and the horizontal axis, the vertical axis and $(0, 0)$ are three other domains of spatial homogeneity ; moreover, the jumps are supposed such that the Markov chain is ergodic. The authors G. Fayolle, R. Iasnogorodski and V. Malyshev elaborate a profound and ingenious analytic approach in order to compute the generating functions of stationary probabilities of these random walks. This approach serves as a starting point for our investigation and for this reason plays a crucial role : preparatory Subsections C.2.1, C.2.2 and C.2.3 proceed along [FIM99] but developed to the situation of the random walks killed at the boundary.

In Subsection C.2.4, using this analytic approach, we analyze the probability of absorption

$$\mathbb{P}_{i_0, j_0} [(X, Y) \text{ is absorbed}].$$

In Section C.3, the absorption probabilities

$$\begin{aligned} q_i^{i_0, j_0} &= \mathbb{P}_{(i_0, j_0)} [(X, Y) \text{ is absorbed at } (i, 0)], \\ \tilde{q}_j^{i_0, j_0} &= \mathbb{P}_{(i_0, j_0)} [(X, Y) \text{ is absorbed at } (0, j)], \\ q_{0,0}^{i_0, j_0} &= \mathbb{P}_{(i_0, j_0)} [(X, Y) \text{ is absorbed at } (0, 0)], \end{aligned} \quad (\text{C.1})$$

are computed, through their generating functions

$$q^{i_0, j_0}(x) = \sum_{i \geq 1} q_i^{i_0, j_0} x^i, \quad \tilde{q}^{i_0, j_0}(y) = \sum_{j \geq 1} \tilde{q}_j^{i_0, j_0} y^j, \quad (\text{C.2})$$

initially defined for $|x| \leq 1$ and $|y| \leq 1$.

When no ambiguity on the initial state can arise, we drop the index (i_0, j_0) and we write rather q_i , \tilde{q}_j , $q_{0,0}$, $q(x)$, $\tilde{q}(y)$ respectively.

Subsection C.3.1 gives first integral representations of both functions q and \tilde{q} on smooth curves, which are almost directly deduced from [FIM99].

In Subsection C.3.2, we look closer at some conformal gluing functions (in the sense of Definition 1 of Part I) that appear in the analysis and we transform the integral representations into ones on real segments (see Theorem C.13), that suit better for further calculations.

In Section C.4, we compute the asymptotic of the Green functions

$$G_{i,j} = \mathbb{E}_{(i_0, j_0)} \left[\sum_{k \geq 0} \mathbf{1}_{\{(X(k), Y(k)) = (i, j)\}} \right], \quad (\text{C.3})$$

as $i + j \rightarrow \infty$ and $j/i \rightarrow \tan(\gamma)$, where $\gamma \in [0, \pi/2]$.

In the case of $\gamma \in]0, \pi/2[$, thanks to [KM98] and [Mal73], it is not a difficult task : the procedure used in [KM98] for the asymptotic of the Green functions (and in fact developed much earlier for the asymptotic of the stationary probabilities in [Mal73]) under the simplifying hypothesis $p_{-1,0} + p_{0,1} + p_{1,0} + p_{0,-1} = 1$ in the interior and with some non-zero jump probabilities from the axes can be generalized to our random walks under (H2).

To state the result, set $\phi(u, v) = \sum_{i,j} p_{i,j} \exp(iu) \exp(jv)$, and let $(u(\gamma), v(\gamma))$ be the unique solution (see [Hen63]) of

$$\text{grad}(\phi(u, v)) / |\text{grad}(\phi(u, v))| = (\cos(\gamma), \sin(\gamma))$$

on the curve $\{(u, v) \in \mathbb{R}^2 : \phi(u, v) = 1\}$. Let also $s_x(\tan(\gamma)) = \exp(u(\gamma))$ and $s_y(\tan(\gamma)) = \exp(v(\gamma))$. With all these notations, $G_{i,j} \sim C [s_x(\tan(\gamma))^{i_0} s_y(\tan(\gamma))^{j_0} - q(s_x(\tan(\gamma))) - \tilde{q}(s_y(\tan(\gamma))) - q_{0,0}] / [i^{1/2} s_x(j/i)^i s_y(j/i)^j]$, where the constant $C > 0$ is made explicit, see Theorem C.15.

It is a more delicate task to study the asymptotic of the Green functions $G_{i,j}$ in the two cases of $j/i \rightarrow 0$ and $j/i \rightarrow \infty$, and this has not been completed in previous works. This is the subject of Subsection C.4.2. In Theorem C.18, we demonstrate that $G_{i,j} \sim C_0 j/i [j_0 s_x(0)^{i_0} s_y(0)^{j_0-1} - \partial \tilde{q}(s_y(0))] / [i^{1/2} s_x(j/i)^i s_y(j/i)^j]$, where the constant $C_0 > 0$ is made explicit. The result for $j/i \rightarrow \infty$ follows after a proper change of the parameters.

The asymptotic of the Green functions when $j/i \rightarrow \tan(\gamma)$, $\gamma \in [0, \pi/2]$ provide explicitly all harmonic functions of the Martin compactification. This leads in particular to

the result very recently obtained in [IRL09], which asserts that the Martin boundary is homeomorphic to $[0, \pi/2]$.

Finally, in Section C.6, using the results of Section C.5 about conformal gluing, we find the asymptotic behavior of the absorption probabilities q_i and \tilde{q}_j as $i \rightarrow \infty$ and $j \rightarrow \infty$. We show that $q_i \sim g(i_0, j_0)/(i^{3/2}\rho^i)$, with some quantities $g(i_0, j_0) > 0$ and $\rho > 1$ made explicit. Moreover, the function $g(i_0, j_0)$ turns out to depend quite interestingly on the “group of Galois automorphisms” of the random walk (in the sense of Definition C.3), see Theorem C.24.

In Chapter C, the analysis is led under (among others) the hypothesis (H4), for reasons motivated in Section C.1. However, all the analytic details remain true under the more general assumption

$$(H4') \quad \sum_{i,j} ip_{i,j} \neq 0 \text{ and } \sum_{i,j} jp_{i,j} \neq 0.$$

C.2 Analytic approach

C.2.1 The fundamental functional equation

Define

$$Q(x, y) = \sum_{i,j \geq 1} G_{i,j} x^{i-1} y^{j-1},$$

the generating function of the Green functions (C.3). With the notations of Section C.1, we can state the functional equation

$$K(x, y)Q(x, y) = q(x) + \tilde{q}(y) + q_{0,0} - x^{i_0} y^{j_0}, \quad (C.4)$$

where K is the following polynomial, depending only on the walk’s transition probabilities :

$$K(x, y) = xy \left[\sum_{i,j} p_{i,j} x^i y^j - 1 \right]. \quad (C.5)$$

Prima facie, Equation (C.4) has a meaning in $\{(x, y) \in \mathbb{C}^2 : |x| < 1, |y| < 1\}$. Also, the proof of (C.4) comes from writing that for $k, m, n \geq 0$,

$$\begin{aligned} \mathbb{P}[(X(k+1), Y(k+1)) = (m, n)] &= \sum_{i,j \geq 1} \mathbb{P}[(X(k), Y(k)) = (i, j)] p_{m-i, n-j} + \\ &+ \sum_{i \geq 1} \mathbb{P}[(X(k), Y(k)) = (i, 0)] \delta_{m,n}^{i,0} + \sum_{j \geq 1} \mathbb{P}[(X(k), Y(k)) = (0, j)] \delta_{m,n}^{0,j} + \\ &+ \mathbb{P}[(X(k), Y(k)) = (0, 0)] \delta_{m,n}^{0,0}, \end{aligned}$$

where $\delta_{m,n}^{i,j} = 1$ if $i = m$ and $j = n$, otherwise 0. It remains to multiply by $x^m y^n$ and then to sum w.r.t. $k, m, n \geq 0$.

C.2.2 The Riemann surface $\{(x, y) \in (\mathbb{C} \cup \{\infty\})^2 : K(x, y) = 0\}$

The polynomial (C.5) can be written alternatively

$$K(x, y) = a(x) y^2 + b(x) y + c(x) = \tilde{a}(y) x^2 + \tilde{b}(y) x + \tilde{c}(y), \quad (C.6)$$

where

$$\begin{aligned} a(x) &= p_{1,1}x^2 + p_{0,1}x + p_{-1,1}, & \tilde{a}(y) &= p_{1,1}y^2 + p_{1,0}y + p_{1,-1}, \\ b(x) &= p_{1,0}x^2 - x + p_{-1,0}, & \tilde{b}(y) &= p_{0,1}y^2 - y + p_{0,-1}, \\ c(x) &= p_{1,-1}x^2 + p_{0,-1}x + p_{-1,-1}, & \tilde{c}(y) &= p_{-1,1}y^2 + p_{-1,0}y + p_{-1,-1}. \end{aligned}$$

Let us also define

$$d(x) = b(x)^2 - 4a(x)c(x), \quad \tilde{d}(y) = \tilde{b}(y)^2 - 4\tilde{a}(y)\tilde{c}(y).$$

We are now going to build the algebraic function $Y(x)$ defined by $K(x, Y(x)) = 0$. Note first that $K(x, y) = 0$ is equivalent to $[b(x) + 2a(x)y]^2 = d(x)$, so that the construction of the function $Y(x)$ is equivalent to that of the square root of the polynomial $d(x)$. For this reason, we need the following precisions on the roots of d .

Lemma C.1.

- * d is a third or fourth degree polynomial, whose all roots are real and mutually distinct.
- * We call its roots the x_k , $k \in \{1, \dots, 4\}$, with eventually $x_4 = \infty$ if $\deg(d) = 3$. It turns out that there are two possibilities. Either the modulus of the roots are mutually distinct and in this case, we enumerate the roots in such a way that $|x_1| < |x_2| < |x_3| < |x_4|$, or there are two pairs of roots and inside of each pair the roots are opposed one from the other and in this case, we enumerate them $0 < x_2 = -x_1 < x_3 = -x_4$. This last case corresponds to the random walks having transition probabilities such that $p_{1,1} + p_{1,-1} + p_{-1,-1} + p_{-1,1} = 1$.
- * Moreover, $|x_1|, |x_2| < 1$ and $|x_3|, |x_4| > 1$.
- * x_2 and x_3 are positive.
- * $x_1 = 0$ (resp. $x_4 = \infty$) if and only if the jump probabilities are such that $p_{-1,0}^2 - 4p_{-1,1}p_{-1,-1} = 0$ (resp. $p_{1,0}^2 - 4p_{1,1}p_{1,-1} = 0$).
- * If $p_{-1,0}^2 - 4p_{-1,1}p_{-1,-1} \neq 0$ (resp. $p_{1,0}^2 - 4p_{1,1}p_{1,-1} \neq 0$) then $\text{sign}(x_1) = \text{sign}(p_{-1,0}^2 - 4p_{-1,1}p_{-1,-1})$ (resp. $\text{sign}(x_4) = \text{sign}(p_{1,0}^2 - 4p_{1,1}p_{1,-1})$).

Proof. All these properties are proved in [FIM99]. Note simply here that it is thanks to the hypothesis (H5), made in Section C.1, that the polynomial d is of degree three or four. \square

There are two branches of the square root of d . Each determination leads to a well defined (*i.e.* single-valued) and meromorphic function on the complex plane \mathbb{C} appropriately cut, that is, in our case, on $\mathbb{C} \setminus ([x_1, x_2] \cup [x_3, x_4])$ – note that if $x_4 < 0$, then $[x_3, x_4]$ means $[x_3, +\infty[\cup]-\infty, x_4]$. We can write, besides, the analytic expression of these two branches Y_0 and Y_1 of Y , namely $Y_0(x) = Y_+(x)$ and $Y_1(x) = Y_-(x)$, where

$$Y_{\pm}(x) = \frac{-b(x) \pm d(x)^{1/2}}{2a(x)}.$$

We now extend the domain of determination of Y from \mathbb{C} to its Riemann surface S , so that Y becomes single-valued on S . Since there are two determinations of the square root of d (opposed one from the other), the Riemann surface S is formed by S_0 and S_1 , two copies of the Riemann sphere $\mathbb{C} \cup \{\infty\}$ cut along $[x_1, x_2]$ and $[x_3, x_4]$, and joined across lines lying above these cuts. This gives a two-sheeted covering surface of $\mathbb{C} \cup \{\infty\}$, branched over x_1, \dots, x_4 . By opening out the cuts in the two sheets, we see that the Riemann surface

associated with Y is homeomorphic to a sphere with one handle attached, that is a Riemann surface of genus one, a torus. For more details about the construction of Riemann surfaces, see for instance Book [SG69].

In a similar way, the equation $K(X(y), y) = 0$ defines also an algebraic function $X(y)$. All the results concerning $X(y)$ can be deduced from the ones for $Y(x)$ after a proper change of the parameters, namely $p_{i,j} \mapsto p_{j,i}$.

To conclude Subsection C.2.2, let us recall from [FIM99] some useful properties of the functions Y and X .

Lemma C.2. (i) $Y_0(1) = c(1)/a(1)$ and $Y_1(1) = 1$. (ii) $Y_0(\{x \in \mathbb{C} : |x| = 1\}) \subset \{y \in \mathbb{C} : |y| < 1\}$ and $Y_1(\{x \in \mathbb{C} : |x| = 1\} \setminus \{1\}) \subset \{y \in \mathbb{C} : |y| > 1\}$. (iii) For $x \in \mathbb{C} \setminus ([x_1, x_2] \cup [x_3, x_4])$, $|Y_0(x)| \leq |Y_1(x)|$, with equality only on $[x_1, x_2] \cup [x_3, x_4]$. (iv) Suppose that $x_4 > 0$ and that the walk is non degenerated, see (H5). In that case, if $p_{1,-1} = 0$, then $\lim_{x \rightarrow \infty} xY_0(x) \in]-\infty, 0[$ and if $p_{1,-1} > 0$, then $\lim_{x \rightarrow \infty} Y_0(x) \in]-\infty, 0[$.

C.2.3 Galois automorphisms and meromorphic continuation

The Riemann surface S associated with the algebraic function Y is naturally endowed with a covering map $\pi : S \rightarrow \mathbb{C} \cup \{\infty\}$, such that for all $x \in \mathbb{C} \setminus ([x_1, x_2] \cup [x_3, x_4])$, $\pi^{-1}(x)$ is composed of exactly two elements, say s_0 and s_1 , such that for $i \in \{0, 1\}$, $s_i \in S_i$ and $\{Y(s_0), Y(s_1)\} = \{Y_0(x), Y_1(x)\}$.

In the same way, the Riemann surface \tilde{S} related to X is endowed with a map $\tilde{\pi} : \tilde{S} \rightarrow \mathbb{C} \cup \{\infty\}$, such that for all $y \in \mathbb{C} \setminus ([y_1, y_2] \cup [y_3, y_4])$, $\tilde{\pi}^{-1}(y)$ is composed of exactly two elements, say \tilde{s}_0 and \tilde{s}_1 , such that $\tilde{s}_i \in \tilde{S}_i$, $i \in \{0, 1\}$ and $\{X(\tilde{s}_0), X(\tilde{s}_1)\} = \{X_0(y), X_1(y)\}$.

The surfaces S and \tilde{S} having the same genus, we consider, from now on, *only one* surface T , conformally equivalent to S and \tilde{S} , with two coverings π and $\tilde{\pi}$. One can say that each $s \in S$ has two (not independent) ‘‘coordinates’’ $(x(s), y(s))$ such that $x(s) = \pi(s)$ and $y(s) = \tilde{\pi}(s)$ and such that, of course, $K(x(s), y(s)) = 0$ for all $s \in T$.

We construct on T the following covering automorphisms ξ and η defined, with the previous notations, by $\xi(s_0) = s_1$ and $\eta(\tilde{s}_0) = \tilde{s}_1$. Thanks to (C.6), for any $s = (x, y) \in T$, ξ and η take the following explicit expressions :

$$\xi(x, y) = \left(x, \frac{c(x)}{a(x)} \frac{1}{y}\right), \quad \eta(x, y) = \left(\frac{\tilde{c}(y)}{\tilde{a}(y)} \frac{1}{x}, y\right). \quad (\text{C.7})$$

ξ and η are obviously of order two, *i.e.* $\xi^2 = \text{id}$ and $\eta^2 = \text{id}$. In [Mal71] and [Mal72], for reasons explained there, they are also called ‘‘Galois automorphisms’’.

Definition C.3. *The group of the random walk W is the group $\langle \xi, \eta \rangle$ generated by ξ and η .*

Being generated by a finite number of elements of order two, W is a Coxeter group. In fact, W is simply a dihedral group, since it is generated by two elements. Define $\delta = \eta\xi$. The order of W is then equal to

$$|W| = 2 \inf\{p > 0 : \delta^p = \text{id}\},$$

it can be eventually infinite. The finiteness of this group, and in that event its order, will turn out to be decisive in the sequel, notably in Subsection C.2.4 and Section C.6.

As implied in [FIM99], it is quite difficult to characterize geometrically the walks having an associated group W of order $2n$, except for little orders. This is how that in [FIM99], the authors prove that W is of order four if and only if

$$\Delta = \begin{vmatrix} p_{1,1} & p_{1,0} & p_{1,-1} \\ p_{0,1} & -1 & p_{0,-1} \\ p_{-1,1} & p_{-1,0} & p_{-1,-1} \end{vmatrix} \quad (\text{C.8})$$

is equal to zero. In particular, this is the case of the walks having transition probabilities verifying $p_{-1,0} + p_{0,1} + p_{1,0} + p_{0,-1} = 1$. It is also proved, in [FIM99], that the walks with jump probabilities such that $p_{-1,1} + p_{1,0} + p_{0,-1} = 1$ – in other words, the processes that can be interpreted as walks in the Weyl chamber of $\mathfrak{sl}_3(\mathbb{C})$, see Pictures C.1 and C.2 – have a group of order six, for any values of the parameters. As for the walks in the Weyl chamber of $\mathfrak{sp}_4(\mathbb{C})$, see Picture C.1, they have, except for exceptional values of the parameters, a group of order infinite. We add here that the walks with $p_{1,1} = p_{1,0}$, $p_{-1,-1} = p_{-1,0}$ and $p_{1,1} + p_{-1,-1} = 1/2$, drawn in Picture C.2, have a group of order eight.

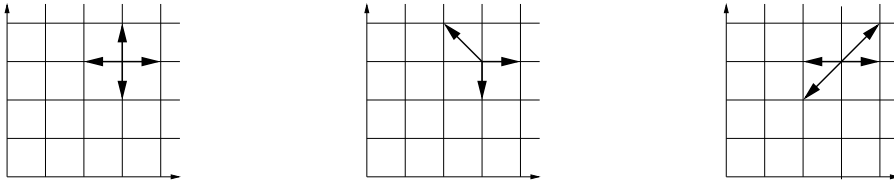

FIGURE C.2 – Random walks having a group W of order four, six and eight respectively

We are now going to continue the functions q and \tilde{q} , initially defined on the unit disc, up to $\mathbb{C} \setminus [x_3, x_4]$ and $\mathbb{C} \setminus [y_3, y_4]$, as holomorphic functions.

Continuing these functions has a twofold interest. Indeed, firstly, in Section C.3, we will have, in order to find explicit expressions of q and \tilde{q} , to solve boundary value problems, with boundary conditions on closed curves that lie possibly in the exterior of the unit disc \mathcal{D} . Secondly, in Section C.4, when we will calculate the asymptotic of the Green functions, the quantity $x^{i_0} y^{j_0} - q(x) - \tilde{q}(y) - q_{0,0}$ will naturally appear, evaluated at some (x, y) – in fact, the saddle-point – that is not in \mathcal{D}^2 .

In order to succeed in continuing q and \tilde{q} , we are going to use a uniformization of the curve $\mathcal{K} = \{(x, y) \in (\mathbb{C} \cup \{\infty\})^2 : K(x, y) = 0\}$. Being a Riemann surface of genus one, \mathcal{K} is homeomorphic to some quotient \mathbb{C}/Γ , where Γ is a two-dimensional lattice, that is to say to a parallelogram whose the opposed edges are identified. In [FIM99], such a lattice Γ and even a uniformization of \mathbb{C}/Γ are made explicit. Indeed, the authors find there $\omega_1 \in i\mathbb{R}$ and $\omega_2 \in \mathbb{R}$ as well as two functions $F(p, p')$ and $G(p, p')$, such that $\mathcal{K} = \{(x(\omega), y(\omega)), \omega \in \mathbb{C}/\Gamma\}$, where $x(\omega) = F(\wp_{1,2}(\omega), \wp'_{1,2}(\omega))$, $y(\omega) = G(\wp_{1,2}(\omega), \wp'_{1,2}(\omega))$, $\Gamma = \omega_1\mathbb{Z} \oplus \omega_2\mathbb{Z}$ and where $\wp_{1,2}$ is the Weierstrass elliptic function associated with the periods ω_1 and ω_2 , that are equal to :

$$\omega_1 = i \int_{x_1}^{x_2} \frac{dx}{[-d(x)]^{1/2}}, \quad \omega_2 = \int_{x_2}^{x_3} \frac{dx}{[d(x)]^{1/2}}, \quad \omega_3 = \int_{X(y_1)}^{x_1} \frac{dx}{[d(x)]^{1/2}}, \quad (\text{C.9})$$

$\omega_3 \in]0, \omega_2[$ being a period that will turn out to be quite important in the sequel. In addition, the functions F and G are also made explicit in [FIM99] : for instance, if $x_4 \neq \infty$, then $F(p, p') = x_4 + d'(x_4)/[p - d''(x_4)/6]$ and if $x_4 = \infty$, $F(p, p') = [6p - d'''(0)]/d'''(0)$.

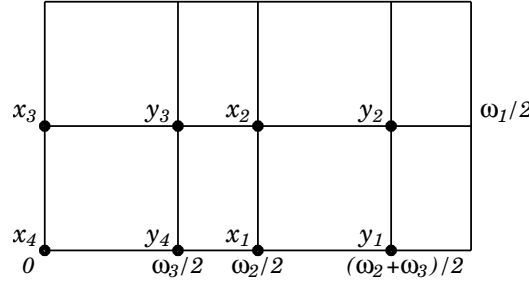

FIGURE C.3 – Location of the cuts on the covering \mathbb{C}/Γ

Moreover, on \mathbb{C}/Γ , the automorphisms ξ and η take the following particularly nice form

$$\xi(\omega) = -\omega, \quad \eta(\omega) = -\omega + \omega_3, \quad \delta(\omega) = \eta\xi(\omega) = \omega + \omega_3. \quad (\text{C.10})$$

In particular, the following result holds.

Proposition C.4. *The group $W = \langle \xi, \eta \rangle$ has a finite order if and only if ω_3/ω_2 is rational. In this case, the order of W is given by $2 \inf\{p > 0 : p\omega_3/\omega_2 \in \mathbb{Z}\}$.*

Any function h of the variable x (resp. y) defined on some domain $D \subset \mathbb{C}$ can be lifted on $\{\omega \in \mathbb{C}/\Gamma : x(\omega) \in D\}$ (resp. $\{\omega \in \mathbb{C}/\Gamma : y(\omega) \in D\}$) by setting $H(\omega) = h(x(\omega))$ (resp. $H(\omega) = h(y(\omega))$). In particular, we can lift the generating functions q and \tilde{q} and we set $Q(\omega) = q(x(\omega))$ and $\tilde{Q}(\omega) = \tilde{q}(y(\omega))$, they are well defined on $\{\omega \in \mathbb{C}/\Gamma : |x(\omega)| \leq 1\}$ and $\{\omega \in \mathbb{C}/\Gamma : |y(\omega)| \leq 1\}$ respectively. Note that on $\{\omega \in \mathbb{C}/\Gamma : |x(\omega)| \leq 1, |y(\omega)| \leq 1\}$, Equation (C.4) yields $Q(\omega) + \tilde{Q}(\omega) + q_{0,0} - x(\omega)^{i_0}y(\omega)^{j_0} = 0$. Applying several times the Galois automorphisms ξ and η to any point of this domain and laying down the relationships $Q(\omega) = Q(\xi(\omega))$ and $\tilde{Q}(\omega) = \tilde{Q}(\eta(\omega))$, the authors of [FIM99] prove the following fundamental result.

Proposition C.5. *The functions Q and \tilde{Q} can be continued as holomorphic functions on $(\mathbb{C}/\Gamma) \setminus [0, \omega_1]$ and $(\mathbb{C}/\Gamma) \setminus [\omega_3/2, \omega_3/2 + \omega_1]$ respectively. Furthermore,*

$$Q(\omega) = Q(\xi(\omega)), \quad \tilde{Q}(\omega) = \tilde{Q}(\eta(\omega)), \quad \forall \omega \in \mathbb{C}/\Gamma, \\ Q(\omega) + \tilde{Q}(\omega) + q_{0,0} - x(\omega)^{i_0}y(\omega)^{j_0} = 0, \quad \forall \omega \in [\omega_3/2, \omega_2] \times [0, \omega_1/i].$$

Corollary C.6. *The functions q and \tilde{q} admit holomorphic continuations on $\mathbb{C} \setminus [x_3, x_4]$ and $\mathbb{C} \setminus [y_3, y_4]$ respectively.*

C.2.4 About the probability of absorption

In the forthcoming Section C.3, we will find explicitly $q(x)$, $\tilde{q}(y)$ and $q_{0,0}$, that will provide of course the probability of absorption $q(1) + \tilde{q}(1) + q_{0,0}$. However, this expression will be usable difficultly. In this Subsection C.2.4, we prove in Corollary C.9 that in a special case of finite groups of the random walk (see Definition C.3), the probability of absorption takes a particularly nice form. Furthermore, in the case of the group of any order, Proposition C.10 gives the precise exponential asymptotic of the absorption probability as $i_0, j_0 \rightarrow \infty$.

First, we prove that for ω in $[0, \omega_3/2] \times [0, \omega_1/i]$, the quantity $Q(\omega) + \tilde{Q}(\omega) + q_{0,0} - x(\omega)^{i_0}y(\omega)^{j_0}$ can be considerably simplified in some cases, namely when the group is finite (*i.e.* when $\omega_2/\omega_3 \in \mathbb{Q}$) and when, in addition, $\omega_2/\omega_3 \in \mathbb{Z}$.

This is for example the case of the walks such that Δ (defined in (C.8)) equals zero, for which $\omega_2/\omega_3 = 2$ – indeed, we have already seen that both assertions $\Delta = 0$ and $\omega_2/\omega_3 = 2$ are equivalent to the fact that W is of order four.

This is also the case of the walk in the Weyl chamber of $\mathfrak{sl}_3(\mathbb{C})$, see Picture C.2, since in this case the group is of order six, hence ω_2/ω_3 is equal to $3/2$ or 3 , and by a direct calculation or by Corollary B.19 of Chapter B, we have that $\omega_2/\omega_3 = 3$.

On the other hand, this is not the case of the walk whose transition probabilities are represented on the right part of Picture C.2, since then $\omega_3 = 3\omega_2/4$, see Chapter B.

Theorem C.7. *Suppose that $\omega_2/\omega_3 \in \mathbb{Z}$; in particular, this implies that W is of order $2\omega_2/\omega_3$. Then, if $\omega \in [0, \omega_3/2] \times [0, \omega_1/\iota]$,*

$$Q(\omega) + \tilde{Q}(\omega) + q_{0,0} - x(\omega)^{i_0} y(\omega)^{j_0} = - \sum_{w \in W} (-1)^{l(w)} x(w(\omega))^{i_0} y(w(\omega))^{j_0}, \quad (\text{C.11})$$

where $l(w)$ is the length of the automorphism w , that is the smallest r for which we can write $w = s_1 \cdots s_r$, with s_i equal to ξ or η .

Proof. The key point of the proof of Theorem C.7, that also explains why we have done the hypothesis $\omega_2/\omega_3 \in \mathbb{Z}$, is that in this case, and in this case only, the fundamental domain $\chi_0 = [0, \omega_2/(2n)] \times [0, \omega_1/\iota]$ and the domain $[0, \omega_3/2] \times [0, \omega_1/\iota]$ of Proposition C.5 coincide (by “ χ_0 is a fundamental domain”, we mean that each $\omega \in \mathbb{C}/\Gamma$ is conjugate under W to one and only one point of χ_0).

Let us first give a proof in the case of the groups of order four. Note that $Q + \tilde{Q} + q_{0,0} = Q(\xi) + \tilde{Q}(\eta) + q_{0,0}$, since Q (resp. \tilde{Q}) is invariant w.r.t. ξ (resp. η), thanks to Proposition C.5. So $Q + \tilde{Q} + q_{0,0} = Q(\xi) + \tilde{Q}(\xi) + q_{0,0} + Q(\eta) + \tilde{Q}(\eta) + q_{0,0} - [Q(\eta) + \tilde{Q}(\xi) + q_{0,0}]$. Using once again the invariance properties of Q and \tilde{Q} , we can write $Q + \tilde{Q} + q_{0,0} = Q(\xi) + \tilde{Q}(\xi) + q_{0,0} + Q(\eta) + \tilde{Q}(\eta) + q_{0,0} - [Q(\xi\eta) + \tilde{Q}(\eta\xi) + q_{0,0}]$. Since the order of W is four, $\xi\eta = \eta\xi$ and the previous equation becomes $Q + \tilde{Q} + q_{0,0} = Q(\xi) + \tilde{Q}(\xi) + q_{0,0} + Q(\eta) + \tilde{Q}(\eta) + q_{0,0} - [Q(\xi\eta) + \tilde{Q}(\xi\eta) + q_{0,0}]$.

Now we remark that if $\omega \in \chi_0$, then for all $w \in W \setminus \{\text{id}\}$, $w(\omega) \in (\mathbb{C}/\Gamma) \setminus \chi_0$. Indeed, we will prove in Lemma C.8 below that χ_0 is a fundamental domain. In addition, thanks to Proposition C.5, the functional equation $Q + \tilde{Q} + q_{0,0} - x^{i_0} y^{j_0} = 0$ is verified in $[\omega_3/2, \omega_2] \times [0, \omega_1/\iota]$, domain which coincides with $(\mathbb{C}/\Gamma) \setminus \chi_0$. In other words, for any of three elements $w \in W \setminus \{\text{id}\}$, we can replace $Q(w) + \tilde{Q}(w) + q_{0,0}$ by $x(w)^{i_0} y(w)^{j_0}$. Theorem C.7 is thus proved in the case of a group W of order four.

In the general case $\omega_2/\omega_3 = n$, let us denote by $w_{1,k}$ and $w_{2,k}$ the two reduced words of length $k \in \{1, \dots, n-1\}$, i.e. the words $s_1 \cdots s_k$ and $s_2 \cdots s_k s_1$, where for $r \geq 1$, $s_{2r} = \xi$ and $s_{2r-1} = \eta$; denote also by w_n the only word of length n . The fact that there is only one word of length n follows from the equality $\inf\{p > 0 : \delta^p = \text{id}\} = \inf\{p > 0 : s_1 s_2 \cdots s_p = s_2 \cdots s_p s_1\}$. Then, e.g. by induction, we prove that

$$\begin{aligned} Q(\omega) + \tilde{Q}(\omega) &= \sum_{k=1}^{n-1} (-1)^{k+1} [Q(w_{1,k}(\omega)) + \tilde{Q}(w_{1,k}(\omega)) + Q(w_{2,k}(\omega)) + \tilde{Q}(w_{2,k}(\omega))] \\ &\quad - (-1)^n [Q(w_n(\omega)) + \tilde{Q}(w_n(\omega))]. \end{aligned}$$

Since $W = \{\text{id}, w_{1,1}, w_{2,1}, \dots, w_{1,n-1}, w_{2,n-1}, w_n\}$ and since $[0, \omega_3/2] \times [0, \omega_1/\iota]$ is a fundamental domain, if $\omega \in [0, \omega_3/2] \times [0, \omega_1/\iota] = [0, \omega_2/(2n)] \times [0, \omega_1/\iota]$, then thanks to Proposition C.5, for any $w \in W \setminus \{\text{id}\}$, $Q(w(\omega)) + \tilde{Q}(w(\omega)) + q_{0,0} = x(w(\omega))^{i_0} y(w(\omega))^{j_0}$. Moreover, $l(w_n) = n$ and for $k \in \{1, \dots, n-1\}$ and $i \in \{1, 2\}$, $l(w_{i,k}) = k$, so that (C.11) is proved. \square

Lemma C.8. *Suppose that the group W is of order $2n$. Then for any $k \in \{0, \dots, 2n-1\}$, the domain $\chi_k = [k\omega_2/(2n), (k+1)\omega_2/(2n)] \times [0, \omega_1/\iota[$ is a fundamental domain, i.e. each $\omega \in [0, \omega_2] \times [0, \omega_1/\iota[$ is conjugate under W to one and only one point of χ_k .*

Proof. Denote by $\Lambda_\mu = \mu + [0, \omega_1]$ the vertical segment with abscissa μ . Then with (C.10), we can describe the actions of ξ and η on this segment. So, for any μ in $[0, \omega_2]$, $\xi(\Lambda_\mu) = \Lambda_{\omega_2-\mu}$. Also, if $\mu \in [0, \omega_3]$, then $\eta(\Lambda_\mu) = \Lambda_{\omega_3-\mu}$ and if $\mu \in]\omega_3, \omega_2]$ then $\eta(\Lambda_\mu) = \Lambda_{\omega_3+\omega_2-\mu}$. Of course, we also know the action of the elements of the group W on the domains $\chi_k = [k\omega_2/(2n), (k+1)\omega_2/(2n)] \times [0, \omega_1/\iota[$, since we know how these automorphisms act on the boundaries of these sets.

Suppose for a while that k is even. Then, $\cup_{p=0}^{n-1} \delta^p(\chi_k) = \cup_{q=0}^{n-1} \chi_{2q}$. In particular, there exists $m \in \{0, \dots, n-1\}$ such that $\delta^m(\chi_k) = \chi_0$. Thanks to (C.10), we have $\xi(\chi_0) = \chi_{2n-1}$, so that $\xi\delta^m(\chi_k) = \chi_{2n-1}$. Also, $\cup_{p=0}^{n-1} \delta^p(\chi_{2n-1}) = \cup_{q=0}^{n-1} \chi_{2q+1}$. Of course, $(\cup_{q=0}^{n-1} \chi_{2q+1}) \cup (\cup_{q=0}^{n-1} \chi_{2q}) = [0, \omega_2] \times [0, \omega_1/\iota[$ and $W = \{\text{id}, \delta, \dots, \delta^{n-1}, \xi\delta^m, \delta\xi\delta^m, \dots, \delta^{n-1}\xi\delta^m\}$, for any $m \in \{0, \dots, n-1\}$. For example, in Picture C.4 are represented the domain χ_0 and its images under W , in the particular case $\omega_3 = \omega_2/n$.

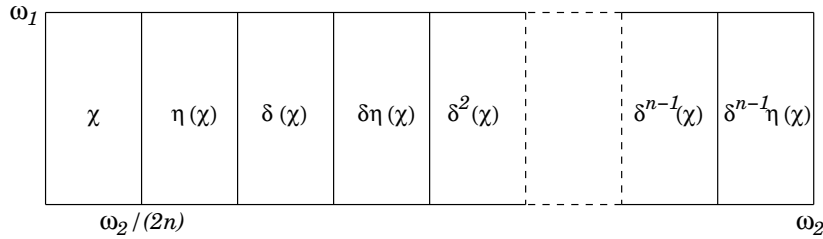

FIGURE C.4 – $\chi_0 = [0, \omega_2/(2n)] \times [0, \omega_1/\iota[$ is a fundamental domain

Lemma C.8 is thus proved if k is even. The proof is quite similar in case of odd k , so we omit it. \square

Corollary C.9. *Suppose that $\omega_2/\omega_3 \in \mathbb{Z}$. Then the probability of absorption is equal to*

$$\mathbb{P}_{i_0, j_0} [(X, Y) \text{ is absorbed}] = Q(1) + \tilde{Q}(1) + q_{0,0} = 1 - \sum_{w \in W} (-1)^{l(w)} x^{i_0} y^{j_0} (w(1, 1)).$$

Proof. The proof is based on the fact that the point lying over $(1, 1)$ belongs to $[0, \omega_3/2] \times [0, \omega_1/\iota[$, in such a way that Corollary C.9 is an immediate consequence of Theorem C.7. \square

We can therefore quite easily calculate the probability of being absorbed for the walks verifying $\Delta = 0$, since in this case the group is of order four and $\omega_2/\omega_3 = 2$. Corollary C.9 also applies to the walk in the Weyl chamber of $\mathfrak{sl}_3(\mathbb{C})$, whose transition probabilities are drawn in the middle of Picture C.2, since in this case $\omega_2/\omega_3 = 3$.

In the general case, the probability of absorption $Q(1) + \tilde{Q}(1) + q_{0,0}$ verifies the following double inequality.

Proposition C.10. *The probability of absorption is such that*

$$A/2 \leq \mathbb{P}_{i_0, j_0} [(X, Y) \text{ is absorbed}] \leq A,$$

where we have set

$$A = \left[\frac{p_{1,-1} + p_{0,-1} + p_{-1,-1}}{p_{1,1} + p_{0,1} + p_{-1,1}} \right]^{i_0} + \left[\frac{p_{-1,1} + p_{-1,0} + p_{-1,-1}}{p_{1,1} + p_{1,0} + p_{1,-1}} \right]^{j_0}.$$

Proof. We begin by considering the equality

$$\begin{aligned} 2[Q(\omega) + \tilde{Q}(\omega) + q_{0,0}] &= Q(\xi(\omega)) + \tilde{Q}(\xi(\omega)) + q_{0,0} + Q(\eta(\omega)) + \tilde{Q}(\eta(\omega)) + q_{0,0} \\ &\quad + Q(\omega) - Q(\eta(\omega)) + \tilde{Q}(\omega) - \tilde{Q}(\xi(\omega)), \end{aligned}$$

got by using the invariance properties of Q and \tilde{Q} asserted in Proposition C.5. In particular, if $\omega \in [0, \omega_3/2] \times [0, \omega_1/l]$, then $\xi(\omega)$ and $\eta(\omega)$ belong to $\omega \in [\omega_3/2, \omega_2] \times [0, \omega_1/l]$, so that by using once again Proposition C.5, we obtain that $2[Q(\omega) + \tilde{Q}(\omega) + q_{0,0}]$ is equal to

$$x(\xi(\omega))^{i_0} y(\xi(\omega))^{j_0} + x(\eta(\omega))^{i_0} y(\eta(\omega))^{j_0} + Q(\omega) - Q(\eta(\omega)) + \tilde{Q}(\omega) - \tilde{Q}(\xi(\omega)). \quad (\text{C.12})$$

Then, if we take the value of ω lying over $(1, 1)$ – that belongs to $[0, \omega_3/2] \times [0, \omega_1/l]$, as noticed in the proof of Corollary C.9 –, and if we use that for this ω , $x(\eta(\omega)) = c(1)/a(1)$ and $y(\xi(\omega)) = \tilde{c}(1)/\tilde{a}(1)$, we obtain

$$2[q(1) + \tilde{q}(1) + q_{0,0}] = A + [q(1) - q(\tilde{c}(1)/\tilde{a}(1))] + [\tilde{q}(1) - \tilde{q}(c(1)/a(1))].$$

Then, using that $c(1)/a(1) > 0$ and $\tilde{c}(1)/\tilde{a}(1) > 0$ implies that $q(\tilde{c}(1)/\tilde{a}(1)) > 0$ and $\tilde{q}(c(1)/a(1)) > 0$; in turn, these inequalities allow us to get the lower bound.

Using now that $c(1)/a(1) < 1$ and $\tilde{c}(1)/\tilde{a}(1) < 1$ – what is equivalent to the positivity of the two drifts, in accordance with our assumption (H4) – as well as the fact that q and \tilde{q} are increasing allows us to get the upper bound. \square

C.3 Explicit expression of the absorption probabilities generating functions

C.3.1 Riemann boundary value problem with shift

Using the notations of Subsection C.2.2, we define the curves

$$X([y_1, y_2]), \quad Y([x_1, x_2]). \quad (\text{C.13})$$

In [FIM99] is proved that these two curves $X([y_1, y_2])$ and $Y([x_1, x_2])$ are quartics, symmetrical w.r.t. the horizontal axis, closed, simple and included in $\mathbb{C} \setminus ([x_1, x_2] \cup [x_3, x_4])$ and $\mathbb{C} \setminus ([y_1, y_2] \cup [y_3, y_4])$ respectively.

The reason of introducing these curves appears now : the functions q and \tilde{q} defined in (C.2) verify the following boundary conditions on $X([y_1, y_2])$ and $Y([x_1, x_2])$:

$$\begin{aligned} \forall t \in X([y_1, y_2]) : \quad q(t) - q(\bar{t}) &= t^{i_0} Y_0(t)^{j_0} - \bar{t}^{i_0} Y_0(\bar{t})^{j_0}, \\ \forall t \in Y([x_1, x_2]) : \quad \tilde{q}(t) - \tilde{q}(\bar{t}) &= X_0(t)^{i_0} t^{j_0} - X_0(\bar{t})^{i_0} \bar{t}^{j_0}. \end{aligned} \quad (\text{C.14})$$

The way to obtain these boundary conditions is described in Section A.1, so we refer to Chapter A for the details.

The function q , as a generating function of probabilities, is well defined on the closed unit disc and, with Corollary C.6, q is continuable into a holomorphic function on $\mathbb{C} \setminus [x_3, x_4]$, domain that contains the bounded domain delimited by $X([y_1, y_2])$, see Lemma A.2.

Now we have the problem *to find q holomorphic inside of $X([y_1, y_2])$, continuous up to the boundary $X([y_1, y_2])$, and verifying the boundary condition (C.14). Moreover, $q(0) = 0$.*

Problems with boundary conditions like (C.14) are called Riemann-Carleman boundary value problems. A classical way to study this kind of problems consists in reducing them to Riemann-Hilbert problems (*i.e.* with boundary conditions on a segment), for which there exists a suitable and complete theory, see *e.g.* [Gak66, Lu93, Lit00]. The conversion between these two families of problems is done thanks to the use of “conformal gluing functions”, notion defined in Definition 1 of Part I.

For the walks such that $p_{-1,0} + p_{0,1} + p_{1,0} + p_{0,-1} = 1$, we easily see that $X([y_1, y_2])$ and $Y([x_1, x_2])$ are simply the circles of center 0 and radius $[p_{-1,0}/p_{1,0}]^{1/2}$ and $[p_{0,-1}/p_{0,1}]^{1/2}$ respectively; the functions $p_{1,0}t + p_{-1,0}/t$ and $p_{0,1}t + p_{0,-1}/t$ are then clearly proper CGF for the sets $\mathcal{G}X([y_1, y_2])$ and $\mathcal{G}Y([x_1, x_2])$ – here and throughout the sequel, $\mathcal{G}X([y_1, y_2])$ and $\mathcal{G}Y([x_1, x_2])$ denote the connected components of $\mathbb{C} \setminus X([y_1, y_2])$ and $\mathbb{C} \setminus Y([x_1, x_2])$ which contain x_1 and y_1 respectively.

In the general case, it is very pleasant to notice that we still have the explicit expression of suitable CGF for the sets $\mathcal{G}X([y_1, y_2])$ and $\mathcal{G}Y([x_1, x_2])$. The following result is due to [FIM99]. Define, for $t \in \mathbb{C}$,

$$w(t) = \wp_{1,3}(-[\omega_1 + \omega_2]/2 + x^{-1}(t)), \quad (\text{C.15})$$

where the $\omega_i, i \in \{1, 2, 3\}$ are defined in (C.9), $\wp_{1,3}$ is the classical Weierstrass function associated with the periods ω_1 and ω_3 , x^{-1} is the reciprocal function of the uniformization built in Subsection C.2.3 – we recall that it was $x(\omega) = x_4 + d'(x_4)/[\wp_{1,2}(\omega) - d''(x_4)/6]$ if $x_4 \neq \infty$ and $x(\omega) = [6\wp_{1,2}(\omega) - d''(0)]/d'''(0)$ if $x_4 = \infty$, $\wp_{1,2}$ being the Weierstrass function with periods ω_1 and ω_2 .

Then, w defined in (C.15) is single-valued and meromorphic on $\mathcal{G}X([y_1, y_2])$, continuous up to its boundary and establishes a conformal mapping of the domain $\mathcal{G}X([y_1, y_2])$ onto $\mathbb{C} \setminus [w(X(y_1)), w(X(y_2))]$. Moreover, on $\mathcal{G}X([y_1, y_2])$, w has one pole of order one, at x_2 .

Proposition C.11. *The function w defined in (C.15) is a CGF for the set $\mathcal{G}X([y_1, y_2])$.*

Proposition C.11 and the different properties mentioned above it are proved in [FIM99]. Then, following Subsection 5.4 of this book – though making a use of the index lightly different –, we obtain the following integral representation for the function q .

Proposition C.12. *Denote by $X([y_1, y_2])^+$ the intersection of the curve $X([y_1, y_2])$ with the upper half-plane. Then the function q admits, in $\mathcal{G}X([y_1, y_2])$, the following integral representation, w being the function defined in (C.15) :*

$$q(x) = \frac{1}{2\pi i} \int_{X([y_1, y_2])^+} [t^{i_0} Y_0(t)^{j_0} - \bar{t}^{i_0} Y_0(\bar{t})^{j_0}] \left[\frac{\partial w(t)}{w(t) - w(x)} - \frac{\partial w(t)}{w(t) - w(0)} \right] dt.$$

C.3.2 Study of the integral representations of the generating functions

Subsection C.3.2 aims at simplifying the integral representation of q obtained in Proposition C.12. This simplification will be useful for several reasons : first, the formulation of Proposition C.12 does not highlight the singularities of q and hardly entails to obtain the asymptotic of the absorption probabilities; furthermore, it makes appear q asymmetrically as an integral on $X([y_1, y_2])^+$.

Before stating, in Theorem C.13, the final result, let us define

$$\mu_{j_0}(t) = \frac{1}{[2a(t)]^{j_0}} \sum_{k=0}^{(j_0-1)/2} C_{j_0}^{2k+1} d(t)^k [-b(t)]^{j_0-(2k+1)}. \quad (\text{C.16})$$

The function μ_{j_0} is such that for all $t \rightarrow [x_1, x_2]^+$ (resp. $t \rightarrow [x_1, x_2]^-$), $Y_0(t)^{j_0} - \overline{Y_0(t)^{j_0}}$ is equal to $-2i[-d(t)]^{1/2}\mu_{j_0}(t)$ (resp. $2i[-d(t)]^{1/2}\mu_{j_0}(t)$).

Theorem C.13. *The function q admits in $\mathcal{G}X([y_1, y_2])$ the following integral representation :*

$$q(x) = x^{i_0}Y_0(x)^{j_0} + \frac{1}{\pi} \int_{x_1}^{x_2} t^{i_0}\mu_{j_0}(t) \left[\frac{\partial w(t)}{w(t) - w(x)} - \frac{\partial w(t)}{w(t) - w(0)} \right] [-d(t)]^{1/2} dt, \quad (\text{C.17})$$

where the function w is defined in (C.15) and μ_{j_0} in (C.16).

At the first sight, the function q appears in (C.17) as the sum of a function holomorphic on $\mathbb{C} \setminus ([x_1, x_2] \cup [x_3, x_4])$ and an other holomorphic on $\mathbb{C} \setminus (w^{-1}(w([x_1, x_2])) \cup [x_3, x_4])$. We will later split this expression into two terms (see (C.54) and (C.55)), where both of them will be holomorphic near $[x_1, x_2]$ (by Lemma C.25 for the first one, by (C.59) and (C.61) for the second), so that this expression will give that q is holomorphic in the neighborhood of $[x_1, x_2]$ – what we already knew, since Lemma C.1 implies that $[x_1, x_2] \subset \mathcal{D}$.

Proof of Theorem C.13. We start by expressing the integral obtained in Proposition C.12 as an integral on a closed contour, namely $X([y_1, y_2])$.

Making the change of variable $t \mapsto \bar{t}$ and using that for t on $X([y_1, y_2])$, $w(t) = w(\bar{t})$, we obtain

$$q(x) = \frac{1}{2\pi i} \int_{X([y_1, y_2])} t^{i_0}Y_0(t)^{j_0} \left[\frac{\partial w(t)}{w(t) - w(x)} - \frac{\partial w(t)}{w(t) - w(0)} \right] dt. \quad (\text{C.18})$$

Then, we transform (C.18) into an integral on the cut $[x_1, x_2]$. To do this, we start by remarking that the function of two variables $(t, x) \mapsto \partial w(t)/[w(t) - w(x)] - (x_2 - x)/[(x_2 - t)(t - x)]$ is continuable into a function holomorphic in $\mathcal{G}X([y_1, y_2])^2$. This property comes from the fact that w is one-to-one in $\mathcal{G}X([y_1, y_2])$ and has a pole of order one at x_2 . In particular, the function

$$\Theta(t, x) = \frac{\partial w(t)}{w(t) - w(x)} - \frac{\partial w(t)}{w(t) - w(0)} - \frac{x}{t(t - x)}, \quad (\text{C.19})$$

initially well defined on $\mathcal{G}X([y_1, y_2])^2 \setminus \{(u, u) : u \in \mathcal{G}X([y_1, y_2])\}$, is continuable into a holomorphic function on the whole $\mathcal{G}X([y_1, y_2])^2$, again denoted by Θ .

Consider now the contour $\mathcal{T}_\epsilon = X([y_1, y_2])_\epsilon \cup \mathcal{S}_\epsilon^1 \cup \mathcal{S}_\epsilon^2 \cup \mathcal{C}_\epsilon^1 \cup \mathcal{C}_\epsilon^2 \cup \mathcal{D}_\epsilon^1 \cup \mathcal{D}_\epsilon^2$, represented on Picture C.5 below.

A consequence of the holomorphy of Θ in $\mathcal{G}X([y_1, y_2])^2$ is that, for all $x \in \mathcal{G}X([y_1, y_2])$,

$$\int_{\mathcal{T}_\epsilon} t^{i_0}Y_0(t)^{j_0}\Theta(t, x)dt = 0.$$

In particular, letting $\epsilon \rightarrow 0$ and using the definition of μ_{j_0} given in (C.16), we obtain

$$\frac{1}{2\pi i} \int_{X([y_1, y_2])} t^{i_0}Y_0(t)^{j_0}\Theta(t, x)dt = \frac{1}{\pi} \int_{x_1}^{x_2} t^{i_0}\mu_{j_0}(t)\Theta(t, x)[-d(t)]^{1/2} dt. \quad (\text{C.20})$$

Furthermore, the residue theorem implies that for all x inside of the bounded domain delimited by \mathcal{T}_ϵ ,

$$\frac{1}{2\pi i} \int_{\mathcal{T}_\epsilon} \frac{t^{i_0-1}Y_0(t)^{j_0}}{t - x} dt = x^{i_0-1}Y_0(x)^{j_0}.$$

So, letting $\epsilon \rightarrow 0$ and using the definition of μ_{j_0} yields

$$\frac{1}{2\pi i} \int_{X([y_1, y_2])} \frac{t^{i_0-1} Y_0(t)^{j_0}}{t-x} dt = x^{i_0-1} Y_0(x)^{j_0} + \frac{1}{\pi} \int_{x_1}^{x_2} \frac{t^{i_0-1} \mu_{j_0}(t)}{t-x} [-d(t)]^{1/2} dt. \quad (\text{C.21})$$

Note that in order to obtain (C.20) and (C.21), we have used that the integral on $\mathcal{S}_\epsilon^1 \cup \mathcal{S}_\epsilon^2$ of a function holomorphic in the neighborhood of $\mathcal{S}_\epsilon^1 \cup \mathcal{S}_\epsilon^2$ goes to zero with ϵ , since the two contours \mathcal{S}_ϵ^1 and \mathcal{S}_ϵ^2 get closer of the same contour but covered in the two opposite directions. For \mathcal{C}_ϵ^1 and \mathcal{C}_ϵ^2 , we have used the fact that the integral of a function integrable goes to zero as the length of the contour goes to zero.

Finally, Theorem C.13 follows from (C.19), (C.20) and (C.21).

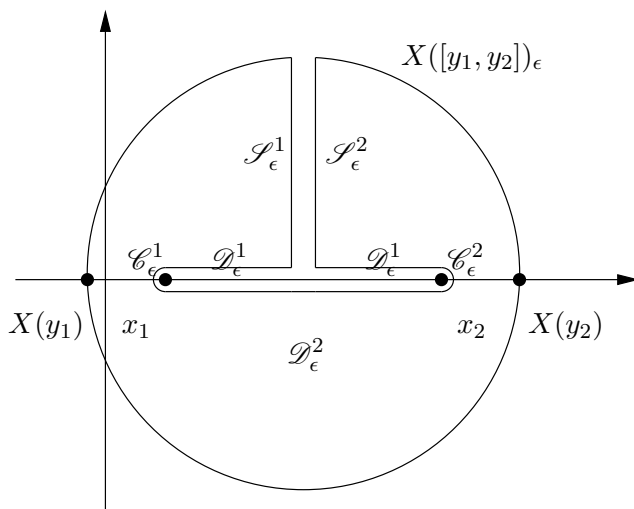

FIGURE C.5 – The contour of integration \mathcal{T}_ϵ

□

Of course, by a similar analysis, we can obtain integral representations for the function \tilde{q} . Moreover, in order to get explicitly the unknown quantity $q_{0,0}$, it is enough to evaluate Equation (C.4) at any (x, y) such that $|x|, |y| < 1$ and $K(x, y) = 0$, for example $(1 - \epsilon, Y_0(1 - \epsilon))$ where ϵ is sufficiently small, see Lemma C.2.

Remark C.14. *In this Section C.3, we were interested in the explicit expression of the functions q and \tilde{q} . Note that it could also be possible to study their nature. In fact, as in [FR10], we could show that if the group W is finite, then the generating functions q and \tilde{q} are holonomic, and we could find an effective criterion for q and \tilde{q} to be even algebraic.*

C.4 Asymptotic of the Green functions

In Section C.4, we find the asymptotic of the Green functions (C.3), as $i + j \rightarrow \infty$ and $j/i \rightarrow \tan(\gamma)$, γ lying in $[0, \pi/2]$.

C.4.1 First case : $\gamma \in]0, \pi/2[$

As it has been said in Section C.1, in the case $\gamma \in]0, \pi/2[$, the procedure is essentially the same as in [Mal73] and [KM98]; below, we just outline some important details.

First of all, it follows from (C.4) and Cauchy's formulas that for ϵ small enough,

$$G_{i,j} = \frac{1}{[2\pi i]^2} \int_{\{|x|=1-\epsilon\}} \frac{q(x)}{x^i} \left[\int_{\{|y|=1-\epsilon\}} \frac{dy}{K(x,y)y^j} \right] dx \quad (\text{C.22})$$

$$+ \frac{1}{[2\pi i]^2} \int_{\{|y|=1-\epsilon\}} \frac{\tilde{q}(y) + q_{0,0}}{y^j} \left[\int_{\{|x|=1-\epsilon\}} \frac{dx}{K(x,y)x^i} \right] dy \quad (\text{C.23})$$

$$- \frac{1}{[2\pi i]^2} \int_{\{|y|=1-\epsilon\}} \frac{1}{y^{j-j_0}} \left[\int_{\{|x|=1-\epsilon\}} \frac{dx}{K(x,y)x^{i-i_0}} \right] dy. \quad (\text{C.24})$$

Then we apply the residue theorem at infinity to the three inner integrals above. Since $K(x,y) = a(x)[y - Y_0(x)][y - Y_1(x)] = \tilde{a}(y)[x - X_0(y)][x - X_1(y)]$, we have to know the positions of $Y_i(x)$ and $X_i(y)$, $i \in \{0, 1\}$ w.r.t. the circle of center 0 and radius $1 - \epsilon$ when $|x| = |y| = 1 - \epsilon$. For this, we are going to prove that for any x, y such that $|x| = |y| = 1 - \epsilon$ and any $\epsilon > 0$ small enough,

$$|Y_0(x)| < 1 - \epsilon, \quad |Y_1(x)| > 1 - \epsilon, \quad |X_0(y)| < 1 - \epsilon, \quad |X_1(y)| > 1 - \epsilon. \quad (\text{C.25})$$

Thanks to a proper change of the parameters $(p_{i,j})_{i,j}$, it is of course sufficient to prove the first two inequalities.

We already know, from Lemma C.2, that $Y_1(\{x \in \mathbb{C} : |x| = 1\} \setminus \{1\}) \subset \{y \in \mathbb{C} : |y| > 1\}$ and $Y_0(\{x \in \mathbb{C} : |x| = 1\}) \subset \{y \in \mathbb{C} : |y| < 1\}$. In particular, by continuity, this leads immediately to the first inequality in (C.25), for sufficiently small values of ϵ . This also entails that there exists $\theta_0(\epsilon)$, going to 0 as ϵ goes to 0, such that for all $x = (1 - \epsilon) \exp(i\theta)$ with $\theta \in]\theta_0(\epsilon), 2\pi - \theta_0(\epsilon)[$, $|Y_1(x)| > 1 - \epsilon$.

To conclude, it is enough to show that for all $x = (1 - \epsilon) \exp(i\theta)$ with $\theta \in]-\theta_0(\epsilon), \theta_0(\epsilon)[$, $|Y_1(x)| > 1 - \epsilon$. For this, let us prove that there exists a neighborhood of 1, independent of ϵ , where the curves $Y_1(\{x \in \mathbb{C} : |x| = 1 - \epsilon\})$ and $Y_1(\{x \in \mathbb{C} : |x| = 1\})$ don't intersect; then, we will also show that $Y_1(1 - \epsilon) > Y_1(1) = 1$. In order to show that the two above curves don't intersect, remark that if they do, this means that $Y_1(x) = Y_1(\hat{x})$, with some x, \hat{x} such that $|x| = 1$, $|\hat{x}| = 1 - \epsilon$. This last equality is equivalent to $\hat{x}x = \tilde{c}(Y_1(x))/\tilde{a}(Y_1(x))$. Since $Y_1(1) = 1$ and $\tilde{c}(1)/\tilde{a}(1) \in]0, 1[$, the previous equality is not possible in a neighborhood of 1 for x and \hat{x} . To prove then that $Y_1(1 - \epsilon) > 1$, we remark that an explicit calculation shows that $Y_1(x) > 1$ if and only if $a(x) + b(x) + c(x) < 0$. But the polynomial $a + b + c$ goes to ∞ when $x \rightarrow \pm\infty$ and has two real roots, $\tilde{c}(1)/\tilde{a}(1) < 1$ and 1, so that $Y_1(1 - \epsilon) > 1$.

Hence the inner integral of (C.22) (resp. (C.23), (C.24)) is equal to the residue at $Y_1(x)$ (resp. $X_1(y)$) with the constant $-2\pi i$, the residue at infinity being zero. Then, letting $\epsilon \rightarrow 0$, $G_{i,j}$ is represented as the sum of the simple integrals

$$G_{i,j} = -\frac{1}{2\pi i} \int_{\{|x|=1\}} \frac{q(x)}{[d(x)]^{1/2} x^i Y_1(x)^j} dx - \frac{1}{2\pi i} \int_{\{|y|=1\}} \frac{\tilde{q}(y) + q_{0,0} - X_1(y)^{i_0} y^{j_0}}{[\tilde{d}(y)]^{1/2} X_1(y)^i y^j} dy. \quad (\text{C.26})$$

Both integrals above are typical to apply the saddle-point method, see [Fed86].

To find the suitable saddle-points for the function $\ln(xY_1(x)^{\tan(\gamma)})$, or equivalently for $\ln(X_1(y)y^{\tan(\gamma)})$, let us first have, for $\gamma \in]0, \pi/2[$, a closer look on the critical points of $\chi_{\gamma,0}$ and $\chi_{\gamma,1}$, defined by

$$\chi_{\gamma,0}(x) = xY_0(x)^{\tan(\gamma)}, \quad \chi_{\gamma,1}(x) = xY_1(x)^{\tan(\gamma)}. \quad (\text{C.27})$$

The equations $\partial\chi_{\gamma,0}(x) = 0$ and $\partial\chi_{\gamma,1}(x) = 0$ are equivalent to

$$\begin{aligned} & \pm [d(x)]^{1/2} [a(x)c(x) - x(\partial a(x)c(x) - a(x)\partial c(x)) \tan(\gamma)/2] \\ & = x \tan(\gamma) [a(x)c(x)\partial b(x) - b(x)(\partial a(x)c(x) + a(x)\partial c(x))/2]. \end{aligned} \quad (\text{C.28})$$

Taking the square of both sides above, we obtain that $P(\gamma, x) = 0$, where $P(\gamma, x)$ is the eight degree polynomial

$$P(\gamma, x) = -[a(x)c(x) + x \tan(\gamma)r(x)]d(x) + (x \tan(\gamma))^2 P_l(x), \quad (\text{C.29})$$

where we note

$$P_l(x) = r(x)^2 - r_1(x)r_2(x) = \lim_{\gamma \rightarrow \pi/2} \frac{P(\gamma, x)}{(x \tan(\gamma))^2} \quad (\text{C.30})$$

and

$$r = a\partial c - c\partial a, \quad r_1 = b\partial a - a\partial b, \quad r_2 = c\partial b - b\partial c. \quad (\text{C.31})$$

For $\gamma \in]0, \pi/2[$, the eight roots of the polynomial $P(\gamma, x)$ are the four critical points of $\chi_{\gamma,0}(x)$ and the four ones of $\chi_{\gamma,1}(x)$.

It is immediate that in the limiting case $\gamma = 0$, its roots are the roots of a and c as well as the branch points x_i , $i \in \{1, \dots, 4\}$.

If $\gamma = \pi/2$, two of its roots are 0, two are equal to ∞ and four of them are the $X(y_i)$, $i \in \{1, \dots, 4\}$, which are, besides, the roots of $P_l(x)$.

Note that under the restrictive hypothesis $p_{-1,0} + p_{0,1} + p_{1,0} + p_{0,-1} = 1$, the critical points can be expressed by radicals. Indeed, in this case, the polynomial (C.29) is equal to $(\tan(\gamma)^2 - 1)x^2 P_{1,4}(\gamma, x) P_{2,3}(\gamma, x)$, where $P_{1,4}(\gamma, x)$ and $P_{2,3}(\gamma, x)$ are polynomials of the second degree, namely

$$P_{1,4}(\gamma, x) = p_{1,0}x^2 - \frac{1 + T(\gamma)}{1 - \tan(\gamma)^2}x + p_{-1,0}, \quad P_{2,3}(\gamma, x) = p_{1,0}x^2 - \frac{1 - T(\gamma)}{1 - \tan(\gamma)^2}x + p_{-1,0},$$

where

$$T(\gamma) = [1 - (1 - \tan(\gamma)^2)(1 - 4p_{0,-1}p_{0,1} + 4p_{-1,0}p_{1,0} \tan(\gamma)^2)]^{1/2}.$$

The saddle-point for the first integral in (C.26) is then the biggest root of $P_{2,3}(\gamma, x)$. This is the unique critical point of $\chi_{\gamma,1}(x)$ such that $x > 0$ and $Y_1(x) > 0$. In [KM98], it has been characterized as the solution of (C.32) below.

Let us do it in the general case, *i.e.* without assuming that $p_{-1,0} + p_{0,1} + p_{1,0} + p_{0,-1} = 1$. We need to introduce the function

$$\phi(u, v) = \sum_{i,j} p_{i,j} \exp(iu) \exp(jv).$$

The equation $K(x, y) = 0$ with $x, y > 0$ is equivalent to $\phi(u, v) = 1$ with $u = \ln(x)$ and $v = \ln(y)$. If $x > 0$ is the critical point of $\chi_{0,\gamma}(x)$ such that $Y_0(x) > 0$ (resp. the one of

$\chi_{1,\gamma}(x)$ such that $Y_1(x) > 0$), then after some algebraic manipulations with $u = \ln(x)$ and $v = \ln(Y_0(x))$ (resp. $v = \ln(Y_1(x))$), we see that the equation (C.28) is equivalent to

$$\frac{\partial_u \phi(u, v)}{\partial_v \phi(u, v)} = \tan(\gamma). \quad (\text{C.32})$$

Then, either

$$\frac{\text{grad}(\phi(u, v))}{|\text{grad}(\phi(u, v))|} = (\cos(\gamma), \sin(\gamma)) \quad (\text{C.33})$$

or

$$\frac{\text{grad}(\phi(u, v))}{|\text{grad}(\phi(u, v))|} = (\cos(\gamma + \pi), \sin(\gamma + \pi)). \quad (\text{C.34})$$

The mapping $(u, v) \mapsto \text{grad}(\phi(u, v))/|\text{grad}(\phi(u, v))|$ is a homeomorphism from $D = \{(u, v) \in \mathbb{R}^2 : \phi(u, v) = 1\}$ onto the unit circle, see [Hen63]. Hence, for any $\gamma \in [0, \pi/2]$, there is one solution of (C.33) on D , that we call $(u(\gamma), v(\gamma))$, and one solution of (C.34) on D , that we denote by $(u(\gamma + \pi), v(\gamma + \pi))$.

Thus, the positive critical point of $\chi_{\gamma,0}(x)$ such that $Y_0(x) > 0$ and the one of $\chi_{\gamma,1}(x)$ with $Y_1(x) > 0$ are among $\exp(u(\gamma))$ and $\exp(u(\gamma + \pi))$. In addition, for $i \in \{0, 1\}$, $\exp(u(\gamma))$ (resp. $\exp(u(\gamma + \pi))$) is critical for $\chi_{i,\gamma}(x)$ if and only if $\exp(v(\gamma))$ (resp. $\exp(v(\gamma + \pi))$) equals $Y_i(\exp(u(\gamma)))$ (resp. $Y_i(\exp(u(\gamma + \pi)))$). Then, we verify that $\exp(v(\gamma)) = Y_1(\exp(u(\gamma)))$ and $\exp(v(\gamma + \pi)) = Y_0(\exp(u(\gamma + \pi)))$, so that $\exp(u(\gamma))$ is the critical point of $\chi_{\gamma,1}(x)$ and $\exp(u(\gamma + \pi))$ is the one of $\chi_{\gamma,0}(x)$. Indeed, for $i \in \{0, 1\}$,

$$\partial_v \phi(u(\gamma), Y_i(\exp(u(\gamma)))) = [2Y_i(\exp(u(\gamma)))a(\exp(u(\gamma))) + b(\exp(u(\gamma)))]/Y_i(\exp(u(\gamma))). \quad (\text{C.35})$$

Moreover, on $[x_2, x_3]$, $2a(x)Y_1(x) + b(x) = d(x)^{1/2}$ and $2a(x)Y_0(x) + b(x) = -d(x)^{1/2}$, so that (C.35) is negative for $i = 0$ and positive for $i = 1$, what answers the problem.

In what follows, we set $s_x(\tan(\gamma)) = \exp(u(\gamma))$ and $s_y(\tan(\gamma)) = Y_1(\exp(u(\gamma)))$.

The mapping $\gamma \mapsto (s_x(\tan(\gamma)), s_y(\tan(\gamma)))$ is a homeomorphism between $[0, \pi/2]$ and $\{(x, y) \in \mathbb{C}^2 : x > 0, y > 0, K(x, y) = 0\}$. Moreover, $s_x(0) = x_3$, $s_y(0) = Y(x_3)$, $s_x(\infty) = X(y_3)$ and $s_y(\infty) = y_3$. When γ runs $[0, \pi/2]$, $s_x(\tan(\gamma))$ monotonously decreases from x_3 to $X(y_3)$ and $s_y(\tan(\gamma))$ monotonously increases from $Y(x_3)$ to y_3 .

Finally, note that the unique critical point of $\tilde{\chi}_{\gamma,1}(y) = X_1(y)y^{\tan(\gamma)}$ with $y > 0$ and $X_1(y) > 0$ is obviously $s_y(\tan(\gamma))$ and that $X_1(s_y(\tan(\gamma))) = s_x(\tan(\gamma))$.

Theorem C.15.

* *Suppose first that $p_{1,1} + p_{1,-1} + p_{-1,-1} + p_{-1,1} < 1$. Then the Green functions (C.3) admit the following asymptotic, as $i + j \rightarrow \infty$ and $j/i \rightarrow \tan(\gamma)$, γ lying in $]0, \pi/2[$:*

$$G_{i,j} \sim C(\gamma) \frac{s_x(\tan(\gamma))^{i_0} s_y(\tan(\gamma))^{j_0} - q(s_x(\tan(\gamma))) - \tilde{q}(s_y(\tan(\gamma))) - q_{0,0}}{i^{1/2} s_x(j/i)^i s_y(j/i)^j},$$

where the constant $C(\gamma) > 0$ is equal to

$$C(\gamma) = \frac{s_y(\tan(\gamma))}{[2\pi]^{1/2} \tilde{d}(s_y(\tan(\gamma)))} \left[-\partial_y^2 \left(\frac{X_1(s_y(\tan(\gamma)))y}{s_x(\tan(\gamma))} y^{\tan(\gamma)} \right) \Big|_{y=1} \right]^{-1/2}.$$

* Suppose now that $p_{1,1} + p_{1,-1} + p_{-1,-1} + p_{-1,1} = 1$. If, in addition, $i_0 + j_0$ and $i + j$ don't have the same parity, then $G_{i,j} = 0$; if they have the same parity, then the asymptotic of $G_{i,j}$ is obtained by replacing $C(\gamma)$ by $2C(\gamma)$ in the one above.

Note that thanks to Section C.3, all the quantities appearing in the asymptotic of the Green functions above are explicit.

Remark C.16. Thanks to Theorem C.7, if $\omega_2/\omega_3 \in \mathbb{Z}$, then the quantity

$$s_x(\tan(\gamma))^{i_0} s_y(\tan(\gamma))^{j_0} - q(s_x(\tan(\gamma))) - \tilde{q}(s_y(\tan(\gamma))) - q_{0,0}$$

which appears in the asymptotic of the Green functions given in Theorem C.15 above can be considerably simplified.

For instance, if $\omega_2/\omega_3 = 2$, then the latter equals

$$\left[s_x(\tan(\gamma))^{i_0} - ([p_{-1,0}/p_{1,0}]/s_x(\tan(\gamma)))^{i_0} \right] \cdot \left[s_y(\tan(\gamma))^{j_0} - ([p_{0,-1}/p_{0,1}]/s_y(\tan(\gamma)))^{j_0} \right],$$

$s_x(\tan(\gamma))$ being, in this case, the biggest root of $P_{2,3}$ and $s_y(\tan(\gamma)) = Y_1(s_x(\tan(\gamma)))$.

Proof of Theorem C.15. We appropriately shift the contour of integration $\{|x| = 1\}$ (resp. $\{|y| = 1\}$) in the first (resp. second) integral of (C.26) to a contour Γ_γ (resp. $\tilde{\Gamma}_\gamma$) passing through $s_x(\tan(\gamma))$ (resp. $s_y(\tan(\gamma))$), which is the saddle-point of order one.

Γ_γ is the contour of steepest descent (*i.e.* the imaginary part of $xY_1(x)^{\tan(\gamma)}$ is zero on it) in a neighborhood of $s_x(\tan(\gamma))$ and, outside this neighborhood, Γ_γ remains “higher” than $s_x(\tan(\gamma))$ in the sense of the level curves of the function $\chi_{\gamma,1}$. The construction of Γ_γ is done as in [Mal73] and [KM98], therefore we omit the details.

Likewise, we construct the contour $\tilde{\Gamma}_\gamma$.

Then, by Cauchy's theorem, the first (resp. second) term in (C.26) equals the integral over Γ_γ (resp. $\tilde{\Gamma}_\gamma$), the asymptotic of which is computed by the saddle-point method. \square

C.4.2 Second case : $\gamma = 0, \pi/2$

For that purpose, we first need to know the behavior of $s_x(j/i) - s_x(0)$ and $s_y(j/i) - s_y(0)$ when j/i is in a neighborhood of 0.

Lemma C.17. Let P_l be the polynomial defined in (C.30). The following expansions hold as $j/i \rightarrow 0$:

$$s_x(0) - s_x(j/i) = \frac{x_3^2 P_l(x_3)}{-a(x_3)c(x_3)\partial d(x_3)} (j/i)^2 + O(j/i)^3, \quad (\text{C.36})$$

$$s_y(j/i) - s_y(0) = \frac{x_3 P_l(x_3)^{1/2}}{2a(x_3)^{3/2}c(x_3)^{1/2}} j/i + O(j/i)^2. \quad (\text{C.37})$$

Proof. Start by proving Equation (C.36). On the one hand, by using (C.29), we obtain that $P(\arctan(j/i), x_3) = s_x(j/i)^2 P_l(x_3)$; on the other hand, by definition of $P(\arctan(j/i), x)$ and also with (C.29), we get that $P(\arctan(j/i), x_3) = (x_3 - s_x(j/i))R(j/i)$, with $R(0) = -a(x_3)c(x_3)\partial d(x_3) \neq 0$. Equation (C.36) follows immediately.

Then, to prove (C.37), start by remarking that $Y_1(x) - Y_1(x_3) = b(x_3)/[2a(x_3)] - b(x)/[2a(x)] + d(x)^{1/2}/[2a(x)]$, so that in the neighborhood of x_3 , $Y_1(x) - Y_1(x_3) = U(x) + [(-\partial d(x_3))^{1/2}/[2a(x_3)]] [x_3 - x]^{1/2} (1 + V(x))$, with U, V holomorphic at x_3 , where they take the value 0. Moreover, for all $j/i \in [0, \infty]$, $s_y(j/i) = Y_1(s_x(j/i))$, see Subsection C.4.1. This yields $s_y(j/i) - s_y(0) = [(-\partial d(x_3))^{1/2}/[2a(x_3)]] [x_3 - s_x(j/i)]^{1/2} + O(x_3 - s_x(j/i))$. Finally, using (C.36), we obtain (C.37). \square

Theorem C.18.

- * Suppose first that $p_{1,1} + p_{1,-1} + p_{-1,-1} + p_{-1,1} < 1$. Then the Green functions admit the following asymptotic, as $i \rightarrow \infty$, $j > 0$ and $j/i \rightarrow 0$:

$$G_{i,j} \sim C_0 \frac{j}{i} \frac{j_0 s_x(0)^{i_0} s_y(0)^{j_0-1} - \partial \tilde{q}(s_y(0))}{i^{1/2} s_x(j/i)^i s_y(j/i)^j},$$

where the constant $C_0 > 0$ is equal to

$$C_0 = \left(\frac{2}{\pi}\right)^{1/2} \frac{s_x(0)^{1/2} \partial s_y(0)}{[-\tilde{d}(s_y(0)) \partial^2 X_1(s_y(0))]^{1/2}},$$

and where $s_x(0) = x_3$, $s_y(0) = Y_1(x_3)$, $\partial s_y(0)$ being obtained from Lemma C.17.

An analogous result holds as $j \rightarrow \infty$, $i > 0$ and $i/j \rightarrow 0$, after a proper change of the parameters $(p_{i,j})_{i,j}$.

- * Suppose now that $p_{1,1} + p_{1,-1} + p_{-1,-1} + p_{-1,1} = 1$. If in addition $i_0 + j_0$ and $i + j$ don't have the same parity, then $G_{i,j} = 0$; if they have the same parity, then the asymptotic of $G_{i,j}$ is obtained from the above by replacing C_0 by $2C_0$.

Once again with Section C.3, the different quantities which appear in the asymptotic of the Green functions above are completely explicit.

Corollary C.19. For the walks verifying the assumptions (H1), (H2), (H3), (H4) and (H5), the Martin compactification of \mathbb{Z}_+^2 is homeomorphic to the closure of $\{(i, j)/(1 + \|(i, j)\|) : (i, j) \in \mathbb{Z}_+^2\}$ in \mathbb{R}^2 .

Proof of Theorem C.18. Let us first suppose that $p_{1,1} + p_{1,-1} + p_{-1,-1} + p_{-1,1} < 1$.

In (C.26), $G_{i,j}$ appears as the sum of two integrals, one on the contour $\{|x| = 1\}$ and the other on $\{|y| = 1\}$. Using Cauchy's Theorem, we are first going to move these contours up to new ones, that go through the saddle-points $s_x(j/i)$ and $s_y(j/i)$ respectively. In order to define these new contours of integration, we need to introduce the following functions, eventually multivalued :

$$\kappa_{j/i}(x) = \ln(x) + \frac{j}{i} \ln\left(\frac{Y_1(s_x(j/i)x)}{s_y(j/i)}\right), \quad \tilde{\kappa}_{j/i}(y) = \ln\left(\frac{X_1(s_y(j/i)y)}{s_x(j/i)}\right) + \frac{j}{i} \ln(y). \quad (\text{C.38})$$

According to Subsection C.4.1, the function $\kappa_{j/i}$ (resp. $\tilde{\kappa}_{j/i}$) has, for any $j/i > 0$, a critical point at 1, where it takes the value 0. Consider now the functions $x_{j/i}(t)$ and $y_{j/i}(t)$, defined in neighborhoods $V_{x,j/i}(0)$ and $V_{y,j/i}(0)$ of 0 by

$$\kappa_{j/i}(x_{j/i}(t)) = t^2, \quad \tilde{\kappa}_{j/i}(y_{j/i}(t)) = t^2, \quad (\text{C.39})$$

and $\text{sign}(\text{Im}(x_{j/i}(t))) = \text{sign}(\text{Im}(y_{j/i}(t))) = \text{sign}(t)$ – where $\text{Im}(u)$ denotes the imaginary part of u . These last relationships are fixed in order to define $x_{j/i}$ and $y_{j/i}$ not ambiguously.

Inverting (C.39), we obtain the explicit expression of $x_{j/i}$ and $y_{j/i}$. Here, inverting can be done by using the so-called Bürman-Lagrange formula, see *e.g.* [Cha90], that permit to write the coefficients of the Taylor series of a reciprocal function as integrals in terms of the direct function.

As $j/i \rightarrow 0$, then $s_y(j/i) \rightarrow s_y(0) \in]y_2, y_3[$. In particular,

$$\tilde{\rho} = \inf_{j/i \in [0,1]} \inf \{y_3/s_y(j/i) - 1, 1 - y_2/s_y(j/i)\},$$

is positive and is such that $\tilde{\kappa}_{j/i}$ is holomorphic in the disc $1 + \tilde{\rho}\mathcal{D}$, for any $j/i \in [0, 1]$. Using the Bürman-Lagrange formula, we see that the radius of $V_{y,j/i}(0)$ does not vanish as $j/i \rightarrow 0$; therefore, $y_{j/i}(t)$ is defined and holomorphic in the disc $\rho\mathcal{D}$, ρ being positive and independent of $j/i \in [0, 1]$.

Moreover, the functions $x_{j/i}(t)$ and $y_{j/i}(t)$ are joined together by :

$$x_{j/i}(-t) = \frac{X_1(s_y(j/i)y_{j/i}(t))}{s_x(j/i)}, \quad y_{j/i}(-t) = \frac{Y_1(s_x(j/i)x_{j/i}(t))}{s_y(j/i)}. \quad (\text{C.40})$$

The identity (C.40) is just a consequence of the ‘‘automorphy relationships’’ proved in [FIM99] : for x (resp. y) exterior to some curve (what is the case here), $X_1(Y_1(x)) = x$ (resp. $Y_1(X_1(y)) = y$). For this reason and since 1 is a critical point of order one of $\kappa_{j/i}$, we obtain that $x_{j/i}(t) \in \{X_1(s_y(j/i)y_{j/i}(-t))/s_x(j/i), X_1(s_y(j/i)y_{j/i}(t))/s_x(j/i)\}$. It is then enough to calculate the sign of the imaginary part in order to identify which of the two possibilities actually happens : we have $x_{j/i}(t) = X_1(s_y(j/i)y_{j/i}(-t))/s_x(j/i)$.

The first equality of (C.40) shows that $x_{j/i}$ is holomorphic as well in $V_{x,j/i}(0) = \rho\mathcal{D}$, for any $j/i \in [0, 1]$.

The functions

$$\hat{x}_{j/i}(t) = s_x(j/i)x_{j/i}(t), \quad \hat{y}_{j/i}(t) = s_y(j/i)y_{j/i}(t)$$

determine, of course, the paths of steepest descent for the functions $\ln(xY_1(x)^{j/i})$ and $\ln(X_1(y)y^{j/i})$ respectively.

Note that the limiting curve $\hat{x}_0(t)$ runs the real line decreasingly from $\hat{x}_0(\rho)$ to $\hat{x}_0(0) = x_3$ and then increasingly from x_3 to $\hat{x}_0(\rho)$ when t runs $[-\rho, \rho]$: indeed, $x_0(t) = \exp(t^2)$. As for the function $\hat{y}_0(t) = Y_1(\hat{x}_0(-t))$, it runs the values of the curve $Y([\hat{x}_0(\rho), x_3])$.

For any ρ small enough, we are now going to define two closed contours

$$\mathcal{C}_{\rho,j/i,x} = x_{j/i}([-\rho, \rho]) \cup \mathcal{A}_{\rho,j/i,x}, \quad \mathcal{C}_{\rho,j/i,y} = y_{j/i}([-\rho, \rho]) \cup \mathcal{A}_{\rho,j/i,y},$$

where $\mathcal{A}_{\rho,j/i,x}$ and $\mathcal{A}_{\rho,j/i,y}$ verify the following three properties.

- (i) There exists a constant $c(\rho) > 0$ such that $|\kappa_{j/i}(x)|, |\tilde{\kappa}_{j/i}(y)| > c(\rho)$ for any $x \in \mathcal{A}_{\rho,j/i,x}$, $y \in \mathcal{A}_{\rho,j/i,y}$ and any j/i small enough.
- (ii) The first (resp. second) integrand in (C.26) doesn't have any singularity in the domain bounded by $\{|x| = 1\}$ (resp. $\{|y| = 1\}$) and $s_x(j/i)\mathcal{C}_{\rho,j/i,x}$ (resp. $s_y(j/i)\mathcal{C}_{\rho,j/i,y}$).
- (iii) There exists a constant $L(\rho)$ such that for all j/i small enough, the lengths of both contours $\mathcal{C}_{\rho,j/i,x}$ and $\mathcal{C}_{\rho,j/i,y}$ are bounded by $L(\rho)$.

Let us construct such a contour $\mathcal{A}_{\rho,j/i,x}$.

We may take, for $\mathcal{A}_{\rho,0,x}$, the circle of center 0 and radius $x_0(\rho) > 1$. Then, for any $x \in \mathcal{A}_{\rho,0,x}$, $|\kappa_0(x)| = |\ln(x)| = \ln(x_0(\rho)) > \ln(x_0(\rho))/2$. Let us then set

$$\mathcal{A}_{\rho,j/i,x} = \{|x_{j/i}(\rho)| \exp(i\theta) : \theta \in]\arg(x_{j/i}(\rho)), 2\pi - \arg(x_{j/i}(\rho))[\}.$$

Since $\hat{x}_{j/i}(\rho) \rightarrow \hat{x}_0(\rho) = x_3 \exp(\rho^2)$ as $j/i \rightarrow 0$ and since the only possible zeros of Y_1 are at 0 and ∞ , the property (i) remains valid for $\kappa_{j/i}(x)$ with $c(\rho) = \ln(x_0(\rho))/4$, for any j/i small enough.

Furthermore, the singularities of the first integrand in (C.26) are the zeros of d , *i.e.* the branch points x_i , $i \in \{1, \dots, 4\}$. But with Lemma C.1, x_1 and x_2 are inside of the unit disc.

As for x_3 and x_4 , they are outside of $s_x(j/i)\mathcal{C}_{\rho,j/i,x}$: indeed, x_3 is outside of this contour by construction, and x_4 also lies outside of $s_x(j/i)\mathcal{C}_{\rho,j/i,x}$ for ρ small enough, because $|x_4| > x_3$, since we have supposed $p_{1,1} + p_{1,-1} + p_{-1,-1} + p_{-1,1} < 1$, see once again Lemma C.1. So (ii) is verified and (iii) is also and obviously verified.

We can also construct $\mathcal{A}_{\rho,j/i,y}$ starting by $\mathcal{A}_{\rho,0,y}$. Since $s_y(0)$ is a critical point of X_1 , the level line $\{y \in \mathbb{C} : |X_1(y)| = x_3\}$ has a double point at $s_y(0)$ and $\{y \in \mathbb{C} : |X_1(y)| = x_3\} \setminus \{s_y(0)\}$ has two connected components. Moreover, thanks to Lemma C.20, the set $\{y \in \mathbb{C} : |y| = s_y(0)\} \setminus \{s_y(0)\}$ lies in the domain $\{y \in \mathbb{C} : |X_1(y)| > x_3\}$. For this reason and since $-s_y(0) \in]-y_3, -y_2[[-|y_4|, -|y_1|$, one can clearly construct a contour $\mathcal{A}_{\rho,0,y}$ that verifies (i), (ii) and (iii). Then, by continuity of the different quantities w.r.t. j/i , one can build contours $\mathcal{A}_{\rho,j/i,y}$ satisfying to (i), (ii) and (iii), for any j/i small enough.

Let us go back to (C.26). Before passing from double integrals in (C.22), (C.23) and (C.24) to the simple ones in (C.26), it is convenient to subtract the constant $q(x_3)$ from the numerator of (C.22) and add it to the numerator of (C.23). Next, we move the contours $\{|x| = 1\}$ and $\{|y| = 1\}$ to $s_x(j/i)\mathcal{C}_{\rho,j/i,x}$ and $s_y(j/i)\mathcal{C}_{\rho,j/i,y}$; thanks Cauchy's theorem and since by construction the contours avoid the singularities of the integrands, the value of the integrals is not changed.

Then, after the changes of variable $x \mapsto s_x(j/i)x$ and $y \mapsto s_y(j/i)y$ in (C.26), we obtain that $G_{i,j} = -K_{i,j}/[s_x(j/i)^i s_y(j/i)^j]$, where $K_{i,j}$ is defined by :

$$K_{i,j} = \frac{s_x(j/i)}{2\pi i} \int_{\mathcal{C}_{\rho,j/i,x}} \frac{q(s_x(j/i)x) - q(x_3)}{[d(s_x(j/i)x)]^{1/2}} \exp(-i\kappa_{j/i}(x)) dx + \frac{s_y(j/i)}{2\pi i} \times \quad (C.41)$$

$$\times \int_{\mathcal{C}_{\rho,j/i,y}} \frac{\tilde{q}(s_y(j/i)y) + q_{0,0} + q(x_3) - X_1(s_y(j/i)y)^{i_0} (s_y(j/i)y)^{j_0}}{[\tilde{d}(s_y(j/i)y)]^{1/2}} \exp(-i\tilde{\kappa}_{j/i}(y)) dy.$$

Let us now split $K_{i,j} = K_{i,j,1} + K_{i,j,2}$, where $K_{i,j,1}$ (resp. $K_{i,j,2}$) is obtained from $K_{i,j}$ by integrating only on the contours $x_{j/i}([-\rho, \rho])$ and $y_{j/i}([-\rho, \rho])$ (resp. $\mathcal{A}_{\rho,j/i,x}$ and $\mathcal{A}_{\rho,j/i,y}$).

We are now going to prove that the asymptotic of $K_{i,j,1}$ leads to the result announced in Theorem C.18 and that $K_{i,j,2}$ is exponentially negligible – in the sense of (C.42).

We start by studying $K_{i,j,2}$. First of all, we consider the two quantities

$$S_{1,\delta} = \sup_{j/i \in [0, \delta]} \sup_{x \in \mathcal{C}_{\rho,j/i,x}} \left| \frac{q(s_x(j/i)x) - q(x_3)}{[d(s_x(j/i)x)]^{1/2}} \right|,$$

$$S_{2,\delta} = \sup_{j/i \in [0, \delta]} \sup_{y \in \mathcal{C}_{\rho,j/i,y}} \left| \frac{\tilde{q}(s_y(j/i)y) + q_{0,0} + q(x_3) - X_1(s_y(j/i)y)^{i_0} (s_y(j/i)y)^{j_0}}{[\tilde{d}(s_y(j/i)y)]^{1/2}} \right|,$$

and we prove that, for δ sufficiently small, they are finite.

The fact that, for δ small enough, $S_{1,\delta}$ is finite comes from the three following properties.

Firstly, we recall (see Corollary C.6) that q is holomorphic on $\mathbb{C} \setminus [x_3, x_4]$, whence in particular on $x_3\mathcal{D}$. Moreover, it is continuable holomorphically through every point of the circle of center 0 and radius x_3 , except x_3 . This is why q , and therefore also $[q - q(x_3)]/d^{1/2}$, are bounded in a neighborhood of every point of the circle of center 0 and radius x_3 , except eventually at x_3 .

Secondly, it can be easily deduced from the proofs of the forthcoming Lemmas C.25 and C.26 that in the neighborhood of x_3 , $q(x) = q(x_3) + C[x_3 - x]^{1/2} + O(x_3 - x)$, where C is some non-zero constant. So $[q - q(x_3)]/d^{1/2}$ is also bounded in the neighborhood of x_3 .

Thirdly, the contour $s_x(j/i)\mathcal{C}_{\rho,j/i,x}$ avoids, by construction, the branch points x_1, x_2 and x_4 .

The fact that the quantity $S_{2,\delta}$ is finite follows similarly : first, by construction, the contours $s_y(j/i)\mathcal{C}_{\rho,j/i,y}$ avoids the branch points $y_i, i \in \{1, \dots, 4\}$; also, the poles of X_1 being isolated, $s_y(j/i)\mathcal{C}_{\rho,j/i,y}$ can be chosen such that it remains away from them.

Remembering the properties (i) and (iii) of $\mathcal{A}_{\rho,j/i,x}$ and $\mathcal{A}_{\rho,j/i,y}$, we deduce that for any $i > 0$ and any j/i small enough,

$$|K_{i,j,2}| \leq [L(\rho)/(2\pi)] [x_3 S_{1,\delta} + y_3 S_{2,\delta}] \exp(-ic(\rho)). \quad (\text{C.42})$$

Let us now turn to $K_{i,j,1}$. Making in (C.41) the two changes of variable $x = x_{j/i}(t)$ and $y = y_{j/i}(t)$, we represent $K_{i,j,1}$ as an integral on the segment $[-\rho, \rho]$. Moreover, using (C.26) as well as the following equality (that comes from (C.4) and (C.40))

$$s_x(j/i)\partial_t x_{j/i}(-t) [\tilde{d}(s_y(j/i)y_{j/i}(-t))]^{1/2} = -s_y(j/i)\partial_t y_{j/i}(t) [d(s_x(j/i)x_{j/i}(-t))]^{1/2}, \quad (\text{C.43})$$

we obtain that $K_{i,j,1} = \int_{-\rho}^{\rho} f_{j/i}(t) \exp(-it^2) dt$, where $f_{j/i}(t)$ equals

$$[q(X_1(\hat{y}_{j/i}(t))) + \tilde{q}(\hat{y}_{j/i}(t)) + q_{0,0} - X_1(\hat{y}_{j/i}(t))^{i_0} \hat{y}_{j/i}(t)^{j_0}] \partial_t \hat{y}_{j/i}(t) / [\tilde{d}(\hat{y}_{j/i}(t))]^{1/2},$$

and $\hat{y}_{j/i}(t) = s_y(j/i)y_{j/i}(t)$.

We are now going to need the following consequence of Proposition C.5 and Corollary C.6 : for all $x \in \mathbb{C} \setminus [x_3, x_4]$,

$$q(x) = x^{i_0} Y_0(x)^{j_0} - \tilde{q}(Y_0(x)) - q_{0,0}. \quad (\text{C.44})$$

This yields that $f_{j/i}(t)$ is equal to :

$$\begin{aligned} & \left[\tilde{q}(\hat{y}_{j/i}(t)) - \tilde{q} \left(\frac{c(X_1(\hat{y}_{j/i}(t)))}{a(X_1(\hat{y}_{j/i}(t))) \hat{y}_{j/i}(t)} \right) - X_1(\hat{y}_{j/i}(t))^{i_0} \times \right. \\ & \left. \times \left(\hat{y}_{j/i}(t)^{j_0} - \left(\frac{c(X_1(\hat{y}_{j/i}(t)))}{a(X_1(\hat{y}_{j/i}(t))) \hat{y}_{j/i}(t)} \right)^{j_0} \right) \right] \partial_t \hat{y}_{j/i}(t) / [\tilde{d}(\hat{y}_{j/i}(t))]^{1/2}. \end{aligned} \quad (\text{C.45})$$

In particular, this expression (C.45) of $f_{j/i}$, added to the holomorphy of $y_{j/i}$ in $\rho\mathcal{D}$ for some $\rho > 0$ independent of $j/i \in [0, 1]$, implies that $f_{j/i}$ is holomorphic in a disc of center 0 and of radius positive and independent of j/i , for j/i small enough.

Therefore $f_{j/i}(t)$ can be written as

$$f_{j/i}(t) = f_{j/i}(0) + t\partial f_{j/i}(0) + t^2\partial^2 f_{j/i}(0)/2 + t^3\partial^3 f_{j/i}(0)/6 + t^4 g_{j/i}(t),$$

where $g_{j/i}$ is also holomorphic in some centered disc of radius positive and independent of j/i , for j/i sufficiently small. Reducing eventually ρ and δ , we have that

$$G = \sup_{j/i \in [0, \delta]} \sup_{t \in [-\rho, \rho]} |g_{j/i}(t)|$$

is finite. Then, applying Laplace's method, we obtain the following upper bound, valid for any $i, j > 0$ and $j/i \in [0, \delta]$:

$$\left| K_{i,j,1} - \frac{1}{2\pi\iota} \left[\frac{\pi^{1/2} f_{j/i}(0)}{i^{1/2}} + \frac{\pi^{1/2} \partial^2 f_{j/i}(0)}{4i^{3/2}} \right] \right| \leq \frac{3\pi^{1/2} G}{4i^{5/2}} + C \exp(-i\rho^2), \quad (\text{C.46})$$

with some constant $C > 0$.

To conclude the analysis of $K_{i,j,1}$, it remains to evaluate the asymptotic expansions of $f_{j/i}(0)$ and $\partial^2 f_{j/i}(0)$ as $j/i \rightarrow 0$.

Taking $t = 0$ in (C.45), we derive that $f_{j/i}(0)$ is equal to

$$\begin{aligned} & \left[\tilde{q}(s_y(j/i)) - \tilde{q} \left(\frac{c(X_1(s_y(j/i)))}{a(X_1(s_y(j/i))) s_y(j/i)} \right) - X_1(s_y(j/i))^{i_0} \times \right. \\ & \left. \times \left(s_y(j/i)^{j_0} - \left(\frac{c(X_1(s_y(j/i)))}{a(X_1(s_y(j/i))) s_y(j/i)} \right)^{j_0} \right) \right] s_y(j/i) \partial y_{j/i}(0) / [\tilde{d}(s_y(j/i))]^{1/2}. \end{aligned} \quad (\text{C.47})$$

Remark now that $s_y(0)^2 = c(s_x(0))/a(s_x(0))$ - indeed, $s_y(0) = Y_1(s_x(0))$ and $s_x(0) = x_3 -$, in such a way that for any (suitable) function F ,

$$F(s_y(j/i)) - F([c(s_x(j/i))/a(s_x(j/i))]/s_y(j/i)) = 2\partial F(s_y(0))\partial s_y(0)j/i + o(j/i),$$

$\partial s_y(0)$ being obtained from Lemma C.17.

Using this fact successively for $F(y) = \tilde{q}(y)$ and $F(y) = y^{j_0}$, we expand the member between square brackets in (C.47) as $2[\partial \tilde{q}(s_y(0)) - j_0 s_x(0)^{i_0} s_y(0)^{j_0-1}] \partial s_y(0) j/i + o(j/i)$. The functions $s_x(j/i)$ and $s_y(j/i)$ being continuous on $[0, \infty]$, the Taylor coefficients of $y_{j/i}(t)$ depend continuously on j/i , so that $\partial y_{j/i}(0) \rightarrow \partial y_0(0)$ as $j/i \rightarrow 0$.

Let us compute the value of $\partial y_0(0)$. To get it, we differentiate twice (C.39); this yields

$$\partial y_{j/i}(0)^2 \partial^2 \left(\frac{X_1(s_y(j/i)y)}{s_x(j/i)} y^{j/i} \right) \Big|_{y=1} = 2. \quad (\text{C.48})$$

In addition, an explicit calculation gives

$$\lim_{j/i \rightarrow 0} \partial^2 \left(\frac{X_1(s_y(j/i)y)}{s_x(j/i)} y^{j/i} \right) \Big|_{y=1} = \frac{s_y(0)^2}{s_x(0)} \partial^2 X_1(s_y(0)). \quad (\text{C.49})$$

Equations (C.48) and (C.49) imply that $\partial y_0(0) = \iota [-2s_x(0)/\partial^2 X_1(s_y(0))]^{1/2}/s_y(0)$, the complex number ι coming from the fact that $\partial^2 X_1(s_y(0))$ is negative. Hence, we obtain that $f_{j/i}(0) = l_1 j/i [1 + o(1)]$, where

$$l_1 = -\iota \frac{2^{3/2} s_x(0)^{1/2} \partial s_y(0) [j_0 s_x(0)^{i_0} s_y(0)^{j_0-1} - \partial \tilde{q}(s_y(0))]}{[-\tilde{d}(s_y(0)) \partial^2 X_1(s_y(0))]^{1/2}}. \quad (\text{C.50})$$

The Taylor coefficients of $y_{j/i}$ depending continuously on j/i , so do the ones of $f_{j/i}$. So $\partial^2 f_{j/i}(0) \rightarrow \partial^2 f_0(0)$ as $j/i \rightarrow 0$.

But $f_{j/i}$ is an odd function on $[-\rho, \rho]$. To see this, we remark first that (C.6) yields $c(\hat{x}_0(t))/[a(\hat{x}_0(t))Y_1(\hat{x}_0(t))] = Y_0(\hat{x}_0(t))$. Moreover, $Y_1(\hat{x}_0(-t)) = Y_0(\hat{x}_0(t))$, so that \hat{x}_0

being even (remember that $\hat{x}_0(t)$ is equal to $x_3 \exp(t^2)$), the function within the square brackets in (C.45) is odd. In addition, using (C.43) we obtain that $\partial \hat{y}_0(t)/[\tilde{d}(\hat{y}_0(t))]^{1/2} = -\partial \hat{x}_0(-t)/[d(\hat{x}_0(-t))]^{1/2}$. Being the product of two odd functions, $\partial \hat{x}_0/[d(\hat{x}_0)]^{1/2}$ is even, so that $\partial \hat{y}_0/[\tilde{d}(\hat{y}_0)]^{1/2}$ is also even. This implies that f_0 is odd and, as an immediate consequence, $\partial^2 f_0(0) = 0$ and $\partial^2 f_{j/i}(0) = o(1)$ as $j/i \rightarrow 0$.

Bringing together (C.42), (C.46) as well as the expansions $f_{j/i}(0) = l_1 j/i [1 + o(1)]$ and $\partial^2 f_{j/i}(0) = o(1)$ with l_1 defined in (C.50), we obtain that as $j/i \rightarrow 0$,

$$G_{i,j} = -\frac{1}{s_x(j/i)^i s_y(j/i)^j} \left[\frac{1}{2\pi i} \frac{\pi^{1/2} l_1 j/i [1 + o(1)]}{i^{1/2}} + o(1/i^{3/2}) \right] + O(\exp(-ic(\rho))). \quad (\text{C.51})$$

This concludes the proof of Theorem C.18 in the case $p_{1,1} + p_{1,-1} + p_{-1,-1} + p_{-1,1} < 1$.

We now briefly explain the notable differences in the case $p_{1,1} + p_{1,-1} + p_{-1,-1} + p_{-1,1} = 1$. In this situation, all the functions considered are odd or even : for instance, Y_i and X_i , $i \in \{0, 1\}$ are odd (see Subsection C.2.2), d and \tilde{d} are even (see Lemma C.20), q and \tilde{q} have the parity of $i_0 + j_0$ (see Equation (C.2)), $G_{i,j} = 0$ if $i + j$ and $i_0 + j_0$ don't have the same parity (see (C.3) or (C.26)).

If $i + j$ and $i_0 + j_0$ have the same parity, then we can obtain the asymptotic of the Green functions $G_{i,j}$ with essentially the same analysis as in the case $p_{1,1} + p_{1,-1} + p_{-1,-1} + p_{-1,1} < 1$, the only significant change being that we have now to take under account the contribution of two critical points, namely the point $(s_x(j/i), s_y(j/i))$, as before, but now also $(-s_x(j/i), -s_y(j/i))$. In particular, the contour of integration $\mathcal{C}_{\rho,j/i,x}$ (resp. $\mathcal{C}_{\rho,j/i,x}$) have to go at once through $s_x(j/i)$ and $-s_x(j/i)$ (resp. $s_y(j/i)$ and $-s_y(j/i)$) – they can be *e.g.* taken symmetrical w.r.t. the vertical axis.

This fact implies that the asymptotic of the $G_{i,j}$ is, in this case, twice compared to (C.51), in accordance with the conclusions of Theorem C.18. \square

The following result has been used in the proof of Theorem C.18.

Lemma C.20. *If $p_{1,1} + p_{1,-1} + p_{-1,-1} + p_{-1,1} < 1$, then for any y belonging to $\{y \in \mathbb{C} : |y| = s_y(0)\} \setminus \{s_y(0)\}$, we have $|X_1(y)| > x_3$.*

If $p_{1,1} + p_{1,-1} + p_{-1,-1} + p_{-1,1} = 1$, then for any $y \in \{y \in \mathbb{C} : |y| = s_y(0)\} \setminus \{\pm s_y(0)\}$, we have $|X_1(y)| > x_3$.

Proof. As a direct consequence of Lemma C.1, we obtain that X_1 is meromorphic in the neighborhood of every point of $] -y_3, -y_2[$, since $] -y_3, -y_2[\subset] -|y_4|, -|y_1|[$. Let us now show the two following facts.

- (i) If $p_{1,1} + p_{1,-1} + p_{-1,-1} + p_{-1,1} < 1$, then for any $y \in [y_2, y_3]$, $|X_1(-y)| > |X_1(y)|$.
- (ii) If $p_{1,1} + p_{1,-1} + p_{-1,-1} + p_{-1,1} = 1$, then for any $y \in [y_2, y_3] = [-y_1, -y_4]$, $X_1(-y) = -X_1(y)$.

Start by noting that $X_1(y) \leq 0$ (resp. $X_1(y) \geq 0$) on $[y_4, y_1]$ (resp. $[y_2, y_3]$), as this is proved in [FIM99]. Thus, the unique possibility on $[y_2, y_3]$ to have $|X_1(-y)| = |X_1(y)|$ is that $X_1(y) = -X_1(-y)$. After calculation, we obtain that this is equivalent to $(p_{0,1}y^2 + p_{0,-1})^2(p_{1,1}y^2 + p_{1,-1})(p_{-1,1}y^2 + p_{-1,-1}) + [(p_{-1,0}p_{1,-1} - p_{1,0}p_{-1,-1})^2 + p_{0,-1}(p_{-1,0}p_{1,-1} + p_{1,0}p_{-1,-1})]y^2 + [p_{-1,0}p_{1,0}(1 - 2(p_{1,-1}p_{-1,1} + p_{-1,-1}p_{1,1})) + p_{-1,0}p_{1,-1}(p_{0,1} + p_{-1,0}p_{1,1}) + p_{-1,0}p_{1,1}(p_{0,-1} + p_{-1,0}p_{1,-1}) + p_{1,0}p_{-1,-1}(p_{0,1} + p_{1,0}p_{-1,1}) + p_{1,0}p_{-1,1}(p_{0,-1} + p_{1,0}p_{-1,-1})]y^4 + [(p_{1,0}p_{-1,1} - p_{-1,0}p_{1,1})^2 + p_{0,1}(p_{1,0}p_{-1,1} + p_{-1,0}p_{1,1})]y^6 = 0$.

If $p_{1,1} + p_{1,-1} + p_{-1,-1} + p_{-1,1} < 1$ (resp. $p_{1,1} + p_{1,-1} + p_{-1,-1} + p_{-1,1} = 1$), then the previous equality holds for none (resp. any) $y \in [y_2, y_3]$. Therefore (ii) is proved. To show (i), we remark that an explicit calculation leads to $|X_1(-1)| > 1 = X_1(1)$, so that by continuity, $|X_1(-y)| > |X_1(y)|$ for all $y \in [y_2, y_3]$.

We prove now Lemma C.20 in the case $p_{1,1} + p_{-1,-1} + p_{1,-1} + p_{-1,1} < 1$. In fact, we are going to show that $\{y \in \mathbb{C} : |y| = s_y(0)\} \cap \{y \in \mathbb{C} : |X_1(y)| = x_3\} = \{s_y(0)\}$. This is enough since

- * on the one hand, this implies that either for all $y \in \{y \in \mathbb{C} : |y| = s_y(0)\} \setminus \{s_y(0)\}$, $|X_1(y)| > x_3$, or for all $y \in \{y \in \mathbb{C} : |y| = s_y(0)\} \setminus \{s_y(0)\}$, $|X_1(y)| < x_3$,
- * on the other hand, thanks to (i), $|X_1(-s_y(0))| > X_1(s_y(0)) = x_3$,

so that by continuity, we will be able to conclude.

Let $y^* \in \{y \in \mathbb{C} : |y| = s_y(0)\}$ be such that $|X_1(y^*)| = x_3$. Setting $\hat{x} = X_1(y^*)/x_3$ and $\hat{y} = y^*/s_y(0)$, and then using that $K(x_3, s_y(0)) = 0$ and $K(X_1(y^*), y^*) = 0$, we obtain $\hat{K}(\hat{x}, \hat{y}) = 0$, where

$$\hat{K}(\hat{x}, \hat{y}) = \hat{x}\hat{y} \left[\sum_{i,j} \hat{p}_{i,j} \hat{x}^i \hat{y}^j - 1 \right], \quad \hat{p}_{i,j} = p_{i,j} x_3^i s_y(0)^j.$$

Clearly, for any i and j , $\hat{p}_{i,j} \geq 0$; in addition, $\sum_{i,j} \hat{p}_{i,j} = 1$, since $K(x_3, s_y(0)) = 0$. From elementary considerations about sums of complex numbers, it follows that having simultaneously $\sum_{i,j} \hat{p}_{i,j} = 1$, $\sum_{i,j} \hat{p}_{i,j} \hat{x}^i \hat{y}^j = 1$ and $|\hat{x}| = |\hat{y}| = 1$ leads necessarily to $\hat{x} = \hat{y} = 1$, so that $y^* = s_y(0)$.

We would do the proof in the case $p_{1,1} + p_{1,-1} + p_{-1,-1} + p_{-1,1} = 1$ by using similar arguments as above, as well as the fact that $x_4 = -x_3$. \square

C.5 Fine properties of the conformal gluing functions

The aim of Section C.5 is to study some fine properties of the CGF w defined in (C.15). They will be particularly useful in Section C.6, where we will find the asymptotic of the absorption probabilities (C.1).

Firstly, by the same reasoning as for Theorem B.7 of Chapter B, we prove the following result – remember (see Proposition C.4) that the group W of Definition C.3 is finite if and only if $\omega_2/\omega_3 \in \mathbb{Q}$.

Theorem C.21. *If $\omega_2/\omega_3 \in \mathbb{Q}$ (resp. $\omega_2/\omega_3 \notin \mathbb{Q}$), then the CGF w defined in (C.15) is algebraic (resp. non-holonomic).*

Moreover, if $\omega_2/\omega_3 \in \mathbb{Q}$, denoting by $P(w, t)$ the minimal polynomial of w , then the degree of P in w (resp. t) equals $\inf\{k > 0 : k\omega_2/\omega_3 \in \mathbb{Z}\}$ (resp. $\inf\{k > 0 : k\omega_3/\omega_2 \in \mathbb{Z}\}$). In particular, if $\omega_2/\omega_3 \in \mathbb{Z}$, then w is rational.

In addition, examples of CGF can be found in Theorem A.7 of Chapter A as well as in Propositions B.26, B.27, B.28, B.29 of Chapter B.

As an other example, for the second walk of Picture C.2, which has jump probabilities such that $p_{-1,1} + p_{1,0} + p_{0,-1} = 1$, the function

$$\frac{t}{[t - x_2] [t - [p_{-1,1}p_{0,-1}/(p_{1,0}^2 x_2)]^{1/2}]^2}$$

is a suitable CGF for the set $\mathcal{G}X([y_1, y_2])$.

Secondly, we are interested in the behavior of the CGF w near x_3 , and we show now the following result.

Theorem C.22. *The function w defined on $\mathcal{G}X([y_1, y_2])$ by (C.15) can be continued up to \mathbb{C} . This continuation of w is meromorphic on $\mathbb{C} \setminus [x_3, x_4]$, possibly even on \mathbb{C} , if and only if $\omega_2/\omega_3 \in \mathbb{Z}$. Furthermore, w has a simple pole at x_2 and $[\omega_2/(2\omega_3)]$ double poles at points belonging to $]x_2, x_3[\cap(\mathbb{C} \setminus \mathcal{G}X([y_1, y_2]))$. The behavior of w at x_3 depends on the group W as follows.*

- * If $\omega_2/\omega_3 \in 2\mathbb{Z}$, then w has a simple pole at x_3 .
- * If $\omega_2/\omega_3 \in 2\mathbb{Z} + 1$, then w is holomorphic at x_3 .
- * If $\omega_2/\omega_3 \notin \mathbb{Z}$, then w can be written as $w_1(t) + w_2(t)[x_3 - t]^{1/2}$, where w_1 and w_2 are holomorphic at x_3 and $w_2(x_3) \neq 0$.

Proof. The explicit formulation (C.15) of w entails that we have to study the reciprocal function of the first coordinate of the uniformization (x, y) . But with Subsection C.2.3, we get $x(\omega) = t$ if and only if $\wp_{1,2}(\omega) = f(t)$, where $f(t) = d''(x_4)/6 + d'(x_4)/(t - x_4)$ if $x_4 \neq \infty$ and $f(t) = d''(0)/6 + d'''(0)t/6$ if $x_4 = \infty$.

In addition, by construction, in both cases, $f(X(y_1)) = \wp_{1,2}([\omega_2 + \omega_3]/2)$, $f(X(y_2)) = \wp_{1,2}([\omega_1 + \omega_2 + \omega_3]/2)$, $f(x_1) = \wp_{1,2}(\omega_2/2)$, $f(x_2) = \wp_{1,2}([\omega_1 + \omega_2]/2)$ and $f(X([y_1, y_2])) = \wp_{1,2}([\omega_2 + \omega_3]/2, [\omega_2 + \omega_3]/2 + \omega_1)$, see Picture C.3. In particular, f is one-to-one from $\mathcal{G}X([y_1, y_2])$ onto $\wp_{1,2}([\omega_2/2, \omega_2/2 + \omega_3/2[\times]0, \omega_1/\iota[)$.

We recall now from [HC44] that on the parallelogram $[0, \omega_2[\times [0, \omega_1/\iota[$, $\wp_{1,2}$ takes each value twice. Moreover, in $[0, \omega_2/2[\times [0, \omega_1/\iota[$ or in $[\omega_2/2, \omega_2[\times [0, \omega_1/\iota[$, $\wp_{1,2}$ is one-to-one. For these reasons and since $\omega_3 \in]0, \omega_2[$, see Subsection C.2.3, we obtain the existence of a function ω defined on \mathbb{C} , two-valued for $t \in \mathbb{R} \setminus [x_2, x_3]$ and one-valued everywhere else, that verifies, for all $t \in \mathbb{C}$, $\wp_{1,2}(\omega(t)) = f(t)$; furthermore, $\omega(\mathbb{C}) = [\omega_2/2, \omega_2[\times [0, \omega_1/\iota[$.

We show now that though ω is two-valued on $\mathbb{R} \setminus [x_2, x_3]$, w defined by (C.15) is single-valued on $\mathbb{C} \setminus [x_3, x_4]$. Let us do this by studying precisely the equation $\wp_{1,2}(\omega) = f(t)$ at the points t where it has more than one solution.

- * For $t \in [x_4, x_1]$, the two values of $\omega(t)$, say $\omega_1(t)$ and $\omega_2(t)$, are such that $\omega_1(t) \in [\omega_2/2, \omega_2]$, $\omega_2(t) \in [\omega_1 + \omega_2/2, \omega_1 + \omega_2]$ and $\omega_2(t) - \omega_1(t) = \omega_1$.
- * For $t \in [x_1, x_2]$, these two values of $\omega(t)$ verify $\omega_1(t), \omega_2(t) \in [\omega_2/2, \omega_2/2 + \omega_1]$ and $\omega_1(t) - [\omega_1 + \omega_2]/2 = [\omega_1 + \omega_2]/2 - \omega_2(t)$.
- * For $t \in [x_3, x_4]$, the two values of $\omega(t)$ fulfill $\omega_1(t), \omega_2(t) \in [\omega_2, \omega_2 + \omega_1]$ and $\omega_1(t) - \omega_2/2 = \omega_2/2 - \omega_2(t)$.

Using now the facts that $\wp_{1,2}$ is even and ω_1 periodic, we obtain that w is in fact single-valued on $[x_4, x_1]$ and $[x_1, x_2]$, hence on $\mathbb{C} \setminus [x_3, x_4]$, as announced.

In order to show that w has a simple pole at x_2 , we can for instance use an explicit expression of $\omega(t)$. For example, for all $t \in [x_2, X(y_2)]$,

$$\omega(t) = \frac{\omega_1 + \omega_2}{2} + \int_{f(x_2)}^{f(t)} \frac{du}{[4(u - f(x_1))(u - f(x_2))(u - f(x_3))]^{1/2}}.$$

Using then in (C.15) that $\wp_{1,3}(\omega) = 1/\omega^2 + O(\omega^2)$ and that $\wp_{1,3}$ is even, we obtain that

$$w(t) = \frac{[f(x_1) - f(x_2)][f(x_2) - f(x_3)]}{\partial f(x_2)} \frac{1}{x_2 - t} + \widehat{w}(t),$$

where \hat{w} is holomorphic at x_2 .

We are now going to study the behavior of the function w in the neighborhood of x_3 , and for this, let us consider separately the three cases $\Delta = 0$, $\Delta < 0$ and $\Delta > 0$, Δ being the determinant defined in (C.8).

First of all, we show that $\Delta = 0$ (resp. $\Delta < 0$, $\Delta > 0$) implies $\omega_3 = \omega_2/2$ (resp. $\omega_3 > \omega_2/2$, $\omega_3 < \omega_2/2$). In Subsections C.2.3-C.2.4, we have proved that $\Delta = 0$ is equivalent to $\omega_2/\omega_3 = 2$. As a consequence, in order to prove that $\Delta < 0$ (resp. $\Delta > 0$) is equivalent to $\omega_3 > \omega_2/2$ (resp. $\omega_3 < \omega_2/2$), it is sufficient to prove that there exists *one* walk verifying simultaneously $\Delta < 0$ and $\omega_3 > \omega_2/2$ (resp. $\Delta > 0$ and $\omega_3 < \omega_2/2$). Indeed, using then the continuity of ω_2, ω_3 and Δ w.r.t. the parameters $(p_{i,j})_{i,j}$ (see (C.8)-(C.9)) as well as the intermediate value theorem, we will obtain the result for *all* walks.

But it is proved in [FIM99] that the second walk of Picture C.2 (verifying $p_{-1,1} + p_{1,0} + p_{0,-1} = 1$) is such that $\omega_2/\omega_3 = 3$ and $\Delta = p_{-1,1}p_{1,0}p_{0,-1} > 0$, and that the walk with jumps $p_{-1,-1} + p_{1,0} + p_{0,1} = 1$ verifies $\omega_2/\omega_3 = 3/2$ and $\Delta = -p_{-1,-1}p_{1,0}p_{0,1} < 0$.

Define now $R = [0, \omega_3] \times [-\omega_1/(2i), \omega_1/(2i)]$ and remember that $\omega(\mathbb{C}) - [\omega_1 + \omega_2]/2 = [0, \omega_2/2] \times [-\omega_1/(2i), \omega_1/(2i)]$.

- * Suppose that $\Delta = 0$. Then $\omega_2/\omega_3 = 2$ and $R = \omega(\mathbb{C}) - [\omega_1 + \omega_2]/2$, so that, by the same analysis as the one done above for x_2 , we find that w has a pole of order one at x_3 .
- * Suppose now that $\Delta < 0$. Then $\omega_3 > \omega_2/2$ and $\omega(\mathbb{C}) - [\omega_1 + \omega_2]/2$ is strictly included in R , in such a way that w has, except at x_2 , no poles and is two-valued on $[x_3, x_4]$.
- * Suppose at last that $\Delta > 0$. This implies that $\omega_3 < \omega_2/2$, thus $\omega(\mathbb{C}) - [\omega_1 + \omega_2]/2$ contains strictly R . Moreover, setting $n = \lfloor \omega_2/(2\omega_3) \rfloor$, we have

$$\omega(\mathbb{C}) - \frac{\omega_1 + \omega_2}{2} = \bigcup_{k=0}^{n-1} (k\omega_3 + R) \bigcup \hat{R}, \quad \hat{R} = [n\omega_3/2, \omega_2/2] \times [-\omega_1/(2i), \omega_1/(2i)].$$

This equality, added to the fact that $\wp_{1,3}$ has, on the parallelogram $[0, \omega_3] \times [0, \omega_1/i]$, only one pole, at 0 and of order two, shows that w has $n = \lfloor \omega_2/(2\omega_3) \rfloor$ double poles at points lying in $]x_2, x_3[\cap(\mathbb{C} \setminus \mathcal{G}X([y_1, y_2]))$.

** Consider the particular case $\omega_2/\omega_3 \in 2\mathbb{Z}$. Then the rectangle \hat{R} is reduced to one point and $\omega([x_3, x_4]) - [\omega_1 + \omega_2]/2$ is congruent to $[-\omega_1/(2i), \omega_1/(2i)]$, so that for the same reasons as in the case $\Delta = 0$, we get that w has a simple pole at x_3 .

** Consider next the other particular case $\omega_2/\omega_3 \in 2\mathbb{Z} + 1$. Then $\omega([x_3, x_4]) - [\omega_1 + \omega_2]/2$ is congruent to $\omega_3/2 + [-\omega_1/(2i), \omega_1/(2i)]$, in the neighborhood of which $\wp_{1,3}$ is holomorphic, so that w has no pole at x_3 in this case.

** If $\omega_2/\omega_3 \notin \mathbb{Z}$, then $\omega([x_3, x_4]) - [\omega_1 + \omega_2]/2$ is congruent neither to $\omega_3/2 + [-\omega_1/(2i), \omega_1/(2i)]$ nor to $[-\omega_1/(2i), \omega_1/(2i)]$, in particular, w has no pole at x_3 .

Consider now more global aspects, and let us show that w is meromorphic on \mathbb{C} if and only if $\omega_2/\omega_3 \in \mathbb{Z}$. For this, we recall from the beginning of the proof that for $t \in [x_3, x_4]$, the two values of $\omega(t)$ are such that $\omega_1(t), \omega_2(t) \in [\omega_2, \omega_2 + \omega_1]$ and $\omega_1(t) - \omega_2/2 = \omega_2/2 - \omega_2(t)$.

- * Above, we have shown that if $\omega_2/\omega_3 \in 2\mathbb{Z}$ (resp. $\omega_2/\omega_3 \in 2\mathbb{Z} + 1$), then $\omega([x_3, x_4]) - [\omega_1 + \omega_2]/2$ is congruent to $[-\omega_1/(2i), \omega_1/(2i)]$ (resp. $\omega_3/2 + [-\omega_1/(2i), \omega_1/(2i)]$). But $\wp_{1,3}(\omega)$ and $\wp_{1,3}(\omega_3/2 + \omega)$ are even functions of ω , so that in both cases, w is single-valued and meromorphic in the neighborhood of $[x_3, x_4]$.

* Suppose now that $\omega_2/\omega_3 \notin \mathbb{Z}$. Since $\omega(x_3) = \omega_1/2 + \omega_2$, it is possible to write $w(t) = \wp_{1,3}(\omega_2/2 + [\omega(t) - \omega(x_3)])$. On the other hand, if ω is close to zero, then

$$\wp_{1,3}(\omega_2/2 + \omega) = \wp_{1,3}(\omega_2/2) + \sum_{k=1}^{\infty} \frac{\partial^{2k} \wp_{1,3}(\omega_2/2)}{(2k)!} \omega^{2k} + \omega \sum_{k=0}^{\infty} \frac{\partial^{2k+1} \wp_{1,3}(\omega_2/2)}{(2k+1)!} \omega^{2k}.$$

Also, by a similar calculation as the one done when we have studied the behavior of w in the neighborhood of x_2 , we get

$$\begin{aligned} \omega(t) - \omega(x_3) &= \int_{f(t)}^{f(x_3)} \frac{du}{[4(u - f(x_1))(u - f(x_2))(u - f(x_3))]^{1/2}} \\ &= - \left[\frac{-\partial f(x_3)(x_3 - t)}{4(f(x_3) - f(x_2))(f(x_3) - f(x_1))} \right]^{1/2} [1 + (t - x_3)\check{w}(t)], \end{aligned}$$

where \check{w} is holomorphic at x_3 . Therefore, in a neighborhood of x_3 , we can write $w(t)$ as the sum $w(t) = w_1(t) + w_2(t)[x_3 - t]^{1/2}$, where w_1 and w_2 are holomorphic at x_3 , $w_1(x_3) = \wp_{1,3}(\omega_2/2)$ and

$$w_2(x_3) = -\partial \wp_{1,3}(\omega_2/2) \left[\frac{-\partial f(x_3)}{4(f(x_3) - f(x_2))(f(x_3) - f(x_1))} \right]^{1/2}. \quad (\text{C.52})$$

This closes the proof of Theorem C.22. \square

C.6 Asymptotic of the absorption probabilities

Section C.6 aims at studying the asymptotic of the absorption probabilities (C.1). First of all, remark that they are related to the Green functions *via*

$$\begin{aligned} \mathbb{P}_{(i_0, j_0)}[(X, Y) \text{ is absorbed at } (i, 0)] &= p_{1,-1}G_{i-1,1} + p_{0,-1}G_{i,1} + p_{-1,-1}G_{i+1,1}, \\ \mathbb{P}_{(i_0, j_0)}[(X, Y) \text{ is absorbed at } (0, j)] &= p_{-1,1}G_{1,j-1} + p_{-1,0}G_{1,j} + p_{-1,-1}G_{1,j+1}, \end{aligned} \quad (\text{C.53})$$

in such a way that their asymptotic as i and j go to infinity can be obtained from the one of the Green functions in the limiting cases $\gamma = 0$ and $\gamma = \pi/2$. The following result is thus a consequence of Theorem C.18 and of the identities (C.53).

Corollary C.23.

* Suppose first that $p_{1,1} + p_{1,-1} + p_{-1,-1} + p_{-1,1} < 1$. Then the absorption probabilities (C.1) admit the following asymptotic as $i \rightarrow \infty$:

$$\mathbb{P}_{(i_0, j_0)}[(X, Y) \text{ is absorbed at } (i, 0)] \sim C_1 \frac{j_0 s_x(0)^{i_0} s_y(0)^{j_0-1} - \partial_y \tilde{q}(s_y(0))}{i^{3/2} s_x(1/i)^i},$$

where $C_1 = [C_0/s_y(0)] \cdot [p_{1,-1}s_x(0) + p_{0,-1} + p_{-1,-1}/s_x(0)]$, C_0 being the same constant as in the statement of Theorem C.18.

The asymptotic of the absorption probabilities $\mathbb{P}_{(i_0, j_0)}[(X, Y) \text{ is absorbed at } (0, j)]$ as $j \rightarrow \infty$ can be obtained from the one above after a suitable change of the parameters $(p_{i,j})_{i,j}$.

- * Suppose now that $p_{1,1} + p_{1,-1} + p_{-1,-1} + p_{-1,1} = 1$. If in addition $i_0 + j_0$ and i (resp. j) don't have the same parity, then $\mathbb{P}_{(i_0, j_0)}[(X, Y) \text{ is absorbed at } (i, 0)] = 0$ (resp. $\mathbb{P}_{(i_0, j_0)}[(X, Y) \text{ is absorbed at } (0, j)] = 0$); if they have the same parity, the asymptotic of the absorption probabilities is obtained from the one above by multiplying by two.

Thanks to Sections C.3 and C.4, the different quantities appearing in the asymptotic of the absorption probabilities are totally explicit. Nevertheless, the way in which they depend on the parameters $(p_{i,j})_{i,j}$ – notably on the group W – is far from clear, and the rest of Section C.6 is devoted to the description of this dependence.

Theorem C.24. *The constant*

$$C_1 [j_0 s_x(0)^{i_0} s_y(0)^{j_0-1} - \partial_y \tilde{q}(s_y(0))]$$

appearing in the statement of Corollary C.23 can be written as $A_1 + A_2$, with A_1 and A_2 defined as follows.

- * Suppose first that $p_{1,1} + p_{1,-1} + p_{-1,-1} + p_{-1,1} < 1$. Then

$$A_1 = \frac{j_0 s_x(0)^{i_0}}{4} \left[\frac{-s_x(0) \partial_x d(s_x(0))}{\pi a(s_x(0)) c(s_x(0))} \left(\frac{c(s_x(0))}{a(s_x(0))} \right)^{j_0} \right]^{1/2},$$

$$A_2 = C_2 \int_{x_1}^{x_2} \frac{\partial_t w(t) t^{i_0} \mu_{j_0}(t) [-d(t)]^{1/2}}{[w(t) - w(s_x(0))]^2} dt,$$

where a, c, d, x_1, x_2 are defined in Subsection C.2.2, w in Equation (C.15), μ_{j_0} in (C.16), $s_x(0) = x_3$ in Subsection C.4.1; as for the constant C_2 , it is made explicit just below.

- ** In general, we have

$$C_2 = \partial_{\wp_{1,3}(\omega_2/2)} \left[\frac{-x_3 \partial f(x_3)}{\pi (f(x_3) - f(x_2))(f(x_3) - f(x_1))} \right]^{1/2},$$

where f is defined in Section C.5.

- ** If $\omega_2/\omega_3 \in 2\mathbb{Z} + 1$, then $C_2 = A_2 = 0$.

- ** If $\omega_2/\omega_3 \in 2\mathbb{Z}$, then

$$A_2 = -\frac{j_0 x_2^{i_0}}{4\pi^{1/2}} \left[-\frac{x_3 \partial_x d(x_2) \operatorname{res}[w, x_2]}{a(x_2) c(x_2) \operatorname{res}[w, x_3]} \left(\frac{c(x_2)}{a(x_2)} \right)^{j_0} \right]^{1/2},$$

where for $k \in \{2, 3\}$, $\operatorname{res}[w, x_k]$ denotes the residue of the function w at x_k – we will see, in the proof of Lemma C.26 below, that these residues are non-zero.

- * Suppose now that $p_{1,1} + p_{1,-1} + p_{-1,-1} + p_{-1,1} = 1$. Then with the notations above,

$$C_1 [j_0 s_x(0)^{i_0} s_y(0)^{j_0-1} - \partial_y \tilde{q}(s_y(0))] = 2[A_1 + A_2].$$

The whole rest of Section C.6 consists in proving Theorem C.24.

By Theorem C.13 and thanks to (C.19), q can be split as $q = q_1 + q_2$, where

$$q_1(x) = x^{i_0} Y_0(x)^{j_0} + \frac{x}{\pi} \int_{x_1}^{x_2} \frac{t^{i_0-1} \mu_{j_0}(t)}{t-x} [-d(t)]^{1/2} dt, \quad (\text{C.54})$$

$$q_2(x) = \frac{1}{\pi} \int_{x_1}^{x_2} t^{i_0} \mu_{j_0}(t) \Theta(t, x) [-d(t)]^{1/2} dt. \quad (\text{C.55})$$

Theorem C.24 will be then an immediate consequence of Lemmas C.25 and C.26 below, that deal with the asymptotic behavior of the Taylor coefficients of q_1 and q_2 respectively.

Lemma C.25. *The function q_1 , initially defined in $\mathbb{C} \setminus ([x_1, x_2] \cup [x_3, x_4])$ by (C.54), admits a holomorphic continuation on $\mathbb{C} \setminus [x_3, x_4]$. We still note q_1 this continuation and we set $q_1(x) = \sum_{i=0}^{\infty} q_{1,i} x^i$.*

* Suppose first that $p_{1,1} + p_{1,-1} + p_{-1,-1} + p_{-1,1} < 1$. Then as $i \rightarrow \infty$:

$$q_{1,i} \sim \frac{j_0 s_x(0)^{i_0}}{4} \left[\frac{-s_x(0) \partial_x d(s_x(0))}{\pi a(s_x(0)) c(s_x(0))} \left(\frac{c(s_x(0))}{a(s_x(0))} \right)^{j_0} \right]^{1/2} \frac{1}{i^{3/2} x_3^i}. \quad (\text{C.56})$$

* Suppose now that $p_{1,1} + p_{1,-1} + p_{-1,-1} + p_{-1,1} = 1$. Then the process can reach $(i, 0)$ if and only if i and $i_0 + j_0$ have the same parity. In particular, if i and $i_0 + j_0$ don't have the same parity, then $q_{1,i} = 0$. If they have the same parity, then $q_{1,i}$ is equivalent to two times the right member of (C.56).

Lemma C.26. *The function q_2 defined by (C.55) is holomorphic in $\mathbb{C} \setminus (w^{-1}([x_1, x_2]) \setminus [x_1, x_2])$, and we set $q_2(x) = \sum_{i=0}^{\infty} q_{2,i} x^i$.*

* Suppose first that $p_{1,1} + p_{1,-1} + p_{-1,-1} + p_{-1,1} < 1$.

** If $\omega_2/\omega_3 \notin \mathbb{Z}$, then as $i \rightarrow \infty$:

$$q_{2,i} \sim \partial \varphi_{1,3}(\omega_2/2) \left[\frac{-x_3 \partial f(x_3)}{\pi(f(x_3) - f(x_2))(f(x_3) - f(x_1))} \right]^{1/2} \times \int_{x_1}^{x_2} \frac{\partial_t w(t) t^{i_0} \mu_{j_0}(t) [-d(t)]^{1/2}}{[w(t) - w(x_3)]^2} dt \frac{1}{i^{3/2} x_3^i}, \quad (\text{C.57})$$

where, if $x_4 \neq \infty$, then $f(t) = d''(x_4)/6 + d'(x_4)/(t - x_4)$ and, if $x_4 = \infty$, then $f(t) = d''(0)/6 + d'''(0)t/6$.

** If $\omega_2/\omega_3 \in 2\mathbb{Z} + 1$, then as $i \rightarrow \infty$: $q_{2,i} = o(q_{1,i})$.

** If $\omega_2/\omega_3 \in 2\mathbb{Z}$, then as $i \rightarrow \infty$:

$$q_{2,i} \sim -\frac{j_0 x_2^{i_0}}{4\pi^{1/2}} \left[-\frac{x_3 \partial_x d(x_2) \operatorname{res}[w, x_2]}{a(x_2) c(x_2) \operatorname{res}[w, x_3]} \left(\frac{c(x_2)}{a(x_2)} \right)^{j_0} \right]^{1/2} \frac{1}{i^{3/2} x_3^i}, \quad (\text{C.58})$$

$\operatorname{res}(w, x_k)$ denoting, for $k \in \{2, 3\}$, the residue of the function w at x_k , where from Theorem C.22, it has a pole of order one.

* Suppose now that $p_{1,1} + p_{1,-1} + p_{-1,-1} + p_{-1,1} = 1$. If i and $i_0 + j_0$ don't have the same parity, then $q_{2,i} = 0$. If they have the same parity and if $\omega_2/\omega_3 \notin \mathbb{Z}$ (resp. $\omega_2/\omega_3 \in 2\mathbb{Z} + 1$, $\omega_2/\omega_3 \in 2\mathbb{Z}$), then the asymptotic of $q_{2,i}$ is given by two times the right member of (C.57) (resp. is negligible w.r.t. (C.56), is given by two times the right member of (C.58)).

Proof of Lemma C.25.

* Let us suppose first that $x_4 > 0$.

If \mathcal{C}_ϵ denotes the contour represented on the left of Picture C.6 below, applying the residue theorem at infinity entails that, for all x inside of the infinite domain delimited by \mathcal{C}_ϵ ,

$$\frac{1}{2\pi i} \int_{\mathcal{C}_\epsilon} \frac{t^{i_0-1} Y_0(t)^{j_0}}{t-x} dt = x^{i_0-1} Y_0(x)^{j_0} - P_\infty [x^{i_0-1} Y_0(x)^{j_0}],$$

where $P_\infty[x^{i_0-1}Y_0(x)^{j_0}]$ is the principal part at infinity of $x^{i_0-1}Y_0(x)^{j_0}$ – which is meromorphic at infinity, since $x_4 > 0$.

Furthermore, by definition of μ_{j_0} , see (C.16),

$$\lim_{\epsilon \rightarrow 0} \frac{1}{2i} \int_{\mathcal{C}_\epsilon} \frac{t^{i_0-1}Y_0(t)^{j_0}}{t-x} dt = \int_{x_3}^{x_4} \frac{t^{i_0-1}\mu_{j_0}(t)}{t-x} [-d(t)]^{1/2} dt - \int_{x_1}^{x_2} \frac{t^{i_0-1}\mu_{j_0}(t)}{t-x} [-d(t)]^{1/2} dt.$$

Therefore, the function q_1 is just equal to :

$$q_1(x) = \frac{x}{\pi} \int_{x_3}^{x_4} \frac{t^{i_0-1}\mu_{j_0}(t)}{t-x} [-d(t)]^{1/2} dt + xP_\infty[x^{i_0-1}Y_0(x)^{j_0}]. \quad (\text{C.59})$$

Moreover, with Lemma C.2, we get that the degree of the polynomial $xP_\infty[x^{i_0-1}Y_0(x)^{j_0}]$ is equal to i_0 if $p_{1,-1} \neq 0$, to $-\infty$ if $p_{1,-1} = 0$ and $i_0 \leq j_0$, and to $i_0 - j_0$ if $p_{1,-1} = 0$ and $i_0 > j_0$.

In all cases, if i is larger than this degree, then the following equality holds :

$$q_{1,i} = \frac{1}{\pi} \int_{x_3}^{x_4} \frac{\mu_{j_0}(t)}{t^{i+1-i_0}} [-d(t)]^{1/2} dt. \quad (\text{C.60})$$

We can then easily obtain the asymptotic of this integral as i goes to infinity, by using Laplace's method, see *e.g.* [Cha90].

Precisely, we make an expansion of the numerator of the integrand of (C.60) in the neighborhood of x_3 , namely

$$\mu_{j_0}(t)[-d(t)]^{1/2} = \mu_{j_0}(x_3)[-d(x_3)]^{1/2}[t-x_3]^{1/2} + [t-x_3]^{3/2}F(t),$$

where F is holomorphic at x_3 . But classically,

$$\int_{x_3}^{x_4} \frac{[t-x_3]^{1/2}}{t^i} dt = \frac{\pi^{1/2}}{2} \frac{1}{i^{3/2}x_3^{i-3/2}} + O\left(\frac{1}{i^{5/2}x_3^i}\right), \quad \int_{x_3}^{x_4} \frac{[t-x_3]^{3/2}}{t^i} dt = O\left(\frac{1}{i^{5/2}x_3^i}\right),$$

so that simplifying $\mu_{j_0}(x_3)$ – using for this (C.16) and the fact that $d(x_3) = 0$ –, we get (C.56).

* Suppose now that $x_4 < 0$ and assume, in addition, that $p_{1,1} + p_{1,-1} + p_{-1,-1} + p_{-1,1} < 1$.

In this case, Y_0 is no more meromorphic at infinity and has thus no principal part at infinity, the previous argument does not run anymore.

However, we are going to show that the asymptotic (C.56) is still correct. To that purpose, fix $R > -x_4$ and apply the classical residue theorem to $t^{i_0-1}Y_0(t)^{j_0}/(t-x)$ on the contour $\mathcal{C}_{\epsilon,R}$ described on the right side of Picture C.6. After that ϵ has gone to zero, we obtain

$$x^{i_0-1}Y_0(x)^{j_0} = -\frac{1}{\pi} \int_{x_1}^{x_2} \frac{t^{i_0-1}\mu_{j_0}(t)}{t-x} [-d(t)]^{1/2} dt + \frac{1}{\pi} \int_{x_3}^R \frac{t^{i_0-1}\mu_{j_0}(t)}{t-x} [-d(t)]^{1/2} dt + F_R(x), \quad (\text{C.61})$$

where F_R is defined by

$$F_R(x) = \frac{1}{2\pi i} \int_{\{u \in \mathbb{C}: |u|=R\}} \frac{t^{i_0-1}Y_0(t)^{j_0}}{t-x} dt + \frac{1}{\pi} \int_{-R}^{x_4} \frac{t^{i_0-1}\mu_{j_0}(t)}{t-x} [-d(t)]^{1/2} dt.$$

In particular, with (C.54) and (C.61), we get

$$q_1(x) = \frac{1}{\pi} \int_{x_3}^R \frac{t^{i_0-1} \mu_{j_0}(t)}{t-x} [-d(t)]^{1/2} dt + F_R(x).$$

The first (resp. second) Cauchy-type integral in the sum defining F_R is holomorphic in the disc $R\mathcal{D}$ (resp. $-x_4\mathcal{D}$), so that F_R is holomorphic in $-x_4\mathcal{D}$. Moreover, since we have supposed that $p_{1,1} + p_{1,-1} + p_{-1,-1} + p_{-1,1} < 1$, Lemma C.1 yields $x_3 < -x_4$. In particular, this implies that as i goes to infinity, the i th coefficient of the Taylor series at 0 of F_R is equal to $o(1/r^k)$, for any $x_3 < r < -x_4$. These coefficients will be therefore negligible w.r.t. the ones of

$$\frac{1}{\pi} \int_{x_3}^R \frac{t^{i_0-1} \mu_{j_0}(t)}{t-x} [-d(t)]^{1/2} dt.$$

We calculate the asymptotic of the coefficients of the function just above using Laplace's method, exactly as in the case $x_4 > 0$; the asymptotic (C.56) is thus actually still valid.

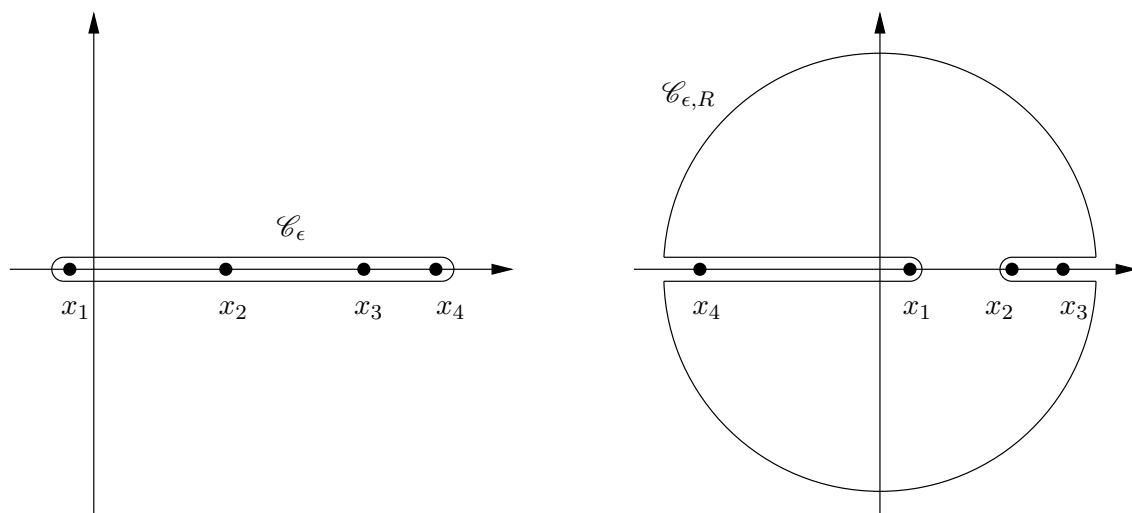

FIGURE C.6 – Contours of integration in the cases $x_4 > 0$ and $x_4 < 0$ respectively

* If $p_{1,1} + p_{1,-1} + p_{-1,-1} + p_{-1,1} = 1$ (which implies, see Lemma C.1, that $x_4 = -x_3 < 0$), then the process can reach $(i, 0)$ if and only if i and $i_0 + j_0$ have the same parity.

In particular, if i and $i_0 + j_0$ don't have the same parity, then $\mathbb{P}_{(i_0, j_0)}[(X, Y) \text{ is absorbed at } (i, 0)] = 0$ – besides, we could show by a direct calculation that in this case $q_{1,i} = 0$, using that $[x_4, x_1] = [-x_3, -x_2]$ as well as the fact that Y_0, Y_1 and w are odd functions.

If they have the same parity, then the asymptotic of the coefficients of F_R is no more negligible : indeed, with Lemma C.1, $x_4 = -x_3$. After having used the identity $\mu_{j_0}(-t) = (-1)^{j_0-1} \mu_{j_0}(t)$, see (C.16), we obtain that

$$\frac{1}{\pi} \int_{-R}^{x_4} \frac{t^{i_0-1} \mu_{j_0}(t)}{t-x} [-d(t)]^{1/2} dt = \frac{(-1)^{i_0+j_0}}{\pi} \int_{x_3}^R \frac{t^{i_0-1} \mu_{j_0}(t)}{t+x} [-d(t)]^{1/2} dt. \quad (\text{C.62})$$

For this reason and once again with Laplace's method, we get that if i and $i_0 + j_0$ have the same parity, then the asymptotic of $q_{1,i}$ is given by two times (C.56). \square

Proof of Lemma C.26.

* To prove Lemma C.26 in the case $\omega_2/\omega_3 \notin \mathbb{Z}$ and $p_{1,1} + p_{1,-1} + p_{-1,-1} + p_{-1,1} < 1$, we will use the following reasoning.

** Firstly, we are going to show that q_2 is, for $\epsilon > 0$ sufficiently small, holomorphic in $x_3((1 + \epsilon)\mathcal{D} \setminus [1, 1 + \epsilon])$, see Picture C.7.

** Secondly, we will prove that in the neighborhood of x_3 ,

$$q_2(x) = U(x) + V(x)[x_3 - x]^{1/2}, \quad (\text{C.63})$$

with U, V holomorphic at x_3 and

$$V(x_3) = \frac{w_2(x_3)}{\pi} \int_{x_1}^{x_2} \frac{\partial_t w(t) t^{i_0} \mu_{j_0}(t) [-d(t)]^{1/2}}{[w(t) - w(x_3)]^2} dt, \quad (\text{C.64})$$

$w_2(x_3)$ being defined in (C.52).

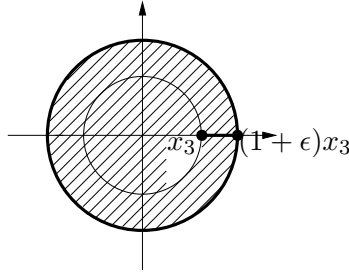

FIGURE C.7 – The domain $x_3((1 + \epsilon)\mathcal{D} \setminus [1, 1 + \epsilon])$

To conclude, it will be then enough to use the well-known principle explained hereunder. If $H(x) = \sum_{i=0}^{\infty} H_i x^i$ is a function holomorphic in $\rho((1 + \epsilon)\mathcal{D} \setminus [1, 1 + \epsilon])$ and such that near ρ ,

$$H(x) = h_0(x) + \sum_{k=1}^d h_k(x)[1 - x/\rho]^{\theta_k},$$

where the h_k are holomorphic near ρ , not vanishing at ρ for $k \in \{1, \dots, d\}$, the $\theta_1 < \dots < \theta_d$ are rational but not integer, then as $i \rightarrow \infty$, $H_i \sim h_1(\rho)\rho^{-i}/[\Gamma(-\theta_1)i^{\theta_1+1}]$.

First of all, q_2 is clearly holomorphic on $x_3((1 + \epsilon)\mathcal{D} \setminus [1, 1 + \epsilon])$, by Corollary C.6 and thanks to the assumption $p_{1,1} + p_{1,-1} + p_{-1,-1} + p_{-1,1} < 1$ – otherwise, q_2 would have a singularity at $x_4 = -x_3$.

Let us now show (C.63)-(C.64).

In the proof of Theorem C.22, we have proved that near x_3 , $w(t) = w_1(t) + w_2(t)[x_3 - t]^{1/2}$, with w_1, w_2 holomorphic at x_3 , where they take the values given by (C.52).

In particular, in the neighborhood of x_3 , we can write $q_2(x) = U(x) + V(x)[x_3 - x]^{1/2}$, with U, V holomorphic at x_3 ; moreover, with (C.55), $V(x_3)$ is equal to the announced value (C.64).

Then, thanks to the principle introduced above, Lemma C.26 follows immediately in the case $\omega_2/\omega_3 \notin \mathbb{Z}$ and $p_{1,1} + p_{1,-1} + p_{-1,-1} + p_{-1,1} < 1$.

* Suppose now that $\omega_2/\omega_3 \in 2\mathbb{Z}$ and $p_{1,1} + p_{1,-1} + p_{-1,-1} + p_{-1,1} < 1$. In this case, the previous argument does not work, since w has no algebraic singularity but a pole at x_3 , see the proof of Theorem C.22.

In fact we have, thanks to Theorem C.22,

$$\lim_{x \rightarrow x_2^+} w(x) = \lim_{x \rightarrow x_3^-} w(x) = -\infty.$$

More generally, from Theorem C.22 and its proof, we deduce the existence a holomorphic function σ defined (at least) in a neighborhood of $[x_2, x_3]$ and such that

$$\sigma^2 = \text{id}, \quad \sigma(x_3) = x_2, \quad w(\sigma) = w.$$

In addition, we have already seen that the function

$$\frac{\partial w(t)}{w(t) - w(x)} - \frac{x_2 - x}{(x_2 - t)(t - x)} \quad (\text{C.65})$$

is holomorphic in $\mathcal{G}X([y_1, y_2])^2$, whence *a fortiori* near (x_2, x_2) , and in fact in the neighborhood of $\{(u, u) : u \in \mathcal{G}X([y_1, y_2])\}$.

On the other hand, the function (C.65) is not holomorphic at (x_2, x_3) , and in fact not holomorphic at every point of $\{(u, \sigma(u)) : u \in \mathcal{G}X([y_1, y_2])\}$. Let us now introduce

$$\frac{\partial w(t)}{w(t) - w(x)} - \frac{x_2 - x}{(x_2 - t)(t - x)} - \frac{\partial \sigma(t)(x_3 - x)}{(x_3 - \sigma(t))(\sigma(t) - x)}.$$

It is holomorphic in the neighborhood of $\{(u, \sigma(u)) : u \in \mathcal{G}X([y_1, y_2])\}$. This is why

$$\widehat{\Theta}(t, x) = \Theta(t, x) - \frac{\partial \sigma(t)x}{\sigma(t)(\sigma(t) - x)} \quad (\text{C.66})$$

is holomorphic in a neighborhood of $[x_1, x_2] \times R\mathcal{D}$, where $R > x_3$. In particular, for any $t \in [x_1, x_2]$, $x \mapsto \widehat{\Theta}(t, x)$ is holomorphic on $R\mathcal{D}$. Therefore, the i th coefficient of the Taylor series at zero of the function

$$\frac{1}{\pi} \int_{x_1}^{x_2} t^{i_0} \mu_{j_0}(t) \widehat{\Theta}(t, x) [-d(t)]^{1/2} dt$$

equals $o(1/r^i)$ with $r > x_3$. As a consequence, it is exponentially negligible w.r.t. to (C.56).

Finally, it remains to evaluate the contribution of the coefficients of $q_3(x)$, defined by

$$\frac{x}{\pi} \int_{x_1}^{x_2} \frac{\partial \sigma(t) \mu_{j_0}(t) t^{i_0} / \sigma(t)}{\sigma(t) - x} [-d(t)]^{1/2} dt = -\frac{x}{\pi} \int_{x_3}^{\sigma(x_1)} \frac{\sigma(t)^{i_0} \mu_{j_0}(\sigma(t)) / t}{t - x} [-d(\sigma(t))]^{1/2} dt, \quad (\text{C.67})$$

where the second equality above comes from the change of variable $t \mapsto \sigma(t)$.

In order to find the asymptotic of its coefficients, we apply Laplace's method. In fact, we will obtain (C.58) as soon as we will have proved that

$$\partial \sigma(x_3) = \frac{\text{res}(w, x_2)}{\text{res}(w, x_3)}. \quad (\text{C.68})$$

To do this, start by differentiating the equality $w(t) = w(\sigma(t))$; we obtain that $\partial \sigma(x_3) = \lim_{x \rightarrow x_3} \partial w(t) / \partial w(\sigma(t))$, what implies

$$\partial \sigma(x_3) = \lim_{x \rightarrow x_3} \frac{\text{res}(w, x_3) [\sigma(t) - x_2]^2}{\text{res}(w, x_2) [t - x_3]^2},$$

Since $\partial\sigma(x_3) \neq 0$, Equation (C.68) follows immediately.

* Suppose presently that $\omega_2/\omega_3 \in 2\mathbb{Z} + 1$. In this case, since w has a pole at x_2 but is holomorphic at x_3 by Theorem C.22, the function Θ is holomorphic on $[x_1, x_2] \times R\mathcal{D}$, where $R > x_3$. In particular, for any $t \in [x_1, x_2]$, $x \mapsto \Theta(t, x)$ is holomorphic on $R\mathcal{D}$. This is why the i th coefficient of the Taylor series at 0 of q_2 is in this case equal to $o(1/R^i)$, where $R > x_3$. For this reason, $q_{2,i} = o(q_{1,i})$.

An other way to prove this fact is the following. If $\omega_2/\omega_3 \in 2\mathbb{Z} + 1$, then $\omega_2/2$ is congruent to $\omega_3/2$, and as an immediate consequence $\partial_{\wp_{1,3}}(\omega_2/2) = 0$, so that $w_2(x_3) = 0$, see (C.52), whence the right member of (C.57) becomes zero.

* Suppose now that $p_{1,1} + p_{1,-1} + p_{-1,-1} + p_{-1,1} = 1$ and note that for these walks, we can equally have $\omega_2/\omega_3 \in 2\mathbb{Z}$, $\omega_2/\omega_3 \in 2\mathbb{Z} + 1$ or $\omega_2/\omega_3 \notin \mathbb{Z}$.

In fact, as in the proof of Lemma C.25, we have, as well as the contribution of the point x_3 , to take under account the one of the point x_4 , equal in this case to $-x_3$. So we do the same analysis, but then we have in addition a term like (C.64) or (C.67), with x_4 instead x_3 .

By doing then the change of variable $t \mapsto -t$ as in (C.62), we obtain that if i and $i_0 + j_0$ don't have the same parity, then the contribution is zero, and if they have, then the asymptotic of $q_{2,i}$ is given by two times (C.57), using once again Laplace's method and an adaptation of the principle explained at the beginning of the proof for odd or even functions. \square

Chapitre D

Green functions and Martin compactification for killed random walks related to $SU(3)$ *

In this chapter, we consider the random walks killed at the boundary of the quarter plane \mathbb{Z}_+^2 , with homogeneous non-zero jump probabilities to the eight nearest neighbors and drift zero in the interior, and which admit a positive harmonic polynomial of degree three. For these processes, we find the asymptotic of the Green functions along all infinite paths of states, and from this we deduce that the Martin compactification is the one-point compactification.

D.1 Introduction and main results

First introduced for Brownian motion by R. Martin in 1941, the concept of Martin compactification has then been extended for countable discrete time Markov chains by J. Doob and G. Hunt at the end of the fifties. The purpose of this theory is to describe the asymptotic behavior of the Markov chains and also to characterize all their non-negative superharmonic and harmonic functions, see *e.g.* [Dyn69].

For a transient Markov chain with state space E , the *Martin compactification* of E is the smallest compactification \hat{E} of E for which the Martin kernels $z \mapsto k_z^{z_0} = G_z^{z_0}/G_z^{z_1}$ extend continuously – by $G_z^{z_0}$ we mean the *Green functions* of the process, *i.e.* the mean number of visits made by the process at z starting at z_0 , and we note z_1 a reference state. $\hat{E} \setminus E$ is usually called the *full Martin boundary*. Clearly for $\alpha \in \hat{E}$, $z_0 \mapsto k_\alpha^{z_0}$ is superharmonic; then $\partial_m E = \{\alpha \in \hat{E} \setminus E : z_0 \mapsto k_\alpha^{z_0} \text{ is minimal harmonic}\}$ is called the *minimal Martin boundary* – a harmonic function h is said minimal if $0 \leq \tilde{h} \leq h$ with \tilde{h} harmonic implies $\tilde{h} = ch$ for some constant c . Then, every superharmonic (resp. harmonic) function h can be written as $h(z_0) = \int_{\hat{E}} k_z^{z_0} \mu(dz)$ (resp. $h(z_0) = \int_{\partial_m E} k_z^{z_0} \mu(dz)$), where μ is some finite measure, uniquely characterized in the second case above.

The case of the *homogeneous* random walks in \mathbb{Z}^d is now completely understood. First, their minimal Martin boundary is found in [DSW60], thanks to Choquet-Deny theory. Furthermore, in the case of a *non-zero drift*, P. Ney and F. Spitzer find, in their well-known paper [NS66], the asymptotic of the Green functions, by using exponential changes

*. The bulk of this work is appeared in the “Electronic Communications in Probability” as [Ras10b].

of measure and the local limit theorem ; this gives consequently the concrete realization of the Martin compactification, in that case the sphere. Additionally, in the case of a *drift zero*, the asymptotic of the Green functions is computed in [Spi64] ; it follows that the Martin compactification consists in the one-point compactification.

Results on Martin boundary for *non-homogeneous* random walks are scarcer and more recent. We concentrate here our analysis on important and recently extensively studied examples that are the random walks in \mathbb{Z}^d killed at the boundary of cones. They are related to many areas of probability, as *e.g.* to non-colliding random walks or quantum processes.

On the one hand, the case of the *non-zero drift* is now rather well studied.

In [Bia92c], P. Biane considers quantum random walks on the dual of compact Lie groups and, by restriction, arrives at classical random walks with non-zero drift killed at the boundary of the Weyl chamber of the dual. Solving an equation of Choquet-Deny type, he finds the minimal Martin boundary of these processes.

When the compact Lie group is $SU(d)$ and the associated random walk has non-zero drift, the Martin compactification is obtained in [Col04], by finding the asymptotic of the Green kernels.

Recently, in [IR09a], I. Ignatiouk-Robert obtains the Martin compactification of the random walks in \mathbb{Z}_+^d with non-zero drift and killed at the boundary. She uses there an original approach based on large deviations theory in order to compute the asymptotic of the Martin kernels. Unfortunately, her methods seem quite difficult to extend up to the case of the drift zero. Also, they do not provide the asymptotic of the Green functions.

This asymptotic in the case of the dimension $d = 2$ is found in Chapter C.

On the other hand, results on Martin boundary for killed random walks with *drift zero* are quite rare. The simplest example of the cartesian product is due to [PW92]. An interesting case comes again from quantum processes : in [Bia92a], P. Biane shows that the minimal Martin boundary of the random walk with zero drift and killed at the boundary of the Weyl chamber of the dual of $SU(d)$ is reduced to one point.

It is immediate from [Bia91] that this classical random walk in the Weyl chamber of the dual of $SU(d)$ is, for $d = 3$, the random walk spatially homogeneous on the lattice $\{i + j \exp(i\pi/3), (i, j) \in \mathbb{Z}^2\}$ with jump probabilities as represented on the left of Picture D.1.

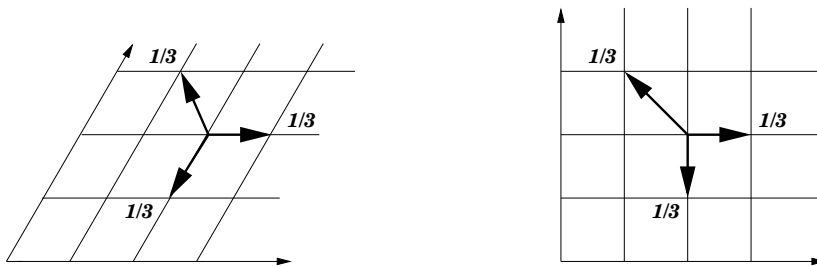

FIGURE D.1 – Random walk in the Weyl chamber of the dual of $SU(3)$

Obviously, a suitable linear transformation maps the lattice $\{i + j \exp(i\pi/3) : (i, j) \in \mathbb{Z}^2\}$ into \mathbb{Z}^2 , see Picture D.1 ; in this way, the Weyl chamber $\{i + j \exp(i\pi/3) : (i, j) \in \mathbb{Z}_+^2\}$ becomes \mathbb{Z}_+^2 .

For $d = 3$, the killed random walk considered by P. Biane in [Bia91] can therefore be viewed as an element of

$$\mathcal{P}^0 = \{ \text{random walks in } \mathbb{Z}_+^2 \text{ with non-zero jump probabilities } (p_{i,j})_{-1 \leq i,j \leq 1} \text{ to the eight nearest neighbors, with drift zero and killed at the boundary} \}$$

with jump probabilities as drawn on the right of Picture D.1 – above, “drift zero” means that $p_{1,1} + p_{1,0} + p_{1,-1} = p_{-1,1} + p_{-1,0} + p_{-1,-1}$ and $p_{1,1} + p_{0,1} + p_{-1,1} = p_{1,-1} + p_{0,-1} + p_{-1,-1}$. In this setting, P. Biane proves, in [Bia92a], that $(i_0, j_0) \mapsto i_0 j_0 (i_0 + j_0)$ is the only positive harmonic function for this process.

By the same methods, it can certainly be shown that there is only one positive harmonic function for the “dual” walk, namely for the random walk with jump probabilities $p_{-1,0} = p_{0,1} = p_{1,-1} = 1/3$. In particular, if we set $\mathcal{P}_{p, \text{SU}(3)} = \{ \text{random walks of } \mathcal{P}^0 \text{ such that } p_{0,-1} = p_{-1,1} = p_{1,0} = \mu, p_{-1,0} = p_{0,1} = p_{1,-1} = \nu, \mu + \nu = 1/3 \}$ – in other words, $\mathcal{P}_{p, \text{SU}(3)}$ is the set of all cartesian products of the random walk on the dual of $\text{SU}(3)$ with its dual, see on the left of Picture D.2 below –, it follows from [PW92] that any process of $\mathcal{P}_{p, \text{SU}(3)}$ has also a minimal Martin boundary reduced to one point.

In Chapter D, we introduce the set

$$\mathcal{P}_{1,0} = \{ \text{random walks of } \mathcal{P}^0 \text{ for which } (i_0, j_0) \mapsto i_0 j_0 (i_0 + j_0) \text{ is harmonic} \}.$$

Note that we have $\mathcal{P}_{p, \text{SU}(3)} \subset \mathcal{P}_{1,0}$, but we will see in Remark D.4 that the inclusion is strict. More generally, we define

$$\mathcal{P}_{\alpha, \beta} = \{ \text{random walks of } \mathcal{P}^0 \text{ for which } (i_0, j_0) \mapsto i_0 j_0 (i_0 + \alpha j_0 + \beta) \text{ is harmonic} \}. \quad (\text{D.1})$$

Since any harmonic function for a killed process takes the value zero on the boundary, $\mathcal{P}_{\alpha, \beta}$ is in fact exactly the set of *all* killed random walks in \mathbb{Z}_+^2 to the eight nearest neighbors admitting a harmonic polynomial of degree three.

The description of the set $\mathcal{P}_{\alpha, \beta}$ in terms of the $(p_{i,j})_{i,j}$ is rather cumbersome but not difficult to obtain, it is postponed until Remark D.4. Let us just note here that if $\alpha > 2$ or $\alpha < 1/2$, then for all β , $\mathcal{P}_{\alpha, \beta} = \emptyset$; if $\alpha = 1/2$ or $\alpha = 2$, then for all $\beta \neq 0$, $\mathcal{P}_{\alpha, \beta} = \emptyset$, and $\mathcal{P}_{\alpha, 0}$ is reduced to one walk; and if $\alpha \in]1/2, 2[$ and $|\beta|$ is small enough, then $\mathcal{P}_{\alpha, \beta}$ is a (non-empty) set with two free parameters, properly described in Remark D.4. We have represented on the right of Picture D.2 an example of a process belonging to $\mathcal{P}_{\alpha, 0}$, for any $\alpha \in [1/2, 2]$.

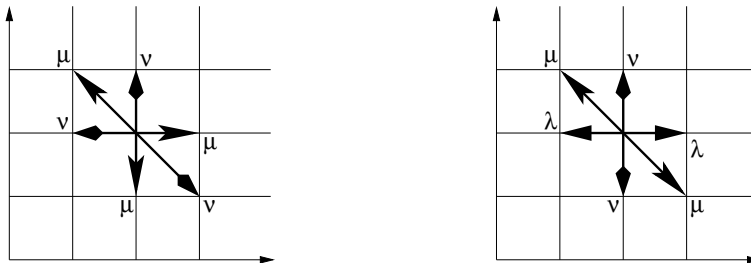

FIGURE D.2 – On the left, a generic walk of $\mathcal{P}_{p, \text{SU}(3)}$ ($\mu + \nu = 1/3$); on the right, an example of walk of $\mathcal{P}_{\alpha, 0}$ ($\lambda = \alpha(\alpha - 1/2)/[2 - \alpha + 2\alpha^2]$, $\mu = (\alpha/2)/[2 - \alpha + 2\alpha^2]$ and $\nu = (1 - \alpha/2)/[2 - \alpha + 2\alpha^2]$)

Moreover, note that considering in this thesis $\mathcal{P}_{\alpha,\beta}$ is all the more natural as the set $\mathcal{P}_p = \{\text{random walks of } \mathcal{P}^0 \text{ for which } (i_0, j_0) \mapsto i_0 j_0 \text{ is harmonic}\}$ is also studied here, see Section D.4 of this chapter.

Our first result deals with the Green functions – below, (X, Y) denotes the coordinates of the random walk and $\mathbb{E}_{(i_0, j_0)}$ the conditional expectation given $(X(0), Y(0)) = (i_0, j_0)$ –

$$G_{i,j}^{i_0, j_0} = \mathbb{E}_{(i_0, j_0)} \left[\sum_{k \geq 0} \mathbf{1}_{\{(X(k), Y(k)) = (i, j)\}} \right], \quad (\text{D.2})$$

and, more precisely, with their asymptotic along *all* paths of states.

Theorem D.1. *Suppose that the process belongs to $\mathcal{P}_{\alpha,\beta}$. Then the Green functions (D.2) admit the following asymptotic as $i + j \rightarrow \infty$ and $j/i \rightarrow \tan(\gamma)$, γ lying in $[0, \pi/2[$:*

$$G_{i,j}^{i_0, j_0} \sim C i_0 j_0 (i_0 + \alpha j_0 + \beta) \frac{ij(i + \alpha j)}{[i^2 + \alpha ij + \alpha^2 j^2]^3}, \quad (\text{D.3})$$

where $C > 0$ depends only on the parameters $(p_{i,j})_{i,j}$ and is made explicit in the proof.

In the particular case of the random walk killed at the boundary of the Weyl chamber of the dual of SU(3), the asymptotic (D.3) is, for $\gamma \in]0, \pi/2[$, proved in [Bia91]. Theorem D.1 actually completes this result for that very particular random walk and gives in fact the asymptotic of the Green functions for a much larger class of processes.

In addition, Theorem D.1 has the following consequence.

Corollary D.2. *The Martin compactification of any process belonging to $\mathcal{P}_{\alpha,\beta}$ is the one-point compactification.*

Furthermore, the asymptotic (D.3) of the Green functions in the two limit cases $\gamma = 0$ and $\gamma = \pi/2$ enables us to obtain the asymptotic of the absorption probabilities

$$\begin{aligned} q_i^{i_0, j_0} &= \mathbb{P}_{(i_0, j_0)} [\exists k \geq 1 : (X(k), Y(k)) = (i, 0)], \\ \tilde{q}_j^{i_0, j_0} &= \mathbb{P}_{(i_0, j_0)} [\exists k \geq 1 : (X(k), Y(k)) = (0, j)]. \end{aligned} \quad (\text{D.4})$$

Indeed, the absorption probabilities (D.4) are related to the Green functions (D.2) through (C.53), so that from Theorem D.1, we immediately obtain the following result.

Corollary D.3. *Suppose that the process belongs to $\mathcal{P}_{\alpha,\beta}$. Then the absorption probabilities (D.4) admit the following asymptotic as $i \rightarrow \infty$:*

$$q_i^{i_0, j_0} \sim C(p_{1,-1} + p_{0,-1} + p_{-1,-1}) i_0 j_0 (i_0 + \alpha j_0 + \beta) \frac{1}{i^4},$$

where $C > 0$ is the same constant as in the statement of Theorem D.1.

The same asymptotic holds for $\tilde{q}_i^{i_0, j_0}$, after having replaced $(p_{1,-1} + p_{0,-1} + p_{-1,-1})$ above by $(p_{-1,1} + p_{-1,0} + p_{-1,-1})/\alpha^5$.

The asymptotic analysis of the absorption probabilities in the case of a non-zero drift being obtained in Chapter C, Corollary D.3 thus gives an example of the behavior of these probabilities in the case of a drift zero.

To prove Theorem D.1, we are going to develop methods initiated in [FIM99] and based on complex analysis, what will allow us to express *explicitly* the Green functions (D.2). Indeed, in [FIM99], the authors G. Fayolle, R. Iasnogorodski and V. Malyshev elaborate a profound and ingenious analytic approach for studying the stationary probabilities for random walks to the eight nearest neighbors in a quarter plane supposed ergodic, *i.e.* such that $p_{1,1}+p_{1,0}+p_{1,-1} < p_{-1,1}+p_{-1,0}+p_{-1,-1}$ and $p_{1,1}+p_{0,1}+p_{-1,1} < p_{1,-1}+p_{0,-1}+p_{-1,-1}$.

We are going to see here that this analytical approach can be extended up to the case of the random walks in the quarter plane \mathbb{Z}_+^2 with drift zero and killed at the boundary : Section D.2 of this chapter first broadens the analysis begun in Part 6 of [FIM99] for the drift zero, and then shows how this applies in the case of the random walks of $\mathcal{P}_{\alpha,\beta}$.

It is worth noting that this approach *via* complex analysis is intrinsic to the complex plane ; for this reason, it seems really a difficult task to generalize it in higher dimension.

Let us conclude this introductory part by describing the set $\mathcal{P}_{\alpha,\beta}$ defined in (D.1) in terms of the jump probabilities $(p_{i,j})_{i,j}$.

Remark D.4. *The fact that the two drifts are equal to zero gives two equations and the fact that the sum of the jump probabilities is one yields an other one. Moreover, the harmonicity of $h(i_0, j_0) = i_0 j_0 (i_0 + \alpha j_0 + \beta)$, which reads $h(i_0, j_0) = \sum_{i,j} p_{i,j} h(i_0 + i, j_0 + j)$, leads to ten equations, by identification of the coefficients of the third degree polynomials above.*

It turns out that some of these equations are trivial and that some other ones are linearly dependent, we finally obtain six equations linearly independent. We can therefore express all the eight jump probabilities $(p_{i,j})_{i,j}$ in terms of $p_{1,1}$ and $p_{1,0}$ only, and we get :

- * $p_{-1,0} = -[\alpha(1 - 2\alpha - \beta) + 8p_{1,1} + (4 - 3\alpha + 2\alpha^2 + \alpha\beta)p_{1,0}]/[\alpha(1 + 2\alpha + \beta)],$
- * $p_{-1,1} = [\alpha(1 - \alpha - \beta) + 2(4 + 3\alpha + 2\alpha^2 + \alpha\beta)p_{1,1} + 2(2 + \alpha^2 + \alpha\beta)p_{1,0}]/[2\alpha(1 + 2\alpha + \beta)],$
- * $p_{0,1} = -[-(1 + \alpha + \beta) + 4(2 + 2\alpha + \beta)p_{1,1} + 2(2 + \alpha + \beta)p_{1,0}]/[2(1 + 2\alpha + \beta)],$
- * $p_{1,-1} = [\alpha^2 + (-1 + 2\alpha - \beta)p_{1,1} - (1 + \beta + 2\alpha^2)p_{1,0}]/[1 + 2\alpha + \beta],$
- * $p_{0,-1} = -[(-1 - 3\alpha - \beta + 4\alpha^2) + 4(-2 + 2\alpha - \beta)p_{1,1} + (-4 + 6\alpha - 2\beta - 8\alpha^2)p_{1,0}]/[2(1 + 2\alpha + \beta)],$
- * $p_{-1,-1} = [\alpha(1 - 3\alpha - \beta + 2\alpha^2) + 2(4 - 3\alpha + 2\alpha^2 - \alpha\beta)p_{1,1} + 2(2 - 3\alpha + 3\alpha^2 - 2\alpha^3)p_{1,0}]/[2\alpha(1 + 2\alpha + \beta)].$

The properties of $\mathcal{P}_{\alpha,\beta}$ mentioned below (D.1) are immediately obtained by studying the sign of the jump probabilities above in terms of α , β , $p_{1,1}$ and $p_{1,0}$.

D.2 Explicit expression of the Green functions

Section D.2 aims at obtaining an explicit expression of the Green functions (D.2), what we will succeed in doing in Theorem D.8 below. This forthcoming expression of the Green functions will be, in turn, the starting point of Section D.3, where we will find their asymptotic.

In order to prove Theorem D.8, we need to state two results, namely Equation (D.6) and Proposition D.6. Precisely, Equation (D.6) is a functional equation between the generating function of the Green functions (D.2) and the ones of the absorption probabilities (D.4), and Proposition D.6 establishes some quite important properties of the generating functions of the absorption probabilities.

The proof of Proposition D.6 turns out to require considering the Riemann surface defined by $\{(x, y) \in (\mathbb{C} \cup \{\infty\})^2 : \sum_{i,j} p_{i,j} x^i y^j = 1\}$, for this reason we begin Section D.2 by studying – and, in fact, by uniformizing – this surface.

It seems of interest to us to introduce this Riemann surface in whole generality ; this is why, at the beginning of Section D.2, we are going to suppose that the process belongs to \mathcal{P}^0 – and not necessarily to $\mathcal{P}_{\alpha,\beta}$.

To begin with, we define the generating functions of the Green functions (D.2) and of the absorption probabilities (D.4) by

$$Q^{i_0,j_0}(x,y) = \sum_{i,j \geq 1} G_{i,j}^{i_0,j_0} x^{i-1} y^{j-1}, \quad q^{i_0,j_0}(x) = \sum_{i \geq 1} q_i^{i_0,j_0} x^i, \quad \tilde{q}^{i_0,j_0}(y) = \sum_{j \geq 1} \tilde{q}_j^{i_0,j_0} y^j \quad (\text{D.5})$$

and $q_{0,0}^{i_0,j_0} = \mathbb{P}_{(i_0,j_0)}[\exists k \geq 1 : (X(k), Y(k)) = (0,0)]$. Of course, Q^{i_0,j_0} , q^{i_0,j_0} and \tilde{q}^{i_0,j_0} are holomorphic in their unit disc. With these notations, we can state the following functional equation on $\{(x,y) \in \mathbb{C}^2 : |x| < 1, |y| < 1\}$:

$$K(x,y) Q^{i_0,j_0}(x,y) = q^{i_0,j_0}(x) + \tilde{q}^{i_0,j_0}(y) + q_{0,0}^{i_0,j_0} - x^{i_0} y^{j_0}, \quad (\text{D.6})$$

where $K(x,y) = xy \left[\sum_{i,j} p_{i,j} x^i y^j - 1 \right]$. Equation (D.6) is obtained exactly as in Subsection C.2.1 of Chapter C.

The polynomial $K(x,y)$ defined above can obviously be written as

$$K(x,y) = a(x)y^2 + b(x)y + c(x) = \tilde{a}(y)x^2 + \tilde{b}(y)x + \tilde{c}(y),$$

with

$$a(x) = p_{1,1}x^2 + p_{0,1}x + p_{-1,1}, \quad b(x) = p_{1,0}x^2 - x + p_{-1,0}, \quad c(x) = p_{1,-1}x^2 + p_{0,-1}x + p_{-1,-1},$$

$$\tilde{a}(y) = p_{1,1}y^2 + p_{1,0}y + p_{1,-1}, \quad \tilde{b}(y) = p_{0,1}y^2 - y + p_{0,-1}, \quad \tilde{c}(y) = p_{-1,1}y^2 + p_{-1,0}y + p_{-1,-1}.$$

Let us also define the polynomials

$$d(x) = b(x)^2 - 4a(x)c(x), \quad \tilde{d}(y) = \tilde{b}(y)^2 - 4\tilde{a}(y)\tilde{c}(y).$$

It is proved in Part 2.3 of [FIM99] that for any random walk of \mathcal{P}^0 , d (resp. \tilde{d}) has one simple root in $] -1, 1[$, that we call x_1 (resp. y_1), a double root at 1, and a simple root in $\mathbb{R} \cup \{\infty\} \setminus [-1, 1]$, that we note x_4 (resp. y_4).

For example, in the case of $SU(3)$, *i.e.* for the random walk with transition probabilities as in Picture D.1, we immediately obtain $x_1 = 0$, $y_1 = 1/4$, $x_4 = 4$ and $y_4 = \infty$.

From a general point of view, it is shown in Part 2.3 of [FIM99] that the branch point x_1 (resp. y_1) is positive, zero or negative depending on whether $p_{-1,0}^2 - 4p_{-1,1}p_{-1,-1}$ (resp. $p_{0,-1}^2 - 4p_{1,-1}p_{-1,-1}$) is positive, zero or negative, and that x_4 (resp. y_4) is positive, infinite or negative depending on whether $p_{1,0}^2 - 4p_{1,1}p_{1,-1}$ (resp. $p_{0,1}^2 - 4p_{1,1}p_{-1,1}$) is positive, zero or negative.

Let us now have a look to the surface defined by $\{(x,y) \in (\mathbb{C} \cup \{\infty\})^2 : K(x,y) = 0\}$, that we note \mathcal{K} for the sake of brevity. Note first that $K(x,y) = 0$ is equivalent to $[b(x) + 2a(x)y]^2 = d(x)$ or to $[\tilde{b}(y) + 2\tilde{a}(y)x]^2 = \tilde{d}(y)$. As a consequence, it follows from the particular form of d or of \tilde{d} (two distinct simple roots different from 1 and one double root at 1) that the surface \mathcal{K} has genus zero, and is thus homeomorphic to a sphere $\mathbb{C} \cup \{\infty\}$, see *e.g.* Parts 4.17 and 5.12 of [JS87]. Therefore, this Riemann surface can be rationally uniformized, in the sense that it is possible to find two rational functions $x(z)$ and $y(z)$,

such that $\mathcal{K} = \{(x(z), y(z)) : z \in \mathbb{C} \cup \{\infty\}\}$; moreover, a standard uniformization (for an account of the concept of uniformization, see Part 4.9 of [JS87]) is :

$$x(z) = \frac{(z - z_1)(z - 1/z_1)}{(z - z_0)(z - 1/z_0)}, \quad y(z) = \frac{(z - Lz_3)(z - L/z_3)}{(z - Lz_2)(z - L/z_2)}, \quad (\text{D.7})$$

where

$$\begin{aligned} z_0 &= [2 - (x_1 + x_4) + 2[(1 - x_1)(1 - x_4)]^{1/2}] / [x_4 - x_1], \\ z_1 &= [x_1 + x_4 - x_1x_4 + 2[x_1x_4(1 - x_1)(1 - x_4)]^{1/2}] / [x_4 - x_1], \\ z_2 &= [2 - (y_1 + y_4) + 2[(1 - y_1)(1 - y_4)]^{1/2}] / [y_4 - y_1], \\ z_3 &= [y_1 + y_4 - y_1y_4 + 2[y_1y_4(1 - y_1)(1 - y_4)]^{1/2}] / [y_4 - y_1], \end{aligned}$$

and where L is a complex number of modulus 1. Note that z_0 and z_1 (resp. z_2 and z_3) have a modulus equal to one or are real, according to the signs of x_1 and x_4 (resp. y_1 and y_4).

For example, in the case of $\text{SU}(3)$, it follows from a direct calculation that

$$z_0 = \exp(-2i\pi/3), \quad z_1 = 1, \quad z_2 = \exp(-i\pi/3), \quad z_3 = \exp(i\pi/3), \quad L = \exp(-i\pi/3).$$

In the general case, in order to find L , we need to introduce a group of automorphisms naturally associated with the surface \mathcal{K} . To begin with, let us remark that with the previous notations, $K(x, y) = 0$ entails $K(x, [c(x)/a(x)]/y) = 0$ and $K([\tilde{c}(y)/\tilde{a}(y)]/x, y) = 0$; it is therefore natural to consider the group generated by the two bilinear transformations $\hat{\xi}(x, y) = (x, [c(x)/a(x)]/y)$ and $\hat{\eta}(x, y) = ([\tilde{c}(y)/\tilde{a}(y)]/x, y)$, which is called, in [FIM99], the *group of the random walk*.

These automorphisms $\hat{\xi}$ and $\hat{\eta}$ define two automorphisms ξ and η of the uniformization space $\mathbb{C} \cup \{\infty\}$, characterized by :

$$\xi \circ \xi = 1, \quad x \circ \xi = x, \quad y \circ \xi = [c(x)/a(x)]/y, \quad \eta \circ \eta = 1, \quad y \circ \eta = y, \quad x \circ \eta = [\tilde{c}(y)/\tilde{a}(y)]/x. \quad (\text{D.8})$$

With (D.7) and (D.8), we obtain that they are equal to :

$$\xi(z) = 1/z, \quad \eta(z) = L^2/z. \quad (\text{D.9})$$

In particular, it is immediate that the group $W = \langle \xi, \eta \rangle$ generated by ξ and η is isomorphic to the dihedral group of order $2 \inf\{n > 0 : L^{2n} = 1\}$. For example, in the case of $\text{SU}(3)$ for which $L = \exp(-i\pi/3)$, W is of order six – this fact is (differently) proved in Part 4.1 of [FIM99].

A crucial fact is that this property is actually verified by *any* random walk of $\mathcal{P}_{\alpha, \beta}$, since we have the following.

Proposition D.5. *For any process of $\mathcal{P}_{\alpha, \beta}$, $L = \exp(-i\pi/3)$.*

Proof. With (D.7), we have $y(L) = y_1$; in addition by (D.9), $\eta(L) = L$, so that with (D.8), we obtain $x(L)^2 = \tilde{c}(y_1)/\tilde{a}(y_1)$. This implies that $x(L) = -[\tilde{c}(y_1)/\tilde{a}(y_1)]^{1/2}$ – indeed, we easily show that the roots of $K(x, y_1)$ have to be negative. By using again (D.7), we get $L + 1/L = [\tilde{a}(y_1)^{1/2}(z_1 + 1/z_1) + \tilde{c}(y_1)^{1/2}(z_0 + 1/z_0)] / [\tilde{a}(y_1)^{1/2} + \tilde{c}(y_1)^{1/2}]$. In particular, $L + 1/L$ can be expressed explicitly in terms of the jump probabilities $(p_{i,j})_{i,j}$. By using then Remark D.4 and after simplification, we get $L = \exp(-i\pi/3)$. \square

From now on, we suppose that the process belongs to $\mathcal{P}_{\alpha,\beta}$.

For a better understanding of the surface \mathcal{K} as well as for a coming use, we are now going to be interested in the transformations through the uniformization (x, y) of some important cycles, namely the branch cuts $[x_1, x_4]$, $[y_1, y_4]$ and the unit circles $\{|x| = 1\}$, $\{|y| = 1\}$. First, by using (D.7) and Proposition D.5, we immediately obtain :

$$x^{-1}([x_1, x_4]) = \mathbb{R} \cup \{\infty\}, \quad y^{-1}([y_1, y_4]) = \exp(-i\pi/3)\mathbb{R} \cup \{\infty\}. \quad (\text{D.10})$$

As for the cycles $x^{-1}(\{|x| = 1\})$ and $y^{-1}(\{|y| = 1\})$, their explicit expression (calculated starting from (D.7)) shows that they are real elliptic curves, which are located as in the middle of Picture D.3 below.

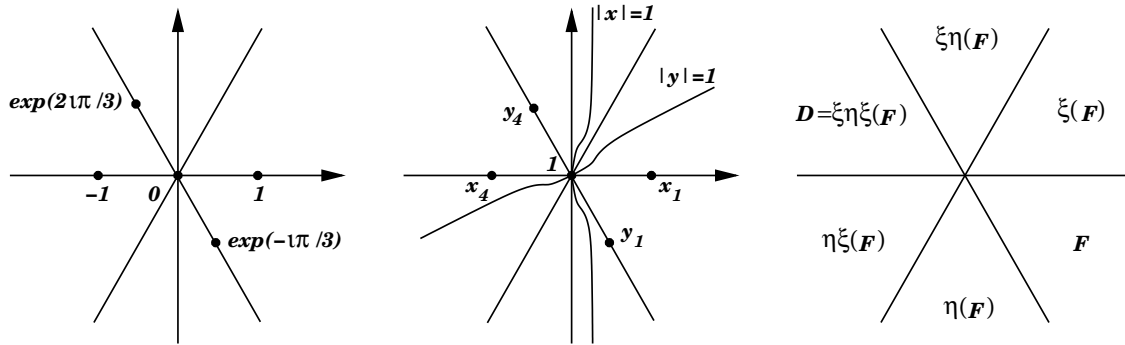

FIGURE D.3 – The uniformization space $\mathbb{C} \cup \{\infty\}$, with on the left some important elements of it, in the middle the corresponding elements through the uniformization (x, y) , and on the right the images of the cone $F = \{x \exp(i\theta) : x \geq 0, -\pi/3 \leq \theta \leq 0\}$ through the six elements of the group $W = \langle \xi, \eta \rangle$

Note also that with (D.9) and Proposition D.5, we immediately obtain $\xi(\exp(i\theta)\mathbb{R}_+) = \exp(-i\theta)\mathbb{R}_+$ and $\eta(\exp(i\theta)\mathbb{R}_+) = \exp(-i(\theta + 2\pi/3))\mathbb{R}_+$. In particular, if we denote by F the set $\{x \exp(i\theta) : x \geq 0, -\pi/3 \leq \theta \leq 0\}$, we have – see also on the right of Picture D.3 –

$$\bigcup_{w \in W} w(F) = \mathbb{C}. \quad (\text{D.11})$$

Thanks to the group $W = \langle \xi, \eta \rangle$ and to (D.11), we are now going to continue the lifted functions $Q^{i_0, j_0}(z) = q^{i_0, j_0}(x(z))$ and $\tilde{Q}^{i_0, j_0}(z) = \tilde{q}^{i_0, j_0}(y(z))$; this fact will turn out to be of the highest importance in the proof of Theorem D.8 – the latter being crucial, since it will be the starting point of the forthcoming Section D.3.

Note that in the sequel, we are often going to write $x^{i_0}y^{j_0}(z)$ instead of $x(z)^{i_0}y(z)^{j_0}$.

Proposition D.6. *The functions $Q^{i_0, j_0}(z) = q^{i_0, j_0}(x(z))$ and $\tilde{Q}^{i_0, j_0}(z) = \tilde{q}^{i_0, j_0}(y(z))$ can be meromorphically continued from respectively $\{z \in \mathbb{C} : |x(z)| \leq 1\}$ and $\{z \in \mathbb{C} : |y(z)| \leq 1\}$ up to respectively $\mathbb{C} \setminus \exp(i\pi)[0, \infty]$ and $\mathbb{C} \setminus \exp(2i\pi/3)[0, \infty]$. These continuations verify*

$$Q^{i_0, j_0}(z) = Q^{i_0, j_0}(\xi(z)), \quad \tilde{Q}^{i_0, j_0}(z) = \tilde{Q}^{i_0, j_0}(\eta(z)) \quad (\text{D.12})$$

for all $z \in \mathbb{C}$, and

$$Q^{i_0, j_0}(z) + \tilde{Q}^{i_0, j_0}(z) + q_{0,0}^{i_0, j_0} - x^{i_0}y^{j_0}(z) = \left\{ \right.$$

$$\begin{aligned}
& 0 && \text{if } z \notin D \quad (\text{D.13a}) \\
& - \sum_{w \in W} (-1)^{l(w)} x^{i_0} y^{j_0}(w(z)) && \text{if } z \in D \quad (\text{D.13b})
\end{aligned}$$

where we have set $D = \{x \exp(i\theta) : x \geq 0, 2\pi/3 \leq \theta \leq \pi\}$ and $l(w)$ for the length of w , i.e. the smallest r for which we can write $w = w_1 \cdots w_r$, with w_1, \dots, w_r equal to ξ or η .

Remark D.7. In $\{z \in \mathbb{C} : |x(z)| \leq 1, |y(z)| \leq 1\} \subset \mathbb{C} \setminus D$, the identity (D.13a) follows directly from (D.6).

Proof of Proposition D.6. In order to prove Proposition D.6, we are going to use strongly the decomposition (D.11) : precisely, we are going to define Q^{i_0, j_0} and \tilde{Q}^{i_0, j_0} piecewise, by defining them on each of the six domains $w(F)$ that appear in the decomposition (D.11), to be equal to some functions $Q_w^{i_0, j_0}$ and $\tilde{Q}_w^{i_0, j_0}$. It will then be enough to show that the functions Q^{i_0, j_0} and \tilde{Q}^{i_0, j_0} so-defined verify the conclusions of Proposition D.6.

* In $F = \{x \exp(i\theta) : x \geq 0, -\pi/3 \leq \theta \leq 0\} \subset \{z \in \mathbb{C} : |x(z)| \leq 1, |y(z)| \leq 1\}$, see Picture D.1, we are going to use the most natural way to define Q^{i_0, j_0} and \tilde{Q}^{i_0, j_0} , i.e. their power series. So we set, for $z \in F$, $Q_1^{i_0, j_0}(z) = q^{i_0, j_0}(x(z))$ and $\tilde{Q}_1^{i_0, j_0}(z) = \tilde{q}^{i_0, j_0}(y(z))$ – the subscript 1 standing for the identity element of the group $W = \langle \xi, \eta \rangle$.

* Next, we define $Q_\xi^{i_0, j_0}$, $\tilde{Q}_\xi^{i_0, j_0}$ on $\xi(F)$ and $Q_\eta^{i_0, j_0}$, $\tilde{Q}_\eta^{i_0, j_0}$ on $\eta(F)$ by

$$\begin{aligned}
\forall z \in \xi(F) & : Q_\xi^{i_0, j_0}(z) = Q_1^{i_0, j_0}(\xi(z)), & \tilde{Q}_\xi^{i_0, j_0}(z) &= -Q_\xi^{i_0, j_0}(z) - q_{0,0}^{i_0, j_0} + x^{i_0} y^{j_0}(z), \\
\forall z \in \eta(F) & : \tilde{Q}_\eta^{i_0, j_0}(z) = \tilde{Q}_1^{i_0, j_0}(\eta(z)), & Q_\eta^{i_0, j_0}(z) &= -\tilde{Q}_\eta^{i_0, j_0}(z) - q_{0,0}^{i_0, j_0} + x^{i_0} y^{j_0}(z).
\end{aligned}$$

* Then, we define $Q_{\xi\eta}^{i_0, j_0}$, $\tilde{Q}_{\xi\eta}^{i_0, j_0}$ on $\xi\eta(F)$ and $Q_{\eta\xi}^{i_0, j_0}$, $\tilde{Q}_{\eta\xi}^{i_0, j_0}$ on $\eta\xi(F)$ by

$$\begin{aligned}
\forall z \in \xi\eta(F) & : Q_{\xi\eta}^{i_0, j_0}(z) = Q_\eta^{i_0, j_0}(\xi(z)), & \tilde{Q}_{\xi\eta}^{i_0, j_0}(z) &= -Q_{\xi\eta}^{i_0, j_0}(z) - q_{0,0}^{i_0, j_0} + x^{i_0} y^{j_0}(z), \\
\forall z \in \eta\xi(F) & : \tilde{Q}_{\eta\xi}^{i_0, j_0}(z) = \tilde{Q}_\xi^{i_0, j_0}(\eta(z)), & Q_{\eta\xi}^{i_0, j_0}(z) &= -\tilde{Q}_{\eta\xi}^{i_0, j_0}(z) - q_{0,0}^{i_0, j_0} + x^{i_0} y^{j_0}(z).
\end{aligned}$$

* At last, we define $Q_{\xi\eta\xi}^{i_0, j_0}$ and $\tilde{Q}_{\xi\eta\xi}^{i_0, j_0}$ on $\xi\eta\xi(F) = \eta\xi\eta(F)$ by

$$\forall z \in \xi\eta\xi(F) : Q_{\xi\eta\xi}^{i_0, j_0}(z) = Q_{\eta\xi}^{i_0, j_0}(\xi(z)), \quad \tilde{Q}_{\xi\eta\xi}^{i_0, j_0}(z) = \tilde{Q}_{\xi\eta}^{i_0, j_0}(\eta(z)).$$

Therefore we have, for each of the six domains $w(F)$ of the decomposition (D.11), defined two functions $Q_w^{i_0, j_0}$ and $\tilde{Q}_w^{i_0, j_0}$. Then, as said at the beginning of the proof, we set $Q^{i_0, j_0}(z) = Q_w^{i_0, j_0}(z)$ and $\tilde{Q}^{i_0, j_0}(z) = \tilde{Q}_w^{i_0, j_0}(z)$ for all $z \in w(F)$ and all $w \in W$.

With this construction, (D.12) and (D.13a) are immediately obtained. To prove (D.13b), we can use the fact that it is possible to express *all* the functions $Q_w^{i_0, j_0}$, $\tilde{Q}_w^{i_0, j_0}$ in terms *only* of $Q_1^{i_0, j_0}$, $\tilde{Q}_1^{i_0, j_0}$, $q_{0,0}^{i_0, j_0}$, $x^{i_0} y^{j_0}$: we give e.g. the expressions of $Q_{\xi\eta\xi}^{i_0, j_0}$ and $\tilde{Q}_{\xi\eta\xi}^{i_0, j_0}$ on $\xi\eta\xi(F)$:

$$\begin{aligned}
Q_{\xi\eta\xi}^{i_0, j_0}(z) &= Q_1^{i_0, j_0}(\xi\eta\xi(z)) - x^{i_0} y^{i_0}(\eta\xi(z)) + x^{i_0} y^{i_0}(\xi(z)), \\
\tilde{Q}_{\xi\eta\xi}^{i_0, j_0}(z) &= \tilde{Q}_1^{i_0, j_0}(\xi\eta\xi(z)) - x^{i_0} y^{i_0}(\xi\eta(z)) + x^{i_0} y^{i_0}(\eta(z)).
\end{aligned}$$

We therefore obtain (D.13b), since with (D.13a) we get $Q_1^{i_0, j_0}(\xi\eta\xi(z)) + \tilde{Q}_1^{i_0, j_0}(\xi\eta\xi(z)) + q_{0,0}^{i_0, j_0} = x^{i_0} y^{j_0}(\xi\eta\xi(z))$ for $z \in \xi\eta\xi(F)$, and since $W = \{1, \xi, \eta, \eta\xi, \xi\eta, \xi\eta\xi\}$. \square

Theorem D.8. *For any $i, j, i_0, j_0 > 0$,*

$$G_{i,j}^{i_0,j_0} = \frac{-[z_0 - 1/z_0]/\Omega_x}{2\pi i [p_{1,0}^2 - 4p_{1,1}p_{1,-1}]^{1/2}} \int_{\exp(i\theta)[0,\infty]} \left[\frac{1}{z} \sum_{w \in W} (-1)^{l(w)} x^{i_0} y^{j_0} (w(z)) \right] \frac{dz}{x(z)^i y(z)^j}, \quad (\text{D.14})$$

where $\theta \in [2\pi/3, \pi]$ and where we have set $\Omega_x = z_0 + 1/z_0 - [z_1 + 1/z_1] = 4(x_4 - 1)(x_1 - 1)/(x_4 - x_1) < 0$.

Proof. We have already noticed that the generating function of the Green functions (defined in (D.5)) is holomorphic in $\{(x, y) \in \mathbb{C}^2 : |x| < 1, |y| < 1\}$. As a consequence and by using (D.6), Cauchy's formulas allow us to write its coefficients $G_{i,j}^{i_0,j_0}$ as the following double integrals :

$$G_{i,j}^{i_0,j_0} = \frac{1}{[2\pi i]^2} \iint_{\{|x|=|y|=1\}} \frac{q^{i_0,j_0}(x) + \tilde{q}^{i_0,j_0}(y) + q_{0,0}^{i_0,j_0} - x^{i_0} y^{j_0}}{K(x, y) x^i y^j} dx dy.$$

Then, by using the uniformization (D.7), the location of the cycles $\{|x|=1\}$ and $\{|y|=1\}$, see Picture D.3, the residue theorem at infinity and Cauchy's theorem, we obtain that :

$$G_{i,j}^{i_0,j_0} = \frac{1}{2\pi i} \int_{\exp(i\theta)[0,\infty]} \frac{Q^{i_0,j_0}(z) + \tilde{Q}^{i_0,j_0}(z) + q_{0,0}^{i_0,j_0} - x^{i_0} y^{j_0}(z)}{[\partial_y K(x(z), y(z))] x(z)^i y(z)^j} x'(z) dz, \quad (\text{D.15})$$

θ being any angle lying in $[2\pi/3, \pi] - [2\pi/3, \pi]$ because on the one hand, it is not possible to take $\theta > \pi$, since $\exp(i\pi)[0, \infty]$ is a singular curve for Q^{i_0,j_0} , and on the other hand, it is not allowed to have $\theta < 2\pi/3$, since $\exp(2i\pi/3)[0, \infty]$ is a singular curve for \tilde{Q}^{i_0,j_0} , see Proposition D.6.

Then, from (D.7) and from the fact that $\partial_y K(x(z), y(z)) = d(x(z))^{1/2}$, we remark that we have

$$x'(z)/\partial_y K(x(z), y(z)) = \frac{[z_0 - 1/z_0]/(z_0 + 1/z_0 - [z_1 + 1/z_1])}{[p_{1,0}^2 - 4p_{1,1}p_{1,-1}]^{1/2} z}.$$

In this way and by using (D.13b) in (D.15), we get (D.14). \square

D.3 Asymptotic of the Green functions

Beginning of the proof of Theorem D.1. For any $\theta \in [2\pi/3, \pi]$, the function $x(z)^i y(z)^j$ is larger than 1 in modulus on $\exp(i\theta)[0, \infty]$, see Picture D.3. Moreover, it goes to 1 when and only when z goes to 0 or to ∞ . This is why it seems natural to decompose the contour $\exp(i\theta)[0, \infty]$ into a part near 0, an other near ∞ and the remaining part, and to think that the parts near 0 and ∞ will lead to the asymptotic of $G_{i,j}^{i_0,j_0}$ and that the remaining part will lead to a negligible contribution. In this way appears the question of finding the best possible contour in order to achieve this idea ; in other words, it is a matter of finding the value of θ for which the calculation of the asymptotic of (D.14) on $\exp(i\theta)[0, \infty]$ will be the easiest, among all the possibilities $\theta \in [2\pi/3, \pi]$.

For this, we are going to consider with details the function $x(z)^i y(z)^j$, or equivalently the function $\chi_{j/i}(z) = \ln(x(z)) + (j/i) \ln(y(z))$. Incidentally, this is why, from now on, we suppose that $j/i \in [0, M]$ for some $M < \infty$. Indeed, the function $\chi_{j/i}$ is manifestly not appropriate to the values j/i going to ∞ , for such j/i , we will consider later the function

$(i/j)\chi_{j/i}(z) = (i/j)\ln(x(z)) + \ln(y(z))$. Nevertheless, M can be so large as wished, and in what follows, we assume that some $M > 0$ is fixed.

Now we set $\chi_{j/i}(z) = \sum_{p \geq 0} \nu_p(j/i)z^p$, this function is *a priori* well defined for z in a neighborhood of 0. Moreover, with (D.7) we obtain that $\nu_0(j/i) = 0$ and that for all $p \geq 1$,

$$p\nu_p(j/i) = (z_0^p + 1/z_0^p - [z_1^p + 1/z_1^p]) + (j/i)(z_2^p + 1/z_2^p - [z_3^p + 1/z_3^p])/L^p. \quad (\text{D.16})$$

Likewise we easily prove, by using (D.7), that for z near ∞ , $\chi_{j/i}(z) = \sum_{p \geq 0} \overline{\nu}_p(j/i)/z^p$.

Consider now the steepest descent path associated with $\chi_{j/i}$, that is the function $z_{j/i}(t)$ defined by $\chi_{j/i}(z_{j/i}(t)) = t$. By inverting the latter equality, we immediately obtain that the half-line $(1/\nu_1(j/i))[0, \infty]$ is tangent at 0 and at ∞ to the steepest descent path.

Now we set, for the sake of brevity, $\rho_{j/i} = 1/\nu_1(j/i)$. With this notation, let us now answer the question asked above, that dealt with finding the value of θ for which the asymptotic of $G_{i,j}^{i_0,j_0}$ will be the most easily calculated : we are going to choose $\theta = \arg(\rho_{j/i}) \in [2\pi/3, \pi]$, and the decomposition of the contour $\exp(i\theta)[0, \infty]$ will be

$$\exp(i\theta)[0, \infty] = (\rho_{j/i}/|\rho_{j/i}|)([0, \epsilon] \cup \epsilon, 1/\epsilon \cup [1/\epsilon, \infty]).$$

By using this decomposition in (D.14), we consider now that the Green functions are the sum of three terms, and we are going to study successively the contribution of each of these terms.

But first of all, we simplify the expression of $\rho_{j/i}$. Setting $\Omega_y = z_2 + 1/z_2 - [z_3 + 1/z_3] = 4(y_4 - 1)(y_1 - 1)/(y_4 - y_1)$ and using (D.16), we immediately obtain that $\nu_1(j/i) = \Omega_x + (j/i)\Omega_y/L$. But it turns out that for all the walks of $\mathcal{P}_{\alpha,\beta}$, we have $\Omega_y = \alpha\Omega_x$ - this follows from a direct calculation starting from the explicit expression of the branch points x_1, x_4, y_1, y_4 in terms of the jump probabilities $(p_{i,j})_{i,j}$ and by using Remark D.4. Therefore we have :

$$\rho_{j/i} = \frac{1}{\nu_1(j/i)} = \frac{1}{\Omega_x} \frac{1}{1 + (j/i)\alpha \exp(i\pi/3)}. \quad (\text{D.17})$$

Contribution of the neighborhood of 0. In order to evaluate the asymptotic of the integral (D.14) on the contour $(\rho_{j/i}/|\rho_{j/i}|)[0, \epsilon]$, we are going to use the expansion of the function $(1/z) \sum_{w \in W} (-1)^{l(w)} x^{i_0} y^{j_0} (w(z))$ at 0 - expansion that we will obtain in Equation (D.21) below. This is why we begin by studying the asymptotic of the following integral, for any non-negative integer k :

$$\int_{(\rho_{j/i}/|\rho_{j/i}|)[0, \epsilon]} \frac{z^k}{x(z)^i y(z)^j} dz. \quad (\text{D.18})$$

By using the equality $1/[x(z)^i y(z)^j] = \exp(-i\chi_{j/i}(z))$ as well as the expansion (D.16) of $\chi_{j/i}$ at 0 and then making the change of variable $z = \rho_{j/i}t$, we obtain that (D.18) is equal to

$$\rho_{j/i}^{k+1} \int_0^{\epsilon/|\rho_{j/i}|} t^k \exp(-it) \exp\left(-i\nu_2(j/i)(\rho_{j/i}t)^2\right) \exp\left(-i \sum_{p \geq 3} \nu_p(j/i)(\rho_{j/i}t)^p\right) dt. \quad (\text{D.19})$$

Now we set $m = \max\{|z_0|, 1/|z_0|, |z_1|, 1/|z_1|, |z_2|, 1/|z_2|, |z_3|, 1/|z_3|\}$. Then with (D.16), we get $|\nu_p(j/i)| \leq 4m^p(1+M)$. Thus, for all $t \in [0, \epsilon/|\rho_{j/i}|]$, $|-i \sum_{p \geq 3} \nu_p(j/i)(\rho_{j/i}t)^p| \leq 4(1+M)i(m\epsilon)^3/(1-m\epsilon)$. This is why $\exp(-i \sum_{p \geq 3} \nu_p(j/i)(\rho_{j/i}t)^p) = 1 + O(i\epsilon^3)$, the O

being independent of $j/i \in [0, M]$ and of $t \in [0, \epsilon/|\rho_{j/i}|]$. The integral (D.19) can thus be calculated as

$$(\rho_{j/i}/i)^{k+1} [1 + O(i\epsilon^3)] \int_0^{i\epsilon/|\rho_{j/i}|} t^k \exp(-t) [1 - \nu_2(j/i) \rho_{j/i}^2 t^2 / i + O(t^4/i^2)] dt.$$

Let us now choose ϵ such that $i\epsilon/|\rho_{j/i}| \rightarrow \infty$ and $O(i\epsilon^3) = o(1/i)$, e.g. $\epsilon = 1/i^{3/4}$. For this choice of ϵ , we obtain that the integral (D.18) is equal to

$$(\rho_{j/i}/i)^{k+1} [1 + o(1/i)] [k! - \nu_2(j/i) \rho_{j/i}^2 (k+2)!/i + O(1/i^2)], \quad (\text{D.20})$$

where the o and O above are independent of $j/i \in [0, M]$.

We are presently ready to find the asymptotic of the integral (D.14) on the contour $(\rho_{j/i}/|\rho_{j/i}|)[0, \epsilon]$. To begin with, we have the following expansion in the neighborhood of 0 (directly obtained from (D.7), (D.9) and Remark D.4) :

$$\sum_{w \in W} (-1)^{l(w)} x^{i_0} y^{j_0} (w(z)) = (i3^{3/2}/2) \alpha \Omega_x^3 i_0 j_0 (i_0 + \alpha j_0 + \beta) z^3 + O(z^6). \quad (\text{D.21})$$

Equation (D.21) implies then that the integral (D.14) on the contour $(\rho_{j/i}/|\rho_{j/i}|)[0, \epsilon]$ equals

$$\frac{-[z_0 - 1/z_0]/\Omega_x}{2\pi i [p_{1,0}^2 - 4p_{1,1}p_{1,-1}]^{1/2}} \int_{(\rho_{j/i}/|\rho_{j/i}|)[0, \epsilon]} \frac{(i3^{3/2}/2) \alpha \Omega_x^3 i_0 j_0 (i_0 + \alpha j_0 + \beta) z^2 + O(z^5)}{x(z)^i y(z)^j} dz.$$

So, with (D.18) and (D.20) applied for $k = 2$ and $k = 5$, we obtain that the integral (D.14) on the contour $(\rho_{j/i}/|\rho_{j/i}|)[0, \epsilon]$ is equal to

$$\frac{-[z_0 - 1/z_0] 3^{3/2} \alpha \Omega_x^2}{4\pi [p_{1,0}^2 - 4p_{1,1}p_{1,-1}]^{1/2}} i_0 j_0 (i_0 + \alpha j_0 + \beta) (\rho_{j/i}/i)^3 [2 - 24\nu_2(j/i) \rho_{j/i}^2 / i + o(1/i)]. \quad (\text{D.22})$$

Contribution of the neighborhood of ∞ . The part of the contour close to ∞ , namely $(\rho_{j/i}/|\rho_{j/i}|)[1/\epsilon, \infty]$, is related to the part $(\rho_{j/i}/|\rho_{j/i}|)[0, \epsilon]$ by the mapping $z \mapsto 1/\bar{z}$. Furthermore, it is clear from (D.7) that for $f = x$, $f = y$ or $f = \sum_{w \in W} (-1)^{l(w)} x^{i_0} y^{j_0} (w)$, $f(1/\bar{z}) = \overline{f(z)}$. Therefore, the change of variable $z \mapsto 1/\bar{z}$ directly entails that the contribution of the integral (D.14) near ∞ is the complex conjugate of its contribution near 0.

Contribution of the intermediate part. We first recall from Proposition D.6 that D denotes $\{x \exp(i\theta) : x \geq 0, 2\pi/3 \leq \theta \leq \pi\}$ and we define $A_\epsilon = \{z \in \mathbb{C} : \epsilon \leq |z| \leq 1/\epsilon\}$. Clearly (see Picture D.3), there exist $\eta_{x,\epsilon} > 0$ and $\eta_{y,\epsilon} > 0$ such that for all $z \in D \cap A_\epsilon$, $|x(z)| \geq 1 + \eta_{x,\epsilon}$ and $|y(z)| \geq 1 + \eta_{y,\epsilon}$. In fact, since $x'(0) = \Omega_x \neq 0$ and $y'(0) = \Omega_y/L \neq 0$, it is possible to take $\eta_{x,\epsilon} \geq \eta\epsilon$ and $\eta_{y,\epsilon} \geq \eta\epsilon$ for some $\eta > 0$ independent of ϵ small enough.

Let us now consider the function

$$s(z) = \frac{1}{x^{i_0} y^{j_0}(z)} \left[\sum_{w \in W} (-1)^{l(w)} x^{i_0} y^{j_0}(w(z)) \right],$$

and let us show that $\sup_{z \in D} |s(z)|$ is finite. For this, it is sufficient to prove that s has no pole in the closed domain $D \cup \{\infty\}$.

By (D.7), the only zeros of the denominator of s are at $z_1, 1/z_1, Lz_3, L/z_3$ which, as we easily check, belong to $-(D \cup \overline{D})$. Also, by (D.7) and (D.9), the only poles of the numerator of s are at $L^{2k}z_0, L^{2k}/z_0, L^{2k+1}z_2, L^{2k+1}/z_2$ for $k \in \{0, 1, 2\}$. Next, we verify that both z_0 and Lz_2 belong to D , so that among the twelve previous points, in fact only z_0 and Lz_2 are in D . But in the definition of s , we took care of dividing by $x^{i_0}y^{j_0}$, so that s is in fact holomorphic near these two points. Moreover, s is clearly holomorphic at ∞ . Finally, we have proved that the meromorphic function s has no pole in the closed domain $D \cup \{\infty\}$, hence s is bounded in $D \cup \{\infty\}$, in other words $\sup_{z \in D} |s(z)|$ is finite.

In particular, the modulus of the contribution of the integral (D.14) on the intermediate part $(\rho_{j/i}/|\rho_{j/i}|)\epsilon, 1/\epsilon[\subset D \cap A_\epsilon$ can be bounded from above by

$$\frac{|z_0 - 1/z_0|/|\Omega_x|}{2\pi|p_{1,0}^2 - 4p_{1,1}p_{1,-1}|^{1/2}} \frac{1}{\epsilon^2} \frac{\sup_{z \in D} |s(z)|}{(1 + \eta\epsilon)^{i-i_0}(1 + \eta\epsilon)^{j-j_0}}. \quad (\text{D.23})$$

Note that the presence of the term $1/\epsilon^2$ in (D.23) is due to the following : one $1/\epsilon$ appears as an upper bound of the length of the contour, the other $1/\epsilon$ comes from an upper bound of the modulus of the term $1/z$ present in the integrand of (D.14).

Then, as before we take $\epsilon = 1/i^{3/4}$, and we use the following straightforward upper bound, valid for i large enough : $1/(1 + \eta/i^{3/4})^i \leq \exp(-(\eta/2)i^{1/4})$. We finally obtain that for i large enough, (D.23) is equal to $O(i^{3/2} \exp(-(\eta/2)i^{1/4}))$. We are going to see soon that this contribution is negligible w.r.t. the sum of the contributions of the integral (D.14) in the neighborhoods of 0 and ∞ .

Conclusion. We have shown that the contribution of the integral (D.14) in the neighborhood of 0 is given by (D.22), that the contribution of (D.14) in the neighborhood of ∞ is equal to the complex conjugate of (D.22), and that the contribution of the remaining part equals $O(i^{3/2} \exp(-(\eta/2)i^{1/4}))$. Moreover, starting from (D.17), we immediately get that $(\rho_{j/i}/i)^3 - (\overline{\rho_{j/i}/i})^3 = -i3^{3/2}\alpha ij(i + \alpha j)/[\Omega_x(i^2 + \alpha ij + \alpha^2 j^2)]^3$. In this way, we obtain

$$G_{i,j}^{i_0,j_0} = \frac{-[z_0 - 1/z_0]3^{3/2}\alpha\Omega_x^2}{4\pi(p_{1,0}^2 - 4p_{1,1}p_{1,-1})^{1/2}} i_0 j_0 (i_0 + \alpha j_0 + \beta) \times \quad (\text{D.24})$$

$$\times \left[\frac{-2i3^{3/2}\alpha ij(i + \alpha j)}{[\Omega_x(i^2 + \alpha ij + \alpha^2 j^2)]^3} - 24 \frac{\nu_2(j/i)\rho_{j/i}^5 - \overline{\nu_2(j/i)}\overline{\rho_{j/i}}^5}{i^4} + o(1/i^4) \right].$$

* If $\gamma \in]0, \pi/2[$ and $j/i \rightarrow \tan(\gamma)$, then $ij(i + \alpha j)/(i^2 + \alpha ij + \alpha^2 j^2)^3 \sim C_{\gamma,\alpha}/i^3$ with $C_{\gamma,\alpha} > 0$: Theorem D.1 for $\gamma \in]0, \pi/2[$ is thus an immediate consequence of (D.24). In that case, there was in fact no need to make an expansion with two terms in (D.22) and (D.24) above, one single term would have been accurate enough.

* If $j/i \rightarrow \tan(0) = 0$, then $ij(i + \alpha j)/(i^2 + \alpha ij + \alpha^2 j^2)^3 \sim (j/i)/i^3$. By using the explicit expressions of $\nu_2(j/i)$ and $\rho_{j/i}$, see respectively (D.16) and (D.17), we easily obtain that $\nu_2(j/i)\rho_{j/i}^5 - \overline{\nu_2(j/i)}\overline{\rho_{j/i}}^5 = O(j/i)$. This implies that the sum of the two last terms in the square brackets of (D.24) equals $O((j/i)/i^4) + o(1/i^4)$, which is obviously negligible w.r.t. $(j/i)/i^3$. Theorem D.1 is therefore also proved in the case $\gamma = 0$.

* In order to prove Theorem D.1 in the case $\gamma = \pi/2$, we would consider $(i/j)\kappa_{j/i}$ rather than $\kappa_{j/i}$, and we would use then exactly the same analysis, we omit the details.

Finally, to prove that the constant C in the statement of Theorem D.1 is positive, it is clearly enough to show that $i[z_0 - 1/z_0]/[(p_{1,0}^2 - 4p_{1,1}p_{1,-1})^{1/2}\Omega_x]$ is positive.

For this, note first that from its definition, it is immediate that $\Omega_x < 0$. Moreover, it follows from the beginning of Section D.2 that if $x_4 > 0$, then $\iota[z_0 - 1/z_0] < 0$ and $(p_{1,0}^2 - 4p_{1,1}p_{1,-1})^{1/2} > 0$; if $x_4 < 0$, then $[z_0 - 1/z_0] > 0$ and $\iota/(p_{1,0}^2 - 4p_{1,1}p_{1,-1})^{1/2} < 0$; and if $x_4 = \infty$, by taking the limit in anyone of the two previous cases, we obtain that $\iota[z_0 - 1/z_0]/[(p_{1,0}^2 - 4p_{1,1}p_{1,-1})^{1/2}] < 0$.

A few words about the analytical approach used here. The two key identities in the proof of Theorem D.1 are *first* the explicit expression of the Green functions (D.15), and *then* the expansion (D.13b) of $Q^{i_0,j_0} + \tilde{Q}^{i_0,j_0} + q_{0,0}^{i_0,j_0} - x^{i_0}y^{j_0}$ at 0, which is the numerator of the integrand in (D.15).

It is worth noting that for any walk of $\mathcal{P}^0 \supset \mathcal{P}_{\alpha,\beta}$, it is still possible to obtain (D.15) – without additional technical details, besides.

On the other hand, obtaining explicitly the expansion of $Q^{i_0,j_0} + \tilde{Q}^{i_0,j_0} + q_{0,0}^{i_0,j_0} - x^{i_0}y^{j_0}$ at 0 in the general setting seems to us quite difficult – all the more so as this expansion has to comprise several terms, since *a priori* it could happen that several terms lead to non-negligible contributions in the asymptotic of the Green functions.

It is more imaginable (though technically difficult) to obtain this expansion for the walks for which an equality like (D.13b) holds; this will be the partial subject of Chapter E. Unfortunately, having such an equality is far from being systematic, even for the processes associated with a finite group W : for example, the random walk with jump probabilities $p_{1,1} = p_{0,-1} = p_{-1,0} = 1/3$ has manifestly a group W of order six, but does not verify an identity like (D.13b).

D.4 Interlude

Chapter D on walks related to $SU(3)$ is presently concluded.

Nevertheless, in this final Section D.4, we would like to study briefly the family

$$\mathcal{P}_p = \{\text{random walks of } \mathcal{P}^0 \text{ for which } (i_0, j_0) \mapsto i_0 j_0 \text{ is harmonic}\},$$

and more precisely, we wish to comment on Theorem 21 as well as on Corollaries 22-23 of Part I, and to show two related results, namely Proposition D.9 and Corollary D.10 below.

First of all, the proofs of Theorem 21 and Corollaries 22-23 of Part I are simpler than the ones of Theorem D.1 and Corollaries D.2-D.3 of this chapter, since the group is then of order 4 and not 6 as here, and so we omit the details.

Let us now turn to a quite different possibility to obtain asymptotic results for the Green functions, *via* the behavior of the absorption probabilities (D.4) and the functional equation (D.6).

Proposition D.9. *Suppose that $p_{1,0} + p_{0,-1} + p_{-1,0} + p_{0,1} = 1$, as well as $p_{1,0} = p_{-1,0}$ and $p_{0,1} = p_{0,-1}$. Then the function q^{i_0,j_0} defined by (D.4) and (D.5) is holomorphic in $(1 + \epsilon)\mathcal{D} \setminus [1, 1 + \epsilon]$, for $\epsilon > 0$ small enough, and in the neighborhood of 1 is equal to*

$$\begin{aligned} q^{i_0,j_0}(x) &= q^{i_0,j_0}(1) + i_0(x-1)[1 + (x-1)f^{i_0,j_0}(x)] \\ &\quad - \frac{2i_0j_0}{\pi}[p_{1,0}/p_{0,1}]^{1/2}(x-1)^2 \ln(1-x)[1 + (x-1)g^{i_0,j_0}(x)], \end{aligned}$$

where f^{i_0,j_0} and g^{i_0,j_0} are holomorphic at 1.

In particular, we immediately obtain that $\partial q^{i_0, j_0}(1) = i_0$; in this perspective, see [CB83] and [Coh92a], where more general results are proved.

Before proving Proposition D.9, let us state the second of the two announced results. For $a, k \in \mathbb{Z}_+$, define

$$\Gamma_{a,k} = \{(i, j) \in \mathbb{Z}_+^2 : i - 1 + a(j - 1) = k\},$$

and note $G_{\Gamma_{a,k}}^{i_0, j_0}$ the Green functions associated with $\Gamma_{a,k}$, i. e. $G_{\Gamma_{a,k}}^{i_0, j_0} = \sum_{(i,j) \in \Gamma_{a,k}} G_{i,j}^{i_0, j_0}$.

Corollary D.10. *The following asymptotic holds as $k \rightarrow \infty$:*

$$G_{\Gamma_{a,k}}^{i_0, j_0} \sim \frac{2i_0 j_0}{\pi [p_{1,0} p_{0,1}]^{1/2}} \frac{1}{k}.$$

Proof. Let Q^{i_0, j_0} be the generating function of the Green functions, see (D.5). We start by remarking that for $a \in \mathbb{Z}_+$,

$$Q^{i_0, j_0}(x, x^a) = \sum_{i, j \geq 1} G_{i,j}^{i_0, j_0} x^{i-1+a(j-1)} = \sum_{k \geq 0} x^k \sum_{(i,j) \in \Gamma_{a,k}} G_{i,j}^{i_0, j_0} = \sum_{k \geq 0} x^k G_{\Gamma_{a,k}}^{i_0, j_0}.$$

In addition, (D.6) gives $Q^{i_0, j_0}(x, x^a) = [q^{i_0, j_0}(x) + \tilde{q}^{i_0, j_0}(x^a) - x^{i_0+a j_0}]/K(x, x^a)$. Also, applied to q^{i_0, j_0} and \tilde{q}^{i_0, j_0} , Proposition D.9 leads to

$$\begin{aligned} q^{i_0, j_0}(x) + \tilde{q}^{i_0, j_0}(x^a) - x^{i_0+a j_0} = \\ \frac{-2i_0 j_0}{\pi} ([p_{1,0}/p_{0,1}]^{1/2} + a^2 [p_{0,1}/p_{1,0}]^{1/2}) \ln(1-x) [1 + (x-1)l_1(x)], \end{aligned}$$

where l_1 is holomorphic at 1. Moreover, an easy calculation gives $K(x, x) = (x-1)^2 x/2$; more generally, for any $a > 0$, $K(x, x^a) = (x-1)^2 P_a(x)$, where

$$P_a(x) = p_{0,1} x \left[\sum_{k=1}^{a-1} k(x^{k-1} + x^{2a-1-k}) + (a + p_{1,0}/p_{0,1})x^{a-1} \right],$$

In particular, $P_a(1) = p_{0,1} a^2 + p_{1,0}$. In this way, we obtain that $Q^{i_0, j_0}(x, x^a) = -C \ln(1-x)[1 + (x-1)l_2(x)]$, where l_2 is holomorphic at 1 and

$$C = \frac{2i_0 j_0}{\pi P_a(1)} ([p_{1,0}/p_{0,1}]^{1/2} + a^2 [p_{0,1}/p_{1,0}]^{1/2}) = \frac{2i_0 j_0}{\pi [p_{1,0} p_{0,1}]^{1/2}}.$$

Corollary D.10 follows then immediately – see the proof of Lemma C.26 of Chapter C or the one of the forthcoming Proposition F.5 of Chapter F for the complete details in a context of the same spirit. \square

Let us now underline two facts around Corollary D.10.

Firstly, it is surprising that the asymptotic of $G_{\Gamma_{a,k}}^{i_0, j_0}$ does not depend on $a > 0$.

Secondly, this result is in fact also true for $a = 0$. In order to show this, we have to adapt a little the proof done just above, since the explicit expression of $P_a(x)$ given above is no more valid; to overcome that, we simply have to use the equality $K(x, 1) = p_{1,0}(x-1)^2$, the proof would be then exactly the same as previously.

Proof of Proposition D.9. The proof is lightly different according to $i_0 \leq j_0$ or $i_0 > j_0$: indeed, in the first case, the polynomial $xP_\infty[x^{i_0-1}Y_0(x)^{j_0}]$ is identically zero whereas in the second one, it is non-zero (of degree $i_0 - j_0$).

We choose to do the proof in the first case, knowing that in the other it is enough, in order to show that Proposition D.9 is still valid, to make an induction on $i_0 - j_0$.

Under this assumption, with (C.16), (C.54), (C.55), (C.59) and the change of variable $t \mapsto 1/t$, we get

$$q^{i_0, j_0}(x) = \frac{x}{\pi} \int_1^{x_4} \frac{t^{i_0} - 1/t^{i_0}}{t(t-x)} \mu_{j_0}(t) [-d(t)]^{1/2} dt. \quad (\text{D.25})$$

Using twice that $1/(t-x) = 1/(t-1) + (x-1)/[(t-x)(t-1)]$, we obtain $q^{i_0, j_0}(x)/x = q^{i_0, j_0}(1) + (x-1)H_1^{i_0, j_0} + (x-1)^2 H_2^{i_0, j_0}(x)$, where

$$\begin{aligned} H_1^{i_0, j_0} &= \frac{1}{\pi} \int_1^{x_4} (t^{i_0} - 1/t^{i_0}) \frac{\mu_{j_0}(t)}{t(t-1)^2} [-d(t)]^{1/2} dt, \\ H_2^{i_0, j_0}(x) &= \frac{1}{\pi} \int_1^{x_4} (t^{i_0} - 1/t^{i_0}) \frac{\mu_{j_0}(t)}{t(t-1)^2(t-x)} [-d(t)]^{1/2} dt. \end{aligned}$$

Now we notice that the function

$$l^{i_0, j_0}(t) = (t^{i_0} - 1/t^{i_0}) \frac{\mu_{j_0}(t)}{t(t-1)^2} [-d(t)]^{1/2}$$

which appears in both $H_1^{i_0, j_0}$ and $H_2^{i_0, j_0}(x)$ is continuable into a function holomorphic in the neighborhood of 1. Indeed, we recall from Section D.2 that 1 is a double root of d .

We still note $l^{i_0, j_0}(t)$ this continuation and write $l^{i_0, j_0}(t) = \sum_{k \geq 0} l_k^{i_0, j_0} (t-1)^k$. The $l_k^{i_0, j_0}$ can of course be calculated, for instance,

$$l_0^{i_0, j_0} = 2i_0 \mu_{j_0}(1) p_{1,0} [(x_4 - 1)(1 - x_1)]^{1/2} = 2i_0 i_0 [p_{1,0}/p_{0,1}]^{1/2},$$

where the second equality above comes from noting that $\mu_{j_0}(1) = j_0/[2p_{0,1}]$ and $(x_4 - 1)(1 - x_1) = 4p_{0,1}/p_{1,0}$.

Let us now study $H_1^{i_0, j_0}$ and $H_2^{i_0, j_0}(x)$, and start with the latter.

First, we split the integral $H_2^{i_0, j_0}(x)$ as $\int_1^{1+\epsilon} l^{i_0, j_0}(t)/(t-x) dt + \int_{1+\epsilon}^{x_4} l^{i_0, j_0}(t)/(t-x) dt$, where $\epsilon \in [0, x_4 - 1]$. The fact that the second term in the last sum is as a function of x holomorphic in $(1+\epsilon)\mathcal{D}$ is clear.

In addition, it is easily shown that

$$\int_1^{1+\epsilon} \frac{(t-1)^k}{t-x} dt = P_k(x) + (x-1)^k \ln \left(\frac{1+\epsilon-x}{1-x} \right), \quad (\text{D.26})$$

where P_0 is the zero polynomial, and, for $k \geq 1$, P_k is a polynomial of degree $k-1$.

This leads to

$$\int_1^{1+\epsilon} \frac{l^{i_0, j_0}(t)}{t-x} dt = \sum_{k \geq 0} l_k^{i_0, j_0} P_k(x) + \ln \left(\frac{1+\epsilon-x}{1-x} \right) l^{i_0, j_0}(x). \quad (\text{D.27})$$

This is here that having split $H_2^{i_0, j_0}(x)$ in two terms turns out to be useful : if we had left x_4 as the upper bound of the integral, it would have been quite possible that the

function $\sum_{k \geq 0} l_k^{i_0, j_0} P_k$ does not exist. Indeed, the radius of convergence of l^{i_0, j_0} is equal to $\inf\{1 - x_1, x_4 - 1\}$ and for $k \geq 1$,

$$P_k(1) = \epsilon^k / k,$$

as we see by taking $x = 1$ in (D.26). However, for sufficiently small values of ϵ , the function $\sum_{k \geq 0} l_k^{i_0, j_0} P_k$ exists well and truly.

We have thus shown that $H_2^{i_0, j_0}(x)$ is holomorphic in $(1 + \epsilon)\mathcal{D} \setminus [1, 1 + \epsilon[$ and has at 1 the same singularity as the right member of (D.27).

To complete the proof of Proposition D.9, it remains to study the term $H_1^{i_0, j_0}$, and in particular, to show that

$$H_1^{i_0, j_0} + q^{i_0, j_0}(1) = i_0.$$

We recall that we have supposed $i_0 \leq j_0$, so that differentiating and taking $x = 1$ in the equality (D.25) yields

$$\partial_x q^{i_0, j_0}(1) = H_1^{i_0, j_0} + q^{i_0, j_0}(1) = \frac{1}{\pi} \int_1^{x_4} (t^{i_0} - 1/t^{i_0}) \frac{\mu_{j_0}(t)}{(t-1)^2} [-d(t)]^{1/2} dt.$$

In the rest of the proof, we adopt the notations of the forthcoming Subsection F.2.1.

Now we make the change of variable $t = t_2(u, 1)$, see (F.5), which we note rather $t_2(u)$; after some simplifications, we find

$$\partial_x q^{i_0, j_0}(1) = \frac{p_{1,0}}{\pi} \int_{-1}^1 \frac{t_2(u)^{i_0} - t_1(u)^{i_0}}{[(1 - k_1(u))(1 - k_2(u))]^{1/2}} U_{j_0-1}(-u) \left[\frac{1-u}{1+u} \right]^{1/2} du,$$

where $k_1(u) = -2p_{0,1}u + 2p_{1,0}$, $k_2(u) = -2p_{0,1}u - 2p_{1,0}$ and the U_p are the Chebyshev polynomials of the second kind, see [Sze75].

Using the explicit expressions of t_2 and $t_1 = 1/t_2$ written in (F.5), we notice that $[t_2(u)^{i_0} - t_1(u)^{i_0}]/[(1 - k_1(u))(1 - k_2(u))]^{1/2}$ is in fact a polynomial in u of degree $i_0 - 1$, that we denote by $P_{i_0-1}(u)$. Moreover, it turns out that $P_{i_0-1}(-1) = i_0/p_{1,0}$.

Define now $Q_{i_0-2}(u)$, the polynomial of degree $i_0 - 2$ defined by

$$P_{i_0-1}(u) = P_{i_0-1}(-1) + (u+1)Q_{i_0-2}(u).$$

With these notations,

$$\partial_x q^{i_0, j_0}(1) = \frac{i_0}{\pi} \int_{-1}^1 U_{j_0-1}(-u) \left[\frac{1-u}{1+u} \right]^{1/2} du + \frac{p_{1,0}}{\pi} \int_{-1}^1 Q_{i_0-2}(u) U_{j_0-1}(-u) [1-u^2]^{1/2} du.$$

The second term in the sum above equals zero. Indeed, being the $(j_0 - 1)$ th orthogonal polynomial for the weight $\mathbf{1}_{]-1,1[}(u)[1-u^2]^{1/2}$, we have $\int_{-1}^1 U_{j_0-1}(u)P(u)[1-u^2]^{1/2} du = 0$ for any polynomial P having a degree less or equal than $j_0 - 2$, that is actually the case for Q_{i_0-2} , since we have supposed that $i_0 \leq j_0$.

As for the first term in the sum above, using an induction and the recurrence relationship verified by the Chebyshev polynomials, namely

$$U_{j_0+1}(u) = 2uU_{j_0}(u) - U_{j_0-1}(u),$$

see [Sze75], we obtain that for any $j_0 > 0$, $\int_{-1}^1 U_{j_0-1}(-u)[(1-u)/(1+u)]^{1/2} du = \pi$. Proposition D.9 is proved. \square

Chapitre E

Martin boundary for killed random walks in the Weyl chamber of the dual of $\mathrm{Sp}(4)$ *

In Chapter E, we consider a family of random walks killed at the boundary of the Weyl chamber of the dual of $\mathrm{Sp}(4)$, which verifies the following additional property : for any $n \geq 3$, there is in this family a walk associated with a reflection group of order $2n$. Moreover, the case $n = 4$ corresponds to a well-known process that appears naturally by studying quantum random walks on the dual of $\mathrm{Sp}(4)$. For all the walks in this family, we find the exact asymptotic of the Green functions along all infinite paths of states. In particular, we deduce that the Martin compactification is the one-point compactification. We also calculate the exact asymptotic of the absorption probabilities as the absorption site goes to infinity.

E.1 Introduction

Random walks conditioned on staying in cones of \mathbb{Z}^d attract more and more attention in the mathematical community, as they appear in several distinct domains. An historically important example is constituted by the so-called non-colliding random walks, in other words by the processes (Z_1, \dots, Z_d) composed of d independent and identically distributed random walks conditioned on never leaving the Weyl chamber $\{z \in \mathbb{R}^d : z_1 < \dots < z_d\}$. These processes appeared in the eigenvalues description of important matrix-valued stochastic processes, see [Dys62], and are recently again very much studied, see *e.g.* [EK08] and the references therein. Another important area where random processes conditioned on never leaving cones of \mathbb{Z}^d appear is the domain of the quantum random walks, non-commutative generalizations of the classical random walks, see *e.g.* [Bia91] and [Bia92c].

A usual way to condition a process Z on staying in a cone consists in using a Doob h -transform. Indeed, if h is harmonic for Z , positive inside of the cone and equal to zero on its boundary, then the Doob h -transform of Z will obviously never hit the boundary of the cone. Moreover, such a function h is very naturally positive harmonic for the process Z killed at the boundary of the cone.

It is therefore natural to be interested in finding positive harmonic functions associated

*. The bulk of this work is taken from the preprint [Ras09].

with processes killed at the boundary of cones, and more generally to be interested in the Martin compactification of such processes, that can be obtained *e.g.* from the exact asymptotic of the Green functions.

In this context, the case of random walks in \mathbb{Z}^d with *non-zero drift* has held a great and fruitful deal of attention from the mathematical community, particularly for $d = 2$.

This is how that in [Bia92c], by studying quantum random walks in the Weyl chamber of the dual of Lie groups, P. Biane is naturally led to consider the case of $SU(3)$ and $Sp(4)$, and in this way the classical random walks with non-zero drift, having transition probabilities inside of the Weyl chamber as represented on Picture E.1 below and killed at the boundary of the Weyl chamber – it is actually possible to obtain classical random walks from quantum random walks by restricting the latter ones, initially defined on non-commutative von Neumann algebras, to commutative subalgebras, see [Bia92c]. Thanks to Choquet-Deny theory, P. Biane finds then all minimal non-negative harmonic functions associated with these walks. Nevertheless, this approach does not allow him to find the Martin compactification of these processes.

In the more general case of the eight nearest neighbors random walks with non-zero drift and killed at the boundary of a quarter plane, we give in Chapter C the exact asymptotic of the Green functions along all infinite paths of states, as well as the asymptotic of the absorption probabilities as the absorption site goes to infinity. These results allow us to obtain the Martin compactification of these processes.

In [IR08], I. Ignatiouk-Robert obtains, for all $d \geq 1$, the Martin compactification of the random walks killed at the boundary of the half-space $\mathbb{Z}^d \times \mathbb{Z}_+$, with non-zero drift and with an exponential decay of the transition probabilities. I. Ignatiouk-Robert proposes there a new approach for the analysis of the Martin compactification, based on large deviations. Then, I. Ignatiouk-Robert and C. Loree develop successfully these methods in [IRL09], and they obtain the Martin compactification of the random walks in \mathbb{Z}_+^2 killed at the boundary, having a non-zero drift and with an exponential decay of the transition probabilities. Under similar hypotheses and for all $d \geq 3$, I. Ignatiouk-Robert finds recently, in the work [IR09a], the Martin compactification of the killed random walks in \mathbb{Z}_+^d .

However, these methods seem not powerful for a more detailed study, as *e.g.* for the computation of the exact asymptotic of the Green functions or for the calculation of the absorption probabilities at different sites of the boundary. In addition, having a non-zero drift is an essential hypothesis for their application. Last but not least, the results of [IR09a] are conditioned by the fact of been able (page 5 of [IR09a]) “to identify the positive harmonic functions of a random walk on \mathbb{Z}^d which has zero mean and is killed at the first exit from \mathbb{Z}_+^d . Unfortunately, for $d \geq 2$, there are no general results in this domain.”

As may the existence of this open problem suggest, the results dealing with the Martin compactification or the asymptotic of Green functions for random walks in \mathbb{Z}^d killed at the boundary and with *drift zero* are actually scarce, even for $d = 2$.

The simplest case in dimension $d = 2$ is the one of the cartesian product of two one-dimensional simple random walks with zero mean. The fact that the Martin boundary of these random walks is reduced to one point and the explicit expression of the underlying unique harmonic function can be obtained from [PW92]. In addition, we find in this thesis the exact asymptotic of the Green functions for these processes, see Theorem 21 of Part I.

From a Lie group theory point of view, the previous case corresponds to the group product $SU(2) \times SU(2)$, which is associated with a *reducible* rank-2 root system, see [Bou75]. This is next natural to be interested in the classical random walks that can be obtained

from the construction made by P. Biane in [Bia92c] starting from Lie groups associated with an *irreducible* rank-2 root system. It turns out that there are only two such Lie groups, namely $SU(3)$ and $Sp(4)$: indeed, there are three Lie groups with an underlying irreducible rank-2 root system, $SU(3)$, $Sp(4)$ and the exceptional Lie group G_2 , but G_2 has no minuscule weight, see [Bou75], and for this reason the construction of P. Biane does not apply, see [Bia92c].

In the case of $SU(3)$, the construction proceeded in [Bia92c] leads to consider the walk with transition probabilities equal to $1/3$ as represented on the left of Picture E.1 below. In [Bia91], P. Biane makes explicit a suitable harmonic function h , such that the associated Doob h -transform of the previous process will never hit the boundary of the Weyl chamber – he expresses h as the dimension of some representation of $SU(3)$. In addition, he computes the exact asymptotic of the Green functions of the killed process along all infinite paths of states, *except* the ones which are tangent to the boundary of the Weyl chamber. However, the asymptotic of the Green functions along the paths of states tangent to the boundary couldn't be obtained by using these methods. The object of Chapter D was notably to find this lacking result.

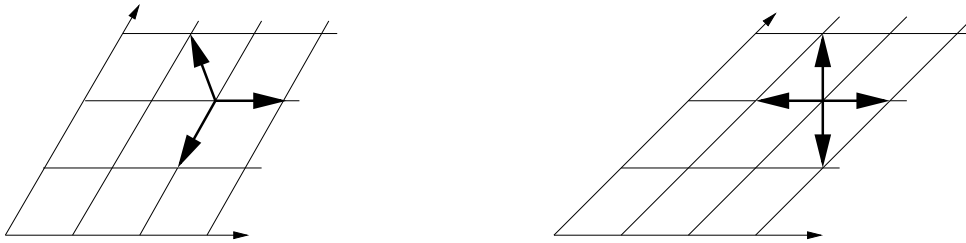

FIGURE E.1 – Random walks in the Weyl chamber of the dual of $SU(3)$ and $Sp(4)$

It is therefore natural to consider now the case of $Sp(4)$, in order to complete the case of the Lie groups associated with an irreducible rank-2 root system. Applying to $Sp(4)$ the way described in [Bia92c] in order to get classical processes starting from quantum random walks on lattices, we obtain naturally the random walk with transition probabilities equal to $1/4$ as drawn on the right of Picture E.1 above and killed at the boundary of the octant. Straightforwardly, by making some adequate linear transformation, this process becomes the random walk $(X(k), Y(k))_{k \geq 0}$ *spatially homogeneous inside of the quarter plane \mathbb{Z}_+^2 and such that, if the $p_{i,j} = \mathbb{P}[(X(k+1), Y(k+1)) = (i_0 + i, j_0 + j) \mid (X(k), Y(k)) = (i_0, j_0)]$ denote the transition probabilities, then*

(H1) $p_{1,0} + p_{1,-1} + p_{-1,0} + p_{-1,1} = 1, p_{1,0} = p_{-1,0}, p_{1,-1} = p_{-1,1},$

(H2) $\{(i, 0) : i \geq 1\} \cup \{(0, j) : j \geq 1\}$ is absorbing,

(H3) $p_{1,0} = p_{-1,0} = 1/4$ and $p_{1,-1} = p_{-1,1} = 1/4.$

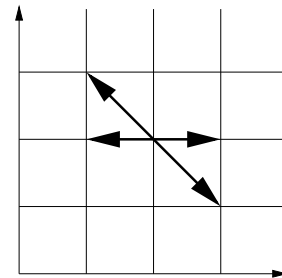

As he does in [Bia91] for the walk in the Weyl chamber of the dual of $SU(3)$, P. Biane makes explicit, for this process, a suitable harmonic function h such that the underlying Doob h -transform will never hit the boundary, see [Bia92c]. Note also that this random walk is partially the subject of [DO05], where the authors are interested in making explicit the exit time queues associated with some processes.

Having said that, neither the Martin compactification, nor the asymptotic of the Green functions, nor the asymptotic of the absorption probabilities have been yet calculated for this process – up to our knowledge.

In order to obtain explicit formulas for the Green functions as well as for the absorption probabilities associated with the process satisfying to (H1), (H2) and (H3), we wish to use complex analysis methods partially inspired by [FIM99]. As presented in Section 1 of Part I, G. Fayolle, R. Iasnogorodski and V. Malyshev elaborate there a profound and ingenious analytic approach in order to obtain explicit expressions for the generating function of the stationary probabilities for some ergodic random walks in a quarter plane.

In Chapter C of this thesis, we have developed these methods to the case of the generating functions of the Green functions and of the absorption probabilities for some walks in a quarter plane killed at the boundary and having a positive drift.

In Chapter D, we have begun to extend this approach to the case of the killed random walks having a drift zero inside of the quadrant.

We are going here to pursue its development ; by the way, Subsections E.2.1 and E.5.2 of this Chapter E are strongly inspired by [FIM99].

In [FIM99], the authors also highlight the importance and the influence of the *group of the random walk*, notion that we have already encountered in the previous chapters.

Let us consider this group in details in the case of the walks verifying the hypothesis (H1) above. For this, we introduce the polynomial K (which is actually a simple transformation of the transition probabilities generating function) defined by :

$$K(x, y) = xy[p_{1,0}x + p_{-1,0}/x + p_{1,-1}x/y + p_{-1,1}y/x - 1]. \quad (\text{E.1})$$

If $K(x, y) = 0$, then with (E.1) it is immediate that $K(\hat{\xi}(x, y)) = 0$ and $K(\hat{\eta}(x, y)) = 0$, where

$$\hat{\xi}(x, y) = \left(x, \frac{x^2}{y}\right), \quad \hat{\eta}(x, y) = \left(\frac{p_{-1,1}y + p_{-1,0}}{p_{1,0}y + p_{1,-1}}, \frac{y}{x}\right).$$

The group of the random walk is then $W = \langle \hat{\xi}, \hat{\eta} \rangle$, the group of automorphisms of the algebraic curve $\{(x, y) \in (\mathbb{C} \cup \{\infty\})^2 : K(x, y) = 0\}$ generated by $\hat{\xi}$ and $\hat{\eta}$.

It is already known, see *e.g.* [BMM09] or Chapter B, that under (H1) and (H3), W is of order eight.

More generally, we will prove here (see Remark E.3) that in fact the group W is finite if and only if there exists some rational number r such that $p_{1,0} = p_{-1,0} = \sin(r\pi)^2/2$ and $p_{1,-1} = p_{-1,1} = \cos(r\pi)^2/2$.

In Chapter E, we wish to study the processes verifying (H1), (H2) and (H3'), where

$$(\text{H3}') \quad p_{1,0} = p_{-1,0} = \sin(\pi/n)^2/2 \text{ and } p_{1,-1} = p_{-1,1} = \cos(\pi/n)^2/2.$$

We will show that under these hypotheses, W is of order $2n$, see Subsection E.2.2 and particularly (E.11).

Note that for $n = 4$, the assumptions (H3) and (H3') are the same.

Remark also that for $n = 3$, the process satisfying to (H1), (H2) and (H3') is the same as the one of Chapter D represented on the left of Picture D.2 for $\alpha = 2$.

The family constituted by the union, for $n \geq 3$, of the walks verifying (H1) and (H3') is therefore in some sense representative of all the random walks having a finite group W . Indeed, among the set of all the walks with an underlying group W of finite order, there is

in this family a representative for the subclass of the walks having a group W of order $2n$, for any $n \geq 3$ – let us recall that the case of the processes such that the group W has order 4 corresponds essentially to the product case and has already been considered in this thesis, see Subsection D.4 of Chapter D. This representativeness property seemed to us quite important, and for this reason, we have thought that it was interesting not only to deal with the particular case $n = 4$, *i.e.* with the walk in the Weyl chamber of the dual of $\mathrm{Sp}(4)$, but rather with the case of all these walks, for $n \geq 3$.

Chapter E is then hinged on two results.

* The first of these two results is related to the asymptotic of the Green functions

$$G_{i,j}^{i_0,j_0} = \mathbb{E}_{(i_0,j_0)} \left[\sum_{k \geq 0} \mathbf{1}_{\{(X(k), Y(k)) = (i,j)\}} \right], \quad (\text{E.2})$$

$\mathbb{E}_{(i_0,j_0)}$ denoting the conditional expectation given $(X(0), Y(0)) = (i_0, j_0)$.

We prove in Theorem E.10 of Section E.4 that as $i + j \rightarrow \infty$ and $j/i \rightarrow \tan(\gamma)$, $\gamma \in [0, \pi/2]$,

$$G_{i,j}^{i_0,j_0} \sim A_n f_n(i_0, j_0) \frac{\sin(n \arctan(\frac{j/i}{1+j/i} \tan(\pi/n)))}{[\cos(\pi/n)^2 (i^2 + 2ij) + j^2]^{n/2}},$$

where A_n is some positive constant depending only on the transition probabilities and f_n a harmonic function for (X, Y) , defined and studied with details in Section E.3.

In particular, from this result we obtain that the Martin compactification of the process satisfying to (H1), (H2) and (H3') is, for any $n \geq 3$, the one-point compactification, see Corollary E.12.

Therefore, Chapter E gives a partial answer in the case $d = 2$ to the open problem highlighted by I. Ignatiouk-Robert in [IR09a], since Corollary E.12 implies that there is, up to the positive multiplicative constants, only one positive harmonic function for each process in the infinite family of two-dimensional killed random walks that we consider in Chapter E – family which is, as already said, representative of the set of all the two-dimensional killed random walks having a finite group.

* The second of the two results is the subject of Section E.5 and deals with the probabilities of absorption

$$\begin{aligned} q_i^{i_0,j_0} &= \mathbb{P}_{(i_0,j_0)} [(X, Y) \text{ is absorbed at } (i, 0)], \\ \tilde{q}_j^{i_0,j_0} &= \mathbb{P}_{(i_0,j_0)} [(X, Y) \text{ is absorbed at } (0, j)], \end{aligned} \quad (\text{E.3})$$

$\mathbb{P}_{(i_0,j_0)}$ denoting the conditional probability given $(X(0), Y(0)) = (i_0, j_0)$.

Firstly, in Subsection E.5.1, we show that a consequence of the asymptotic of the Green functions is that as the site i goes to infinity,

$$q_i^{i_0,j_0} \sim B_n f_n(i_0, j_0) \frac{1}{i^{n+1}},$$

where B_n is some positive constant depending only on the transition probabilities and f_n the same harmonic function as before. A similar result holds, of course, for the asymptotic of the $\tilde{q}_j^{i_0,j_0}$ as the site j goes to infinity.

Secondly, in Subsection E.5.2, we are interested in the exact distribution of the site of absorption, and we find integral representations for the generating functions

$$q^{i_0, j_0}(x) = \sum_{i \geq 1} q_i^{i_0, j_0} x^i, \quad \tilde{q}^{i_0, j_0}(y) = \sum_{j \geq 1} \tilde{q}_j^{i_0, j_0} y^j, \quad (\text{E.4})$$

using for this some arguments based on [FIM99] and on Chapter C.

Thirdly, in Subsection E.5.3, by studying closely the function q^{i_0, j_0} – notably some conformal gluing functions that appear in the integrand of the integral representations of (E.4) obtained in Subsection E.5.2 –, we give an other proof of the asymptotic of the absorption probabilities (E.3).

Subsection E.5.2 is also the opportunity to analyze fine properties of these conformal gluing functions in the case of a drift zero – their study in the case of a non-zero drift being done in Chapters A, B and C of this thesis.

It is worth noting that from a technical point of view, the only moments where we make use of the finiteness and of the order of the group W are the following : firstly, when we simplify the quantity $q^{i_0, j_0}(x) + \tilde{q}^{i_0, j_0}(y) - x^{i_0} y^{j_0}$, see Subsection E.2.2 and particularly Proposition E.1 ; secondly, when we find the explicit form of the conformal gluing functions, see Subsection E.5.2.

E.2 Analytic approach

E.2.1 A functional equation

Subsection E.2.1 consists in preparatory results and is inspired by the book [FIM99].

Denote by $Q^{i_0, j_0}(x, y) = \sum_{i, j=1}^{\infty} G_{i, j}^{i_0, j_0} x^{i-1} y^{j-1}$ the generating function of the Green functions (E.2). With this notation and with (E.4), we can state the following functional equation :

$$K(x, y) Q^{i_0, j_0}(x, y) = q^{i_0, j_0}(x) + \tilde{q}^{i_0, j_0}(y) - x^{i_0} y^{j_0}, \quad (\text{E.5})$$

K being defined in (E.1). *A priori*, Equation (E.5) has a meaning in $\{(x, y) \in \mathbb{C}^2 : |x| < 1, |y| < 1\}$. The proof of (E.5) is obtained exactly as in Subsection C.2.1 of Chapter C.

When no ambiguity on the initial state can arise, we will drop the index i_0, j_0 and we will write $G_{i, j}, Q(x, y), q_i, q(x), \tilde{q}_j, \tilde{q}(y)$ for $G_{i, j}^{i_0, j_0}, Q^{i_0, j_0}(x, y), q_i^{i_0, j_0}, q^{i_0, j_0}(x), \tilde{q}_j^{i_0, j_0}, \tilde{q}^{i_0, j_0}(y)$.

Let us now have a look to the algebraic curve $\{(x, y) \in (\mathbb{C} \cup \{\infty\})^2 : K(x, y) = 0\}$, that we note \mathcal{K} for the sake of briefness. Start by writing the polynomial (E.1) alternatively

$$K(x, y) = a(x)y^2 + b(x)y + c(x) = \tilde{a}(y)x^2 + \tilde{b}(y)x + \tilde{c}(y), \quad (\text{E.6})$$

where $a(x) = p_{1, -1}, b(x) = p_{1, 0}x^2 - x + p_{1, 0}, c(x) = p_{1, -1}x^2$ and $\tilde{a}(y) = p_{1, 0}y + p_{1, -1}, \tilde{b}(y) = -y, \tilde{c}(y) = p_{1, -1}y^2 + p_{1, 0}y$. Set also $d(x) = b(x)^2 - 4a(x)c(x)$ and $\tilde{d}(y) = \tilde{b}(y)^2 - 4\tilde{a}(y)\tilde{c}(y)$. We have

$$d(x) = p_{1, 0}^2(x-1)^2(x^2 + 2x(1 - 1/p_{1, 0}) + 1), \quad \tilde{d}(y) = -4p_{1, 0}p_{1, -1}y(y-1)^2. \quad (\text{E.7})$$

The polynomial d has a double root at 1 and two simple roots at positive points, that we note $x_1 < 1 < x_4$. As for \tilde{d} , it has a double root at 1 and a simple root at 0. We also note $y_1 = 0$ and $y_4 = \infty$.

Then with (E.6), we remark that $K(x, y) = 0$ is equivalent to $[b(x) + 2a(x)y]^2 = d(x)$ or to $[\tilde{b}(y) + 2\tilde{a}(y)x]^2 = \tilde{d}(y)$. In particular, it follows from the particular form of d or of \tilde{d} , see (E.7), that the surface \mathcal{K} has genus zero and is thus (see [JS87]) homeomorphic to a sphere. As a consequence, this Riemann surface can be rationally uniformized, in the sense that it is possible to find two rational functions, say π and $\tilde{\pi}$, such that $\mathcal{K} = \{(\pi(s), \tilde{\pi}(s)) : s \in \mathbb{C} \cup \{\infty\}\}$. Furthermore, as remarked in Chapter 6 of [FIM99], we can take $\pi(s) = [x_4 + x_1]/2 + [(x_4 - x_1)/4](s + 1/s)$, x_1 and x_4 being defined below (E.7); it is then possible to deduce a correct expression for $\tilde{\pi}$, since by construction the equality $K(\pi, \tilde{\pi}) = 0$ has to hold.

For more details about the construction of Riemann surfaces, see for instance [JS87].

E.2.2 Uniformization and meromorphic continuation

But rather than the uniformization $(\pi, \tilde{\pi})$ proposed in [FIM99] and recalled at the end of the previous subsection, we prefer using an other, that will turn out to be quite more convenient. This new uniformization, that we call (x, y) , is just equal to $(\pi \circ L, \tilde{\pi} \circ L)$, where

$$L(z) = \frac{z_0 z - 1}{z - z_0}, \quad z_0 = -\exp(-i\pi/n).$$

We note that z_0 is such that $\pi(z_0) = \pi(\bar{z}_0) = \tilde{\pi}(z_0) = \tilde{\pi}(\bar{z}_0) = 1$ and that its explicit expression above is due to (H3'), for more details see Remark E.3. Then, starting from the formulations of $(\pi, \tilde{\pi})$ and of L , we easily show that the expression of the new uniformization can be

$$x(z) = \frac{(z + z_0)(z + \bar{z}_0)}{(z - z_0)(z - \bar{z}_0)}, \quad y(z) = \frac{(z + z_0)^2}{(z - z_0)^2}. \tag{E.8}$$

Compared to $(\pi, \tilde{\pi})$, this uniformization (x, y) has the significant advantage of transforming the important cycles (*i.e.* the branch cuts $[x_1, x_4]$ and $[y_1, y_4]$, the unit circles $\{|x| = 1\}$ and $\{|y| = 1\}$) into very simple cycles, since the following equalities hold, see also Picture E.2 :

$$\begin{aligned} x^{-1}([x_1, x_4]) &= \mathbb{R} \cup \{\infty\}, & x^{-1}(\{|x| = 1\}) &= i\mathbb{R} \cup \{\infty\}, \\ y^{-1}([y_1, y_4]) &= z_0\mathbb{R} \cup \{\infty\}, & y^{-1}(\{|y| = 1\}) &= z_0 i\mathbb{R} \cup \{\infty\}. \end{aligned} \tag{E.9}$$

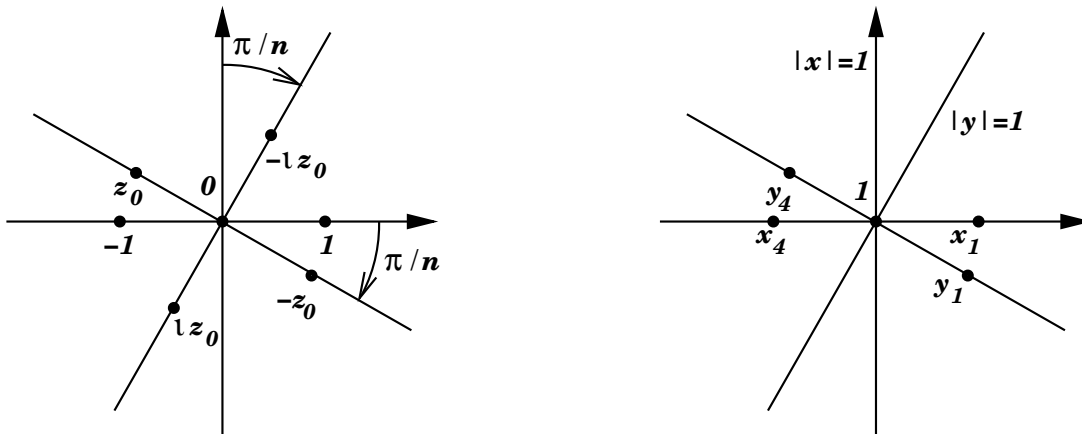

FIGURE E.2 – The uniformization space $\mathbb{C} \cup \{\infty\}$, with on the left some important elements of it, and on the right the corresponding elements through the functions x and y

To obtain (E.9), it is sufficient to use the explicit expressions of the branch points x_1, x_4, y_1, y_4 , see below (E.7), as well as the explicit formulation of the uniformization, see (E.8).

Let us go back to $\hat{\xi}$ and $\hat{\eta}$, the automorphisms of the algebraic curve \mathcal{K} introduced in Section E.1. Thanks to the uniformization (E.8), they define two automorphisms ξ and η on $\mathbb{C} \cup \{\infty\}$, which are characterized by

$$\xi^2 = 1, \quad x \circ \xi = x, \quad y \circ \xi = \frac{x^2}{y}, \quad \eta^2 = 1, \quad y \circ \eta = y, \quad x \circ \eta = \frac{p_{1,-1}y^2 + p_{1,0}y}{p_{1,0}y + p_{1,-1}} \frac{1}{x}. \quad (\text{E.10})$$

Using the well-known characterization of the automorphisms of the Riemann sphere $\mathbb{C} \cup \{\infty\}$, (E.8) and (E.10), we obtain that ξ and η have the following expressions :

$$\xi(z) = 1/z, \quad \eta(z) = \exp(-2i\pi/n)/z. \quad (\text{E.11})$$

The expression of η in terms of n , above, is due to the assumption (H3'), see Remark E.3 for more details. Note also that leading to these particularly nice analytic expressions of ξ and η is an other very pleasant property of the uniformization (x, y) .

As in Section E.1, we call the group generated by ξ and η

$$W_n = \langle \xi, \eta \rangle$$

the *group of the random walk*. In the situation of Chapter E, W_n is isomorphic to the dihedral group of order $2n$, *i.e.* to the group of symmetries of a regular polygon with n sides, ξ and η playing the role of the two reflections.

We are now going to state and prove Proposition E.1, which is actually the main result of Subsection E.2.2, and that deals with the continuation of the generating functions q and \tilde{q} defined in (E.4). But for this, we need to describe the action of the elements of W_n on some cones of the plane, and to find some fundamental domains of the plane for the action of W_n – we say that D is a fundamental domain of the plane for the action of W_n if $\cup_{w \in W_n} w(D) = \mathbb{C}$ and if in addition the union is disjoint.

Let us take the following notation : for $\theta_1 \leq \theta_2$,

$$\Lambda(\theta_1, \theta_2) = \{t \exp(i\theta) : 0 \leq t \leq \infty, \theta_1 \leq \theta \leq \theta_2\}$$

is the cone with vertex at 0 and opening angles θ_1, θ_2 . In particular, $\Lambda(\theta, \theta) = \exp(i\theta)\mathbb{R}_+ \cup \{\infty\}$. Thanks to (E.11), we obtain that the action of ξ and η on these cones is simply given by $\xi(\Lambda(\theta_1, \theta_2)) = \Lambda(-\theta_2, -\theta_1)$ and $\eta(\Lambda(\theta_1, \theta_2)) = \Lambda(-\theta_2 - 2\pi/n, -\theta_1 - 2\pi/n)$. These facts are illustrated on the left of Picture E.3.

Define now, for $k \in \{0, \dots, n\}$,

$$D_k^+ = \Lambda\left(\frac{k-1}{n}\pi, \frac{k}{n}\pi\right), \quad D_k^- = \Lambda\left(-\frac{k+1}{n}\pi, -\frac{k}{n}\pi\right).$$

Sometimes, we will write D_0 instead of $D_0^+ = D_0^-$ and D_n instead of $D_n^+ = D_n^-$. Clearly,

$$D_0 \cup D_n \cup \bigcup_{k=1}^{n-1} D_k^+ \cup \bigcup_{k=1}^{n-1} D_k^- = \mathbb{C} \cup \{\infty\}. \quad (\text{E.12})$$

The definitions of D_k^+ and D_k^- , as well as (E.12), are illustrated on the right of Picture E.3.

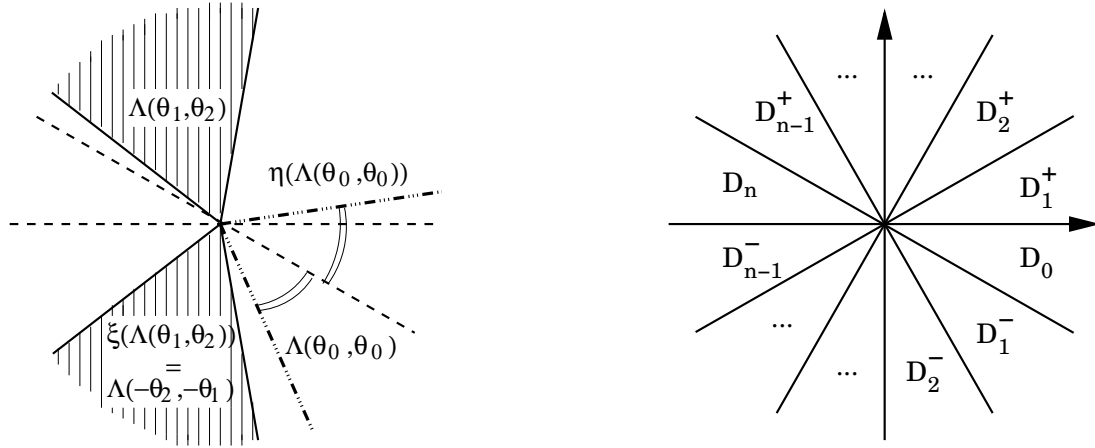

FIGURE E.3 – Important cones of the uniformization space

It is immediate that for any $k \in \{1, \dots, n\}$, we have $D_k^+ = \xi(D_{k-1}^-)$ and $D_k^- = \eta(D_{k-1}^+)$. In particular, for any $2k \in \{1, \dots, n\}$,

$$D_{2k}^+ = ((\xi \circ \eta)^k)(D_0), \quad D_{2k}^- = ((\eta \circ \xi)^k)(D_0).$$

Likewise, for any $2k+1 \in \{1, \dots, n\}$,

$$D_{2k+1}^+ = (\xi \circ (\eta \circ \xi)^k)(D_0), \quad D_{2k+1}^- = (\eta \circ (\xi \circ \eta)^k)(D_0).$$

With (E.12), these equalities prove that $\cup_{w \in W_n} w(D_0) = \mathbb{C} \cup \{\infty\}$, in such a way that D_0 is a fundamental domain for the action of W_n on \mathbb{C} – this is not quite exact, since each half-line $\Lambda(k\pi/n, k\pi/n)$, $k \in \{0, \dots, 2n-1\}$ appears twice in the union $\cup_{w \in W_n} w(D_0)$.

We are now able to state and prove Proposition E.1, after the weak recall on the lifting of functions that follows : any function h of the variable x (resp. y) defined on some domain $D \subset \mathbb{C}$ can be lifted on $\{z \in \mathbb{C} \cup \{\infty\} : x(z) \in D\}$ (resp. $\{z \in \mathbb{C} \cup \{\infty\} : y(z) \in D\}$) by setting $H(z) = h(x(z))$ (resp. $H(z) = h(y(z))$).

In particular, we can lift the generating functions q and \tilde{q} defined in (E.4), and we set $Q(z) = q(x(z))$ and $\tilde{Q}(z) = \tilde{q}(y(z))$, they are well defined on $\{z \in \mathbb{C} \cup \{\infty\} : |x(z)| \leq 1\}$ and $\{z \in \mathbb{C} \cup \{\infty\} : |y(z)| \leq 1\}$ respectively. As a consequence, on $\{z \in \mathbb{C} \cup \{\infty\} : |x(z)| \leq 1, |y(z)| \leq 1\}$ (which is equal to $\Lambda(-\pi/2, \pi/2 - \pi/n)$, see Picture E.2), the functional equation (E.5) yields $Q(z) + \tilde{Q}(z) - x^{i_0} y^{j_0}(z) = 0$ – in the sequel, we will often write $x^{i_0} y^{j_0}(z)$ instead of $x(z)^{i_0} y(z)^{j_0}$.

Proposition E.1. *The functions $Q(z) = q(x(z))$ and $\tilde{Q}(z) = \tilde{q}(y(z))$ can be meromorphically continued from respectively $\Lambda(-\pi/2, \pi/2)$ and $\Lambda(-\pi/2 - \pi/n, \pi/2 - \pi/n)$ up to respectively $\mathbb{C} \setminus \Lambda(\pi, \pi)$ and $\mathbb{C} \setminus \Lambda(\pi - \pi/n, \pi - \pi/n)$. Moreover, these continuations verify*

$$Q(z) = Q(\xi(z)), \quad \tilde{Q}(z) = \tilde{Q}(\eta(z)), \quad \forall z \in \mathbb{C}, \quad (\text{E.13})$$

and

$$Q(z) + \tilde{Q}(z) - x^{i_0} y^{j_0}(z) = \begin{cases} 0 & \text{if } z \notin \Lambda(\pi - \pi/n, \pi) \\ - \sum_{w \in W_n} (-1)^{l(w)} x^{i_0} y^{j_0}(w(z)) & \text{if } z \in \Lambda(\pi - \pi/n, \pi) \end{cases} \quad (\text{E.14})$$

where $l(w)$ is the length of w , that is the smallest r for which we can write $w = w_1 \cdots w_r$, with w_1, \dots, w_r equal to ξ or η .

Remark E.2. As a consequence of Proposition E.1, the generating functions q and \tilde{q} can be continued as meromorphic functions from the unit disc up to $\mathbb{C} \setminus [1, x_4]$ and $\mathbb{C} \setminus [1, y_4]$ respectively. Indeed, the formulas $q(x) = Q(z)$ if $x(z) = x$ and $\tilde{q}(y) = \tilde{Q}(z)$ if $y(z) = y$ define q and \tilde{q} not ambiguously, thanks to (E.13). Moreover, since $x(\Lambda(\pi, \pi)) = [1, x_4]$ and $y(\Lambda(\pi - \pi/n, \pi - \pi/n)) = [1, y_4]$, see (E.9) and Picture E.2, the previous formulas yield meromorphic continuations on $\mathbb{C} \setminus [1, x_4]$ and $\mathbb{C} \setminus [1, y_4]$ respectively.

Proof of Proposition E.1. In order to prove Proposition E.1, we are going to use strongly the decomposition (E.12), and precisely, we are going to define Q and \tilde{Q} piecewise, by defining them on each of the $2n$ domains D that appear in the decomposition (E.12) to be equal to some functions Q_D and \tilde{Q}_D , it will then suffice to show that the functions Q and \tilde{Q} so-defined verify the conclusions of Proposition E.1.

* In $D_0 \subset \{z \in \mathbb{C} \cup \{\infty\} : |x(z)| \leq 1, |y(z)| \leq 1\}$, we are going to use the most natural way to define Q_{D_0} and \tilde{Q}_{D_0} , i.e. their power series, and for $z \in D_0$ we set $Q_{D_0}(z) = q(x(z))$ and $\tilde{Q}_{D_0}(z) = \tilde{q}(y(z))$.

* Then, for $k \in \{1, \dots, n-1\}$, we define $Q_{D_k^+}, \tilde{Q}_{D_k^+}$ on D_k^+ and $Q_{D_k^-}, \tilde{Q}_{D_k^-}$ on D_k^- by

$$\begin{aligned} \forall z \in D_k^+ = \xi(D_{k-1}^-) & : Q_{D_k^+}(z) = Q_{D_{k-1}^-}(\xi(z)), \quad \tilde{Q}_{D_k^+}(z) = -Q_{D_k^+}(z) + x^{i_0}y^{j_0}(z), \\ \forall z \in D_k^- = \eta(D_{k-1}^+) & : \tilde{Q}_{D_k^-}(z) = \tilde{Q}_{D_{k-1}^+}(\eta(z)), \quad Q_{D_k^-}(z) = -\tilde{Q}_{D_k^-}(z) + x^{i_0}y^{j_0}(z). \end{aligned}$$

* At last, for $z \in D_n$, we set $Q_{D_n}(z) = Q_{D_{n-1}^-}(\xi(z))$ and $\tilde{Q}_{D_n}(z) = \tilde{Q}_{D_{n-1}^+}(\eta(z))$.

Therefore we have, for each of the $2n$ domains D of the decomposition (E.12), defined two functions Q_D and \tilde{Q}_D . Then, as said at the beginning of the proof, we set $Q(z) = Q_D(z)$ and $\tilde{Q}(z) = \tilde{Q}_D(z)$, for all $z \in D$ and for all domains D that appear in (E.12).

With this construction, (E.13) and (E.14) are immediately obtained. In order to prove (E.15), we can use the fact that it is possible to express *all* the functions Q_D, \tilde{Q}_D in terms of Q_{D_0}, \tilde{Q}_{D_0} and $x^{i_0}y^{j_0}$ only; we give, e.g., the expression of $Q_{D_{2k}^+}$, for any $2k \in \{1, \dots, n\}$:

$$Q_{D_{2k}^+}(z) = -\tilde{Q}_{D_0}((\eta \circ \xi)^k(z)) + \sum_{p=0}^{k-1} x^{i_0}y^{j_0}(\xi \circ (\eta \circ \xi)^p(z)) - \sum_{p=1}^{k-1} x^{i_0}y^{j_0}((\eta \circ \xi)^p(z)), \quad (\text{E.16})$$

as well as the one of $\tilde{Q}_{D_{2k}^-}$, for any $2k \in \{1, \dots, n\}$:

$$\tilde{Q}_{D_{2k}^-}(z) = -Q_{D_0}((\xi \circ \eta)^k(z)) + \sum_{p=0}^{k-1} x^{i_0}y^{j_0}(\eta \circ (\xi \circ \eta)^p(z)) - \sum_{p=1}^{k-1} x^{i_0}y^{j_0}((\xi \circ \eta)^p(z)). \quad (\text{E.17})$$

As a consequence, we obtain (E.15) for even values of n . Indeed, for this it is actually sufficient first to add $Q_{D_n}(z)$ and $\tilde{Q}_{D_n}(z)$, in other words the equalities (E.16) and (E.17) above for $k = n/2$, then to remark that if n is even, $(\xi \circ \eta)^{n/2} = (\eta \circ \xi)^{n/2}$, next to use that for $z \in D_n$, $Q_{D_0}((\xi \circ \eta)^{n/2}(z)) + \tilde{Q}_{D_0}((\xi \circ \eta)^{n/2}(z)) = x^{i_0}y^{j_0}((\xi \circ \eta)^{n/2}(z))$, see (E.14), and finally to remark that W_n equals

$$\{1, \eta\xi, \dots, (\eta\xi)^{n/2-1}, \xi\eta, \dots, (\xi\eta)^{n/2-1}, \xi, \dots, \xi(\eta\xi)^{n/2-1}, \eta, \dots, \eta(\xi\eta)^{n/2-1}, (\xi\eta)^{n/2}\}.$$

Likewise, we could write the expressions in terms of Q_{D_0}, \tilde{Q}_{D_0} and $x^{i_0}y^{j_0}$ of

$$Q_{D_{2k}^-}, \tilde{Q}_{D_{2k}^+}, Q_{D_{2k+1}^+}, \tilde{Q}_{D_{2k+1}^+}, Q_{D_{2k+1}^-}, \tilde{Q}_{D_{2k+1}^-},$$

and we would verify that (E.15) is still true for odd n . Proposition E.1 is proved. \square

Remark E.3. We can now explain why the assumption (H3') concerning the values of the transition probabilities is both natural and necessary for our study.

If we suppose (H1) but no more (H3'), then the uniformization (E.8) is the same, with $z_0 = -[2p_{1,-1}]^{1/2} + i[2p_{1,0}]^{1/2}$. The transformations (E.9) of the important cycles through the uniformization are also still valid, and the automorphism ξ is yet again equal to $\xi(z) = 1/z$. As for η , it takes the value $\eta(z) = z_0^2/z$; in particular, the group of the random walk $W = \langle \xi, \eta \rangle$ is finite if and only if there exists an integer p such that $z_0^{2p} = 1$. In this case, if n denotes the smallest of these positive integers p , then the group W is of order $2n$.

If a such n does not exist, then there is no hope to find a fundamental domain for the action of the group W , neither to obtain any equality like (E.15).

If a such n exists, then by using the fact that $z_0^{2n} = 1$, in other words the fact that $(-[2p_{1,-1}]^{1/2} + i[2p_{1,0}]^{1/2})^{2n} = 1$, we immediately obtain that $p_{1,0} = \sin(q\pi/n)^2/2$, for some integer q having a greatest common divisor with n equal to 1.

In this last case, we have $z_0 = -\exp(-iq\pi/n)$, and it is easily proved that the domain bounded by the cycles $x^{-1}([1, x_4])$ and $y^{-1}([1, y_4])$, namely $\Lambda(\arg(z_0), \pi) = \Lambda(\pi - q\pi/n, \pi)$, is a fundamental domain for the action of W if and only if $q = 1$. In particular, having an equality like (E.15) is possible if and only if $q = 1$, see the proof of Proposition E.1.

But it turns out that having an equality like (E.15) is essential in what follows, particularly in Section E.4, where we have to know very precisely the behavior of $Q(z) + \bar{Q}(z) - x^{i_0}y^{j_0}(z)$ near 0 and ∞ .

For all these reasons, we assume here that $p_{1,0} = \sin(\pi/n)^2/2$ for some integer n , in other words (H3').

E.3 Harmonic functions

Section E.3 aims at introducing and studying some harmonic function associated with the process, which will be of the highest importance in the forthcoming Sections E.4 and E.5.

It turns out that this harmonic function will be obtained from the expansion near 0 of $\sum_{w \in W_n} (-1)^{l(w)} x^{i_0} y^{j_0}(w(z))$, quantity which is appeared naturally in (E.15); this is why we begin here by studying closely the behavior of this sum in the neighborhood of 0.

Note first that thanks to the expression (E.11) of the automorphisms ξ and η , we have

$$\sum_{w \in W_n} (-1)^{l(w)} x^{i_0} y^{j_0}(w(z)) = \sum_{k=0}^{n-1} [x^{i_0} y^{i_0}(\exp(-2ik\pi/n)z) - x^{i_0} y^{i_0}(\exp(-2ik\pi/n)/z)]. \tag{E.18}$$

Let us now take the following notations for the expansion at 0 of the function $x^{i_0}y^{j_0}$:

$$x^{i_0}y^{j_0}(z) = \sum_{p \geq 0} \kappa_p(i_0, j_0) z^p, \tag{E.19}$$

and remark that with (E.8), we obtain that for z close to 0,

$$x^{i_0}y^{j_0}(1/z) = \sum_{p \geq 0} \bar{\kappa}_p(i_0, j_0) z^p. \tag{E.20}$$

In a general setting, if f is holomorphic in a neighborhood of 0 with expansion $f(z) = \sum_{p \geq 0} f_p z^p$, then $\sum_{k=0}^{n-1} f(\exp(-2ik\pi/n)z) = \sum_{k=0}^{n-1} f(\exp(2ik\pi/n)z) = \sum_{p \geq 0} n f_{np} z^{np}$.

This is why, by using (E.19) and (E.20), we obtain that the sum (E.18) is equal to

$$\sum_{w \in W_n} (-1)^{l(w)} x^{i_0} y^{j_0} (w(z)) = \sum_{p \geq 1} n [\kappa_{np}(i_0, j_0) - \overline{\kappa_{np}}(i_0, j_0)] z^{np}. \quad (\text{E.21})$$

We are now going to be interested in the term corresponding to $p = 1$ in the sum (E.21), and we set

$$f_n(i_0, j_0) = n [\kappa_n(i_0, j_0) - \overline{\kappa_n}(i_0, j_0)] / [(-1)^n i]. \quad (\text{E.22})$$

Proposition E.4. *The function f_n defined in (E.22) verifies the following assertions :*

- (i) f_n is a real polynomial in the variables i_0, j_0 of degree exactly n .
- (ii) f_n is a harmonic function for the process (X, Y) .
- (iii) $f_n(i_0, 0) = f_n(0, j_0) = 0$ for all integers i_0 and j_0 .
- (iv) If $i_0 > 0$ and $j_0 > 0$, then $f_n(i_0, j_0) > 0$.

Corollary E.5. *The Doob f_n -transform process of (X, Y) will never hit the boundary.*

Remark E.6. *Writing an explicit formula for the function f_n is quite possible. Indeed, by using Cauchy's product, κ_n (and therefore also f_n) can be written in terms of the coefficients of the expansions of x and y at 0, and these coefficients are easily calculated, see Equation (E.24) below. As examples, we give the factorized form of f_3, f_4 and f_6 :*

$$\begin{aligned} f_3(i_0, j_0) &= 24 \cdot 3^{1/2} \cdot i_0 j_0 (i_0 + 2j_0), \\ f_4(i_0, j_0) &= (256/3) \cdot i_0 j_0 (i_0 + 2j_0)(i_0 + j_0), \\ f_6(i_0, j_0) &= (288/5) 3^{1/2} \cdot i_0 j_0 (i_0 + 2j_0)(i_0 + j_0) ((i_0 + 2j_0/3)(i_0 + 4j_0/3) + 10/9). \end{aligned}$$

We don't write the explicit expression of f_n for general values of n , since it wouldn't really be usable, nor efficient actually.

Remark E.7. *The explicit expression and the harmonicity of the function f_4 have already been obtained by P. Biane in [Bia91].*

The quantity $f_4(i_0, j_0)$ also appears as a multiplicative factor in the asymptotic tail distribution of the hitting time of the boundary of \mathbb{Z}_+^2 for the process (X, Y) associated with $n = 4$ and starting from the initial state (i_0, j_0) . Indeed, in Chapter F, denoting by $\tau = \inf\{k \geq 0 : X(k) = 0 \text{ or } Y(k) = 0\}$, we will prove that $\mathbb{P}_{(i_0, j_0)}[\tau > k] \sim C f_4(i_0, j_0)/k^2$, see Proposition F.23.

In particular, we can specify Corollary E.5 in the case $n = 4$. Indeed, using the following equality for $l < k$ (obtained from the strong Markov property of the process (X, Y)) :

$$\mathbb{P}_{(i_0, j_0)} [(X(l), Y(l)) = (i, j) | \tau > k] = \mathbb{P}_{(i_0, j_0)} [(X(l), Y(l)) = (i, j)] \frac{\mathbb{P}_{(i, j)}[\tau > k - l]}{\mathbb{P}_{(i_0, j_0)}[\tau > k]},$$

the asymptotic of Chapter F yields that the Doob f_4 -transform process is equal in distribution to the limit, as the time k goes to ∞ , of the process conditioned on the event $[\tau > k]$.

Remark E.8. *Proposition E.4 shows that for any $n \geq 3$, there exists at least one positive harmonic function for the process (X, Y) ; we will prove in Corollary E.12 of Section E.4 that for all $n \geq 3$, f_n is in fact the unique positive harmonic function for the process (X, Y) , up to the positive multiplicative constants.*

Proof of Proposition E.4. The fact that f_n takes real values is immediate from its definition. For the rest of the proof of (i), we are going to use the following straightforward fact : for any $f(z) = 1 + \sum_{p \geq 1} f_{p,1} z^p$, note $1 + \sum_{p \geq 1} f_{p,i} z^p$ the expansion at 0 of $f(z)^i$; then $f_{p,i}$ is a polynomial of degree equal or less than p in i , with dominant term equal to $f_{1,1}^p i^p / p!$. In particular, $f_{p,i}$ is of degree exactly p if and only if $f_{1,1} \neq 0$.

In our case, it is immediate from (E.8) that $\kappa_1(1, 0) = -4 \cos(\pi/n) \neq 0$ and $\kappa_1(0, 1) = -4 \exp(i\pi/n) \neq 0$. This is why, for any non-negative integer p , $\kappa_p(i, 0)$ is a polynomial of degree p in i and, likewise, $\kappa_p(0, j)$ is a polynomial of degree p in j . In particular, $\kappa_n(i, j) = \sum_{p=0}^n \kappa_p(0, j) \kappa_{n-p}(i, 0)$ is a polynomial in i, j of degree n , with dominant term equal to

$$\sum_{p=0}^n \frac{\kappa_1(0, 1)^p}{p!} j^p \frac{\kappa_1(1, 0)^{n-p}}{(n-p)!} i^{n-p}.$$

In this way, we obtain that f_n is a polynomial in i, j of degree n , with dominant term equal to, after simplification,

$$\frac{2^{2n+1}}{(n-1)!} \sum_{p=1}^{n-1} C_n^p \sin(p\pi/n) \cos(\pi/n)^{n-p} j^p i^{n-p}. \quad (\text{E.23})$$

Assertion (i) follows then immediately.

To prove (ii), it is enough to show that κ_n is harmonic. To show that, start by using the obvious equality $x^{i-1} y^{j-1}(z) K(x(z), y(z)) = 0$, which reads $x^i y^j(z) = p_{1,0} x^{i+1} y^j(z) + p_{1,0} x^{i-1} y^j(z) + p_{1,-1} x^{i+1} y^{j-1}(z) + p_{1,-1} x^{i-1} y^{j+1}(z)$. Then, (E.19) yields that

$$\sum_{p \geq 0} [\kappa_p(i, j) - p_{1,0} \kappa_p(i+1, j) - p_{1,0} \kappa_p(i-1, j) - p_{1,-1} \kappa_p(i+1, j-1) - p_{1,-1} \kappa_p(i-1, j+1)] z^p$$

is identically zero ; this means that all the κ_p , $p \geq 0$ are harmonic, hence in particular κ_n .

In order to prove (iii), we need to know explicitly the expansions of x and y at 0. From (E.8), we immediately obtain these expansions :

$$x(z) = 1 + \frac{4}{\tan(\pi/n)} \sum_{p \geq 1} (-1)^p \sin(p\pi/n) z^p, \quad y(z) = 1 + 4 \sum_{p \geq 1} (-1)^p p \exp(ip\pi/n) z^p. \quad (\text{E.24})$$

We show now the first part of (iii), namely the fact that $f_n(i, 0) = 0$ for all non-negative integer i . As it can be remarked from (E.24), the coefficients of x are real ; for this reason, for all integers i and p , $\kappa_p(i, 0)$ is also real and thus $f_p(i, 0) = 0$; in particular, $f_n(i, 0) = 0$.

As for the second part of (iii), namely the fact that for all $j \in \mathbb{Z}_+$, $f_n(0, j) = 0$, we prove that $\kappa_n(0, j)$ is real – however, it isn't true that for all j and p , $\kappa_p(0, j)$ is real.

In order to obtain $\kappa_p(0, j)$ – that is, the p th coefficient of the Taylor series of $y(z)^j$ –, we add all the terms of the form $\kappa_{p_1}(0, 1) \kappa_{p_2}(0, 1) \cdots \kappa_{p_j}(0, 1)$ with $p_1 + \cdots + p_j = p$, this is nothing else but the Cauchy's product of the j series $y(z)$. In other words, using (E.24), we add terms of the form $p_1 \cdots p_j (-1)^{p_1 + \cdots + p_j} \exp(i(p_1 + \cdots + p_j)\pi/n)$. As a consequence, $\kappa_p(0, j)$ can be written as $\varphi_p(j) (-1)^p \exp(ip\pi/n)$, with $\varphi_p(j) > 0$ if $j > 0$.

In the particular case $p = n$, we obtain $\kappa_n(0, j) = -\varphi_n(j) (-1)^n$; $\kappa_n(0, j)$ is therefore real and, immediately, $f_n(0, j) = 0$.

We prove now (iv). With (E.24), it is clear that the sequence $\kappa_0(1, 0), \dots, \kappa_{n-1}(1, 0)$ is alternating, in the sense that for all $p \in \{0, \dots, n-1\}$, $(-1)^p \kappa_p(1, 0) > 0$. In particular,

it follows from general results on power series that the sequence $\kappa_0(i, 0), \dots, \kappa_{n-1}(i, 0)$ is still alternating, for any $i > 0$.

In addition, by using the Cauchy's product of $x(z)^i$ and $y(z)^j$, we obtain that $\kappa_n(i, j) = \kappa_n(i, 0) + \kappa_n(0, j) + \sum_{p=1}^{n-1} (-1)^p \exp(ip\pi/n) \varphi_p(j) \kappa_{n-p}(i, 0)$. Then, by definition of $f_n(i, j)$ and by using the fact that $\kappa_n(i, 0)$ and $\kappa_n(0, j)$ are real, we get

$$f_n(i, j) = 2n (-1)^n \sum_{p=1}^{n-1} (-1)^p \sin(p\pi/n) \varphi_p(j) \kappa_{n-p}(i, 0).$$

But we have already proved that $\varphi_p(j) > 0$ if $j > 0$ and that $(-1)^{n-p} \kappa_{n-p}(i, 0) > 0$ if $i > 0$; f_n is thus written, above, as the sum of $n - 1$ positive terms, and is, therefore, positive. \square

Remark E.9. *The dominant term of f_n is very directly related to the réduite of the cone $\Lambda(0, \pi/n)$ – which is, by definition (see e.g. [Var99]), the unique function harmonic for the Brownian motion, positive inside of the cone $\Lambda(0, \pi/n)$ and equal to zero on its boundary.*

In order to illustrate this fact, let

$$\phi(x, y) = ((x + y)/\sin(\pi/n), y/\cos(\pi/n)).$$

Then, noting (X, Y) the random walk studied in this chapter, $\phi(X, Y)$ is a process with a covariance equal to the identity and with values in the cone $\Lambda(0, \pi/n)$.

If now $h(u, v)$ denotes the réduite of $\Lambda(0, \pi/n)$ – that is, in polar coordinate, $h(u, v) = h(r \cos(\theta), r \sin(\theta)) = r^n \sin(n\theta)$ –, then obviously

$$h(u, v) = \sum_{p=0}^{(n-1)/2} C_n^{2p+1} (-1)^p u^{n-(2p+1)} v^{2p+1},$$

and we easily check that up to a multiplicative constant, $h(\phi(x, y))$ equals the dominant term of $f_n(x, y)$, equal to $(2^{2n+1}/(n-1)!) \sum_{p=1}^{n-1} C_n^p \sin(p\pi/n) \cos(\pi/n)^{n-p} x^p y^{n-p}$, see (E.23).

However, f_n is not, in the general case, equal to its a dominant coefficient, since f_n is not homogeneous, in general, see Remark E.6.

E.4 Asymptotic of the Green functions and Martin compactification

E.4.1 Statement of the results

Theorem E.10. *The Green functions (E.2) admit the following asymptotic as $i + j \rightarrow \infty$ and $j/i \rightarrow \tan(\gamma)$, $\gamma \in [0, \pi/2]$:*

$$G_{i,j}^{i_0, j_0} \sim \frac{2}{\pi} \frac{(n-1)!}{4^n \sin(2\pi/n)} f_n(i_0, j_0) \frac{\sin(n \arctan(\frac{j/i}{1+j/i} \tan(\pi/n)))}{[\cos(\pi/n)^2 (i^2 + 2ij) + j^2]^{n/2}}. \quad (\text{E.25})$$

Remark E.11. *Set $N_n(j/i) = \sin(n \arctan((j/i)/(1+j/i) \tan(\pi/n)))$ – this quantity appears in the asymptotic (E.25). Let γ be in $[0, \pi/2]$ and suppose that j/i goes to $\tan(\gamma)$.*

If $\gamma \in]0, \pi/2[$, then $N_n(j/i)$ goes to $N_n(\tan(\gamma))$, which belongs to $]0, \infty[$.

If $\gamma = 0$ or $\gamma = \pi/2$, then $N_n(j/i)$ goes to 0. More precisely, $N_n(j/i) = n \tan(\pi/n) [j/i + O(j/i)^2]$ if $\gamma = 0$ and $N_n(j/i) = (n \tan(\pi/n)/(1 + \tan(\pi/n)^2)) [i/j + O(i/j)^2]$ if $\gamma = \pi/2$.

Corollary E.12. *The Martin compactification is the one-point compactification.*

E.4.2 Proofs

Sketch of the proof of Theorem E.10. We are going to begin by expressing $G_{i,j}$, in (E.26), as a double integral, using for this Cauchy's formulas and Equation (E.5). Then we will make the change of variable given by the uniformization (E.8) and we will apply the residue theorem; in this way, we will obtain $G_{i,j}$ as the sum $G_{i,j,1} + G_{i,j,2}$ of two single integrals w.r.t. the uniformization variable but on two contours *a priori* different, see (E.27) and (E.28). Then we will show, using Cauchy's theorem and Proposition E.1, that it is possible to move these contours of integration until having the same contours for the integrals $G_{i,j,1}$ and $G_{i,j,2}$. Finally, using (E.15), we will obtain (E.29), which is the most important explicit formulation of the $G_{i,j}$, starting from which we will get their asymptotic. In (E.29), $G_{i,j}$ will be written as an integral on $\exp(i\theta)\mathbb{R}_+ \cup \{\infty\}$, for some $\theta \in [\pi - \pi/n, \pi]$.

After having chosen an appropriate value of $\theta \in [\pi - \pi/n, \pi]$, see (E.31), we will see that this is quite natural to decompose the contour into three parts, namely a neighborhood of 0, one of ∞ and an intermediate part. Indeed, the function $x(z)^i y(z)^j$ that appears in the integrand of (E.29) is on the contour $\exp(i\theta)\mathbb{R}_+ \cup \{\infty\}$ close to 1 near 0, ∞ and strictly larger than 1 elsewhere. Next, we will study successively these contributions in three paragraphs, using for this essentially the Laplace's method, what will conclude the proof of Theorem E.10.

Beginning of the proof of Theorem E.10. Equation (E.5) yields immediately that the generating function Q of the Green functions is holomorphic in $\{(x, y) \in \mathbb{C}^2 : |x| < 1, |y| < 1\}$. As a consequence and using again Equation (E.5), the Cauchy's formulas allow us to write its coefficients $G_{i,j}$ as the following double integrals :

$$G_{i,j} = \frac{1}{[2\pi i]^2} \iint_{\substack{|x|=1 \\ |y|=1}} \frac{Q(x, y)}{x^i y^j} dx dy = \frac{1}{[2\pi i]^2} \iint_{\substack{|x|=1 \\ |y|=1}} \frac{q(x) + \tilde{q}(y) - x^{i_0} y^{j_0}}{x^i y^j K(x, y)} dx dy, \quad (\text{E.26})$$

where the circles $\{|x| = 1\} = \{|y| = 1\} = \{\exp(i\theta) : \theta \in [0, 2\pi]\}$ are orientated according to the increasing values of θ .

With (E.26), we can thus write $G_{i,j}$ as the sum $G_{i,j} = G_{i,j,1} + G_{i,j,2}$, where

$$G_{i,j,1} = \frac{1}{[2\pi i]^2} \int_{|x|=1} \frac{q(x)}{x^i} \int_{|y|=1} \frac{dy}{y^j K(x, y)} dx,$$

$$G_{i,j,2} = \frac{1}{[2\pi i]^2} \int_{|y|=1} \frac{\tilde{q}(y)}{y^j} \int_{|x|=1} \frac{dx}{x^i K(x, y)} dy + \frac{1}{[2\pi i]^2} \int_{|y|=1} \frac{1}{y^{j-j_0}} \int_{|x|=1} \frac{dx}{x^{i-i_0} K(x, y)} dy.$$

We are now going to make in $G_{i,j,1}$ the change of variable $x = x(z)$. For this we remark that if $\Lambda(\pi/2, \pi/2) = \{t : t \in [0, \infty]\}$ is orientated according to the increasing values of t , then the equality $x(\Lambda(\pi/2, \pi/2)) = -\{|x| = 1\}$ between orientated contours holds, see (E.9) and Picture E.2. In this way and by using in addition the identity $q(x(z)) = Q(z)$, we obtain

$$G_{i,j,1} = -\frac{1}{[2\pi i]^2} \int_{\Lambda(\pi/2, \pi/2)} \frac{Q(z)}{x(z)^i} \int_{|y|=1} \frac{dy}{y^j K(x(z), y)} x'(z) dz.$$

But $K(x(z), y) = 0$ if and only if $y \in \{y(z), x(z)^2/y(z)\}$, see (E.10). Moreover, if z belongs to $\Lambda(\pi/2, \pi/2) \setminus \{0, \infty\}$, then $|y(z)| > 1$, see Picture E.2. Therefore, the residue theorem at infinity entails that for such z , $\int_{|y|=1} dy/[y^j K(x(z), y)] = -2\pi i/[y(z)^j \partial_y K(x(z), y(z))]$.

Finally, we have proved that

$$G_{i,j,1} = \frac{1}{2\pi i} \int_{\Lambda(\pi/2, \pi/2)} \frac{Q(z)}{x(z)^i y(z)^j} \frac{x'(z)}{\partial_y K(x(z), y(z))} dz. \tag{E.27}$$

A similar reasoning yields

$$G_{i,j,2} = -\frac{1}{2\pi i} \int_{\Lambda(-\pi/2-\pi/n, -\pi/2-\pi/n)} \frac{\tilde{Q}(z) - x(z)^{i_0} y(z)^{j_0}}{x(z)^i y(z)^j} \frac{y'(z)}{\partial_x K(x(z), y(z))} dz. \tag{E.28}$$

We are now going to explain why it is possible to move the contours of integration of both integrals (E.27) and (E.28) up to $\Lambda(\theta, \theta)$, for any $\theta \in [\pi - \pi/n, \pi]$ – see Picture E.4 below.

Start by considering $G_{i,j,1}$ in (E.27). Thanks to Cauchy’s theorem, it is sufficient to show that the integrand of $G_{i,j,1}$ is holomorphic inside of $\Lambda(\pi/2, \pi)$, horizontally hatched on Picture E.4, and this is what we are going to prove.

On one hand, in this domain, with (E.1) and (E.8), we obtain $x'(z)/\partial_y K(x(z), y(z)) = -i/(2[p_{1,0}p_{1,-1}]^{1/2}z)$, which has manifestly no pole inside of $\Lambda(\pi/2, \pi)$. On the other hand, it is possible to deduce from the proof of Proposition E.1 that the only poles of Q are at z_0 and \bar{z}_0 . In particular, using (E.8), we obtain that for i or j large enough, $Q(z)/[x(z)^i y(z)^j]$ has no pole in $\Lambda(\pi/2, \pi)$. Therefore, for i or j large enough, the integrand of $G_{i,j,1}$ has no pole in $\Lambda(\pi/2, \pi)$ and we can thus move the contour from $\Lambda(\pi/2, \pi/2)$ to $\Lambda(\theta, \theta)$, for any $\theta \in [\pi/2, \pi]$. Note that it isn’t possible to move the contour beyond $\Lambda(\pi, \pi)$, since $\Lambda(\pi, \pi)$ is a singular curve for Q – indeed, recall that $\Lambda(\pi, \pi) = x^{-1}([1, x_4])$ and see Proposition E.1.

By similar considerations, we obtain that it is possible to move the initial contour of integration of $G_{i,j,2}$ up to $\Lambda(\theta, \theta)$, for any $\theta \in [\pi - \pi/n, 3\pi/2 - \pi/n]$.

In particular, if we wish to have the same contour of integration for $G_{i,j,1}$ and $G_{i,j,2}$, we can choose $\Lambda(\theta, \theta)$, for any $\theta \in [\pi - \pi/n, \pi] = [\pi/2, \pi] \cap [\pi - \pi/n, 3\pi/2 - \pi/n]$.

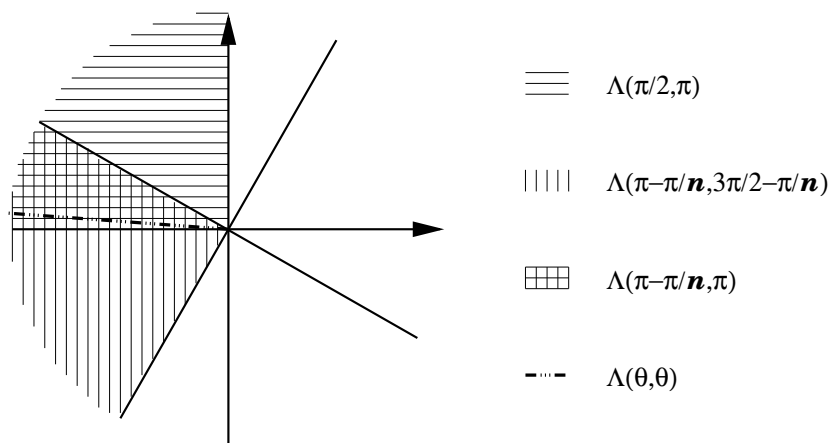

FIGURE E.4 – Change of the contours of integration for both integrals (E.27) and (E.28)

Then, using the equality $x'(z)/\partial_y K(x(z), y(z)) = -y'(z)/\partial_x K(x(z), y(z))$, that comes from differentiating $K(x(z), y(z)) = 0$, as well as (E.27), (E.28) and (E.15) – we can use (E.15) since $\theta \in [\pi - \pi/n, \pi]$ and thus $\Lambda(\theta, \theta) \subset \Lambda(\pi - \pi/n, \pi)$ –, we obtain the following

final formulation for $G_{i,j}$, θ being any angle in $[\pi - \pi/n, \pi]$:

$$G_{i,j} = \frac{1}{4\pi[p_{1,0}p_{1,-1}]^{1/2}} \int_{\Lambda(\theta,\theta)} \left[\frac{1}{z} \sum_{w \in W_n} (-1)^{l(w)} x^{i_0} y^{j_0}(w(z)) \right] \frac{1}{x(z)^i y(z)^j} dz. \quad (\text{E.29})$$

The function $x(z)^i y(z)^j$ is on the contour $\Lambda(\theta, \theta) \subset \Lambda(\pi - \pi/n, \pi)$ larger than 1 in modulus, see Picture E.2. Moreover, it goes to 1 when and only when z goes to 0 or to ∞ . This is why it seems natural to decompose the contour $\Lambda(\theta, \theta)$ into a part near 0, an other near ∞ and the remaining part, and to think that the parts near 0, ∞ will lead to the asymptotic of $G_{i,j}$ and that the remaining part will lead to a negligible contribution. But how to find the best contour in order to achieve this idea? In other words, how to find the value of $\theta \in [\pi - \pi/n, \pi]$ for which the calculation of the asymptotic of (E.29) will be the easiest?

For this, we are going to consider with details the function $x(z)^i y(z)^j$, or equivalently

$$\chi_{j/i}(z) = \ln(x(z)) + (j/i) \ln(y(z)).$$

Incidentally this is why, from now on, we suppose that $j/i \in [0, M]$, for some $M < \infty$. Indeed, the function $\chi_{j/i}$ is manifestly not adapted to the values j/i going to ∞ ; for such j/i , we will consider, later, the function $(i/j)\chi_{j/i}(z) = (i/j) \ln(x(z)) + \ln(y(z))$. Nevertheless, M can be so large as wished and in what follows, we assume that some $M > 0$ is fixed.

With (E.8), we easily obtain the explicit expansion of $\chi_{j/i}$ at 0 :

$$\chi_{j/i}(z) = \sum_{p \geq 0} \nu_{2p+1}(j/i) z^{2p+1}, \quad \nu_{2p+1}(j/i) = \frac{2}{2p+1} [z_0^{2p+1} + \bar{z}_0^{2p+1} + 2(j/i) \bar{z}_0^{2p+1}]. \quad (\text{E.30})$$

Likewise, again with (E.8), we get that for z near ∞ , $\chi_{j/i}(z) = \sum_{p=0}^{\infty} \overline{\nu_{2p+1}}(j/i) 1/z^{2p+1}$.

Consider now the steepest descent path associated with $\chi_{j/i}$, in other words the function $z_{j/i}(t)$ defined by $\chi_{j/i}(z_{j/i}(t)) = t$. By inverting the latter equality, we easily obtain that the half-line $(1/\nu_1(j/i))\mathbb{R}_+ \cup \{\infty\}$ is tangent at 0 and at ∞ to this steepest descent path.

Let us now set

$$\rho_{j/i} = 1/\nu_1(j/i) = 1/[2(z_0 + \bar{z}_0 + 2(j/i)\bar{z}_0)]. \quad (\text{E.31})$$

With this notation, we now answer the question asked above, that dealt with the fact of finding the value of θ for which the asymptotic of the Green functions (E.29) will be the most easily calculated : we choose $\theta = \arg(\rho_{j/i})$ - note that, from (E.31), we easily obtain that $\arg(\rho_{j/i}) \in [\pi - \pi/n, \pi]$ -, and the decomposition of the contour $\Lambda(\theta, \theta)$ is

$$\Lambda(\arg(\rho_{j/i}), \arg(\rho_{j/i})) = (\rho_{j/i}/|\rho_{j/i}|)[0, \epsilon] \cup (\rho_{j/i}/|\rho_{j/i}|)\epsilon, 1/\epsilon[\cup (\rho_{j/i}/|\rho_{j/i}|)[1/\epsilon, \infty].$$

According to this decomposition and to (E.29), we consider now $G_{i,j}$ as the sum of three terms and we are going to study successively the contribution of each of these three terms.

Contribution of the neighborhood of 0. In order to evaluate the asymptotic of the integral (E.29) on the contour $(\rho_{j/i}/|\rho_{j/i}|)[0, \epsilon]$, we are going to use the expansion at 0 of the function

$$\frac{1}{z} \sum_{w \in W_n} (-1)^{l(w)} x^{i_0} y^{j_0}(w(z)).$$

This is why we begin here by studying the asymptotic of the following integral, k being some non-negative integer :

$$\int_{(\rho_{j/i}/|\rho_{j/i}|)[0,\epsilon]} \frac{z^k}{x(z)^i y(z)^j} dz. \quad (\text{E.32})$$

Using the equality $1/[x(z)^i y(z)^j] = \exp(-i\chi_{j/i}(z))$ as well as the expansion (E.30) of $\chi_{j/i}$ at 0 and then making the change of variable $z = \rho_{j/i}t$, we obtain that (E.32) is equal to

$$\rho_{j/i}^{k+1} \int_0^{\epsilon/|\rho_{j/i}|} t^k \exp(-it) \exp\left(-i \sum_{p \geq 1} \nu_{2p+1}(j/i) (\rho_{j/i}t)^{2p+1}\right) dt. \quad (\text{E.33})$$

But with (E.30), $|\nu_{2p+1}(j/i)| \leq 4(M+1)$ and therefore for all $t \in [0, \epsilon/|\rho_{j/i}|]$, we have $|-i \sum_{p=1}^{\infty} \nu_{2p+1}(j/i) (\rho_{j/i}t)^{2p+1}| \leq i\epsilon^3 4(M+1)/(1-\epsilon^2)$. This is why

$$\exp\left(-i \sum_{p \geq 1} \nu_{2p+1}(j/i) (\rho_{j/i}t)^{2p+1}\right) = 1 + O(i\epsilon^3),$$

the O being independent of $j/i \in [0, M]$ and of $t \in [0, \epsilon/|\rho_{j/i}|]$. The integral (E.33) can thus be calculated as

$$\rho_{j/i}^{k+1} [1 + O(i\epsilon^3)] \int_0^{\epsilon/|\rho_{j/i}|} t^k \exp(-it) dt = (\rho_{j/i}/i)^{k+1} [1 + O(i\epsilon^3)] \int_0^{i\epsilon/|\rho_{j/i}|} t^k \exp(-t) dt.$$

In the sequel, we choose $\epsilon = 1/i^{3/4}$, so that $i\epsilon/|\rho_{j/i}| \rightarrow \infty$ and $O(i\epsilon^3) = O(1/i^{5/4})$.

We could be surprised by this choice of ϵ ; in fact, we will see in the forthcoming paragraph "Conclusion" that in order to obtain the asymptotic of the Green functions along the paths of states $(i, j) \in \mathbb{Z}_+^2$ such that $j/i \rightarrow \tan(\gamma) \in]0, \infty[$, it would have been sufficient to have $O(i\epsilon^3) = o(1)$, but for the paths $(i, j) \in \mathbb{Z}_+^2$ such that $j/i \rightarrow 0$, it is necessary to have $O(i\epsilon^3) = o(1/i)$, what affords the choice $\epsilon = 1/i^{3/4}$.

Finally, we obtain that for this choice of ϵ , the integral (E.32) is equal to

$$\int_{(\rho_{j/i}/|\rho_{j/i}|)[0,\epsilon]} \frac{z^k}{x(z)^i y(z)^j} dz = (\rho_{j/i}/i)^{k+1} k! [1 + O(1/i^{5/4})], \quad (\text{E.34})$$

where O is independent of $j/i \in [0, M]$.

Presently, we are ready to find the asymptotic of the integral (E.29) on the contour $(\rho_{j/i}/|\rho_{j/i}|)[0, \epsilon]$. First, in accordance with (E.21), we have that this integral equals

$$\frac{1}{4\pi[p_{1,0}p_{1,-1}]^{1/2}} \sum_{p \geq 1} n [\kappa_{np}(i_0, j_0) - \overline{\kappa_{np}}(i_0, j_0)] \int_{(\rho_{j/i}/|\rho_{j/i}|)[0,\epsilon]} \frac{z^{np-1}}{x(z)^i y(z)^j} dz.$$

Thus clearly, with (E.34), we obtain that all the terms corresponding to $p \geq 2$ in the sum above will be negligible w.r.t. the term associated to $p = 1$. In addition, by using the definition (E.22) of the harmonic function f_n as well as (E.34) for $k = pn - 1$ and $p \geq 1$, we get that the integral (E.29) on the contour $(\rho_{j/i}/|\rho_{j/i}|)[0, \epsilon]$ is equal to

$$\frac{1}{4\pi[p_{1,0}p_{1,-1}]^{1/2}} (-1)^n (n-1)! f_n(i_0, j_0) (\rho_{j/i}/i)^n [1 + O(1/i^{5/4})]. \quad (\text{E.35})$$

Contribution of the neighborhood of ∞ . The part of the contour close to ∞ , namely $(\rho_{j/i}/|\rho_{j/i}|)[1/\epsilon, \infty]$, is related to the part $(\rho_{j/i}/|\rho_{j/i}|)[0, \epsilon]$ by the transformation $z \mapsto 1/\bar{z}$. Moreover, it is clear from (E.8) that for $f = x$, $f = y$, or $f = \sum_{w \in W_n} (-1)^{l(w)} x^{i_0} y^{j_0}(w)$,

$$f(1/\bar{z}) = \overline{f(z)}.$$

Therefore, the change of variable $z \mapsto 1/\bar{z}$ immediately gives us that the contribution of the integral (E.29) near ∞ is the complex conjugate of its contribution near 0.

Contribution of the intermediate part. Let A_ϵ be the annular domain $\{z \in \mathbb{C} : \epsilon \leq |z| \leq 1/\epsilon\}$. According to Picture E.2, for all $z \in \Lambda(\pi - \pi/n, \pi) \cap A_\epsilon$, $|x(z)| > 1 + \eta_{x,\epsilon}$ and $|y(z)| > 1 + \eta_{y,\epsilon}$, where $\eta_{x,\epsilon} > 0$ and $\eta_{y,\epsilon} > 0$. In fact, since $x'(0) \neq 0$ and $y'(0) \neq 0$, we can take $\eta_{x,\epsilon} > \eta\epsilon$ and $\eta_{y,\epsilon} > \eta\epsilon$, for some $\eta > 0$ independent of ϵ small enough.

Let us now consider

$$L = \sup_{z \in \Lambda(\pi - \pi/n, \pi)} \left| \left[\sum_{w \in W_n} (-1)^{l(w)} x^{i_0} y^{j_0}(w(z)) \right] / \left[x^{i_0} y^{j_0}(z) \right] \right|,$$

and let us show that L is finite. For this, it is enough to prove that the function s , defined by $s(z) = \left[\sum_{w \in W_n} (-1)^{l(w)} x^{i_0} y^{j_0}(w(z)) \right] / \left[x^{i_0} y^{j_0}(z) \right]$, has no pole in $\Lambda(\pi - \pi/n, \pi)$ – including ∞ . But by using (E.8) and (E.11), we see that the only poles of the numerator of s are the $z_0 \exp(2ip\pi/n)$, for $p \in \{0, \dots, n-1\}$. Among these n points, only z_0 is in $\Lambda(\pi - \pi/n, \pi)$. But in s , we have taken care of dividing by $x^{i_0} y^{j_0}(z)$, so that s is in fact holomorphic near z_0 . Moreover, it is easily shown that s is holomorphic at ∞ . Finally, we have proved that s has no pole in $\Lambda(\pi - \pi/n, \pi)$, hence s is bounded in $\Lambda(\pi - \pi/n, \pi)$; in other words, L is finite.

The modulus of the contribution of (E.29) on the intermediate part $(\rho_{j/i}/|\rho_{j/i}|)\epsilon, 1/\epsilon[\subset \Lambda(\pi - \pi/n, \pi) \cap A_\epsilon$ can therefore be bounded from above by

$$\frac{1}{4\pi[p_{1,0}p_{1,-1}]^{1/2}} \frac{1}{\epsilon^2} \frac{L}{(1 + \eta\epsilon)^{i-i_0} (1 + \eta\epsilon)^{j-j_0}}. \quad (\text{E.36})$$

Note that the presence of the term $1/\epsilon^2$ in (E.36) is due to the following : one $1/\epsilon$ appears as an upper bound of the length of the contour, the other $1/\epsilon$ comes from an upper bound of the modulus of the term $1/z$ present in the integrand of (E.29).

Then we take, as before, $\epsilon = 1/i^{3/4}$, and we use the following straightforward upper bound, valid for i large enough : $1/[1 + \eta/i^{3/4}]^i \leq \exp(-[\eta/2]i^{1/4})$. We finally obtain that for i large enough, (E.36) is equal to $O(i^{3/2} \exp(-[\eta/2]i^{1/4}))$.

Conclusion. We have seen that the contribution of the integral (E.29) in the neighborhood of 0 is given by (E.35), that the contribution of (E.29) in the neighborhood of ∞ is equal to the complex conjugate of (E.35) and that the contribution of the remaining part can be written as $O(i^{3/2} \exp(-[\eta/2]i^{1/4}))$. Therefore, with (E.29) and (E.35), we obtain

$$G_{i,j} = \frac{1}{4\pi[p_{1,0}p_{1,-1}]^{1/2}} (-1)^n (n-1)! f_n(i_0, j_0) i \left[(\rho_{j/i}/i)^n - (\overline{\rho_{j/i}/i})^n \right] + O(1/i^{n+5/4}). \quad (\text{E.37})$$

Moreover, starting from (E.31), we easily get

$$(\rho_{j/i}/i)^n - (\overline{\rho_{j/i}/i})^n = \frac{2i(-1)^{n+1} \sin(n \arctan(\frac{j/i}{1+j/i} \tan(\pi/n)))}{4^n [\cos(\pi/n)^2 (i^2 + 2ij) + j^2]^{n/2}}.$$

The latter equality, (E.37) and Remark E.11 conclude the proof of Theorem E.10 in the case of $\gamma \in [0, \pi/2[$.

- * Note that having $o(1/i^n)$ instead of $O(1/i^{n+5/4})$ would have been sufficient for $\gamma \in]0, \pi/2[$, since in this case, Remark E.11 implies that $(\rho_{j/i}/i)^n - (\overline{\rho_{j/i}}/i)^n \sim K_\gamma/i^n$ with $K_\gamma \neq 0$.
- * On the other hand, if $\gamma = 0$ then $(\rho_{j/i}/i)^n - (\overline{\rho_{j/i}}/i)^n \sim K_0 j/i^{n+1}$ with $K_0 \neq 0$ and it is necessary to have something like $o(1/i^{n+1})$ in (E.37), as it is actually the case with $O(1/i^{n+5/4})$.

To prove Theorem E.10 in the case $\gamma = \pi/2$, we would consider $(i/j)\kappa_{j/i}$ rather than $\kappa_{j/i}$, and we would use then exactly the same analysis; we omit the details.

E.5 Absorption probabilities

Let us now be interested in the absorption probabilities of the random walk, properly defined in (E.3). Precisely, we are going to consider two aspects of these probabilities, namely their exact distribution and their asymptotic tail distribution.

First of all, in Subsection E.5.1, we get the asymptotic of these absorption probabilities, as a direct consequence of Theorem E.10.

Then, in Subsection E.5.2, we find the exact distribution of the absorption site, by use of some analytic methods based on [FIM99] and Chapter C.

Finally, in Subsection E.5.3, we show how the exact results of Subsection E.5.2 lead to the asymptotic already obtained in Subsection E.5.1. It will be the opportunity to study finely the properties of the conformal gluing functions (see Definition 1 of Part I) in the case of a drift zero – the study of these functions in the case of a non-zero drift being done in Chapters A, B and C of this thesis.

The technical details being essentially the same for q and \tilde{q} , we are going to focus on q in Subsections E.5.1, E.5.2 and E.5.3; of course, similar results could be obtained for \tilde{q} .

E.5.1 Asymptotic of the absorption probabilities, a first method

Proposition E.13. *The probabilities of absorption (E.3) admit the following asymptotic as the absorption site i goes to infinity :*

$$\mathbb{P}_{(i_0, j_0)}[(X, Y) \text{ is absorbed at } (i, 0)] \sim \frac{1}{2\pi} \frac{n!}{[4 \cos(\pi/n)]^n} f_n(i_0, j_0) \frac{1}{i^{n+1}},$$

f_n being the harmonic function defined in (E.22).

Proof. Proposition E.13 follows immediately by using the asymptotic (E.25) of the Green functions obtained in Theorem E.10, as well as Remark E.11, in the obvious equality (see also (C.53)) $\mathbb{P}_{(i_0, j_0)}[(X, Y) \text{ is absorbed at } (i, 0)] = p_{1, -1} G_{i-1, 1}$. \square

E.5.2 Integral representation of the generating functions

In [FIM99] is explained how to obtain explicitly the generating functions of stationary probabilities in the case of some ergodic walks in a quarter plane. In Section C.3 of Chapter C, we have developed this analysis to the case of the generating functions of absorption probabilities for some processes in a quarter plane that are killed at the boundary and that have a positive drift.

In fact, the methods of [FIM99] can be similarly generalized to the case of the random walks in a quarter plane killed at the boundary and with zero drift. In other words, it is possible, in our case, to obtain explicitly the generating functions of absorption probabilities q and \tilde{q} defined by (E.4). Since the ideas are essentially the same as in [FIM99] and Chapter C, we don't write the details and we refer to these two works for the technical aspects of this approach.

Before stating the result giving the explicit expression of q , we need some definitions.

First, let $X(y)$ be the two-valued function such that $K(X(y), y) = 0$. Note that with (E.6), we immediately obtain $X(y) = [-\tilde{b}(y) \pm \tilde{d}(y)^{1/2}]/[2\tilde{a}(y)]$.

Consider now the curve $X([y_1, 1])$.

For $y \in]y_1, 1[$, $\tilde{d}(y) < 0$, see (E.7), the two values of $X(y)$ are thus distinct and complex conjugate the one from the other. Since $\tilde{d}(y_1) = \tilde{d}(1) = 0$, the two values of $X(y_1)$ and $X(1)$ are the same (and are respectively equal to 0 and 1). In particular, the curve $X([y_1, 1])$ is closed and symmetrical w.r.t. to the real axis.

We denote by $\mathcal{G}X([y_1, 1])$ the interior of the bounded domain delimited by $X([y_1, 1])$.

Moreover, a , b and d being considered in (E.6)-(E.7), let us now define μ_{j_0} as in (C.16) of Chapter C.

Then, the result giving the explicit expression of q is the following – for the proof, see (C.16), (C.13), (C.54) and (C.59) in Sections C.3 and C.6 of Chapter C.

Proposition E.14. *The function q can be meromorphically continued from the unit disc up to $\mathbb{C} \setminus [1, y_4]$, where it admits the following integral representation :*

$$\frac{1}{\pi} \int_1^{x_4} t^{i_0} \mu_{j_0}(t) \frac{[-d(t)]^{1/2}}{t-x} dt + \frac{1}{\pi} \int_{x_1}^1 t^{i_0} \mu_{j_0}(t) \left[\frac{\partial u(t)}{u(t) - u(x)} - \frac{1}{t-x} \right] [-d(t)]^{1/2} dt + r(x).$$

Above, r is a polynomial and u is a conformal gluing function for $\mathcal{G}X([y_1, 1])$, see below.

We recall from Definition 1 of Part I that by a conformal gluing function (CGF) u for the set $\mathcal{G}X([y_1, 1])$ we mean a function (i) meromorphic in $\mathcal{G}X([y_1, 1])$, (ii) establishing a conformal mapping of $\mathcal{G}X([y_1, 1])$ onto the whole complex plane cut along some arc, (iii) such that for all t in $X([y_1, 1])$, $u(t) = u(\bar{t})$.

The existence – but no explicit expression – of u in our situation is obtained by making use of quite general results on conformal gluing, so to complete Proposition E.14, it remains to find *explicitly* a CGF u ; this is precisely the subject of the end of Subsection E.5.2.

Before beginning our study, it is worth noting that the situation is here completely different as the one encountered in Chapters A, B and C since the drift is presently equal to zero.

In order to obtain explicitly a CGF u , we are going to use strongly the uniformization (x, y) . Indeed, it seems *a priori* difficult to find u because the curve $X([y_1, 1])$ is not especially ordinary; on the other hand, $X([y_1, 1])$ is the image through the uniformization of a quite ordinary curve, since with (E.9) we have $X([y_1, 1]) = x(\Lambda(-\pi/n, -\pi/n))$, see Picture E.2. In particular, we also have $\mathcal{G}X([y_1, 1]) = x(\Lambda(-\pi/n, 0))$.

Moreover, let us remark that if $z \in \Lambda(-\pi/n, -\pi/n)$, then $\overline{x(z)} = x(z_0^2/z)$.

The two last paragraphs entail that by setting $v = u \circ x$, u being the CGF and x the first coordinate of the uniformization (E.8), the problem of finding a CGF u is transformed into the following : to make explicit a function v (i) meromorphic in $\Lambda(0, -\pi/n)$, (ii) establishing a conformal mapping of $\Lambda(0, -\pi/n)$ onto the complex plane cut along some

arc, (iii) verifying, for all z in $\Lambda(-\pi/n, -\pi/n)$, $v(z_0^2 z) = v(z)$, (iv) such that, for all z in $\mathbb{C} \cup \{\infty\}$, $v(z) = v(1/z)$ – this last condition appears because $v = u \circ x$ and because for all z in $\mathbb{C} \cup \{\infty\}$, $x(z) = x(1/z)$, see (E.10).

A solution of this new problem is easily found : we can take $v(z) = z^n + 1/z^n$. As a consequence, the function $u(t) = x^{-1}(t)^n + 1/x^{-1}(t)^n$ is a CGF for the curve $X([y_1, 1])$.

The function x^{-1} has two branches, x_+^{-1} and x_-^{-1} , equal to $x_{\pm}^{-1}(t) = [-\cos(\pi/n)(1+t) \pm (4t - \sin(\pi/n)^2(1+t)^2)^{1/2}]/[t-1]$. In particular, since $x_+^{-1}(t)x_-^{-1}(t) = 1$, the CGF $u(t)$ can be written as $x_+^{-1}(t)^n + x_-^{-1}(t)^n$; therefore the choice of the determination of x^{-1} in the definition of the CGF u doesn't matter. Moreover, from the explicit expressions of x_+^{-1} and x_-^{-1} , we easily deduce that u is a rational function of the form $u(t) = P(t)/(t-1)^n$, where P is a real polynomial of degree n and such that $P(1) \neq 0$.

Now that we have obtained explicitly a CGF u , Proposition E.14 is complete. We would like, however, to know the partial fraction expansion of $\partial u(t)/[u(t) - u(x)]$ – we will use it importantly in Subsection E.5.3. For this, we need the following remark about the automorphisms of the group W_n .

Let us prove that the application $w \mapsto x \circ w \circ x^{-1}$ maps the Weyl group W_n onto $\{x \circ (\eta \circ \xi)^p \circ x^{-1}, 0 \leq p \leq n-1\}$, which is manifestly a group of order n . For this, we remark that each automorphism $w \in W_n$ defines naturally two automorphisms $w_{x,+}$ and $w_{x,-}$ by the formula $w_{x,\pm} = x \circ w \circ x_{\pm}^{-1}$. Since $x \circ \xi = x$, we have $(\xi \circ w)_{x,\pm} = w_{x,\pm}$ and since $x_+^{-1}x_-^{-1} = 1$, we get $w_{x,+} = (w \circ \xi)_{x,-}$. This is why $\{w_{x,\pm}, w \in W_n\}$ is in fact not of order $2n$ but of order n , and is equal to $\{x \circ (\eta \circ \xi)^p \circ x^{-1}, 0 \leq p \leq n-1\}$. In the sequel, we note $\Delta_p = x \circ (\eta \circ \xi)^p \circ x^{-1}$.

With the last paragraphs, we can write the partial fraction expansion of $\partial u(t)/[u(t) - u(x)]$. Indeed, using on the one hand that u has a pole at 1 of order n and on the other hand that $u(t) = u(x)$ if and only if $t = \Delta_p(x)$, for some $p \in \{0, \dots, n-1\}$ – indeed, $v(z) = v(y)$ if and only if $z = w(y)$ for some $w \in W_n$ –, we get

$$\frac{\partial u(t)}{u(t) - u(x)} = \sum_{p=0}^{n-1} \frac{1}{t - \Delta_p(x)} - \frac{n}{t-1}.$$

Then with Proposition E.14, we immediately obtain that there exists a polynomial s such that

$$q(x) = \frac{1}{\pi} \int_1^{x_4} \frac{t^{i_0} \mu_{j_0}(t)}{t-x} [-d(t)]^{1/2} dt + \sum_{p=1}^{n-1} \frac{1}{\pi} \int_{x_1}^1 \frac{t^{i_0} \mu_{j_0}(t)}{t - \Delta_p(x)} [-d(t)]^{1/2} dt + s(x). \quad (\text{E.38})$$

E.5.3 Asymptotic of the absorption probabilities, a second method

Let us now give an other proof of Proposition E.13. For this, we are going to study closely the quantity $q(x)$, equal to $\sum_{i \geq 1} \mathbb{P}_{(i_0, j_0)}[(X, Y) \text{ is absorbed at } (i, 0)]x^i$, see (E.4).

More precisely, we are going to show that q is holomorphic in $(1 + \epsilon)\mathcal{D} \setminus [1, 1 + \epsilon[$ for some $\epsilon > 0$ and that near 1,

$$q(x) = -\frac{1}{2\pi} \frac{f_n(i_0, j_0)}{[4 \cos(\pi/n)]^n} (x-1)^n \ln(1-x) [1 + (x-1)h_1(x)] + h_2(x), \quad (\text{E.39})$$

where h_1 and h_2 are holomorphic at 1. Then, Proposition E.13 will be a direct consequence of (E.39) and of the well-known result below.

Lemma E.15. Let $l(x) = \sum_{i \geq 0} l_i x^i$ be a function

- * holomorphic in $(1 + \epsilon)\mathcal{D} \setminus [1, 1 + \epsilon[$ for some $\epsilon > 0$,
- * such that in the neighborhood of 1, $l(x) = m_1(x)(x - 1)^q \ln(1 - x) + m_2(x)$, where m_1, m_2 are holomorphic at 1, $m_1(1) \neq 0$ and q is a non-negative integer.

Then, as $i \rightarrow \infty$, $l_i \sim -m_1(1)q!/i^{q+1}$.

Let us now begin the proof of Proposition E.13. First, note that as a generating function of probabilities, it is clear that q is holomorphic in the open unit disc \mathcal{D} . Moreover, with Remark E.2, we can get that q is holomorphic in $(1 + \epsilon)\mathcal{D} \setminus [1, 1 + \epsilon[$ for some $\epsilon > 0$. It remains consequently to prove (E.39). For this, we need the following result.

Lemma E.16. Let k be a non-negative integer. There exist two functions holomorphic at 1, f_k and g_k , such that, in the neighborhood of 1, we have

$$\int_1^{x_4} \frac{(t-1)^k}{t-s} dt = -(s-1)^k \ln(1-s) + f_k(s), \quad \int_{x_1}^1 \frac{(t-1)^k}{t-s} dt = (s-1)^k \ln(s-1) + g_k(s).$$

Note that the proof of Lemma E.16 is straightforward, since the integrals that appear in its statement are easily calculated explicitly.

Take now the following notations (we recall that d is defined in (E.7), μ_{j_0} in (C.16) and we denote by ϵ some small positive number) :

$$\forall t \in [1 - \epsilon, 1] : \quad t^{i_0} \mu_{j_0}(t) [-d(t)]^{1/2} = \sum_{k \geq 1} \alpha_k(i_0, j_0) (t-1)^k, \quad (\text{E.40})$$

and note that, for $t \in [1, 1 + \epsilon]$, we have $t^{i_0} \mu_{j_0}(t) [-d(t)]^{1/2} = -\sum_{k \geq 1} \alpha_k(i_0, j_0) (t-1)^k$.

With this notation, using (E.38) and Lemma E.16, we obtain that for x close to 1,

$$q(x) = \frac{1}{\pi} \sum_{k \geq 1} \alpha_k(i_0, j_0) \left[(x-1)^k \ln(1-x) + \sum_{p=1}^{n-1} (\Delta_p(x) - 1)^k \ln(\Delta_p(x) - 1) \right] + h_0(x), \quad (\text{E.41})$$

where h_0 can be written in terms of the f_k and g_k of Lemma E.16. An important fact is that h_0 is symmetrical in $\Delta_1, \dots, \Delta_{n-1}$ and is therefore holomorphic in the neighborhood of 1.

Moreover, since $\Delta_p(1) = 1$ and $\Delta'_p(1) \neq 0$, we have $\ln(\Delta_p(x) - 1) = \ln(1-x) + l_p(x)$, with $\sum_{p=1}^{n-1} l_p(x)$ holomorphic at 1. In this way, (E.41) becomes

$$q(x) = \frac{\ln(1-x)}{\pi} \sum_{k \geq 1} \alpha_k(i_0, j_0) \sum_{p=0}^{n-1} (\Delta_p(x) - 1)^k + h_2(x), \quad (\text{E.42})$$

with h_2 holomorphic in the neighborhood of 1.

Consider now $\sum_{p=0}^{n-1} (\Delta_p(x) - 1)^k$ that appears in (E.42) above, or rather

$$A_k(z) = \sum_{p=0}^{n-1} (\Delta_p(x(z)) - 1)^k.$$

By definition of Δ_p , we have $\Delta_p \circ x = x \circ (\eta \circ \xi)^p$, see Subsection E.5.2, and in addition, $(\eta \circ \xi)^p(z) = \exp(-2ip\pi/n)z$; therefore,

$$A_k(z) = \sum_{p=0}^{n-1} (x(\exp(-2ip\pi/n)z) - 1)^k.$$

Evaluating now (E.42) at $x = x(z)$, the quantity $\sum_{k=1}^{\infty} \alpha_k(i_0, j_0) A_k(z)$ appears, and we are now going to prove that in the neighborhood of 0,

$$\sum_{k \geq 1} \alpha_k(i_0, j_0) A_k(z) = ((-1)^{n+1}/2) f_n(i_0, j_0) z^n + O(z^{2n}). \quad (\text{E.43})$$

We first recall a notation of Subsection E.5.2, namely $x_{\pm}^{-1}(t) = [-\cos(\pi/n)(1+t) \pm (4t - \sin(\pi/n)^2(1+t)^2)^{1/2}]/[t-1]$, and now we show that for t near 1, the equality below holds :

$$-2i \sum_{k \geq 1} \alpha_k(i_0, j_0) (t-1)^k = \sum_{q \geq 0} [\kappa_q(i_0, j_0) - \overline{\kappa}_q(i_0, j_0)] x_+^{-1}(t)^q. \quad (\text{E.44})$$

In order to prove the equality (E.44) for t in a neighborhood of 1, we are going to prove it first for $t \in [1-\epsilon, 1]$.

So, if $t \in [1-\epsilon, 1]$, (E.40) yields $-2i \sum_{k \geq 1} \alpha_k(i_0, j_0) (t-1)^k = -2it^{i_0} \mu_{j_0}(t) [-d(t)]^{1/2}$. But the latter quantity can be calculated as follows :

$$t^{i_0} [(-b(t) - i[-d(t)]^{1/2})/(2a(t))]^{j_0} - t^{i_0} [(-b(t) + i[-d(t)]^{1/2})/(2a(t))]^{j_0}.$$

In addition, we easily check that for $t \in [x_1, 1]$, $y(x_+^{-1}(t)) = (-b(t) - [-d(t)]^{1/2})/(2a(t))$ and $y(1/x_+^{-1}(t)) = (-b(t) + i[-d(t)]^{1/2})/(2a(t))$. Therefore, for $t \in [1-\epsilon, 1]$ we have

$$-2i \sum_{k \geq 1} \alpha_k(i_0, j_0) (t-1)^k = x^{i_0} y^{j_0} (x_+^{-1}(t)) - x^{i_0} y^{j_0} (1/x_+^{-1}(t)).$$

Then, it remains to use (E.19) and (E.20) in order to obtain (E.44) for all $t \in [1-\epsilon, 1]$. Next, by analytic continuation, (E.44) holds in fact on any disc with center at 1 and with radius small enough.

In particular, if we apply (E.44) to $t = \Delta_p(x(z))$ (which is close to 1 if z is close to 0), if in addition we use the fact that $x_+^{-1}(\Delta_p(x(z))) = (\eta \circ \xi)^p(z) = \exp(-2ip\pi/n)z$ and if finally we add these equalities w.r.t. $p \in \{0, \dots, n-1\}$, we obtain, by definition of the A_k ,

$$-2i \sum_{k \geq 1} \alpha_k(i_0, j_0) A_k(z) = \sum_{q \geq 0} [\kappa_q(i_0, j_0) - \overline{\kappa}_q(i_0, j_0)] z^q \sum_{p=0}^{n-1} \exp(-2ipq\pi/n),$$

which, by using the explicit expression of f_n , see (E.22), immediately entails (E.43).

We are now going to conclude the proof of Equation (E.39). For this, note that

$$\begin{aligned} \sum_{k \geq 1} \alpha_k(i_0, j_0) \sum_{p=0}^{n-1} (\Delta_p(x) - 1)^k &= \sum_{k \geq 1} \alpha_k(i_0, j_0) A_k(x_+^{-1}(x)) \\ &= ((-1)^{n+1}/2) f_n(i_0, j_0) x_+^{-1}(x)^n + O(x_+^{-1}(x)^{2n}) \\ &= \frac{-f_n(i_0, j_0)}{2[4\cos(\pi/n)]^n} (x-1)^n + O(x-1)^{n+1}. \end{aligned}$$

Indeed, the first equality above is obtained by definition of the functions A_k , the second one is immediate from (E.43) and the third one is a consequence of the expansion of x_+^{-1} at 1, namely $x_+^{-1}(t) = -(t-1)/[4\cos(\pi/n)] + \dots$. Then, with (E.42), we obtain that

$$q(x) = \frac{\ln(1-x)}{\pi} \frac{-f_n(i_0, j_0)}{2[4\cos(\pi/n)]^n} (x-1)^n [1 + (x-1)h_1(x)] + h_2(x), \quad (\text{E.45})$$

where h_1 and h_2 is holomorphic near 1. Finally, by using Lemma E.15 in Equation (E.45), we immediately obtain Proposition E.13.

Chapitre F

Hitting time of the boundary

F.1 Distribution of the hitting times of both axes and of the origin

In Section F.1, we consider the random walks $(X(k), Y(k))_{k \geq 0}$ in the quadrant \mathbb{Z}_+^2 with the following properties – below, let us denote the jump probabilities by $\mathbb{P}[(X(k+1), Y(k+1)) = (i_0 + i, j_0 + j) \mid (X(k), Y(k)) = (i_0, j_0)] = p_{(i_0, j_0), (i_0, j_0) + (i, j)}$.

- * For all (i_0, j_0) such that $i_0, j_0 > 0$, $p_{(i_0, j_0), (i_0, j_0) + (i, j)}$ does not depend on (i_0, j_0) and can thus be denoted by $p_{i, j}$.
- * If $|i| > 1$ or $|j| > 1$, then $p_{i, j} = 0$.
- * The boundary $\{(0, 0)\} \cup \{(i, 0) : i \geq 1\} \cup \{(0, j) : j \geq 1\}$ is absorbing.
- * In the list $p_{1,1}, p_{1,0}, p_{1,-1}, p_{0,-1}, p_{-1,-1}, p_{-1,0}, p_{-1,1}, p_{0,-1}$, there are no three consecutive zeros.

However, no assumption on the drifts $\sum_{i,j} i p_{i,j}$ and $\sum_{i,j} j p_{i,j}$ is made.

First of all, let us observe that the exact distributions of the hitting times of both axes and of the origin are explicitly known, since the generating functions

$$\begin{aligned} q^{i_0, j_0}(1, z) &= \sum_{k \geq 0} \mathbb{P}_{(i_0, j_0)}[(X, Y) \text{ hits the horizontal axis at time } k] z^k, \\ \tilde{q}^{i_0, j_0}(1, z) &= \sum_{k \geq 0} \mathbb{P}_{(i_0, j_0)}[(X, Y) \text{ hits the vertical axis at time } k] z^k, \\ q_0^{i_0, j_0}(z) &= \sum_{k \geq 0} \mathbb{P}_{(i_0, j_0)}[(X, Y) \text{ hits the origin at time } k] z^k \end{aligned}$$

are here made explicit. Indeed, defining

$$\begin{aligned} q^{i_0, j_0}(x, z) &= \sum_{k \geq 0, i \geq 1} \mathbb{P}_{(i_0, j_0)}[(X, Y) \text{ hits } (i, 0) \text{ at time } k] x^i z^k, \\ \tilde{q}^{i_0, j_0}(y, z) &= \sum_{k \geq 0, j \geq 1} \mathbb{P}_{(i_0, j_0)}[(X, Y) \text{ hits } (0, j) \text{ at time } k] y^j z^k, \\ q_0^{i_0, j_0}(z) &= \sum_{k \geq 0} \mathbb{P}_{(i_0, j_0)}[(X, Y) \text{ hits } (0, 0) \text{ at time } k] z^k, \end{aligned}$$

the same analysis as the one which led to Theorem B.5 of Part II yields the following result.

Theorem F.1. *The functions $q^{i_0, j_0}(x, z)$ and $\tilde{q}^{i_0, j_0}(y, z)$ above are equal to*

$$\begin{aligned} q^{i_0, j_0}(x, z) &= x^{i_0} Y_0(x, z)^{j_0} \\ &+ \int_{x_1(z)}^{x_2(z)} t^{i_0} \mu_{j_0}(t, z) \left[\frac{\partial_t w(t, z)}{w(t, z) - w(x, z)} - \frac{\partial_t w(t, z)}{w(t, z) - w(0, z)} \right] [-d(t, z)]^{1/2} dt, \\ \tilde{q}^{i_0, j_0}(y, z) &= X_0(y, z)^{i_0} y^{j_0} \\ &+ \int_{y_1(z)}^{y_2(z)} t^{j_0} \tilde{\mu}_{i_0}(t, z) \left[\frac{\partial_t \tilde{w}(t, z)}{\tilde{w}(t, z) - \tilde{w}(y, z)} - \frac{\partial_t \tilde{w}(t, z)}{\tilde{w}(t, z) - \tilde{w}(0, z)} \right] [-\tilde{d}(t, z)]^{1/2} dt, \end{aligned} \quad (\text{F.1})$$

where

$$\begin{aligned} \mu_{j_0}(t, z) &= \frac{1}{[2a(t, z)]^{j_0}} \sum_{k=0}^{(j_0-1)/2} C_{j_0}^{2k+1} d(t, z)^k [-b(t, z)]^{j_0-(2k+1)}, \\ \tilde{\mu}_{i_0}(t, z) &= \frac{1}{[2\tilde{a}(t, z)]^{i_0}} \sum_{k=0}^{(i_0-1)/2} C_{i_0}^{2k+1} \tilde{d}(t, z)^k [-\tilde{b}(t, z)]^{i_0-(2k+1)}, \end{aligned}$$

and where w and \tilde{w} are conformal gluing functions (CGF), see Definition 1 of Part I, for the sets $\mathcal{G}X([y_1(z), y_2(z)])$ and $\mathcal{G}Y([x_1(z), x_2(z)])$ respectively.

In order to obtain $q_0^{i_0, j_0}(z)$, it is then enough to evaluate the functional equation (F.2) below (which we prove exactly as in Chapter C) at any (x, y, z) such that $K(x, y, z) = 0$, $z \in]0, 1[$ and $|x|, |y| < 1$,

$$K(x, y, z) Q^{i_0, j_0}(x, y, z) = q^{i_0, j_0}(x, z) + \tilde{q}^{i_0, j_0}(y, z) + q_0^{i_0, j_0}(z) - x^{i_0} y^{j_0}, \quad (\text{F.2})$$

where we have noted $Q^{i_0, j_0}(x, y, z) = \sum_{i, j \geq 1, k \geq 0} \mathbb{P}_{(i_0, j_0)}[(X(k), Y(k)) = (i, j)] x^{i-1} y^{j-1} z^k$.

*

The rest of Chapter F is devoted to the study of the asymptotic tail distribution of the hitting times of both axes and of the origin.

Important motivations for this analysis have been presented in Part I.

Let us just recall here that a precise knowledge of the asymptotic tail distribution of the hitting time of the boundary τ enables us to express the limit as $k \rightarrow \infty$ of the process conditioned on $[\tau > k]$ as some Doob h -process.

The typical reasoning we are going to use here is the following :

- * we first show that $q^{i_0, j_0}(1, z)$ (resp. $\tilde{q}^{i_0, j_0}(1, z)$, $q_0^{i_0, j_0}(z)$) is holomorphic in $\rho((1 + \epsilon)\mathcal{D} \setminus [1, 1 + \epsilon])$, see Picture F.1, and has at ρ a (logarithmic or algebraic) singularity,
- * next, we find the precise behavior of $q^{i_0, j_0}(1, z)$ (resp. $\tilde{q}^{i_0, j_0}(1, z)$, $q_0^{i_0, j_0}(z)$) at ρ ,
- * we apply the results of [Jun31], [Pól74] or [FO90], that give then the exact asymptotic of the coefficients of functions verifying the two properties above.

In the general case, the second *item* above seems to us a quite difficult task, notably since the dependence of the CGF w and \tilde{w} w.r.t. the variable z is very complex ; this is why we restrict ourself, in the forthcoming Sections F.2, F.3 and F.4, to the particular cases for which it appears to us possible to overcome this analytical difficulty – and these cases turn out to correspond with the walks having, for all z , a finite group of automorphisms as well as rational CGF w and \tilde{w} .

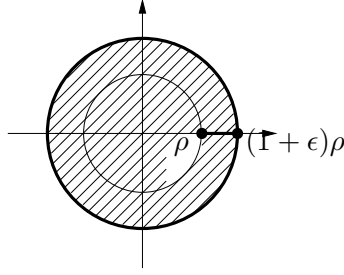

FIGURE F.1 – The domain $\rho((1 + \epsilon)\mathcal{D} \setminus [1, 1 + \epsilon])$

F.2 Case of a group of order 4 for all z

The bulk of Section F.2 is devoted to the study of the walks verifying $p_{-1,0} + p_{0,1} + p_{1,0} + p_{0,-1} = 1$, which admit a group of order 4 for all z , in accordance with Chapter B.

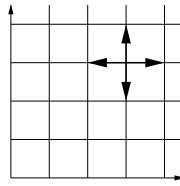

FIGURE F.2 – Processes considered in Subsections F.2.1, F.2.2, F.2.3 and F.2.4

Only in the final Subsection F.2.5, we will explain how to generalize the different results up to the case of the walks having for all z a group of order 4 and two zero drifts.

Let us remark that these walks admit a particularly nice description in terms of the parameters, since we have the following.

Lemma F.2. *A process has for all z a group of order 4 and two zero drifts if and only if the set $(p_{i,j})_{-1 \leq i,j \leq 1}$ has a horizontal or vertical symmetry - i.e. either $p_{i,j} = p_{i,-j}$ or $p_{i,j} = p_{-i,j}$ for all i and j .*

Proof. Adapting the arguments given in Part 4.1 of [FIM99], we get that the group has, for some fixed value of z , order 4 if and only if $\Delta(z) = 0$, $\Delta(z)$ being defined in Lemma F.13.

As a consequence, the group is of order 4 for all z if and only if $\Delta(1) = \partial\Delta(1) = 0$.

Consider now the system composed of the equations (*) $p_{1,1} + p_{1,0} + p_{1,-1} = p_{-1,1} + p_{-1,0} + p_{-1,-1}$, (*) $p_{1,1} + p_{0,1} + p_{-1,1} = p_{1,-1} + p_{0,-1} + p_{-1,-1}$, (*) $\Delta(1) = 0$, (*) $\partial\Delta(1) = 0$, (*) $\sum_{-1 \leq i,j \leq 1} p_{i,j} = 1$, (*) $p_{i,j} \geq 0$.

After calculations, this implies that either $p_{1,1} = p_{1,-1}$, $p_{0,1} = p_{0,-1}$ and $p_{-1,1} = p_{-1,-1}$, in other words $a = c$, or $p_{1,1} = p_{-1,1}$, $p_{1,0} = p_{-1,0}$ and $p_{1,-1} = p_{-1,-1}$, i.e. $\tilde{a} = \tilde{c}$. \square

The starting point of Section F.2 is the following refinement of Theorem F.1, peculiar to the walks satisfying to $p_{-1,0} + p_{0,1} + p_{1,0} + p_{0,-1} = 1$.

Proposition F.3. *Suppose that $p_{-1,0} + p_{0,1} + p_{1,0} + p_{0,-1} = 1$. For $x \in \mathbb{C} \setminus [x_3(z), x_4(z)]$ and $z \in]0, 1/(2[p_{1,0}p_{-1,0}]^{1/2} + 2[p_{0,1}p_{0,-1}]^{1/2})[$, the function $q^{i_0, j_0}(x, z)$ admits the following integral representation :*

$$\frac{x}{\pi} \int_{x_3(z)}^{x_4(z)} [t^{i_0} - ([p_{-1,0}/p_{1,0}]/t)^{i_0}] \frac{\mu_{j_0}(t, z) [-d(t, z)]^{1/2}}{t(t-x)} dt + xP_\infty[x^{i_0-1}Y_0(x, z)^{j_0}].$$

Proof. The proof is essentially the same as the one of Equation (D.25). \square

F.2.1 A change of variable *via* the Chebyshev polynomials

Subsection F.2.1 aims at making a change of variable in the integral representation of q^{i_0, j_0} stated in Proposition F.3 ; in this way, we will obtain our final formulation of q^{i_0, j_0} , starting from which we will get all the results of Subsections F.2.2, F.2.3 and F.2.4.

Define $\hat{b}(t, z) = b(t, z)/[4a(t, z)c(t, z)]^{1/2}$; then $t \mapsto \hat{b}(t, z)$ is clearly a diffeomorphism between $]x_1(z), x_2(z)[$ (resp. $]x_3(z), x_4(z)[$) and $] - 1, 1[$. Moreover, μ_{j_0} expresses itself in a quite natural way in this new variable \hat{b} , since the following equality holds :

$$\mu_{j_0}(t, z)[- d(t, z)]^{1/2} = \left(\frac{c(t, z)}{a(t, z)} \right)^{j_0/2} U_{j_0-1}(- \hat{b}(t, z)) [1 - \hat{b}(t, z)^2]^{1/2}, \tag{F.3}$$

where the U_p are the Chebyshev polynomials of the second kind. We recall (see [Sze75]) that they are the orthogonal polynomials related to the weight $u \mapsto [1 - u^2]^{1/2} \mathbf{1}_{]-1, 1[}(u)$ and that their explicit expression is

$$U_p(u) = \frac{(u + [u^2 - 1]^{1/2})^{p+1} - (u - [u^2 - 1]^{1/2})^{p+1}}{2[u^2 - 1]^{1/2}} = \sum_{k=0}^{p/2} C_{p+1}^{2k+1} (u^2 - 1)^k u^{p-2k}. \tag{F.4}$$

Let us now introduce two properties of the Chebyshev polynomials of the second kind that we will especially use here (for a proof, see *e.g.* [Sze75]) : firstly, they have the parity of their order, *i.e.* $U_p(-u) = (-1)^p U_p(u)$; secondly, in the neighborhood of 1, they admit the expansion $U_p(u) = (p + 1)[1 + p(p + 2)(u - 1)/3 + O(u - 1)^2]$.

We are now ready to make the change of variable $t \mapsto \hat{b}(t, z)$ previously mentioned. In this aim, note that $\hat{b}(t, z) = u$ if and only if $b(t, z) - 2u[p_{0,1}p_{0,-1}]^{1/2}zt = 0$, in other words if and only if $t = t_-(u, z)$ or $t = t_+(u, z)$, where

$$t_{\pm}(u, z) = \frac{1 + 2[p_{0,1}p_{0,-1}]^{1/2}uz \pm [(1 + 2[p_{0,1}p_{0,-1}]^{1/2}uz)^2 - 4p_{1,0}p_{-1,0}z^2]^{1/2}}{2p_{1,0}z}. \tag{F.5}$$

Since $t_+(-1, z) = x_3(z)$ and $t_+(1, z) = x_4(z)$, making the change of variable $t \mapsto \hat{b}(t, z)$ (and taking $x = 1$) in Proposition F.3 leads to the following.

Proposition F.4. *For $z \in]0, 1/(2[p_{1,0}p_{-1,0}]^{1/2} + 2[p_{0,1}p_{0,-1}]^{1/2})[$, $q^{i_0, j_0}(1, z)$ equals*

$$P^{i_0, j_0}(z) + \frac{1}{\pi} \left(\frac{p_{0,-1}}{p_{0,1}} \right)^{j_0/2} \int_{-1}^1 [t_+(u, z)^{i_0} - t_-(u, z)^{i_0}] \frac{\partial_u t_+(u, z) U_{j_0-1}(-u)}{t_+(u, z)(t_+(u, z) - 1)} [1 - u^2]^{1/2} du, \tag{F.6}$$

where $P^{i_0, j_0}(z)$ is the polynomial $xP_{\infty}[x^{i_0-1}Y_0(x, z)^{j_0}]$ evaluated at $x = 1$.

To conclude Subsection F.2.1, let us set $k_1(u) = -2[p_{0,1}p_{0,-1}]^{1/2}u + 2[p_{1,0}p_{-1,0}]^{1/2}$ as well as $k_2(u) = -2[p_{0,1}p_{0,-1}]^{1/2}u - 2[p_{1,0}p_{-1,0}]^{1/2}$. With these notations, we have $t_{\pm}(u, z) = (1 + 2[p_{0,1}p_{0,-1}]^{1/2}uz \pm [(1 - k_1(u)z)(1 - k_2(u)z)]^{1/2})/(2p_{1,0}z)$. Moreover, we easily show the two following identities :

$$\begin{aligned} \partial_u t_{\pm}(u, z) &= \pm t_{\pm}(u, z) \frac{2[p_{0,1}p_{0,-1}]^{1/2}z}{[(1 - k_1(u)z)(1 - k_2(u)z)]^{1/2}}, \\ \frac{1}{t_+(u, z) - 1} &= \frac{1}{2} \frac{[(1 - k_1(u)z)(1 - k_2(u)z)]^{1/2} - [1 + (2[p_{0,1}p_{0,-1}]^{1/2}u - 2p_{1,0})z]}{1 + (2[p_{0,1}p_{0,-1}]^{1/2}u - (p_{1,0} + p_{-1,0}))z}. \end{aligned} \tag{F.7}$$

F.2.2 The gambler ruin

Consider the identity (F.6), in which we use (F.7) and we do $p_{1,0}, p_{-1,0} \rightarrow 0$. In addition, we take $i_0 = 1$ in order to lighten the technical details. The expression (F.6) then becomes :

$$q^{1,j_0}(1, z) = \frac{1}{\pi} \left(\frac{p_{0,-1}}{p_{0,1}} \right)^{j_0/2} \int_{-1}^1 \frac{2[p_{0,1}p_{0,-1}]^{1/2} z}{1 + 2[p_{0,1}p_{0,-1}]^{1/2} u} U_{j_0-1}(-u) [1 - u^2]^{1/2} du. \quad (\text{F.8})$$

Not unexpectedly, the latter equals $[(1 - [1 - 4p_{0,1}p_{0,-1}z^2]^{1/2}) / (2p_{0,1}z)]^{j_0}$, which is, in accordance with [Fel57], the generating function of the ruin probabilities for the gambler ruin problem, *i.e.* $\sum_{k \geq 0} \mathbb{P}_{j_0}[\text{a gambler having an initial fortune } j_0 \text{ is ruined at time } k] z^k$.

Let us sketch the proof of this fact.

Start by showing that for $p \in \mathbb{Z}_+$ and $t \in \mathbb{C} \setminus [-1, 1]$,

$$\frac{1}{\pi} \int_{-1}^1 \frac{u^p}{u - t} [1 - u^2]^{1/2} du = t^p (t^2 - 1)^{1/2} - P_\infty [t^p (t^2 - 1)^{1/2}], \quad (\text{F.9})$$

where $P_\infty[f]$ denotes the principal part of f at infinity.

In order to obtain (F.9), integrate the function $u^p [1 - u^2]^{1/2} / (u - t)$ on a closed contour surrounding at a distance $\epsilon > 0$ the segment $[-1, 1]$, next, use the residue theorem at infinity and at last, do ϵ going to zero.

Now in (F.8) we expand U_{j_0-1} according to the powers of u and we apply (F.9) to each term in the so-obtained sum. Using the linearity of the principal part, (F.8) then becomes :

$$q^{1,j_0}(1, z) = - \left(\frac{p_{0,-1}}{p_{0,1}} \right)^{j_0/2} (U_{j_0-1}(u) (u^2 - 1)^{1/2} - P_\infty [U_{j_0-1}(u) (u^2 - 1)^{1/2}]), \quad (\text{F.10})$$

where we have set $u = 1 / (2[p_{0,1}p_{0,-1}]^{1/2} z)$.

Introduce now the Chebyshev polynomials T_p of the first kind. We recall that they are the orthogonal polynomials associated with the weight $u \mapsto [1 - u^2]^{-1/2} \mathbf{1}_{[-1,1]}(u)$ and that their explicit formulation is

$$T_p(u) = \frac{(u + [u^2 - 1]^{1/2})^p + (u - [u^2 - 1]^{1/2})^p}{2}. \quad (\text{F.11})$$

Moreover, in [Sze75] is shown that there exists the following link between the Chebyshev polynomials of the first and second kinds :

$$P_\infty [U_p(u) (u^2 - 1)^{1/2}] = T_{p+1}(u), \quad P_\infty [T_{p+1}(u) (u^2 - 1)^{-1/2}] = U_p(u).$$

The latter relationships allow us to simplify considerably (F.10) and we find :

$$q^{1,j_0}(1, z) = - \left(\frac{p_{0,-1}}{p_{0,1}} \right)^{j_0/2} (U_{j_0-1}(u) (u^2 - 1)^{1/2} - T_{j_0}(u)),$$

where $u = 1 / (2[p_{0,1}p_{0,-1}]^{1/2} z)$.

But with (F.4) and (F.11), $U_{j_0-1}(u) (u^2 - 1)^{1/2} - T_{j_0}(u) = -[u - (u^2 - 1)^{1/2}]^{j_0}$, so that the proof is actually concluded.

F.2.3 Drift zero

Proposition F.5. *We suppose here again that $p_{-1,0} + p_{0,1} + p_{1,0} + p_{0,-1} = 1$ and in addition that $p_{-1,0} = p_{1,0}$ as well as $p_{0,-1} = p_{0,1}$. Then, as $k \rightarrow \infty$, following asymptotic holds :*

$$\mathbb{P}_{(i_0, j_0)}[(X, Y) \text{ hits the horizontal axis at time } k] \sim \frac{i_0 j_0}{2\pi [p_{1,0} p_{0,1}]^{1/2}} \frac{1}{k^2}. \tag{F.12}$$

The asymptotic of $\mathbb{P}_{(i_0, j_0)}[(X, Y) \text{ hits the vertical axis at time } k]$ is exactly the same.

Denote by τ the hitting time of the boundary. Since $\mathbb{P}_{(i_0, j_0)}[\tau = k] = \mathbb{P}_{(i_0, j_0)}[(X, Y) \text{ hits the horizontal axis at time } k] + \mathbb{P}_{(i_0, j_0)}[(X, Y) \text{ hits the vertical axis at time } k]$, it follows directly from Proposition F.5 that $\mathbb{P}_{(i_0, j_0)}[\tau > k] \sim i_0 j_0 / (\pi [p_{1,0} p_{0,1}]^{1/2} k)$.

Corollary F.6. *Setting $h(i_0, j_0) = i_0 j_0$, the Doob h -process of (X, Y) coincides, in distribution, with the limit as $k \rightarrow \infty$ of the process conditioned on $[\tau > k]$.*

Proof of Proposition F.5. We are going to prove that $q^{i_0, j_0}(1, z)$, which is the generating function $q^{i_0, j_0}(1, z) = \sum_{k \geq 0} \mathbb{P}_{(i_0, j_0)}[(X, Y) \text{ hits the horizontal axis at time } k] z^k$, is holomorphic in $(1 + \epsilon)\mathcal{D} \setminus [1, 1 + \epsilon[$ for $\epsilon > 0$ sufficiently small (let us recall that \mathcal{D} denotes the open unit disc) and that in the neighborhood of 1,

$$q^{i_0, j_0}(1, z) = h^{i_0, j_0}(z) + g^{i_0, j_0}(z)(z - 1) \ln(1 - z), \tag{F.13}$$

where h^{i_0, j_0} and g^{i_0, j_0} are holomorphic at 1 and $g^{i_0, j_0}(1) = -i_0 j_0 / (2\pi [p_{1,0} p_{0,1}]^{1/2})$.

To conclude, it will be then enough to use the famous principle explained hereunder. If $q(z) = \sum_{k \geq 0} q_k z^k$ is a function holomorphic in $(1 + \epsilon)\mathcal{D} \setminus [1, 1 + \epsilon[$ and equal, near 1, to $q(z) = s(z) + r(z) \ln(1 - z)$, s and r being holomorphic in the neighborhood of 1, then as $k \rightarrow \infty$, $q_k \sim (-1)^m \partial^m r(1) / k^{m+1}$, where $m = \inf\{p \in \mathbb{Z}_+ : \partial^p r(1) \neq 0\}$.

Setting $p_{-1,0} = p_{1,0}$ and $p_{0,-1} = p_{0,1}$ in (F.6), we get that up to the polynomial $P^{i_0, j_0}(z)$, $q^{i_0, j_0}(1, z)$ is equal to

$$\frac{p_{0,1} z}{\pi} \int_{-1}^1 \frac{t_+(u, z)^{i_0} - t_-(u, z)^{i_0}}{[(1 - k_1(u)z)(1 - k_2(u)z)]^{1/2}} U_{j_0-1}(-u) \left(\left[\frac{1 - k_2(u)z}{1 - k_1(u)z} \right]^{1/2} - 1 \right) [1 - u^2]^{1/2} du. \tag{F.14}$$

In particular, it becomes clear from (F.14) that q^{i_0, j_0} is holomorphic in $(1 + \epsilon)\mathcal{D} \setminus [1, 1 + \epsilon[$, for $\epsilon > 0$ small enough. It remains thus to prove (F.13).

Using in (F.14) the expressions of t_- and t_+ given in (F.5), we immediately notice that

$$\frac{p_{0,1} z}{\pi} \frac{t_+(u, z)^{i_0} - t_-(u, z)^{i_0}}{[(1 - k_1(u)z)(1 - k_2(u)z)]^{1/2}} U_{j_0-1}(-u)$$

is a polynomial in u and z . In particular, we can write the latter function, say $F^{i_0, j_0}(u, z)$, as a finite sum $F^{i_0, j_0}(u, z) = \sum_{i, j \geq 0} F_{i, j}^{i_0, j_0}(u + 1)^i (z - 1)^j$, with $F_{0, 0}^{i_0, j_0} = i_0 j_0 p_{0,1} / (\pi p_{1,0})$.

Since adding a polynomial will obviously not change the asymptotic of the coefficients of $q^{i_0, j_0}(1, z)$, we can focus in the sequel on

$$r^{i_0, j_0}(z) = \int_{-1}^1 F^{i_0, j_0}(u, z) \left[\frac{1 - k_2(u)z}{1 - k_1(u)z} \right]^{1/2} [1 - u^2]^{1/2} du.$$

Consider now $G^{i_0, j_0}(u, z) = F^{i_0, j_0}(u, z)[1 - k_2(u)z]^{1/2}$. Since $k_2(-1) = 2(p_{0,1} - p_{1,0}) < 1$, the function of two variables G^{i_0, j_0} is holomorphic in $(1 + \epsilon)\mathcal{D}^2$, for $\epsilon > 0$ small enough.

In particular, it follows that G^{i_0, j_0} can be expanded according to the powers $(u+1)^i(z-1)^j$, say $G^{i_0, j_0}(u, z) = \sum_{i, j \geq 0} G_{i, j}^{i_0, j_0}(u+1)^i(z-1)^j$, where $G_{0,0}^{i_0, j_0} = 2i_0j_0p_{0,1}/(\pi[p_{1,0}]^{1/2})$.

With these notations,

$$r^{i_0, j_0}(z) = \sum_{i, j \geq 0} G_{i, j}^{i_0, j_0}(z-1)^j \int_{-1}^1 (1-u)^i \frac{[1-u^2]^{1/2}}{[1-k_1(-u)z]^{1/2}} du.$$

Thanks to Lemma F.7 below, we get the existence of two functions holomorphic at 1, namely $f^{i_0, j_0}(z) = \sum_{i, j \geq 0} G_{i, j}^{i_0, j_0} f_i(z)(z-1)^j$ and $g^{i_0, j_0}(z) = \sum_{i, j \geq 0} G_{i, j}^{i_0, j_0} g_i(z)(z-1)^{i+j}$, such that

$$r^{i_0, j_0}(z) = f^{i_0, j_0}(z) + g^{i_0, j_0}(z)(z-1) \ln(1-z).$$

Moreover, once again with Lemma F.7, $g^{i_0, j_0}(1) = G_{0,0}^{i_0, j_0} g_0(1) = -i_0j_0/(2\pi[p_{0,1}p_{1,0}]^{1/2})$. Equation (F.13) follows immediately. \square

Lemma F.7. *Let $i \in \mathbb{Z}_+$. The function F_i defined by*

$$F_i(z) = \int_{-1}^1 (1-u)^i \frac{[1-u^2]^{1/2}}{[1-k_1(-u)z]^{1/2}} du$$

is holomorphic in $(1 + \epsilon)\mathcal{D} \setminus [1, 1 + \epsilon[$, for $\epsilon > 0$ small enough. Moreover, there exist two functions f_i and g_i holomorphic at 1 and verifying $g_i(1) \neq 0$ such that near 1, $F_i(z) = f_i(z) + g_i(z)(z-1)^{i+1} \ln(1-z)$. Furthermore, $g_0(1) = -1/(4[p_{0,1}]^{3/2})$.

Proof. The fact that for small $\epsilon > 0$, F_i is holomorphic in $(1 + \epsilon)\mathcal{D} \setminus [1, 1 + \epsilon[$ is clear from its explicit expression. We are thus going to concentrate the details on the behavior of F_i at 1.

For lightening the technical details, we assume in the rest of the proof that $p_{1,0} < p_{0,1}$.

First, in the integral F_i , we replace the lower bound -1 by $-p_{1,0}/p_{0,1} > -1$. This does not change the behavior of F_i at 1, since this replacement is simply equivalent to add to F_i a function having a radius of convergence strictly larger than 1.

Then, the change of variable $v^2 = k_1(-u) = 2[p_{0,1}u + p_{1,0}]$ yields

$$\int_{-p_{1,0}/p_{0,1}}^1 (1-u)^i \frac{[1-u^2]^{1/2}}{[1-k_1(-u)z]^{1/2}} du = \frac{2}{(2p_{0,1})^{2+i}} \int_0^1 \frac{[1-v^2]^{1/2+i}}{[1-zv^2]^{1/2}} v(v^2+2[p_{0,1}-p_{1,0}])^{1/2} dv.$$

Next, using the expansion of $v^{1/2}$ at 1, we develop $v(v^2+2[p_{0,1}-p_{1,0}])^{1/2}$ according to the powers of $1-v^2$ and we get $v(v^2+2[p_{0,1}-p_{1,0}])^{1/2} = \sum_{k \geq 0} c_k(1-v^2)^k$, with $c_0 = 2[p_{0,1}]^{1/2}$, etc.

In a few lines, we will demonstrate that there exist ψ_k and ϕ_k , holomorphic at 1 and verifying $\phi_k(1) \neq 0$, such that

$$\int_0^1 \frac{[1-v^2]^{1/2+k}}{[1-zv^2]^{1/2}} dv = \psi_k(z) + \phi_k(z)(z-1)^{k+1} \ln(1-z). \quad (\text{F.15})$$

But before showing Equation (F.15), we prove how this identity allows us to complete the proof of Lemma F.7. With the notations of (F.15), let us take the definitions $\tilde{f}_i(z) = 2/(2p_{0,1})^{i+2} \sum_{k \geq 0} c_k \psi_{k+i}(z)$ and $g_i(z) = 2/(2p_{0,1})^{i+2} \sum_{k \geq 0} c_k \phi_{k+i}(z)(z-1)^k$. Then,

$$\int_{-p_{1,0}/p_{0,1}}^1 (1-u)^i \frac{[1-u^2]^{1/2}}{[1-k_1(-u)z]^{1/2}} du = \tilde{f}_i(z) + (z-1)^{i+1} \ln(1-z) g_i(z). \quad (\text{F.16})$$

Next, we change the lower bound $-p_{1,0}/p_{0,1}$ in -1 , what replaces \tilde{f}_i by another function holomorphic at 1, that we call f_i , but what does not change the function g_i , for the reasons already explained at the beginning of the proof.

So it remains to prove (F.15). The proof consists in expressing the integrals in the left hand side member of (F.15) in terms of K and E , the two classical Legendre complete elliptic integrals of the first and second kinds, defined by

$$K(z) = \int_0^1 \frac{dv}{[(1-v^2)(1-zv^2)]^{1/2}}, \quad E(z) = \int_0^1 \frac{[1-zv^2]^{1/2}}{[1-v^2]^{1/2}} dv$$

and then in using well-known results concerning these elliptic integrals (see *e.g.* in [SG69]), notably the ones related to their behavior in the neighborhood of 1.

Both K and E are manifestly holomorphic in $(1+\epsilon)\mathcal{D} \setminus [1, 1+\epsilon]$ for any $\epsilon > 0$, and from the so-called Abel's identity, see *e.g.* [SG69], it can be deduced that near 1, $K(z) = \rho_K(z) + \sigma_K(z) \ln(1-z)$ and $E(z) = \rho_E(z) + \sigma_E(z)(z-1) \ln(1-z)$, where the four functions $\rho_K, \sigma_K, \rho_E, \sigma_E$ are holomorphic at 1, $\sigma_K(1) = -1/2$ and $\sigma_E(1) = 1/4$.

In addition, for any $k \in \mathbb{Z}_+$, we can find two polynomials P_k and Q_k , such that

$$\int_0^1 \frac{[1-v^2]^{1/2+k}}{[1-zv^2]^{1/2}} dv = \frac{1}{z^{k+1}} [Q_k(z)K(z) + P_k(z)E(z)].$$

These polynomials can be explicitly calculated; for instance, $Q_0(z) = z-1$ and $P_0(z) = 1$. Therefore, setting $\psi_k(z) = (Q_k(z)\rho_K(z) + P_k(z)\rho_E(z))/z^{k+1}$ and $\tilde{\phi}_k(z) = (Q_k(z)\sigma_K(z) + P_k(z)\sigma_E(z)(z-1))/z^{k+1}$, we obtain that

$$\int_0^1 \frac{[1-v^2]^{1/2+k}}{[1-zv^2]^{1/2}} dv = \psi_k(z) + \tilde{\phi}_k(z) \ln(1-z).$$

Then, to prove (F.15), it is enough to verify that we can write $\tilde{\phi}_k(z)$ as $(z-1)^{k+1}\phi_k(z)$, with ϕ_k holomorphic at 1.

For example, for $k=0$, thanks to the explicit expression of Q_0 and P_0 given above, we have $\tilde{\phi}_0 = (z-1)(\sigma_K(z) + \sigma_E(z))/z$, whence the result by setting $\phi_0(z) = (\sigma_K(z) + \sigma_E(z))/z$.

For general values of $k \in \mathbb{Z}_+$, we omit this verification, the calculations being indeed somewhat tedious – essentially because of the complex expressions of Q_k and P_k .

To prove the last fact claimed in Lemma F.7, *i.e.* the equality $g_0(1) = -1/(4[p_{0,1}]^{3/2})$, we remark that $g_0(1) = 2c_0(\sigma_K(1) + \sigma_E(1))/(2p_{0,1})^2 = -1/(4[p_{0,1}]^{3/2})$. \square

F.2.4 Non-zero drift

In Subsection F.2.3, we were interested in the case of two zero drifts, *i.e.* $p_{-1,0} = p_{1,0}$ and $p_{0,-1} = p_{0,1}$; in this Subsection F.2.4, we are going to state analogous results as Proposition F.5 when two (*cf.* Proposition F.8) or one (*cf.* Proposition F.10) of the drifts are non-zero.

Proposition F.8. *We suppose here that $p_{-1,0} + p_{0,1} + p_{1,0} + p_{0,-1} = 1$ and in addition that $p_{-1,0} < p_{1,0}$ as well as $p_{0,-1} < p_{0,1}$. Then, as $k \rightarrow \infty$, $\mathbb{P}_{(i_0, j_0)}[(X, Y) \text{ hits the horizontal axis at time } k]$ admits the following asymptotic :*

$$\frac{j_0}{2\pi^{1/2}[p_{0,1}p_{0,-1}]^{1/4}} \left(\frac{p_{0,-1}}{p_{0,1}}\right)^{j_0/2} \left[1 - \left(\frac{p_{-1,0}}{p_{1,0}}\right)^{i_0}\right] \frac{(p_{1,0} + p_{-1,0} + 2[p_{0,1}p_{0,-1}]^{1/2})^{k+1/2}}{k^{3/2}}. \quad (\text{F.17})$$

The asymptotic of $\mathbb{P}_{(i_0, j_0)}[(X, Y) \text{ hits the vertical axis at time } k]$ is then got thanks to an adequate change of the parameters in (F.17).

Proof. We are going to show that for $\epsilon > 0$ sufficiently small, $q^{i_0, j_0}(1, z)$ is holomorphic in $\rho((1 + \epsilon)\mathcal{D} \setminus [1, 1 + \epsilon])$, where $\rho = 1/(p_{1,0} + p_{-1,0} + 2[p_{0,1}p_{0,-1}]^{1/2})$, and that near ρ ,

$$q^{i_0, j_0}(1, z) = g^{i_0, j_0}(z) + f^{i_0, j_0}(z)[1 - z/\rho]^{1/2}, \quad (\text{F.18})$$

where g^{i_0, j_0} and f^{i_0, j_0} are holomorphic at ρ and

$$f^{i_0, j_0}(\rho) = -\frac{j_0}{[p_{0,1}p_{0,-1}]^{1/4}} \left(\frac{p_{0,-1}}{p_{0,1}}\right)^{j_0/2} \left[1 - \left(\frac{p_{-1,0}}{p_{1,0}}\right)^{i_0}\right] (p_{1,0} + p_{-1,0} + 2[p_{0,1}p_{0,-1}]^{1/2})^{1/2}. \quad (\text{F.19})$$

To conclude, it will be then enough to use the principle explained below – and already introduced in the proof of Lemma C.26 in Chapter C.

If $H(z) = \sum_{k \geq 0} H_k z^k$ is a function holomorphic in $\rho((1 + \epsilon)\mathcal{D} \setminus [1, 1 + \epsilon])$ and such that near ρ ,

$$H(z) = h_0(z) + \sum_{i=1}^d h_i(z)[1 - z/\rho]^{\theta_i},$$

where the h_i are holomorphic near ρ , not vanishing at ρ for $i \in \{1, \dots, d\}$, the $\theta_1 < \dots < \theta_d$ are rational but not integer, then as $k \rightarrow \infty$, $H_k \sim h_1(\rho)\rho^{-k}/[\Gamma(-\theta_1)k^{\theta_1+1}]$.

Proposition F.4 entails that up to the polynomial $P^{i_0, j_0}(z)$, $q^{i_0, j_0}(1, z)$ is equal to

$$\begin{aligned} & \frac{1}{\pi} \left(\frac{p_{0,-1}}{p_{0,1}}\right)^{j_0/2} \int_{-1}^1 (t_+(u, z)^{i_0} - t_-(u, z)^{i_0}) \frac{2[p_{0,1}p_{0,-1}]^{1/2} z}{[(1 - k_1(u)z)(1 - k_2(u)z)]^{1/2}} \times \\ & \times \frac{1}{2} \frac{[(1 - k_1(u)z)(1 - k_2(u)z)]^{1/2} - (1 - k_4(u)z)}{1 - k_3(u)z} U_{j_0-1}(-u)[1 - u^2]^{1/2} du, \end{aligned} \quad (\text{F.20})$$

where we have set $k_1(u) = -2[p_{0,1}p_{0,-1}]^{1/2}u + 2[p_{1,0}p_{-1,0}]^{1/2}$, $k_2(u) = -2[p_{0,1}p_{0,-1}]^{1/2}u - 2[p_{1,0}p_{-1,0}]^{1/2}$, $k_3(u) = -2[p_{0,1}p_{0,-1}]^{1/2}u + p_{1,0} + p_{-1,0}$ and $k_4(u) = -2[p_{0,1}p_{0,-1}]^{1/2}u + 2p_{1,0}$.

Let us also define

$$\rho = 1/k_3(-1) = 1/(2[p_{0,1}p_{0,-1}]^{1/2} + p_{1,0} + p_{-1,0}).$$

Due to the obvious inequalities $2[p_{1,0}p_{-1,0}]^{1/2} < p_{1,0} + p_{-1,0} < 2p_{1,0}$, the integral (F.20) is manifestly holomorphic in $\rho((1 + \epsilon)\mathcal{D} \setminus [1, 1 + \epsilon])$. Therefore, in order to prove Proposition F.8, it is enough to demonstrate (F.18) and (F.19).

For this, we define $F^{i_0, j_0}(u, z) = (t_+(u, z)^{i_0} - t_-(u, z)^{i_0})[p_{0,1}p_{0,-1}]^{1/2} z U_{j_0-1}(-u) / [(1 - k_1(u)z)(1 - k_2(u)z)]^{1/2} - (1 - k_4(u)z) / [(1 - k_1(u)z)(1 - k_2(u)z)]^{1/2}$, in such a way that the integral (F.20) can be expressed as

$$\frac{1}{\pi} \left(\frac{p_{0,-1}}{p_{0,1}}\right)^{j_0/2} \int_{-1}^1 \frac{F^{i_0, j_0}(u, z)}{1 - k_3(u)z} [1 - u^2]^{1/2} du. \quad (\text{F.21})$$

$(u, z) \mapsto F^{i_0, j_0}(u, z)$ defined above is certainly not holomorphic in the whole \mathbb{C}^2 , but is holomorphic in $(1 + \epsilon)(\mathcal{D} \times \rho\mathcal{D})$, if $\epsilon > 0$ is small enough. Indeed, since $2[p_{1,0}p_{-1,0}]^{1/2} < p_{1,0} + p_{-1,0} < 2p_{1,0}$, we immediately notice that for $i \in \{1, 2, 4\}$, the functions $(u, z) \mapsto (1 - k_i(u)z)^{1/2}$ are holomorphic in $(1 + \epsilon)(\mathcal{D} \times \rho\mathcal{D})$, for sufficiently small values of $\epsilon > 0$.

In particular, we can write the expansion of $F^{i_0, j_0}(u, z)$ in the neighborhood of $(-1, \rho)$, say $F^{i_0, j_0}(u, z) = \sum_{i, j \geq 0} F_{i, j}^{i_0, j_0} (1+u)^i (1-z/\rho)^j$, with coefficients $F_{i, j}^{i_0, j_0}$ that can be explicitly calculated; for instance, using that

$$[k_3(-1) - k_1(-1)][k_3(-1) - k_2(-1)] = (p_{1,0} - p_{-1,0})^2, \quad t_+(-1, k_3(-1)) = 1,$$

we find $F_{0,0}^{i_0, j_0} = 2j_0[1 - (p_{-1,0}/p_{1,0})^{i_0}][p_{0,1}p_{0,-1}]^{1/2}/k_3(-1)$.

Now, with the notations of Lemma F.9 below, we set

$$\begin{aligned} \tilde{g}^{i_0, j_0}(z) &= \frac{1}{\pi} \left(\frac{p_{0,-1}}{p_{0,1}} \right)^{j_0/2} \sum_{i, j \geq 0} F_{i, j}^{i_0, j_0} g_i(z) [1 - z/\rho]^j, \\ f^{i_0, j_0}(z) &= \frac{1}{\pi} \left(\frac{p_{0,-1}}{p_{0,1}} \right)^{j_0/2} \sum_{i, j \geq 0} F_{i, j}^{i_0, j_0} f_i(z) [1 - z/\rho]^{i+j}. \end{aligned}$$

Then, the integral (F.21) is equal to $\tilde{g}^{i_0, j_0}(z) + f^{i_0, j_0}(z)[1 - z/\rho]^{1/2}$, with $f^{i_0, j_0}(1)$ given by (F.19), in such a way that Equations (F.18) and (F.19) are proved. \square

Lemma F.9. *Let $i \in \mathbb{Z}_+$ and $k_3(u) = -2[p_{0,1}p_{0,-1}]^{1/2}u + p_{1,0} + p_{-1,0}$. Then the function G_i defined by*

$$G_i(z) = \int_{-1}^1 (1-u)^i \frac{[1-u^2]^{1/2}}{1 - k_3(-u)z} du$$

is holomorphic in $\rho((1+\epsilon)\mathcal{D} \setminus [1, 1+\epsilon])$, for $\epsilon > 0$ small enough and $\rho = 1/k_3(-1)$. Moreover, there exist two functions g_i and f_i holomorphic at ρ and verifying $f_i(\rho) \neq 0$ such that near ρ , $G_i(z) = g_i(z) + f_i(z)[1 - z/\rho]^{i+1/2}$. In addition, $f_0(\rho) = -(\pi/2)/(\rho[p_{0,1}p_{0,-1}]^{1/2})^{3/2}$.

Proof. The proof of Lemma F.9 is based on the fact that G_i can be explicitly calculated :

$$G_i(z) = -\frac{\pi}{2} \frac{1}{z[p_{0,1}p_{0,-1}]^{1/2}} \left((1-Z)^i (Z^2 - 1)^{1/2} - P_\infty [(1-Z)^i (Z^2 - 1)^{1/2}] \right), \quad (\text{F.22})$$

where $P_\infty[f]$ is the principal part at infinity of f and where we have set $Z = (1 - z[p_{1,0} + p_{-1,0}]) / (2[p_{0,1}p_{0,-1}]^{1/2}z)$.

In order to prove (F.22), start by remarking that $1 - k_3(-u)z = -2z[p_{0,1}p_{0,-1}]^{1/2}(u - Z)$, where Z is as above. Then, integrate the function $(1-u)^i [u^2 - 1]^{1/2} / (u - Z)$ on a closed contour surrounding at a distance $\epsilon > 0$ the segment $[-1, 1]$, next use the residue theorem at infinity and at last, do ϵ going to zero. We get

$$\int_{-1}^1 (1-u)^i \frac{[1-u^2]^{1/2}}{u-Z} du = \pi \left((1-Z)^i (Z^2 - 1)^{1/2} - P_\infty [(1-Z)^i (Z^2 - 1)^{1/2}] \right),$$

from which (F.22) and thus also Lemma F.9 are immediate consequences. \square

Proposition F.10. *We suppose here that $p_{-1,0} + p_{0,1} + p_{1,0} + p_{0,-1} = 1$ and in addition that $p_{-1,0} = p_{1,0}$ as well as $p_{0,-1} < p_{0,1}$. Then, as $k \rightarrow \infty$,*

$\mathbb{P}_{(i_0, j_0)}[(X, Y) \text{ hits the horizontal axis at time } k] \sim$

$$\frac{i_0 j_0}{2\pi [p_{1,0}]^{1/2} [p_{0,1}p_{0,-1}]^{1/4}} \left(\frac{p_{0,-1}}{p_{0,1}} \right)^{j_0/2} \frac{[2(p_{1,0} + [p_{0,1}p_{0,-1}]^{1/2})]^k}{k^2}, \quad (\text{F.23})$$

$$\mathbb{P}_{(i_0, j_0)}[(X, Y) \text{ hits the vertical axis at time } k] \sim \frac{i_0}{[\pi p_{1,0}]^{1/2}} \left[1 - \left(\frac{p_{0,-1}}{p_{0,1}} \right)^{j_0} \right] \frac{1}{(2p_{0,1})^{j_0}} \frac{1}{k^{3/2}}. \quad (\text{F.24})$$

Proof. The proof of (F.23) is quite similar to the one of (F.12), whereas the proof of (F.24) is essentially the same as the one of (F.17); we omit the details. \square

Remark F.11. *Note that (F.23) formally implies (F.12). Likewise, (F.24) formally follows from (F.17) – after a proper change of the parameters. But remarkably, it is not possible to obtain (F.23) starting from (F.17) and then making the drift go to zero.*

F.2.5 Generalization of Subsection F.2.3

In this subsection, we are going to extend the range of the results of Subsection F.2.3. Precisely, we are going to consider here the set of all the walks associated for all z with a group of order 4 and having in addition two zero drifts, *i.e.* $p_{1,1} + p_{1,0} + p_{1,-1} = p_{-1,1} + p_{-1,0} + p_{-1,-1}$ and $p_{1,1} + p_{0,1} + p_{-1,1} = p_{1,-1} + p_{0,-1} + p_{-1,-1}$ – this set of walks is described in terms of the parameters in Lemma F.2. For all these walks, we are going to prove the following extension of Proposition F.5.

Proposition F.12. *We suppose here that the process has for all z a group of order 4 and that the two drifts are zero. Then, as $k \rightarrow \infty$, $\mathbb{P}_{(i_0, j_0)}[(X, Y) \text{ hits the horizontal axis at time } k]$ admits the following asymptotic :*

$$\frac{i_0 j_0}{2\pi [(p_{1,1} + p_{1,0} + p_{1,-1})(p_{1,1} + p_{0,1} + p_{-1,1})]^{1/2} k^2}.$$

The asymptotic of $\mathbb{P}_{(i_0, j_0)}[(X, Y) \text{ hits the vertical axis at time } k]$ is exactly the same.

Proof. We give here only a sketch of the proof of Proposition F.12, since the details are mainly the same as the ones for the proof of Proposition F.5.

First of all, note that Lemma F.2 implies that under the assumptions of Proposition F.12, either $\tilde{a} = \tilde{c}$ or $a = c$. In the sequel, let us suppose that $\tilde{a} = \tilde{c}$, we would deal with the symmetrical case $a = c$ similarly.

First, let us be interested in $\mathbb{P}_{(i_0, j_0)}[(X, Y) \text{ hits the horizontal axis at time } k]$, or equivalently, in their generating function $q^{i_0, j_0}(1, z)$.

If $\tilde{a} = \tilde{c}$, then the curve $X([y_1(z), y_2(z)], z)$ is simply the unit circle – indeed, note that for $y \in [y_1(z), y_2(z)]$, $|[-\tilde{b}(y, z) \pm \tilde{d}(y, z)^{1/2}]/[2\tilde{a}(y, z)]| = |\tilde{c}(y, z)/\tilde{a}(y, z)|^{1/2} = 1$. An adequate CGF is thus just $w(t, z) = t + 1/t$ and after some calculations, Theorem F.1 yields

$$q^{i_0, j_0}(x, z) = \frac{x}{\pi} \int_{x_3(z)}^{x_4(z)} [t^{i_0} - 1/t^{i_0}] \frac{\mu_{j_0}(t, z) [-d(t, z)]^{1/2}}{t(t-x)} dt + x P_\infty [x^{i_0-1} Y_0(x, z)^{j_0}]. \quad (\text{F.25})$$

Then, we could adapt the change of variable $t = t_+(u, z)$ made in Subsection F.2.1, next, with some additional technical details, we could follow the proof of Proposition F.5 and finally, we would obtain the asymptotic of $\mathbb{P}_{(i_0, j_0)}[(X, Y) \text{ hits the horizontal axis at time } k]$ claimed in Proposition F.12.

Let us now be interested in $\mathbb{P}_{(i_0, j_0)}[(X, Y) \text{ hits the vertical axis at time } k]$, or equivalently, in their generating function $\tilde{q}^{i_0, j_0}(1, z)$.

By applying Lemma F.13 below, we obtain that the curve $Y([x_1(z), x_2(z)], z)$ is a circle (possibly degenerated into a straight line), say of center $\gamma(z)$ and radius $\rho(z)$ – which can,

besides, easily be made explicit from the proof of Lemma F.13. In particular, the function $\tilde{w}(t, z) = t + \rho(z)^2/(t - \gamma(z))$ is clearly a suitable CGF for the set $\mathcal{G}Y([x_1(z), x_2(z)], z)$.

Define now the function $\sigma(t, z) = \gamma(z) + \rho(z)^2/(t - \gamma(z))$. Among many noteworthy relationships, it satisfies to $\tilde{w}(\sigma(t, z), z) = \tilde{w}(t, z)$ and $\sigma([y_1(z), y_2(z)], z) = [y_3(z), y_4(z)]$. Skipping over the details, Theorem F.1 becomes

$$\tilde{q}^{i_0, j_0}(y, z) = \frac{y}{\pi} \int_{y_3(z)}^{y_4(z)} [t^{j_0} - \sigma(t, z)^{j_0}] \frac{\tilde{\mu}_{i_0}(t, z) [-\tilde{d}(t, z)]^{1/2}}{t(t - y)} dt + yP_\infty [X_0(y, z)^{i_0} y^{j_0 - 1}].$$

Then we could, one more time, adapt the change of variable $t = t_+(u, z)$ proposed in Subsection F.2.1 and in this way, we would get the asymptotic of $\mathbb{P}_{(i_0, j_0)}[(X, Y)$ hits the vertical axis at time $k]$ announced in the statement of Proposition F.12. \square

Lemma F.13. *Suppose that*

$$\Delta(z) = \begin{vmatrix} p_{1,1} & p_{1,0} & p_{1,-1} \\ p_{0,1} & -1/z & p_{0,-1} \\ p_{-1,1} & p_{-1,0} & p_{-1,-1} \end{vmatrix} = 0.$$

Then the curves $X([y_1(z), y_2(z)], z)$ and $Y([x_1(z), x_2(z)], z)$ are circles, eventually degenerated into straight lines.

Proof of Lemma F.13. The proof is based on the possibility of expressing both curves $X([y_1(z), y_2(z)], z)$ and $Y([x_1(z), x_2(z)], z)$ as quartics. The arguments given in this aim [FIM99] for the particular case $z = 1$ can be actually adapted to any value of z and we get

$$Y([x_1(z), x_2(z)], z) = \{(u, v) \in \mathbb{R}^2 : q(u, v)^2 - q_1(u, v, z)q_2(u, v, z) = 0\},$$

where $q(u, v)$, $q_1(u, v, z)$ and $q_2(u, v, z)$ are respectively equal to

$$\begin{vmatrix} p_{1,1} & p_{1,0} & p_{1,-1} \\ 1 & -2u & u^2 + v^2 \\ p_{-1,1} & p_{-1,0} & p_{-1,-1} \end{vmatrix}, \quad \begin{vmatrix} 1 & -2u & u^2 + v^2 \\ p_{0,1} & -1/z & p_{0,-1} \\ p_{-1,1} & p_{-1,0} & p_{-1,-1} \end{vmatrix}, \quad \begin{vmatrix} p_{1,1} & p_{1,0} & p_{1,-1} \\ p_{0,1} & -1/z & p_{0,-1} \\ 1 & -2u & u^2 + v^2 \end{vmatrix}.$$

Note that this expression of $Y([x_1(z), x_2(z)], z)$ in terms of three determinants is new, compared to [FIM99]. Of course, we could write a similar expression for $X([y_1(z), y_2(z)], z)$.

We are now going to establish some relationships between the coefficients of the three polynomials above, but before, take the notations $q_i(u, v, z) = \alpha_i(z) - 2\beta_i u + \gamma_i(z)(u^2 + v^2)$, for $i \in \{1, 2\}$.

Then, by simple calculations, we verify the three following facts : firstly, $\alpha_1(z)\gamma_2(z) - \alpha_2(z)\gamma_1(z) = -\Delta(z)/z$; secondly, $\alpha_1(z)\beta_2 - \alpha_2(z)\beta_1 = -p_{0,-1}\Delta(z)$; thirdly, $\gamma_1(z)\beta_2 - \gamma_2(z)\beta_1 = p_{0,1}\Delta(z)$.

In particular, if $\Delta(z) = 0$, then the polynomials q_1 and q_2 are proportional. In addition to that, the Cramer's formulas entail that $q_z(u, v)/z = p_{1,0}q_1(u, v, z) + p_{-1,0}q_2(u, v, z) + 2u\Delta(z)$, so that if $\Delta(z) = 0$, then q , q_1 and q_2 are multiple of the same polynomial. *A priori*, it may quite happen that one or even several of q , q_1 and q_2 are zero ; in fact, we could show that at most one of these three polynomials can be equal to zero, otherwise the walk would be degenerated – we recall that a walk is said to be degenerated if there are (at least) three consecutive zeros in $p_{1,1}, p_{1,0}, p_{1,-1}, p_{0,-1}, p_{-1,-1}, p_{-1,0}, p_{-1,-1}, p_{-1,0}, p_{-1,-1}, p_{0,1}$ –, which would be contrary to the assumptions done here, see the beginning of Chapter F.

So in any non degenerated case, we can write that $Y([x_1(z), x_2(z)], z) = \{(u, v) \in \mathbb{R}^2 : r(u, v, z) = 0\}$, where r stands for any non-zero polynomial among q, q_1 and q_2 .

But clearly the curve $\{(u, v) \in \mathbb{R}^2 : r(u, v, z) = 0\}$ is a circle (eventually degenerated in a straight line), for which we could easily write the center and the radius, the proof of Lemma F.13 is therefore completed.

To be exhaustive, let us give here the single possibilities for $Y([x_1(z), x_2(z)], z)$ and $X([y_1(z), y_2(z)], z)$ to be straight lines.

- (i) $Y([x_1(z), x_2(z)], z)$ is a straight line if and only if $p_{0,1} + p_{1,-1} + p_{0,-1} + p_{-1,-1} = 1$; in that case, $Y([x_1(z), x_2(z)], z) = \{(u, v) \in \mathbb{R}^2 : 2p_{0,1}zu = 1\}$ and $X([y_1(z), y_2(z)], z)$ is the circle of center 0 and radius $[p_{-1,-1}/p_{1,-1}]^{1/2}$.
- (ii) $X([y_1(z), y_2(z)], z)$ is a straight line if and only if $p_{1,0} + p_{-1,1} + p_{-1,0} + p_{-1,-1} = 1$; in that case, $X([y_1(z), y_2(z)], z) = \{(u, v) \in \mathbb{R}^2 : 2p_{1,0}zu = 1\}$ and $Y([x_1(z), x_2(z)], z)$ is the circle of center 0 and radius $[p_{-1,-1}/p_{-1,1}]^{1/2}$.

The proof of both facts (i) and (ii) consists simply in a play with the parameters, so we omit it. □

F.3 Case of a group of order 6 for all z

Results of Section F.3 deal with the two walks of Picture F.3 below – more generally, we could obtain similar results for all the walks having, for all z , a group of order 6.



FIGURE F.3 – Walks studied in Section F.3 (the jump probabilities are equal to $1/3$ on the left and to $1/6$ on the right) associated, for all z , with a group of order 6

Proposition F.14. *For both processes represented on Picture F.3, the following asymptotic holds as $k \rightarrow \infty$:*

$$\mathbb{P}_{(i_0, j_0)}[(X, Y) \text{ hits the horizontal axis at time } k] \sim \frac{9}{16} \left(\frac{3}{\pi}\right)^{1/2} \frac{i_0 j_0 (i_0 + j_0)}{k^{5/2}}.$$

The asymptotic of $\mathbb{P}_{(i_0, j_0)}[(X, Y) \text{ hits the vertical axis at time } k]$ is exactly the same.

With the same arguments that have allowed us to obtain Corollary F.6 from Proposition F.5, Proposition F.14 implies the following result.

Corollary F.15. *Setting $h(i_0, j_0) = i_0 j_0 (i_0 + j_0)$, the Doob h -process of (X, Y) coincides in distribution with the limit as $k \rightarrow \infty$ of the process conditioned on $[\tau > k]$, τ denoting the hitting time of the boundary.*

Of course, the proof of Proposition F.14 is essentially similar for the two processes of Picture F.3 and we choose to present here the details only for the process on the right.

Historically, we were interested in this particular random walk for reasons related to the voter model, that we are now going to introduce, in Subsection F.3.1. Then, in Subsection F.3.2, we will obtain the exact distribution of the hitting times of each of the axes. Finally, in Subsection F.3.3, we will be interested in the asymptotic tail distribution of these hitting times and we will prove Proposition F.14.

F.3.1 The voter model

By “the voter model”, we mean a continuous-time process on $\{0, 1\}^{\mathbb{Z}}$ which can be interpreted as follows : initially, there is zero or one particle at each site of \mathbb{Z} , then a particle appears (resp. disappears) at an empty (resp. occupied) site x according to an exponential law with a rate proportional to the number of nearest neighbors of x occupied (resp. empty). Moreover, we assume that the initial state appertains to the set of configurations having a finite number of empty (resp. occupied) sites on the left (resp. right) of the origin 0. In particular, this implies that at any time the process will belong to this set of configurations. As a consequence there is, at any time, a finite number of “01” (resp. “10”), *i.e.* a finite number of pairs of sites $(x, x + 1)$ with zero (resp. one) particle at x and one (resp. zero) particle at $x + 1$.

The underlying discrete-time voter model is the Markov chain with the following dynamic : denote by \mathcal{C}_n the configuration at time n (and remember that according to the previous paragraph, there is only a finite number of “01” and “10” in \mathcal{C}_n), next, in order to construct \mathcal{C}_{n+1} , one first chooses with a uniform distribution one of these “01” and “10” in \mathcal{C}_n , then one replaces it, with probability 1/2, by “00” or “11”.

If the voter model starts from the Heaviside configuration, *i.e.* the configuration having only occupied (resp. empty) sites on the left (resp. right) of the origin, then at any time, the process will be a translation of it. This fact suggests to consider the following equivalence relation : two configurations are said to be equivalent if they are translations the one of the other.

From now on, we are going to work on the underlying quotient space, the equivalence classes of which being identified by finite sets of positive integers $(X_1, Y_1, \dots, X_N, Y_N)$:

$$\dots 111 \overbrace{0000}^{X_1} \overbrace{111}^{Y_1} \overbrace{00000}^{X_2} \overbrace{11111}^{Y_2} \dots \overbrace{000}^{X_N} \overbrace{1111}^{Y_N} 000 \dots, \tag{F.26}$$

N being the number of finite blocks of zeros (or ones) and X_i (resp. Y_i), $i \in \{1, \dots, N\}$ the size of the i th block of zeros (resp. ones). The number N of finite blocks of zeros is obviously a non-increasing function of the time ; also $N = 0$ corresponds to the class of the Heaviside configuration.

We refer to [Lig85] for additional details about the voter model and, more generally, for further information about interacting particle systems.

*

By an adequate use of some Lyapunov functions, the authors of [BFMP01] prove in their work that if τ denotes the hitting time of the Heaviside configuration, then $\mathbb{E}[\tau^{3/2-\epsilon}] < \infty$ for any $\epsilon > 0$ and any initial configuration of particles. Next, to prove that $\mathbb{E}[\tau^{3/2+\epsilon}] = \infty$ for any $\epsilon > 0$ and any initial state different from the Heaviside configuration, they remark

that it suffices to show it only for the initial states such that $N = 1$ in (F.26). So, with the notations of (F.26), they consider the process $(X_1, Y_1) = (X_1(k), Y_1(k))_{k \geq 0}$, that we rename here (X, Y) .

$$\dots 111 \overbrace{000000}^{X(k)} \overbrace{11111}^{Y(k)} 000 \dots$$

(X, Y) is a Markov chain on \mathbb{Z}_+^2 which is absorbed as it reaches the boundary, since the Heaviside configuration is an absorbing state for the voter model. Moreover, using the dynamic of the discrete-time voter model explained above, we obtain that (X, Y) has homogeneous transition probabilities in the interior of \mathbb{Z}_+^2 equal to (with obvious notations) $p_{1,0} = p_{1,-1} = p_{0,-1} = p_{-1,0} = p_{-1,1} = p_{0,1} = 1/6$ and the others to 0, see on the right of Picture F.3.

Set now

$$\tau = \inf\{k \geq 0 : X(k) = 0 \text{ or } Y(k) = 0\}.$$

Equivalently, from the point of view of the voter model, τ is the hitting time of the Heaviside configuration starting from an initial configuration such that $N = 1$ in (F.26).

Then, using the work [AIM96] (about passage time moments for reflected random walks in \mathbb{Z}_+^2), the authors of [BFMP01] prove that $\mathbb{E}_{(i_0, j_0)}[\tau^{3/2+\epsilon}] = \infty$ for any $\epsilon > 0$ and any initial state (i_0, j_0) inside of \mathbb{Z}_+^2 .

*

Now we would like to emphasize some other approaches that lead to rather precise results concerning the hitting time τ .

Firstly, in [Var99], N. Varopoulos analyzes the hitting time of the boundary of cones for centered and non-correlated d -dimensional random walks. He obtains, for large k , lower and upper bounds for the probability that the process doesn't have left the cone at time k . By linear mappings, these results can be extended to correlated random walks. Applying these quite general findings to our situation, we obtain the existence of two positive quantities $C_1(i_0, j_0)$ and $C_2(i_0, j_0)$ such that for k large enough,

$$\frac{C_1(i_0, j_0)}{k^{3/2}} \leq \mathbb{P}_{(i_0, j_0)}[\tau > k] \leq \frac{C_2(i_0, j_0)}{k^{3/2}}.$$

Secondly, motivated by constructing some processes conditioned on staying in the same order at any time as Doob h -processes, the authors of the article [EK08] examine "ordered random walks" and study the time when for the first time these processes become not ordered. In this way, they consider d independent copies of the simple random walk on \mathbb{Z} , say W_1, \dots, W_d , such that $0 < W_1(0) < \dots < W_d(0)$ and they show that if $\tilde{\tau} = \inf\{k \geq 0 : \exists i, W_i(k) = W_{i+1}(k)\}$, then

$$\mathbb{P}_{(W_1(0), \dots, W_d(0))}[\tilde{\tau} > k] \sim_{k \rightarrow \infty} K_d \prod_{1 \leq i < j \leq d} (W_j(0) - W_i(0)) \frac{1}{k^{d(d-1)/4}},$$

where $K_d > 0$ is some constant. By using these results for $d = 3$, it is certainly possible to obtain the asymptotic of $\mathbb{P}_{(i_0, j_0)}[\tau > k]$ in our situation.

*

In this work we will start, in Subsection F.3.2, by finding explicitly the exact distribution of the hitting times of both axes. In other words we will obtain, for any time k , an explicit formulation for the probability to hit at time k the Heaviside configuration in the voter model starting from an initial state such that $N = 1$ in (F.26); we will also obtain the additional information of the size of the blocks at the absorption time.

Then in Subsection F.3.3, we will prove Proposition F.14 on the asymptotic tail distribution of the hitting times of both axes.

F.3.2 Exact distribution of the hitting times of both axes

Proposition F.16. $q^{i_0, j_0}(1, z) = q_1^{i_0, j_0}(1, z) + q_2^{i_0, j_0}(1, z) + q_3^{i_0, j_0}(1, z)$, where :

$$\begin{aligned} q_1^{i_0, j_0}(1, z) &= Y_0(1, z)^{j_0}, & q_2^{i_0, j_0}(1, z) &= \frac{1}{\pi} \int_{x_1(z)}^{x_2(z)} \frac{t^{i_0-1}}{t-1} \mu_{j_0}(t, z) [-d(t, z)]^{1/2} dt, \\ q_3^{i_0, j_0}(1, z) &= \frac{1}{\pi} \int_{x_1(z)}^{x_2(z)} t^{i_0} \left[\frac{1}{t - X_1(Y_0(1, z), z)} + \right. \\ &\quad \left. + \frac{1}{t - X_1(Y_1(1, z), z)} - \frac{1}{t+1} \right] \mu_{j_0}(t, z) [-d(t, z)]^{1/2} dt. \end{aligned}$$

Proof. We have already proved that $q^{i_0, j_0}(1, z)$ equals (F.1). Moreover, a suitable CGF w for the curve $X([y_1(z), y_1(z)], z)$ is found in Proposition B.27 of Chapter B. In order to conclude, it is enough to put in (F.1) the partial fraction expansion of $\partial_t w(t, z)/[w(t, z) - w(1, z)] - \partial_t w(t, z)/[w(t, z) - w(0, z)]$, namely $x/[t(t-1)] + 1/[t - X_1(Y_0(1, z), z)] + 1/[t - X_1(Y_1(1, z), z)] - 1/[t+1]$. \square

The end of Subsection F.3.2 aims at obtaining an explicit expression of $q^{i_0, j_0}(1, z)$ which is efficient (in the sense of the calculation of the asymptotic of its coefficients). In order to achieve this, we are going to make the change of variable $\hat{b}(t, z) = b(t, z)/[4a(t, z)c(t, z)]^{1/2}$ in the integrals of Proposition F.16.

$t \mapsto \hat{b}(t, z)$ is clearly a diffeomorphism between $]x_1(z), x_2(z)[$ and $] -1, 1[$; in addition, $\hat{b}(t, z) = u$ implies $b(t, z)^2 - 4u^2 a(t, z) c(t, z) = 0$, which, as a polynomial in the variable t , is reciprocal, so that we can quite easily obtain and write the explicit expression of its roots, called the $t_i(u, z)$, $i \in \{1, \dots, 4\}$. Defining $T(u, z) = 3/z + u^2 - u[2 + u^2 + 6/z]^{1/2}$, then $t_2(u, z) = T(u, z) - [T(u, z)^2 - 1]^{1/2}$, $t_3(u, z) = T(u, z) + [T(u, z)^2 - 1]^{1/2}$, $t_1(u, z) = t_2(-u, z)$ and $t_4(u, z) = t_3(-u, z)$. Note that we have enumerated the $t_i(u, z)$ in such a way that for $i \in \{1, \dots, 4\}$, $t_i(1, z) = x_i(z)$.

Moreover, it turns out that for all $u \in [-1, 1]$, $\hat{b}(t_2(u, z), z) = -u$, so that the following result is an immediate consequence of the change of variable $t = t_2(u, z)$ in Proposition F.16 as well as of the identity (F.3).

Corollary F.17. For all $z \in]0, 1[$, $q^{i_0, j_0}(1, z) = q_1^{i_0, j_0}(1, z) + q_2^{i_0, j_0}(1, z) + q_3^{i_0, j_0}(1, z)$, where :

$$\begin{aligned} q_1^{i_0, j_0}(1, z) &= [(3 - z - 3[(1 - z)(1 + z/3)]^{1/2}) / (2z)]^{j_0}, \\ q_2^{i_0, j_0}(1, z) &= \frac{1}{\pi} \int_{-1}^1 \frac{U_{j_0-1}(u)t_2(u, z)^{i_0+j_0/2-1}}{t_2(u, z) - 1} \partial_u t_2(u, z) [1 - u^2]^{1/2} du, \\ q_3^{i_0, j_0}(1, z) &= \frac{1}{\pi} \int_{-1}^1 U_{j_0-1}(u)t_2(u, z)^{i_0+j_0/2} \left[\frac{1}{t_2(u, z) - X_1(Y_0(1, z), z)} + \right. \\ &\quad \left. + \frac{1}{t_2(u, z) - X_1(Y_1(1, z), z)} - \frac{1}{t_2(u, z) + 1} \right] \partial_u t_2(u, z) [1 - u^2]^{1/2} du. \end{aligned}$$

F.3.3 Asymptotic tail distribution of the hitting times

In order to prove Proposition F.14, we are going to use the same approach as in Section F.2; namely, we are going to prove that $q^{i_0, j_0}(1, z)$ is holomorphic in $(1 + \epsilon)\mathcal{D} \setminus [1, 1 + \epsilon[$ and that in the neighborhood of 1,

$$q^{i_0, j_0}(1, z) = (3/4)3^{1/2}i_0j_0(i_0 + j_0)[1 - z]^{3/2}[1 + o(1)] + h_0^{i_0, j_0}(z), \quad (\text{F.27})$$

where $h_0^{i_0, j_0}$ is holomorphic at 1; it will then be enough to use the results of [FO90].

For this, according to Corollary F.17, we are going to consider successively $q_1^{i_0, j_0}(1, z)$, $q_2^{i_0, j_0}(1, z)$ and $q_3^{i_0, j_0}(1, z)$ in respectively Propositions F.18, F.19 and F.20. Proposition F.14 will be then an immediate consequence of these three results.

Proposition F.18. $q_1^{i_0, j_0}(1, z)$ is holomorphic in $(1 + \epsilon)\mathcal{D} \setminus [1, 1 + \epsilon[$ and in the neighborhood of 1 is equal to

$$q_1^{i_0, j_0}(1, z) = -j_03^{1/2}[1 - z]^{1/2}[1 + (3 + 4j_0^2)(1 - z)/8 + f_{1,1}^{i_0, j_0}(z)(z - 1)^2] + f_{1,2}^{i_0, j_0}(z),$$

where $f_{1,1}^{i_0, j_0}$ and $f_{1,2}^{i_0, j_0}$ are holomorphic at 1.

Proposition F.19. $q_2^{i_0, j_0}(1, z)$ is holomorphic in $(1 + \epsilon)\mathcal{D} \setminus [1, 1 + \epsilon[$ and in the neighborhood of 1 is equal to

$$\begin{aligned} q_2^{i_0, j_0}(1, z) &= \frac{3^{1/2}j_0}{2}[1 - z]^{1/2}[1 + (1/2)(3/4 + j_0^2)(1 - z) + f_{2,1}^{i_0, j_0}(z)(1 - z)^2] \\ &\quad + \frac{3^{1/2}j_0}{2\pi}(i_0 + j_0/2 - 1/2) \ln(1 - z) [1 + (1 - z)f_{2,2}^{i_0, j_0}(z)] + f_{2,3}^{i_0, j_0}(z), \end{aligned}$$

where $f_{2,1}^{i_0, j_0}$, $f_{2,2}^{i_0, j_0}$ and $f_{2,3}^{i_0, j_0}$ are holomorphic at 1.

Proposition F.20. $q_3^{i_0, j_0}(1, z)$ is holomorphic in $(1 + \epsilon)\mathcal{D} \setminus [1, 1 + \epsilon[$ and in the neighborhood of 1 is equal to

$$\begin{aligned} q_3^{i_0, j_0}(1, z) &= \frac{3^{1/2}j_0}{16}(1 - z)^{1/2}[8 + (3 + 4j_0^2 + 12i_0(i_0 + j_0))(1 - z) + f_{3,1}^{i_0, j_0}(z)(1 - z^2)] \\ &\quad - \frac{3^{1/2}j_0}{4\pi}(2i_0 + j_0 - 1) \ln(1 - z) [1 + (1 - z)f_{3,2}^{i_0, j_0}(z)] + f_{3,3}^{i_0, j_0}(z), \end{aligned}$$

where $f_{3,1}^{i_0, j_0}$, $f_{3,2}^{i_0, j_0}$ and $f_{3,3}^{i_0, j_0}$ are holomorphic at 1.

Proof of Proposition F.18. It follows directly from the expression of $q_1^{j_0, j_0}(1, z)$ written in Corollary F.17. \square

In order to prove Propositions F.19-F.20, we are going to need the two following results, that deal with the behavior of some integrals with parameters near their singularities.

Lemma F.21. *For any $k \in \mathbb{Z}_+$, let P_k be the principal part at infinity of $[Z^2 - 1]^{1/2}(1 - Z)^k$, i.e. the only polynomial such that $[Z^2 - 1]^{1/2}(1 - Z)^k - P_k(Z)$ goes to zero as $|Z|$ goes to infinity. Then*

$$\int_{-1}^1 \frac{(1-u)^k [1-u^2]^{1/2}}{1-z(1+2u)/3} du = \frac{3\pi}{2z} \left[(1+z/3)^{1/2} \left(\frac{-3}{2z} \right)^{k+1} (1-z)^{k+1/2} + P_k \left(\frac{3}{2z} - \frac{1}{2} \right) \right].$$

Proof. For $\epsilon > 0$, we consider the closed contour $\mathcal{A}_\epsilon^+ \cup \mathcal{A}_\epsilon^- \cup \mathcal{B}_\epsilon^+ \cup \mathcal{B}_\epsilon^-$, where $\mathcal{A}_\epsilon^\pm = \{\pm 1 \mp i\epsilon \exp(it), t \in [0, \pi]\}$ and $\mathcal{B}_\epsilon^\pm = \{\pm i\epsilon \mp t, t \in [-1, 1]\}$. Then we apply on it the residue theorem at infinity to the function $(1-u)^k [1-u^2]^{1/2} / [1-z(1+2u)/3]$ and we let ϵ going to zero. \square

Lemma F.22. *For any $k \in \mathbb{Z}_+$, the integrals written in the left hand side of (F.28) and (F.29) are holomorphic in $(1+\epsilon)\mathcal{D} \setminus [1, 1+\epsilon[$ for $\epsilon > 0$ small enough. In the neighborhood of 1, they are equal to*

$$\int_{-1}^1 \frac{(1-u)^k [1-u^2]^{1/2}}{[1-z(1+2u)/3]^{1/2}} du = \ln(1-z)(1-z)^{k+1} \alpha_k(z) + \beta_k(z), \quad (\text{F.28})$$

$$\int_{-1}^1 \frac{(1-u)^k [1-u^2]^{1/2}}{[1-z(1+2u)/3]^{3/2}} du = \ln(1-z)(1-z)^k \gamma_k(z) + \delta_k(z), \quad (\text{F.29})$$

where $\alpha_k, \beta_k, \gamma_k, \delta_k$ are holomorphic at 1, $\alpha_k(1) \neq 0$ and $\gamma_k(1) \neq 0$. Moreover, $\alpha_0(1) = 3^{3/2}/4$, $\gamma_0(1) = -3^{3/2}/2$, $\gamma'_0(1) = -3^{1/2}99/32$ and $\gamma_1(1) = 3^{1/2}27/8$.

Proof. The fact that the integrals written in the left hand side of (F.28) and (F.29) are, for $\epsilon > 0$ small enough, holomorphic in $(1+\epsilon)\mathcal{D} \setminus [1, 1+\epsilon[$ is clear from their expression.

Let us now study their behavior near 1 and start by considering (F.28).

Replace first the lower bound -1 by $-1/2$ in the integral (F.28). This is equivalent to add a function holomorphic in some $(1+\epsilon)\mathcal{D}$ and this will eventually change β_k but not α_k in the right hand side member of (F.28). Then, the change of variable $v^2 = (1+2u)/3$ gives

$$\int_{-1/2}^1 \frac{(1-u)^k [1-u^2]^{1/2}}{[1-z(1+2u)/3]^{1/2}} du = 3^{1/2} \left(\frac{3}{2} \right)^{k+1} \int_0^1 \frac{[1-v^2]^{k+1/2}}{[1-zv^2]^{1/2}} [1+3v^2]^{1/2} v dv. \quad (\text{F.30})$$

By using the expansion of $v^{1/2}$ in the neighborhood of 1, we can develop the function $[1+3v^2]^{1/2}v$ according to the powers of $v^2 - 1$: $[1+3v^2]^{1/2}v = 2 + (7/4)[v^2 - 1] + \dots$. But in Subsection F.2.3, we have proved, using the elliptic integrals theory, that for any $k \in \mathbb{Z}_+$ there exist two functions ϕ_k and ψ_k , holomorphic in the neighborhood of 1 and verifying $\phi_k(1) \neq 0$, such that

$$\int_0^1 \frac{[1-v^2]^{1/2+k}}{[1-zv^2]^{1/2}} dv = \ln(1-z)(z-1)^{k+1} \phi_k(z) + \psi_k(z), \quad (\text{F.31})$$

we have there also proved that $\phi_0(1) = 1/4$. The equality (F.28) is then an immediate consequence of (F.30), of the expansion of $[1 + 3v^2]^{1/2}v$ according to the powers of $v^2 - 1$ and of the repeated use of the identity (F.31). The fact that $\alpha_0(1) = 3^{3/2}/4$ comes from the equality $\phi_0(1) = 1/4$.

Likewise, we could prove the equality (F.29) and we could obtain the announced values of $\gamma_0(1)$, $\gamma'_0(1)$ and $\gamma_1(1)$. \square

Proof of Proposition F.19. We recall from Corollary F.17 that

$$q_2^{i_0, j_0}(1, z) = \frac{1}{\pi} \int_{-1}^1 \frac{U_{j_0-1}(u)t_2(u, z)^{i_0+j_0/2-1}}{t_2(u, z) - 1} \partial_u t_2(u, z) [1 - u^2]^{1/2} du, \quad (\text{F.32})$$

where $t_2(u, z) = T(u, z) - [T(u, z)^2 - 1]^{1/2}$ and $T(u, z) = 3/z + u^2 - u[2 + u^2 + 6/z]^{1/2}$. In particular, the fact that $q_2^{i_0, j_0}(1, z)$ is holomorphic in $(1 + \epsilon)\mathcal{D} \setminus [1, 1 + \epsilon[$ is clear, since making the change of variable $u \mapsto -u$ in (F.32) allows us to write it as the integral on $[0, 1]$ of some function holomorphic in $\mathcal{D} \times ((1 + \epsilon)\mathcal{D} \setminus [1, 1 + \epsilon[)$ – note that any function symmetrical in $(T(u, z), T(-u, z))$ is holomorphic w.r.t. z .

Let us now study the behavior of $q_2^{i_0, j_0}(1, z)$ in the neighborhood of 1. For this, we are first going to transform (F.32), until obtaining an expression that makes clearly appear the singularities of $q_2^{i_0, j_0}(1, z)$.

An easy calculation entails that $\partial_u t_2 = \partial_u T / (1 - t_3^2)$. Moreover, by definition of the t_i (see Subsection F.3.2), $(z^2/36) \prod_{i=1}^4 (t - t_i(u, z))$ is equal to $b(t, z)^2 - 4u^2 a(t, z) c(t, z)$. In particular, $\prod_{i=1}^4 (1 - t_i(u, z)) = (36/z^2)(1 - z(1 + 2u)/3)(1 - z(1 - 2u)/3)$. So we have :

$$\frac{\partial_u t_2(u, z)}{t_2(u, z) - 1} = \frac{z^2 \partial_u T(u, z) (1 - t_1(u, z)) (1 - t_4(u, z)) (1 - t_2(u, z))}{18(1 - z(1 - 2u)/3)(t_2(u, z) - t_3(u, z))(1 - z(1 + 2u)/3)}. \quad (\text{F.33})$$

Let us now expand the quantity $(1 - t_2(u, z))t_2(u, z)^{i_0+j_0/2-1}$ according to the powers of $[T(u, z)^2 - 1]^{1/2}$, say $(1 - t_2(u, z))t_2(u, z)^{i_0+j_0/2-1} = \sum_{k \geq 0} F_k^{i_0, j_0}(u, z) [T(u, z)^2 - 1]^{k/2}$.

With these notations, (F.32) and (F.33), we get

$$q_2^{i_0, j_0}(1, z) = \sum_{k \geq 0} \int_{-1}^1 \frac{z^2 \partial_u T(u, z) (1 - t_1(u, z)) (1 - t_4(u, z))}{18(1 - z(1 - 2u)/3)} F_k^{i_0, j_0}(u, z) \times \quad (\text{F.34})$$

$$\times \frac{[T(u, z)^2 - 1]^{k/2}}{(t_2(u, z) - t_3(u, z))(1 - z(1 + 2u)/3)} U_{j_0-1}(u) [1 - u^2]^{1/2} du.$$

Below, we are going to study the behavior near 1 of each integral in the sum (F.34).

*

Let us start by the ones corresponding to $k \in \{0, 1, 2\}$ in the sum (F.34). First, note that

$$F_0^{i_0, j_0} = T^{i_0+j_0/2-1}(1 - T), \quad F_1^{i_0, j_0} = T^{i_0+j_0/2-2}[T - (i_0 + j_0/2 - 1)(1 - T)],$$

$$F_2^{i_0, j_0} = T^{i_0+j_0/2-3}(i_0 + j_0/2 - 1)[(1 - T)(i_0 + j_0/2 - 2)/2 - T].$$

Now we set $F^{j_0}(u, z) = -z^2 \partial_u T(u, z) (1 - t_1(u, z)) (1 - t_4(u, z)) U_{j_0-1}(u) / (36(1 - z(1 - 2u)/3))$ and

$$G_0^{i_0, j_0}(u, z) = [F^{j_0}(u, z) F_0^{i_0, j_0}(u, z) z^2 [T(-u, z)^2 - 1]^{1/2}] / [3(z + 3)(1 - z(1 - 2u)/3)^{1/2}],$$

$$G_1^{i_0, j_0}(u, z) = F^{j_0}(u, z) F_1^{i_0, j_0}(u, z),$$

$$G_2^{i_0, j_0}(u, z) = [F^{j_0}(u, z) F_2^{i_0, j_0}(u, z) 3(z + 3)(1 - z(1 - 2u)/3)^{1/2}] / [z^2 [T_1(-u, z)^2 - 1]^{1/2}].$$

Since $t_2(u, z) - t_3(u, z) = -2[T(u, z)^2 - 1]^{1/2}$ and since $(t_2(u, z) - t_3(u, z))(t_1(u, z) - t_4(u, z)) = 12(z+3)^2[(1-z(1+2u)/3)(1-z(1-2u)/3)]^{1/2}/z^2$, the sum of the three terms for $k \in \{0, 1, 2\}$ in (F.34) is equal to

$$\sum_{k=0}^2 \int_{-1}^1 \frac{G_k^{i_0, j_0}(u, z)[1-u^2]^{1/2}}{[1-z(1+2u)/3]^{(3-k)/2}} du. \quad (\text{F.35})$$

Using now the expansion of the Chebyshev polynomials at 1 (see Subsection F.2.1), we obtain the expansion $G_0^{i_0, j_0}(u, z) = -2j_0(u-1)/9 - j_0(z-1)/3 + \sum_{k+l \geq 2} G_{0, k, l}^{i_0, j_0}(u-1)^k(z-1)^l$. Then, with a repeated use of (F.29) of Lemma F.22, we get

$$\int_{-1}^1 \frac{G_0^{i_0, j_0}(u, z)[1-u^2]^{1/2}}{[1-z(1+2u)/3]^{3/2}} du = j_0 3^{1/2} \ln(1-z) [(1-z)/4 + (1-z)^2 g_0^{i_0, j_0}(z)] + f_0^{i_0, j_0}(z),$$

$f_0^{i_0, j_0}$ and $g_0^{i_0, j_0}$ being holomorphic at 1.

In the same way, $G_1^{i_0, j_0}(u, z) = \sum_{k+l \geq 2} G_{1, k, l}^{i_0, j_0}(u-1)^k(z-1)^l - j_0/3 - j_0(6j_0^2 + 35 - 48i_0 - 24j_0)(u-1)/54 + j_0(-53 + 48i_0 + 24j_0)(z-1)/36$. A repeated application of Lemma F.21 gives then that

$$\begin{aligned} \int_{-1}^1 \frac{G_1^{i_0, j_0}(u, z)[1-u^2]^{1/2}}{1-z(1+2u)/3} du &= f_1^{i_0, j_0}(z) + j_0 3^{1/2} [1-z]^{1/2} \times \\ &\times [1/2 + (3/4 + j_0^2)(1-z)/4 + (1-z)^2 g_1(z)], \end{aligned}$$

$f_1^{i_0, j_0}$ and $g_1^{i_0, j_0}$ being holomorphic at 1.

At last, we have $G_2^{i_0, j_0}(u, z) = 2j_0(i_0 + j_0/2 - 1)/3 + \sum_{k+l \geq 1} G_{2, k, l}^{i_0, j_0}(u-1)^k(z-1)^l$. So with a repeated use of (F.28) of Lemma F.22, we get

$$\begin{aligned} \int_{-1}^1 \frac{G_2^{i_0, j_0}(u, z)[1-u^2]^{1/2}}{[1-z(1+2u)/3]^{1/2}} du &= f_2^{i_0, j_0}(z) + j_0(i_0 + j_0/2 - 1) 3^{1/2} \times \\ &\times \ln(1-z) [(1-z)/2 + (1-z)^2 g_2^{i_0, j_0}(z)], \end{aligned}$$

$f_2^{i_0, j_0}$ and $g_2^{i_0, j_0}$ being holomorphic at 1.

*

Let us now consider the terms corresponding to $k \geq 3$ in the sum (F.34).

Note first that if k is odd and larger than 3, then the associated function in (F.34) is in fact holomorphic in the neighborhood of 1 : indeed, for this it is enough to notice that $t_2(u, z) - t_3(u, z) = -2[T(u, z)^2 - 1]^{1/2}$. For this reason, all the terms associated in (F.34) with values of k odd and larger than 3 don't have any singularity at 1.

On the other hand, if k is even and larger than 3, then the underlying term in the sum (F.34) can be written as

$$\int_{-1}^1 [1-z(1+2u)/3]^{(k-3)/2} H_k^{i_0, j_0}(u, z)[1-u^2]^{1/2} du,$$

where $H_k^{i_0, j_0}(u, z)$ is some function holomorphic in the neighborhood of (1, 1). The last integral is obviously equal to

$$\int_{-1}^1 [1-z(1+2u)/3]^{(k-2)/2} H_k^{i_0, j_0}(u, z)[1-u^2]^{1/2} [1-z(1+2u)/3]^{-1/2} du.$$

Then, expanding $[1 - z(1 + 2u)/3]^{(k-2)/2} H_k^{i_0, j_0}(u, z)$ w.r.t. the powers of $(u - 1)^k (z - 1)^l$ and using (F.28) of Lemma F.22, we obtain that the integral above equals $\ln(1 - z)(z - 1)^{k-2} g_k^{i_0, j_0}(z) + f_k^{i_0, j_0}(z)$, $f_k^{i_0, j_0}$ and $g_k^{i_0, j_0}$ being holomorphic at 1.

Finally, the sum of all the terms corresponding in (F.34) to even k larger than 3 can be written, in the neighborhood of 1, as $\ln(1 - z)(1 - z)^2 g^{i_0, j_0}(z) + f^{i_0, j_0}(z)$, where f^{i_0, j_0} and g^{i_0, j_0} are holomorphic at 1.

*

Putting the latter fact together with (F.35) concludes the proof of Proposition F.19. \square

Proof of Proposition F.20. The proof of Proposition F.20 is completely similar to the one of Proposition F.19, so we omit it. \square

F.4 Case of a group of order 8 for all z and extensions

The analysis of Sections F.2 and F.3 can be formally extended up to the case of any process having, for all z , a rational CGF. Indeed, if so we can make the partial fraction expansion of

$$\frac{\partial_t w(t, z)}{w(t, z) - w(1, z)} - \frac{\partial_t w(t, z)}{w(t, z) - w(0, z)}$$

in the identity (F.1) – which is true for any walk – and then we can hope to conclude by similar calculations as the ones realized in Sections F.2 and F.3.

For instance, in the case of the walk on Picture F.4 below which has, for all z , a group of order 8 and a rational CGF, see Proposition B.29 in Chapter B, let us give without proof (the details are totally similar to the ones of Sections F.2 and F.3) the following result.

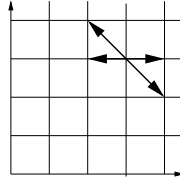

FIGURE F.4 – A walk with for all z a group of order 8 and a rational CGF (all the jump probabilities above are equal to 1/4)

Proposition F.23. *For the process represented on Picture F.4, the following asymptotic holds as $k \rightarrow \infty$:*

$$\mathbb{P}_{(i_0, j_0)}[(X, Y) \text{ hits the horizontal axis at time } k] \sim \frac{1}{3\pi} \frac{i_0 j_0 (i_0 + j_0) (i_0 + 2j_0)}{k^3}.$$

If k and i_0 don't have the same parity, then $\mathbb{P}_{(i_0, j_0)}[(X, Y) \text{ hits the vertical axis at time } k] = 0$. If they have the same parity, then the following asymptotic holds as $k \rightarrow \infty$:

$$\mathbb{P}_{(i_0, j_0)}[(X, Y) \text{ hits the vertical axis at time } k] \sim \frac{8}{3\pi} \frac{i_0 j_0 (i_0 + j_0) (i_0 + 2j_0)}{k^3}.$$

Corollary F.24. *Setting $h(i_0, j_0) = i_0 j_0 (i_0 + j_0)(i_0 + 2j_0)$, the Doob h -process of (X, Y) coincides in distribution with the limit as $k \rightarrow \infty$ of the process conditioned on $[\tau > k]$, τ denoting the hitting time of the boundary.*

On the other hand, for $n \geq 5$, no examples of walks having, for all z , a group of order $2n$ are known – at this time.

Finding the asymptotic tail distribution of the hitting times for any walk considered in Section F.1 seems to us a quite difficult task ; we hope keenly to develop this theme in the next few years.

Bibliographie

- [AFM95] I. M. Asymont, G. Fayolle, and M. V. Menshikov. Random walks in a quarter plane with zero drifts : transience and recurrence. *J. Appl. Probab.*, 32(4) :941–955, 1995.
- [AI97] S. Aspandiiarov and R. Iasnogorodski. Tails of passage-times and an application to stochastic processes with boundary reflection in wedges. *Stochastic Process. Appl.*, 66(1) :115–145, 1997.
- [AIM96] S. Aspandiiarov, R. Iasnogorodski, and M. Menshikov. Passage-time moments for nonnegative stochastic processes and an application to reflected random walks in a quadrant. *Ann. Probab.*, 24(2) :932–960, 1996.
- [Ayy09] A. Ayyer. Towards a human proof of Gessel’s conjecture. *J. Integer Seq.*, 12(4) :Article 09.4.2, 15, 2009.
- [BCK⁺10] A. Bostan, F. Chyzak, M. Kauers, L. Pech, and M. van Hoeij. Computing walks in a quadrant : a computer algebra approach via creative telescoping. *In preparation*, 2010.
- [BFMP01] V. Belitsky, P. A. Ferrari, M. V. Menshikov, and S. Y. Popov. A mixture of the exclusion process and the voter model. *Bernoulli*, 7(1) :119–144, 2001.
- [Bia91] P. Biane. Quantum random walk on the dual of $SU(n)$. *Probab. Theory Related Fields*, 89(1) :117–129, 1991.
- [Bia92a] P. Biane. Équation de Choquet-Deny sur le dual d’un groupe compact. *Probab. Theory Related Fields*, 94(1) :39–51, 1992.
- [Bia92b] P. Biane. Frontière de Martin du dual de $SU(2)$. In *Séminaire de Probabilités, XXVI*, volume 1526 of *Lecture Notes in Math.*, pages 225–233. Springer, Berlin, 1992.
- [Bia92c] P. Biane. Minuscule weights and random walks on lattices. In *Quantum probability & related topics*, QP-PQ, VII, pages 51–65. World Sci. Publ., River Edge, NJ, 1992.
- [Bia08] P. Biane. Introduction to random walks on noncommutative spaces. In *Quantum potential theory*, volume 1954 of *Lecture Notes in Math.*, pages 61–116. Springer, Berlin, 2008.
- [BK09] A. Bostan and M. Kauers. The complete generating function for Gessel walks is algebraic. *To appear in the Proceedings of the AMS. Preprint* : <http://arxiv.org/abs/0909.1965>, 2009.
- [BMM09] M. Bousquet-Mélou and M. Mishna. Walks with small steps in the quarter plane. *To appear in “Algorithmic Probability and Combinatorics”, special volume of the Contemporary Mathematics series of the AMS. Preprint* : <http://fr.arxiv.org/abs/0810.4387>, 2009.

- [BMP03] M. Bousquet-Mélou and M. Petkovsek. Walks confined in a quadrant are not always D-finite. *Theor. Comput. Sci.*, 307(2) :257–276, 2003.
- [Bou75] N. Bourbaki. *Éléments de mathématique*. Hermann, Paris, 1975. Fasc. XXXVIII : Groupes et algèbres de Lie. Chapitre VII : Sous-algèbres de Cartan, éléments réguliers. Chapitre VIII : Algèbres de Lie semi-simples déployées, Actualités Scientifiques et Industrielles, No. 1364.
- [Bru91] M.-F. Bru. Wishart processes. *J. Theoret. Probab.*, 4(4) :725–751, 1991.
- [CB83] J. W. Cohen and O. J. Boxma. *Boundary value problems in queueing system analysis*, volume 79 of *North-Holland Mathematics Studies*. North-Holland Publishing Co., Amsterdam, 1983.
- [CDD⁺07] W. Y. C. Chen, E. Y. P. Deng, R. R. X. Du, R. P. Stanley, and C. H. Yan. Crossings and nestings of matchings and partitions. *Trans. Amer. Math. Soc.*, 359(4) :1555–1575 (electronic), 2007.
- [Cha90] B. Chabat. *Introduction à l'analyse complexe. Tome 1*. Traduit du Russe : Mathématiques. [Translations of Russian Works : Mathematics]. “Mir”, Moscow, 1990. Fonctions d’une variable. [Functions of one variable], Translated from the Russian by Djilali Embarek.
- [Coh88a] J. W. Cohen. On entrance time distributions for two-dimensional random walks. In *Computer performance and reliability (Rome, 1987)*, pages 25–41. North-Holland, Amsterdam, 1988.
- [Coh88b] J. W. Cohen. On entrance times of a homogeneous N -dimensional random walk : an identity. *J. Appl. Probab.*, (Special Vol. 25A) :321–333, 1988. A celebration of applied probability.
- [Coh92a] J. W. Cohen. *Analysis of random walks*, volume 2 of *Studies in Probability, Optimization and Statistics*. IOS Press, Amsterdam, 1992.
- [Coh92b] J. W. Cohen. On the random walk with zero drifts in the first quadrant of \mathbb{R}_2 . *Comm. Statist. Stochastic Models*, 8(3) :359–374, 1992.
- [Coh94] J. W. Cohen. On a class of two-dimensional nearest-neighbour random walks. *J. Appl. Probab.*, 31A :207–237, 1994. Studies in applied probability.
- [Col04] B. Collins. Martin boundary theory of some quantum random walks. *Ann. Inst. H. Poincaré Probab. Statist.*, 40(3) :367–384, 2004.
- [DM09] Y. Doumerc and J. Moriarty. Exit problems associated with affine reflection groups. *Probab. Theory Related Fields*, 145(3-4) :351–383, 2009.
- [DO05] Y. Doumerc and N. O’Connell. Exit problems associated with finite reflection groups. *Probab. Theory Related Fields*, 132(4) :501–538, 2005.
- [Doo59] J. L. Doob. Discrete potential theory and boundaries. *J. Math. Mech.*, 8 :433–458 ; erratum 993, 1959.
- [DSW60] J. L. Doob, J. L. Snell, and R. E. Williamson. Application of boundary theory to sums of independent random variables. In *Contributions to probability and statistics*, pages 182–197. Stanford Univ. Press, Stanford, Calif., 1960.
- [Dyn69] E. Dynkin. The boundary theory of Markov processes (discrete case). *Uspehi Mat. Nauk*, 24(2 (146)) :3–42, 1969.
- [Dys62] F. Dyson. A Brownian-motion model for the eigenvalues of a random matrix. *J. Mathematical Phys.*, 3 :1191–1198, 1962.

- [EK08] P. Eichelsbacher and W. König. Ordered random walks. *Electron. J. Probab.*, 13 :no. 46, 1307–1336, 2008.
- [Fed86] M. V. Fedoryuk. Asymptotic methods in analysis. In *Current problems of mathematics. Fundamental directions, Vol. 13 (Russian)*, Itogi Nauki i Tekhniki, pages 93–210. Akad. Nauk SSSR Vsesoyuz. Inst. Nauchn. i Tekhn. Inform., Moscow, 1986.
- [Fel57] W. Feller. *An introduction to probability theory and its applications. Vol. I*. John Wiley and Sons, Inc., New York, 1957. 2nd ed.
- [FH84] L. Flatto and S. Hahn. Two parallel queues created by arrivals with two demands. I. *SIAM J. Appl. Math.*, 44(5) :1041–1053, 1984.
- [FI79] G. Fayolle and R. Iasnogorodski. Two coupled processors : the reduction to a Riemann-Hilbert problem. *Z. Wahrsch. Verw. Gebiete*, 47(3) :325–351, 1979.
- [FIM99] G. Fayolle, R. Iasnogorodski, and V. Malyshev. *Random walks in the quarter-plane*, volume 40 of *Applications of Mathematics (New York)*. Springer-Verlag, Berlin, 1999. Algebraic methods, boundary value problems and applications.
- [Fla85] L. Flatto. Two parallel queues created by arrivals with two demands. II. *SIAM J. Appl. Math.*, 45(5) :861–878, 1985.
- [FMM92] G. Fayolle, V. A. Malyshev, and M. V. Menshikov. Random walks in a quarter plane with zero drifts. I. Ergodicity and null recurrence. *Ann. Inst. H. Poincaré Probab. Statist.*, 28(2) :179–194, 1992.
- [FO90] P. Flajolet and A. Odlyzko. Singularity analysis of generating functions. *SIAM J. Discrete Math.*, 3(2) :216–240, 1990.
- [FR10] G. Fayolle and K. Raschel. On the holonomy or algebraicity of generating functions counting lattice walks in the quarter-plane. *To appear in Markov Processes and Related Fields. Preprint* : <http://arxiv.org/abs/1004.1733>, pages 1–18, 2010.
- [FS09] P. Flajolet and R. Sedgewick. *Analytic combinatorics*. Cambridge University Press, Cambridge, 2009.
- [Gak66] F. D. Gakhov. *Boundary value problems*. Translation edited by I. N. Sneddon. Pergamon Press, Oxford, 1966.
- [Ges86] I. Gessel. A probabilistic method for lattice path enumeration. *J. Statist. Plann. Inference*, 14(1) :49–58, 1986.
- [Gra99] D. J. Grabiner. Brownian motion in a Weyl chamber, non-colliding particles, and random matrices. *Ann. Inst. H. Poincaré Probab. Statist.*, 35(2) :177–204, 1999.
- [HC44] A. Hurwitz and R. Courant. *Vorlesungen über allgemeine Funktionentheorie und elliptische Funktionen*. Interscience Publishers, Inc., New York, 1944.
- [Hen63] P.-L. Hennequin. Processus de Markoff en cascade. *Ann. Inst. H. Poincaré*, 18 :109–195 (1963), 1963.
- [Hun60] G. A. Hunt. Markoff chains and Martin boundaries. *Illinois J. Math.*, 4 :313–340, 1960.
- [HW96] D. G. Hobson and W. Werner. Non-colliding Brownian motions on the circle. *Bull. London Math. Soc.*, 28(6) :643–650, 1996.

- [IR08] I. Ignatiouk-Robert. Martin boundary of a killed random walk on a half-space. *J. Theoret. Probab.*, 21(1) :35–68, 2008.
- [IR09a] I. Ignatiouk-Robert. Martin boundary of a killed random walk on \mathbb{Z}_+^d . *Preprint* : <http://arxiv.org/abs/0909.3921>, pages 1–49, 2009.
- [IR09b] I. Ignatiouk-Robert. Martin boundary of a reflected random walk on a half-space. *Probab. Theory Related Fields*, pages 1–49, 2009.
- [IRL09] I. Ignatiouk-Robert and C. Loree. Martin boundary of a killed random walk on a quadrant. *To appear in Annals of Probability*. *Preprint* : <http://arxiv.org/abs/0903.0070>, pages 1–39, 2009.
- [Joh00] K. Johansson. Shape fluctuations and random matrices. *Comm. Math. Phys.*, 209(2) :437–476, 2000.
- [Joh02] K. Johansson. Non-intersecting paths, random tilings and random matrices. *Probab. Theory Related Fields*, 123(2) :225–280, 2002.
- [JS87] G. Jones and D. Singerman. *Complex functions*. Cambridge University Press, Cambridge, 1987. An algebraic and geometric viewpoint.
- [Jun31] R. Jungen. Sur les séries de Taylor n’ayant que des singularités algébrico-logarithmiques sur leur cercle de convergence. *Comment. Math. Helv.*, 3(1) :266–306, 1931.
- [KKZ09] M. Kauers, C. Koutschan, and D. Zeilberger. Proof of Ira Gessel’s lattice path conjecture. *Proceedings of the National Academy of Sciences*, 106(28) :11502–11505, 2009.
- [KM98] I. A. Kurkova and V. A. Malyshev. Martin boundary and elliptic curves. *Markov Process. Related Fields*, 4(2) :203–272, 1998.
- [KO01] W. König and N. O’Connell. Eigenvalues of the Laguerre process as non-colliding squared Bessel processes. *Electron. Comm. Probab.*, 6 :107–114 (electronic), 2001.
- [Kön05] W. König. Orthogonal polynomial ensembles in probability theory. *Probab. Surv.*, 2 :385–447 (electronic), 2005.
- [KOR02] W. König, N. O’Connell, and S. Roch. Non-colliding random walks, tandem queues, and discrete orthogonal polynomial ensembles. *Electron. J. Probab.*, 7 :no. 5, 24 pp. (electronic), 2002.
- [KR09a] I. Kurkova and K. Raschel. Explicit expression of the counting generating function for Gessel’s walk. *Preprint* : <http://arxiv.org/abs/0912.0457>, 2009.
- [KR09b] I. Kurkova and K. Raschel. Random walks in $(\mathbb{Z}_+)^2$ with non-zero drift absorbed at the axes. *To appear in Bulletin de la Société Mathématique de France*. *Preprint* : <http://arxiv.org/abs/0903.5486>, 2009.
- [KS03] I. A. Kurkova and Y. M. Suhov. Malyshev’s theory and JS-queues. Asymptotics of stationary probabilities. *Ann. Appl. Probab.*, 13(4) :1313–1354, 2003.
- [KS09] W. König and P. Schmid. Random walks conditioned to stay in Weyl chambers of type C and D. *Preprint* : <http://arxiv.org/abs/0911.0631>, pages 1–12, 2009.

- [KT04] M. Katori and H. Tanemura. Symmetry of matrix-valued stochastic processes and noncolliding diffusion particle systems. *J. Math. Phys.*, 45(8) :3058–3085, 2004.
- [Law89] D. Lawden. *Elliptic functions and applications*, volume 80 of *Applied Mathematical Sciences*. Springer-Verlag, New York, 1989.
- [Lig85] T. M. Liggett. *Interacting particle systems*, volume 276 of *Grundlehren der Mathematischen Wissenschaften [Fundamental Principles of Mathematical Sciences]*. Springer-Verlag, New York, 1985.
- [Lit00] G. Litvinchuk. *Solvability theory of boundary value problems and singular integral equations with shift*, volume 523 of *Mathematics and its Applications*. Kluwer Academic Publishers, Dordrecht, 2000.
- [Lu93] J. K. Lu. *Boundary value problems for analytic functions*, volume 16 of *Series in Pure Mathematics*. World Scientific Publishing Co. Inc., River Edge, NJ, 1993.
- [Mal71] V. A. Malyshev. Positive random walks and Galois theory. *Uspehi Mat. Nauk*, 26(1(157)) :227–228, 1971.
- [Mal72] V. A. Malyshev. An analytical method in the theory of two-dimensional positive random walks. *Sib. Math. J.*, 13(6) :917–929, 1972.
- [Mal73] V. A. Malyshev. Asymptotic behavior of the stationary probabilities for two-dimensional positive random walks. *Sib. Math. J.*, 14(1) :109–118, 1973.
- [Mar41] R. S. Martin. Minimal positive harmonic functions. *Trans. Amer. Math. Soc.*, 49 :137–172, 1941.
- [MMVW08] I. M. MacPhee, M. V. Menshikov, S. Volkov, and A. R. Wade. Passage-time moments and hybrid zones for the exclusion-voter model. *Preprint* : <http://arxiv.org/abs/0810.0392>, pages 1–37, 2008.
- [MR09] M. Mishna and A. Rechnitzer. Two non-holonomic lattice walks in the quarter plane. *Theor. Comput. Sci.*, 410(38-40) :3616–3630, 2009.
- [NS66] P. Ney and F. Spitzer. The Martin boundary for random walk. *Trans. Amer. Math. Soc.*, 121 :116–132, 1966.
- [O’C03a] N. O’Connell. Conditioned random walks and the RSK correspondence. *J. Phys. A*, 36(12) :3049–3066, 2003. Random matrix theory.
- [O’C03b] N. O’Connell. A path-transformation for random walks and the Robinson-Schensted correspondence. *Trans. Amer. Math. Soc.*, 355(9) :3669–3697 (electronic), 2003.
- [O’C03c] N. O’Connell. Random matrices, non-colliding processes and queues. In *Séminaire de Probabilités, XXXVI*, volume 1801 of *Lecture Notes in Math.*, pages 165–182. Springer, Berlin, 2003.
- [OY02] N. O’Connell and M. Yor. A representation for non-colliding random walks. *Electron. Comm. Probab.*, 7 :1–12 (electronic), 2002.
- [Pin09] S. Ping. A probabilistic approach to enumeration of Gessel walks. *Preprint* : <http://arxiv.org/abs/0903.0277>, pages 1–14, 2009.
- [Pól74] G. Pólya. *Collected papers*. The MIT Press, Cambridge, Mass.-London, 1974. Vol. 1 : Singularities of analytic functions, Edited by R. P. Boas, *Mathematicians of Our Time*, Vol. 7.

- [PRY04] F. Pakovich, N. Roytvarf, and Y. Yomdin. Cauchy-type integrals of algebraic functions. *Israel J. Math.*, 144 :221–291, 2004.
- [PW92] M. Picardello and W. Woess. Martin boundaries of cartesian products of Markov chains. *Nagoya Math. J.*, 128 :153–169, 1992.
- [PW08] M. Petkovsek and H. Wilf. On a conjecture of Ira Gessel. *Preprint* : <http://arxiv.org/abs/0807.3202>, pages 1–11, 2008.
- [Ras09] K. Raschel. Martin boundary for killed random walks in the Weyl chamber of the dual of $\mathrm{Sp}(4)$. *Preprint* : <http://arxiv.org/abs/0910.4355>, pages 1–22, 2009.
- [Ras10a] K. Raschel. Counting walks in a quadrant : a unified approach via boundary value problems. *Preprint* : <http://arxiv.org/abs/>, pages 1–22, 2010.
- [Ras10b] K. Raschel. Green functions and martin compactification for killed random walks related to $\mathrm{su}(3)$. *Electronic Communications in Probability*, 15 :176–190, 2010.
- [SG69] G. Sansone and J. Gerretsen. *Lectures on the theory of functions of a complex variable. II : Geometric theory*. Wolters-Noordhoff Publishing, Groningen, 1969.
- [Spi64] F. Spitzer. *Principles of random walk*. The University Series in Higher Mathematics. D. Van Nostrand Co., Inc., Princeton, N.J.-Toronto-London, 1964.
- [Sze75] G. Szegő. *Orthogonal polynomials*. American Mathematical Society, Providence, R.I., fourth edition, 1975. American Mathematical Society, Colloquium Publications, Vol. XXIII.
- [Var99] N. T. Varopoulos. Potential theory in conical domains. *Math. Proc. Cambridge Philos. Soc.*, 125(2) :335–384, 1999.
- [Var00] N. T. Varopoulos. Potential theory in conical domains. II. *Math. Proc. Cambridge Philos. Soc.*, 129(2) :301–319, 2000.