

N° d'ordre: D.U. 1933

UNIVERSITÉ BLAISE PASCAL

U.F.R. Sciences et Technologies

ÉCOLE DOCTORALE DES SCIENCES FONDAMENTALES

N°: 608

THÈSE

présentée pour obtenir le grade de

DOCTEUR D'UNIVERSITÉ

Spécialité: Mathématiques appliquées

Par: **Qilong GU**

Diplomé d'Etudes Approfondies

SOLUTIONS GLOBALES, LIMITE DE RELAXATION, CONTRÔLABILITÉ ET OBSERVABILITÉ EXACTES FRONTIÈRES POUR DES SYSTÈMS HYPERBOLIQUES QUASI-LINÉAIRES

Soutenue publiquement le 18 juin 2009, devant la commission d'examen

Messieurs	Youcef Amirat	Président
	Jean-François Coulombel	Examineur
	Yue-Jun Peng	Directeur de thèse
	Marius Tucsnak	Rapporteur
	Cheng-Zhong Xu	Rapporteur

Remerciements

Tout d'abord, je tiens à remercier très sincèrement mes directeurs de thèse, Tatsien Li et Yue-Jun Peng. Ils ont fait preuve à mon égard d'une très grande disponibilité tout au long de ces années. Leurs compétences scientifiques, leur rigueur, leur ouverture d'esprit mais aussi leur bonne humeur m'ont permis de mener ce travail à terme. Travailler avec eux a été fort agréable et très enrichissant.

J'adresse un grand merci à Marius Tucsnak et Cheng-Zhong Xu d'avoir bien voulu être les rapporteurs de ma thèse. Je remercie également Youcef Amirat et Jean-François Coulombel d'avoir accepté de faire partie du jury.

Je remercie Tiehu Qin, Yi Zhou et Shu Wang qui m'ont fait beaucoup de propositions enrichissantes. Grace à leurs aides, j'ai pu améliorer ma thèse. Je remercie également Jiaxing Hong, Jin Chen, Libing Wang, Zhiqiang Wang, Zhen Lei, Lixin Yu, Claire Chainais pour leurs conseils, et Chunlian Zhou, Marie-Paule Bressoulaly et Valérie Sourlier, qui m'ont beaucoup aidé du point de vu administratif.

Merci à tous les collègues: Yongfu Yang, Fei Guo, Wei Chen, Yan Guan, Weiwei Han, Aihua Chen, Lina Guo, Mohamed Lasmer HAJJEJ.... À chaque fois, nos discussions furent fructueuses. Je remercie, particulièrement, Zhiqiang Wang et Yongfu Yang, pour leur soutien perpétuel.

Je n'oublie pas de remercier à mes autres amis: Cengbo Zheng, Wei Wu, Wei Yang, XinXiang Li, Xiang Chen, Jianli Liu, Peipei Shang, Fhima Mehdi, Vander Vennet Nikolas. Leur amitié est très précieuse.

Enfin j'adresse une pensée à toute ma famille, et plus particulièrement mes parents pour leur amour, leur compréhension et leurs encouragements durant toutes ces années. Je suis heureux de pouvoir dire que je les aime.

SOLUTIONS GLOBALES, LIMITE DE RELAXATION, CONTRÔLABILITÉ ET OBSERVABILITÉ EXACTES FRONTIÈRES POUR DES SYSTÈMS HYPERBOLIQUES QUASI-LINÉAIRES

RÉSUMÉ

Cette thèse est essentiellement composée de deux parties. Dans la première partie, on étudie le système d'Euler-Maxwell. En utilisant la méthode d'intégration de l'énergie classique, on montre l'existence et l'unicité de solutions régulières globales du système avec données initiales petites. Ensuite, on étudie la limite de relaxation en montrant que, le système d'Euler-Maxwell converge vers les équations de dérive-diffusion quand le temps de relaxation tend vers zéro.

Dans la deuxième partie, on cherche la contrôlabilité et l'observabilité exactes frontières de systèmes hyperboliques quasi-linéaires dans un réseau du type d'arbre. On établit des résultats d'existence de la contrôlabilité et l'observabilité par des méthodes constructives qui sont basées sur la théorie de la solution C^1 semi-globale du système hyperbolique quasi-linéaire du premier ordre avec conditions initiales et frontières.

L'application concerne le modèle physique du fluide non-stationnaire dans un réseau du type d'arbre des canaux ouverts, pour lequel des résultats sont obtenus dans les cas sub-critique et super-critique. Par une comparaison des solutions dans ces deux cas, on trouve des dualités de la contrôlabilité et l'observabilité. Enfin, par une méthode semblable, on obtient la contrôlabilité exacte frontière des équations d'ondes quasi-linéaires dans un réseau du type d'arbre des cordes.

Mots clés: équations d'Euler-Maxwell, équations de dérive-diffusion, limite de relaxation, existence globale de solutions régulières, contrôlabilité exacte frontière, observabilité exacte frontière, système hyperbolique quasi-linéaire, système de Saint-Venant, équation d'onde quasi-linéaire, réseau du type d'arbre

GLOBAL SOLUTIONS, RELAXATION LIMIT, EXACT BOUNDARY CONTROLLABILITY AND OBSERVABILITY FOR QUASILINEAR HYPERBOLIC SYSTEMS

ABSTRACT

This thesis is essentially composed of two parts. In the first part, I study the Euler-Maxwell system. Using the classical method of energy integral, I prove the existence and uniqueness of global solutions to the system with small initial data. After that, I study the relaxation limit. I prove that, as the relaxation time tends to zero, the Euler-Maxwell system converges to the drift-diffusion models.

In the second part, I study the exact boundary controllability and observability of quasilinear hyperbolic systems in a tree-like network. In this part, based on the theory of the semi-global C^1 solution of the mixed initial-boundary value problem for first order quasilinear hyperbolic systems, I deal with the controllability and observability with a constructive method.

Taking the unsteady flows in a tree-like network of open canals as a physical model, I consider the exact boundary controllability and observability in subcritical and supercritical situations, respectively. By the comparison of these two cases, I find some duality of the controllability and observability. Meanwhile, using the similar way, I get the exact boundary controllability of quasilinear wave equations on a tree-like planar network of stings.

Keywords: Euler-Maxwell equations, drift-diffusion equation, relaxation limit, global existence of smooth solution, exact boundary controllability, exact boundary observability, quasilinear hyperbolic system, Saint-Venant system, quasilinear wave equation, tree-like network

Contents

I	Introduction	13
1	Le système d'Euler-Maxwell	15
1.1	Présentation générale	15
1.2	Quelques résultats sur le système d'Euler-Maxwell	17
2	La contrôlabilité et l'observabilité exactes frontières	21
2.1	La position du problème	21
2.2	L'état des recherches	25
2.3	Quelques résultats sur la contrôlabilité et l'observabilité	28
II	Study on compressible Euler-Maxwell equations	31
3	Global existence of smooth solutions and relaxation limit	33
3.1	Introduction	33
3.2	Global existence of smooth solutions	35
3.3	Proof of Proposition 3.2	39
3.4	Formal asymptotic expansion	45
3.5	The zero-relaxation limit	48
3.6	Proof of Proposition 3.3	52
III	Exact boundary controllability and observability for quasilinear	

hyperbolic systems on a tree-like network	57
4 Exact boundary controllability of unsteady flows	59
4.1 Introduction	59
4.2 Exact boundary controllability in a star-like network	60
4.3 Exact boundary controllability of unsteady flows in a star-like network of open canals	68
4.4 Exact boundary controllability of unsteady flows in a tree-like network of open canals	73
5 Exact boundary controllability of unsteady supercritical flows	79
5.1 Introduction	79
5.2 Preliminaries	80
5.3 Exact boundary controllability of unsteady supercritical flows in a single open canal	81
5.4 Exact boundary controllability of unsteady supercritical flows in a tree-like network of open canals	84
5.5 Proof of Theorem 5.3	88
6 Exact boundary controllability for quasilinear wave equations	93
6.1 Introduction	93
6.2 Exact boundary controllability for quasilinear wave equations	94
6.3 Exact boundary controllability for quasilinear wave equations in a star-like planar network of strings	96
6.4 Exact boundary controllability for quasilinear wave equations in a tree-like planar network of strings	107
7 Exact boundary observability of unsteady flows	111
7.1 Introduction	111
7.2 Preliminaries	112
7.3 Exact boundary observability of unsteady flows in a single open canal . . .	115

7.4	Exact boundary observability of unsteady flows in a star-like network of open canals	119
7.5	Exact boundary observability of unsteady flows in a tree-like network of open canals	131
7.6	Implicit duality between controllability and observability	138
8	Exact boundary observability of unsteady supercritical flows	141
8.1	Introduction	141
8.2	Exact boundary observability for a kind of quasilinear hyperbolic systems .	142
8.3	Exact boundary observability of unsteady supercritical flows in a single open canal	144
8.4	Exact boundary observability of unsteady supercritical flows in a star-Like network of open canals	148
8.5	Exact boundary observability of unsteady supercritical flows in a tree-like network of open canals	153

Part I

Introduction

Chapter 1

Le système d'Euler-Maxwell

Dans ce chapitre, on introduit le système d'Euler-Maxwell et l'arrière-plan de la recherche. On donne les résultats sur l'existence et l'unicité de solutions régulières globales du système d'Euler-Maxwell avec données initiales petites et sur la limite de relaxation vers le système de dérive-diffusion.

1.1 Présentation générale

Le système d'Euler-Maxwell décrit le phénomène d'électro-magnétisme. Il contient des équations d'Euler et des équations de Maxwell. Dans le cas unipolaire, les équations d'Euler sont composées de l'équation de la conservation de la masse

$$\partial_t n + \operatorname{div}(nu) = 0 \tag{1.1.1}$$

et des équations de la conservation de la quantité du mouvement

$$\partial_t(nu) + \operatorname{div}(nu \otimes u) + \nabla p(n) = -n(E + \gamma u \times B) - \frac{nu}{\tau}. \tag{1.1.2}$$

Les équations de Maxwell sont un système hyperbolique de lois de conservation,

$$\begin{cases} \gamma \lambda^2 \partial_t E - \nabla \times B = \gamma nu, & \lambda^2 \operatorname{div} E = 1 - n, \\ \gamma \partial_t B + \nabla \times E = 0, & \operatorname{div} B = 0. \end{cases} \tag{1.1.3}$$

Ici, les inconnues sont la densité d'électrons $n = n(t, x)$, la vitesse d'électrons $u = u(t, x)$, la champ électrique $E = E(t, x)$ et la champ magnétique $B = B(t, x)$. Les paramètres

physiques $c = \frac{1}{\gamma}$, λ , τ sont constantes qui représentent la vitesse de la lumière, la longueur de Debye et le temps de relaxation, respectivement. La fonction $p = p(n)$ représente la pression, qui est régulière et strictement croissante pour $n > 0$.

Quand (n, u, E, B) est assez régulière, pour $n > 0$, l'équation (1.1.2) est équivalente à

$$\partial_t u + (u \cdot \nabla)u + \nabla h(n) = -E - \gamma u \times B - \frac{u}{\tau}, \quad (1.1.4)$$

où $h = h(n)$ est la fonction d'enthalpie, qui satisfait

$$h(n) = \int_1^n \frac{p'(s)}{s} ds. \quad (1.1.5)$$

En effet,

$$\operatorname{div}(nu \otimes u) = u \operatorname{div}(nu) + n(u \cdot \nabla)u, \quad (1.1.6)$$

avec (1.1.1), on obtient (1.1.4).

La première étude du système d'Euler-Maxwell avec le terme de relaxation est donnée par Chen. Dans [7], l'existence globale de solutions faibles est prouvée en une dimension d'espace. Récemment, Peng et Wang ont établi une série de résultats sur des limites du système lorsque des petits paramètres tendent vers zéro (voir [58]-[61]). Dans [58] et [59], ils étudient la limite non relativiste $c \rightarrow \infty$ et la limite de quasi-neutralité $\lambda \rightarrow 0$, respectivement. Quand $c \rightarrow \infty$, le système d'Euler-Maxwell devient le système d'Euler-Poisson compressible, et quand $\lambda \rightarrow 0$, il devient le système d'e-MHD. Dans [60], la limite combinée de $c \rightarrow \infty$ et $\lambda \rightarrow 0$ est étudiée. Dans [61], ils donnent une analyse asymptotique du système d'Euler-Maxwell dans le cas bipolaire avec des paramètres petits.

Il convient de mentionner que les résultats sur le système d'Euler-Poisson sont très utiles pour étudier le système d'Euler-Maxwell, voir par exemple, [5], [6], [10], [20], [25], [26], [57], [62], [67], [68], [69], [70], [73]. Le système d'Euler-Poisson s'écrit

$$\begin{cases} \partial_t n + \operatorname{div}(nu) = 0, \\ \partial_t(nu) + \operatorname{div}(nu \otimes u) + \nabla p(n) = n \nabla \phi - \frac{nu}{\tau}, \\ -\lambda^2 \Delta \phi = 1 - n. \end{cases} \quad (1.1.7)$$

Cependant, ces deux systèmes sont de nature différente. Ceci est dû à la différence de couplages et à la différence entre l'équation de Poisson, qui est elliptique, et les équations de Maxwell qui sont hyperboliques. Donc la poursuite des recherches sur le système d'Euler-Maxwell sont significatives.

1.2 Quelques résultats sur le système d'Euler-Maxwell

Dans le chapitre 3, on étudie le système d'Euler-Maxwell. On établit l'existence globale de solutions régulières en montrant que l'énergie est contrôlée dans la norme H^s par les données initiales qui sont proches de l'état d'équilibre.

On considère le système d'Euler-Maxwell (1.1.1)-(1.1.3) avec la condition initiale périodique

$$t = 0 : \quad (n, u, E, B) = (n_0^\tau, u_0^\tau, E_0^\tau, B_0^\tau), \quad \text{sur } \mathbb{T} = (\mathbb{R}/2\pi)^3. \quad (1.2.1)$$

Theorem 1.1. (Existence globale de solutions régulières) *Soient $s \geq \frac{7}{2}$ et \bar{B} une constante donnée. Alors il existe une constante $\delta > 0$ telle que si*

$$\|(n_0^\tau - 1, u_0^\tau, E_0^\tau, B_0^\tau - \bar{B})\|_s \leq \delta, \quad (1.2.2)$$

le système (1.1.1)-(1.1.3) avec la condition initiale (1.2.1) admet une solution globale unique $(n, u, E, B) \in C([0, \infty); H^s(\mathbb{T}))$. De plus, pour tout $t > 0$, on a

$$\|(n - 1, u, E, B - \bar{B})(t)\|_s^2 + \int_0^t \|(n - 1, u)\|_s^2 dt \leq C \|(n_0^\tau - 1, u_0^\tau, E_0^\tau, B_0^\tau - \bar{B})\|_s^2, \quad (1.2.3)$$

où C est une constante positive.

Pour des systèmes hyperboliques de lois de conservation, La condition de Kawashima est bien connue pour étudier des solutions globales. En fait, beaucoup de modèles physiques satisfont la condition de Kawashima. On montre que cette condition n'est pas satisfaite par le système d'Euler-Maxwell. Donc, le résultat est non trivial.

On étudie ensuite la limite de relaxation $\tau \rightarrow 0$ dans le système d'Euler-Maxwell. On montre la convergence du système d'Euler-Maxwell vers les équations de dérive-diffusion quand $\tau \rightarrow 0$. De plus, on établit la convergence d'un développement asymptotique à l'ordre quelconque.

Pour cela, on fait un changement de variable en temps sur équations (1.1.1)-(1.1.3)

$$s = \tau t \quad (1.2.4)$$

et écrit t à la place de s encore. Soient $\lambda = \gamma = 1$, les équations (1.1.1)-(1.1.3) deviennent

$$\begin{cases} \partial_t n + \frac{1}{\tau} \operatorname{div}(nu) = 0, \\ \partial_t u + \frac{1}{\tau}(u \cdot \nabla)u + \frac{1}{\tau} \nabla h(n) = -\frac{E}{\tau} - \frac{u \times B}{\tau} - \frac{u}{\tau^2}, \\ \partial_t E - \frac{1}{\tau} \nabla \times B = \frac{nu}{\tau}, \quad \operatorname{div} E = 1 - n, \\ \partial_t B + \frac{1}{\tau} \nabla \times E = 0, \quad \operatorname{div} B = 0. \end{cases} \quad (1.2.5)$$

Soit $(n_0, u_0, E_0, B_0) \in H^s(\mathbb{T})$, qui satisfait la condition de compatibilité

$$u_0 = -\nabla(h(n_0) - \phi_0), \quad E_0 = -\nabla\phi_0, \quad B_0 = 0, \quad (1.2.6)$$

où ϕ_0 satisfait

$$-\Delta\phi_0 = 1 - n_0, \quad \int_{\mathbb{T}} \phi_0 dx = 0. \quad (1.2.7)$$

De même, soit $(n_1, u_1, E_1, B_1) \in H^s(\mathbb{T})$, qui satisfait la condition de compatibilité

$$u_1 = -\nabla(h'(n_0)n_1 - \phi_1), \quad E_1 = -\nabla\phi_1, \quad B_1 = B^1(0, \cdot), \quad (1.2.8)$$

où ϕ_1 satisfait

$$\Delta\phi_1 = n_1, \quad \int_{\mathbb{T}} \phi_1 dx = 0. \quad (1.2.9)$$

Ici B^1 est déterminé uniquement par (n_0, u_0, E_0, B_0) (voir Chapitre 3).

Theorem 1.2. *Soit $s > \frac{5}{2}$. On suppose qu'il existe une constante $C_1 > 0$ telle que*

$$\|(n_0^\tau, u_0^\tau, E_0^\tau, B_0^\tau) - \sum_{j=0}^1 \tau^j (n_j, \tau u_j, E_j, B_j)\|_s \leq C_1 \tau^2. \quad (1.2.10)$$

Alors il existe $T > 0$, indépendant de τ , tel que le système (1.2.5) avec la condition initiale (1.2.1) ait une solution unique

$$(n^\tau, u^\tau, E^\tau, B^\tau) \in C([0, T], H^s(\mathbb{T})) \cap C^1([0, T], H^{s-1}(\mathbb{T})). \quad (1.2.11)$$

De plus,

$$\|(n^\tau, \frac{u^\tau}{\tau}, E^\tau, B^\tau) - (n^0, u^0, E^0, B^0)\|_s \leq C_2 \tau, \quad (1.2.12)$$

où C_2 est une constante positive indépendante de τ , (n^0, ϕ^0) est une solution des équations de dérive-diffusion

$$\begin{cases} \partial_t n^0 - \operatorname{div}(n^0 \nabla(h(n^0) - \phi^0)) = 0, \\ -\Delta\phi^0 = 1 - n^0, \end{cases} \quad (1.2.13)$$

avec la condition initiale

$$n^0(0, x) = n_0(x), \quad x \in \mathbb{T}, \quad (1.2.14)$$

et

$$u^0 = -\nabla(h(n^0) - \phi^0), \quad E^0 = -\nabla\phi^0, \quad B^0 = 0. \quad (1.2.15)$$

Chapter 2

La contrôlabilité et l'observabilité exactes frontières

Dans ce chapitre, on expose la contrôlabilité et l'observabilité exactes frontières de systèmes hyperboliques quasi-linéaires dans un réseau du type d'arbre. On introduit d'abord la position du problème et l'état des recherches. Ensuite, on décrit les résultats sur la contrôlabilité et l'observabilité des systèmes.

2.1 La position du problème

Dans cette section, on expose la position du problème sur trois aspects, c'est-à-dire: le concept de la contrôlabilité et l'observabilité exactes frontières, le réseau du type d'arbre et le fluide non-stationnaire dans des canaux ouverts. On considère la contrôlabilité et l'observabilité des systèmes hyperboliques quasi-linéaires en une dimension d'espace:

$$\frac{\partial u}{\partial t} + A(u) \frac{\partial u}{\partial x} = F(u), \quad 0 \leq x \leq L, \quad (2.1.1)$$

où $u = (u_1, \dots, u_n)^T$ est une fonction vectorielle, inconnue de (t, x) , $A(u)$ est une matrice carrée d'ordre n , $F(u) = (f_1(u), \dots, f_n(u))^T$ est une fonction vectorielle de u avec

$$F(0) = 0. \quad (2.1.2)$$

Par (2.1.2), on sait que $u = 0$ est une solution particulière du système (2.1.1).

Ici, on donne la définition de la contrôlabilité exacte frontière des systèmes hyperboliques. Pour tout état initial φ et tout état final ψ donnés, il existe $T > 0$ et des contrôles sur les noeuds, tels que la solution u du système (équation (2.1.1) avec les conditions données) peut varier de φ à ψ sur l'intervalle $[t_0, t_0 + T]$, où t_0 est le temps initial du contrôle, et T est le temps de la contrôlabilité.

Pour le système hyperbolique, il existe deux sortes de contrôles, qui sont le contrôle frontière qui apparaît dans des conditions frontières (toutes ou partie) et le contrôle interne qui apparaît dans des équations. Dans des applications, il est très difficile d'étudier le contrôle interne. En revanche, le contrôle frontière est plus facile à aborder. Donc, la contrôlabilité que l'on étudie ici est juste la contrôlabilité frontière.

Quand on considère la contrôlabilité frontière, le temps de la contrôlabilité $T > 0$ doit être assez grand car le système hyperbolique a la vitesse finie de propagation, ce qui empêche la contrôlabilité frontière dans un instant court. En fait, pour une donnée initiale, il y a une solution unique du problème de Cauchy sur son domaine déterminé maximum. De même, pour une donnée finale, il y a une solution unique sur son domaine déterminé maximum par la résolution du problème de Cauchy rétrogradé. Afin d'assurer la cohérence, les deux domaines ne doivent pas se rencontrer. Donc, T doit être convenablement grand. Ceci est une condition nécessaire pour la contrôlabilité exacte frontière. Dans la pratique, T est choisi le plus petit possible.

Dans le cas linéaire, un problème de la contrôlabilité peut être transformé à un problème dual de l'observabilité grâce à la méthode HUM (Hilbert Uniqueness Method). Malheureusement, cette méthode ne s'applique pas au système quasi-linéaire. Ici on reprend la définition de l'observabilité exacte frontière dans [33] et [34]. Pour tout état initial φ , il existe $T > 0$ et des quantités observables. En observant les quantités sur l'intervalle $[t_0, t_0 + T]$, la donnée initiale $u(t_0, x) = \varphi$ peut être déterminée uniquement par des valeurs observées. Dans cette thèse, on discute séparément de la contrôlabilité et l'observabilité exactes frontières et donne quelques dualités entre eux.

Maintenant on introduit le réseau du type d'arbre. Un réseau du type d'arbre peut être décrit comme une figure sans boucle (voir Figure 2.1.1), dans laquelle les segments sont appelés cordes, les sommets A, B, C, D, E sont appelés noeuds simples et les sommets F, G, H sont appelés noeuds multiples. Des conditions données sur les noeuds simples sont

appelées conditions frontières, alors que des conditions données sur les noeuds multiples sont appelées conditions d'interfaces. En particulier, s'il y a un seul noeud multiple, le réseau est du type d'étoile. S'il y a seulement deux noeuds simples, le réseau est du type de corde (voir Figure 2.1.2).

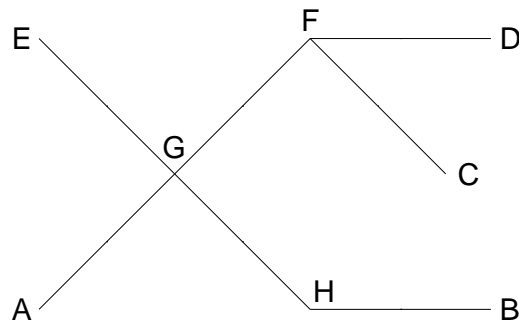

Fig. 2.1.1 Un réseau du type d'arbre

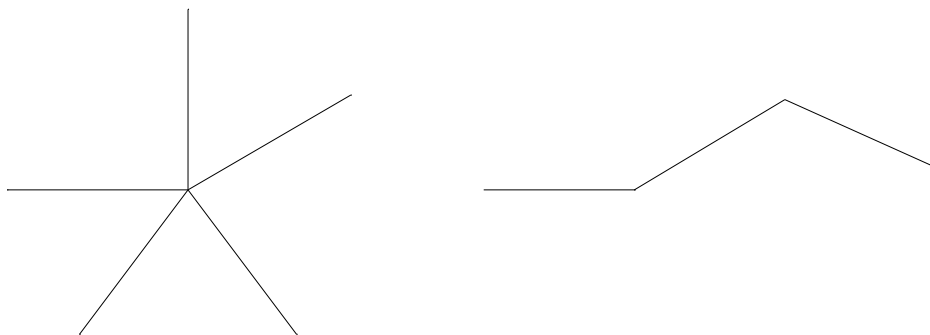

Fig. 2.1.2 Des réseaux du type d'étoile et de corde

Pour un système hyperbolique sur un réseau du type d'arbre, toutes les variables inconnues satisfont les équations sur les cordes correspondantes, les conditions frontières et les conditions d'interfaces sur les noeuds correspondants. L'ensemble des systèmes peut être considéré comme beaucoup de sous-systèmes sur les cordes, et soumis aux contraintes

des conditions d'interfaces.

Donc, pour certain réseau du type d'arbre donné arbitrairement, le problème dans cette partie est de savoir comment choisir les contrôles (resp. les quantités observables) et le temps de la contrôlabilité (resp. le temps de l'observabilité) sur les noeuds (noeuds simples ou noeuds multiples), tels que la contrôlabilité (resp. l'observabilité) du système hyperbolique soit construite sur l'ensemble du réseau.

Il existe beaucoup d'applications concernant la contrôlabilité et l'observabilité exactes frontières du système hyperbolique, par exemple, dans le fluide non-stationnaire dans des canaux ouverts et dans des cordes vibrantes. Les travaux principaux dans cette thèse concerne le fluide non-stationnaire, que l'on introduit dans la suite.

Le modèle du fluide non-stationnaire est donné dans [30]. Pour un canal horizontal et cylindrique, soit $x \in [0, L]$ la longueur paramétrique sur le canal. Si on néglige la friction, la vitesse moyenne du fluide $V = V(t, x)$ et l'aire de la section immergée $A = A(t, x)$ satisfont le système de Saint-Venant:

$$\begin{cases} \frac{\partial A}{\partial t} + \frac{\partial(AV)}{\partial x} = 0, \\ \frac{\partial V}{\partial t} + \frac{\partial S}{\partial x} = 0, \quad t \geq 0, \quad 0 \leq x \leq L, \end{cases} \quad (2.1.3)$$

où

$$S = \frac{1}{2}V^2 + gh(A) + gY_b, \quad (2.1.4)$$

g est la constante de la gravité, Y_b est l'altitude constante,

$$h = h(A) \quad (2.1.5)$$

est la profondeur de l'eau qui est une fonction régulière de A , avec

$$h'(A) > 0. \quad (2.1.6)$$

Pour le problème du fluide non-stationnaire dans un réseau du type d'arbre, sont satisfaits sur tous les canaux, les systèmes, les conditions frontières et les conditions d'interface. Les conditions d'interface dans les cas sub-critique (la vitesse est petite) et super-critique (la vitesse est grande) sont données dans les chapitres 4 et 5.

On note que, comme ce problème a un sens physique, les contrôles et les quantités observées que l'on choisit sont des quantités physiques. Une question fondamentale est de

savoir choisir convenablement ces quantités et de déterminer le temps de la contrôlabilité et de l'observabilité.

2.2 L'état des recherches

Le premier travail sur la contrôlabilité frontière des équations hyperboliques aux dérivées partielles est donné par Russell en 1960. Dans [64], il introduit la notion de la contrôlabilité et de la stabilité de systèmes linéaires et donne beaucoup de problèmes ouverts. Plus tard, Lions construit HUM, qui fournit un cadre général pour étudier le problème au système hyperbolique, en particulier à l'équations d'onde (voir [53], [54]). Le HUM, qui prouve la contrôlabilité par construisant une inégalité d'observabilité du problème dual pour la solution faible, est un repère dans ce domaine de recherche. Ensuite, cette méthode est développée et promue par des mathématiciens. Dans [29], Lasić et Triggiani établissent la contrôlabilité globale pour un système semi-linéaire, qui donne une application aux équations d'onde semi-linéaires. Dans [74], [75], Zuazua obtient des résultats de la contrôlabilité exacte frontière des équations d'onde semi-linéaires et les applique au réseau du type d'arbre [14]. Dans ce dernier article, il montre le résultat suivant. S'il y a k noeuds simples dans un réseau, on peut trouver $k - 1$ contrôles. Dans Figure 2.2.1, il y a 5 noeuds simples, donc il faut 4 contrôles. Ici, le symbole "•" signifie un noeud simple où il y a un contrôle.

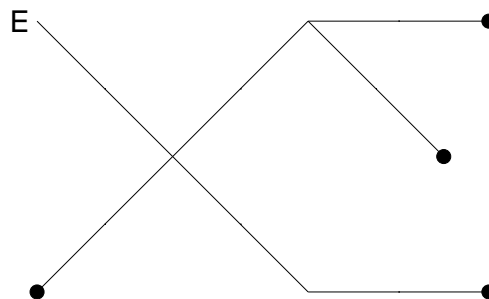

Fig 2.2.1 La contrôlabilité du système d'onde dans un réseau du type d'arbre

Généralement, HUM est une méthode indirecte. Elle est utile pour des cas linéaires et semi-linéaires, mais pas pour les cas quasi-linéaires. Un résultat pour la contrôlabilité exacte du système hyperbolique quasi-linéaire en dimension 1 est du à Cirinà [8], [9]. Par une méthode constructive directe différente de HUM, avec des contrôles frontières linéaires, Cirinà établit la contrôlabilité locale (la condition finale $\psi = 0$) pour le système hyperbolique quasi-linéaire sous forme diagonale.

Plus récemment, Li Tatsien et ses collaborateurs établissent une méthode constructive générale. Ils donnent une théorie complète de la contrôlabilité exacte frontière du système hyperbolique quasi-linéaire en dimension 1 avec des conditions frontières non-linéaires. Dans la situation classique, Li Tatsien et Zhang Binyu [52], Li Tatsien, Rao Bopeng et Jin Yi [45], [46] établissent la contrôlabilité exacte frontière pour le système hyperbolique quasi-linéaire:

$$\begin{cases} \frac{\partial r}{\partial t} + \lambda(r, s) \frac{\partial r}{\partial x} = 0, \\ \frac{\partial s}{\partial t} + \mu(r, s) \frac{\partial s}{\partial x} = 0, \end{cases} \quad (2.2.1)$$

avec les conditions frontières non-linéaires, où

$$\lambda(r, s) < 0 < \mu(r, s). \quad (2.2.2)$$

Ces résultats sont étendus au système hyperbolique quasi-linéaire général avec les valeurs propres non nulles par Li Tatsien et Rao Bopeng [41], [42]:

$$l_i(u) \left(\frac{\partial u}{\partial t} + \lambda_i(u) \frac{\partial u}{\partial x} \right) = \mu_i(u) \quad (i = 1, \dots, n), \quad (2.2.3)$$

où

$$\lambda_r(u) < 0 < \lambda_s(u) \quad (r = 1, \dots, m; s = m + 1, \dots, n). \quad (2.2.4)$$

Basé sur cette théorie, on étudie la contrôlabilité exacte frontière du système hyperbolique quasi-linéaire dans un réseau du type d'arbre. Dans [31] et [32], l'auteur trouve la contrôlabilité exacte frontière dans un réseau du type d'étoile et dans un réseau du type de corde. Plus tard ces résultats sont obtenus dans un réseau du type d'arbre de N canaux (voir [43] et [44]). Ce dernier cas est décrit par le système de Saint-Venant

$$\begin{cases} \frac{\partial A_i}{\partial t} + \frac{\partial(A_i V_i)}{\partial x} = 0, \\ \frac{\partial V_i}{\partial t} + \frac{\partial S_i}{\partial x} = 0, \end{cases} \quad (i = 1, \dots, N), \quad (2.2.5)$$

où $A_i = A_i(t, x)$ et $V_i = V_i(t, x)$ sont l'aire de la section immergée et la vitesse moyenne de l'eau dans le i -ème canal, respectivement. Ici,

$$S_i = \frac{1}{2}V_i^2 + gh_i(A_i) + gY_{bi} \quad (i = 1, \dots, N), \quad (2.2.6)$$

g est la constante du gravité, Y_{bi} est l'altitude constante et

$$h_i = h_i(A_i) \quad (i = 1, \dots, N) \quad (2.2.7)$$

est la profondeur de l'eau. On montre qu'il faut N contrôles pour un réseau avec N cordes. Dans Figure 2.2.2, il y a 7 cordes, donc il faut 7 contrôles. Ici, le symbole "•" signifie le noeud où il y a un contrôle.

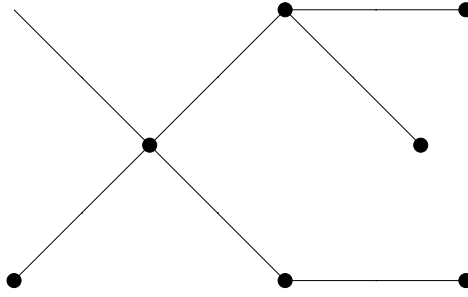

Fig. 2.2.2 La contrôlabilité exacte frontière dans un réseau du type d'arbre I

Ces résultats sont obtenus avec beaucoup plus de contrôles que celui dans [14]. Il est donc améliorable. En effet, les équations d'onde peuvent être transformées à un système hyperbolique du premier ordre. Dans cette thèse, on améliore le résultat de Li Tatsien et Rao Bopeng en utilisant autant de contrôles que celui dans [14]. De plus, on applique le résultat à un réseau des cordes et trouve qu'il correspond à celui dans [14] pour le cas quasi-linéaire.

Il existe d'autres études sur la contrôlabilité frontière du système hyperbolique quasi-linéaire, voir [23], [24], etc. Mais elles sont effectuées entre deux états stationnaires, qui sont des solutions particulières du système. Ceci est différent de l'étude dans la thèse. Dans

[24], l'auteur introduit la notion super-critique, complément de la notion sub-critique. Les méthodes qu'on utilise dans cette thèse sont totalement différentes dans ces deux cas.

Il y a très peu de résultats d'observabilité dans le cas quasi-linéaire. Dans [33] et [34], Li Tatsien établit une théorie d'observabilité exacte frontière du système hyperbolique quasi-linéaire. Pour le système avec les valeurs propres non nulles dans un canal, on peut trouver des quantités observables sur les frontières, telles que la condition initiale soit contrôlée par la condition finale et les valeurs observées pour la norme C^1 . Dans le même document, l'auteur donne des dualités entre la contrôlabilité et l'observabilité: le temps de la contrôlabilité et le temps de l'observabilité sont équivalents et le nombre des contrôles et celui des quantités observées sont aussi équivalents. On applique ces résultats au réseau du type d'arbre dans cette thèse.

2.3 Quelques résultats sur la contrôlabilité et l'observabilité

On étudie la contrôlabilité exacte frontière du système hyperbolique quasi-linéaire dans les chapitres 4 et 6.

On utilise la même méthode pour le problème du fluide non-stationnaire dans le réseau du type d'arbre. D'abord, on traite des conditions frontières et des conditions d'interface. Comme les conditions ont des sens physiques, on montre que le problème mixte est bien-posé. Ensuite, par une idée dans [37], on peut obtenir l'existence de solutions semi-globales dans le réseau.

Puisque toutes les valeurs propres du système de Saint-Venant sont non nulles, on peut permuter les variables t et x . En utilisant les conditions d'interfaces et la méthode dans [31] et [32], on construit une solution des équations étape par étape dans le réseau. Notons que cette solution constructive n'est pas unique en général.

Enfin, on montre que la solution ainsi construite satisfait la condition initiale et la condition finale. Ce qui détermine les contrôles cherchés puisque sont toutes satisfaites les équations, les conditions initiales, les conditions finales, les conditions d'interface et une partie des conditions frontières.

Dans le chapitre 4, on étudie la contrôlabilité exacte frontière du fluide non-stationnaire dans le cas sub-critique. Avec la même procédure que celle dans [43] et [44], on établit la

contrôlabilité en réduisant le nombre de contrôles. En notant le i -ème canal par indice i , on a

Theorem 2.1. *Dans un réseau du type d'arbre avec k noeuds simples, il faut $k - 1$ contrôles pour la contrôlabilité exacte frontière du fluide non-stationnaire. Dans Figure 2.3.1, le symbole "•" signifie le noeud simple où il faut un contrôle. De plus, le temps de la contrôlabilité T satisfait*

$$T > \max_{i \in \mathcal{S}} \sum_{j \in \mathcal{D}_i} \frac{L_j}{|\tilde{\lambda}_1^{(j)}|} + \max_{i \in \mathcal{S}} \sum_{j \in \mathcal{D}_i} \frac{L_j}{\tilde{\lambda}_2^{(j)}}, \quad (2.3.1)$$

où L est la longueur du canal, $\tilde{\lambda}_i (i = 1, 2)$ sont les deux valeurs propres du système (dans le cas sub-critique, une valeur propre est positive et l'autre est négative), \mathcal{S} est l'ensemble des noeuds privé de E et \mathcal{D}_i est l'ensemble des indices des canaux par lesquels sont joints E et un autre noeud simple.

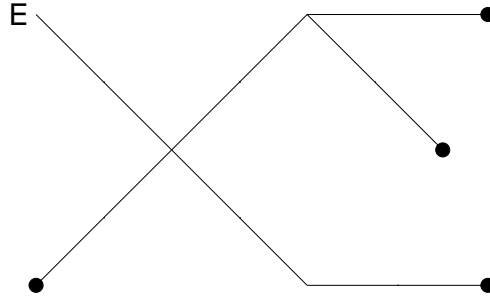

Fig. 2.3.1 La contrôlabilité exacte frontière dans un réseau du type d'arbre II

On remarque que Figure 2.3.1 et Figure 2.2.1 sont la même. Il implique que l'amélioration des résultats dans [43] et [44] est naturelle. Mais, on a besoin de plus de temps de contrôlabilité quand on réduit le nombre de contrôles.

Dans le chapitre 5, on étudie la contrôlabilité exacte frontière du fluide non-stationnaire dans le cas super-critique, où les fonctions frontières sont totalement différentes de celles du cas sub-critique. Par les résultat ci-dessous, on sait que les nombres des contrôles et les temps de la contrôlabilité sont aussi différents dans les deux cas.

Theorem 2.2. *Dans un réseau du type d'arbre avec k noeuds simples, il faut $2(k - 1)$ contrôles pour la contrôlabilité exacte frontière du fluide non-stationnaire. Dans Figure 2.3.1, le symbole "•" signifie le noeud simple où il faut deux contrôles. De plus, le temps de la contrôlabilité T satisfait*

$$T > \max \left(\max_{i \in \mathcal{S}} \sum_{j \in \mathcal{D}_i} \frac{L_j}{|\tilde{\lambda}_1^{(j)}|}, \max_{i \in \mathcal{S}} \sum_{j \in \mathcal{D}_i} \frac{L_j}{|\tilde{\lambda}_2^{(j)}|} \right). \quad (2.3.2)$$

Dans le chapitre 6, par une méthode semblable à celle dans le chapitre 4 et par la transformation de l'équation d'onde quasi-linéaire du second ordre aux équations hyperboliques quasi-linéaires du premier ordre, on montre la contrôlabilité exacte frontière du système dans un réseau du type d'arbre des cordes vibrants. Ce résultat est le même que celui dans [14]. Cependant, il est valable pour des équations non-linéaires alors que la méthode dans [14] n'est valable que dans le cas semi-linéaire.

Dans les chapitre 7 et 8, on étudie l'observabilité exacte frontière du fluide non-stationnaire dans les cas sub-critique et super-critique, respectivement. Après avoir montré l'observabilité, on la compare avec la contrôlabilité et établit les dualités entre eux.

Theorem 2.3. *Dans le cas sub-critique, ainsi que dans le cas super-critique, le nombre de contrôles est le même que le nombre de quantités observées, et le temps de la contrôlabilité et de l'observabilité sont de même.*

Part II

Study on compressible Euler-Maxwell equations

Chapter 3

Global existence of smooth solutions and relaxation limit

3.1 Introduction

This work is concerned with the Euler-Maxwell equations. We consider a plasma consisting of electrons of charge $q_e = -1$ and a single species of ions of charge $q_i = 1$. Let n_e, u_e (respectively, n_i, u_i) be the density and velocity vector of the electrons (respectively, ions), E and B be respectively the electric field and magnetic field. They are functions of a three-dimensional position vector $x \in \mathbb{T}$ and of the time $t > 0$, where $\mathbb{T} = (\mathbb{R}/2\pi)^3$ is the torus. The fields E and B are coupled to the electron density through the Maxwell equations and act on electrons via the Lorentz force. Let $c = \frac{1}{\gamma} = (\epsilon_0 \nu_0)^{-\frac{1}{2}}$ be the speed of light, λ be the scaled Debye length and τ_e, τ_i be the momentum relaxation time, where ϵ_0 and ν_0 are the vacuum permittivity and permeability. The dynamics of the compressible particles obey the Euler-Maxwell system (see [4], [7], [63]):

$$\begin{cases} \partial_t n_\alpha + \operatorname{div}(n_\alpha u_\alpha) = 0, \\ \partial_t(n_\alpha u_\alpha) + \operatorname{div}(n_\alpha u_\alpha \otimes u_\alpha) + \nabla p_\alpha(n_\alpha) = q_\alpha n_\alpha (E + \gamma u_\alpha \times B) - \frac{n_\alpha u_\alpha}{\tau_\alpha}, \\ \gamma \lambda^2 \partial_t E - \nabla \times B = \gamma(n_e u_e - n_i u_i), \quad \lambda^2 \operatorname{div} E = n_i - n_e, \\ \gamma \partial_t B + \nabla \times E = 0, \quad \operatorname{div} B = 0, \end{cases} \quad (3.1.1)$$

for $\alpha = e, i$ and $(t, x) \in (0, \infty) \times \mathbb{T}$, where $u_\alpha \otimes u_\alpha$ stands for the tensor product and $p_\alpha = p_\alpha(n_\alpha)$ is the pressure with suitably smooth function of n_α and strictly increasing for $n_\alpha > 0$. The system is complemented with the initial conditions:

$$t = 0 : \quad (n_\alpha, u_\alpha, E, B) = (n_{\alpha,0}^\tau, u_{\alpha,0}^\tau, E_0^\tau, B_0^\tau), \quad \alpha = e, i. \quad (3.1.2)$$

The first mathematical study of the Euler-Maxwell equations with extra relaxation terms is given by Chen(see [7]), where the global existence of weak solutions in one-dimensional case is established. And then, based on the studies of the asymptotic limits in the Euler-Poisson system(see [5], [6], [10], [20], [25], [26], [57], [62], [67], [68], [69], [70], [73]. In [58] and [59], the authors proved respectively that, for the Euler-Maxwell system, the non-relativistic limit $c \rightarrow \infty$ is the (one-fluid) compressible Euler-Poisson system and the quasi-neutral limit $\lambda \rightarrow 0$ is the electron magnetohydrodynamics equations. In [60], the combined limit of c and λ has been given. And in [61], the asymptotic expansions in the Euler-Maxwell equations with small parameters have been researched.

In this paper, we first deal with global existence of smooth solutions of the Cauchy problem (3.1.1) with (3.1.2). With the energy integral, we prove the convergence of the H^s norms of the unknown variables, which helps us to get the conclusion. As we will see, since this system does not satisfy the Kawashima condition, the proof is indispensable. After that, we consider the zero-relaxation limit $\tau_\alpha \rightarrow 0$. This is different from the asymptotic of Euler-Poisson equations since the Poisson equations, which are elliptic, are essentially different from the Maxwell equations, which are hyperbolic. To get the conclusion, we use the method of asymptotic expansions constructed by drift-diffusion equations and prove the convergence of the error equations.

For the sake of convenience, we will research Euler-Maxwell equations under the unipolar condition first. We assume that in the plasma the ions are non-moving and become a uniform background with a fixed unit density. This means we consider the condition that the density of ions n_i is equal to 1 and the velocity of ions u_i vanishes. Using (n, u) instead of (n_e, u_e) and noting the second equation in system (3.1.1) is equivalent to

$$\partial_t u_\alpha + (u_\alpha \cdot \nabla) u_\alpha + \nabla h_\alpha(n_\alpha) = q_\alpha(E + \gamma u_\alpha \times B) - \frac{u_\alpha}{\tau_\alpha}, \quad (3.1.3)$$

where the enthalpy $h(n)$ is defined by

$$h_\alpha(n_\alpha) = \int_1^{n_\alpha} \frac{p'_\alpha(s)}{s} ds, \quad (3.1.4)$$

system (3.1.1) with (3.1.2) now becomes

$$\begin{cases} \partial_t n + \operatorname{div}(nu) = 0, \\ \partial_t u + (u \cdot \nabla)u + \nabla h(n) = -E - \gamma u \times B - \frac{u}{\tau}, \\ \gamma \lambda^2 \partial_t E - \nabla \times B = \gamma nu, \quad \lambda^2 \operatorname{div} E = 1 - n, \\ \gamma \partial_t B + \nabla \times E = 0, \quad \operatorname{div} B = 0, \end{cases} \quad (3.1.5)$$

$$t = 0 : \quad (n, u, E, B) = (n_0^\tau, u_0^\tau, E_0^\tau, B_0^\tau). \quad (3.1.6)$$

We will see later that the research is also valid for the bipolar system.

For the use in this paper, we recall some results about linear system of curl-div equations and calculus inequalities in Sobolev spaces.

Lemma 3.1. (see [58]) For any given smooth functions f and g ,

$$\begin{cases} \nabla \times B = f, \\ \operatorname{div} B = g \end{cases} \quad (3.1.7)$$

with $\operatorname{div} f = 0$ and $m(g) = 0$, where

$$m(g) = \int_{\mathbb{T}} g dx, \quad (3.1.8)$$

this system has a unique smooth solution B , in the class $m(B) = 0$.

Lemma 3.2. (see [55]) For any fixed integer $s > \frac{5}{2}$, suppose $A \in H^s$ and $U \in H^{s-1}$, then for all multi-indices α with $|\alpha| \leq s$, $\partial^\alpha(AU) - A\partial^\alpha U \in L^2$ and

$$\|\partial^\alpha(AU) - A\partial^\alpha U\| \leq C \|A\|_s \|U\|_{|\alpha|-1}. \quad (3.1.9)$$

3.2 Global existence of smooth solutions

In this section, we construct the global existence of smooth solution of Euler-Maxwell equations. Still considering the system (3.1.5) with the initial condition (3.1.6), we have

Theorem 3.1. (Global existence of the smooth solutions) *Assume that $s \geq s_0 \geq \frac{3}{2} + 2$. Let \bar{B} be any given constant. Then there exists positive constants $\delta > 0$ sufficiently small and $C > 0$ such that if it holds that*

$$\|(n_0^\tau - 1, u_0^\tau, E_0^\tau, B_0^\tau - \bar{B})\|_s \leq \delta, \quad (3.2.1)$$

then the system (3.1.5)-(3.1.6) has a unique global solution $(n, u, E, B) \in C([0, \infty); H^s(\mathbb{T}))$ satisfying, for all $t > 0$,

$$\|(n - 1, u, E, B - \bar{B})(t)\|_s^2 + \int_0^t \|(n - 1, u)\|_s^2 dt \leq C \|(n_0^\tau - 1, u_0^\tau, E_0^\tau, B_0^\tau - \bar{B})\|_s^2. \quad (3.2.2)$$

Moreover,

$$\limsup_{t \rightarrow \infty} \sup_{x \in \mathbb{T}} |(n - 1, u)(x, t)| = 0. \quad (3.2.3)$$

Remark 3.1. Theorem 3.1 can be extended easily to the two-fluid Euler-Maxwell system by using the method of this paper. We omit it. Also, by using the method of this paper, we can obtain a better result than the known ones about the compressible Euler system with relaxation term given by the papers like [73, 12] et al. Namely, we can prove that any global small smooth solution of the compressible Euler system with relaxation term decays exponentially to the constant stationary state as $t \rightarrow \infty$.

Let (n, u, E, B) be the unknown solution to the problem (3.1.5) and (3.1.6). Denoting

$$(N, u, E, G) = (n - 1, u, E, B - \bar{B}), \quad (3.2.4)$$

we have

$$\begin{cases} \partial N + \operatorname{div}((1 + N)u) = 0, \\ \partial u + (u \cdot \nabla)u + \nabla h(1 + N) = -(E + \gamma u \times (B^0 + G)) - \frac{u}{\tau}, \\ \gamma \lambda^2 \partial E - \nabla \times G = \gamma(1 + N)u, \quad \gamma \partial G + \nabla \times E = 0, \\ \lambda^2 \operatorname{div} E = -N, \quad \operatorname{div} G = 0, \end{cases} \quad x \in \Omega, t > 0, \quad (3.2.5)$$

with

$$t = 0 : \quad (N, u, E, G) = (N_0^\tau, u_0^\tau, E_0^\tau, G_0^\tau) = (n_0^\tau - 1, u_0^\tau, E_0^\tau, B_0^\tau - \bar{B}). \quad (3.2.6)$$

Set

$$W_I = \begin{pmatrix} N \\ u \end{pmatrix}, \quad W_{II} = \begin{pmatrix} E \\ G \end{pmatrix}, \quad W = \begin{pmatrix} W_I \\ W_{II} \end{pmatrix} = \begin{pmatrix} N \\ u \\ E \\ G \end{pmatrix},$$

$$W_0 = \begin{pmatrix} N_0^T \\ u_0^T \\ E_0^T \\ G_0^T \end{pmatrix}, \quad D_0 = \begin{pmatrix} \mathbf{I}_{4 \times 4} & \mathbf{0} \\ \mathbf{0} & D_0^{II} \end{pmatrix} = \begin{pmatrix} \mathbf{I}_{4 \times 4} & \mathbf{0} \\ \mathbf{0} & \begin{pmatrix} \lambda^2 \gamma \mathbf{I}_{3 \times 3} & \mathbf{0} \\ \mathbf{0} & \gamma \mathbf{I}_{3 \times 3} \end{pmatrix} \end{pmatrix},$$

$$A_i(W) = \begin{pmatrix} A_i^I(W) & \mathbf{0} \\ \mathbf{0} & A_i^{II} \end{pmatrix} = \begin{pmatrix} \begin{pmatrix} u_i & (N+1)e_i^T \\ h'(N+1)e_i & u_i \mathbf{I}_{3 \times 3} \end{pmatrix} & \mathbf{0} \\ \mathbf{0} & \begin{pmatrix} \mathbf{0} & L_i \\ L_i^T & \mathbf{0} \end{pmatrix} \end{pmatrix},$$

$$K_1(W) = \begin{pmatrix} K_1^I(W) \\ K_1^{II}(W) \end{pmatrix} = \begin{pmatrix} 0 \\ -E \\ u \\ 0 \end{pmatrix}, \quad K_2(W) = \begin{pmatrix} K_2^I(W) \\ K_2^{II}(W) \end{pmatrix} = \begin{pmatrix} 0 \\ -\frac{u}{\tau} \\ 0 \\ 0 \end{pmatrix},$$

$$K_3(W) = \begin{pmatrix} K_3^I(W) \\ K_3^{II}(W) \end{pmatrix} = \begin{pmatrix} 0 \\ -\gamma u \times B^0 \\ 0 \\ 0 \end{pmatrix}, \quad K_4(W) = \begin{pmatrix} K_4^I(W) \\ K_4^{II}(W) \end{pmatrix} = \begin{pmatrix} 0 \\ -\gamma u \times G \\ Nu \\ 0 \end{pmatrix},$$

where (e_1, e_2, e_3) is the canonical basis of \mathbb{R}^3 , y_i denotes the i -th component of $y \in \mathbb{R}^3$ and $L_i (i = 1, 2, 3)$ is given as

$$L_1 = \begin{pmatrix} 0 & 0 & 0 \\ 0 & 0 & 1 \\ 0 & -1 & 0 \end{pmatrix}, \quad L_2 = \begin{pmatrix} 0 & 0 & -1 \\ 0 & 0 & 0 \\ 1 & 0 & 0 \end{pmatrix}, \quad L_3 = \begin{pmatrix} 0 & 1 & 0 \\ -1 & 0 & 0 \\ 0 & 0 & 0 \end{pmatrix}. \quad (3.2.7)$$

From (3.2.5), the redundant equations $\lambda^2 \operatorname{div} E = -N$ and $\operatorname{div} G = 0$ hold as soon as they are satisfied by the initial data. Thus the problem (3.2.5)-(3.2.6) for the unknown W can

be rewritten into the following form

$$\begin{cases} D_0 \partial_t W + \sum_{i=1}^3 A_i(W) \partial_{x_i} W = \sum_{j=1}^4 K_j(W), \\ t = 0 : \quad W = W_0, \end{cases} \quad (3.2.8)$$

with

$$\lambda^2 \operatorname{div} E(x, 0) = -N(x, 0), \quad \operatorname{div} G(x, 0) = 0, \quad (3.2.9)$$

which can be guaranteed by the assumptions on the initial data.

It is easy to see that the equations for W in (3.2.8) are symmetrizable hyperbolic, i.e. if we introduce

$$A_0(W) = \begin{pmatrix} \begin{pmatrix} h'(N+1) & 0 \\ 0 & (N+1)\mathbf{I}_{3 \times 3} \end{pmatrix} & \mathbf{0} \\ \mathbf{0} & \mathbf{I}_{6 \times 6} \end{pmatrix},$$

which is positively definite when $N+1 \geq M_0 > 0$ for $\|N\|_{L^\infty} \leq \frac{1}{2}$, then $A_0 D_0$ and $\tilde{A}_i(W) = A_0(W) A_i(W)$ are symmetric for all $1 \leq i \leq 3$. Note that, for smooth solutions, the Euler-Maxwell system (3.1.5)-(3.1.6) is equivalent to that of (3.2.5)-(3.2.6) or (3.2.8). Thus, by the standard existence theory of local smooth solutions for symmetrizable hyperbolic equations (see [27, 55]), we have the following result.

Proposition 3.1. *Let W_0 satisfy $W_0 \in H^s(\mathbb{T})$, $s > \frac{3}{2} + 2$ and $\|N_0\|_s \leq \kappa$ for some given $\kappa > 0$ (to be chosen so that $1 + N_0 > 0$, for example $\kappa C_s < 1$, where C_s is the Sobolev's embedding constant). Then there exists $0 < T(\kappa, \|W_0\|_s) \leq \infty$, the maximal existence time, and a unique smooth solution $W \in \bigcap_{l=0}^1 C^l([0, T]; H^{s-l}(\mathbb{T}))$ of the system (3.2.5)-(3.2.6) or (3.2.8) on $[0, T)$.*

To prove Theorem 3.1, the key point is to establish the following a priori estimates

Proposition 3.2. (A priori estimates) *If there exists $\delta > 0$ sufficiently small such that, for any $T > 0$, it holds*

$$\sup_{0 \leq t \leq T} \|W(t)\|_s \leq \delta, \quad (3.2.10)$$

then the estimate (3.2.2) holds for all $t \in [0, T]$.

We will prove this proposition in next section.

Lemma 3.3. *Under the assumption of Proposition 3.2, we have*

$$\|W(t)\|_{L^2}^2 + \frac{2}{\tau} \int_0^t \|u(t)\|_{L^2}^2 dt \leq C\|W(0)\|_{L^2}^2, \quad 0 \leq t \leq T. \quad (3.3.2)$$

Step 2: H^s estimate of $W(t)$

For the higher order Sobolev's estimate, one have

Lemma 3.4. *Under the assumption of Proposition 3.2, we have*

$$\begin{aligned} & \|W(t)\|_s^2 + \frac{1}{\tau} \|N(t)\|_{s-1}^2 + \int_0^t (\|N(t)\|_s^2 + \frac{1}{\tau} \|u(t)\|_s^2) dt \\ & \leq C\|W(0)\|_s^2 + \frac{C}{\tau} \|N(0)\|_{s-1}^2 + \frac{C}{\tau} \int_0^t \|W_I(t)\|_s \|N(t)\|_{s-1}^2 dt \\ & \quad + C \int_0^t (\|W_{II}\|_s \|W_I(t)\|_s^2 + \|W_I(t)\|_s^3) dt, \quad 0 \leq t \leq T. \end{aligned} \quad (3.3.3)$$

Proof: The basic idea of proving Lemma 3.4 is to use H^s estimates of $W_I(t)$ to control H^s estimates of $W_{II}(t)$. To this end, we rewrite the system (3.2.8) of matrix form as

$$\partial_t W_I + \sum_{i=1}^3 A_i^I(W_I) \partial_{x_i} W_I = \sum_{j=1}^4 K_j^I(W), \quad (3.3.4)$$

$$D_0^{II} \partial_t W_{II} + \sum_{i=1}^3 A_i^{II} \partial_{x_i} W_{II} = \sum_{j=1}^4 K_j^{II}(W). \quad (3.3.5)$$

Here $A_i^I(W_I)$ is a matrix which depends only upon W_I while A_i^{II} is a constant symmetric matrix.

Let α is a multi-index with the length $0 \leq |\alpha| \leq s$.

Taking ∂_x^α of the equations (3.3.4) and acting the symmetrizer matrix $A_0^I(N)$ on the resulting equation, one can get

$$A_0^I(N) \partial_x^\alpha \partial_t W_I + \sum_{i=1}^3 A_0^I(N) A_i^I(W_I) \partial_{x_i} \partial_x^\alpha W_I = \sum_{j=1}^4 A_0^I(N) \partial_x^\alpha K_j^I(W) + J_1, \quad (3.3.6)$$

where the symmetrizer J_1 is defined by

$$J_1 = - \sum_{i=1}^3 A_0^I(N) [\partial_x^\alpha (A_i^I(W_I) \partial_{x_i} W_I) - A_i^I(W_I) \partial_{x_i} \partial_x^\alpha W_I],$$

which can be controlled by

$$\begin{aligned} \|J_1\|_{L^2} & \leq C \|A_0^I(N)\|_{L^\infty} \left(\|\nabla A_i^I(W_I)\|_{L^\infty} \|D_x^{s-1} \partial_{x_i} W_I\|_{L^2} + \|\partial_{x_i} W_I\|_{L^\infty} \|D_x^s A_i^I(W_I)\|_{L^2} \right) \\ & \leq C \|W_I\|_s^2 \end{aligned} \quad (3.3.7)$$

for some constant C , independent of τ .

Similarly, taking ∂_x^α of the equations (3.3.5) and using the fact that D_0^{II} and A_j^{II} are constant matrices, one have

$$D_0^{II} \partial_x^\alpha \partial_t W_{II} + \sum_{i=1}^3 A_i^{II} \partial_{x_i} \partial_x^\alpha W_{II} = \sum_{j=1}^4 \partial_x^\alpha K_j^{II}(W), \quad (3.3.8)$$

Now adding the resulting equations of taking the inner product of the equations (3.3.6) and (3.3.8) with $\partial_x^\alpha W_I$ and $\partial_x^\alpha W_{II}$ respectively, and using the fact that the matrix $A_0^I(N)A_j^I(W_I)$ is symmetric, one get the energy estimate

$$\begin{aligned} & \frac{d}{dt} \int_{\mathbb{T}} (A_0(N) D_0 \partial_x^\alpha W \cdot \partial_x^\alpha W) dx \\ &= 2 \int_{\mathbb{T}} ((J_1 \cdot \partial_x^\alpha W_I) dx + \int_{\mathbb{T}} (\operatorname{div} A^I(W_I) \partial_x^\alpha W_I \cdot \partial_x^\alpha W_I) dx \\ & \quad + 2 \sum_{j=1}^4 \int_{\mathbb{T}} (A_0^I(N) \partial_x^\alpha K_j^I(W) \cdot \partial_x^\alpha W_I + \partial_x^\alpha K_j^{II}(W) \cdot \partial_x^\alpha W_{II}) dx, \end{aligned} \quad (3.3.9)$$

where

$$\operatorname{div} A^I(W_I) = \frac{\partial A_0^I(N)}{\partial t} + \sum_{i=1}^3 \frac{\partial A_i^I(W_I)}{\partial x_i},$$

which can be controlled by

$$\|\operatorname{div} A^I(W_I)\|_{L^\infty} \leq C(1 + \|W_I\|_s) \|W_I\|_s. \quad (3.3.10)$$

Let us estimate each term in the right hand side of (3.3.9).

For the first two terms, by Cauchy-Schwartz's inequality and using the estimates (3.3.7) and (3.3.10), one have

$$\begin{aligned} & \int_{\mathbb{T}} (J_1 \cdot \partial_x^\alpha W_I)(x, t) dx + \int_{\mathbb{T}} (\operatorname{div} A^I(W_I) \partial_x^\alpha W_I \cdot \partial_x^\alpha W_I)(x, t) dx \\ & \leq C(1 + \|W_I\|_s) \|W_I\|_s^3. \end{aligned} \quad (3.3.11)$$

For the third term, by using the definitions of (matrix) functions $A_0^I(N), K_i^I(W), i = 1, \dots, 4$, and noting that there exists some cancelations between $K_i^I(W)$ and $K_i^{II}(W)$, we have

$$\begin{aligned} & 2 \sum_{j=1}^4 \int_{\mathbb{T}} (A_0^I(N) \partial_x^\alpha K_j^I(W) \cdot \partial_x^\alpha W_I + \partial_x^\alpha K_j^{II}(W) \cdot \partial_x^\alpha W_{II}) dx \\ &= -\frac{2}{\tau} \int_{\mathbb{T}} (1 + N) |\partial_x^\alpha u|^2(x, t) dx - 2 \int_{\mathbb{T}} [(N \partial_x^\alpha E + (1 + N) \partial_x^\alpha (u \times G)) \partial_x^\alpha u + \partial_x^\alpha (Nu) \partial_x^\alpha E] dx \\ & \leq -\frac{1}{\tau} \int_{\mathbb{T}} |\partial_x^\alpha u|^2 dx + C \|W_{II}\| \|W_I\|_s^2. \end{aligned} \quad (3.3.12)$$

Here we have used the elementary Sobolev's inequality $\|\partial_x^\alpha(fg)\|_{L^2} \leq \|fg\|_s \leq \|f\|_s \|g\|_s$ for $0 \leq |\alpha| \leq s$ and $s \geq s_0$.

Putting (3.3.11) and (3.3.12) into (3.3.9), and integrating on $[0, t], t \in [0, T]$, with respect to t , one get

$$\begin{aligned} & \|W(t)\|_s^2 + \frac{1}{\tau} \int_0^t \|u(\cdot, t)\|_s^2 dt \\ & \leq C \|W(t=0)\|_s^2 + C \int_0^t (\|W_{II}\|_s \|W_I\|_s^2 + (1 + \|W_I\|_s) \|W_I\|_s^3) dt. \end{aligned} \quad (3.3.13)$$

Here C is a constant which depends upon λ^2 and γ , but does depend upon τ and the time $T > 0$.

To control the second term of the right hand side of (3.3.13) by its left hand side's term, we establish the relation between N and u by using the Euler part of Euler-Maxwell system.

Let β be a multi-index with the length $0 \leq |\beta| \leq s - 1$.

Taking ∂_x^β of the second equation of (3.2.5), and taking the inner product of the resulting equations with $\partial_x^\beta \nabla N$, one get

$$\begin{aligned} & (h'(1+N)\partial_x^\beta \nabla N, \partial_x^\beta \nabla N) + (\partial_x^\beta E, \partial_x^\beta \nabla N) \\ & = -(\partial_x^\beta (h'(1+N)\nabla N) - h'(1+N)\partial_x^\beta \nabla N, \partial_x^\beta \nabla N) - (\partial_x^\beta \partial_t u, \partial_x^\beta \nabla N) \\ & \quad - (\partial_x^\beta (u \cdot \nabla u + \gamma u \times (B^0 + G)), \partial_x^\beta \nabla N) - \frac{1}{\tau} (\partial_x^\beta u, \partial_x^\beta \nabla N) \end{aligned} \quad (3.3.14)$$

Let us estimate each term in (3.3.14).

First, one have

$$\begin{aligned} & (h'(1+N)\partial_x^\beta \nabla N, \partial_x^\beta \nabla N) + (\partial_x^\beta E, \partial_x^\beta \nabla N) \\ & = (h'(1+N)\partial_x^\beta \nabla N, \partial_x^\beta \nabla N) - (\partial_x^\beta \operatorname{div} E, \partial_x^\beta \nabla N) \\ & = (h'(1+N)\partial_x^\beta \nabla N, \partial_x^\beta \nabla N) + \frac{1}{\lambda} \|\partial_x^\beta N\|_{L^2}^2 \\ & \geq \frac{h'(\frac{1}{2})}{2} \|N\|_s^2. \end{aligned} \quad (3.3.15)$$

By the estimate technique of Morse inequality, one get

$$-(\partial_x^\beta (h'(1+N)\nabla N) - h'(1+N)\partial_x^\beta \nabla N, \partial_x^\beta \nabla N) \leq \frac{h'(\frac{1}{2})}{8} \|N\|_s^2 + C \|N\|_{s-1}^4. \quad (3.3.16)$$

$$\begin{aligned}
-(\partial_x^\beta \partial_t u, \partial_x^\beta \nabla N) &= (\partial_x^\beta \partial_t \operatorname{div} u, \partial_x^\beta N) \\
&= \frac{d}{dt} (\partial_x^\beta \operatorname{div} u, \partial_x^\beta N) - (\partial_x^\beta \operatorname{div} u, \partial_x^\beta \partial_t N) \\
&= \frac{d}{dt} (\partial_x^\beta \operatorname{div} u, \partial_x^\beta N) + (\partial_x^\beta \operatorname{div} u, \partial_x^\beta \operatorname{div}((1+N)u)) \\
&\leq \frac{d}{dt} (\partial_x^\beta \operatorname{div} u, \partial_x^\beta N) + (\partial_x^\beta \operatorname{div} u, \partial_x^\beta \operatorname{div}((1+N)u)) \\
&\leq \frac{d}{dt} (\partial_x^\beta \operatorname{div} u, \partial_x^\beta N) + (1 + \|N\|_{H^s}) \|u\|_s^2
\end{aligned} \tag{3.3.17}$$

$$\begin{aligned}
&-(\partial_x^\beta (u \cdot \nabla u + \gamma u \times (B^0 + G)), \partial_x^\beta \nabla N) \\
&\leq \frac{h'(\frac{1}{2})}{8} \|N\|_s^2 + C(1 + \|u\|_s^2) \|u\|_{s-1}^2 + C\|G\|_{s-1}^2 \|u\|_{s-1}^2.
\end{aligned} \tag{3.3.18}$$

Because we want to obtain the uniform estimate with respect to τ , we must deal with the term containing $\frac{1}{\tau}$.

$$\begin{aligned}
-\frac{1}{\tau} (\partial_x^\beta u, \partial_x^\beta \nabla N) &= \frac{1}{\tau} (\partial_x^\beta \operatorname{div} u, \partial_x^\beta N) \\
&= -\frac{1}{\tau} (\partial_x^\beta (\frac{\partial_t N + u \cdot \nabla N}{1+N}), \partial_x^\beta N) \\
&= -\frac{1}{\tau} (\frac{\partial_t \partial_x^\beta N}{1+N}, \partial_x^\beta N) - \frac{1}{\tau} (\frac{u \cdot \nabla \partial_x^\beta N}{1+N}, \partial_x^\beta N) \\
&\quad - \frac{1}{\tau} (\partial_x^\beta (\frac{\partial_t N}{1+N}) - \frac{\partial_t \partial_x^\beta N}{1+N}, \partial_x^\beta N) - \frac{1}{\tau} (\partial_x^\beta (\frac{u \cdot \nabla N}{1+N}) - \frac{u \cdot \nabla \partial_x^\beta N}{1+N}, \partial_x^\beta N) \\
&\leq -\frac{1}{2\tau} \frac{d}{dt} (\frac{1}{1+N} \partial_x^\beta N, \partial_x^\beta N) + \frac{C}{\tau} \|W_I(t)\|_s \|N(t)\|_{s-1}^2,
\end{aligned} \tag{3.3.19}$$

Since

$$\begin{aligned}
&\|\partial_x^\beta (\frac{\partial_t N}{1+N}) - \frac{\partial_t \partial_x^\beta N}{1+N}\|_{L^2} \\
&\leq C(\|\nabla(\frac{1}{1+N})\|_{L^\infty} \|D_x^{s-2} \partial_t N\|_{L^2} + \|\partial_t N\|_{L^\infty} \|D_x^{s-1}(\frac{1}{1+N})\|_{L^2}) \\
&\leq C(\|N\|_{s-1} \|W_I(t)\|_s + \|W_I(t)\|_s \|N\|_{s-1}) \\
&\leq C\|N\|_{s-1} \|W_I(t)\|_s,
\end{aligned}$$

$$\begin{aligned}
&\|\partial_x^\beta (\frac{u \cdot \nabla N}{1+N}) - \frac{u \cdot \nabla \partial_x^\beta N}{1+N}\|_{L^2} \\
&\leq C(\|\nabla(\frac{u}{1+N})\|_{L^\infty} \|D_x^{s-2} \nabla N\|_{L^2} + \|\nabla N\|_{L^\infty} \|D_x^{s-1}(\frac{u}{1+N})\|_{L^2}) \\
&\leq C(\|W_I(t)\|_s \|N\|_{s-1} + \|N\|_{s-1} \|W_I(t)\|_s) \\
&\leq C\|N\|_{s-1} \|W_I(t)\|_s
\end{aligned}$$

and $s \geq s_0 \geq \frac{3}{2} + 2$.

Thus, (3.3.14), together with (3.3.15)-(3.3.19), gives

$$\begin{aligned}
& \frac{1}{\tau} \|N(t)\|_{s-1}^2 - \sum_{0 \leq |\beta| \leq s-1} (\partial_x^\beta \operatorname{div} u, \partial_x^\beta N) + \int_0^t \|N(t)\|_s^2 dt \\
& \leq \|W(0)\|_s^2 + \frac{C}{\tau} \|N(0)\|_{s-1}^2 + \frac{C}{\tau} \int_0^t \|W_I(t)\|_s \|N(t)\|_{s-1}^2 dt \\
& \quad + C \int_0^t (\|u(t)\|_s^2 + \|W_I(t)\|_s^3 + \|W_I(t)\|_s^4) dt \\
& \quad + C \int_0^t \|W_I(t)\|_s^2 \|W_{II}(t)\|_s^2 dt. \tag{3.3.20}
\end{aligned}$$

Combining (3.3.13) and (3.3.20), and using the assumption $\|W(t)\|_s \leq \delta$ for sufficiently small δ , one can get (3.3.3).

Step 3: The end of Proposition 3.2

Now for any given and fixed $\tau > 0$, by using the assumption $\|W(t)\|_s \leq \delta$ for sufficiently small δ , it follows from the estimate (3.3.3) that there exists a positive constant C , depending on τ and not depending upon the any given time $T > 0$, such that

$$\|W(t)\|_s^2 + \int_0^t \|W_I(t)\|_s^2 dt \leq C \|W(0)\|_s^2, \quad 0 \leq t \leq T,$$

which yields to the desired estimate (3.2.2).

Only if one have the estimate (3.2.2), we can obtain (3.2.3) as follows. In fact, it follows from (3.2.2) and the equations (3.2.5) that

$$\int_0^\infty \|(n-1, u)(\cdot, t)\|_s^2 dt < \infty$$

and

$$\|\partial_t(n-1, u)\|_{s-1} \leq C < \infty,$$

and then we can get (3.2.3).

Theorem 3.1 follows from the standard argument by using the local existence (Proposition 3.1), the a priori estimate (3.2.2) given in Proposition 3.2 and the continuous extension argument.

Remark 3.3. We keep the parameter τ in the above estimates because we can obtain the relaxation limit of the small global smooth solutions of the Euler-Maxwell system.

Namely, it follows the a priori estimate (3.3.3) that there exist constants C and $\tau_0 > 0$ such that, for any $\tau \leq \tau_0$, the Euler-Maxwell system (3.1.5)-(3.1.6) has a unique global smooth solution $(n^\tau, u^\tau, E^\tau, B^\tau) \in C([0, \infty]; H^s(\mathbb{T}))$ satisfying

$$\begin{aligned} & \| (n^\tau - 1, u^\tau, E^\tau, B^\tau - B^0)(\cdot, t) \|_s + \frac{1}{\tau} \| (n^\tau - 1)(\cdot, t) \|_{s-1} \\ & \leq C \| (n^\tau - 1, u^\tau, E^\tau, B^\tau - B^0)(\cdot, 0) \|_s + \frac{C}{\tau} \| (n^\tau - 1)(\cdot, 0) \|_{s-1} \rightarrow 0 \text{ as } \tau \rightarrow 0. \end{aligned}$$

3.4 Formal asymptotic expansion

We now study the zero-relaxation limit of Euler-Maxwell equations. To perform the limit $\tau \rightarrow 0$ in (3.1.5), we introduce a time scaling

$$s = \tau t \tag{3.4.1}$$

still using t instead of s . Since we study the zero-relaxation limit under the conditions $\gamma = O(1)$ and $\lambda = O(1)$, we further assume that $\gamma = \lambda = 1$. Euler-Maxwell system (3.1.5) becomes

$$\begin{cases} \partial_t n + \frac{1}{\tau} \operatorname{div}(nu) = 0, \\ \partial_t u + \frac{1}{\tau}(u \cdot \nabla)u + \frac{1}{\tau} \nabla h(n) = -\frac{E}{\tau} - \frac{u \times B}{\tau} - \frac{u}{\tau^2}, \\ \partial_t E - \frac{1}{\tau} \nabla \times B = \frac{nu}{\tau}, \quad \operatorname{div} E = 1 - n, \\ \partial_t B + \frac{1}{\tau} \nabla \times E = 0, \quad \operatorname{div} B = 0. \end{cases} \tag{3.4.2}$$

for $t > 0$, $x \in \mathbb{T}$. And for the relaxation limit, we suppose the initial data is a periodic one.

To obtain the existence and uniqueness of the solution of system (3.4.2) with (3.1.6), we need to find an approximate solution $(n_\tau, u_\tau, E_\tau, B_\tau)$ of system (3.4.2) under the form of a power series in τ . From the momentum equation for u_τ , it is easy to see that $u_\tau \rightarrow 0$ if $\tau \rightarrow 0$. By [61], we have following conclusion:

If the initial data of $(n_\tau, u_\tau, E_\tau, B_\tau)$ admit an asymptotic expansion with respect to τ ,

$$(n_\tau, u_\tau, E_\tau, B_\tau)(0, x) = \sum_{j \geq 0} \tau^j (n_j, \tau u_j, E_j, B_j)(x), \tag{3.4.3}$$

where $(n_j, u_j, E_j, B_j)_{j \geq 0}$ are sufficiently smooth with $n_0 > 0$ in \mathbb{T} and satisfy the compatibility conditions respectively (see (3.4.12)-(3.4.13), (3.4.17)-(3.4.18), (3.4.23)-(3.4.25) below),

then the solution has the following form:

$$(n_\tau, u_\tau, E_\tau, B_\tau) = \sum_{j \geq 0} \tau^j (n^j, \tau u^j, E^j, B^j), \quad (3.4.4)$$

where $(n^j, u^j, E^j, B^j)_{j \geq 0}$ are the unique solutions of the following systems respectively:

$$\begin{cases} \partial_t n^0 + \operatorname{div}(n^0 u^0) = 0, \\ \nabla h(n^0) = -E^0 - u^0, \\ \nabla \times B^0 = 0, \quad \operatorname{div} B^0 = 0, \\ \nabla \times E^0 = 0, \quad \operatorname{div} E^0 = 1 - n^0, \end{cases} \quad (3.4.5)$$

$$\begin{cases} \partial_t n^1 + \operatorname{div}(n^1 u^0 + n^0 u^1) = 0, \\ \nabla(h'(n^0)n^1) = -E^1 - u^0 \times B^0 - u^1, \\ \partial_t E^0 - \nabla \times B^1 = n^0 u^0, \quad \operatorname{div} B^1 = 0, \\ \partial_t B^0 + \nabla \times E^1 = 0, \quad \operatorname{div} E^1 = -n^1, \end{cases} \quad (3.4.6)$$

$$\begin{cases} \partial_t n^j + \operatorname{div}\left(\sum_{k=0}^j n^k u^{j-k}\right) = 0, \\ \partial_t u^{j-2} + \sum_{k=0}^{j-2} (u^k \cdot \nabla) u^{j-2-k} + \nabla(h'(n^0)n^j + h^{j-1}((n^k)_{k \leq j-1})) \\ = -E^j - \sum_{k=0}^{j-1} u^k \times B^{j-1-k} - u^j, \\ \partial_t E^{j-1} - \nabla \times B^j = \sum_{k=0}^{j-1} n^k u^{j-1-k}, \quad \operatorname{div} B^j = 0, \\ \partial_t B^{j-1} + \nabla \times E^j = 0, \quad \operatorname{div} E^j = -n^j, \end{cases} \quad (j \geq 2) \quad (3.4.7)$$

where $h^{j-1}(j \geq 2)$ is a function only decided by $n^k(k \leq j-1)$ and is defined by

$$h\left(\sum_{j \geq 0} \tau^j n^j\right) = h(n^0) + h'(n^0) \sum_{j \geq 1} \tau^j n^j + \sum_{j \geq 2} \tau^j h^{j-1}((n^k)_{k \leq j-1}). \quad (3.4.8)$$

Moreover, system (3.4.5) can be deduced to a classical drift-diffusion equations:

$$\begin{cases} \partial_t n^0 - \operatorname{div}(n^0 \nabla(h(n^0) - \phi^0)) = 0, \\ -\Delta \phi^0 = 1 - n^0, \end{cases} \quad t > 0, \quad x \in \mathbb{T} \quad (3.4.9)$$

with the initial conditions:

$$n^0(0, x) = n_0(x), \quad x \in \mathbb{T}, \quad (3.4.10)$$

and

$$u^0 = -\nabla(h(n^0) - \phi^0), \quad E^0 = -\nabla\phi^0, \quad B^0 = 0. \quad (3.4.11)$$

From (3.4.11) we can get the zero-order compatibility conditions:

$$u_0 = -\nabla(h(n_0) - \phi_0), \quad E_0 = -\nabla\phi_0, \quad B_0 = 0, \quad (3.4.12)$$

where ϕ_0 is determined by

$$-\Delta\phi_0 = 1 - n_0, \quad m(\phi_0) = 0. \quad (3.4.13)$$

System (3.4.6) can be deduced to a linearized drift-diffusion equations:

$$\begin{cases} \partial_t n^1 - \operatorname{div}(n^0 \nabla(h'(n^0)n^1 - \phi^1)) + \operatorname{div}(n^1 u^0) = 0, \\ \Delta\phi^1 = n^1, \end{cases} \quad t > 0, \quad x \in \mathbb{T} \quad (3.4.14)$$

with the initial conditions:

$$n^1(0, x) = n_1(x), \quad x \in \mathbb{T}, \quad (3.4.15)$$

and

$$u^1 = -\nabla(h'(n^0)n^1 - \phi^1), \quad E^1 = -\nabla\phi^1. \quad (3.4.16)$$

Since B^1 can also be solved by the third equation of (3.4.6), we get the first-order compatibility conditions:

$$u_1 = -\nabla(h'(n_0)n_1 - \phi_1), \quad E_1 = -\nabla\phi_1, \quad B_1 = B^1(0, \cdot), \quad (3.4.17)$$

where ϕ_1 is determined by

$$\Delta\phi_1 = n_1, \quad m(\phi_1) = 0. \quad (3.4.18)$$

For $j \geq 2$, system (3.4.7) can be deduced to a linearized drift-diffusion equations, too. Since B^j can be solved uniquely in the class $m(B^j) = 0$, we deduce the existence of a given vector function ψ^j with $\operatorname{div}B^j = 0$ such that $B^j = -\nabla \times \psi^j$. So

$$\begin{cases} \partial_t n^j - \operatorname{div}(n^0 \nabla(h'(n^0)n^j - \phi^j)) + \operatorname{div}(n^j u^0) \\ = f^j((n^k, u^k, E^k, B^k)_{0 \leq k \leq j-1}) + \operatorname{div}(n^0 \partial_t \psi^{j-1}), \\ \Delta\phi^j = n^j + \partial_t(\operatorname{div}\psi^{j-1}), \end{cases} \quad t > 0, \quad x \in \mathbb{T} \quad (3.4.19)$$

with the initial conditions:

$$n^j(0, x) = n_j(x), \quad x \in \mathbb{T}, \quad (3.4.20)$$

and

$$u^j = -\partial_t \psi^{j-1} - \nabla(h'(n^0)n^j - \phi^j) + g^j((n^k, u^k, E^k, B^k)_{0 \leq k \leq j-1}), \quad (3.4.21)$$

$$E^j = \partial_t \psi^{j-1} - \nabla \phi^j, \quad (3.4.22)$$

where f^j, g^j are given smooth functions. Thus, we can get the high-order compatibility conditions for $j \geq 2$:

$$u_j = -\partial_t \psi^{j-1}(0, \cdot) - \nabla(h'(n_0)n_j - \phi_j) + g^j((n_k, u_k, E_k, B_k)_{0 \leq k \leq j-1}), \quad (3.4.23)$$

$$E_j = \partial_t \psi^{j-1}(0, \cdot) - \nabla \phi_j, \quad B_j = B^j(0, \cdot), \quad (3.4.24)$$

where ϕ_j is determined by

$$\Delta \phi_j = n_j + \partial_t(\operatorname{div} \psi^{j-1}(0, \cdot)), \quad m(\phi_j) = 0. \quad (3.4.25)$$

3.5 The zero-relaxation limit

We construct an approximate solution following §3.4. Let

$$(n_\tau^m, u_\tau^m, E_\tau^m, B_\tau^m) = \sum_{j=0}^m \tau^j (n^j, \tau u^j, E^j, B^j) \quad (3.5.1)$$

with $m \geq 2$ and $(n^j, u^j, E^j, B^j)_{0 \leq j \leq m}$ being given as in §3.4. Let T_1 be the maximal existent time of the solutions to (3.4.5), (3.4.6) and (3.4.7) for $j \leq m$. Then, we have the following result:

Theorem 3.2. *Suppose $p \in C^\infty(\mathbb{T})$, $(n_j, u_j, E_j, B_j) \in H^s(\mathbb{T})$ for $j = 0, 1, \dots, m$, $m \geq 2$ and satisfy the compatibility conditions (3.4.12)-(3.4.13), (3.4.17)-(3.4.18) and (3.4.23)-(3.4.25) respectively. Suppose for any fixed integer $s > \frac{5}{2}$,*

$$\|(n_0^\tau, u_0^\tau, E_0^\tau, B_0^\tau) - \sum_{j=0}^{m-1} \tau^j (n_j, \tau u_j, E_j, B_j)\|_s \leq C\tau^m. \quad (3.5.2)$$

Then there exists $T_2 \in (0, T_1]$, independent of τ such that the problem (3.4.2) with (3.1.6) has a unique solution

$$(n^\tau, u^\tau, E^\tau, B^\tau) \in C([0, T_2], H^s(\mathbb{T})) \cap C^1([0, T_2], H^{s-1}(\mathbb{T})) \quad (3.5.3)$$

satisfying

$$\|(n^\tau, u^\tau, E^\tau, B^\tau) - (n_\tau^m, u_\tau^m, E_\tau^m, B_\tau^m)\|_s \leq C\tau^m, \quad (3.5.4)$$

where C is a positive constant independent of τ .

Proof: By (3.4.5)-(3.4.7), and noting (3.5.1), the approximate solution satisfies

$$\begin{cases} \partial_t n_\tau^m + \frac{1}{\tau} \operatorname{div}(n_\tau^m u_\tau^m) = R_n^\tau, \\ \partial_t u_\tau^m + \frac{1}{\tau} (u_\tau^m \cdot \nabla) u_\tau^m + \frac{1}{\tau} \nabla h(n_\tau^m) = -\frac{E_\tau^m}{\tau} - \frac{u_\tau^m}{\tau^2} - \frac{u_\tau^m \times B_\tau^m}{\tau} + R_u^\tau, \\ \partial_t E_\tau^m - \frac{1}{\tau} \nabla \times B_\tau^m = \frac{n_\tau^m u_\tau^m}{\tau} + R_E^\tau, \quad \operatorname{div} E_\tau^m = 1 - n_\tau^m, \\ \partial_t B_\tau^m + \frac{1}{\tau} \nabla \times E_\tau^m = 0, \quad \operatorname{div} B_\tau^m = 0, \end{cases} \quad (3.5.5)$$

where the remainders R_n^τ , R_u^τ and R_E^τ satisfy

$$\sup_{0 \leq t \leq T} \|(R_n^\tau, R_u^\tau, R_E^\tau)\|_{s_0} \leq C\tau^m, \quad (3.5.6)$$

for any $0 \leq s_0 \leq s$, since $(n_\tau^m, u_\tau^m, E_\tau^m, B_\tau^m) \in H^s([0, T] \times \mathbb{T})$.

Let $(n^\tau, u^\tau, E^\tau, B^\tau)$ be the unknown solutions to the problem (3.4.2), and denote by

$$(N^\tau, U^\tau, F^\tau, G^\tau) = (n^\tau - n_\tau^m, u^\tau - u_\tau^m, E^\tau - E_\tau^m, B^\tau - B_\tau^m). \quad (3.5.7)$$

From the equations (3.4.2) and (3.5.5), we know that the errors $(N^\tau, U^\tau, F^\tau, G^\tau)$ satisfy the following problem:

$$\begin{cases} \partial_t N^\tau + \frac{1}{\tau} \operatorname{div}(N^\tau U^\tau + N^\tau u_\tau^m + n_\tau^m U^\tau) = -R_n^\tau, \\ \partial_t U^\tau + \frac{1}{\tau} ((U^\tau + u_\tau^m) \cdot \nabla) U^\tau + \frac{1}{\tau} (U^\tau \cdot \nabla) u_\tau^m + \frac{1}{\tau} \nabla (h(N^\tau + n_\tau^m) - h(n_\tau^m)) \\ \quad = -\frac{F^\tau}{\tau} - \frac{U^\tau}{\tau^2} - \frac{1}{\tau} ((U^\tau + u_\tau^m) \times G^\tau + U^\tau \times B_\tau^m) - R_u^\tau, \\ \partial_t F^\tau - \frac{1}{\tau} \nabla \times G^\tau = \frac{1}{\tau} (N^\tau U^\tau + N^\tau u_\tau^m + n_\tau^m U^\tau) - R_E^\tau, \quad \operatorname{div} F^\tau = -N^\tau, \\ \partial_t G^\tau + \frac{1}{\tau} \nabla \times F^\tau = 0, \quad \operatorname{div} G^\tau = 0, \\ t = 0: \quad (N^\tau, U^\tau, F^\tau, G^\tau) = (n_0^\tau - \sum_{j=0}^m \tau^j n_j, u_0^\tau - \sum_{j=0}^m \tau^{j+1} u_j, \\ \quad \quad \quad E_0^\tau - \sum_{j=0}^m \tau^j E_j, B_0^\tau - \sum_{j=0}^m \tau^j B_j). \end{cases} \quad (3.5.8)$$

Set

$$W_I^\tau = \begin{pmatrix} N^\tau \\ U^\tau \end{pmatrix}, \quad W_{II}^\tau = \begin{pmatrix} F^\tau \\ G^\tau \end{pmatrix}, \quad W^\tau = \begin{pmatrix} W_I^\tau \\ W_{II}^\tau \end{pmatrix},$$

$$\begin{aligned}
W_{I0}^\tau &= \begin{pmatrix} n_0^\tau - \sum_{j=0}^m \tau^j n_j \\ u_0^\tau - \sum_{j=0}^m \tau^{j+1} u_j \end{pmatrix}, \quad W_{II0}^\tau = \begin{pmatrix} E_0^\tau - \sum_{j=0}^m \tau^j E_j \\ B_0^\tau - \sum_{j=0}^m \tau^j B_j \end{pmatrix}, \\
A_i^I(W_I^\tau) &= (U^\tau + u_\tau^m)_i \mathbf{I}_{4 \times 4} + \begin{pmatrix} 0 & (N^\tau + n_\tau^m) e_i^T \\ h'(N^\tau + n_\tau^m) e_i & 0 \end{pmatrix}, \\
A_i^{II} &= \begin{pmatrix} 0 & L_i \\ L_i^T & 0 \end{pmatrix}, \quad A_i(W^\tau) = \begin{pmatrix} A_i^I(W_I^\tau) & 0 \\ 0 & A_i^{II} \end{pmatrix} \\
H_1(W_I^\tau) &= \begin{pmatrix} -(U^\tau \cdot \nabla) n_\tau^m - N^\tau \operatorname{div} u_\tau^m \\ -(U^\tau \cdot \nabla) u_\tau^m - (h'(N^\tau + n_\tau^m) - h'(n_\tau^m)) \nabla n_\tau^m \\ N^\tau U^\tau + N^\tau u_\tau^m + n_\tau^m U^\tau \\ 0 \end{pmatrix}, \\
H_2(W_I^\tau) &= \begin{pmatrix} 0 \\ -U^\tau \\ 0 \\ 0 \end{pmatrix}, \quad R^\tau = \begin{pmatrix} R_n^\tau \\ R_u^\tau \\ R_E^\tau \\ 0 \end{pmatrix}, \\
H_3(W_I^\tau, W_{II}^\tau) &= \begin{pmatrix} 0 \\ -F^\tau - (U^\tau + u_\tau^m) \times G^\tau - U^\tau \times B_\tau^m \\ 0 \\ 0 \end{pmatrix},
\end{aligned}$$

where (e_1, e_2, e_3) is the canonical basis of \mathbb{R}^3 , $\mathbf{I}_{d \times d}$ is a $d \times d$ unit matrix, y_i denotes the i -th component of $y \in \mathbb{R}^3$ and $L_i (i = 1, 2, 3)$ is given as (3.2.7).

From (3.5.8), the redundant equations $\operatorname{div} F^\tau = -N^\tau$ and $\operatorname{div} G^\tau = 0$ hold as soon as they are satisfied by the initial data. Then the problem (3.5.8) can be rewritten as

$$\begin{cases} \partial_t W^\tau + \frac{1}{\tau} \sum_{i=1}^3 A_i(W_I^\tau) \partial_{x_i} W^\tau = \frac{1}{\tau} H_1(W_I^\tau) + \frac{1}{\tau^2} H_2(W_I^\tau) + \frac{1}{\tau} H_3(W_I^\tau, W_{II}^\tau) - R^\tau, \\ t = 0: \quad W^\tau = W_0^\tau, \end{cases} \quad (3.5.9)$$

with

$$\operatorname{div} F^\tau(x, 0) = -N^\tau(x, 0), \quad \operatorname{div} G^\tau(x, 0) = 0, \quad (3.5.10)$$

which can be guaranteed by the assumptions on the initial data.

It is easy to see that the equations of W^τ in (3.5.9) are symmetrizable hyperbolic, i.e. if we introduce

$$A_0(W_I^\tau) = \begin{pmatrix} \begin{pmatrix} (h'(N^\tau + n_\tau^m)) & 0 \\ 0 & (N^\tau + n_\tau^m)\mathbf{I}_{3 \times 3} \end{pmatrix} & \mathbf{0} \\ \mathbf{0} & \mathbf{I}_{6 \times 6} \end{pmatrix},$$

which is positively definite when $0 < C_1 \leq (N^\tau + n_\tau^m) \leq C_2$ for a sufficient small τ , then $\tilde{A}_i(W_I^\tau) = A_0(W_I^\tau)A_i(W_I^\tau)$ are symmetric for all $1 \leq i \leq 3$. Here the condition $0 < C_1 \leq (N^\tau + n_\tau^m) \leq C_2$ is satisfied since $n_\tau^m \rightarrow n^0$ and $\|N^\tau\|_{L^\infty} \rightarrow 0$ as $\tau \rightarrow 0$.

Thus, the key point for proving Theorem 3.2 is the following a priori estimate.

Proposition 3.3. *Let $s > \frac{5}{2}$ and $m \geq 2$. Suppose*

$$\|W_0^\tau\|_s \leq D_1 \tau^m \quad (3.5.11)$$

for some constant $D_1 > 0$ independent of τ . Then there exists constant $D_2 > 0$, such that the solution of (3.5.9) satisfies

$$\sup_{0 \leq t \leq T_2} \|W^\tau\|_s \leq D_2 \tau^m, \quad (3.5.12)$$

We will prove this proposition in next section and this finishes the proof of Theorem 3.2.

Now we consider the situation for $m = 2$. By theorem 3.2,

$$\|(n^\tau, u^\tau, E^\tau, B^\tau) - (n_\tau^2, u_\tau^2, E_\tau^2, B_\tau^2)\|_s \leq C\tau^2, \quad (3.5.13)$$

so

$$\|(n^\tau, E^\tau, B^\tau) - (n^0, E^0, B^0)\|_s \leq C\tau, \quad \|u^\tau - \tau u^0\|_s \leq C\tau^2, \quad (3.5.14)$$

which means

$$\|(n^\tau, \frac{u^\tau}{\tau}, E^\tau, B^\tau) - (n^0, u^0, E^0, B^0)\|_s \leq C\tau. \quad (3.5.15)$$

We get

Theorem 3.3. *Suppose $p \in C^\infty(\mathbb{T})$, suppose $(n_j, u_j, E_j, B_j) \in H^s(\mathbb{T})$ for $j = 0, 1$, and satisfy the compatibility conditions (3.4.12)-(3.4.13) and (3.4.17)-(3.4.18) respectively. Suppose for any fixed integer $s > \frac{5}{2}$,*

$$\|(n_0^\tau, u_0^\tau, E_0^\tau, B_0^\tau) - \sum_{j=0}^1 \tau^j (n_j, \tau u_j, E_j, B_j)\|_s \leq C\tau^2 \quad (3.5.16)$$

Then there exists $T > 0$, such that the problem (3.4.2) with (3.1.6) has a unique solution

$$(n^\tau, u^\tau, E^\tau, B^\tau) \in C([0, T], H^s(\mathbb{T})) \cap C^1([0, T], H^{s-1}(\mathbb{T})) \quad (3.5.17)$$

satisfying

$$\|(n^\tau, \frac{u^\tau}{\tau}, E^\tau, B^\tau) - (n^0, u^0, E^0, B^0)\|_s \leq C\tau, \quad (3.5.18)$$

where C is a positive constant independent of τ .

By Theorem 3.3, we know that when $\tau \rightarrow 0$, the limit for the Euler-Maxwell equations is the drift-diffusion equation. We get the existence and uniqueness of the solution of system (3.4.2), which can be approximated by the solution of drift-diffusion system (3.4.9) and (3.4.11).

3.6 Proof of Proposition 3.3

We first prove the following lemmas.

Lemma 3.5. *Under the assumptions of Proposition 3.3, we have*

$$\begin{aligned} & \|W_I^\tau(T)\|_s^2 + \frac{1}{\tau^2} \int_0^T \|U^\tau\|_s^2 dt \\ & \leq C \int_0^T (\|W_I^\tau\|_s^2 + \|W_{II}^\tau\|_s^2 + \|U^\tau\|_s^2 \|G^\tau\|_s^2 + \frac{1}{\tau^2} \|W_I^\tau\|_s^4) dt + CT\tau^{2m}. \end{aligned} \quad (3.6.1)$$

Proof: Let $\alpha \in \mathbb{N}^3$ with $|\alpha| \leq s$, and $(W_{I\alpha}^\tau, W_{II\alpha}^\tau) = \partial_x^\alpha (W_I^\tau, W_{II}^\tau)$. Differentiating the first two equation of (3.5.9) with x for a multi-index α , we have

$$\begin{aligned} & \partial_t W_{I\alpha}^\tau + \frac{1}{\tau} \sum_{i=1}^3 A_i^I(W_I^\tau) \partial_{x_i} W_{I\alpha}^\tau \\ & = \frac{1}{\tau} (\partial_x^\alpha H_1^I(W_I^\tau) + \partial_x^\alpha H_3^I(W_I^\tau, W_{II}^\tau)) + \frac{1}{\tau^2} \partial_x^\alpha H_2^I(W_I^\tau) - \partial_x^\alpha R_I^\tau \\ & \quad + \frac{1}{\tau} \sum_{i=1}^3 (A_i^I(W_I^\tau) \partial_{x_i} W_{I\alpha}^\tau - \partial_x^\alpha (A_i^I(W_I^\tau) \partial_{x_i} W_I^\tau)) \end{aligned} \quad (3.6.2)$$

Employing the classical energy estimate of symmetric hyperbolic equation, we multiple (3.6.2) by $W_{I\alpha}^\tau \cdot A_0^I(W_I^\tau)$ and obtain

$$\begin{aligned}
& \partial_t(W_{I\alpha}^\tau \cdot A_0^I(W_I^\tau)W_{I\alpha}^\tau) + \frac{1}{\tau} \sum_{i=1}^3 \partial_{x_i}(W_{I\alpha}^\tau \cdot \tilde{A}_i^I(W_I^\tau)W_{I\alpha}^\tau) - \frac{2}{\tau^2} W_{I\alpha}^\tau \cdot A_0^I(W_I^\tau) \partial_x^\alpha H_2^I(W_I^\tau) \\
= & \frac{2}{\tau} W_{I\alpha}^\tau \cdot A_0^I(W_I^\tau) (\partial_x^\alpha H_1^I(W_I^\tau) + \partial_x^\alpha H_3^I(W_I^\tau, W_{II}^\tau)) - 2W_{I\alpha}^\tau \cdot A_0^I(W_I^\tau) \partial_x^\alpha R_I^\tau \\
& + \frac{2}{\tau} \sum_{i=1}^3 W_{I\alpha}^\tau \cdot A_0^I(W_I^\tau) (A_i^I(W_I^\tau) \partial_{x_i} W_{I\alpha}^\tau - \partial_x^\alpha (A_i^I(W_I^\tau) \partial_{x_i} W_I^\tau)) \\
& + W_{I\alpha}^\tau \cdot (\partial_t A_0^I(W_I^\tau) + \frac{1}{\tau} \sum_{i=1}^3 \partial_{x_i} \tilde{A}_i^I(W_I^\tau)) W_{I\alpha}^\tau. \tag{3.6.3}
\end{aligned}$$

Integrate this equation on \mathbb{T} and estimate each term one by one. We get

$$W_{I\alpha}^\tau \cdot \partial_x^\alpha H_2^I(W_I^\tau) = -|U_\alpha^\tau|^2. \tag{3.6.4}$$

Since

$$\begin{aligned}
W_{I\alpha}^\tau \cdot \partial_x^\alpha H_1^I(W_I^\tau) &= -N_\alpha^\tau \partial_x^\alpha ((U^\tau \cdot \nabla) n_\tau^m + N^\tau \operatorname{div} u_\tau^m) \\
&\quad - U_\alpha^\tau \cdot \partial_x^\alpha ((U^\tau \cdot \nabla) u_\tau^m + (h'(N^\tau + n_\tau^m) - h'(n_\tau^m)) \nabla n_\tau^m) \tag{3.6.5}
\end{aligned}$$

by Morse inequality, we get

$$\frac{1}{\tau} \int_{\mathbb{T}} |W_{I\alpha}^\tau \cdot \partial_x^\alpha H_1^I(W_I^\tau)| dx \leq C_\epsilon \|W_I^\tau\|_{|\alpha|}^2 + \frac{\epsilon}{\tau^2} \|U^\tau\|_{|\alpha|}^2, \tag{3.6.6}$$

here and hereafter, ϵ denotes a small constant independent of τ and C_ϵ denotes a positive constant depending on ϵ . Since

$$W_{I\alpha}^\tau \cdot \partial_x^\alpha H_3^I(W_I^\tau) = -U_\alpha^\tau \cdot \partial_x^\alpha (F^\tau + (U^\tau + u_\tau^m) \times G^\tau + U^\tau \times B_\tau^m), \tag{3.6.7}$$

by Morse inequality, we also get

$$\begin{aligned}
& \frac{1}{\tau} \int_{\mathbb{T}} |W_{I\alpha}^\tau \cdot \partial_x^\alpha H_3^I(W_I^\tau, F^\tau, G^\tau)| dx \\
\leq & \frac{\epsilon}{\tau^2} \|U_\alpha^\tau\|^2 + C_\epsilon \int_{\mathbb{T}} |\partial_x^\alpha (F^\tau + (U^\tau + u_\tau^m) \times G^\tau + U^\tau \times B_\tau^m)|^2 dx \\
\leq & \frac{\epsilon}{\tau^2} \|U_\alpha^\tau\|^2 + C_\epsilon (\|W_{II}^\tau\|_{|\alpha|}^2 + \|U^\tau\|_{|\alpha|}^2 \|G^\tau\|_s^2 + \|U^\tau\|_{|\alpha|}^2), \tag{3.6.8}
\end{aligned}$$

here the last inequality, we use the embedding inequality. We can also get

$$\begin{aligned}
& \frac{1}{\tau} \int_{\mathbb{T}} \sum_{i=1}^3 |W_{I\alpha}^\tau \cdot (A_i^I(W_I^\tau) \partial_{x_i} W_{I\alpha}^\tau - \partial_x^\alpha (A_i^I(W_I^\tau) \partial_{x_i} W_I^\tau))| dx \\
& \leq C_\epsilon \|W_{I\alpha}^\tau\|^2 + \frac{\epsilon}{\tau^2} \int_{\mathbb{T}} \sum_{i=1}^3 |A_i^I(W_I^\tau) \partial_{x_i} W_{I\alpha}^\tau - \partial_x^\alpha (A_i^I(W_I^\tau) \partial_{x_i} W_I^\tau)|^2 dx \\
& \leq C_\epsilon \|W_{I\alpha}^\tau\|^2 + \frac{\epsilon}{\tau^2} \|W_I^\tau\|_s^4,
\end{aligned} \tag{3.6.9}$$

here the last inequality, we use Lemma 3.2.

Since

$$\tilde{A}_i^I = A_0^I A_i^I = (U^\tau + u_m^\tau)_i A_0^I + (N^\tau + n_\tau^m) h' C_i, \quad (i = 1, 2, 3) \tag{3.6.10}$$

where $C_i (i = 1, 2, 3)$ is a constant matrix, we have

$$\begin{aligned}
& \partial_t A_0^I + \frac{1}{\tau} \sum_{i=1}^3 \partial_{x_i} \tilde{A}_i^I \\
& = (A_0^I)' \partial_t (N^\tau + n_\tau^m) + \frac{1}{\tau} \sum_{i=1}^3 \partial_{x_i} ((U^\tau + u_m^\tau)_i A_0^I) + \frac{1}{\tau} \sum_{i=1}^3 \partial_{x_i} (N^\tau + n_\tau^m) h' C_i \\
& = (A_0^I)' (\partial_t (N^\tau + n_\tau^m) + \frac{1}{\tau} \nabla (N^\tau + n_\tau^m) \cdot (U^\tau + u_m^\tau)) + \frac{1}{\tau} \operatorname{div} (U^\tau + u_m^\tau) A_0^I \\
& \quad + \frac{1}{\tau} \sum_{i=1}^3 \partial_{x_i} (N^\tau + n_\tau^m) h' C_i \\
& = \frac{\operatorname{div} (U^\tau + u_m^\tau)}{\tau} (A_0^I - (N^\tau + n_\tau^m) (A_0^I)') + \frac{1}{\tau} \sum_{i=1}^3 \partial_{x_i} (N^\tau + n_\tau^m) h' C_i,
\end{aligned} \tag{3.6.11}$$

here the last equality, we use the first equation of (3.4.2). Since

$$|\operatorname{div} (U^\tau + u_m^\tau)| \leq C (\|W_I^\tau\|_s + \tau), \tag{3.6.12}$$

we obtain

$$\begin{aligned}
& \int_{\mathbb{T}} |W_{I\alpha}^\tau \cdot (\partial_t A_0^I(W_I^\tau) + \frac{1}{\tau} \sum_{i=1}^3 \partial_{x_i} \tilde{A}_i^I(W_I^\tau)) W_{I\alpha}^\tau| dx \\
& \leq C \|W_{I\alpha}^\tau\|^2 (1 + \frac{1}{\tau} \|W_I^\tau\|_s) \\
& \leq C (\|W_I^\tau\|_s^2 + \frac{1}{\tau^2} \|W_{I\alpha}^\tau\|^4).
\end{aligned} \tag{3.6.13}$$

Together with (3.6.3), (3.6.4), (3.6.6), (3.6.8), (3.6.9) and (3.6.13) and noting (3.5.11), integrating from 0 to T with $T \in (0, T_2)$ and summing up over all $|\alpha| \leq s$, we get (3.6.1).

Lemma 3.6. *Under the assumptions of Proposition 3.3, we have*

$$\|W_{II}^\tau(T)\|_s^2 \leq \int_0^T \left(\frac{\epsilon}{\tau^2} \|W_I^\tau\|_s^4 + \frac{\epsilon}{\tau^2} \|U^\tau\|_s^2 + \epsilon \|W_I^\tau\|_s^2 + C_\epsilon \|W_{II}^\tau\|_s^2 \right) dt + CT\tau^{2m}. \quad (3.6.14)$$

Proof: Similarly to the proof of Lemma 3.5, we differentiate the third and fourth equations of (3.5.9) with x for a multi-index α . We get

$$\begin{cases} \partial_t F_\alpha^\tau - \frac{1}{\tau} \nabla \times G_\alpha^\tau = \frac{1}{\tau} \partial_x^\alpha (N^\tau U^\tau + N^\tau u_\tau^m + n_\tau^m U^\tau) - \partial_x^\alpha R_E^\tau, \\ \partial_t G_\alpha^\tau + \frac{1}{\tau} \nabla \times F_\alpha^\tau = 0. \end{cases} \quad (3.6.15)$$

By the vector analysis formula

$$\operatorname{div}(f \times g) = (\nabla \times f) \cdot g - (\nabla \times g) \cdot f, \quad (3.6.16)$$

the singular term appearing in Sobolev's energy estimates vanishes, i.e.,

$$\int_{\mathbb{T}} \left(-\frac{1}{\tau} \nabla \times G_\alpha^\tau \cdot F_\alpha^\tau + \frac{1}{\tau} \nabla \times F_\alpha^\tau \cdot G_\alpha^\tau \right) dx = \frac{1}{\tau} \int_{\mathbb{T}} \operatorname{div}(F_\alpha^\tau \times G_\alpha^\tau) dx = 0. \quad (3.6.17)$$

Hence, we get from (3.6.15) that

$$\begin{aligned} & \frac{d}{dt} \|W_{II\alpha}^\tau\|^2 \\ & \leq C \int_{\mathbb{T}} \frac{1}{\tau} (|\partial_x^\alpha (N^\tau U^\tau)| + |\partial_x^\alpha (N^\tau u_\tau^m)| + |\partial_x^\alpha (n_\tau^m U^\tau)|) |F_\alpha^\tau| + |\partial_x^\alpha R_E^\tau| |F_\alpha^\tau| dx \\ & \leq \frac{\epsilon}{\tau^2} \|W_I^\tau\|_{|\alpha|}^4 + \frac{\epsilon}{\tau^2} \|U^\tau\|_{|\alpha|}^2 + \epsilon \|W_I^\tau\|_{|\alpha|}^2 + \epsilon \tau^{2m} + C_\epsilon \|W_{II\alpha}^\tau\|^2. \end{aligned} \quad (3.6.18)$$

Noting (3.5.11), we integrate (3.6.18) from 0 to T with $T \in (0, T_2)$ and sum up over all $|\alpha| \leq s$, it follows (3.6.14).

Finally, we combine (3.6.1) and (3.6.14) together. We get

$$\|(W_I^\tau, W_{II}^\tau)(T)\|_s^2 \leq C \int_0^T (\|(W_I^\tau, W_{II}^\tau)\|_s^2 + \frac{1}{\tau^2} \|(W_I^\tau, W_{II}^\tau)\|_s^4) dt + CT\tau^{2m} \quad (3.6.19)$$

Applying the Gronwall's inequality to (3.6.19), we get

$$\sup_{0 \leq t \leq T_2} \|(W_I^\tau, W_{II}^\tau)(t)\|_s^2 \leq CT_2 \tau^{2m} e^{CT_2}. \quad (3.6.20)$$

This finishes the proof of Proposition 3.3.

Remark 3.4. Since the proof of Proposition 3.3 for the bipolar system is identical as the proof for the unipolar one, Theorem 3.2, 3.3 and Proposition 3.3 are still valid under the bipolar condition.

Part III

Exact boundary controllability and observability for quasilinear hyperbolic systems on a tree-like network

Chapter 4

Exact boundary controllability of unsteady flows

4.1 Introduction

The one-dimensional mathematical model of unsteady flows in an open canal was given by de Saint-Venant [15]. In [30], the authors gave a corresponding model of Saint-Venant system for a network of open canals, in which the interface conditions at any given joint point of open canals are given.

In recent years, based on the semi-global classical solution in [37], the exact boundary controllability for general first order quasilinear hyperbolic systems has been established (see [41], [42]). Then this result has been applied to get the exact boundary controllability of unsteady flows in a network of open canals(see [31], [32], [43],[44]). In [43] and [44], a tree-like network of N open canals was treated by N controls.

On the other hand, the exact boundary observability for a tree-like network of N open canals has been realized in [22], in which the authors proved that if the tree-like network has M simple nodes, then the number of the observed values is equal to $M - 1$, which is much less than N . Since in many cases there is an implicit duality between controllability and observability(see [35]), the result given in [43] and [44] should be improved. Moreover, we can also get the same impression form [14] in which the exact boundary controllability with less controls was established for a tree-like network of strings in the linear case. In

fact, in [32] the author has shown that in order to get the exact boundary controllability, it needs only one control for a string-like network no matter how many canals in it.

In this paper, by establishing the exact boundary controllability for a quasilinear hyperbolic system on a network with certain interface conditions, we will give the exact boundary controllability of unsteady flows in a tree-like network of open canals with general topology. This result is consistent with the result in [22] from the view point of the implicit duality. In this paper we will use the basic idea of globally constructing the piecewise C^1 solution on the whole network suggested in [32] to improve the result in [43] and [44] so that the exact boundary controllability can be realized only by $M - 1$ controls, M being the number of simple nodes in a tree-like network of N open canals.

This paper is organized as follows. The exact boundary controllability for a quasilinear hyperbolic system on a star-like network with certain interface conditions will be established in §4.2. Then the exact boundary controllability of unsteady flows in a star-like network and in a tree-like network of open canals will be presented in §4.3 and §4.4 respectively.

4.2 Exact boundary controllability in a star-like network

In this section, we consider a star-like network, composed of N "strings" with a common joint point O . Let E_i and L_i be another node and the length, respectively, of the i -th "string" ($i = 1, \dots, N$) (see Figure 4.1). For $i = 1, \dots, N$, taking the joint point O as $x = 0$, the i -th "string" can be parameterized lengthwise by $x \in [0, L_i]$.

On i -th "string", we consider the following 2×2 quasilinear hyperbolic system of diagonal form

$$\begin{cases} \frac{\partial r_i}{\partial t} + \lambda_1^{(i)}(r_i, s_i) \frac{\partial r_i}{\partial x} = f_1^{(i)}(r_i, s_i), \\ \frac{\partial s_i}{\partial t} + \lambda_2^{(i)}(r_i, s_i) \frac{\partial s_i}{\partial x} = f_2^{(i)}(r_i, s_i), \end{cases} \quad (4.2.1)$$

where $(r_i, s_i)^T$ is the unknown vector function of (t, x) , $\lambda_1^{(i)}(r_i, s_i)$, $\lambda_2^{(i)}(r_i, s_i)$ and $F^{(i)}(r_i, s_i) = (f_1^{(i)}(r_i, s_i), f_2^{(i)}(r_i, s_i))^T$ are suitably smooth vector functions with

$$F^{(i)}(0, 0) = 0. \quad (4.2.2)$$

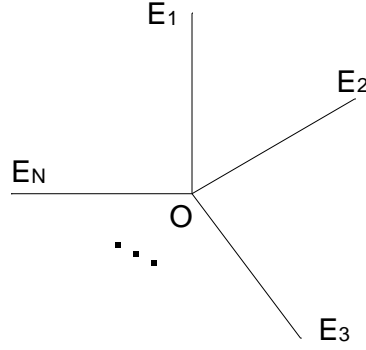

Fig.4.1 A star-like network

In what follows we suppose that on the domain under consideration

$$\lambda_1^{(i)}(r_i, s_i) < 0 < \lambda_2^{(i)}(r_i, s_i) \quad (i = 1, \dots, N), \quad (4.2.3)$$

which means that there are no zero eigenvalues.

We prescribe the mixed initial-boundary value problem for system (4.2.1) with the following initial condition

$$t = 0 : \quad (r_i, s_i) = (\varphi_i(x), \psi_i(x)), \quad 0 \leq x \leq L_i \quad (i = 1, \dots, N), \quad (4.2.4)$$

the boundary conditions on $x = L_i$,

$$x = L_i : \quad r_i = g_1^{(i)}(t, s_i) + h_1^{(i)}(t) \quad (i = 1, \dots, N) \quad (4.2.5)$$

and the interface conditions on $x = 0$,

$$x = 0 : \quad s_i = g_2^{(i)}(t, r_1, \dots, r_N) + h_2^{(i)}(t) \quad (i = 1, \dots, N), \quad (4.2.6)$$

where $h_j^{(i)}$ and $g_j^{(i)}$ ($i = 1, \dots, N, j = 1, 2$) are suitably smooth functions and, without loss of generality, we may suppose that

$$g_1^{(i)}(t, 0) \equiv 0, \quad g_2^{(i)}(t, 0, \dots, 0) \equiv 0 \quad (i = 1, \dots, N). \quad (4.2.7)$$

In order to get the exact boundary controllability, we need the following hypotheses.

(H1) For each $i = 1, \dots, N$, in a neighbourhood of $(r_i, s_i) = 0$, the boundary condition (4.2.5) on $x = L_i$ can be equivalently rewritten as

$$x = L_i : \quad s_i = \bar{g}_1^{(i)}(t, r_i) + \bar{h}_1^{(i)}(t), \quad (4.2.8)$$

in which

$$\bar{g}_1^{(i)}(t, 0) \equiv 0 \quad (4.2.9)$$

and then

$$C^1 \text{ norm of } h_1^{(i)}(t) \text{ small enough} \iff C^1 \text{ norm of } \bar{h}_1^{(i)}(t) \text{ small enough.} \quad (4.2.10)$$

(H2) In a neighbourhood of $(r_i, s_i) = 0 (i = 1, \dots, N)$, the interface conditions (4.2.6) on $x = 0$ can be equivalently rewritten as

$$x = 0 : \quad r_i = \bar{g}_2^{(i)}(t, s_1, \dots, s_N) + \bar{h}_2^{(i)}(t) \quad (i = 1, \dots, N), \quad (4.2.11)$$

in which

$$\bar{g}_2^{(i)}(t, 0, \dots, 0) \equiv 0 \quad (i = 1, \dots, N) \quad (4.2.12)$$

and then

$$\begin{aligned} & C^1 \text{ norms of } h_2^{(i)}(t) (i = 1, \dots, N) \text{ small enough} \\ \iff & C^1 \text{ norms of } \bar{h}_2^{(i)}(t) (i = 1, \dots, N) \text{ small enough.} \end{aligned} \quad (4.2.13)$$

(H3) In a neighbourhood of $(r_i, s_i) = 0 (i = 1, \dots, N)$, the interface conditions (4.2.6) on $x = 0$ can be also equivalently rewritten as

$$\begin{aligned} x = 0 : \quad & s_N = \tilde{g}^{(1)}(t, r_1, s_1, \dots, s_{N-1}) + \tilde{h}^{(1)}(t), \\ & r_i = \tilde{g}^{(i)}(t, r_1, s_1, \dots, s_{N-1}) + \tilde{h}^{(i)}(t) \quad (i = 2, \dots, N), \end{aligned} \quad (4.2.14)$$

in which

$$\tilde{g}^{(i)}(t, 0, \dots, 0) \equiv 0 \quad (i = 1, \dots, N) \quad (4.2.15)$$

and then

$$\begin{aligned} & C^1 \text{ norms of } h_2^{(i)}(t) (i = 1, \dots, N) \text{ small enough} \\ \iff & C^1 \text{ norms of } \tilde{h}^{(i)}(t) (i = 1, \dots, N) \text{ small enough.} \end{aligned} \quad (4.2.16)$$

Theorem 4.1. *Suppose that $\lambda_j^{(i)}, F^{(i)}, g_j^{(i)}$ ($i = 1, \dots, N, j = 1, 2$) are all C^1 functions with respect to their arguments. Suppose furthermore that (4.2.2)-(4.2.3) and (4.2.7) hold. Let*

$$T > \frac{L_1}{|\lambda_1^{(1)}(0)|} + \frac{L_1}{\lambda_2^{(1)}(0)} + \max_{i=2, \dots, N} \frac{L_i}{|\lambda_1^{(i)}(0)|} + \max_{i=2, \dots, N} \frac{L_i}{\lambda_2^{(i)}(0)}. \quad (4.2.17)$$

Under assumptions (H1)-(H3), for any given initial data (φ_i, ψ_i) and final data (Φ_i, Ψ_i) ($i = 1, \dots, N$) with small piecewise C^1 norm $\sum_{i=1}^N \|(\varphi_i, \psi_i)\|_{C^1[0, L_i]}$ and $\sum_{i=1}^N \|(\Phi_i, \Psi_i)\|_{C^1[0, L_i]}$, and for any given $h_1^{(1)}$ and $h_2^{(i)}$ ($i = 1, \dots, N$) with small C^1 norms $\|h_1^{(1)}\|_{C^1[0, T]}$ and $\|h_2^{(i)}\|_{C^1[0, T]}$ ($i = 1, \dots, N$), such that the conditions of piecewise C^1 compatibility are satisfied at the points $(t, x) = (0, L_1), (T, L_1), (0, 0)$ and $(T, 0)$ respectively, there exist boundary controls $h_1^{(i)} \in C^1[0, T]$ ($i = 2, \dots, N$) with small C^1 norm, such that the corresponding mixed initial boundary value problem (4.2.1), (4.2.4)-(4.2.6) admits a unique semi-global piecewise C^1 solution $(r_i(t, x), s_i(t, x))$ ($i = 1, \dots, N$) with small norm $\sum_{i=1}^N \|(r_i, s_i)\|_{C^1[R_i(T)]}$ on the domain

$$R(T) = \bigcup_{i=1}^N R_i(T), \quad (4.2.18)$$

in which

$$R_i(T) = \{(t, x) | 0 \leq t \leq T, 0 \leq x \leq L_i\}, \quad (4.2.19)$$

and $(r_i(t, x), s_i(t, x))$ ($i = 1, \dots, N$) exactly satisfy the final condition

$$t = T : \quad (r_i, s_i) = (\Phi_i(x), \Psi_i(x)), \quad 0 \leq x \leq L_i \quad (i = 1, \dots, N). \quad (4.2.20)$$

Here, the number N of canals is equal to the number M of simple nodes, and the number of controls is equal to $N - 1 = M - 1$.

In order to get Theorem 4.1, it suffices to prove the following lemma.

Lemma 4.1. *Under the assumptions of Theorem 4.1, system (4.2.1) admits a piecewise C^1 solution $(r_i(t, x), s_i(t, x))$ ($i = 1, \dots, N$) with small norm $\sum_{i=1}^N \|(r_i, s_i)\|_{C^1[R_i(T)]}$ on the domain $R(T) = \bigcup_{i=1}^N R_i(T)$, which satisfies simultaneously the boundary condition (4.2.5) for $i = 1$ on $x = L_1$, the interface conditions (4.2.6) on $x = 0$, the initial condition (4.2.4) and the final condition (4.2.20).*

Proof. By (4.2.17) there exists $\epsilon_0 > 0$ so small that

$$\begin{aligned} T > & \max_{|(r_1, s_1)| \leq \epsilon_0} \frac{L_1}{|\lambda_1^{(1)}(r_1, s_1)|} + \max_{|(r_1, s_1)| \leq \epsilon_0} \frac{L_1}{\lambda_2^{(1)}(r_1, s_1)} \\ & + \max_{\substack{i=2, \dots, N \\ |(r_i, s_i)| \leq \epsilon_0}} \frac{L_i}{|\lambda_1^{(i)}(r_i, s_i)|} + \max_{\substack{i=2, \dots, N \\ |(r_i, s_i)| \leq \epsilon_0}} \frac{L_i}{\lambda_2^{(i)}(r_i, s_i)}. \end{aligned} \quad (4.2.21)$$

Let

$$T_1 = \max_{|(r_1, s_1)| \leq \epsilon_0} \frac{L_1}{\lambda_2^{(1)}(r_1, s_1)} + \max_{\substack{i=2, \dots, N \\ |(r_i, s_i)| \leq \epsilon_0}} \frac{L_i}{|\lambda_1^{(i)}(r_i, s_i)|}, \quad (4.2.22)$$

$$T_2 = \max_{\substack{i=2, \dots, N \\ |(r_i, s_i)| \leq \epsilon_0}} \frac{L_i}{|\lambda_1^{(i)}(r_i, s_i)|}, \quad (4.2.23)$$

$$T_3 = \max_{|(r_1, s_1)| \leq \epsilon_0} \frac{L_1}{|\lambda_1^{(1)}(r_1, s_1)|} + \max_{\substack{i=2, \dots, N \\ |(r_i, s_i)| \leq \epsilon_0}} \frac{L_i}{\lambda_2^{(i)}(r_i, s_i)} \quad (4.2.24)$$

and

$$T_4 = \max_{\substack{i=2, \dots, N \\ |(r_i, s_i)| \leq \epsilon_0}} \frac{L_i}{\lambda_2^{(i)}(r_i, s_i)}. \quad (4.2.25)$$

This lemma will be proved by several steps.

(i) We first solve the following forward mixed initial-boundary value problem for system (4.2.1) with the initial condition (4.2.4), the boundary condition (4.2.5) for $i = 1$ on $x = L_1$, the interface conditions (4.2.6) on $x = 0$ and the artificial boundary condition

$$r_i = f^{(i)}(t) \quad (4.2.26)$$

on $x = L_i$ ($i = 2, \dots, N$), where $f^{(i)}(t)$ ($i = 2, \dots, N$) are any given C^1 functions of t with small C^1 norm on $[0, T_1]$, such that the conditions of C^1 compatibility are satisfied at the points $(0, L_i)$ ($i = 2, \dots, N$), respectively. By [37] and [51], under the assumptions of Theorem 4.1, it is easy to see that this problem has a unique semi-global piecewise C^1 solution $U^I(t, x) = \{u_i^I(t, x) | i = 1, \dots, N\}$ with small piecewise C^1 norm on the domain $R(T_1) = \bigcup_{i=1}^N R_i(T_1)$, where $u_i^I = (r_i^I, s_i^I)$ ($i = 1, \dots, N$). In particular, we have

$$|U^I(t, x)| \leq \epsilon_0, \quad \forall (t, x) \in R(T_1). \quad (4.2.27)$$

Then, we can determine the value of $u_1^I = (r_1^I, s_1^I)$ on $x = L_1$ as

$$u_1^I = a(t), \quad 0 \leq t \leq T_1, \quad (4.2.28)$$

which has a small $C^1[0, T_1]$ norm and satisfies the boundary condition (4.2.5) for $i = 1$ on $x = L_1$ for $0 \leq t \leq T_1$. Similarly, we can also determine the values of $u_i^I (i = 1, \dots, N)$ on $x = 0$ as

$$u_i^I = b^{(i)}(t), \quad 0 \leq t \leq T_1 \quad (i = 1, \dots, N) \quad (4.2.29)$$

which have small $C^1[0, T_1]$ norms and satisfy the interface conditions (4.2.6) on $x = 0$ for $0 \leq t \leq T_1$.

(ii) We next solve the following backward mixed initial-boundary value problem for system (4.2.1) with the final condition (4.2.20), the boundary condition (4.2.5) for $i = 1$ on $x = L_1$, the interface conditions (4.2.6) on $x = 0$ and the artificial boundary condition

$$s_i = \bar{f}^{(i)}(t) \quad (4.2.30)$$

on $x = L_i (i = 2, \dots, N)$, where $\bar{f}^{(i)}(t) (i = 2, \dots, N)$ are any given C^1 functions of t with small C^1 norm on $[T - T_3, T]$, such that the conditions of C^1 compatibility are satisfied at the points $(t, x) = (T, L_i) (i = 2, \dots, N)$, respectively. Under assumptions (H1)-(H2), similar to step (i), this problem has a unique semi-global piecewise C^1 solution $U^{II}(t, x) = \{u_i^{II}(t, x) | i = 1, \dots, N\}$ with small piecewise C^1 norm on the domain $R^{II} = \bigcup_{i=1}^N \{(t, x) | T - T_3 \leq t \leq T, 0 \leq x \leq L_i\}$, where $u_i^{II} = (r_i^{II}, s_i^{II}) (i = 1, \dots, N)$. In particular, we have

$$|U^{II}(t, x)| \leq \epsilon_0, \quad \forall (t, x) \in R^{II}. \quad (4.2.31)$$

Then, we can determine the value of u_1^{II} on $x = L_1$ as

$$u_1^{II} = \bar{a}(t), \quad T - T_3 \leq t \leq T, \quad (4.2.32)$$

which has a small $C^1[T - T_3, T]$ norm and satisfies the boundary condition (4.2.5) for $i = 1$ on $x = L_1$ for $T - T_3 \leq t \leq T$. In the meantime, we can also determine the values of $u_i^{II} (i = 1, \dots, N)$ on $x = 0$ as

$$u_i^{II} = \bar{b}^{(i)}(t), \quad T - T_3 \leq t \leq T \quad (i = 1, \dots, N), \quad (4.2.33)$$

which have small $C^1[T - T_3, T]$ norms and satisfy the interface conditions (4.2.6) on $x = 0$ for $T - T_3 \leq t \leq T$.

(iii) We now construct $\tilde{a}(t) \in C^1[0, T]$ with small C^1 norm, such that

$$\tilde{a}(t) = \begin{cases} a(t), & 0 \leq t \leq T_1, \\ \bar{a}(t), & T - T_3 \leq t \leq T \end{cases} \quad (4.2.34)$$

and $\tilde{a}(t)$ satisfies the boundary condition (4.2.5) for $i = 1$ on $x = L_1$ for the whole interval $0 \leq t \leq T$.

Noting that there is no zero eigenvalues for system (4.2.1), by changing the status of t and x , we now solve the following leftward mixed initial-boundary value problem on the domain $R_1(T)$ for system (4.2.1) for $i = 1$ with the initial condition

$$x = L_1 : \quad u_1 \stackrel{\text{def}}{=} (r_1, s_1) = \tilde{a}(t), \quad 0 \leq t \leq T \quad (4.2.35)$$

and the boundary conditions

$$t = 0 : \quad r_1 = \varphi_1(x), \quad 0 \leq x \leq L_1, \quad (4.2.36)$$

$$t = T : \quad s_1 = \Psi_1(x), \quad 0 \leq x \leq L_1 \quad (4.2.37)$$

where φ_1 and Ψ_1 are given in (4.2.4) and (4.2.20), respectively.

It is easy to see that the conditions of C^1 compatibility at the points $(t, x) = (0, L_1)$ and (T, L_1) are satisfied, respectively. By [37] and [51] again, there exists a unique semi-global C^1 solution $u_1 = u_1(t, x) = (r_1(t, x), s_1(t, x))$ with small C^1 norm on $R_1(T)$. In particular, we have

$$|u_1(t, x)| \leq \epsilon_0, \quad \forall (t, x) \in R_1(T). \quad (4.2.38)$$

We now prove that

$$t = 0 : \quad u_1 = (\varphi_1, \psi_1), \quad 0 \leq x \leq L_1, \quad (4.2.39)$$

$$t = T : \quad u_1 = (\Phi_1, \Psi_1), \quad 0 \leq x \leq L_1 \quad (4.2.40)$$

and

$$x = 0 : \quad u_1 = b^{(1)}(t), \quad 0 \leq t \leq T_2, \quad (4.2.41)$$

$$x = 0 : \quad u_1 = \bar{b}^{(1)}(t), \quad T - T_4 \leq t \leq T, \quad (4.2.42)$$

where T_2 and T_4 are given by (4.2.23) and (4.2.25) respectively.

Since both $u_1(t, x)$ and $u_1^I(t, x)$ satisfy system (4.2.1) for $i = 1$, the initial condition (4.2.35) for $0 \leq t \leq T_1$ and the boundary condition (4.2.36), by the uniqueness of C^1 solution(cf. [51]), it is easy to see that

$$u_1(t, x) \equiv u_1^I(t, x) \quad (4.2.43)$$

on the domain

$$\{(t, x) | 0 \leq t \leq T_2 + \frac{(T_1 - T_2)x}{L_1}, 0 \leq x \leq L_1\}. \quad (4.2.44)$$

Thus, in particular, we get (4.2.39) and (4.2.41). In a similar way we can prove (4.2.40) and (4.2.42).

(iv) Let $\tilde{b}^{(1)}(t)$ be the value of $u_1(t, x)$ on $x = 0$. The $C^1[0, T]$ norm of $\tilde{b}^{(1)}(t)$ is small and

$$\tilde{b}^{(1)}(t) = \begin{cases} b^{(1)}(t), & 0 \leq t \leq T_2, \\ \bar{b}^{(1)}(t), & T - T_4 \leq t \leq T. \end{cases} \quad (4.2.45)$$

We now construct $s_i(t) = \tilde{b}_2^{(i)}(t) \in C^1[0, T] (i = 2, \dots, N - 1)$ with small C^1 norm, such that

$$\tilde{b}_2^{(i)}(t) = \begin{cases} b_2^{(i)}(t), & 0 \leq t \leq T_2, \\ \bar{b}_2^{(i)}(t), & T - T_4 \leq t \leq T \end{cases} \quad (i = 2, \dots, N - 1). \quad (4.2.46)$$

By assumption (H3), substituting $r_1 = r_1(t)$ and $s_i = s_i(t) (i = 1, \dots, N - 1)$ into (4.2.14), we can uniquely determine the value of $r_i (i = 2, \dots, N)$ and s_N on $x = 0$. Let $\tilde{b}^{(i)}(t) = (r_i(t), s_i(t)) (i = 2, \dots, N)$. It is easy to see that $\tilde{b}^{(i)}(t) (i = 2, \dots, N)$ have small $C^1[0, T]$ norms and satisfy

$$\tilde{b}^{(i)}(t) = \begin{cases} b^{(i)}(t), & 0 \leq t \leq T_2, \\ \bar{b}^{(i)}(t), & T - T_4 \leq t \leq T \end{cases} \quad (i = 2, \dots, N). \quad (4.2.47)$$

Moreover, $\tilde{b}^{(i)}(t) (i = 1, \dots, N)$ satisfy the interface conditions (4.2.6).

(v) Finally, for $i = 2, \dots, N$, we solve the following rightward mixed initial-boundary value problem on the domain $R_i(T)$ for system (4.2.1) with the initial condition

$$x = 0 : \quad u_i \stackrel{\text{def}}{=} (r_i, s_i) = \tilde{b}^{(i)}(t), \quad 0 \leq t \leq T \quad (4.2.48)$$

and the boundary conditions

$$t = 0 : \quad s_i = \psi_i(x), \quad 0 \leq x \leq L_i, \quad (4.2.49)$$

$$t = T : \quad r_i = \Phi_i(x), \quad 0 \leq x \leq L_i, \quad (4.2.50)$$

where $\psi_i(x)$ and $\Phi_i(x)$ are given in (4.2.4) and (4.2.20), respectively.

For each $i = 2, \dots, N$, the conditions of C^1 compatibility at the points $(t, x) = (0, 0)$ and $(T, 0)$ are satisfied respectively and there exists a unique semi-global C^1 solution $u_i = u_i(t, x) = (r_i(t, x), s_i(t, x))$ with small C^1 norm on $R_i(T)$. In particular, we have

$$|u_i(t, x)| \leq \epsilon_0, \quad \forall (t, x) \in R_i(T) \quad (i = 2, \dots, N). \quad (4.2.51)$$

We now prove that, for $i = 2, \dots, N$,

$$t = 0: \quad u_i = (\varphi_i, \psi_i), \quad 0 \leq x \leq L_i, \quad (4.2.52)$$

$$t = T: \quad u_i = (\Phi_i, \Psi_i), \quad 0 \leq x \leq L_i. \quad (4.2.53)$$

In fact, for each $i = 2, \dots, N$, both $u_i(t, x)$ and $u_i^I(t, x)$ satisfy system (4.2.1), the initial condition (4.2.48) for $0 \leq t \leq T_2$ and the boundary condition (4.2.49), by the uniqueness of C^1 solution(cf. [51]), it is easy to see that

$$u_i(t, x) \equiv u_i^I(t, x) \quad (4.2.54)$$

on the domain

$$\{(t, x) | 0 \leq t \leq T_2(1 - \frac{x}{L_i}), 0 \leq x \leq L_i\}. \quad (4.2.55)$$

Then, in particular, we get (4.2.52). In a similar way we can prove (4.2.53).

Thus, let

$$U(t, x) = \left\{ u_i(t, x) = (r_i(t, x), s_i(t, x)), \quad \forall (t, x) \in R_i(T) \quad (i = 1, \dots, N) \right\}. \quad (4.2.56)$$

$U(t, x)$ is the solution required by Lemma 4.1.

4.3 Exact boundary controllability of unsteady flows in a star-like network of open canals

In this section, we use Theorem 4.1 to get the exact boundary controllability of unsteady flows in a star-like network composed of N horizontal and cylindrical canals, which can be parameterized as in §4.2(also see Figure 4.1).

Suppose that there is no friction, the corresponding system can be given as a Saint-Venant system(see [30], [31]),

$$\begin{cases} \frac{\partial A_i}{\partial t} + \frac{\partial(A_i V_i)}{\partial x} = 0, \\ \frac{\partial V_i}{\partial t} + \frac{\partial S_i}{\partial x} = 0, \end{cases} \quad t \geq 0, \quad 0 \leq x \leq L_i \quad (i = 1, \dots, N), \quad (4.3.1)$$

where, for the i -th canal, $A_i = A_i(t, x)$ stands for the area of the cross section at x occupied by the water at time t , $V_i = V_i(t, x)$ the average velocity over the cross section and

$$S_i = \frac{1}{2} V_i^2 + g h_i(A_i) + g Y_{ib}, \quad (4.3.2)$$

in which g is the gravity constant, constant Y_{ib} denotes the altitude of the bed and

$$h_i = h_i(A_i) \quad (4.3.3)$$

is the depth of the water, $h_i(A_i)$ being a suitably smooth function of A_i , such that

$$h'_i(A_i) > 0. \quad (4.3.4)$$

The initial condition is given by

$$t = 0 : \quad (A_i, V_i) = (A_{i0}(x), V_{i0}(x)), \quad 0 \leq x \leq L_i \quad (i = 1, \dots, N). \quad (4.3.5)$$

At the simple node of each canal we have the flux boundary condition

$$x = L_i : \quad A_i V_i = q_i(t) \quad (i = 1, \dots, N), \quad (4.3.6)$$

while, at the joint point O , we have the total flux interface condition

$$\sum_{i=1}^N A_i V_i = q_0(t) \quad (4.3.7)$$

and the energy-type interface conditions

$$S_i = S_1 \quad (i = 2, \dots, N). \quad (4.3.8)$$

For an equilibrium state $(A_i, V_i) = (A_{i0}, V_{i0})$ of system (4.3.1) with $A_{i0} > 0$ ($i = 1, \dots, N$), which belongs to a subcritical case, i.e.,

$$|V_{i0}| < \sqrt{g A_{i0} h'_i(A_{i0})} \quad (i = 1, \dots, N), \quad (4.3.9)$$

and, corresponding to (4.3.7)-(4.3.8), satisfies

$$\sum_{i=1}^N A_{i0} V_{i0} = 0, \quad (4.3.10)$$

$$S_{i0} = S_{10} \quad (i = 2, \dots, N), \quad (4.3.11)$$

where

$$S_{i0} = \frac{1}{2} V_{i0}^2 + g h_i(A_{i0}) + g Y_{bi} \quad (i = 1, \dots, N), \quad (4.3.12)$$

we have

Theorem 4.2. *Let*

$$T > \left(\frac{L_1}{|\tilde{\lambda}_1^{(1)}|} + \frac{L_1}{\tilde{\lambda}_2^{(1)}} \right) + \max_{i=2, \dots, N} \frac{L_i}{|\tilde{\lambda}_1^{(i)}|} + \max_{i=2, \dots, N} \frac{L_i}{\tilde{\lambda}_2^{(i)}}, \quad (4.3.13)$$

where

$$\tilde{\lambda}_1^{(i)} = V_{i0} - \sqrt{g A_{i0} h_i'(A_{i0})} < 0 < \tilde{\lambda}_2^{(i)} = V_{i0} + \sqrt{g A_{i0} h_i'(A_{i0})} \quad (i = 1, \dots, N). \quad (4.3.14)$$

For any given initial state $(A_{i0}(x), V_{i0}(x))$ and final state $(A_{iT}(x), V_{iT}(x))$ ($i = 1, \dots, N$) with small norms $\sum_{i=1}^N \|(A_{i0}(x) - A_{i0}, V_{i0}(x) - V_{i0})\|_{C^1[0, L_i]}$ and $\sum_{i=1}^N \|(A_{iT}(x) - A_{i0}, V_{iT}(x) - V_{i0})\|_{C^1[0, L_i]}$, and for any given $q_0(t)$ and $q_1(t)$ with small norms $\|q_0(t)\|_{C^1[0, T]}$ and $\|q_1(t) - A_{10} V_{10}\|_{C^1[0, T]}$, such that the conditions of C^1 compatibility are satisfied at $(t, x) = (0, 0), (T, 0), (0, L_1)$ and (T, L_1) , respectively, there exists boundary controls $q_i(t)$ ($i = 2, \dots, N$) with small norms $\|q_i(t) - A_{i0} V_{i0}\|_{C^1[0, T]}$ ($i = 2, \dots, N$), such that the corresponding mixed initial-boundary value problem (4.3.1), (4.3.5)-(4.3.8) admits a unique semi-global piecewise C^1 solution $(A_i, V_i) = (A_i(t, x), V_i(t, x))$ ($i = 1, \dots, N$) with small norm $\sum_{i=1}^N \|(A_i - A_{i0}, V_i - V_{i0})\|_{C^1[R_i(T)]}$ on the domain $R(T) = \bigcup_{i=1}^N R_i(T)$, which exactly satisfies the final condition

$$t = T : \quad (A_i, V_i) = (A_{iT}(x), V_{iT}(x)), \quad 0 \leq x \leq L_i \quad (i = 1, \dots, N). \quad (4.3.15)$$

Here, the number N of canals is equal to the number M of simple nodes, and the number of controls is equal to $N - 1 = M - 1$.

Proof. In a neighbourhood of the subcritical equilibrium state $(A_{i0}, V_{i0})(i = 1, \dots, N)$, (4.3.1) is a hyperbolic system with real eigenvalues

$$\begin{cases} \lambda_1^{(i)} = V_i - \sqrt{gA_i h'_i(A_i)} < 0, \\ \lambda_2^{(i)} = V_i + \sqrt{gA_i h'_i(A_i)} > 0, \end{cases} \quad (i = 1, \dots, N). \quad (4.3.16)$$

For $i = 1, \dots, N$, introducing the Riemann invariants r_i and s_i as

$$\begin{cases} 2r_i = V_i - V_{i0} - G_i(A_i), \\ 2s_i = V_i - V_{i0} + G_i(A_i), \end{cases} \quad (4.3.17)$$

where

$$G_i(A_i) = \int_{A_{i0}}^{A_i} \sqrt{\frac{gh'_i(A_i)}{A_i}} dA_i, \quad (4.3.18)$$

we have

$$\begin{cases} V_i = r_i + s_i + V_{i0}, \\ A_i = H_i(s_i - r_i) > 0, \end{cases} \quad (4.3.19)$$

where H_i is the inverse function of $G_i(A_i)$ and

$$H_i(0) = A_{i0}, \quad (4.3.20)$$

$$H'_i(0) = \sqrt{\frac{A_{i0}}{gh'_i(A_{i0})}} > 0. \quad (4.3.21)$$

Thus, system (4.3.1) can be equivalently rewritten as

$$\begin{cases} \frac{\partial r_i}{\partial t} + \lambda_1^{(i)}(r_i, s_i) \frac{\partial r_i}{\partial x} = 0, \\ \frac{\partial s_i}{\partial t} + \lambda_2^{(i)}(r_i, s_i) \frac{\partial s_i}{\partial x} = 0, \end{cases} \quad t \geq 0, \quad 0 \leq x \leq L_i \quad (i = 1, \dots, N), \quad (4.3.22)$$

where

$$\begin{cases} \lambda_1^{(i)}(r_i, s_i) = r_i + s_i + V_{i0} - \sqrt{gH_i(s_i - r_i)h'_i(H_i(s_i - r_i))} < 0, \\ \lambda_2^{(i)}(r_i, s_i) = r_i + s_i + V_{i0} + \sqrt{gH_i(s_i - r_i)h'_i(H_i(s_i - r_i))} > 0, \end{cases} \quad (i = 1, \dots, N). \quad (4.3.23)$$

For $i = 1, \dots, N$, the boundary condition (4.3.6) becomes

$$x = L_i : \quad P_i \stackrel{\text{def}}{=} (r_i + s_i + V_{i0})H_i(s_i - r_i) - q_i(t) = 0. \quad (4.3.24)$$

Since in a neighbourhood of $(r_i, s_i) = (0, 0)$,

$$\frac{\partial P_i}{\partial r_i} = \sqrt{\frac{A_{i0}}{gh'_i(A_{i0})}} \left(-V_{i0} + \sqrt{gA_{N0}h'_N(A_{N0})} \right) > 0, \quad (4.3.25)$$

$$\frac{\partial P_i}{\partial s_i} = \sqrt{\frac{A_{i0}}{gh'_i(A_{i0})}} \left(V_{i0} + \sqrt{gA_{N0}h'_N(A_{N0})} \right) > 0, \quad (4.3.26)$$

(4.3.6) can be equivalently rewritten as

$$x = L_i : \quad r_i = g_1^{(i)}(t, s_i) + h_1^{(i)}(t) \quad (4.3.27)$$

or

$$x = L_i : \quad s_i = \bar{g}_1^{(i)}(t, r_i) + \bar{h}_1^{(i)}(t) \quad (4.3.28)$$

with

$$g_1^{(i)}(t, 0) \equiv \bar{g}_1^{(i)}(t, 0) \equiv 0 \quad (4.3.29)$$

and then

$$\begin{aligned} \|q_i(t) - A_{i0}V_{i0}\|_{C^1[0,T]} \text{ small} &\iff \|h_1^{(i)}(t)\|_{C^1[0,T]} \text{ small} \\ &\iff \|\bar{h}_1^{(i)}(t)\|_{C^1[0,T]} \text{ small.} \end{aligned} \quad (4.3.30)$$

At $x = 0$, the interface conditions (4.3.7)-(4.3.8) now become

$$Q_1 \stackrel{\text{def}}{=} \sum_{i=1}^N (r_i + s_i + V_{i0}) H_i(s_i - r_i) - q_0(t) = 0, \quad (4.3.31)$$

$$\begin{aligned} Q_i &\stackrel{\text{def}}{=} \frac{1}{2} (r_i + s_i + V_{i0})^2 + gh_i(H_i(s_i - r_i)) + gY_{bi} \\ &\quad - \left(\frac{1}{2} (r_1 + s_1 + V_{10})^2 + gh_1(H_1(s_1 - r_1)) + gY_{b1} \right) = 0 \quad (i = 2, \dots, N). \end{aligned} \quad (4.3.32)$$

Since in a neighbourhood of $(r_i, s_i) = (0, 0) (i = 1, \dots, N)$,

$$\det \left| \frac{\partial(Q_1, \dots, Q_N)}{\partial(s_1, \dots, s_N)} \right| = \prod_{i=1}^N (V_{i0} + \sqrt{gA_{i0}h'_i(A_{i0})}) \cdot \sum_{i=1}^N \sqrt{\frac{A_{i0}}{gh'_i(A_{i0})}} \neq 0, \quad (4.3.33)$$

$$\det \left| \frac{\partial(Q_1, \dots, Q_N)}{\partial(r_1, \dots, r_N)} \right| = - \prod_{i=1}^N (V_{i0} - \sqrt{gA_{i0}h'_i(A_{i0})}) \cdot \sum_{i=1}^N \sqrt{\frac{A_{i0}}{gh'_i(A_{i0})}} \neq 0 \quad (4.3.34)$$

and

$$\begin{aligned} \det \left| \frac{\partial(Q_1, \dots, Q_N)}{\partial(r_2, \dots, r_N, s_N)} \right| &= \prod_{i=2}^{N-1} (V_{i0} - \sqrt{gA_{i0}h'_i(A_{i0})}) \\ &\quad \cdot \sqrt{\frac{A_{N0}}{gh'_N(A_{N0})}} (V_{N0}^2 - gA_{N0}h'_N(A_{N0})) \neq 0, \end{aligned} \quad (4.3.35)$$

(4.3.7)-(4.3.8) can be equivalently rewritten as

$$x = 0 : \quad s_i = g_2^{(i)}(t, r_1, \dots, r_N) + h_2^{(i)}(t) \quad (i = 1, \dots, N) \quad (4.3.36)$$

or

$$x = 0 : \quad r_i = \bar{g}_2^{(i)}(t, s_1, \dots, s_N) + \bar{h}_2^{(i)}(t) \quad (i = 1, \dots, N) \quad (4.3.37)$$

or

$$x = 0 : \quad \begin{cases} s_N = \tilde{g}^{(1)}(t, r_1, s_1, \dots, s_{N-1}) + \tilde{h}^{(1)}(t), \\ r_i = \tilde{g}^{(i)}(t, r_1, s_1, \dots, s_{N-1}) + \tilde{h}^{(i)}(t) \quad (i = 2, \dots, N) \end{cases} \quad (4.3.38)$$

with

$$g_2^{(i)}(t, 0, \dots, 0) \equiv \bar{g}_2^{(i)}(t, 0, \dots, 0) \equiv \tilde{g}^{(i)}(t, 0, \dots, 0) \equiv 0 \quad (i = 1, \dots, N), \quad (4.3.39)$$

and then

$$\begin{aligned} \|q_0(t)\|_{C^1[0,T]} \text{ small} &\iff \|h_2^{(i)}(t)\|_{C^1[0,T]} \text{ small} \quad (i = 1, \dots, N) \\ &\iff \|\bar{h}_2^{(i)}(t)\|_{C^1[0,T]} \text{ small} \quad (i = 1, \dots, N) \\ &\iff \|\tilde{h}^{(i)}(t)\|_{C^1[0,T]} \text{ small} \quad (i = 1, \dots, N). \end{aligned} \quad (4.3.40)$$

Thus, Theorem 4.2 follows directly from Theorem 4.1.

4.4 Exact boundary controllability of unsteady flows in a tree-like network of open canals

Using a method similar to that in §4.3, in this section we consider the exact boundary controllability of unsteady flows in a tree-like network composed by N horizontal and cylindrical canals: C_1, \dots, C_N . Without loss of generality, we suppose that one end of canal C_1 is a simple node in the network. We take this simple node as the starting node E (see Figure 4.2).

For the i -th canal, let d_{i0} and d_{i1} be the x -coordinates of its two ends and $L_i = d_{i1} - d_{i0}$ be its length. For simplicity, in what follows we simply say node d_{i0} (resp. d_{i1}) instead of the node corresponding to d_{i0} (resp. d_{i1}). We always suppose that node d_{i0} is closer to E

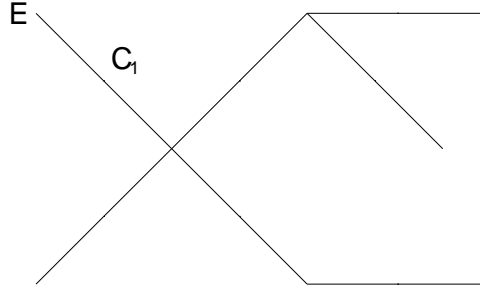

Fig.4.2 A tree-like network

than node d_{i1} in the network (node d_{10} is just E). Suppose that there is no friction, the corresponding Saint-Venant system can be written as

$$\begin{cases} \frac{\partial A_i}{\partial t} + \frac{\partial(A_i V_i)}{\partial x} = 0, \\ \frac{\partial V_i}{\partial t} + \frac{\partial S_i}{\partial x} = 0, \end{cases} \quad t \geq 0, \quad d_{i0} \leq x \leq d_{i1} \quad (i = 1, \dots, N), \quad (4.4.1)$$

where

$$S_i = \frac{1}{2} V_i^2 + g h_i(A_i) + g Y_{bi} \quad (i = 1, \dots, N) \quad (4.4.2)$$

with

$$h'_i(A_i) > 0 \quad (i = 1, \dots, n) \quad (4.4.3)$$

and $Y_{bi} (i = 1, \dots, N)$ being constants.

The initial condition is given by

$$t = 0 : \quad (A_i, V_i) = (A_{i0}(x), V_{i0}(x)), \quad d_{i0} \leq x \leq d_{i1} \quad (i = 1, \dots, N). \quad (4.4.4)$$

Let \mathcal{M} and \mathcal{S} be two subsets of $\{1, \dots, N\}$, such that $i \in \mathcal{M}$ if and only if d_{i1} is a multiple node, while, $i \in \mathcal{S}$ if and only if d_{i1} is a simple node.

At d_{10} , we have the flux boundary condition

$$x = d_{10} : \quad A_1 V_1 = q_0(t). \quad (4.4.5)$$

Similarly, for any $i \in \mathcal{S}$, we have the flux boundary condition

$$x = d_{i1} : \quad A_i V_i = q_i(t). \quad (4.4.6)$$

Moreover, for any $i \in \mathcal{M}$, we have the following interface conditions

$$x = d_{i1} : \quad \sum_{j \in \mathcal{J}_i} A_j V_j = A_i V_i + q_i(t), \quad (4.4.7)$$

$$S_j = S_i, \quad \forall j \in \mathcal{J}_i, \quad (4.4.8)$$

where \mathcal{J}_i denotes the set of all the indices j such that node d_{j0} is just node d_{i1} .

Similar to Theorem 4.2, we have

Theorem 4.3. *Let*

$$T > \max_{i \in \mathcal{S}} \sum_{j \in \mathcal{D}_i} \frac{L_j}{|\widetilde{\lambda}_1^{(j)}|} + \max_{i \in \mathcal{S}} \sum_{j \in \mathcal{D}_i} \frac{L_j}{\widetilde{\lambda}_2^{(j)}}, \quad (4.4.9)$$

where \mathcal{D}_i stands for the set of indices corresponding to all the canals in the unique string-like subnetwork connecting nodes d_{i0} and d_{i1} .

Suppose that $(A_{i0}, V_{i0})(i = 1, \dots, N)$ is an subcritical equilibrium state of system (4.4.1), namely, for each $i = 1, \dots, N$,

$$|V_{i0}| < \sqrt{g A_{i0} h'_i(A_{i0})} \quad (4.4.10)$$

and for each $i \in \mathcal{M}$,

$$x = d_{i1} : \quad \sum_{j \in \mathcal{J}_i} A_{j0} V_{j0} = A_{i0} V_{i0} \quad (4.4.11)$$

$$S_{j0} = S_{i0}, \quad \forall j \in \mathcal{J}_i. \quad (4.4.12)$$

For any given initial state $(A_{i0}(x), V_{i0}(x))$ and final state $(A_{iT}(x), V_{iT}(x))(i = 1, \dots, N)$ with small norms $\sum_{i=1}^N \|(A_{i0}(x) - A_{i0}, V_{i0}(x) - V_{i0})\|_{C^1[d_{i0}, d_{i1}]}$ and $\sum_{i=1}^N \|(A_{iT}(x) - A_{i0}, V_{iT}(x) - V_{i0})\|_{C^1[d_{i0}, d_{i1}]}$, and for any given $q_0(t)$ and $q_i(t)(i \in \mathcal{M})$ with small norms $\|q_0(t) - A_{10} V_{10}\|_{C^1[0, T]}$ and $\sum_{i \in \mathcal{M}} \|q_i(t)\|_{C^1[0, T]}$, such that the corresponding conditions of piecewise C^1 compatibility are satisfied at $(0, d_{10}), (T, d_{10})$ and $(0, d_{i0}), (T, d_{i0})(i \in \mathcal{M})$, respectively, there exists boundary controls $q_i(t)(i \in \mathcal{S})$ with small norm $\sum_{i \in \mathcal{S}} \|q_i(t) - A_{i0} V_{i0}\|_{C^1[0, T]}$, such that the corresponding mixed initial-boundary value problem (4.4.1), (4.4.4)-(4.4.8)

admits a unique semi-global piecewise C^1 solution $(A_i, V_i) = (A_i(t, x), V_i(t, x))(i = 1, \dots, N)$ with small norm $\sum_{i=1}^N \|(A_i - A_{i0}, V_i - V_{i0})\|_{C^1[R_i(T)]}$ on the domain $R(T) = \bigcup_{i=1}^N R_i(T)$, which exactly satisfies the final condition

$$t = T : (A_i, V_i) = (A_{iT}(x), V_{iT}(x)), \quad d_{i0} \leq x \leq d_{i1} \quad (i = 1, \dots, N). \quad (4.4.13)$$

Thus, for a tree-like network with M simple nodes, the number of controls is equal to $M - 1$.

Proof. By introducing the Riemann invariants as in the proof of Theorem 4.2, system (4.4.1) can be rewritten in a diagonal form. Again by the proof of Theorem 4.2, hypotheses (H1)-(H3) are satisfied at all related nodes respectively. Therefore, this theorem can be proved in a completely similar way to the proof of Theorem 4.1.

Indeed, after having solved a forward problem and a backward problem on this tree-like network as in step (i) and step (ii) of the proof of Lemma 4.1, we can solve a rightward problem as in step (iii) and get (A_1, V_1) on canal C_1 . Then as in step (iv), we can determine $(A_j, V_j)(j \in \mathcal{J}_1)$ by (A_1, V_1) at node d_{11} . Consider $d_{j0}(j \in \mathcal{J}_1)$ as a new starting node and do step (iii) and then step (iv) again. Noting (4.4.9), it is easy to see that we can continue this procedure until we get the solution $(A_i, V_i)(i = 1, \dots, N)$ on the whole network. This finishes the proof.

Remark 4.1. Comparing with the results given in [43] and [44], the number of controls is reduced in this paper. In fact, in [43] and [44], at each node except E , one control is needed, then the number of controls is equal to N , the number of canals(The number of nodes is equal to $N + 1$!). However, in this paper we need only one control acting on each simple node except E , then the number of controls is equal to $M - 1$, M being the number of simple nodes. See Figure 4.3, the left one corresponds to the result given in [43] and [44], while, the right one shows the result given in this paper. In this figure, "•" stands for the node on which there is one control.

On the other hand, correspondingly, the controllability time is larger in this paper. In fact, in [43] and [44], the controllability time T is asked to satisfy

$$T > \max_{i=1, \dots, N} \left(\frac{L_i}{|\bar{\lambda}_1^{(i)}|} + \frac{L_i}{\bar{\lambda}_2^{(i)}} \right), \quad (4.4.14)$$

while, the controllability time T is given by (4.4.9) in this paper.

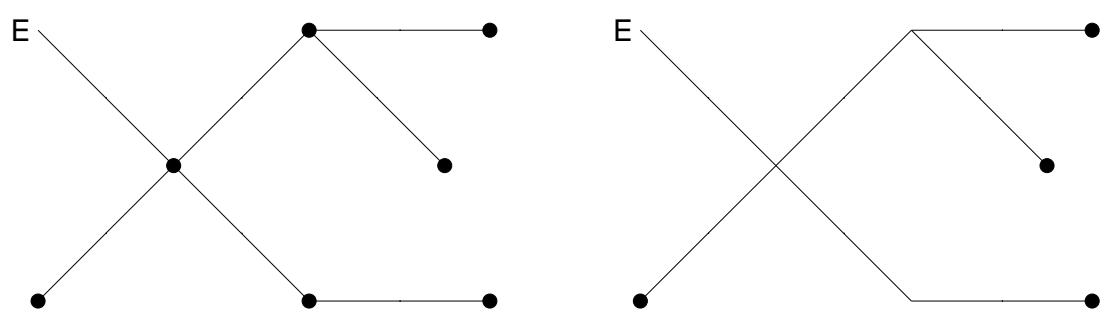

Fig.4.3 Comparison of two results

Chapter 5

Exact boundary controllability of unsteady supercritical flows

5.1 Introduction

The one-dimensional mathematical model of unsteady flows in an open canal is given by Saint-Venant system [15], which has been frequently used by hydraulic engineers in their practice(see [10], [11], [23], [24], [16], [17], [18]).

Using the theory on the semi-global C^1 solution and the exact boundary controllability for quasilinear hyperbolic systems(cf [37]), in the subcritical case, the exact boundary controllability of unsteady flows in both single open canal and a star-like network of open canals was obtained in [31]. The exact boundary controllability of unsteady flows in a string-like network of open canals was established in [32]. And later on, the exact boundary controllability of unsteady flows in a tree-like network of open canals with general topology was established in [44].

In [24], the supercritical case was mentioned. The author gave the interface conditions in a tree-like network under the supercritical hypothesis and established the controllability of steady flows.

In this paper, we will use the interface conditions given in [24] to establish the exact boundary controllability of unsteady supercritical flows in a tree-like network of open canals with general topology.

This paper is organized as follows. We recall the results on the exact boundary controllability for quasilinear hyperbolic systems in §5.2, then the corresponding exact boundary controllability of unsteady supercritical flow in a single open canal will be given in §5.3. The exact boundary controllability of unsteady supercritical flows in a tree-like network of open canals will be presented in §5.4 and proved in §5.5 respectively.

5.2 Preliminaries

For the purpose of this paper, in this section we recall the results given in [37], [41] and [42] only for quasilinear hyperbolic systems of diagonal form

$$\frac{\partial u_i}{\partial t} + \lambda_i(u) \frac{\partial u_i}{\partial x} = F_i(u) \quad (i = 1, \dots, n), \quad (5.2.1)$$

where $u = (u_1, \dots, u_n)^T$ is the unknown vector function of (t, x) , $\lambda_i(u)$ and $F_i(u)$ are C^1 functions of u and

$$F_i(0) = 0 \quad (i = 1, \dots, n). \quad (5.2.2)$$

Suppose that on the domain under consideration

$$\lambda_i(u) < 0 \quad (i = 1, \dots, n) \quad (\text{resp. } \lambda_i(u) > 0 \quad (i = 1, \dots, n)). \quad (5.2.3)$$

Consider the mixed initial-boundary value problem for system (5.2.1) with the following initial condition

$$t = 0: \quad u = \varphi(x), \quad 0 \leq x \leq L \quad (5.2.4)$$

and boundary conditions

$$x = L: \quad u_i = h_i(t) \quad (i = 1, \dots, n) \quad (5.2.5)$$

$$(\text{resp. } x = 0: \quad u_i = h_i(t) \quad (i = 1, \dots, n))$$

where φ , h_i ($i = 1, \dots, n$) are C^1 functions with respect to their arguments. Moreover, the conditions of C^1 compatibility are assumed to be satisfied at points $(t, x) = (0, L)$. (*resp.* $(t, x) = (0, 0)$)

By [41] and [42], we have

Theorem 5.1. *Let*

$$T > \max_{i=1, \dots, n} \frac{L}{|\lambda_i(0)|}. \quad (5.2.6)$$

Under the assumptions mentioned above, for any given initial state $\varphi(x)$ and final state $\psi(x)$ with small C^1 norms $\|\varphi\|_{C^1[0,L]}$ and $\|\psi\|_{C^1[0,L]}$, system (5.2.1) has a C^1 solution with small C^1 norm on the domain

$$R(T) = \{(t, x) | 0 \leq t \leq T, 0 \leq x \leq L\}, \quad (5.2.7)$$

which satisfies the initial condition (5.2.4) and the final condition

$$t = T: \quad u = \psi(x), \quad 0 \leq x \leq L \quad (5.2.8)$$

simultaneously. Then, there exist boundary controls $h_i \in C^1[0, T]$ ($i = 1, \dots, n$) with small C^1 norm, such that the corresponding mixed initial-boundary value problem (5.2.1) and (5.2.4)-(5.2.5) admits a unique semi-global C^1 solution $u = u(t, x)$ with small C^1 norm on $R(T)$, which satisfies the final condition (5.2.8) exactly.

5.3 Exact boundary controllability of unsteady supercritical flows in a single open canal

Now we apply the theory on the exact boundary controllability to unsteady supercritical flows. In this section we first consider the case of a single open canal. Let L be the length of the canal. Taking the x -axis along the inverse direction of flow, this canal can be parameterized lengthwise by $x \in [0, L]$. Suppose that there is no friction and the canal is horizontal and cylindrical, the corresponding Saint-Venant system can be written as (cf. [15], [30], [31])

$$\begin{cases} \frac{\partial A}{\partial t} + \frac{\partial(AV)}{\partial x} = 0, \\ \frac{\partial V}{\partial t} + \frac{\partial S}{\partial x} = 0, \end{cases} \quad t \geq 0, \quad 0 \leq x \leq L, \quad (5.3.1)$$

where $A = A(t, x)$ stands for the area of the cross section at x occupied by the water at time t , $V = V(t, x)$ is the average velocity over the cross section and

$$S = \frac{1}{2}V^2 + gh(A) + gY_b, \quad (5.3.2)$$

where g is the gravity constant, constant Y_b denotes the altitude of the bed of canal and

$$h = h(A) \quad (5.3.3)$$

is the depth of the water, $h(A)$ being a suitably smooth function of A such that

$$h'(A) > 0. \quad (5.3.4)$$

The initial condition is

$$t = 0: \quad (A, V) = (A_0(x), V_0(x)), \quad 0 \leq x \leq L, \quad (5.3.5)$$

while, at $x = L$, the boundary conditions is given as follows:

$$x = L: \quad Q \stackrel{\text{def}}{=} AV = q(t), \quad V = v(t). \quad (5.3.6)$$

Moreover, the conditions of C^1 compatibility are supposed to be satisfied at the point $(t, x) = (0, L)$.

By means of Theorem 5.1, we have the following theorem on the exact boundary controllability.

Theorem 5.2. *Consider an equilibrium state $(A, V) = (A_0, V_0)$ of system (5.3.1) with $A_0 > 0$, which belongs to the supercritical case, i.e.,*

$$|V_0| > \sqrt{gA_0h'(A_0)}. \quad (5.3.7)$$

Without loss of generality, corresponding to (5.3.6), we suppose that

$$V_0 < -\sqrt{gA_0h'(A_0)}. \quad (5.3.8)$$

Let

$$T > \frac{L}{|\tilde{\lambda}_2|} = \max \left(\frac{L}{|\tilde{\lambda}_1|}, \frac{L}{|\tilde{\lambda}_2|} \right), \quad (5.3.9)$$

where

$$\tilde{\lambda}_1 = V_0 - \sqrt{gA_0h'(A_0)} < \tilde{\lambda}_2 = V_0 + \sqrt{gA_0h'(A_0)} < 0. \quad (5.3.10)$$

For any given initial state $(A_0(x), V_0(x)) \in C^1[0, L]$ and final state $(A_T(x), V_T(x)) \in C^1[0, L]$ with small C^1 norms $\|A_0(x) - A_0, V_0(x) - V_0\|_{C^1[0, L]}$ and $\|A_T(x) - A_0, V_T(x) - V_0\|_{C^1[0, L]}$, system (5.3.1) possesses a C^1 solution with small C^1 norm on the domain

$$R(T) = \{(t, x) | 0 \leq t \leq T, 0 \leq x \leq L\}, \quad (5.3.11)$$

which satisfies the initial condition (5.3.5) and the final condition

$$t = T : \quad (A, V) = (A_T(x), V_T(x)), \quad 0 \leq x \leq L \quad (5.3.12)$$

simultaneously. Then, there exist boundary controls $q(t)$ and $v(t) \in C^1[0, T]$ with small C^1 norms $\|q(t) - A_0 V_0\|_{C^1[0, T]}$ and $\|v(t) - V_0\|_{C^1[0, T]}$, such that the corresponding mixed initial-boundary value problem (5.3.1) and (5.3.5)-(5.3.6) admits a unique semi-global C^1 solution $(A, V) = (A(t, x), V(t, x))$ with small C^1 norm $\|(A - A_0, V - V_0)\|_{C^1}$ on $R(T)$, which satisfies the final condition (5.3.12) exactly.

Proof: In a neighbourhood of the supercritical equilibrium state (A_0, V_0) , (5.3.1) is a strictly hyperbolic system with two distinct real eigenvalues

$$\lambda_1 = V - \sqrt{gAh'(A)} < \lambda_2 = V + \sqrt{gAh'(A)} < 0. \quad (5.3.13)$$

Introducing the Riemann invariants r and s as follows:

$$\begin{cases} 2r = V - V_0 - G(A), \\ 2s = V - V_0 + G(A), \end{cases} \quad (5.3.14)$$

where

$$G(A) = \int_{A_0}^A \sqrt{\frac{gh'(A)}{A}} dA, \quad (5.3.15)$$

we have

$$\begin{cases} V = r + s + V_0, \\ A = H(s - r) > 0, \end{cases} \quad (5.3.16)$$

where H is the inverse function of $G(A)$ with

$$H(0) = A_0, \quad (5.3.17)$$

$$H'(0) = \sqrt{\frac{A_0}{gh'(A_0)}} > 0. \quad (5.3.18)$$

Taking (r, s) as new unknown variables, the equilibrium state $(A, V) = (A_0, V_0)$ corresponds to $(r, s) = (0, 0)$ and system (5.3.1) reduces to the following system of diagonal form:

$$\begin{cases} \frac{\partial r}{\partial t} + \lambda_1(r, s) \frac{\partial r}{\partial x} = 0, \\ \frac{\partial s}{\partial t} + \lambda_2(r, s) \frac{\partial s}{\partial x} = 0, \end{cases} \quad (5.3.19)$$

where

$$\begin{cases} \lambda_1(r, s) = r + s + V_0 - \sqrt{gH(s-r)h'(H(s-r))} < 0, \\ \lambda_2(r, s) = r + s + V_0 + \sqrt{gH(s-r)h'(H(s-r))} < 0. \end{cases} \quad (5.3.20)$$

Boundary condition (5.3.6) now becomes

$$x = L : \quad P_1(t, r, s) \stackrel{\text{def}}{=} (r + s + V_0)H(s-r) - q(t) = 0, \quad (5.3.21)$$

$$P_2(t, r, s) \stackrel{\text{def}}{=} (r + s + V_0) - v(t) = 0. \quad (5.3.22)$$

When $(r, s) = (0, 0)$, noting (5.3.8), we have

$$\det \left| \frac{\partial(P_1, P_2)}{\partial(r, s)} \right| = -2V_0 \sqrt{\frac{A_0}{gh'(A_0)}} > 0. \quad (5.3.23)$$

By the implicit function theorem, in a neighbourhood of $(r, s) = (0, 0)$, (5.3.21)-(5.3.22) can be equivalently rewritten as

$$x = L : \quad r = a(t), \quad s = b(t), \quad (5.3.24)$$

where a and b are C^1 functions with respect to their arguments, and

$$\|q(t) - A_0V_0, v(t) - V_0\|_{C^1[0, T]} \text{ is suitable small} \Leftrightarrow \|a(t), b(t)\|_{C^1[0, T]} \text{ is suitable small} \quad (5.3.25)$$

Thus, Theorem 5.2 follows directly from Theorem 5.1.

5.4 Exact boundary controllability of unsteady supercritical flows in a tree-like network of open canals

Now, we consider the exact boundary controllability of unsteady supercritical flows in a tree-like network composed of N open canals: C_1, \dots, C_N . Choose a single node as the end point E and suppose the water flows from other single nodes to the point E (see Figure 5.1, in which " \leftarrow " means the direction of the flow of the water).

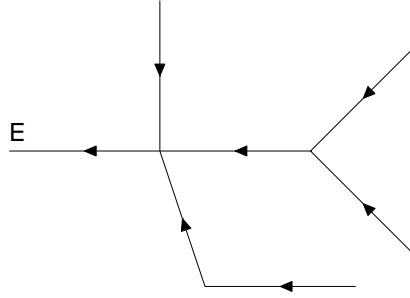

Fig.5.1 A tree-like network

Let d_{i0} and d_{i1} be the x -coordinates of two ends of the i -canal C_i , $d_{i0} < d_{i1}$ and $L_i = d_{i1} - d_{i0}$ be its length. The water in the i -canal flows from d_{i1} to d_{i0} . We still suppose that there is no friction and all the canals are horizontal and cylindrical, the corresponding Saint-Venant system can be written as(cf. [30], [44])

$$\begin{cases} \frac{\partial A_i}{\partial t} + \frac{\partial(A_i V_i)}{\partial x} = 0, \\ \frac{\partial V_i}{\partial t} + \frac{\partial S_i}{\partial x} = 0, \end{cases} \quad t \geq 0, \quad d_{i0} \leq x \leq d_{i1} \quad (i = 1, \dots, N), \quad (5.4.1)$$

where, for the i -th canal, $A_i = A_i(t, x)$ stands for the area of the cross section at x occupied by the water at time t , $V_i = V_i(t, x)$ the average velocity over the cross section and

$$S_i = \frac{1}{2} V_i^2 + g h_i(A_i) + g Y_{ib}, \quad (5.4.2)$$

where g is the gravity constant, constant Y_{ib} denotes the altitude of the bed and

$$h_i = h_i(A_i) \quad (5.4.3)$$

is the depth of the water, $h_i(A_i)$ being a suitably smooth function of A_i , such that

$$h_i'(A_i) > 0. \quad (5.4.4)$$

The initial condition is

$$t = 0 : \quad (A_i, V_i) = (A_{i0}(x), V_{i0}(x)), \quad d_{i0} \leq x \leq d_{i1} \quad (i = 1, \dots, N). \quad (5.4.5)$$

When d_{i1} is a simple node, we have the flux boundary condition

$$x = d_{i1} : \quad A_i V_i = q_{i1}(t), \quad V_i = v_{i1}(t). \quad (5.4.6)$$

While, when d_{i1} is a multiple node, we have the total energy interface conditions(cf. [30],[24])

$$\sum_{j \in J_{i1}, j \neq i} A_j V_j S_j = A_i V_i S_i \quad (5.4.7)$$

and the total flux interface condition

$$\sum_{j \in J_{i1}, j \neq i} A_j V_j = A_i V_i \quad (5.4.8)$$

at d_{i1} , where J_{i1} denotes the set of indices corresponding to all the canals jointed at d_{i1} .

Theorem 5.3. *Consider a supercritical equilibrium state $(A_i, V_i) = (A_{i0}, V_{i0})(i = 1, \dots, N)$ of system (5.4.1) with $A_{i0} > 0(i = 1, \dots, N)$, which satisfies*

$$V_{i0} < -\sqrt{g A_{i0} h'_i(A_{i0})} \quad (i = 1, \dots, N). \quad (5.4.9)$$

Let

$$\tilde{\lambda}_{i1} = V_{i0} - \sqrt{g A_{i0} h'_i(A_{i0})} < \tilde{\lambda}_{i2} = V_{i0} + \sqrt{g A_{i0} h'_i(A_{i0})} < 0 \quad (5.4.10)$$

and let

$$T > \max_{d_{i1} \in K} \sum_{j \in D_i} \frac{L_j}{|\tilde{\lambda}_{j2}|}, \quad (5.4.11)$$

where K stands for the set of all simple nodes except the point E , and D_i the set of indices corresponding to all the canals of the string-like subnetwork connecting the points E and d_{i1} .

For any given initial state $(A_{i0}(x), V_{i0}(x))$ and final state $(A_{iT}(x), V_{iT}(x))(i = 1, \dots, N)$ with small norms $\sum_{i=1}^N \|A_{i0}(x) - A_{i0}, V_{i0}(x) - V_{i0}\|_{C^1[d_{i0}, d_{i1}]}$ and $\sum_{i=1}^N \|A_{iT}(x) - A_{i0}, V_{iT}(x) - V_{i0}\|_{C^1[d_{i0}, d_{i1}]}$, such that the conditions of C^1 compatibility are satisfied at every multiple node on $t = 0$ and $t = T$ respectively, system (5.4.1) possesses a piecewise C^1 solution on the domain $\bigcup_{i=1}^N R_i(T)$, where

$$R_i(T) = \{(t, x) | 0 \leq t \leq T, d_{i0} \leq x \leq d_{i1}\} \quad (i = 1, \dots, N), \quad (5.4.12)$$

such that this solution satisfies the initial condition (5.4.5), the final condition

$$t = T : \quad (A_i, V_i) = (A_{iT}(x), V_{iT}(x)), \quad d_{i0} \leq x \leq d_{i1} \quad (i = 1, \dots, N) \quad (5.4.13)$$

and the interface conditions (5.4.7)-(5.4.8) at every multiple node. Then, there exist boundary controls $q_{i1}(t)$ and $v_{i1}(t) \in C^1[0, T]$ with small C^1 norms $\|q_{i1}(t) - A_{i0}V_{i0}\|_{C^1[0, T]}$ and $\|v_{i1}(t) - V_{i0}\|_{C^1[0, T]}$ for all the simple nodes $d_{i1} \in K$, such that the corresponding mixed initial-boundary value problem (5.4.1) and (5.4.5)-(5.4.8) admits a unique semi-global C^1 solution $(A_i, V_i) = (A_i(t, x), V_i(t, x))$ with small norm $\sum_{i=1}^N \|(A_i - A_{i0}, V_i - V_{i0})\|_{C^1[R_i(T)]}$ on the domain $\bigcup_{i=1}^N R_i(T)$, which satisfies the final condition (5.4.13) exactly.

We will prove this theorem in the next section.

Remark 5.1. If K consists of k simple nodes, namely, there are $k + 1$ simple nodes in the network, then we need $2k$ boundary controls.

Remark 5.2. For a star-like network composed of N canals (cf. [31]), without loss of generality, suppose that the point E belongs to the canal C_1 , then we need $2(N - 1)$ boundary controls, and the controllability time is given by

$$T > \frac{L_1}{|\tilde{\lambda}_{12}|} + \max_{i=2, \dots, N} \frac{L_i}{|\tilde{\lambda}_{i2}|} \quad (5.4.14)$$

(see Figure 2, in which "•" means the simple nodes on which we will give boundary controls).

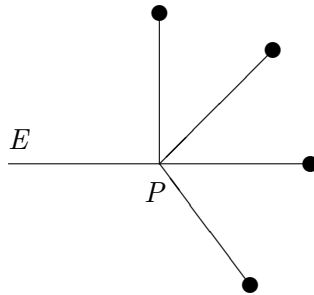

Fig.5.2 A star-like network

Remark 5.3. For a string-like network composed of N canals (cf. [32]), we need only 2 boundary controls at another simple end of the network and the controllability time is given by

$$T > \sum_{i=1}^N \frac{L_i}{|\tilde{\lambda}_{i2}|} \quad (5.4.15)$$

(see Figure 5.3, in which "•" means the simple node on which we will give boundary controls).

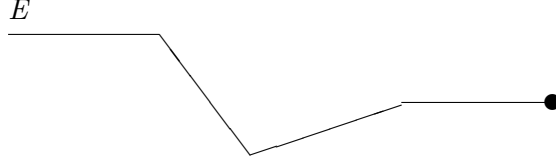

Fig.5.3 A string-like network

5.5 Proof of Theorem 5.3

First we consider some simpler network mentioned in remarks of Section 5.4.

Lemma 5.1. *Theorem 5.3 is true if the network has a star configuration.*

Proof: Suppose that the star-like network under consideration has N canals: C_1, \dots, C_N . Let E be the simple node of the canal C_1 and P be the multiple node (see Figure 5.2).

By [31], in order to prove this lemma, we only need to find a solution of system (5.4.1), which satisfies initial condition (5.4.5), final condition (5.4.13) and interface condition (5.4.7)-(5.4.8).

In a neighbourhood of the supercritical equilibrium state $(A_{i0}, V_{i0})(i = 1, \dots, N)$, (5.4.1) is a hyperbolic system with real eigenvalues

$$\lambda_{i1} = V_i - \sqrt{gA_i h'_i(A_i)} < \lambda_{i2} = V_i + \sqrt{gA_i h'_i(A_i)} < 0 \quad (i = 1, \dots, N). \quad (5.5.1)$$

For $i = 1, \dots, N$, introducing the Riemann invariants r_i and s_i as follows:

$$\begin{cases} 2r_i = V_i - V_{i0} - G_i(A_i), \\ 2s_i = V_i - V_{i0} + G_i(A_i), \end{cases} \quad (5.5.2)$$

where

$$G_i(A_i) = \int_{A_{i0}}^{A_i} \sqrt{\frac{gh'_i(A_i)}{A_i}} dA_i, \quad (5.5.3)$$

we have

$$\begin{cases} V_i = r_i + s_i + V_{i0}, \\ A_i = H_i(s_i - r_i) > 0, \end{cases} \quad (5.5.4)$$

where H_i is the inverse function of $G_i(A_i)$ with

$$H_i(0) = A_{i0}, \quad (5.5.5)$$

$$H'_i(0) = \sqrt{\frac{A_{i0}}{gh'_i(A_{i0})}} > 0. \quad (5.5.6)$$

Taking $(r_i, s_i)(i = 1, \dots, N)$ as new unknown variables, system (5.4.1) reduces to the following system of diagonal form:

$$\begin{cases} \frac{\partial r_i}{\partial t} + \lambda_{i1}(r_i, s_i) \frac{\partial r_i}{\partial x} = 0, \\ \frac{\partial s_i}{\partial t} + \lambda_{i2}(r_i, s_i) \frac{\partial s_i}{\partial x} = 0, \end{cases} \quad (i = 1, \dots, N), \quad (5.5.7)$$

where

$$\begin{cases} \lambda_{i1}(r_i, s_i) = r_i + s_i + V_{i0} - \sqrt{gH_i(s_i - r_i)h'_i(H_i(s_i - r_i))} < 0, \\ \lambda_{i2}(r_i, s_i) = r_i + s_i + V_{i0} + \sqrt{gH_i(s_i - r_i)h'_i(H_i(s_i - r_i))} < 0, \end{cases} \quad (i = 1, \dots, N). \quad (5.5.8)$$

The interface conditions (5.4.7)-(5.4.8) at the point P can be rewritten as

$$\begin{aligned} P_1 &\triangleq \sum_{i=2}^N (r_i + s_i + V_{i0})H_i(s_i - r_i) \left(\frac{1}{2}(r_i + s_i + V_{i0})^2 + gh_i(H_i(s_i - r_i)) + gY_i \right) \\ &- (r_1 + s_1 + V_{10})H_1(s_1 - r_1) \left(\frac{1}{2}(r_1 + s_1 + V_{10})^2 + gh_1(H_1(s_1 - r_1)) + gY_1 \right) = 0, \end{aligned} \quad (5.5.9)$$

$$P_2 \triangleq \sum_{i=2}^N (r_i + s_i + V_{i0})H_i(s_i - r_i) - (r_1 + s_1 + V_{10})H_1(s_1 - r_1) = 0. \quad (5.5.10)$$

Since when $(r_i, s_i) = (0, 0)(i = 1, \dots, N)$,

$$\det \left| \frac{\partial(P_1, P_2)}{\partial(r_1, s_1)} \right| = 2A_{10}V_{10} \sqrt{\frac{A_{10}}{gh'_1(A_{10})}} (V_{10}^2 - gA_{10}h'_1(A_{10})) < 0, \quad (5.5.11)$$

by the implicit function theorem, in a neighbourhood of $(r_i, s_i) = (0, 0)(i = 1, \dots, N)$, (5.5.9)-(5.5.10) can be equivalently rewritten as

$$r_1 = g_{11}(t, r_2, s_2, \dots, r_N, s_N), \quad (5.5.12)$$

$$s_1 = g_{12}(t, r_2, s_2, \dots, r_N, s_N), \quad (5.5.13)$$

where g_{11} and g_{12} are C^1 functions with respect to their arguments with

$$g_{11}(t, 0, \dots, 0) \equiv g_{12}(t, 0, \dots, 0) \equiv 0. \quad (5.5.14)$$

From Theorem 5.2, we know that, for each $i = 2, \dots, N$, we can find a C^1 solution

$$(r_i, s_i) = (r_i(t, x), s_i(t, x)), \quad 0 \leq t \leq T, \quad d_{i0} \leq x \leq d_{i1} \quad (5.5.15)$$

on C_i , which satisfies the corresponding initial condition (5.4.5) and final condition (5.4.13) respectively. Putting (5.5.15) into (5.5.12)-(5.5.13) gives

$$r_1 = g_{11}(t, r_2(t, d_{20}), \dots, s_N(t, d_{N0})) \stackrel{\text{def}}{=} h_1(t), \quad (5.5.16)$$

$$s_1 = g_{12}(t, r_2(t, d_{20}), \dots, r_N(t, d_{N0})) \stackrel{\text{def}}{=} h_2(t), \quad (5.5.17)$$

where $h_1(t)$ and $h_2(t)$ are C^1 functions of t with small C^1 norms. Use Theorem 5.2 again, we can find a solution

$$(r_1, s_1) = (r_1(t, x), s_1(t, x)), \quad 0 \leq t \leq T, \quad d_{10} \leq x \leq d_{11}, \quad (5.5.18)$$

which satisfies the initial condition (5.4.5) and the final condition (5.4.13) for $i = 1$.

Obviously, $(r_i, s_i)(i = 1, \dots, N)$ satisfy the interface conditions (5.4.7)-(5.4.8). This finishes the proof.

Lemma 5.2. *Theorem 5.3 is true if the network has a string configuration.*

Noting that when $N = 2$ in Lemma 5.1, the network becomes the simplest string-like one, this proof is similar to the proof of Lemma 5.1.

We now prove Theorem 5.3.

For the proof, we use the induction on the number N of the canals.

For $N = 1$ and 2, by Theorem 5.2 and Lemma 5.1, Theorem 5.3 is true. Suppose that Theorem 5.3 is true for $N \leq k$, we want to find a piecewise C^1 solution which satisfies the initial condition (5.4.5), the final condition (5.4.13) and all the interface conditions (5.4.7)-(5.4.8) for $N = k + 1$.

Introducing the Riemann invariants r_i and $s_i(i = 1, \dots, N)$ as in the preceding section. Let E be the simple node of canal C_1 and P be the multiple node $x = d_{11}$ of C_1 . We cut the network at P so that the original network is separated into some subnetworks composed of C_1 and some branches denoted by G_2, \dots, G_l (see Figure 5.4, in which "•" means the simple nodes on which we will give boundary controls).

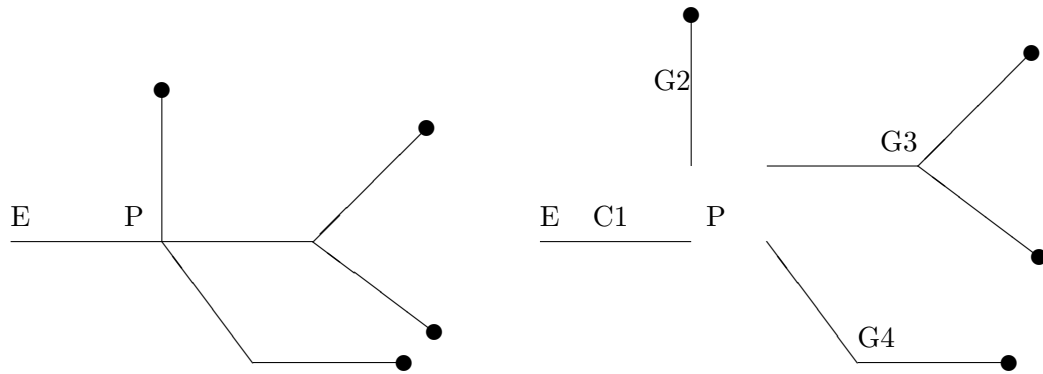

Fig.5.4

By induction, we can find a piecewise C^1 solution on each subnetwork $G_h (h = 2, \dots, l)$, which satisfies the initial condition (5.4.5), the final condition (5.4.13) and the corresponding interface conditions (5.4.7)-(5.4.8) respectively.

Suppose that the canals C_1, \dots, C_l are joined at P . Since we have already known the piecewise C^1 solutions on the subnetworks $G_2, \dots, G_l, (r_2, s_2), \dots, (r_l, s_l)$ are known at the point P . From (5.5.16)-(5.5.17), the interface conditions on P can be equivalently rewritten as

$$r_1 = h_1(t), \tag{5.5.19}$$

$$s_1 = h_2(t), \tag{5.5.20}$$

where $h_1(t)$ and $h_2(t)$ are C^1 functions of t with small C^1 norm. By Theorem 5.2, we can find a C^1 solution on C_1 which satisfies the initial condition (5.4.5) and the final condition (5.4.13). Obviously, the interface conditions (5.4.7)-(5.4.8) are satisfied on the multiple node P , too.

This finishes the proof of Theorem 5.3.

Chapter 6

Exact boundary controllability for quasilinear wave equations

6.1 Introduction

There are many publications concerning the exact controllability for linear hyperbolic systems (see [53]-[54], [64] and the references therein). In the semilinear case, some results on the exact boundary controllability for semilinear wave equations are obtained by Zuazua [74]-[75], Emanuilov [19] and Lasiecka and Triggiani [29], etc.

On the other hand, the exact boundary controllability for linear wave equations with Dirichlet boundary conditions on a planar tree-like network has been studied. The first result of this type was given in [65], in which the exact controllability for certain specific networks is obtained by means of boundary controls acting on all but one simple nodes. This result was later greatly extended in books [28] and [14] respectively. Thus, for a planar tree-like network of linear strings with Dirichlet boundary conditions, if the network has k simple nodes, then the number of controls is equal to $k - 1$.

Moreover, some related study on the stabilization for linear wave equations with Dirichlet boundary conditions can be found in [1]-[3], [14], [56].

In recent years, based on the result on the semi-global classical solution (see [37]), the exact boundary controllability for general first order quasilinear hyperbolic systems has

been established (see [41]-[42]), then this result has been applied to get the exact boundary controllability for 1-D quasilinear wave equations (see [48]-[49]).

This paper is organized as follows. The exact boundary controllability for a quasilinear wave equation on a single string will be presented in §6.2. Then, in §6.3, the existence and uniqueness of semi-global C^2 solution on a star-like planar network of strings with general boundary conditions will be established, and based on this, we get the local exact boundary controllability for quasilinear wave equations on a star-like planar network of strings. With a similar method, the local exact boundary controllability for quasilinear wave equations on a tree-like planar network of strings will be presented in §6.4.

6.2 Exact boundary controllability for quasilinear wave equations

For the purpose of this paper, in this section we recall the results about the exact boundary controllability for quasilinear wave equations on a single string given in [48] and [49]. Consider the following 1- D quasilinear wave equation

$$\frac{\partial^2 u}{\partial t^2} - \frac{\partial}{\partial x} \left(K \left(u, \frac{\partial u}{\partial x} \right) \right) = F \left(u, \frac{\partial u}{\partial x}, \frac{\partial u}{\partial t} \right), \quad (6.2.1)$$

where $K = K(u, v)$ is a given C^2 function of u and v , such that

$$K_v(u, v) > 0, \quad (6.2.2)$$

and $F = F(u, v, w)$ is a given C^1 function of u, v and w , satisfying

$$F(0, 0, 0) = 0. \quad (6.2.3)$$

Moreover, without loss of generality, we may assume that

$$K(0, 0) = 0. \quad (6.2.4)$$

On one end $x = 0$, we give any one of the following physically meaningful boundary

conditions:

$$u = h(t) \quad (\text{Dirichlet type}), \quad (6.2.5a)$$

$$u_x = h(t) \quad (\text{Neumann type}), \quad (6.2.5b)$$

$$u_x - \alpha u = h(t) \quad (\text{Third type}), \quad (6.2.5c)$$

$$u_x - \beta u_t = h(t) \quad (\text{Dissipative type}), \quad (6.2.5d)$$

where α and β are given positive constants, $h(t)$ is a C^2 function (in case (6.2.5a)) or a C^1 function (in case (6.2.5b)-(6.2.5d)).

Similarly, on another end $x = L$, the boundary condition is any one of the following conditions:

$$u = \bar{h}(t) \quad (\text{Dirichlet type}), \quad (6.2.6a)$$

$$u_x = \bar{h}(t) \quad (\text{Neumann type}), \quad (6.2.6b)$$

$$u_x + \bar{\alpha} u = \bar{h}(t) \quad (\text{Third type}), \quad (6.2.6c)$$

$$u_x + \bar{\beta} u_t = \bar{h}(t) \quad (\text{Dissipative type}), \quad (6.2.6d)$$

where $\bar{\alpha}$ and $\bar{\beta}$ are given positive constants, $\bar{h}(t)$ is a C^2 function (in case (6.2.6a)) or a C^1 function (in case (6.2.6b)-(6.2.6d)).

By [48] and [49], we have

Theorem 6.1. *Let*

$$T > \frac{2L}{\sqrt{K_v(0,0)}}. \quad (6.2.7)$$

Suppose that

$$\beta \neq \frac{1}{\sqrt{K_v(0,0)}}, \quad (6.2.8)$$

where β is given in (6.2.5d). For any given initial data (φ, ψ) and final data (Φ, Ψ) with small norms $\|(\varphi, \psi)\|_{C^2[0,L] \times C^1[0,L]}$ and $\|(\Phi, \Psi)\|_{C^2[0,L] \times C^1[0,L]}$, and for any given function $h(t)$ with small norm $\|h\|_{C^2[0,T]}$ (in case (6.2.5a)) or $\|h\|_{C^1[0,T]}$ (in case (6.2.5b-6.2.5d)), such that the conditions of C^2 compatibility are satisfied at the points $(t, x) = (0, 0)$ and $(T, 0)$ respectively, there exists a boundary control $\bar{h}(t)$ with small norm $\|\bar{h}\|_{C^2[0,T]}$ (in case

(6.2.6a)) or $\|\bar{h}\|_{C^1[0,T]}$ (in case (6.2.6b-6.2.6d)), such that the mixed initial-boundary value problem for equation (6.2.1) with the initial condition

$$t = 0: \quad u = \varphi(x), \quad u_t = \psi(x), \quad 0 \leq x \leq L, \quad (6.2.9)$$

one of the boundary conditions (6.2.5) on $x = 0$ and one of the boundary conditions (6.2.6) on $x = L$ admits a unique C^2 solution $u = u(t, x)$ with small C^2 norm on the domain

$$R(T) = \{(t, x) \mid 0 \leq t \leq T, \quad 0 \leq x \leq L\}, \quad (6.2.10)$$

which exactly satisfies the final condition

$$t = T: \quad u = \Phi(x), \quad u_t = \Psi(x), \quad 0 \leq x \leq L. \quad (6.2.11)$$

6.3 Exact boundary controllability for quasilinear wave equations in a star-like planar network of strings

In this section, we consider a star-like planar network which is composed of N strings with a common joint point O . Take the joint point O as $x = 0$. Let E_i and L_i be another node and the length of the i -th string ($i = 1, \dots, N$), respectively (see Figure 6.1).

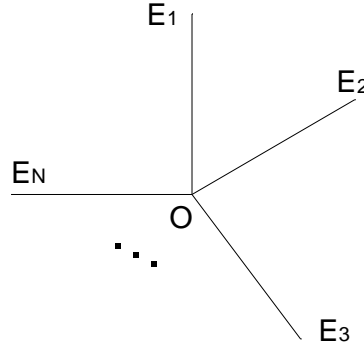

Fig.6.1 A star-like planar network of strings

We consider the following quasilinear wave equation on the i -th string

$$\frac{\partial^2 u^i}{\partial t^2} - \frac{\partial}{\partial x} \left(K_i \left(u^i, \frac{\partial u^i}{\partial x} \right) \right) = F_i \left(u^i, \frac{\partial u^i}{\partial x}, \frac{\partial u^i}{\partial t} \right) \quad (i = 1, \dots, N), \quad (6.3.1)$$

where, for $i = 1, \dots, N$, $K_i = K_i(u, v)$ is a given C^2 function of u and v , such that

$$K_{iv}(u, v) > 0, \quad (6.3.2)$$

and $F_i = F_i(u, v, w)$ is a given C^1 function of u, v and w , satisfying

$$F_i(0, 0, 0) = 0. \quad (6.3.3)$$

Moreover, without loss of generality, we assume that

$$K_i(0, 0) = 0. \quad (6.3.4)$$

The initial condition is given by

$$t = 0 : \quad u^i = \varphi_i(x), \quad u_t^i = \psi_i(x), \quad 0 \leq x \leq L_i \quad (i = 1, \dots, N). \quad (6.3.5)$$

For $i = 1, \dots, N$, on the simple node E_i , we give any one of the following boundary conditions:

$$u^i = h_i(t) \quad (\text{Dirichlet type}), \quad (6.3.6a)$$

$$u_x^i = h_i(t) \quad (\text{Neumann type}), \quad (6.3.6b)$$

$$u_x^i + \alpha_i u^i = h_i(t) \quad (\text{Third type}), \quad (6.3.6c)$$

$$u_x^i + \beta_i u_t^i = h_i(t) \quad (\text{Dissipative type}), \quad (6.3.6d)$$

where α_i and β_i are given positive constants, $h_i(t)$ is a C^2 function (in case (6.3.6a)) or a C^1 function (in case (6.3.6b)-(6.3.6d)) and the conditions of C^2 compatibility are satisfied at $(0, L_i)(i = 1, \dots, N)$. While, on the multiple node O , we have the interface conditions

$$\begin{cases} \sum_{i=1}^N K_i(u^i, u_x^i) = 0, \\ u^i = u^1 \quad (i = 2, \dots, N). \end{cases} \quad (6.3.7)$$

The first condition in (6.3.7) simply means that the total stress at O is equal to zero, while, the second part of conditions in (6.3.7) shows the continuity of displacements at O .

For the purpose of getting the exact boundary controllability on the star-like network of strings, we need the existence and uniqueness of semi-global piecewise C^2 solution on it. In order to get it in a unified way, we first reduce each quasilinear wave equation to a first order quasilinear hyperbolic system.

For $i = 1, \dots, N$, setting

$$v^i = u_x^i, \quad w^i = u_t^i, \quad (6.3.8)$$

equation (6.3.1) can be reduced to

$$\begin{cases} \frac{\partial u^i}{\partial t} = w^i, \\ \frac{\partial v^i}{\partial t} - \frac{\partial w^i}{\partial x} = 0, \\ \frac{\partial w^i}{\partial t} - K_{iv}(u^i, v^i) \frac{\partial v^i}{\partial x} = F_i(u^i, v^i, w^i) + K_{iu}(u^i, v^i) v^i \\ \quad \stackrel{\text{def}}{=} \tilde{F}_i(u^i, v^i, w^i), \end{cases} \quad (i = 1, \dots, N), \quad (6.3.9)$$

where $\tilde{F}_i(u^i, v^i, w^i)$ is still a C^1 function of u^i, v^i and w^i , satisfying

$$\tilde{F}_i(0, 0, 0) = 0. \quad (6.3.10)$$

For $i = 1, \dots, N$, noting (6.3.2), (6.3.9) is a strictly hyperbolic system with three distinct real eigenvalues $\lambda_j^i (j = 1, 2, 3)$:

$$\lambda_1^i = -\sqrt{K_{iv}(u^i, v^i)} < \lambda_2^i = 0 < \lambda_3^i = \sqrt{K_{iv}(u^i, v^i)}. \quad (6.3.11)$$

Thus, the characteristics for system (6.3.9) are given by

$$\frac{dx}{dt} = \lambda_j^i \quad (j = 1, 2, 3). \quad (6.3.12)$$

Moreover, the corresponding left eigenvectors can be taken as

$$l_1^i = (0, \sqrt{K_{iv}}, 1), \quad l_2^i = (1, 0, 0), \quad l_3^i = (0, -\sqrt{K_{iv}}, 1). \quad (6.3.13)$$

Let

$$U^i = (u^i, v^i, w^i)^T \quad (6.3.14)$$

and

$$v_j^i = l_j^i(U^i)U^i \quad (j = 1, 2, 3), \quad (6.3.15)$$

namely,

$$v_1^i = \sqrt{K_{iv}(u^i, v^i)}v^i + w^i, \quad v_2^i = u^i, \quad v_3^i = -\sqrt{K_{iv}(u^i, v^i)}v^i + w^i. \quad (6.3.16)$$

We have

$$\begin{cases} v_1^i + v_3^i = 2w^i, \\ v_1^i - v_3^i = 2\sqrt{K_{iv}(w^i, v^i)}v^i. \end{cases} \quad (6.3.17)$$

With this reduction, the initial condition (6.3.5) now becomes

$$t = 0: \quad U^i = (\varphi_i(x), \varphi_i'(x), \psi_i(x))^T, \quad 0 \leq x \leq L_i. \quad (6.3.18)$$

For $i = 1, \dots, N$, noting the condition of C^0 compatibility: $h_i(0) = \varphi_i(L_i)$, the boundary condition (6.3.6) on the i -th simple node will be correspondingly replaced by

$$w^i = h_i'(t), \quad (6.3.19a)$$

$$v^i = h_i(t), \quad (6.3.19b)$$

$$v^i + \alpha_i w^i = h_i(t), \quad (6.3.19c)$$

$$v^i + \beta_i w^i = h_i(t). \quad (6.3.19d)$$

It is easy to see that, at least in a neighbourhood of $U = 0$, the boundary condition (6.3.19) can be rewritten as

$$v_1^i + v_3^i = 2h_i'(t), \quad (6.3.20a)$$

$$v_1^i - v_3^i = 2\sqrt{K_{iv}(v_2^i, h_i(t))}h_i(t), \quad (6.3.20b)$$

$$v_1^i - v_3^i = 2\sqrt{K_{iv}(v_2^i, h_i(t) - \alpha_i v_2^i)}(h_i(t) - \alpha_i v_2^i), \quad (6.3.20c)$$

$$v_1^i - v_3^i = \sqrt{K_{iv}(v_2^i, h_i(t) - \frac{1}{2}\beta_i(v_1^i + v_3^i))}(2h_i(t) - \beta_i(v_1^i + v_3^i)). \quad (6.3.20d)$$

Then, it can be rewritten as

$$v_1^i = G_{i1}(t, v_2^i, v_3^i) + H_{i1}(t), \quad (6.3.21)$$

or, when

$$\beta_i \neq \frac{1}{\sqrt{K_{iv}(0, 0)}}, \quad (6.3.22)$$

as

$$v_3^i = \bar{G}_{i3}(t, v_1^i, v_2^i) + \bar{H}_{i3}(t). \quad (6.3.23)$$

On the other hand, noting the conditions of C^0 compatibility at O , the interface condition (6.3.7) can be correspondingly replaced by

$$\begin{cases} \sum_{i=1}^N K_i(u^i, v^i) = 0, \\ w^i = w^1 \quad (i = 2, \dots, N), \end{cases} \quad (6.3.24)$$

and then it can be rewritten as

$$\begin{cases} P_1 \stackrel{\text{def}}{=} \sum_{i=1}^N K_i(u^i, v^i) = 0, \\ P_i \stackrel{\text{def}}{=} v_1^i + v_3^i - v_1^1 - v_3^1 = 0. \quad (i = 2, \dots, N). \end{cases} \quad (6.3.25)$$

Since, noting (6.3.2) and (6.3.16), in a neighbourhood of $U = 0$ we have

$$\det \left| \frac{\partial(P_1, \dots, P_N)}{\partial(v_3^1, \dots, v_3^N)} \right| = \sum_{i=1}^N K_{iv} \frac{\partial v^i}{\partial v_3^i} < 0, \quad (6.3.26)$$

$$\det \left| \frac{\partial(P_1, \dots, P_N)}{\partial(v_1^1, \dots, v_1^N)} \right| = \sum_{i=1}^N K_{iv} \frac{\partial v^i}{\partial v_1^i} > 0, \quad (6.3.27)$$

the interface condition (6.3.7) on the multiple node O can be rewritten as

$$v_3^i = G_{i3}(t, v_1^1, \dots, v_1^N, v_2^1, \dots, v_2^N) + H_{i3}(t) \quad (i = 1, \dots, N), \quad (6.3.28)$$

or

$$v_1^i = \bar{G}_{i1}(t, v_2^1, \dots, v_2^N, v_3^1, \dots, v_3^N) + \bar{H}_{i1}(t) \quad (i = 1, \dots, N). \quad (6.3.29)$$

Then, by means of the results on the existence and uniqueness of semi-global C^1 solution given in [37](also see [35]), it is easy to get the following Lemmas.

Lemma 6.1. *Under the assumptions given at the beginning of this section, suppose furthermore that the conditions of piecewise C^2 compatibility or C^2 compatibility are satisfied at the points $(t, x) = (0, 0)$ and $(0, L_i)$ ($i = 1, \dots, N$), respectively. For any given $T_0 > 0$, the forward mixed initial-boundary value problem (6.3.1) and (6.3.5)-(6.3.7) admits a unique semi-global piecewise C^2 solution $u^i = u^i(t, x)$ ($i = 1, \dots, N$) with small piecewise C^2 norm on the domain $R(T_0) = \bigcup_{i=1}^N R_i(T_0)$, where*

$$R_i(T_0) = \{(t, x) \mid 0 \leq t \leq T_0, \quad 0 \leq x \leq L_i\}, \quad (6.3.30)$$

provided that, for $i = 1, \dots, N$, the norms $\|(\varphi_i, \psi_i)\|_{C^2[0, L_i] \times C^1[0, L_i]}$ and $\|h_i\|_{C^2[0, T_0]}$ (for (6.3.6a)) or $\|h_i\|_{C^1[0, T_0]}$ (for (6.3.6b)-(6.3.6d)) are small enough.

Lemma 6.2. *Under the assumptions given at the beginning of this section, and suppose that (6.3.22) hold for $i = 1, \dots, N$. For any given $T_0 > 0$, suppose furthermore that the conditions of piecewise C^2 compatibility or C^2 compatibility are satisfied at the points $(t, x) = (T_0, 0)$ and (T_0, L_i) ($i = 1, \dots, N$), respectively. Then the backward mixed initial-boundary value problem (6.3.1), (6.3.6)-(6.3.7) and the final condition*

$$t = T_0 : \quad u^i = \Phi_i(x), \quad u_t^i = \Psi_i(x), \quad 0 \leq x \leq L_i \quad (i = 1, \dots, N) \quad (6.3.31)$$

admits a unique semi-global piecewise C^2 solution $u^i = u^i(t, x)$ ($i = 1, \dots, N$) with small piecewise C^2 norm on the domain $R(T_0)$, provided that, for $i = 1, \dots, N$, the norms $\|(\Phi_i, \Psi_i)\|_{C^2[0, L_i] \times C^1[0, L_i]}$ and $\|h_i\|_{C^2[0, T_0]}$ (for (6.3.6a)) or $\|h_i\|_{C^1[0, T_0]}$ (for (6.3.6b)-(6.3.6d)) are small enough.

Based on these two lemmas, we have

Theorem 6.2. *Let*

$$T > \frac{2L_1}{\sqrt{K_{1v}(0, 0)}} + \max_{i=2, \dots, N} \frac{2L_i}{\sqrt{K_{iv}(0, 0)}}. \quad (6.3.32)$$

Suppose that

$$\beta_1 \neq \frac{1}{\sqrt{K_{1v}(0, 0)}}, \quad (6.3.33)$$

where β_1 is given in (6.3.6d) for $i = 1$. For any given initial data (φ_i, ψ_i) ($i = 1, \dots, N$) and final data (Φ_i, Ψ_i) ($i = 1, \dots, N$) with small norms $\sum_{i=1}^N \|(\varphi_i, \psi_i)\|_{C^2[0, L] \times C^1[0, L]}$ and $\sum_{i=1}^N \|(\Phi, \Psi)\|_{C^2[0, L] \times C^1[0, L]}$, and for any given function $h_1(t)$ with small norm $\|h_1\|_{C^2[0, T]}$ (in case (6.3.6a)) or $\|h_1\|_{C^1[0, T]}$ (in case (6.3.6b-6.3.6d)), such that the conditions of C^2 compatibility or piecewise C^2 compatibility are satisfied at the points $(t, x) = (0, L_1), (T, L_1)$ and $(0, 0), (T, 0)$, respectively, there exists boundary controls $h_i(t)$ ($i = 2, \dots, N$) with small norms $\|h_i\|_{C^2[0, T]}$ ($i = 2, \dots, N$) (in case (6.3.6a)) or $\|h_i\|_{C^1[0, T]}$ ($i = 2, \dots, N$) (in case (6.3.6b-6.3.6d)), such that the mixed initial-boundary value problem for system (6.3.1) with the initial condition (6.3.5), the boundary condition (6.3.6) on $x = L_i$ ($i = 1, \dots, N$) and the interface condition (6.3.7) on $x = 0$ admits a unique piecewise C^2 solution $u^i = u^i(t, x)$ ($i = 1, \dots, N$) with small piecewise C^2 norm on the domain $R(T) = \bigcup_{i=1}^N R_i(T)$, where

$$R_i(T) = \{(t, x) \mid 0 \leq t \leq T, \quad 0 \leq x \leq L_i\}, \quad (6.3.34)$$

which exactly satisfies the final condition

$$t = T : \quad u^i = \Phi_i(x), \quad u_t^i = \Psi_i(x), \quad 0 \leq x \leq L_i \quad (i = 1, \dots, N). \quad (6.3.35)$$

In order to get Theorem 6.2, it suffices to prove the following lemma.

Lemma 6.3. *Under the assumptions of Theorem 6.2, system (6.3.1) admits a piecewise C^2 solution $u^i(t, x)$ ($i = 1, \dots, N$) with small norm $\sum_{i=1}^N \|u^i\|_{C^2[R_i(T)]}$ on the domain $R(T) = \bigcup_{i=1}^N R_i(T)$, which satisfies simultaneously the boundary condition (6.3.6) for $i = 1$ on $x = L_1$, the interface condition (6.3.7) on $x = 0$, the initial condition (6.3.5) and the final condition (6.3.35).*

Proof. Noting (6.3.32), there exists an $\epsilon_0 > 0$ so small that

$$T > \max_{|(u^1, v^1)| \leq \epsilon_0} \frac{2L_1}{\sqrt{K_{1v}(u^1, v^1)}} + \max_{i=2, \dots, N} \max_{|(u^i, v^i)| \leq \epsilon_0} \frac{2L_i}{\sqrt{K_{iv}(u^i, v^i)}}. \quad (6.3.36)$$

Let

$$T_1 = \max_{|(u^1, v^1)| \leq \epsilon_0} \frac{L_1}{\sqrt{K_{1v}(u^1, v^1)}} + \max_{i=2, \dots, N} \max_{|(u^i, v^i)| \leq \epsilon_0} \frac{L_i}{\sqrt{K_{iv}(u^i, v^i)}} \quad (6.3.37)$$

and

$$T_2 = \max_{i=2, \dots, N} \max_{|(u^i, v^i)| \leq \epsilon_0} \frac{L_i}{\sqrt{K_{iv}(u^i, v^i)}}. \quad (6.3.38)$$

(i) We first consider the following forward mixed initial-boundary value problem for system (6.3.1) with the initial condition (6.3.5), the interface condition (6.3.7), the boundary condition (6.3.6) for $i = 1$ on $x = L_1$, and the following artificial boundary conditions

$$x = L_i : \quad u^i = f_i(t) \quad (i = 2, \dots, N), \quad (6.3.39)$$

where f_i ($i = 2, \dots, N$) are any given C^2 functions of t with small $C^2[0, T_1]$ norm and the conditions of C^2 compatibility at the point $(t, x) = (0, L_i)$ ($i = 2, \dots, N$) are assumed to be satisfied, respectively. Then, by Lemma 6.1, there exists a unique semi-global piecewise C^2 solution $u = u_I(t, x) = (u_I^1(t, x), \dots, u_I^N(t, x))$ on the domain $R^I = \bigcup_{i=1}^N R_i^I$, where

$$R_i^I = \{(t, x) | 0 \leq t \leq T_1, 0 \leq x \leq L_i\} \quad (i = 1, \dots, N), \quad (6.3.40)$$

which has a small piecewise C^2 norm, in particular,

$$|(u_I, \frac{\partial u_I}{\partial x})| \leq \epsilon_0, \quad \forall (t, x) \in R^I. \quad (6.3.41)$$

Thus, we can determine the corresponding value of (u_I^1, u_{Ix}^1) at $x = L_1$ as

$$x = L_1 : \quad (u_I^1, u_{Ix}^1) = (a_1(t), a_2(t)), \quad 0 \leq t \leq T_1, \quad (6.3.42)$$

the $C^2[0, T_1]$ norm of $a_1(t)$ and the $C^1[0, T_1]$ norm of $a_2(t)$ are small and $(a_1(t), a_2(t))$ satisfies the boundary condition (6.3.6) for $i = 1$ at $x = L_1$ on the interval $0 \leq t \leq T_1$. Similarly, we can also determine the values of (u_I, u_{Ix}) at $x = 0$ as

$$x = 0 : \quad (u_I^i, u_{Ix}^i) = (b_{i1}(t), b_{i2}(t)), \quad 0 \leq t \leq T_1 \quad (i = 1, \dots, N), \quad (6.3.43)$$

the $C^2[0, T_1]$ norm of $b_{i1}(t)(i = 1, \dots, N)$ and the $C^1[0, T_1]$ norm of $b_{i2}(t)(i = 1, \dots, N)$ are small and $(b_{i1}(t), b_{i2}(t))(i = 1, \dots, N)$ satisfy the interface condition (6.3.7) at $x = 0$ on the interval $0 \leq t \leq T_1$.

(ii) We next consider the following backward mixed initial-boundary value problem for system (6.3.1) with the final condition (6.3.35), the interface condition (6.3.7), the boundary condition (6.3.6) for $i = 1$, and the following artificial boundary conditions

$$x = L_i : \quad u^i = g_i(t) \quad (i = 2, \dots, N), \quad (6.3.44)$$

where $g_i(i = 2, \dots, N)$ are any given C^2 functions of t with small $C^2[T - T_1, T]$ norms and the conditions of C^2 compatibility at the point $(t, x) = (T, L_i)(i = 2, \dots, N)$ are assumed to be satisfied, respectively. Then, by Lemma 6.2, there exists a unique semi-global piecewise C^2 solution $u = u_{II}(t, x) = (u_{II}^1(t, x), \dots, u_{II}^N(t, x))$ on the domain $R^{II} = \bigcup_{i=1}^N R_i^{II}$, where

$$R_i^{II} = \{(t, x) | T - T_1 \leq t \leq T, 0 \leq x \leq L_i\} \quad (i = 1, \dots, N), \quad (6.3.45)$$

which has a small piecewise C^2 norm, in particular,

$$|(u_{II}, \frac{\partial u_{II}}{\partial x})| \leq \epsilon_0, \quad \forall (t, x) \in R^{II}. \quad (6.3.46)$$

Thus, we can determine the corresponding value of (u_{II}^1, u_{IIx}^1) at $x = L_1$ as

$$x = L_1 : \quad (u_{II}^1, u_{IIx}^1) = (\bar{a}_1(t), \bar{a}_2(t)), \quad T - T_1 \leq t \leq T, \quad (6.3.47)$$

the $C^2[T - T_1, T]$ norm of $\bar{a}_1(t)$ and the $C^1[T - T_1, T]$ norm of $\bar{a}_2(t)$ are small and $(\bar{a}_1(t), \bar{a}_2(t))$ satisfies the boundary condition (6.3.6) for $i = 1$ at $x = L_1$ on the interval $T - T_1 \leq t \leq T$. Similarly, we can determine the values of (u_{II}, u_{IIx}) at $x = 0$

as

$$x = 0 : \quad (u_{II}^i, u_{IIx}^i) = (\bar{b}_{i1}(t), \bar{b}_{i2}(t)), \quad T - T_1 \leq t \leq T \quad (i = 1, \dots, N), \quad (6.3.48)$$

the $C^2[T - T_1, T]$ norm of $\bar{b}_{i1}(t)$ ($i = 1, \dots, N$) and the $C^1[T - T_1, T]$ norm of $\bar{b}_{i2}(t)$ ($i = 1, \dots, N$) are small and $(\bar{b}_{i1}(t), \bar{b}_{i2}(t))$ ($i = 1, \dots, N$) satisfy the interface condition (6.3.7) at $x = 0$ on the interval $T - T_1 \leq t \leq T$.

(iii) We now construct $\tilde{a}_1(t) \in C^2[0, T]$ with small C^2 norm and $\tilde{a}_2(t) \in C^1[0, T]$ with small C^1 norm, such that

$$(\tilde{a}_1(t), \tilde{a}_2(t)) = \begin{cases} (a_1(t), a_2(t)), & 0 \leq t \leq T_1, \\ (\bar{a}_1(t), \bar{a}_2(t)), & T - T_1 \leq t \leq T \end{cases} \quad (6.3.49)$$

and $(\tilde{a}_1(t), \tilde{a}_2(t))$ satisfies the boundary condition (6.3.6) for $i = 1$ at $x = L_1$ on the whole interval $0 \leq t \leq T$.

Noting (6.3.2), we now change the status of t and x and consider the following leftward mixed initial-boundary value problem for system (6.3.1) for $i = 1$ with the initial condition

$$x = L_1 : \quad u^1 = \tilde{a}_1(t), \quad u_x^1 = \tilde{a}_2(t), \quad 0 \leq t \leq T \quad (6.3.50)$$

and the boundary conditions

$$t = 0 : \quad u^1 = \varphi_1(x), \quad 0 \leq x \leq L_1, \quad (6.3.51)$$

$$t = T : \quad u^1 = \Phi_1(x), \quad 0 \leq x \leq L_1, \quad (6.3.52)$$

where $\varphi^1(x)$ and $\Phi^1(x)$ are given by (6.3.5) and (6.3.35) respectively.

Obviously, the conditions of C^2 compatibility at the points $(t, x) = (0, L_1)$ and (T, L_1) are satisfied respectively. Then, by Lemma 6.1, there exists a unique semi-global C^2 solution $u^1 = u^1(t, x)$ with small C^2 norm on the domain $R_1(T) = \{(t, x) | 0 \leq t \leq T, 0 \leq x \leq L_1\}$ and

$$|(u^1, \frac{\partial u^1}{\partial x})| \leq \epsilon_0, \quad \forall (t, x) \in R_1(T). \quad (6.3.53)$$

Since both $u^1(t, x)$ and $u_I^1(t, x)$ satisfy system (6.3.1) for $i = 1$, the initial condition (6.3.50) on $0 \leq t \leq T_1$ and the boundary condition (6.3.51), it is easy to see that

$$u^1(t, x) \equiv u_I^1(t, x) \quad (6.3.54)$$

on the domain

$$\{(t, x) | 0 \leq t \leq T_2 + \frac{(T_1 - T_2)x}{L_1}, 0 \leq x \leq L_1\}. \quad (6.3.55)$$

Thus, in particular, we get

$$t = 0: \quad u^1 = \varphi_1(x), \quad u_t^1 = \psi_1(x), \quad 0 \leq x \leq L_1 \quad (6.3.56)$$

and

$$x = 0: \quad u^1 = b_{11}(t), \quad u_x^1 = b_{12}(t), \quad 0 \leq t \leq T_2, \quad (6.3.57)$$

where $\varphi_1(x)$ and $\psi_1(x)$ are given by (6.3.5), $b_{11}(t)$ and $b_{12}(t)$ are given by (6.3.43).

In a similar way we get

$$t = T: \quad u^1 = \Phi_1(x), \quad u_t^1 = \Psi_1(x), \quad 0 \leq x \leq L_1 \quad (6.3.58)$$

and

$$x = 0: \quad u^1 = \bar{b}_{11}(t), \quad u_x^1 = \bar{b}_{12}(t), \quad T - T_2 \leq t \leq T, \quad (6.3.59)$$

where $\Phi_1(x)$ and $\Psi_1(x)$ are given by (6.3.35), $\bar{b}_{11}(t)$ and $\bar{b}_{12}(t)$ are given by (6.3.48).

(iv) Let $(\tilde{b}_{11}(t), \tilde{b}_{12}(t))$ be the value of (u^1, u_x^1) on $x = 0$. The $C^2[0, T]$ norm of $\tilde{b}_{11}(t)$ and the $C^1[0, T]$ norm of $\tilde{b}_{12}(t)$ are small and

$$(\tilde{b}_{11}(t), \tilde{b}_{12}(t)) = \begin{cases} (b_{11}(t), b_{12}(t)), & 0 \leq t \leq T_2, \\ (\bar{b}_{11}(t), \bar{b}_{12}(t)), & T - T_2 \leq t \leq T. \end{cases} \quad (6.3.60)$$

We now construct $\tilde{b}_{i2}(t) \in C^1[0, T] (i = 2, \dots, N - 1)$ with small C^1 norm, such that

$$\tilde{b}_{i2}(t) = \begin{cases} b_{i2}(t), & 0 \leq t \leq T_2, \\ \bar{b}_{i2}(t), & T - T_2 \leq t \leq T \end{cases} \quad (i = 2, \dots, N - 1), \quad (6.3.61)$$

where $b_{i2}(t)$ and $\bar{b}_{i2}(t) (i = 2, \dots, N - 1)$ are given by (6.3.43) and (6.3.48) respectively. Noting (6.3.2), the interface condition (6.3.7) together with $u^1 = \tilde{b}_{11}(t)$ and $u_x^i = \tilde{b}_{i2}(t) (i = 1, \dots, N - 1)$ can uniquely determine the value of $u^i (i = 2, \dots, N)$ and u_x^N at $x = 0$ on the interval $[0, T]$. Let $\tilde{b}_{i1}(t) = u^i (i = 2, \dots, N)$ and $\tilde{b}_{N2}(t) = u_x^N$ at $x = 0$ on the interval

$[0, T]$. It is easy to see that $\tilde{b}_{i1}(t) (i = 2, \dots, N)$ have small $C^2[0, T]$ norms, $\tilde{b}_{N2}(t)$ has a small $C^1[0, T]$ norm and

$$(\tilde{b}_{i1}(t), \tilde{b}_{i2}(t)) = \begin{cases} (b_{i1}(t), b_{i2}(t)), & 0 \leq t \leq T_2, \\ (\bar{b}_{i1}(t), \bar{b}_{i2}(t)), & T - T_2 \leq t \leq T, \end{cases} \quad (i = 2, \dots, N), \quad (6.3.62)$$

where $(b_{i1}(t), b_{i2}(t))$ and $(\bar{b}_{i1}(t), \bar{b}_{i2}(t))$ are given by (6.3.43) and (6.3.48) respectively. Obviously, $(\tilde{b}_{i1}(t), \tilde{b}_{i2}(t)) (i = 1, \dots, N)$ satisfy the interface condition (6.3.7).

(v) Finally, for $i = 2, \dots, N$, we solve the following rightward mixed initial-boundary value problem on the domain $R_i(T) = \{(t, x) | 0 \leq t \leq T, 0 \leq x \leq L_i\}$ for system (6.3.1) with the initial condition

$$x = 0 : \quad u^i = \tilde{b}_{i1}(t), \quad u_x^i = \tilde{b}_{i2}(t), \quad 0 \leq t \leq T \quad (6.3.63)$$

and the boundary conditions

$$t = 0 : \quad u^i = \varphi_i(x), \quad 0 \leq x \leq L_i, \quad (6.3.64)$$

$$t = T : \quad u^i = \Phi_i(x), \quad 0 \leq x \leq L_i, \quad (6.3.65)$$

where $\varphi_i(x)$ and $\Phi_i(x)$ are given by (6.3.5) and (6.3.35) respectively.

For each $i = 2, \dots, N$, the conditions of C^2 compatibility at the points $(t, x) = (0, 0)$ and $(T, 0)$ are satisfied respectively and there exists a unique semi-global C^2 solution $u^i = u^i(t, x)$ with small C^2 norm on each $R_i(T)$. In particular, we have

$$|(u^i, \frac{\partial u^i}{\partial x})| \leq \epsilon_0, \quad \forall (t, x) \in R_i(T) \quad (i = 2, \dots, N). \quad (6.3.66)$$

Since for each $i = 2, \dots, N$, both $u^i(t, x)$ and $u_I^i(t, x)$ satisfy system (6.3.1), the initial condition (6.3.63) for $0 \leq t \leq T_2$ and the boundary condition (6.3.64), it is easy to see that

$$u^i(t, x) \equiv u_I^i(t, x) \quad (6.3.67)$$

on the domain

$$\{(t, x) | 0 \leq t \leq T_2(1 - \frac{x}{L_i}), 0 \leq x \leq L_i\}. \quad (6.3.68)$$

Then, in particular, we get

$$t = 0 : \quad u^i = \varphi_i(x), \quad u_t^i = \psi_i(x), \quad 0 \leq x \leq L_i. \quad (6.3.69)$$

In a similar way we get

$$t = T : \quad u^i = \Phi_i(x), \quad u_t^i = \Psi_i(x), \quad 0 \leq x \leq L_i. \quad (6.3.70)$$

Thus, $(u^1(t, x), \dots, u^N(t, x))$ is a solution required by Lemma 6.3.

Remark 6.1. *From the proof of Lemma 6.3, the boundary controls which realize the exact boundary controllability are not unique.*

6.4 Exact boundary controllability for quasilinear wave equations in a tree-like planar network of strings

Using a method similar to that in §6.3, in this section we consider the local exact boundary controllability for quasilinear wave equations in a tree-like planar network composed of N strings: C_1, \dots, C_N . Without loss of generality, we suppose that one end of string C_1 is a simple node in the network. We take this simple node as the starting node E (see Figure 2).

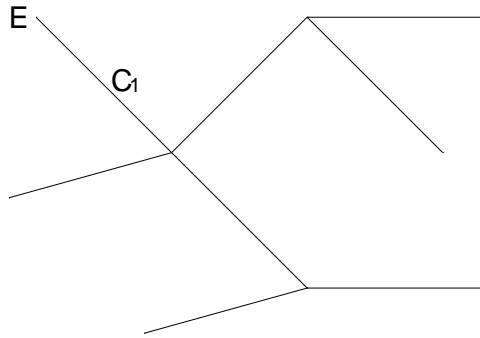

Fig.6.2 A tree-like planar network of strings

For the i -th string, let d_{i0} and d_{i1} be the x -coordinates of its two ends and $L_i = d_{i1} - d_{i0}$ its length. For simplicity, in what follows we simply say node d_{i0} (resp. d_{i1}) instead of the node corresponding to d_{i0} (resp. d_{i1}). We always suppose that node d_{i0} is closer to E than node d_{i1} in the network (node d_{i0} is just E).

For $i = 1, \dots, N$, we consider the following quasilinear wave equations on the string C_i

$$\frac{\partial^2 u^i}{\partial t^2} - \frac{\partial}{\partial x} \left(K_i(u^i, \frac{\partial u^i}{\partial x}) \right) = F_i(u^i, \frac{\partial u^i}{\partial x}, \frac{\partial u^i}{\partial t}), \quad d_{i0} \leq x \leq d_{i1} \quad (i = 1, \dots, N), \quad (6.4.1)$$

where $K_i = K_i(u, v)$ is a given C^2 function of u and v , such that

$$K_{iv}(u, v) > 0, \quad (6.4.2)$$

and $F_i = F_i(u, v, w)$ is a given C^1 function of u, v and w , satisfying

$$F_i(0, 0, 0) = 0. \quad (6.4.3)$$

Moreover, without loss of generality, we assume that

$$K_i(0, 0) = 0. \quad (6.4.4)$$

The initial condition for system (6.4.1) is given by

$$t = 0: \quad u^i = \varphi_i(x), \quad u_t^i = \psi_i(x), \quad d_{i0} \leq x \leq d_{i1} \quad (i = 1, \dots, N). \quad (6.4.5)$$

Let \mathcal{M} and \mathcal{S} be two subsets of $\{1, \dots, N\}$, such that $i \in \mathcal{M}$ if and only if d_{i1} is a multiple node, while, $i \in \mathcal{S}$ if and only if d_{i1} is a simple node.

At any simple node d_{i0} or d_{i1} ($i \in \mathcal{S}$), the boundary condition is given as any one of (6.3.6), while at any multiple node d_{i1} ($i \in \mathcal{M}$), we have the interface condition

$$\begin{cases} \sum_{j \in \mathcal{J}_i} K_j(u^j, u_x^j) = K_i(u^i, u_x^i), \\ u^j = u^i, \quad \forall j \in \mathcal{J}_i, \end{cases} \quad (6.4.6)$$

where \mathcal{J}_i denotes the set of all the indices j such that node d_{j0} is just node d_{i1} .

Similar to Theorem 6.2, we have

Theorem 6.3. *Let*

$$T > 2 \max_{i \in \mathcal{S}} \sum_{j \in \mathcal{D}_i} \frac{L_j}{\sqrt{K_{jv}(0, 0)}}, \quad (6.4.7)$$

where \mathcal{D}_i stands for the set of indices corresponding to all the canals in the unique string-like subnetwork connecting nodes d_{i0} and d_{i1} . Suppose that

$$\beta_1 \neq \frac{1}{\sqrt{K_{1v}(0, 0)}}, \quad (6.4.8)$$

where β_1 is given in (6.3.6d) for $i = 1$. For any given initial data $(\varphi_i, \psi_i)(i = 1, \dots, N)$ and final data $(\Phi_i, \Psi_i)(i = 1, \dots, N)$ with small norms $\sum_{i=1}^N \|(\varphi_i, \psi_i)\|_{C^2[0,L] \times C^1[0,L]}$ and $\sum_{i=1}^N \|(\Phi_i, \Psi_i)\|_{C^2[0,L] \times C^1[0,L]}$, and for any given function $h_1(t)$ with small norm $\|h_1\|_{C^2[0,T]}$ (in case (6.3.6a)) or $\|h_1\|_{C^1[0,T]}$ (in case (6.3.6b-6.3.6d)), such that the conditions of C^2 compatibility or piecewise C^2 compatibility are satisfied at the points $(t, x) = (0, L_1), (T, L_1)$ and $(0, d_{i0}), (T, d_{i0})(i \in \mathcal{M})$, respectively, there exists boundary controls $h_i(t)(i \in \mathcal{S})$ with small norms $\|h_i\|_{C^2[0,T]}(i \in \mathcal{S})$ (in case (6.3.6a)) or $\|h_i\|_{C^1[0,T]}(i \in \mathcal{S})$ (in case (6.3.6b-6.3.6d)), such that on the domain $R(T) = \bigcup_{i=1}^N R_i(T)$, where $R_i(T)$ is given by (6.3.34), the mixed initial-boundary value problem for system (6.4.1) with the initial condition (6.4.5), the boundary condition (6.3.6) on all simple nodes d_{i0} and $d_{i1}(i \in \mathcal{S})$ and the interface condition (6.4.6) on all multiple nodes $d_{i1}(i \in \mathcal{M})$ admits a unique piecewise C^2 solution $u^i = u^i(t, x)(i = 1, \dots, N)$ with small piecewise C^2 norm, which exactly satisfies the final condition

$$t = T : \quad u^i = \Phi_i(x), \quad u_t^i = \Psi_i(x), \quad d_{i0} \leq x \leq d_{i1} \quad (i = 1, \dots, N). \quad (6.4.9)$$

This theorem can be proved in a completely similar way as in the proof of Theorem 6.2.

Proof. Indeed, after having solved a forward problem and a backward problem on this tree-like network as in step (i) and step (ii) of the proof of Lemma 6.3, we can solve a rightward problem as in step (iii) and get u^1 on canal C_1 . Then, as in step (iv), we can determine $u^j(j \in \mathcal{J}_1)$ at node d_{11} (in a non-unique way!) by u^1 and the interface condition (6.4.6) at d_{11} . Consider $d_{j0}(j \in \mathcal{J}_1)$ as a new starting node and do step (iii) and step (iv) again. Noting (6.4.7), it is easy to see that we can continue this procedure until we get the solution $u^i(i = 1, \dots, N)$ on the whole network. This finishes the proof.

Remark 6.2. In conclusion, for a tree-like network with k simple nodes, we need only $k - 1$ controls. The controls are given on the simple nodes except the starting one, and each simple node has one control on it.

Remark 6.3. If the boundary conditions (6.3.6b)-(6.3.6d) on the simple node d_{i0} or

$d_{i1}(i \in \mathcal{S})$ are replaced respectively by

$$K_i(u^i, u_x^i) = h_i(t), \quad (6.4.10)$$

$$K_i(u^i, u_x^i) + \alpha_i u^i = h_i(t) \quad (6.4.11)$$

and

$$K_i(u^i, u_x^i) + \beta_i u_t^i = h_i(t), \quad (6.4.12)$$

the conclusion of Theorem 6.3 is still valid, provided that (6.4.8) is replaced by

$$\beta_1 \neq \sqrt{K_{1v}(0, 0)}. \quad (6.4.13)$$

Remark 6.4. For linear wave equations with Dirichlet boundary conditions on a planar tree-like network, as shown in [14], [28] and [65], if we want to reduce the number of controlled simple nodes, then the problem on the exact boundary controllability becomes much more complicated and it depends very sensitively on both the topology of the network and the diophantine properties of the lengths of the strings involved. What should be the corresponding situation in the quasilinear case is still an open problem.

Chapter 7

Exact boundary observability of unsteady flows

7.1 Introduction

The one-dimensional mathematical model of unsteady flows in an open canal was given by de Saint-Venant [15]. In [30], the authors gave a corresponding model of Saint-Venant system for a network of open canals, in which the interface conditions at any given joint point of open canals are given.

In recent years, based on the result on the semi-global classical solution in [37], the exact boundary controllability for general first order quasilinear hyperbolic systems has been established (see [41] and [42]). Then this result has been applied to get the exact boundary controllability of unsteady flows in a network of open canals(see [31], [32], [43] and [44]). After that, the exact boundary observability for first order quasilinear hyperbolic systems has been studied in [33] and [34].

In this paper we will establish the exact boundary observability of unsteady flows in a tree-like network of open canals with general topology, in which the observed values are physically meaningful and practically handleable. Moreover, we always assume that the observed value is accurate, i.e., there is no measuring error in the observation. After that, together with the result in [21], an implicit duality between controllability and observability in this situation can be found.

This paper is organized as follows. We recall the known results on the exact boundary observability for first order quasilinear hyperbolic systems in §7.2, then the corresponding exact boundary observability of unsteady flows in a single open canal and in a star-like network of open canals will be presented in §7.3-§7.4 respectively. Then, the exact boundary observability of unsteady flows in a tree-like network of open canals will be given in §7.5. Finally, an implicit duality between controllability and observability on a tree-like network of open canals will be given in §7.6.

7.2 Preliminaries

For the purpose of this paper, in this section we recall the results given in [33] and [34]. We consider the following one-dimensional first order quasilinear hyperbolic system of diagonal form

$$\frac{\partial u}{\partial t} + \Lambda(u) \frac{\partial u}{\partial x} = F(u), \quad (7.2.1)$$

where $u = (u_1, \dots, u_n)^T$ is the unknown vector function of (t, x) , $\Lambda(u) = \text{diag}\{\lambda_1(u), \dots, \lambda_n(u)\}$ is an $n \times n$ diagonal matrix, and $F(u) = (f_1(u), \dots, f_n(u))^T$ is a suitably smooth vector function with

$$F(0) = 0. \quad (7.2.2)$$

In what follows we suppose that there are no zero eigenvalues, namely, on the domain under consideration

$$\lambda_r(u) < 0 < \lambda_s(u) \quad (r = 1, \dots, m; s = m + 1, \dots, n). \quad (7.2.3)$$

The boundary conditions are prescribed in the following most general form for the wellposedness:

$$x = 0 : \quad u_s = G_s(t, u_1, \dots, u_m) + H_s(t) \quad (s = m + 1, \dots, n), \quad (7.2.4)$$

$$x = L : \quad u_r = G_r(t, u_{m+1}, \dots, u_n) + H_r(t) \quad (r = 1, \dots, m), \quad (7.2.5)$$

where H_i and G_i ($i = 1, \dots, n$) are suitably smooth functions and

$$G_i(t, 0, \dots, 0) \equiv 0 \quad (i = 1, \dots, n). \quad (7.2.6)$$

By [33] and [34], we have the following two theorems.

Theorem 7.1. (Two-side observation). *Let*

$$T > L \max_{\substack{r=1, \dots, m \\ s=m+1, \dots, n}} \left(\frac{1}{|\lambda_r(0)|}, \frac{1}{\lambda_s(0)} \right). \quad (7.2.7)$$

Suppose that the $C^1[0, T]$ norm of $H(t) = (H_1(t), \dots, H_n(t))$ is suitably small. For any given initial condition

$$t = 0: \quad u = \varphi(x), \quad 0 \leq x \leq L, \quad (7.2.8)$$

such that $\|\varphi\|_{C^1[0, L]}$ is suitably small and the conditions of C^1 compatibility for the mixed initial-boundary value problem (7.2.1), (7.2.8) and (7.2.4)-(7.2.5) are satisfied at the points $(t, x) = (0, 0)$ and $(0, L)$ respectively, if we have the observed values $u_r = \bar{u}_r(t)$ ($r = 1, \dots, m$) at $x = 0$ and $u_s = \bar{\bar{u}}_s(t)$ ($s = m + 1, \dots, n$) at $x = L$ on the interval $[0, T]$, then the initial data $\varphi(x)$ can be uniquely determined and the following observability inequality holds:

$$\|\varphi\|_{C^1[0, L]} \leq C \left(\sum_{r=1}^m \|\bar{u}_r\|_{C^1[0, T]} + \sum_{s=m+1}^n \|\bar{\bar{u}}_s\|_{C^1[0, T]} + \|H\|_{C^1[0, T]} \right), \quad (7.2.9)$$

here and hereafter, C denotes a positive constant.

Remark 7.1. *The key points in the proof of Theorem 7.1 are as follows:*

1. *The value of solution $u = \bar{u}(t)$ at $x = 0$ can be uniquely determined by the observed values $u_r = \bar{u}_r(t)$ ($r = 1, \dots, m$) at $x = 0$ together with the boundary condition (7.2.4) on $x = 0$, and*

$$\|\bar{u}\|_{C^1[0, T]} \leq C \left(\sum_{r=1}^m \|\bar{u}_r\|_{C^1[0, T]} + \sum_{s=m+1}^n \|H_s\|_{C^1[0, T]} \right). \quad (7.2.10)$$

2. *The value of solution $u = \bar{\bar{u}}(t)$ at $x = L$ can be uniquely determined by the observed values $u_s = \bar{\bar{u}}_s(t)$ ($s = m + 1, \dots, n$) at $x = L$ together with the boundary condition (7.2.5) on $x = L$, and*

$$\|\bar{\bar{u}}\|_{C^1[0, T]} \leq C \left(\sum_{s=m+1}^n \|\bar{\bar{u}}_s\|_{C^1[0, T]} + \sum_{r=1}^m \|H_r\|_{C^1[0, T]} \right). \quad (7.2.11)$$

3. *Changing the status of t and x , two maximum determinate domains of the leftward Cauchy problem with the initial data $u = \bar{u}(t)$ ($0 \leq t \leq T$) on $x = 0$ and the rightward Cauchy problem with the initial data $u = \bar{\bar{u}}(t)$ ($0 \leq t \leq T$) on $x = L$ must intersect each*

other. Then we can find $T_0 (0 < T_0 < T)$ such that the solution u at $t = T_0$ can be uniquely determined and

$$\|u\|_{C^1[0,L]} \leq C \left(\sum_{r=1}^m \|\bar{u}_r\|_{C^1[0,T]} + \sum_{s=m+1}^n \|\bar{u}_s\|_{C^1[0,T]} + \|H\|_{C^1[0,T]} \right). \quad (7.2.12)$$

With these points, by solving a backward mixed initial-boundary value problem, we get Theorem 7.1.

Theorem 7.2. (one-side observation). Suppose that the number of positive eigenvalues is equal to that of negative ones:

$$n - m = m, \quad \text{i.e.,} \quad n = 2m. \quad (7.2.13)$$

Suppose furthermore that in a neighbourhood of $u = 0$, the boundary condition (7.2.5) on $x = L$ can be equivalently written as

$$x = L: \quad u_s = \bar{G}_s(t, u_1, \dots, u_m) + \bar{H}_s(t) \quad (s = m + 1, \dots, n) \quad (7.2.14)$$

with

$$\bar{G}_s(t, 0, \dots, 0) \equiv 0 \quad (s = m + 1, \dots, n), \quad (7.2.15)$$

then

$$C_1 \sum_{r=1}^m \|H_r\|_{C^1} \leq \sum_{s=m+1}^n \|\bar{H}_s\|_{C^1} \leq C_2 \sum_{r=1}^m \|H_r\|_{C^1}, \quad (7.2.16)$$

where C_1 and C_2 are positive constants. Suppose finally that $\|H\|_{C^1[0,T]}$ is suitably small.

Let

$$T > L \left(\max_{r=1, \dots, m} \frac{1}{|\lambda_r(0)|} + \max_{s=m+1, \dots, n} \frac{1}{\lambda_s(0)} \right). \quad (7.2.17)$$

For any given initial condition (7.2.8) with the same property as presented in Theorem 7.1, if we have the observed values $u_r = \bar{u}_r(t) (r = 1, \dots, m)$ at $x = 0$ on the interval $[0, T]$, then the initial data $\varphi(x)$ can be uniquely determined and the following observability inequality holds:

$$\|\varphi\|_{C^1[0,L]} \leq C \left(\sum_{r=1}^m \|\bar{u}_r\|_{C^1[0,T]} + \|H\|_{C^1[0,T]} \right). \quad (7.2.18)$$

Remark 7.2. *The key points in the proof of Theorem 7.2 are as follows:*

1. *The value of solution $u = \bar{u}(t)$ at $x = 0$ can be uniquely determined by the observed values $u_r = \bar{u}_r(t) (r = 1, \dots, m)$ at $x = 0$ together with the boundary condition (7.2.4) on $x = 0$, and (7.2.10) holds.*

2. *Changing the status of t and x , the maximum determinate domain of the rightward Cauchy problem with the initial data $u = \bar{u}(t) (0 \leq t \leq T)$ on $x = 0$ intersects the line $x = L$. Then we can find $T_0 (0 < T_0 < T)$ such that the solution u at $t = T_0$ can be uniquely determined and*

$$\|u\|_{C^1[0,L]} \leq C \left(\sum_{r=1}^m \|\bar{u}_r\|_{C^1[0,T]} + \|H\|_{C^1[0,T]} \right). \tag{7.2.19}$$

With these points, by solving a backward mixed initial-boundary value problem, we get Theorem 7.2.

We illustrate the procedure of resolution by Figure 1, in which the observation is taken on the bold point "●" but not on the hollow point "○".



Fig.7.1 A single canal

7.3 Exact boundary observability of unsteady flows in a single open canal

Now we apply the result on the exact boundary observability to unsteady flows. In this section we first consider the case of a single open canal. Let L be the length of the canal. Taking the x -axis along the direction of flow, this canal can be parameterized lengthwise by $x \in [0, L]$. Suppose that there is no friction and the canal is horizontal and cylindrical, the corresponding Saint-Venant system can be written as (cf. [15], [30] and [31])

$$\begin{cases} \frac{\partial A}{\partial t} + \frac{\partial(AV)}{\partial x} = 0, \\ \frac{\partial V}{\partial t} + \frac{\partial S}{\partial x} = 0, \end{cases} \quad t \geq 0, \quad 0 \leq x \leq L, \tag{7.3.1}$$

where $A = A(t, x)$ stands for the area of the cross section at x occupied by the water at time t , $V = V(t, x)$ is the average velocity over the cross section and

$$S = \frac{1}{2}V^2 + gh(A) + gY_b, \quad (7.3.2)$$

where g is the gravity constant, constant Y_b denotes the altitude of the bed of canal and

$$h = h(A) \quad (7.3.3)$$

is the depth of the water, $h(A)$ being a suitably smooth function of A , such that

$$h'(A) > 0. \quad (7.3.4)$$

At two ends of the canal the flux boundary conditions are given as follows:

$$x = 0 : \quad Q \stackrel{\text{def}}{=} AV = q(t) \quad (7.3.5)$$

and

$$x = L : \quad Q \stackrel{\text{def}}{=} AV = p(t). \quad (7.3.6)$$

By means of Theorems 7.1-7.2 and Remarks 7.1-7.2, we have the following two theorems on the exact boundary observability.

Theorem 7.3. *For any given equilibrium state $(A, V) = (A_0, V_0)$ of system (7.3.1) with $A_0 > 0$, which belongs to the subcritical case, i.e.,*

$$|V_0| < \sqrt{gA_0h'(A_0)}, \quad (7.3.7)$$

let

$$T > \max\left(\frac{1}{|\tilde{\lambda}_1|}, \frac{1}{\tilde{\lambda}_2}\right), \quad (7.3.8)$$

where

$$\tilde{\lambda}_1 = \frac{1}{L}(V_0 - \sqrt{gA_0h'(A_0)}) < 0, \quad \tilde{\lambda}_2 = \frac{1}{L}(V_0 + \sqrt{gA_0h'(A_0)}) > 0. \quad (7.3.9)$$

Suppose that $\|q(t) - A_0V_0\|_{C^1[0,T]}$ and $\|p(t) - A_0V_0\|_{C^1[0,T]}$ are suitably small. For any given initial condition

$$t = 0 : \quad (A, V) = (A_0(x), V_0(x)), \quad 0 \leq x \leq L, \quad (7.3.10)$$

such that the norm $\|(A_0(x) - A_0, V_0(x) - V_0)\|_{C^1[0,L]}$ is suitably small and the conditions of C^1 compatibility with (7.3.1) and (7.3.5)-(7.3.6) are satisfied at the points $(t, x) = (0, 0)$ and $(0, L)$ respectively, if we have the observed values $A = \bar{a}(t)$ at $x = 0$ and $A = \bar{\bar{a}}(t)$ at $x = L$ on the interval $[0, T]$, then the initial data $(A_0(x), V_0(x))$ can be uniquely determined and the following observability inequality holds:

$$\begin{aligned} \|(A_0(x) - A_0, V_0(x) - V_0)\|_{C^1[0,L]} &\leq C(\|\bar{a}(t) - A_0\|_{C^1[0,T]} + \|\bar{\bar{a}}(t) - A_0\|_{C^1[0,T]}) \\ &\quad + \|q(t) - A_0V_0\|_{C^1[0,T]} + \|p(t) - A_0V_0\|_{C^1[0,T]}. \end{aligned} \quad (7.3.11)$$

Theorem 7.4. *Let*

$$T > \left(\frac{1}{|\tilde{\lambda}_1|} + \frac{1}{\tilde{\lambda}_2} \right), \quad (7.3.12)$$

where $\tilde{\lambda}_1$ and $\tilde{\lambda}_2$ are given by (7.3.9). Under the assumptions of Theorem 7.3, if we have the observed values $A = \bar{a}(t)$ at $x = 0$ (resp. $A = \bar{\bar{a}}(t)$ at $x = L$) on the interval $[0, T]$, then the initial data $(A_0(x), V_0(x))$ can be uniquely determined and the following observability inequality holds:

$$\begin{aligned} \|(A_0(x) - A_0, V_0(x) - V_0)\|_{C^1[0,L]} &\leq C \left(\|\bar{a}(t) - A_0\|_{C^1[0,T]} \text{ (resp. } \|\bar{\bar{a}}(t) - A_0\|_{C^1[0,T]}) \right. \\ &\quad \left. + \|q(t) - A_0V_0\|_{C^1[0,T]} + \|p(t) - A_0V_0\|_{C^1[0,T]} \right). \end{aligned} \quad (7.3.13)$$

Proof of Theorem 7.3. In a neighbourhood of the subcritical equilibrium state (A_0, V_0) , (7.3.1) is a strictly hyperbolic system with two distinct real eigenvalues

$$\lambda_1 \stackrel{\text{def}}{=} V - \sqrt{gAh'(A)} < 0 < \lambda_2 \stackrel{\text{def}}{=} V + \sqrt{gAh'(A)}. \quad (7.3.14)$$

Introducing the Riemann invariants r and s as follows:

$$\begin{cases} 2r = V - V_0 - G(A), \\ 2s = V - V_0 + G(A), \end{cases} \quad (7.3.15)$$

where

$$G(A) = \int_{A_0}^A \sqrt{\frac{gh'(A)}{A}} dA, \quad (7.3.16)$$

we have

$$\begin{cases} V = r + s + V_0, \\ A = H(s - r) > 0, \end{cases} \quad (7.3.17)$$

where H is the inverse function of $G(A)$, and

$$H(0) = A_0, \quad (7.3.18)$$

$$H'(0) = \sqrt{\frac{A_0}{gh'(A_0)}} > 0. \quad (7.3.19)$$

Taking (r, s) as new unknown variables, the equilibrium state $(A, V) = (A_0, V_0)$ corresponds to $(r, s) = (0, 0)$ and system (7.3.1) reduces to the following system of diagonal form:

$$\begin{cases} \frac{\partial r}{\partial t} + \lambda_1(r, s) \frac{\partial r}{\partial x} = 0, \\ \frac{\partial s}{\partial t} + \lambda_2(r, s) \frac{\partial s}{\partial x} = 0, \end{cases} \quad (7.3.20)$$

where

$$\begin{cases} \lambda_1(r, s) = r + s + V_0 - \sqrt{gH(s-r)h'(H(s-r))} < 0, \\ \lambda_2(r, s) = r + s + V_0 + \sqrt{gH(s-r)h'(H(s-r))} > 0, \end{cases} \quad (7.3.21)$$

boundary conditions (7.3.5)-(7.3.6) become

$$x = 0 : \quad (r + s + V_0)H(s - r) = q(t), \quad (7.3.22)$$

$$x = L : \quad (r + s + V_0)H(s - r) = p(t), \quad (7.3.23)$$

and the corresponding observed values become

$$x = 0 : \quad H(s - r) = \bar{a}(t), \quad 0 \leq t \leq T, \quad (7.3.24)$$

$$x = L : \quad H(s - r) = \bar{\bar{a}}(t), \quad 0 \leq t \leq T. \quad (7.3.25)$$

Moreover, the initial condition (7.3.10) can be written as

$$t = 0 : \quad (r, s) = (r_0(x), s_0(x)), \quad (7.3.26)$$

where

$$r_0(x) = \frac{1}{2}(V_0(x) - V_0 - G(A_0(x))), \quad s_0(x) = \frac{1}{2}(V_0(x) - V_0 + G(A_0(x))). \quad (7.3.27)$$

Noting (7.3.16), by (7.3.22) and (7.3.24) we have

$$x = 0 : \quad \begin{cases} r = \frac{1}{2}\left(\frac{q(t)}{\bar{a}(t)} - V_0 - \int_{A_0}^{\bar{a}(t)} \sqrt{\frac{gh'(A)}{A}} dA\right), \\ s = \frac{1}{2}\left(\frac{q(t)}{\bar{a}(t)} - V_0 + \int_{A_0}^{\bar{a}(t)} \sqrt{\frac{gh'(A)}{A}} dA\right), \end{cases} \quad 0 \leq t \leq T. \quad (7.3.28)$$

Then, noting that we may assume $\bar{a}(t) \geq \bar{a} > 0$, where \bar{a} is a constant, it follows from (7.3.28) that

$$\|(r, s)\|_{C^1[0, T]} \leq C(\|\bar{a}(t) - A_0\|_{C^1[0, T]} + \|q(t) - A_0 V_0\|_{C^1[0, T]}). \quad (7.3.29)$$

Similarly, at $x = L$, (r, s) can be uniquely determined by $\bar{a}(t)$ and $p(t)$, and

$$\|(r, s)\|_{C^1[0, T]} \leq C(\|\bar{a}(t) - A_0\|_{C^1[0, T]} + \|p(t) - A_0 V_0\|_{C^1[0, T]}). \quad (7.3.30)$$

Thus, by Theorem 7.1 and Remark 7.1, and noting (7.3.8), $(r_0(x), s_0(x))$ can be uniquely determined and

$$\begin{aligned} \|(r_0(x), s_0(x))\|_{C^1[0, L]} &\leq C(\|\bar{a}(t) - A_0\|_{C^1[0, T]} + \|\bar{a}(t) - A_0\|_{C^1[0, T]} \\ &\quad + \|q(t) - A_0 V_0\|_{C^1[0, T]} + \|p(t) - A_0 V_0\|_{C^1[0, T]}). \end{aligned} \quad (7.3.31)$$

Then, noting (7.3.27), it is easy to see that $(A_0(x), V_0(x))$ can be uniquely determined and (7.3.11) holds. This proves Theorem 7.3.

Theorem 7.4 can be similarly proved by the means of Theorem 7.2 and Remark 7.2.

7.4 Exact boundary observability of unsteady flows in a star-like network of open canals

In this section, we consider unsteady flows in a star-like network of open canals, composed of N horizontal and cylindrical canals with a common joint point O . Let L_i be the length of the i -th canal ($i = 1, \dots, N$). For $i = 1, \dots, N$, taking the joint point O as $x = 0$, the i -th canal can be parameterized lengthwise by $x \in [0, L_i]$ and all the quantities associated with the i -th canal are indexed by i .

Suppose that there is no friction, the corresponding Saint-Venant system is (cf. [30] and [31])

$$\begin{cases} \frac{\partial A_i}{\partial t} + \frac{\partial(A_i V_i)}{\partial x} = 0, \\ \frac{\partial V_i}{\partial t} + \frac{\partial S_i}{\partial x} = 0, \end{cases} \quad t \geq 0, \quad 0 \leq x \leq L_i \quad (i = 1, \dots, N), \quad (7.4.1)$$

where

$$S_i = \frac{1}{2} V_i^2 + g h_i(A_i) + g Y_{bi} \quad (i = 1, \dots, N), \quad (7.4.2)$$

with $Y_{bi} (i = 1, \dots, N)$ being constants and

$$h'_i(A_i) > 0 \quad (i = 1, \dots, N). \quad (7.4.3)$$

The interface conditions at the joint point O are given by

$$\sum_{i=1}^N A_i V_i = q_0(t) \quad (7.4.4)$$

and

$$S_i = S_1 \quad (i = 2, \dots, N), \quad (7.4.5)$$

while, at another end of each canal we have the flux boundary condition

$$x = L_i : \quad A_i V_i = q_i(t) \quad (i = 1, \dots, N). \quad (7.4.6)$$

Consider an equilibrium state $(A_i, V_i) = (A_{i0}, V_{i0})$ of system (7.4.1) with $A_{i0} > 0 (i = 1, \dots, N)$, which belongs to a subcritical case, i.e.,

$$|V_{i0}| < \sqrt{gA_{i0}h'_i(A_{i0})} \quad (i = 1, \dots, N), \quad (7.4.7)$$

and, corresponding to (7.4.4)-(7.4.5), satisfies

$$\sum_{i=1}^N A_{i0} V_{i0} = 0, \quad (7.4.8)$$

$$S_{i0} = S_{10} \quad (i = 2, \dots, N), \quad (7.4.9)$$

where

$$S_{i0} = \frac{1}{2} V_{i0}^2 + gh_i(A_{i0}) + gY_{bi} \quad (i = 1, \dots, N). \quad (7.4.10)$$

Theorem 7.5. *Let*

$$T > \max_{i=1, \dots, N} \frac{1}{|\tilde{\lambda}_{i1}|} + \max_{i=1, \dots, N} \frac{1}{\tilde{\lambda}_{i2}}, \quad (7.4.11)$$

where

$$\tilde{\lambda}_{i1} = \frac{1}{L_i} (V_{i0} - \sqrt{gA_{i0}h'_i(A_{i0})}) < 0 < \tilde{\lambda}_{i2} = \frac{1}{L_i} (V_{i0} + \sqrt{gA_{i0}h'_i(A_{i0})}) \quad (i = 1, \dots, N). \quad (7.4.12)$$

Suppose that $\|q_0(t)\|_{C^1[0,T]}$ and $\|q_i(t) - A_{i0}V_{i0}\|_{C^1[0,T]}$ ($i = 1, \dots, N$) are suitably small. For any given initial condition

$$t = 0: \quad (A_i, V_i) = (A_{i0}(x), V_{i0}(x)), \quad 0 \leq x \leq L_i \quad (i = 1, \dots, N), \quad (7.4.13)$$

satisfying that $\sum_{i=1}^N \|(A_{i0}(x) - A_{i0}, V_{i0}(x) - V_{i0})\|_{C^1[0, L_i]}$ is suitably small and the conditions of piecewise C^1 compatibility with (7.4.1) and (7.4.4)-(7.4.6) are satisfied at the joint point O and all other ends, if we have the observed values $A_i = a_i(t)$ at $x = L_i$ ($i = 1, \dots, N$) on the interval $[0, T]$, then the initial data $(A_{i0}(x), V_{i0}(x))$ ($i = 1, \dots, N$) can be uniquely determined and the following observability inequality holds:

$$\begin{aligned} \sum_{i=1}^N \|(A_{i0}(x) - A_{i0}, V_{i0}(x) - V_{i0})\|_{C^1[0, L_i]} &\leq C \left(\sum_{i=1}^N \|a_i(t) - A_{i0}\|_{C^1[0, T]} \right. \\ &\quad \left. + \sum_{i=1}^N \|q_i(t) - A_{i0}V_{i0}\|_{C^1[0, T]} + \|q_0(t)\|_{C^1[0, T]} \right). \end{aligned} \quad (7.4.14)$$

Proof. In a neighbourhood of the subcritical equilibrium state (A_{i0}, V_{i0}) ($i = 1, \dots, N$), (7.4.1) is a hyperbolic system with real eigenvalues

$$\begin{cases} \lambda_{i1} = V_i - \sqrt{gA_i h'_i(A_i)} < 0, \\ \lambda_{i2} = V_i + \sqrt{gA_i h'_i(A_i)} > 0, \end{cases} \quad (i = 1, \dots, N). \quad (7.4.15)$$

For $i = 1, \dots, N$, introducing the Riemann invariants r_i and s_i as follows:

$$\begin{cases} 2r_i = V_i - V_{i0} - G_i(A_i), \\ 2s_i = V_i - V_{i0} + G_i(A_i), \end{cases} \quad (7.4.16)$$

where

$$G_i(A_i) = \int_{A_{i0}}^{A_i} \sqrt{\frac{gh'_i(A_i)}{A_i}} dA_i, \quad (7.4.17)$$

we have

$$\begin{cases} V_i = r_i + s_i + V_{i0}, \\ A_i = H_i(s_i - r_i) > 0, \end{cases} \quad (7.4.18)$$

where H_i is the inverse function of $G_i(A_i)$, and

$$H_i(0) = A_{i0}, \quad (7.4.19)$$

$$H'_i(0) = \sqrt{\frac{A_{i0}}{gh'_i(A_{i0})}} > 0. \quad (7.4.20)$$

Thus, system (7.4.1) can be equivalently rewritten as

$$\begin{cases} \frac{\partial r_i}{\partial t} + \lambda_{i1}(r_i, s_i) \frac{\partial r_i}{\partial x} = 0, \\ \frac{\partial s_i}{\partial t} + \lambda_{i2}(r_i, s_i) \frac{\partial s_i}{\partial x} = 0, \end{cases} \quad t \geq 0, \quad 0 \leq x \leq L_i \quad (i = 1, \dots, N), \quad (7.4.21)$$

where

$$\begin{cases} \lambda_{i1}(r_i, s_i) = r_i + s_i + V_{i0} - \sqrt{gH_i(s_i - r_i)h'_i(H_i(s_i - r_i))} < 0, \\ \lambda_{i2}(r_i, s_i) = r_i + s_i + V_{i0} + \sqrt{gH_i(s_i - r_i)h'_i(H_i(s_i - r_i))} > 0, \end{cases} \quad (i = 1, \dots, N). \quad (7.4.22)$$

Moreover, the initial condition (7.4.13) becomes

$$t = 0 : \quad (r_i, s_i) = (r_{i0}(x), s_{i0}(x)), \quad 0 \leq x \leq L_i \quad (i = 1, \dots, N), \quad (7.4.23)$$

where

$$\begin{aligned} r_{i0}(x) &= \frac{1}{2}(V_{i0}(x) - V_{i0} - G_i(A_{i0}(x))), \\ s_{i0}(x) &= \frac{1}{2}(V_{i0}(x) - V_{i0} + G_i(A_{i0}(x))), \end{aligned} \quad (i = 1, \dots, N). \quad (7.4.24)$$

As in the proof of Theorem 7.3, for $i = 1, \dots, N$, at $x = L_i$, r_i, s_i could be uniquely determined by $a_i(t), q_i(t)$ as follows:

$$r_i = \frac{1}{2} \left(\frac{q_i(t)}{a_i(t)} - V_{i0} - \int_{A_{i0}}^{a_i(t)} \sqrt{\frac{gh'_i(A_i)}{A_i}} dA_i \right), \quad (7.4.25)$$

$$s_i = \frac{1}{2} \left(\frac{q_i(t)}{a_i(t)} - V_{i0} + \int_{A_{i0}}^{a_i(t)} \sqrt{\frac{gh'_i(A_i)}{A_i}} dA_i \right). \quad (7.4.26)$$

Then, noting that we may assume $a_i(t) \geq a_{i0} > 0 (i = 1, \dots, N)$, where $a_{i0} (i = 1, \dots, N)$ are constants, for $i = 1, \dots, N$, at $x = L_i$ we have

$$\|(r_i, s_i)\|_{C^1[0, T]} \leq C(\|a_i(t) - A_{i0}\|_{C^1[0, T]} + \|q_i(t) - A_{i0}V_{i0}\|_{C^1[0, T]}). \quad (7.4.27)$$

At $x = 0$, the interface conditions now become

$$P_1 \stackrel{\text{def}}{=} \sum_{i=1}^N (r_i + s_i + V_{i0})H_i(s_i - r_i) - q_0(t) = 0, \quad (7.4.28)$$

$$\begin{aligned} P_i &\stackrel{\text{def}}{=} \frac{1}{2}(r_i + s_i + V_{i0})^2 + gh_i(H_i(s_i - r_i)) + gY_{bi} \\ &\quad - \left(\frac{1}{2}(r_1 + s_1 + V_{10})^2 + gh_1(H_1(s_1 - r_1)) + gY_{b1} \right) = 0 \quad (i = 2, \dots, N). \end{aligned} \quad (7.4.29)$$

Since in a neighbourhood of $(r_i, s_i) = (0, 0) (i = 1, \dots, N)$,

$$\det \left| \frac{\partial(P_1, \dots, P_N)}{\partial(s_1, \dots, s_N)} \right| = \prod_{i=1}^N (V_{i0} + \sqrt{gA_{i0}h'_i(A_{i0})}) \cdot \sum_{i=1}^N \sqrt{\frac{A_{i0}}{gh'_i(A_{i0})}} \neq 0, \quad (7.4.30)$$

$$\det \left| \frac{\partial(P_1, \dots, P_N)}{\partial(r_1, \dots, r_N)} \right| = - \prod_{i=1}^N (V_{i0} - \sqrt{gA_{i0}h'_i(A_{i0})}) \cdot \sum_{i=1}^N \sqrt{\frac{A_{i0}}{gh'_i(A_{i0})}} \neq 0, \quad (7.4.31)$$

(7.4.28)-(7.4.29) can be equivalently rewritten as

$$s_i = b_i(t, r_1, \dots, r_N) + c_i(t) \quad (i = 1, \dots, N) \quad (7.4.32)$$

or

$$r_i = \bar{b}_i(t, s_1, \dots, s_N) + \bar{c}_i(t) \quad (i = 1, \dots, N) \quad (7.4.33)$$

with

$$b_i(t, 0, \dots, 0) \equiv \bar{b}_i(t, 0, \dots, 0) \equiv 0 \quad (i = 1, \dots, N) \quad (7.4.34)$$

and

$$\begin{aligned} \|q_0(t)\|_{C^1[0,T]} \text{ small} &\iff \|c_i(t)\|_{C^1[0,T]} \text{ small} \quad (i = 1, \dots, N) \\ &\iff \|\bar{c}_i(t)\|_{C^1[0,T]} \text{ small} \quad (i = 1, \dots, N). \end{aligned} \quad (7.4.35)$$

Since system (7.4.21) has no zero eigenvalues, for each i , we may change the status of t and x , use the value (r_i, s_i) at $x = L_i$ as the initial data and solve a leftward Cauchy problem. Noting (7.4.11), all the maximum determined domains of these solutions must intersect with $x = 0$ and contain a common interval on it. Thus, Theorem 7.5 can be proved by means of a method similarly to the proof of Theorem 7.2 and Remark 7.2.

We illustrate the previous procedure of resolution by Figure 2, in which the observation is taken on all the simple nodes "•" and there is no observation on the joint node "◦". The total number of observed values is equal to N .

Theorem 7.6. *Let*

$$T > \max_{i=1, \dots, N-1} \frac{1}{|\tilde{\lambda}_{i1}|} + \max_{i=1, \dots, N-1} \frac{1}{\tilde{\lambda}_{i2}} + \left(\frac{1}{|\tilde{\lambda}_{N1}|} + \frac{1}{\tilde{\lambda}_{N2}} \right), \quad (7.4.36)$$

where $\tilde{\lambda}_{i1}$ and $\tilde{\lambda}_{i2} (i = 1, \dots, N)$ are given by (7.4.12). Under the assumptions of Theorem 7.5, if we observe $A_i = a_i(t)$ at $x = L_i (i = 1, \dots, N - 1)$ on the interval $[0, T]$, then the

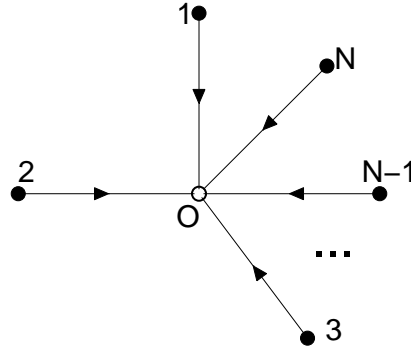

Fig.7.2 The observation on a star-like network I

initial data $(A_{i0}(x), V_{i0}(x))(i = 1, \dots, N)$ can be uniquely determined and the following observability inequality holds:

$$\begin{aligned} \sum_{i=1}^N \|(A_{i0}(x) - A_{i0}, V_{i0}(x) - V_{i0})\|_{C^1[0, L_i]} \leq C \left(\sum_{i=1}^{N-1} \|a_i(t) - A_{i0}\|_{C^1[0, T]} \right. \\ \left. + \sum_{i=1}^N \|q_i(t) - A_{i0}V_{i0}\|_{C^1[0, T]} + \|q_0(t)\|_{C^1[0, T]} \right). \end{aligned} \quad (7.4.37)$$

Proof. As in the proof of Theorem 7.5, (7.4.25)-(7.4.27) are still satisfied at $x = L_i$ for $i = 1, \dots, N - 1$. Therefore, for each $i = 1, \dots, N - 1$, by changing the status of t and x and solving a leftward Cauchy problem with the initial condition:

$$x = L_i : \quad (r_i, s_i) = (r_i(t, L_i), s_i(t, L_i)), \quad (7.4.38)$$

we get the corresponding C^1 solution (r_i, s_i) on its maximum determinate domain.

Noting (7.4.36), all these maximum determinate domains must intersect with $x = 0$ and contain a common interval denoted by $[T_1, T - T_2]$, whose length satisfies

$$T - (T_1 + T_2) > \frac{1}{|\tilde{\lambda}_{N1}|} + \frac{1}{\tilde{\lambda}_{N2}}, \quad (7.4.39)$$

and on this common interval, for $i = 1, \dots, N - 1$, (r_i, s_i) can be uniquely determined by $a_i(t), q_i(t)$, and

$$\|(r_i, s_i)\|_{C^1[T_1, T - T_2]} \leq C(\|a_i(t) - A_{i0}\|_{C^1[0, T]} + \|q_i(t) - A_{i0}V_{i0}\|_{C^1[0, T]}). \quad (7.4.40)$$

Now we utilize the interface conditions (7.4.28) and (7.4.29)(in which we take $i = N$). Since in a neighbourhood of $(r_i, s_i) = (0, 0)(i = 1, \dots, N)$,

$$\det \left| \frac{\partial(P_1, P_N)}{\partial(r_N, s_N)} \right| = 2 \sqrt{\frac{A_{N0}}{gh'_N(A_{N0})}} (gh'_N(A_{N0})A_{N0} - V_{N0}^2) > 0, \quad (7.4.41)$$

we get that at $x = 0$, (r_N, s_N) can be written as

$$\begin{cases} r_N = R_N(t, r_1, \dots, r_{N-1}, s_1, \dots, s_{N-1}) + \tilde{R}_N(t), \\ s_N = S_N(t, r_1, \dots, r_{N-1}, s_1, \dots, s_{N-1}) + \tilde{S}_N(t), \end{cases} \quad (7.4.42)$$

where

$$R_N(t, 0, \dots, 0) \equiv S_N(t, 0, \dots, 0) \equiv 0 \quad (7.4.43)$$

and

$$\|q_0(t)\|_{C^1[0,T]} \text{ small} \iff \|\tilde{R}_N(t)\|_{C^1[0,T]} \text{ small} \iff \|\tilde{S}_N(t)\|_{C^1[0,T]} \text{ small}. \quad (7.4.44)$$

Thus, at $x = 0$, on the interval $T_1 \leq t \leq T - T_2$, (r_N, s_N) can be uniquely determined by $a_i(t), q_i(t)(i = 1, \dots, N - 1)$ and $q_0(t)$, and

$$\begin{aligned} \|(r_N, s_N)\|_{C^1[T_1, T-T_2]} &\leq C \left(\sum_{i=1}^{N-1} \|a_i(t) - A_{i0}\|_{C^1[0,T]} \right. \\ &\quad \left. + \sum_{i=1}^{N-1} \|q_i(t) - A_{i0}V_{i0}\|_{C^1[0,T]} + \|q_0(t)\|_{C^1[0,T]} \right). \end{aligned} \quad (7.4.45)$$

Then we solve a rightward Cauchy problem for system (7.4.21)(in which we take $i = N$), with the initial condition

$$x = 0 : \quad (r_N, s_N) = (r_N(t, 0), s_N(t, 0)), \quad T_1 \leq t \leq T - T_2. \quad (7.4.46)$$

Noting (7.4.39), as in the proof of Theorem 7.4, the corresponding maximum determined domain of the solution must intersect with $x = L_N$. Therefore, there exists $T_0 > 0$ such that at $t = T_0$, $(r_i, s_i)(i = 1, \dots, N)$ can be uniquely determined by $a_i(t), q_i(t)(i = 1, \dots, N - 1)$ and $q_0(t)$, and

$$\begin{aligned} \|(r_i, s_i)\|_{C^1[0, L_i]} &\leq C \left(\sum_{i=1}^{N-1} \|a_i(t) - A_{i0}\|_{C^1[0,T]} + \sum_{i=1}^{N-1} \|q_i(t) - A_{i0}V_{i0}\|_{C^1[0,T]} \right. \\ &\quad \left. + \|q_0(t)\|_{C^1[0,T]} \right) \quad (i = 1, \dots, N). \end{aligned} \quad (7.4.47)$$

On the other hand, the flux boundary condition (7.4.6)(in which we take $i = N$) can be equivalently written as

$$s_N = g_N(t, r_N) + h_N(t), \quad (7.4.48)$$

where

$$g_N(t, 0) \equiv 0 \quad (7.4.49)$$

and

$$\|h_N(t)\|_{C^1[0,T]} \text{ small} \iff \|q_N(t) - A_{N0}V_{N0}\|_{C^1[0,T]} \text{ small}. \quad (7.4.50)$$

So, by solving a backward mixed initial-boundary value problem for system (7.4.21) with the final condition

$$t = T_0 : \quad (r_i, s_i) = (r_i(T_0, x), s_i(T_0, x)) \quad (i = 1, \dots, N), \quad (7.4.51)$$

the interface condition (7.4.33) on $x = 0$, and the boundary condition (7.4.26) on $x = L_i$ for $i = 1, \dots, N - 1$ and (7.4.48) at $x = L_N$, as in the proof of Theorem 7.2, we can prove that

$$\begin{aligned} \sum_{i=1}^N \|(r_{i0}(x), s_{i0}(x))\|_{C^1[0,L_i]} &\leq C \left(\sum_{i=1}^{N-1} \|a_i(t) - A_{i0}\|_{C^1[0,T]} \right. \\ &\quad \left. + \sum_{i=1}^N \|q_i(t) - A_{i0}V_{i0}\|_{C^1[0,T]} + \|q_0(t)\|_{C^1[0,T]} \right). \end{aligned} \quad (7.4.52)$$

Finally, using (7.4.24), we get the conclusion of Theorem 7.6.

We illustrate the previous procedure of resolution by Figure 7.3, in which one observation is taken on each bold simple node "●", but not on a hollow simple node "○" and on the joint node "◦". The total number of observed values is equal to $N - 1$.

Theorem 7.7. *Let*

$$N \geq 3, \quad 1 \leq k \leq N - 2 \quad (7.4.53)$$

and

$$T > \max_{i=1, \dots, k} \frac{1}{|\widetilde{\lambda}_{i1}|} + \max_{i=1, \dots, k} \frac{1}{\widetilde{\lambda}_{i2}} + \max_{i=k+1, \dots, N} \frac{1}{|\widetilde{\lambda}_{i1}|} + \max_{i=k+1, \dots, N} \frac{1}{\widetilde{\lambda}_{i2}}. \quad (7.4.54)$$

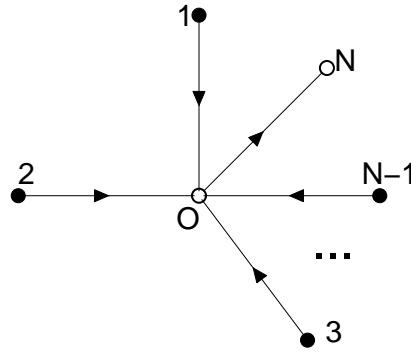

Fig.7.3 The observation on a star-like network II

Under the assumptions of Theorem 7.5, if we observe $A_i = a_i(t)$ at $x = L_i$ for $i = 1, \dots, k$ and $V_i = v_i(t)$ at $x = 0$ for $i = k + 1, \dots, N - 1$ on the interval $[0, T]$, then the initial data $(A_{i0}(x), V_{i0}(x))(i = 1, \dots, N)$ can be uniquely determined and the following observability inequality holds:

$$\begin{aligned} \sum_{i=1}^N \|(A_{i0}(x) - A_{i0}, V_{i0}(x) - V_{i0})\|_{C^1[0, L_i]} &\leq C \left(\sum_{i=1}^k \|a_i(t) - A_{i0}\|_{C^1[0, T]} \right. \\ &+ \sum_{i=k+1}^{N-1} \|v_i(t) - V_{i0}\|_{C^1[0, T]} + \sum_{i=1}^N \|q_i(t) - A_{i0}V_{i0}\|_{C^1[0, T]} \\ &\left. + \|q_0(t)\|_{C^1[0, T]} \right). \end{aligned} \tag{7.4.55}$$

Proof. The proof of Theorem 7.7 is similarly to that of Theorem 7.6, we just want to find $T_0(0 < T_0 < T)$ such that at $t = T_0$, $(r_i, s_i)(i = 1, \dots, N)$ can be uniquely determined by $q_i(t)(i = 1, \dots, N)$, $q_0(t)$ and all the observed values.

For this purpose, for each $i = 1, \dots, k$, we first use the observed value $A_i = a_i(t)$ and the boundary condition (7.4.6) on $x = L_i$ to determine the value of solution (r_i, s_i) at $x = L_i$ as the initial data, then solve the corresponding leftward Cauchy problem and get $(r_i, s_i)(i = 1, \dots, k)$ on a common and suitably large interval at $x = 0$. Next, we check that at $x = 0$, $(r_i, s_i)(i = k + 1, \dots, N)$ can be uniquely expressed by $(r_i, s_i)(i = 1, \dots, k)$ and the observed values $V_i = v_i(t)(i = k + 1, \dots, N - 1)$. In fact, by the interface condition

(7.4.29) and the observed values $V_i = v_i(t) (i = k + 1, \dots, N - 1)$, we have

$$\begin{cases} \tilde{P}_i \stackrel{\text{def}}{=} r_i + s_i + V_{i0} - v_i(t) = 0, \\ P_i \stackrel{\text{def}}{=} \frac{1}{2}(r_i + s_i + V_{i0})^2 + gh_i(H_i(s_i - r_i)) + gY_{bi} \\ \quad - \left(\frac{1}{2}(r_1 + s_1 + V_{10})^2 + gh_1(H_1(s_1 - r_1)) + gY_{b1}\right) = 0. \end{cases} \quad (7.4.56)$$

Since in a neighbourhood of $(r_i, s_i) = (0, 0) (i = 1, \dots, N)$, for each $m = k + 1, \dots, N - 1$, we have

$$\det \left| \frac{\partial(\tilde{P}_m, P_m)}{\partial(r_m, s_m)} \right| = 2\sqrt{gh'_m(A_{m0})A_{m0}} > 0, \quad (7.4.57)$$

then (r_m, s_m) can be uniquely determined by the observed value $v_m(t)$ and (r_1, s_1) on the same common interval at $x = 0$. Finally, using the method given in the proof of Theorem 7.6, we can uniquely determine (r_N, s_N) on the same interval at $x = 0$. Thus, taking the value of solution $(r_i, s_i) (i = k + 1, \dots, N)$ at $x = 0$ as the initial data and solving the corresponding rightward Cauchy problem, similarly to the proof of Theorem 7.6, we get Theorem 7.7.

We illustrate the previous procedure of resolution by Figure 7.4, in which one observation is taken on each bold simple node "●", $N - k - 1$ observations are taken on the joint node "⊙" and there is no observation on any hollow simple node "○". The total number of observed values is equal to $N - 1$.

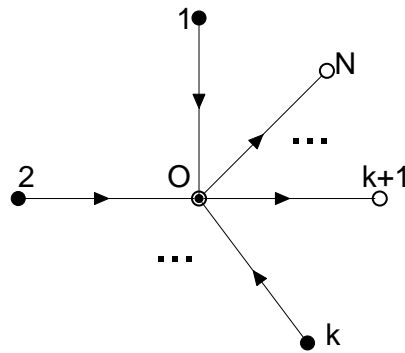

Fig.7.4 The observation on a star-like network III

Theorem 7.8. *Under the assumptions of Theorem 7.5, still suppose that (7.4.11) holds. If we observe $A_1 = a_1(t)$ and $V_i = v_i(t) (i = 1, \dots, N-1)$ at $x = 0$ on the interval $[0, T]$, then the initial data $(A_{i0}(x), V_{i0}(x)) (i = 1, \dots, N)$ can be uniquely determined and the following observability inequality holds:*

$$\begin{aligned} \sum_{i=1}^N \|(A_{i0}(x) - A_{i0}, V_{i0}(x) - V_{i0})\|_{C^1[0, L_i]} &\leq C(\|a_1(t) - A_{10}\|_{C^1[0, T]} \\ &+ \sum_{i=1}^{N-1} \|v_i(t) - V_{i0}\|_{C^1[0, T]} + \sum_{i=1}^N \|q_i(t) - A_{i0}V_{i0}\|_{C^1[0, T]} \\ &+ \|q_0(t)\|_{C^1[0, T]}). \end{aligned} \quad (7.4.58)$$

Proof. We consider the conditions at the joint point $x = 0$. From the observed values, at $x = 0$ we have

$$\begin{cases} A_1 = H_1(s_1 - r_1) = a_1(t), \\ V_1 = r_1 + s_1 + V_{10} = v_1(t), \end{cases} \quad (7.4.59)$$

then

$$\begin{cases} r_1 = \frac{1}{2} \left(v_1(t) - V_{10} - \int_{A_{10}}^{a_1(t)} \sqrt{\frac{gh'_1(A_1)}{A_1}} dA_1 \right), \\ s_1 = \frac{1}{2} \left(v_1(t) - V_{10} + \int_{A_{10}}^{a_1(t)} \sqrt{\frac{gh'_1(A_1)}{A_1}} dA_1 \right) \end{cases} \quad (7.4.60)$$

and

$$\|(r_1, s_1)\|_{C^1[0, T]} \leq C(\|a_1(t) - A_{10}\|_{C^1[0, T]} + \|v_1(t) - V_{10}\|_{C^1[0, T]}). \quad (7.4.61)$$

Similarly to the proof of Theorem 7.7, we can uniquely determine $(r_i, s_i) (i = 2, \dots, N-1)$ on the interval $[0, T]$ at $x = 0$ and

$$\begin{aligned} \|(r_i, s_i)\|_{C^1[0, T]} &\leq C(\|a_1(t) - A_{10}\|_{C^1[0, T]} + \|v_1(t) - v_{10}\|_{C^1[0, T]} \\ &+ \|v_i(t) - V_{i0}\|_{C^1[0, T]}), \quad (i = 2, \dots, N-1). \end{aligned} \quad (7.4.62)$$

Finally, by (7.4.42), (r_N, s_N) can be uniquely determined on $[0, T]$ at $x = 0$ and

$$\begin{aligned} \|(r_N, s_N)\|_{C^1[0, T]} &\leq C(\|a_1(t) - A_{10}\|_{C^1[0, T]} + \sum_{i=1}^{N-1} \|v_i(t) - V_{i0}\|_{C^1[0, T]} \\ &+ \|q_0(t)\|_{C^1[0, T]}). \end{aligned} \quad (7.4.63)$$

Thus, for each $i = 1, \dots, N$, taking the value of solution (r_i, s_i) on $[0, T]$ at $x = 0$ as the initial data and solving the corresponding rightward Cauchy problem, we get Theorem 7.8 by Theorem 7.2 and Remark 7.2.

We illustrate the previous procedure of resolution by Figure 7.5, in which N observations are all taken on the joint node "•" and no observation is taken on any simple node "○". The total number of observed values is equal to N .

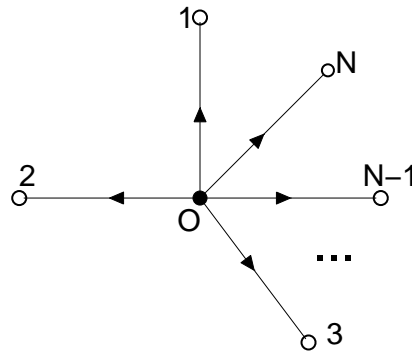

Fig.7.5 The observation on a star-like network IV

Remark 7.3. From Theorems 7.5-7.8, for a star-like network of N open canals, we need at least $N - 1$ observed values. In particular, when all the observed values are taken on the joint point or on all the simple nodes, we need N observed values.

Remark 7.4. The observability time decreases when the number of observed values increase. For instance, in Theorem 7.6 we need more observability time than in Theorem 7.5. Moreover, in Theorem 7.5 and Theorem 7.8, we have the same number of observed values and the same observability time.

Remark 7.5. Sometimes, the flux boundary condition (7.4.6) on the simple nodes can be replaced by the following water level boundary conditions

$$x = L_i : \quad A_i = a_i(t) \quad (i = 1, \dots, N). \quad (7.4.64)$$

In this case, we should take $V_i (i = 1, \dots, N)$ as the observed values on the simple nodes.

It is easy to verify that all the conclusions are still valid, provided the C^1 norms $\|a_i(t) - A_{i0}\|_{C^1}$ ($i = 1, \dots, N$) are small enough.

Remark 7.6. In engineering, instead of (7.4.5) one uses also the following water level interface conditions

$$x = 0 : \quad h_i(A_i) + Y_{bi} = h_1(A_1) + Y_{b1} \quad (i = 2, \dots, N). \quad (7.4.65)$$

In this case, since (7.4.30)-(7.4.31) become

$$\det \left| \frac{\partial(P_1, \dots, P_N)}{\partial(s_1, \dots, s_N)} \right| = \sum_{i=1}^N \frac{1}{h'_i(A_{i0})} (V_{i0} + \sqrt{gA_{i0}h'_i(A_{i0})}) \cdot \prod_{i=1}^N \sqrt{\frac{A_{i0}h'_i(A_{i0})}{g}} \neq 0, \quad (7.4.66)$$

$$\det \left| \frac{\partial(P_1, \dots, P_N)}{\partial(r_1, \dots, r_N)} \right| = (-1)^N \sum_{i=1}^N \frac{1}{h'_i(A_{i0})} (V_{i0} - \sqrt{gA_{i0}h'_i(A_{i0})}) \cdot \prod_{i=1}^N \sqrt{\frac{A_{i0}h'_i(A_{i0})}{g}} \neq 0, \quad (7.4.67)$$

(7.4.41) becomes

$$\det \left| \frac{\partial(P_1, P_N)}{\partial(r_N, s_N)} \right| = 2A_{N0}h'_N(A_{N0}) \sqrt{\frac{A_{N0}}{gh'_N(A_{N0})}} > 0 \quad (7.4.68)$$

and (7.4.57) becomes

$$\det \left| \frac{\partial(\tilde{P}_i, P_i)}{\partial(r_i, s_i)} \right| = 2 \sqrt{\frac{A_{i0}h'_i(A_{i0})}{g}} > 0, \quad (7.4.69)$$

we still have Theorems 7.5-7.8.

7.5 Exact boundary observability of unsteady flows in a tree-like network of open canals

We now consider the exact boundary observability of unsteady flows in a tree-like network composed by N open canals: c_1, \dots, c_N (see Figure 7.6, in which $N = 7$).

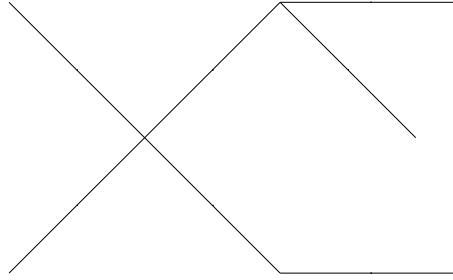

Fig.7.6 A tree-like network

Let d_{i0} and d_{i1} be the x -coordinates of two ends of the i -canal and $L_i = d_{i1} - d_{i0}$ its length. We still suppose that there is no friction and the canals are horizontal and cylindrical, then the corresponding Saint-Venant system can be written as

$$\begin{cases} \frac{\partial A_i}{\partial t} + \frac{\partial(A_i V_i)}{\partial x} = 0, \\ \frac{\partial V_i}{\partial t} + \frac{\partial S_i}{\partial x} = 0, \end{cases} \quad t \geq 0, \quad d_{i0} \leq x \leq d_{i1} \quad (i = 1, \dots, N), \quad (7.5.1)$$

where

$$S_i = \frac{1}{2}V_i^2 + gh_i(A_i) + gY_{bi} \quad (i = 1, \dots, N) \quad (7.5.2)$$

with

$$h'_i(A_i) > 0 \quad (i = 1, \dots, n) \quad (7.5.3)$$

and $Y_{bi} (i = 1, \dots, N)$ being constants.

When d_{i0} (resp. d_{i1}) is a simple node, we have the flux boundary condition

$$x = d_{i0} : \quad A_i V_i = q_{i0}(t) \quad (\text{resp. } x = d_{i1} : \quad A_i V_i = q_{i1}(t)). \quad (7.5.4)$$

While, when d_{i0} (resp. d_{i1}) is a multiple node, we denote by J_{i0} (resp. J_{i1}) the set of indices corresponding to all the canals jointed at d_{i0} (resp. d_{i1}). At d_{i0} (resp. d_{i1}) we have the energy-type interface conditions(cf. [30],[43], [44])

$$S_i = S_j, \quad \forall j \in J_{i0} \quad (\text{resp. } \forall j \in J_{i1}) \quad (7.5.5)$$

and the total flux interface condition

$$\sum_{j \in J_{i0}} \pm A_j V_j = Q_{i0}(t) \quad (\text{resp.} \quad \sum_{j \in J_{i1}} \pm A_j V_j = Q_{i1}(t)). \quad (7.5.6)$$

Following the results in §7.4, we choose a group of variables as observed values.

First, we arbitrarily give a direction on each canal(see Figure 7.7).

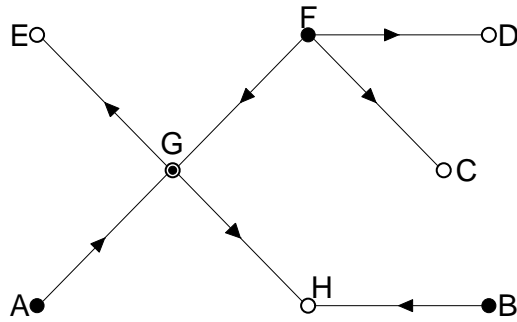

Fig.7.7 The observation on a tree-like network

For a simple node i , if the direction on the corresponding canal starts from this node, we observe $A_i = a_i(t)$. While, if the direction directs to it, we don't take the observation at this node. In Figure 7.7, we choose one observed value at points A and B, while there is no observation at points C, D and E.

For a multiple node, without loss of generality, we suppose that it is the joint point of canals $c_1, \dots, c_k (k > 1)$. If all the k directions start from this node, then we observe k values $A_1 = a_1(t), V_1 = v_1(t), \dots, V_{k-1} = v_{k-1}(t)$ on it. In Figure 7.7, at point F, we choose three observed values since $k = 3$. If there are $l (0 < l < k)$ directions, say c_1, \dots, c_l , direct to it, then we observe $k - l - 1$ values $V_{l+1} = v_{l+1}(t), \dots, V_{k-1} = v_{k-1}(t)$. In Figure 7.7, at point G, we will choose only one observed value since $k = 4$ and $l = 2$. If all the directions direct to this multiple node, then we don't take the observation at this point. In Figure 7.7, we will not take the observation at point H.

Using this way to choose the observed values, we can get the next theorem.

Theorem 7.9. *Suppose that $(A_{i0}, V_{i0})(i = 1, \dots, N)$ is an subcritical equilibrium state for system (7.5.1) and (7.5.4)-(7.5.6). For any given initial condition*

$$t = 0 : \quad (A_i, V_i) = (A_{i0}(x), V_{i0}(x)) \quad (i = 1, \dots, N), \quad (7.5.7)$$

satisfying the conditions of piecewise C^1 compatibility and $\sum_{i=1}^N \|(A_{i0}(x) - A_{i0}, V_{i0}(x) - V_{i0})\|_{C^1[d_{i0}, d_{i1}]}$ suitably small, there exist $T > 0$ large enough, such that if all $\|q_i(t) - A_{i0}V_{i0}\|_{C^1[0, T]}$ and $\|Q_i(t)\|_{C^1[0, T]}$ are sufficient small, then we can choose the observed values on the interval $[0, T]$ according to the way mentioned above, such that the initial data can be uniquely determined and we have the corresponding observability inequality.

Proof. Introduce the Riemann invariants $(r_i, s_i)(i = 1, \dots, N)$ as before.

To prove this theorem, we need only to verify that there exists $T_0(0 < T_0 < T)$, such that at $t = T_0$, $(r_i, s_i)(i = 1, \dots, N)$ can be uniquely determined by the observed values and all given $q_i(t), Q_i(t)$. We will prove, by induction on the number M of the multiple nodes, that there exists T_1 and $T_2(0 < T_1 < T_2)$, such that on the interval $[T_1, T_2]$, $(r_i, s_i)(i = 1, \dots, N)$ can be uniquely determined on the whole network.

Suppose that there is only one multiple node, it is actually a star-like network and it is easy to see that the conclusion follows from Theorems 7.5-7.8.

Suppose that the conclusion is true for $M \leq m$. We now consider the case $M = m + 1$. We choose a multiple node P arbitrarily. Without loss of generality, we suppose there are k canals c_1, \dots, c_k jointed at this point, and, on c_1, \dots, c_l , the direction of the canal directs to P , while on c_{l+1}, \dots, c_k , the direction of the canal starts from P .

By cutting the network at the multiple node P , we get k subnetworks: G_1, \dots, G_k (See Figure 7.8, in which $k = 4$ and $l = 2$). In each subnetwork, since the number of multiple nodes is certainly equal to or less than m , by the hypothesis of induction, the corresponding conclusion holds.

For G_1, \dots, G_l , by the hypothesis of induction, there is no need for boundary observation at point P , then by §7.4, when $T > 0$ is large enough, there exists \tilde{T}_1 and $\tilde{T}_2(0 < \tilde{T}_1 < \tilde{T}_2 < T)$, such that on the interval $[\tilde{T}_1, \tilde{T}_2]$, $(r_i, s_i)(i = 1, \dots, l)$ can be uniquely determined by the corresponding observed values and $q_i(t), Q_i(t)$. In particular at point P , $(r_i, s_i)(i = 1, \dots, l)$ can be uniquely determined on the interval $[\tilde{T}_1, \tilde{T}_2]$.

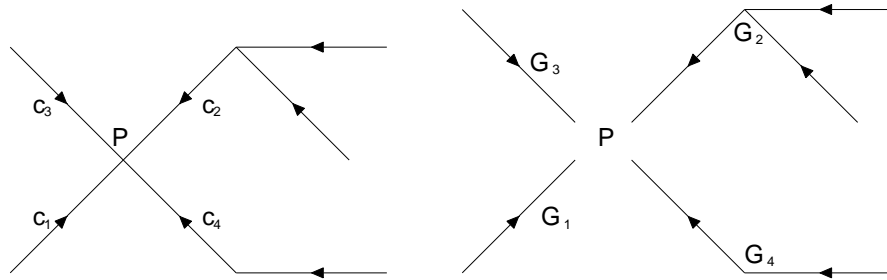

Fig.7.8

Now using the interface condition (7.5.5) and (7.5.6) at point P , similarly to §7.4, $(r_i, s_i)(i = l + 1, \dots, k)$ can also be uniquely determined on the interval $[\tilde{T}_1, \tilde{T}_2]$ at point P .

When $T > 0$ is large enough, $\tilde{T}_2 - \tilde{T}_1$ is also large enough, then by the hypothesis of induction again, there exists T_1 and $T_2(\tilde{T}_1 < T_1 < T_2 < \tilde{T}_2)$, such that on the interval $[T_1, T_2]$, $(r_i, s_i)(i = l + 1, \dots, k)$ can be uniquely determined on the subnetwork $G_i(i = l + 1, \dots, k)$ respectively.

Thus, Theorem 7.9 can be proved in a way similarly to the proof of Theorems 7.5-7.8.

Theorem 7.10. *For any given tree-like network of open canals, if there are m simple nodes, then we need at least $m - 1$ observed values. Moreover, the number of the observed values is equal to $m - 1$ if and only if there is no starting or ending multiple node, namely, no multiple node, for which all related directions point to or start from it.*

Proof. According to the previous way of selecting the observed values, if a multiple node is neither starting nor ending multiple node, we have

$$\begin{aligned} & \text{The number of the observed values on this multiple node} + 1 \\ & = \text{The number of canals, the direction of which starts from this multiple node,} \end{aligned} \tag{7.5.8}$$

while, if a multiple node or a simple node is a starting or ending node, we have

$$\begin{aligned} & \text{The number of the observed values on this multiple node} \\ & = \text{The number of canals, the direction of which starts from this multiple node.} \end{aligned} \tag{7.5.9}$$

The combination of (7.5.8) and (7.5.9) implies

$$\begin{aligned} & \text{The number of the observed values} + \text{the number of the multiple nodes} \\ & \geq \text{The number of the canals,} \end{aligned} \quad (7.5.10)$$

moreover, the equality in (7.5.10) holds if and only if there are neither starting nor ending multiple nodes in the network.

Thus, since

$$\begin{aligned} & \text{The number of the simple nodes} + \text{the number of the multiple nodes} \\ & = \text{The number of the nodes} \\ & = \text{The number of the canals} + 1, \end{aligned} \quad (7.5.11)$$

we get

$$\begin{aligned} & \text{The number of the observed values} \\ & \geq \text{the number of the simple nodes} - 1 = m - 1, \end{aligned} \quad (7.5.12)$$

moreover, the equality in (7.5.12) holds if and only if there are neither starting nor ending multiple nodes in the network. This finishes the proof.

Finally, we give some examples.

Example 7.1. *We choose a simple node arbitrarily and release a signal from this node. This gives a direction on the corresponding canal. Then we release a signal from another node (multiple node) of this canal and this gives the corresponding directions on all other canals jointed at that multiple node. We continue this procedure until the directions are given on all canals. If we select the observed values according to the previous way, then the initial data can be uniquely determined. In this situation, since there are no starting or ending multiple nodes in the network, by Theorem 7.10 we need only $m - 1$ observed values.*

See Figure 7.9, in which point A is the starting simple node chosen arbitrarily. There are five simple nodes in the network. We need one observed value at point A, one observed value at point F and two observed values at point G. No observation is needed on the multiple node H and all the simple nodes except A.

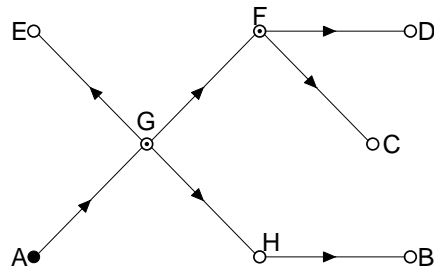

Fig.7.9

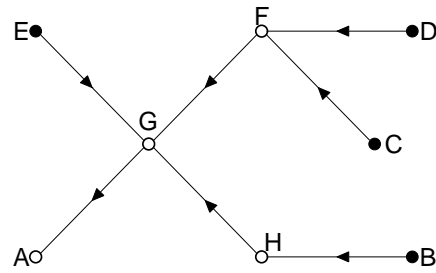

Fig.7.10

Example 7.2. *If we take all the opposite directions in Example 7.1, then the initial data can also be uniquely determined. In this situation, there is no need of observation on any given multiple node and on the ending simple node A, and all the observed values are taken on the simple nodes except A. Hence, similarly to Example 7.1, we still need $m - 1$ observed values.*

See Figure 7.10. We still need four observed values and we have one observed value on each simple node except point A.

Example 7.3. *If we choose a multiple node arbitrarily and release a signal from this node. Any multiple node receiving a signal releases signals on all other canals jointed at this node, until the directions are given on all canals. Select the observed values according to the previous way, the initial data can be uniquely determined. In this situation, (7.5.8) still holds on the multiple nodes except the starting node, on which (7.5.9) holds. Thus, (7.5.10) should be replaced by*

$$\begin{aligned} & \text{the number of the observed values} + \text{the number of the multiple nodes} \\ & = \text{the number of the canals} + 1. \end{aligned} \tag{7.5.13}$$

Consequently, noting (7.5.11), we need m observed values. This time all the observed values are taken on the multiple nodes.

See Figure 7.11, in which point G is the starting multiple node chosen arbitrarily. We now need five observed values, of which four are taken on point G and one is taken on point F.

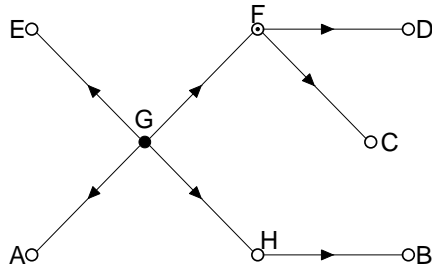

Fig.7.11

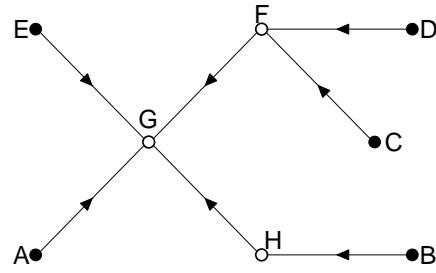

Fig.7.12

Example 7.4. *If we take all the opposite directions in Example 7.3, then the initial data can also be uniquely determined. In this situation, the starting multiple node G in Example 7.3 becomes the ending multiple node and all the simple nodes become the starting nodes. Then, according to the previous way of selecting the observed values, it is easy to see that there is no need of observation on any given multiple node and all the observed values are taken on the simple nodes. Hence, we still need m observed values.*

See Figure 7.12. We still need five observed values and we have one observed value on each simple node.

7.6 Implicit duality between controllability and observability

Now we can get an implicit duality between the exact boundary controllability and the exact boundary observability for unsteady flows in a tree-like network.

In fact, according to the results given in [21] for unsteady flows in a tree-like network of open canals, we choose the observed values as follows:

On simple node E , we observe $A_1 = a_1(t)$. On each multiple node $d_{i1}(i \in \mathcal{M})$, for any given $\bar{j} \in \mathcal{J}_i$, we observe $V_j = v_j(t)(j \in \mathcal{J}_i, j \neq \bar{j})$. The general principle is that we use one observed value on simple node E and $k - 2$ observed values on any multiple node jointed by k canals. Thus, the number of total observed values is just equal to $M - 1$, M being the number of simple nodes. See Figure 7.13, in which "●" and "○" stand for the

observed simple node and the observed multiple node, respectively. We need one observed value on simple node E , two observed values on multiple node G and one observed value on multiple nodes F . The total number of observed values is equal to $M - 1 = 4$.

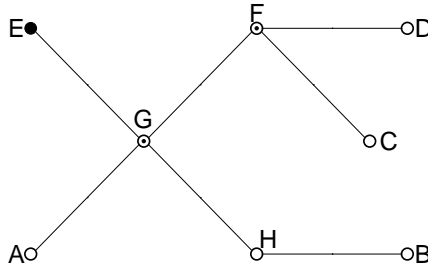

Fig.7.13 The duality between the controllability and the observability

Comparing the result in this paper with the result in [21], we can find an implicit duality between the exact boundary controllability and the exact boundary observability for unsteady flows in a tree-like network of open canals as follows:

1. Both the number of observed values and the number of controls are equal to $M - 1$, M being the number of simple nodes in the network.
2. Both the observability time and the controllability time satisfy the same inequality (4.4.9):

$$T > \max_{i \in \mathcal{S}} \sum_{j \in \mathcal{D}_i} \frac{L_j}{|\tilde{\lambda}_1^{(j)}|} + \max_{i \in \mathcal{S}} \sum_{j \in \mathcal{D}_i} \frac{L_j}{\tilde{\lambda}_2^{(j)}}$$

3. The observed values are taken only on simple node E and the multiple nodes, while the controls are acted only on the simple nodes except E .

Chapter 8

Exact boundary observability of unsteady supercritical flows

8.1 Introduction

The one-dimensional mathematical model of unsteady flows in an open canal was given by de Saint-Venant [15]. In [30], the authors gave a corresponding model of Saint-Venant system for a network of open canals, in which the interface conditions at any given joint point of open canals are given.

In recent years, based on the result on the semi-global classical solution in [37], the exact boundary controllability for general first order quasilinear hyperbolic systems has been established(see [41] and [42]). Then this result has been applied to get the exact boundary controllability of unsteady subcritical flows in a network of open canals(see [31], [32], [43] and [44]). On the other hand, with the interface conditions given in [23], the exact boundary controllability of unsteady supercritical flows in a tree-like network of open canals has been established(see [21]).

Moreover, the exact boundary observability for first order quasilinear hyperbolic systems has been studied in [33] and [34], in which an implicit duality between the exact boundary controllability and the exact boundary observability is also given. Based on this result, the exact boundary observability of unsteady subcritical flows in a tree-like network of open canals has been obtained(see [22]).

In this paper, under the assumption that the observed value is accurate, i.e., there is no measuring error in the observation, we will establish the exact boundary observability of supercritical unsteady flows in a tree-like network of open canals with general topology, in which the observed values are physically meaningful and practically handleable. Moreover, we will also show an implicit duality between the exact boundary controllability and the exact boundary observability for unsteady supercritical flows.

This paper is organized as follows. We recall the known results on the exact boundary observability for first order quasilinear hyperbolic systems in §8.2, then the corresponding exact boundary observability of unsteady supercritical flows in a single open canal and in a star-like network of open canals will be presented in §8.3 and §8.4. Finally the exact boundary observability of unsteady flows in a tree-like network of open canals will be given in §8.5.

8.2 Exact boundary observability for a kind of quasilinear hyperbolic systems

For the purpose of this paper, in this section we recall the result given in [33] and [34] only for the following quasilinear hyperbolic system of diagonal form

$$\frac{\partial u_i}{\partial t} + \lambda_i(u) \frac{\partial u_i}{\partial x} = F_i(u) \quad (i = 1, \dots, n), \quad (8.2.1)$$

where $u = (u_1, \dots, u_n)^T$ is the unknown vector function of (t, x) , $\lambda_i(u)$ and $F_i(u)$ ($i = 1, \dots, n$) are C^1 functions of u ,

$$F_i(0) = 0 \quad (i = 1, \dots, n) \quad (8.2.2)$$

and on the domain under consideration

$$\begin{aligned} \lambda_i(u) < 0 \quad (i = 1, \dots, n) \\ (\text{resp. } \lambda_i(u) > 0 \quad (i = 1, \dots, n)). \end{aligned} \quad (8.2.3)$$

The boundary conditions are given as follows:

$$\begin{aligned} x = L : \quad u_i = h_i(t) \quad (i = 1, \dots, n) \\ (\text{resp. } x = 0 : \quad u_i = h_i(t) \quad (i = 1, \dots, n)), \end{aligned} \quad (8.2.4)$$

where $h_i(i = 1, \dots, n)$ are C^1 functions of t .

By means of [33] and [34], we have

Theorem 8.1. *Let*

$$T > \max_{i=1, \dots, n} \frac{L}{|\lambda_i(0)|}. \quad (8.2.5)$$

For any given initial condition

$$t = 0: \quad u = \varphi(x), \quad 0 \leq x \leq L, \quad (8.2.6)$$

such that $\|\varphi\|_{C^1[0,L]}$ is suitably small and the conditions of C^1 compatibility for the mixed initial-boundary value problem (8.2.1), (8.2.6) and (8.2.4) are satisfied at the point $(t, x) = (0, L)$ (resp. $(0, 0)$), if we have the observed values $u_i = \bar{u}_i(t)$ ($i = 1, \dots, n$) at $x = 0$ (resp. $u_i = \bar{\bar{u}}_i(t)$ ($i = 1, \dots, n$) at $x = L$) on the interval $[0, T]$, then the initial data $\varphi(x)$ can be uniquely determined and the following observability inequality holds:

$$\|\varphi\|_{C^1[0,L]} \leq C \sum_{i=1}^n \|\bar{u}_i\|_{C^1[0,T]}, \quad (\text{resp.} \quad \|\varphi\|_{C^1[0,L]} \leq C \sum_{i=1}^n \|\bar{\bar{u}}_i\|_{C^1[0,T]}), \quad (8.2.7)$$

here and hereafter, C denotes a positive constant.

Proof: We given the proof under the assumption that all eigenvalues $\lambda_i(u)$ ($i = 1, \dots, n$) are negative(see (8.2.3)).

Since there is no zero eigenvalue, we may change the status of t and x and solve a rightward Cauchy problem for system (8.2.1) with the initial condition

$$x = 0: \quad u = \bar{u}(t), \quad 0 \leq t \leq T, \quad (8.2.8)$$

where $\bar{u}(t) = (\bar{u}_1(t), \dots, \bar{u}_n(t))^T$ with small C^1 norm. By the theory of semi-global C^1 solution for quasilinear hyperbolic systems(see [37]), there exists a unique C^1 solution $u = \tilde{u}(t, x)$ on the whole maximum determinate domain and

$$\|\tilde{u}\|_{C^1} \leq C \sum_{i=1}^n \|\bar{u}_i\|_{C^1[0,T]}. \quad (8.2.9)$$

Obviously, $u = \tilde{u}(t, x)$ is the restriction of the solution $u = u(t, x)$ to the original mixed problem on the corresponding domain.

By (8.2.5), the maximum determinate domain must intersect $x = L$ and contains the interval $0 \leq x \leq L$ on the x -axis. Thus the initial data can be uniquely determined and the observability inequality (8.2.7) holds.

8.3 Exact boundary observability of unsteady supercritical flows in a single open canal

Now we apply the theory on the exact boundary observability to unsteady supercritical flows. In this section we first consider the case of a single open canal. Let L be the length of the canal. Taking the x -axis along the inverse direction of flow, this canal can be parameterized lengthwise by $x \in [0, L]$. Suppose that there is no friction and the canal is horizontal and cylindrical, the corresponding Saint-Venant system can be written as (see. [15], [30], [31])

$$\begin{cases} \frac{\partial A}{\partial t} + \frac{\partial(AV)}{\partial x} = 0, \\ \frac{\partial V}{\partial t} + \frac{\partial S}{\partial x} = 0, \end{cases} \quad t \geq 0, \quad 0 \leq x \leq L, \quad (8.3.1)$$

where $A = A(t, x)$ stands for the area of the cross section at x occupied by the water at time t , $V = V(t, x)$ is the average velocity over the cross section and

$$S = \frac{1}{2}V^2 + gh(A) + gY_b, \quad (8.3.2)$$

where g is the gravity constant, constant Y_b denotes the altitude of the bed of canal and

$$h = h(A) \quad (8.3.3)$$

is the depth of the water, $h(A)$ being a suitably smooth function of A such that

$$h'(A) > 0. \quad (8.3.4)$$

Consider an equilibrium state $(A, V) = (A_0, V_0)$ of system (8.3.1) with $A_0 > 0$, which belongs to the supercritical case, i.e.,

$$|V_0| > \sqrt{gA_0h'(A_0)}. \quad (8.3.5)$$

Without loss of generality, we suppose that

$$V_0 < -\sqrt{gA_0h'(A_0)}. \quad (8.3.6)$$

The boundary conditions is then given as follows:

$$x = L : \quad Q \stackrel{\text{def}}{=} AV = q(t), \quad V = v(t). \quad (8.3.7)$$

By Theorem 8.1, we have the following theorem on the exact boundary observability.

Theorem 8.2. *Under assumption (8.3.6), let*

$$T > \frac{L}{|\tilde{\lambda}_2|} = \max\left(\frac{L}{|\tilde{\lambda}_1|}, \frac{L}{|\tilde{\lambda}_2|}\right), \quad (8.3.8)$$

where

$$\tilde{\lambda}_1 \stackrel{\text{def}}{=} V_0 - \sqrt{gA_0h'(A_0)} < \tilde{\lambda}_2 \stackrel{\text{def}}{=} V_0 + \sqrt{gA_0h'(A_0)} < 0. \quad (8.3.9)$$

For any given initial condition

$$t = 0: \quad (A, V) = (A_0(x), V_0(x)), \quad 0 \leq x \leq L, \quad (8.3.10)$$

such that the norm $\|(A_0(x) - A_0, V_0(x) - V_0)\|_{C^1[0,L]}$ is suitably small and the conditions of C^1 compatibility with (8.3.1) and (8.3.7) are satisfied at the point $(t, x) = (0, L)$, if we have the observed values $A = a(t)$ and $V = v(t)$ at $x = 0$ on the interval $[0, T]$, then the initial data $(A_0(x), V_0(x))$ can be uniquely determined and the following observability inequality holds:

$$\|(A_0(x) - A_0, V_0(x) - V_0)\|_{C^1[0,L]} \leq C(\|a(t) - A_0\|_{C^1[0,T]} + \|v(t) - V_0\|_{C^1[0,T]}). \quad (8.3.11)$$

Proof: In a neighbourhood of the supercritical equilibrium state (A_0, V_0) , (8.3.1) is a strictly hyperbolic system with two distinct real eigenvalues

$$\lambda_1 \stackrel{\text{def}}{=} V - \sqrt{gAh'(A)} < \lambda_2 \stackrel{\text{def}}{=} V + \sqrt{gAh'(A)} < 0. \quad (8.3.12)$$

Introducing the Riemann invariants r and s as follows:

$$\begin{cases} 2r = V - V_0 - G(A), \\ 2s = V - V_0 + G(A), \end{cases} \quad (8.3.13)$$

where

$$G(A) = \int_{A_0}^A \sqrt{\frac{gh'(A)}{A}} dA, \quad (8.3.14)$$

we have

$$\begin{cases} V = r + s + V_0, \\ A = H(s - r) > 0, \end{cases} \quad (8.3.15)$$

where H is the inverse function of $G(A)$ with

$$H(0) = A_0, \quad (8.3.16)$$

$$H'(0) = \sqrt{\frac{A_0}{gh'(A_0)}} > 0. \quad (8.3.17)$$

Taking (r, s) as new unknown variables, the equilibrium state $(A, V) = (A_0, V_0)$ corresponds to $(r, s) = (0, 0)$ and system (8.3.1) reduces to the following system of diagonal form:

$$\begin{cases} \frac{\partial r}{\partial t} + \lambda_1(r, s) \frac{\partial r}{\partial x} = 0, \\ \frac{\partial s}{\partial t} + \lambda_2(r, s) \frac{\partial s}{\partial x} = 0, \end{cases} \quad (8.3.18)$$

where

$$\begin{cases} \lambda_1(r, s) = r + s + V_0 - \sqrt{gH(s-r)h'(H(s-r))} < 0, \\ \lambda_2(r, s) = r + s + V_0 + \sqrt{gH(s-r)h'(H(s-r))} < 0. \end{cases} \quad (8.3.19)$$

Boundary condition (8.3.7) now becomes

$$x = L : \quad P_1(t, r, s) \stackrel{\text{def}}{=} (r + s + V_0)H(s-r) - q(t) = 0, \quad (8.3.20)$$

$$P_2(t, r, s) \stackrel{\text{def}}{=} (r + s + V_0) - v(t) = 0 \quad (8.3.21)$$

and the corresponding observed values become

$$x = 0 : \quad H(s-r) = a(t), \quad 0 \leq t \leq T, \quad (8.3.22)$$

$$r + s + V_0 = v(t), \quad 0 \leq t \leq T. \quad (8.3.23)$$

Moreover, the initial condition (8.3.10) can be written as

$$t = 0 : \quad (r, s) = (r_0(x), s_0(x)), \quad (8.3.24)$$

where

$$r_0(x) = \frac{1}{2}(V_0(x) - V_0 - G(A_0(x))), \quad s_0(x) = \frac{1}{2}(V_0(x) - V_0 + G(A_0(x))). \quad (8.3.25)$$

When $(r, s) = (0, 0)$, noting (8.3.6), we have

$$\det \left| \frac{\partial(P_1, P_2)}{\partial(r, s)} \right| = -2V_0 \sqrt{\frac{A_0}{gh'(A_0)}} > 0. \quad (8.3.26)$$

By the implicit function theorem, in a neighbourhood of $(r, s) = (0, 0)$, (8.3.20)-(8.3.21) can be equivalently rewritten as

$$x = L : \quad r = \alpha(t), \quad s = \beta(t), \tag{8.3.27}$$

where α and β are C^1 functions of t . Moreover, noting (8.3.14), by (8.3.22) and (8.3.23), at $x = 0$ we have

$$\begin{cases} r = r(t) \stackrel{\text{def}}{=} \frac{1}{2} \left(v(t) - V_0 - \int_{A_0}^{a(t)} \sqrt{\frac{gh'(A)}{A}} dA \right), \\ s = s(t) \stackrel{\text{def}}{=} \frac{1}{2} \left(v(t) - V_0 + \int_{A_0}^{a(t)} \sqrt{\frac{gh'(A)}{A}} dA \right), \end{cases} \quad 0 \leq t \leq T \tag{8.3.28}$$

and

$$\|(r, s)\|_{C^1[0,T]} \leq C(\|a(t) - A_0\|_{C^1[0,T]} + \|v(t) - V_0\|_{C^1[0,T]}). \tag{8.3.29}$$

Thus, noting (8.3.8), by Theorem 8.1 $(r_0(x), s_0(x))$ can be uniquely determined by the observed values $r(t)$ and $s(t)$ ($0 \leq t \leq T$) at $x = 0$ and

$$\|(r_0(x), s_0(x))\|_{C^1[0,L]} \leq C(\|a(t) - A_0\|_{C^1[0,T]} + \|v(t) - V_0\|_{C^1[0,T]}). \tag{8.3.30}$$

Then, noting (8.3.25), it is easy to see that $(A_0(x), V_0(x))$ can be uniquely determined and (8.3.11) holds. This proves Theorem 8.2.

The procedure of resolution given by Theorem 8.2 can be illustrated by Figure 8.1, in which the point $E(x = 0)$ is the end point of the water flow and "→" stands for the direction of the water flow. Moreover, we need only two observed values taken at E (marked by ●), but no observation at another end (marked by ○).



Fig.8.1 A single canal

8.4 Exact boundary observability of unsteady supercritical flows in a star-Like network of open canals

Now, we consider the exact boundary observability of unsteady supercritical flows in a star-like network composed of N open canals: c_1, \dots, c_N . Let the multiple node be the point O . Suppose that the single node of canal c_1 is the ending point E and the water flows from other single nodes (through O) to the point E (see Figure 8.2, in which " \rightarrow " stands for the direction of the water flow).

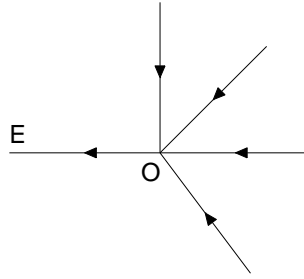

Fig.8.2 A star-like network

Let L_i be the length of the i -th canal ($i = 1, \dots, N$). For $i = 1, \dots, N$, taking the joint point O as $x = 0$, the i -th canal can be parameterized lengthwise by $x \in [0, L_i]$ and all the quantities associated with the i -th canal are indexed by i .

Suppose that there is no friction and all the canals are horizontal and cylindrical, the corresponding Saint-Venant system is (see [30], [31])

$$\begin{cases} \frac{\partial A_i}{\partial t} + \frac{\partial(A_i V_i)}{\partial x} = 0, \\ \frac{\partial V_i}{\partial t} + \frac{\partial S_i}{\partial x} = 0, \end{cases} \quad t \geq 0, \quad 0 \leq x \leq L_i \quad (i = 1, \dots, N), \quad (8.4.1)$$

where

$$S_i = \frac{1}{2} V_i^2 + g h_i(A_i) + g Y_{bi} \quad (i = 1, \dots, N), \quad (8.4.2)$$

Y_{bi} ($i = 1, \dots, N$) being constants and

$$h'_i(A_i) > 0 \quad (i = 1, \dots, N). \quad (8.4.3)$$

The interface conditions at the joint point O are given by the total energy interface condition

$$\sum_{i=1}^N A_i V_i S_i = 0 \quad (8.4.4)$$

and the total flux interface condition

$$\sum_{i=1}^N A_i V_i = 0 \quad (8.4.5)$$

(cf. [23], [21]), while, at another end of each canal except E we have the boundary conditions

$$x = L_i : \quad Q_i \stackrel{\text{def}}{=} A_i V_i = q_{i1}(t), \quad V_i = v_{i1}(t) \quad (i = 2, \dots, N). \quad (8.4.6)$$

Consider an equilibrium state $(A_i, V_i) = (A_{i0}, V_{i0})$ of system (8.4.1) with $A_{i0} > 0$ ($i = 1, \dots, N$), which belongs to a supercritical case, i.e.,

$$V_{i0} < -\sqrt{gA_{i0}h'_i(A_{i0})} \quad (i = 1, \dots, N), \quad (8.4.7)$$

and, corresponding to (8.4.4)-(8.4.5), satisfies

$$\sum_{i=1}^N A_{i0} V_{i0} S_{i0} = 0, \quad (8.4.8)$$

$$\sum_{i=1}^N A_{i0} V_{i0} = 0, \quad (8.4.9)$$

where

$$S_{i0} = \frac{1}{2} V_{i0}^2 + gh_i(A_{i0}) + gY_{bi} \quad (i = 1, \dots, N). \quad (8.4.10)$$

Theorem 8.3. *Let*

$$T > \frac{1}{|\tilde{\lambda}_{12}|} + \max_{i=2, \dots, N} \frac{1}{|\tilde{\lambda}_{i2}|}, \quad (8.4.11)$$

where

$$\tilde{\lambda}_{i1} \stackrel{\text{def}}{=} \frac{1}{L_i} (V_{i0} - \sqrt{gA_{i0}h'_i(A_{i0})}) < \tilde{\lambda}_{i2} \stackrel{\text{def}}{=} \frac{1}{L_i} (V_{i0} + \sqrt{gA_{i0}h'_i(A_{i0})}) < 0 \quad (i = 1, \dots, N). \quad (8.4.12)$$

For any given initial condition

$$t = 0 : \quad (A_i, V_i) = (A_{i0}(x), V_{i0}(x)), \quad 0 \leq x \leq L_i \quad (i = 1, \dots, N), \quad (8.4.13)$$

satisfying that $\sum_{i=1}^N \|(A_{i0}(x) - A_{i0}, V_{i0}(x) - V_{i0})\|_{C^1[0, L_i]}$ is suitably small and the conditions of piecewise C^1 compatibility with (8.4.1) and (8.4.4)-(8.4.6) are satisfied at the joint point O and all other ends except E , if we have the observed values $A_1 = a_1(t), V_1 = v_1(t)$ at point E and $A_i = a_i(t), V_i = v_i(t) (i = 2, \dots, N-1)$ at point O on the interval $[0, T]$ (the number of observed values is equal to $2(N-1)$), then the initial data $(A_{i0}(x), V_{i0}(x)) (i = 1, \dots, N)$ can be uniquely determined and the following observability inequality holds:

$$\begin{aligned} & \sum_{i=1}^N \|(A_{i0}(x) - A_{i0}, V_{i0}(x) - V_{i0})\|_{C^1[0, L_i]} \\ & \leq C \left(\sum_{i=1}^{N-1} \|a_i(t) - A_{i0}\|_{C^1[0, T]} + \sum_{i=1}^{N-1} \|v_i(t) - V_{i0}\|_{C^1[0, T]} \right). \end{aligned} \quad (8.4.14)$$

Proof: In a neighbourhood of the supercritical equilibrium state $(A_{i0}, V_{i0}) (i = 1, \dots, N)$, (8.4.1) is a hyperbolic system with real eigenvalues

$$\lambda_{i1} \stackrel{\text{def}}{=} V_i - \sqrt{gA_i h'_i(A_i)} < \lambda_{i2} \stackrel{\text{def}}{=} V_i + \sqrt{gA_i h'_i(A_i)} < 0 \quad (i = 1, \dots, N). \quad (8.4.15)$$

For $i = 1, \dots, N$, introducing the Riemann invariants r_i and s_i as follows:

$$\begin{cases} 2r_i = V_i - V_{i0} - G_i(A_i), \\ 2s_i = V_i - V_{i0} + G_i(A_i), \end{cases} \quad (8.4.16)$$

where

$$G_i(A_i) = \int_{A_{i0}}^{A_i} \sqrt{\frac{gh'_i(A_i)}{A_i}} dA_i, \quad (8.4.17)$$

we have

$$\begin{cases} V_i = r_i + s_i + V_{i0}, \\ A_i = H_i(s_i - r_i) > 0, \end{cases} \quad (8.4.18)$$

where H_i is the inverse function of $G_i(A_i)$, and

$$H_i(0) = A_{i0}, \quad (8.4.19)$$

$$H'_i(0) = \sqrt{\frac{A_{i0}}{gh'_i(A_{i0})}} > 0. \quad (8.4.20)$$

Thus, system (8.4.1) can be equivalently rewritten as

$$\begin{cases} \frac{\partial r_i}{\partial t} + \lambda_{i1}(r_i, s_i) \frac{\partial r_i}{\partial x} = 0, \\ \frac{\partial s_i}{\partial t} + \lambda_{i2}(r_i, s_i) \frac{\partial s_i}{\partial x} = 0, \end{cases} \quad t \geq 0, \quad 0 \leq x \leq L_i \quad (i = 1, \dots, N), \quad (8.4.21)$$

where

$$\begin{aligned} & \lambda_{i1}(r_i, s_i) \stackrel{\text{def}}{=} r_i + s_i + V_{i0} - \sqrt{gH_i(s_i - r_i)h'_i(H_i(s_i - r_i))} \\ < & \lambda_{i2}(r_i, s_i) \stackrel{\text{def}}{=} r_i + s_i + V_{i0} + \sqrt{gH_i(s_i - r_i)h'_i(H_i(s_i - r_i))} < 0, \quad (i = 1, \dots, N) \end{aligned} \quad (8.4.22)$$

Moreover, the initial condition (8.4.13) becomes

$$t = 0 : \quad (r_i, s_i) = (r_{i0}(x), s_{i0}(x)), \quad 0 \leq x \leq L_i \quad (i = 1, \dots, N), \quad (8.4.23)$$

where

$$\begin{cases} r_{i0}(x) = \frac{1}{2}(V_{i0}(x) - V_{i0} - G_i(A_{i0}(x))), \\ s_{i0}(x) = \frac{1}{2}(V_{i0}(x) - V_{i0} - G_i(A_{i0}(x))), \end{cases} \quad (i = 1, \dots, N). \quad (8.4.24)$$

As in the proof of Theorem 8.2, (r_1, s_1) at $x = L_1$ and (r_i, s_i) ($i = 2, \dots, N - 1$) at $x = 0$ can be uniquely determined by the observed values $a_i(t)$ and $v_i(t)$ ($i = 1, \dots, N - 1$), respectively, as follows:

$$\begin{cases} r_i = \frac{1}{2} \left(v_i(t) - V_{i0} - \int_{A_{i0}}^{a_i(t)} \sqrt{\frac{gh'_i(A_i)}{A_i}} dA_i \right), \\ s_i = \frac{1}{2} \left(v_i(t) - V_{i0} + \int_{A_{i0}}^{a_i(t)} \sqrt{\frac{gh'_i(A_i)}{A_i}} dA_i \right), \end{cases} \quad (i = 1, \dots, N - 1) \quad (8.4.25)$$

and

$$\|(r_i, s_i)\|_{C^1[0, T]} \leq C(\|a_i(t) - A_{i0}\|_{C^1[0, T]} + \|v_i(t) - V_{i0}\|_{C^1[0, T]}) \quad (i = 1, \dots, N - 1) \quad (8.4.26)$$

Now, for $i = 1$, changing the status of t and x in (8.4.21) and using (8.4.25) as the initial data on $x = L_1$, we can solve a leftward Cauchy problem on canal c_1 . As in the proof of Theorem 8.1, noting (8.4.11), we get that $(r_{10}(x), s_{10}(x))$ can be uniquely determined by $a_1(t)$ and $v_1(t)$ and

$$\|(r_{10}(x), s_{10}(x))\|_{C^1[0, L_1]} \leq C(\|a_1(t) - A_{10}\|_{C^1[0, T]} + \|v_1(t) - V_{10}\|_{C^1[0, T]}); \quad (8.4.27)$$

moreover, there exists T_1 :

$$T_1 > \max_{i=2, \dots, N} \frac{1}{|\widetilde{\lambda}_{i2}|}, \quad (8.4.28)$$

such that at $x = 0$, on the interval $[0, T_1]$, (r_1, s_1) can be also uniquely determined by $a_1(t)$ and $v_1(t)$ and

$$\|(r_1, s_1)\|_{C^1[0, T_1]} \leq C(\|a_1(t) - A_{10}\|_{C^1[0, T]} + \|v_1(t) - V_{10}\|_{C^1[0, T]}). \quad (8.4.29)$$

At $x = 0$, the interface conditions (8.4.4) and (8.4.5) now become

$$P_1 \stackrel{\text{def}}{=} \sum_{i=1}^N (r_i + s_i + V_{i0}) H_i(s_i - r_i) \left(\frac{1}{2} (r_i + s_i + V_{i0})^2 + gh_i(H_i(s_i - r_i)) + gY_i \right) \quad (8.4.30)$$

and

$$P_2 \stackrel{\text{def}}{=} \sum_{i=1}^N (r_i + s_i + V_{i0}) H_i(s_i - r_i) = 0. \quad (8.4.31)$$

Since when $(r_i, s_i) = (0, 0) (i = 1, \dots, N)$,

$$\det \left| \frac{\partial(P_1, P_2)}{\partial(r_N, s_N)} \right| = 2A_{N0} V_{N0} \sqrt{\frac{A_{i0}}{gh'_i(A_{i0})}} (V_{N0}^2 - gA_{N0} h'_N(A_{N0})) < 0, \quad (8.4.32)$$

by the implicit function theorem, in a neighbourhood of $(r_i, s_i) = (0, 0) (i = 1, \dots, N)$, (8.4.30)-(8.4.31) can be equivalently rewritten as

$$\begin{cases} r_N = g_{N1}(r_1, s_1, \dots, r_{N-1}, s_{N-1}), \\ s_N = g_{N2}(r_1, s_1, \dots, r_{N-1}, s_{N-1}), \end{cases} \quad (8.4.33)$$

where g_{N1} and g_{N2} are C^1 functions with respect to their arguments with

$$g_{N1}(0, \dots, 0) = g_{N2}(0, \dots, 0) = 0. \quad (8.4.34)$$

So at $x = 0$, on the interval $[0, T_1]$, (r_N, s_N) can be uniquely determined by $a_i(t)$ and $v_i(t) (i = 1, \dots, N - 1)$ and

$$\|(r_N, s_N)\|_{C^1[0, T_1]} \leq C \left(\sum_{i=1}^{N-1} \|a_i(t) - A_{i0}\|_{C^1[0, T]} + \sum_{i=1}^{N-1} \|v_i(t) - V_{i0}\|_{C^1[0, T]} \right). \quad (8.4.35)$$

Now, for $i = 2, \dots, N$, changing the status of t and x in (8.4.21) and using (8.4.25) and (8.4.33) as the initial data on $x = 0$, we can solve the rightward Cauchy problem on each canal c_i respectively. Noting (8.4.28), as in the proof of Theorem 8.1, we get that $(r_{i0}(x), s_{i0}(x)) (i = 2, \dots, N)$ can be uniquely determined and

$$\begin{aligned} \|(r_{i0}(x), s_{i0}(x))\|_{C^1[0, L_i]} &\leq C \left(\sum_{i=1}^{N-1} \|a_i(t) - A_{i0}\|_{C^1[0, T]} \right. \\ &\quad \left. + \sum_{i=1}^{N-1} \|v_i(t) - V_{i0}\|_{C^1[0, T]} \right) \quad (i = 2, \dots, N). \end{aligned} \quad (8.4.36)$$

Noting (8.4.24), the combination of (8.4.27) and (8.4.36) yields the desired conclusion.

The procedure of resolution given by Theorem 8.3 can be illustrated by Figure 8.3, in which at the node marked by \bullet , all related values should be observed, at the node marked by \odot , a part of related values should be observed, and at the node marked by \circ , no observation is needed.

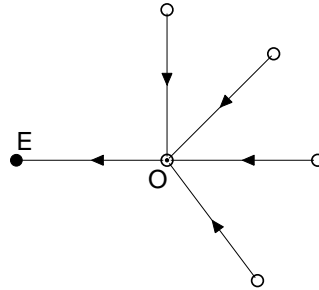

Fig.8.3 The observation on a star-like network

8.5 Exact boundary observability of unsteady supercritical flows in a tree-like network of open canals

We now consider the exact boundary observability of unsteady flows in a tree-like network composed by N open canals: c_1, \dots, c_N . Suppose that a single node is the end point E and the water flows from other single nodes to the point E (see Figure 8.4, in which "→" stands for the direction of the water flow).

For $i = 1, \dots, N$, let d_{i0} and d_{i1} be the x -coordinates of two ends of the i -canal C_i , $d_{i0} < d_{i1}$ and $L_i = d_{i1} - d_{i0}$ be its length. Suppose that the water in the i -canal flows from d_{i1} to d_{i0} ($i = 1, \dots, N$). Under the assumption that there is no friction and all the canals are horizontal and cylindrical, the corresponding Saint-Venant system can be written as

$$\begin{cases} \frac{\partial A_i}{\partial t} + \frac{\partial(A_i V_i)}{\partial x} = 0, \\ \frac{\partial V_i}{\partial t} + \frac{\partial S_i}{\partial x} = 0, \end{cases} \quad t \geq 0, \quad d_{i0} \leq x \leq d_{i1} \quad (i = 1, \dots, N), \quad (8.5.1)$$

where S_i ($i = 1, \dots, N$) are given by (8.4.2).

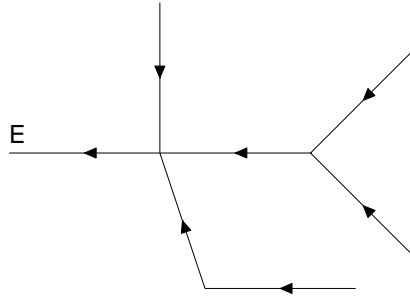

Fig.8.4 A tree-like network

When d_{i1} is a simple node, we have the flux boundary condition

$$x = d_{i1} : \quad Q_i \stackrel{\text{def}}{=} A_i V_i = q_{i1}(t), \quad V_i = v_{i1}(t). \tag{8.5.2}$$

While, when d_{i1} is a multiple node, at d_{i1} we have the total energy interface condition

$$\sum_{j \in J_{i1}, j \neq i} A_j V_j S_j = A_i V_i S_i \tag{8.5.3}$$

and the total flux interface condition

$$\sum_{j \in J_{i1}, j \neq i} A_j V_j = A_i V_i, \tag{8.5.4}$$

where J_{i1} denotes the set of indices corresponding to all the canals jointed at d_{i1} .

Based on Theorem 8.3, we choose a group of observed values as follows:

For simple nodes, we take the observation only on the end point E. Suppose E is the simple node of canal c_i , we observe A_i and V_i on it.

For any given multiple node, suppose that it is the joint point of k canals: c_{i_1}, \dots, c_{i_k} , which constitute a star-like subnetwork. Suppose that the end point for this star-like subnetwork belongs to c_{i_1} , we observe $A_{i_2}, V_{i_2}, \dots, A_{i_{k-1}}, V_{i_{k-1}}$ on this multiple node: there are $2(k - 2)$ observed values on it.

Using this principle, we can get the following theorems.

Theorem 8.4. *Consider a supercritical equilibrium state $(A_i, V_i) = (A_{i0}, V_{i0})(i = 1, \dots, N)$ of system (8.4.1) with $A_{i0} > 0(i = 1, \dots, N)$, which satisfies*

$$V_{i0} < -\sqrt{g A_{i0} h'_i(A_{i0})} \quad (i = 1, \dots, N). \tag{8.5.5}$$

Let

$$\tilde{\lambda}_{i1} \stackrel{\text{def}}{=} V_{i0} - \sqrt{gA_{i0}h'_i(A_{i0})} < \tilde{\lambda}_{i2} \stackrel{\text{def}}{=} V_{i0} + \sqrt{gA_{i0}h'_i(A_{i0})} < 0 \quad (8.5.6)$$

and

$$T > \max_{d_{i1} \in K} \sum_{j \in D_i} \frac{L_j}{|\tilde{\lambda}_{j2}|}, \quad (8.5.7)$$

where K stands for the set of all simple nodes except point E , and D_i the set of indices corresponding to all the canals in the string-like subnetwork connecting the points E and d_{i1} .

For any given initial condition

$$t = 0 : \quad (A_i, V_i) = (A_{i0}(x), V_{i0}(x)) \quad (i = 1, \dots, N), \quad (8.5.8)$$

such that the conditions of piecewise C^1 compatibility are satisfied and $\sum_{i=1}^N \|(A_{i0}(x) - A_{i0}, V_{i0}(x) - V_{i0})\|_{C^1[d_{i0}, d_{i1}]}$ is suitably small, if we choose the observed values on the interval $[0, T]$ according to the principle mentioned above, then the initial data can be uniquely determined and we have the corresponding observability inequality.

This theorem can be proved similarly to the proof of Theorem 8.3.

More precisely, we have the following Theorem.

Theorem 8.5. *For any given tree-like network of open canals, if there are l simple nodes, then we need $2(l - 1)$ observed values.*

Proof: We prove this theorem by induction on the number m of the multiple nodes. If there is only 1 multiple node in the network, then it is a star-like network and the conclusion comes directly from Theorem 8.3.

Suppose that the conclusion is valid for any given network with m multiple nodes. Consider a network with $m + 1$ multiple nodes and l simple nodes. Cutting the network at a multiple node M such that this network can be regarded as a subnetwork with m multiple nodes plus k canals, each of which has one original simple node (see Figure 8.5).

This subnetwork should have $l - (k - 1)$ simple nodes, according to the assumption of induction, we need $2[l - (k - 1) - 1] = 2(l - k)$ observed values for the subnetwork and there is no observation at M . Moreover, the star-like network with M as its center

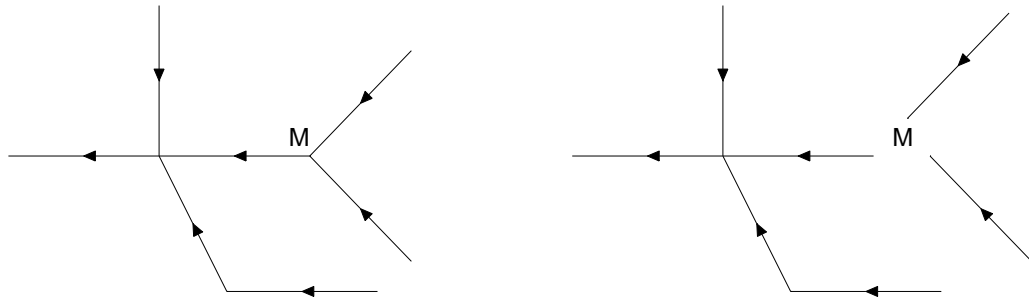

Fig.8.5

node contains $k + 1$ canals, then, by Theorem 8.4, for the original network, we need $2(k - 1)$ observed values at M and there is no observation at all the original simple nodes in this star-like subnetwork. Therefore, the total number of the observed values is equal to $2(l - k) + 2(k - 1) = 2(l - 1)$.

Thus, Theorem 8.5 is obtained by induction.

Remark 8.1. Comparing with the results given in [21], we can find an implicit duality between the exact boundary controllability and the exact boundary observability of unsteady supercritical flows in a tree-like network as follows:

1. In a tree-like network, the number of the observed values is equal to the number of the boundary controls. If the network contains l simple nodes, then both the number of the observed values and the number of the boundary controls are equal to $2(l - 1)$.

2. The observability time is equal to the controllability time. Both of them satisfy (8.5.7).

3. The observed values are given on the ending simple node E and all the multiple nodes, while the controls are acted only on the simple nodes except E (See Figure 8.6, in which the observations are taken on bold nodes "•", while the boundary controls are acted on hollow nodes "○").

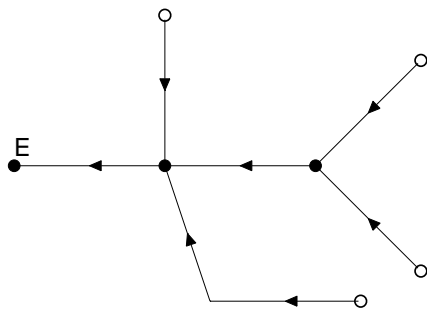

Fig.8.6 The duality between the controllability and the observability

Bibliography

- [1] K. Ammari and M. Jellouli, *Stabilization of star-shaped networks of strings*, *Differential Integral Equations*, 17 (2004), 1395-1410.
- [2] K. Ammari and M. Jellouli, *Remark on stabilization of tree-shaped networks of strings*, *Applications of Mathematics*, 52 (2007), 327-343.
- [3] K. Ammari, M. Jellouli, and M. Khenissi, *Stabilization of generic trees of strings*, *J. Dyn. Control Syst.*, 11 (2005), 177-193.
- [4] C. Besse, J. Claudel, P. Degond, et al, *A model hierarchy for ionospheric plasma modeling*, *Math. Models Meth. Appl. Sci.*, 14 (2004), 393-415.
- [5] Y. Brenier, *Convergence of the Vlasov-Poisson system to the incompressible Euler equations*, *Commun. Part. Diff. Eq.*, 25 (2000), 737-754.
- [6] H. Brézis, F. Golse and R. Sentis, *Analyse asymptotique de l'équation de Poisson couplée à la relation de Boltzmann, Quasi-neutralité des plasmas*, *C. R. Acad. Sci. Paris*, 321 (1995), 953-959.
- [7] F. Chen, *Introduction to Plasma Physics and Controlled Fusion*, Vol. 1, Plenum Press, New York, 1984.
- [8] M. Cirinà, *Boundary controllability of nonlinear hyperbolic systems*, *SIAM J. Control Optim.*, 7 (1969), 198-212.
- [9] M. Cirinà, *Nonlinear hyperbolic problems with solutions on preassigned sets*, *Michigan Math. J.*, 17 (1970), 193-209.

- [10] S. Cordier and E. Grenier, *Quasineutral limit of an Euler-Poisson system arising from plasma physics*, Commun. Part. Diff. Eq., 25 (2000), 1099-1113.
- [11] J.-M. Coron, B. d'Andréa-Novel and G. Bastin, *A Lyapunov approach to control irrigation canals modeled by Saint-Venant equations*, in CD-Rom Proceedings, Paper F1008-5, ECC99, Karlsruhe, Germany, 1999.
- [12] J. F. Coulombel and T. Goudon, *The strong relaxation limit of the multidimensional isothermal Euler equation*, Trans. Amer. Math. Soc., 359 (2007), 637-648.
- [13] C. M. Dafermos, *Hyperbolic conservation laws in continuum physics*, A Series of Comprehensive Studies in Mathematics, 2000.
- [14] R. Dáger and E. Zuazua, *Wave Propagation, Observation and Control in 1-D Flexible Multi-structures*, Mathematiques and Applications 50, 2000.
- [15] B. De Saint-Venant, *Théorie du mouvement non permanent des eaux, avec application aux crues des rivières et l'introduction des marées dans leur lit*, C. R. Acad. Sci., 73 (1871), 147-154, 237-240.
- [16] J. de Halleux, B. d'Andréa-Novel J.-M., Coron and G. Bastin, *A Lyapunov approach for the control of multi reach channels modeled by Saint-Venant equations*, in CD-Rom Proceedings, NOLCOS'01, St-Petersburg, Russia, June 2001.
- [17] J. de Halleux and G. Bastin, *Stabilization of Saint-Venant equations using Riemann invariants: Application to waterways with mobile spillways*, in CD-Rom Proceedings, Barcelona, Spain, July 2002.
- [18] J. de Halleux, C. Prieur, J.-M. Coron, B. d'Andréa-Novel and G. Bastin, *Boundary feedback control in networks of open channels*, Automatica, 39 (2003), 1365-1376.
- [19] O. Yu. Emanuilov, *Boundary control by semilinear evolution equations*, Russian Math. Surveys, 44 (1989), 183-184.
- [20] T. Goudon, A. Jungel and Yuejun Peng *Zero-mass-electrons limits in hydrodynamic models for plasma*, Appl. Math. Lett., 12 (1999), 75-79.

- [21] Qilong Gu, *Exact boundary controllability of unsteady supercritical flows in a tree-like network of open canals*, Math. Meth. Appl. Sci., 31 (2008), 1497-1508.
- [22] Qilong Gu and Tatsien Li, *Exact boundary observability of unsteady flows in a tree-like network of open canals*, Math. Meth. Appl. Sci., 32 (1009), 395-418.
- [23] M. Gugat and G. Leugering, *Global boundary controllability of the de St. Venant equations between steady states*, Ann. I. H. Poincare-AN, 20 (2003), 1-11.
- [24] M. Gugat, G. Leugering and EJP. Georg Schmidt, *Global controllability between steady supercritical flows in channel networks*, Math. Meth. Appl. Sci., 27 (2004), 781-802.
- [25] A. Jüngel and Yuejun Peng, *A hierarchy of hydrodynamic models for plasmas. Zero-relaxation-time limit*, Commun. Part. Diff. Eq., 24 (1999), 1007-1033.
- [26] A. Jüngel and Yuejun Peng, *Zero-relaxation-time limits in the hydrodynamic equations for plasmas revisited*, Z. angew. Math. Phys., 51 (2000), 385-396.
- [27] T. Kato, *Nonstationary flow of viscous and ideal fluids in \mathbb{R}^3* , J. Funct. Anal., 9 (1972), 296-305.
- [28] J. E. Lagnese, G. Leugering, and E. J. P. G. Schmidt, *Modeling, analysis and control of multi-link structures*, Systems and Control: Foundations and Applications, Birkhäuser-Basel, 1994.
- [29] I. Lasiecka and R. Triggiani, *Exact controllability of semilinear abstract systems with applications to waves and plates boundary control problems*, Appl. Math. Optim., 23 (1991), 109-154.
- [30] G. Leugering and E. G. Schmidt, *On the modelling and stabilization of flows in networks of open canals*, SIAM J. Control Optim., 41 (2002), 164-180.
- [31] Tatsien Li , *Exact boundary controllability of unsteady flows in a network of open canals*, Math. Nachr., 278 (2005), 278-289.
- [32] Tatsien Li, *Exact controllability for quasilinear hyperbolic systems and its application to unsteady flows in a network of open canals.*, Math. Meth. Appl. Sci., 27 (2004), 1089-1114.

- [33] Tatsien Li , *Observabilité exacte frontière pour des systèmes hyperboliques quasi linéaires*, C. R. Acad. Sci. Paris, Ser. I, 342 (2006), 937-942.
- [34] Tatsien Li, *Exact boundary observability for quasilinear hyperbolic systems*, ESIAM: Control, Optimisation and Calculus of Variations (2008), DOI:10.1051/COCV:2008007.
- [35] Tatsien Li, *Controllability and Observability for Quasilinear Hyperbolic Systems*, AIMS Series on Applied Mathematics, Vol. 3, 2008.
- [36] Tatsien Li, *Global Classical Solutions for Quasilinear Hyperbolic Systems*, Masson, J. Wiley, 1994.
- [37] Tatsien Li and Yi Jin, *Semi-global C^1 solution to the mixed initial-boundary value problem for quasilinear hyperbolic systems*, Chinese Ann. Math. Ser. B, 22 (2001), 325-336.
- [38] Tatsien Li and Yuejun Peng, *The mixed initial-boundary value problem for reducible quasilinear hyperbolic systems with linearly degenerate characteristics*, Nonlinear Anal., 52 (2003), 573-583.
- [39] Tatsien Li and Yuejun Peng, *Global C^1 solution to the initial-boundary value problem for diagonal hyperbolic systems with linearly degenerate characteristics*, J. Partial Diff. Eqs. 16 (2003), 8-17.
- [40] Tatsien Li and Yuejun Peng, *Cauchy problem for weakly linearly degenerate hyperbolic systems in diagonal form*, Nonlinear Anal., 55 (2003), 937-949.
- [41] Tatsien Li and Bopeng Rao, *Exact boundary controllability for quasilinear hyperbolic systems*, SIAM J. Control Optim., 41 (2003), 1748-1755.
- [42] Tatsien Li and Bopeng Rao, *Local exact boundary controllability for a class of quasilinear hyperbolic systems*, Chinese Ann. Math. Ser. B, 23 (2002), 209-218.
- [43] Tatsien Li and Bopeng Rao, *Contrôlabilité exacte frontière de l'écoulement d'un fluide non-stationnaire dans un réseau du type d'arbre de canaux ouverts*, C. R. Acad. Sci. Paris, Ser. I, 339 (2004), 867-872.

- [44] Tatsien Li and Bopeng Rao, *Exact boundary controllability of unsteady flows in a tree-like network of open canals*, Methods and Applications of Analysis, 11 (2004), 353-366.
- [45] Tatsien Li, Bopeng Rao and Yi Jin, *Semi-global C^1 solution and exact boundary controllability for reducible quasilinear hyperbolic systems*, M2AN, 34 (2000), 399-408.
- [46] Tatsien Li, Bopeng Rao and Yi Jin, *Solution C^1 semi-globale et contrôlabilité exacte frontière de systèmes hyperboliques quasi linéaires*, C. R. Acad. Sci. Paris, Ser. I, 333 (2001), 219-224.
- [47] Tatsien Li and Zhiqiang Wang, *A note on the exact controllability for nonautonomous hyperbolic systems*, Commun. Pure Appl. Anal., 6 (2007), 229-235.
- [48] Tatsien Li and Lixin Yu, *Contrôlabilité exacte frontière pour les équations des ondes quasi linéaires unidimensionnelles*, C. R. Acad. Sci. Paris, Ser. I, 337 (2003), 271-276.
- [49] Tatsien Li and Lixin Yu, *Exact boundary controllability for 1-D quasilinear wave equations*, SIAM J. Control Optim., 45 (2006), 1074-1083.
- [50] Tatsien Li and Lixin Yu, *Exact controllability for first order quasilinear hyperbolic systems with zero eigenvalues*, Chinese Ann. Math. Ser. B, 24 (2003), 415-422.
- [51] Tatsien Li and Wenci Yu, *Boundary Value Problems for Quasilinear Hyperbolic Systems*, Duke University Mathematics Series V, 1985.
- [52] Tatsien Li and Bingyu Zhang, *Global exact controllability of a class of quasilinear hyperbolic systems*, J. Math. Anal. Appl., 225 (1998), 289-311.
- [53] J. L. Lions, *Contrôlabilité Exacte, Perturbations et Stabilization de Systèmes Distribués*, Vol. I, Masson, 1988.
- [54] J. L. Lions, *Exact controllability, stabilization and perturbations for distributed systems*, SIAM Rev., 30 (1988), 1-68.
- [55] A. Majda, *Compressible Fluid Flow and Systems of Conservation Laws in Several Space Variables*, New York, Springer-Verlag, 1984.

- [56] S. Nicaise and J. Valein, *Stabilization of the wave equation on 1-D networks with a delay term in the nodal feedbacks*, Netw. Heterog. Media (electronic), 2 (2007), 425-479.
- [57] Yuejun Peng, *Some asymptotic analysis in steady-state Euler-Poisson equations for potential flow*, Asymptotic Anal., 36 (2003), 75-92.
- [58] Yuejun Peng and Shu Wang, *Convergence of compressible Euler-Maxwell equations to compressible Euler-Poisson equations*, Chinese Ann. Math. Ser. B., 28 (2007), 583-602.
- [59] Yuejun Peng and Shu Wang, *Rigorous derivation of incompressible e-MHD equations from compressible Euler-Maxwell equations*, SIAM J. Math. Anal. 40 (2008), 540-565.
- [60] Yuejun Peng and Shu Wang, *Convergence of compressible Euler-Maxwell equations to incompressible Euler equations*, Commun. Part. Diff. Eq., 33 (2008), 349-376.
- [61] Yuejun Peng and Shu Wang, *Asymptotic expansions in two-fluid compressible Euler-Maxwell equations with small parameters*, Discrete Contin. Dyn. Syst., 23 (2009), 415-433.
- [62] Yuejun Peng and Yaguang Wang, *Convergence of compressible Euler-Poisson equations to incompressible type Euler equations*, Asymptotic Anal., 41 (2005), 141-160.
- [63] H. Rishbeth and O. K. Garriott, *Introduction to Ionospheric Physics*, Academic Press, 1969.
- [64] D. L. Russell, *Controllability and stabilizability theory for linear partial differential equations, Recent progress and open questions*, SIAM Rev., 20 (1978), 639-739.
- [65] E.J.P.G. Schmidt, *On the modeling and exact control lability of networks of vibrating strings*, SIAM J. Control. Optim., 30 (1992), 229-245.
- [66] D. Serre, *Systèmes de Lois de Conservation II*, Diderot: Paris, 1996.
- [67] M. Slemrod and N. Sternberg, *Quasi-neutral limit for the Euler-Poisson system*, J. Nonlinear Sciences, 11 (2001), 193-209.

- [68] I. Violet, *Existence of solutions and asymptotic limits of the Euler-Poisson and the quantum drift-diffusion systems*, Thèse de l'université Clermont-Ferrand 2, 2006.
- [69] Shu Wang, *Quasineutral limit of Euler-Poisson system with and without viscosity*, Commun. Part. Diff. Eq., 29 (2004), 419-456.
- [70] Shu Wang and Song Jiang, *The convergence of the Navier-Stokes-Poisson system to the incompressible Euler equations*, Commun. Part. Diff. Eq., 31 (2006), 571-591.
- [71] Zhiqiang Wang, *Exact boundary controllability for nonautonomous quasilinear wave equations*, Math. Meth. Appl. Sci., 30 (2007), 1311-1327.
- [72] Zhiqiang Wang, *Exact Controllability for nonautonomous first order quasilinear hyperbolic systems*, Chinese Ann. Math. Ser. B., 27 (2006), 643-656.
- [73] Wenan Yong, *Diffusive relaxation limit of multidimensional isentropic hydrodynamical models for semiconductors*, SIAM J. Appl. Math., 64 (2004), 1737-1748.
- [74] E. Zuazua, *Exact controllability for the semilinear wave equation*, J. Math. Pures et Appl., 69 (1990), 1-31.
- [75] E. Zuazua, *Exact controllability for semilinear wave equations*, Ann. I. H. Poincaré-AN, 10 (1993), 109-129.
- [76] E. Zuazua, *Controllability of partial differential equations and its semi-discrete approximation*, Discrete Contin. Dyn. Syst., 8 (2002), 469-513.

RÉSUMÉ

Cette thèse est essentiellement composée de deux parties. Dans la première partie, on étudie le système d'Euler-Maxwell. En utilisant la méthode d'intégration de l'énergie classique, on montre l'existence et l'unicité de solutions régulières globales du système avec données initiales petites. Ensuite, on étudie la limite de relaxation en montrant que, le système d'Euler-Maxwell converge vers les équations de dérive-diffusion quand le temps de relaxation tend vers zéro.

Dans la deuxième partie, on cherche la contrôlabilité et l'observabilité exactes frontières de systèmes hyperboliques quasi-linéaires dans un réseau du type d'arbre. On établit des résultats d'existence de la contrôlabilité et l'observabilité par des méthodes constructives qui sont basées sur la théorie de la solution C^1 semi-globale du système hyperbolique quasi-linéaire du premier ordre avec conditions initiales et frontières. Ensuite, on trouve des dualités de la contrôlabilité et l'observabilité.

ABSTRACT

This thesis is essentially composed of two parts. In the first part, I study the Euler-Maxwell system. Using the classical method of energy integral, I prove the existence and uniqueness of global solutions to the system with small initial data. After that, I study the relaxation limit. I prove that, as the relaxation time tends to zero, the Euler-Maxwell system converges to the drift-diffusion models.

In the second part, I study the exact boundary controllability and observability of quasilinear hyperbolic systems in a tree-like network. In this part, based on the theory of the semi-global C^1 solution of the mixed initial-boundary value problem for first order quasilinear hyperbolic systems, I deal with the controllability and observability with a constructive method. Then, I find some duality of the controllability and observability.