



HAL
open science

Design and optimization of wireless backhaul networks

Alvinice Kodjo

► **To cite this version:**

Alvinice Kodjo. Design and optimization of wireless backhaul networks. Other [cs.OH]. Université Nice Sophia Antipolis, 2014. English. NNT : 2014NICE4140 . tel-01165064

HAL Id: tel-01165064

<https://theses.hal.science/tel-01165064>

Submitted on 18 Jun 2015

HAL is a multi-disciplinary open access archive for the deposit and dissemination of scientific research documents, whether they are published or not. The documents may come from teaching and research institutions in France or abroad, or from public or private research centers.

L'archive ouverte pluridisciplinaire **HAL**, est destinée au dépôt et à la diffusion de documents scientifiques de niveau recherche, publiés ou non, émanant des établissements d'enseignement et de recherche français ou étrangers, des laboratoires publics ou privés.

UNIVERSITÉ DE NICE - SOPHIA ANTIPOLIS
ÉCOLE DOCTORALE DES SCIENCES ET TECHNOLOGIES DE
L'INFORMATION ET DE LA COMMUNICATION

THÈSE

pour obtenir le titre de

Docteur en Sciences

de l'Université de Nice - Sophia Antipolis

Mention : INFORMATIQUE

Présentée par

Alvinice KODJO

Titre français

Dimensionnement et optimisation des réseaux de collecte sans fil

**Equipe projet COATI
INRIA, I3S (CNRS/UNS)**

Thèse dirigée par

David COUDERT - COATI (INRIA, I3S (CNRS/UNS))

Soutenance le 18 Décembre 2014

Jury:

<i>Président:</i>	Philippe MICHELON	-	LIA (Avignon, France)
<i>Rapporteurs:</i>	Hervé RIVANO	-	INRIA (Lyon, France)
	Dritan NACE	-	UTC (Compiègne, France)
<i>Examinators:</i>	Brigitte JAUMARD	-	CSE - UC (Montréal, Canada)
	Patrick BEATINI	-	3ROAM (Sophia Antipolis, France)

Acknowledgements

I would not have been able to arrive at the end of this thesis without the support and the encouragements of several people. I want to take this opportunity to sincerely thank them.

My heartfelt thanks to my advisor Dr David Coudert for all the confidence he placed in me throughout these years. He was always available to discuss with me when I was lost and provided me precious advices for solving my difficult problems. I also thank him for for the great patience he showed during the review of my manuscript.

I would like to thank Pr Dritan Nace and Dr Hervé Rivano who accepted to review my thesis. Their comments and suggestions helped me to provide clear explanations on essential elements of my thesis.

I am also thankful to all my co-authors without whom I would not certainly have obtained such qualities of results. It was a pleasure and a good experience for me to work with all of them. A special thanks to Pr Brigitte Jaumard who welcomed me in her team during a month in Montreal and who also agreed to be a member of my jury. I learnt a lot by working with her and I am grateful for the excellent example she has provided me as researcher and teacher.

I thank all the current and past members of the Mascotte/Coati team thanks to who it was always a pleasure to come to work. Thank you for pleasant moments shared together. My thanks also go to all my friends from Ubinet and Inria. One thousand thanks to Patricia Lachaume for the friendship and the kindness which she always showed with me. She is a very beautiful and a great lady I can never forget.

My life in Nice and Sophia would have been rather solitary without the presence of the members of the Bisso family. Thank you infinitely for the love, the friendship and the support during all this period.

To my dear Aminath Badarou who is more than a friend, I want to sincerely thank you for everything you have done for me in my life. She understands me better than anyone and always has the right words to confort me. We still have a lot to share.

I would like to express my infinite gratitude and my love to my dear parents, my brothers and sisters. Thank you Mom and Dad for your support and your prayers. You sacrificed a lot so I can be the woman I am today and I cannot thank you enough for that. A big thank to my sisters and brother for always being present by my side.

Finally, I dedicate this thesis to my lovely son Leroy-Jethro who is and will forever be the main engine of my life.

Résumé

L'essentiel des travaux de cette thèse porte sur les réseaux de collectes de données sans fil. Ce type de réseaux présente l'avantage de permettre un déploiement facile et rapide à des coûts relativement faibles tout en offrant des capacités pouvant aller jusqu'à 1Gbps sur des liens d'une centaine de kilomètres. Nous avons étudié différents problèmes d'optimisation dans ces réseaux qui représentent de vrais challenges pour les industriels du secteur.

Le premier problème porte sur l'allocation de capacités sur les liens à coût minimum. Il a été résolu par une approche de programmation linéaire avec génération de colonnes. Notre modèle permet de résoudre des problèmes de grandes tailles. De plus, nous obtenons rapidement des solutions de très bonnes qualités.

Nous avons ensuite étudié le problème du partage d'infrastructure réseau entre opérateurs virtuels. L'objectif est alors de maximiser les revenus de l'opérateur de l'infrastructure physique tout en satisfaisant les demandes et les contraintes de qualité de service des opérateurs virtuels clients du réseau. Dans ce contexte, nous avons proposé une modélisation du problème en programmation linéaire en nombres entiers mixte. Notre formulation est robuste aux variations de trafic des opérateurs virtuels.

Un autre point de dépenses dans ce type de réseau est la consommation d'énergie. De nombreux opérateurs cherchent aujourd'hui à réduire la consommation d'énergie des réseaux, à la fois en utilisant des équipements plus performants et en utilisant des solutions de routage plus adaptées. Nous avons proposé une solution robuste, de routage basée sur la consommation d'énergie du réseau. Le modèle proposé est basé sur les réseaux backbone mais il devrait être assez aisément adaptable aux réseaux de collectes sans fil. Notre solution a été formulée en utilisant un programme linéaire en nombre entiers mixte. Nous avons aussi proposé des heuristiques afin de trouver assez rapidement des solutions pour de grandes instances.

Le dernier travail de cette thèse porte sur les réseaux radio cognitifs et plus précisément sur le problème de partage de bande passante. Nous l'avons formalisé en utilisant un programme linéaire mais avec une autre approche d'optimisation robuste. Ce modèle diffère des autres cas d'optimization robuste abordé plus haut par la position des termes incertains du modèle. Pour la résolution, nous nous sommes basés sur la formulation linéaire à 2-niveaux proposé par Michel Minoux.

Cette thèse a été effectuée en partenariat avec la PME 3ROAM (<http://www.3roam.com>) et en collaboration avec différents chercheurs de diverses universités dans le monde. Elle a été co-financée par la région PACA et la PME 3ROAM.

Abstract

The main work of this thesis focuses on the wireless backhaul networks. This type of network has the advantage of allowing rapid and easy deployment at relatively low costs while offering capacity of up to 1Gbps over links of a hundred of kilometers. We studied different optimization problems in such networks that represent real challenges for industrial sector.

The first issue addressed in Chapter 3 focuses on the capacity allocation on the links at minimum cost. It was solved by a linear programming approach with column generation. Our method solves the problems on large size networks. In addition, we quickly obtain very good quality solutions.

We then studied the problem of network infrastructure sharing between virtual operators. The objective is to maximize the revenue of the operator of the physical infrastructure while satisfying the demands (constraints of quality of service) of virtual operators customers of the network. In this context, we proposed a model to the problem using mixed integer linear programming. Our formulation is robust to changes in traffic demands of virtual operators.

Another operational expenditure in this type of network is the energy consumption. Many operators are now seeking to reduce network energy consumption, both by using more efficient equipments and by using more appropriate routing solutions. We proposed a robust energy-aware routing solution for the network. The proposed model is based on backbone networks, but it can easily be adapted to wireless backhaul networks. Our solution was formulated using a mixed integer linear program. We also proposed heuristics to find efficient solutions for large networks.

The last work of this thesis focuses on cognitive radio networks and more specifically on the problem of bandwidth sharing. We formalized it using a linear program with a different approach to robust optimization. This model differs from other cases of robust optimization discussed above by the position of the uncertain terms in the model. We based our solution on the 2-stage linear robust formulation proposed by Michel Minoux.

This thesis was carried out in partnership with the SME 3ROAM (<http://www.3roam.com>) and in collaboration with various researchers from different universities in the world. It was co-funded by the PACA province and the SME 3ROAM.

Contents

1	Introduction	1
1.1	Motivation and Context	1
1.2	Broadband Wireless Access technologies	4
1.3	Dimensioning and dynamic routing in Backhaul Networks	7
1.4	Routing real fluctuated traffic in microwave wireless networks	8
1.5	Energy saving	8
1.6	Tools and Techniques	9
1.7	Thesis Organization and Contributions	10
1.8	List of publications	11
2	Preliminaries	13
2.1	Linear Programming	13
2.2	Column generation	15
2.3	Robust optimization	16
2.3.1	Γ -robustness	17
2.3.2	2-stage Robust LP with RHS uncertainty	18
2.4	Introduction to the Optimization Programming Language, OPL	19
3	Dimensioning of Microwave Wireless Networks	23
3.1	Introduction	24
3.2	Related Work	25
3.2.1	Literature Review	25
3.2.2	Budget Constrained Optimization Model	25
3.3	Network Model	27
3.3.1	Definitions and Assumptions	28
3.3.2	Problem formulation	28
3.3.3	An Illustrative Example	30
3.4	Solution of the Model	31
3.4.1	The Random Column Enumeration (RCE) heuristic	34
3.4.2	The Modified Column Generation (MCG) heuristic	35
3.4.3	Initial Solution of the RMP	36
3.5	Numerical Results	37
3.5.1	Resolution process	38
3.5.2	Solution quality	38
3.5.3	Validation of the Results: Comparison with those of [CKCN14]	40
3.6	Conclusion	40

4	Infrastructure sharing	43
4.1	Introduction	43
4.2	Problem definition and nominal formulation	46
4.2.1	Problem situation	46
4.2.2	Static model formulation	46
4.3	Robust model	48
4.4	Computational results	50
4.4.1	Computation settings and test instances	50
4.4.2	Results and discussion	51
4.5	Model limits	56
4.6	Heuristics	57
4.6.1	Powerset method	57
4.6.2	Nominal-based method	57
4.6.3	Greedy method	59
4.6.4	Heuristics performance	59
4.7	Conclusion	62
5	Energy-aware Routing in Backbone Networks	63
5.1	Context and motivation	64
5.2	Related Works	66
5.2.1	Energy-aware Routing (EAR)	66
5.2.2	Redundancy Elimination	68
5.2.3	GreenRE - Energy Savings with Redundancy Elimination	69
5.3	Robust-GreenRE Model	72
5.3.1	Compact formulation	75
5.3.2	Constraint generation (Exact Algorithm)	76
5.3.3	Heuristic Algorithm	78
5.4	Computational Evaluation	80
5.4.1	Test instances and Experimental settings	80
5.4.2	Results and Discussion	81
5.5	Conclusion	89
6	Conclusion	91
A	Optimization in Cognitive Radio Networks	93
A.1	Cognitive Radio Networks	94
A.2	Related works and problem definition	95
A.3	Nominal model	98
A.4	Robust model	99
A.5	Conclusion	103
B	Résumé des Travaux de thèse	105
B.1	Contexte et motivation	105
B.2	Les technologies d'accès à haut débit	108

B.3 Dimensionnement et routage dynamique dans les réseaux de collecte à micro ondes	112
B.4 Routage des requêtes de volumes variables dans les réseaux de collecte à micro ondes	113
B.5 Les économies d'énergie	114
B.6 Nos contributions	115
B.7 Liste des publications	121
B.8 Conclusion	121
Bibliography	123

List of Figures

1.1	Example of Wireless backhaul network	2
1.2	Global microwave market [HR09]	3
1.3	Forecast backhaul connections in Europe [Obs10]	4
1.4	Microwave link components	6
2.1	Column generation algorithm flowchart	17
2.2	OPL program of Example 2.1.1	22
3.1	Column Generation Process	32
3.2	MCG Process	36
3.3	Cost saving vs. the worst case	39
3.4	Reliability vs. the worst case	39
4.1	Example of fixed broadband wireless network	44
4.2	Traffic demands in Abilene network [KKR13]	49
4.3	Evolution of the revenue (4.3a), number of satisfied VNOs (4.3b), and total number of satisfied demands (4.3c) as a function of Γ	52
4.4	Repartition of satisfied demands per VNO when Γ increases for Abilene, Atlanta, and Polska.	53
4.5	Repartition of satisfied demand per VNO for Dfn.	53
4.6	Evolution of the revenue (4.6a) and number of satisfied demands (4.6b) on Dfn instance for different values of β and Γ	54
4.7	Dfn instance with three VNOs such that $ D_1 = 65 = R_1$, $ D_2 = 25 = R_2$, and $ D_3 = 20 = R_3$	55
4.8	Resolution performance comparison with $\Gamma = 5$	61
4.9	Resolution performance comparison with $\Gamma = 7$	62
5.1	Energy profiles	66
5.2	Example of Shortest Path Routing (SPR) vs. Energy-aware Routing (EAR)	67
5.3	Reduction of end-to-end link load using WOC	68
5.4	GreenRE with 50% of traffic redundancy	69
5.5	Example of robustness	72
5.6	Diagram of constraint generation method	76
5.7	Example of iterations of the CG method	78
5.8	Routing and RE-router placement on Abilene network	81
5.9	Upper bound and lower bound: <i>Compact Formulation (CF)</i> vs. <i>Constraint Generation (CG)</i>	83
5.10	Optimality gaps: <i>Compact Formulation (CF)</i> vs. <i>Constraint Generation (CG)</i>	84

5.11	Comparison of proposed methods on Abilene.	85
5.12	Energy savings vs. robustness for Abilene, Geant and Germany50 network	86
5.13	CDF load of all links including links in sleep mode for Abilene, Geant and Germany50 networks.	88
5.14	Robust-GreenRE vs. GreenRE vs. EAR.	89
A.1	Cognitive radio Network architecture [ALVM06]	95
A.2	A CRN instance	97
A.3	Constraint generation process	103
B.1	Exemple d'un réseau de collecte sans fil	106
B.2	Marché globale des liaisons à micro ondes [HR09]	107
B.3	Evolution et prévisions du nombre de liaisons des réseaux de collecte en Europe [Obs10]	108
B.4	Composants d'un lien à micro ondes	111
B.5	Le processus d'exécution du MCG	117
B.6	Gain énergétique vs. robustesse pour Abilene, Geant et Germany50 network	120
B.7	Robust-GreenRE vs. GreenRE vs. EAR.	120

List of Tables

3.1	Modulation discrete probability distributions	31
3.2	Configurations for $z_{\ell_1, b_1} = z_{\ell_2, b_1} = z_{\ell_3, b_1} = 1$	31
3.3	Modulation schemes and Bandwidth efficiency	37
3.4	CG Results	38
3.5	Resolution time (minutes)	40
4.1	Test instances settings	51
4.2	Dfn results in function of Γ	55
4.3	Resolution time in seconds as function of Γ	56
5.1	Demands and redundancy rates variation	73
5.2	9 cases of the robustness	73
5.3	Constraint Generation (CG) vs. Compact Formulation (CF) vs. Heuristic for Abilene network.	82

Introduction

Contents

1.1	Motivation and Context	1
1.2	Broadband Wireless Access technologies	4
1.3	Dimensioning and dynamic routing in Backhaul Networks	7
1.4	Routing real fluctuated traffic in microwave wireless networks	8
1.5	Energy saving	8
1.6	Tools and Techniques	9
1.7	Thesis Organization and Contributions	10
1.8	List of publications	11

As the use of broadband services via mobile internet devices such as smartphones continues to grow, network operators have to regularly upgrade their network capacity to meet customers expectations. Among the available technologies, microwave appears as a cost-effective transmission solution for extending the network coverage and for providing bandwidth-intensive services to customers located in remote areas. In this thesis, we study multiple optimization problems related to the cost-effectiveness of fixed microwave backhaul networks. The backhaul network can be defined as the portion of the network infrastructure that provides interconnection between the base station and the core network (see Fig. 1.1). In this chapter we first motivate the context of our work and then present the available broadband wireless technologies. Finally, we briefly define the problems we studied, we introduce the methodologies used to solve them and we conclude this chapter by presenting our contributions and the thesis organisation.

1.1 Motivation and Context

The advent of broadband services (high definition TV, Voice over IP, Video On Demand) has generated a rapid growth in data traffic, and consequently the need for higher data bandwidth. Due to this growth, "Backhauling" that means "getting data to the backbone", has become a central challenge for network operators. Not only do the operators need to improve customers experience, but they also have to generate sufficient revenues with regard to their capital and operational expenditures. To solve this problem, operators have to install infrastructures that improve

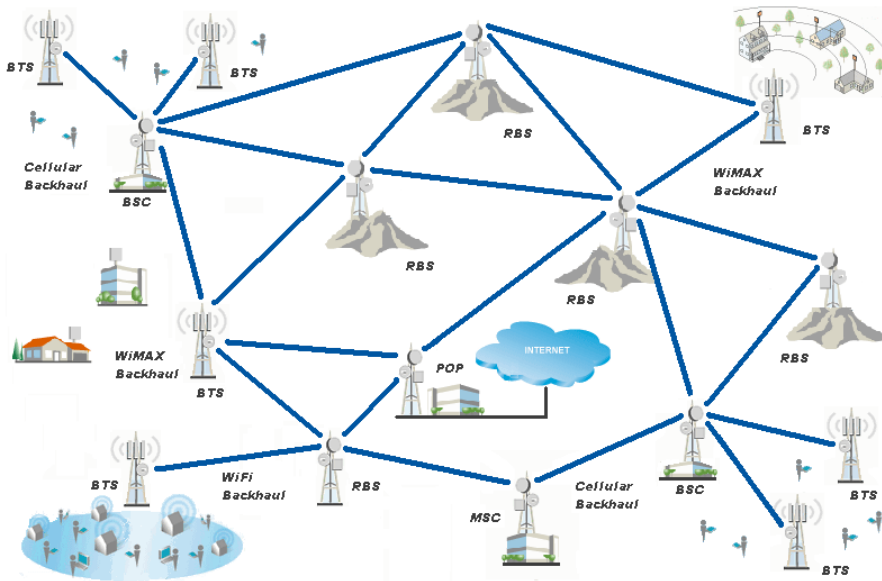

Figure 1.1: Example of Wireless backhaul network

their network capacity while using cost efficient technologies. Looking to the backhaul options, operators have the choice among several transmission technologies for building a backhaul network: the copper, the optical fiber and the microwave.

Copper cable is the traditional medium used for backhaul networks. It is the most widely deployed technology in telecommunication networks for historical reasons, and because it offered at the beginning enough bandwidth for a voice signal transmission. Nowadays, it can carry up to 100Mbps, but over half a kilometer only. However the current broadband technologies require from eight to sixteen times more capacity than the one offered by the basic unit of copper cable used in GSM. Moreover the price of copper increases linearly with capacity. As a consequence, it is not a cost efficient choice for backhaul network [TZJ11].

Optical fiber is the second well known transmission technology used to deploy backhaul network. Fiber links are being installed and used increasingly during the last decade because of the very high capacity they offered compared to the copper. The optical technology is already offering Tb/s over hundreds of kilometers while some research work succeed to reach 1Pbps over 50km [Pea13]. However, the cost for deploying an optical fiber backhaul network is so high that operators are reluctant to invest in it for reaching remote areas with few inhabitants. Indeed, the return on investment for operators is low (if not null). The deployment cost is even higher when the geographical access conditions are difficult (mountains, forests, deserts, swamps, jungles...).

The last medium which is the object of this thesis is the microwave technology. This technology is a cost effective alternative to optical fiber when there is a need to provide high speed data connection in remote locations. Indeed, the capital expenditure needed to install one link is around €20.000, all devices and man-power

included. The operational cost varies from one country to another. For instance, the cost for renting the frequency and the bandwidth for establishing one link in France ranges between €1.000 and €5.000 per year. This technology enables the deployment of point-to-point communication links (with clear line-of-sight) with a bit rate of up to 1Gbps between sites at distance up to 100km. It is therefore a very good choice for reaching remote locations, and so extending the coverage of a network operator.

Beside, it is forecast that the global mobile and wireless backhaul market will grow from \$13.11 billion in 2013 to \$23.3 billion by 2018 [mar13]. This fast growth is driven by the vast deployment of the LTE networks all over the world. In particular, the highest increase of the market is expected in south America and in emerging countries. The microwave backhaul network appears as the best solution for the latter mainly because of its cost-effectiveness. Fig. 1.2 represents the global repartition of the transmission technologies in telecommunication market in 2009 and Fig. 1.3 shows the forecast, done in 2010, of microwave backhaul connection in Europe for the next five years.

Though this technology is highly attractive for network manufacturers and operators, it received very little attention from the research domain. As previous research work, Napoleao Nepomuceno addressed, in [Nep10], some optimization issues related to point-to-point microwave backhauls. Also authors in [HGZD12] and in [HEOL13] presented respectively the challenges of a multi-gigabit wireless backhaul system and the new challenges for backhaul when the line of sight, needed for point-to-point, does not exist.

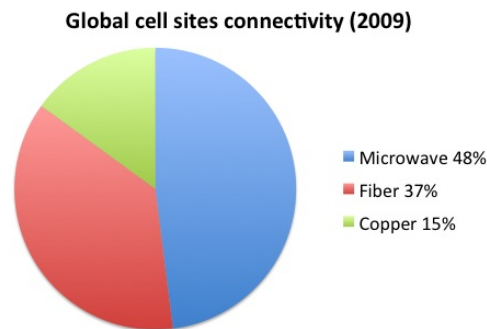

Figure 1.2: Global microwave market [HR09]

All these previous reasons represented the motivation of our studies during this thesis. We tried, from a mathematical research point of view, to answer some interesting optimization problems that occur in this kind of network. We were mainly driven by cost optimization in wireless microwave networks. We firstly considered the minimum cost design of this network while routing dynamically all the demands with a high network reliability. We also investigated on different strategies to make the backhaul network cost-effective and even profitable in terms of revenue. All of these issues were solved using linear programming methods that are explained in

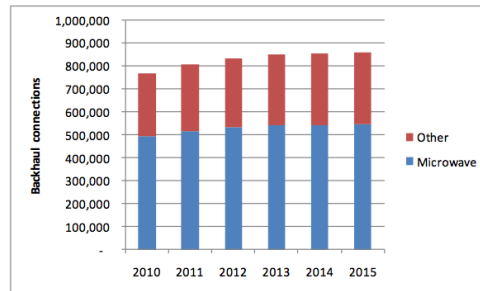

Figure 1.3: Forecast backhaul connections in Europe [Obs10]

the next chapter.

1.2 Broadband Wireless Access technologies

Since the launch of mobile networks and the popularization of the Internet through the World Wide Web application, consumers' habits have changed drastically from the unique use of voice services to the intensive utilization of data oriented services such as VoIP, real time-video and online-gaming among others. This has led to a rapid development of fixed broadband access technologies such as DSL (Digital Subscriber Line) and T1/E1 services, commonly used to access the Internet from residential and offices location in urban areas. However there is still a need for delivering these bandwidth-consuming services to the increasing number of mobile users, wherever they are located.

The aim of the emerging wireless data networks is to provide ubiquitous broadband access and wireless service, comparable to that of wireline networks, to wireless users. According to their coverage areas, wireless data networks can be categorized either as a Wireless Local Area Network (WLAN), a Wireless Metropolitan Area Network (WMAN) or as a Wireless Wide Area Network (WWAN).

WLANs with their coverage area of a few hundred meters are mostly used in home and office environment. They are commonly used through Access Point (AP) to which stations are connected in a point-to-multipoint (PMP) manner and can offer data rates up to 100Mb/s with 802.11n [VN10]. The most notable of WLANs is the IEEE802.11-Wifi family but we can also distinguish the HiperLAN [Joh99, DAB⁺02]. Finally we have to notice that there exists also a decentralized working mode of WLAN where all stations can talk to each others in an adhoc mode.

WMANs are wireless networks that enable users to establish wireless connections between multiple locations within a metropolitan area. Consequently, their coverage area is approximately the size of a city. Different technologies have been developed in the context of WMANs. The most known are IEEE801.16-WiMax family, Hiper ACCES and HiperMAN. They provide broadband con-

nectivity to fixed, LOS (Line Of Sight), NLOS (Non-LOS) but also mobile subscribers. They are based on cells covered using Base Station (BS) to which Subscriber Stations (SS), that can be buildings or vehicles, are connected. A mesh topology mode is also supported by WMANs. WiMax helps to provide an aggregate data raw rate of up to 135Mb/s based on the modulation used in LOS communication, while up to 75Mb/s is offered in NLOS communication, and HiperMAN can support up to 25Mb/s for each sector of an AP. More technical details about these technologies are available in [KT07].

WWANs are commonly used to connect multiple WMANs located in physically distant areas. They mainly consist in satellite systems used principally in the downlink way. Another WWAN technology developed is the IEEE802.20 known as the Mobile Broadband Wireless Network (MBWA). The main goal of MBWA is to provide broadband access to highly mobile devices moving at a speed of up to 250km/h [BXG07] (in a car, a train, etc.).

Data from/to multiple WLANs can be aggregated and transmitted over a WMAN to the Internet and WWAN can help to interconnect different WMANs covering different areas. Beside these previous technologies, mobile technologies such as 3G (UMTS, HSPA, CDMA200, EV-DO) and 4G (LTE, LTE-Advanced) systems are also considered as broadband wireless access networks since they are nowadays providing high mobile data rates for their customers. They offer peak data rates up to 14,4 Mb/s to mobile devices. All of these technologies are transmitting data through the air using radio frequencies (RF). In the context of our research, we focused on the WMANs. More precisely, we studied problems related to a WMAN subnetwork that uses point-to-point (PtP) microwaves links to connect Base Stations (BSs) together and to route data traffic through the Internet or the backbone network.

A single one-way microwave link between two stations located at fixed points includes four major elements: a transmitter, a receiver, transmission lines and antennas (see Fig. 1.4). The transmitter produces the microwave signal that carries the information to be communicated. It generates the microwave energy using the appropriate frequency and power, and modulates it with the input signal. From the transmitter, the signal is sent to the antenna through the transmission line. This latter is also in charge, at the receiving end of the microwave link, of transmitting the signal from the antenna to the receiver. At microwave frequencies, coaxial cables and especially waveguides are the most frequently transmission lines used by engineers. The last elements of a microwave radio system are the antennas that are highly directional. On the transmitting end, the antenna emits the microwave signal from the transmission line into free space. At the receiver site, an antenna pointed toward the transmitting station collects the signal energy and feeds it into the transmission line for processing by the receiver. The microwave antennas characteristic of concentrating the received signal allows communication over long distances using small amounts of power. Finally, the receiver extracts information from the signal by demodulation [IG]. Transmitter and receiver components are usually referred to

as indoor unit (IDU) while the antenna is the outdoor unit (ODU). Nowadays, IDUs functions have evolved such that in addition to packet forwarding, packet routing is also possible.

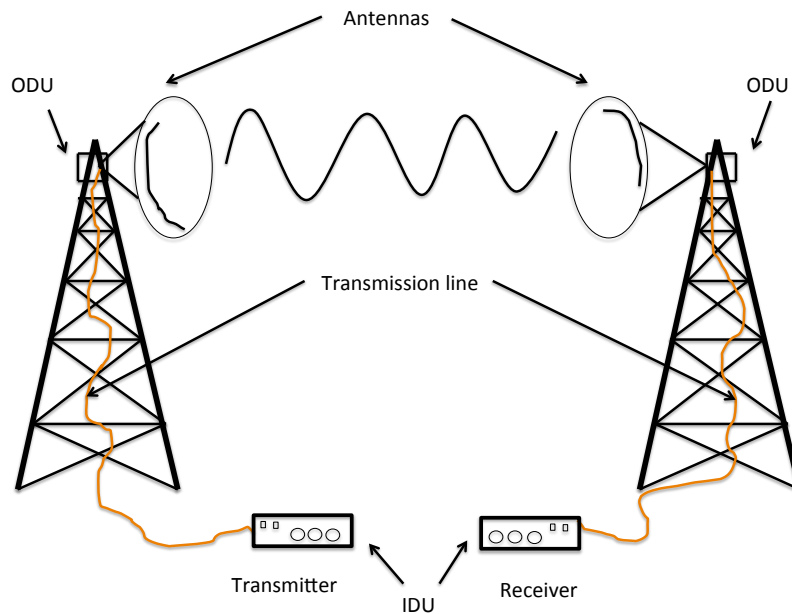

Figure 1.4: Microwave link components

Most of the commercially used terrestrial microwave PtP systems use frequencies from approximately 2 GHz to 60 GHz with maximum hop length of around 200km [Leh10]. Microwave PtP links operate either in licensed or unlicensed frequency bands. However unlicensed bands, because they are accessible to everyone, have the drawbacks of high interference probability and less data security that made the licensed bands the most used by network operators. Licensed microwave link frequencies used for wireless backhaul in a PtP wireless backhaul operate at the 6 GHz, 11 GHz, 18 GHz and 23 GHz bands. The reader is referred to [Nep10] for more details about requirements for the link power budget of a PtP microwave link and the adaptive modulation it is subject to.

Although the multiple advantages of microwave backhaul networks and their cost-effectiveness, PtP microwave transmissions are affected by external factors such as excessive rains, thunderstorms, high winds, earthing and selective fading among others. This, in addition to the renewal cost of the frequency licenses and bandwidths make the minimum cost design of a wireless backhaul network a difficult optimization problem. This is the first we address in this thesis.

In order to reduce the operational expenditures of such a network, we also studied a minimum cost power consumption problem using an energy aware routing (EAR) approach. In addition, we worked on a multi-operators microwave backhaul network, with the objective of maximizing the revenue of the network infrastructure owner

with respect to the demand satisfaction constraints. In this problem, we considered traffic volumes that vary in time and different quality of service (QoS) policy for each network operator. These different problems are properly explained in the next sections.

1.3 Dimensioning and dynamic routing in Backhaul Networks

For any network operator or service provider, the main goal is to maximize its revenue while ensuring the satisfaction of its customers. In the context of telecommunication networks, in order to meet the needs of clients and offer them a good quality of experience, one of the key elements is to have a network with sufficient capacity on its links. Network operators should thus design their networks such that enough capacities are available on links to serve all clients needs anywhere and at anytime. For microwave backhaul network, this requirement has a central place since the base stations traffic needs have to be fully met. Otherwise the data that have to be transported will either be delayed or lost. The capacity allocation on microwave network links is closely related to the efficient utilisation of the radio frequency spectrum resource. However this resource is limited and regulated, and thus expensive. The challenge here is then to cost-efficiently provide sufficient capacity in order to meet customer satisfaction. From a technical point of view, to determine the capacity of a microwave link, we need to know the channel bandwidth B and the modulation scheme m -QAM used to transmit data, with QAM standing for Quadratic Adaptive Modulation. We use the following formula to calculate the capacity:

$$\text{Capacity}[bps] = n.B[Hz] \quad \text{where } n = \log_2 m$$

While the modulation scheme used in microwave radio systems is based on the adaptive modulation system, the bandwidth assignment on each link is a network engineer's decision. In fact, the adaptive modulation system refers to the automatic modulation adjustment that a wireless system can make to prevent some weather-related fading. It has been developed mainly to help the radio network to adapt itself in bad transmission context in order to meet the bit error rate (BER) requirements. To reduce the total cost of bandwidths license renewal fees on the whole network, there is a difficult optimization problem to be solved by the engineer at the network planning step. The main constraint of this problem is to satisfy all the traffic demands. This constraint corresponds to the satisfaction of the well-known multi-commodities flow (MCF) problem [GCF99, Tom66, BCGT98]. The MCF problem consists in routing commodities (here data traffic) from their sources to their sinks through a given network with respect to the capacity of the links. The minimum cost bandwidth assignment problem, with the constraint of high network reliability, was studied by Napoleão Nepomuceno in his thesis [Nep10] using a chance-constrained programming method.

Unlike the work of Nepomuceno, in this thesis we solved this problem when considering a dynamic routing of demands. This differs from the previous work in the static data routing they have adopted. We also modeled the problem such that the solution is scalable and applicable to large networks (hundreds of links). This work, done in collaboration with David Coudert, Brigitte Jaumard (Concordia University, Canada), Mejdî Kaddour (Oran University, Algeria) and Napoleão Nepomuceno (Fortaleza University, Brazil), involves the utilization of mixed integer linear programs (MILP) through a column generation method as well as a local search algorithm. Chapter 3 is devoted to the resolution of this problem.

1.4 Routing real fluctuated traffic in microwave wireless networks

As pointed out previously, microwave backhaul network represents an attractive solution for telecom operators and wireless Internet service providers to offer high speed data rate to customers living in rural environment. However, it may not be cost-effective for a network operator to fully deploy its own infrastructure, especially when the number of targeted customers is small. An idea to overcome this difficulty is to share the network infrastructure among several network operators aiming at covering the same geographical area. This strategy is also recommended by national telecommunications regulatory authorities for an efficient use of the radio spectrum among multiples operators. In this infrastructure sharing context, with the assumption that the network is already designed, we first investigated the revenue maximization problem for the network infrastructure owner. This objective was subject to the constraint of satisfying the maximum demands for each virtual network operator with respect to their respective QoS policy. We then took in consideration the uncertainty of traffic demands to make the problem as realistic as possible. To tackle this problem, we firstly propose an integer linear program (ILP) and a robust optimization method to handle the uncertainty factor. This problem, solved in collaboration with David Coudert and Christelle Caillouet (University of Nice Sophia Antipolis) is detailed in Chapter 4 of this thesis.

1.5 Energy saving

In the search for cost optimization strategies for backhaul networks, power consumption has been identified as a non-negligible portion of operators operational expenditures (OPEX). In 2011, Tombaz et al have reported in [TMW⁺11], based on [PVD⁺08], that 0,5% of the global energy is consumed by mobile communication and around 80% of the power consumption in the mobile networks stems from the radio access network, namely radio base stations. With the installation of a larger number of base stations required to satisfy the ever-increasing traffic demand, this number is expected to double by 2020. This makes power consumption one of the major issues to address by network operators especially in order to reduce their

OPEX. It is mentioned in the Next Generation Mobile Networks optimised backhaul requirement [All08, requirement R88], that different consumption modes should be available so that backhaul hardware could automatically switch to the one with lowest power consumption. The idea, for backhaul network operators is then to find a solution to adapt their energy consumption to their traffic, in such a way that unused base stations consume as few energy as possible.

The same problem also occurs in the Internet core network. Based on recent studies, the power consumption of Internet's infrastructure is estimated to be between 1.1% and 1.9% of the 16 TW used by the humanity [BAH⁺09, RM11, BHT11, HBF⁺11]. In [TBA⁺08], authors identify that most Internet energy is consumed by access network and routers. They also state that this consumption will increase to over 4% as the access rate increases and that IP routers will be the energy bottleneck of the Internet.

A proposal to limit this energy consumption growth is to use energy aware routing (EAR) [CSB⁺08, CMN09, BCRR12]. So together with Truong Khoa Phan, previously PhD student in the Coati team, we decided to investigate this problem in the context of backbone networks. Our main objective was to minimize the total energy consumption of the network under some specific constraints. Based on Phan's previous works [GMPR12, CKPT13], the problem was first tackled using EAR combined to the so called Redundancy Elimination (RE) technique [AGA⁺08, ZCM11, ZA14]. Then, using the robust optimization method, we extended the formulation introducing some uncertainty on the traffic demand. Linear programs, a heuristic and an exact algorithms were developed to solve this problem. We present this work in Chapter 5 of this manuscript.

Even if EAR and RE are not yet available in microwave backhaul networks, we believe that our models could be adapted and applicable to this kind of networks.

1.6 Tools and Techniques

Throughout this thesis, our approach was first to propose as simple as possible models using linear programming (LP). This results either in simple LP models, or in an Integer Linear Program (ILP) or even in a Mixed Integer Linear Program (MILP). To handle uncertainties, when it is the case, we apply the adequate robust optimization method with necessary modifications. When the model appears to be difficult to solve or non linear, we investigate on the most suitable way to overpass the difficulty, sometimes using column generation, constraint generation, constraint reformulation or heuristic method.

In order to validate the relevance and the quality of our models, we run some experiments with test instances taken from available online libraries such as SNDlib [OWPT10], using a commercial solver, CPLEX [III14]. The models are coded using different languages depending on the model complexity. Python, Java and Optimization Programming Language (OPL) are the most used during our thesis. Based on our simulation results, when the optimal solution appears difficult

to get, we try to propose some alternative approaches such as greedy algorithm or local search method. We finalize the work with a deep analysis of our results.

1.7 Thesis Organization and Contributions

We start this manuscript by defining and explaining the main concepts of the mathematical tools we used to help the readers to understand our mathematical approaches.

In **Chapter 2**, we first give a brief description of linear programming, the subclass method of operation research commonly used in this thesis. We then introduce the readers to the Column Generation method, and how it helps to overpass resolution difficulties when facing big instances. The robust optimization concept, used to handle uncertainties in our models is developed in the next section. We end this chapter by initiating the reader to a programming language, OPL for optimization programming language, that we used to implement most of our models.

Chapter 3 is devoted to the minimum cost bandwidth assignment problem in microwave backhaul networks. The objective is to propose a solution that guarantees a dynamic routing of traffic demand, even under bad channel conditions, and that can also be applied to big instances. The column generation method was used for this purpose. A column generation heuristic combined with a local search approach is used to overcome a non-linear and non convex term in the objective function of our model. Experimental tests on realistic network topologies using our resolution approach highlight a cost saving up to 45%. This work is concluded by a comparative study with the results gotten in [CKCN14].

This study has been done in collaboration with David Coudert, Brigitte Jau-mard (Concordia University, Canada), Mejdî Kaddour (Oran University, Algeria) and Napoleão Nepomuceno (Fortaleza University, Brazil) and the results have been submitted in [KJN⁺14].

In **Chapter 4**, we investigated on maximizing the total income of a physical network operator (PNO) when sharing its infrastructure with multiple virtual operators (VNO) under demand uncertainties and QoS constraints. The Γ -robust approach developed by Bertsimas and Sim [BS04] helped to propose a solution in which the PNO can offer a best effort service to all its customers while maximizing its revenue. Finally, we proposed different heuristics to solve this problem with larger network instances.

The results of this work, done in collaboration with David Coudert and Christelle Caillouet-Molle (University of Nice Sophia-Antipolis, France), have been published in [CCK13, KCCM14].

Chapter 5 concerns an advanced problem of energy consumption. Motivated by the goal to adapt the energy consumption of the network to the quantity and the content of the traffic, we used the GreenRE model proposed by Coudert et al [CKPT13] and extended it by considering uncertainties on traffic volume and compression rate. The robust optimization model developed through a MILP, plus a heuristic, helped us to save from 16% to 28% of energy compared to the classical GreenRE method.

This work has been done in collaboration with David Coudert and Truong Khoa Phan¹ (University of Nice Sophia-Antipolis, France). The results of this chapter lead to the following publications [CKP14a, CKP14b].

Appendix A presents a preliminary work on cognitive radio mesh network. The goal of these networks is the utilization of unused radio spectrum. Unauthorized users, called secondary users, are allowed to transmit on unused frequency carriers even if they are licensed bands. Nonetheless they have to release the channel as soon as a licensed user, called primary user, starts its transmission. We were interested in this technology and more precisely in the spectrum assignment problem under uncertainty on the primary users transmission time. In the LP model we proposed, we tried to maximize the overall throughput of secondary users transmissions using different transmission channels. Unlike the precedent robust models we worked on before, in this case, the uncertainty is on the right-hand side of the LP which forced us to apply the 2-stage robust method proposed by Minoux in [Min07]. Non-linearities of the model are tackled through a constraint generation method. This is an ongoing work that we have to conclude with consistent simulation results.

This work is done in collaboration with Mejdj Kaddour (University of Oran, Algeria).

1.8 List of publications

We list below the publications associated to the research presented in this thesis.

[KJN⁺14] A. Kodjo, B. Jaumard, N. Nepomuceno, M. Kaddour, D. Coudert. *Dimensioning microwave wireless networks*, submitted to IEEE International Conference on Communications (ICC), 2015, UK.

[CKP14a] D. Coudert, A. Kodjo, and T.K. Phan. *Robust Energy-aware Routing with Redundancy Elimination*, 2014 (Research report and Journal in revision).

[CKP14b] D. Coudert, A. Kodjo and T.K. Phan. *Robust Optimization for Energy-aware Routing with Redundancy Elimination* In ALGOTEL 2014, France.

¹now at University College London, UK

- [**KCCM14**] A. Kodjo, D. Coudert and C. Caillouet-Molle. *Optimisation robuste pour le partage de reseaux d'accès micro-ondes entre operateurs* In ROADEF, 2014, France.
- [**CCK13**] C. Caillouet-Molle, D. Coudert and A. Kodjo *Robust optimization in multi-operators microwave backhaul networks*. In IEEE Global Information Infrastructure and Networking Symposium (GIIS) 2013, Italy.

This thesis was supported by SME 3ROAM based in Sophia Antipolis, and the PACA province.

Preliminaries

Contents

2.1	Linear Programming	13
2.2	Column generation	15
2.3	Robust optimization	16
2.3.1	Γ -robustness	17
2.3.2	2-stage Robust LP with RHS uncertainty	18
2.4	Introduction to the Optimization Programming Language, OPL	19

In this chapter, we briefly present the different mathematical methods used as modelisation tools for the problems studied throughout this thesis. We start with a definition of the linear programming method and the presentation of the duality concept. Then, we introduce the column generation algorithm used in Chapter 3 of this thesis. The robust optimization methods used to handle data uncertainty in the problems we studied is also presented. We finally conclude this chapter with an introduction to a mathematical programming language that made the development of ours models easier.

2.1 Linear Programming

Linear Programming (LP) is a fundamental area of mathematical programming. It is concerned with the optimization (maximization or minimization) of a linear function of the form $f(x_1, x_2, \dots, x_n) = c_1x_1 + c_2x_2 + \dots + c_nx_n$, called *objective function*, while satisfying a set of linear equality and/or inequality constraints.

Let $x = (x_1, x_2, \dots, x_n)^T$ be the vector of the decision variables and $c = (c_1, c_2, \dots, c_n)^T$ be the vector of coefficients of the objective function. When using matrix notation, a linear program can therefore be of the form:

$$\begin{aligned}
 \max \quad & \sum_{j \in J} c_j x_j \\
 \text{s.t.} \quad & \sum_{j \in J} A^j x_j \leq b \\
 & x_j \geq 0 \quad \forall j \in J
 \end{aligned} \tag{2.1}$$

where $|J| = n$ and $A \in \mathbb{R}^{m \times n} = \{A^j, j \in J\}$ is the *constraint matrix* in which the element a_{ij} corresponds to the coefficient of the variable x_j in the i^{th} constraint and $b \in \mathbb{R}^m$, called the *right-hand-side vector* represents the maximal requirements to be satisfied. The program constraints defines the *feasible set* corresponding to the set of vectors satisfying all the constraints of the program. A vector x^* is called the *optimal solution* or *optimum* of a LP if it is the one among the feasible set that has the best value of the objective function. Many combinatorial optimization problems are modeled with linear programming. In this thesis, we use linear programming to model optimization problems arising in telecommunication networks. A modelisation using LP of the so-called multicommodity flow (MCF) problem, which is the basis of most of the problems studied in this thesis, is presented in Example 2.1.1.

Example 2.1.1. Let $G = (V, E)$ be a directed graph, where V is the set of nodes, E is the set of edges and each edge $(u, v) \in E$ has a capacity $c(u, v) \geq 0$. Consider also a set $D = \{d_i = (s_i, t_i), i = 1 \dots k\}$ of k demands where s_i and t_i are respectively the demand source and destination. The objective of this MCF is to find the flows that maximize the network throughput while satisfying the *capacity constraints*. This problem is modeled as follows:

LP

$$\text{Maximize } \sum_{i=1 \dots k} \sum_{w \in V} f_i(s_i, w)$$

subject to:

$$\begin{aligned} \sum_{v \in V} f_i(u, v) &= \sum_{w \in V} f_i(w, u) && \forall u \in V - \{s_i, t_i\}, \forall i = 1 \dots k \\ \sum_{w \in V} f_i(w, t_i) &= \sum_{v \in V} f_i(s_i, v) && \forall i = 1 \dots k \\ \sum_{i=1 \dots k} f_i(u, v) &\leq c(u, v) && \forall (u, v) \in E \\ f_i(u, v) &\geq 0 && \forall (u, v) \in E, \forall i = 1 \dots k \end{aligned}$$

The first two constraints are usually referred to as *flow conservation constraints* while the last constraint represents the capacity constraints. We talk about Integer Linear Program (ILP) when all variables are integral and about Mixed Integer Linear Program (MILP) when only some of the variables have to be integral.

One important property of linear programming is the notion of **duality**. To any linear program of the form presented in Model (2.1), called *primal*, is associated another linear program, called *dual* of the following form:

$$\begin{aligned} \min \quad & b^T y \\ \text{s.t.} \quad & A^T y \geq c \\ & y \in \mathbb{R}^{+m} \end{aligned} \tag{2.2}$$

with the same vectors c and b and the same matrix A . $y = (y_1, y_2, \dots, y_m)$ is the vector of the dual variables where each variable y_i is associated to the i^{th} constraint of the primal model. Notice that the dual of the dual is the primal and that when the primal has n variables and m constraints, its dual has m variables and n constraints. Let x and y be feasible solutions of respectively the primal and the dual. Then:

$$b^T y = y^T b \geq y^T (Ax) = (y^T A)x = (A^T y)x \geq cx \quad (2.3)$$

This relation between the primal and the dual, called the ***weak duality theorem***, shows that the objective value of any feasible solution of a dual is an upper bound of the any feasible solution of the primal and consequently an upper bound of the optimal solution of the primal. This is useful for estimating the gap between a feasible solution and the optimum when feasible solutions are available but finding the optimal one is too hard.

Furthermore, it has been proved through the ***strong duality theorem***, that if the primal has an optimal solution x^* , then the optimal solution y^* of the dual is such that

$$c^T x^* = b^T y^*$$

This relation is very important when solving some LP models. In Chapter 3 of this thesis, we use the dual values to express the reduced cost of variables, when applying the column generation method presented in the next section. When dealing with robust optimization method in Chapters 4 and 5, we use the strong duality theorem. This allows us to express our optimization problem in a compact formulation that is easier to solve than the original primal model.

2.2 Column generation

Column generation refers to linear programming (LP) algorithms designed to solve large-scale problems in which there are a huge number of variables compared to the number of constraints. In general, these linear programs are too large to consider all the variables explicitly. It is known that only a tiny fraction of the variables is needed to prove optimality. So the goal of column generation is to find the optimal solution of the problem without enumerating all variables, but by generating only the variables which have the potential to improve the objective function. To achieve that, the problem to be solved (the *master problem*, MP) is split into two sub-problems: the *restricted master problem* (RMP) and the *pricing problem* (PP).

Let us consider the MP of the form of the Model (2.1) and let $J' \subseteq J$ be a subset of indices in J . The RMP is the master problem in which we consider only the variables with indices in J' . Notice that when all the variables needed to find the optimal solution of the MP will be generated and available in the RMP, then the RMP optimal solution will be the MP optimal solution. The PP is a new problem created to generate the variables that can improve the MP objective function. The column generation algorithm consists in solving iteratively the RMP followed by

the PP until no more variable that can improve the RMP current solution can be generated by the PP.

The pricing problem is particular since its objective function has the following form:

$$r_{j^*} = \text{Maximize}\{c_j - y^* A^j \mid j \in J\}$$

where y^* is the dual optimal solution of the RMP. The pricing objective function is referred to as *the reduced cost*. When the MP is a minimization function, the pricing objective is to be minimized too. Depending on the value of r_{j^*} , two situations are possible:

- If $r_{j^*} \geq 0$ (resp. $r_{j^*} \leq 0$ in the minimization case), then the variable x_{j^*} is added to J' and its coefficients (c_{j^*}, A^{j^*}) to the RMP.
- If $r_{j^*} < 0$ (resp. $r_{j^*} > 0$ in the minimization case), it means that there is no more variable that can improve the RMP objective value. So the optimal solution of the MP is found by solving the RMP.

If a new variable is added to the RMP, then the RMP is solved to optimality, its dual values are derivated to solve the new pricing problem and the process continues until no more variable is generated.

When the MP is a MILP, the column generation algorithm is run firstly with a relaxation of the RMP until no more variable can be generated by the PP. Then based, on the generated variables, the integer version of the RMP is resolved. The flowchart of this column generation algorithm is presented in Fig. 2.1.

The effectiveness and the performance of the column generation method is very dependent on the way to generate the columns. Indeed the pricing problems of many real life problems, when column generation is applied, are often NP-Hard. An example of this case is presented in Chapter 3 where the pricing objective function is non-linear. We overcome this difficulty by generating the variables through an heuristic algorithm. Other methods are available in the litterature to solve the pricing model. The reader is referred to [DL05, DDS05, Van05] for more details about this method.

2.3 Robust optimization

In general, when we define a linear program, like the one presented in Model (2.1), we consider all the input parameters (c, A and b) as exact known values. However in pratice, for many problems, the values of these parameters are uncertain. Robust optimization is the field of optimization theory that deals with optimization problems in which data uncertainty is considered for some input data. This uncertainty can be expressed in terms of probability distribution, like in stochastic programming, but in robust linear programming there is an uncertainty set, $\mathcal{U} \subseteq \mathbb{R}^n \times \mathbb{R}^{m \times n} \times \mathbb{R}^m$, that contains all possible values for the data (c, A, b) . In

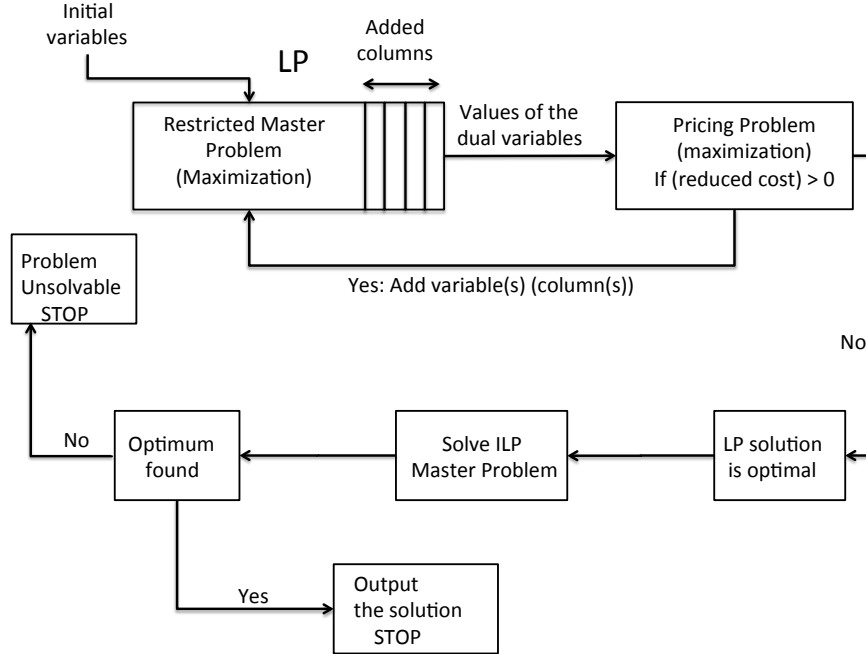

Figure 2.1: Column generation algorithm flowchart

the literature, different uncertainty sets have been considered when solving robust problems. For example, ellipsoidal uncertainty set and an uncertainty set modeled as a polyhedron have been respectively considered in [BTEGN09, AYP11]. Many more or less conservative approaches have also been developed to solve linear robust models [Soy73, EGOL98, BTN00, BTN02, BS03, Min07]. In this thesis, we are interested in Γ -robustness and in the 2-stage robust LP.

2.3.1 Γ -robustness

Γ -robustness is the subfield of linear robust optimization domain which considers that the parameters (c, b) , as presented in Model (2.1), are certain while the elements of the vectors A^j are uncertain. Assume the i^{th} constraint of this model expressed in inequation (2.4).

$$\sum_{j \in J} a_{ij} x_j \leq b_i \quad (2.4)$$

a_{ij} is here considered as a random variable taking values in the interval $[\bar{a}_{ij} - \hat{a}_{ij}, \bar{a}_{ij} + \hat{a}_{ij}]$ with \bar{a}_{ij} being its average (or nominal) value and \hat{a}_{ij} its maximum deviation. The Γ -robustness approach has been proposed by Bertsimas and Sim in [BS04]. They take the advantage of a particular uncertainty set to provide a less conservative robust formulation compared to others robust models proposed in the literature [Soy73, EGOL98, BTN00, BTN02]. They considered that it is unlikely that all a_{ij} fluctuate and reach their peak values simultaneously, in contrary to Soyster

in [Soy73] that considered the same uncertain interval but proposed a model for the case where all a_{ij} have a value equal to $\bar{a}_{ij} + \hat{a}_{ij}$. For that, they defined a real parameter $0 \leq \Gamma \leq |J|$ that represents the robustness level considered. Thus the Γ -robust solution stays optimal for all the cases where up to Γ of the uncertain coefficients are allowed to change. For the sake of simplicity, we consider here Γ as an integer value. The objective of Γ -robustness is to find the optimal solution x when Γ many (but arbitrary) coefficients deviate from their nominal values. Under this assumption, Constraint (2.4) is replaced by:

$$\sum_{j \in J} \bar{a}_{ij} x_j + \max_{\{S | S \subseteq J, |S| = \Gamma\}} \sum_{j \in S} \hat{a}_{ij} x_j \leq b_i \quad (2.5)$$

where $\delta(x, \Gamma) = \max_{\{S | S \subseteq J, |S| = \Gamma\}} \sum_{j \in S} \hat{a}_{ij} x_j$ is the maximum deviation that can be introduced in the constraint by at most Γ coefficients fluctuating simultaneously. Moreover, it has been proved by Bertsimas and Sim that given an arbitrary realisation, the probability that constraint (2.5) is violated is about $1 - \Phi(\frac{\Gamma-1}{\sqrt{p}})$, where Φ is the cumulative distribution function of a standard normal and p is the number of uncertain coefficients. With this model of uncertainty, Bertsimas and Sim show that finding an optimal Γ -robust solution can be reduced to solving an ordinary linear program only moderately increased in size, thus opening the way to large scale applications.

Γ -robustness is used in Chapters 4 and 5 of this thesis to model some traffic uncertainty considered in our problems. With this technique, we were able to formulate the robust counterpart of the studied problems as linear programs. This method, applied in multiple network optimization problems in the literature [KKR11, CKPT13, CKS13], has the main advantage to offer a good trade-off between the level of robustness and the cost of the solution. However this formulation is not satisfying when the uncertainty is on the Right-hand-side (RHS) of the LP. Indeed, when the objective is uncertain, Γ -robustness can be applied by transforming the objective into a constraint. Therefore, Minoux proposes a method to handle this RHS uncertainty that is more natural in certain situations [Min07, Min11]. We present it in the next section.

2.3.2 2-stage Robust LP with RHS uncertainty

RHS uncertainty in LP is a particular subclass of *columnwise* uncertainty model, unlike the "rowwise" when coefficients of a row are uncertain (Γ -robustness case). A first natural idea to handle such problems is to use the LP duality to reformulate them as robust LPs with uncertainty on the objective. Minoux [Min07] shows in this restrictive case that the objective of the robust counterpart of a dual problem is totally different from the one of the dual of a robust model. So one can not use standard duality theory to convert a columnwise uncertain linear program into a rowwise uncertain linear program while preserving equivalence.

Also, Minoux proposed a model to handle the 2-stage robust LP problem with RHS uncertainty [Min11]. They are problems or applications in which the process of

decision-making under uncertainty can be decomposed in two successive steps. The first stage concerns the decisions to be made before knowing anything about which realization of uncertainty will arise while the second stage is related to the decision taken after realization of uncertainty. The choice of these models was made because they can produce less conservative solutions as compared with single-stage robust LP models with RHS uncertainty. Model (2.6) represents the general form of these problems.

$$\begin{aligned} \max \quad & c^T y \\ \text{s.t.} \quad & A_1 y + A_2 z \leq b \\ & y, z \geq 0 \end{aligned} \tag{2.6}$$

with b taking value in the uncertainty set B . y and z are respectively the first and second stage variables. y is a feasible solution for the robust model when it belongs to the set $Y = \{y | y \geq 0 \text{ and } \forall b \in \mathcal{B}, \exists z \geq 0 : A_2 z \leq b - A_1 y\}$ and the optimal solution corresponds to

$$\max_{y \in Y} c^T y$$

Based on Farka's Lemma [DJ14], the author derives a large scale LP model for the robust model. However a direct resolution of this model can be very difficult due to its tremendous number of constraints. A proposed way to overcome this difficulty is to apply the constraint generation method using a specific nonconvex separation problem. It has been proved that these problems are generally NP-Hard but polynomial algorithms can be found for some applications.

This method has been applied to the cognitive network problem studied in the Appendix of this thesis. We detail there the methodology to obtain the large scale LP of the robust model and also to define the specific separation problem adapted to our application.

2.4 Introduction to the Optimization Programming Language, OPL

Once an optimization problem is modeled as a linear program, it remains to use it for solving different problems instances. It is also important to compare the performances of the proposed model with other formulations, if any. This is useful for identifying the advantages and the drawbacks of the formulation and eventually propose improvements. To do so, we use various programming languages to implement (and solve) the mathematical model using some optimization solvers.

In the context of this thesis, different programming languages have been used, depending on the model complexity: Python, Java and Optimization Programming Language (OPL). Python and Java are well-known programming languages so we

will not present them here. OPL¹ is a high-level optimization language currently developed by IBM to ease mathematical programming. For instance, it facilitates the implementation and test of linear programs using column generations. In the following, we give a brief overview of the OPL language.

OPL, is a modeling language for mathematical programming and combinatorial optimization problems modeled using LP, ILP, MILP or Constraint Programming (CP). It has originally been developed by Pascal van Hentenryck. Like others modeling languages such as AMPL [FGK93] and GAMS [BM04], OPL allows the user to code mathematical models with a syntax similar to their algebraic notation. This allows for a very concise and readable definition of problems in the domain of optimization. Among its features, it proposes some new concepts for scheduling and resource allocation problems. It also allows to import data from databases or Excel spreadsheets.

An OPL program consists of three (3) main sections:

1. Declaration of the constants and decision variables. This section is concerned with the elements that compose the model. For each input of the problem, the user specifies its type and its value. OPL supports 2 data types, the basic ones (integer, float, string, boolean) and the data collections (set, tuple, array, range). These *constants* can be initialized directly in the model file (.mod) or in a specific data file (.dat). Initializing the data in a separate file has the advantage that it can be different for various problem instances. Concerning the problem variables, the user defines their types and the domain of their values. The decision variables are declared using the keyword *dvar*. Strictly positive variables are declared using one of the data types *int⁺* and *float⁺*. However variables in OPL can be of different types such as arrays.
2. Expression of the optimization model (objective function and constraints). The maximization or minimization objective is described and the user expresses the constraints that must be fulfilled for a solution to be feasible. The model is specified using
maximize ... subject to.
Though when no optimization is need, the set of constraints is specified using the keyword *solve*.
3. Customization of the search procedure or the solving algorithm. This section is dedicated to the expression of the searching method. This is the place where the user can implement a specific algorithm that uses the model variables and that is needed to solve the problem. It is also the place where the model is generated and given to the solver for searching the solutions.

OPL allows multiple operations on the data. For instance, classical operations such as addition and multiplication are available on floats and integers. Other

¹Although this section resembles an advertisement for a commercial tool, this is not our objective. The objective of this section is only to share a user experience on a tool that allowed us to implement quite easily complex formulations.

2.4. Introduction to the Optimization Programming Language, OPL 21

operations like getting the maximum or the minimum value of a set or rounding a float are also possible. A complete list of available operations on data using OPL is referenced in [VH99] and also available online. Fig. 2.2 shows how to write the problem of Example 2.1.1 using OPL.

As explained before, OPL is a modeling language that helps to express the constraints on decision variables. However, an optimization application might also need functionality for manipulating data. This “non-modeling” expressiveness of the OPL language is called scripting and available as OPL Script. It interacts with OPL models and helps to combine them. For instance, the customization of the search procedure is done using OPL Script. It manipulates scripting variables denoted by means of the keyword *var*. Note that these variables are different from OPL modeling decision variables. OPL Script is used in three different situations:

- Preprocessing: to prepare the data that will be used by the model.
- Postprocessing: to work on or to manipulate model solutions
- Flow control: to define combinations of the data and the model and to solve the model. It is also used to chain multiple models like in the case of column generation.

The development and the deployment of optimization problems modeled using OPL are simplified when using the IBM ILOG CPLEX Optimization Studio [III14]. This software package combines the solver engines such as IBM CPLEX and IBM CP Optimizer [III14] with a tightly integrated IDE and the modeling language OPL. With IBM academic Initiative, researchers and students can have a free access to IBM ILOG CPLEX Optimization studio and CPLEX solvers. All documentation about this language are available online. To get help when using this language, IBM teams and OPL users are reachable for technical discussions on the IBM forum.

```

//Constants
int numNodes = ...;
//set of nodes
range nodes = 1..numNodes;
tuple link{
    key int id;
    int source;
    int dest;
    float capa;
}
//set of links
{link} links = ...;
tuple dmd{
    key int id;
    int source;
    int desti;
}
//set of demands
{dmd} demands = ...;
//Decision variables
dvar float+ f[demands][links];
//Objective function
maximize sum(i in demands) (sum(e in links:e.source == i.source) f[i][e]);
//constraints
subject to{
    //flow conservation constraints
    forall(i in demands, v in nodes:(v!=i.source && v!=i.desti))
        ct1:
            sum(e in links:e.source==v) f[i][e] - sum(e in links:e.dest==v) f[i][e] == 0;
    forall(i in demands)
        ct2:
            sum(e in links:e.dest==i.desti) f[i][e] - sum(e in links:e.source==i.source) f[i][e] == 0;
//capacity constraints
    forall(e in links)
        ct3:
            sum(i in demands) f[i][e] <= e.capa;
}

//Customization section
main{
    var modelDef = thisOplModel.modelDefinition;
    var modelData = thisOplModel.dataElements;
    //Solver to use
    var modelCplex = new IloCplex();
    //Definition of the model
    var modelOpl = new IloOplModel(modelDef, modelCplex);
    //Addition of the data input to the model
    modelOpl.addDataSource(modelData);
    //Generation of the model
    modelOpl.generate();
    //Resolution of the model
    if(modelCplex.solve()){
        writeln("The optimal solution is found");
    }
    else{
        writeln("Model unsolvable");
    }
}

```

Figure 2.2: OPL program of Example 2.1.1

Dimensioning of Microwave Wireless Networks

Contents

3.1	Introduction	24
3.2	Related Work	25
3.2.1	Literature Review	25
3.2.2	Budget Constrained Optimization Model	25
3.3	Network Model	27
3.3.1	Definitions and Assumptions	28
3.3.2	Problem formulation	28
3.3.3	An Illustrative Example	30
3.4	Solution of the Model	31
3.4.1	The Random Column Enumeration (RCE) heuristic	34
3.4.2	The Modified Column Generation (MCG) heuristic	35
3.4.3	Initial Solution of the RMP	36
3.5	Numerical Results	37
3.5.1	Resolution process	38
3.5.2	Solution quality	38
3.5.3	Validation of the Results: Comparison with those of [CKCN14]	40
3.6	Conclusion	40

We aim at dimensioning fixed broadband microwave wireless networks under unreliable channel conditions. As the capacity of microwave links is prone to variations, such a dimensioning differs from the classical ones. Considering that link capacities of these networks vary depending on channel conditions, this problem can be formulated as the determination of the minimum cost bandwidth assignment on the links of the network in which the traffic requirements can be met with high probability.

This problem was previously studied in [CKCN14]. The optimization model proposed here represents a major step forward since we consider dynamic routing. Experimental results show that the obtained solutions can save up to 45% of bandwidth cost compared to the case where a bandwidth over-provisioning policy is applied uniformly over all the links. Comparisons with previous work also show that

we can solve much larger instances than before in significantly shorter computing times, with a comparable reliability level.

3.1 Introduction

Offering a good quality service in telecommunications requires first of all a precise design and dimensioning of the network. The dimensioning consists in assigning sufficient resources to networks to ensure in good conditions the routing of the traffic. This step is much more crucial when designing microwave backauls to guarantee a high network reliability. Actually, weather conditions and variability in time and in the space of the radio propagation channel introduce data transmission outage events. A common solution applied by network operators is the capacity over-provisioning of their networks.

In microwave networks, a link's capacity is determined using the channel bandwidth and the modulation scheme used to transmit the traffic. However, the radio spectrum is a limited and expensive natural resource whose efficient use is proned by regulatory authorities. Thus, capacity overprovisioning is not cost effective for network operators, especially when extending their network coverage in remote areas. This is the reason that motivated us to study the minimum cost dimensioning problem of microwave networks. We aim at assigning to each network link the minimum cost bandwidth that allow the routing of all traffic demands with high probability. This problem entails a complex design decision aiming at balancing bandwidth-cost efficiency and network reliability in order to cope with channel fluctuations.

To overcome outage events due to fading phenomena, modern microwave systems employ adaptive modulation and coding which has been proved to considerably enhance link performance [GC97, GC98]. In practice, to keep the BER (Bit error rate) performance, this technique entails the variability of the link's capacity.

Fading phenomena are described in statistical terms and the probability of fades of a particular magnitude can be evaluated through analytical techniques [Bar72, Vig75, Cra96]. Coudert *et al* proposed in [CNR10] to identify a finite set of efficient radio configurations, for which no configuration that presents better bandwidth efficiency for a lower SNR (signal to noise ratio) requirement exists. They had then associated a discrete probability distribution with these selected configurations, derived either from statistical studies or from fading models and power budget calculations.

Under the assumption of a discrete probability distribution is known for each microwave link and bandwidth, we propose here an optimization model to dimension fixed broadband wireless microwave networks under unreliable channel conditions. The model determines the minimum cost bandwidth assignment of the links in the network such that a required reliability level of the solution is satisfied, i.e., the selection of bandwidth is made in order to reduce bandwidth costs while guaranteeing that traffic requirements can be met with high probability. We assume dynamic routing (i.e., routing decisions are made according to channel conditions) so as to

reduce the bandwidth over-provisioning during network planning.

The chapter is organized as follows. In Section 3.2, we discuss the recent related studies on dimensioning microwave networks. The proposed dimensioning model is presented in Section 3.3 together with the assumed bandwidth/modulation probability distribution. We then devise a solution of the model in Section 3.4. It is based on a decomposition technique in order to ensure a scalable solution scheme. Numerical results are described in Section 3.5 and conclusions are drawn in the last section.

3.2 Related Work

We first survey the recent work on the dimensioning of microwave networks (Section 3.2.1), and then summarize the very recent work of [CKCN14] that we will use in order to validate the newly proposed dimensioning model (Section 3.2.2).

3.2.1 Literature Review

Computing the probability that a subset of nodes in a probabilistic network is connected is a classical computationally difficult problem [Bal86], even for the case in which the subset of nodes is restricted to a single source-destination pair, viz. the two-terminal network reliability problem [BJ88]. To the best of our knowledge, [DBH⁺07] was the first work to investigate the reliability of fixed broadband wireless networks. The authors, however, assumed very strong hypotheses (e.g. single source-destination flow, uncapacitated network, unqualified failures) and applied currently available algorithms for the two-terminal network reliability problem. They only presented results for a network with 5 nodes and 7 links.

Recently, the problem of determining the minimum cost bandwidth assignment of a network while guaranteeing a reliability level of the solution was studied in [CCKN11a, CCKN11b, CKCN14]. The authors proposed a chance-constrained programming approach in which, if the optimal bandwidth assignment and routing of traffic demands are accomplished, the reliability criterion guarantees that network flows remain feasible with high probability. Under the assumption that links suffer fades independently, they proposed reformulations to standard MILP models.

One important remark to be made with respect to these previous approaches is that they consider static routing. In fact, bandwidth assignment and routing decisions take place in different time and, therefore, it is possible to save bandwidth utilization by adopting dynamic routing.

3.2.2 Budget Constrained Optimization Model

In [CKCN14], to overcome the resolution challenges of the model defined for the original problem, the authors proposed as well an alternative budget constrained formulation for which they present a reliability analysis based on different budget

values. Instead of minimizing the bandwidth cost, it aims at maximizing the network reliability while a certain budget \mathcal{B} is not exceeded.

The network topology is modeled as a digraph $G = (V, L)$, where each node $v \in V$ denotes a radio base station and each link $\ell = (u, v) \in L$ represents a microwave link from u to v , with $u, v \in V$. Let $\omega^+(v)$ ($\omega^-(v)$) denote the set of outgoing (incoming) links of node v . The sets of possible bandwidths and modulations are denoted as B and M , respectively. $B_\ell \subseteq B$ denotes the possible bandwidths available on link ℓ , and $M_\ell^b \subseteq M$ denotes those modulations available on ℓ given that bandwidth $b \in B_\ell$ was chosen.

Each link $\ell \in L$ can be associated to a bandwidth $b \in B_\ell$ and, in this case, a hypothesis on a modulation $m \in M_\ell^b$ is then assumed. Let COST_b be the cost associated to the bandwidth choice b and CAPAC_{bm} be the link capacity for a given bandwidth choice b and a specific modulation m . We recall that the capacity of a link is obtained as the product of the bandwidth value and the bandwidth efficiency of the modulation. Let ρ_ℓ^{bm} be the probability that link ℓ , assuming bandwidth choice b , is running at modulation m or higher (i.e., a modulation that presents better bandwidth efficiency). Therefore, a feasible routing of traffic demands to a link ℓ operating at bandwidth choice b and running at configuration m is also feasible if the link runs at configurations higher than m .

The traffic requirements are modeled by a matrix $D = [D_{sd}]$, where s, d and D_{sd} denote respectively the origin, the destination and the volume a demand. Let $\mathcal{SD} = \{(s, d) \in V^2 : D_{sd} > 0\}$ be the set of traffic demands. Let $a_{\ell, bm}$ be the binary decision variable indicating whether the bandwidth/modulation pair (b, m) is assigned or not to link $\ell \in L$. The flow variables φ_ℓ^{sd} denote the amount of D_{sd} routed on link $\ell \in L$. The budget constrained approach is then modeled as follows:

$$\max \sum_{\ell \in L} \sum_{b \in B_\ell} \sum_{m \in M_\ell^b} \log(\rho_\ell^{bm}) a_{\ell, bm} \quad (3.1)$$

subject to:

$$\sum_{\ell \in \omega^-(v)} \varphi_\ell^{sd} - \sum_{\ell \in \omega^+(v)} \varphi_\ell^{sd} = \begin{cases} -D_{sd}, & \text{if } v = s, \\ D_{sd}, & \text{if } v = d, \\ 0, & \text{otherwise} \end{cases} \quad \forall v \in V, (s, d) \in \mathcal{SD} \quad (3.2)$$

$$\sum_{(s, d) \in \mathcal{SD}} \varphi_\ell^{sd} \leq \sum_{b \in B_\ell} \sum_{m \in M_\ell^b} \text{CAPAC}_{bm} a_{\ell, bm} \quad \forall \ell \in L \quad (3.3)$$

$$\sum_{b \in B_\ell} \sum_{m \in M_\ell^b} a_{\ell, bm} \leq 1 \quad \forall \ell \in L \quad (3.4)$$

$$\sum_{\ell \in L} \sum_{b \in B_\ell} \sum_{m \in M_\ell^b} \text{COST}_b a_{\ell, bm} \leq \mathcal{B} \quad (3.5)$$

$$\varphi_\ell^{sd} \geq 0 \quad \forall \ell \in L, (s, d) \in \mathcal{SD} \quad (3.6)$$

$$a_{\ell, bm} \in \{0, 1\} \quad \forall \ell \in L, b \in B_\ell, m \in M_\ell^b. \quad (3.7)$$

The objective of this formulation, as expressed with (3.1), is to maximize the

network reliability associated to the selected bandwidth assignment. The flow conservation and the capacity constraints are represented respectively by (3.2) and (3.3). The assignment of at most one bandwidth/modulation pair is described by the constraint (3.4) while the satisfaction of the budget constraint is ensured by the constraint (3.5).

Due to the signal fading phenomena and to the adaptive modulation and coding used in microwave networks, an interesting network reliability measure should evaluate more than the probability of the network to stay connected. Indeed, it is important to also consider the network ability to transmit the required traffic regardless of its status. This is what is expressed in the chance-constrained reliability expression (3.8) that represents the probability that the capacity constraint is satisfied for every links for the assigned bandwidth and configuration.

$$R = \mathbb{P} \left[\sum_{(s,d) \in \mathcal{SD}} \varphi_{\ell}^{sd} \leq \sum_{b \in B_{\ell}} \sum_{m \in M_{\ell}^b} \text{CAPAC}_{bm} a_{\ell,bm} \quad \forall \ell \in L \right] \quad (3.8)$$

If link outage events are independent then the network reliability can be re-written as the product of the probability on each link. If, for a link ℓ , a configuration m is used having bandwidth b installed, then configurations higher than m also satisfy the capacity constraint (3.3). Thus the network reliability can be extended by considering the cumulative probability distribution of configuration as done in the budget-constrained approach. Consequently,

$$R = \prod_{\ell \in L} \left(\sum_{b \in B_{\ell}} \sum_{m \in M_{\ell}^b} \rho_{\ell}^{bm} a_{\ell,bm} \right)$$

This expression is equivalent to the reliability expression in (3.1) by the use of the logarithmic function and also due to binary value of the variables $a_{\ell,bm}$. A consequence of considering the cumulative probability is that the solution of this model is the worst configuration for which this routing is feasible. All network configurations with the same bandwidth assignment and link configurations higher than the one of the worst case are considered in this network reliability and the same flow routing can be applied. However, configurations with at least one link running at configuration lower than the one installed will result in demand unsatisfaction. The main drawback of this approach is that the network operator does not take advantage of the additional capacity provided by higher configuration for the demand routing. This is what we overpass by considering in our proposition the dynamic routing of the demand.

3.3 Network Model

In this section, we propose a new approach for solving the minimum cost bandwidth assignment problem under high reliability constraint. We first define the assumptions and the variables used in this formulation.

3.3.1 Definitions and Assumptions

For the sake of clarity, our model is based on the same notations and definitions related to network topology model, radio configurations and traffic demands, used in Section 3.2.2. Note however that we add here $M_\ell \subseteq M$ to denote all the modulations available on link ℓ regardless on a particular bandwidth b , and the set BM_ℓ to represent the bandwidth/modulation pairs available on ℓ . Also, the definition of the probability distribution associated to the pairs in BM_ℓ is slightly different. Instead of using the cumulative probability distribution denoted by ρ_ℓ^{bm} above, we denote by $\pi_{\ell,bm}$ the probability that exactly the modulation m is running on link ℓ having installed the bandwidth b . Hence we have:

$$\sum_{(b,m) \in \text{BM}_\ell} \pi_{\ell,bm} = 1 \quad \forall \ell \in L, \forall b \in B_\ell \quad (3.9)$$

We introduce in the following the notion of *configuration* which is defined as the set of links configurations in the network. In particular, a configuration c corresponds to a network dimensioning (i.e., bandwidth choice for each link) and, given the dimensioning, a radio configuration (i.e., modulation for each link). Formally, the binary parameters $a_{\ell,b}^c$ and $a_{\ell,m}^c$ denote whether the link ℓ uses the bandwidth b and the modulation m , respectively, within the configuration c . The parameter $a_{\ell,bm}^c$ is set to 1 for some link ℓ if the corresponding bandwidth and modulation parameters are also equal to 1. Naturally, only one bandwidth and one modulation could be used by a link ℓ in a configuration c .

With the assumption of independence between the probability distribution of each link, the occurrence probability p^c of a configuration c can be written as:

$$p^c = \prod_{\ell \in L} \sum_{(b,m) \in \text{BM}_\ell} \pi_{\ell,bm} a_{\ell,bm}^c \quad \forall c \in C \quad (3.10)$$

where C represents the set of all possible configurations.

Note that, in our model, it is possible that not all the traffic demands are completely satisfied by the configurations in C . Indeed, we define by the parameter δ_{sd}^c the amount of unsatisfied demand from source node s to destination node d , due to capacity constraints of configuration c .

3.3.2 Problem formulation

Our objective is to assign the bandwidths on the links in L so that the total bandwidth renting cost is minimized but also the amount of unsatisfied demands. As output of our solution, we will have a set of network configurations, all with the optimal bandwidth assignment, that allow a dynamic routing of the traffic under radio propagation environment variation. The main variables of our model are:

- x_c : set to 1 if the scenario c is considered, 0 otherwise

- $z_{\ell,b}$: set to 1 if bandwidth b is used on link ℓ in all the considered configurations, 0 otherwise.
- z_{ℓ} : bandwidth cost of link ℓ

Furthermore, we denote by the variable $y_{\ell,bm}$ the amount of unfeasibility with respect to the discrete probability distribution of modulation for given link $\ell \in L$ and $(b, m) \in \text{BM}_{\ell}$. An important point here is that we do not consider all the possible configurations in our solution because many of them are very unlikely. Thus, if we denote by C' the set of considered configurations ($x_c = 1, c \in C'$), $\sum_{c \in C'} p^c$ will be strictly less than 1. So, the total probability that some link ℓ uses the configuration (b, m) in the solution does not necessarily match the given probability $\pi_{\ell,bm}$. Here is where the variable $y_{\ell,bm}$ comes into play. Yet, we ensure that the solution provides a satisfactory grade of service to the network operator by enforcing that $p = \sum_{c \in C'} p^c$ is at least some minimum value p_{\min} , generally close to 1. In the sequel, we refer to this probability sum p as *the network reliability*. So the configurations in C' cover the scenarios that appear in the network $p\%$ of the time, and the model should ensure a feasible routing for each of them.

Our optimization model can be stated as follows:

$$\min \sum_{\ell \in L} z_{\ell} + \text{PENAL}_1 \sum_{(s,d) \in \mathcal{SD}} \sum_{c \in C} \delta_{sd}^c p^c x_c + \text{PENAL}_2 \sum_{\ell \in L} \sum_{(b,m) \in \text{BM}_{\ell}} y_{\ell,bm} \quad (3.11)$$

$$\sum_{c \in C} p^c x_c \geq p_{\min} \quad (3.12)$$

$$\sum_{c \in C} a_{\ell,bm}^c p^c x_c + y_{\ell,bm} = z_{\ell,b} \pi_{\ell,bm} \quad \forall \ell \in L, m \in M_{\ell},$$

$$b \in B_{\ell} : (b, m) \in \text{BM}_{\ell} \quad (3.13)$$

$$\sum_{b \in B_{\ell}} z_{\ell,b} = 1 \quad \forall \ell \in L \quad (3.14)$$

$$\text{COST}_b z_{\ell,b} \leq z_{\ell} \quad \forall \ell \in L, b \in B_{\ell} \quad (3.15)$$

$$z_{\ell,b} \in \{0, 1\} \quad \forall \ell \in L, b \in B_{\ell} \quad (3.16)$$

$$z_{\ell} \geq 0 \quad \forall \ell \in L \quad (3.17)$$

$$x_c \in \{0, 1\} \quad \forall c \in C \quad (3.18)$$

$$y_{\ell,bm} \in [0, 1] \quad \forall \ell \in L, (b, m) \in \text{BM}_{\ell}. \quad (3.19)$$

PENAL_1 and PENAL_2 are positive constants which penalize any amount of demand dissatisfaction and probability unfeasibility in the solution, respectively. The probability unfeasibility level of each link ℓ ($y_{\ell,bm}$) is determined in constraint (3.13) according to the considered configurations (x_c) and the assigned bandwidth b ($z_{\ell,b}$). The constraint (3.15) determines the bandwidth cost value for a given link. Note that the variables z_{ℓ} are not restricted in constraint(3.17) to be integers even if the cost values are always so: this will simplify the solution of the model.

The number of constraints of this problem is in the order of $O(|L| \times |\text{BM}|)$. This remains reasonable as the number of elements of BM is quite limited in practice.

3.3.3 An Illustrative Example

Consider a small microwave network with three links : ℓ_1, ℓ_2, ℓ_3 . We use the following bandwidth and modulation values:

- $B = \{b_1 = 7\text{MHz}, b_2 = 14\text{MHz}\}$
- $M = \{m_1 = \text{QPSK}, m_2 = 16\text{QAM}\}$

Thus

$$\text{BM} = \{(7\text{MHz}, \text{QPSK}), (7\text{MHz}, 16\text{QAM}), (14\text{MHz}, \text{QPSK}), (14\text{MHz}, 16\text{QAM})\}$$

The discrete probability distributions of the bandwidth/modulation pair of each link are given in Table 3.1. Note that the number of possible network configurations in this example is $4^3 = 64$. Table 3.2 shows only the network scenarios corresponding to the network dimensioning $z_{\ell_1, b_1} = z_{\ell_2, b_1} = z_{\ell_3, b_1} = 1$.

Table 3.1: Modulation discrete probability distributions

Links	π_{ℓ,b_1m_1}	π_{ℓ,b_1m_2}	π_{ℓ,b_2m_1}	π_{ℓ,b_2m_2}
ℓ_1	0.1	0.9	0.2	0.8
ℓ_2	0.2	0.8	0.3	0.7
ℓ_3	0.1	0.9	0.2	0.8

Table 3.2: Configurations for $z_{\ell_1,b_1} = z_{\ell_2,b_1} = z_{\ell_3,b_1} = 1$

L/BM		c_1	c_2	c_3	c_4	c_5	c_6	c_7	c_8
ℓ_1	(b_1, m_1)	1	1	1	1	0	0	0	0
	(b_1, m_2)	0	0	0	0	1	1	1	1
	(b_2, m_1)	0	0	0	0	0	0	0	0
	(b_2, m_2)	0	0	0	0	0	0	0	0
ℓ_2	(b_1, m_1)	1	1	0	0	1	1	0	0
	(b_1, m_2)	0	0	1	1	0	0	1	1
	(b_2, m_1)	0	0	0	0	0	0	0	0
	(b_2, m_2)	0	0	0	0	0	0	0	0
ℓ_3	(b_1, m_1)	1	0	1	0	1	0	1	0
	(b_1, m_2)	0	1	0	1	0	1	0	1
	(b_2, m_1)	0	0	0	0	0	0	0	0
	(b_2, m_2)	0	0	0	0	0	0	0	0
p^c		0.002	0.018	0.008	0.072	0.018	0.162	0.072	0.648

Assume that each link carries a traffic demand which can be satisfied by any bandwidth/modulation pair in BM and a cost of \$1 per 1Mhz of bandwidth. Clearly, a solution that assigns b_1 to each link will be the less-costly to the network operator. Furthermore, if all eight configurations are selected, the reliability will be equal to 1 and the terms multiplied by $PENAL_1$ and $PENAL_2$ in (3.11) will be zero. Hence, the objective function is minimized. However, if a minimum reliability level of 0.8 would satisfy the network operator as well, the solution consisting in the three configurations c_6 , c_7 and c_8 would satisfy all the requirements with a reliability level of $0.882 = 0.162 + 0.072 + 0.648$.

Now, if we consider larger problem instances (see Section 3.5), it will be computationally extremely hard to consider all the possible configurations. Hence, an alternative for the network operator is to deal only with a reasonable number of configurations while ensuring an acceptable reliability level.

3.4 Solution of the Model

A straightforward solution to the problem presented in (3.11)-(3.19) would require to enumerate all the possible configurations which is intractable even with moderate-size instances. In this section, we describe a solution process based on *Column*

Generation which splits the original problem into two subproblems: *the Restricted Master Problem (RMP)* and *the Pricing Problem*. The RMP is a linear-relaxed version of the original problem where only a limited subset of configurations are considered, while the pricing is a is another problem created to generate only the variables (configurations) which have the potential to improve the objective function, i.e., to find variables with negative reduced costs. The process alternates between these two problems until the following optimality condition is satisfied: no more configurations with a negative reduced cost can be derived. This process is depicted in Fig. 3.1.

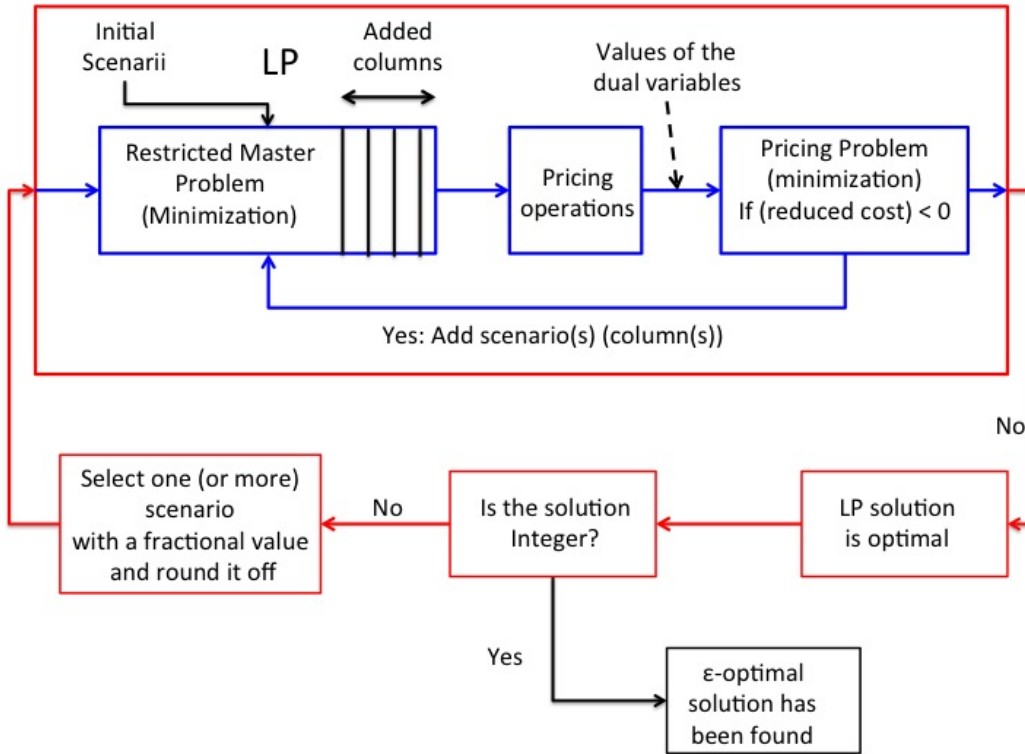

Figure 3.1: Column Generation Process

The objective of the pricing problem consists in minimizing the reduced cost of variables x_c . From constraints (3.11) to (3.13), we have deduced this objective as follows:

$$\min \overline{\text{COST}} = \prod_{\ell \in L} p_{\ell} \left(\text{PENAL}_1 \sum_{(s,d) \in \mathcal{SD}} \delta_{sd} - u^{(3.12)} - \sum_{\ell \in L} \sum_{(b,m) \in \text{BM}_{\ell}} u_{\ell,bm}^{(3.13)} a_{\ell,bm} \right) \quad (3.20)$$

where $u^{(3.12)}$ (≥ 0) and $u_{\ell,bm}^{(3.13)}$ (≤ 0) are dual values corresponding to constraints (3.12) and (3.13), respectively. p_{ℓ} is the probability of the bandwidth/modulation pair affected to the link ℓ in the constructed configuration. Note also that we omit the index c to alleviate the notations.

The set of constraints of the pricing problem is as follows:

$$p_\ell = \sum_{(b,m) \in \text{BM}_\ell} \pi_{\ell,bm} a_{\ell,bm} \quad \forall \ell \in L \quad (3.21)$$

$$\sum_{\ell \in \omega^-(v)} \varphi_\ell^{sd} - \sum_{\ell \in \omega^+(v)} \varphi_\ell^{sd} = \begin{cases} -D_{sd} + \delta_{sd} & v = s \\ D_{sd} - \delta_{sd} & v = d \\ 0 & \text{otherwise} \end{cases} \quad \forall v \in V, (s,d) \in \mathcal{SD} \quad (3.22)$$

$$\sum_{(s,d) \in \mathcal{SD}} \varphi_\ell^{sd} \leq \left(\sum_{m \in M_\ell} m \times a_{\ell,m} \right) \times \left(\sum_{b \in B_\ell} b \times a_{\ell,b} \right) \quad \forall \ell \in L \quad (3.23)$$

$$\sum_{m \in M_\ell} a_{\ell,m} = 1 \quad \forall \ell \in L \quad (3.24)$$

$$\sum_{b \in B_\ell} a_{\ell,b} = 1 \quad \forall \ell \in L \quad (3.25)$$

$$\sum_{(b,m) \in \text{BM}_\ell} a_{\ell,bm} = 1 \quad \forall \ell \in L \quad (3.26)$$

$$a_{\ell,bm} = a_{\ell,m} a_{\ell,b} \quad \forall \ell \in L, m \in M, b \in B : (b,m) \in \text{BM}_\ell \quad (3.27)$$

$$\varphi_\ell^{sd} \geq 0 \quad \forall \ell \in L, (s,d) \in \mathcal{SD} \quad (3.28)$$

$$a_{\ell,bm} \in \{0,1\} \quad \forall \ell \in L, m \in M, b \in B : (b,m) \in \text{BM}_\ell \quad (3.29)$$

$$a_{\ell,b} \in \{0,1\} \quad \forall \ell \in L, b \in B_\ell \quad (3.30)$$

$$a_{\ell,m} \in \{0,1\} \quad \forall \ell \in L, m \in M_\ell \quad (3.31)$$

$$\delta_{sd} \geq 0 \quad \forall (s,d) \in \mathcal{SD} \quad (3.32)$$

$$0 \leq p_\ell \leq 1 \quad \forall \ell \in L \quad (3.33)$$

In particular, Constraint (3.22) enforces the flow conservation rule, while the constraint (3.23) limits the amount of flow transmitted on each link by the corresponding attributed capacity in this configuration. Note that, with a slight abuse of notation, m denotes also in this formulation the number of bits encoded per symbol in the corresponding modulation.

Solving this pricing problem rises two main issues. The first one which is the product of $a_{\ell,m}$ and $a_{\ell,b}$ variables is easy to overcome by equivalently rewriting the quadratic constraints (3.27) as:

$$a_{\ell,bm} \geq a_{\ell,m} + a_{\ell,b} - 1 \quad (3.34)$$

$$a_{\ell,m} \geq a_{\ell,bm} \quad (3.35)$$

$$a_{\ell,b} \geq a_{\ell,bm} \quad (3.36)$$

The second issue, that is the product of p_ℓ variables present in the objective function, is more challenging due to the non convexity of this term. In the following sections, we propose two heuristic approaches to overcome the resolution challenges of this pricing problem.

3.4.1 The Random Column Enumeration (RCE) heuristic

The idea of this heuristic comes from the discrete aspect of the searching space of the pricing problem. Although the exponential number of configurations of a network instance (exactly $\prod_{\ell \in L} |BM_\ell|$), these configurations can be enumerate. Moreover, depending on the bandwidth and the modulation assigned to each link, a link probability can be calculate using Constraint (3.21) and consequently the configuration probability is obtained using $p = \prod_{\ell \in L} p_\ell$.

So this heuristic, whose goal is to generate configurations with negative reduced cost, consists in a random generation, based on the modulation probability distribution, of a network configuration. It means to assign randomly a value to the variables $a_{\ell,bm}, \forall \ell \in L, bm \in BM_\ell$ that satisfies Constraints (3.23) to (3.26) and (3.28) to (3.30) and thus help to find the configuration probability p . Using the pricing model, the heuristic then checks if there exists a feasible routing for the demands such that the pricing objective value is negative. If yes, then this column is added to the subset of configurations considered in the RMP. Otherwise, the heuristic searches in the neighborhood of the current configuration for another configuration with negative reduced cost. If at this point no configuration has been found, this processus is repeated $\#_Attempts$ times until a useful configuration is found (Algorithm 1). The column generation process is then resolved as the same way just by replacing the pricing problem resolution by the RCE heuristic.

Algorithm 1: RCE Heuristic

Inputs:

- A graph $G = (V, L)$;
- Demand set \mathcal{SD} ;
- Probability distribution $\pi_{\ell,bm}, \forall \ell \in L, (b, m) \in BM_\ell$

Output: A probability vector $p = (p_{\ell_1}, \dots, p_{\ell_{|L|}})$ that provides a negative value for the pricing objective function

for $\#_Attempts$ iterations **do**

$p :=$ A randomly generated probability vector;

if $(REDCOST(p) < 0)$ (*reduced cost of p*) **then**

return p ;

for $Iter_max$ iterations **do**

$N(p) :=$ A set of N_p neighbor configurations of p

a neighbor is obtained by changing randomly one (b, m) in p ;

$\tilde{p} := \arg \min_{p' \in N(p)} REDCOST(p')$;

if $REDCOST(\tilde{p}) < 0$ **then**

return \tilde{p} ;

$p := \tilde{p}$;

Though this heuristic has the ability to generate many configurations with negative reduced cost for small size instances, applying it to larger size instances will not be efficient due to the huge size of the search space. Indeed, the RCE heuristic searches, at each iteration of the column generation process, for a configuration with negative reduced cost in at most $\#_Attempts$ of different and randomly chosen neighborhoods. When no interesting configuration is found, the algorithm stops with the assumption that no more useful configuration can be found. When the size of the search space is very large, this heuristic may miss many available configurations with negative reduced cost at the time the algorithm ends. Hence we propose an alternative method for generating the configurations that relies on a modified version of the MILP pricing problem.

3.4.2 The Modified Column Generation (MCG) heuristic

To overcome the difficulty to solve the pricing problem because of the presence of the non convex term, we introduce here a slight transformation in this problem. As mentioned before, configurations generated by the pricing problem are only those for which the objective value of the pricing problem is negative. We know that the term $\prod_{\ell \in L} p_{\ell}$ is always positive and thus will not affect the sign of the pricing problem objective function. So the idea here is to generate the variables (configurations) using the same pricing problem from which the non-linear term of the objective is removed. In this way we are guaranteed to solve the pricing problem while generating all useful configurations that can improve the RMP objective function. Moreover, we consider only the configurations that satisfy all the traffic requirements. After a new configuration c is found through this modified pricing model, we use a local search heuristic in order to generate other valid configurations that will also be added to the RMP. The aim of this heuristic is to speed up the resolution of the problem. These configurations are obtained from c by modifying the modulation of some randomly selected links of configuration c .

The resolution algorithm, (see Fig. 3.2), consists then in solving iteratively the RMP and the modified pricing problem until no more configuration with negative reduced cost can be found. This is followed by an ILP resolution of the RMP that results in a set of network configurations with a minimum bandwidth cost. Notice that this algorithm, because of the use of the modified pricing problem is a heuristic method. In order to increase the solution reliability, we apply a post-optimization procedure.

It first chooses the configuration c_1 that has the highest probability among those that were selected by the ILP resolution of the RMP. At this stage, the bandwidth of each link is already assigned. Then, we derive new configurations by modifying the modulation of some randomly chosen links of c_1 . Then using the modified pricing problem, we verify the existence of a routing solution for these configurations. If it exists, then the new derivative configurations will be added to the RMP. This contributes to increase the final solution reliability without changing the bandwidth assignment cost.

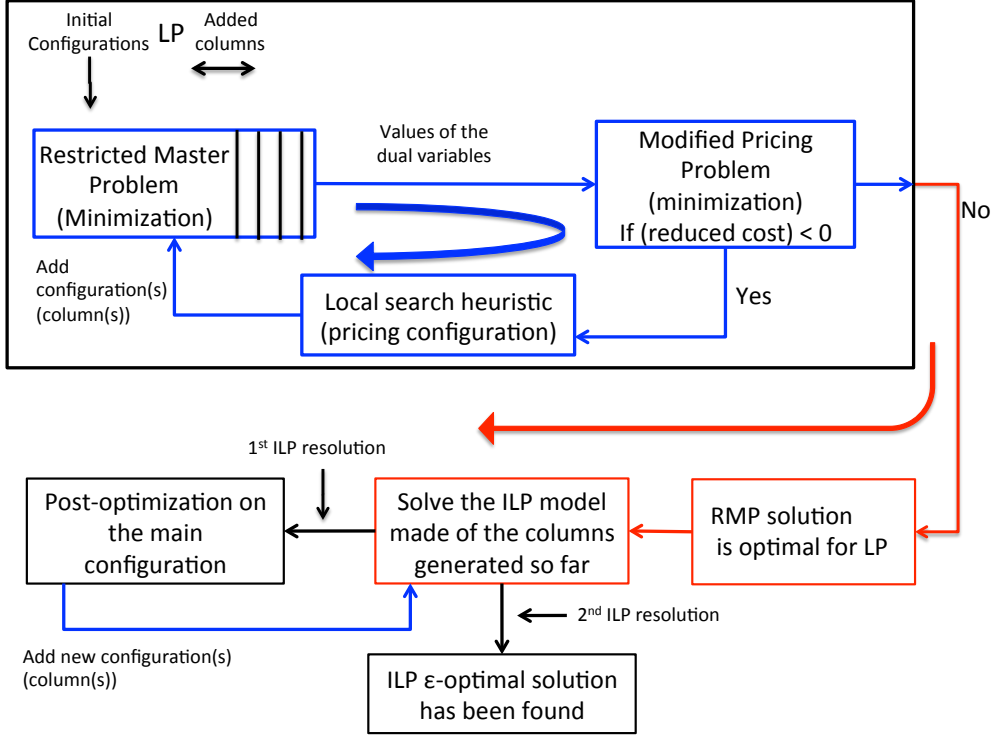

Figure 3.2: MCG Process

3.4.3 Initial Solution of the RMP

Solving the RMP model requires an input value for p_{min} and a subset of initial configurations such that the constraint (3.12) is satisfied. However, it can be difficult for large instances to find these elements for which feasible solutions are available. We overcome this problem by applying, before the execution of the process in Fig 3.2, a new column generation algorithm for which the RMP objective function is described in (3.37) subject to the constraints (3.13) - (3.19).

$$\max \sum_{c \in C} p^c x_c - \text{PENAL}_1 \sum_{(v_s, v_d) \in \mathcal{SD}} \sum_{c \in C} \delta_{sd}^c p^c x_c \quad (3.37)$$

The objective function of the corresponding pricing problem is rewritten as follows:

$$\max \overline{\text{COST}}' = (1 - \text{PENAL}_1) \sum_{(s,d) \in \mathcal{SD}} \delta_{sd} \prod_{\ell \in L} p_\ell - \prod_{\ell \in L} p_\ell \sum_{\ell \in L} \sum_{(b,m) \in \text{BM}_\ell} u_{\ell, bm}^{(3.13)} a_{\ell, bm} \quad (3.38)$$

and its constraints are the same as in the previous pricing problem. It aims to generate variables that maximize the p_{min} value and the non-linearity in the pricing is overcome using the heuristic approach described in the previous section. Note

that, as we now solve a maximization problem, a new configuration will be added to the initial RMP if the corresponding reduced cost $\overline{\text{COST}}'$ is strictly positive.

When no more new variables can be generated, then the MCG heuristic process can be run using the objective value of the first RMP as p_{min} .

3.5 Numerical Results

In order to highlight the performance and to validate the quality of our MCG heuristic, we have conducted numerical experiments. This section is devoted to the presentation and the analysis of the solutions obtained by this heuristic on different instances. For the experiment instances, we considered a set of realistic network topologies proposed by SNDlib [OWPT10] with the traffic demands rescaled as in [CKCN14]:

- Polska with 12 nodes and 36 links;
- Atlanta with 15 nodes and 44 links;
- France with 25 nodes and 90 links;
- Germany50 with 50 nodes and 176 links

For the radio parameters, each link can operate at a bandwidth of 7 MHz, 14 MHz and 28 MHz. The available modulation and coding schemes for these bandwidths and their bandwidth efficiency are presented in Table 3.3.

Table 3.3: Modulation schemes and Bandwidth efficiency

Modulation and coding scheme	Bandwidth efficiency (bps/hz)
m_1 : 16-QAM coded	3.6
m_2 : 16-QAM uncoded	4.0
m_3 : 64-QAM coded	5.4
m_4 : 64-QAM uncoded	6.0
m_5 : 256-QAM coded	7.2
m_6 : 256-QAM uncoded	8.0

This leads to 18 (b, m) pairs. Note that the network instances as well as the radio parameters are identical to those used in [CKCN14]. To normalize our computational results, we set a monetary cost of \$1000 per 1MHz of bandwidth. Besides, based on the Vigants-Barnett radio fading model [Vig75], the resulting probability distributions of the considered modulations are such that $\forall \ell \in L, \forall b \in B, \pi_{\ell, bm_6}$ is in the order of 0.999 while all other modulations probabilities are around 10^{-5} . We also limited the execution duration of the column generation loop between the RMP and the PP to two hours. Other parameters are given as follows:

- $\text{PENAL}_1 = 40,000$;

- $\text{PENAL}_2 = 50$;
- $p_{\min} = 0.9$.

3.5.1 Resolution process

The high variability of the probability distributions described above and the independence between link probabilities produce a tremendous number of possible configurations with very low probability value. In order to prevent generating such meaningless configurations, e.g., with probability in order of 10^{-75} , we add the following constraint to the modified pricing problem.

$$p_\ell \geq 0.1 \quad \ell \in L \quad (3.39)$$

Table 3.4: CG Results

	Polska	Atlanta	France	Germany50
# Generated conf.	606	635	629	454
# Used conf.	78	16	102	17

Table 3.4 shows that the number of total configurations generated by our resolution process represents only a very tiny fraction of the number of possible configurations, which is $\prod_{\ell \in L} |BM_\ell|$. That means that our process focus primarily on the most significant configurations in terms of probability and demand satisfaction. Also, we can observe that the best solutions in terms of cost will consider only a limited number of configurations while reaching the desired reliability level, as described below. Note that all the generated configurations satisfy the totality of traffic demands, i.e., $\delta_{sd} = 0, \forall (s, d) \in \mathcal{SD}$. This gives additional strength to our definition of the network reliability since our solution now covers very high percentage of the most frequent configurations while ensuring satisfaction of all traffic requirement.

3.5.2 Solution quality

We highlight here the quality of the solutions obtained by our MCG method. Fig. 3.3 shows, for each network topology, the cost saving that can be achieved by the network operator compared to the worst case where the highest cost bandwidth is installed on every links. The results expose a significant cost saving ranging from 33% to 45%, while achieving a high reliability level. As the saving increases with the network size, one would also notice some decrease in the reliability. This is due in part to Constraint (3.39) but mostly to the fact that it is much harder to maintain the same reliability level because the configuration probabilities would decrease by an order of magnitude by just adding one link to the network.

The quality of our method can also be evaluated through the reliability gaps between our solutions and the worst case, as shown in Fig. 3.4. We can see that the

reliability level is not that much compromised even if the total installed bandwidth is minimized.

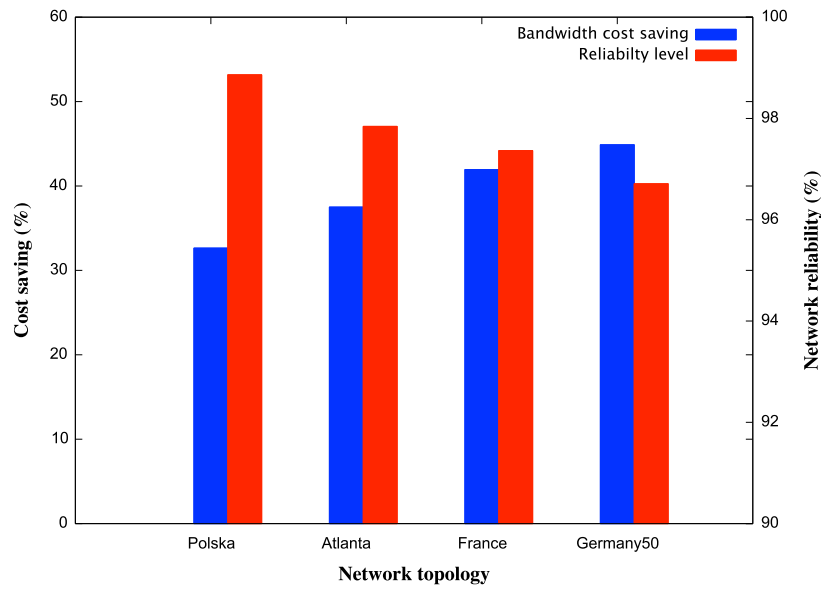

Figure 3.3: Cost saving vs. the worst case

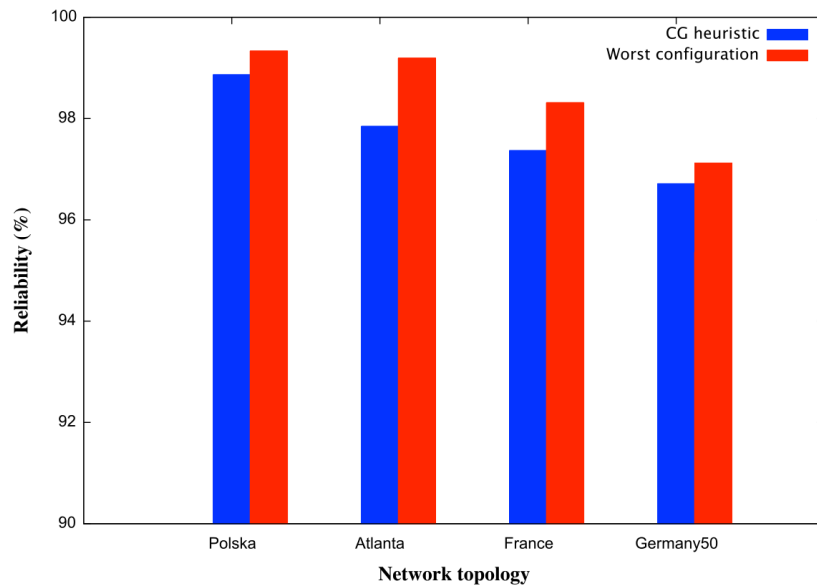

Figure 3.4: Reliability vs. the worst case

Table 3.5: Resolution time (minutes)

	Polska	Atlanta	France	Germany50
MCG heuristic	7	32	131*	148*
Budget constrained	21	120	nf	–

*: CG process is stopped after 2 hours.

nf: no feasible solution was reported, – : not considered.

3.5.3 Validation of the Results: Comparison with those of [CKCN14]

Another way to evaluate our model is to compare its results with those reported by Claßen *et al.* [CKCN14]. First, it is important to mention that the problem addressed in [CKCN14] is slightly different from ours. As exposed in Section 3.2.2, the methodology followed in [CKCN14] is to maximize the reliability for a fixed budget \mathcal{B} (Constraints (3.1) to (3.5)). The budget value \mathcal{B} is thus an input parameter of the model. To find the minimum cost bandwidth assignment, the model needs to be solved for multiple budgets values until no solution can be found. While this approach allows for finding a good compromise between the cost and the reliability, its drawback is the long computation time required to find the minimum cost solution.

Using this budget constrained formulation, the optimal solutions provide 36%, 39% and 40% of cost savings for Polska, Atlanta and France networks, respectively. The results of the MCG heuristic depicted in Fig. 3.3 are inferior by no more than 3% for Polska and Atlanta while it performs better on France instance as no solution has been found with the same cost in their case. Also, the reliability levels are very close as the gap is less than 1% for these three topologies.

In summary, the budget constraint model provides better solutions on small network instances while our heuristic based on column generation scales much better. This is explained by the ILP formulation of the budget constrained method that is not scalable. We believe that obtaining feasible solutions with this approach in a reasonable amount of time is very unlikely for large instances, such as Germany50. Table 3.5 summarizes a comparison of the computation times required in both cases to obtain solutions corresponding to the same cost. Not only our model is the fastest one, but also it provides good results for large instances in a relatively short amount of time.

3.6 Conclusion

In this chapter, we have proposed a new linear programming formulation, using column generation, for the dimensioning of fixed broadband microwave wireless networks under unreliable channel conditions. Furthermore, we have shown how to overcome the difficulty raised by the non-linear (and non convex) objective of the pricing problem by using a heuristic. We have assessed the potential of our approach on large scale instances. In particular, we were able to solve instances that were not

reachable by other methods.

As future work, we plan to improve the heuristic used to solve the pricing problem in order to increase the reliability of the solutions, and eventually find solutions with smaller cost. We would also like to propose a fixed budget formulation in order to build the Pareto front of the solution space. Moreover, we will investigate on the correlations of the links fades that are due to environmental (weather) conditions.

Infrastructure sharing

Contents

4.1	Introduction	43
4.2	Problem definition and nominal formulation	46
4.2.1	Problem situation	46
4.2.2	Static model formulation	46
4.3	Robust model	48
4.4	Computational results	50
4.4.1	Computation settings and test instances	50
4.4.2	Results and discussion	51
4.5	Model limits	56
4.6	Heuristics	57
4.6.1	Powerset method	57
4.6.2	Nominal-based method	57
4.6.3	Greedy method	59
4.6.4	Heuristics performance	59
4.7	Conclusion	62

In this chapter, we consider the problem of infrastructure sharing of a wireless backhaul network among multiple network operators for routing their traffic. We investigate in particular on the revenue maximization problem for the infrastructure owner when subject to uncertain traffic requirements and prescribed service level agreements (SLA). We use robust optimization to study the tradeoff between revenue maximization and the allowed level of uncertainty in the traffic demands. We propose a mixed integer linear program and some heuristics to solve the problem. To show the effectiveness of our model, we analyse based on test results on realistic scenarios, the price of robustness, i.e. the additional price to pay in order to obtain a feasible solution for the robust scheme.

4.1 Introduction

As explained before, microwave represents a promising technology for the deployment of fixed broadband wireless (FBW) networks (Fig.4.1). It is used not only by network operators but also for deploying private networks, for instance between



Figure 4.1: Example of fixed broadband wireless network

different sites of a same company, in commercial harbors, etc. However, the installation and the operation of a whole wireless backhaul network generates a huge investment. Thus for a network operator, it is not always cost effective to deploy its own infrastructure (tradeoff between the cost of the infrastructure and the expected revenue of providing Internet access). Typically, rural areas have longer return of investments than dense cities.

Therefore, the need for optimizing FBW networks is twofold. On the one hand, wireless telecommunication operators have to offer maximum territory coverage with high quality of service and at low cost to attract clients and so make profits. On the other hand, revenue maximization is strongly impacted by the deployment and operation costs of both the wireless base stations and the backhaul network. An interesting alternative to face this difficulty is to rent some network capacity to another operator.

To increase profits in FBW networks, recent studies have considered the reduction of both the capital and operational expenditures. Relating to the capital expenditures, the work presented in chapter 3 and in [CCKN11a, CCKN11b] addresses the minimum cost capacity planning problem in FBW networks using microwave links. Through respectively a column generation approach and a joint optimization of data routing and bandwidth assignment to links, it was possible, to reduce the total renewal fees of licenses. Moreover, the problem of reducing the overall power consumption of the FBW network, which is part of the expenses, has been considered first in [CNT11]. In chapter 5 of this thesis, we also tackled this problem using specific network greening technologies.

In addition to these solutions, a new idea for optimizing FBW networks is to apply the concept of infrastructure sharing to generate new income. Infrastructure sharing consists in general, in renting some network equipments, such as sites, antennas or BTS, to other network operators. For instance, wireless base stations in remote areas with low traffic are often shared between operators to reduce investment, and most of the high points where to install antennas are rented to dedicated companies.

In this chapter, we assumed that the owner of the network infrastructure can lease the network capacity to others operators under commercial terms. Following the actual separation between infrastructure and services, we considered two kinds of network operators: the Physical Network Operator (PNO) that owns and operates the FBW network infrastructure (antennas, radio links, etc.) and the Virtual Network Operator (VNO) that rents capacity from the PNO and uses the infrastructure to deliver services to its clients. In fact, many network operators are of both kinds since it is hardly cost effective to fully deploy its own infrastructure for achieving full coverage of a country.

We considered that the service level agreement (SLA) signed between the PNO and a VNO includes not only quality-of-service (QoS) requirements such as delays and satisfiability among concurrent flows, but also the capacity requirements over time. Motivated by an efficient computation of the optimal solution of our problem, we first derived a mathematical formulation of the infrastructure sharing with SLA problem with the objective of maximizing the PNO revenue. We then extended this formulation considering uncertain traffic demands, where each demand has a mean and peak value. To do so, we used the Γ -robustness approach mentioned in chapter 1. The Γ parameter here corresponds to the degree of robustness, i.e. the level of conservatism of the robust solution. This allows a better flexibility than traditional too conservative robust models like the model of Soyster. From a practical point of view, it is unlikely that all the VNO traffic requirements reach their peak value at the same time. Therefore we considered the case where the number of demands deviating from their mean value is bounded by Γ . Making Γ vary from 0 to the total number of demands allows us to study the so-called *price of robustness*, i.e. the additional price to pay in order to obtain a feasible solution for the robust scheme.

In Section 4.2, we carefully define the problem and present its mathematical formulation when demands are considered static. Section 4.3 is devoted to the robust formulation adapted to the cases when demand requirements are considered variables. We report on computational results in Section 4.4 and we discuss the model limits in Section 4.5. We then propose several methods to speed up the resolution in Section 4.6 and conclude with a perspective problem.

4.2 Problem definition and nominal formulation

4.2.1 Problem situation

We consider a fixed broadband wireless network composed of multiple towers on which one or many Base Transceiver Stations (BTS) are installed. Each BTS as explained in the chapter 1 (Introduction) consists of three basic components: an indoor unit, an outdoor unit and the antenna used to transmit and receive the signal into/from free space. Two BTS located on different towers can be connected to each other with point-to-point wireless links, and two different BTS located on the same tower are connected through a switch link connecting their indoor units. This network is owned by a PNO who wants to increase its revenue by sharing its infrastructure with interested VNOs. These latter are not willing at investing by constructing their own networks but at serving their clients in the same geographic area as the PNO. Together with the PNO, each VNO agrees on the SLA on its amount of traffic requirements and the PNO's revenue in case of satisfaction. They also define the conditions of the VNO's satisfaction and the level of QoS the PNO should offer. The QoS parameter considered here is the end-to-end delay of each demand that should not exceed a predefined value. The goal of this study is to determine the best set of VNOs that maximizes the total revenue of the PNO while satisfying all their constraints.

4.2.2 Static model formulation

We modeled our problem on a digraph $G = (V, E)$ where V represents a set of towers and each link $(u, v) \in E$ represents a fixed directed radio link from an antenna of a BTS located on node u to an antenna of a BTS located on node v . To each link (u, v) is associated a capacity value C_{uv} . We were also given a set of n candidates VNOs and the traffic demand for a VNO q is represented by a set $D_q = \{(s_q^k, t_q^k, d_q^k), k = 1, \dots, |D_q|, q = 1, \dots, n\}$ with s_q^k, t_q^k and d_q^k respectively the source, the destination and the volume of the k^{th} demand of the q^{th} VNO.

In order to efficiently compute the delay in the backhaul network, we made the following two assumptions.

1. The propagation delay on a link (delay needed for a symbol to reach the reception antenna from the emission one) is considered to be negligible regarding to its transmission delay in a router (delay needed to decode it, to send it from the antenna to the indoor unit, to treat it in the router, to send it to another indoor unit, to re-code it and to send it to the antenna for emission). This hypothesis is based on the fact that in microwave networks, propagation delays are in order of tens of microseconds (μs) while transmission delays are in order of milliseconds (ms) [Leh10].
2. We also consider the transmission delay of a unit of traffic demand in a router of the infrastructure is known by advance and denoted by τ . It corresponds to

a maximum value corresponding to the worst case where there is congestion in the router.

We then assumed that the maximum end-to-end transmission delay for a VNO q is $T_q, q = 1..n$. So a demand (s_q^k, t_q^k, d_q^k) of a VNO q is considered satisfied through our backhaul network if and only if the volume of traffic demand d_q^k can be totally routed in the network from the source node s_q^k to the destination node d_q^k , respecting the capacity available on each link of the routing path, and with a total transmission delay less or equal to T_q . In turn, we considered that a VNO satisfaction is met (or that a VNO can be served) if and only if at least a percentage β of its total number of demands are satisfied (remaining demands are served in best effort mode).

Considering that the PNO increases its revenue every time it satisfies a VNO, the main purpose of our problem is to maximize the total revenue on this network, with respect to the delay and satisfiability constraints for each VNO.

Let $X_{q,uv}^k, \forall \{u, v\} \in E, k = 1, \dots, |D_q|, q = 1, \dots, n$ be a binary variable representing whether or not the k^{th} demand of the q^{th} VNO is routed through the link (u, v) . The binary variables g_q^k and a_q denote respectively the satisfaction of the k^{th} demand of the q^{th} VNO, and the overall satisfaction of the q^{th} VNO.

From all considerations above, we formulated the problem with the following integer linear model:

$$\max \sum_{q=1}^n R_q a_q \quad (4.1)$$

$$\text{s.t.} \quad \sum_{v/(u,v) \in E} X_{q,uv}^k - \sum_{v/(v,u) \in E} X_{q,vu}^k = \begin{cases} g_q^k & \text{if } u = s_q^k, \\ -g_q^k & \text{if } u = t_q^k, \\ 0 & \text{otherwise} \end{cases} \quad \forall u \in V, k = 1 \dots |D_q|, q = 1 \dots n \quad (4.2)$$

$$\sum_{q=1}^n \sum_{k=1}^{|D_q|} d_q^k X_{q,uv}^k \leq C_{uv} \quad \forall (u, v) \in E \quad (4.3)$$

$$\tau \cdot \sum_{(u,v) \in E} X_{q,uv}^k \leq T_q \cdot g_q^k \quad \forall k = 1 \dots |D_q|, q = 1 \dots n \quad (4.4)$$

$$\sum_{k=1}^{|D_q|} g_q^k \geq \beta |D_q| a_q \quad \forall q = 1 \dots n \quad (4.5)$$

$$a_q, X_{q,uv}^k, g_q^k \in \{0, 1\} \quad (4.6)$$

The problem aims to maximize the total revenue of the network where R_q represents the revenue associated to VNO q . Constraints (4.3) corresponds to the link capacity constraints limiting the total amount of flow routed on a link, while constraint (4.2) ensures that the demand is routed on at most one path when the demand can be satisfied. Constraints (4.4) are used to determine if a demand k is

satisfied or not regarding to the delay recommendation of the q^{th} VNO. The transmission delay of a demand is calculated as the product of the maximum delay at a node τ by the number of traffic nodes in which this demand is routed from the source to the destination. The binary variable g_q^k is set to 0 if the transmission delay of a demand is greater than T_q , and consequently forces the associate flow variables to 0. Finally, Constraints (4.5) decide if a VNO can be satisfied or not depending on the percentage β .

One can add to this model Constraint (4.7) that forces all demand satisfaction variables for a VNO to 0 if this VNO can not be satisfied. Nevertheless, we have decided not to put it in our model in order to evaluate the percentage of demands that can be satisfied for a VNO even if all its requirements are not met.

$$g_q^k \leq a_q \quad \forall k = 1 \dots |D_q|, q = 1 \dots n \quad (4.7)$$

In the next section, we extended our model by taking into account the variations of traffic load happening in telecommunications networks. The new model will be robust against these variations and will help to cost-effectively serve the VNOs.

4.3 Robust model

In the model described in the previous section, we considered that all traffic demands are static. However in telecommunication networks, traffic fluctuates over time. Fig. 4.2 shows real traffic traces of the three source-destination pairs: (a) Washington D.C. - Los Angeles, (b) Seattle - Indianapolis, and (c) Seattle - Chicago in the US Abilene Internet2 network in intervals of 5 mins during the first 10 days of July 2004 [KKR13]. We observe that, at some points, each traffic demand can achieve a maximum (peak) value. In order to take these variations into account in our optimization model, we defined a new approach based on robust optimization with uncertainty parameter. More precisely in our approach, we consider the influence of demand uncertainty on the quality and the feasibility of the model for infrastructure sharing with SLA. So, we modeled the traffic demand d_q^k as random variable taking its value in a symmetric interval $[\bar{d}_q^k - \hat{d}_q^k, \bar{d}_q^k + \hat{d}_q^k]$, where \bar{d}_q^k is called the nominal value and \hat{d}_q^k the maximum deviation value.

We assumed that at most a few number of demands fluctuate at the same time. Indeed, it is unlikely to have all the traffic demands of all the VNOs reaching their peak value simultaneously. We can see in Fig. 4.2 that the traffic peaks do not occur simultaneously for the three demands. This confirms the assumption that the number of simultaneous demand peaks is bounded [KKR13]. This encourages us to use the method of Bertsimas and Sim [BS04] that is less conservative than other robust models. We thus denote by Γ , called the robustness parameter, the maximum number of demands that can deviate simultaneously in the network and reach their peak value $\bar{d}_q^k + \hat{d}_q^k$. Let $0 \leq \Gamma \leq \sum_{q=1}^n |D_q|$ be the possible values of Γ .

Taking into account these considerations, we modified our model to make it robust against the worst situation, which corresponds to a set of Γ demands max-

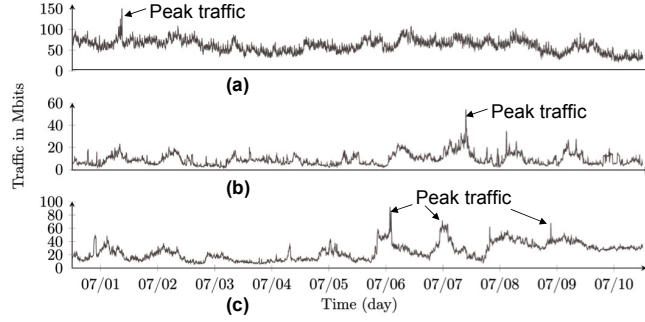

Figure 4.2: Traffic demands in Abilene network [KKR13]

imizing the deviation. When integrating the Γ -robust approach into the static model (4.1)-(4.6), only the demand volume will be affected and then only constraints (4.3) has to be modified. Indeed, due to the demand uncertainties, (4.3) will now be transformed into Constraints (4.8) where $D = \cup_{k=1 \dots |D_q|} \{(s_q^k, t_q^k, d_q^k)\}$ is the union set of all traffic demands.

$$\sum_{q=1}^n \sum_{k=1}^{|D_q|} \bar{d}_q^k X_{q,uv}^k + \max_{\{S/S \subseteq D, |S|=\Gamma\}} \sum_{(s_q^k, t_q^k, d_q^k) \in S} \hat{d}_q^k X_{q,uv}^k \leq C_{uv} \quad \forall (u, v) \in E \quad (4.8)$$

The maximization term added to the capacity constraint in (4.8) represents here the maximum traffic volume that can be added in the network if the Γ demands reach their peak values. The complexity of this term come from the exponential number of subset S that can not be all enumerate. We have to find another way to determine this value. Based on the new robust approach developed in [BS04] and knowing the value of $X_{q,uv}^k$ for $(u, v) \in E$ and Γ , the maximum part of the Constraints (4.8) can be re-written in a compact formulation as follows:

$$\begin{aligned} \delta(X, \Gamma) &= \max_{\{S/S \subseteq D, |S|=\Gamma\}} \sum_{(s_q^k, t_q^k, d_q^k) \in S} \hat{d}_q^k X_{q,uv}^k \\ &= \max \sum_{q=1}^n \sum_{k=1}^{|D_q|} \hat{d}_q^k X_{q,uv}^k Z_{q,uv}^k \end{aligned} \quad (4.9a)$$

$$\text{s.t.} \quad \sum_{q=1}^n \sum_{k=1}^{|D_q|} Z_{q,uv}^k \leq \Gamma \quad [\sigma_{uv}] \quad (4.9b)$$

$$0 \leq Z_{q,uv}^k \leq 1 \quad \forall q = 1 \dots n, k = 1 \dots |D_q| \quad [\rho_{q,uv}^k] \quad (4.9c)$$

where variable $Z_{q,uv}^k$ indicates which percentage of deviation occurs for demand d_q^k while (4.9b) is used to limit the size of the set S . By using the strong duality theorem [Chv83] and the dual variables $\sigma_{uv}, \rho_{q,uv}^k$ of the precedent model, we get :

$$\delta(X, \Gamma) = \min \sum_{q=1}^n \sum_{k=1}^{|D_q|} \rho_{q,uv}^k + \Gamma \sigma_{uv} \quad (4.10a)$$

s.t.

$$\sigma_{uv} + \rho_{q,uv}^k \geq \hat{d}_q^k X_{q,uv}^k \quad \forall q = 1 \dots n, k = 1 \dots |D_q| \quad (4.10b)$$

$$\sigma_{uv}, \rho_{q,uv}^k \geq 0 \quad \forall q = 1 \dots n, k = 1 \dots |D_q| \quad (4.10c)$$

From this, we can write the robust model of our original problem as follows:

$$\max \sum_{q=1}^n R_q a_q$$

Subject to Equations (4.2), (4.4), (4.5), (4.6), and

$$\sum_{q=1}^n \sum_{k=1}^{|D_q|} d_q^k X_{uv,q}^k + \sum_{q=1}^n \sum_{k=1}^{|D_q|} \rho_{q,uv}^k + \Gamma \sigma_{uv} \leq C_{uv} \quad \forall (u, v) \in E \quad (4.11)$$

$$\sigma_{uv} + \rho_{q,uv}^k \geq \hat{d}_q^k X_{q,uv}^k \quad \forall q = 1 \dots n, k = 1 \dots |D_q| \quad (u, v) \in E \quad (4.12)$$

$$\sigma_{uv}, \rho_{q,uv}^k \geq 0 \quad \forall q = 1 \dots n, k = 1 \dots |D_q| \quad (u, v) \in E \quad (4.13)$$

The traffic deviation induces in the worst case much more flow in the network compared to the static one. Using the same network capacity and the same QoS policies, some satisfiable requests in the static case can no longer be in the robust case. This implies a revenue reduction for the PNO and helps us to state that the nominal solution is an upper bound of the robust solution.

4.4 Computational results

4.4.1 Computation settings and test instances

Given the absence of topology instances for microwave backhaul networks available in the literature, we constructed instances for our problem using networks topologies taken from the SNDlib library [OWPT10]. We used the network topology and the traffic matrix of four instances from that library, namely Abilene, Atlanta, Dfn, and Polska, on which we applied a scaling factor on the nominal traffic volumes to cope with links capacities of 1 Gbits/sec (best possible link capacity using nowadays microwave technology). We have then randomly defined the number of traffic demands D_q for VNO q , the revenue R_q for a satisfied VNO q (relative numbers to be multiplied for instance by 1000\$ per year), and split the traffic demands arbitrarily into several groups, each associated to a VNO. All settings have been reported in Table 4.1.

For each instance, we set the possible deviation to 60%, 50%, 50% and 40% of the nominal traffic demands respectively for Abilene, Atlanta, Dfn and Polska. Finally, we set $\tau = 1$ and $\beta = 90\%$ such that a VNO is satisfied only if few of its demands can not be correctly routed.

Table 4.1: Test instances settings

	V	E	D	VNO 1		VNO 2		VNO 3		VNO 4		VNO 5	
				D_1	R_1	D_2	R_2	D_3	R_3	D_4	R_4	D_5	R_5
Abilene	12	30	132	74	55	58	40						
Atlanta	15	44	210	70	55	70	40	70	40				
Dfn	11	94	110	39	55	41	40	39	40				
Polska	12	36	66	13	55	12	55	12	100	16	95	13	95

4.4.2 Results and discussion

We solved the constructed instances for all possible values of Γ using the Cplex solver [III14] on a computer equipped with a 2.9 Ghz Intel Core i7 CPU and 8 GB of RAM. We have set a time limit of 2 hours for solving an instance. We have got optimal solutions for almost all instances and a small optimality gap for few of them. We analyse our results in the next subsections, starting with the price of robustness.

4.4.2.1 Price of robustness

We have reported in Fig. 4.3 for each instances the evolution of the revenue, the number of satisfied VNOs, and the total number of satisfied demands when Γ increases. The general shape of the plots is similar for all instances. When $\Gamma = 0$, no traffic deviation is allowed, and so the reported results are for the nominal traffic demands, and when $\Gamma = |D|$, all traffic demands are at their peak.

In Fig. 4.3a we observe that the revenue decreases as soon as some traffic variations are allowed, and that it quickly reaches a plateau which shows us that above a certain value, the number Γ of uncertain demands does not have any impact on the VNO satisfaction. This is an important indication for the PNO in the tradeoff between investment for increasing the capacity of the network and potential revenue increase (difference between the revenue for $\Gamma = 0$ and the plateau). In fact, in the robust model, the sum of the peak traffic requirements increases with Γ . Since the link capacities are fixed, it is no longer possible to accept all the traffic demands (as shown in Fig. 4.3c) and so only a subset of the VNOs can be satisfied as shown with Fig. 4.3b.

Recall that our model tries to maximize the total number of satisfied demands in the network, even if at the end, the VNO itself cannot be satisfied due to the percentage β defined in the SLA. This can be observed in Fig. 4.3c. The number of satisfied demands of an unsatisfied VNO depends mainly on the residual capacity in the network when demands of the satisfied VNO are well routed, which in turn depends on the volume of these last demands.

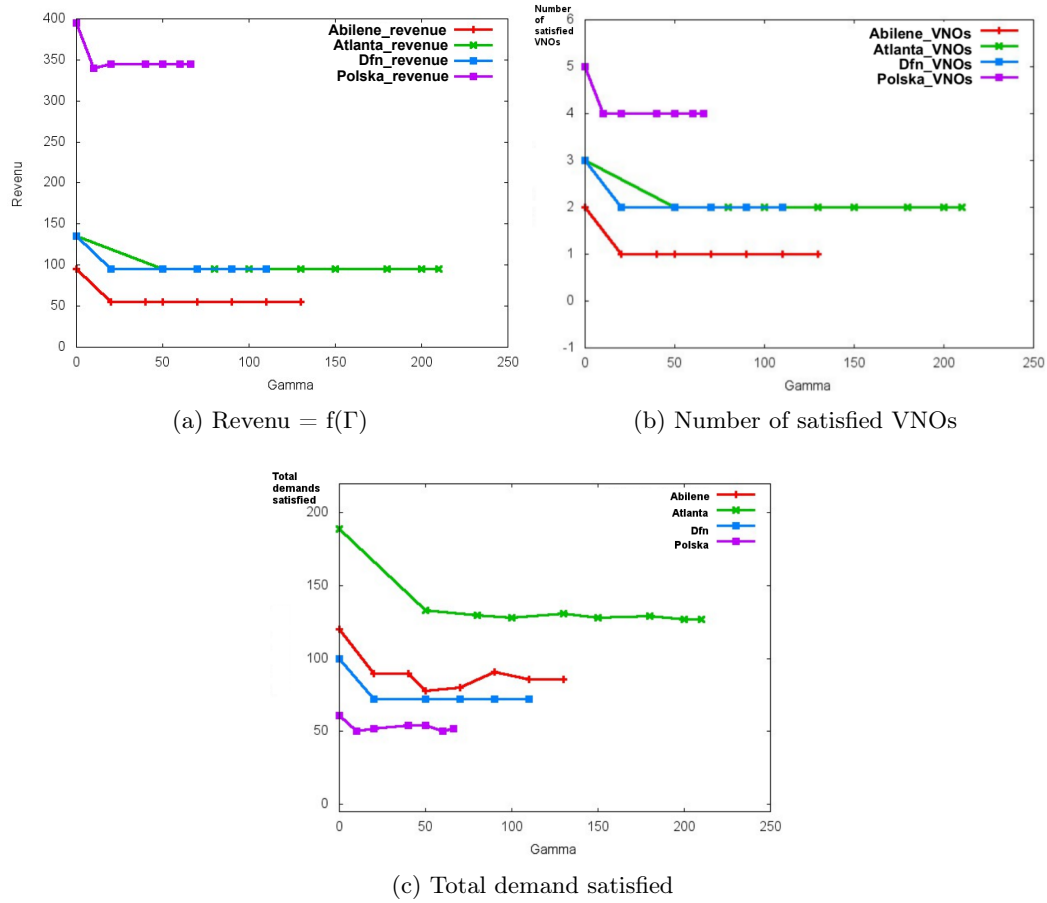
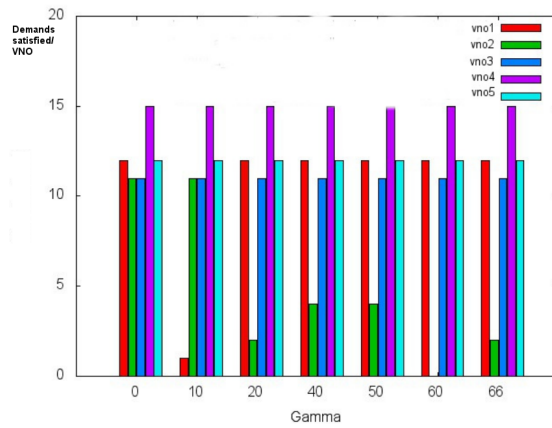

Figure 4.3: Evolution of the revenue (4.3a), number of satisfied VNOs (4.3b), and total number of satisfied demands (4.3c) as a function of Γ .

Figs. 4.4b, 4.4c, 4.4a and 4.5 present the repartition of the satisfied demands per VNO respectively in Abilene, Atlanta, Polska, and Dfn networks when the robustness parameter Γ increases. For instance, the changes in the subset of satisfied VNOs when Γ increases can be observed in Fig. 4.4c. When $\Gamma \geq 50$, only two VNOs can be satisfied, either VNO1 and VNO2, or VNO1 and VNO3, and the variations are explained by the evolution of the total number of satisfied demands, which also depends on the volume of these demands. The plateau on the revenue observed in Fig. 4.3a is explained by that fact that VNO2 and VNO3 provide the same revenue for the PNO. Clearly, if the revenue for VNO3 was higher than the revenue for VNO2, the model would always choose the subset with VNO1 and VNO3 since it can be satisfied for all values of Γ .

4.4.2.2 Impact of the parameter β

Here, we investigate on the impact of the parameter β on the satisfaction of VNOs when using the worst case of the QoS policy. Recall that this parameter expresses



(a) Polska

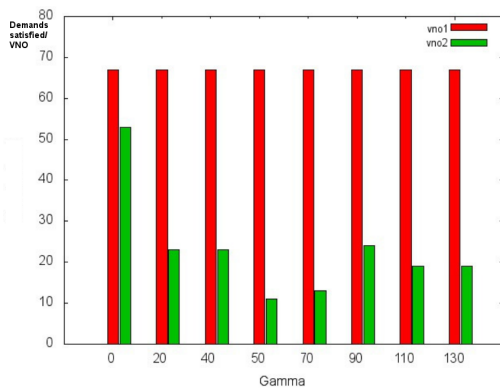

(b) Abilene

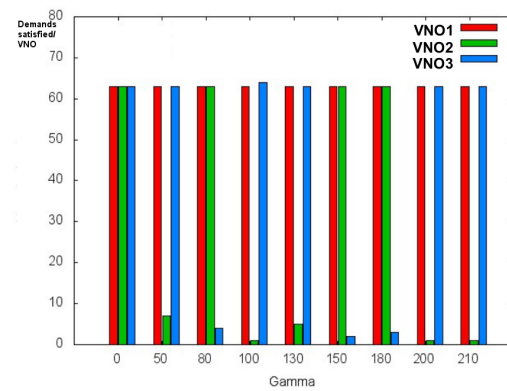

(c) Atlanta

Figure 4.4: Repartition of satisfied demands per VNO when Γ increases for Abilene, Atlanta, and Polska.

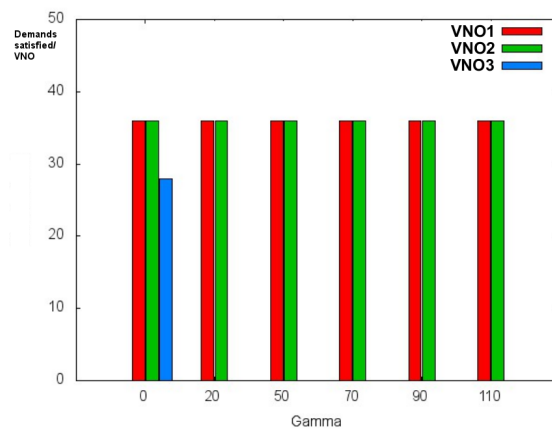

Figure 4.5: Repartition of satisfied demand per VNO for Dfn.

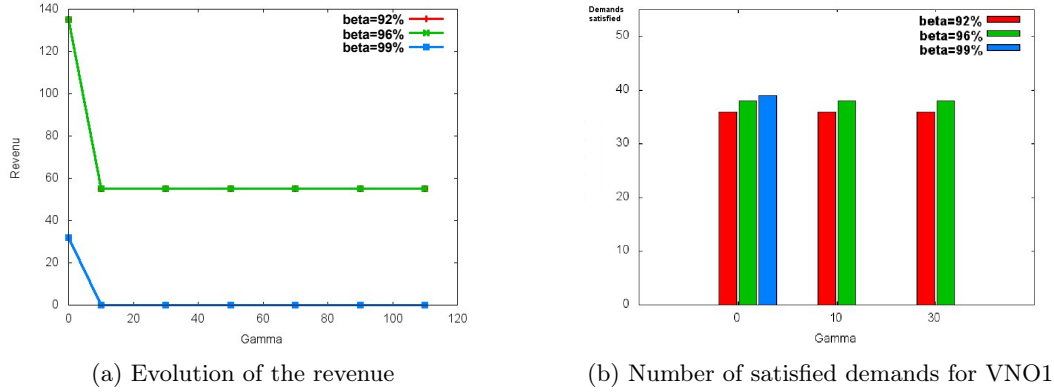

Figure 4.6: Evolution of the revenue (4.6a) and number of satisfied demands (4.6b) on Dfn instance for different values of β and Γ .

the percentage of traffic demands to satisfy in order to accept the VNO. Other traffic demands can be served on a best effort basis.

We have solved the Dfn instance with different values of β : 92%, 96%, and 99%. The results are reported in Figs. 4.6a and 4.6b. We observe in Fig. 4.6a a drastic drop down of the revenue when β increases. Recall that the revenue for $\beta = 90\%$ reported in Fig. 4.3a was even higher. This indicates that this stronger satisfaction requirement of the VNOs forces the PNO to accept less VNOs. For instance, when $\beta = 99\%$ and for values of $\Gamma \geq 10$, none of the VNO can be satisfied.

In Fig. 4.6b, we observe that the percentage of satisfied traffic demands for VNO1 is larger when $\beta = 96\%$ than when $\beta = 92\%$. Indeed, the first objective of our model is to maximize the revenue and so to choose the right number of satisfied VNO. Then, since we never force variables g_q^k to zero if VNO q is not satisfied, the model will route many traffic demands independently of the satisfaction of the VNOs. This can also be observed in Fig. 4.4b where although VNO1 is the only satisfied VNO as soon as $\Gamma \geq 20$, many traffic demands of VNO2 can be satisfied. Such information can be used by the PNO in the negotiation of the terms of a SLA with a VNO.

4.4.2.3 Variation of number of satisfied VNOs

In this section, we present additional experiments to show that our model helps the PNO to determine the best subset of satisfied VNOs in order to maximize its revenue. To this end, we modified the number of demands per VNO on the Dfn topology. Now, demands are 65, 25, and 20 respectively for VNO1, VNO2 and VNO3, and the corresponding revenues are also 65, 25, and 20. We set $\beta = 90\%$.

As for previous experiments, the network has enough capacity to accept all VNOs and traffic demands when there is no traffic variations ($\Gamma = 0$ in Fig. 4.7a). However, as soon as we start having some traffic variations ($\Gamma > 0$), it is no longer possible to satisfy all VNOs. We observe in Fig. 4.7a that only one VNO is satisfied

Table 4.2: Dfn results in function of Γ

Γ	0	10	30	≥ 50
Revenue	110	90	65	45
VNOs	1, 2, 3	1, 2	1	2, 3

when $\Gamma = 30$, but that two VNOs are satisfied for larger values of Γ . Since we maximize the total revenue of the PNO, it can be better to satisfy fewer VNOs with bigger revenue. Meanwhile, the revenue as reported in Fig. 4.7c drops down until it reaches a plateau for $\Gamma \geq 50$. We summarize the revenue and associated satisfied VNOs for different values of Γ in Table 4.2.

Last, we observe in Fig. 4.7b that for all values of Γ , the network has enough residual capacity to serve some of the traffic demands of unsatisfied VNOs. Again, this information is useful for the PNO, either to propose an increase of the parameter β for the accepted VNOs, or to propose alternative SLAs for unsatisfied VNOs. Moreover, it is a good indication on the additional capacity to install in the network in order to satisfy all VNOs and so increase revenues. This network extension problem constitutes one of the perspectives of our actual model.

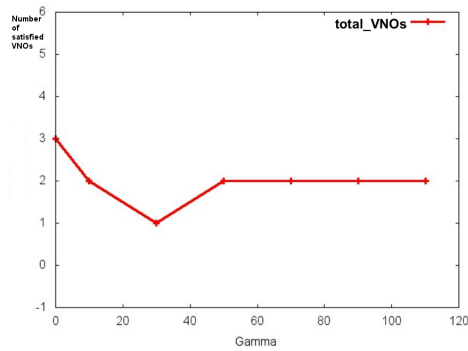

(a) Evolution of the number of satisfied VNOs.

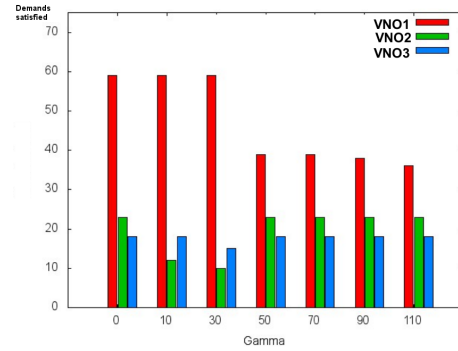

(b) Evolution of the number of satisfied demands.

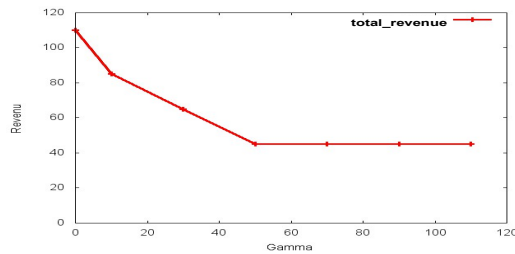

(c) Evolution of the revenue.

Figure 4.7: Dfn instance with three VNOs such that $|D_1| = 65 = R_1$, $|D_2| = 25 = R_2$, and $|D_3| = 20 = R_3$.

Table 4.3: Resolution time in seconds as function of Γ

Network \ Γ	0	1	3	5	7	10
Abilene	0.49	2.03	4.31	19.53	14.31	7.21
Polska	1.67	9.27	5.28	8.78	23.24	16.48
Dfn_50	1.05	4.17	4.99	11.35	8.66	6.38
Dfn_55	1.12	4.77	5.55	26.72	7203	5576.23
Dfn_60	1.20	4.69	20.23	39.55	7203.26	7203.16
Dfn_65	1.27	5.52	683.46	7203.44	7203.27	860.76

4.5 Model limits

With a time limit of two hours, Table 4.3 shows the resolution time of our previous instances. It appears that the resolution time of the robust model can be huge depending on different parameters of the problem instance. For the smallest values of Γ , the optimal solutions have been found quickly and the solutions are the same. With the value of Γ increasing, at some point, the VNOs subset solution changes because one previously satisfiable VNO becomes unsatisfiable. This situation increases the resolution time until the situation in which it is easy to check the unsatisfaction of a VNO. For example, with the Dfn network with 65 demands for VNO 1 and $\Gamma = 5$, the model ran for 2 hours with a solution not optimal of VNOs 1 and 2 satisfied and trying to satisfy VNO 3 while with $\Gamma = 10$ we got the optimal solution with VNOs 1 and 3 satisfied and VNO 2 unsatisfied. We tested the robust model on limited size instances (number of network nodes and links, number of candidate VNOs). Adding more VNOs implies having more demands, which add new variables and constraints to our model. However the joint computation of robust traffic routing, feasible paths for end-to-end delay, and VNO selection leads sometimes to intractable models in a reasonable time. Even with a small number of VNOs, the robust parameter Γ and the total number of demands have a strong impact on the resolution time. That is the case when we considered in Table 4.3 different number of demands (from 50 to 65) for VNO 1 in Dfn network which has 3 VNOs.

Our goal in the next section is thus to propose alternative resolution algorithms that are scalable and compute good quality solutions on these hard instances in relatively small time. Because the network topology is fixed input of the problem, our methods aim at limiting the impact of the robust model inputs (candidate VNOs, demands).

Let define by X a subset of VNOs already selected to be satisfied and by Y the subset of candidates VNOs.

4.6 Heuristics

In this section we present different algorithms providing good solutions for the infrastructure sharing with SLA. In the following, let X be a possible solution of the problem (i.e. a subset of satisfied VNOs) which feasibility will be checked, and Y be the original set of candidate VNOs.

4.6.1 Powerset method

In this method, instead of considering a set of candidates VNOs, we considered different set X of chosen VNOs. Then, we checked the feasibility of the robust model considering X as its solution. Indeed, we considered all subsets of VNOs in the powerset of the original set of candidate VNOs Y , except the empty one. The advantage of this method is that instead of solving the entire robust model to optimality, the solver will stop the resolution as soon as a constraint violation is found with the solution X . Because all subset will be checked, this algorithm will provide us the optimal robust solution. Practically, in order to gain in time, we checked only the subsets with total revenue higher than the best current feasible one and that does not contain a subset already known to be unfeasible. This method is explained in Algorithm 2.

4.6.2 Nominal-based method

This method, presented in Algorithm 3, consists in solving first the nominal model with the aim of reducing the size of Y . This new subset of candidate VNOs and its demands are then used as input to solve the robust model. This method does not provide the optimal solution but only a lower bound to the robust problem. Nonetheless the solution quality can be compared with an upper bound given by the objective value of the nominal resolution. In the following example, we explain why the solution of this method does not give the optimal solution.

Suppose we have $Y = \{b_1, b_2, b_3, b_4, b_5\}$ with respectively 4, 4, 2, 3 and 2 as revenue. Let A be the subset of VNOs in the optimal solution of the nominal model and B the one of the robust model. Suppose $A = \{b_1, b_2, b_4\}$ and $B = \{b_1, b_2, b_3\}$. So our robust optimal revenue is 11. Though if we had used the nominal based method, A would be considered as the subset of candidates VNOs for the robust model. And we would have $C = \{b_1, b_2\}$ with an objective value of 8 as solution, less than the optimal one. On the other hand, when using Y as input for the robust model, it is not possible to have an objective value higher than the one of A . This is because the robust model adds more traffic volume to the problem compared to the nominal case. This proves as said in Section 4.3, that the nominal optimal solution is an upper bound to our robust problem. Moreover, the nominal-based method gives a lower bound solution.

Algorithm 2: Powerset method

Inputs:

- A graph $G = (V, E)$ with link capacities;
- A set Y of VNOs and their demands matrix;
- (β, Γ, τ)

Outputs: A subset S of VNOs maximizing the total revenue

Initialization:

- best-cost := 0;
- $S := \{\}$;
- $U := \{\}$ is the set of unfeasible subsets of VNOs;
- $Y' := \text{Powerset}(Y) \setminus \{\emptyset\}$;

```

for subset  $X$  in  $Y'$  do
  if  $\sum_{q \in X} R_q \geq \text{best-cost}$  then
    if  $X \cap U = \emptyset$  then
      Set  $a_q = 1 \forall q \in X$  and  $a_q = 0 \forall q \in Y \setminus X$ ;
      if the robust model with the new values of  $a_q$  is feasible then
         $S := X$  ;
        best-cost :=  $\sum_{q \in X} R_q$ 
      else
         $U.append(X)$ ;
    else
       $U.append(X)$ ;
return  $S$ ;

```

Algorithm 3: Nominal-based method

Inputs:

- A graph $G = (V, E)$ with link capacities;
- A set Y of VNOs and their demands matrix;
- (β, Γ, τ)

Outputs: A subset S of VNOs maximizing the total revenue;

$S_1 :=$ Solution of nominal model with Y ;

$S :=$ Solution of robust model with S_1 as input;

return S ;

4.6.3 Greedy method

In this method, we searched for the best solution based on the price paid by a VNO when its satisfaction is met. The higher is this price paid by a VNO, the higher is the PNO interest for him. We firstly sorted VNOs in the decreasing order of their revenue. Then, we searched for the best subset of VNOs S_1 with the highest revenue that is feasible for the robust model. As soon as S_1 is found, at each iteration, we added to it one VNO from those not in S_1 , starting from the one with the highest revenue; and we checked the feasibility of this new subset. If it is not feasible, then we made the test with the next VNO otherwise we updated S_1 before moving to the next iteration. We iterated until all VNOs are checked. Once again, in this method, we just checked the feasibility of a predefined solution by finding a good routing. The heuristic is detailed in Algorithm 4.

This method does not provide the optimal solution but a lower bound. For example, suppose we have found S_1 with a revenue of 15 and that $U = \{b_1, b_2, b_3, b_4\}$ with respective revenues of 6, 4, 3 and 2. While testing the new VNOs subsets, we have: $\{\{S_1 + b_1\}, \{S_1 + b_2 + b_3\}, \{S_1 + b_2 + b_4\}\}$ unsatisfiable and $\{S_1 + b_2\}$ satisfied with a revenue of 19. At the same time, the subset $\{S_1 + b_3 + b_4\}$ with revenue 20 is also satisfiable. The satisfaction of b_2 in the greedy algorithm excludes the optimal solution $\{S_1 + b_3 + b_4\}$.

4.6.4 Heuristics performance

To evaluate the performance of our heuristics, we tested them on the last used Dfn network with $\Gamma = 5$ and 7. It is the same instance as in Fig. 4.7. The robust resolution applied to this instance, with the solver, has run for more than 10000 seconds without finding the optimal solution.

Algorithm 4: Greedy method

Inputs:

- A graph $G = (V, E)$ with link capacities;
- A set Y of VNOs and their demands matrix;
- (β, Γ, τ)

Outputs: A subset S of VNOs maximizing the total revenue;

Initialization:

- best-cost := 0;
- $S := \{\}$;
- $U := \{\}$ set of rejected VNOs;
- $Y' := Y$ in the decreasing order based on the revenue;
- feas := False boolean to check feasibility;

```

while  $len(Y') \geq 0$  and  $feas = False$  do
  if Robust model unfeasible with  $Y'$  then
     $e :=$  last element of  $Y'$ ;
     $U.append(e)$ ;
     $Y' := Y' \setminus e$ ;
  else
     $S_1 := Y'$ ;
     $feas := True$ ;
    if  $len(U) > 0$  then
       $U := U$  in the decreasing order based on the revenue;
      while  $len(U) > 0$  do
         $x :=$  first element of  $U$ ;
         $U := U \setminus x$ ;
        if Robust model feasible with  $S_1 \cup x$  then
           $S_1 := S_1 \cup x$ ;
   $S := S_1$ ;
return  $S$ ;

```

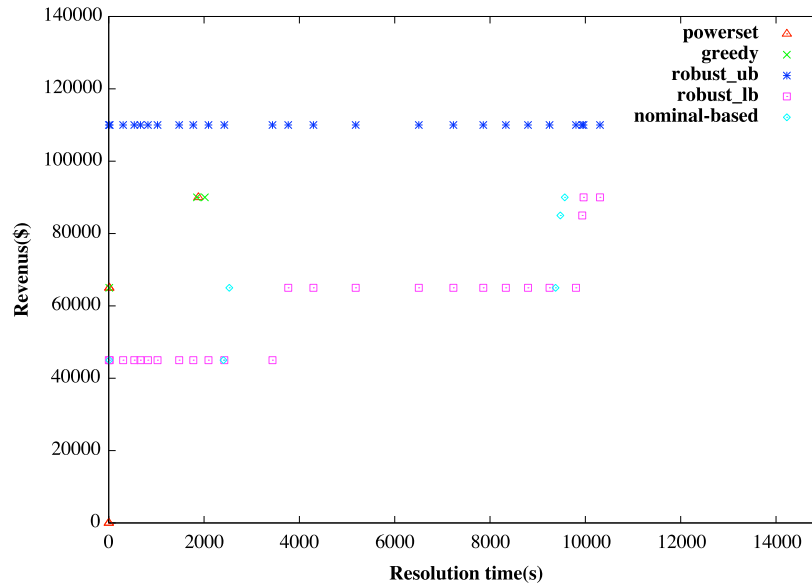
Figure 4.8: Resolution performance comparison with $\Gamma = 5$

Figs. 4.8 and 4.9 show the evolution in the time of the robust model solution bounds, and of the heuristics solutions. These figures highlight the good performance of the powerset and the greedy heuristics in terms of resolution time and objective value. Indeed, these two heuristics provide in 2000s the same solution found by the robust model in 10000s (Fig. 4.8). In Fig. 4.9, the objective value found by the heuristics in 8000s is better than the best solution found by the robust model in 16000s. It also appears, from the results, that the powerset and the greedy methods output the same objective value in approximately the same resolution time. We may say they perform the same way. Their strength comes from the feasibility checking of subsets of VNOs with the robust model instead of their resolution. However we have to notice, that larger is the network instance, more resolution time is needed for the heuristics to find, at each iteration, a good routing solution. Thus, we can conclude that these heuristics provide generally good solution in less time than the robust model.

On the other hand, the nominal-based method has performed as the model resolution using the solver. This is explained by the fact that in these instances, the first step of this algorithm does not reduce the size of Y . So with these instances, this method solve the original robust model in the second step of the algorithm. the solution quality and resolution time are then as the same as the one of the robust resolution with the solver.

Finally, we observe that the objective solution output by the three heuristics always lies in the interval between the upper and lower bounds of the robust model solution. This helps to identify the quality of the solution, which with our instances is usually close to the upper bound.

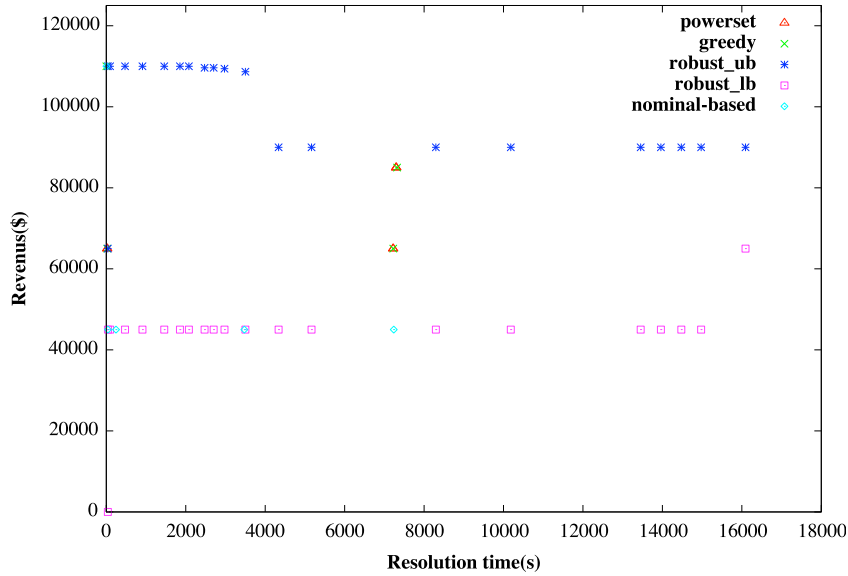
Figure 4.9: Resolution performance comparison with $\Gamma = 7$

4.7 Conclusion

In this chapter, we have investigated on the price of robustness in shared backhaul networks subject to stochastic traffic requirements issued from multiple virtual network operators. We have proposed a MILP formulation of the revenue maximization problem subject to parameterized levels of uncertainty using robust optimization. The proposed formulation includes end-to-end delay constraints. Our experiments, performed on realistic instances, highlight the influence of the robustness parameter Γ , as well as the satisfaction level β of a VNO, on the potential revenue of the PNO. They also give hints to the PNO on the tradeoff between additional investments for increasing network capacity and expected increase of revenue. We have also proposed other methods to faster the problem resolution with intractable instances.

As a perspective problem, it would be interesting to solve the capacity increase problem. The problem can be considered in the case of planning new links installation and in the case of capacity increase of existing links using robust optimization. Another element than can be improved is the QoS parameter considered. Indeed, instead of considering a constant time delay for each packet at each node, one can use a packet queuing system with different entrance and service rates.

Energy-aware Routing in Backbone Networks

Contents

5.1	Context and motivation	64
5.2	Related Works	66
5.2.1	Energy-aware Routing (EAR)	66
5.2.2	Redundancy Elimination	68
5.2.3	GreenRE - Energy Savings with Redundancy Elimination	69
5.3	Robust-GreenRE Model	72
5.3.1	Compact formulation	75
5.3.2	Constraint generation (Exact Algorithm)	76
5.3.3	Heuristic Algorithm	78
5.4	Computational Evaluation	80
5.4.1	Test instances and Experimental settings	80
5.4.2	Results and Discussion	81
5.5	Conclusion	89

The work of this chapter is motivated by the search of methods that can reduce the energy consumption of cellular mobile radio networks in order, firstly to make them cost-effective and secondly to reduce the ICT impact on the global warming. Among the multiple approaches proposed in the literature, we were interested in the Energy Aware Routing (EAR) and the Redundancy Elimination (RE). These techniques are applied to a backbone network with the goal to minimize its energy consumption, even when variations in traffic load are registered.

We first model the problem in case of static traffic demands. The model combines the selection of the nodes where to install RE with EAR and so the minimization of active links.

Then we extend the model to cope with fluctuations of trafficed and RE rate. We formulate this robust optimization problem as a Mixed Integer Linear Program (MILP). We also propose an efficient heuristic algorithm that is suitable for large networks.

We conduct a numerical evaluation of our models and heuristics using real traffic traces on Abilene, Geant and Germany50 networks. Our results show that our approach allows for 16-28% extra energy savings with respect to the classical EAR model.

5.1 Context and motivation

Recent studies have shown that ICT is responsible for 2% to 10% of the world-wide power consumption [Glo07, CMN11]. For example, the Global e-Sustainability Initiative estimated the overall network energy requirement for European telecommunication is around 35.8 TWh in 2020 [BDB⁺11]. The main consumers in cellular networks are data servers, backhaul routers and base stations (BS) which constitutes between 60 to 80% of the overall network power consumption [PVD⁺08]. With a base station consuming up to 700W during its active mode [PVD⁺08], backhaul network represents a principal energy consumer and requires solutions to lower its power consumption.

Traditionally, networks are always designed to meet the peak-hour traffic demand. Therefore during normal periods, the traffic load is typically well below the network capacity. Following this observation, people have proposed, in the literature, energy-aware routing (EAR) to minimize the number of used links while all the traffic demands are routed without any overloaded links [CMN11, GS03, ZYLZ10]. Another research topic that has also been active recently is traffic redundancy elimination (RE) [AGA⁺08, AMAR09, SGG10, ZCM11]. It consists in splitting packets into small chunks, each is indexed with a small key, that are cached along traffic flows as long as they are popular. Then, keys are substituted to chunks in traffic flows to avoid sending multiple times the same content, and the original data are recovered on downstream routers based on the cache synchronization between the sending and the receiving routers. Therefore, traffic redundancy is removed and traffic volumes of flows between the two routers are reduced. To apply RE to the BSs of a microwave backhaul networks, these infrastructures should be connected to devices having IP router functions. This is not yet the case today but a report conducted by Heavy Reading [HR13a, HR13b] on microwave backhaul evolution helped to realise the wish of network operators (74% of those who answered) to have a router connected to microwave node of their backhaul network that can apply L3 protocols by 2016. This motivates us a good base to find an energy-aware routing solution combined to RE technique for microwave backhaul network. Before this method could be tested with microwave backhaul networks, we use it to increase the energy efficiency for IP backbone networks.

In fact, in IP networks, the backbone and more precisely IP routers, are those that consume a majority of energy [TBA⁺08]. For simplicity, a traffic flow from which redundancy has been removed is called a *compressed flow*. We use interchangeably the notation *compression rate* or *RE rate* to denote how much traffic redundancy can be eliminated.

From energy savings perspective, RE has a drawback since it increases energy consumption of routers [GMPR12]. To find a good trade-off, in [GMPR12], the authors proposed GreenRE - a model that combines EAR and RE to increase energy efficiency for backbone network. In the GreenRE model, each of the demand has a static traffic volume and is associated with a constant factor of redundant traffic. To handle future changes and guarantee a certain level of quality of service (QoS)

(avoiding overloaded links), the peak volumes of traffic demand and the lowest RE rates are used as the worst case realization. Such assumption clearly leads to inefficient usage of network resources and poor energy savings. To alleviate this limitation of the GreenRE model, we decided, here, to take into account in the optimization process the uncertainty on traffic volumes and RE rates. By using this extra information, we are able to obtain a design which would be closely related to the dynamics of the traffic pattern, hence significantly increase energy savings compared to previous proposals.

In mathematical literature, the technology-independent Γ -robustness, presented in Chapter 2, has been introduced in [BS03, BS04] and then successfully applied to various network design problems [KKR13, CKPT13, CKS13]. This approach is based on an observation that in real traffic traces, only a few of the demands are simultaneously at their peaks. So, the authors considered a parameter $\Gamma > 0$ so that at most Γ demands deviate simultaneously from their nominal traffic volumes. Based on this assumption, the so-called robust solution is a solution that is feasible for any subset of Γ demands simultaneously at their peaks, other demands are being at their nominal values. The originality of the method is the expression of the maximum sum of deviation over all possible subsets of Γ demands as a unique linear program (LP). However, this LP formulation may have an exponential number of constraints. To overcome this issue, the LP formulation is transformed into a compact one using the duality theorem.

In the following, we first give a presentation of the EAR and RE concepts and their application in the research. Then we recall the definition and give a reformulation of the GreenRE model, which is the basis of our study. As contribution to this work,

- First, we define and explain the impact of fluctuations in demands volumes and RE rates on the GreenRE formulation.
- Then we derive the robust model corresponding to ours problem using the Γ -robust model.
- Because of the exponential number of constraints in this model, we propose three different methods to solve it. The first is a Mixed Integer Linear Program (MILP), called compact formulation, directly derived from the robust model using the duality property and some variables relaxations. Depending on the problem instance, this method can provide the optimal solution, but in general, it provides a lower bound of the energy savings. The second method is an iterative algorithm, called Exact Algorithm. It aims at identifying the subset of demands that will have the highest impact on the GreenRE model when demands fluctuation are taken into account. It helps to find the exact value of the energy savings. The last method is a heuristic that is proposed to overcome the NP-Hardness of the Robust-GreenRE problem when applied to large instance. Its goal is to find a good quality solution in a relatively small computation time.

- Finally, through numerical simulations on real-life network instances and data traffic, we show the energy savings offered by our different methods.

5.2 Related Works

5.2.1 Energy-aware Routing (EAR)

EAR aims at using network protocols to control the whole network, so as to minimize energy consumption while preserving QoS requirements. Before going into detail of EAR, we first present an energy profile of a router from a traffic load point of view. An energy profile is defined as the dependence of the energy consumption of a router on its traffic load. In fact, there are several energy profiles in which different functions are used to describe the relationship between energy consumption and traffic load on router [RGM09]. In this section, we present the two main energy profiles: “idleEnergy” and “fully proportional” models (Fig. 5.1).

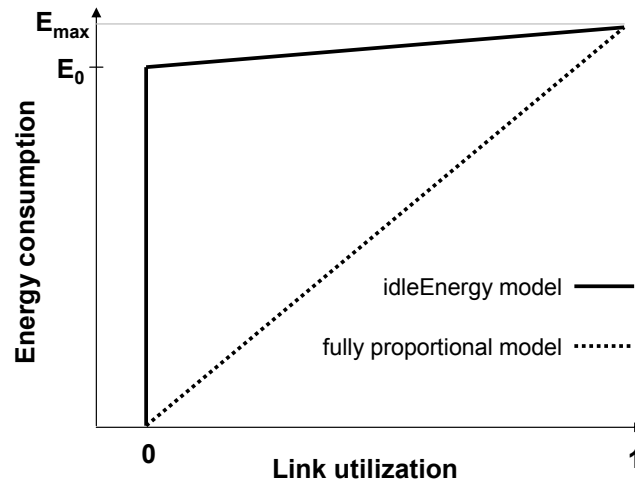

Figure 5.1: Energy profiles

Fully Proportional Model. This model represents an ideal case where energy consumption varies linearly with the device utilization, between 0 and E_{max} . As stated in [BCL⁺10], network devices could present such a behavior if techniques like Dynamic Voltage Scaling (DVS), modular switching fabrics, etc. are applied to the components of the devices. Furthermore, the authors in [NIR⁺12] have proposed methods to build a power-proportional software router. Such a model is desired in green networking. However, today network devices are not power-proportional, and it is considered as a futuristic scenario.

IdleEnergy Model. This model is also named “on/off” energy profile. It has been shown in [CSB⁺08] that the energy consumption of today network equipments

is not proportional to the quantity of the transported traffic. In practice, network device’s energy consumption grows linearly between a minimum value E_0 and a maximum value E_{max} which correspond respectively to the idle state and the maximum utilization state (Fig. 5.1). For more details, a database of power consumption values for ICT network equipments is presented in [VHIV⁺12].

In this chapter, we focus on the “idleEnergy model” to design and evaluate efficient energy-aware routing (EAR) protocol. We refer the reader to [GGNS13, GNTS13] for more general studies on energy-aware problem (with different energy profiles). In our work, the most basic notion of EAR include mechanisms for turning off or putting components into sleep mode. In general, networks are designed with redundant links and over-provisioning bandwidth to accommodate traffic bursts as well as to allow rerouting when links fail. As a result, the networks are under-utilized most of the time, leaving a large room for energy savings. Intuitively, it is possible to have multiple paths between a pair of source-destination in a network. When traffic load is low, we can aggregate the traffic into a few links so that other links do not carry any traffic. Then, idle links of routers can be put into sleep mode for saving energy. In fact, turning off entire routers can earn significant energy savings. However, it is difficult from a practical point of view as it takes time for turning on/off and also reduces life cycle of devices. Therefore, like existing works [CCLRP13, GMPR12], we assume to turn off (or put into sleep mode) only links to save energy.

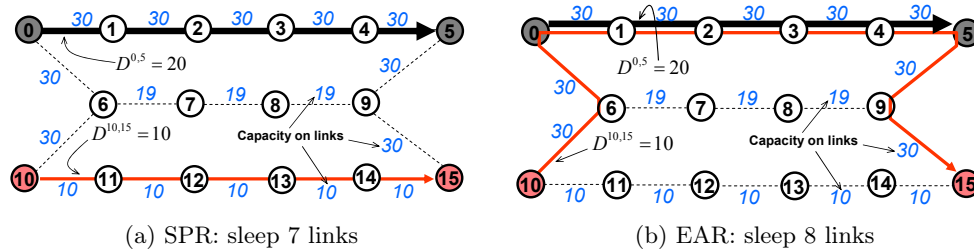

Figure 5.2: Example of Shortest Path Routing (SPR) vs. Energy-aware Routing (EAR)

As an example of EAR, we refer to Fig. 5.2. There are two traffic demands $0 \rightarrow 5$ and $10 \rightarrow 15$ with volumes $D^{0,5} = 20$ Gbps and $D^{10,15} = 10$ Gbps. The shortest path routing, as shown in Fig. 5.2a, uses 10 active links whereas the remaining 7 links can be put into sleep mode. However, taking energy consumption into account, in Fig. 5.2b, EAR solution allows to put 8 links into sleep mode, thus energy consumption is further decreased. The problem of minimizing the number of active links under QoS constraints can be precisely formulated using MILP. However, this problem is known to be NP-Hard [GMMO10], and currently exact solutions can only be found for small networks. Therefore, many heuristic algorithms have been proposed to find admissible solutions for large networks [CMN11, GMMO10].

5.2.2 Redundancy Elimination

Internet traffic exhibits a large amount of redundancy when different users access the same or similar contents. Therefore, several works [SW00, AGA⁺08, AMAR09, ASA09, SGG10, ZCM11] have explored how to eliminate traffic redundancy on the network. Spring et al. [SW00] developed the first system to remove redundant bytes from any traffic flows. Following this approach, several commercial vendors have introduced Wide area network Optimization Controller (WOC) - a device that can remove duplicate content from network transfers [Blu, GC07, Riv]. WOCs are installed at individual sites of small Internet Service Providers (ISPs) or enterprises to offer end-to-end RE between pairs of sites. As shown in Fig. 5.3, the patterns of previously sent data are stored into the

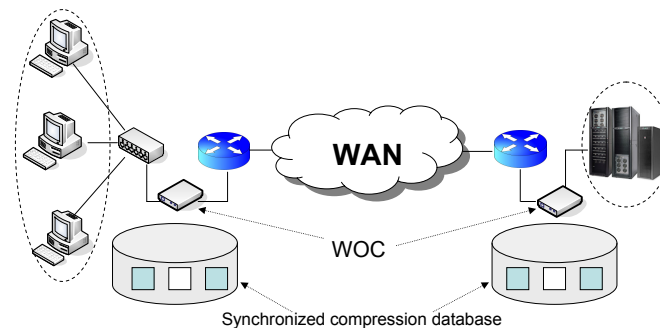

Figure 5.3: Reduction of end-to-end link load using WOC

databases of the WOCs at both the sending and the receiving sides. The technique used to synchronize the databases at peering WOCs can be found in [GC07]. Whenever the WOC at the sending side notices the same data pattern coming from the sending hosts, it substitutes the original data with a small signature (*encoding process*). The receiving WOC then recovers the original data by looking up the signature in its database (*decoding process*). Because signatures are only a few bytes in size, sending signatures instead of actual data gives significant bandwidth savings.

Recently, the success of WOC deployment has motivated researchers to explore the benefits of deploying RE in routers across the entire Internet [AGA⁺08, AMAR09, ASA09, SGG10]. The core techniques used here are similar to those used by the WOC: each router on the network has a local cache to store previously sent data. This data are then used to encode and decode data packets later on. Obviously, this technique requires heavy computation and large memory for the local cache. However, Anand et al. [ASA09] have shown that on a desktop equipped with a 2.4 GHz CPU and 1 GB RAM, the prototype can work at 2.2 Gbps and 10 Gbps respectively for encoding and decoding packets. Moreover, they believe that higher throughput can be obtained if the prototype is implemented in hardware. Several real traffic traces have been collected to show that up to 50% of the traffic load can be reduced with RE support [AMAR09, ASA09, SGG10].

In next sub-section, we recall the GreenRE model - the first model of *energy-aware routing with RE support* [GMPR12]. Although RE was initially designed for bandwidth savings, it is also interesting for reducing the network power consumption.

5.2.3 GreenRE - Energy Savings with Redundancy Elimination

In the GreenRE model, RE is used to virtually increase capacity of the network links. However, as shown in [GMPR12], a drawback is that when a router performs RE, it consumes more energy than usual. This introduces a trade-off between enabling RE on routers and putting links into sleep mode. We show that it is a non-trivial task to find which routers should perform RE and which links should be put into sleep mode to minimize energy consumption for a backbone network.

5.2.3.1 Example of GreenRE model

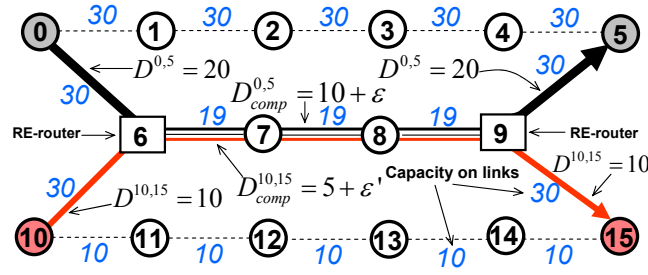

(a) 10 links in sleep mode, 2 enabled RE-routers

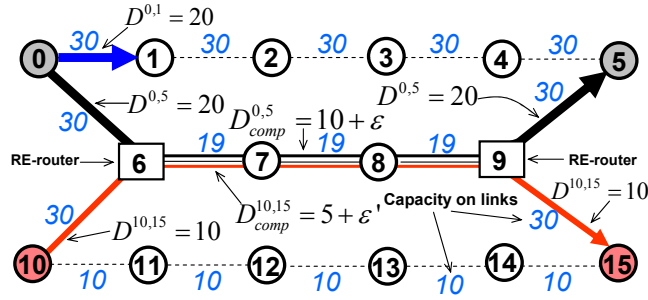

(b) 9 links in sleep mode, 2 enabled RE-routers

Figure 5.4: GreenRE with 50% of traffic redundancy

The example presented in Fig. 5.4a has two traffic demands $D^{0,5} = 20$ Gbps and $D^{10,15} = 10$ Gbps. Let a RE-router consume 30 Watts [GMPR12] and a link consume 200 Watts [CMN11]. Assume that 50% of the traffic is redundant and RE service is enabled at routers 6 and 9, thus the traffic flows $0 \rightarrow 5$ and $10 \rightarrow 15$ passing through links (6, 7, 8, 9) are reduced to $(10 + \epsilon)$ Gb and $(5 + \epsilon')$ Gb, respectively

where $\varepsilon, \varepsilon'$ denotes the total size of the signatures used for each flow. In reality, each signature is only a few bytes in size [GC07], therefore $\varepsilon, \varepsilon'$ are small and the routing in Fig. 5.4a is feasible without any congestion. As a result, the GreenRE solution allows to put 10 links in sleep mode and to enable 2 RE-routers which saves $(10 \times 200 - 2 \times 30) = 1940$ Watts, compared to the saving of $8 \times 200 = 1600$ Watts of the EAR solution (Fig. 5.2b). It is noted that, in some extreme cases, GreenRE even helps to find feasible routing solution meanwhile it is impossible for the classical EAR. For example, if we add a third demand from router 0 to router 1 with volume 20 Gbps, then Fig. 5.4b is a feasible solution. However, without RE-routers, no feasible solution is found because there is not enough capacity to route all the three demands.

5.2.3.2 Problem Formulation

We consider a communication backbone network where nodes represent routers with multiple interfaces that are used to create physical links. The GreenRE problem is defined on an undirected graph $G = (V, E)$ where V is a set of routers and E represents a set of links. In this network, any physical link between two routers is a bi-directional link, one direction is for the down-stream and the opposite direction is for the up-stream. We use the notation $\{uv\}$ to denote a physical link (without direction) and uv as an arc with direction from u to v . A link $\{uv\}$ is considered to be active if there is data going through at least one of its directions. Each active link $\{uv\}$ and router u is respectively associated with a power consumption value $PE_{\{uv\}} = 200$ Watts [CMN11] and $PN_u = 30$ Watts [GMPR12]. We are given a set $\mathcal{D} = \{(s, t) \in V \times V : s \neq t\}$ representing the traffic demands, where D^{st} denotes the volume of demand from s to t . Let $\lambda^{st} \in [0, 1)$ be the percentage of traffic redundancy of the demand (s, t) . Corresponding to λ^{st} , we define $\gamma^{st} = (1 - \lambda^{st})$ which represents the percentage of unique (non redundant) traffic. For instance, for a 10 Gbps traffic demand with $\lambda^{st} = 40\%$ of redundancy, its volume can be reduced by RE technique to $10 \times \gamma^{st} = 6$ Gbps of non-redundant traffic. For simplicity, a traffic flow from which redundancy has been removed is called a *compressed flow*.

We use binary variables $x_{\{uv\}}$ and w_u to denote respectively activated links and RE-routers. $N(u)$ is the set of neighbors of u in the graph G . Variables f_{uv}^{st} and $g_{uv}^{st}, \forall \{uv\} \in E, (s, t) \in \mathcal{D}$ denote the fraction of normal and compressed flows (s, t) on link (u, v) .

We reformulate the GreenRE model as follows:

$$\min \quad \sum_{\{uv\} \in E} PE_{\{uv\}} x_{\{uv\}} + \sum_{u \in V} PN_u w_u \quad (5.1)$$

$$\text{s.t.} \quad \sum_{v \in N(u)} (f_{vu}^{st} + g_{vu}^{st} - f_{uv}^{st} - g_{uv}^{st}) = \begin{cases} -1 & \text{if } u = s, \\ 1 & \text{if } u = t, \\ 0 & \text{otherwise} \end{cases} \quad \forall u \in V, (s, t) \in \mathcal{D} \quad (5.2)$$

$$\sum_{(s,t) \in \mathcal{D}} D^{st} (f_{uv}^{st} + \gamma^{st} g_{uv}^{st}) \leq \mu C_{uv} x_{\{uv\}} \quad \forall \{uv\} \in E \quad (5.3)$$

$$\sum_{v \in N(u)} (g_{uv}^{st} - g_{vu}^{st}) \leq w_u \quad \forall u \in V, (s, t) \in \mathcal{D} \quad (5.4)$$

$$\sum_{v \in N(u)} (g_{vu}^{st} - g_{uv}^{st}) \leq w_u \quad \forall u \in V, (s, t) \in \mathcal{D} \quad (5.5)$$

$$0 \leq f_{uv}^{st}, g_{uv}^{st} \leq 1 \quad \forall (u, v) \in E, (s, t) \in \mathcal{D} \quad (5.6)$$

$$x_{\{uv\}}, w_u \in \{0, 1\} \quad \forall \{uv\} \in E, u \in V \quad (5.7)$$

The objective function (5.1) is to minimize the power consumption of the network represented by the number of active links and activated RE-routers. Constraints (5.2) establish flow conservation constraints when considering simultaneously the normal (f_{uv}^{st}) and the compressed (g_{uv}^{st}) flows. Note that both the normal and the compressed flows can be fractional. The constraints (5.2) indicate that the sum of flows entering in a router is equal to the sum of flows outgoing from it except if the router is either the source or the destination of the demand. For example, suppose that a normal flow f_{vu}^{st} enters in a router u and leaves it with 50% of compressed flow, then we have $f_{vu}^{st} = 1$, $g_{vu}^{st} = 0$, $f_{uv}^{st} = 0.5$ and $g_{uv}^{st} = 0.5$ making thus the difference equal to 0. We use constraints (5.3), where μ denotes the link utilization in percentage, to limit the available capacity of a link. Constraints (5.4) and (5.5) are used to determine whether RE service is enabled on router u or not. If it is not ($w_u = 0$), the router u only forwards flows without compression or decompression, then the amount of compressed flows incoming and outgoing the router u is unchanged. It is noted that if a flow is compressed, it needs to be decompressed somewhere on the way to its destination. This requirement is implicitly embedded in the constraints (5.5). For instance, assume that a destination node t is not a RE-router ($w_t = 0$). When a compressed flow g_{vt}^{st} reaches its destination, because t is the last node on its path, the flow can not be decompressed. Consider the constraints (5.5), we have $u = t$, then $\sum_{v \in N(u)} g_{vt}^{st} > 0$ (the compressed flow enters node t) and $\sum_{v \in N(u)} g_{tv}^{st} = 0$ (t is the destination node). Therefore, the constraint (5.5) is violated and the flow should be decompressed before or at least at the destination node ($w_t = 1$).

Although the GreenRE model is already a complex task, it does not take the fluctuation in real-life traffic into account. In practice, the actual traffic demand D^{st} and the redundant rate γ^{st} fluctuate and are not known in advance. Hence,

a Robust-GreenRE model should be proposed to address this issue by taking both traffic demand and redundancy rate uncertainty into account while satisfying the capacity constraints (5.3).

5.3 Robust-GreenRE Model

We propose in this section a Robust-GreenRE model to deal with the traffic uncertainty like we did in chapter 4 .

In the Robust-GreenRE model, two values determining percentage of non-redundant traffic are given for each traffic demand: a nominal (default) value $\bar{\gamma}^{st} \in (0, 1]$ and a deviation $\hat{\gamma}^{st}$ such that $0 \leq \hat{\gamma}^{st}, \bar{\gamma}^{st} + \hat{\gamma}^{st} \leq 1$ and the actual non-redundant rate $\gamma^{st} \in [\bar{\gamma}^{st}, \bar{\gamma}^{st} + \hat{\gamma}^{st}]$. Similarly, each traffic demand is given by a nominal value $\bar{D}^{st} \geq 0$ and a deviation $\hat{D}^{st} \geq 0$ such that the actual demand volume $D^{st} \in [\bar{D}^{st}, \bar{D}^{st} + \hat{D}^{st}]$. Potentially, each demand is expressed with its default value: $D^{st} = \bar{D}^{st}$ and $D_{comp}^{st} = \bar{\gamma}^{st} \times \bar{D}^{st}$. In the worst case realization, the peak values should be used and each traffic pair is expressed by $D^{st} = (\bar{D}^{st} + \hat{D}^{st})$ and $D_{comp}^{st} = (\bar{\gamma}^{st} + \hat{\gamma}^{st}) \times (\bar{D}^{st} + \hat{D}^{st})$. Given two integral parameters $0 \leq \Gamma_d, \Gamma_\gamma \leq |\mathcal{D}|$ ($|\mathcal{D}|$ is the total number of demands), we denote $Q \subseteq \mathcal{D}$, $|Q| \leq \Gamma_d$, a set of traffic pairs allowed to deviate simultaneously from their nominal traffic volumes. Similarly, $Q' \subseteq \mathcal{D}$, $|Q'| \leq \Gamma_\gamma$, is a set of demands in which all RE rates can deviate simultaneously. Observe that demands in $Q \cap Q'$ are simultaneously at their peak traffic and lowest RE rates. Given $(\Gamma_d, \Gamma_\gamma)$ as the desired robustness of the network, the Robust-GreenRE problem is to minimize the energy consumption of the network while satisfying the link capacity constraints whenever at most Γ_d demands and Γ_γ RE rates deviate simultaneously from their nominal values.

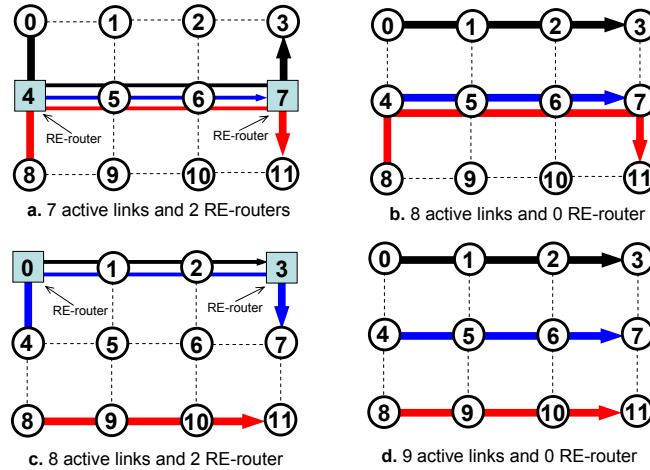

Figure 5.5: Example of robustness

Let us analyze the example of Fig. 5.5 to see that it is non-trivial to solve the Robust-GreenRE problem. We consider a (3×4) grid with a capacity of 4 Mbps

Table 5.1: Demands and redundancy rates variation

Demand (s, t)	\bar{D}^{st}	\hat{D}^{st}	$\bar{\gamma}^{st}$	$\hat{\gamma}^{st}$
(0, 3)	3	1	0.5	0.3
(4, 7)	2	1	0.6	0.3
(8, 11)	1	2	0.7	0.3

per direction of each links. There are three traffic demands to be routed: (0, 3), (4, 7) and (8, 11), each with respective nominal traffic volumes \bar{D}^{st} and deviation \hat{D}^{st} (resp. nominal RE rates $\bar{\gamma}^{st}$ and deviation $\hat{\gamma}^{st}$) as shown in Table 5.1. As shown in Fig. 5.5a, this is the optimal solution for the case in which no uncertainty is defined ($\Gamma_d = \Gamma_\gamma = 0$). In this solution, we activate two RE-routers at nodes 4 and 7 and the total traffic passing through links (4 – 5 – 6 – 7) is equal to $\bar{D}^{0,3} \times \bar{\gamma}^{0,3} + \bar{D}^{4,7} \times \bar{\gamma}^{4,7} + \bar{D}^{8,11} \times \bar{\gamma}^{8,11} = 3 \times 0.5 + 2 \times 0.6 + 1 \times 0.7 = 3.4 < 4$.

Table 5.2: 9 cases of the robustness

Case	Q	Q'	Best solution	Link load l_{uv} (Mbps)
1	(0,3)	(0,3)	Fig. 1b 1600 Watts	$l_{0,1,2,3} = 4, l_{4,5,6,7} = 3,$ $l_{8,4} = l_{7,11} = 1$
2	(0,3)	(4,7)	Fig. 1b 1600 Watts	$l_{0,1,2,3} = 4, l_{4,5,6,7} = 3,$ $l_{8,4} = l_{7,11} = 1$
3	(0,3)	(8,11)	Fig. 1b 1600 Watts	$l_{0,1,2,3} = 4, l_{4,5,6,7} = 3,$ $l_{8,4} = l_{7,11} = 1$
4	(4,7)	(0,3)	Fig. 1b 1600 Watts	$l_{0,1,2,3} = 3, l_{4,5,6,7} = 4,$ $l_{8,4} = l_{7,11} = 1$
5	(4,7)	(4,7)	Fig. 1b 1600 Watts	$l_{0,1,2,3} = 3, l_{4,5,6,7} = 4,$ $l_{8,4} = l_{7,11} = 1$
6	(4,7)	(8,11)	Fig. 1b 1600 Watts	$l_{0,1,2,3} = 3, l_{4,5,6,7} = 4,$ $l_{8,4} = l_{7,11} = 1$
7	(8,11)	(0,3)	Fig. 1c 1660 Watts	$l_{0,1,2,3} = 3.6, l_{4,0} = 2,$ $l_{8,9,10,11} = 3, l_{3,7} = 2$
8	(8,11)	(4,7)	Fig. 1c 1660 Watts	$l_{0,1,2,3} = 3.3, l_{4,0} = 2,$ $l_{8,9,10,11} = 3, l_{3,7} = 2$
9	(8,11)	(8,11)	Fig. 1c 1660 Watts	$l_{0,1,2,3} = 2.7, l_{4,0} = 2,$ $l_{8,9,10,11} = 3, l_{3,7} = 2$

Consider now the robust case in which $\Gamma_d = \Gamma_\gamma = 1$. There are 9 possible cases for the combinations of deviation in traffic volumes and RE rate as reported in Table 5.2. In Case 1, demand (0, 3) deviates both on its traffic volume and RE rate. Thus the solution of Fig. 5.5a is infeasible because the traffic volume passing through links (4 – 5 – 6 – 7) is $(\bar{D}^{0,3} + \hat{D}^{0,3}) \times (\bar{\gamma}^{0,3} + \hat{\gamma}^{0,3}) + \bar{D}^{4,7} \times \bar{\gamma}^{4,7} +$

$\bar{D}^{8,11} \times \bar{\gamma}^{8,11} = (3 + 1) \times (0.5 + 0.3) + 2 \times 0.6 + 1 \times 0.7 = 5.1 > 4$. The optimal solution in this case is presented in Fig. 5.5b in which 8 links are activated and no RE-router is used. The power consumption is $8 \times 200 = 1600$ Watts. In Case 9, both the traffic volume and the RE rate of demand (8, 11) deviate simultaneously. The solution in Fig. 5.5b is infeasible in this case even if we enable RE-routers at node 4 and 7 since the total traffic passing through links (4 – 5 – 6 – 7) will be $\bar{D}^{4,7} \times \bar{\gamma}^{4,7} + (\bar{D}^{8,11} + \hat{D}^{8,11}) \times (\bar{\gamma}^{8,11} + \hat{\gamma}^{8,11}) = 2 \times 0.6 + (1+2) \times (0.7+0.3) = 4.2 > 4$. In Case 9, the optimal solution is the one of Fig. 5.5c with 8 active links and 2 RE-routers. However, in the Robust-GreenRE model with $\Gamma_d = \Gamma_\gamma = 1$, any demand can deviate from its nominal volume or RE rate, as long as at most one demand and one RE rate deviate their volumes at the same time. Consequently, a solution is feasible if and only if it satisfies all of the 9 cases. Hence, Fig. 5.5d is the only feasible solution since Fig. 5.5c is infeasible for Case 1 of Table 5.2.

The idea of robustness is that we should reserve some space in the link capacity to accommodate the fluctuation in the traffic volumes and RE rates. To do so, we define a function $\delta(f, g, \Gamma_d, \Gamma_\gamma)$ such that the capacity constraints satisfy:

$$\sum_{(s,t) \in \mathcal{D}} \bar{D}^{st} (f_{uv}^{st} + \bar{\gamma}^{st} g_{uv}^{st}) + \delta(f, g, \Gamma_d, \Gamma_\gamma) \leq \mu C_{uv} x_{uv} \quad (5.3')$$

The problem now is to find the value of the function $\delta(f, g, \Gamma_d, \Gamma_\gamma)$. To answer this question, we use the notations $Q_d = Q \setminus Q'$, $Q_\gamma = Q' \setminus Q$ and $Q_{d\gamma} = Q \cap Q'$ as independent sets such that: $Q_{d\gamma}$ contains demands in which both traffic volumes and RE rates can deviate, Q_d (resp. Q_γ) contains demands in which only traffic volumes (resp. RE rates) can deviate from their nominal values. Indeed, we can formulate the problem using the two sets Q (demands variation) and Q' (RE rates variation). However, the final formulation will be non-linear. Therefore the three sets Q_d , Q_γ and $Q_{d\gamma}$ have to be used to overcome this problem. For simplicity, we use the notation e instead of uv , $\forall \{uv\} \in E$. Then the worst case scenario when considering fluctuation on an arc e is given by:

$$\begin{aligned} & \sum_{(s,t) \in \mathcal{D}} \bar{D}^{st} f_e^{st} + \max_{Q \subseteq \mathcal{D}} \left\{ \sum_{(s,t) \in Q} \hat{D}^{st} f_e^{st} \right\} + \sum_{(s,t) \in \mathcal{D}} \bar{D}^{st} \bar{\gamma}^{st} g_e^{st} \\ & \quad + \\ & \max_{Q_\gamma = Q' \setminus Q} \left\{ \sum_{(s,t) \in Q_\gamma} \bar{D}^{st} \hat{\gamma}^{st} g_e^{st} \right\} + \max_{Q_{d\gamma} = Q \cap Q'} \left\{ \sum_{(s,t) \in Q_{d\gamma}} (\hat{D}^{st} \hat{\gamma}^{st} + \hat{D}^{st} \bar{\gamma}^{st} + \bar{D}^{st} \hat{\gamma}^{st}) g_e^{st} \right\} \\ & \quad + \\ & \max_{Q_d = Q \setminus Q'} \left\{ \sum_{(s,t) \in Q_d} \hat{D}^{st} \bar{\gamma}^{st} g_e^{st} \right\} \leq \mu C_e x_e \quad (5.3'') \end{aligned}$$

Obviously, Constraints (5.3') and (5.3'') are equivalent if $\delta(f, g, \Gamma_d, \Gamma_\gamma)$ is the maximum part of Constraint (5.3''). Constraint (5.3'') can be rewritten as a set of many constraints corresponding to all possible sets Q_d , Q_γ and $Q_{d\gamma}$, but the resulting model has an exponential number of constraints. We thus propose three methods to overcome this difficulty.

5.3.1 Compact formulation

Given f_e^{st} , g_e^{st} , Γ_d , and Γ_γ , the function $\delta(f, g, \Gamma_d, \Gamma_\gamma)$ can be computed by:

$$(primal) \quad \delta(f, g, \Gamma_d, \Gamma_\gamma) = \max \sum_{(s,t) \in \mathcal{D}} \left(\widehat{D}^{st} f_e^{st} (z_{e,Q_d}^{st} + z_{e,Q_{d\gamma}}^{st}) + \overline{D}^{st} \widehat{\gamma}^{st} g_e^{st} z_{e,Q_\gamma}^{st} \right. \\ \left. + (\widehat{D}^{st} \widehat{\gamma}^{st} + \widehat{D}^{st} \overline{\gamma}^{st} + \overline{D}^{st} \widehat{\gamma}^{st}) g_e^{st} z_{e,Q_{d\gamma}}^{st} + \widehat{D}^{st} \overline{\gamma}^{st} g_e^{st} z_{e,Q_d}^{st} \right)$$

$$\text{s.t.} \quad \sum_{(s,t) \in \mathcal{D}} (z_{e,Q_d}^{st} + z_{e,Q_{d\gamma}}^{st}) \leq \Gamma_d \quad \forall e \in E \quad [\pi_{e,d}] \quad (5.3a)$$

$$\sum_{(s,t) \in \mathcal{D}} (z_{e,Q_\gamma}^{st} + z_{e,Q_{d\gamma}}^{st}) \leq \Gamma_\gamma \quad \forall e \in E \quad [\pi_{e,\gamma}] \quad (5.3b)$$

$$z_{e,Q_d}^{st} + z_{e,Q_{d\gamma}}^{st} + z_{e,Q_\gamma}^{st} \leq 1 \quad \forall e \in E, (s,t) \in \mathcal{D} \quad [\sigma_e^{st}] \quad (5.3c)$$

$$z_{e,Q_d}^{st} \in \{0, 1\} \quad \forall e \in E \quad [\rho_{e,d}^{st}] \quad (5.3d)$$

$$z_{e,Q_\gamma}^{st} \in \{0, 1\} \quad \forall e \in E \quad [\rho_{e,\gamma}^{st}] \quad (5.3e)$$

$$z_{e,Q_{d\gamma}}^{st} \in \{0, 1\} \quad \forall e \in E \quad [\rho_{e,d\gamma}^{st}] \quad (5.3f)$$

where binary variables z_{e,Q_d}^{st} , z_{e,Q_γ}^{st} and $z_{e,Q_{d\gamma}}^{st}$ denote whether a traffic pair (s, t) belongs respectively to the sets Q_d , Q_γ , $Q_{d\gamma}$ or not. Note that, a traffic demand (s, t) belongs exactly to one and only one of the three sets Q_d , Q_γ and $Q_{d\gamma}$. Constraints (5.3a) and (5.3b) are used to limit size of the set $|Q| = |Q_d \cup Q_{d\gamma}| \leq \Gamma_d$ and $|Q'| = |Q_\gamma \cup Q_{d\gamma}| \leq \Gamma_\gamma$. Constraint (5.3c) indicates that no traffic pair (s, t) can belong to more than one of the three sets Q_d , Q_γ and $Q_{d\gamma}$.

We now need to find LP duality of the above primal problem using dual variables $\pi_{e,d}$, $\pi_{e,\gamma}$, σ_e^{st} , $\rho_{e,d}^{st}$, $\rho_{e,d\gamma}^{st}$ and $\rho_{e,\gamma}^{st}$. To do so, we first relax the last three constraints (5.3d), (5.3e) and (5.3f) to real variables: $0 \leq z_{e,Q_d}^{st}, z_{e,Q_{d\gamma}}^{st}, z_{e,Q_\gamma}^{st} \leq 1$. By employing LP duality for the relaxation of the primal, we obtain:

$$(dual) \quad \delta_{relax}(f, g, \Gamma_d, \Gamma_\gamma) = \min \Gamma_d \pi_{e,d} + \Gamma_\gamma \pi_{e,\gamma} + \sum_{(s,t) \in \mathcal{D}} (\sigma_e^{st} + \rho_{e,d}^{st} + \rho_{e,\gamma}^{st} + \rho_{e,d\gamma}^{st})$$

$$\text{s.t.} \quad \pi_{e,d} + \sigma_e^{st} + \rho_{e,d}^{st} \geq \widehat{D}^{st} (f_e^{st} + \overline{\gamma}^{st} g_e^{st}) \quad \forall (s,t) \in \mathcal{D} \quad (5.3a')$$

$$\pi_{e,d} + \pi_{e,\gamma} + \sigma_e^{st} + \rho_{e,d\gamma}^{st} \geq \widehat{D}^{st} f_e^{st} + \left(\widehat{D}^{st} \widehat{\gamma}^{st} + \widehat{D}^{st} \overline{\gamma}^{st} + \overline{D}^{st} \widehat{\gamma}^{st} \right) g_e^{st} \\ \forall (s,t) \in \mathcal{D} \quad (5.3b')$$

$$\pi_{e,\gamma} + \sigma_e^{st} + \rho_{e,\gamma}^{st} \geq \overline{D}^{st} \widehat{\gamma}^{st} g_e^{st} \quad \forall (s,t) \in \mathcal{D} \quad (5.3c')$$

$$\pi_{e,d}, \pi_{e,\gamma}, \sigma_e^{st}, \rho_{e,d}^{st}, \rho_{e,\gamma}^{st}, \rho_{e,d\gamma}^{st} \geq 0 \quad \forall (s,t) \in \mathcal{D} \quad (5.3d')$$

Since the primal problem is a *max* problem, the optimal value of the relaxation of the primal $\delta_{relax}(f, g, \Gamma_d, \Gamma_\gamma)$ is greater or equal to the original one $\delta(f, g, \Gamma_d, \Gamma_\gamma)$.

As a result, the objective of the duality of the relaxation is also greater or equal to $\delta(f, g, \Gamma_d, \Gamma_\gamma)$ and it makes the capacity constraint strongly robust. By embedding this duality of the relaxation into (5.1)–(5.7), the (strong) Robust-GreenRE problem can be compactly formulated by replacing Constraint (5.3) with:

$$\sum_{(s,t) \in \mathcal{D}} (\sigma_e^{st} + \rho_{e,d}^{st} + \rho_{e,\gamma}^{st} + \rho_{e,d\gamma}^{st}) + \sum_{(s,t) \in \mathcal{D}} \bar{D}^{st} (f_e^{st} + \bar{\gamma}^{st} g_e^{st}) + \Gamma_d \pi_{e,d} + \Gamma_\gamma \pi_{e,\gamma} \leq \mu C_e x_e \quad \forall e \in E \quad (5.8)$$

and adding constraints (5.3a'), (5.3b'), (5.3c') and (5.3d') to the deterministic model (5.1)–(5.7).

5.3.2 Constraint generation (Exact Algorithm)

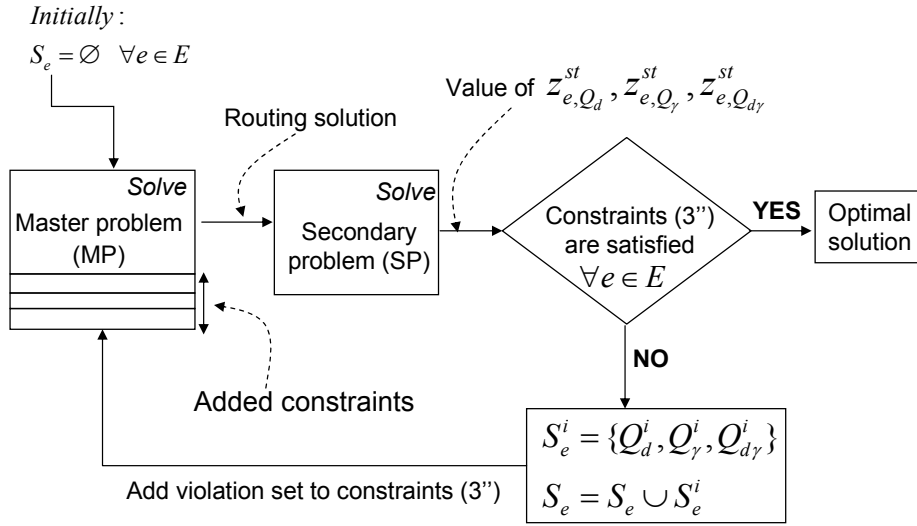

Figure 5.6: Diagram of constraint generation method

The compact formulation in some cases gives a stronger robustness than what we need. Therefore, we pay more and the result obtained is a lower bound on energy savings. In this section, we present an algorithm that aims at finding the exact solution of the Robust-GreenRE model. We refer the reader to the explanation in [KKR13] for a similar method applied for the case in which only demand variation is considered. The main idea is to generate iteratively subsets of traffic demands representing demands which traffic volumes and/or RE rates may deviate from their nominal values. Let us call:

- *Master Problem (MP)*: deterministic ILP formulated with Constraints (5.1)–(5.7);

- *Secondary Problem (SP)*: primal model of the compact formulation, so Constraints (5.3a)–(5.3f) with the primal objective function.

We define for each link e of the network a set $S_e^i = \{Q_d^i, Q_{d\gamma}^i, Q_\gamma^i\}$ of demands which does not satisfy the constraints (5.3'') (or (5.3')) where $S_e = \{S_e^i\}$, for all $e \in E$ at each iteration i of the algorithm (Fig. 5.6).

Initially, we set $S_e = \emptyset$ for all $e \in E$. We start the algorithm by solving the MP to find a first feasible routing. Then, we use the values of f_e^{st} and g_e^{st} given by the routing solution as inputs for determining $\delta(f, g, \Gamma_d, \Gamma_\gamma)$ using the SP. Based on the objective value of the SP, we check if constraints (5.3'') are satisfied or not for each link. As soon as we find a capacity violation on a link, we use the values of z_{e, Q_d}^{st} , $z_{e, Q_{d\gamma}}^{st}$ and z_{e, Q_γ}^{st} to determine $Q_d^i, Q_{d\gamma}^i, Q_\gamma^i$. We define S_e^i and update $S_e = S_e \cup S_e^i$. Finally, we add a new constraint corresponding to the violated constraint (5.3'') and S_e^i to the Master Problem. This new constraint prevents the demands in S_e^i to be routed simultaneously on the same link. This process is repeated until there is no more violation. If at one step, the Master Problem is infeasible, we conclude that there is no solution satisfying the robustness. Otherwise, the final solution is optimal for Robust-GreenRE.

It is important to understand that the feasible solutions (resp. upper bounds) of the MP found in the intermediate iterations are not feasible solutions (resp. upper bounds) for Robust-GreenRE. Indeed, the solution computed by MP at intermediate iteration is feasible only for some subsets of Γ_d and Γ_γ demands deviating but not all of them. Therefore, it can not represent the value $\delta(f, g, \Gamma_d, \Gamma_\gamma)$ as expressed in the *primal* model. This is more explained in the following example. Nonetheless, the lower bounds of the intermediate steps are valid lower bounds for Robust-GreenRE.

Example Let us consider a network with nodes $V = \{A, B, C\}$ and bi-directional links $E = \{AB, AC, BC\}$. Each link has a capacity of 2 Mbps in each direction. Let us also consider the set of demands $\mathcal{D} = \{(A, B), (A, C), (B, C)\}$ all with nominal volume of 1 Mbps, deviation volume of 0.5 Mbps and no compression rate. We set $\Gamma_d = 33\%$ and $\Gamma_\gamma = 0\%$.

Fig. 5.7 shows different possible iterations of the CG method (the sequence is not unique). The first solution, reported in Fig. 5.7a, is a feasible routing computed by MP when no deviation is allowed. Since $\Gamma_d = 33\%$, at least one demand can deviate its volume and we identify with SP capacity violations on links AB and BC . Therefore, we add constraints for sets $S_{AB}^1 = \{(A, B), (A, C)\}$ and $S_{BC}^1 = \{(B, C), (A, C)\}$ to MP and then proceed with next iteration. The CG method reports successively the solution of Fig. 5.7b with capacity violation on link AB , the solution of Fig. 5.7c with capacity violation on link AB , and the solution of Fig. 5.7d without capacity violation. Consequently, the solution of Fig. 5.7d is optimal for this instance. We observe that the optimal solution has 3 active links, while the solutions found at intermediate iterations have only 2 active links, and so a lower power consumption than the optimal solution for Robust-GreenRE. This shows that the cost of the feasible solutions (and so upper bounds) reported at each intermediate

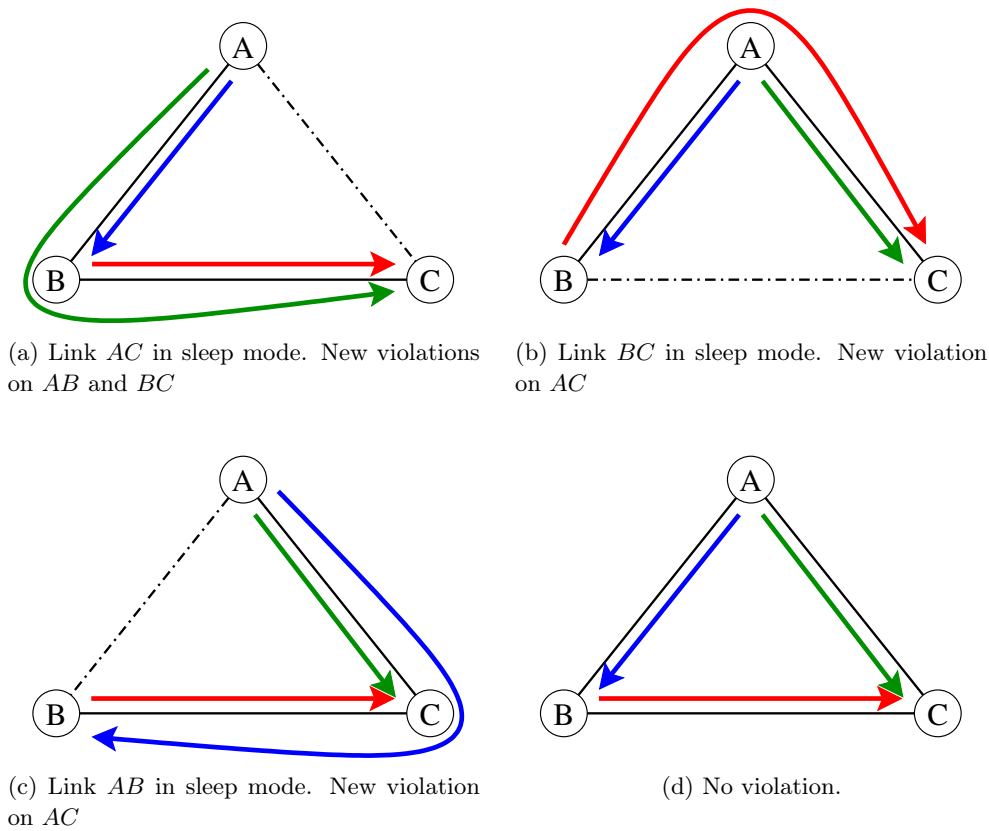

Figure 5.7: Example of iterations of the CG method

iteration of the CG method are not valid upper bounds for Robust-GreenRE. Recall however that the lower bounds computed at intermediate iterations are valid lower bounds for Robust-GreenRE.

5.3.3 Heuristic Algorithm

Energy-aware routing problem is known to be NP-Hard [GMMO10]. Also we now present a heuristic algorithm based on the compact ILP formulation to quickly find efficient solutions for large networks. Since the power consumption of a link (200 Watts [CMN11]) is much more than an enabled RE-router (30 Watts [GMPR12]), the heuristic gives priority to the minimization of the number of active links. In summary, the heuristic algorithm has two steps: the first step is to use as few active links as possible, and then we minimize the number of RE-routers in the second step.

Step 1 of Algorithm 5 is a constraints satisfaction problem returning a feasible routing. Hence, we use the MILP of the compact formulation without objective function. Our simulations show that it is quite fast to find such a feasible routing solution even for large networks (see Section 5.4). In each round of the algorithm,

Algorithm 5: Heuristic for robust energy-aware routing with redundancy elimination

Inputs:

- A graph $G = (V, E)$ modeling the network with link capacity C_{uv} ;
- The robust parameters $(\Gamma_d, \Gamma_\gamma)$;
- A set of demands \mathcal{D} .

Output: A feasible solution minimizing the number of RE-routers on the set of active links E .

Step 1: *Minimize the number of active links by removing low loaded links*

```

Find a feasible routing solution called  $P\_current$ ;
Let  $S$  be an ordered list initialized with the links of  $G$  sorted by increasing
traffic load in  $P\_current$ ;
Let  $R := \emptyset$  be the set of links that cannot be removed;
repeat
     $e := S.lowest\_loaded\_link()$  such that  $e \notin R$ ;
     $S := S \setminus \{e\}$ ;
    if a feasible robust routing  $P\_new$  on  $E \setminus \{e\}$  is found then
         $S\_new :=$  list of links sorted by increasing traffic load in  $P\_new$ ;
        if  $P\_new$  has less active links than  $P\_current$  then
             $P\_current := P\_new$ ;
             $S := S\_new$ ;
             $E := E \setminus \{e\}$ ;
        else
             $R := R \cup \{e\}$ ;
until  $(S = \emptyset)$  or  $(R = S)$ ;
Return the final feasible routing solution (if any);

```

Step 2: *Find feasible solution minimizing the number of RE-routers on the set of active links E found in Step 1.*

└ We use the compact ILP formulation to minimize the number of RE-routers.

we try to remove a link with low load and then to find and evaluate a new feasible routing using less active links. The idea behind this algorithm is that we try to turn off low loaded links and to accommodate their traffic on other links in order to reduce the total number of active links. Observe that unused links (i.e. links that are not carrying traffic) are not considered in the set S since the removal of such a link will result in a routing P_{new} equal to the routing $P_{current}$.

If a feasible routing is found in Step 1, and so a set of active links, we proceed in Step 2 to minimize the number of enabled RE-routers. More precisely, we use the compact ILP formulation in which the objective function is set to $\min \sum_{u \in V} w_u$. Furthermore, we set all binary variables associated to active links to 1 and the others to 0 (this speed-up the resolution of the MILP).

To further reduce the computation time of Algorithm 5, we can consider additional heuristic. For instance, in Step 1, while removing a low loaded link (and so setting a binary variable to 0) we can also set the variable $x_{\{uv\}}$ associated to a heavily loaded link to 1. Indeed, such link will certainly be part of the final solution. In addition, we can add some valid cut-inequalities to speed-up the resolution of the MILP [KPT13].

5.4 Computational Evaluation

5.4.1 Test instances and Experimental settings

We solved the Robust-GreenRE model with IBM ILOG CPLEX 12.4 solver [III14]. All computations were carried out on a computer equipped with a 2.7 Ghz CPU and 8 GB RAM. We consider real-life traffic traces collected from the SNDlib [OWPT10]: the U.S. Internet2 Network (Abilene) ($|V| = 12$, $|E| = 15$, $|\mathcal{D}| = 130$), the Geant network ($|V| = 22$, $|E| = 36$, $|\mathcal{D}| = 387$) and the Germany50 ($|V| = 50$, $|E| = 88$, $|\mathcal{D}| = 1595$). Note that, in section 5.4.2.1, we use a simplified Abilene network in which only a half of demands are used (65 demands, randomly chosen). It is because an exponential number of constraints can be added to the constraint generation model and so the overall computation time is more than 10 hours. Capacity is set to $C_{uv} = 5/10/20$ Gbps for each arc of the Abilene/ Germany50/ Geant network, respectively.

In our test instances, each traffic demand has two values: the nominal and the peak volumes during one day period. These values can be collected using the dynamic traffic from the SNDlib. To achieve a network with high link utilization, all traffic was scaled with a factor of three. To avoid individual bottlenecks, we add parallel links to increase capacity on some specific links. To find parallel links, we first relax the variables $x_{\{uv\}}$ to integer variables in the Master Problem. Then, we find the routing solution for the worst case scenario ($\Gamma_d = \Gamma_\gamma = 100\%$) using the relaxed Master Problem. The links (u, v) in which $x_{\{uv\}} > 1$ would be the congested links, so we add more capacity on these links and call them as parallel links. According to [AGA⁺08, AMAR09], based on real traffic traces, an upper bound on traffic redundancy is assumed to 50%. In the simulations, we use $\bar{\gamma} = 0.5$

and $\hat{\gamma} = 0.3$ and for each scenario, we vary the robust parameters (Γ_d, Γ_γ) in between 0 and the total demands ($|\mathcal{D}|$).

5.4.2 Results and Discussion

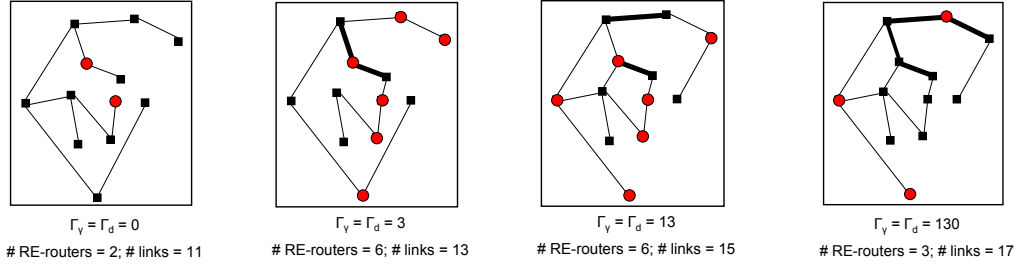

Figure 5.8: Routing and RE-router placement on Abilene network

Before discussing particular trends or characteristics of solutions, we want to give a visualization of a typical solution of Robust-GreenRE. In Fig. 5.8, we present solutions for the Abilene network. The figure indicates by line thickness, that the edge is employed with parallel links. It is noted, that the $\Gamma_\gamma = \Gamma_d = 0$ case mirrors the GreenRE model with nominal demands and RE rates while $\Gamma_\gamma = \Gamma_d = 130$ means the GreenRE model is with all peak values of traffic demands and RE rates. The subset of chosen edges is printed black and the activated RE-routers are displayed as circles. In a typical solution, between two and six RE-routers are activated. We observed that this number can change independently of the Γ value. For instance, 2 RE-routers are needed when $\Gamma_\gamma = \Gamma_d = 0$. This number increases to 6 when $\Gamma_\gamma = \Gamma_d = 3$ or 13. However, the number of RE-routers reduces to 3 when $\Gamma_\gamma = \Gamma_d = 130$. A prognosis is difficult to give, since the number of RE-routers is highly dependent on the traffic volumes, the capacity, and the network topology. Clearly, the same holds for the employed edges and depending on the demands and the employed RE-routers. However, in general, an increase in Γ leads to higher capacity requirement and more links and/or RE-routers need to be used.

5.4.2.1 Gap between different methods

In this section, we compare on the simplified Abilene network the energy savings offered by the three proposed methods: Constraints Generation (CG), Compact Formulation (CF), and Heuristic.

We have reported in Table 5.3 for various values of Γ_γ, Γ_d the optimality gap of the solutions obtained with each method in less than 10 hours of computation. For CG method, we have also reported the number of violations which corresponds to the number of added constraints. We observe that an increase in the level of robustness (represented by Γ_γ , and Γ_d) leads to a higher number of violations and so to a larger computation time. The CG method can find optimal solution in less

than 10 hours for small Γ_γ, Γ_d and for $\Gamma_\gamma = \Gamma_d = 100\%$ (i.e., all traffic demands are at their peaks). However, when $\Gamma_\gamma = \Gamma_d = 10\%$ and 20% , the CG method is not able to find optimal solutions. As explained in Section 5.3.2, as long as the optimality of the solution is not proven (i.e. no capacity violation is found), we have no guarantee that the returned solution is a feasible solution for Robust-GreenRE. Nonetheless, since we get optimal solution for the case $\Gamma_\gamma = \Gamma_d = 100\%$ which is the worse case scenario, we can use this solution to evaluate the lower bounds of the CG method when $\Gamma_\gamma = \Gamma_d = 10\%$ and 20% . This way, we conclude that for the optimality gap for these cases is around 20% .

The CF method reveals much faster since it is able to prove the optimality of the solution before the time limit in all cases but when $\Gamma_\gamma = \Gamma_d = 10\%$ of total demands. In this later case, a solution with optimality gap of 2.5% is returned. Recall nonetheless that CF computes only a lower bound on the possible energy-savings offered by Robust-GreenRE.

Finally, and as expected, the heuristic algorithm is the fastest method. All feasible solutions are found in less than 50 seconds. To evaluate the quality of the solutions returned by the heuristic, we have reported in Table 5.3 the optimality gap as the ratio of the value of the solution computed with the heuristic over the best lower bound returned by the solver for the CG method. The optimality gap is less than 5% for small values of Γ_γ, Γ_d , and it is around 25% for larger values. This indicates that the heuristic is able to quickly returned good solutions.

Table 5.3: Constraint Generation (CG) vs. Compact Formulation (CF) vs. Heuristic for Abilene network.

$\Gamma_\gamma, \Gamma_d(\%)$	CG method			CF method		Heuristic	
	# violations	opt gap (%)	time (s)	opt gap (%)	time (s)	opt gap (%)	time (s)
0	0	0	700	0	150	0	≤ 50
2	5 870	0	1 800	0	1 240	4	≤ 50
5	36 164	0	23 300	0	9 000	5	≤ 50
10	64 841	18.9	36 000	2.5	36 000	24	≤ 50
20	64 433	20.6	36 000	0	22 000	27	≤ 50
100	65 576	0	36 000	0	1 400	7	≤ 50

To perform a deeper analysis of behavior of the Constraints Generation (CG) and Compact Formulation (CF) methods, we have plotted in Figs. 5.9 and 5.10 the evolution over time of respectively the upper bound, the lower bound (Fig. 5.9), and the optimality gap (Fig. 5.10) obtained by the solver. Recall that the upper bounds reported for CG method before the optimality proof are not necessarily upper bounds for Robust-GreenRE, but lower bounds are.

We observe that the main drawback of the CG method for these instances is in the lower bounds. These bounds are very low and the CG method needs a lot of time to improve them and so reduce the optimality gap. For instance, in the case $\Gamma_d = \Gamma_\gamma = 20\%$ reported in Fig. 5.9e, the improvement of the initial lower

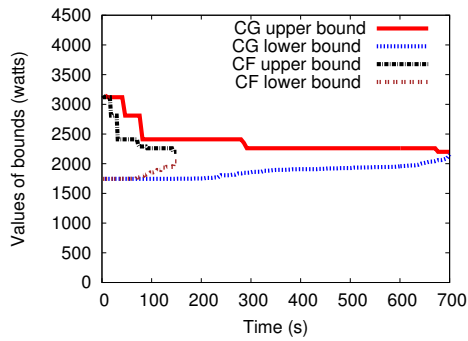

(a) Abilene $\Gamma_d = \Gamma_\gamma = 0\%$

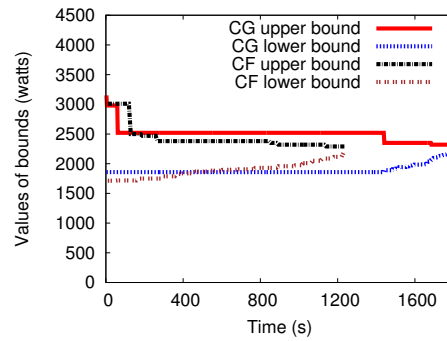

(b) Abilene $\Gamma_d = \Gamma_\gamma = 2\%$

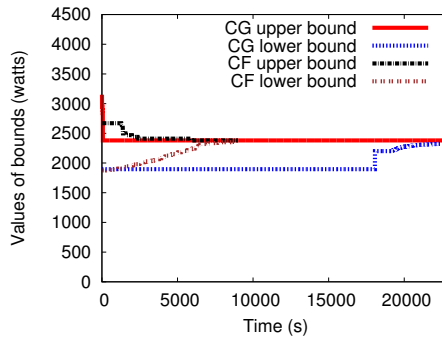

(c) Abilene $\Gamma_d = \Gamma_\gamma = 5\%$

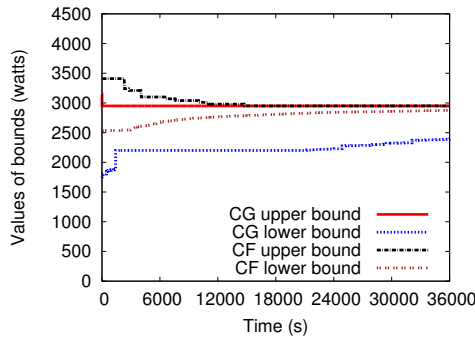

(d) Abilene $\Gamma_d = \Gamma_\gamma = 10\%$

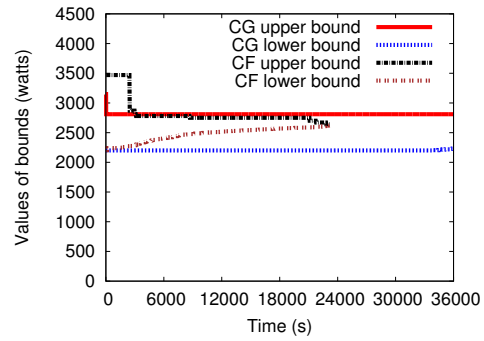

(e) Abilene $\Gamma_d = \Gamma_\gamma = 20\%$

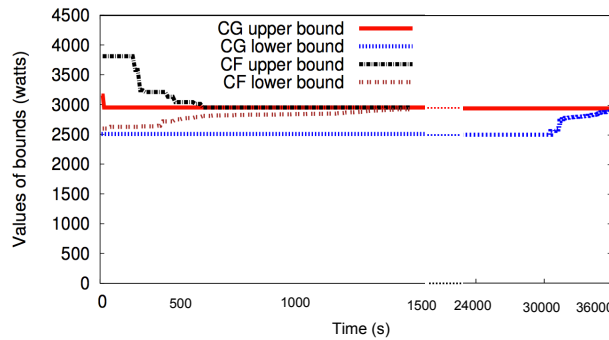

(f) Abilene $\Gamma_d = \Gamma_\gamma = 100\%$

Figure 5.9: Upper bound and lower bound: *Compact Formulation (CF)* vs. *Constraint Generation (CG)*

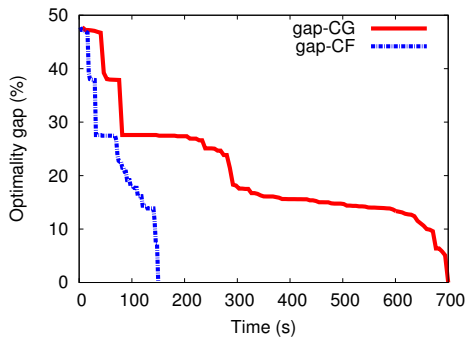
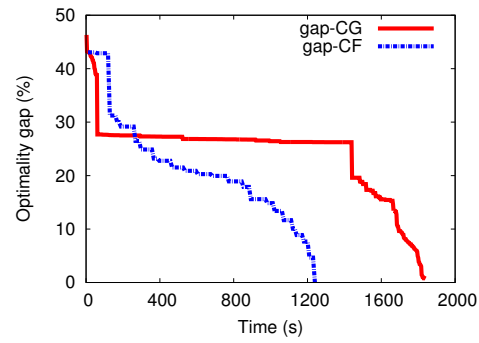
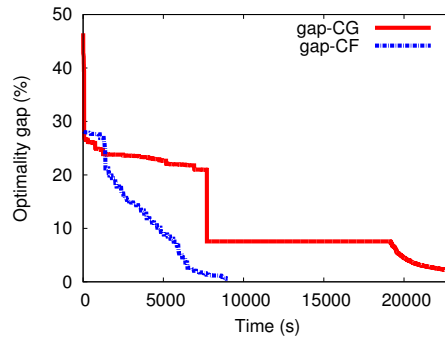
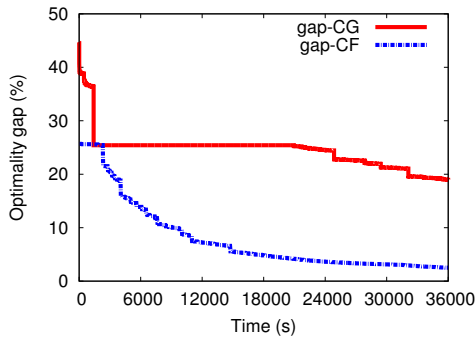
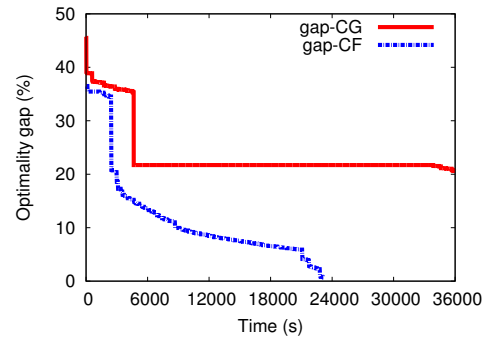
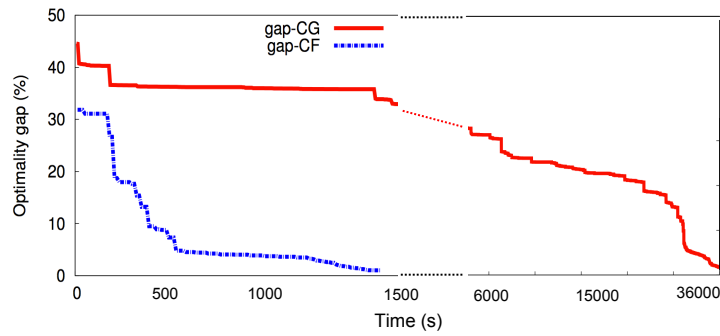
(a) Abilene $\Gamma_d = \Gamma_\gamma = 0\%$ (b) Abilene $\Gamma_d = \Gamma_\gamma = 2\%$ (c) Abilene $\Gamma_d = \Gamma_\gamma = 5\%$ (d) Abilene $\Gamma_d = \Gamma_\gamma = 10\%$ (e) Abilene $\Gamma_d = \Gamma_\gamma = 20\%$ (f) Abilene $\Gamma_d = \Gamma_\gamma = 100\%$ Figure 5.10: Optimality gaps: *Compact Formulation (CF)* vs. *Constraint Generation (CG)*

bound after 10 hours of computation is almost null. The CF method has a different behavior since both upper and lower bounds are regularly improved, and, except for the case $\Gamma_d = \Gamma_\gamma = 10\%$, the optimality of the current feasible solution is proved much before the time limit of 10 hours. Furthermore, the upper bounds of the CF method correspond to feasible solution for Robust-GreenRE.

We show in Fig. 5.10 another view of the evolution: the evolution of the optimality gap. When this gap reaches zero, the optimality of the current feasible solution is proved. Clearly, the CF method outperforms the CG method in term of improving optimality gap for these instances. However, it is noted that we can only find the exact solution using the CG method. The optimal solution obtained with the CF method is only a lower bound on the energy savings that can be made with the CG method (see section 5.3.2).

We now compare in Fig. 5.11 the performances of the three methods in terms of energy savings (y-axis) for various levels of robustness (x-axis). In this plot, both Γ_d and Γ_γ vary with the same value, e.g. robustness = 5% means $\Gamma_d = \Gamma_\gamma = 0.05 \times |\mathcal{D}|$. The percentage of energy savings is the ratio of the amount of energy saved in the Robust-GreenRE case over the total amount of energy consumed when all links are activated. It is computed using the following formula: $\frac{(200|E'| - 30W)}{200|E|}$ where $|E'|$ is the number of links in sleep mode, W is the number of RE-routers, and $|E|$ is the total number of links in the network (see the example in Section 5.2.3.1). We have not reported energy savings for the CG method with $\Gamma_d = \Gamma_\gamma = 10\%$ and 20% since we were not able to find feasible solution for Robust-GreenRE in these cases.

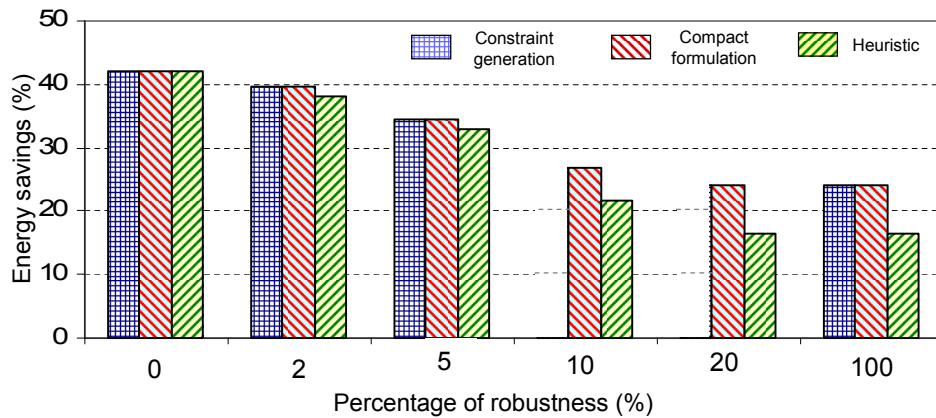

Figure 5.11: Comparison of proposed methods on Abilene.

We observe that the maximum gap reported in Fig. 5.11 between the heuristic and the CG (and CF) method is 7.63%, and this gap decreases for small values of Γ_d and Γ_γ . Recall that measurements performed on real networks have shown that only a small fraction of the traffic demands deviate simultaneously from their nominal values [KKR13]. Furthermore, the aim of robust optimization is precisely to take benefit of that fact in order to improve the design of the network, and in our case to save more energy. We have seen that our heuristic algorithm offers

good performances both in terms of running time and quality of the solution in this setting. Thus in the sequel, we will use our heuristic to evaluate the Robust-GreenRE model on larger instances.

Finally, we have to mention that the CG method was not able to find any optimal solution for Geant and Germany50 networks within the 10 hour computation time limit. Furthermore, the feasible solutions found (if any) with the CF method for these networks were worse than the solutions computed by the heuristic. Indeed, the CF method involve such a large number of variables and constraints for these instances, that we can hardly expect to find good feasible solutions within acceptable computation time. The CG and CF methods can thus be used only for instances at the scale of the Abilene instance, and they were useful to evaluate the behavior of the heuristic on such instances.

5.4.2.2 Energy savings vs. robustness

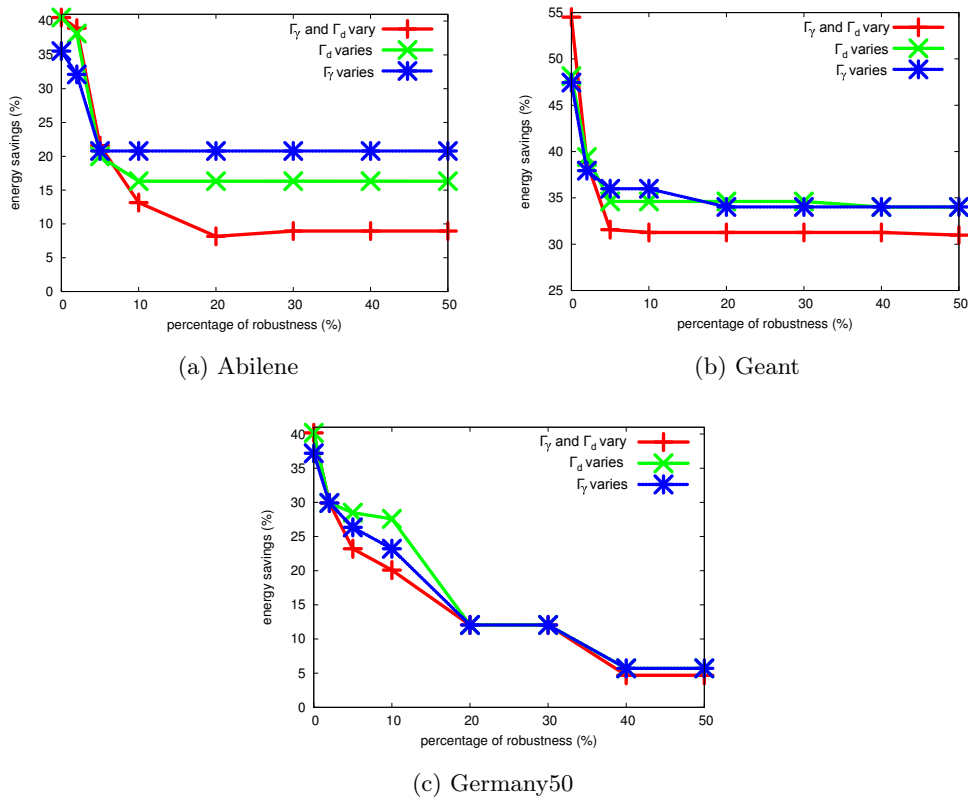

Figure 5.12: Energy savings vs. robustness for Abilene, Geant and Germany50 network

Fig. 5.12 shows the trade-off between energy savings and the level of robustness regarding the parameters (Γ_d, Γ_γ). We consider three test cases (1) both Γ_d and Γ_γ , (2) only Γ_γ and (3) only Γ_d vary their values. In the Case 1, both Γ_d and

Γ_γ vary with the same value of robustness. Note that, when $\Gamma_\gamma = \Gamma_d = 100\%$, all demands and compression rates are at the worst case, therefore the Robust-GreenRE is equivalent to the deterministic GreenRE. In Case 2 (resp. Case 3), while Γ_γ (resp. Γ_d) varies, Γ_d (resp. Γ_γ) is set to 2% of the total demands. In all the three networks, the solutions do not change when $\Gamma_d, \Gamma_\gamma \geq \frac{|D|}{2}$, thus the x-axis is cut at 50%. We observe that energy savings are proportional to $1/\Gamma$. Indeed, large values of Γ reduce the interest for robust optimization. More precisely, when $\Gamma_d, \Gamma_\gamma \geq 30\%$, energy savings offered by the Robust-GreenRE model are almost the same as the GreenRE model, while when $\Gamma_d, \Gamma_\gamma \leq 20\%$ the Robust-GreenRE model allows for significant energy savings. An explanation of this phenomenon can be found in the distribution of the demand volumes. A small fraction of the demands dominates the others in volume. Hence, when the values of Γ_d, Γ_γ covers all of these dominating demands, increasing Γ_d, Γ_γ does not affect the routing solution and the percentage of energy savings remains stable. In Case 2 and Case 3, when only Γ_d or Γ_γ varies its value, the same phenomenon is observed. It means Γ_d and Γ_γ have almost the same role in contributing to the robustness of the network.

5.4.2.3 Link utilization

We now evaluate the impact of Robust-GreenRE on links utilization. Intuitively, since any energy-aware routing scheme operating in the idleEnergy model, as described in Section 5.2.1, aims at minimizing the number of active links, fewer links are used to carry the traffic. Consequently, active links are expected to be highly loaded. To analyze this behavior, we have plotted in Fig. 5.13 the cumulative distribution function (CDF) of the links load for Abilene, Geant and Germany50 networks. The CDF describes the fraction of the links having their utilizations (loads) less or equal to a given value. Here, the utilization of a link is measured as the maximum load induced by the routing for any subset of Γ_d demands that are simultaneously at their peak and any subset of Γ_γ with reduced redundancy elimination rate. More precisely, the utilization of a link is computed as the value of the left hand side of the constraint (5.3'). Thus, this is the worst case scenario in the range of the allowed fluctuation defined by Γ_d and Γ_γ .

In Fig. 5.13 we include links that are in sleep mode and so with null load. For ease of observation, we only show three cases of robustness for each network, the other cases follow similar curve patterns. As shown in Fig. 5.13, Geant and Germany50 networks have low traffic load. For instance, 80% of the links of Geant and Germany50 networks have a load respectively under 40% and 20% of their capacities. Traffic on Abilene network is heavier, however there is no overloaded link and 80% of the links have an utilization of less than 70%. Since a higher value of robustness means that more traffic demands are at peak values, the computed link utilization is high when the level of robustness is high. For example, in Abilene network with 5% of robustness, 85% of the links are under 40% utilization, while for 20% (resp. 100%) of robustness, it is only 65% (resp. 45%) of the links that are under 40% utilization.

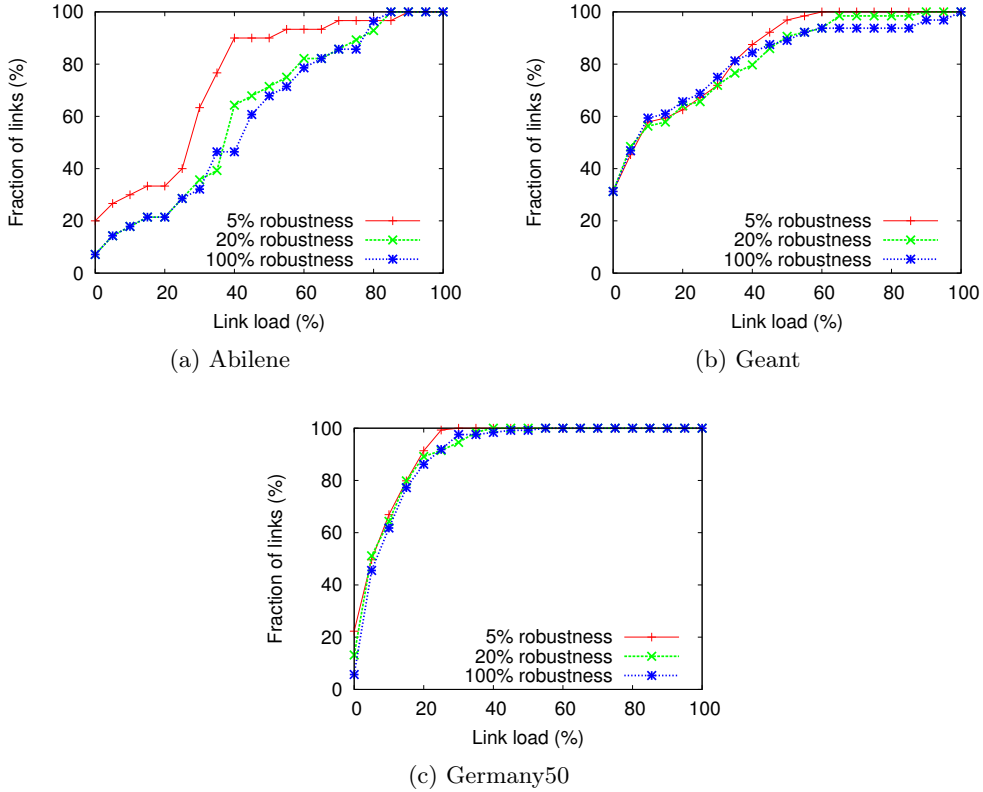

Figure 5.13: CDF load of all links including links in sleep mode for Abilene, Geant and Germany50 networks.

5.4.2.4 Robust-GreenRE vs. GreenRE vs. Classical EAR

In Fig. 5.14, we compare the Robust-GreenRE model with the GreenRE and the classical EAR (no compression) models for small values of Γ_d and Γ_γ . Since the GreenRE model does not take into account RE rate deviation, we set $\gamma^{st} = 0.8$ (20% of traffic is redundant) and for EAR model, γ^{st} is set to 1.0 (no compression). Furthermore, since traffic volume variations are not handled by GreenRE and EAR models, all demands are at peak. When $\Gamma_d = \Gamma_\gamma = 0\%$, all traffic demands are at their nominal values, the Robust-GreenRE model becomes the GreenRE model with nominal traffic demands, namely the GreenRE_{nominal}. Therefore, energy savings of the Robust-GreenRE model is in between that of the GreenRE_{nominal} and the GreenRE models. We observe that, in Germany50 network, the EAR and the GreenRE models offer a small amount of energy savings. A forecast is difficult to give, since energy savings is dependent on both the network topology and the traffic matrix. One parameter that can be used to explain the phenomenon is that the volume of peak traffic in Germany50 network is much bigger than the nominal one (the average ratio of the peak over the nominal traffic is around 6). That is why the Robust-GreenRE model provides higher energy savings than the EAR and

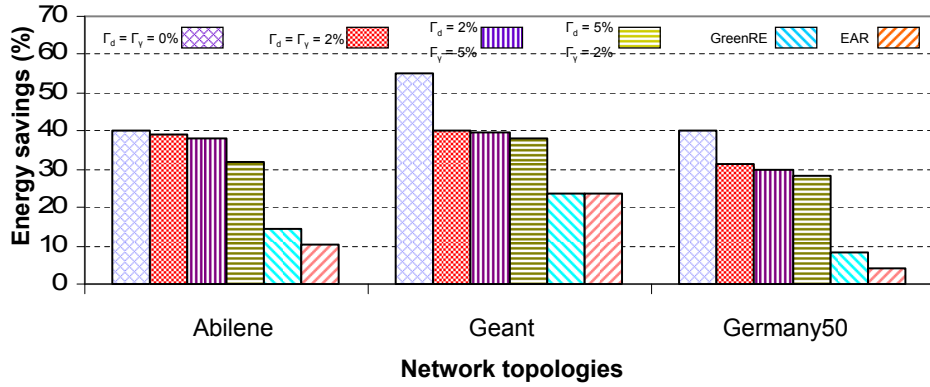

Figure 5.14: Robust-GreenRE vs. GreenRE vs. EAR.

the GreenRE model in Germany50 network. It is noted that the Robust-GreenRE model is more efficient than the GreenRE model when only few traffic demands fluctuate their volumes and RE rates (Γ is relatively small). When Γ is quite big, e.g. $\Gamma \geq 20\%$, the Robust-GreenRE and the GreenRE models yield almost the same amount of energy saving (as shown in Fig. 5.12). However, this result does not invalidate the benefit of Γ -robustness because in real-life traffic, only a few demands will vary their traffic simultaneously [KKR13]. In summary, when $\Gamma = 2 - 5\%$, the Robust-GreenRE model outperforms the other models and allows for 16 – 28% additional energy savings in all the considered networks.

5.5 Conclusion

In this work, we have formally defined and modeled the Robust-GreenRE problem and applied it to backbone networks. Taking into account the uncertainties of traffic volumes and redundancy elimination rates, the Robust-GreenRE model provides a more accurate evaluation of energy savings for backbone networks. Based on real-life traffic traces, we have shown a significant improvement of energy savings compared with other models. As future work, we shall investigate implementation issues and impacts of Robust-GreenRE model on QoS and fault tolerance. We shall also look into other available methods that together with EAR, could be directly applied to wireless backhaul networks.

Conclusion

With the increasing demand of data bandwidth, high-speed and reliable services by mobile subscribers and with the improvements in the access networks, the capacity bottleneck of cellular networks has moved toward the backhaul. In this thesis, we have studied several optimization problems related to the minimization of the CAPEX and OPEX of backhaul networks, and on the improvement of the revenues of the network operator.

In Chapter 3, we studied the problem of dimensioning a fixed broadband wireless network under unreliable conditions. It consists in assigning bandwidth, thus capacity, to the links in order to minimize the annual fees of renting the bandwidth while all the demands are satisfied with high probability. In our formulation, we considered a dynamic routing approach of demands and we proposed a column generation algorithm to solve the problem. To assess our method, we have performed numerical evaluation on realistic network instances. Our results show that our approach allows for up to 45% of cost savings regarding to the worst case. A comparison of our results with those of previous work validates the efficiency of our solution, specifically on large instances.

In Chapter 4, we applied the infrastructure sharing concept to backhaul networks, that is highly recommended by regulatory authorities. The goal was to help the owner of the network infrastructure to increase its income by renting its network to other operators. We thus investigate the problem of maximizing the total renting revenue of the PNO in a multi-operator network context and under demand uncertainties and QoS requirements. We formally defined a Γ -robust Mixed Integer Linear Program (MILP) to model the problem, and we evaluated our formulation on several real-life network topologies. In particular, we analyzed the impact of the robustness level and that of the agreed SLA on the PNO revenue. However, our ILP formulation is hard to solve on large-scale networks. Also, we proposed different heuristics to find efficient solutions in lower resolution time. Our experiments showed the computation time reductions offered by the greedy and the powerset heuristics with almost the same solutions quality.

Besides, we worked on the green networking field, more specifically we investigated the problem of reducing the energy consumption of backbone networks. We combined the strengths of energy-aware routing (EAR) with the concept of data traffic redundancy elimination (RE) to maximize the energy saving in the context of variable demand volumes and RE rates. We formalized the problem as a MILP using Γ -robustness method. We proposed three different resolution methods for this

NP-hard problem. The simulation results on different network instances highlighted an extra energy savings from 16% to 28% with respect to the simple EAR model.

In this thesis, we have investigated some open questions related to the optimization and the cost-effectiveness of microwave backhaul networks. Nonetheless, many questions remain open. For instance, further algorithmic improvements are needed for the resolution of the problem of dimensioning a fixed broadband wireless networks under unreliable conditions, in particular to speed up the exploration of the feasibility set of the pricing problem and improve the reliability of the solutions. Another research direction is to introduce in this design problem some correlation between microwave links configurations. More precisely, environmental conditions may affect simultaneously geographically localized links. For instance, a storm will affect the radio propagation of all links incident to a particular node of the network. The inclusion of such correlation into the design problem may lead to another expression of a network scenario probability, and help to propose a more realistic solution to this problem.

Another interesting question is related to the long term deployment and improvement of backhaul networks. Typically, the network operator needs accurate recommendations on where and when to invest for either adding new microwave links (densification or coverage extension), or to connect to a neighboring optical network, or to install a new optical link, or even to stop using a link that is no longer useful. This raised many challenging questions that are hard to solve.

With respect to the energy-efficiency of microwave backhaul networks, some hardware and software innovations should be done in the IDU and ODU equipments to enable the use of our solution. It has been proved in [TMF⁺14] that the power consumption of the wireless backhaul networks can account for up to 50% of the total power consumption of the wireless access network. Greening and designing energy-efficient backhaul network will then become a hot research topic. We plan to investigate other methods, more adapted to backhaul networks, like the dynamic adaptation of BS power consumption as a function of the traffic load.

Finally, we are currently studying a radio spectrum efficiency problem in the context of Cognitive Radio Networks (CRNs). In the first step of this work, presented in the Appendix of this thesis, we formalized how to maximize a CRN throughput when exploiting unused radio spectrum. We also intend to adapt the robustness concept to the many optimization problems related to this highly variable network.

Optimization in Cognitive Radio Networks

Contents

A.1 Cognitive Radio Networks	94
A.2 Related works and problem definition	95
A.3 Nominal model	98
A.4 Robust model	99
A.5 Conclusion	103

In this last chapter, we investigate on maximizing the throughput of the secondary users of a cognitive radio network (CRN). This problem is derived from the efficient utilization problem of the radio spectrum. We first propose a basic LP model that ensures the good use of each channel under interference conditions, the use of channels by the primary users whenever needed and the respect of the capacity constraints.

Primary Licensed users have high priority to communicate on the radio channels. Secondary users, in turn, operate on the channels when they are not in use by any primary user. However, a secondary user must stop an ongoing transmission whenever it detects the presence of a primary user on the channel. Because of their priority, the occupancy of each channel by the primary users is uncertain. Our objective, here, is to propose a robust optimization model that considers this uncertainty while maximizing the amount of data traffic transmitted by a set of secondary users in a multihop fashion to a set of gateways.

The remainder of this chapter is organized as follows. We present in section [A.1](#), more details about CRNs and their characteristics. This is followed by a brief state of the art of our problem in section [A.2](#). In section [A.3](#), we introduce our problem settings and present the nominal problem formulation. Section [A.4](#) is devoted to the transformation of the nominal model in the robust one when considering uncertainties on primary users transmission. We also present the resolution algorithm of the problem using this robust model. We then conclude this chapter by presenting some perspectives for this work.

A.1 Cognitive Radio Networks

The radio frequency spectrum is a limited natural resource regulated by governmental or international agencies. It is assigned to wireless or mobile networks operators with a license (annual or pluri-annual fees). However, this assignment results in unused portions of spectrum, called spectrum holes or white space, and in an under-utilization of the assigned ones. Cognitive Radio (CR) has emerged as a promising technology to exploit the existing spectrum in an opportunistic manner.

CR is a radio or a system that can sense the environment and dynamically and autonomously adjusts its radio operating parameters to modify the system operation [TZFS13]. CR techniques enable four main functions [ALVM06, TZFS13] :

- i The *Spectrum sensing* that helps to determine which portions of the spectrum is available.
- ii The *Spectrum management or assignment* function which selects the best available band or channel according to some criteria.
- iii The *Spectrum sharing* enables access coordination to the selected channel with others users.
- iv The *Spectrum mobility* that incorporates the handover between channels in order to avoid interfering with primary transmissions.

In CRNs, there are two types of users: primary users (PU) and secondary users (SU). PU are the priority spectrum users, that have been assigned spectrum license for long-term usage. SU are users that have no license for accessing spectrum bands [DVT08]. They are equipped with CR device designed, among others, to sense the presence of primary users and to tune the radio interfaces to the spectrum band which is not in use at any point of time for their own communication [KAA09].

A CR network architecture basically consists of primary networks and secondary networks [CPP+08] as shown in Fig. A.1. Primary networks are the existing wireless network infrastructures like GSM, UMTS, Wifi that have been assigned licenses to operate in specific frequency bands. They consist of base stations, access points and primary users. They generally do not have any functionalities for sharing the spectrum with secondary users. Secondary networks are cognitive networks whose components do not have license to access any frequency bands. However the spectrum access is allowed opportunistically. Secondary networks can operate either in infrastructure or in ad hoc modes. In infrastructure mode, secondary base stations provide one-hop communication to SU and they have the ability to discover spectrum holes [TZFS13]. In ad hoc mode, each SU needs to have all CR capabilities and is responsible for determining its actions based on the local observation [ALC09].

Due to the fluctuating nature of the available spectrum, cognitive radio network faces multiple challenges, all associated to each of its functionalities. For example, concerning the spectrum sensing, a SU should be able to detect a primary user transmitting on a channel in few second. Though the required SNR for detection

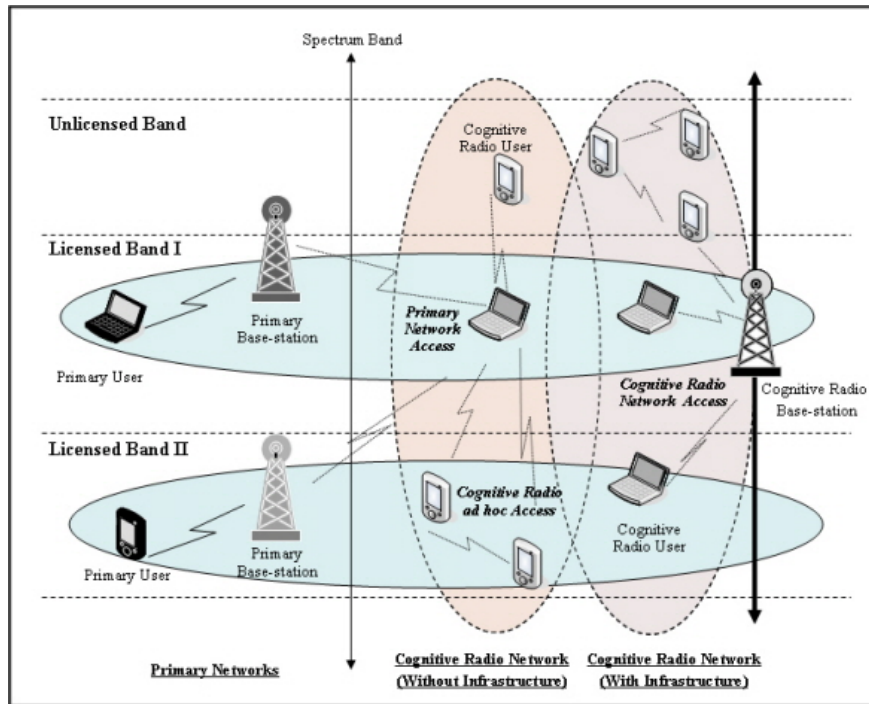

Figure A.1: Cognitive radio Network architecture [ALVM06]

may be very low if the primary user signal is faded. Also CRNs should avoid interference with primary networks. In this work, we are interested in the Spectrum Assignment (SA) problem.

Controlling the interference is essential to achieve maximum performance in wireless networks. SA is a key mechanism that limits the interference between CR devices and licensed users. It is responsible for assigning the most appropriate frequency band(s) at the interface of a CR device according to some criteria (maximum throughput, fairness, spectral efficiency, etc.), while avoiding causing interference to primary networks [TZFS13]. The objective that we targeted in this chapter is to maximize the total secondary users throughput in a predefined period of time, when these users can transmit on unused spectrum channels. We are given a set of available transmission channels and the time period reserved for primary users on each channel is also known in advance. Each node of the network, except the gateway nodes, has a routing function and can also be used by SU to inject data in the network. In the next section, we present some related works and the definition of our problem.

A.2 Related works and problem definition

In wireless networks and environments, Channel Assignment (CA) is a well-known problem that aims to assign channels to radio devices interfaces in order to minimize the interference caused by users operating on the same channel. Spectrum

assignment, while related to CA, has some specificities that differentiate it from this latter, in particular its dynamicity. Indeed, in CRN, SA function should determine, for each SU, not only the central frequency but also the spectrum bandwidth to be used by the SU. Furthermore, this operation has to be frequently repeated for the same SU due to the spectrum mobility. Multiple approaches have been developed in the literature to handle this problem in the context of CRNs. Some works used the interference or the transmission power as criterion [WRL10, LJJ10, AAM11] while for others, the goal was the spectral efficiency [BBL08, LZ09, YLH10]. Like in our study, many studies have sought to maximize the SU or network throughput [HLI07, MYQ08, LZ09, SA11]. Fairness, minimum risk, delay, and price are others criteria used for assigning spectrum to SUs in CRNs [PZZ06, CLLC07, MCG09, LGL09, GSS⁺10]. When developing their models or spectrum assignment algorithms with the objective to maximize the throughput, the aforementioned works used various constraints such as the minimum transmission power, the maximum interference-SINR, or even some QoS requirements.

In our study, we assumed that a set of secondary users can inject their data in the network, via the router, to be transmitted for example through the Internet. To do so, all the data should be sent to a network gateway. Therefore, we tried to solve a throughput maximization problem under capacity and interference constraints. We also consider some parameters uncertainty that we will explain later. We assumed that we have a cognitive radio mesh network used by primary and secondary users and composed by multiple fixed routers nodes. We also distinguished a set of gateway nodes in this network to which secondary users want to transmit data. There exists, for each node, a valid path towards at least one gateway. This path may be formed by several transmission links. We assumed that each router has two radio interfaces, such that one radio is used exclusively for receiving traffic from other nodes, while the second radio is dedicated to traffic transmission. Note that each gateway has only one radio interface tuned in reception mode but the case where some gateways have multiple radio can be easily handled by co-locating a sufficient number of single radio gateways. We are also given a predefined set of orthogonal radio channels $\mathcal{K} = \{1, \dots, K\}$ and a set $\alpha = \{\alpha_1, \alpha_2, \dots, \alpha_K\}$ of time fractions used by primary users on each channels. In fact, if we consider the channel $k \in \mathcal{K}$, primary users can use this channel for data transmission for a time fraction α_k without being disturbed by any secondary user.

Parallel transmissions on the same channel are subject to the so-called protocol interference model, where a transmission on an activable link is considered as successful when the intended receiver node falls outside the interference range R_I of other non-intended transmitters. Note that for each transmitter, $R_I \geq R_T$ where R_T is its transmission range. Let $I_f(\ell)$ be the set of links $\ell' \in E$, $\ell' \neq \ell$, whose respective transmitter is at a distance less than or equal to R_I from the destination of ℓ . Thus to avoid the interference of parallel transmissions, any link in $I_f(\ell)$ can not transmit on the same channel as link ℓ at the same time period. Moreover, we define $\Lambda(\ell)$ as the set of links that cause primary interferences to ℓ , including ℓ itself. A primary interference on link ℓ is identified when there is a data transmission on

a link sharing one radio interface with ℓ at the same time, wherever it is on the same channel or not (See Fig. A.2). Every link that shares a radio interface on an endpoint with ℓ is thus added to $\Lambda(\ell)$. More explanations about this interference model is given in the example A.2.1. To ensure some level of fairness, each router i should be able to inject into the network an amount of at least γ_i of local user traffic per time unit.

Example A.2.1. Let us consider the network instance of Fig. A.2, and let us suppose that channel $k = 1$ is used for transmission on link L_3 during a time period $d_{L_3,1}$. $\Lambda(L_3) = \{L_2, L_4\}$ because all these links share a radio interface with L_3 .

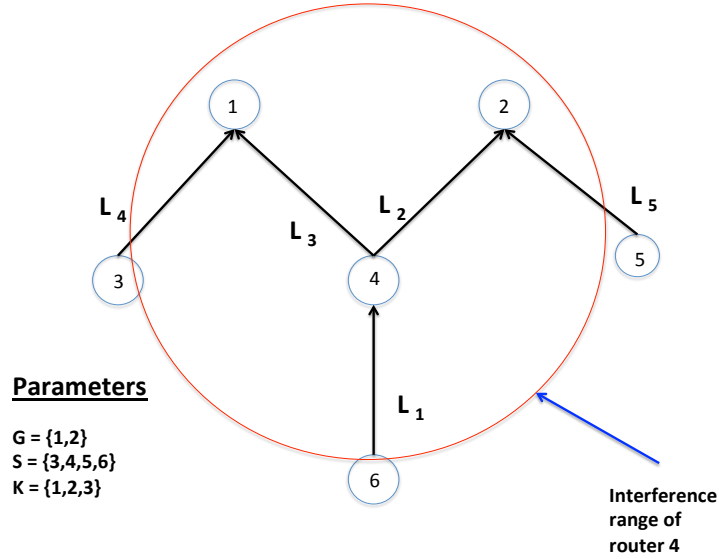

Figure A.2: A CRN instance

Also $L_5 \notin I_f(L_3)$ but $L_4 \in I_f(L_3)$.

Finally, during the $d_{L_3,1}$ time period, no transmission can be done on links L_2 and L_4 but a transmission can be done on L_1 using any channel.

Our objective in this study, is to maximize the throughput of overall traffic that reaches the gateways during a time period of one unit. We have to output the routing flows and the fraction of time during which each channel was assigned to a link for either a data transmission or a data reception.

We firstly propose the so-called nominal model, for the case when we considered all the input parameters as static values. Then in order to propose a robust model, we will take into account some uncertainty parameters.

A.3 Nominal model

This network is represented as a directed graph $D = (S \cup G, E)$ where S is the set of routers that injects in the network and relay the traffic of secondary users, and G is the set of gateways nodes. E represents the sets of activable links in D , i.e., links where the distance between the origin and the destination is less than R_T . Because of the spectrum mobility in CRN, a channel is not assigned to a unique SU for the whole transmission time like in traditional wireless networks. Instead we consider that one SU can use channel c_1 to transmit for time period d_1 and then channel c_2 for another time period d_2 and so on. So in our model, what matters is the time period during which a link has used a channel to transmit or to receive data. In the sequel, the transmitter and the receiver of a link ℓ are denoted by $t(\ell)$ and $r(\ell)$, respectively.

To model properly our problem, we need to define the following variables:

- f_ℓ represents for each link $\ell \in E$, the traffic flow transmitted from router $t(\ell)$ to router $r(\ell)$ during a time unit.
- $d_{\ell k}$ denotes for each link $\ell \in E$ and each channel k in $\{1, \dots, K\}$, the time fraction where link ℓ is activated on channel k .

The data rate that can be supported on a link ℓ per time unit is denoted as θ_ℓ . We assume that as long as a primary user is transmitting over a channel, all secondary users must remain silent on that channel. Now, the problem could be stated as follows:

Model (1)

$$\max \sum_{\substack{\ell \in E \\ r(\ell) \in G}} f_\ell \quad (\text{A.1})$$

s.t.

$$\sum_{\ell \in E, r(\ell)=i} f_\ell - \sum_{\ell \in E, t(\ell)=i} f_\ell \leq -\gamma_i, \quad \forall i \in S \quad (\text{A.2.1})$$

$$f_\ell \leq \theta_\ell \sum_{k=1}^K d_{\ell k} \quad \forall \ell \in E \quad (\text{A.2.2})$$

$$d_{\ell k} + \sum_{\ell' \in I_f(\ell)} d_{\ell' k} + \sum_{\substack{k'=1, \ell' \in \Lambda(\ell) \\ k' \neq k}}^K d_{\ell' k'} \leq 1 - \alpha_k \quad \forall \ell \in E, k = 1, \dots, K \quad (\text{A.2.3})$$

$$f_\ell \geq 0 \quad \forall \ell \in E \quad (\text{A.2.4})$$

$$d_{\ell k} \geq 0 \quad \forall \ell \in E, \forall k = 1, \dots, K \quad (\text{A.2.5})$$

Constraint (A.2.1) states that the difference between outgoing and ingoing flows on a router must be at least γ_i . Constraint (A.2.2) expresses that the flow routed

on link ℓ should be at most equal to its capacity calculated as the product of θ_ℓ and the sum of time period in which a channel is assigned to this link. θ_ℓ represents here the capacity of each link in terms of the number of packets per time unit. Constraint (A.2.3) provides a sufficient condition on each channel k so that a given link ℓ with transmission duration fraction $d_{\ell,k}$ could be scheduled with both primary and secondary interfering links in non-overlapping time intervals. This constraint also considers the time fraction α_k reserved to primary users. For instance, this constraint expresses the impossibility of transmission by links in $I_f(\ell)$ using channel k and by links in $\Lambda(\ell)$ using any channel during the time period when a link ℓ is transmitting over channel k . Moreover, with these $d_{\ell,k}$, we are able to establish a channel assignment scheduling in the total transmission period without any conflict.

A.4 Robust model

In the sequel, we assume there exists m primary users. Each such user may possibly transmits on any channel $k = 1 \dots K$, but with a known time fraction equal to λ_p ($p = 1, \dots, m$). Hence, the vector $\alpha = (\alpha_1, \alpha_2, \dots, \alpha_K)$ denoting the time fraction occupied by primary users becomes *uncertain*. This vector belongs to an uncertainty set β defined with the binary parameters b_{pk} which indicate if primary user p is transmitting on channel k . In particular, each element α_k is upper bounded by 1 and defined as:

$$\alpha_k = \sum_{p=1}^m b_{pk} \lambda_p \quad (\text{A.3})$$

where the parameters b_{pk} are subject to the following constraint that states that a primary user occupies at most one channel at the time:

$$\sum_{k=1}^K b_{pk} \leq 1, \quad p = 1 \dots m \quad (\text{A.4})$$

To handle the parameters uncertainty, a branch of Operational Research has proposed multiple methods using robust linear programming [Soy73, BTEGN09, BS04, Min11]. These works are different from stochastic programming methods which rely on probability distributions of uncertain problem parameters. Two classes of robust optimization methods can be distinguished: those using column-wise uncertainty and those using row-wise uncertainty. Our model falls inside the class of robust LP with RHS uncertainty which is a particular type of column-wise uncertainty.

Our model can be viewed as a problem in which the process of decision-making under uncertainty can be decomposed in two successive steps (two-stage decision making). For instance, in the first stage and without knowing any realization of the uncertainty, we can guarantee a certain throughput for the network. Then, after the realization of the uncertainty, the goal would be to find a channel assignment

on links and a flow that help to have the predefined throughput. Consequently and inspired by the work of Minoux [Min11], our model can be rewritten in the following compact form:

$$\max \quad c^T f$$

s.t:

$$\begin{aligned} Af + Bd &\leq b \\ f &\geq 0, \quad d \geq 0 \end{aligned}$$

Now, two types of decision variables can be distinguished from our model

- f is a vector formed by the flow variables f_ℓ such that $r(\ell) \in G$ (the flow variables of incoming links of gateways nodes). These variables could be referred to as the "here and now" decisions.
- d is a vector formed by the variables f_ℓ with $r(\ell) \in S$ and by the variables $d_{\ell k}$. It corresponds to the "wait and see" decisions.

The matrices A and B with the vector c are composed of constant parameters. The vector b has some uncertain components corresponding to the RHS terms of constraints (A.2.3).

A vector f is considered as a solution to the robust problem if a corresponding feasible vector d exists for any possible RHS vector b in the uncertainty set β . Formally, the set of feasible solutions for the first stage variables f is:

$$F = \{f | f \geq 0, \forall b \in \beta, \exists d \geq 0 : Bd \leq b - Af\}$$

Thus, the initial robust model can be reformulated as:

$$\max_{f \in F} \{c^T f\}$$

From Farkas' Lemma [DJ14], a necessary and sufficient condition for the existence of such d in F is that: $u^T(b - Af) \geq 0$ for all u in the polyhedral cone: $\Gamma = \{u | u^T B \geq 0, u \geq 0\}$.

Denoting u^1, u^2, \dots, u^q , the extreme rays of Γ , the set F can be equivalently represented by the following inequalities:

$$(u^j)^T Af \leq (u^j)^T b, \quad \forall b \in \beta, \forall j = 1, \dots, q$$

This is equivalent to:

$$(u^j)^T Af \leq \min_{b \in \beta} \{(u^j)^T b\}, \quad \forall j = 1, \dots, q \quad (\text{A.5})$$

Each ray $u \in \Gamma$ is a vector of dimension n equals to the number of constraints in Model (1). Therefore u could be described through the following ordered components, corresponding to the constraints (A.2.1), (A.2.2), (A.2.3), respectively:

- $x_i, \forall i \in S$ corresponding to the constraints (A.2.1)
- $y_\ell, \forall \ell \in E$ corresponding to the constraints (A.2.2)
- $z_{\ell k}, \forall \ell \in E, k = 1, \dots, K$ corresponding to (A.2.3)

From Model (1) and from (A.5), the robust 2-stage optimization problem is then formulated as:

Model (I)

$$\max \sum_{\substack{\ell \in E \\ r(\ell) \in G}} f_\ell \quad (\text{A.6})$$

s.t.

$$\sum_{\substack{\ell \in E \\ r(\ell) \in G}} f_\ell (y_\ell^j - x_{t(\ell)}^j) \leq \psi^j \quad j = 1, \dots, q \quad (\text{A.7})$$

$$f_\ell \geq 0, \quad \ell \in E, r(\ell) \in G \quad (\text{A.8})$$

where $\psi^j = \min_{b \in \beta} \{(u^j)^T b\}$

However, the above problem is generally hard to solve due to the potentially huge number of constraints (extreme rays). A more efficient approach is to apply *constraint generation*, where the main idea is to solve Model (I'), a relaxed version of (I), by considering only a limited number of constraints (rays), and then to check the feasibility of the solution \bar{f} with respect to any other constraint of the form:

$$(u)^T A \bar{f} - \min_{b \in \beta} \{(u)^T b\} \leq 0, \quad \forall u \in \Gamma$$

This leads us to a second problem (II), called the *separation problem*, which is:

$$\min_{u \in \Gamma} \left\{ \min_{b \in \beta} \{u^T b\} - u^T A \bar{f} \right\}$$

In our particular case, this problem could be written as follows:

$$\min_{\substack{u \in \Gamma \\ b \in \beta}} \{u^T b - u^T A \bar{f}\}$$

s.t.

$$\begin{aligned} u^T B &\geq 0 & \forall u \in \Gamma \\ u &\geq 0 & \forall u \in \Gamma \end{aligned}$$

We have:

$$\begin{aligned}
u^T b &= - \sum_{i \in S} \gamma_i x_i + \sum_{\ell \in L} \sum_{k=1}^K z_{\ell k} (1 - \alpha_k) \\
&= - \sum_{i \in S} \gamma_i x_i + \sum_{\ell \in L} \sum_{k=1}^K z_{\ell k} \left(1 - \sum_{p=1}^m b_{pk} \lambda_p\right) \\
u^T A \bar{f} &= \sum_{\substack{\ell \in E \\ r(\ell) \in G}} \bar{f}_\ell \left(y_\ell^j - x_{t(\ell)}^j\right)
\end{aligned}$$

$u^T b$ has as many components as the vector d so $u^T b \geq 0$ means that each component is positive. From Model (I), we have

$$\begin{aligned}
y_\ell - x_{t(\ell)} + x_{r(\ell)} &\geq 0 && \forall \ell \in E, r(\ell) \in S \\
-\theta_\ell y_\ell + z_{\ell k} + \sum_{\substack{\ell' \in E \\ \ell \in I_f(\ell')}} z_{\ell' k} + \sum_{\substack{k'=1, \ell \in \Lambda(\ell') \\ k' \neq k}}^K z_{\ell' k'} &\geq 0, && \forall \ell \in E, k = 1, \dots, K
\end{aligned}$$

Model (II)

$$\min \sum_{\substack{\ell \in E \\ r(\ell) \in G}} (x_{t(\ell)} - y_\ell) \bar{f}_\ell - \sum_{i \in S} \gamma_i x_i + \sum_{\substack{\ell \in E \\ t(\ell) \in G}} \sum_{k=1}^K z_{\ell k} \left(1 - \sum_{p=1}^m b_{pk} \lambda_p\right)$$

s.t.

$$\begin{aligned}
x_{r(\ell)} - x_{t(\ell)} + y_\ell &\geq 0, && \ell \in E, d(\ell) \in S \\
-\theta_\ell y_\ell + z_{\ell k} + \sum_{\substack{\ell' \in E \\ \ell \in I_f(\ell')}} z_{\ell' k} + \sum_{\substack{k'=1, \ell \in \Lambda(\ell') \\ k' \neq k}}^K z_{\ell' k'} &\geq 0, && \ell \in E, k = 1, \dots, K \\
\sum_{p=1}^m b_{pk} \lambda_p &\leq 1, && k = 1, \dots, K \\
\sum_{k=1}^K b_{pk} &\leq 1, && p = 1, \dots, m \\
x_i \geq 0, y_\ell \geq 0, z_{\ell k} \geq 0, &&& i \in S, \ell \in E, k = 1, \dots, K \\
b_{pk} \in \{0, 1\}, p = 1, \dots, m, &&& k = 1, \dots, K
\end{aligned}$$

The Model (II) is nonlinear as the objective includes products of variables $z_{\ell k}$ with b_{pk} . A straightforward linearization is to introduce additional continuous variables w_{lkp} to the model so that the objective is rewritten as:

$$\min \sum_{\substack{\ell \in E \\ r(\ell) \in G}} (x_{t(\ell)} - y_\ell) \bar{f}_\ell - \sum_{i \in S} \gamma_i x_i + \sum_{\substack{\ell \in E \\ t(\ell) \in G}} \sum_{k=1}^K z_{\ell k} - \sum_{\substack{\ell \in E \\ d(\ell) \in G}} \sum_{k=1}^K \sum_{p=1}^m w_{\ell pk} \lambda_p \quad (\text{A.10})$$

Moreover, we add the following constraints:

$$\begin{aligned} w_{\ell pk} &\leq M b_{pk}, \quad \ell \in E, p = 1, \dots, m, k = 1, \dots, K \\ w_{\ell pk} &\leq z_{\ell k}, \quad \ell \in E, p = 1, \dots, m, k = 1, \dots, K \\ w_{\ell pk} &\geq z_{\ell k} - M(1 - b_{pk}) \\ &\ell \in E, p = 1, \dots, m, k = 1, \dots, K \\ w_{\ell pk} &\geq 0, \quad \ell \in E, p = 1, \dots, m, k = 1, \dots, K \end{aligned}$$

where M is a big constant.

If the solution u of the separation problem has an objective value greater than or equal to zero, the current \bar{f} can be considered as the optimal solution of the robust problem, otherwise u is added to the master problem (I') which is then solved again. Fig. A.3 presents the constraint generation process that connects the previous models.

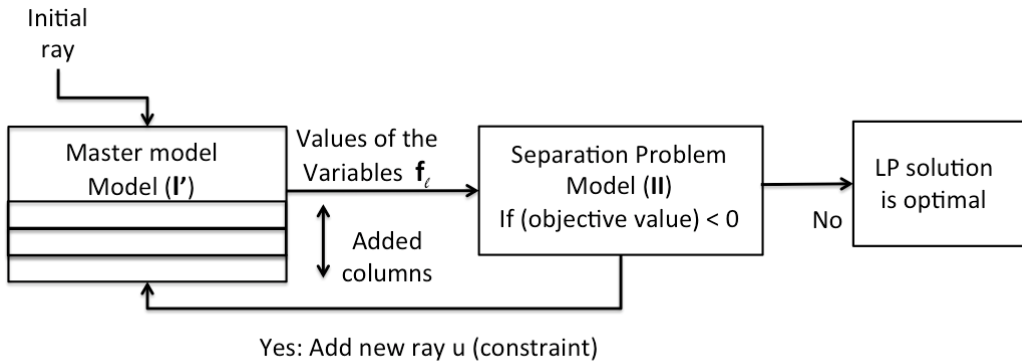

Figure A.3: Constraint generation process

A.5 Conclusion

Solving this robust model appears as a long process since the separation problem of the constraint generation algorithm is a MILP and also contains a big M constant. We may have to generate huge number of extreme rays before stopping the process. Finally, we have to perform multiple experiments with different network size to validate the quality of our approach. This is an ongoing work, which is why we can not present here any numerical results. After the resolution of this problem, another interesting issue would be to express, in a less conservative way, the interference model such that a feasible time scheduling can always be found.

Résumé des Travaux de thèse

Contents

B.1	Contexte et motivation	105
B.2	Les technologies d'accès à haut débit	108
B.3	Dimensionnement et routage dynamique dans les réseaux de collecte à micro ondes	112
B.4	Routage des requêtes de volumes variables dans les réseaux de collecte à micro ondes	113
B.5	Les économies d'énergie	114
B.6	Nos contributions	115
B.7	Liste des publications	121
B.8	Conclusion	121

L'usage intensif et croissant des services à haut débit au travers des appareils comme les smartphones et tablettes exigent une amélioration permanente de la capacité des réseaux de la part des opérateurs de télécommunications. Les technologies sans fil à micro ondes apparaissent comme une solution efficace à ces besoins, en particulier pour étendre la couverture réseau et apporter l'Internet à haut débit vers les territoires isolés difficilement accessibles par réseaux filaires. Les travaux présentés dans cette thèse concernent l'optimisation des coûts dans les réseaux de collecte de données fixes sans fil à micro ondes. Un réseau de collecte, qui généralement couvre une centaine de kilomètres, peut être défini comme la portion de l'architecture d'un réseau de télécommunication qui assure l'interconnection entre les principaux points d'accès que sont les stations de base (BS) et le coeur du réseau (Voir Fig B.1). Nous présentons, dans ce résumé, le contexte de notre étude et les technologies sans fil à haut débit qui existent. Ensuite, nous présentons brièvement les problèmes étudiés dans cette thèse et les méthodes utilisées pour les résoudre. Nous clôturons ce chapitre par une conclusion générale sur notre recherche et une présentation de nos contributions.

B.1 Contexte et motivation

L'avènement des services de données comme la Voix sur IP, la TV haute définition ou la Vidéo à la Demande, ont généré une croissance rapide du trafic de données et par conséquent un besoin en très haut débit. En raison de cette évolution des besoins, la

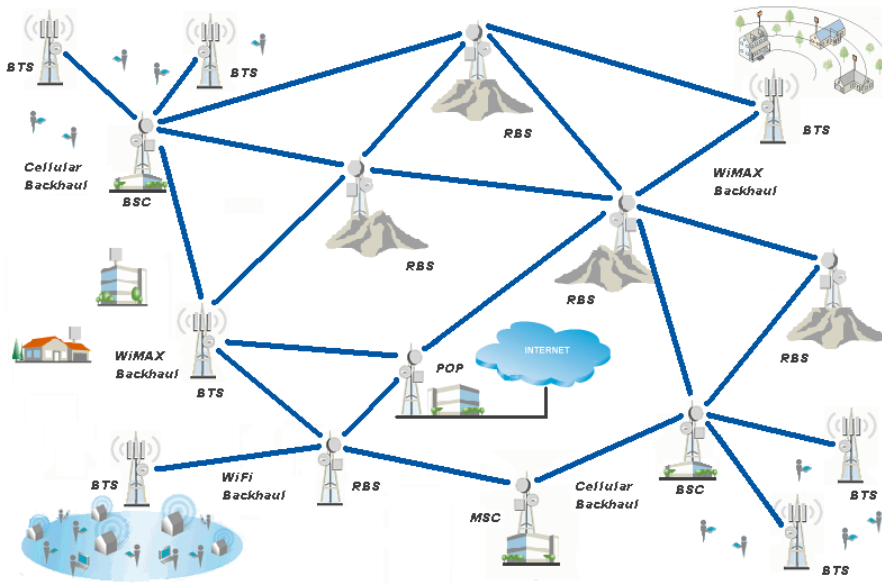

Figure B.1: Exemple d'un réseau de collecte sans fil

collecte des données est devenue un enjeu central pour les opérateurs de réseaux. En effet, les opérateurs doivent actuellement investir suffisamment dans leur infrastructure pour permettre une montée en débit des liens du réseau de collecte existant et étendre leur couverture réseau. Ceci doit être fait de façon à générer suffisamment de revenu pour couvrir les investissements. Il leur est donc indispensable de déployer des technologies de transmission de données économiquement rentables. La transmission de données dans les réseaux de collecte peut s'effectuer par trois medias: par le cuivre, par les faisceaux hertziens à micro ondes et par la fibre optique.

La fibre optique apparaît comme la technologie de transmission la plus connue actuellement pour la mise en place des réseaux de collecte. En effet, la fibre optique est de plus en plus utilisée dans les zones urbaines durant cette dernière décennie en raison des hauts débits qu'elle offre en comparaison aux autres technologies de transmission. Elle permet d'atteindre de nos jours des débits de l'ordre du Tbps sur des centaines de kilomètres. Néanmoins, le coût de déploiement et d'installation d'un réseau optique est tellement élevé que les opérateurs sont réticents à investir dans cette technologie pour desservir les territoires éloignés, à cause du faible retour sur investissement. En outre, le déploiement de cette technologie s'avère assez complexe et plus coûteux quand les conditions d'accès sont difficiles (forêts, montagnes, déserts, jungles...).

Le cuivre est le canal traditionnel de transmission de données. Cette technologie avait été très largement déployée pour établir les liaisons téléphonique. Elle a ensuite été utilisée pour le transport de données. De nos jours, le cuivre peut fournir jusqu'à 100Mbps de débit sur un demi kilomètre de distance. Cependant les réseaux de collecte nécessitent des débits huit à seize fois plus grand que la capacité offerte par une paire de cuivre utilisé en GSM. Par ailleurs, le coût du cuivre varie linéaire-

ment en fonction de la capacité offerte. Par conséquent, la transmission par cuivre n'apparaît pas comme une solution efficace pour déployer des réseaux de collecte de données.

Le dernier média de transmission, objet de cette thèse, est la technologie des micro ondes. Elle est une alternative économique lorsqu'il faut assurer la couverture réseau haut débit d'une région rurale éloignée. En effet, le coût d'installation d'un lien radio micro-onde est de l'ordre de €20.000, tandis que le coût d'exploitation varie de €1.000 et €5.000 en France. Cette technologie permet le déploiement de communications point-à-point avec des débits de l'ordre de 1Gbps sur des distances pouvant atteindre une centaine de kilomètres. En outre, cette technologie est facilement et rapidement déployable ne nécessitant que l'installation et la configuration des BS. Elle représente ainsi une très bonne solution pour l'extension de la couverture des réseaux et pour offrir le haut débit dans les zones rurales.

La Figure B.2 présente la répartition mondiale des technologies de transmission dans le domaine des télécommunications en 2009. Les prévisions faites en 2010 (Fig B.3) montrent une croissance du nombre de connexions par faisceaux hertziens à micro ondes dans les réseaux de collecte en Europe entre 2010 et 2015. De plus, une étude réalisée en 2013 [mar13] prévoit une nette croissance du marché mondial des réseaux de collectes sans fil passant de \$13.11 milliards en 2013 à \$23.3 milliards en 2018. Ces prévisions témoignent de l'intérêt porté à cette technologie par les opérateurs télécoms. Cet intérêt est justifié par le vaste déploiement dans le monde de la 4^{ème} génération de la technologie de réseaux mobile LTE (Long Term Evolution). En effet, les micro ondes apparaissent comme la meilleure solution de transmission, particulièrement pour les opérateurs en Amérique du sud et dans les pays émergents en raison de son rapport coût-efficacité.

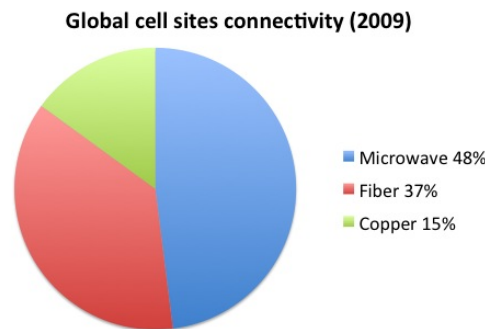

Figure B.2: Marché globale des liaisons à micro ondes [HR09]

En dépit de l'intérêt porté par les industriels à cette technologie, peu de travaux de recherche portent sur l'étude de réseaux de collecte constitués de liens micro-ondes point-à-point. Dans sa thèse, Napoleao Nepomuceno [Nep10] a étudié plusieurs problèmes d'optimisation dans ces réseaux. Dans [HGZD12] et [HEOL13], les auteurs ont respectivement présentés les enjeux des réseaux de collecte sans fil multi-gigabit et ceux des réseaux à micro ondes point-à-multipoint sans visibilité directe.

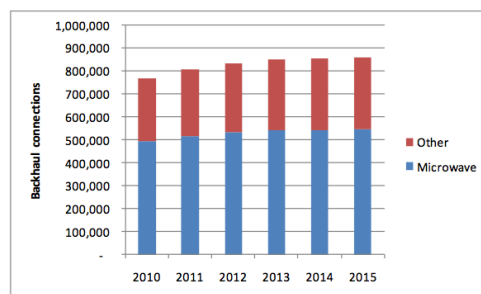

Figure B.3: Evolution et prévisions du nombre de liaisons des réseaux de collecte en Europe [Obs10]

Cette thèse s’inscrit dans la continuité des travaux débutés par Napoleão Nepomuceno et elle présente des algorithmes et des modèles d’optimisation de coûts liés à certaines problématiques des réseaux de collectes sans fil à micro ondes. Nous nous sommes focalisés d’abord sur la minimisation des coûts d’exploitation de ces réseaux tout en offrant un routage dynamique des requêtes. Nous avons également proposé des stratégies de réduction de la consommation d’énergie et d’accroissement des revenus du réseau. L’ensemble des problèmes étudiés au cours de cette thèse ont été résolus en utilisant différentes méthodes de la programmation linéaire. Avant de donner une brève définition des problèmes que nous avons abordés, nous présentons dans la section suivante les technologies d’accès à haut débit et les particularités de la transmission par faisceaux hertziens à micro ondes.

B.2 Les technologies d’accès à haut débit

Les habitudes des utilisateurs des réseaux de télécommunications ont considérablement évolué depuis l’avènement de l’Internet et du lancement des réseaux mobiles. En effet, ces deux dernières décennies ont vu la naissance et l’utilisation d’une multitude de services télécoms plus orientés données que voix. On peut entre autres citer la Voix sur IP (VoIP), le streaming vidéo, les jeux vidéo en ligne. Tout ceci a résulté en un développement très rapide des technologies réseaux offrant un accès résidentiel haut débit tels que la ligne d’accès numérique (Digital Subscriber Line) ou le câble pour la transmission audiovisuelle. Cependant, le besoin en très haut débit reste croissant pour fournir ces services aux utilisateurs mobiles indépendamment de leur position géographique.

Le but des nouveaux réseaux sans fil est d’offrir aux utilisateurs mobiles un accès à haut débit et des services sans fil de manière ubiquitaire de qualité comparable à celle offerte par les réseaux filaires. Suivant leur zone de couverture, les réseaux sans fil sont considérés soit comme des réseaux locaux (WLAN), soit des réseaux métropolitains (WMAN) ou soit des réseaux étendus (WWAN).

Les WLANs (Wireless Local Area Networks) sont utilisés pour assurer la couverture réseau des résidences et des entreprises et n’ont ainsi qu’une portée

d'environ une centaine de mètres. Ils offrent des débits pouvant atteindre 100Mbps avec le 802.11n [VN10] et sont utilisés au travers de points d'accès auxquels peuvent se connecter les stations de travail. La technologie WLAN la plus répandue est le IEEE 802.11 plus connu sous le nom de WiFi. Mais dans ce type de réseaux nous distinguons également la technologie HiperLAN (High Performance Radio LAN) [Joh99, DAB⁺02]. Notons qu'il est également possible de configurer les WLANs en mode ad hoc de sorte que toutes les stations puissent communiquer directement entre elles sans passer par un point d'accès.

Les WMANs (Wireless Metropolitan Area Networks) sont des réseaux permettant aux utilisateurs d'établir des connexions sans fil entre plusieurs emplacements au sein d'une région urbaine. Par conséquent, ces réseaux couvrent des zones de la taille d'une ville. Ils permettent d'interconnecter plusieurs WLANs. Plusieurs technologies ont été développées dans le contexte des WMANs, les plus répandues étant les réseaux de la famille IEEE801.16-WiMax, les réseaux HiperMANs et le Hiper Acces. Ils fournissent une connectivité à haut débit aux utilisateurs fixes, en visibilité directe ou non mais aussi aux utilisateurs mobiles. Ils fonctionnent sur le principe de couverture cellulaire assurée par les stations de bases auxquelles se connectent les stations d'abonnés pouvant être des immeubles ou des véhicules, soit en mode point à point ou point à multipoint. Les WMANs supportent également les topologies maillées donc sans infrastructures. Le Wimax fournit un débit agrégé de 135Mbps suivant la modulation utilisée en visibilité directe alors qu'un débit allant jusqu'à 75Mbps peut être atteint pour des communications en absence de visibilité directe. Les réseaux HiperMANs peuvent supporter des débits de 25Mbps pour chaque secteur du point d'accès. Le lecteur est invité à se reporter à [KT07] pour plus de détails sur ces technologies.

Les WWANs (Wireless Wide Area Networks) sont communément utilisés pour connecter différents WMANs situés dans des régions assez éloignées. Ils sont principalement constitués de systèmes satellitaires utilisés essentiellement en transmission descendante. Le IEEE802.20 connu sous le nom de Réseaux mobile sans fil à haut débit (MBWA) est une autre technologie WWAN. Son objectif principal est de fournir un accès haut débit aux appareils hautement mobiles et se déplaçant à des vitesses de l'ordre de 250km/h comme les voitures et trains [BXG07].

Pour résumer, Les utilisateurs transmettent grâce aux WLANs leurs données qui sont agrégées et transmises à travers les réseaux WMANs vers l'Internet. Ensuite les WWANs assurent l'interconnection entre plusieurs WMANs de diverses zones du monde. En dehors des technologies mentionnées précédemment, on distingue aussi les technologies mobiles tels que les systèmes 3G (UMTS, HSPA, CDMA2000, EV-DO) et 4G (LTE, LTE-Avancé) qui sont également considérés comme des réseaux sans fil à haut débit. En effet, ils fournissent des débits pouvant atteindre 14,4 Mbps

aux appareils mobiles. Toutes ces technologies transmettent les données en utilisant les fréquences radio (RF) et l'air comme canal de transmission. Les problèmes étudiés dans le cadre de notre thèse se situent au niveau des réseaux WMANs. Nous nous intéressons aux WMANs utilisant les liaisons point-à-point à micro ondes pour interconnecter les stations de bases entre elles et qui favorisent la transmission des données de/vers l'Internet.

Une liaison à micro-onde est donc un système de communication qui utilise des faisceaux d'ondes radio dans la gamme des fréquences de micro ondes pour transmettre des informations entre deux points fixes de la terre. Une liaison à micro ondes unidirectionnelle entre deux stations fixes est constituée de quatre éléments: l'émetteur, le récepteur, les lignes de transmission et les antennes (Voir Fig. B.4). L'émetteur produit un signal radio qui contient les informations à transmettre. Pour cela, il génère un support d'ondes radioélectriques avec une certaine fréquence et un niveau de puissance donné. Ensuite il module cette onde avec le signal d'entrée (qui est l'information) afin de transmettre l'information utile. Le signal est transmis depuis l'émetteur à l'antenne d'émission par la ligne de transmission. Cette dernière est également chargée, à l'extrémité de réception du lien, de transmettre le signal depuis l'antenne réceptrice au récepteur. Avec les fréquences micro ondes, ce sont essentiellement les guides d'ondes qui sont utilisés comme ligne de transmission. Les derniers composants de ce système radio sont les antennes qui sont directionnelles. A la source, l'antenne émet le signal radio reçu par la ligne de transmission dans l'espace, sachant qu'elle est en visibilité directe avec l'antenne de réception. Au niveau de la destination, l'antenne réceptrice collecte le signal reçu et l'insère dans la ligne de transmission pour qu'il soit traité par le récepteur. La caractéristique de concentration du signal par les antennes à micro onde favorise des communications sur de longues distances en utilisant de petites puissances d'émission. Enfin le récepteur extrait l'information utile du signal reçu par la démodulation. L'émetteur et le récepteur sont communément appelés les "Indoor Units" (IDUs) tandis que l'antenne est appelée "Outdoor Unit" (ODU). Notons que les IDUs actuels sont équipés de fonctionnalités tels que le relais et le routage des paquets.

La majorité des systèmes point-à-point à micro ondes commercialisés fonctionnent avec des fréquences entre 2Ghz et 60Ghz avec une distance maximale de 200km entre 2 antennes [Leh10]. Les liaisons point-à-point à micro ondes opèrent dans les bandes de fréquences sous license ou sans license. Tout le monde peut exploiter les bandes de fréquences libres sans besoin de demande de licences, ce qui peut entraîner de l'interférence pour des utilisateurs sur la même bande de fréquences et à distance rapprochées. Cela soulève également des questions de sécurité des données qui pourraient être accessibles par tout récepteur câblé sur la même fréquence si des protocoles de cryptage ne sont pas employés. Ceci justifie l'utilisation des bandes de fréquences avec license par les opérateurs de réseaux. Les bandes de 6Ghz, 11Ghz, 18GHz et 23Ghz sont celles utilisées pour les liaisons point-à-point des réseaux de collecte sans fil à micro ondes. Vous trouverez plus de détails concernant le calcul du budget de puissance d'un lien radio à micro onde et le système de modulation adaptative auquel il est soumis dans [Nep10].

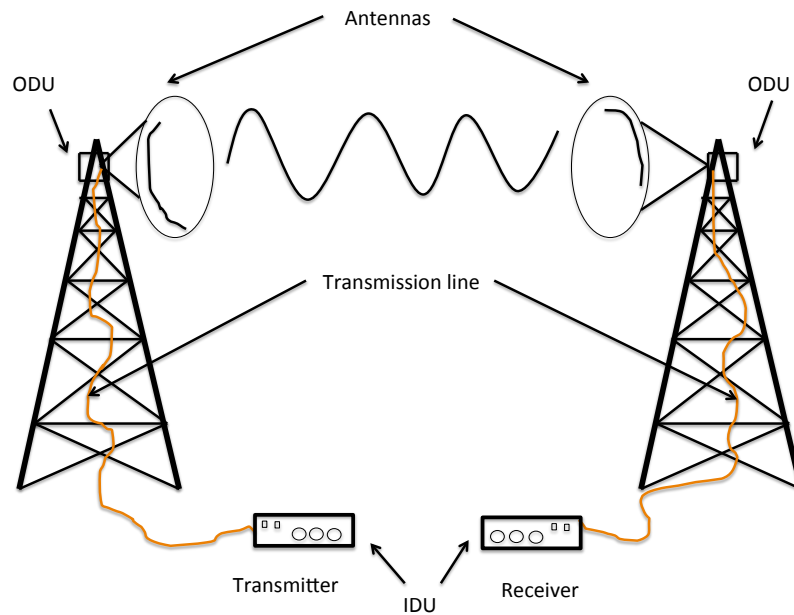

Figure B.4: Composants d'un lien à micro ondes

En dépit des nombreux avantages des réseaux de collecte utilisant les liaisons radio à micro ondes et de leur rentabilité en coût d'investissement, les communications point-à-point à micro ondes sont affectées par de multiples facteurs externes. Parmi les facteurs dégradant la qualité de ces communications, nous pouvons citer les événements climatiques (pluies, orages, vents violents, etc.), les catastrophes naturelles (tremblements de terre, éruptions volcaniques, etc...) et les phénomènes d'évanouissement du signal. De plus l'utilisation des bandes de fréquences avec licence nécessitent l'acquiescement d'une redevance annuelle dont le coût est non négligeable. La combinaison de ces différents facteurs transforme la conception et le dimensionnement à coût minimum d'un réseau de collecte à micro ondes satisfaisant toutes les demandes en un problème d'optimisation complexe. Ceci représente le premier problème étudié dans le cadre de cette thèse.

Dans l'optique de réduire au mieux les coûts d'exploitation de ce type de réseau, nous avons également étudié le problème de la réduction de la consommation d'énergie de ces réseaux en utilisant un routage des données en fonction de la consommation énergétique. Enfin nous avons travaillé dans le contexte des réseaux de collecte à micro ondes multi-opérateurs dans le but de maximiser les revenus du détenteur du réseau. Dans ce problème où la satisfaction des demandes des opérateurs clients reste une priorité, nous avons également considéré des politiques de qualité de service (QoS) de chaque opérateur ainsi qu'une variation du volume du trafic dans le temps. Nous donnons dans les sections suivantes plus de détails sur ces différents problèmes étudiés.

B.3 Dimensionnement et routage dynamique dans les réseaux de collecte à micro ondes

Le but principal pour chaque opérateur de réseaux ou chaque fournisseur de services est de maximiser ses gains tout en satisfaisant sa clientèle. Dans le cadre des réseaux de télécommunications, un élément primordial à la satisfaction des besoins est un réseau bien dimensionné en terme de capacité des liens. Il est alors indispensable pour les opérateurs de concevoir leurs réseaux de sorte à installer sur chaque lien suffisamment de capacité pour satisfaire les demandes de communications à tout moment et en tout lieu. Cette exigence est d'autant plus forte dans les réseaux de collecte de données car les stations de bases doivent pouvoir router toutes les demandes qui leur arrivent. Dans le cas contraire, la transmission des données subit soit des délais énormes soit les données sont perdues, impactant négativement la qualité des services offerts. L'allocation de capacité dans ces réseaux est étroitement liée à l'utilisation efficace du spectre radio. En effet le spectre radio étant une ressource naturelle rare, il est associé à des coûts d'exploitation assez élevé. Le défi consiste donc à fournir de manière rentable la capacité nécessaire à satisfaire la clientèle.

Techniquement, la capacité d'un lien à micro onde se calcule en fonction de la largeur de bande B et du schéma de modulation qui y sont utilisés. Pour supporter les applications à haut débit, les systèmes à micro ondes utilisent la modulation d'amplitude en quadrature (QAM) où un schéma m -QAM présente m différentes combinaisons d'amplitude et de phase. Chacune des combinaisons représente un motif à n bits appelé *symbole* avec $n = \log_2 m$. Ainsi la capacité C d'un lien peut être estimée par:

$$\text{Capacity}[bps] = n.B[Hz]$$

Le système d'adaptation de la modulation fait référence à un ajustement automatique de la modulation utilisée en fonction de l'état du lien. Il a été développé principalement pour permettre au système radio de s'auto-réguler en cas de mauvaise transmission afin de respecter les seuils de taux d'erreurs des bits (BER). Alors que nous savons que la modulation utilisée sur un lien à micro ondes est basée sur le système d'adaptation de modulation, l'affectation de la largeur de bande B sur un lien requiert une décision de l'ingénieur. Ce dernier doit donc, durant la phase de planification du réseau, résoudre un problème d'optimisation assez complexe afin de réduire le total des coûts de licences des bandes de fréquences. La principale contrainte de ce problème est la satisfaction de toutes les requêtes clients. Elle implique la résolution d'un problème de multiflot (MCF) [GCF99, Tom66, BCGT98]. Le problème de multiflot consiste à router un ensemble de requêtes depuis leurs sources jusqu'à leurs destinations en passant par un réseau en fonction des capacités de celui-ci. En outre, à cause des variations subies par le canal radio, un certain niveau de fiabilité du réseau doit être garanti dans les réseaux de collecte à micro ondes. Ce problème d'affectation de largeur de bandes à coût minimum avec fiabil-

ité a été étudié par Nepomuceno durant sa thèse [Nep10] en utilisant une approche probabilistique de chance-constrained programming.

Contrairement aux travaux de Nepomuceno, nous avons dans cette thèse résolu ce problème en considérant un routage dynamique des demandes. Ainsi suivant les atténuations de signal sur les liens et les adaptations de modulation requises, les requêtes pourront être re-acheminées suivant les nouvelles capacités des liens, modifiant ainsi les flots. Cette approche apporte beaucoup plus de souplesse dans le réseau contrairement aux travaux précédents qui ont considéré un routage totalement statique. Un unique schéma d'acheminement des données était utilisé indépendamment de l'état du canal. Nous avons également modélisé ce problème de sorte à appliquer sa solution à des réseaux de grandes tailles, ce qui était difficilement possible. L'étude et la résolution de ce problème ont été fait en collaboration avec Brigitte Jaumard (Université de Concordia, Montréal, Canada), Mejdî Kaddour (Université d'Oran, Algérie), Napoleão Nepomuceno (Univeristé de Fortaleza, Brésil) et David Coudert (Université de Nice Sophia Antipolis). Nous avons modélisé ce problème sous forme d'un programme linéaire en nombre entiers mixtes (MILP). Il fut résolu en utilisant une méthode de génération de colonnes et une heuristique de recherche locale.

B.4 Routage des requêtes de volumes variables dans les réseaux de collecte à micro ondes

Comme mentionné précédemment, les réseaux sans fil à micro onde représentent une solution attractive pour les opérateurs afin de déployer leurs réseaux de collecte dans les zones rurales. Cependant, il peut s'avérer non rentable pour un opérateur de déployer sa propre infrastructure de réseaux de collecte à micro ondes, en particulier dans les zones à faible densité d'habitation à cause du faible retour sur investissement. Une solution pour contourner cet obstacle est le concept de partage d'infrastructure entre opérateurs proné par les autorités de régulation depuis plusieurs années. Contrairement au partage de sites ou d'équipements que conseillent ces autorités, nous avons étudié le problème de partage de capacité du réseau entre plusieurs opérateurs. Dans le contexte d'un réseau de collecte déployé par un opérateur (le détenteur de l'infrastructure réseau) que nous nommons le PNO (Physical Network Operator), la capacité des liens de ce réseaux est louée à d'autres opérateurs virtuels VNOs (Virtual Network Operators) qui souhaitent acheminer les requêtes de leurs clients. L'objectif que nous avons visé est de maximiser le revenu total du PNO sous les contraintes de satisfaction des demandes des VNOs tout en respectant leurs différentes politiques de qualité de services. Nous avons en premier lieu formulé le problème en considérant des volumes de trafic fixes et de ce modèle nous avons déduit le modèle robuste dans lequel le volume de plusieurs requêtes peut varier. Ce problème étudié en collaboration avec David Coudert et Christelle Caillouet (Université de Nice Sophia-Antipolis) a été résolu avec une formulation en programme linéaire en nombre entiers (ILP).

B.5 Les économies d'énergie

Dans la recherche de stratégies d'optimisation des coûts pour les réseaux de collecte sans fil à micro ondes, la consommation d'énergie a été identifiée comme prenant une part non négligeable dans les coûts d'exploitation de ces réseaux. En 2011, Tombaz *et al.*, dans leurs travaux [TMW⁺11] ont reporté que les communications mobiles occupent 0.05% de la consommation mondiale d'énergie et que 80% de cette énergie provient des réseaux d'accès et plus précisément des stations de bases. Avec le grand nombre de stations de base à installer pour satisfaire la demande toujours croissante en trafic, la consommation d'énergie des réseaux mobiles devrait doubler d'ici 2020. Par conséquent la consommation d'énergie est amenée à devenir une problématique importante à régler pour les opérateurs télécoms afin de réduire leurs coûts d'exploitation. La recommandation R88 [All08, requirement R88] du forum des opérateurs mobiles appelé NGMN (Next Generation Mobile Networks) stipule que plusieurs modes de consommation d'énergie devraient être définies afin que les équipements des réseaux de collecte puissent automatiquement basculer vers celui qui permet de minimiser leur taux de consommation d'énergie. Les opérateurs doivent donc trouver les mécanismes pour adapter la consommation d'énergie des stations de base en fonction du volume de trafic en transit dans ces stations.

Ce problème de consommation d'énergie se pose également dans le "cœur" de réseau Internet. Basée sur des études récentes, la consommation d'énergie des infrastructures d'Internet est estimée entre 1.1% et 1.9% des 16 TW que consomme le monde [BAH⁺09, RM11, BHT11, HBF⁺11]. Dans [TBA⁺08], les auteurs ont remarqué que la majeure partie de la consommation d'énergie de l'Internet provient des réseaux d'accès et des routeurs. Ils ont prévu une augmentation rapide de cette consommation de 4% au vue de l'augmentation des débits d'accès transformant ainsi les routeurs IPs en goulots d'étranglement énergétique de l'Internet.

Une proposition pour limiter cette croissance de la consommation d'énergie est d'utiliser une technique de routage des données en fonction de la consommation d'énergie dans le réseau nommée EAR (Energy Aware Routing) [CSB⁺08, CMN09, BCRR12]. A cause de l'inexistence actuelle d'équipements permettant d'éteindre les liens des réseaux de collecte, nous avons étudié ensemble avec Truong Khoa Phan (Université de Nice sophia Antipolis) l'optimisation de la consommation d'énergie appliquée aux réseaux backbones. Notre objectif était de minimiser la consommation d'énergie dans le réseau tout en étant en mesure de router l'ensemble des requêtes. Nous avons proposé plusieurs formulations du modèle en combinant l'utilisation de l'EAR et d'une autre méthode, nommée RE (Redundancy Elimination) [AGA⁺08, ZCM11, ZA14] avec des valeurs de demandes fixes ou variables. Le problème fut modélisé dans sa forme robuste par des programmes linéaires en nombres entiers mixtes (MILP) et nous avons proposé différents algorithmes et heuristiques pour sa résolution. Ces travaux ont été effectués en espérant une application de cette méthode aux réseaux de collecte sans fil une fois les équipements physiques disponibles.

L'ensemble des différents problèmes étudiés dans le cadre de cette thèse ont été modélisés en utilisant la programmation linéaire résultant ainsi en des modèles

soit ILP ou MILP. Ensuite nous avons appliqué la méthode de la Γ -robustesse aux modèles contenant des variables dont les valeurs sont incertaines. Les solutions optimales obtenues grâce aux modèles robustes restent réalisables et optimales quelque soient les valeurs que prennent les variables incertaines. Enfin pour chaque modèle proposé, un ensemble de tests numériques ont été effectués avec plusieurs instances de simulation de la library SNDlib [OWPT10] afin de déterminer les forces et faiblesses des méthodes de résolution. Les différents algorithmes ont été implémentés soit en utilisant le langage de programmation Python, soit Java ou soit OPL(Optimization Programming Language). Ce dernier a la particularité d'être un langage de modélisation mathématique de haut niveau permettant une implémentation rapide d'algorithmes complexes tels que la génération de colonnes ou de contraintes. Plus encore, ce langage est spécifiquement adapté à la recherche opérationnelle (Programmation linéaire et programmation par contrainte) et offre une interface pour communiquer avec le solveurs CPLEX [III14] de IBM ILOG. Les résultats des simulations sont ensuite analysés suivant les différents paramètres en entrée au problème. Dans le cas où le modèle s'avère difficile à résoudre pour de larges instances, nous proposons, des heuristiques dont l'objectif est de trouver des solutions réalisables proche de l'optimal dans des délais plus courts.

Dans la section suivante, nous présentons brièvement le développement de nos travaux de même que les résultats obtenus.

B.6 Nos contributions

Dans le **Chapitre 2** de ce manuscrit, nous définissons en détail les concepts de la programmation linéaire. Nous avons également présenté la notion de la dualité et deux théorèmes de la dualité qui nous ont été utiles durant nos travaux. Il s'agit de la dualité faible et de la dualité forte. Nous introduisons ensuite l'algorithme de génération de colonnes. Cet algorithme nous a été utile pour proposer une solution qui passe à l'échelle pour le problème de dimensionnement de réseau. Cette méthode est essentiellement utilisée dans le cas de modèles linéaires contenant un très grand nombre de variables. A l'optimum, la plupart des variables étant nulles, seul un petit sous-ensemble de variables doit être pris en compte pour résoudre le problème. L'algorithme permet alors d'identifier uniquement les variables qui sont susceptibles d'améliorer la solution courante. Nous présentons également en détail le sous-domaine de la recherche opérationnelle qu'est l'optimisation robuste. Nous définissons deux méthodes d'optimisation robuste: la Γ -robustesse et la méthode de résolution des programmes linéaires à 2 étapes avec l'incertitude à droite. Nous clôturons ce chapitre par une introduction au langage de programmation OPL avec en appui un exemple pratique.

Le **Chapitre 3** est consacré au problème de dimensionnement des réseaux de collecte avec liaisons à micro onde. Nous avons commencé par définir le problème qui nous intéressait ainsi que les différents paramètres qui le complexifie. On peut mentionner entre autres les phénomènes d'atténuation qui affectent la qualité du

signal et l'utilisation de la modulation adaptative pour y remédier. Cela entraîne des variations de la capacité des liens. Cette variation des capacités des liens définit un environnement de routage des informations incertain. Afin de s'y adapter, nous avons opté pour un routage dynamique des requêtes contrairement à une précédente étude [CKCN14] qui utilisait du routage statique. La principale contrainte du problème consiste à garantir un haut niveau de fiabilité du réseau pour le routage des demandes. Le but de ce problème est d'allouer les largeurs de bandes aux différents liens afin de minimiser le coût total de dimensionnement du réseau. L'affectation de largeurs de bandes est équivalente à la définition de la capacité du lien à cause de la relation existante entre les deux paramètres mentionnée plus haut. Dans la précédente étude de ce problème, les auteurs avaient utilisé une approche chance-constrained qui a résulté en un modèle difficile à résoudre. Le problème a alors été reformulé en un problème à budget fixé. Il s'agit alors de maximiser la fiabilité du réseau pour un budget \mathcal{B} sur le coût des largeurs de bandes. Ceci permet d'obtenir une solution dont le coût est une borne supérieure à la solution optimale du problème original.

Pour la résolution de ce modèle, nous avons supposé connaître la distribution de probabilité des modulations sur la base de la largeur de bande utilisée. Cela nous a permis de définir la notion de configuration de lien et de configuration du réseau. La configuration d'un lien représente la paire (b, m) de largeur de bande b et de modulation m qui y sont utilisées. La configuration du réseau représente l'ensemble des configurations des liens qui le composent. La modulation des liens étant variable, différentes configurations de réseau sont possibles. A partir de la distribution de probabilité des modulations sur chaque lien, nous pouvons estimer la probabilité p^c que le réseau utilise la configuration c . Ensuite, en utilisant l'ensemble des configurations valides (i.e., permettant de router le trafic), nous formulons le problème d'affectation des largeurs de bandes sous forme de programme linéaire en nombre entiers mixtes. L'objectif est de minimiser le coût de l'affectation tout en offrant une fiabilité de réseau élevé. Cela revient à trouver un ensemble de configurations de réseaux, dans lequel c'est la même largeur de bande qui est affectée à un même lien donné dans toutes les configurations. La fiabilité du réseau est obtenue en sommant les probabilités des configurations sélectionnées. Le nombre de configurations possible étant exponentiel, nous utilisons le principe de la génération de colonnes en subdivisant le problème original en deux sous-problèmes:

MP : Le *master problem* permet de sélectionner un sous-ensemble des configurations considérées dont le coût de l'affectation de largeur de bande est minimal;

PP : Le *pricing problem* détermine de nouvelles configurations valides permettant d'améliorer la fonction objective du MP.

Du fait de l'expression du calcul de la probabilité d'une configuration, le PP est non-linéaire. Pour contourner cette difficulté, nous supprimons ce calcul du PP, résolvons une version plus contrainte du PP (recherche dans un sous-espace des

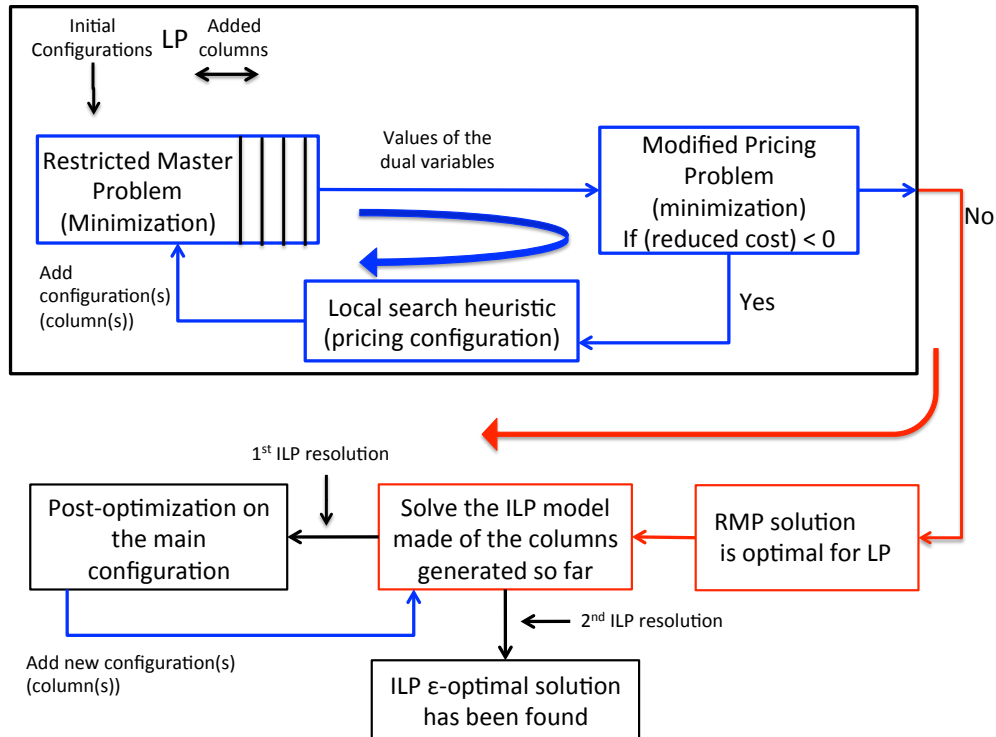

Figure B.5: Le processus d'exécution du MCG

solutions valides), puis appliquons une heuristique de recherche locale sur la solution obtenue pour générer un ensemble de configurations intéressantes à injecter dans le MP (Voir Fig. B.5).

Les tests numériques effectués avec cette méthode suggèrent des réductions de coûts jusqu'à 45% (comparé au coût maximal possible) et avec des fiabilités de au moins 96%. De plus, après comparaison avec les résultats de [CKCN14], nous observons que l'approche chance-constrained programming produit de meilleures solutions sur les petites instances tandis que notre approche (avec génération de colonnes) passe à l'échelle et offre de meilleures performances avec les grandes instances.

Dans le **Chapitre 4**, nous étudions le problème de partage d'infrastructure entre plusieurs opérateurs dans un réseau de collecte sans fil. Un opérateur physique (PNO) possédant l'infrastructure propose donc de louer la capacité de son réseau sans fil fixe à haut débit à des opérateurs virtuels (VNO). Un contrat (SLA) est signé entre le PNO et chaque VNO afin de spécifier les conditions de qualité de service attendues, entre autres le délai de bout en bout pour chaque demande. Nous nous intéressons, pour le PNO, à maximiser le revenu locatif de son infrastructure tout en garantissant à chaque VNO accepté les termes de son SLA. Nous considérons également une incertitude dans les volumes de trafic pour chaque VNO. Nous utilisons donc l'optimisation robuste pour la formulation mathématique dans laquelle nous intégrons des contraintes de délais. Nous nous basons sur la méthode développée

par Bertsimas et Sim dans laquelle un paramètre Γ spécifie le nombre de demandes qui peuvent varier simultanément de leur valeur nominale et atteindre leur pic. En faisant varier Γ de 0 au nombre total de demandes, nous étudions le prix de la robustesse afin de garantir une solution réalisable dans le pire-cas pour des scénarios réels. Les tests sur des instances de la librairie SNDlib re-adaptées à notre modèle permettent de ressortir la caractéristique "best-effort" du modèle. En effet, les résultats montrent que le PNO essaie de satisfaire au mieux tous les VNOs tout en donnant une priorité aux VNOs à plus fort gain. Toutefois, l'application de ce modèle à des instances de grande taille a démontré ses limites principalement sur le temps de calcul. Nous proposons alors plusieurs heuristiques permettant d'accélérer la résolution du problème tout en obtenant des solutions proche de la solution optimale. Les deux plus intéressantes heuristiques sont la méthode du *Powerset* et celle utilisant l'algorithme glouton.

Nous dédions le **Chapitre 5** à l'optimisation de la consommation d'énergie dans les réseaux backbones. La majorité de la consommation d'énergie dans les réseaux coeurs, et plus précisément dans les routeurs IPs est due au nombre d'éléments actifs tandis que la charge de trafic n'y a qu'un impact minime [CMN11]. Cela a conduit à la définition de l'EAR (energy-aware routing) ayant comme objectif de minimiser le nombre de liens actifs tout en satisfaisant toutes les requêtes sans aucune surcharge de liens. La technique d'élimination de la redondance (RE) est la seconde méthode permettant de réduire la consommation d'énergie que nous exploitons. Elle vise à réduire la charge des liens du réseau coeur et consiste à fractionner les paquets IP en plusieurs petits morceaux, chacun étant indexé avec une petite clé. Les morceaux sont ensuite remplacés par les clés dans les flots de trafic (compression) et les informations originales sont récupérées sur les routeurs en aval (décompression). Toutefois, la fonctionnalité RE présente l'inconvénient d'augmenter la consommation d'énergie des routeurs. Une précédente étude avait combiné ces deux techniques en une seule appelée GreenRE [GMPR12] afin d'en tirer le meilleur profit. Dans notre approche, nous étudions une version robuste du GreenRE dans laquelle nous considérons une incertitude sur les volumes de trafic et sur les taux de compression de la RE. Nous avons donc appliqué l'idée de la Γ -robustesse à notre problème et avons formellement défini la RobustGreenRE sous forme de programme linéaire en nombre entiers mixtes. La contrainte affectée par la variation des volumes de trafic et de taux de compression est la contrainte de capacité de notre modèle. L'idée du MILP RobustGreenRE est donc de réserver une certaine capacité sur les liens pour gérer la fluctuation du trafic. Γ_d volumes de trafic et Γ_γ taux de compression sont autorisés à varier de leurs valeurs nominales à la fois. Le modèle résultant de l'expression de la capacité réservée aux demandes variables sous forme mathématique a un nombre exponentiel de contraintes. Il est donc très difficile à résoudre. Nous proposons donc trois méthodes de résolution de ce MILP.

- *Formulation compacte*: Nous formulons la capacité réservée pour la fluctuation

des demandes sous forme d'un ILP appelé primal. En utilisant le théorème de la dualité, nous exprimons le problème dual du primal que nous intégrons ensuite dans la formulation MILP GreenRE. Cette nouvelle formulation nous permet d'avoir une borne inférieure à la solution optimale du MILP Robust-GreenRE

- *Génération de contraintes*: cette algorithmme consiste à générer de manière itérative les sous-ensembles de demandes de trafic qui peuvent dévier de leurs valeurs nominales de demande ou de taux de compression. L'algorithme résout premièrement le modèle MILP GreenRE avec toutes les demandes prises à leurs valeurs nominales. Sur la base de la solution de routage de ce modèle, nous résolvons le modèle primal (de la formulation compacte) pour déterminer un sous-ensemble de demandes qui violent la contrainte de capacité. Ce sous-ensemble est alors rajouté en entrée au MILP GreenRE. Le processus est répété ainsi jusqu'à ce qu'il n'existe plus de sous-ensemble de demandes violant la contrainte de capacité. Cette méthode fournit la solution exacte à notre problème. Cependant il est très long à résoudre d fait du nombre exponentiel de contraintes.
- *L'heuristique*: Cette méthode est composée de deux phases. Au cours de la première phase, tous les routeurs sont considérés comme des routeurs RE. Nous essayons sur cette base de trouver la solution minimisant le nombre de liens actifs. Dans la deuxième phase, nous désactivons le service RE sur le plus de routeurs possible en se basant sur la solution de routage de la première phase.

Les simulations numériques effectuées grâce à l'implémentation de trois méthodes de résolution et appliquées à des instances réelles de SNDlib ont démontré qu'un gain conséquent d'énergie est possible pour $\Gamma_d, \Gamma_\gamma \leq 20\%$. Cependant pour $\Gamma_d, \Gamma_\gamma \geq 30\%$, les gains qu'offre le RobustGreenRE sont identiques (Fig. B.6). Ceci se justifie par la présence des plus grandes valeurs de demandes dans les premiers 20%, ainsi l'augmentation de la valeur de Γ_d, Γ_γ au delà de ce nombre n'impacte plus le routage et donc plus la consommation d'énergie. Enfin une étude comparative de notre solution avec le GreenRE et l'EAR montre que cette dernière est la moins performante tandis que c'est le RobustGreenRE qui est la meilleure. Elle offre en effet entre 16 et 28% de gain supplémentaire sur toutes les instances considérées (Fig. B.7).

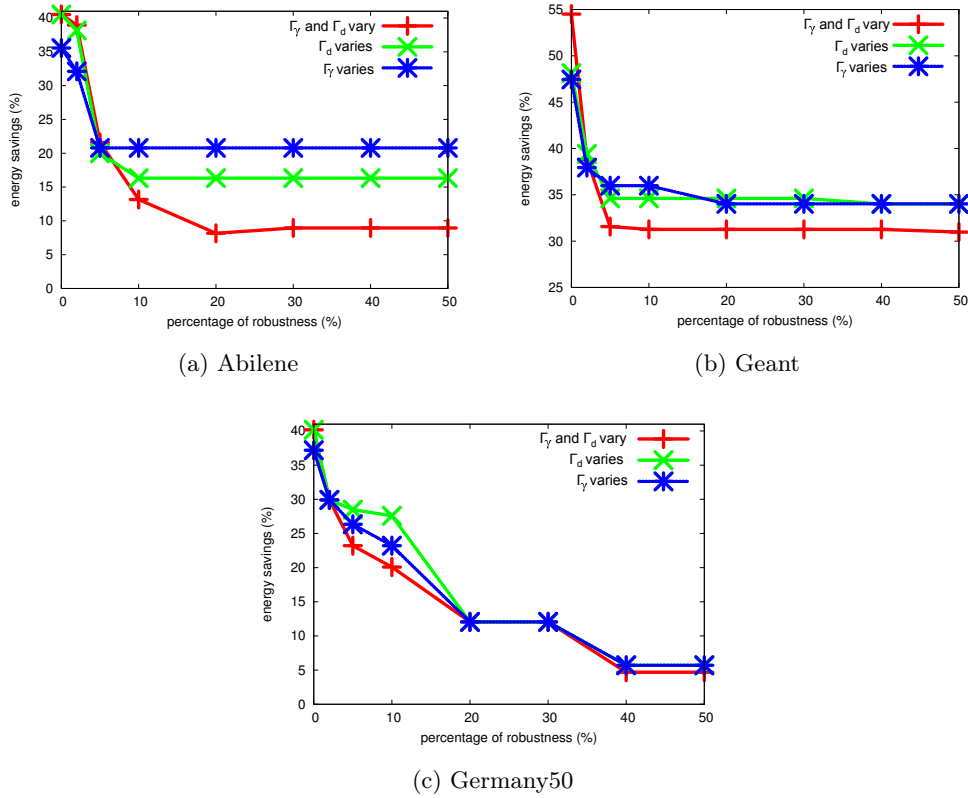

Figure B.6: Gain énergétique vs. robustesse pour Abilene, Geant et Germany50 network

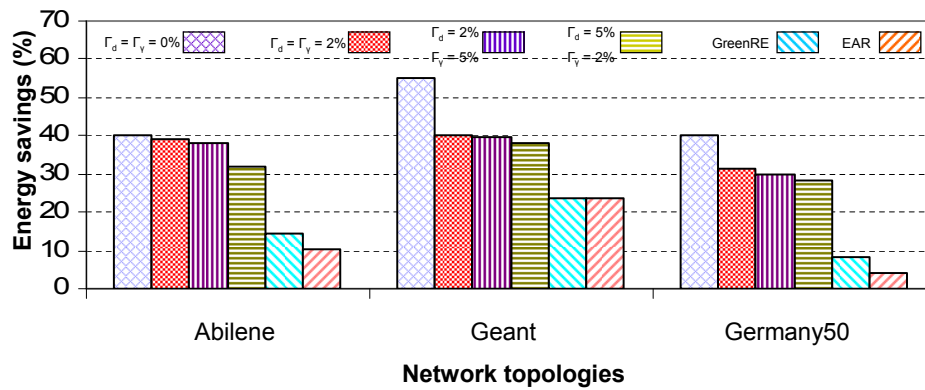

Figure B.7: Robust-GreenRE vs. GreenRE vs. EAR.

B.7 Liste des publications

Nous présentons ici la liste des publications faisant objet de notre recherche.

- [**KJN⁺15**] A. Kodjo, B. Jaumard, N. Nepomuceno, M. Kaddour, D. Coudert. *Dimensionnement des réseaux de collecte de données sans fil par génération de colonnes* In ROADEF, 2015, France.
- [**KJN⁺14**] A. Kodjo, B. Jaumard, N. Nepomuceno, M. Kaddour, D. Coudert. *Dimensioning microwave wireless networks*, submitted to IEEE International Conference on Communications (ICC), 2015, UK.
- [**CKP14a**] D. Coudert, A. Kodjo, and T.K. Phan. *Robust Energy-aware Routing with Redundancy Elimination*, 2014 (Research report and Journal in revision).
- [**CKP14b**] D. Coudert, A. Kodjo and T.K. Phan. *Robust Optimization for Energy-aware Routing with Redundancy Elimination* In ALGOTEL 2014, France.
- [**KCCM14**] A. Kodjo, D. Coudert and C. Caillouet-Molle. *Optimisation robuste pour le partage de reseaux d'accès micro-ondes entre operateurs* In ROADEF, 2014, France.
- [**CCK13**] C. Caillouet-Molle, D. Coudert and A. Kodjo *Robust optimization in multi-operators microwave backhaul networks*. In IEEE Global Information Infrastructure and Networking Symposium (GIIS) 2013, Italy.

Cette thèse a été financée par la PME 3ROAM basée à Sophia Antipolis, et la province PACA.

B.8 Conclusion

Avec l'amélioration des technologies des réseaux d'accès permettant de fournir du haut débit, le goulot d'étranglement du réseau de télécommunications est déplacé vers le réseau de collecte. Tout au long de cette thèse, nous avons travaillé sur plusieurs problèmes relatifs à l'utilisation des liaisons à micro ondes point à point comme technologie de transmission dans les réseaux de collecte. Notre principal objectif était de minimiser les coûts de dimensionnement et d'exploitation de cette technologie.

Nous avons premièrement étudié le problème du dimensionnement à coût minimal des réseaux sans fil fixes à haut débit dans des conditions non fiables. Nous avons proposé une solution basée sur le routage dynamique des demandes permettant des réductions allant jusqu'à 45% du coût le plus élevé et des fiabilités d'au moins 96% sur de larges réseaux. Notre solution présente également l'avantage de passer aisément à l'échelle pour des instances de grande taille.

Nous avons également abordé le concept des réseaux "verts" en utilisant la technique du GreenRE pour réduire la consommation d'énergie des réseaux coeur. Nous avons significativement amélioré l'efficacité énergétique de ces réseaux grâce à notre modèle de RobustGreenRE. Nous avons également proposé une heuristique adaptée à la résolution de ce problème sur de larges instances. Les résultats des simulations démontrent une amélioration en consommation d'énergie de l'ordre de 16 à 28% supplémentaire comparée à l'EAR.

Enfin, grâce au partage de la capacité du réseau entre plusieurs opérateurs, nous avons proposé une solution intéressante aux détenteurs des réseaux de collecte physique pour améliorer leur revenu. Le modèle MILP formalisant ce problème combine les contraintes de routage des demandes, celles de qualité de service et de SLA. Plus encore, elle est robuste à la variation du volume de Γ demandes simultanément. Due à sa lenteur de résolution sur de grandes instances, nous avons également proposé plusieurs heuristiques à ce problème.

En dépit des multiples résultats de notre thèse, plusieurs problèmes spécifiques aux réseaux de collecte sans fil restent ouverts. Concernant le problème de dimensionnement, plusieurs améliorations algorithmiques devraient y être rajoutées afin d'accélérer l'exécution de l'algorithme de génération de colonnes et d'améliorer la fiabilité du réseau. Il existe également certains paramètres du problème que nous n'avons pas pu considérer dans notre modélisation. Il s'agit entre autres de la variation du volume du trafic mais également de la corrélation existante entre les configurations des liens à micro ondes. Une modélisation plus complète du problème pourrait réduire davantage les coûts de dimensionnement pour les opérateurs.

Une autre direction de recherche intéressante concerne le déploiement et l'extension sur le long terme des réseaux de collecte. Les besoins en débit ne faisant qu'augmenter, les opérateurs auront besoin de recommandations sur quand et où installer de nouveaux liens à micro ondes ou des liens à fibre optique ou quand arrêter l'utilisation d'un lien radio. Ceci soulève plusieurs problèmes d'optimisation difficile à résoudre.

Concernant l'efficacité énergétique des réseaux de télécommunications, les opérateurs gagneraient à adapter aux réseaux de collecte les solutions proposées pour les réseaux backbone. Il a été en effet prouvé que la consommation d'énergie des BS compte pour 50% de la consommation énergétique des réseaux d'accès. Avec la densification du déploiement des stations de base, l'efficacité énergétique des réseaux de collecte deviendra assez rapidement un sujet de recherche très intéressant.

Enfin, nous complétons les travaux de notre thèse en nous intéressant à l'utilisation efficace du spectre radio. Nous avons dans ce sens démarré une étude, décrite dans l'**Appendix A**, sur le problème de partage de spectre dans les réseaux radio cognitifs (CRNs). Nous envisageons d'adapter le concept de la robustesse au problème de maximisation du débit des CRNs dans cet environnement hautement instable. Plusieurs problèmes intéressants restent également ouverts dans ce domaine de recherche.

Bibliography

- [AAM11] G. Alnwaimi, K. Arshad, and K. Moessner, “Dynamic spectrum allocation algorithm with interference management in co-existing networks,” *IEEE Communications Letters*, vol. 15, no. 9, pp. 932–934, 2011. (Cited in page 96.)
- [AGA⁺08] A. Anand, A. Gupta, A. Akella, S. Seshan, and S. Shenker, “Packet caches on routers: The implications of universal redundant traffic elimination,” *SIGCOMM Computer Communication Review*, vol. 38, no. 4, pp. 219–230, Aug. 2008. (Cited in pages 9, 64, 68, 80 and 114.)
- [ALC09] I. F. Akyildiz, W.-Y. Lee, and K. R. Chowdhury, “Crahn’s: Cognitive radio ad hoc networks,” *Ad Hoc Networks*, vol. 7, no. 5, pp. 810–836, 2009. (Cited in page 94.)
- [All08] N. Alliance, “NGMN optimised backhaul requirements,” *Next Generation Mobile Networks Alliance*, p. 19, Aug. 2008. (Cited in pages 9 and 114.)
- [ALVM06] I. F. Akyildiz, W.-Y. Lee, M. C. Vuran, and S. Mohanty, “Next generation/dynamic spectrum access/cognitive radio wireless networks: a survey,” *Computer Networks*, vol. 50, no. 13, pp. 2127–2159, 2006. (Cited in pages x, 94 and 95.)
- [AMAR09] A. Anand, C. Muthukrishnan, A. Akella, and R. Ramjee, “Redundancy in network traffic: Findings and implications,” in *ACM International Joint Conference on Measurement and Modeling of Computer Systems (SIGMETRICS)*. ACM, 2009, pp. 37–48. (Cited in pages 64, 68 and 80.)
- [ASA09] A. Anand, V. Sekar, and A. Akella, “SmartRE: An architecture for coordinated network-wide redundancy elimination,” *SIGCOMM Computer Communication Review*, vol. 39, no. 4, pp. 87–98, Aug. 2009. (Cited in page 68.)
- [AYP11] A. Altin, H. Yaman, and M. C. Pinar, “The robust network loading problem under hose demand uncertainty: formulation, polyhedral analysis, and computations,” *INFORMS Journal on Computing*, vol. 23, no. 1, pp. 75–89, 2011. (Cited in page 17.)
- [BAH⁺09] J. Baliga, R. Ayre, K. Hinton, W. V. Sorin, and R. S. Tucker, “Energy consumption in optical ip networks,” *IEEE/OSA Journal of Lightwave Technology*, vol. 27, no. 13, pp. 2391–2403, 2009. (Cited in pages 9 and 114.)

- [Bal86] M. O. Ball, “Computational complexity of network reliability analysis: An overview,” *IEEE Transactions on Reliability*, vol. 35, no. 3, pp. 230–239, 1986. (Cited in page 25.)
- [Bar72] W. T. Barnett, “Multipath propagation at 4, 6 and 11 GHz,” *Bell System Technical Journal*, vol. 51, no. 2, pp. 311–361, 1972. (Cited in page 24.)
- [BBL08] S.-S. Byun, I. Balasingham, and X. Liang, “Dynamic spectrum allocation in wireless cognitive sensor networks: Improving fairness and energy efficiency,” in *Vehicular Technology Conference, 2008. VTC 2008-Fall. IEEE 68th.* IEEE, 2008, pp. 1–5. (Cited in page 96.)
- [BCGT98] D. Bienstock, S. Chopra, O. Günlük, and C.-Y. Tsai, “Minimum cost capacity installation for multicommodity network flows,” *Mathematical programming*, vol. 81, no. 2, pp. 177–199, 1998. (Cited in pages 7 and 112.)
- [BCL⁺10] A. P. Bianzino, C. Chaudet, F. Larroca, D. Rossi, and J. Rougier, “Energy-aware routing: A reality check,” in *IEEE GLOBECOM Workshop*, Dec. 2010, pp. 1422–1427. (Cited in page 66.)
- [BCRR12] A. P. Bianzino, C. Chaudet, D. Rossi, and J. Rougier, “A survey of green networking research,” *Communications Surveys & Tutorials, IEEE*, vol. 14, no. 1, pp. 3–20, 2012. (Cited in pages 9 and 114.)
- [BDB⁺11] R. Bolla, F. Davoli, R. Bruschi, K. Christensen, F. Cucchietti, and S. Singh, “The potential impact of green technologies in next-generation wireline networks: Is there room for energy saving optimization?” *IEEE Communications Magazine*, vol. 49, no. 8, pp. 80 – 86, Aug. 2011. (Cited in page 64.)
- [BHT11] J. Baliga, K. Hinton, and R. S. Tucker, *Energy consumption of the Internet*. University of Melbourne, Department of Electrical and Electronic Engineering, 2011. (Cited in pages 9 and 114.)
- [BJ88] T. B. Brecht and C. C. J., “Lower bounds on two-terminal network reliability,” *Discrete Applied Mathematics*, vol. 21, no. 3, pp. 185–198, 1988. (Cited in page 25.)
- [Blu] “BlueCoat: WAN Optimization,” <http://www.bluecoat.com/>. (Cited in page 68.)
- [BM04] M. R. Bussieck and A. Meeraus, “General algebraic modeling system (gams),” in *Modeling languages in mathematical optimization*. Springer, 2004, pp. 137–157. [Online]. Available: <http://www.gams.com/> (Cited in page 20.)

- [BS03] D. Bertsimas and M. Sim, “Robust discrete optimization and network flows,” *Mathematical Programming*, vol. 98, no. 1-3, pp. 49 – 71, 2003. (Cited in pages 17 and 65.)
- [BS04] —, “The price of robustness,” *Operations Research*, vol. 52, no. 1, pp. 35–53, 2004. (Cited in pages 10, 17, 48, 49, 65 and 99.)
- [BTEGN09] A. Ben-Tal, L. El Ghaoui, and A. Nemirovski, *Robust optimization*. Princeton University Press, 2009. (Cited in pages 17 and 99.)
- [BTN00] A. Ben-Tal and A. Nemirovski, “Robust solutions of linear programming problems contaminated with uncertain data,” *Mathematical programming*, vol. 88, no. 3, pp. 411–424, 2000. (Cited in page 17.)
- [BTN02] —, “Robust optimization - methodology and application,” *Mathematical Programming*, vol. 92, pp. 453–480, 2002. (Cited in page 17.)
- [BXG07] W. Bolton, Y. Xiao, and M. Guizani, “IEEE 802.20: mobile broadband wireless access,” *IEEE Wireless Communications*, vol. 14, no. 1, pp. 84–95, 2007. (Cited in pages 5 and 109.)
- [CCK13] C. Caillouet, D. Coudert, and A. Kodjo, “Robust optimization in multi-operators microwave backhaul networks,” in *Global Information Infrastructure Symposium (GIIS)*. IEEE, 2013, pp. 1–6. (Cited in pages 10, 12 and 121.)
- [CCKN11a] G. Claßen, D. Coudert, A. Koster, and N. Nepomuceno, “Bandwidth assignment for reliable fixed broadband wireless networks,” in *12th IEEE International Symposium on a World of Wireless Mobile and Multimedia Networks (WoWMoM)*, Jun. 2011, pp. 1–6. (Cited in pages 25 and 44.)
- [CCKN11b] —, “A chance-constrained model & cutting planes for fixed broadband wireless networks,” in *International Network Optimization Conference (INOC)*, ser. Lecture Notes in Computer Science, vol. 6701, Hamburg, Germany, Jun. 2011, pp. 37–42. (Cited in pages 25 and 44.)
- [CCLRP13] L. Chiaraviglio, A. Cianfrani, E. Le Rouzic, and M. Polverini, “Sleep modes effectiveness in backbone networks with limited configurations,” *Computer Networks*, vol. 57, no. 15, pp. 2931–2948, 2013. (Cited in page 67.)
- [Chv83] V. Chvatal, *Linear Programming*. W. H. Freeman, 1983. (Cited in page 49.)
- [CKCN14] G. Claßen, A. M. Koster, D. Coudert, and N. Nepomuceno, “Chance-constrained optimization of reliable fixed broadband wireless networks,” *INFORMS Journal on Computing*, vol. 26, no. 4, pp. 893–909, 2014. (Cited in pages v, 10, 23, 25, 37, 40, 116 and 117.)

- [CKP14a] D. Coudert, A. Kodjo, and K. Phan, “Robust energy-aware routing with redundancy elimination,” Research Report RR-8457, Jan. 2014. [Online]. Available: <https://hal.inria.fr/hal-00936745> (Cited in pages 11 and 121.)
- [CKP14b] —, “Robust optimization for energy-aware routing with redundancy elimination,” in *ALGOTEL 2014–16èmes Rencontres Francophones sur les Aspects Algorithmiques des Télécommunications*, 2014, pp. 1–4. (Cited in pages 11 and 121.)
- [CKPT13] D. Coudert, A. M. Koster, T. K. Phan, and M. Tieves, “Robust redundancy elimination for energy-aware routing,” in *Green Computing and Communications (GreenCom), 2013 IEEE and Internet of Things (iThings/CPSCoM), IEEE International Conference on and IEEE Cyber, Physical and Social Computing*. IEEE, 2013, pp. 179–186. (Cited in pages 9, 11, 18 and 65.)
- [CKS13] G. Claßen, A. M. C. A. Koster, and A. Schmeink, “A robust optimisation model and cutting planes for the planning of energy-efficient wireless networks,” *Computers and Operations Research*, vol. 40, no. 1, pp. 80 – 90, 2013. (Cited in pages 18 and 65.)
- [CLLC07] G. Cheng, W. Liu, Y. Li, and W. Cheng, “Spectrum aware on-demand routing in cognitive radio networks,” in *New Frontiers in Dynamic Spectrum Access Networks, 2007. DySPAN 2007. 2nd IEEE International Symposium on*. IEEE, 2007, pp. 571–574. (Cited in page 96.)
- [CMN09] L. Chiaraviglio, M. Mellia, and F. Neri, “Energy-aware backbone networks: a case study,” in *Communications Workshops, 2009. ICC Workshops 2009. IEEE International Conference on*. IEEE, 2009, pp. 1–5. (Cited in pages 9 and 114.)
- [CMN11] —, “Minimizing ISP network energy cost: Formulation and solutions,” *IEEE/ACM Transaction in Networking*, vol. 20, no. 2, pp. 463 – 476, Apr. 2011. (Cited in pages 64, 67, 69, 70, 78 and 118.)
- [CNR10] D. Coudert, N. Nepomuceno, and H. Rivano, “Power-efficient radio configuration in fixed broadband wireless networks,” *Computer Communications, Special Section on Hot Topics in Mesh Networking*, vol. 33, no. 8, pp. 898–906, May 2010. [Online]. Available: <http://dx.doi.org/10.1016/j.comcom.2010.01.006> (Cited in page 24.)
- [CNT11] D. Coudert, N. Nepomuceno, and I. Tahiri, “Energy saving in fixed wireless broadband networks,” in *International Network Optimization Conference (INOC)*, ser. Lecture Notes in Computer Science, vol. 6701, Hamburg, Germany, Jun. 2011, pp. 484–489. (Cited in page 44.)

- [CPP⁺08] K.-C. Chen, Y.-J. Peng, N. Prasad, Y.-C. Liang, and S. Sun, “Cognitive radio network architecture: part i—general structure,” in *Proceedings of the 2nd international conference on Ubiquitous information management and communication*. ACM, 2008, pp. 114–119. (Cited in page 94.)
- [Cra96] R. K. Crane, *Electromagnetic wave propagation through rain*. John Wiley & Sons, 1996. (Cited in page 24.)
- [CSB⁺08] J. Chabarek, J. Sommers, P. Barford, C. Estan, D. Tsang, and S. Wright, “Power awareness in network design and routing,” in *IEEE International Conference on Computer Communications (INFOCOM)*, Apr. 2008, pp. 1130–1138. (Cited in pages 9, 66 and 114.)
- [DAB⁺02] A. Doufexi, S. Armour, M. Butler, A. Nix, D. Bull, J. McGeehan, and P. Karlsson, “A comparison of the HIPERLAN/2 and IEEE 802.11 a wireless LAN standards,” *Communications Magazine, IEEE*, vol. 40, no. 5, pp. 172–180, 2002. (Cited in pages 4 and 109.)
- [DBH⁺07] S. Dominiak, N. Bayer, J. Habermann, V. Rakocevic, and B. Xu, “Reliability analysis of IEEE 802.16 mesh networks,” in *2nd IEEE/IFIP International Workshop on Broadband Convergence Networks, BcN 2007*, 2007, pp. 1–12. (Cited in page 25.)
- [DDS05] G. Desaulniers, J. Desrosiers, and M. M. Solomon, *Column generation*. Springer, 2005, vol. 5. (Cited in page 16.)
- [DJ14] N. Dinh and V. Jeyakumar, “Farkas lemma: three decades of generalizations for mathematical optimization,” *TOP, the official journal of the Spanish Society of Statistics and Operations Research*, vol. 22, no. 1, pp. 1–22, 2014. (Cited in pages 19 and 100.)
- [DL05] J. Desrosiers and M. E. Lübbecke, *A primer in column generation*. Springer, 2005. (Cited in page 16.)
- [DVT08] N. Devroye, M. Vu, and V. Tarokh, “Cognitive radio networks,” *Signal Processing Magazine, IEEE*, vol. 25, no. 6, pp. 12–23, 2008. (Cited in page 94.)
- [EGOL98] L. El Ghaoui, F. Oustry, and H. Lebret, “Robust solutions to uncertain semidefinite programs,” *SIAM Journal on Optimization*, vol. 9, no. 1, pp. 33–52, 1998. (Cited in page 17.)
- [FGK93] R. Fourer, D. Gay, and B. Kernighan, *Ampl*. Boyd & Fraser, 1993. (Cited in page 20.)
- [GC97] A. Goldsmith and S.-G. Chua, “Variable-rate variable-power MQAM for fading channels,” *IEEE Transactions on Communications*, vol. 45, pp. 1218–1230, 1997. (Cited in page 24.)

- [GC98] ———, “Adaptive coded modulation for fading channels,” *IEEE Transactions on Communications*, vol. 46, no. 5, pp. 595–602, 1998. (Cited in page 24.)
- [GC07] T. Grevers and J. Christner, *Application Acceleration and WAN Optimization Fundamentals*, ser. Fundamentals series. Cisco Press, Jul. 2007. (Cited in pages 68 and 70.)
- [GCF99] B. Gendron, T. G. Crainic, and A. Frangioni, *Multicommodity capacitated network design*. Springer, 1999. (Cited in pages 7 and 112.)
- [GGNS13] R. G. Garroppo, S. Giordano, G. Nencioni, and M. G. Scutellà, “Mixed integer non-linear programming models for green network design,” *Computers and Operations Research*, vol. 40, no. 1, pp. 273–281, 2013. (Cited in page 67.)
- [Glo07] “Global action plan,” <http://globalactionplan.org.uk>, 2007. (Cited in page 64.)
- [GMMO10] F. Giroire, D. Mazaauric, J. Moulhierac, and B. Onfroy, “Minimizing routing energy consumption: from theoretical to practical results,” in *IEEE/ACM Green Computing and Communications (GreenCom)*, Dec. 2010, pp. 252–259. (Cited in pages 67 and 78.)
- [GMPR12] F. Giroire, J. Moulhierac, T. K. Phan, and F. Roudaut, “Minimization of network power consumption with redundancy elimination,” in *IFIP TC 6 International Conferences on Networking (NETWORKING)*, ser. Lecture Notes in Computer Science, vol. 7289. Springer, 2012, pp. 247–258. (Cited in pages 9, 64, 67, 69, 70, 78 and 118.)
- [GNTS13] R. G. Garroppo, G. Nencioni, L. Tavanti, and M. G. Scutellà, “Does traffic consolidation always lead to network energy savings?” *IEEE Communications Letters*, vol. 17, no. 9, pp. 1852–1855, 2013. (Cited in page 67.)
- [GS03] M. Gupta and S. Singh, “Greening of the Internet,” in *ACM Special Interest Group on Data Communication (SIGCOMM)*. ACM, 2003, pp. 19–26. (Cited in page 64.)
- [GSS⁺10] Y. Ge, J. Sun, S. Shao, L. Yang, and H. Zhu, “An improved spectrum allocation algorithm based on proportional fairness in cognitive radio networks,” in *Communication Technology (ICCT), 2010 12th IEEE International Conference on*. IEEE, 2010, pp. 742–745. (Cited in page 96.)
- [HBF⁺11] K. Hinton, J. Baliga, M. Z. Feng, R. Ayre, and R. Tucker, “Power consumption and energy efficiency in the internet,” *Network, IEEE*, vol. 25, no. 2, pp. 6–12, 2011. (Cited in pages 9 and 114.)

- [HEOL13] J. Hansryd, J. Edstam, B.-E. Olsson, and C. Larsson, “Non-line-of-sight microwave backhaul for small cells,” *Ericsson Review*, vol. 3, Feb. 2013. (Cited in pages 3 and 107.)
- [HGZD12] X. Huang, Y. J. Guo, A. Zhang, and V. Dyadyuk, “A multi-gigabit microwave backhaul,” *Communications Magazine, IEEE*, vol. 50, no. 3, pp. 122–129, 2012. [Online]. Available: <http://ieeexplore.ieee.org/stamp/stamp.jsp?arnumber=6163591> (Cited in pages 3 and 107.)
- [HLI07] A. T. Hoang, Y.-C. Liang, and M. Islam, “Maximizing throughput of cognitive radio networks with limited primary users’ cooperation,” in *Communications, 2007. ICC’07. IEEE International Conference on*. IEEE, 2007, pp. 5177–5182. (Cited in page 96.)
- [HR09] Heavy-Reading, “Ethernet backhaul quartely market tracker,” Heavy Reading Research, Tech. Rep., 2009. (Cited in pages ix, x, 3 and 107.)
- [HR13a] ——. (2013, May) Converged microwave routers: A heavy reading survey analysis. Report. Heavy Reading. [Online]. Available: http://www.heavyreading.com/details.asp?sku_id=3147&skuitem_itemid=1547 (Cited in page 64.)
- [HR13b] ——. (2013, September) Global mobile operator study on converged microwave routers. Presentation. Aviat-Heavy reading. [Online]. Available: http://www.aviatnetworks.com/media/files/HeavyReading_CMRRReport_23Sep13.pdf (Cited in page 64.)
- [IG] IEEE-GHN. Microwave link networks. News. IEEE Global History Network. [Online]. Available: http://www.ieeeahn.org/wiki/index.php/Microwave_Link_Networks (Cited in page 5.)
- [II14] IBM-ILOG. (2014) Cplex optimizer. IBM. [Online]. Available: <http://www-01.ibm.com/software/commerce/optimization/cplex-optimizer/> (Cited in pages 9, 21, 51, 80 and 115.)
- [Joh99] M. Johnsson, “Hiperlan/2—the broadband radio transmission technology operating in the 5 ghz frequency band,” in *HiperLAN/2 Global Forum*, vol. 2, 1999. (Cited in pages 4 and 109.)
- [KAA09] Y. R. Kondareddy, N. Andrews, and P. Agrawal, “On the capacity of secondary users in a cognitive radio network,” in *Sarnoff Symposium, 2009. SARNOFF’09. IEEE*. IEEE, 2009, pp. 1–5. (Cited in page 94.)
- [KCCM14] A. Kodjo, D. Coudert, and C. Caillouet-Molle, “Optimisation robuste pour le partage de réseaux d’accès micro-ondes entre opérateurs,” in *ROADEF-15ème congrès annuel de la Société française de recherche*

- opérationnelle et d'aide à la décision*, 2014. (Cited in pages 10, 12 and 121.)
- [KJN⁺14] A. Kodjo, B. Jaumard, N. Nepomuceno, M. Kaddour, and D. Coudert, “Dimensioning microwave wireless networks,” 2014. (Cited in pages 10, 11 and 121.)
- [KJN⁺15] —, “Dimensionnement des réseaux de collecte de données sans fil par génération de colonnes,” in *ROADEF-16ème congrès annuel de la Société française de recherche opérationnelle et d'aide à la décision*, 2015. (Cited in page 121.)
- [KKR11] A. M. Koster, M. Kutschka, and C. Raack, “On the robustness of optimal network designs,” in *Communications (ICC), 2011 IEEE International Conference on*. IEEE, 2011, pp. 1–5. (Cited in page 18.)
- [KKR13] A. M. C. A. Koster, M. Kutschka, and C. Raack, “Robust network design: Formulations, valid inequalities, and computations,” *Networks*, vol. 61, no. 2, pp. 128–149, 2013. (Cited in pages ix, 48, 49, 65, 76, 85 and 89.)
- [KPT13] A. M. C. A. Koster, T. K. Phan, and M. Tieves, “Extended cutset inequalities for the network power consumption problem,” in *International Network Optimization Conference (INOC)*, ser. Electronic Notes in Discrete Mathematics, vol. 41. Elsevier, Jun. 2013, pp. 69–76. (Cited in page 80.)
- [KT07] M. S. Kuran and T. Tugcu, “A survey on emerging broadband wireless access technologies,” *Computer Networks*, vol. 51, no. 11, pp. 3013–3046, 2007. (Cited in pages 5 and 109.)
- [Leh10] H. Lehpamer, *Microwave Transmission Networks: Planning, Design, and Deployment*, 2nd ed. New York: McGraw-Hill, 2010. (Cited in pages 6, 46 and 110.)
- [LGL09] N. Li, L. Gong, and S. Li, “Price-based spectrum-allocation relay routing in cognitive radio networks,” in *Information, Communications and Signal Processing, 2009. ICSP 2009. 7th International Conference on*. IEEE, 2009, pp. 1–5. (Cited in page 96.)
- [LJJ10] D. H. Lee, W. S. Jeon, and D. G. Jeong, “Joint channel assignment and routing in cognitive radio-based wireless mesh networks,” in *Vehicular Technology Conference (VTC 2010-Spring), 2010 IEEE 71st*. IEEE, 2010, pp. 1–5. (Cited in page 96.)
- [LZ09] X. Li and S. A. R. Zekavat, “Distributed channel assignment in cognitive radio networks,” in *Proceedings of the 2009 International Conference on Wireless Communications and Mobile Computing: Connecting the World Wirelessly*. ACM, 2009, pp. 989–993. (Cited in page 96.)

- [mar13] marketsandmarkets.com. (2013, November) Mobile and wireless backhaul market [by equipment (microwave, millimeter wave, sub 6 ghz, test and measurement), by services (network, system integration, professional)] - worldwide market forecasts and analysis (2013 - 2018). Report. Market and Maerket. Forecast and analysis about mobile and wireless backhaul market (2013-2018). [Online]. Available: <http://www.marketsandmarkets.com/Market-Reports/mobile-wireless-backhaul-market-1034.html> (Cited in pages 3 and 107.)
- [MCG09] I. Malanchini, M. Cesana, and N. Gatti, “On spectrum selection games in cognitive radio networks,” in *Global Telecommunications Conference, 2009. GLOBECOM 2009. IEEE*. IEEE, 2009, pp. 1–7. (Cited in page 96.)
- [Min07] M. Minoux, “Duality, Robustness, and 2-stage robust LP decision models. Application to Robust PERT Scheduling,” *Annales du LAMSADE*, Tech. Rep. 7, Oct. 2007. [Online]. Available: <https://hal.archives-ouvertes.fr/hal-00180529> (Cited in pages 11, 17 and 18.)
- [Min11] —, “On 2-stage robust LP with RHS uncertainty: complexity results and applications,” *Journal of Global Optimization*, vol. 49, no. 3, pp. 521–537, 2011. (Cited in pages 18, 99 and 100.)
- [MYQ08] X. Mao, G. Yu, and P. Qiu, “On achievable rates and spectrum allocation in cognitive wireless networks,” in *Communications, Circuits and Systems, 2008. ICCAS 2008. International Conference on*. IEEE, 2008, pp. 323–327. (Cited in page 96.)
- [Nep10] N. Nepomuceno, “Network optimization for wireless microwave backhaul,” Ph.D. dissertation, Ecole doctorale STIC, Université de Nice-Sophia Antipolis, Dec. 2010. [Online]. Available: <http://tel.archives-ouvertes.fr/tel-00593412/> (Cited in pages 3, 6, 7, 107, 110 and 113.)
- [NIR⁺12] L. Niccolini, G. Iannaccone, S. Ratnasamy, J. Chandrashekar, and L. Rizzo, “Building a power-proportional software router,” in *USENIX Annual Technical Conference*. Boston, MA, USA: USENIX Association, Jun. 2012, pp. 89–100. [Online]. Available: <http://dl.acm.org/citation.cfm?id=2342821.2342829> (Cited in page 66.)
- [Obs10] I. Observatory, “Spectrum and technology issues for microwave backhaul in europe,” Innovation Observatory, Cambridge broadband networks, Tech. Rep., 2010. [Online]. Available: <http://cbl.com/sites/all/files/userfiles/files/Spectrum-and-Technology-Issues-for-Microwave-Backhaul-in-Europe.pdf> (Cited in pages ix, 4 and 108.)

- [OWPT10] S. Orlowski, R. Wessälly, M. Pióro, and A. Tomaszewski, “SNDlib 1.0 - survivable network design library,” *Networks*, vol. 55, no. 3, pp. 276–286, 2010. [Online]. Available: <http://sndlib.zib.de> (Cited in pages 9, 37, 50, 80 and 115.)
- [Pea13] M. Peach. (2013, January) Nec and corning achieve petabit optical transmission. Petabit optical transmission. [Online]. Available: <http://optics.org/news/4/1/29> (Cited in page 2.)
- [PVD⁺08] M. Pickavet, W. Vereecken, S. Demeyer, P. Audenaert, B. Vermeulen, C. Develder, D. Colle, B. Dhoedt, and P. Demeester, “Worldwide energy needs for ict: The rise of power-aware networking,” in *Advanced Networks and Telecommunication Systems, 2008. ANTS’08. 2nd International Symposium on*. IEEE, 2008, pp. 1–3. (Cited in pages 8 and 64.)
- [PZZ06] C. Peng, H. Zheng, and B. Y. Zhao, “Utilization and fairness in spectrum assignment for opportunistic spectrum access,” *Mobile Networks and Applications*, vol. 11, no. 4, pp. 555–576, 2006. (Cited in page 96.)
- [RGM09] J. Restrepo, C. Gruber, and C. Machuca, “Energy profile aware routing,” in *IEEE International Conference on Communications – Workshop on Green Communications*, Jun. 2009, pp. 1–5. (Cited in page 66.)
- [Riv] “Steelhead for WAN optimization,” http://www.riverbed.com/us/solutions/wan_optimization/. (Cited in page 68.)
- [RM11] B. Raghavan and J. Ma, “The energy and emergy of the internet,” in *Proceedings of the 10th ACM Workshop on Hot Topics in Networks*. ACM, 2011, p. 9. (Cited in pages 9 and 114.)
- [SA11] B. Salameh and H. Ahmad, “Throughput-oriented channel assignment for opportunistic spectrum access networks,” *Mathematical and Computer Modelling*, vol. 53, no. 11, pp. 2108–2118, 2011. (Cited in page 96.)
- [SGG10] Y. Song, K. Guo, and L. Gao, “Redundancy-aware routing with limited resources,” in *International Conference on Computer Communications and Networks (ICCCN)*, Aug. 2010, pp. 1–6. (Cited in pages 64 and 68.)
- [Soy73] A. L. Soyster, “Convex programming with set-inclusive constraints and applications to inexact linear programming,” *Operations research*, vol. 21, no. 5, pp. 1154–1157, 1973. (Cited in pages 17, 18 and 99.)
- [SW00] N. T. Spring and D. Wetherall, “A protocol-independent technique for eliminating redundant network traffic,” *SIGCOMM Computer Communication Review*, vol. 30, no. 4, pp. 87–95, Aug. 2000. (Cited in page 68.)

- [TBA⁺08] R. Tucker, J. Baliga, R. Ayre, K. Hinton, and W. Sorin, “Energy consumption in IP networks,” in *ECOC Symposium on Green ICT*, 2008, p. 1. (Cited in pages 9, 64 and 114.)
- [TMF⁺14] S. Tombaz, P. Monti, F. Farias, M. Fiorani, L. Wosinska, and J. Zander, “Is backhaul becoming a bottleneck for green wireless access networks?” in *Communications (ICC), 2014 IEEE International Conference on*, June 2014, pp. 4029–4035. (Cited in page 92.)
- [TMW⁺11] S. Tombaz, P. Monti, K. Wang, A. Vastberg, M. Forzati, and J. Zander, “Impact of backhauling power consumption on the deployment of heterogeneous mobile networks,” in *Global Telecommunications Conference (GLOBECOM 2011), 2011 IEEE*. IEEE, 2011, pp. 1–5. (Cited in pages 8 and 114.)
- [Tom66] J. Tomlin, “Minimum-cost multicommodity network flows,” *Operations Research*, vol. 14, no. 1, pp. 45–51, 1966. (Cited in pages 7 and 112.)
- [TZFS13] E. Z. Tragos, S. Zeadally, A. G. Fragkiadakis, and V. A. Siris, “Spectrum assignment in cognitive radio networks: A comprehensive survey.” *IEEE Communications Surveys and Tutorials*, vol. 15, no. 3, pp. 1108–1135, 2013. (Cited in pages 94 and 95.)
- [TZJ11] O. Tipmongkolsilp, S. Zaghoul, and A. Jukan, “The evolution of cellular backhaul technologies: Current issues and future trends,” *Communications Surveys Tutorials, IEEE*, vol. 13, no. 1, pp. 97–113, First 2011. (Cited in page 2.)
- [Van05] F. Vanderbeck, “Implementing mixed integer column generation,” in *Column Generation*. Springer, 2005, pp. 331–358. (Cited in page 16.)
- [VH99] P. Van Hentenryck, *The OPL Optimization Programming Language*. Cambridge, MA, USA: MIT Press, 1999. (Cited in page 21.)
- [VHIV⁺12] W. Van Heddeghem, F. Idzikowski, W. Vereecken, D. Colle, M. Pickavet, and P. Demeester, “Power consumption modeling in optical multilayer networks,” *Photonic Network Communications*, vol. 24, no. 2, pp. 86–102, 2012. (Cited in page 67.)
- [Vig75] A. Vigants, “Space-diversity engineering,” *Bell System Technical Journal*, vol. 54, no. 1, pp. 103–142, 1975. (Cited in pages 24 and 37.)
- [VN10] S. J. Vaughan-Nichols, “Gigabit Wi-Fi is on its way,” *Computer*, vol. 43, no. 11, pp. 11–14, 2010. (Cited in pages 4 and 109.)
- [WRL10] H. Wang, J. Ren, and T. Li, “Resource allocation with load balancing for cognitive radio networks,” in *Global Telecommunications Conference (GLOBECOM 2010), 2010 IEEE*. IEEE, 2010, pp. 1–5. (Cited in page 96.)

-
- [YLH10] L. Yu, C. Liu, and W. Hu, “Spectrum allocation algorithm in cognitive ad-hoc networks with high energy efficiency,” in *Green Circuits and Systems (ICGCS), 2010 International Conference on*. IEEE, 2010, pp. 349–354. (Cited in page 96.)
- [ZA14] Y. Zhang and N. Ansari, “On protocol-independent data redundancy elimination,” *Communications Surveys Tutorials, IEEE*, vol. 16, no. 1, pp. 455–472, First 2014. (Cited in pages 9 and 114.)
- [ZCM11] E. Zohar, I. Cidon, and O. O. Mokryn, “The power of prediction: Cloud bandwidth and cost reduction,” *SIGCOMM Computer Communication Review*, vol. 41, no. 4, pp. 86–97, Aug. 2011. (Cited in pages 9, 64, 68 and 114.)
- [ZYLZ10] M. Zhang, C. Yi, B. Liu, and B. Zhang, “GreenTE: Power-aware traffic engineering,” in *IEEE International Conference on Network Protocols (ICNP)*, Oct. 2010, pp. 21–30. (Cited in page 64.)