



**HAL**  
open science

**Ingénierie des systèmes basés sur les modèles (MBSE)  
appliquée au processus de conception de simulation  
complexe : vers une ontologie de la modélisation et la  
simulation pour favoriser l'échange des connaissances en  
entreprise étendue**

Göknur Sirin

► **To cite this version:**

Göknur Sirin. Ingénierie des systèmes basés sur les modèles (MBSE) appliquée au processus de conception de simulation complexe : vers une ontologie de la modélisation et la simulation pour favoriser l'échange des connaissances en entreprise étendue. Other. Ecole Centrale Paris, 2015. English. NNT : 2015ECAP0024 . tel-01168567

**HAL Id: tel-01168567**

**<https://theses.hal.science/tel-01168567v1>**

Submitted on 26 Jun 2015

**HAL** is a multi-disciplinary open access archive for the deposit and dissemination of scientific research documents, whether they are published or not. The documents may come from teaching and research institutions in France or abroad, or from public or private research centers.

L'archive ouverte pluridisciplinaire **HAL**, est destinée au dépôt et à la diffusion de documents scientifiques de niveau recherche, publiés ou non, émanant des établissements d'enseignement et de recherche français ou étrangers, des laboratoires publics ou privés.



CentraleSupélec  
« CENTRALE SUPELEC »

**THÈSE**  
présentée par

**Göknur SIRIN**

pour l'obtention du

**GRADE DE DOCTEUR**

Spécialité : Génie Industriel

Laboratoire d'accueil: Laboratoire de Génie Industriel

**SUJET:**

**Supporting Multidisciplinary Vehicle Modeling:  
Towards an Ontology-based Knowledge Sharing in Collaborative  
Model Based Systems Engineering Environment**

soutenue le : 20 Mars 2015

devant un jury composé de :

Bernard Yannou, CentraleSupélec, directeur de thèse

Eric Landel, Renault S.A., tuteur industriel

Irem Tümer, Oregon State University, rapporteur

Eric Bonjour, INP Lorraine, rapporteur

Daniel Krob, Ecole Polytechnique, examinateur

Chris Paredis, Georgia Institute of Technology, examinateur

Torgeir Welo, Norwegian University of Science and Technology, examinateur

2015



# Résumé

Les systèmes industriels (automobile, aérospatial, etc.) sont de plus en plus complexes à cause des contraintes économiques et écologiques. Cette complexité croissante impose des nouvelles contraintes au niveau du développement. La question de la maîtrise de la capacité d'analyse de leurs architectures est alors posée. Pour résoudre cette question, les outils de modélisation et de simulation sont devenus une pratique courante dans les milieux industriels afin de comparer les multiples architectures candidates. Ces outils de simulations sont devenus incontournables pour conforter les décisions. Pourtant, la mise en œuvre des modèles physiques est de plus en plus complexe et nécessite une compréhension spécifique de chaque phénomène simulé ainsi qu'une description approfondie de l'architecture du système, de ses composants et des liaisons entre composants. L'objectif de cette thèse est double. Le premier concerne le développement d'une méthodologie et des outils nécessaires pour construire avec précision les modèles de simulation des architectures de systèmes qu'on désire étudier. Le deuxième s'intéresse à l'introduction d'une approche innovante pour la conception, la production et l'intégration des modèles de simulations en mode « plug and play » afin de garantir la conformité des résultats aux attentes. Notamment, aux niveaux de la qualité et la maturité. Pour accomplir ces objectifs, des méthodologies et des processus d'ingénierie des systèmes basés sur les modèles (MBSE) ainsi que les systèmes d'information ont été utilisés. Ce travail de thèse propose pour la première fois un processus détaillé et un outil pour la conception des modèles de simulation. Un référentiel commun nommé « Modèle de Carte d'Identité (MIC) » a été développé pour standardiser et renforcer les interfaces entre les métiers et les fournisseurs sur les plans organisationnels et techniques. MIC garantit l'évolution et la gestion de la cohérence de l'ensemble des règles et les spécifications des connaissances des domaines métiers dont la sémantique est multiple. MIC renforce également la cohérence du modèle et réduit les anomalies qui peuvent interférer pendant la phase dite IVVQ pour Intégration, Vérification, Validation, Qualification. Finalement, afin de structurer les processus de conception des modèles de simulation, le travail s'est inspiré des cadres de l'Architecture d'Entreprise en reflétant les exigences d'intégration et de standardisation du modèle opératoire de l'entreprise. Pour valider les concepts introduits dans le cadre de cette thèse, des études de cas tirés des domaines automobile et aérospatiale ont été réalisées. L'objectif de cette validation est d'observer l'amélioration significative du processus actuel en termes d'efficacité, de réduction de l'ambiguïté et des malentendus dans la modélisation et la simulation du système à concevoir.

# Abstract

Simulation models are widely used by industries as an aid for decision making to explore and optimize a broad range of complex industrial systems' architectures. The increased complexity of industrial systems (cars, airplanes, etc.), ecological and economic concerns implies a need for exploring and analysing innovative system architectures efficiently and effectively by using simulation models. However, simulation designers currently suffer from limitations which make simulation models difficult to design and develop in a collaborative, multidisciplinary design environment. The multidisciplinary nature of simulation models requires a specific understanding of each phenomenon to simulate and a thorough description of the system architecture, its components and connections between components. To accomplish these objectives, the Model-Based Systems Engineering (MBSE) and Information Systems' (IS) methodologies were used to support the simulation designer's analysing capabilities in terms of methods, processes and design tool solutions. The objective of this thesis is twofold. The first concerns the development of a methodology and tools to build accurate simulation models. The second focuses on the introduction of an innovative approach to design, product and integrate the simulation models in a "plug and play" manner by ensuring the expected model fidelity. However, today, one of the major challenges in full-vehicle simulation model creation is to get domain level simulation models from different domain experts while detecting any potential inconsistency problem before the IVVQ (Integration, Verification, Validation, and Qualification) phase. In the current simulation model development process, most of the defects such as interface mismatch and interoperability problems are discovered late, during the IVVQ phase. This may create multiple wastes, including rework and, may-be the most harmful, incorrect simulation models, which are subsequently used as basis for design decisions. In order to address this problem, this work aims to reduce late inconsistency detection by ensuring early stage collaborations between the different suppliers and OEM. Thus, this work integrates first a Detailed Model Design Phase to the current model development process and, second, the roles have been re-organized and delegated between design actors. Finally an alternative architecture design tool is supported by an ontology-based DSL (Domain Specific Language) called Model Identity Card (MIC). The design tools and mentioned activities perspectives (e.g. decisions, views and viewpoints) are structured by inspiration from Enterprise Architecture Frameworks. To demonstrate the applicability of our proposed solution, engine-after treatment, hybrid parallel propulsion and electric transmission models are tested across automotive and aeronautic industries.

# Table of contents

<b>Résumé</b> .....	<b>ii</b>
<b>Abstract</b> .....	<b>iii</b>
<b>Table of contents</b> .....	<b>iv</b>
<b>List of tables</b> .....	<b>viii</b>
<b>List of figures</b> .....	<b>ix</b>
<b>List of abbreviations</b> .....	<b>xi</b>
<b>Acknowledgements</b> .....	<b>xi</b>
<b>Extended summary</b> .....	<b>1</b>
<b>Résumé étendu</b> .....	<b>6</b>
Contexte global: AS-IS.....	7
Enjeux industriel et académique.....	10
Vue d'ensemble des travaux de recherche .....	16
Etat de l'art .....	16
Objectif .....	20
Question de recherche.....	20
Objectives spécifiés.....	21
Apports et perspectives .....	23
Cadre methodologique .....	23
Limites et perspectives .....	25
Reference #0.....	27
<b>Dissertation Structure</b> .....	<b>28</b>
<b>1 Chapter 1: Introduction</b> .....	<b>31</b>
1.1 Research and company context .....	31

1.1.1	Domain Model Language (DSL) and SysML.....	35
1.1.2	Model Exchange and Exploitation Barriers in Multidisciplinary Modeling.....	36
1.2	Research objectives.....	38
1.4	Research methodology.....	38
<b>1.5</b>	<b>Reference #1.....</b>	<b>41</b>
<b>2</b>	<b>Chapitre 2: Research overview.....</b>	<b>42</b>
2	State of the art.....	43
2.1	Modeling and Simulation (M&S) as a complex system.....	43
2.2	Complex system architecture and modularity.....	45
2.2.1	Component and port-based modeling.....	47
2.3	Model exchange: interoperability and inconsistency problems.....	49
2.3.1	Product Life Cycle (PLC) and inconsistency.....	51
2.4	Specified research objectives.....	52
2.4	Reference #2.....	53
<b>3</b>	<b>Chapter 3: Paper #1. Characteristics of a Good Multidisciplinary Model Design Practice: Toward a Value-Added Thinking.....</b>	<b>57</b>
3.1	Introduction.....	58
3.2	Background and state of the art.....	60
3.2.1	Methodological positioning: value in multidisciplinary model development process.....	63
3.3	Characteristics of a good multidisciplinary model design processes.....	66
3.3.1	Multidisciplinary collaborative process and stakeholder organization.....	67
3.3.2	Product level: Referential architecture and simulation models.....	72
3.3.2.1	Vehicle architecture and architecture reuse.....	73
3.3.2.2	Knowledge generation and appropriate model reuse strategy.....	75
3.3.2.2.1	Model refactoring.....	76
3.3.2.2.2	Model reuse.....	77
3.3.2.2.2.1	Model reuse (via modification): white box model.....	77
3.3.2.2.2.2	Single source of authority or right from me.....	78

3.3.2.2.2.3 Model reuse: black box model .....	79
3.4 Case study .....	80
3.5 Conclusions .....	83
3.6 Reference #3 .....	84
<b>4 Chapter 4: Paper #2. Multidisciplinary Simulation Model Development: towards an inconsistency detection method during the design stage .....</b>	<b>90</b>
4.1 Introduction .....	90
4.2 State of the art .....	92
4.2.1 Related research methods and industrial projects .....	92
4.3 Proposed methodology .....	93
4.3.1 Model Identity Card (MIC).....	93
4.3.2 Model of Intention (MoI) .....	100
4.3.3 Proposed methodology: a mixed approach.....	102
4.4 Case study.....	104
4.4.1 First step: Formal model architecting.....	105
4.4.2 Second step: Model Identity Card (MIC) creation.....	107
4.4.3 Third step: MoI building.....	111
4.5 Comparative analysis of request packages and supplier models.....	115
4.5.1 Supplier model reception .....	115
4.5.2 Battery models comparison .....	116
4.5.3 Global models comparison .....	117
4.6 Conclusions and future consideration .....	118
4.7 References #4.....	119
<b>5 Chapter 5: Paper #3. A Model Identity Card to Support Simulation Model Development Process in a Collaborative Multidisciplinary Design Environment.....</b>	<b>123</b>
5.1 Introduction .....	123
5.1.1 Background.....	123
5.1.2 Problem statement and our contributions.....	125



5.2	Methodology and state of the art .....	128
5.2.1	Step 1: Formal vehicle architecture design .....	130
5.2.2	Step 2: Vehicle and domain models specifications with Model Identity Card (MIC) .....	131
5.2.3	Step 3: Correctness control at the early design phase.....	133
5.3	Model Identity Card (MIC) .....	133
5.3.1	Motivation for M&S meta-model creation .....	133
5.3.2	Roadmap for MIC creation .....	134
5.4	Case study .....	141
5.4.1	Demonstration scenario and MIC validation.....	141
5.4.1.1	Step1: Formal system architecture design based on non-formal model architecture .....	141
5.4.1.2	Step2: Vehicle and domain models specifications with Model Identity Card (MIC) .....	142
5.4.1.3	Step 3: Correctness control at the early design phase .....	146
5.5	Validation protocol.....	147
5.6	Limitation and future considerations.....	150
5.8	Reference # 5 .....	152
<b>6</b>	<b>Chapter 6: Conduct Change: Tool Development and Deployment .....</b>	<b>156</b>
6.1	arKIitect Systems Engineering (SE) Tool and its Customization .....	156
6.1.1	Model Identity Card (MIC) and arKIitect Systems Engineering Tool Integration .....	159
6.2	Graphical User Interface (GUI) for Model Specification .....	163
6.3	Consistency Properties and Check .....	166
<b>7</b>	<b>Chapter 7: Conclusion and perspective .....</b>	<b>170</b>
	<b>Personal Publications.....</b>	<b>168</b>
	Journal papers.....	168
	Conference papers .....	168
A.	Appendix.....	171

## List of tables

Table 0-1 Les Acteur de Modelisation .....	15
Table 2-1 Complexity in multidisciplinary M&S environment .....	43
Table 3-1 Actors and their activities .....	72
Table 4-1 Model parameters .....	114
Table 4-2 Battery model State of Charge (SoC) test .....	116
Table 5-1 MIC classes and their attributes .....	136
Table 5-2 Interface attributes .....	138

# List of figures

Figure 0-1	Processus Actuel, V Cycle.....	11
Figure 0-2	Architecture de modèle.....	15
Figure 0-3	La solution proposée .....	19
Figure 0-4	Contribution.....	21
Figure 0-5	Dissertation Structure .....	28
Figure 1-1	Architecture Design Tool and DSL.....	34
Figure 1-2	Transparency agreement and early stage collaboration .....	37
Figure 1-3	Research methodology .....	38
Figure 1-4	Problem-based and theory-based engineering design research methods.....	39
Figure 2-1	Vehicle decomposition.....	47
Figure 2-2a	Port-based design representation .....	49
Figure 2-2b	Port-based design representation and causality.....	50
Figure 3-1	Value for Product and Process Perspectives .....	62
Figure 3-2	Add value to the current Simulation Model Development Process .....	66
Figure 3-3	Majors design actors and concurrent activity.....	70
Figure 3-4	Pull model development process .....	71
Figure 3-5	Vehicle architecture and model.....	75
Figure 3-6	Model reuse strategy, general view.....	77
Figure 3-7	Model Reuse in Engineering Practice.....	79
Figure 3-8	Proposed Process: Link between organization, process and product perspective .....	81
Figure 4-1	Collaboration between major M&S actors .....	92
Figure 4-2	RFLP Methodology.....	94
Figure 4-3	Conceptual Design Stage.....	96
Figure 4-4	Main Classes and Attributes.....	99
Figure 4-5	Interface Specification.....	100
Figure 4-6	Methodology to support simulation model building based on I&I and MoI .....	101
Figure 4-7	Collaboration between Model Architect and Model Supplier: Information Flow2 .....	102
Figure 4-8	Proposed Methodology .....	103
Figure 4-9	Hybrid parallel architecture .....	105
Figure 4-10	Formal Model Architecture Design .....	107
Figure 4-11	Model Specification with MIC1.....	108
Figure 4-12	Model Specification with MIC2.....	109
Figure 4-13	Interface Specification with MIC .....	110
Figure 4-14	Global model including electric motor and battery blank models .....	111
Figure 4-15	Model delivers to suppliers.....	113
Figure 4-16	Battery MoI - MoR comparison.....	115
Figure 4-17	Global model MoI - MoR comparison .....	117
Figure 5-1	Research Gap in Collaborative Model Development Process .....	127
Figure 5-2	Integrated model design phase to V-cycle systems engineering process.....	129
Figure 5-3	MIC Concept.....	133
Figure 5-4	A part of MIC Meta-Model.....	135
Figure 5-5	Interface Characterization .....	137
Figure 5-6	Object Model classes grouping.....	140
Figure 5-7	GUI MIC Interface description / Port creation .....	143
Figure 5-8	GUI In-coming, out- coming ports.....	144

Figure 5-9	Generated block diagram (formal version)	144
Figure 5-10	GUI MIC Model Characteristics	145
Figure 5-11	Interoperability Check	146
Figure 5-12	Proof of Concept	147
Figure 5-13	Sources of ambiguity	148
Figure 5-14	Ambiguity reduction	148
Figure 5-15	Sources of rework and expected improvement	150
Figure 6-1	Hierarchical representation of a system	158
Figure 6-2	Simulation model view creation	158
Figure 6-3	System, Component and Port	159
Figure 6-4	Model and Interface Nature	160
Figure 6-5	MIC concept (left side) and created new objects in arKIitect desing tool (right side)	161
Figure 6-6	MIC Port and Variable Specification	162
Figure 6-7	Architecture created with defined graphical editor and MIC	163
Figure 6-8	MIC GUI for model specification	164
Figure 6-9	MIC Consistency Check	167
Figure 6-10	Causality in Amesim Tool	168

## List of abbreviations

AFIS	Association Française d'Ingénierie Système
API	Application Programming Interface
AUTOSAR	Automotive Open System ARchitecture
CAE	Computer Aided Engineering
CAD	Computer Aided Design
CAFE	Corporate Average Fuel Efficiency Standards
CE	Concurrent Engineering
DARPA	Defense Advanced Research Projects Agency
DoD	Department of Defense
IVVQ	Integration, Verification, Validation, and Qualification
IC	Internal Combustion
ISO	International Organization for Standardization
M&S	Modeling and Simulations
MBSE	Model-Based Systems Engineering
MIC	Model Identity Card
MoI	Model of Intention
NASA	National Aeronautics and Space Administration
OEM	Original Equipment Manufacturer
SA	System Architecture
SE	Systems Engineering
PDM	Product Data Management
PLM	Product Lifecycle Management
PLC	Product Life Cycle
RFLP	(Requirements > Fonctionnal > Logical > Physical)
SDM	Simulation Data Management
STEP	STandard for the Exchange of Product model data
XML	eXtensible Markup Language

## Acknowledgements/ Remerciements

First of all, I would like to warmly thank the jury members of this PhD thesis: Eric Bonjour, Daniel Krob, Irem Tümer, Chris Paredis and Torgeir Welo for accepting to review and examine this thesis. I appreciated their encouragement, insightful comments, and hard questions.

J'aimerais remercier tout d'abord, Bernard Yannou, mon directeur de thèse, pour la confiance et pour la liberté qu'il m'a accordée ainsi que pour son écoute et ses conseils car ils m'ont été précieux. Je tiens ensuite remercier à Eric Landel, tuteur industriel, pour sa connaissance du domaine, son enthousiasme et pour sa gentillesse et surtout son professionnalisme. Il est à l'origine de ce sujet de recherche et a inspiré ce travail.

Je tiens ensuite à remercier à ceux sans qui cette thèse n'aurait pas été la même de par leur participation à mes différents travaux avec une mention spéciale à Frederic Ravet, Emmanuel Arnaux, Jean-Marc Gilles, Laurent Noyelle, Amin El-Bakkali, Benjamin Guay de Renault Technocentre et Saina Hassanzadeh de KI pour l'intérêt qu'ils ont porté à ma thèse.

Je tiens à remercier les membres du projet SIM d'IRT SystemX pour les échanges productifs. J'en viens maintenant à remercier tous mes collègues et mes amis de Renault, d'IRT SystemX et du LGI.

Je voudrais de plus accorder une mention spéciale à Jean-Claude Bocquet, le directeur du LGI, aux « fonctions supports » du laboratoire. Merci à vous quatre, Corinne Ollivier, Sylvie Guillemain, Delphine Martin et Carole Stoll, pour votre aide et votre bonne humeur.

Pour conclure, je tiens à remercier du fond du cœur les membres de la famille Sirin et à mon ange Gabriel.

# Extended Summary

*This PhD thesis dissertation results from a collaboration between Ecole Centrale Paris and Renault Technocentre under a CIFRE (Conventions Industrielles de Formation par la REcherche) contract between March 2012 and March 2015.*

Simulation models are widely used by Original Equipment Manufacturers (OEMs) as an aid for decision making to explore and optimize a broad range of vehicle architectures. However, simulations designers currently suffer from limitations which make simulation models difficult to design and develop for complex multidisciplinary system analysis. The design and development of complex systems is shifting towards a distributed and collaborative paradigm. Furthermore, multidisciplinary simulation model development activity is a complex and highly interactive social and design process that covers the individual engineering disciplines (e.g. aerodynamics, mechanical, electromagnetics, thermal, noise, vibration,) and implies various design actors (e.g. System Architect, Model Architect and Model Provider). This is particularly challenging for the design of multidisciplinary systems in which components in different disciplines are tightly coupled to achieve optimal system performance. The simulation environments for such a paradigm, therefore, require substantial transparency agreement and collaboration at early design stage. Since the quality of complex multidisciplinary simulation model strongly depends on inputs from multiple sources, the semantics and the definition of the interfaces need to be accurate and complete within or between model components and outside environment (e.g. human and environment). Nevertheless, today's siloed and decoupled way of working may create some unnecessary iteration during model integration phase (e.g. co-simulation), which often results in increased product development lead-time and cost. From a value perspective, this is particularly wasteful since the 'cost of learning' is higher in the final integrating stage. Several factors may cause inconsistencies during the integration of domain level simulation models into a system level model; such as lack of early transparency agreement and interface specification, interoperability based mismatch, human error and lack of common understanding etc.

The above mentioned challenges address the needs of several software tool providers and OEMs as aerospace and automotive where the design engineers provide digital tools and methods to develop, operate and maintain complex systems. The overarching goal of this dissertation is to manage the concurrent design of credible simulation models during a vehicle design process while aiming to detect any model inconsistencies problems before the Integration / Verification / Validation / Qualification (IVVQ) phase.

To this aim, the research issue has been first split it into three interrelated design objectives:

1. **Follow a formal, precise process:** The modelling process should be established according to ‘good modelling practices’ to design and manage any multidisciplinary simulation model.
2. **Create a credible multidisciplinary model:** The model can only be ‘useful’, if it is developed based on adequate explicit descriptions of the design problem.
3. **Support a robust collaboration:** Information flows between design actors should be standardized and supported by a common terminology to decrease the ambiguity and misunderstanding.

The first objective – a valuable process based on a good modelling practices – comprises the second and third, which is related to the quality of the model and collaboration issues because, it is important to acknowledge that the quality of the final product is the implicit outcome of a sequence of activities made through the process. The first objective consists furthermore in the optimization of all standard steps of the modeling process such as model design, development, integration, validation, verification and decision making. However, one of the gaps that we noticed during our research investigation in the OEMs is that there is no clear and formal simulation model specification agreement between the design actors at early model design phase (or conceptual design phase – downstream phase of V cycle process). Thus to improve early model design phase, a broader motivating question is addressed:

*“How should one design and guide the development of multidisciplinary simulation models?”*

Thus, this work proposes a detailed model design phase which is typically composed of the following steps:

1. **A System World Specification** which is made of:
  - an operation scenario,
  - a functional system architecture,
  - a system analysis application plan with other systems (vehicle and sub systems level).



## 2- A Model World Specification which is made of:

- a structural formal vehicle architecture,
- a vehicle domain level models specification (e.g. model and its interfaces),
- a complete system level model architecture with negotiated domain model interfaces and related model specifications,
- an early certification (correctness control) before contracting suppliers - advanced checked options for detecting potential inconsistencies before IVVQ -.

More researchers are recognizing the benefits of Model-Based Systems Engineering (MBSE) for managing complex system architectures in a formal way. However, semantic misunderstandings and simple human error can still lead to inconsistencies when specifying a vehicle architecture with a MBSE language (e.g. SysML). Thus to support model consistency within an MBSE methodology, an ontology based meta-model named “Model Identity Card (MIC)” is developed. MIC in this case plays a role in the specification of such systems and improves the reliability of the systems by facilitating checking the match between the system requirements and the design solution. MIC includes some important and refined characteristics of simulation model such as modeling assumptions and interfaces specifications. Another MIC objective is to simplify engineering knowledge capture and ambiguity reduction between design actors. MIC also helps to support a clear simulation model request creation and design artefact negotiation. Finally, MIC provides an interfaces correctness control for detecting and preventing interface mismatch problems between two domain models. Another contribution of this work is to introduce Agent-Based Concurrent Engineering (CE) environment where the authority delegation is defined and then supported by information flows between different design actors. Since, there is no clear and formal model specification agreement between the System Architect and Model Provider, the interaction of these two actors may create a bottleneck for communication because they do not have the same level of understanding. The System Architects have a functional view (system world) and they are the sponsors of model development activity. They define an operational scenario, a trade-off analysis and provide system based requirements to the Model Providers.

On the other side, Model Providers have a physical view (e.g. Simulation Model World) and they are the domain experts who build models. To reduce the knowledge gap between these two types of design actors and to support the new activities previously mentioned at the detailed model design phase, a new design actor named “**Model Architect**” is introduced. Each Model Architect has a multidisciplinary vision of a product and of simulation knowledge. He also has a deep understanding of the system-level requirements

for the vehicle model, as well as how their models must interface with other domain models. There are multiple activities involved in the Model Architecture business cycle such as:

- understanding the system world requirements and interpreting and translating these requirements in model world,
- analyzing or evaluating and selecting the architecture,
- communicating and playing a transversal view between system architects and model providers.

These activities and proposed MIC meta-model are supported by a new design tool. An industrial tool is used to instantiate the MIC meta-model and a Graphical User Interface (GUI) is developed to create a semantically-rich model characterization support for the mentioned design actors. The design tools and mentioned activities perspectives (e.g. decisions, views and viewpoints) are structured by inspiration from Enterprise Architecture Frameworks (e.g. NAF, TOGAF, and DoDAF).

To demonstrate the applicability of our proposed solution, engine-after treatment, crash and electric transmission models are tested across automotive and aeronautic industries. The aim of this demonstration is to observe the significant improvement of current model design process in term of efficiency, interface mismatches reduction, and ambiguity and misunderstanding reduction. During this case study, some selected design actors (system architects and external/internal providers) have participated to the test scenarios. The objectives of validation of the proposed methods are twofold:

- (i) checking the scalability of MIC, i.e. the capacity to cover different natures of simulation models,
- (ii) qualitative observation to estimate the rate of model rework and ambiguity reduction

According to return of experience of the design actors who are involved in the case study and of our qualitative observations, the knowledge gap between the design actors is decreased by providing a MIC meta-model. (i) The MIC is partially integrated to the company and tested by different engineering teams. Following the test results, we can say that MIC's attributes are accurate and contain sufficient information for characterizing different natures of models (0D reduced, and 1D, 2D and 3D). This kind of test group experimentation is useful to be able to understand the proposed methods' functionality and capacity. Our aim is to make iterations with domain experts in terms of MIC and tool improvement until they succeed in meeting design requirements. The MIC is potentially a useful concept which contains sufficient information system to be modeled. MIC could possibly be applicable to another context such as aeronautics but it would require some work to extend it to support various specific domains of interest.

(ii) Proposed early correctness control within a detailed model design phase aims to reduce the number of inconsistency based anomalies by a factor of 2. With the provided method, it would take approximately less than one staff hour of correctness check time for each defect found (e.g. current situation: inconsistency based rework creates on average, 2 or 3 supplementary staff work per project and 1 to 2 months of delay).

Proposed new activities in the detailed model design phase and MIC concepts will be used in next generation OEM's multidisciplinary vehicle modeling strategy. Finally, the OEM that we worked with is creating a job description for the new design actor 'Model Architect' and is currently recruiting for this position.

As a future consideration, a Model of Intention (MoI) concept will be partially integrated to the detailed model design phase. MoI is a complementary method to MIC and allows to reduce the knowledge gap between Model Architect and Model Suppliers. MoI is an executable model and contains some observable parameters so as to be able to understand the requested models' expected behaviors for a given scenario. The objective of MoI is to fulfil the transition from the real world to the virtual one in the MBSE spirit.

To highlight the main contribution of this PhD thesis, a set of methods have been proposed and validated separately with three different industrial case studies, which has allowed to write and submit three scientific papers [1, 2, 3]. This doctoral dissertation adopts a recent spring-up format — a format that uses published or submitted scientific articles as main chapters.

[1] G. Sirin, L. Gasser, T. Welo, B. Yannou, and E. Landel, 2015. "Characteristics of a Good Multidisciplinary Model Design Practice: Toward a Model Reuse and a Value-Added Thinking", in preparation.

[2] G. Sirin, F. Retho, M. Callot., P. Dessante, E. Landel, B. Yannou, J.C. Vannier, 2014. "Multidisciplinary Simulation Model Development: towards an inconsistency detection method during the design stage", submitted to *Systems, Man and Cybernetics, Part A: Systems and Humans, IEEE Transactions*.

[3] G. Sirin., C.J.J. Paredis, B. Yannou, E. Landel, E. Coatanea, 2014. "A Model Identity Card to Support Simulation Model Development Process in a Collaborative Multidisciplinary Design Environment," *Systems Journal, IEEE, vol.PP, no.99, pp.1, 12*.

**Key words:** *Collaboration, Design Process, Modeling & Simulation, Model Based Systems Engineering, Ontology-driven design, Enterprise Architecture Framework*

## Résumé étendu

Le résumé étendu en français a pour double objectif d'exposer le contexte et la problématique industrielle de notre étude d'une part, et d'autre part de les situer dans les problématiques de recherche du génie industriel. Dans un premier temps, quelques généralités sur l'activité de conception industrielle, notamment la conception de modèle de simulation pluridisciplinaire, sont rappelées. Ceci permet d'introduire et de situer le contexte du constructeur automobile Renault. Puis nous abordons plus précisément les problématiques concernant l'introduction du point de vue de l'architecture et d'un référentiel commun au processus de conception de simulation numérique pour, de même, introduire et situer le contexte de Renault.

### **Contexte global de la conception, simulation, validation des véhicules automobiles: AS-IS**

L'agence d'informations Thomson Reuters a classé en décembre 2012 Renault parmi les 100 entreprises les plus innovantes au monde. Renault est le constructeur dont le flux d'innovations est le plus constant depuis le début de l'histoire automobile. Pour Renault, innover, c'est d'abord concevoir et faire aboutir à un coût abordable des produits et des services qui ont de la valeur pour les clients, développer des technologies qui devancent leurs attentes. Mais c'est aussi imaginer aujourd'hui la voiture de demain, grâce à un travail de prospective et de veille [1]. Pour développer des technologies attirantes et accessibles pour les clients, Renault travaille aujourd'hui autour de 6 axes prioritaires :

- Les architectures innovantes. De la R16 à Twizy en passant par Espace et Twingo, le Groupe a marqué l'histoire dans ce domaine et cette approche reste une priorité pour Renault.
- Les véhicules électriques et leur écosystème. Au-delà d'une gamme de quatre véhicules 100 % électriques déjà sur les routes, Renault poursuit ses efforts notamment pour explorer de nouvelles technologies de batterie, augmenter leur autonomie, réduire les temps de charge et les coûts.

- Les véhicules thermiques. Face aux enjeux de réduction des émissions de CO<sub>2</sub>, Renault se doit de modifier son offre en matière de technologies de motorisation afin de répondre aux objectifs dits de CAFE (Corporate Average Fuel Economy) très ambitieux de l'Union Européenne à l'horizon 2020-2025. Le Groupe s'est fixé comme objectif de diminuer significativement les émissions de CO<sub>2</sub>. En 2013, le Groupe était leader en Europe en émissions de CO<sub>2</sub> et le premier groupe automobile sous les 116g de CO<sub>2</sub>/km sur les ventes de véhicules particuliers [2].
- Le bien être à bord. Renault a pour ambition de développer des innovations qui concourent à faire du déplacement un temps de plaisir et de sérénité comme les technologies électroniques et de connectivité (notamment via les smartphones) : information en temps réel, continuité d'usage entre les différents mondes dans lesquels conducteurs et occupants d'un véhicule évoluent, grâce aussi aux systèmes multimedia embarqués, ou à la personnalisation de l'espace à bord. Le prototype de véhicule autonome et connecté, NEXT TWO, est un exemple de cette démarche.
- Les nouveaux services. Renault travaille pour répondre aux besoins des clients qui cherchent à retrouver dans leurs véhicules les systèmes d'aide à la conduite peuvent être rangés en plusieurs catégories: élargir le champ de vision du conducteur, prévenir les baisses de vigilance, proposer du copilote électronique et des systèmes d'anticollision et des aides au parking. Certaines de ces technologies sont aujourd'hui proposée sur les véhicules, dont le Nouvel Espace, pour faciliter la vie du conducteur.
- A des coûts abordables. Dans une approche centrée sur le client, toutes les innovations sont conçues pour être abordables pour tous, ce qui nécessite de mobiliser toute l'ingénierie des équipes pour simplifier et standardiser les solutions que Renault développe.

Pour s'adapter à ces évolutions, le constructeur dispose principalement de deux leviers.

- Le premier est l'optimisation des technologies traditionnelles actuellement présentes dans les véhicules, par exemple maîtrise de la cylindrée des moteurs (« downsizing »), réduction des frottements, optimisation de l'aérodynamique, maîtrise de la masse, etc...
- Le deuxième levier est l'introduction ou l'exploration de technologies innovantes. Les plus étudiées actuellement portent principalement sur l'électrification des véhicules (ex: véhicule hybride ou 100% électrique).

Les architectures électriques n'ayant que peu évolué depuis une vingtaine d'années, ces ruptures technologiques imposent de nouvelles contraintes de développement (ex : coût, sécurité, quantité d'énergie disponible, poids, volume...) et nécessitent donc des méthodologies et des outils appropriés pour les analyser. Concernant les outils de conception, très nombreux sont les constructeurs qui s'orientent vers d'autres solutions que la réalisation systématique de prototypes physiques en faisant appel à la simulation

numérique dès le début du cycle de développement (cycle en V) [3] pour réduire les coûts et les délais de développement, en particulier pour diminuer le nombre de prototypes physiques et d'heures d'essais. La modélisation et la simulation numérique jouent un rôle central, en privilégiant l'analyse et la mise en œuvre de modèles, d'algorithmes et de méthodes de calcul intensifs innovants. Ces efforts concernent tant l'élaboration, l'étude des modèles et la formalisation de problèmes complexes motivés par les sciences que la mise au point, la validation de nouvelles méthodologies sur de nouvelles architectures de produit.

### **La simulation de systèmes complexes vue comme un système de simulation**

Assurer la bonne qualité du produit et réduire son coût et le temps de conception sont les objectifs principaux de l'industrie actuelle. Par ailleurs, les systèmes industriels (véhicule automobile, spatial etc...) deviennent de plus en plus complexes pour des raisons économiques et écologiques. Les systèmes industriels s'articulent sur plusieurs domaines (mécanique, thermique, magnétique, électrique ...). La complexité du système à concevoir implique de nombreuses interactions et relations entre les sous-systèmes, l'innovation amène une évolution qui pousse les ingénieurs à reconsidérer leurs approches classiques de type mono-disciplinaires pour se tourner davantage vers une approche transverse de type ingénierie système, donc pluridisciplinaire. Pour la conception de système pluridisciplinaire, faire intervenir des métiers ou des fournisseurs externes et des modèles de simulation de nature différente est donc indispensable. Les problèmes considérés, qui se prêtent tout particulièrement à une approche interdisciplinaire, couplent des notions variées, multi-physiques et multi-échelles dans un environnement multi-entreprises (partenaires / sous-traitants). La communication entre les différents métiers est assez difficile car chaque acteur travaillant avec des outils qui leur sont propres. Ceci rend la mise en œuvre des simulations numériques difficile puisqu'elle doit tenir compte aussi de tous ces domaines y compris les méthodes et outils dédiés aux différents domaines d'activités.

Le système complexe est composé d'un grand nombre d'éléments; -- souvent les éléments sont de plusieurs types et possèdent une structure interne qui ne peut être négligée; -- les éléments sont reliés par des interactions non linéaires, souvent de différents types; -- le système est soumis à des influences extérieures à différentes échelles. J.L. Le Moigne [21] et E. Morin [20] ont contribué à développer une théorie voire "une science des systèmes" [22] qui se veut d'abord interdisciplinaire et qui vise à rendre compte de phénomènes complexes. Morin présente aussi les notions d'incertitude et d'indécidabilité comme des concepts étant étroitement liés à la pensée complexe. Ainsi la complexité s'articule autour des relations qu'entretiennent quatre principes qui caractérisent cette pensée qui sont : l'ordre, le désordre, l'organisation

et l'interaction. La complexité croissante des systèmes pose la question de leur maîtrise et, plus globalement, de la compétitivité des entreprises en termes de capacité d'analyser l'architecture avec les moyens de l'ingénierie système. On entend par complexité à la fois la complexité des systèmes eux-mêmes, des cadres contractuels dans lesquels ceux-ci sont réalisés enfin des organisations impliquées dans les phases de définition, réalisation et exploitation. Cette complexité impose de faire évoluer les processus d'ingénierie et les systèmes d'information qui permettent de gérer, partager et capitaliser les données d'ingénierie, et ce sur tout le cycle de vie du produit. Dans ce travail, les moyens de modélisation et simulation ont été considérés comme un système complexe et afin de réduire sa complexité, ce système a été décomposé en trois couches liées; le produit (modèle numérique à produire), le processus de conception et l'organisation (délégation des rôles des ingénieurs de conception). En considérant donc les aspects humains, processus et produit, ce travail propose une approche basée modèle qui va considérer de multiples vues et aider à la création de modèles de simulation.

### **Conception de simulation multidisciplinaire : découplage fort entre système et physiques**

Le processus de l'ingénierie de systèmes prend classiquement la forme d'un "cycle en V" en milieu industriel qui peut se décrire comme la succession des différentes phases d'ingénierie. La branche descendante (la phase amont), qui correspond à une démarche de raffinements successifs qui répond à la phase de conception, partant du général (l'expression des besoins souvent à travers un Cahier des Charges Fonctionnel (CdCF)) pour déboucher sur le particulier. En effet, la première phase de spécification démarre avec le Cahier des charges fonctionnelles (CdCF) en spécifiant les exigences et en créant un plan de validation du système qui sera utilisé en phase finale. La deuxième étape de conception démarre pour aboutir au dossier de conception, composé d'une spécification de l'architecture du système et des spécifications techniques des besoins des constituants, et du plan et tests d'intégration. Ensuite vient l'étape de développement des constituants. Elle peut être vue comme la juxtaposition de multiples sous-cycles en V qui peuvent se dérouler en parallèle. La branche ascendante, quant à elle, détaille les phases d'intégration et de validation du système. Pendant cette étape les constituants sont assemblés entre eux en suivant le plan d'intégration préalablement établi et la dernière étape de validation permet de vérifier que le système répond bien aux besoins initiaux (le CdCF) et en utilisant le plan de validation. [16].

La conception d'un modèle de simulation peut être vue comme un processus de transformation des exigences et l'architecture de système (automobile) en des spécification de modèle de simulation plus en plus détaillées. Le point de départ est une architecture fonctionnelle/logique bâtie sur les exigences de haut niveau (Top Level Requirements) cette méthode est la nécessité de répondre à une question par la simulation.

Cependant, le passage du système vers les analyses comportementales physiques (c.-à-d. modélisant le monde réel) n'est pas simple. La nature des représentations et des modèles principalement utilisés évoluent (d'un point de vue « fonctionnel » à un point de vue « réalisation physiques » en passant par un point de vue « comportemental »), ce qui pose inévitablement la question du maintien de la cohérence entre les différentes vues du système étudié (voir Figure 0-1 et Chapter 4 and 5).

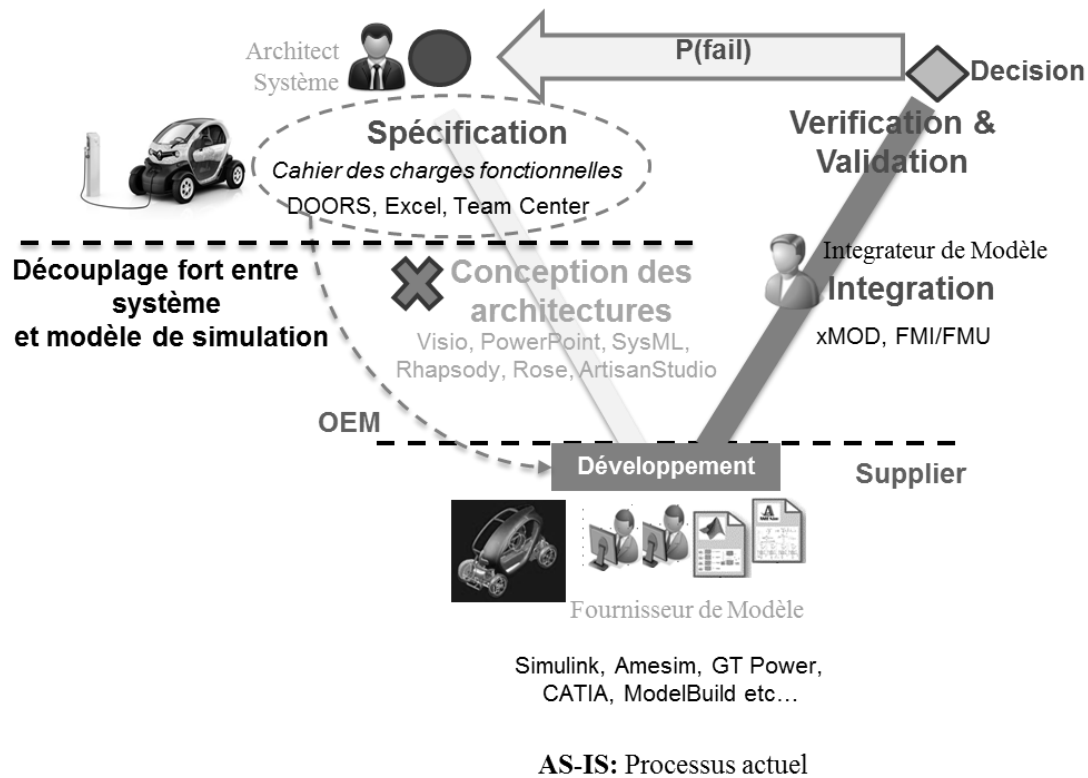

Figure 0-1 Développement de Modèle de Simulation, Processus Actuel, V Cycle

La branche descendante est stratégique pour le succès du développement d'une architecture standard (internal combustion) et surtout pour le succès d'une architecture non-standard, disons innovante (architecture hybride ou pure électrique) où les données de référence et le savoir-faire de métier sont limités (le manque de données d'entrée issues de l'expérimentation). L'ultime objectif de ce travail est de valider au préalable par simulation de haut niveau l'exploration de l'espace de conception architectural.

Afin de gérer le délai et le coût, la conception et le développement des modèles de simulation sont souvent sous-traités auprès de différents fournisseurs (e.g Bosch, Continental, etc...). A l'interne de l'OEM, la Modélisation et la Simulation (M&S) sont pour l'instant surtout mises en œuvre dans le cadre de métiers



(utilisation verticale) ou pour intégrer ou valider les systèmes (utilisation ponctuelle de simulation de constituants du système, d'interfaces avec des systèmes externes). Chaque métier maîtrise bien son domaine et dispose des méthodes et outillages requis pour mener les travaux d'ingénierie dont il a la responsabilité. Ces différents métiers sont des domaines d'expertises confirmées partageant des connaissances et des sémantiques propres à leur domaine (structure, automatique, hydraulique, électronique, etc.) ou discipline (mécanique des solides, du point, des fluides, électromagnétisme, etc) (voir Figure 0-3). Un enjeu particulièrement important pour l'industrie automobile consiste à pouvoir utiliser les modèles de simulations sous forme de boîte noire car la plupart du temps, les sous-modèles arrivent aux OEMs sous un format de boîte noire afin de faciliter le reuse et préservera la propriété intellectuelle. La modèle boîte noire est construit essentiellement sur la base de mesures effectuées sur les entrées et les sorties du processus à modéliser. Chaque boîte noire peut aussi être appelée module ou composant du système. L'avantage de cette modularité est de faciliter l'exploration et la réutilisabilité des composants mais nécessite une abstraction nouvelle : celle de leurs interfaces de communication. Cette abstraction des interfaces de communication devient aujourd'hui le pivot de la conception des modèles pluridisciplinaires. Sur le plan de la conception, on établit aussi tôt que possible les interfaces entre les sous modèle, permettant ainsi aux gens chargés de concevoir chaque homologue de la relation de développer leur module en présumant que l'autre respectera l'interface choisie. Ceci permet le développement en parallèle de chaque paire d'homologues, et réduit les dépendances entre les équipes de travail pendant la période de développement. Dans chaque cas, on accélère et on simplifie la phase de développement, rapportant l'essentiel des problèmes de connectivité, où sont pensées les manières de connecter les homologues entre eux, et d'intégration, où la connexion effective est faite et où les irritants résultant d'erreurs ou d'ambiguïtés sont résolus. En effet, si un module a été pensé en termes d'intégration éventuelle avec d'autres modules, avec des interfaces claires dès le début, on obtiendra un module qui aura en général tendance à bien s'intégrer avec d'autres modules. Autre avantage significatif du développement par boîte noire: ayant défini dès le début les modules et leurs interfaces respectives, on obtient pratiquement un système "prêt à l'emploi". Pourtant, aujourd'hui, même si la phase de conception représente par conséquent une étape éminemment stratégique dans le cycle de vie produit, cette phase de conception n'a jusqu'à présent été outillée ni par un outil de graphique référencé ni par un processus détaillé et donc OEMs détectent des incohérences très tardivement pendant l'intégration des composants (modèle de simulation en boîte noire ou pas).

Au-delà de la problématique de coût et des itérations liées à la détection tardive des erreurs, la non détection de ces dernières peut entraîner des décisions erronées. La question qui se pose est de savoir caractériser l'architecture de modèle hiérarchiquement avec ses composants et ses interfaces. Ceci demande un effort méthodologique et organisationnel, qui, en particulier, doit s'appuyer sur des méthodologies des processus d'ingénierie et les systèmes d'information qui permettent de gérer, partager et capitaliser les données d'ingénierie, et ce sur tout le cycle de vie du produit et sur surtout dans la phase de conception de modèle de simulation [9]. Aujourd'hui, la phase de spécification (vue fonctionnelle, systémique) de la branche descendante de cycle en V a été renforcé par des outils de gestion des exigences et de modélisation SysML comme Doors, Artisan Studio, Team Center et Reqtify etc (voir Figure 0-2). Le projet du développement de simulation pluridisciplinaire a été mené en transférant le cahier des charges fonctionnel aux fournisseurs sans faire la conception détaillée où l'OEM est censé spécifier l'architecture de modèle et les interfaces du système et des sous-systèmes (vue physique) (voir Figure 0-1).

### **Analyse des environnements assistant le processus de développement de modèle de simulation**

Une classification des outils assistant le processus d'ingénierie des exigences, le processus de conception, le développement et l'intégration de systèmes (Figure 0-1) a été identifiée pendant l'audit industriel que nous avons mené chez Renault. Le découplage entre le monde système et modèle qu'on a évoquée précédemment pose aussi le problème de traçabilité en terme de l'outil qu'on utilise car chaque entité a fait ses propres choix d'outils et le passage d'un outil à l'autre n'a pas été assuré (voir Figure 0-2).

**- Outils d'ingénierie des exigences [5] :** le processus d'ingénierie des exigences regroupe le processus de définition et le processus de gestion des exigences système. Les outils d'ingénierie des exigences assistent l'ingénieur système lors de la saisie, la dérivation ou l'allocation des exigences, la saisie des liens d'association de chaque exigence avec sa source, avec sa justification, avec les hypothèses pour lesquelles elle est applicable. Les outils DOORS, Team Center et Excel sont des exemples de cette catégorie d'outils (voir Figure 0-2).

**- Les outils de conception et de développement de systèmes [6] :** parmi les principaux outils de cette catégorie, citons :

- Les outils de modélisation systémique : permettant de représenter les aspects structurels, comportementaux et sémantiques d'un système. Par exemple des outils comme Rhapsody, Rose, ArtisanStudio sont des outils de modélisation en SysML pour une représentation formelle et des outils comme Visio, PowerPoint ou encore MS word sont utilisés pour une représentation non formelle.

- Les outils de modélisation analytique : destinés à évaluer les performances et la fiabilité des systèmes, simuler le comportement des systèmes et proposer des optimisations de solutions de conception (Amesim, Matlab Simulink, GT Power etc...).

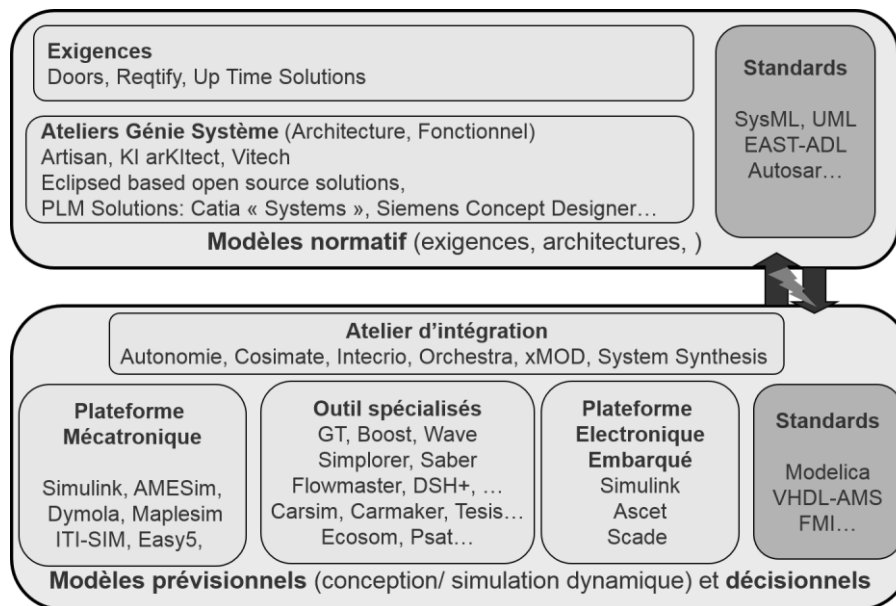

Figure 0-2 Audit Industriel, outils et standards

### - Outils d'intégration

De manière générale, il existe différents types de simulations utilisés lors de la conception des modèles pluridisciplinaires : les simulations éléments finis (2D/3D) qui s'appliquent à l'organe (par exemple modèle magnétique d'un moteur électrique) et les simulations analytiques (0D) qui en général se présentent sous la forme d'une plateforme qui simule un ensemble du système avec les lois de contrôle/commande qui le pilotent (par exemple batterie, onduleur machine et lois de pilotage). Il apparaît dès lors que lier ces deux mondes présente une valeur ajoutée. Les moyens pour y arriver sont multiples : co-simulation (intégration de modèles de solveur différents), et réduction de modèle (identification des modèles 0D à partir des modèles 3D). Dans la phase d'intégration des modèles, il y a des outils et des standards comme xMOD, FMI (Functional Mockup Interface) et FMU – (Functional Mock-up Unit) qui permettent d'envisager la spécification et la co-exécution de modèles à travers des interfaces standardisées pour connecter différents environnements de simulation [10]. Jusqu'à présent, des aspects technologiques, organisationnels, informationnels relatifs à la spécification et la conception ont été abordés mais les acteurs de la phase amont, développement et de la phase aval n'ont pas ou peu été évoqués. Pourtant, si un projet véhicule voit le jour, c'est bien le fait de la synergie des efforts et des intelligences de l'ensemble des acteurs du projet. Ce sont les acteurs de la conception, par leurs interactions, coopérations, argumentations, qui permettent de résoudre

les problèmes de conception malgré leur complexité. Dans le contexte actuel, il y a trois rôles principaux qui font partie d'un projet de modélisation. Ces sont: l'architecte système, le fournisseur de modèle et l'intégrateur (voir Tableau 0-1). Il est en effet primordial de considérer la conception comme un travail d'équipe.

Tableau 0-1 Les acteurs de modélisation dans la phase amont [13]

<b>Architecte Système</b>	L'architecte système (système véhicule ou sous-système) est un rôle clé de l'organisation de la conception véhicule. L'architecte système établit les spécifications du système (système véhicule ou sous-système) et décrit l'architecture (sous-systèmes et leurs interfaces) permettant de répondre à ces spécifications. Il s'appuie pour cela sur un cadre d'architecture adapté à la conception véhicule.
<b>Fournisseur de Modèle</b>	Le fournisseur de modèle prend en compte et, si besoin, négocie la commande de modèle émise par l'architecte système et produit un modèle répondant à cette demande, selon les exigences de coût, délai et qualité. La commande de modèle est accompagnée d'une fiche technique qui spécifie le modèle attendu.
<b>Intégrateur de modèles</b>	L'intégrateur de modèles intègre les modèles selon les principes définis, joue la simulation et formalise les résultats de la simulation en réponse à la demande d'analyse.

Pourtant, la communication entre ces trois acteurs n'est pas garantie car l'architecte système a une vue plutôt fonctionnelle du « système », et le fournisseur et l'intégrateur ont des vues plutôt physique du « modèle ». Afin de faciliter le lien entre l'architecte système et le fournisseur de modèle, un rôle particulier est introduit pour permettre la conception de modèle. Ce nouvel acteur est l'architecte de modèle. Ce rôle permet d'exprimer au mieux les souhaits de l'architecte système qui sont purement liés à la conception et de dialoguer efficacement avec l'expert (fournisseur) pour obtenir le ou les modèles de réalisation souhaités. Le rôle de l'architecte de modèle est relativement nouveau et est détaillé au sein du mémoire de thèse. Dans un tel contexte, chaque acteur fournit une description du système d'ingénierie en utilisant sa propre terminologie dépendante de son point de vue métier (i.e système, modèle ou encore un domaine spécifique comme la mécanique ou la thermique). Pour permettre la collaboration entre ces différents acteurs, il est nécessaire de se conformer à une représentation sémantique commune des concepts et des relations caractérisant les métiers d'ingénierie. De par la nature multiple du système à concevoir, les questions d'architecture du système impliquent une collaboration entre les domaines et les acteurs de conception. La

mise en place d'outils au niveau « architecture système » fondés sur des modèles comportementaux de natures différentes est un point clé et encore aujourd'hui un verrou pour aborder efficacement ensuite les analyses de performances et les optimisations multidisciplinaires nécessaires à la conception de systèmes.

## Vue d'ensemble des travaux de recherche

### Etat de l'art

### Architecture de modèle numérique

Afin de faciliter la conception de modèle pluridisciplinaire, le système est conçu comme un assemblage de composants. Un tel découpage est nécessaire pour introduire de la flexibilité et de la modularité dans l'architecture. L'avantage de cette modularité est de faciliter l'exploration et la réutilisabilité des composants. La conception d'un système mécatronique passe par la conception architecturale qui réalise l'identification de l'architecture du système. Cette activité s'intercale entre la spécification des exigences (vue fonctionnelle) et la conception détaillée de ses constituants (vue organique) [8, 9]. La construction d'un scénario est le point de départ du travail de l'architecte simulation. Le point de sortie est alors la réalisation de modèles et de simulations pour répondre à l'architecte et lui permettre ainsi de prendre des décisions.

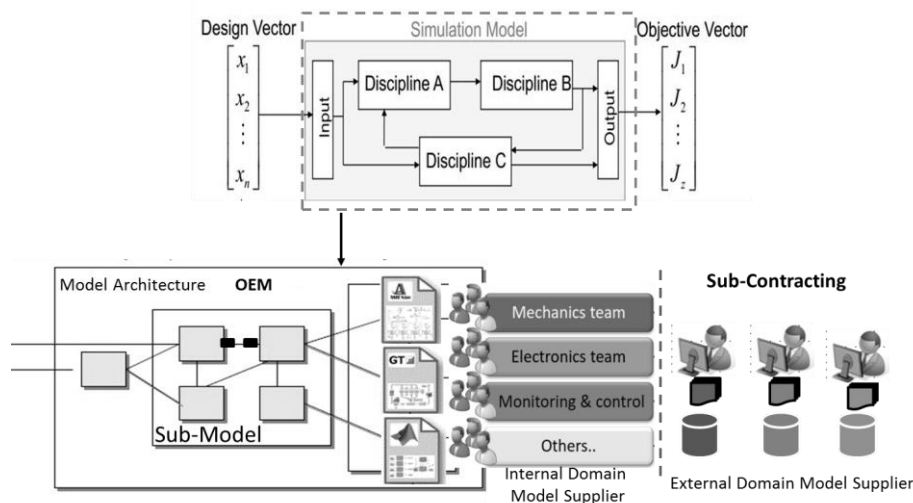

Figure 0-3 Architecture de modèle

Ainsi la conception d'un système consiste surtout à décomposer et rassembler des composants pour respecter des contraintes de performances et de délai/coût du système global et non plus seulement au niveau du composant. L'utilisation de la conception modulaire influence directement la structure des entreprises. L'existence d'une architecture et le référentiel unique partagé permet d'envisager la vérification et la validation complète d'un modèle complet du système dès les premières étapes et tout au long du processus de conception, ce qui permet de découvrir le plus tôt possible les incohérences (incompatibilités) et les problèmes d'intégration susceptibles d'apparaître en particulier aux niveaux des interfaces entre les différents domaines de modèles. La combinaison de l'accroissement de la concurrence du fait de la mondialisation et du développement de nations industrielles puissantes, le besoin de répondre à des besoins de plus en plus variés en exposant de façon pertinente les aspects différenciateurs de l'entreprise, la complexité à différents niveaux des systèmes et des contextes dans lesquels ceux-ci sont réalisés et exploités, le raccourcissement du délai de la mise à jour sur le marché des produits accompagné d'une diminution parfois sévère des budgets, créent un besoin d'innovation sur au moins deux des axes présentés ci-dessus. Désormais, celle-ci est incontournable, que ce soit au niveau des processus d'entreprise ou des concepts, méthodes et moyens déployés pour réaliser l'ingénierie des systèmes.

### **Ingénierie Système (Systems Engineering)**

L'ingénierie système, ou system engineering en anglais, est une démarche méthodologique normalisée de résolution de problèmes. Basée sur des processus multidisciplinaires, des méthodes et outils, elle guide la définition, la conception et la vérification d'un système complexe apportant une solution à un besoin opérationnel. Un système rassemble des produits, processus et personnes qui, une fois intégrés, offrent un service répondant à un besoin. Dans la pratique, l'ingénierie système conjugue des approches descendantes (top-down) et ascendante (bottom-up) itératives. La démarche s'initie par une expression de besoin et une analyse des exigences. Cette première étape nécessite une forte implication et participation de toutes les parties prenantes impactées par le futur système dont les clients finaux. Chaque exigence est déclinée aux niveaux systèmes, sous-systèmes et composants à concevoir, puis traduite en fonction : c'est l'architecture fonctionnelle. Ensuite, pour chaque fonctionnalité, des solutions techniques sont déterminées : c'est l'architecture organique. En parallèle des définitions fonctionnelles et organiques, les parties prenantes déterminent les tests de vérification et de validation adéquats qui seront exécutés dans la seconde phase du cycle, les besoins initiaux, vérifiant ainsi qu'une propriété est mesurable. L'émergence du concept RFLP (Requirements - Fonctionnel - Logical - Physical) est défini par cette logique. La gestion associative de ces quatre mondes prendra du temps mais les enjeux sont là : il en va de l'intégration des aspects comportementaux dans la définition des produits et de leur traçabilité fonctionnelle. Elle permet de recueillir

des exigences liées au produit (R=Requirements), de définir les fonctions du système qui permettront de réaliser ces exigences (F=Functions), de distribuer ces fonctions sur différents composants logiques au sein des différents sous-systèmes (L=Logical) et enfin de définir la géométrie de ces composants et comment ils s'assemblent au sein d'une maquette numérique physique du produit (P=Physical) [11, 12]. Cette approche appelée « RFLP » apporte également à chaque stade différents niveaux de simulation. Le tout forme un ensemble cohérent à même d'apporter le soutien attendu à la conception des systèmes complexes dans leur environnement, de renforcer la maturité des solutions et des architectures retenues.

### **Ingénierie des systèmes basés sur les modèles (MBSE) et maîtrise des interfaces et modélisation SysML**

Développer une approche d'ingénierie basée sur les modèles constitue l'objectif du comité technique Model-Based System Engineering (MBSE) de l'Association Française d'Ingénierie Système (AFIS) [11, 19]. Grâce au MBSE, les entreprises souhaitent maîtriser la complexité des systèmes en assurant la modélisation et la simulation multi-physiques/multi-disciplines d'éléments cohérents entre eux à tous les niveaux de décomposition du système, accroître la collaboration entre métiers (ingénierie mécanique, thermique, hydraulique, électrique, informatique ...). Une telle approche est dite basée sur un modèle, par opposition aux approches basées sur des documents qui reposent sur une collection de modèles « mono-point de vue » disjoints. SysML (Systems Modeling Language) [6] a ainsi vu le jour en tant qu'extension du langage orienté-objet UML (Unified Modeling Language) pour couvrir toutes les étapes de conception de systèmes complexes et hétérogènes. SysML résout principalement les lacunes des autres profils quant aux phases amont de l'ingénierie système (exigences) et la traçabilité de ces exigences lors de la conception. SysML est défini comme un langage de modélisation pour l'ingénierie système capable d'offrir un support pour la modélisation de multiples processus et méthodes. Néanmoins, comme explicité dans le document de spécification, chaque méthodologie peut imposer des contraintes additionnelles sur la manière dont un élément de construction ou un type de diagramme donné peut être utilisé. Cela sous-entend qu'à cause du nombre élevé de champs couverts par l'ingénierie système, une approche interdisciplinaire est difficile à obtenir. De plus, les processus d'ingénierie, tant pour l'ingénierie logicielle que système, ont évolué indépendamment chacun de leur côté. Dans ce contexte, SysML semble être en mesure de devenir un support permettant de rapprocher ces deux familles d'ingénierie.

Cependant, l'état d'avancement actuel du déploiement du *Model Based Systems Engineering* (MBSE) au sein de schémas organisationnels multi partenaires tels que l'entreprise étendue [5] :

- ne permet pas encore la résolution des problématiques de collaboration multi-domaine, multi-métier, en particulier du point de vue de la modélisation et de la simulation, point de vue sujet de l'étude présente,
- pose également la difficulté du partage de l'ingénierie du système (donc du modèle du système) entre partenaires utilisant des méthodes et ateliers d'ingénierie hétérogènes dont l'interopérabilité doit être assurée. SysML ne dispose ni de sémantique nécessaire ni de standards largement déployés.

## **Objectif**

Un enjeu particulièrement important pour l'ingénierie consiste à fournir la capacité méthodologique et un ensemble d'outils permettant à un architecte système et modèle d'évaluer le comportement, la performance, de comparer différentes architectures candidates et, plus généralement, de prendre des décisions sur la base de résultats de simulations dans un environnement collaboratif. Le travail de cette thèse se focalise essentiellement sur les méthodologies et outils permettant, d'une part, de construire et de spécifier les architectures de modèles et, d'autre part, de concevoir, produire et intégrer de façon plus efficiente et robuste des modèles de simulation garantissant des caractéristiques et des critères de qualité (conformité et maturité) conformes aux attentes de l'architecte de modèles.

## **Question de recherche**

Comme le révèle l'état de l'art, l'enjeu consiste désormais à utiliser un processus robuste, une méthodologie bien conçue pour réorganiser la phase de conception de façon transverse aux différents métiers (utilisation horizontale) afin de pouvoir évaluer la conformité du système aux besoins. La finalité de la solution proposée est un outil d'aide à la décision qui permettant de supporter les activités collaborative à la fois technique et organisationnelle de l'architecte système et modèle (voir 0-4). Basé sur l'objectif de la recherche, nous définissons la question de recherche comme suit :



**QUESTION DE RECHERCHE:**

Comment doit-on concevoir et guider le développement de modèles pluridisciplinaires ?

**Objectifs spécifiés**

Afin de structurer les travaux de recherche, nous avons spécifié les objectifs de recherche en deux étapes principaux :

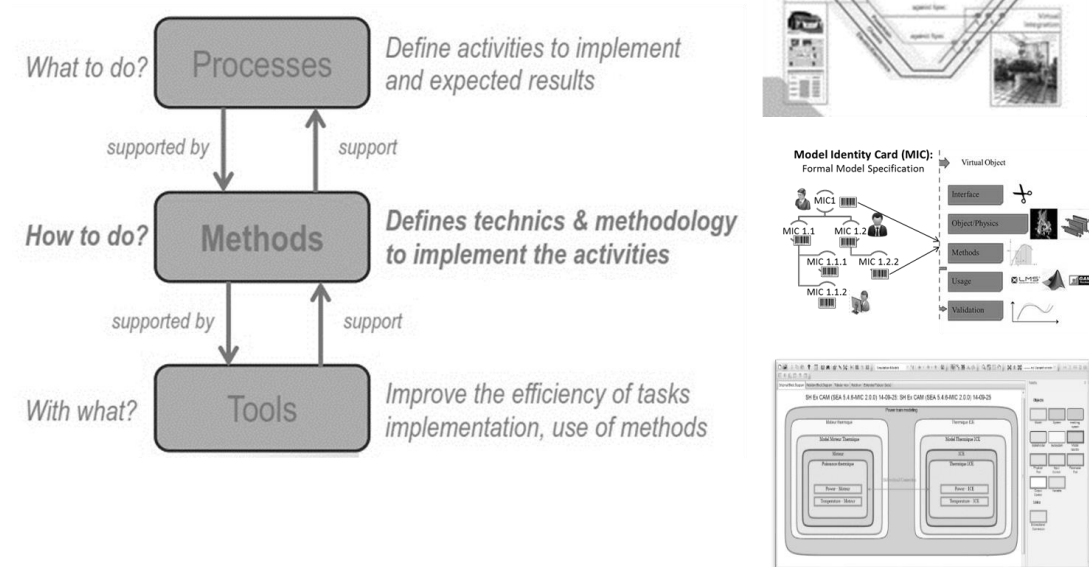

Figure 0-4 La solution proposée

**OBJECTIF 1: DEVELOPPER LE PROCESSUS POUR LA PHASE DE CONCEPTION**

Mettre en place un processus intégré cadrant des activités (acquisition/cycle de vie) afin de répondre à des questions bien précises des différents acteurs. S'assurer que le développement des modèles conduise bien à des résultats cohérents avec les hypothèses émises préalablement et sur lesquelles des décisions d'ingénierie s'appuient. Cela suppose également que les architectes systèmes aient confiance dans les résultats produits par l'exécution du système virtuel afin que celui-ci puisse bien leur permettre d'objectiver et rationaliser les décisions qu'ils prennent.

**OBJECTIF 2 : DEVELOPPER LA METHODE ET L'OUTIL POUR LA CONCEPTION DE MODELE MULTIDISCIPLINAIRES**

Fournir la capacité méthodologique et un ensemble d'outils permettant à un architecte (architecte système, niveau système) d'évaluer le comportement, la performance, de comparer différentes architectures candidates, et plus généralement de prendre des décisions sur la base de résultats de simulations.

**Apports et perspectives****Contribution et gain de l'entreprise**

La contribution la plus importante de ce travail est la détection des incohérences entre ou dans le modèle en phase amont de processus. Renault souhaite réduire le temps de développement et le nombre de redondances d'un facteur 2. Lorsque les exigences et l'architecture sont correctement définies et gérées, elles permettent de réduire de près de 50% les dépassements de projets de modélisation et simulation. Les malentendus, incompréhensions, incohérences entre les modèles et les fournisseurs sont mis en évidence tôt dans la phase de conception détaillée où il est donc encore possible de les corriger [15, 16]. Les acteurs de conception ont la possibilité de clarifier leurs exigences et de détecter les anomalies au fur et à mesure. Pour cela, le travail propose une méthode, un processus, un outil de support et un nouveau métier pour la phase de conception (voir Figure 0-5). Ainsi, pour renforcer la cohérence du modèle au sein d'une méthodologie MBSE, un méta-modèle, référentiel commun nommé « Modèle de carte d'identité (MIC) » a été développé [13]. MIC est développé pour standardiser et renforcer les interfaces entre les métiers sur les plans organisationnels et techniques en garantissant l'évolution et la gestion de la cohérence de l'ensemble des règles et les spécifications des connaissances des domaines dont la sémantique est variée. MIC aide à la

fois à la création de l'architecture de modèle en se penchant sur le problème de la spécification des interfaces entre les modèles et assure les échanges des connaissances métiers entre les acteurs de conception. L'usage de MIC a été facilité par la proposition d'un outil d'aide à la construction et à la spécification de l'architecture de modèles et de ses interfaces (voir Chapitre 4, 5, 6 et Appendix).

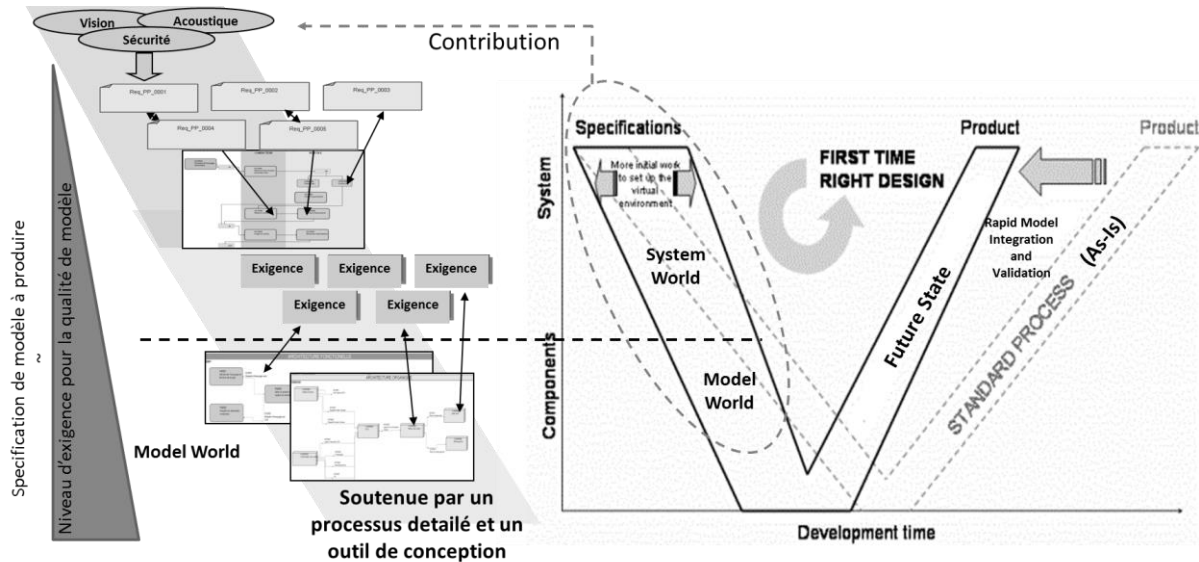

Figure 0-5 Contribution attendue par ma la solution proposée

Finalement, afin de structurer les processus de phase de conception de modèle de simulation, le travail a été inspiré par les cadres de l'Architecture d'Entreprise (DoDAF, NAF and TOGAF) en reflétant les exigences d'intégration et de standardisation du modèle opératoire de l'entreprise [14]. L'architecture d'entreprise fournit une vision à long terme des processus, des systèmes et des technologies de l'entreprise afin que les projets individuels puissent construire des capacités méthodologique (guide méthodologique de bonnes pratiques) et non pas simplement répondre à des besoins immédiats.

## Le cadre méthodologique

Pour définir le cadre méthodologique, nous nous sommes appuyés sur une représentation de type « cycle en V » (voir Figure 0-5). Nous pensons que cette représentation est assez pertinente car le projet modélisation est clairement positionné dans une approche descendante pour la conception et la spécification des architectures de modèles et dans une approche montante pour la vérification et l'intégration de ces modèles.

La branche « descendante » vise à faire correspondre une expression de besoin fonctionnel (en général via une question de l'architecte) à une expression de besoin de simulation (décrire les scénarios que l'on a à simuler). En pratique, la première étape consiste à répondre aux spécifications système par des jeux de modèles en permettant la vérification. Cela aboutit à une cascade d'exigences de simulation qui doit être traduite en « identification, appels, besoins de modèles ». La phase Conception des architectures & Spécification des modèles consiste à définir et à spécifier l'architecture d'un modèle de simulation à partir d'une architecture organique (structurelle) de référence. Il s'agit donc également de pouvoir cascader ces spécifications pour les différents niveaux de décomposition du système à analyser. L'intention de simulation et l'architecture organique de référence sont donc les points de départ de la méthodologie que nous proposons. Un rôle est alors créé et associé à cette phase : celui de **l'Architecte du Modèle** qui est responsable de la définition de l'architecture du modèle intégré et de la spécification (via les MICs) des caractéristiques attendues du modèle intégré et potentiellement des modèles des sous-systèmes. Ces spécifications concernent tout autant les aspects techniques et paramètres de modélisation, les spécifications de modélisation et les paramètres comportementaux propres aux interfaces des modèles, les ressources (software) à utiliser pour produire et simuler le modèle et enfin les critères qualité à respecter. Afin de fournir la capacité méthodologique et un ensemble d'outils permettant à un architecte (architecte véhicule, niveau système) d'évaluer le comportement, la performance, de comparer différentes architectures candidates, et plus généralement de prendre des décisions sur la base de résultats de simulations. Il s'agit d'organiser les données de l'architecte et de lier ces données aux résultats de simulation justifiant – ou non – que les spécifications sont atteintes.

### **Branche « descendante » IVVQ et prise de décision**

Cette phase consiste dans un premier temps à valider les modèles fournis par rapport aux MICs et dans un second temps d'intégrer de façon automatique les modèles des sous-systèmes avec la notion de « plug & play (prêt à l'emploi) ». Dans cette phase l'« architecte modèle » a un rôle d'intégrateur et donc de « fournisseur de modèle » et doit également pouvoir évaluer la qualité du modèle intégré à partir des critères qualités des modèles des sous-systèmes. Une fois le modèle intégré et qualifié, la carte de simulation peut être construite en prenant en compte les conditions limites (pouvant provenir de résultats d'autres simulations), le scénario comportemental (phénomène physique à analyser dans une situation de vie spécifique du produit) et donc les cas de chargement à appliquer au modèle. La phase de calcul peut alors être lancée en utilisant le solveur et les algorithmes appropriés. Enfin, la partie haute de cette branche concerne le post-traitement et l'analyse des résultats bruts ainsi que tous les services et outils d'aide à la décision qui vont permettre à l'« Architecte Système » de faire ses choix d'architecture et/ou de gérer ses

compromis multidisciplinaires. Dans cette phase on peut également inclure tous les aspects liés à la gestion et à la redistribution des résultats (aux interfaces notamment) pour des simulations avals (si la simulation réalisée fait partie d'un processus de simulation plus global).

### **Synthèse sur la définition des rôles « architect système », « architect modèle » et « fournisseur de modèle »**

Le but du projet est de voir la création du métier « *Architect Modèle* » dont le rôle est de réaliser des simulations sur les architectures proposées par le métier déjà existant « *Architect Système* » [13, 18] :

- L'acteur *Architect Système* aura pour rôle de concevoir les architectures, et de vérifier le respect des exigences par rapport aux données fournies par rapport aux modèles testés par l'acteur *Architect Modèle*.
- L'acteur *Architect Modèle* a pour rôle de réaliser plusieurs simulations afin de trouver les paramètres, et les architectures optimales.

Le rôle d'Architect Système a pour l'objectif de définir les architectures organiques (structurelles) candidates à évaluer et à partir desquelles le Architect Modèle génère les architectures des modèles de simulation. C'est lui qui analyse les résultats de simulation (à partir des outils et services d'aide à la décision) et qui fait la sélection des architectures et/ou qui décide du jeu de paramètres optimal dans le cas de compromis multidisciplinaires. C'est également le « Architect Modèle » qui définit et configure l'architecture du modèle de simulation intégré avec en perspective la volonté que les modèles des sous-systèmes puissent s'intégrer rapidement et de façon cohérente. Pour cela il spécifie les caractéristiques des modèles en y intégrant leur intention de simulation (pour quel contexte et quelle simulation ce modèle peut être utilisé) et cascade ces spécifications aux Fournisseurs de modèle des sous-systèmes. Pour s'assurer du bon déroulement des activités et pour automatiser certaines procédures, l'Architect Modèle est donc aussi responsable de définir et piloter le processus de production et d'intégration des modèles. Le Fournisseur de Modèle est responsable de fournir (soit en générant, soit en réduisant, soit en réutilisant) des modèles dont les caractéristiques sont conformes avec les spécifications contenues dans les MICs.

### **Production des modèles et négociation avec les fournisseurs dans la phase amont**

Cette phase consiste à exploiter les Model Identity Card (MICs) soit afin de créer les modèles en conformité avec ces MICs, soit à requêter un « Model Repository » afin de réutiliser des modèles existants qui sont adaptés à l'usage que l'on veut en faire (quel système ? quel comportement (scénario) à analyser ? Et quel type de simulation ?). L'idée est qu'à partir de l'intention de simulation et des MICs fournis par l'architecte

du modèle, on puisse automatiser certaines procédures de transformation (réduction) et de composition de ces modèles. Dans cette phase de production des modèles, le fournisseur de modèle doit, en plus de fournir des modèles en conformité avec les MICs correspondantes, fournir pour chaque modèle une ensemble de critères qualité permettant d'évaluer le niveau de confiance, la maturité ou encore la crédibilité de ce modèle. Le rôle associé à cette phase est celui de « Fournisseur de Modèle qui est responsable d'une part de cascader correctement les MICs aux niveaux des composants enfants du système étudié et, d'autre part, de fournir les modèles avec les critères qualités attendus. MIC sert à la fois à la construction de l'architecture modèle et à la fois à la négociation avec les fournisseurs dans la phase amont.

### Limites et perspectives

Pour prouver l'applicabilité de la solution proposée, la méthodologie, le processus et l'outil proposés sont testés dans les industries automobile et aéronautique. L'objectif de cette démonstration est d'observer l'amélioration significative du processus actuel en termes d'efficacité, de réduction de l'ambiguïté et des malentendus. Au cours de cette étude de cas, certains acteurs de conception sélectionnés (architectes système et prestataires externes / internes) ont participé aux scénarios de test. Les objectifs de la validation des méthodes proposées sont donc :

- (i) vérifier l'évolutivité de modèle de MIC, c'est-à-dire la capacité de couvrir différentes natures de modèles de simulation,
- (ii) l'observation qualitative afin d'estimer le taux de reprise d'un modèle et la réduction de l'ambiguïté.

Le retour d'expérience des acteurs de la conception a impliqué dans l'étude de cas et nos observations qualitatives nous montrent que l'écart de connaissances entre les acteurs de la conception est diminué en fournissant un méta-modèle MIC. (i) Le modèle MIC est partiellement intégré à Renault et testé par différentes équipes d'ingénierie. Après les résultats des tests, nous pouvons dire que les attributs du modèle MIC sont exacts et contiennent suffisamment d'informations pour caractériser différentes natures de modèles (0D réduite, et 1D, 2D et 3D). Le modèle de MIC est potentiellement un concept utile qui contient suffisamment d'informations de système à modéliser. Le modèle MIC pourrait être applicable à un autre contexte comme l'aéronautique, mais il faudrait un travail supplémentaire d'adaptation pour le secteur spécifique.

En tant que perspective, un modèle d'intention (MoI) [17] est partiellement intégré à la phase de conception de processus de modélisations. MoI est une méthode complémentaire de MIC et permet de réduire l'écart de connaissances entre l'Architecte du Modèle et les Fournisseurs. MoI est un modèle exécutable et contient certains paramètres observables de façon à être en mesure de comprendre les comportements attendus des modèles demandés pour un scénario donné. L'objectif de MoI est de répondre à la transition entre le monde réel et le monde virtuel dans l'esprit MBSE. En outre, les aspects qualité des modèles ont été peu abordés dans cette thèse. La qualité des modèles est à étudier suivant deux principaux aspects :

- La conformité du modèle par rapport à des exigences d'utilisation (discipline...), des modes opératoires, des processus.
- La maturité du modèle qui correspond à un niveau de confiance sur un modèle à un instant précis du développement du produit, pour son exploitation dans une activité. C'est par exemple le niveau de confiance d'un résultat par rapport aux données qui ont été utilisées pour le générer (précision des données, utilisation des dernières versions et intégration des dernières modifications, etc.)

## Reference #0

[1] <http://group.renault.com/passion/innovation/renault-laudace-dans-les-genes/>

[2] Hybridcars 2010, HybridCars: December 2009 Dashboard: Year-End Tally  
<http://www.hybridcars.com/hybrid-sales-dashboard/december-2009-dashboard.html>

[3] Systems Engineering Fundamentals, DOD Supplementary text prepared by the defense acquisition university press fort Belvoir, Virginia 22060-5565, USA, 2001.

[4] P. Koen et al., 2001. Providing clarity and a common language to the "Fuzzy Front End." Research Technology Management, 44(2), pp.46–55.

[5] Crescendo (2012). Participants' handbook. Crescendo Forum Innovation in collaborative modelling and simulation to deliver Behavioral Digital Aircraft 19-20 June 2012, France.

<http://cordis.europa.eu/docs/results/234344/final1-crescendo-d017-final-report-20130430-r1.pdf>

[6] Object Modeling Group, 2012, "OMG Systems Modeling Language.", [www.omg.org/spec/SysML/1.3/](http://www.omg.org/spec/SysML/1.3/).

[7] Krob, D. (2009). "Eléments d'architecture des systèmes complexes", Gestion de la Complexité et de l'information Dans les Grands Systèmes Critiques, 179-207.

[8] J.P. Meinadier, "Le métier d'intégration de systèmes", Hermès Sciences Publications, 2002.

[9] N. Suh, "Principles of Design", Oxford University Press, Cambridge, UK, 1990.

- [10] [www.modelisar.com](http://www.modelisar.com)
- [11] Fisher, J., 1998, "Model-Based Systems Engineering: A New Paradigm," INCOSE Insight, 1(3), pp. 3-16.
- [12] E. Thomas and M. Ravachol, "Collaborative complex system design applied to an aircraft system" Available Online: <http://www.ep.liu.se/ecp/076/088/ecp12076088.pdf>
- [13] G. Sirin., C.J.J. Paredis, B. Yannou, E. Landel, E. Coatanea, "A Model Identity Card to Support Simulation Model Development Process in a Collaborative Multidisciplinary Design Environment," Systems Journal, IEEE , vol.PP, no.99, pp.1,12, 2014.  
URL: <http://ieeexplore.ieee.org/stamp/stamp.jsp?tp=&arnumber=7004782&isnumber=4357939>
- [14] H. G. Chale-Gongora, A. Dauron, A. Doufene, D. Krob, 2014. "Un cadre methodologique integre pour l architecture et l optimisation de systemes", In to be published in Revue Génie Logiciel et Systemes, 2014. Available online: [http://strategic.mit.edu/docs/Un\\_cadre\\_m%C3%A9thodologique\\_int%C3%A9gr%C3%A9\\_pour\\_l-architecture\\_et\\_l-optimisation\\_de\\_syst%C3%A8mes-RevueGenieLogiciel2014.pdf](http://strategic.mit.edu/docs/Un_cadre_m%C3%A9thodologique_int%C3%A9gr%C3%A9_pour_l-architecture_et_l-optimisation_de_syst%C3%A8mes-RevueGenieLogiciel2014.pdf)
- [15] Projet CSDL : Conception en phase amont de systèmes complexes sur la plateforme PLM/SLM de Dassault Systèmes Michel Ravachol, Jean-Baptiste Quincy, NAFEMS Paris, june 2012.
- [16] T.R. Browning, 2003, "On Customer Value and Improvement in Product Development Process," Systems Engineering Vol. 6, No.1, pp. 49-61.
- [17] F. Retho, H. Smaoui, J.C. Vannier, and P. Dessante, "Model of intention: A concept to support models building in a complex system design project", ERTS<sup>2</sup> 2014, France.
- [18] G. Sirin, B. Yannou, E. Coatanea and E. Landel, "Creating a Domain Ontology to Support the Numerical Models Exchange between Suppliers and Users in a Complex System Design". ASME (IDETC/CIE), Portland, USA, Aug., 4-7, 2013
- [19] <http://www.afis.fr/>
- [20] E. Morin, "Introduction à la pensée complexe", Paris, ESF, 1992.
- [21] J.L. Le Moigne, "La théorie du système général, Théorie de la modélisation", Paris: Col. SystèmesDécisions, Presses Universitaires de France, 1977.
- [22] H.A. Simon, "Sciences des systèmes, Sciences de l'artificiel", version traduite en français par J.L. Le Moigne, Dunod, 1997.



## Dissertation structure

This doctoral dissertation adopts a recent spring-up format — a format that uses published or submitted scientific articles as main chapters. Utilization of this format requires the PhD candidate and supervisors to have a clear overview of the PhD project since the very beginning, separate the research work into relatively independent parts, and publish each part as scientific paper. This format makes the research work more organized, the objective of each part more clear, and the contribution of each part validated by publication. However, this format also causes a certain degree of redundancy among different articles, for which we ask the comprehension of readers. The main contribution of this PhD project is represented by the following three scientific papers published or submitted:

*[1] G. Sirin, L. Gasser, T. Welo, B. Yannou, and E. Landel, 2015. “Characteristics of Good Multidisciplinary Model Design Practice: Toward a Value-Added Thinking”, submitted to Research in Engineering Design Journal.*

*[2] G. Sirin, F. Retbo, M. Callot, P. Dessante, E. Landel, B. Yannou, J.C. Vannier, 2014. “Multidisciplinary Simulation Model Development: towards an inconsistency detection method during the design stage”, submitted to Systems, Man and Cybernetics, Part A: Systems and Humans, IEEE Transactions.*

*[3] G. Sirin., C.J.J. Paredis, B. Yannou, E. Landel, E. Coatanea, 2014. “A Model Identity Card to support model development process in a Collaborative Multidisciplinary Design Environment”, published in IEEE Systems Journal.*

Relationships between chapters are shown in Figure 0-6.

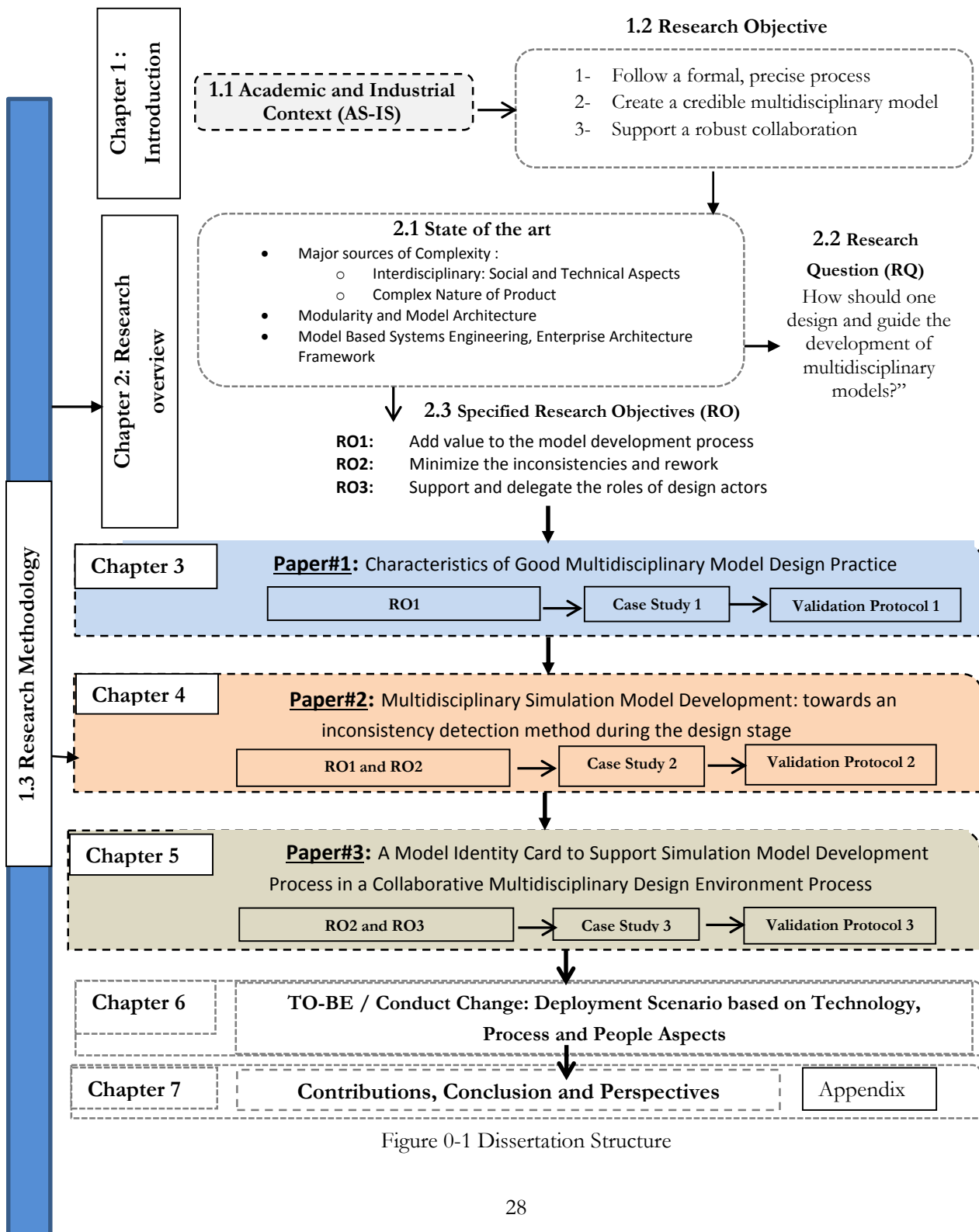

Figure 0-1 Dissertation Structure

**Chapter 1** introduces the general problem and the context in which this research has been conducted. Based on this, the objectives and the scientific approach used in the present thesis are detailed and discussed. In particular, it provides details about the industrial audit as well as research questions which are not explicitly explained in other chapters.

**Chapter 2** gives an overview of the State of the Art, defines research questions and their connection; as well as related research objectives and contributions. In addition, it gives a synopsis of chapters 3, 4 and 5, as well as industrial achievements.

**Chapter 3** describes the first research cycle. This chapter introduces the characteristics of good multidisciplinary model design practice: toward a value-added thinking and gives a mild hybrid vehicle case study.

**Chapter 4** presents Multidisciplinary Simulation Model Development: towards an inconsistency detection method during the design stage. This second research cycle ends with the validation of the overall method on the industrial case.

**Chapter 5** explores the ontology based DSL (Domain Specific Language) called Model Identity Card concept and its development motivation. A Model Identity Card is developed to support model development process in a Collaborative Multidisciplinary Design Environment. An industrial case study is used to illustrate MIC's capacity.

**Chapter 6** introduces a deployment scenario into Renault based on technology, process and people aspects.

**Chapter 7** sums up the contributions and limitations of the thesis and describes possible starting points for future research.

**Appendix** introduces the question of what a numerical model is?

# 1

## Introduction

### 1.1 Research and company context

Simulation models can be used to better understand the impact of different operating conditions on vehicle performance and attributes. In the endeavor to reduce time to market, OEMs (Original Equipment Manufacturers) need to create credible simulation models under uncertainty while aiming to detect any inconsistencies problem before building expensive simulation models. This is particularly challenging for the design of multidisciplinary systems in which components in different disciplines (e.g., mechanics, structural dynamics, hydrodynamics, heat conduction, fluid flow, transport, chemistry, or acoustics) are tightly coupled to achieve optimal system performance [1]. To accurately represent vehicle behavior in a given field situation, simulation models are created as a module by integrating different simulation models within a vehicle model, such as model of chassis, engine and transmission, etc. These sub system simulation models are denoted domain models in the following. Multidisciplinary simulation model development activity is a complex and highly interactive social process involving multiple distributed design teams and companies designing coupled simulation models and making many decisions. Multidisciplinary simulation covers the individual analysis disciplines (aerodynamics, mechanical, electromagnetics, thermal, noise, vibration etc...) and the links coordination between analysis disciplines [2].

Since the quality of complex multidisciplinary simulation model strongly depends on input from multiple sources, efficient collaboration between domain (or discipline) experts is a prerequisite for a successful outcome. However, today's siloed way of working and simulation model development approaches have been developed for individual disciplines, based on discipline-specific simulation tool, language and design conventions. Furthermore, the interoperability between these heterogeneous tools is poor, as well as the transversal and holistic view of design and collaboration between the different disciplines. Moreover, the design and development of domain level simulation models is usually outsourced to different lead suppliers (or provider) to manage time-to-market and cost. Today, one of the problems in this collaborative environment is that models are usually considered as available, ready to be integrated (plug and play) or requested directly from a model provider without specifying any method. However, most of the technology or service provider's simulation model is in a Black Box (BB) format for preserving the intellectual properties. BB models can be interacted only through the inputs and outputs of a well-defined interface. The challenges is using BB model is to take into consideration the number of distinct interface issues, parameters, or messages that have to be passed among the components [3].

Another problem is that the supplier is neither integrated in the model design and specification phase, nor the OEM has access to the simulation model development activity. This decoupled way of working may create some unnecessary iteration during model integration phase, which often results in increased product development lead-time and cost. From our experience, specifying a simulation model is not as trivial as expected; it seems important but underestimated practice. Hence, OEMs must establish an effective methodology, based on different viewpoints of the actors, to create a credible simulation model while avoiding project delays and unexpected rework cost by detecting any inconsistencies problems before building expensive simulation models.

According to de Weck, early design validation and verification may reduce rework in the more expensive implementation and physical prototype validation phase, which is the main driver for product development cost [4]. It has been estimated that the cost of imperfect simulation model interoperability is at least \$1 billion per year for members of the US automotive OEMs [5] and \$400M in an aircraft development program with 1-2 months of delays [6]. There are many potential sources of inconsistency such as error in the simulation model code or mismatch of interfaces connections (i.e., differences in time step, units, solver, hardware and software versioning...). Nevertheless, a significant proportion of defects are associated with interfaces between modules or between requirements and implementation rather than a design or coding error within a single module. However, ensuring global consistency is impossible.

Therefore, the focus must be on managing – that is, identifying and resolving – inconsistencies. In systems engineering, inconsistencies manifest in a variety of forms: violation of well-formedness rules, inconsistencies in redundant information, mismatches between model and test data, and not following heuristics or guidelines. In current practice, most of these inconsistencies are only identified during reviews that are part of the Verification & Validation (V&V) activities [7]. In between these reviews there is a possibility of decisions being made based on inconsistent information and knowledge, which can lead to poor outcomes and costly rework. Typically, the earlier an inconsistency is identified, the cheaper it is to resolve.

A recent paradigm shift in systems engineering known as Model-Based Systems Engineering (MBSE) has the potential for the process of identifying inconsistencies to be performed in an automated fashion [8]. This is made possible by the key principle of MBSE: the use of only formal, i.e., computer-interpretable models. Automated and computer-assisted methods are important enablers for more frequent inconsistency checks and therefore towards continuously V&V systems. For this purpose, systems engineering approaches are adopted by most of companies. This research field comprises concepts, methods and best practises developed in industry in order to master complexity. From this, standards of systems engineering (ANSI/EIA 632, ISO/ICE 15288) and architectural frameworks (C4ISR/AF, MoDAF, DoDAF, TOGAF, NAF) emerged. In particular, SysML is a semi-formal language that is especially adapted for their implementation [10].

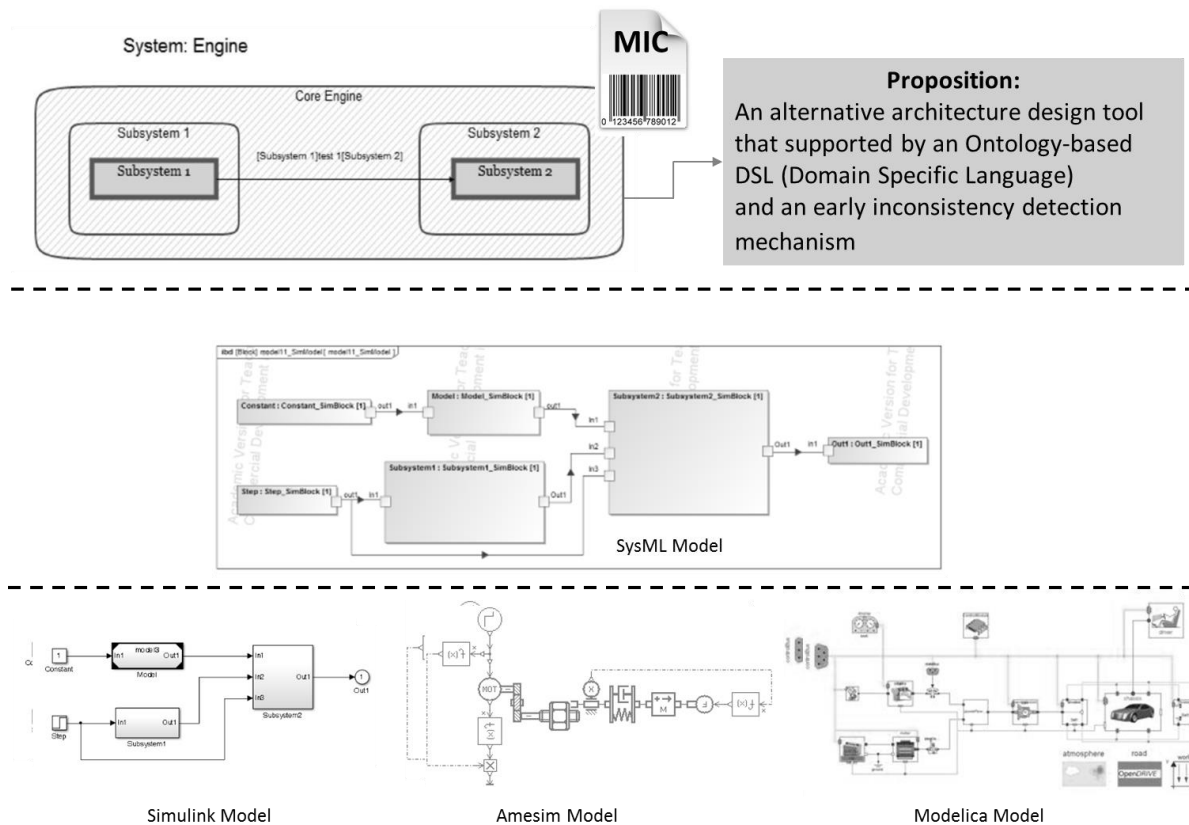

Figure 1-1 Architecture design tool and DSL

Descriptive models are useful for sharing a common view of complex systems as well as improving global understanding and management of them, notably for monitoring initial system requirements; but, as simulation capacities are not fully integrated, none of these models allows defining and exploring architecture design alternatives. They are consequently insufficient to support the creative phase of system architecture design. An alternative way to deal with system architecture design is using modelling and simulation (M&S) tools (see Figure 1-1). However, current M&S tools require precise information and can be used only when the architecture concept is already defined. Indeed, M&S tools cannot be used earlier because defining system architecture involves heterogeneous parts: architecture elements belong to different engineering domains and do not always have the same level of granularity [11]. In addition, the knowledge about architecture elements is incomplete, uncertain and tool dependent. These difficulties hamper modelling and assessment of system behaviour and properties making the definition of architecture a delicate step in system development. Specific methods and tools are still needed to help designers in this process [12]

### 1.1.1 Domain Specific Language (DSL) and SysML

A major open question for advocates of Model-Based Systems Engineering (MBSE) is the question of how system and subsystem engineers may work together. The Systems Modeling Language (SysML), like any language intended for a large audience, is in tension between the desires for simplicity and for expressiveness. In order to be more expressive, many specialized language elements may be introduced, which unfortunately make a complete understanding of the language a more daunting task. While this may be acceptable for systems modelers, it increases the challenge of including subsystem engineers in the modeling effort. One possible answer to this situation is the use of Domain-Specific Languages (DSL), which are fully supported by the Unified Modeling Language (UML). SysML is in fact a DSL for systems engineering. The expressive power of a DSL can be enhanced through the use of diagram customization. Various domains have already developed their own schematic vocabularies. Within the space engineering community, two excellent examples are the propulsion and telecommunication subsystems. A return to simple box-and-line diagrams (e.g., the SysML Internal Block Diagram) are in many ways a step backward (see Figure 1-1). In order to allow subsystem engineers to contribute directly to the model, it is necessary to make a system modeling tool that is as easy to use and accessible as Microsoft PowerPoint and Visio. Due to the lack of systematic method and supporting tool for this phase, the architecture and model specification and formal knowledge exchange between OEM and model suppliers are still done by department based solutions such as local design tools and documents. At the same time, OEMs tend to rush into the architecture and model design phase without exploring all possibilities and estimating their overall performance. In order to support OEMs through the architecture and model specification and design phase, a decision support tool is needed. Thus, this thesis proposes an alternative architecture design tool that is supported by an Ontology-based DSL (Domain Specific Language) and an early inconsistency detection mechanism (see Chapitre 4 and 5).

### 1.1.2 Model exchange and exploitation barriers in multidisciplinary modeling

In today's Renault context, the exchange, reuse and exploitation of models are still limited. Boosting model exchange requires fulfilling expressed and non expressed needs of both model suppliers and model users. For model suppliers, the main needs are, on the one hand, the ability to easily protect the confidential know-how contained in the model and, on the other hand, the ability to expose the model at the right abstraction level. But model users need the ability to quickly use the received models (plug and play) with a reasonable cost and effort.



This requires the ability to understand the models without having to explore all their programming details and without having to be proficient in their modeling languages or development environments.

Building a system model is usually performed through the assembly of its components' or domain level models. A hybrid vehicle is a typical example of a complex system. Its design, development and validation is performed in concurrent cycles, involving various teams, working on a wide range of fields including mechanics, thermodynamics, hydraulics, power electronics, heat transfer, vibrations, control... During these cycles, specific modeling and simulation tools might be preferred by these different teams, for example, AMESim or GT-POWER for engine modeling, Matlab/Simulink for control design, ASCET for control implementation, Dymola for vehicle dynamics, Comsol for Batteries modeling. Model development is an iterative process. Starting from a first version, models are progressively improved, refined, calibrated and validated. For those reasons, there are different models available, at different abstraction levels and precision. However, the integration and exploitation of these models is still limited, mainly due to model exchange obstacles, and the lack of dedicated tools allowing model exploitation.

In current model-based design processes, various obstacles limit the possibilities of model exchange. Among these obstacles, we may cite:

- The difficulty to integrate and exploit heterogeneous models without having to explore their programming details and without having to be proficient in their modeling languages or development environments.
- Model exchange between different entities (for example, an OEM and a tier 1 supplier) requires the protection of the confidential know-how contained in the exchanged models. A current practice within the automotive industry is to exchange controllers or models as Matlab/Simulink mexw32 s-functions. Although this means allows to protect model equations, it does not allow to efficiently personalize the model interface (for example, selecting the variables or signals that may be monitored), nor to numerically integrate the s-functions with different solvers.

Leveraging the interface inconsistency problem requires an early stage collaboration and transparency agreement between OEM and model provider. This is also reflect another another gap that we noticed during our research investigation in Renault is that there is no clear and formal model specification agreement between design actors in early model development stage (or conceptual design phase). One of the interests of this work is to create a more formal and clear model request to the domain model providers, to obtain the right model at the right time (see Figure 0-5 and 1-2).

These activities do not take place in a strict sequence and there are many feedback loops as the multiple stakeholders negotiate among themselves, striving for some consensus. The collaborative multidisciplinary simulation model development process creates a response to the request of the System Architect who searches elements to analyze architecture for a design choice (for more information see chapter 4 and 5).

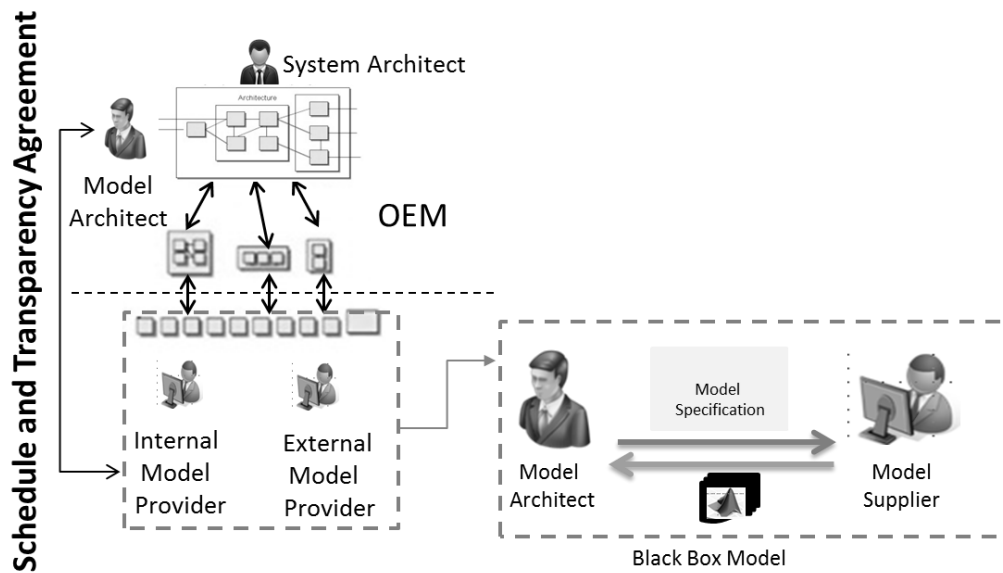

Figure 1-2 Transparency agreement and early stage collaboration

## 1.2 Recherche objectives

To this aim, the research issue has been first split it into three interrelated design objectives:

1. **Follow a formal, precise process:** The modelling process should be established according to ‘good modelling practices’ to design and manage any multidisciplinary simulation model.
2. **Create a credible multidisciplinary model:** The model can only be ‘useful’, if it is developed based on adequate explicit descriptions of the design problem.
3. **Support a robust collaboration:** Information flows between design actors should be standardized and supported by a common terminology to decrease the ambiguity and misunderstanding.

## 1.3 Research methodology

This work is an industrial thesis where knowledge is acquired by experience and the research content is influenced by requirements and conditions that exist in a large organization that develops complex products, such as a vehicle. The research method used is similar to the “Industry-as-laboratory” approach [13] that has frequent exchanges of information between the problem domain (industry) and the academic domain (see Figure 1-3). The methodology followed in this study encompasses and sometimes iterates distinct phases of industrial audit and diagnostic, formulation of encountered scientific issues, proposition of new models and methods to end up with industrial implementations.

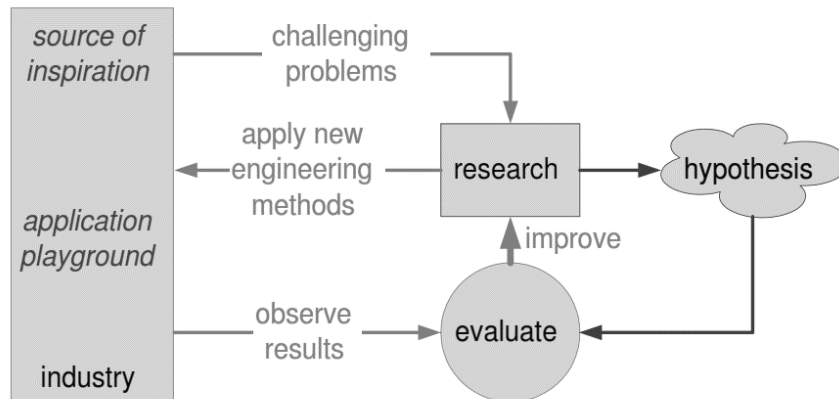

Figure 1-3 Research methodology

To be more explicit, as illustrated in Figure , this research activity is inspired from Jørgensen [14]. Both the problem-based approach and the theory-based approach have been used during the research. Applied research has two starting points: the problem base, typically a phenomenon observed in reality, for example an industrial need in addition to a theory base, where the knowledge gap is established by studying the knowledgebase in literature. The theory base is synthesized into models that are either descriptive or prescriptive. These models are tested and validated against analyzed results from the problem base and may result in new scientific acknowledgements. Though the process seems sequential, it is not as the work of analyzing, synthesizing and synchronizing between the two tracks is highly iterative. At the end of the research, the new scientific acknowledgements come closer to implementation in industry.

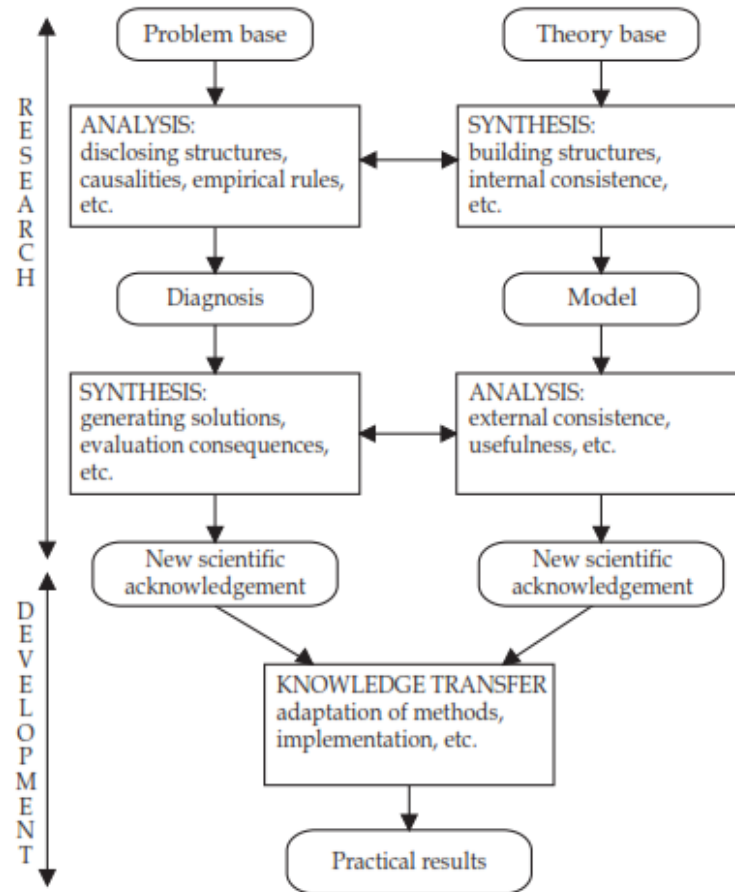

Figure 1-4 Problem-based and theory-based engineering design research methods (Jørgensen 1992) [14]

The research has been performed at the Laboratoire Génie Industriel of Ecole Centrale Paris and at Renault Technocentre. Especially, engineers from Renault SAS were contributed with their time and expertise, opening up their organization as a laboratory. In return, they have benefitted from the results of the research. As the research questions stated in the beginning of this thesis are exploratory rather than quantifying, case studies have been adopted to serve as the main source of information for the left leg of Jørgensen's framework. Case studies are excellent vehicles by which why and how questions may be answered. A variant of the how question is "how much", which in contrast to the original "how" may favor surveys. However, from a wider perspective where the "how" or "what" questions are more explanatory than quantifying, case studies are preferable [15]. Semi-structured interviews and repeated brainstorming sessions (first 5 months of PhD) are used in qualitative research when trying to form an understanding of a particular situation and coming up different industrial needs [16].

In the Research clarification stage and the review based descriptive Study I, interviews are used to create an understanding of the problems that faced by today's industry, as a complement to the literature study. In the prescriptive study, demonstrators are created to illustrate cases from industry. The demonstrators are based on the perceived needs of industry and realized through prescribed methods and tools; they are used as mediating objects in verifying and validating the results through verification by acceptance with selected small groups (see Chapter 5, Validation Protocol for more information).

### Reference #1

- [1] G. Sirin, B. Yannou, E. Coatanea and E. Landel, "Creating Domain Ontology to Support the Numerical Models Exchange between Suppliers and Users in a Complex System Design". ASME 2013 International Design Engineering Technical Conferences and Computers and Information in Engineering Conference Volume 2B: 33rd Computers and Information in Engineering Conference Portland, Oregon, USA, August 4–7, 2013
- [2] M. Ben Gaïd, G. Corde, A. Chasse, B. Léty, R. De La Rubia et M. Ould Abdellahi, " Heterogeneous Model Integration and Virtual Experimentation using xMOD: Application to Hybrid Powertrain Design and Validation", Prague (République Tchèque) 7ème Congrès "EUROSIM" (Modeling et de la Simulation) en septembre 2010.
- [3] C.J.J. Paredis, A. Diaz-calderon, R. Sinha and P.K. Khosla, (2001, Apr). Composable models for simulation-based design. *Engineering with Computers Journal*, Vol.17, No. 2, p. 112-128
- [4] O. De Weck, "Feasibility of a 5x Speedup in System Development due to Meta Design". ASME/DETC2012-70791, 2012.
- [5] D. Ward and S. Helton, "Estimating Return on Investment for SAVI (a Model-Based Virtual Integration Process)," *SAE Int. J. Aerosp.* 4(2):934-943, 2011, doi: 10.4271/2011-01-2576.
- [6] G. Tassej, S.B. Brunnermeier, et S.A Martin. (1999). Interoperability cost analysis of the US automotive supply chain. Research Triangle Institute Final Report. RTI Project 7007-03, Available: [https://www.rti.org/pubs/US\\_Automotive.pdf](https://www.rti.org/pubs/US_Automotive.pdf)
- [7] Nasa Technical Standard, (2008). Standard for models and simulations National Aeronautics and Space Administration Washington, DC 205460001, NASA-STD-7009.
- [8] A. Kerzhner, and C. Paredis (2009), "Using domain specific languages to capture design synthesis knowledge for model-based systems engineering - detc2009-87286". San Diego, California.

- [10] D. Krob, (2009). "Eléments d'architecture des systèmes complexes", Gestion de la Complexité et de l'information Dans les Grands Systèmes Critiques, 179-207.
- [11] D. Scaravetti, (2004). "Formalisation préalable d'un problème de conception, pour l'aide à la décision en conception préliminaire". Ecole Nationale Supérieure d'Arts et Métiers.
- [12] Chakrabarti, A. and Bligh, T. P. (1996). "An approach to functional synthesis of mechanical design concepts: Theory, applications, and emerging research issues", AI EDAM, 10(04): 313-331.
- [13] R. Gunnarson, Vetenskapsteori. Dept of Prim Health Care Göteborg University – Research methodology web site. 2009-03-20. <http://infovoice.se/fou.2011-03-08>.
- [14] Jørgensen, K. A., 1992, "Videnskabelige arbejdsparadigmer ("Scientific Work Paradigms", in Danish)", Institute for Production, Aalborg University Center, Aalborg, Denmark.
- [15] Yin, R. K., 2003, "Case Study Research: Design and Methods", SAGE, Thousand Oaks, CA, USA.
- [16] Robson, C., 2002, "Real World Research: a Resource for Social Scientists and Practitioner-Researchers", Blackwell Publishers, Malden, Mass.; Oxford.

# 2

## Research overview

### 2 State of the art

#### 2.1 Modeling and Simulation (M&S) as a complex system

The fundamental building block of M&S is the model, an abstraction of the real system that is executed over time with different inputs in a simulation. Simulations provide the means to analyze complex systems without physical deployment that can be costly or even dangerous [1]. However, modeling and simulation process is a costly and a complex system itself. A complex system is a system with numerous components and interconnections, interactions or interdependencies that are difficult to describe, understand, predict, manage, design, and/or change [2]. The complex multidisciplinary models' development process require additional time to design and validation. Validation is of paramount importance, especially when models are employed for critical decisions such as in military exercises or in the evaluation of safety decisions [3]. However, the size and complexity of simulation models is hard to grasp. As a result of on-going advances and developments in modeling and simulation, the knowledge is not only becoming more complex to control, but also involves a data flow, interoperability and human based communication problems to be solved, which, in turn, increases the pressure on engineers to ensure better data management and architecture, in order to satisfy the decision makers [4]. In the Modeling and Simulation environment, the complexity problem arises technical and human based factors.



One of them is companies' siloes structure where individual people, departments, or companies, conduct business in a vacuum without taking into consideration the impact their actions have on the entire organization [5]. The current engineering process is typically fragmented into siloes of experts, tools and data. Separate simulation models are constructed one for each of the developers. There is no holistic, transversal and comprehensive view of the simulation model and the data exchange between its stakeholders. There is no organized way for individual domains, or the team as a whole, to manage their design and analysis models over the entire project. On the other hand, the fact that engineering disciplines use different engineering tools such as Simulink, Amesim, GT Power, etc and integration of these tools may create the some interoperability problems. Tableau 2-1 gives an overview of sources of complexity for M&S environment.

Tableau 2-1 Complexity in multidisciplinary M&amp;S environment [6, 15]

<b>Source of Complexity</b>	<b>Examples</b>
- Variety of vehicle architecture and innovation	-standard, electrical, hybrid -family, sport -fuel-efficient, low-emission -luxury and economical vehicle
- The complex nature of product	- A vehicle solution is a complex tradeoff between conflicting performances such as sportive performances, comfort, safety, consumption, environmental impacts, space and cost.
- Diversity of tools and nature of models	- Simulation Tools: Matlab & Simulink, GT Power, Amesim etc... - Nature of models : 0D-1D,3D
- Interdisciplinary and dependency	- Interaction of different engineering domains (disciplines) such as mechanical, electrical, thermic, aerodynamic etc...
- Lack of orchestrated end to end model design process	- It requires to optimize the current model development process with major design actors

<p>- Globalization and distribution of engineering departments and partners</p>	<p>- Collaboration and supervision of simulation tasks is complicated by time-zones, languages, cultures boundaries.</p>
<p>- Collaboration and Engineering Knowledge Sharing</p>	<p>- Today, more than 70% of aircraft and automotive systems and components are provided by partners and suppliers. However, data ownership is not clear. Who owns the data at each phase of the product data lifecycle, what data is transferred from one system to another and who is responsible for the updates? Key issue here is transfer and traceability without full disclosure of intellectual property.</p> <p>- Different disciplines often use different vocabularies, so that semantic differences can cause misunderstandings between teams. To obtain an effective knowledge transmission, a common vocabulary is needed.</p>
<p>- Data Management</p>	<p>- Data volume, visibility, traceability and reuse strategy have to be taking into consideration in the future to ensure the interoperability of processes, data and tools in this heterogeneous environment.</p>
<p>- Lack of Verification and Validation standard</p>	<p>- To produce credible simulation results the simulated environment must be realistic and validated using accepted practices. Model validation should be performed at the lowest level that can be supported by test data in addition to the vehicle level to build confidence that the models can be used for vehicles other than the specific one(s) used for validation. Confidence in a model should be based on the accuracy of the model relative to test data, and the repeatability of the test data should be considered as well [1, 25] .</p>

## 2.2 Complex system architecture and modularity

System architecture can be viewed as an abstract description of the entities of a system and the relationships between them [2]. It is one of the most convenient ways to define and manage complex systems. The system is defined as a set of different elements and relationships to perform a unique function which is not performable by the elements alone. The sub-systems within the system and the components within a sub-system are interconnected or dependent on each other and these relationships define the system architecture [7]. Complexity of a system is defined by the complexity of the interconnections and/or the dependencies in the system architecture [8]. Architecture therefore relates to the structure in terms of components, connections, and constraints of a product, system, process, or element. System Architecture's logical decomposition defines a vehicle into its subsystems, the interfaces of these subsystems in terms of physical energy and logical control flows, and the interactions between the vehicle and the driver. This decomposition means that a single designer or design team can no longer manage the complete product development effort. In the context of automotive design, vehicle may be partitioned by object into body, powertrain, and suspension subsystems (see Figure 2-1) [10]. Aspect partitioning divides the system by discipline. The same automotive design could be partitioned by aspect into structural, aerodynamic, and dynamics disciplines. Focusing on the organizational level, the vehicle partitions affect also the tasks, roles and simulation models delegation between related engineering disciplines. The simulation model creation process involves a number of parallel activities in which experts in different domains create or reuse component (or atomic) level models to build up a full-vehicle system model [13]. One can think of design as a process that consists of decomposition and composition. High-level functions are hierarchically decomposed into functions for subsystems; these sub-functions are then mapped to physical components that are, in turn, recomposed into a complete system. During the process of composition (i.e. synthesis), the designer defines which components are used and how they interact with each other. The integration must pass through the proper management of its interfaces. Together these interfaces raise new system properties that no subsets of its elements have [8]. Consequently, considering and managing all interfaces in a consistent way may become complex. In particular, parameter or component couplings relating to different domains must be exhaustively identified, which is rarely possible.

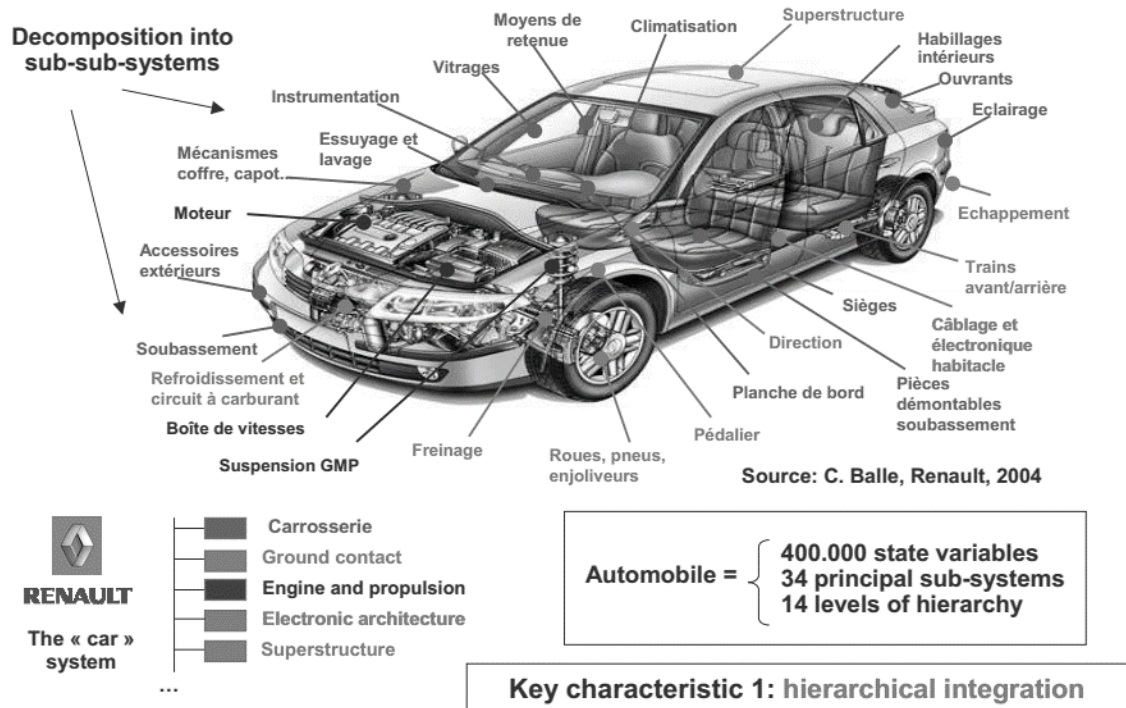

Figure 2-1 Vehicle decomposition

Distributed design teams typically handle the model at different levels of abstraction, ranging from very high-level system decompositions to very low-level detailed specification of components. This is particularly challenging for the design of multi-disciplinary systems in which components in different disciplines (e.g., mechanics, structural dynamics, hydrodynamics, heat conduction, fluid flow, transport, chemistry, or acoustics) are tightly coupled to achieve optimal system performance [12]. Moreover, the design and development of domain level simulation models is usually outsourced to different lead suppliers (or provider) to manage time-to-market and cost. Today, one of the problems in this collaborative environment is that models are usually considered as available, ready to be integrated (plug and play) or requested directly from a model provider without specifying any method. However, most of the technology or service provider’s simulation model is in a Black Box (BB) format for preserving the intellectual properties. BB models can be interacted only through the inputs and outputs of a well-defined interface (see 1-3) [14].

### 2.2.1 Component and port-based modeling

A complete vehicle system model must take the response of the various physical subsystems into account, the function of the controller modules (both subsystem and vehicle level) as well as other external influences like the environment and the driver [2]. Vehicle-level attributes, such as energy, safety management and performance, to be examined and optimized for various operating scenarios. These vehicle-level attributes are tightly coupled; investigating the tradeoffs between these attributes is crucial for system design (see Figure 2-1) [6]. To create multidisciplinary vehicle model, it is necessary to first plan and develop detailed domain analysis models according to vehicle-level goals and requirements. Once these domain models have been planned, developed, verified, and validated, they can be integrated together to simulate a complete vehicle. Capability for the selection and integration of models is improved by model composability [16 and 33]. The compositional modeling paradigm distributes complexity associated with complex system modeling to individual components and facilitates reuse of high-fidelity component models, which are expensive and time consuming to obtain in general. Component-based modeling allows users to quickly and efficiently create high fidelity simulation models by linking independent model objects. Capabilities for the selection and assembly of models can be improved by engineering composability. The advantages of this approach are, however, rapidly offset by the difficulties associated with tracing the impacts of one subsystem design on another one (i.e. managing interfaces among subsystems). This phenomenon is also referred to as a ‘dependency problem’ [19]. To achieve composability of numerical models, Paredis and Diaz-Calderon [16, 17] introduced a port-based modeling paradigm which can be hierarchically defined when it consists of a composition of sub-models, resulting in a compound component. When the sub-models are also compound, multiple levels of hierarchy occur. The composability of a model facilitates to trace the impacts of one subsystem to another one, managing interfaces among subsystems. It is based on two concepts: port and interface. Ports correspond to the points where a component exchanges energy or signals with the environment. (see Figure 2-2a).

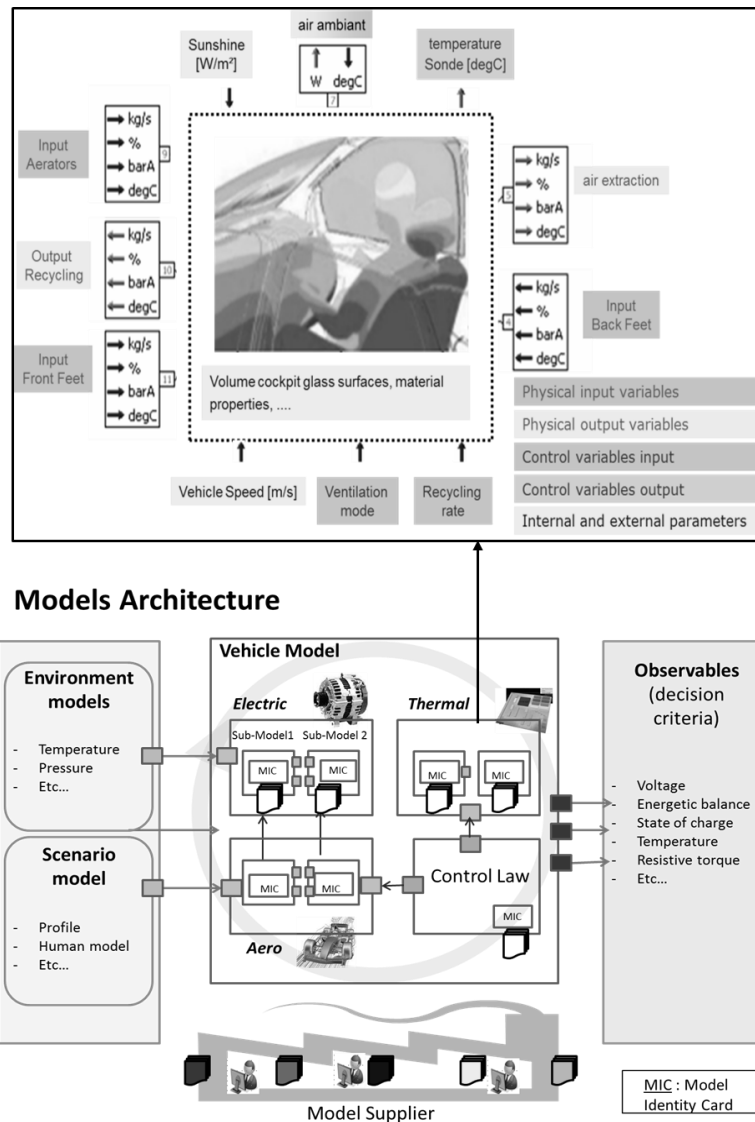

Figure 2-2a Port-based design representation

There is one port for each separate interaction point, and the type of a port matches the type of energy transported. The energy flowing through a port is characterized by their across and through variable, also called effort and flow variables in Bond Graph modeling [20, 21]. According to Eppinger and Salminen [22], interactions between components can be identified along the technical dimensions of spatial, energy, materials and information. The Interface notion is also important because the interaction may include well-specified interfaces. The system interface specification identifies input and output attributes by name, data and communication type (i.e., input, output or bidirectional). The connection mechanism of model specifies the interface definition and connections. If the connection is a causally coupled relationship, it is called

causal connection. The causal connection expresses the interface as input/output relationship in other words; the causality determines the direction of the effort and the flow. If the connection is non-causal relationship, it is called non-causal connection (see Figure 2-2b, Chapter 6 and Appendix). The non-causal connection expresses the interface as variables shared relationship.

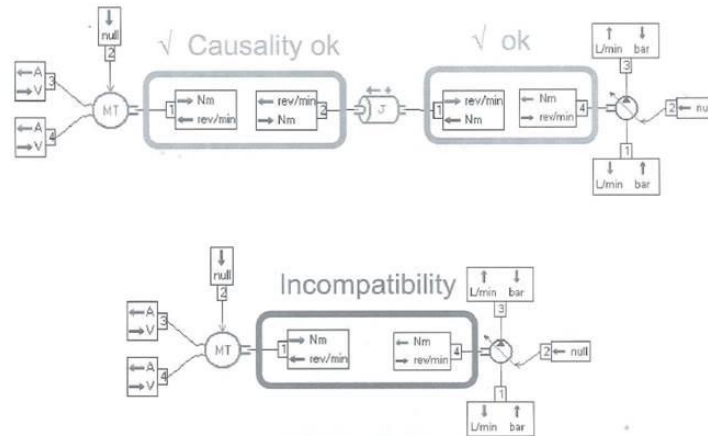

Figure 2-2b Port-based design representation and causality

The result of linking these models is a model architecture that can be used to evaluate the integration performance of the system as well as investigate the interactions and performance of the individual component models. Model users may be able to assemble the model component parts in a plug-in manner, thus minimizing the time, cost and expertise required to construct comprehensive models within the context of their organization [18, 19].

To be able to reuse existing component level models in a black box fashion and to integrate them to a full-vehicle system model, one needs to have a holistic view of the system [23]. This need requires integrating the system architecture into the early design process. It helps also to synchronize between actual needs of the downstream process and what the upstream process is delivering (see Figure 0-). But today, most of the high level model development and integration activities do not integrate product architecture to their model design phase. In this manner, the system level model integration activity is satisfied by finding, modifying and integrating of the existing model without knowing which sub models are meaningful to connect together and how they can be connected to each other and which the interfaces are.

Thus, the approach that we propose provides the system architecture integration in early model building process. System architecture integration facilitates also model plug-in (i.e., model integration phase) activity by providing a holistic sub model integration schema with its interface connections. To make sure that a multidisciplinary model is developed and performed according to customer requirements (i.e., model user), one needs to follow a precise design methodology that we introduce in Chapter 4 and 5.

### 2.3 Model exchange: interoperability and inconsistency problems

Interoperability is the ability of two or more systems to exchange and reuse information efficiently. Multi-disciplinary simulation interoperability includes both simulation metadata and processes (a field known as "Simulation Data Management" SDM or "Simulation and Process Data Management" SPDM [32]) and co-simulation. The works presented below, are basically related to tool and module interoperability problems (tool and library versioning, data exchange standard and co-simulation [30]). Vehicle is a multidisciplinary system which involves different engineering disciplines in their design. Each engineering discipline tends to use its own domain-specific languages and tools to model different aspects of a system concurrently. The concurrent modelling process may introduce inconsistencies due to lack of common knowledge and communication among domain experts. Especially for co-modelling and co-simulation developments, a huge amount of models, versions of models and design alternatives may be produced, which highly increases the design space and the likelihood of yielding inconsistent models. Meanwhile, model exchange and interoperability problems have already been addressed by some industrials such as AP 2633 model exchange standard. AP2633 Simulation Models are black-box models, managed through their high-level interfaces: control, functional and profile [25]. On the other hand, the Functional Mockup Interface (FMI) covers the aspects of model exchange and of co-simulation [24]. Model exchange problems are tackled by developing a tool independent standard for the exchange of dynamic models and for co-simulation based on XML standards. Using the black box model exchange, FMI defines interfaces only and responds to know-how protection (i.e. non disclosure).

On the other hand, an inconsistency is, by definition, a logical contradiction. In practice, many different kinds and types of inconsistencies can be distinguished. For example, inconsistencies can be a result of language non-conformance, or not adhering to heuristics, guidelines or best practices. In current practice, typically only inconsistencies with respect to language conformance are managed automatically, often merely in an ad hoc fashion. The works presented below, are basically related to interface and metadata inconsistency problems. In common practice, many inconsistencies are only identified after decisions, based on inconsistent information and knowledge, have already been made. For example, in a systems engineering workflow, reviews and verification and validation activities often serve this purpose. The costly and infrequent nature of such activities leads to decisions with poor outcomes and costly rework. However, the earlier inconsistencies are identified, the cheaper they are to handle. Therefore, automating at least some early level verification and validation activities has value since this can lead to significant cost savings and, hence, better decision making, and more effective and efficient development. To create a semantically-rich, model characterization support, first, it is necessary to create of a common vocabulary for formally

∩∩

Supporting Multidisciplinary Vehicle Modeling:  
Towards an Ontology-based Knowledge Sharing in Collaborative  
Model Based Systems Engineering Environment



characterizing numerical model of different domain. Multidisciplinary simulation covers the individual analysis disciplines (aerodynamics, mechanical, electromagnetics, thermal, noise, vibration,) and the links coordination between analysis disciplines [28].

Sharing a common vocabulary between the designers and manufacturers allows both sides to identify potential misunderstanding problems before they start [26, 27]. Another contribution of this work is reducing the number of the rework while detecting potential inconsistency problems at the early design stage. Actually, avoiding the misconception is essential to prevent correction on validation phase. Then, the contextual information for the user becomes a key factor for the performance of the task. In addition, visualization improves communication and is useful for interpretation results. One of the key contribution of this thesis is to present a new techniques for interoperating simulation models using ontologies as the basis for representing [29], visualizing, reasoning about, and securely exchanging abstract engineering knowledge between simulation models. The modeling knowledge associated with the development of simulation models ontology has been developed and instantiated to form a knowledge base for representing analysis modeling knowledge. The instances of the knowledge base are the analysis models of real world applications (see Chapter 5 and Appendix)

### **2.3.1 Product Life Cycle (PLC) and inconsistency**

Automating the process of managing inconsistencies necessitates that the information and knowledge being analyzed is captured in a formal manner. In Model-Based Systems Engineering (MBSE) one of the key principles is that only formal, computer-interpretable models should be used. More specifically, MBSE is the formalized application of modeling to support system requirements, design, analysis, verification, and validation activities beginning in the conceptual design phase and continuing throughout development and later life cycle phases. The use of only formal (and, hence, computer-interpretable) models has a significant advantage over what is often referred to as a document-based approach: models can, at the very least theoretically, be integrated computationally. However, in systems engineering the problem hardens due to the fact that models are typically of a heterogeneous and distributed nature, inherently incomplete, and are evolved by numerous stakeholders in parallel, hence often lacking. To help control this complexity, the systems engineering discipline provides a collaborative business methodology that manages all the domains of engineering and development from a holistic point of view. This approach is significantly enhanced and improved through a common view on what needs to be accomplished as well as a common model to develop it in, providing a better understanding for all participants of how the system will operate as a whole. Increasing vehicle complexity requires the ability to manage development decisions proactively and in ways

where the impact of any change can be accessed prior to it being made through virtual design and validation. This can be accomplished through model-based systems engineering methods such as RFLP (requirement, functional, logical, and physical) [31]. RFLP provides a collaborative systems engineering methodology that can capture, manage, and track product requirements with full traceability, all from one engineering desktop window. Model-based engineering as produced by the RFLP approach puts more rigor into the process, providing a link back to requirements for each logical, functional, and physical change.

***RQ: How should one design and guide the development of multidisciplinary models?”***

**SPECIFIED RESEARCH OBJECTIVE and PROPOSED SOLUTION:**

**O1: Maximizing value in the multidisciplinary simulation model development process and to improve outcome value by eliminating unnecessary rework cycles late in the product development process.** In addition, to maximize the value in collaborative modeling environment depends on advances in three interrelated perspectives, namely organization, process and product, covering some key issues which are:

**Process:**

- Supporting to make a decision and to minimize the number of rework.
- Establishing an early stage detailed model design stage (conceptual model design) phase.
- Supporting the roles of all stakeholders directly involved with related design tools.

(a) **Organization:**

- Ensuring collaboration and authority delegation.
- Supporting the knowledge sharing between design actors.

(b) **Product:**

- Defining a model sharing and reuse strategy as an enabler to reduce model recreation and errors associated with new model construction.
- Minimizing the opportunity for inconsistencies.
- Supporting the interoperability between disciplines oriented design tools.

**Proposed Solution:** For this aim, this work proposes an early stage multidisciplinary simulation model design methodology. This methodology consists of reducing the late inconsistency detection by ensuring the early stage collaboration with a clear simulation model request and design artifact negotiation. Information flows between design actors should be standardized and supported by a common terminology to decrease the ambiguity and misunderstanding. This will ultimately contribute to increased confidence in the simulation model and hence decrease development time, resources and cost. Addressing these issues must help identify wastes, inefficiencies, and non-value added activities, that should be eliminated come up with at a more desirable “ideal state” serving as a longer-term goal (see Chapter 3).

**Reference #2**

- [1] C. Szabo, (2010). Composable simulation models and their formal validation, PhD Thesis, Department of computer science, National University of Singapore (NUS).
- [2] Crawley, E., Weck De, O., Eppinger, S., Magee, C., Moses, J., Seering, W., Schindall, J., Wallace, D. and Whitney, D. (2004), "The influence of architecture in engineering systems".
- [3] G. Sirin, B. Yannou, E. Coatanea and E. Landel, "Creating Domain Ontology to Support the Numerical Models Exchange between Suppliers and Users in a Complex System Design". ASME 2013 International Design Engineering Technical Conferences and Computers and Information in Engineering Conference Volume 2B: 33rd Computers and Information in Engineering Conference Portland, Oregon, USA, August 4–7, 2013
- [4] R. Sinha, V.C. Liang, C.J.J. Paredis, and P.K. Khosla, "Modeling and Simulation Methods for Design of Engineering Systems," Journal of Computing and Information Science in Engineering. Vol. 1, 2001.
- [5] J. Britt, Holbrook, «What is interdisciplinary communication? Reflections on the very idea of disciplinary integration." Synthese, September 2012.
- [6] G. Sirin, T. Welo, B. Yannou, E. Landel, "Value Creation in Collaborative Analysis Model Development Processes". Presented at the Conference on ASME (IDETC/CIE), Buffalo, USA, Aug., 17-20, 2014.
- [7] G. Sirin., C.J.J. Paredis, B. Yannou, E. Landel, E. Coatanea, 2014. "A Model Identity Card to Support Simulation Model Development Process in a Collaborative Multidisciplinary Design Environment," Systems Journal, IEEE, vol.PP, no.99, pp.1, 12.
- [8] Crawley, E., Weck De, O., Eppinger, S., Magee, C., Moses, J., Seering, W., Schindall, J., Wallace, D. and Whitney, D. (2004), "The influence of architecture in engineering systems".
- [9] Magee, C. L., & de Weck, O. L. (2004). Complex system classification. Presented at the Fourteenth annual international symposium of the international council on systems engineering (INCOSE).
- [10] D. Turpin, "Changes and Challenges in the Automobile Industry", IMD, March 2010.
- [11] Srinu Chari, "Addressing Engineering Simulation Data Management (SDM) Challenges: How Engineering Enterprises Can Improve Productivity, Collaboration and Innovation", MBA, 2013.
- [12] G. Mocko, R. Malak, C. Paredis and R. Peak, "A knowledge repository for behavioral models in engineering design", ASME International Design Engineering Technical Conferences & Computers and Information in Engineering Conference IDETC/CIE 2004, 2004.
- [13] INCOSE, "Systems Engineering Handbook", SE Handbook Working Group International Council on Systems Engineering, San Diego, 2010.
- [14] R. Glanville (2009), "Black Boxes", Cybernetics and Human Knowing, pp153-167.

- [15] L. Chwif, R. Paul, "On simulation model complexity", Department of Information Systems and Computing, Brunel University, Uxbridge, U.K.
- [16] A.D. Calderon, C. Paredis, and Khosla, P. K., "A Composable Simulation Environment for Mechatronic Systems." SCS 1999 European Simulation Symposium. Erlangen, Germany. Society for Computer Simulation, 1999.
- [17] A.D. Calderon, C. Paredis, and P.K. Khosla, "Reconfigurable Models: A Modeling Paradigm to Support Simulation-Based Design." 2000 Summer Computer Simulation Conference. Vancouver, Canada. Society for Computer Simulation, 2000.
- [18] J. Badin, D. Monticolo, D. Chamoret, S. Gomes, "Using the Knowledge Configuration Model (KCModel) to manage knowledge in configuration for upstream phases of the design process" is accepted in the International Journal on Interactive Design and Manufacturing (IJIDeM), 2011.
- [19] S. Halbach, P. Sharer, S. Pagerit, C. Folkerts, A. Rousseau, "Model Architecture, Methods, and Interfaces for Efficient Math-Based Design and Simulation of Automotive Control Systems", Argonne National Laboratory, 2010.
- [20] Barreto, J. M., "The Role of Bond Graphs in Qualitative Modelling," Proc. IJCAI-89, pp. 84-87.
- [21] Breedveld, P. C., 1984, "A Bond Graph algorithm to determine the equilibrium state of a system," Journal of the Franklin Institute, 318(2).
- [22] S.D. Eppinger, and V. Salminen, "Patterns of Product Development Interactions", International conference on engineering design ICED 01 Glasgow, 2001.
- [23] V. Basili and H.D. Rombach, "Towards A Comprehensive Framework for Reuse: Model-based Reuse Characterization Schemes," University of Maryland, CS-TR-2446, UMIACS-TR-90-47, April 1990.
- [24] Christian Bertsch, Elmar Ahle, Ulrich Schulmeister (2014). The Functional Mockup Interface - seen from an industrial perspective, Proceedings of the 10th International Modelica Conference; March 10-12; 2014; Lund; Sweden.
- [25] Val Serra, S., "AP2633 - Develop, Integrate and Validate Shared Simulation Models," Issue C, Airbus, France, 3 June 2008.
- [26] T. Tudorache, "Employing Ontologies for an Improved Development Process in Collaborative Engineering», Thesis of doctorate, University of Berlin, 2006.
- [27] W. C. Barley, P. M. Leonardi, and D. E. Bailey, "Engineering Objects for Collaboration: Strategies of Ambiguity and Clarity at Knowledge Boundaries", International Communication Association, 2012.

- [28] N. Kanuri, "Ontologies and Methods for Interoperability of Engineering Analysis Models (EAMs) in an E-Design Environment", Masters Theses, University of Massachusetts Amherst, 2007.
- [29] E. Brun, "Ambiguity Reduction in New Product Development Projects", International Journal of Innovation Management, December 2008.
- [30] S. Sicklinger *et al.* (2014). "Interface Jacobian-based Co-Simulation". International Journal for Numerical Methods in Engineering 98 (6): 418–444. doi:10.1002/nme.4637.
- [31] T. Ambroisine, "Mastering increasing product complexity with Collaborative Systems Engineering and PLM ", Dassault Système, France, Available online:  
[http://www.aobs.com/fileadmin/user\\_upload/Downloads/Article-Conferinte-Embedded/04\\_DS\\_Mastering\\_Complexity\\_with\\_Systems\\_Engineering\\_and\\_PLM\\_EW2013.pdf](http://www.aobs.com/fileadmin/user_upload/Downloads/Article-Conferinte-Embedded/04_DS_Mastering_Complexity_with_Systems_Engineering_and_PLM_EW2013.pdf)
- [32] S. Charles, B. Eynard, "Definition of a Simulation Data Management Environment integrated with PDM", Proceedings of International Conference on Engineering Design – ICED'05, Melbourne, Australia, August 15-18, 2005.
- [33] C.J.J. Paredis, A. Diaz-calderon, R. Sinha and P.K. Khosla, (2001, Apr). Composable models for simulation-based design. Engineering with Computers Journal, Vol.17, No. 2, p. 112-128.

# 3

## Paper #1. Characteristics of a Good Multidisciplinary Model Design Practice: Toward a Model Reuse and a Value-Added Thinking

Under Preparation

Göknur Sirin<sup>1,4</sup>, Laurent Gasser<sup>2</sup>, Torgeir Welo<sup>3</sup>, Bernard Yannou<sup>1</sup>, Eric Landel<sup>4</sup>

<sup>1</sup> Ecole Centrale Paris, Laboratoire Génie Industriel, Chatenay-Malabry, France

<sup>2</sup> IRT-SystemX, Paris-Saclay Campus - Nanno INNOV, Palaiseau, France

<sup>3</sup> NTNU, Engineering Design and Materials, Trondheim, Norway

<sup>4</sup> Renault SAS Techno-Centre, Guyancourt, France

**Abstract.** *To develop competitive vehicles, automotive engineers continuously improve their ability to explore and analyze the most relevant system architecture by taking into consideration the vehicle level attributes (e.g., drivability and fuel economy) and innovation (e.g., hybrid or full electric vehicle). In the endeavour to reduce time-to-market, automotive OEMs (Original Equipment Manufacturers) need to create credible simulation models without inconsistencies before building expensive simulation models. The pursuit for shorter lead times and higher product quality calls for increasing amount of concurrent activities and effective cross-functional*

31

Supporting Multidisciplinary Vehicle Modeling:  
Towards an Ontology-based Knowledge Sharing in Collaborative  
Model Based Systems Engineering Environment

*collaboration. In this connection, Systems Engineering (SE) methods are helpful to structure the necessary activities but they fail to address 'value' in much detail. This paper addresses the application of value thinking in multidisciplinary simulation model development within a SE and MBSE context by considering three interrelated perspectives: organization, process, and product. Based on these perspectives, we identify some major problems and suitable characteristics of multidisciplinary simulation model development processes. These characteristics are subsequently explained as a good modeling practice. Only a few of these problems are associated with uncertainty and validation issues to improve model credibility, while the majority is associated with other aspects of the modelling process. An important conclusion of the paper is that to maintain the competitiveness with other manufacturers, an OEM should therefore not only invest in the creation of new systems, but also into advancing its systems engineering capabilities.*



### 3.1 Introduction

In today's competitive environment, there is higher pressures than ever to design an innovative architecture in disruption with the past by analysing any potential architecture (Internal Combustion (IC) engines, hybrid or electric systems) from a variety of attributes including performance, drivability, fuel economy, durability or even thermal behaviour. Both the increased complexity of products and the competition on today's global market imply a need for exploring and analysing mentioned system architectures efficiently and effectively [1-2]. To keep pace with the rapid improvements being made to these modern products (i.e. ground vehicles -cars, trucks, trains- as well as air, space and submarine vehicles) and maintain competitiveness with other manufacturers, design cycles have become shorter and more efficient.

To support these shorter design cycles during the early design exploration phase, companies use more and more sophisticated, multidisciplinary simulation model (or numerical or behavioral models) [1]. Simulation models can be used to better understand the impact of different operating conditions on vehicle performance and attributes. However, there are numerous challenges when designing and modelling such complex system architectures. Some of these challenges include making many design decisions, designing with knowledge from different disciplines, and modelling, exploring and analysing the system architectures. This is particularly challenging for the design of multidisciplinary systems in which components in different disciplines (e.g., mechanics, structural dynamics, hydrodynamics, heat conduction, fluid flow, transport, chemistry, or acoustics) are tightly coupled to achieve optimal system performance [1]. To accurately represent vehicle behaviour in a given field situation, simulation models are created by integrating different simulation models within a vehicle model, such as model of chassis, engine and transmission, etc. These sub system simulation models are denoted domain models in the following. Moreover, each domain model can be developed and evolved following its own semantics and development tools at different rates [3]. On the other hand, there are two modelling philosophies for multidisciplinary simulation. In one approach, all model components are implemented in a single modelling or simulation tool, using common libraries or a common modelling language, and creating a single model comprising elements of all involved disciplines. In a second approach, the coupling of specialized tools by the means of interfaces is performed. This is especially suited for systems where sub-models already exist in specialized tools and where those models are too large and complex to be transferred into a single simulation tool [4]. This paper focuses especially on the second approach.

The design and development of domain level simulation models is usually outsourced to different lead suppliers to manage time-to-market and cost. However, because of the multidisciplinary nature of simulation models, it is key for OEMs to pay close attention to suppliers throughout the design phase, in order to ensure high quality of model deliverables. Since the quality of complex multidisciplinary simulation model strongly depends on input from multiple sources, efficient collaboration between domain experts is a prerequisite for a successful outcome [3]. Hence, ensuring confidence in simulation results, i.e., model credibility, is particularly challenging when domain models within different disciplines are tightly coupled.

A common problem in today's model development process is inconsistencies upon the final models integration stage. From a value perspective, this is particularly wasteful since the 'cost of learning' is higher in the final integrating stage. Incomplete models create undesirable rework that negatively affects cost, schedule and design decision [3]. Several factors may cause inconsistencies during the integration of domain level simulation models into a system level model; for example, the models are not ready to use such that the OEM must modify them before integrating with the other models.

The purpose of this study is to analyze the current simulation model development process of automotive and aeronautics industries. An initial hypothesis for our study is that the challenges are similar for these two industries and that they are both leading sectors when it comes to simulation based vehicle design. The results from the analysis is then further used as a basis to propose a future process. The mentioned future process is based on good modeling practice towards a value focused thinking from three interrelated perspectives: organization, the design process, and the product. Product perspective contains simulation model, referential model architecture, and model specification and calibration and some other documents. Doing so provides a competitive advantage to OEM, by being able to pursue value opportunities efficiently and effectively which may be not accessible to its competitors.

The remainder of this paper is organized as follows. In Section 2, we introduce our methodological positioning based on value thinking with a comparative state-of-the-art review. Section 3 discusses the desirable characteristics of good multidisciplinary modelling practice. In section 4, we give as an industrial case study an overview of the proposed valuable multidisciplinary simulation model development process. The conclusion and discussion are given in Section 5.

### 3.2 Background and State of the Art

Product design is a systematic, goal and human based activity for identifying and exploring the most valuable alternative under uncertainty. In decision theory, such preferences are expressed as “value,” so that striving for the most preferred outcome can be modelled as maximizing value [5].

The systems engineering and design methods, along with associated tools, allow companies to manage the development of complex system. Looking into the future, however, existing methods and tools are not in a position to leverage value opportunities as technology, competition and market (‘the three sharks’, Huithwaite, 2006 [10]) change; e.g., hybrid or fully electric vehicle, cloud computing, advanced design tools or technological and environmental standards. To keep pace with new enabling technologies, a company must continuously improve its methods, processes and tools—specific to its context and application domain—by keeping the overall objective in mind; namely, to maximize value. To maximize the value of its product portfolio [11], a company should therefore not only invest in the creation of new systems but also in advancing its systems engineering capabilities. To improve competitiveness, therefore, value focused thinking principles may have an untapped potential for being applied to model development within a SE context to improve efficiency and effectiveness.

In the literature, various research efforts have been made for including “value” as a complement to traditional systems engineering (SE) processes (INCOSE, 2011) [20] such as The Return on Investment (ROI) of Systems Engineering [26], Lean Systems Engineering [13], Value Focused Thinking [16], Agile Systems Engineering [23] and Value Driven Design (VDD) [9]. What creates value; what generates waste; and what drives the decision in multidisciplinary simulation model development process is the motivation for this research work. Thus, we first analyse Lean Systems Engineering (LSE).

In Lean Systems Engineering, creating value through Product Development Process (PDP) aims at increasing information and knowledge (activities‘outputs). The involved activities and tasks require internal and external inputs supported by resources (human, material, IT resources) to provide the added value outputs. According to Womack and Jones [14], the first step in becoming lean is to understand and specify what portions of a process add value to the customer. Creating value for the customers is an important aspect of engineering design. Decisions made during the design process should always be motivated from what adds value within the solution space [7]. This is also supported by Browning [7], who suggests that process improvement in product development cannot just focus on waste, time or cost reduction as long as the overall purpose is to maximize the product value. According to Browning [7], value is driven not only

by the presence of necessary (value-adding) activities in the product development process but also by the way those activities work together to ensure that they use and produce the right work products, service, and information at the right time. As illustrated in Fig. 3-1, in complex system development, value is driven by the deliverables (inputs and outputs) as well as by the activities—hence value output is higher than the sum of value of individual activities—and the goal is mainly to reduce the risk that the product recipe is unacceptable [8, 9].

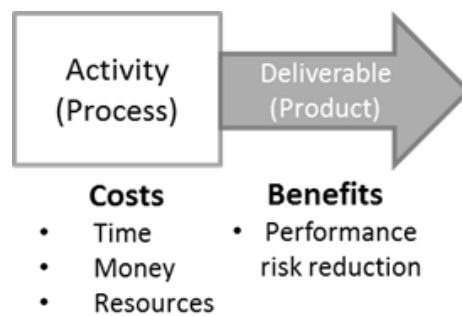

Fig. 3-1 Value for Product and Process Perspectives adapted from [Browning, 2003] [7]

The value perspective in Lean Systems Engineering provides an attractive way to think about process improvements. However, Lean Thinking does not build on decision theory, meaning that there is a need for better guidance for design choices. Such a guidance should essentially translate the desires of customers into terms that are immediately meaningful to design engineers. The guidance should be consistent among vehicle conceptual designers or any engineer making decisions throughout the product development process. However, an iterative approach called Value Driven Design (VDD) is used to address decision theory, which prescribes how preferences should be expressed in terms of an objective, value, or utility function. It is using economic theory to transform systems engineering to better utilize optimization so as to improve the design of large systems. This is also similar to value driven approach of Agile Software Development where project stakeholder's priorities their high-level needs based on the perceived value each would deliver [23]. On the other hand, in Value Driven Design, to design a system, engineers first take system attributes such as the range and fuel consumption of a vehicle, and build a system value model that uses all these attributes as inputs. Next, the conceptual design is optimized to maximize the output of the value model. Then, when the system is decomposed into components, an objective function for each component is derived from the system value model through a sensitivity analysis. [9]. Indeed, the Multi-Objective Optimization (MOO) is also are very useful in the tradeoff analysis and decision making for rapid analysis of the performance and fuel economy of conventional, electric, and hybrid vehicles. Another MOO

method is developed by Smaling and de Weck [25] called “technology infusion assessment methodology” to quantify the potential performance benefits of new technologies using multi-objective Pareto analysis.

Focus on value is also expressed even before VDD by Keeney as Value Focused Thinking in [16] that includes specific tasks and addresses explicitly key elements in structuring decision situations. Value-focused thinking mainly concerns “what is the decision”. The effort to analyzing decision situations can be broken into two parts: what is the problem and what is the solution. On the other hand, Value-Driven Design (VDD) and Value Focused Thinking are the systems engineering approach which strives for the maximization of value rather than for the satisfaction of stakeholder needs as in traditional systems engineering, such as Goal Oriented Requirements Engineering (GORE) [17]. GORE is often characterized in Requirements Engineering (RE) used in systems engineering and design literature as the goal to satisfy a stated need, which then leads to the formulation of a set of requirements to be satisfied [17 and 21]. However, enterprise goals which initiate the goal discovery process do not reflect the actual situation but an idealized one. Finally, it seems to be difficult to deal with the fuzzy concept of the goal [21]. In order to overcome some of the limitations of goal-driven approach, several attempts have been made to merge goals and scenarios, such as Rolland’ CREWS-L’Ecritoire approach developed within the CREWS ESPRIT project [17 and 21]. These two Requirement Engineering approaches are complementary to SE and to value focused thinking methods. The advantage of VDD compared to Lean Systems Engineering is that VDD combines three disciplines (economics, optimization, and systems engineering). It can be defined as: “an improvement to the systems engineering process by employing economics to enable optimization thinking at every level of engineering design” [6]. Thus, VDD is an emerging topic within the industry and academia, providing a concept where designers can utilize value models to represent the value of their product designs as a single objective function. A number of recent programs incorporate VDD themes such as US DARPA (Defense Advanced Research Projects Agency), F6 military satellite program, VDD workshop of Rolls-Royce, and CRESCENDO European project for Digital Aircraft Design [5,12 and 18].

By employing economics in decision making, VDD enables rational decision making in terms of the optimum business and technical solution at every level of engineering design. Based on the three methods (Lean Systems Engineering, Value Focused Thinking and VDD) above, we would like to identify first what creates value in multidisciplinary model development process to identify what is the suitable future state for this process. In lean terms, we seek a suitable “future state” as an intermediate stage towards the not quite attainable “ideal state” serving as an ideal target. Second, we would like to introduce value thinking for any kind of decision support tradeoff analyses that may happen at different levels of abstraction through

simulation model development process (e.g. system architecture and simulation model selection from their alternatives).

### **3.2.1 Methodological positioning: Value in Multidisciplinary Model Development Process**

Building more eco-friendly vehicles ranks high on the development agenda of OEMs and suppliers. As illustrated in Figure 3-2 on the left side, the boundary conditions or external influences that are driving current aircraft and automotive systems architectures, stem from various domains including the political (e.g., energy (oil prices) and legislation policy (Kyoto and CAFÉ protocols)), economic (e.g., cost effectiveness of emissions reducing technology versus alternatives), and environmental (e.g., effects on flora and fauna, global climate change) [25].

All these new concepts and ambition are linked to the successful introduction of hybrid or full electric technology. However, these concepts strongly impact the optimizing fuel economy and NVH behavior that is directly influenced by downsizing the internal combustion engine (ICE) as well as further weight reduction. The challenge in implementing the new technology lies in the architecture one chooses to implement, since there are multiple ways to integrate an electrical motor and a battery reformer in a vehicle (e.g. serie, parallel and serie-parallel hybrid or full electric). When developing a new vehicle based on a chosen architecture, engineers are responsible for meeting a wide variety of often conflicting performance targets. Noise/vibration/harshness (NVH) and fuel economy often must be traded off against each other during the vehicle design process. Throughout the entire simulation based vehicle design process, hundreds of decision are made by different individuals from different disciplines at different levels of abstraction and within different scopes (see Fig. 3-2). Adequate collaborative design environments are needed to ensure that partners and co-design teams can share or/and exchange product data and domain knowledge all along the product development life cycle. Thus partners should be able to bring together their mutual expertise to build dynamically new collective know-how [4].

However, today, many companies try to use the V-cycle system engineering process for product development as proposed by Frosberg and adapted by the National Council on Systems Engineering [6]. However, companies' model building process is typically functioning as a push system rather than a pull system; i.e., a push system is one where an upstream operation transmits work to a subsequent downstream operation without being requested as a need for further processing. The push concept, also called 'over-the-wall-design/modeling', is only efficient when looked at from a local, silo-structure's view point. In a push-

type model development process, testing and integration of system level simulation model are mainly done in later process stages using delivered sub-models (virtual prototypes). This may create multiple wastes, including waiting (i.e., the model is not available when needed or it is sitting waiting for somebody to process it further), over-production (i.e., the model is not needed), which may lead to excess inventory (i.e., data/models not utilized), unnecessary processing (i.e., sending files/models not requested or recreating existing models), and may be the most harmful of them all, namely, defects (i.e., incorrect models), which is subsequently used as basis for design decisions. The company's current model development process does not contain any detailed conceptual design process at the early stage. This means that the complex simulation model design phase is passed quickly with the risk of losing time in efforts to integrate delivered component level models. One of the major sources to wastes for complex simulation model development process in Renault Company is the rework caused by substandard and deficient model designs of component-level models. The root cause may often be the lack of analysis when the design engineer specifies the system architecture in an early phase. This problem can often be avoided by using an iterative early design process. Eliminating design iterations is a central issue in the management of product development (PD) projects. Design iteration is often responsible for increased PD lead-time and cost, and is also a source of major uncertainties in the management of resources, which ultimately may cause resource shortages in other projects within the project portfolio of the company. However, iterations, when planned and managed effectively, can overcome the uncertainties inherent in interdependent development activities and thus, improve and accelerate PD projects.

An alternative model development process must be more effective and efficient than the existing. Thus, the aim of this work is to understand the basic characteristics (enablers and inhibitors) of maximizing value in the multidisciplinary simulation model development process and to improve outcome value by eliminating unnecessary rework cycles late in the product development process. This ultimately contribute to increased confidence in the simulation model and hence decrease development time, resources and cost. In modeling and simulation practice, the applicability of any simulation model depends on the accuracy and reliability of its output. Performance or model accuracy depends on system architecture consistency, uncertainty (sub model and system level model uncertainty, change and uncertainty propagation), used method and design tool, knowledge and data quality that are shared between design actors (see Fig. 3-2).

As illustrated in Fig. 3-2, to be able to evaluate factors that contribute to value creation, addition is paid to analyzing current Model Development Process. Adding a Detailed Conceptual Model Design stage in the current model development process improves the traditional V-cycle because this allows problems to be

identified early. This may reduce rework in the more expensive implementation and physical prototype validation phase, which is the main driver for product development cost [10].

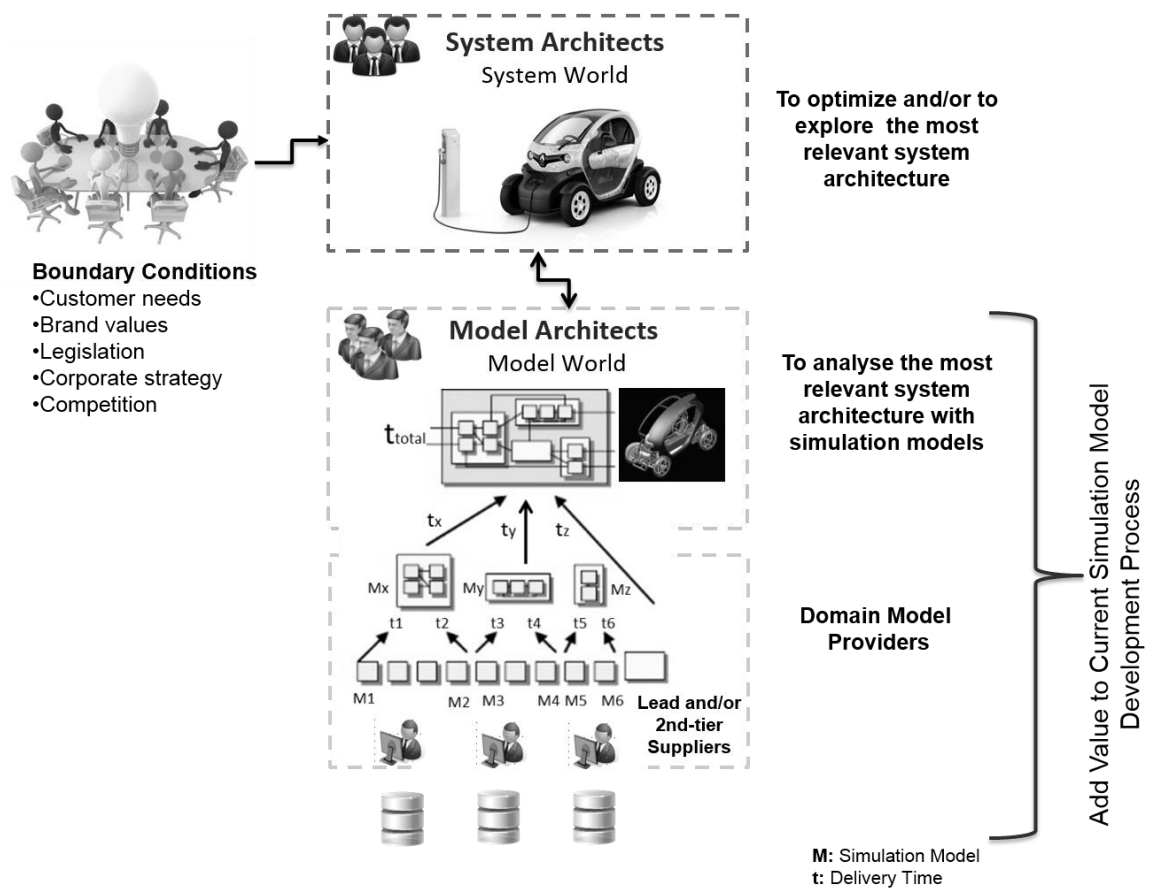

Fig. 3-2 Value-add to the current Simulation Model Development Process

In addition, to maximize the value in collaborative modeling environment depends on advances in three interrelated perspectives (e.g. organization, process and product) addressing the following key issues:

(a) **Process:**

- Supporting to make a decision and to minimize the number of rework.
- Establishing an early stage detailed model design stage (conceptual model design) phase.
- Supporting the roles of all stakeholders directly involved with related design tools.

(b) **Organization:**

- Ensuring collaboration and authority delegation.



- Supporting the knowledge sharing between design actors.

(c) **Product:**

- Defining a model sharing and reuse strategy as an enabler to reduce model recreation and errors associated with new model construction.
- Minimizing the opportunity for inconsistencies.
- Supporting the interoperability between disciplines oriented design tools.

### **3.3 Characteristics of a Good Multidisciplinary Model Design Processes**

The objective of this process is to capture the flow of information and to map activities to certain stakeholders provides a better understanding of the ultimate decision-makers for each step. Coordinating all of the different tasks needed to produce an accurate vehicle model requires developing a thorough understanding of the underlying engineering processes. Thus, it is important to recognize that decision about the product is the implicit outcome of a sequence of decisions made about the process [5]. Oftentimes, engineering tasks are performed in an ad hoc manner and rely on the expertise and experience of the engineers involved to produce results. However, for complex engineering tasks that require coordination among many individuals, this can be a particularly risky approach. Developing an approach that follows a formal, precise process can provide a better understanding of the responsibilities of different engineering teams and areas where issues may arise.

A formal, precise process should define not only the different tasks that stakeholders must perform, but also more specifically, which pieces of information are expected to be exchanged between stakeholders and how this should occur.

#### **3.3.1 Multidisciplinary Collaborative Process and Stakeholder Organization**

It refers to sequence of activities that produces rigorous descriptions of what the products are, what they must do, and how they interact to perform as a system [17]. The process of collaboration across disciplines requires exploration of disciplinary roles, coordination, frequent communication, consensual decision-making, shared values, cultural beliefs within teams/groups, and facilitative support from the organization. This contributes to facilitating the collaborative process. In addition, knowledge sharing is one of the key points in the model development process. Providing a common vocabulary for the Modeling and Simulation

users can help communicate fact-based decision in a maker's assessment of the credibility of Modeling and Simulation results. The ability for users to select from a list of options is an immensely important capability. Because creating full-vehicle simulation models is a multidisciplinary process, it is important that the same strategies are used across different teams of domain experts. By limiting large groups of users to the same vocabulary and set of options whenever possible, inconsistencies arising from miscommunication or misinformation can be reduced significantly. In chapter 5, we propose a Model Identity Card concept to simplify the knowledge sharing and decrease the ambiguity in a collaborative multidisciplinary environment.

Besides the ontology based collaboration, there are some other important points that we should pay attention to create a robust process such as:

- *How to support the roles of all design actors directly involved to the model development process?*
- *How to reduce the ambiguous terminology and a lack of mutual understanding between design actors?*
- *How should we assign authority and responsibility?*
- *How to re-organize the different views and viewpoints based on Enterprise Architecture Framework?*

Furthermore, managing several projects simultaneously is not a trivial issue, especially for companies developing different complex products like automobile engine. One of the key issues is the resource allocation and finding the balance between single project optimum and overall organizational benefits. Nowadays, raising designers' awareness of the value delivered by sub-systems solutions is a major challenge for automotive manufacturers. The "goodness" of a product/service is mainly assessed from a "requirements fulfilment" point of view, not taking the bigger picture in consideration. Consequently, multiple development stages have to be performed in parallel or with some overlap by sharing early preliminary upstream information with downstream stages. The overall 'Parallelism' or Concurrent engineering (CE) principles rest on a single, but powerful, principle that promotes the incorporation of downstream concerns into the upstream phases of a development process. This would lead to shorter development times, improved product quality, and lower development– production costs. Additionally, in a design process there are different stakeholders such as model and system architects, model providers, who have different needs and viewpoints. In Model Based System Engineering, Views and Viewpoints can be used to model the perspectives of different stakeholders and their interests. A viewpoint describes a particular perspective of interest to a set of stakeholders, while a view is a stereotyped package that is said to conform to a particular viewpoint [13] (see Fig. 3-3). In a traditional document-based approach, each

stakeholder works from their own domain-specific tools and documents that they need to perform their tasks. For a model-based approach, this necessity remains. Ideally, each stakeholder would only use models which have been customized to their “view” of the system, in lieu of any documents. Practically speaking, however, this is not yet possible.

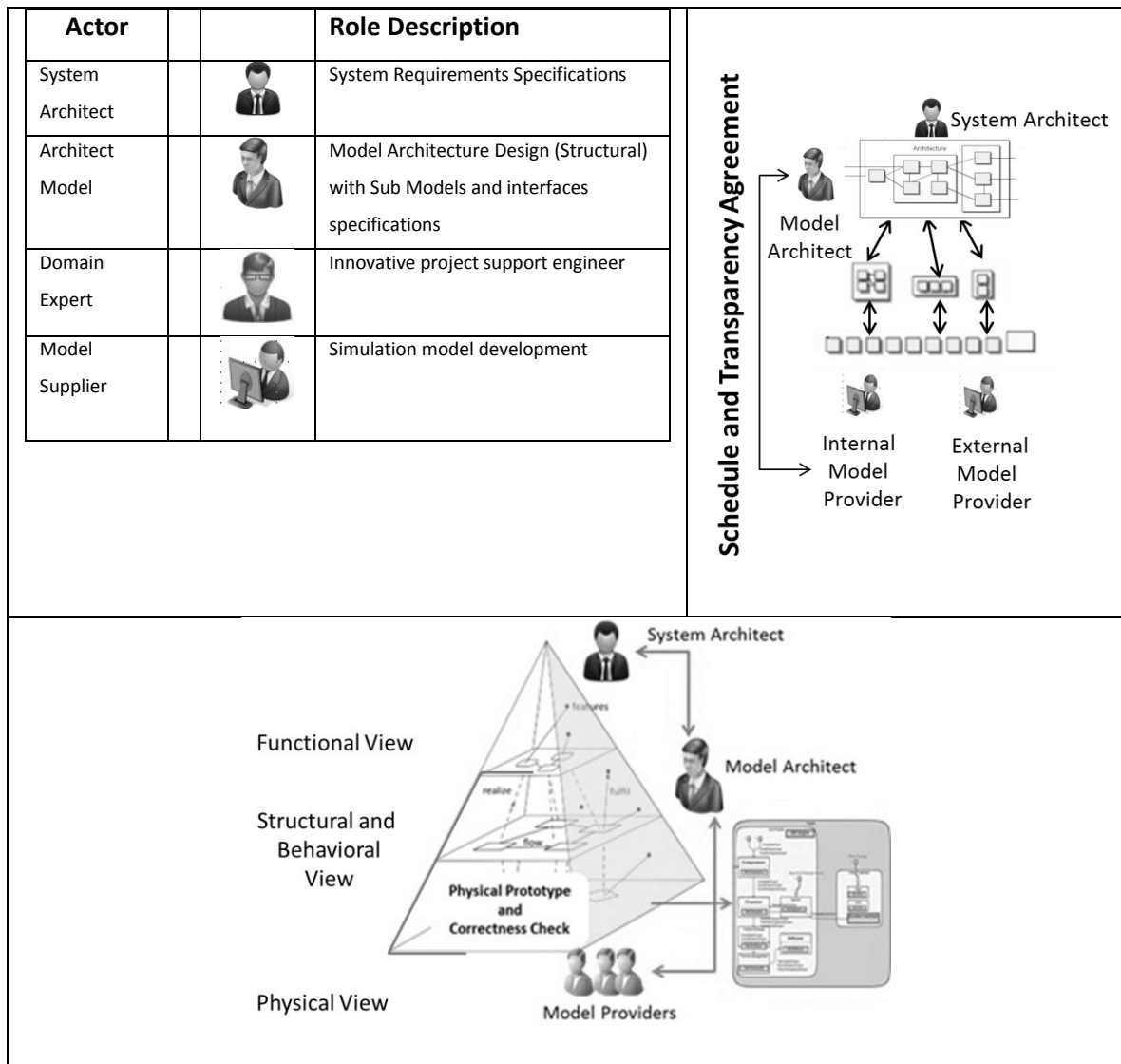

Fig. 3-3 Majors design actors and concurrent activity

Consequently, the proposed pull process concept aim to minimize late feedback and excessive upstream rework by utilizing multifunctional teams and early involvement of downstream activities in upstream stages. The “Flow” principle enables the value creation process to flow smoothly and continuously without waste, such as unintended stops, waiting, rework, or backflow. On the other hand; “Pull” promotes the culture of

tailoring tasks and their outputs to meet the legitimate needs of internal or external customer, while eliminating wasteful activities. In addition, the flow principle contains several measures related to the practices intended to boost the flow. These include frequent clarification of requirements as well as frequent opportunities for decision-making, using effective communications and coordination practices [7-8]. The major aim of this detailed design phase is to promote the communication and engineering data exchange between different design actors especially between external model providers and model architect(s) (see Figs. 3-4 and 3-5).

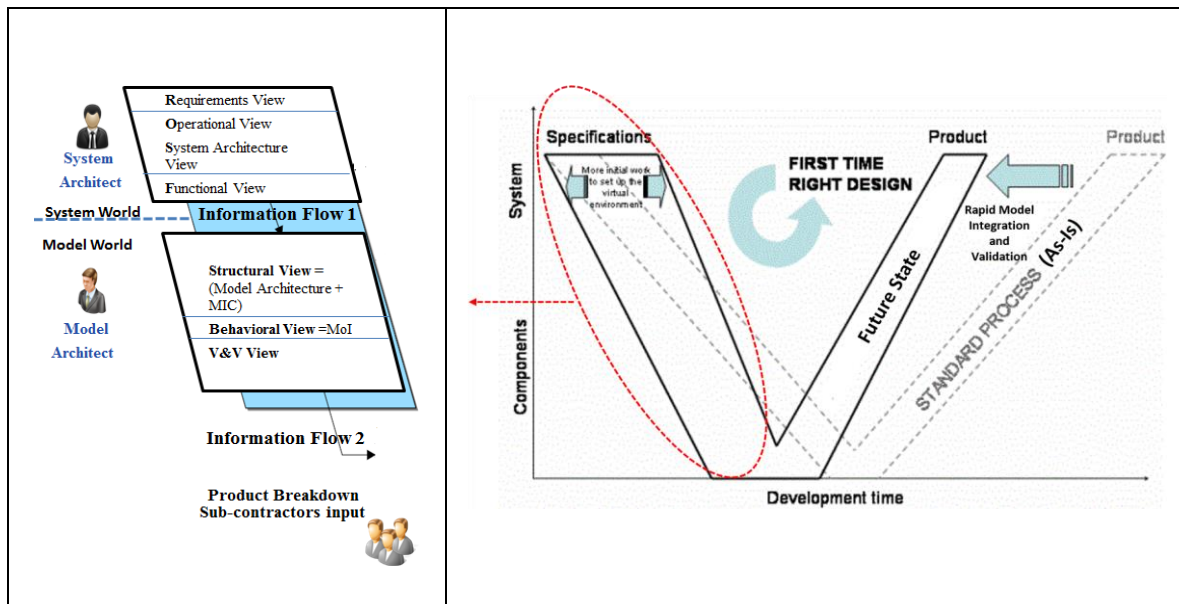

Fig. 3-4 Pull model development process (see Chapter 4 and 5)

The solution proposed to overcome some of the problems indicated above is a detailed Model Design phase integration and a correctness check in early model building process. Thus, definition of project's scope with different views (i.e., functional, structural and physical) in the design phase vastly influences the model development and its overall performance. Understanding the complexity of design in functional, structural and physical contexts at an early stage is important in defining appropriate end facility of the project. Mentioned new activities are orchestrated by a new design actor namely "Model Architect" and supported by a new design tool. To model the perspectives of different stakeholders and their interests, the design tools and mentioned activities are developed by inspiring from Enterprise Architecture Frameworks.

Table 3-1 Actors and their activities

<b>Functional View: System</b> Requirements	<b>Actor 1:</b> System Architect
<b>Activities</b>	Decision: Architecture Selection Based on constraints-Items (time and cost) and action Item (Model Precision)
<ul style="list-style-type: none"> <li>• Create a System Operation Scenario</li> </ul>	Expected model precision based on a decision technique.
<ul style="list-style-type: none"> <li>• Functional System Architecture (level n)</li> </ul>	
<ul style="list-style-type: none"> <li>• System Analysis Application Plan with other systems (Vehicle and sub systems level)</li> </ul>	
<b>Structural View: Model</b> Specification	<b>Actor 2:</b> Model Architect
<ul style="list-style-type: none"> <li>• Specialize Structural Architecture</li> </ul>	
<ul style="list-style-type: none"> <li>• Specialize System or Vehicle Level Model (MIC, Interface)</li> </ul>	
<ul style="list-style-type: none"> <li>• Specialize Domain Level Models (MIC, Interfaces)</li> </ul>	
<ul style="list-style-type: none"> <li>• Fill-out domain model requirements (MIC: Expected Model Specification): schedule and transparency <b>agreement 1</b> with domain model provider</li> </ul>	
<ul style="list-style-type: none"> <li>• Complete Virtual Prototype: Complete System Level Model Architecture with negotiated domain model interfaces and related model specifications</li> </ul>	
<ul style="list-style-type: none"> <li>• Early Certification (Correctness Control) before contracting suppliers: Advanced Checked Options in Virtual Prototype for detecting potential inconsistencies before V&amp;V</li> </ul>	
<b>Behavioral, Physical View:</b> Model Development	<b>Actor3:</b> Domain Model Developer

### 3.3.2 Product Level: Referential Architecture and Simulation Models

Simulation model is iterative and hierarchical in nature so, in order to solve product level complexity problems, a design team typically handles the problem at different levels of abstraction, ranging from very high-level system decompositions to very low-level detailed specification of components. In the course of development of these analysis models of physical systems, engineers make numerous modeling idealizations or assumptions [5]. Capability for the selection and integration of models is improved by model composability. During the process of composition, the designer defines thanks to system architecture which components are used and how they interact with each other's via interface connections [5]. Model development process is becoming more complex and involves not only system simulation requirements, but also the need to manage and share huge amounts of engineering information such as model architecture template (line of products and instantiations), simulation model, its description file (we named it Model Identity Card) and some other model calibration and validation documents (see Fig. 3-4). In addition to technology based data management strategy, we must also define an architecture reuse strategy. Sub model verification and validation do not guarantee system level model credibility. Each sub model may produce valid results and the integration of models can be verified to be correct, but the simulation can still produce invalid results. Most often this occurs when the sub model conceptual design includes factors that are not considered in the system conceptual design, or vice versa. This problem create unnecessary iteration. Minimizing unnecessary iteration not only within, but also across workflows and the extended enterprise reduces rework. Thus this saves costs and protects schedule and in turn improves business value and increases profits. Consequently, late feedback and excessive upstream rework should be minimized; e.g. by utilizing multifunctional teams and early involvement of downstream activities in upstream stages (see Fig. 3-4).

#### Questions and Proposed Solution

- *How can engineers create analysis architectures that can be reused for different vehicles while remaining consistent with the base vehicle architecture?*
- *-How to define a model sharing and reuse strategy as an enabler to reduce model recreation and errors associated with new model construction?*

### 3.3.2.1 Vehicle architecture and architecture reuse

System architecture selection and characterization is extremely useful in complex, multidisciplinary vehicle system analysis. Architectures provide a holistic view of a system and allow different stakeholders to work together with a common basis in the same vehicle system definition [12]. To design a good vehicle, it is necessary to analyze each of these system architectures from a variety of perspectives including performance, fuel economy, or even thermal behavior [2, 13]. Creating all possible system architectures manually is necessary for the first time but the reuse of an existing architecture is recommended because of time and cost concerns. To avoid having to build complete vehicle model architecture from scratch each time, it is useful to develop a pre-wired vehicle model architecture. The approach for achieving this relies on a reference model for vehicle architectures [2]. AUTOSAR, for instance, is the product of an industry-wide effort to produce a standardized architecture for controls design and development that can be used among major OEMs and their suppliers [14]. The term referential architecture has been already addressed and developed internally by Ford Motor Company as the Vehicle Model Architecture (VMA) [2, 15]. The foundation for the entire approach is Vehicle Reference Architecture (VRA) model, a formal SysML model that defines the logical decomposition of a vehicle into its subsystems. Although there have been several research efforts that have focused on enabling structural model design within a MBSE context, most of these efforts have focused on the integration between a Systems Modeling Language (SysML) model and a variety of simulation model tools (Simulink or Modelica) [2, 15] (see Fig. 3-5).

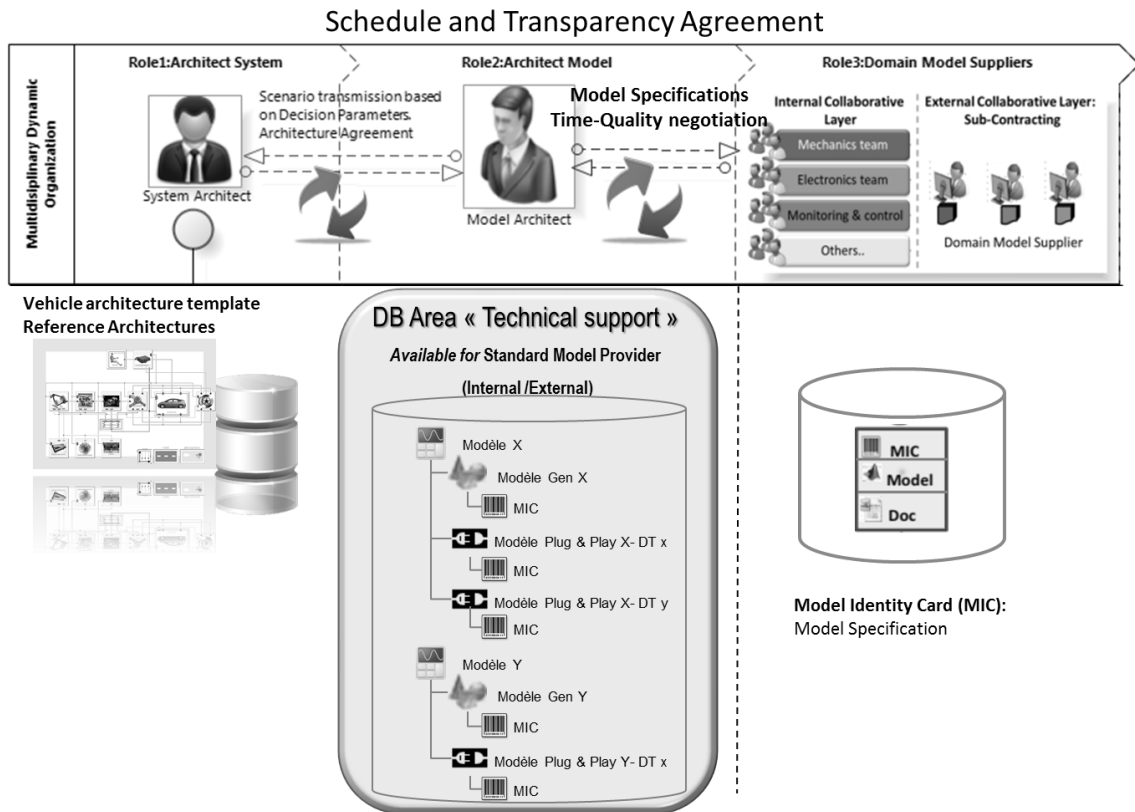

Fig. 3-5 Vehicle architecture and model

Among inhibitors to consistency management, humans who create or provide models can be a primary cause when not conforming to the common language, or laws of nature, or introducing changes in a model. To this end, model provider or developer develop fit-for-purpose instructions model.

A simulation model and its results have to be credible for the decision-makers to accept them as “correct.” Note here that a credible model is not necessarily valid. The following items may increase credibility of a model:

- The decision-maker’s (model user) and model suppliers’ understanding and agreement with the model’s assumptions,
- Demonstration that the model has been verified and validated,
- Reputation of the model developer (provider),
- Importance of conceptual model design and correctness check in early development phase.



For the correctness control, we define correctness as a measurement of how well the system design meets or exceeds its requirements. Due to uncertainty arising from design abstractions as well as system interactions with the environment and its users, correctness is specified as a probability distribution over multiple dimensions. These dimensions include the design hierarchy (i.e., subsystems and components), environment, use conditions, functions, functional failures, and adherence to design rules. After having established the domain level signals (interfaces and domain level model specifications), the model architects integrate these sub models into a full virtual prototype. The model architect can evaluate alternative architectures against different model accuracy constraints. She or he has to detect any potential problem before the IVVQ (Integration, Verification, Validation, and Qualification) phase. The virtual prototype contains various correctness checks for interoperability problems such as domain models software names, versions, models' min/max values, units, the direction of acausal connections, models' accuracy levels, etc...

### **3.3.2.2 Knowledge generation and appropriate model reuse strategy**

The knowledge encapsulated in each analysis model must be standard and coherent to be used by another party. The knowledge must be captured for reuse in future projects. To reduce the possible risk caused by inappropriate model reuse, therefore, one needs to define a robust model reuse strategy. Here documentation alone is insufficient; equally important is model providers' towering knowledge and experience.

This section presents model reuse strategies (refactoring, reuse and plug-in) which provides advantages and disadvantages in achieving balance between model credibility and development time and cost. By reusing a model, designers avoid the expensive and time-consuming task of developing a new model. Designers often adapt models published in reference library, and they copy computer code to make up parts (or all) of their new model (a practice known in the computer engineering community as "code scavenging"), and they invoke software components they have written or purchased previously. However, multidisciplinary analysis model reuse is much more risky than software code reuse because the former requires engineer's deep domain knowledge and system experience [4].

Reuse has different meaning for different modellers. In one case, reuse could be limited to only recomposing existing models from a library, without modification of components. In other contexts, reuse can involve both reuse without modification, as well as modifying an existing component if it meets modelling needs and/or reuse can speed up development (see Fig. 3-6).

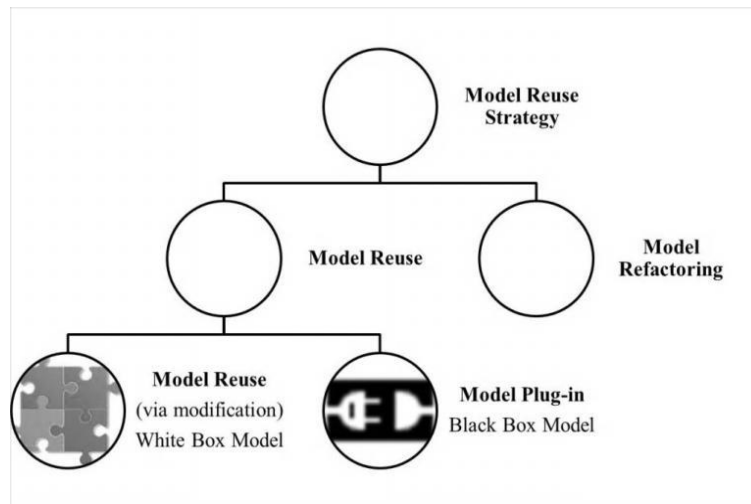

Fig. 3-6 Model Reuse Strategy, General View

### 3.3.2.2.1 Model Refactoring

The way that engineering teams exchange modelling and simulation data is often siloed and highly inefficient. One of the primary consequences of silo structure is model refactoring. The term refactoring refers to developing an existing model from scratch. Change control and version management tend to be manual or more or less absent, and models and simulation data are often stored on local drives or network shares. Different engineering teams in the same organization may be solving the same problem, or even one that has already been solved, and they lack effective ways to achieve good solutions. Refactoring is the source of wastes like inventory, over-processing and over-production. As a result, companies try to find alternative solutions to refactoring for saving time and money. One of the alternatives to model refactoring is establishing a modelling reuse strategy. If correctly developed, reusing existing models provides a high potential in reducing modelling efforts [18].

### 3.3.2.2.2 Model Reuse

One reuse strategy is to consider standard sub-models as a black box, whose functionality may be related to input, output, control variables and decision parameters without any knowledge of its internal workings. The opposite is a white box object or system where its internal components or logic is available for inspection and modification, such as an application code. The model reuse concept may also refer to the case of modifying an existing component or full product models to fulfil purposes for which they were not originally made. Progress in model reuse requires significant developments in several areas such as 1)

understanding what information is needed to support reuse and how this should be represented, 2) developing mechanisms, automated and manual to collect and record this information, 3) understanding how to design for reuse, 4) developing analysis and search tools to locate appropriate existing components, 5) documentation of Validation and Verification (V&V) steps, which cannot be fully fulfilled [19].

#### **3.3.2.2.1 Model Reuse (via modification): White Box Model**

Reusing of the entire simulation model which is complex and particularly challenging for model validation. Model reuse through modification requires well-defined documentation and towering engineer knowledge about the system and the conditions of interest. The diversity of objectives for different simulation uses makes creation of models that can satisfy all intended simulation needs infeasible. On the other hand, if the user lacks critical domain knowledge, model validation can be as time-consuming and costly as developing a similar model from scratch (Model Refactoring) [4]. Possible risks and consequences of reusing models include errors-prone decision, loss of intellectual properties and difficulty to modify a model when requirements change. Thus, the knowledge encapsulated in each numerical model needs to be coherent for it to be used for different purposes. In most cases, however, model developers and users do not have the same level of understanding of the model, which may cause them to use different naming conventions, model organizations, numbers of ports, and other conventions. Not only is it a wasted time for subgroups to duplicate each other's work, it can also introduce errors. Unless a Modeling and Simulation practitioner understands the model's contextual dependencies accurately and unambiguously, model reuse (via modification) will continue to be an ineffective trial-and-error effort. Therefore, the main motivation for model plug-ins is to introduce the 'single source of authority' concept as a part of the model reuse strategy [20]. There exist technologies that may lower the cost of reusing a model or allow reuse of models in previously impractical situations. However, improper reuse of numerical models can undermine these gains as the consequences of a bad decision made with an invalid model can easily outweigh the benefits. The open question about numerical model reuse is not only whether engineers reuse existing models properly, but how valuable they can make the practice throughout the modelling lifecycle.

### 3.3.2.2.2 Single source of authority or right from me

In the M&S reuse activity, there are likely to be at least two groups of people involved, sometimes many more (e.g., external or internal model suppliers). The basic idea is therefore to give the full modification right to the model developer (provider). It means that only the model developer is eligible to modify his/her model. Hence, the model provider is suggested to be the single source of authority in the model reuse strategy deployment [20] (see Fig. 3-7).

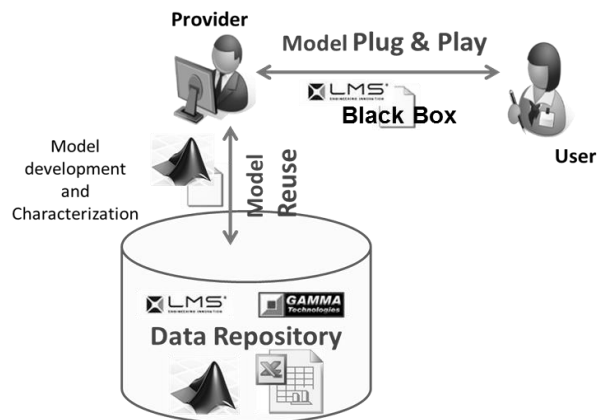

Fig. 3-7 Model Reuse in Engineering Practice

In the literature, the term “Single Source of Authority” is used for access control to a computer system to reduce the likelihood of data being overwritten, or for other security issues. Model providers must be confident that their models are used appropriately and model user can plug-and-play the provided model. In other words, the provided model must comply with the needs of the model users [20]. The term single source of authority is consistent with a term commonly used in the lean community: “Right-from-me” [21]. Right from me, means that we should get it right the first time in all process stages from preparation of tender documents, and model to right-time delivery. In the development of fit-for-purpose instructions model, it is necessary to prevent mistakes to the greatest possible extent. When we discover any non-conformity – abnormal situation, all employees have a duty to act, correct or halt the process.

Everything from mistakes in drawings to faults in the equipment – the people from the previous manufacturing stage or supplier who have caused the non-conformity must be informed immediately (real time).

**3.3.2.2.2.3 Model Reuse: Black Box Model**

Black box model refers here to reuse of an existing model for the same purpose for which it was originally constructed without any modifying. Model users should be able to assemble the existing model in a plug-in manner, thus minimizing the time, cost and expertise required to construct comprehensive models within the context of their organization. This is possible when a model is used on a routine basis to support tactical decision making within known and defined limits. It is not possible, however, to be sure that reuse is viable when a model is used for a purpose different from for which it is built or is used in combination with other models, possibly based on different sets of assumptions. If a model is to be reused for a purpose other than that for which is it's constructed, it is vital to establish a new credibility assessment process against which the model's validity may be assessed in its new environment of use. Assuming that the characteristics of a reused model to transfer from one provider to another, like its credibility will transfer from one application to another, are simply not justified (Figs. 3-7 and 3-8) [18-20]. To sum up, all the value adding activities that we mentioned in our previous sections are illustrated in Fig. 3-8 to link between organization, process and product perspectives.

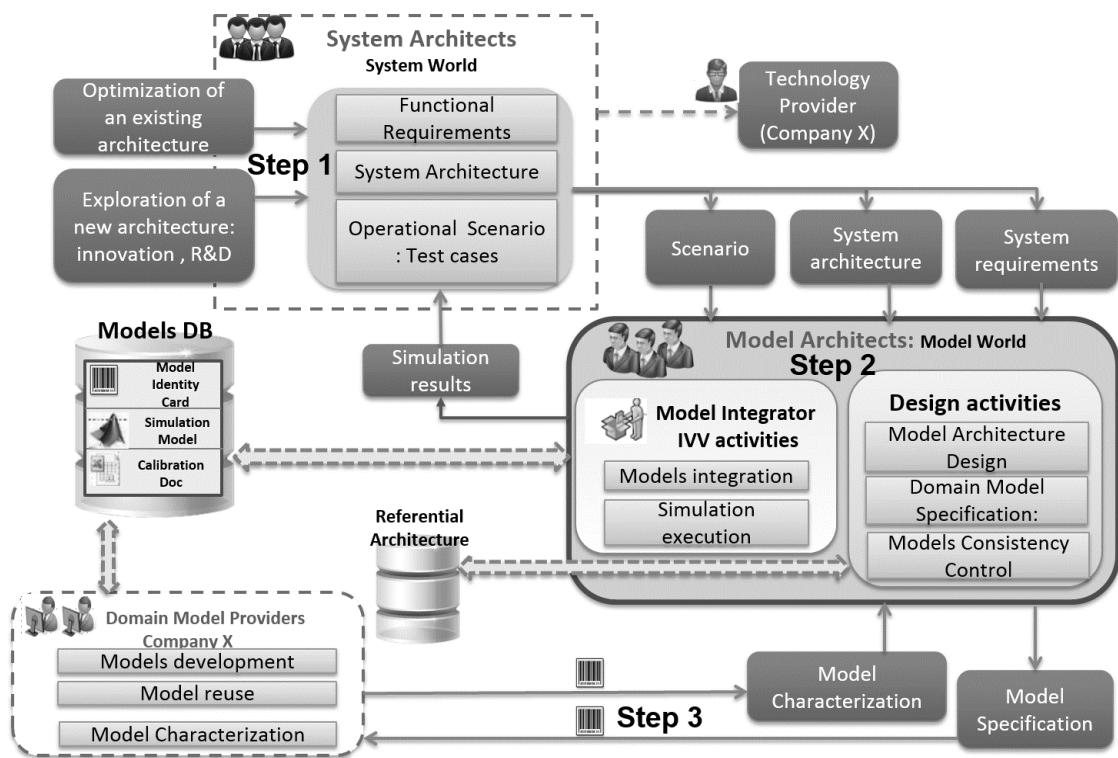

Fig. 3-8 Proposed Process: Link between organization, process and product perspective

### 3.5 Discussion and Conclusions

The application of the reuse strategies depends on the intent of the designer and on the domain point of view. From the organization point of view, the Value Driven Design (VDD) aims to increase the application of best practices among its members. The reuse of models is facilitated by easy access to well-organized model repositories and efficient search engines. Intellectual property of models and limitations in their reuse are clearly stated, with mechanisms enforcing the rules. Finally, a thorough translation of the models characteristics among the disciplinary ontologies reduces misuse of models. From the process point of view, the taken reuse strategy should remain a rational choice into a given situation. Rework, or even refactoring, is legitimate when knowledge transfer is pursued. By creating the simulation anew, the (new) authors gain competence and experience in the field covered by the model. Rework is also perfectly legitimate when extending the validity domain of a model. New algorithms, added parameters, or augmented interfaces justify the rework. Refactoring may be necessary while re-engineering a model to improve its parameterization or better segregate implemented Laws of Nature from nature of materials or geometries. From the product point of view, several practices contribute to the value of a model. As already said, a thorough description of the model characteristics (interfaces, application area...) increases its potential plug-in reuse. Associating verification cases (like analytical exact solutions) and validation data ensures that the model value can be assessed at any time. Finally, parameterized models have more opportunities to be applied in a simulation by proper choice of their parameters. The validation of the model over its entire parametric set may be difficult to obtain, though. As a future consideration, this value based theoretical reflection will be illustrated with an industrial case study to be able to show the link between organization, process and product perspectives.

### REFERENCES #3

- [1] G. Sirin, B. Yannou, E. Coatanéa and E. Landel, "Creating Domain Ontology to Support the Numerical Models Exchange between Suppliers and Users in a Complex System Design". ASME 2013 International Design Engineering Technical Conferences and Computers and Information in Engineering Conference Volume 2B: 33rd Computers and Information in Engineering Conference Portland, Oregon, USA, August 4–7, 2013
- [2] J.M. Branscomb, C.J.J. Paredis, J. Che, and M.J. Jennings, "Supporting Multidisciplinary Vehicle Analysis Using a Vehicle Reference Architecture Model in SysML". Presented at the Conference on Systems Engineering Research CSER, Atlanta, US-GA, March, 12-22, 2013.

- [3] G. Sirin, T. Welo, B. Yannou, E. Landel, "Value Creation in Collaborative Analysis Model Development Processes". Presented at the Conference on ASME (IDETC/CIE), Buffalo, USA, Aug., 17-20, 2014.
- [4] W.R. Kriger, O. Vaculin, W. Kortiiin, "Multi-Disciplinary Simulation of Vehicle System Dynamics", Paper presented at the RTO AVT Symposium on "Reduction of Military Vehicle Acquisition Time and Cost through Advanced Modelling and Virtual Simulation held in Paris, France, 22-25 April 2002, and published in RTO-MP-089.
- [5] B.D. Le and C.J.J. Paredis, "A Conceptual Framework for Value-Driven Design and Systems Engineering", 24th CIRP Design Conference, Published by Elsevier B.V. 2212-8271. 2014.
- [6] D.G. Reinertsen, 1999, "Lean thinking isn't so simple", *Electron Des.*, Vol. 47, No. 19, p.48.
- [7] T. R. Browning, 2003, "On Customer Value and Improvement in Product Development Process," *Systems Engineering* Vol. 6, No.1, pp. 49-61.
- [8] A.C. Ward, 2007, *Lean Product and Process Development*, Lean Enterprise Institute Inc., Cambridge MA, USA.
- [9] Collopy, P., 2005, "Value Driven Design", Briefing presented at the AIAA Value Driven Design Program Management meeting, Lockheed Martin, Orlando, FL, 16-17 Aug.
- [10] B. Huthwaite, (2007), "The Rules of Innovation – Products, Services and Systems", Institute of Lean Innovation, MI, USA.
- [11] R.G. Cooper, and S.J. Edgett, "Lean, Rapid and Profitable New Product Development", Product Development Institute, 2005.
- [12] J. Cheung et al. « Application of Value-Driven Design to Commercial Aero-Engine Systems», Published by the American Institute of Aeronautics and Astronautics, Inc., with permission, 2010.
- [13] "The Guide to Lean Enablers for Managing Engineering Programs", Version 1.0, Published by the Joint MIT PMI INCOSE Community of Practice, May 2012.
- [14] J.P. Womack and D.T Jones, "Lean Thinking. Banish Waste and Create Wealth in Your Corporation", 2. Edition. New York: Simon and Schuster, 2003.
- [15] J. Lee and S.T. Kim, "The Middle-out Systems Engineering for Gray-Box Items and Case Study of Automotive Lock Housing Assembly", INCOSE International Symposium, Las Vegas, NV, June 30-July 3, 2014.
- [16] R.L. Keeney, 2008, "Special Issue Value Focused Thinking", *Military Operations Research*, 13, No. 2, 7-17.

- [17] C. Rolland and N. Prakash, "From Conceptual Modelling to Requirement Engineering", Published in the *Annals of Software Engineering*, Volume 10, Issue 1-4 , pp 151-176, 2001.
- [18] Crescendo (2012). Participants' handbook. Crescendo Forum Innovation in collaborative modelling and simulation to deliver Behavioral Digital Aircraft 19-20 June 2012, France.
- [19] B. H. Taylor, 2012, "Evaluating Methods for Multi-Level System Design of a Series Hybrid Vehicle", Master Thesis, George W. Woodruff School of Mechanical Engineering, Georgia Institute of Technology.
- [20] Haskins, C., 2010, *Systems Engineering Handbook: A Guide for System Life Cycle Processes and Activities*, INCOSE, San Diego.
- [21] C. Rolland and C. B. Achour, 1997, "Guiding the construction of textual use case specifications". *Data and Knowledge Engineering Journal* Vol.25 No 1, pp.125-160.
- [22] C. Bauch, "Lean Product Development: Making waste transparent", Diploma thesis from TUM and MIT, August 2004.
- [23] M. Sliger et S. Broderick, (2008). "The Software Project Manager's Bridge to Agility. Addison-Wesley". p. 46. ISBN 0-321-50275-2.
- [24] S. Nurcan, C. Rolland. "A multi-method for defining the organizational change. *Journal of Information and Software Technology*", Elsevier. *Journal of Information and Software Technology*, Elsevier. 45:2(2003), p. 61-82.
- [25] R. Smaling and O. de Weck, 2006, "Assessing Risks and Opportunities of Technology Infusion in System Design", Published online in Wiley InterScience ([www.interscience.wiley.com](http://www.interscience.wiley.com)). DOI 10.1002/sys.20061, *Systems Engineering*, Vol. 10, No. 1, 2007.
- [26] E.C. Honour, "Demographics in Measuring Systems Engineering Return on Investment (SE-ROI)". INCOSE, 2009.



# 4

## Paper #2.                      Multidisciplinary Simulation Model Development: towards an inconsistency detection method during the design stage

Submitted to:

IEEE Transactions on Systems, Man, and Cybernetics: Systems

Göknur Sirin<sup>1, 4</sup>, Fabien Retho<sup>2, 3</sup>, Martine Callot<sup>3</sup>, Philippe Dessante<sup>2</sup>, Eric Landel<sup>4</sup>, Bernard Yannou<sup>1</sup>, Jean-Claude Vannier<sup>3</sup>

1 Laboratoire Génie Industriel, Ecole Centrale Paris, Châtenay-Malabry, France

2 Département Energie Supélec, Gif-sur-Yvette, 91192, France

3 Airbus Group Innovations, 31025 and 92152, France

4 Techno centre Renault SAS, 78288, France

**Abstract.** *The Integration, Verification and Validation (IVV) practices in the context of simulation based design helps reducing inconsistencies in multidisciplinary systems – i.e. those combining multiple mechanics, structural,*

*hydrodynamic or other complex components. In current multidisciplinary simulation models development process, sub systems' simulation models are usually Verified and Validated (V&V) at supplier level to assess whether a system meets its intended goals, in such scenarios, each system is verified and validated separately – i.e. the mechanic, structural, hydrodynamic etc. However many problems may occur during the actual integration of these modular sub systems' simulations in Original Equipment Manufacturers (OEMs) level that increases the risk of late inconsistencies such as interface mismatches or some other interoperability based problems. In order to address this problem the current work aims to reduce late inconsistency detection by ensuring early stage collaborations between the different suppliers and OEM, it does so by proposing a clear simulation model request. The current approach is validated with an industrial case study to show how a Model Request Package that contains the Model Identity Card (MIC) and Model of Intention (MoI) concepts, helps reducing the knowledge gap and the inconsistencies between the OEMs and the model suppliers.*

## 4.1. Introduction

To accurately represent vehicle behavior in a given field situation, simulation models are created by integrating different simulation models of the sub systems within a vehicle, such as chassis, engine, transmission, etc. These sub, modular system models are referred to as domain models. The simulation model development process involves a number of parallel or/and sequential activities in which experts in different discipline create or reuse domain level models to construct a full vehicle model [1], [2]. This is particularly challenging for the design of multidisciplinary systems in which components in different disciplines (e.g., mechanics, structural dynamics, hydrodynamics, heat conduction, fluid flow, transport, chemistry, or acoustics) are tightly coupled to achieve optimal system performance [2]. Moreover, each disciplinary model can be developed and evolved following its own semantics and development tools at different rates [3].

In today's context, Product Life Cycle Management (PLM) tools are used for the seamlessly integration of all the information specified throughout all phases of the product's life cycle to everyone in the organization (OEM and a global supplier network) [37]. However, system performance is established by a socio-technical system that is not only governed by technology tools (PLM, SDM or CAE) available but also to a large degree by human and well defined process factors [4].

Several problems have been observed during the preliminary study that authors conducted both in automotive and aeronautic industries' simulation model development practice. From this observation two major worlds have been identified, a) the system world including Systems Architect and Technology Provider for any kind of contracting and innovation issues, and b) the model or physical world including Model Architect and Model Provider for model design and development (see

Fig. 4-1).

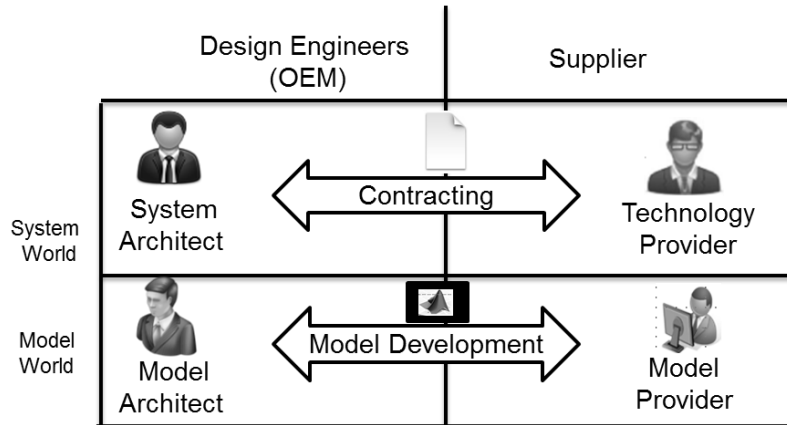

Fig. 4-1 Collaboration between major M&S actors

Today, one of the problems in this collaborative environment is that models are usually considered as available, ready to be integrated or requested directly from an expert (e.g. model provider) without specifying any method. However, most of the technology or service provider's engineering analysis model is in a Black Box (BB) format for preserving the intellectual properties (see

Fig. 4-1). BB models can be interacted only through the inputs and outputs of a well-defined interface. The challenges is using BB model is to take into consideration the number of distinct interface issues, parameters, or messages that have to be passed among the components [4]. Another problem is that the supplier is neither integrated in the model design and specification phase, nor the OEM has access to the simulation model development activity. This decoupled way of working may create some unnecessary iteration during model integration phase, which often results in increased product development lead-time and cost. From our experience, specifying a simulation model is not as trivial as expected; it seems important but underestimated practice. Hence, OEMs must establish an effective methodology, based on different viewpoints of the actors, to create a credible simulation model while avoiding project delays and unexpected rework cost by detecting any inconsistencies problems before building expensive simulation models [6].

The aim of this work is to reduce the late inconsistency detection by ensuring the early stage collaboration with a clear simulation model request and design artifact negotiation. For this aim, this paper proposes an early stage multidisciplinary simulation model design methodology inspired by Model Based Systems Engineering (MBSE) where views and viewpoints can be used to model the perspectives of different stakeholders and their interests [22, 23].

This work introduces the first necessary step for reducing the knowledge gap between design actors (e.g. OEM) and model developer (e.g. supplier) by integrating the system architecture into the simulation model development process, Model Identity Card (MIC) and Model of Intention (MoI). This paper is organized as follows. In Section 4.2, we provide the general literature review about the role of different actors and their views and viewpoints management. In Section 4.3, we introduce our methodology of early phase simulation model design by explaining the formal architecture design, MIC and MoI concepts. Section 4.4 introduces an industrial case study with its validation protocol. The conclusion and future consideration are in Section 4.5.

## 4.2 State of the art

The combination of engineers working in silos with the lack of efficiency in current simulation model development process cause imperfection based on simulation model interfaces mismatches, human errors, miscommunication between teams and misinterpretations that can be due to imprecision, inconsistency and uncertainty [7]. Imperfection and inconsistency are properties of the information itself [7]. In the design environment, it would be ambiguous, vague or approximate information or contradictory conclusions can be derived from the information. Instead, uncertainty means that an agent (i.e. model design engineer) has only partial knowledge about the truth value of a given piece of information. When dealing with multidisciplinary simulation model development process, all decision making occurs under uncertainty. This is due to the physical attributes of the system being analyzed, the environment in which the system operates, and the individuals which operate the system [9, 36]. Uncertainty in the context of Modeling and Simulation (M&S) has been defined by Oberkampf [7].

For example, without knowing the additional model details that still remain to be specified, the results from the model can only be predicted with limited accuracy. Since, the specification uncertainty is large, the overall uncertainty is also large no matter how accurate the model [9]. Thus, the model specification and ensured information flow in modeling practice are the key aspects of its uncertainty, which may imply risk that the product attributes will not ultimately meet user needs.

### 4.2.1 Related Research Methods and Industrial Projects

The approach proposed in this paper is developed to support the building effort of the multidisciplinary virtual product (i.e. simulation model). A virtual product is a global model of the future product (i.e. car, train, aircraft, helicopter, etc.) that can be simulated to predict its behavior with an estimated accuracy and

validity domain. Numerous methodologies that contribute to the virtualization of design with models and simulations have already been developed [24, 25, 26, and 27]. The CRESCENDO European project used this idea to develop the concept of the Behavioral Digital Aircraft [12]. Increasing vehicle complexity requires the ability to manage development decisions proactively and this can be accomplished through a Model Based Systems Engineering methodology such as RFLP (requirement, functional, logical, and physical) [13].

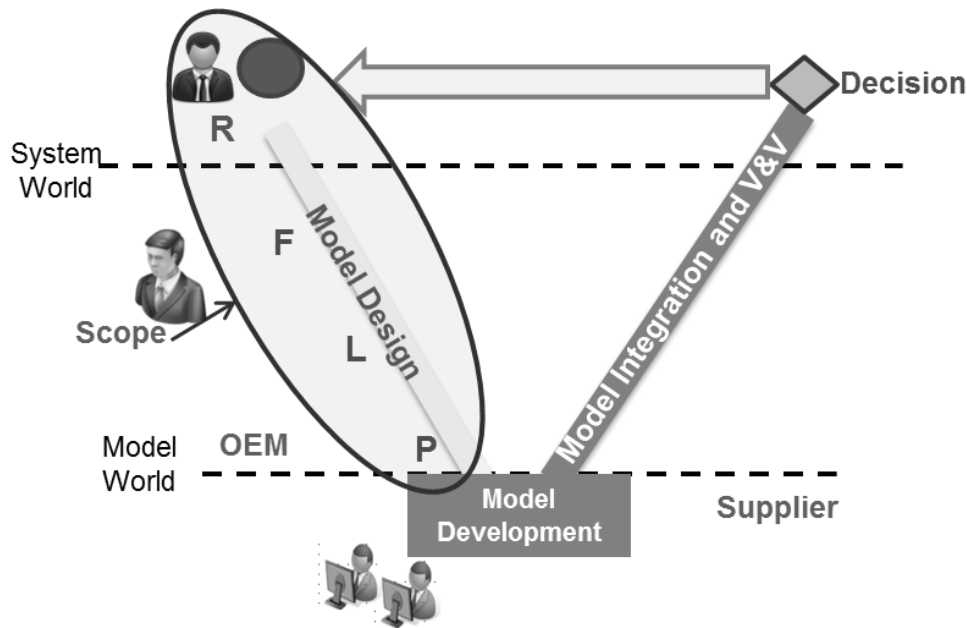

Fig. 4-2 RFLP Methodology

RFLP model describes the left-hand descending branch of the "V-Model". Based on the well-known V-cycle design process, RFLP allows concurrent engineering to coordinate the separate activities and views of distributed design teams. In this context, a viewpoint describes a particular perspective of interest to a set of stakeholders; while a view is a stereotyped package that is said to conform to a particular viewpoint [9] (see Fig. 4-2).

R refines Requirements views, the Functional View (F) defines what the system does operationally with a given scenario (Intended use, purpose, internal functions), the Logical View (L), or logical/organic architecture defines how the system is implemented (i.e. its breakdown structure, block diagram, logical interfaces, and logical connections). The Physical View (P) defines a virtual definition of the real world product. In this paper, we customize these different views based on our needs. Thus, complex simulation

model development process can be described in the context of four interrelated types of knowledge – functional, structural, behavioral, and physical knowledge or views. These views contain numerous sub views itself such as **functional** view contains requirement, system architecture and operational views. Structural knowledge includes definitions of the form, and dimensions of the artifact, its constituent components, and their arrangement and connection to each other. A structural description is sufficient to construct the artifact (simulation model). It includes the necessary information about the artifact’s explicit parameters, which a designer directly determines in order to generate a physical solution to an abstract problem. Behavioral knowledge includes the description of the artifact’s potential behaviors in response to its environment in a given scenario.

As vehicle systems are continuously increasing in complexity, it is essential that there is a process flow to handle the modeling of the vehicle system from beginning to end [2].

There is another industrial methodology called ARCADIA (ARCHitecture Analysis & Design Integrated Approach) that is in operational use since 2008 in Thales Company [38]. ARCADIA is based on architecture-centric and model-driven engineering and it was supported by use of “standard” language such as architecture Framework (e.g. NATO AF or NAF), and SysML/UML. However, ARCADIA promotes driving engineering, no more by requirements only, but mainly by functional need analysis (and operational analysis as well) [38]. Mentioned industrial method does not allow us to design simulation model world. We would like to pull and transform the necessary system related information such as system requirements, functions and operations to design a simulation model in model world.

Thus, the transition from system models (system world) to behavioral physic-based modelling (model world) should be structured first with architecture framework and after then supported by information flows between different design actors (see Fig. 4-3). However, today’s internal communication is ensured by informal knowledge sharing and it becomes an error prone activity because different disciplines often use different vocabularies. Such semantic differences can cause misunderstandings between these actors [1].

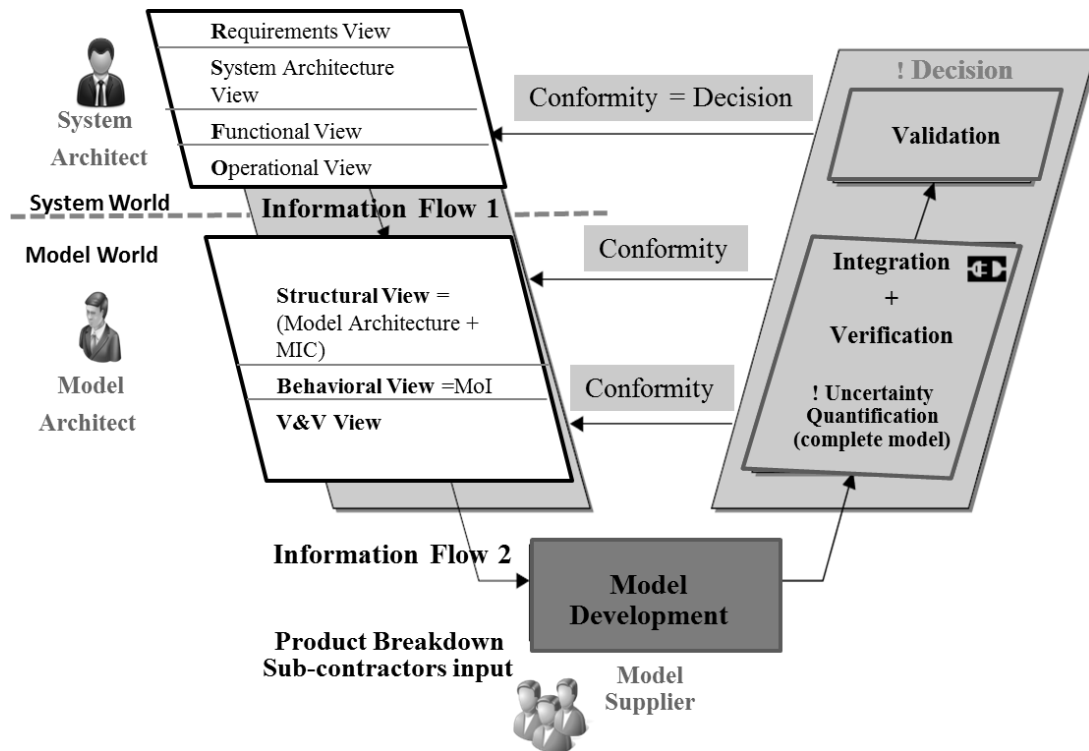

Fig. 4-3 Conceptual Design Stage

Today, in model development environment, there are two main actors; System Architects and Domain Model Providers (i.e., Model Suppliers). **System Architects** are the sponsor of model development activity. He or she defines the technical and project based constraints. He also defines an operational scenario, some decision criteria and provides a system architecture. On the other hand, **Model Provider** are the domain experts who build models with their specific domain knowledge (see Fig. 4-3). One of the gaps that we noticed during our research investigation in the OEMs is that there is no clear and formal model specification agreement between System Architect and Model Provider at early model development stage (or conceptual design phase). In addition, most of the time, interaction of these two actors may create a bottleneck for communication because they do not have the same level of understanding. One of the interests of this work is to create a more formal and clear model request to the domain model providers, to obtain the right model at the right time. Thus, this transversal view from Functional to Physical View should be managed by a new actor of the collaboration named “**Model Architect**”. Each Model Architect has a multidisciplinary vision of a product, and simulation knowledge. They have also a deep understanding of both the system-level requirements for the vehicle model, as well as how their models must interface with



other domain models (see Fig. 4-1). There are multiple activities involved in the Model Architecture business cycle such as:

- understanding the system world requirements and interpreting and translating these requirements in model world,
- analyzing or evaluating and selecting the architecture and
- communicating with system architects and multiple domain level model providers.

These activities do not take place in a strict sequence and there are many feedback loops as the multiple stakeholders negotiate among themselves, striving for some consensus. On the other hand, **Domain Expert** is also a fundamental role that has expertise, experience and knowledge to support Model Provider's final model building and delivering activities.

The collaborative multidisciplinary simulation model development process creates a response to the request of the System Architect who searches elements to analyze architecture for a design choice. The intent of the System Architect is to evaluate whether system requirements are foreseeably satisfied, based on the existing knowledge on the system to be. This evaluation is undertaken using a numerical simulation model of the system to be.

During this conceptual design stage, the **first information flow** provides the following elements: an architecture description, variables of interest, constraints, and scenarios with expected accuracy from System Architect to Model Architect (see Fig. 4-3).

### Architecture Description

The system is functionally and logically described. The logical description covers the topological structure (existing connections among system components, like SysML Internal Block Diagrams) and other properties specific to the nature of the component (for example; density, electrical or thermal resistivity, conductivity, chemical nature). When the System Architect considers several alternatives, each alternative comes with its own architectural description [4, 14].

### Observable Decision Criteria

A variable of interest is a characteristic of the system (related to its behavior, its structure or to any other view point on the system) for which the System Architect is interested in. The variable of interest can be a scalar, a multidimensional vector, or a field in the response space. The noise comfort in a car is such an example.

### Constraints

- ***Technical Constraints***

Unless the System Architect is looking for preliminary or exploratory results, he sets boundaries to surpass (e.g. performance, safety and environment) or to respect (limits) in the response space of variables of interest. The noise level that causes earing damages is such a limit.

- ***Project Constraints***

Project cost and time to development are considered as project constraints.

### Scenarios

Multiple scenarios can be proposed in order to fit with the complexity of the vehicle and the different mission profiles. Such as standardized urban, extra-urban, or mixed gas mileage for a car or in an operational concept (flight profile typical for a short range commuting airliner).

### Expected Accuracy

The applicability of any model depends on the accuracy and reliability of its output. Yet, because all models are imperfect abstractions of reality and precise input data are rarely available, all output values are subject to inaccuracies. Accuracy is the closeness of the agreement between the measured value and true value. High accuracy implies a low error. Thus, depending on the maturity of the design and design specification provided to Model Architect, the System Architect may insist on having a high degree of confidence of the model result produced [10].

Second information flow from Model Architect to Model Provider provides the following elements: early stage simulation model design consisting of a formal architecture representation, a MIC and a MoI. Model Identity Card (MIC) and Model of intention (MoI), concept that we will describe in the next section, were

developed with the aim of supporting structural and behavioral views of simulation model design phase (see Fig. 4-3).

### 4.3 Proposed Methodology

In this section, the authors define the MIC and MoI concepts separately before proposing the mixed method.

#### 4.3.1 Model Identity Card (MIC)

Designers and suppliers need to obtain an effective knowledge exchange through a shared vocabulary. Providing a common vocabulary for the design and development actors can help communicate fact-based decision in a maker's assessment of the credibility of M&S results. The ability for users to select from a list of options is an immensely important capability. By limiting large groups of users to the same vocabulary and set of options whenever possible, inconsistencies arising from miscommunication or misinformation can be reduced significantly [1]. There are some recent, similar research efforts in ontology based systems engineering domain. The most extensive previous research on characterizing model's behavior in engineering analyses is performed by Grosse et al. [15]. This ontology draws upon some of the analysis modeling taxonomies and concepts presented by Noy and McGuinness [16]. They organize the knowledge about engineering analyses models into an ontology, which includes both meta-data (eg, author, documentation and meta-knowledge, such as model idealizations and the corresponding justifications). A similar, although less extensive, meta-model for engineering analysis models has been developed by Mocko et al. [17] but these taxonomies do not include detailed model behavior characteristic and any model validation and verification attributes such as NASA's credibility assessment [18]. Based on the aforementioned standards and methodologies, we have developed MIC meta-model that might be applicable to any numerical model in the context of vehicle manufacturer with some domain specific customization.

MIC meta-model includes some important and refined characteristics of engineering analysis models (object) such as modeling assumptions and interfaces specifications.

The objective of MIC is to simplify analysis models specification, sharing and reducing ambiguity and to reduce the amount of rework caused by interface inconsistency between domain models.

MIC characterizes a model into 2 main classes: Object with 4 sub classes (Object, Methods, Usage and Model Quality) includes the attributes of the model which are stored in the MIC Properties. The second tab (Interface) includes the attributes of the Ports that designer define (see Fig. 4-4).

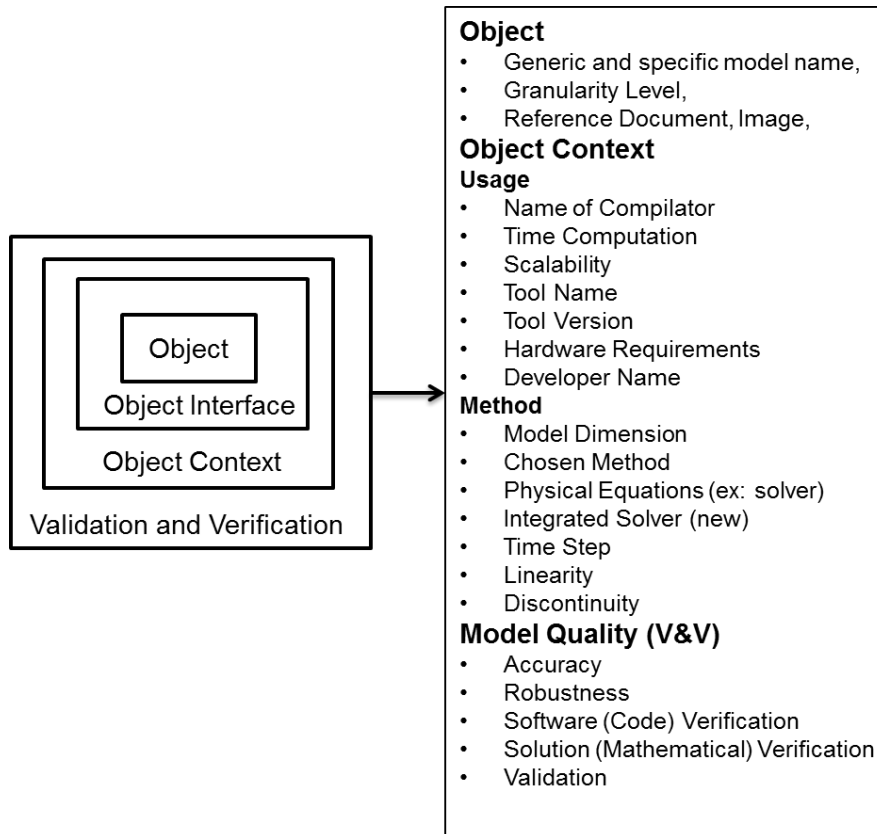

Fig. 4-4 Main Classes and Attributes (see Appendix for more information)

The semantics and the definition of the interfaces need to be accurate and complete because the communication within model components or between model components and outside environment have to be connected with well-defined interfaces [17]. Interface does not contain any information about the internal behavior of the component. Instead, the interface exposes the key parameters whilst encapsulating the implementation of the model, which defines the internal behavior of the component.

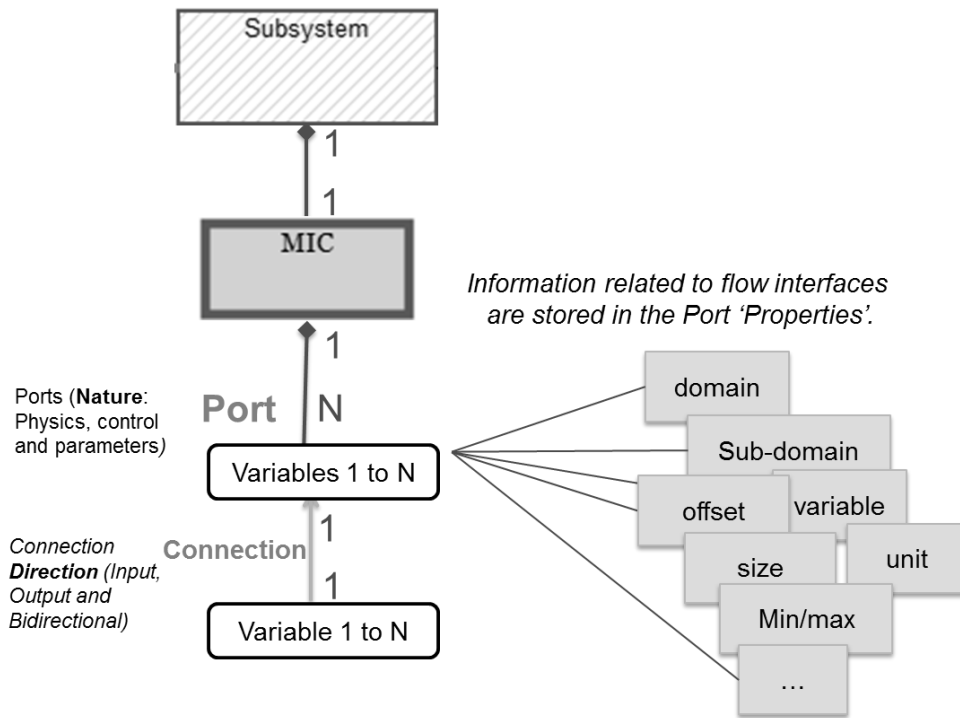

Fig. 4-5 Interface Specification

Following points are some important characteristics of MIC Interface Concept (see Fig. ) such as

- ✓ Each Model, and consequently its MIC, can have several Ports of different Domains (e.g. Mechanical, Electrical, Hydraulic, and Thermal).
- ✓ Each Port is composed of multiple Variables.
- ✓ Variables represent Efforts (voltage, temperature, force, torque, pressure) & Flows (current, entropy, linear velocity, angular velocity, volumetric) that are based on the conservation of energy law in a physical system [19].

### 4.3.2 Model of Intention (MoI)

The MoI is a model-based approach to request and specify models for a given scenario [32], [34]. It allows model supplier and technology provider (expert) to propose an adequate model. This concept is innovative in the design field, but comparable on some aspects to System Specification Model (SSM) [30], Simulation Conceptual Model (SCM) [31] and Prescriptive Model MoI express an expected behavior of a simulation model with a specific estimated role-model. The objective of MoI is to fulfil the transition from the real world to the virtual one in the MBSE spirit. The method developed to support the MoI is based on systems' interactions and impacts (I&I). The I&I concept is to analyze a system by the way of its complexity which provokes inter-system multidisciplinary interactions. The interface specifications from I&I supports the MoI building with ports' inputs, outputs and parameter information detection for a given scenario. Technically, the MoI is a model integrated in a multidisciplinary and executable behavioral global model of the system under design. The objective of this global model is to show expected behavior of the artefact which is representing with the MoI. Model's behavior includes performances requirements, dynamics tendencies, and guides the model providers and the experts.

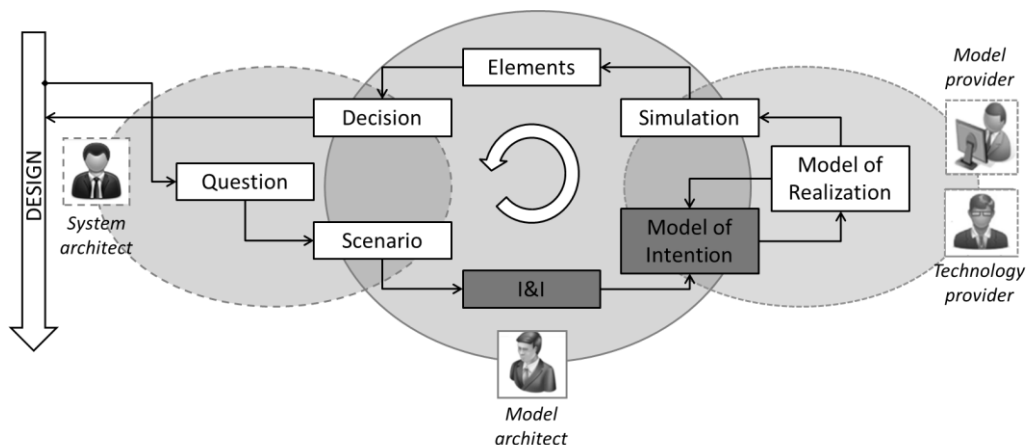

Fig. 4-6 Methodology to support simulation model building based on I&I and MoI – Dark boxes corresponds to contribution

As shown in Fig. 4-4 and 4-6, from left hand to right, the method is explicitly decomposed into the real system specification and virtual aspects specification and realization. The method is initialized by a design question that drives the model request. A first behavioral and executable model is developed in Modelica language that promotes energy exchange in a powerful way [29]. To support propulsion system problems, we have developed Modelica library in order to model easily different architectures. The methodology is ends with performing simulations. According to the scenario, some results of these simulations can be selected to be sent to system architect in order to support its decisions.

### 4.3.3 Proposed Methodology: A Mixed Approach

The MIC and MoI concepts deal with the same objectives: reducing the knowledge gap between designer and model provider with its own philosophy. However, they have complementary concepts for creating a complete model request package. The main difference is that MIC is a formal vocabulary and a MoI is an executable behavioral model.

A MIC tackles with model specification with interface characterization issues but its weak point is its capacity for representing behaviors. These complementarity characteristics allow proposing a robust model request packaging such as (see Fig. 4-7):

- MIC for Structural simulation model design phase with interface specifications (S)
- MoI for Behavioral model design phase (B)

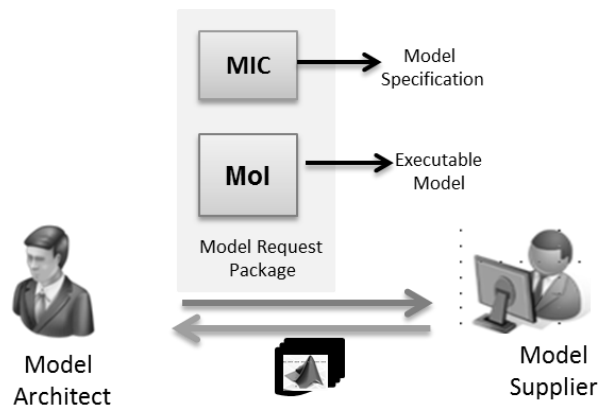

Fig. 4-7 Collaboration between Model Architect and Model Supplier: Information Flow2

As we mentioned earlier, the challenges to use the suppliers' BB model is to take into consideration the number of distinct interface issues, parameters, or messages that have to be passed among the components. However, thanks to proposed clear model request package and formal model architecture design, integration of each BB model can be ensured.

As illustrated in Fig. 4-7 with such model request package, expert and model supplier can manipulate the MoI observable parameters to be able to understand the requested models' expected behaviors for a given scenario. As illustrated in Fig. 4-8, the major role of System Architect is to specify the system to be modeled and to provide the essential system related requirements to the Model Architect (see Fig. Information Flow 1). On the other hand, defined major roles of Model Architect are designing formal model architecture with a model based systems engineering tool, specifying of each sub-models with Model Identity Card and finally generating an executable MoI (see Fig. Information Flow 2).

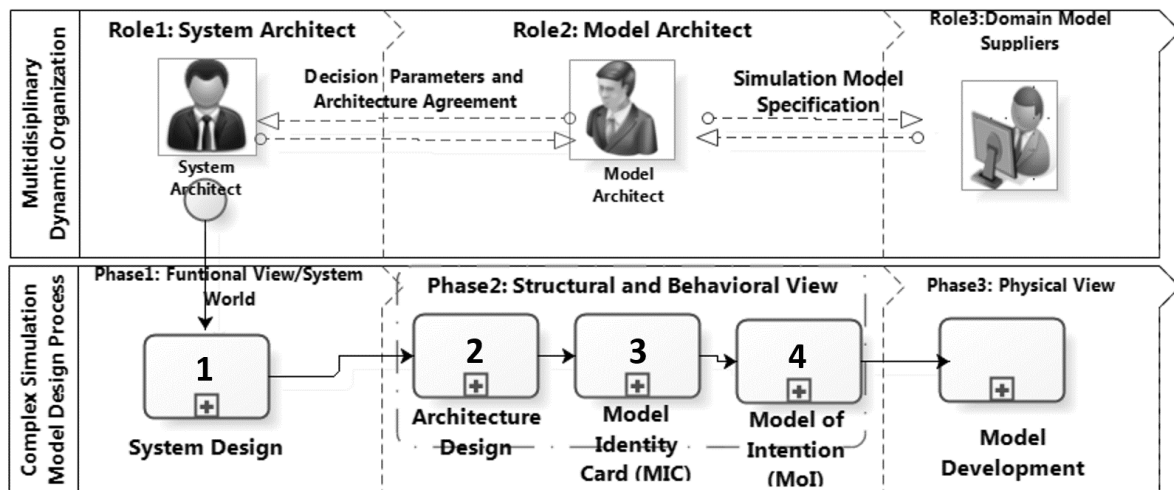

Fig. 4-8. The important steps of the proposed methodology



## 4.4 Case Study

In this section, the authors would like to illustrate the proposed method (see Fig. 4-9) with an industrial case study.

### 4.4.1 First Step: Inputs from the System Architect

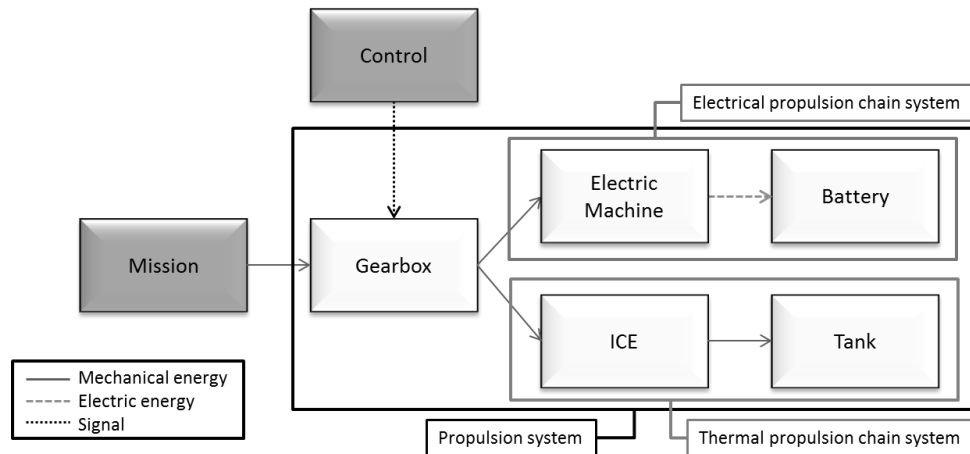

Fig. 4-9 Hybrid parallel architecture

This case is built around a hybrid parallel propulsion system that contains five subsystems (see Fig. 4-9). This architecture can be installed in various type of vehicle, such as car or even aircraft, and allows the product having an additional power source when mission requires it [20], [21] and [28].

The scenario proposed by the system architect is to analyze and pre-size the new electric propulsion chain (technical objective) (see Section 4.2). Observables are the mass of this additional chain and the advantages in term of pure power addition on a sizing objective mission (decision attribute). To obtain these observables, the system architect requests to the model architect a global model which can simulate the entire hybrid parallel propulsion system behavior, including models of electric machine and battery. These two models must be as possible in line with current technologies tendencies. The expected accuracy is to be around a 10% rate of error for each observable.

This section describes all the inputs that system architect delivers to model architect to complete his request (see Section 4.2).

The mission objective is decomposed into five phases with different duration and required power ( $P_{\text{requested}}$ ).

The control is defined with a three modes strategy based on power exchanges ( $P_i$ ):

- Mode 1:  $P_{\text{requested}} \leq P_{\text{max ICE}} \rightarrow P_{\text{requested}} = P_{\text{ICE}}$  ;
- Mode 2:  $P_{\text{requested}} > P_{\text{max ICE}} \rightarrow P_{\text{requested}} = P_{\text{ICE}} + P_{\text{Elec}}$  ;
- Mode 3:  $P_{\text{requested}} > P_{\text{max ICE}} + P_{\text{elec}}$ ; Power requested cannot be satisfied  $\rightarrow$  mission fail.

The other inputs that corresponding to existing and already specified components are the thermal propulsion chain and the gearbox models. This hypothesis is done in order to propose a reengineering problem which reduces the design space and simplifies our demonstration.

#### 4.4.1 Formal Model Architecting

MoI uses SysML modeling convention by default [35], however many engineers today are still unfamiliar with SysML and the training and licenses needed to put SysML tools into practice across large engineering teams can be cost-prohibitive. Thus, in this paper, we adopt a different approach. Rather than assuming that the structural model design is possible with SysML environment, we prefer to use a system engineering tool named arKItect because this tool allows us to easily specify the system architecture in a hierarchical manner. In this tool, the functional flows describe the interactions between the system functions as well as the interactions between the system and the external environment. The flows can be either data or physical flows. Based on a powerful hierarchical type definition, arKItect allows designing very easily our own meta-model by using a given meta-model structure: objects, flows and their composition rules. The design of formal system architecture is one of the activity areas of Model Architects (see Fig. 4-10).

As shown in Fig. 4-10, a part of formal model architecture design is illustrated. To be able to avoid the visual burdens, the authors were identified only one physical connection between Electrical Machine and Battery sub models.

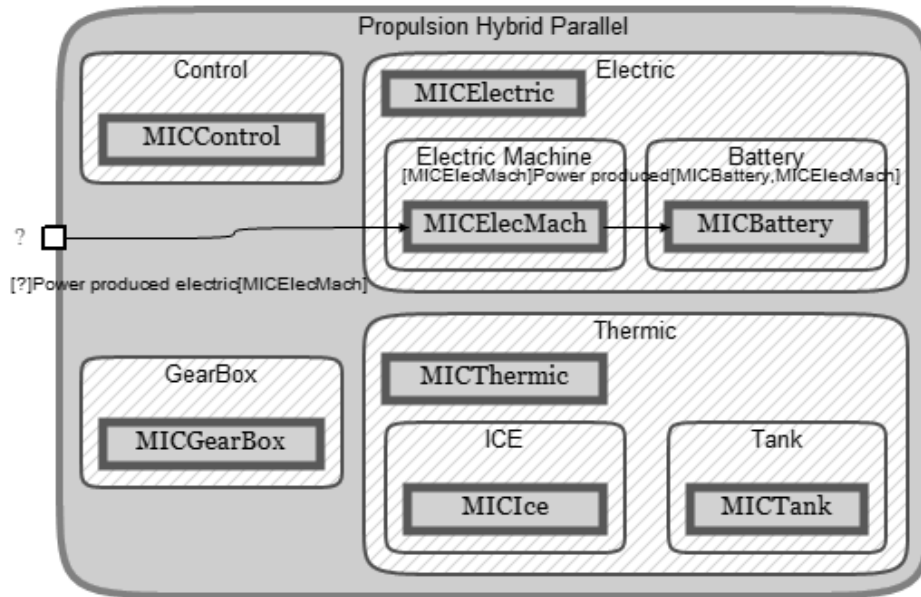

Fig.4-10. Formal Model Architecture Design

Once, the formal model architecture is designed on arKItect MBSE tool, we can identify than each sub models and systems level models with Model Identity Card (MIC). Each sub model has a MIC in which there are enough and necessary information about related model and its port connection with other models.

#### 4.4.2 Second Step: Model Identity Card (MIC) Creation

The Fig. 4-11 and 4-12 show Electrical Machine sub model's specification with MIC. As mentioned in section 4.1, MIC graphical user interface contains two major parts; model characteristics and Port & Variables specification.

The image shows a software interface for model specification, divided into two main sections: 'Object Description' and 'Usage'. The 'Object Description' section includes fields for 'Generic name\*' (ElectricMachine), 'Specific name\*' (ElectricMotor22), 'Granularity level\*' (Component), 'Developer name\*' (J.R), 'Model version no' (1.0), 'Creation date' (04/11/2014), and 'Attachments'. The 'Usage' section includes fields for 'Tool name\*' (Dymola), 'Tool version\*' (7.0), 'Operating System' (Windows), 'Name of compiler' (Compilateur fortran), 'Time computation\*' (Elapsed Time), 'Scalability' (False), and 'Hardware requirements\*' (Core i5, 4 GO). The interface has a light green header with 'Model Characteristics' and 'Ports & Variables' tabs.

Section	Field	Value
Object Description	Generic name*	ElectricMachine
	Specific name*	ElectricMotor22
	Granularity level*	Component
	Developer name*	J.R
	Model version no	1.0
	Creation date	04/11/2014
	Attachments	
Usage	Tool name*	Dymola
	Tool version*	7.0
	Operating System	Windows
	Name of compiler	Compilateur fortran
	Time computation*	Elapsed Time
	Scalability	False
	Hardware requirements*	Core i5, 4 GO

Fig. 4-11 Model Specification with MIC1

The attributes that we use in MIC GUI decrease the ambiguity and misunderstanding between model architect and model provider. This communication problem which might happen has an effect on model quality and decision. Some interoperability problems based on misunderstanding of software versioning, undated libraries and model units, can be decreased by using a MIC. The model provider supposed to fill out also some important attributes before pointing out the relevant model and sending the complete MIC to the model architect. As shown in Fig. 4-11 and 4-12, the model provider must fill important attributes,

such as, the name of method that the model provider used to develop his or her model and the model precision, solver name, dimension, time step, software tool name, versioning etc...

The image shows a user interface for model specification, divided into two main sections: 'Method' and 'Model quality'.

**Method Section:**

- Model dimension\*: OD (dropdown menu)
- Chosen method: OD (dropdown menu)
- Physical equations: Electrical (dropdown menu)
- Time step\*: Fixed (dropdown menu) with an empty text input field to the right.
- Linearity\*: No (text input field)
- Model behavior\*: Continuous (dropdown menu)

**Model quality Section:**

- Accuracy\*: 0,3 (text input field)
- Robustness\*: 1 (text input field)
- Software verification: Reference (text input field)
- Solution verification: Level3-Good (text input field)
- Validation: Level3-Good (text input field)
- Technical control level: Level3-Good (text input field)
- Process control: Level3-Good (text input field)

Fig. 4-12 Model Specification with MIC2

As illustrated in **Erreur ! Source du renvoi introuvable.** 4-13, the model architect characterizes each incoming and out coming ports of related sub models and their connections with each other's. Each port may have more than one variable and we need to define the nature, direction, units, size and min/max value of each variable (see Fig. 4-13).

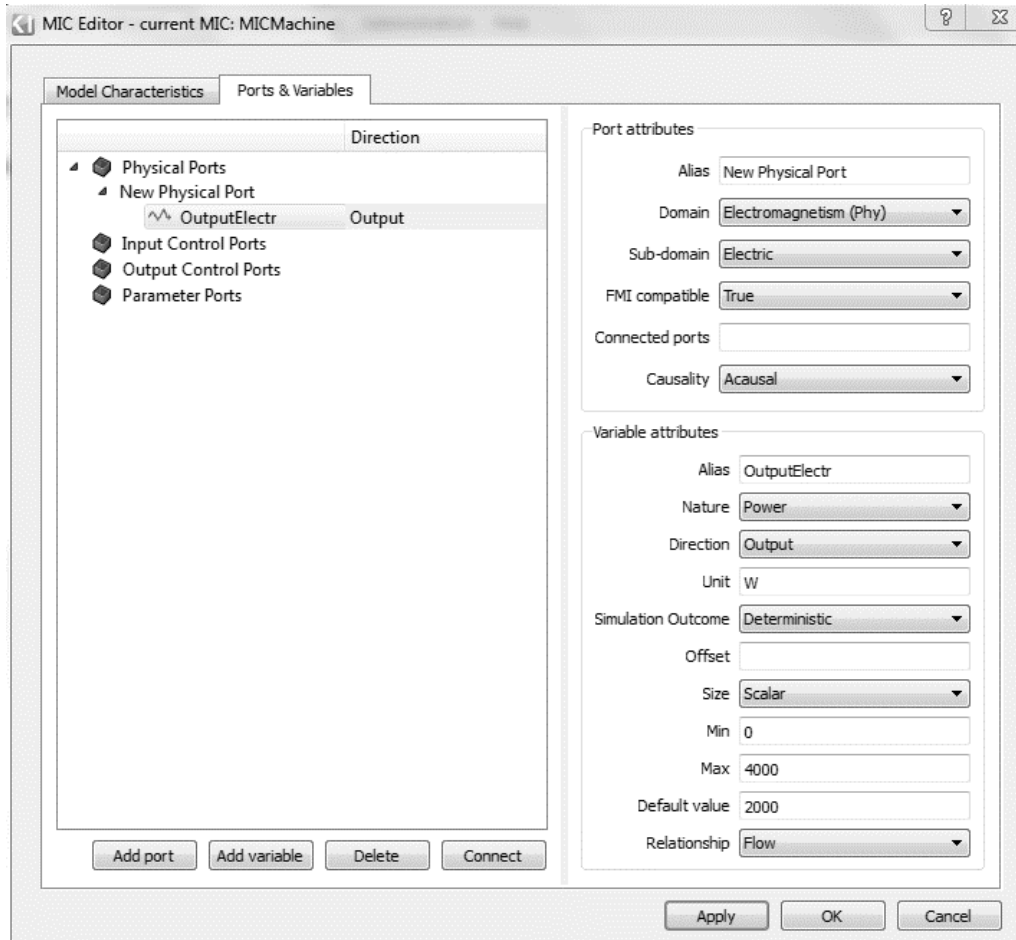

Fig. 4-13 Interface Specification with MIC

Finally, MIC contains various correctness checks for interoperability problems such as domain models software names, versions, models' min/max values, units, the direction of acausal connections, models' accuracy levels, etc.

### 4.4.3 Third Step: MoI Building

In the MoI methodology, four types of models can be requested, under two axes: new model or modification of an existing one; system model or environment model. In this demonstration, it is the request of two new models that is expressed. The first step in the MoI building is to propose an initial first model of architecture. Considering gearbox and thermal chain already specified, models from system architect are used. Control and mission models are customized with existing models of the specific propulsion system library that we have developed for MoI concept building. All requirements, which can be modeled as inequalities in each model, are aggregated under a specific model to stop simulation if an inequality is false. With MIC specification, entire requested models interfaces are defined. In that way, it is possible to create models with ports and parameters directly in Modelica. These two new blank models (no equation inside) are introduced in the global architecture model (see Fig. 4-14).

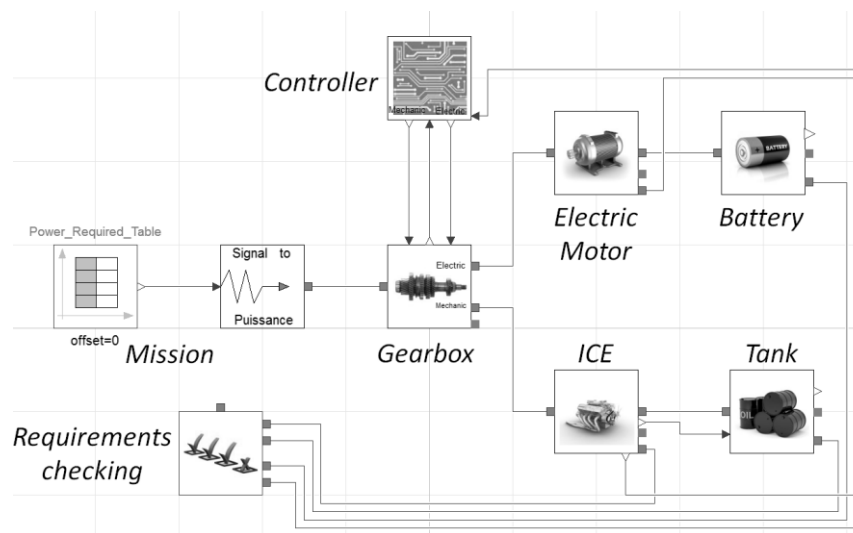

Fig. 4-14. Global model including electric motor and battery blank models

The next step of MoI approach is to introduce simplified behavior that consists in connecting inputs and parameters to outputs, inside blank models.

For the electric motor (EM), two simple equations with two new factors proposed as parameters allows considering the two observables ( $P_{consommee}$  and  $P_{max}$ ):

- The electric motor main function is to deliver a rotational mechanical energy from an electrical one. As a simplest modeling, the efficiency ( $\eta_{EM}$ ) of this conversion is considered as a new parameter.

$$P_{consummed} = P_{delivered}/\eta_{EM} \quad (1)$$

- The electric motor mass is a parameter, as mentioned in MIC. A simple power density parameter ( $\rho_P$ ) is proposed to join mass and maximum power.

$$P_{max} = \rho_P \cdot M_{EM} \quad (2)$$

These two behavioral equations are quite simple to introduce because based on the function or mandatory parameter and are realistic because factor values can be specified with the help of the literature.

For the battery (B) it is only the energy transfer from battery to consumer (EM) that must be modeled. This discharge is the main function because loading function is not used, so not modeled:

- The battery main function is to deliver an electrical energy from a chemical one. Efficiency ( $\eta_B$ ) of this conversion is considered.

$$P_{delivered} = \eta_B \cdot P_B/100 \quad (3)$$

- The battery mass parameter allows us to determine the initial energy quantity, considering that the battery is fully charged at start. To determine this energy, a simple energy density parameter ( $\rho_e$ ) is proposed:

$$E_{(t=0)} = \rho_e \cdot M_B \quad (4)$$

The real behavior is the energy consumption which depends on requested power. Based on the energy definition, we propose to model the energy evolution with:

$$\frac{dE}{dt} = P_B \quad (5)$$

In order to precise our model request, a maximum power rate is proposed to be introduced with a time constant for discharge ( $I_D$ ) to calculate a max power:

$$P_{max} = I_D \cdot E_{(t=0)} \quad (6)$$

With the equation (6), the B model can be refined with the additional equation:

$$\frac{dE}{dt} = P_{max} \text{ if } P_B > P_{max} \quad (7)$$



Finally, if  $E < 0$ , no more energy is available and mission stop (ie simulation stops).

The electric motor and battery MoIs are finished. All behaviors have been modeled with equations composed of factors which represent physical characteristics. The Values of these factors can be proposed as fixed, or with a max and/or min value in order to represent the design space proposed to the supplier team (cf. Table 4-1). The final global model including electric motor and battery EM and B MoIs is visually similar to the model presented in Fig. 4-15 but with 6 new equations and 3 new parameters.

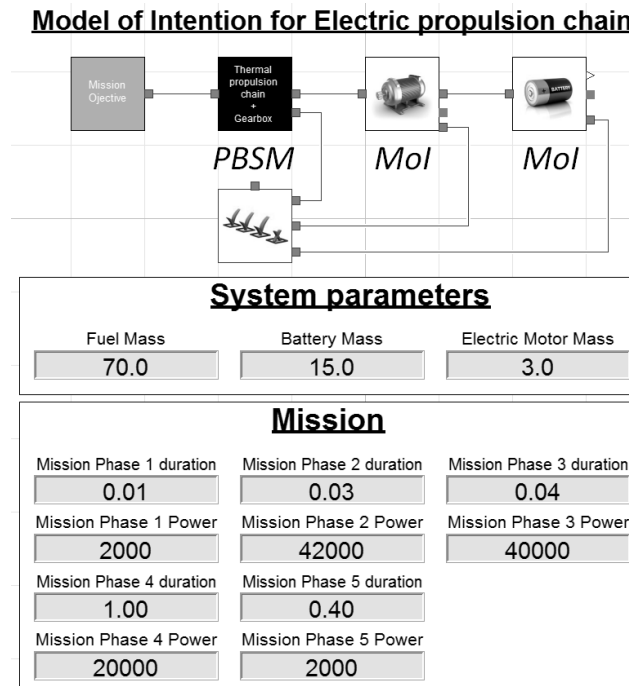

Fig. 4-15 Model delivers to suppliers

Table 4-1 Model parameters

Model	Parameter	Value	Min	Max	Unit
PSBM	$M_{Fuel}$	70	1	100	kg
EM	$\eta_{EM}$	95	Unmodifiable		%
	$M_{EM}$	3	1	40	kg
	$\rho_P$	3000	Unmodifiable		W/kg
B	$\eta_B$	95	Unmodifiable		%
	$M_B$	15	1	40	kg
	$\rho_e$	100	Unmodifiable		Wh/kg
	$I_D$	20	Unmodifiable		1/h
Mission	$D_i$	See Fig. 4-15	Modifiable		h
$i = [1,5]$	$P_i$				W

With the parameters in Table 4-1, numerous simulations can be performed. These induced results support the supplier team with additional behavioral information which allows suppliers to discuss between them in order to propose some advices on technologies to introduce in their model of realization. As example for the electric machine, the choice of synchronous or asynchronous machine can be an advice. Simulation allows also visualizing system limits with a requirement checking.

## 4.5 Comparative Analysis of Request Packages and Supplier Models

### 4.5.1 Supplier model reception

After the reception of model request package, each model suppliers have developed a model called model of realization (MoR). The EM MoR is a synchronous permanent magnet machine model built around 4 equations and 11 parameters. All of these parameters concern physical description of the machine (Radius, pole number.) or factors as motor density or copper ratio. The battery MoR proposes to select between two technologies (called Techno 1 and Techno 2).

Each technology has inside its model personal characteristics values. The global model, which integers these two models at place of respective MoIs, is the simulation model. When we check Modelica global model, 92 equations are presents for global model with MoI and 112 for global model with MoRs. Relatively, the difference of 20 equations shows the gain in complexity.

### 4.5.2. Battery models comparison

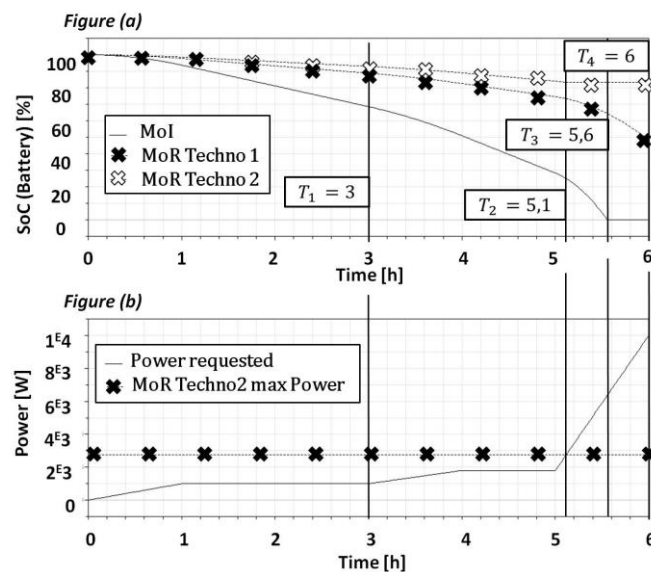

Fig. 4-16 Battery MoI - MoR comparison

The battery behavior needs to be studied alone due to its dependencies of the electric motor model outputs. The Fig. 4-16 shows a local comparison between battery MoI and MoRs for battery masses equal to 80 kg. The graph at the top of the Fig. 4-16.a is a battery discharge comparison between MoI and the two different

technologies modeled with MoR. The graph at the bottom of the Fig. 4-16.b shows in the full line curve the cycle used for this battery models test. The maximum power that can deliver the techno 2 appears also to support the top graph explanation that we propose in the next paragraph.

Table 4-2 Battery model State of Charge (SoC) test

SoC (%)	MoI	MoR T1	MoR T2
@T <sub>1</sub>	68.6	88.9	93
@T <sub>2</sub>	25.6	73.6	83.2
@T <sub>3</sub>	0 (empty)	63	out
@end	out	48.2	out

The battery behavior needs to be studied alone due to its dependencies of the electric motor model outputs. The Fig. 4-16 shows a local comparison between battery MoI and MoRs for battery masses equal to 80 kg. The graph at the top of the Fig. 4-16.a is a battery discharge comparison between MoI and the two different technologies modeled with MoR. The graph at the bottom of the Fig. 4-16.b shows in the full line curve the cycle used for this battery models test. The maximum power that can deliver the techno 2 appears also to support the top graph explanation that we propose in the next paragraph.

Table 4-2 regroupes the battery behavior at four simulation times:

- at T<sub>1</sub>, a long iso-power request is finished. The different models show different SoC for the battery, the use of the MoI show a deeper discharge than the MORs (Techno 1 and Techno 2);
- at T<sub>2</sub>, power requested is too high for Techno 2 because its power limitation is 1100 W (MoR Techno 2 Max power curve is on the bottom graph of Fig. 4-16.b). Techno 2 technology combined with its parameterization is not able to continue the mission ;
- at T<sub>3</sub>, the cycle begins a quick power increase phase. The comparison between MoI and Techno 1 highlights a more than 50% difference ;
- at T<sub>4</sub>, the mission is over. Only the Techno 1 technology has performed the mission.

The MoI is more pessimistic than the MoRs in simulation results. In that way, model supplier and expert have understood MoI because solutions are closer to technology and offer performances better than expected. However, each technology has advantages and drawbacks. The Techno 2 is capable to deliver more energy than Techno 1, but Techno 1 has a faster power exchange time.

### 4.5.3 Global models comparison

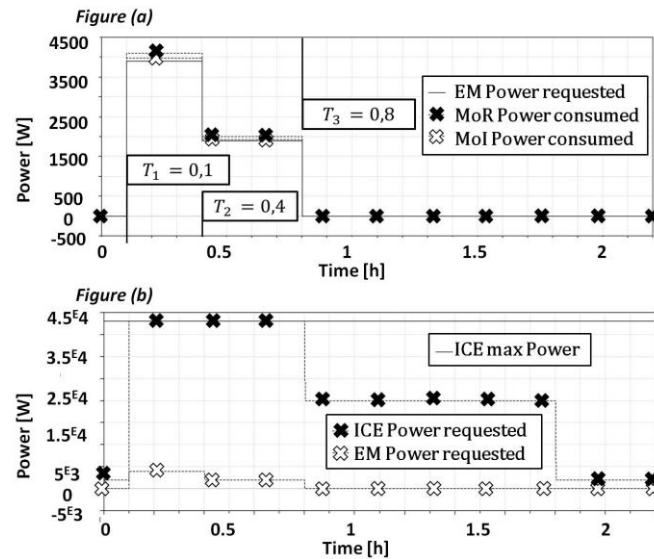

Fig. 4-17. Global model MoI - MoR comparison

After each global model simulations, the power requested to provide by the electric motor is calculated at the controller component model. This power depends on the mission profile and the global model parameterization. The Fig. 4-17 shows a simulation result for a mission. The graph at the top is the comparison of MoI and MoR of electric motor power consumed, and the graph at the bottom is the power distribution between electric motor and ICE, interesting specially when ICE cannot furnish sufficient power for propulsion (ie strategy mode 2). In curves on the top graph of Fig. 4-17, we see that the electric motor is solicited between  $T_1$  and  $T_3$ , with two different step values which separation occurs at  $T_2$ . With the MoI, requested power is lower than with MoR, which is by hypothesis the more reliable model. However the difference is low (around 150 W). Technically, MoR and its parameterization proposed by the supplier team is close to the MoI: MoI modelling and simulation has supported the MoR building. In fine, the request package has successfully performed his objective. From system architect point of view, the objective is to propose materials for the scenario. In that way, simulations performed by model architect allow identifying how and when electric motor is solicited. With curves on the bottom graph of the Fig. 4-17, the ICE is

unable to furnish 3898 W between  $T_1$  and  $T_3$ , during 0.7 h. In the scenario, the system architect wants to know the advantages of electrical propulsion chain addition before considering replacing or modifying the ICE. To estimate the architecture, mass balance is a material requested. In order to test the model, an optimization was done with the minimization of a cost function composed of electric motor and battery masses and considering the mission success. A very first solution calculates an additional mass equals to 9.5 kg to the architecture (7.5 kg of Techno 1 battery and 2 kg for electric motor). For system architect, this kind of information supports his design decisions 5.

#### 4.6 Conclusions and Future Consideration

This paper addresses the common needs of several software tool providers and industrial markets such as aerospace and automotive. It also describes the methods that have been used to improve a successful collaboration between the industrial partners, and the challenging topics that need to be explored within a multidisciplinary environment. Current inefficient way of working creates some unnecessary iterations during model integration phase, which is often responsible for increased product development lead-time and cost, schedule risk. To fulfill this need, the multidisciplinary models need to be understandable and easy to create. Thus, it is necessary to maintain close links with the various disciplines and actors through clear information exchange. Four major roles have been identified such as System Architect, Model Architect, Technology Provider and Domain Model Developer. This work proposes also a multi-view architectural method, aimed at reconciling the necessary high level and detailed design aspects with the help of the mentioned actors.

The integration of the two methodologies; MoI and MIC allows a knowledge gap reduction between model designer and developer. The accuracy of the MIC combined with the simulation capability of the MoI represents a significant advantage. The freedom offered to supplier is counterbalanced by the clear and direct model specification, in order to integrate it in a simulation chain. The large part of misunderstandings is reduced while providing a win-win collaboration. It seems interesting to consider the extension and refinement of the proposed method to support different specific domains of interest. The main long term benefits of this work include significant reductions in time and in late inconsistency detection.

## References #4

- [1] G. Sirin, B. Yannou, E. Coatanea and E. Landel, "Creating Domain Ontology to Support the Numerical Models Exchange between Suppliers and Users in a Complex System Design". ASME 2013 International Design Engineering Technical Conferences and Computers and Information in Engineering Conference Volume 2B: 33rd Computers and Information in Engineering Conference Portland, Oregon, USA, August 4–7, 2013
- [2] J.M. Branscomb, C.J.J. Paredis, J. Che, and M.J. Jennings, "Supporting Multidisciplinary Vehicle Analysis Using a Vehicle Reference Architecture Model in SysML". Presented at the Conference on Systems Engineering Research CSER, Atlanta, US-GA, March, 12-22, 2013.
- [3] X. Zhang and J.F. Broenink, "A Model Management Approach for Co-simulation Model Evolution", In Proceedings of 1st Int. Conference on Simulation and Modeling Methodologies, Technologies and Applications, Noordwijkerhout, NL, pages 168-173, SciTecPress, 2011.
- [4] G. Sirin, T. Welo, B. Yannou, E. Landel, "Value Creation in Collaborative Analysis Model Development Processes". Presented at the Conference on ASME (IDETC/CIE), Buffalo, USA, Aug., 17-20, 2014.
- [5] J. Lee and S.T. Kim, "The Middle-out Systems Engineering for Gray-Box Items and Case Study of Automotive Lock Housing Assembly", INCOSE International Symposium, Las Vegas, NV, June 30-July 3, 2014.
- [6] O. De Weck, "Feasibility of a 5x Speedup in System Development due to Meta Design". Presented at the Conference on ASME/DETC 2012-70791, 2012.
- [7] P. Haase and J. Völker, *Ontology Learning and Reasoning- Dealing with Uncertainty and Inconsistency, Uncertainty Reasoning for the Semantic Web I*, Vol. 5327, pp.366-384, 2008.
- [8] W.L. Oberkampf, (2002). Error and uncertainty in modeling and simulation. *Reliability Engineering & System Safety Book*, 333--357.
- [9] P. Hester, (2012). Epistemic Uncertainty Analysis: An Approach Using Expert Judgment and Evidential Credibility, *International Journal of Quality, Statistics, and Reliability*, vol. 2012, Article ID 617481, 2012.
- [10] B.D. Le and C.J.J. Paredis, "A Conceptual Framework for Value-Driven Design and Systems Engineering", In Proceedings of 24th CIRP Design Conference, Published by Elsevier B.V. 2212-8271. 2014.

- [11] Systems Engineering Fundamentals, DOD Supplementary text prepared by the defense acquisition university press fort Belvoir, Virginia 22060-5565, USA, 2001.  
Available:[http://123management.nl/0/070\\_methode/072\\_kwaliteit/Dod%20Systems%20Engineering.pdf](http://123management.nl/0/070_methode/072_kwaliteit/Dod%20Systems%20Engineering.pdf)
- [12] Crescendo European Project. Participants' handbook. Crescendo Forum Innovation in collaborative modelling and simulation to deliver Behavioral Digital Aircraft 19-20 June 2012, France  
Available:<http://www.crescendo-fp7.eu/pages/downloads/crescendo-handbook-of-results.php>
- [13] S. Kleiner, C. Kramer, Model Based Design with Systems Engineering Based on RFLP Using V6, Smart Product Engineering, pp 93-102, DOI: 10.1007/978-3-642-30817-8\_10, Springer 2013.
- [14] C. Belton et al. (2003). A Vehicle Model Architecture for Vehicle System Control Design," SAE Technical Paper 2003-01-0092, 2003, doi: 10.4271/2003-01-0092.
- [15] I.R. Grosse, J.M. Milton-Benoit and J.C. Wileden. (2005). Ontologies for supporting engineering analysis models. AI EDAM, Vol.19, No.1 p.1-18.
- [16] F.N. Noy and McGuinness, (2001). Ontology Development 101: A Guide to Creating Your First Ontology. Stanford Knowledge Systems Laboratory Technical Report KSL-01-05 and Stanford Medical Informatics Technical Report SMI-2001-0880. Stanford, CA.
- [17] G. Mocko, R.J. Malak, C.J.J. Paredis, and R. Peak, "A Knowledge Repository for Behavioral Models in Engineering Design". 24th ASME Computers and Information in Engineering Conference, Salt Lake City, UT, Sept, 2004.
- [18] Nasa Technical Standard, (2008). Standard for models and simulations National Aeronautics and Space Administration Washington, DC 20546-0001, NASA-STD-7009.
- [19] D. Karnopp and R.C. Rosenberg. (1968). Analysis and Simulation of multiport Systems. The Bond Graph approach to physical systems dynamics, MIT Press.
- [20] K.T. Chau, (2002). Overview of power management in hybrid electric vehicles. Energy Conversion and Management, 43(15), 1953-1968. doi:10.1016/S0196-8904(01)00148-0.
- [21] C. Mi, M. Abdul Marsrur, D. Wenzhong Gao, (2011). Hybrid Electric Vehicles: Principles and Applications with Practical Perspectives, ISBN: 978-0-470-74773-5, 468 pages, June 2011.
- [22] NASA, (2007). Systems Engineering Handbook
- [23] INCOSE, (2006). Systems engineering handbook. INCOSE.
- [24] C. De Tenorio, (2010) Methods for collaborative conceptual design of aircraft power architectures methods for collaborative conceptual design, PhD Thesis.
- [25] P.M. Basset, A. Tremolet, F. Cuzieux, G. Reboul, M. Costes, D. Tristrant, D. Petot, "C.R.E.A.T.I.O.N. the Onera multi-level rotorcraft concepts evaluation tool: the foundations",



Available: <http://add.lsis.org/fr/manifs/jdl612/actes/articles/24.pdf>

- [26] S. Liscouët-Hanke, (2008). A model Based Methodology for Integrated Preliminary Sizing and Analysis of Aircraft Power System Architectures. Architecture. PhD Thesis. INSA de Toulouse. Available: <http://eprint.insa-toulouse.fr/archive/00000251/01/LiscouetHanke.pdf>
- [27] K. Amadori, (2008). A Framework for Knowledge Based Engineering and Design Optimization. Engineering. Available: <http://www.diva-portal.org/smash/get/diva2:18279/FULLTEXT01.pdf>.
- [28] C.C. Chan, (2002). The state of the art of electric and hybrid vehicles. Proceedings of the IEEE, 90(2), 247-275. doi: 10.1109/5.989873.
- [29] P. Fritzson, (2006). Principles of Object-oriented modeling and simulation with Modelica 21. IEEE press ISBN 0-471-47163-1
- [30] RTCA and EUROCAE. Model based development and Verification, supplement of by RTCADo178c/Eurocae ED12C. Technical report, 2012.
- [31] U.S. Dod. Verification, Validation and Accreditation Recommended Practice Guide (MSCO VV&A RPG) Glossary.
- [32] IEEE Standard Glossary of Modeling and Simulation Terminology, IEEE Std 610.3-1989, vol., no., pp.0\_1, 1989 doi: 10.1109/IEEESTD.1989.94599.
- [33] F. Retho, H. Smaoui, J.C. Vannier, and P. Dessante, “Model of intention: A concept to support models building in a complex system design project”, ERTS<sup>2</sup> 2014, France.
- [34] F. Retho, H. Smaoui, J.C. Vannier and P. Dessante. (2014). Le modèle d'intention: Un concept clé entre architecte et expert pour la conception de systèmes complexes, Génie logiciel n°108, Mars 2014.
- [35] [www.uml-sysml.org](http://www.uml-sysml.org).
- [36] M. Carlsson, S. Steinkellner, H. Gavel, J. Ölvander, “Enabling Uncertainty Quantification of Large Aircraft System Simulation Models”, CEAS 2013 Conference, Linköping, Sweden, 2013.
- [37] F. Belkadi, N. Troussier, F. Huet, T. Gidel E. Bonjour and B. Eynard. (2008). PLM-based approach for collaborative design between OEM and suppliers: case study of aeronautic industry”, published in "Computer-Aided Innovation., Cascini (Ed.) (157-168 (vol. 277))" DOI: 10.1007/978-0-387-09697-1 13.
- [38] J.L. Voirin, “Modelling Languages for Functional Analysis Put to the Test of Real Life, Complex Systems Design & Management” In Proceedings of the Third International Conference on Complex Systems Design & Management CSD&M 2012, pp 139-150.

# 5

## Paper #3. A Model Identity Card to Support Simulation Model Development Process in a Collaborative Multidisciplinary Design Environment

Published online:

IEEE Systems Journal

**Göknur Sirin<sup>1,4</sup>, Christiaan J.J. Paredis<sup>2</sup>, Bernard Yannou<sup>1</sup>, Eric Coatanéa<sup>3</sup>, Eric Landel<sup>4</sup>**

*1 Laboratoire Génie Industriel, Ecole Centrale Paris, Chatenay-Malabry, 92290, France*

*2 Georgia Institute of Technology, Woodruff School of Mechanical Engineering, Atlanta, GA 30332, USA*

*3 Product Development research group Department of Engineering Design and Production School of Engineering, Aalto University, FIN-00076 Aalto, Finland*

*4 Techno centre Renault SAS, 78288, France*

**Abstract.** *Today, one of the major challenges in full-vehicle model creation is to get domain models from different experts while detecting any potential inconsistency problem before the IVVQ (Integration, Verification, Validation,*

*and Qualification) phase. To overcome such challenges, Conceptual Design phase has been adapted to the current Model Development Process (MDP). For that, the system engineers start to define the most relevant system architecture by respecting quality and time constraints. Next, the simulation model architects design the delivered system architecture in a more formal way with a modeling and simulation point of view to support the integration of domain level simulation models in a consistent fashion. Finally, the model architects negotiate with different simulation model providers with the aim of specifying vehicle and domain level simulation models and their interfaces connections. To improve knowledge sharing between mentioned actors, we propose a Model Identity Card (MIC) for classifying simulation model knowledge including input/output parameters, method, and usage specifications. The fundamental concepts that form the basis of all simulation models are identified and typed for implementation into a computational environment. An industrial case study of engine-after treatment model is used to show how MICs and integrated model design phase might use in a given scenario. A validation protocol is conducted through a heuristic observation to estimate the rate of model rework and ambiguity reduction.*

## 5.1 Introduction

### 5.1.1 Background

Simulation-based design has gained importance in the past few years in many sectors, especially in aerospace and in automotive manufacturers where modern engineering products are becoming increasingly complex [1]. One of the benefits of employing simulation models is that it makes design verification faster and less expensive; it provides also the designer with immediate feedback on design decision [1]. However, over the last 15 years, in addition to product variety, the environmental (i.e., fuel-efficient, low-emission) and economic concerns increase the complexity of modern products. To keep pace with the rapid improvements being made to these modern products and maintain competitiveness with other manufacturers, design cycles have become shorter and more efficient. To support these shorter design cycles during the early design exploration phase, companies use more and more sophisticated, multidisciplinary simulation model (or numerical or behavioral models) [1]. A complex product development process requires that one decomposes the system to be able to understand the whole's details. In the context of automotive design, a vehicle may be partitioned by objects into body, powertrain, and suspension subsystems. Aspect partitioning divides the system by discipline. The same automotive design could be partitioned by aspects into structural, aerodynamic, and dynamics disciplines. Focusing on the companies' organizational level, the vehicle partitions affect also the tasks, roles and simulation models delegation between related engineering disciplines. The complex, multidisciplinary (or multi-domain) simulation model creation process involves a

number of parallel or/and sequential activities in which experts in different domains, possibly in different companies (i.e., suppliers and sub-tier suppliers) create, reuse and exchange domain (or component or atomic) level simulation models to build up a full-vehicle system model [2]. Each engineering discipline tends to use its own domain-specific languages, tools and methods to model different aspects of a system concurrently. Imperfect interoperability between the OEMs, suppliers and their tooling causes costs overruns and delays. Distributed design teams typically handle the model at different levels of abstraction, ranging from very high-level system decompositions to very low-level detailed specification of components [3]. This is particularly challenging for the design of multidisciplinary systems in which components in different disciplines (e.g., mechanics, structural dynamics, hydrodynamics, heat conduction, fluid flow, transport, chemistry, or acoustics) are tightly coupled to achieve optimal system performance [2]. In this multidisciplinary collaborative design environment, most of the engineers modify the existing simulation models to fulfill a specific purpose for which they were not originally made; it can be a source of inaccuracy, uncertainty, duplication and time delay. To this end, Model Validation and Verification (V&V) plays a key role in mitigation such risks. In this paper a simulation model is considered valid under a set of experimental conditions, if the model's response accuracy is within acceptable range for intended purpose [4, 5]. To be able to build the "right" or "valid" model, in engineering practice, designers need to use the domain level simulation model as a black box fashion. Although, most of the technology or service provider's simulation model is in Black Box (BB) format for preserving the intellectual properties. BB models can be interacted with only through the inputs and outputs of a well-defined interface. The challenges to use BB model is to take into consideration the number of distinct interface issues, parameters, or messages that have to be passed among the components. In addition to the model interface consistency problem, there are many other factors that may cause inconsistencies, such as human error, miscommunication between teams and misunderstood assumptions. These inconsistencies are all sources to uncertainty and its propagation in multidisciplinary modeling environment is more complicated than in a single disciplinary domain [5, 6]. The effect of the uncertainties in one domain model may propagate to another through interrelated variables, and the system output finally suffers from the accumulated effect of the individual uncertainties. Thus, the information flow in modeling practice is one of the key aspects of its uncertainty, which may imply risk that the product attributes does not ultimately meet user needs [2].

### 5.1.2 Problem Statement and Our Contributions

Today, many companies use the V-cycle Systems Engineering process for product development as proposed by Frosberg and adapted by the National Council on Systems Engineering [7]. In this process, OEMs take the responsibility of requirement specification, system design, and integration and Verification and Validation (V&V) steps. This is followed by the supplier, which develops the domain models. Although the simulation model is tested at the supplier level, the OEMs are responsible for the final integration, system and acceptance testing to ensure that the given implementation of a system level model meets its intended goals and demands. In this process, most of the defects are discovered late, during the IVVQ (Integration, Verification, Validation, and Qualification) phase. This may create multiple wastes, including rework and, may-be the most harmful namely, incorrect simulation models, which are subsequently used as basis for design decisions. According to de Weck, early design validation and verification may reduce rework in the more expensive implementation and physical prototype validation phase, which is the main driver for product development cost [8]. It has been estimated that the cost of imperfect simulation model interoperability is at least \$1 billion per year for members of the US automotive OEMs [9] and \$400M in an aircraft development program with 1-2 months of delays [10].

There are many potential sources of inconsistency such as error in the simulation model code or mismatch of interfaces connections (i.e., differences in time step, units, solver, hardware and software versioning...). However, a significant proportion of defects are associated with interfaces between modules or between requirements and implementation rather than a design or coding error within a single module. Leveraging the interface inconsistency problem requires a Conceptual Model Design phase and an interface consistency checking at early development stage. Model Design phase contains schedule and transparency agreement between OEMs and domain model providers. Today, in model development environment, there are two main actors; System Architects and Domain Model Providers. System Architects are the sponsor of model development activity. He or she defines the projects' expected time, cost and decision parameters issues. Domain Model Providers are the domain experts who build models with their specific domain knowledge. As illustrated in Fig. 5-1, the System Architect has a functional view (system world). He defines an operational scenario, a trade-off analysis and provides a draft version of model architecture for Domain Model Providers who has a physical view. One of the gaps that we noticed during our two years of research investigation in the automotive OEM Company is that there is no clear and formal scheduling and transparency agreement between System Architect and Domain Model Provider at early model development stage (or conceptual design phase). In addition, most of the time, interaction of these two actors may create a bottleneck for communication because they do not have the same level of understanding. One of the

interests of this work is to create a more formal and clear model request to the domain model providers, in order to obtain the right model at the right moment. Another gap in model development activity is the lack of detailed Model design phase at early model development stage (downstream of V-cycle) (see Fig. 5-2). As illustrated in Fig. 1, in the middle, Model design activity contains formal model architecture design with domain models' interfaces definitions. Vehicle level and domain level model specifications include an early interfaces consistency control between specified interfaces. Model design phase gives a structural and semi-behavioral view about the system to be modelled. Thus, this transversal view from Functional to Physical View should be managed by a new actor of the collaboration named "Model Architect". Each Model Architect has a multidisciplinary vision of a product, and simulation knowledge. They have also a deep understanding of both the system-level requirements for the vehicle model, as well as how their models must interface with other domain models (see Figs. 5-1 and 5-2).

Therefore, knowledge sharing is one of the key points between these three actors but today's internal communication is ensured by informal knowledge sharing and it becomes an error prone activity because; different disciplines often use different vocabularies, so that semantic differences can cause misunderstandings between these actors [3].

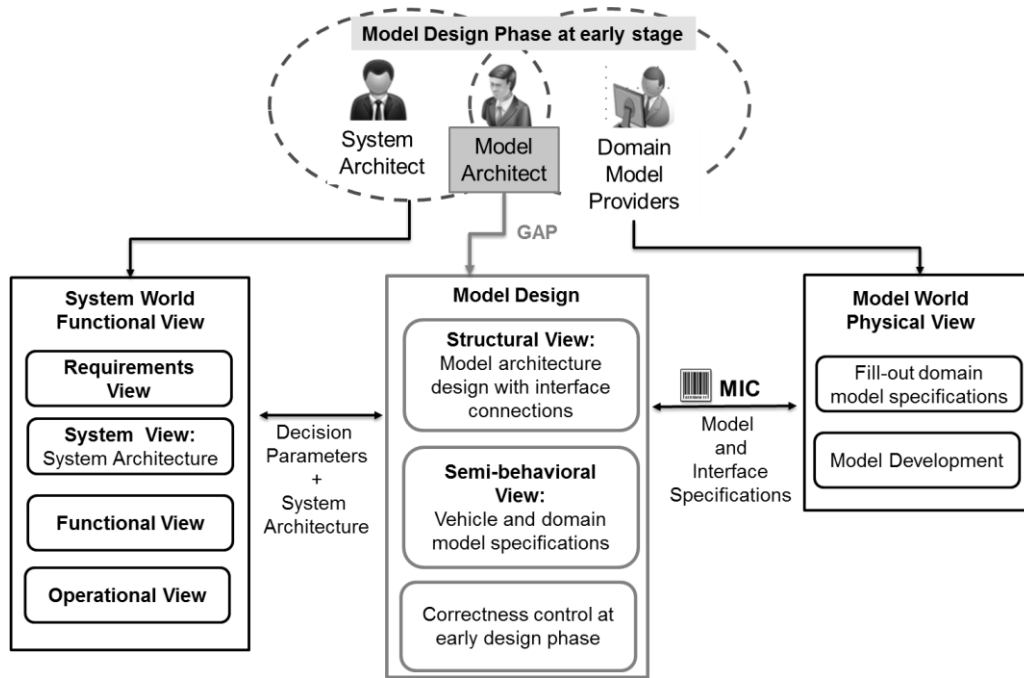

Fig. 5-1 Research Gap in Collaborative Model Development Process

To obtain an effective knowledge transmission, we need to establish a formal knowledge sharing via a common vocabulary. Providing a common vocabulary for the M&S users can help communicate fact-based decision in a maker’s assessment of the credibility of M&S results. The ability for users to select from a list of options is an immensely important capability. Because creating full-vehicle simulation models is a multidisciplinary process, it is important that the same strategies are used across different teams of domain experts. By limiting large groups of users to the same vocabulary and set of options whenever possible, inconsistencies arising from miscommunication or misinformation can be reduced significantly. Consequently, the potential contributions of this work are

- to create a common vocabulary named “Model Identity Card (MIC)” for simplifying simulation models specification, sharing and reducing ambiguity,
- to reduce the amount of rework caused by interface inconsistency between domain models, and
- to propose the tools used to establish and to demonstrate the applicability of the proposed method.

The remainder of this paper is organized as follows. In Section 5.2, we give a general literature review and explain three principal steps of proposed detailed model design phase. In Section 5.3, we introduce our methodology about common vocabulary creation called “Model Identity Card (MIC)” for classifying and

simplifying simulation models specification. Section 5.4 introduces an after treatment model's case study and MIC's validation protocol. The conclusion and future research are given in Section 5.5.

## 5.2 Methodology and state of the art

To create a multidisciplinary vehicle model, it is necessary to plan and develop detailed domain level models according to vehicle-level goals and requirements. Once these domain models have been planned, developed, verified, and validated, they can be integrated together to simulate a complete vehicle. To be able to detect any potential integration problem in the early design phase, we add a detailed model design phase with a correctness check in the current model development process which improves the traditional V-cycle. It helps to synchronize actual needs of the downstream process with what the upstream process delivers. As mentioned earlier, in a design process there are different stakeholders such as Model and System Architects and Model Providers, who have different needs, views and viewpoints. In Model Based System Engineering, views and viewpoints can be used to model the perspectives of different stakeholders and their interests. A viewpoint describes a particular perspective of interest to a set of stakeholders, while a view is a stereotyped package that is said to conform to a particular viewpoint [7]. Dassault Systèmes has already used the MBSE view/viewpoint approach called RFLP (Requirements/ Functional/ Logical/ Physical) in their industrial tool (i.e., Catia V6). RFLP model describes the left-hand descending branch of the "V-Model". Based on the well-known V-cycle design process, RFLP allows concurrent engineering to coordinate the separate activities and views of distributed design teams. R defines Requirements view. The Functional view (F) defines what the system does operational (Intended use). The Logical View (L) or logical/organic architecture defines how the system is implemented, the breakdown structure, the block diagrams, logical interfaces, logical connections, the behavior (discrete behaviors, physics behaviors, and hybrid behavior). The Physical View (P) defines a virtual definition of the real world product. In this paper, we customize these different views based on our needs. We regroup requirement and functional view as a Functional View and we use the term Structural View instead of Logical View (see Fig. 5-1 and Fig. 5-2).



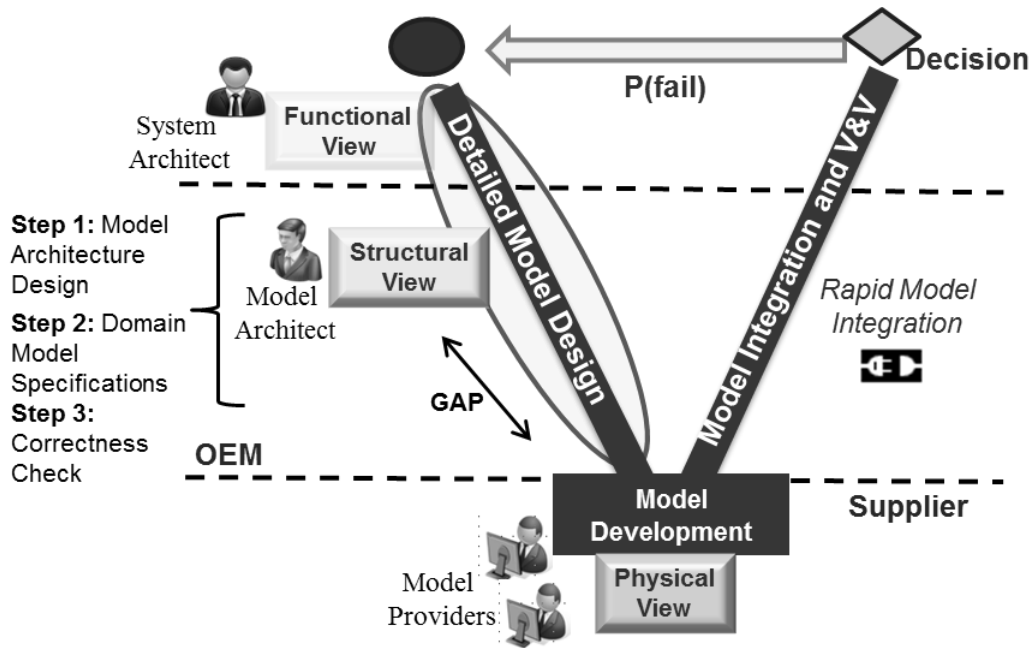

Fig. 5-2. Integrated model design phase to V-cycle systems engineering process

As shown in Fig. 5-2, the communication between stakeholders starts with model specifications, and ends with model delivery with well-defined documentation. To ensure the communication between these stakeholders (i.e.; System Architects, Model Architects and Domain Providers) is a challenging task, they either presume a common understanding of a domain of discourse or state their assumptions explicitly. Communication is ambiguous when the assumption of common understanding is incorrect.

In this section, Detailed Model Design phase are explained through Model Identity Card (MIC). MIC is created more specifically to characterize the model (object itself and its interfaces), and to ensure the transparency agreement between Model Architects and Model Providers. The proposed structural view consists of three main steps which are Formal Architecture Design; Vehicle and Domain Models specifications with MIC and Correctness Control at the early design phase (see Fig. 5-1 and 5-2).

### 5.2.1 Step 1: Formal Vehicle Architecture Design

System architecture selection and characterization is extremely useful in complex, multidisciplinary vehicle system analysis. Architectures provide a holistic view of a system and allow different stakeholders to work together with a common basis in the same vehicle system definition [12]. To design a good vehicle, it is necessary to analyze each of these system architectures from a variety of perspectives including performance, fuel economy, or even thermal behavior [2, 13]. Creating all possible system architectures manually is necessary for the first time but the reuse of an existing architecture is recommended because of time and cost concerns. To avoid having to build complete vehicle model architecture from scratch each time, it is useful to develop a pre-wired vehicle model architecture. The approach for achieving this relies on a reference model for vehicle architectures [2]. AUTOSAR, for instance, is the product of an industry-wide effort to produce a standardized architecture for controls design and development that can be used among major OEMs and their suppliers [14]. The term referential architecture has been already addressed and developed internally by Ford Motor Company as the Vehicle Model Architecture (VMA) [2, 15]. The foundation for the entire approach is Vehicle Reference Architecture (VRA) model, a formal SysML model that defines the logical decomposition of a vehicle into its subsystems. Although there have been several research efforts that have focused on enabling structural model design within a MBSE context, most of these efforts have focused on the integration between a Systems Modeling Language (SysML) model and a variety of simulation model tools (Simulink or Modelica) [2, 15]. However, many engineers today are still unfamiliar with SysML. Because of this, the training and licenses needed to put SysML tools into practice across large engineering teams can be cost-prohibitive. In addition to SysML there are some non-formal architecture design tools such as MS PowerPoint and Visio that design engineers use frequently in current engineering practice because of its easy usage. Thus, in this paper, we adopt a different approach. Rather than assuming that the structural model design is possible with SysML environment, we prefer to use a system engineering tool named arKIitect because this tool allows us to easily specify the architecture of system in a hierarchical manner. In this tool, the functional flows describe the interactions between the system functions as well as the interactions between the system and the external environment. The flows can be either data or physical flows. Based on a powerful hierarchical type definition, arKIitect allows designing very easily our own meta-model by using a given meta-model structure: objects, flows and their composition rules.

To the best of our knowledge there is no similar project that has been developed to support the edition of model characterization via Model Identity Card (MIC) in early M&S design. The design of formal system architecture is one of the activity areas of Model Architects.

### **5.2.2 Step 2: Vehicle and Domain Models Specifications with Model Identity Card (MIC)**

Complete vehicle model allow different vehicle-level attributes, such as energy, safety management and performance to be examined and optimized for various operating scenarios. These vehicle-level attributes are tightly coupled; investigating the tradeoffs between these attributes is crucial for system design. Model architects and domain model providers are supposed to specify the domain and vehicle level models via MIC. While the domain model specifications are intended to specify what kind of model to create, the vehicle model specifications specify how all of those domain models will be integrated. Model requirements include defining the operating system that models should be compatible with, expected accuracy, robustness and which simulation environments will be used to run the integrated vehicle model, and any other guidelines that the domain model should comply with. While domain engineers can view this information, they do not have the authority to directly modify any of it. This distinction is important and is made at several other steps throughout this process. By identifying who has the ultimate authority to make decisions during different phases of the modeling process, the potential software tools and MIC created to support it can be tailored to different users. Another important specification is about predefined set of interfaces so that it may correctly integrate with the other domain models. The set of interfaces modeled is derived directly from the details of the specialized analysis architecture. These specifications are the utmost importance because it could result in major inconsistencies between the models created by different domain engineers. This complete list of model attributes is then reviewed by the model architect, who negotiates with each domain team to develop a consistent set of models for the entire vehicle. These system and model architects must negotiate with both the domain engineers providing interfaces and those receiving interfaces, so that all of the simulation models are compatible. Because this is an iterative process, it may require several rounds of negotiations with all the different teams before a common vehicle-wide set of interfaces can be agreed upon. Using a formal check list and a correctness control is critical for early virtual prototype validation.

Model integration and exchange problems have already been addressed in various industrial projects such as ISO 10303 – STandard for the Exchange of Product model data (STEP) for efficiently exchanging electronic product data between product life cycle tools. Since then, there has been a strong push to effectively use structured knowledge to improve the work in the engineering domain because; the collaboration between knowledge experts in different domains is one of the first steps towards effective

knowledge management strategies [16]. Recent research efforts focused on ontologies and ontology development methods for engineering design. Ontologies are extensively used to formalize domain knowledge with concepts, attributes, relationships and instances resulting in reliable, verifiable and computer-interpretable knowledge mappings of a domain [17]. Formal engineering ontologies are described by Ahmed et al. [18] as a six-stage methodology for engineering design context. Li et al. [19] propose an Engineering Ontology (EO) based semantic framework for representing design information in documents, thus aiding their efficient retrieval. Horváth et al. [20] propose formalizing design concepts using ontologies. It is evident that ontologies not only provided formal structures for concepts and vocabularies, but they also have the potential for supporting inferences based on collective knowledge [21]. Shortly thereafter, the application of the Semantic Web in the field of knowledge management is discussed by Fensel et al. [22]. Earlier efforts in semantic mark-up languages include the Extensible Markup Language (XML), Resource Description Framework (RDF), Ontology Inference Layer (OIL) and Defense Advanced Research Projects Agency (DARPA) Agent Markup Language (DAML). Currently, the Web Ontology Language (OWL) is the de facto standard for developing and representing ontologies. OWL is recommended by the World Wide Web Consortium (W3C) as the ontology language of the Semantic [23, 24].

Ongoing work in the M&S realm, recent versions of the DEVS formalism provide for modularity and integration with HLA (DEVS/HLA), but DEVS does not spell out a formal language [26]. In addition, there are also some industrial standards, such as the language known as the SAE Architecture Analysis & Design Language (AADL). An AADL model describes a system as a hierarchy of components with their interfaces and their interconnections [25]. AADL components fall into two major categories: those that represent the physical hardware and those representing the application software. It describes both functional interfaces, and aspects critical for performance of individual components and assemblies of components. The most extensive previous research on characterizing model's behavior in engineering analyses is performed by Grosse et al. [23]. This ontology draws upon some of the simulation modeling taxonomies and concepts presented by Noy and McGuinness [24]. They organize the knowledge about engineering analyses models into an ontology, which includes both meta-data (eg, author, documentation and meta-knowledge, such as model idealizations and the corresponding justifications. A similar, although less extensive, meta-model for simulation models has been developed by Mocko et al. [13] but these taxonomies do not include detailed model behavior characteristic and any model validation and verification attributes such as Nasa's credibility assessment [27]. Based on the aforementioned standards and methodologies, we have developed MIC meta-model that might be applicable to any numerical model in the context of vehicle manufacturer. MIC meta-model will be explained in section 3.

### 5.2.3 Step 3: Correctness Control at the Early Design Phase

Correctness rules have been defined based on observed model interoperability and integration problems such as inconsistent in units, accuracy intervals, and model and hardware versions. Correctness control at the conceptual design phase can eliminate some of frequently faced problems. The aforementioned three steps are evoked again through an industrial case study in section 5.5.

## 5.3 Model Identity Card (MIC)

### 5.3.1 Motivation for M&S Meta-Model Creation

The need for standardized terminology in design artefact is often overlooked in the literature; however, it is an issue of critical importance. Our primary foundation is based upon the concept that simulation models are knowledge-based abstractions of real systems. On the other hand, the number and the diversity of the simulation models require another level of abstraction called Meta-Model that makes statements about the structure of different nature of model without making statements about their content (see Fig. 5-3). Assuming that symbol  $M$  represents a domain model and  $M (1...n)$  are the different natures of domain models (i.e., 0D-3D),  $\alpha (M)$  is the abstraction of a domain model, - thus  $\gamma (\alpha(M)) \sqsupseteq M$  means that the concretization of model abstraction has to contain necessary information of the model that we aim to specify (see Fig. 5-3).

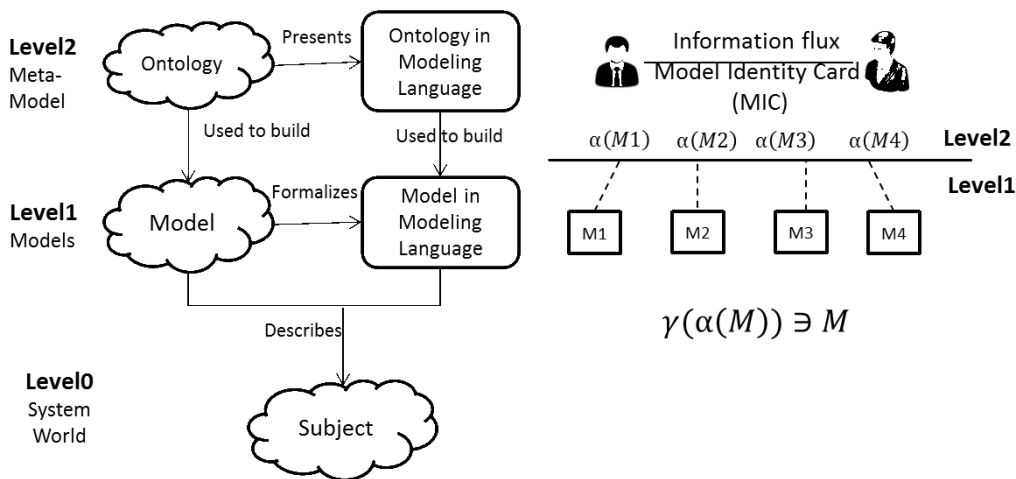

Fig. 5-3 MIC Concept

MIC meta-model includes some important and refined characteristics of simulation models such as modeling assumptions, behavior and interfaces specifications. This can help communicate the most objective decision in a maker's assessment of the credibility of M&S results. To reinforce this fundamental point, the concept described here does not claim to provide a measure of credibility. Its function is to enable clear communication between M&S stakeholders. We argue that formal taxonomy, or vocabulary for the representation of simulation modeling knowledge, is needed to ensure the following aims:

- to facilitate the model specification (object itself and its interfaces),
- to obtain an effective knowledge transmission and
- to reduce the rework caused by interfaces mismatches (Correctness control with MIC (Step3)).

The main long term benefits of this work include significant reductions in time, effort and interface based defect reduction throughout simulation-based decision support activities.

The MIC is developed by fifteen engineers of at least five different disciplines (Thermal Comfort, Motor, Acoustic, Electric, Vibration, etc...) in Renault automotive manufacturer company. They met more than 20 times between September and December 2013 to facilitate and standardize data collection phase using brainstorming and nominal group technique. Nominal group technique is a structured variation of small group discussion methods [28]. The process prevents the domination of discussion by a single person, encourages the more passive group members to participate, and results in a set of prioritized solutions or recommendations. All participants asked to write their ideas anonymously (or in small groups). Then the moderator collected the ideas and each is nominated on by the group based on proposed scenarios. Depending on engineer's domain knowledge and experience, we defined current MIC attributes.

### 5.3.2 Roadmap for MIC Creation

MIC is created according to the following steps:

**Step1.** Identification of main classes and attributes of models.

**Step2.** MIC attributes grouping and MIC graphical user interface creation on arKItect system engineering tool.

**Development Step1:** *Identify main classes and attributes of models*

MIC characterizes a model into 2 main classes: Physical Object with 3 sub classes (Methods, Usage, Validation and Verification) and Interface. Each main class consists of numerous attributes itself (see Fig. 5-4).

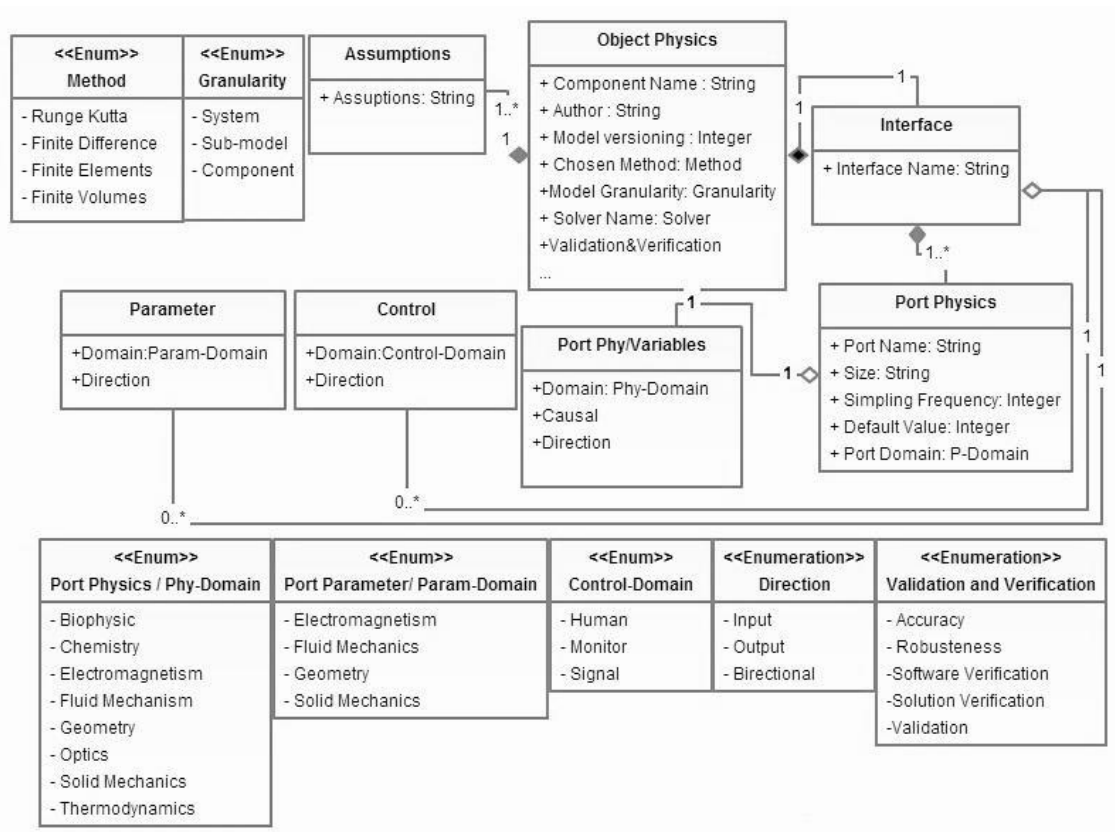

Fig. 5-4 A part of MIC Meta-Model

In Table 1, we identify classes and attributes of all physics based numerical models. The first column is the term employed to represent this modeling knowledge concept (attributes). The second and the third columns are the attributes of related domain and sub-domain and its type, and the fourth column gives some real examples. As shown in Table 1, the Object Physics class consists of some basic attributes such as: Specific Name, Granularity, Author and Model Version etc. Some of the attributes also have sub-attributes; for example, model granularity consists of system, sub-system, and component. The Method sub-class consists of Chosen Method, Precision, Solver, Time Step, Linearity, Continuity and Model Dimension etc. The Usage sub-class consists of Compilability, Time Computation, Scalability, Software Name, Software

and Hardware Version. The Verification and Verification (V&V) sub-class attributes are based on NASA's model credibility assessment [27].



Tableau 5-1 MIC CLASSES AND THEIR ATTRIBUTES

Attributes	Remarques	Type	Example	Main Class
Generic Name *	Physical component regroupment	String	Engine	Object Description
Specific Name *	Unique identifier	String	Compressor	
Granularity Level *	List(System/Sub-system/Componant)	String	Sub-System	
Developer Name *		String	F.Ravet	
Model Version no. *	x.x format	Float	0.1	
Creation Date		Date		
Documentation	References to technical report	String		
Image	References to an image	Image		Usage
Tool Name*	List (Amesim, Matlab Simulink, GT-Power, Open Modelica...)	String	GT-Power	
Tool Version*	x.x format	Float	7,3	
Operating Systems *	Windows, Linux		Windows	
Name of Compiler *	List (INTEL C/C++, INTEL FORTRAN, Visual C++ 2008 express, Visual C++ 2010 express, Visual Studio C++ 2008, Visual Studio C++ 2010, Visual Basic 6, Visual Basic 5, GCC, LCC, Compilateur fortran)	String	Visual C++	
Time Computation*	List (Steady State, Elapsed Time / Real Time)	String	Elapsed Time	
Scalability*	List (Yes/No)	String	Yes	
Hardware Requirements*	CPU, OS etc...	String	Win7, 64bit	Method
Model Dimension	List (0D-3D, mixte)	String	1D	
Chosen Method	List ( Finite Volumes, Finite Elements, Finite Difference, OD...)	String	Finite Difference	
Physical Equations	List (Chemistry, Dynamic behavior of materials, Maxwell, Navier-Stokes, Strength of materials, Electric, Signal, Runge Kutta)	String	Navier-Stokes	
Integrated Solver	List (Controllable Pitch, Fixed Pitch, Without Solver)	String		
Time Step*	List (Second, Minute, Mili-second, Hour, Steady state)	String	Second	
Linearity	List (No/Yes)	String	No	
Model Behavior	List (Continuous, Discrete, Mixed)	String	Yes	Model Quality
Validation of models	1-5 (ref NASA quality metrics)	Float		
Verification of models	1-5 (ref NASA quality metrics)	Float		
Input pedigree	1-5 (ref NASA quality metrics)	Float		
Uncertainties	1-5 (ref NASA quality metrics)	Float		
Robustness	1-5 (ref NASA quality metrics)	Float		
History	1-5 (ref NASA quality metrics)	Float		

All models must have clear interface definitions that implement the communication within model components or between model components and outside environment [31, 32]. Interface does not contain any information about the internal behavior of the component. Instead, the interface encapsulates the implementation of the model, which defines the internal behavior of the component. The meaningful composition of models requires that their behavior along a number of dimensions be understood and characterized in a formal way that avoids the ambiguity of textual documentation and enables automated processes to configure, compose, and mediate component-based simulations [6]. Interface's attributes are developed for respecting laws of conservation. More precisely, all physical systems have in common their conservation laws for energy and mass. Bond graphs concern themselves intimately with the conservation of energy in a physical system. Firstly, the workgroup creates a tree of diagram of Interface description. We distinguish the nature of interface into three main classes which are parameters, control and physics and each main interface class attributes can be divided into domain, sub-domain and unit. This tree diagram provides a good level of abstraction for domains and sub-domains (see Fig. 5-5).

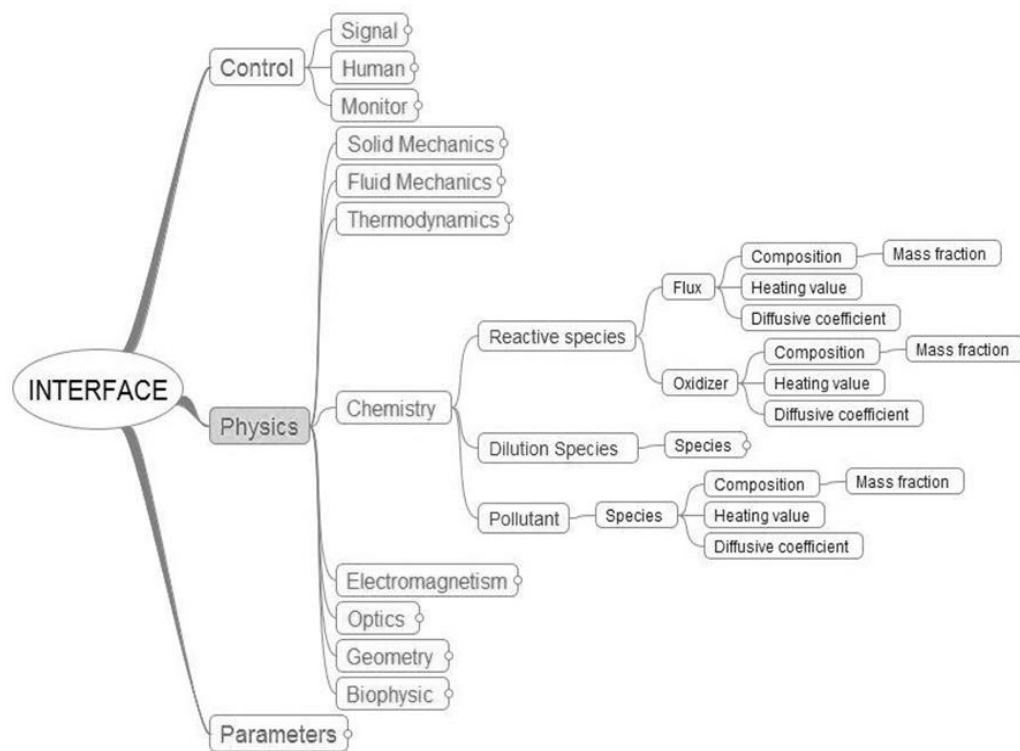

Fig. 5-5 Interface Characterization

Tableau 5-2 Interface attributes (see Appendix)

Attributes	Sub-Attributs	Type	Example	Main Class Name
Port Name		String	ComPReSSion-Input	Interface
Nature	Control (I/O), Parameter, Physical	String	Physics	
Domain	Solid Mechanics, Fluid Mechanics, Thermodynamics, Chemistry, Electromagnetism, Optics, Geometry, Biophysic, Signal, Human, Monitor, Geometry, Durability, Solid Mechanics...	String	Fluid Mechanics	
Causality	List (Acausal, Causal X2, causal X3,Causal X4)			
Direction	Input, Output, Bidirection			
Sub-Domain	Fluid Mechanics (Acoustics,External aerodynamics,Reactive/diphasic flow), Thermodynamic, Chemistry...	String	Reactive/diphasic flow	
Variable	Digital(CAN,Ethernet,Optic Fiber), Analogic (Filaire,Radio), Evaluation(Acoustic Comfort,Vibration Comfort,Thermal Comfort,Performance,Durability,Drivability, Ergonomy,Consomption), Pressure...	String	Pressure	
Unit	List (°C, K, kW, W, bar, Pa)	String	Mpa	
Deterministic /Statistical		String	Deterministic	
Offset		String		
Size *	List(Scalar, Vector, Matrix)	String	Scalar	
Min *		String	1,00E+0,5	
Max *		String	2,00E+0,6	

The system interface specification identifies input and output port by name, data and communication type (i.e., input, output, bidirectional, or causal). We identified causal and non-causal interfaces based on bond graphs representation [29]. The connection mechanism of model specifies the interface definition and connections. If the connection is a causally coupled relationship, it is called causal connection. Causality is the ability of the model to help establish causal relationships between output parameters and input parameters. The causal connection expresses the interface as input/output relationship. If the connection is non-causal relationship, it is called non-causal connection. The non-causal connection expresses the interface as variables shared relationship [6].

As shown in Table 5-2, Interface class consists of several attributes and sub- attributes. Efficient methods

and tools are anticipated for extracting simulation modeling knowledge from engineers, and incorporating this knowledge into a computational environment. Finally, we need methods and associated tools that can exploit the existence of such knowledge in a computational environment, to improve complex model integration and design processes. Therefore, the fundamental concepts that form the basis of all numerical models are identified, described, and typed for implementation into a computational environment. An industrial tool arKIitect is used to instantiate the MIC meta-model and illustrate, how common vocabulary usage such as MIC, might improve the ability of model characterization. We integrate a graphical user interface based on MIC vocabulary to create a semantically-rich model characterization support.

Development Step 2: MIC attributes grouping and integration to the arKIitect system engineering tool

We suppose that each numerical model is as an object and it has various attributes that describe and frame it. Most objects are physically part of a system, and they interact with other objects to create a larger object. In order to extract objects in a system as a unit and understand them, such as, object interfaces, it is necessary to characterize and reuse an object and its interactions with other objects in the system. Here, we decompose the object into three levels which are object itself, object interface and object context (see Fig. 5-6).

In order to characterize the object itself, we have grouped ‘Object physics’, ‘Method’s’ and ‘Model quality’ attributes under the heading: ‘Object’. The object interface consists of all Interface class attributes, additional assumptions and dependencies. Whereas, the object and object interface dimensions provide a snapshot of the object at hand. The object context dimension provides historical information such as: its usage and software version etc (see Fig. 5-6).

ArKIitect system engineering tool is used to characterize the models via a MIC in a hierarchical manner, and to generate semi-automatically structural model architecture as a block diagram. This tool is used also for demonstrating the applicability of MICs to a particular case study.

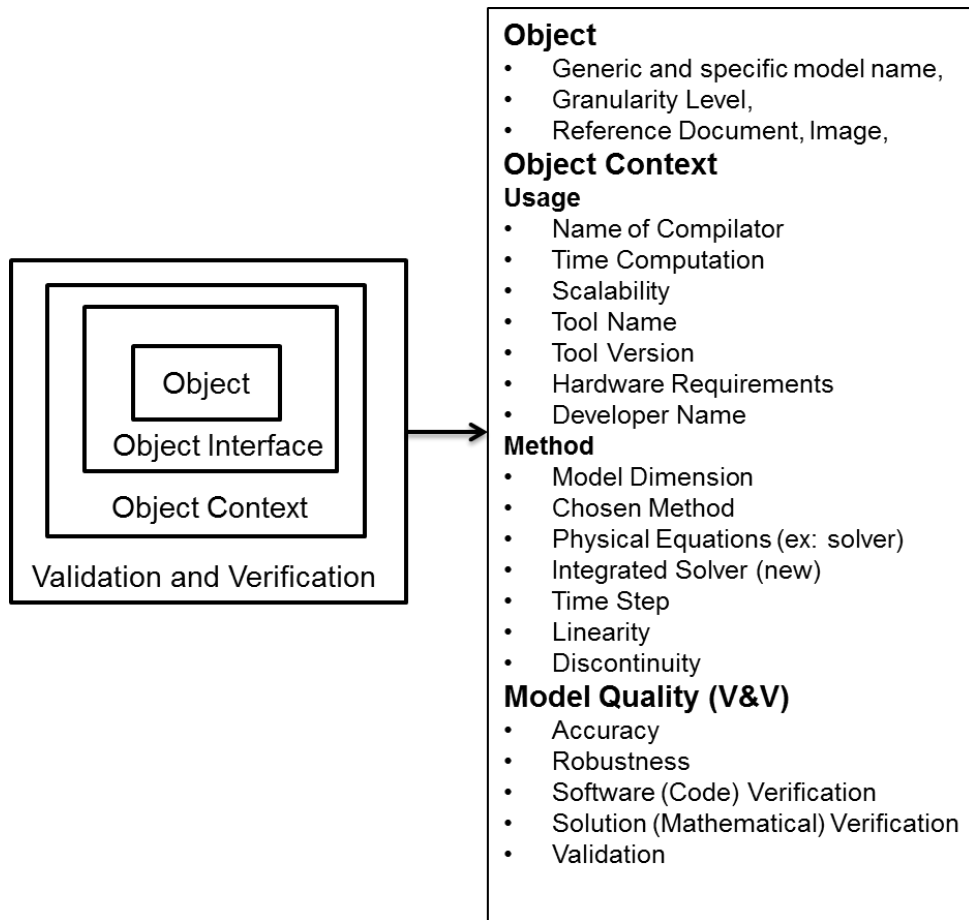

Fig. 5-6 Object Model classes grouping

(Adapted from Basili and Rombach [33])

## 5.4 Case Study

### 5.4.1 Demonstration Scenario and MIC Validation

Today, the simulation model supply especially from an external provider is a bottleneck activity. Automotive manufacturers ask for having a new model or a customized existing model from the suppliers. In the case of a new model supply, from requirement elicitation phase to model integration tests, as there is not a common vocabulary; the probability to fail during the model integration is very high. The source of problem is mostly based on wrong or insufficient knowledge transmission from automotive manufacturer to model suppliers. As the assumption of common understanding is incorrect, the provided model does not totally conform to the requirements and the mentioned activities take a lot of time, typically 1 to 6 months after several meetings and integration tests. In the example scenario, the system architect wishes to know the behavior of after treatment model with defined boundary conditions. The scenario is realized based on the **3 model design steps** that we explained in section 5-2.

Thus, the aims of this Case study are illustrated as below:

- *Formal Vehicle Architecture Design based on non-formal model architecture.*
- *Vehicle and Domain Models Specifications with Model Identity Card (MIC).*
- *Correctness Control at the Early Design Phase (MIC).*

#### 5.4.1.1 Step 1: Formal System Architecture Design based on non-formal model architecture

First, the System Architect provides a draft version of the model plan which is most of the time on MS PowerPoint tool and the study objective.

#### Example:

**Technological objectives:** Optimizing a combination of after-treatment components. List of the components to be simulated: Catalyst, SCR, Particles filter. Engine applications: K9, R9M, M9R.

**Decision:** Volume, Mass and Cost analysis of each after-treatment components.

**Application:** Transient simulation on homologation cycles for passenger car vehicles.

**Expected accuracy:** 10 % on the volume, 5% on the mass and 1% on the cost.

Once the model architect receives and checks the consistency of the model and study objective (see Fig. 5-7), he transforms this model plan into a semantically rich block diagram on the arKitect tool. Formal model architecture integration to the early design process facilitates model use activity as a plug-in manner by providing a holistic sub model integration schema with its interface connections.

The model architect characterizes each incoming and out coming ports of related sub models and their connections with each other's. Each sub model has a MIC in which there are enough and necessary information about related model and its port connection with other models. As an example, we characterize "Combustor/Chamber" sub model's interface by using MIC GUI (Graphical User Interface), see Fig. 5-7 and 5-8. Each port definition consists of Port Name, Port Nature, Direction, Domain, Sub-domain, variables, Units, Size, Min, Max values, Resolution, Accuracy etc (see Table 5-2). Once we define the incoming and outgoing ports and their connections with other sub models one by one, arKitect semi-automatically generates a block diagram, (see Fig. 5-9).

#### **5.4.1.2 Step 2: Vehicle and Domain Models Specifications with Model Identity Card (MIC)**

The attributes that we use in MIC GUI decrease the ambiguity and misunderstanding between model architect and model provider. This communication problem which might happen has an effect on model quality and decision. Some interoperability problems based on misunderstanding of software versioning, undated libraries and model units, can be decreased by using a MIC. By doing this it minimizes time, cost and the expertise required to construct comprehensive models within the context of their organization. Once the model architect sends on-demand requests to the model provider, he/she has to find or develop the requested model. In the context of after treatment example, the model architect sends the request to different engineering domain to be able to create a complete high level model.

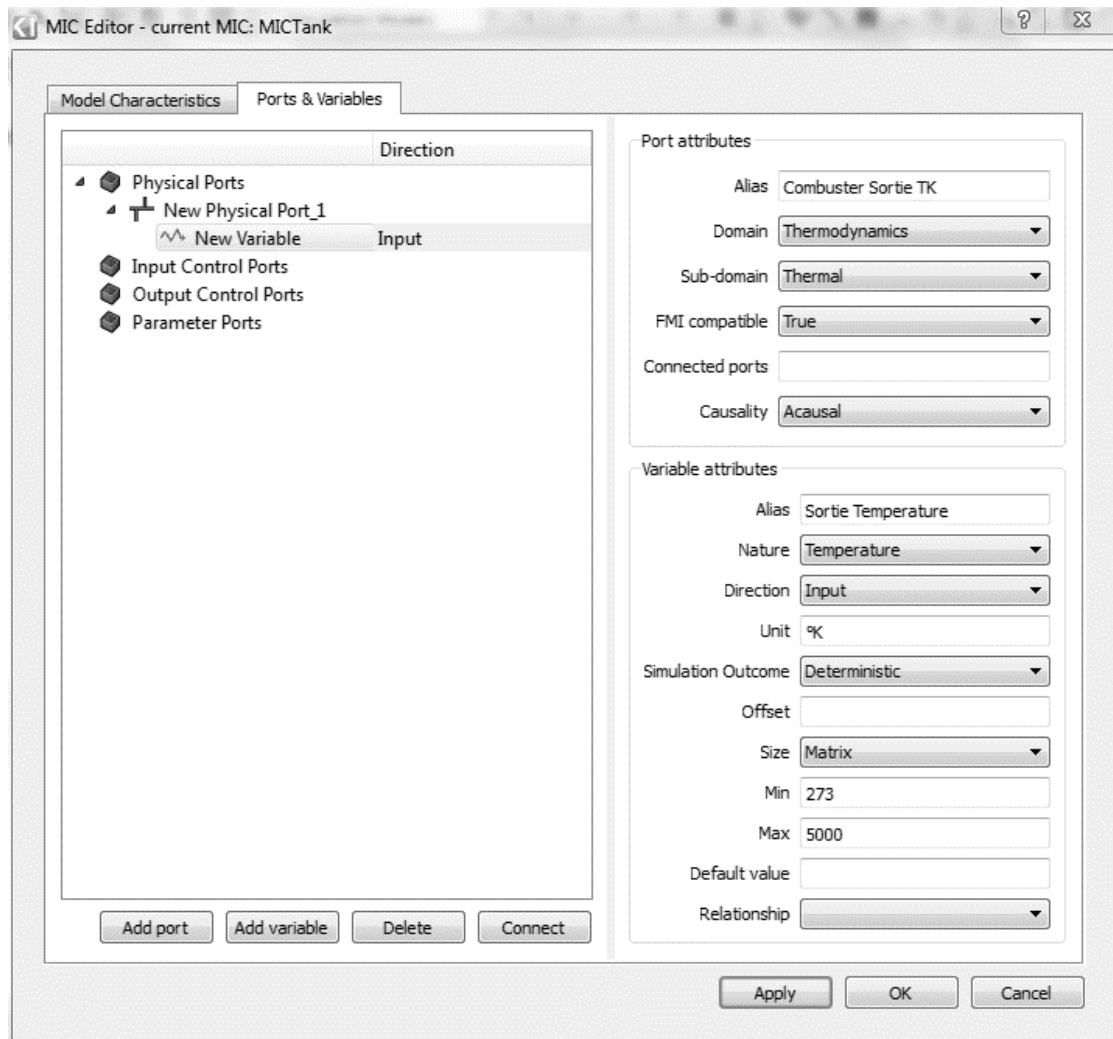

Fig. 5-7 GUI MIC Interface description / Port creation



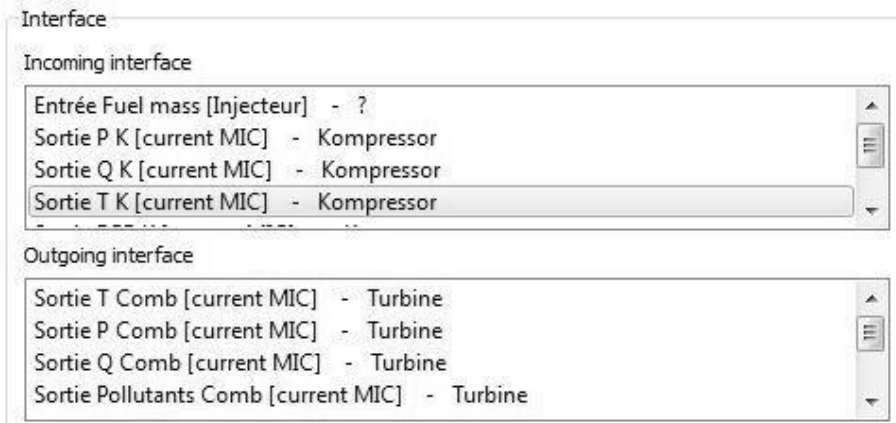

Fig. 5-8 GUI In-coming, out- coming ports

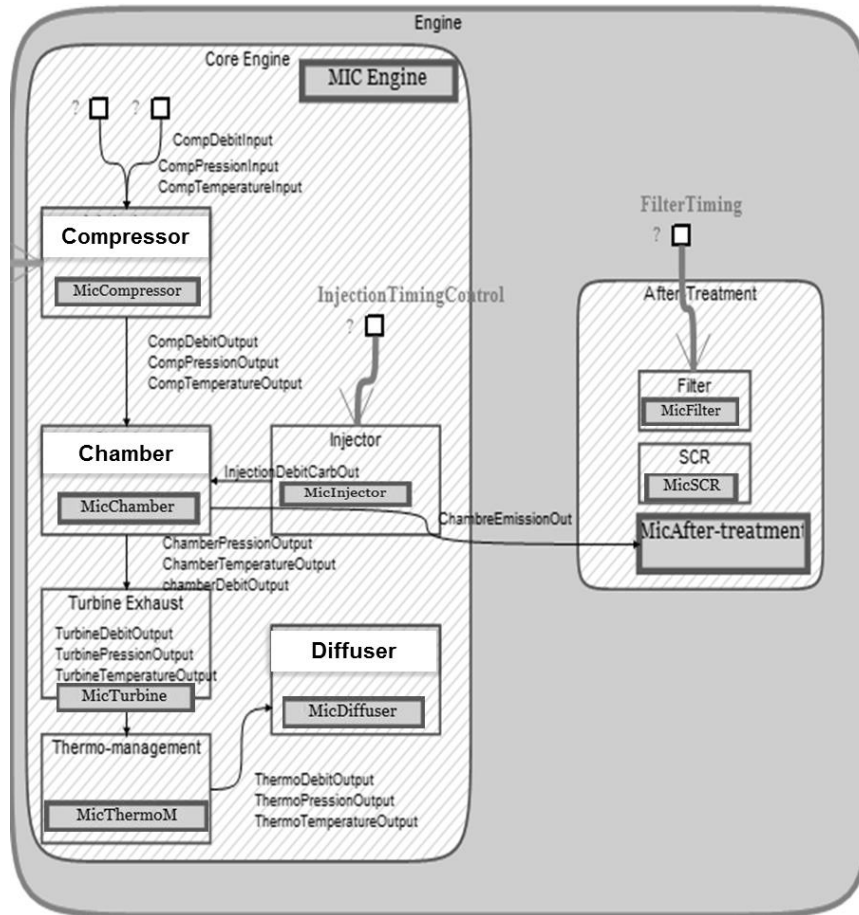

Fig. 5-9 Generated block diagram (formal version)

After having established the communication via MIC, the model provider supposed to fill out also some important attributes before pointing out the relevant model and sending the complete MIC to the model architect. As shown in Fig. 5-10, the model provider must fill important attributes, such as, the name of method that the model provider used to develop his or her model and the model precision, solver name, dimension, time step, software tool name, versioning etc...

The screenshot shows the 'MIC Editor - current MIC: MIC Regulation' window. It has two tabs: 'Model Characteristics' (selected) and 'Ports & Variables'. The 'Model Characteristics' tab is divided into several sections:

- Object Description:** Fields for 'Generic name\*' (Combuster), 'Specific name\*' (R9M Gen 3), 'Granularity level\*' (Subsystem), 'Developer name\*' (F. Ravet), 'Model version no' (0.1), 'Creation date' (15/04/2014), and 'Attachments'.
- Method:** Fields for 'Model dimension\*' (0D), 'Chosen method' (Finite difference), 'Physical equations' (Runge Kutta), 'Time step\*' (Variable), 'Linearity\*' (No), and 'Model behavior\*' (Continuous).
- Usage:** Fields for 'Tool name\*' (GT-Power), 'Tool version\*' (8.2 pr 1), 'Operating System' (Windows), 'Name of compiler' (Visual Studio C++ 2008), 'Time computation\*', 'Scalability' (True), and 'Hardware requirements\*' (32/64 bit).
- Model quality:** Fields for 'Accuracy\*', 'Robustness\*', 'Software verification', 'Solution verification', 'Validation', 'Technical control level', and 'Process control'.
- Notes:** A large empty text area at the bottom.

At the bottom right, there are three buttons: 'Apply', 'OK', and 'Cancel'.

Fig. 5-10 GUI MIC Model Characteristics

### 5.4.1.3 Step 3: Correctness Control at the Early Design Phase

We define correctness as a measurement of how well the system design meets or exceeds its requirements. Due to uncertainty arising from design abstractions as well as system interactions with the environment and its users, correctness is specified over multiple dimensions. These dimensions include the design hierarchy (i.e., subsystems and components), environment, use conditions, functions, functional failures, and adherence to design rules. After having established the domain level signals (interfaces and domain level model specifications), the model architects integrate these sub models into a full virtual prototype. The model architect can evaluate alternative architectures against different model accuracy constraints. She or he has to detect any potential problem before the IVVQ (Integration, Verification, Validation, and Qualification) phase. The virtual prototype contains various correctness checks for interoperability problems such as domain models software names, versions, models' min/max values, units, the direction of acausal connections, models' accuracy levels, etc [see Fig. 5-11].

In the literature there are some related works such as the early stage virtual prototype verification and validation. To address this issue, Van der Velden et al. [34] recently developed a virtual prototype metric called the Probabilistic Certificate of Correctness which computes the probability that the actual physical prototype will meet its benchmark acceptance tests, based on virtual prototype behavior simulations with known confidence and verified model assumptions. This works however does not use Probabilistic Certificate of Correctness methods, it checks basically if there is some incoherence in component level models' interfaces.

	Compatibility	compute	Scalability	Software	ware vers	Time step
MIC Compressor	Yes	Elapsed	Yes	Gt power	7,3	mili sec
MIC Chamber	Yes	Elapsed	Yes	Gt power	7,3	mili sec
MIC Turbine	Yes	Elapsed	Yes	Gt power	7,3	mili sec
MIC Thermo	Yes	Elapsed	Yes	Gt power	7,3	mili sec
MIC Diffuser	Yes	Elapsed	Yes	Gt power	7,3	mili sec
MIC Injector	No	Elapsed	Yes	Gt power	7,3	mili sec

Fig. 5-11 Interoperability Check

### 5.5 Validation Protocol

The validation of the proposed methods consists of two interrelated steps:

- (i) scalability of MIC: capacity to cover different nature of simulation models and
- (ii) heuristic observation to estimate the rate of model rework and ambiguity reduction

(i) As shown below in Fig. 5-12, a validation plan is established to test MIC’s model specification capacity, proposed tool and the GUI’s functionality. To be able to cover different natures of models, we tested MIC with 0D (engine/after treatment, and electric transmission) and 3D (crash) complex model test cases with some selected domain experts.

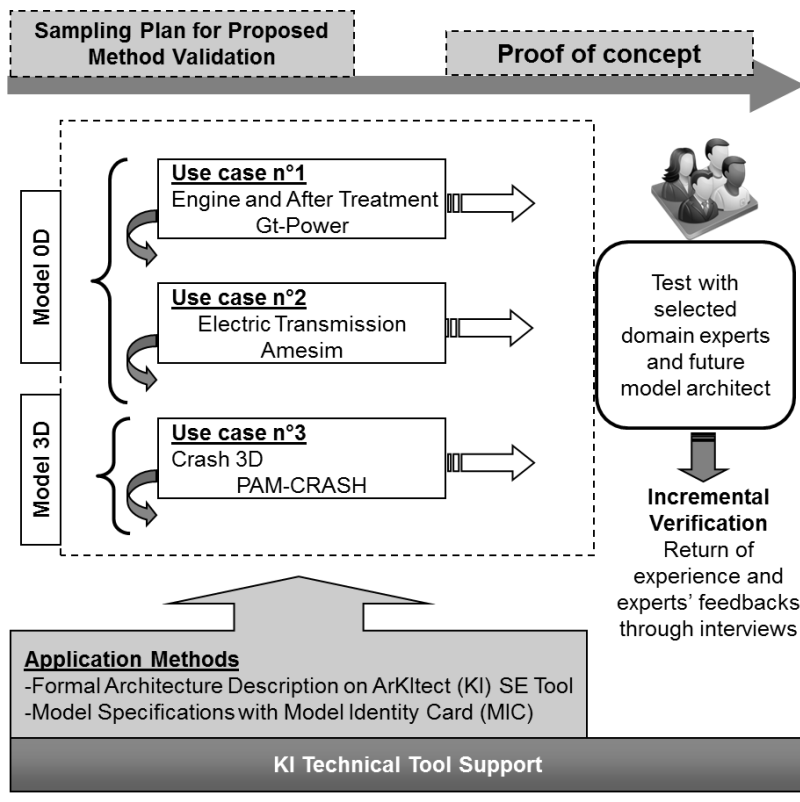

Fig. 5-12 Proof of Concept

This kind of sampling experimentation is useful to be able to understand the proposed methods’ functionality and capacity. Our aim is to make iterations with domain experts in terms of MIC and tool improvement until they arrive at that meets design requirements. Based on return of experience and experts

interviews, we can say that MIC is potentially a useful concept which contains ample information about component and system behavior. In addition, they think that robust conceptual designs in an automated fashion in far less time than the manual system engineering approach. Seeing that the usage of simulation models in the other multidisciplinary systems is similar, experts from different companies and domains face also with similar design challenges. Thus, MIC is potentially generalizable concept to other domains outside of automotive engineering such as aeronautics and transport.

(ii) We argue that formal taxonomy or vocabulary for the representation of simulation modeling knowledge is an essential component of ambiguity reduction. Ambiguity arises as multiple interpretations, and interpretations can be understood as hypotheses. Weick [36, 37] introduces the term ambiguity, which he defines as a combination of two underlying terms: equivocality and lack of clarity. Lack of clarity, according to Weick, stems from ignorance, and is similar to uncertainty, which will be reduced by the availability of more information. Equivocality, on the other hand, stems from confusion, where two or more meanings can be assigned to the same cue. As showed in figure 14, today, 4/10 ambiguity problems resulting from multiplicity as variety interpretations of the same things. For example the terms “parameters and uncertainty” have multiples interpretations based on different perceptions towards engineering domains. Resolving equivocality is possible by discarding alternatives interpretations in a collaborative design environment (see Fig. 5-13 and 5-14).

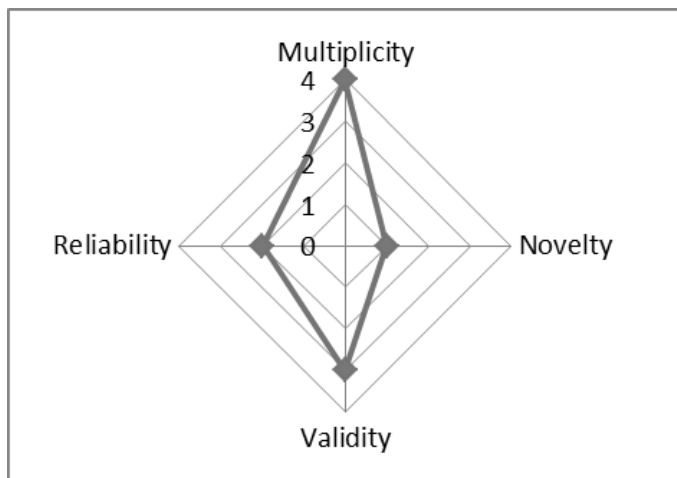

Fig. 5-13 Sources of ambiguity

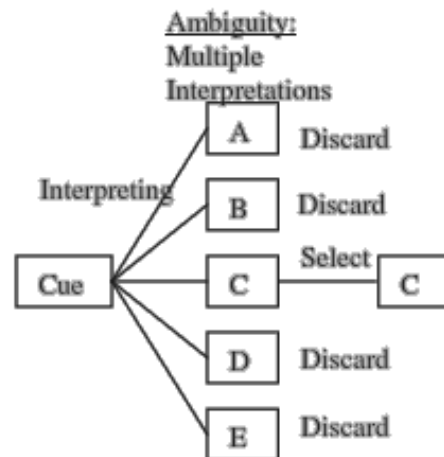

Fig. 5-14 Ambiguity reduction [36]

Sharing a common vocabulary between the designers and manufacturers allows both sides to identify potential misunderstanding problems before they start. Another contribution of this work is reducing the number of the rework while detecting potential inconsistency problems at early design stage. Avoidable rework consumes a large part of development projects, i.e. 20-80 percent depending on the maturity of the organization and the complexity of the products. Therefore, typical rework anomalies may be classified such as

- avoidable rework which consists of the effort spent on fixing difficulties that could have been discovered earlier or avoided altogether. In M&S context, most of rework anomalies are caused by interface consistencies and software and hardware versioning problems (see Fig. 5-15). These anomalies would be detected by correctness control at the early design phase (see section 5.4 for case study). And
- unavoidable rework is work that could not have been avoided because the developers were not aware of or could not foresee the change when developing the software, e.g. changed user requirements or environmental constraints.

Today, 4/10 rework anomalies are caused by inconsistent interfaces values and hardware and software versioning mismatch problems which are potentially avoidable rework anomalies. Since each defect finds after the product was released to OEM, these reworks create on average, 2 or 3 supplementary staff work per project and 1 to 2 months of delay. Early correctness control aims to reduce the number of these anomalies by a factor of 2. With the provided method, it would take approximately less than one staff hour of correctness check time for each defect found (see Fig. 5-15).

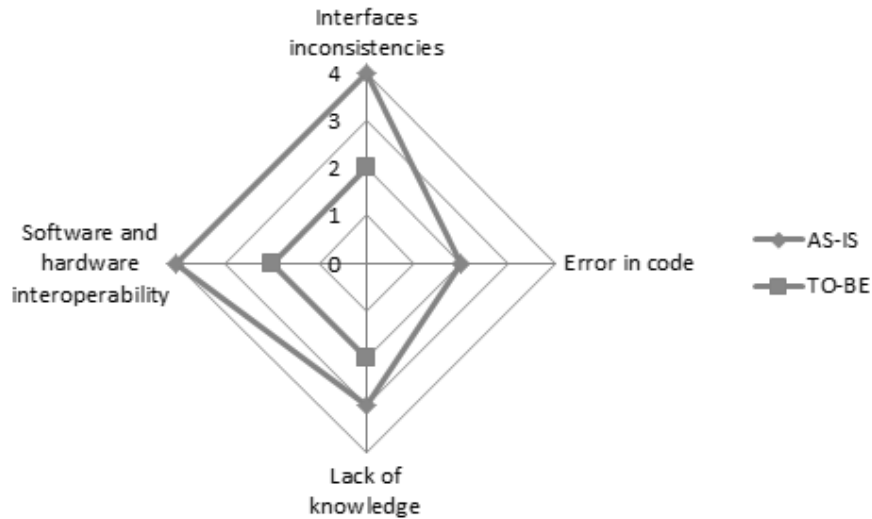

Fig. 5-15 Sources of rework and expected improvement

## 5.6 Limitation and Future Considerations

The overarching goal is to manage the creation of full-vehicle system model by integrating associated domain models to deliver a viable model in less time. To meet this target, this work presents two approaches. First; utilizing architecture based model design phase at the early stage of model development process and the second is to standardize the engineering knowledge transfer thanks to Model Identity Card (MIC). The first characteristic desired for an effective approach is that model architecture integration should be orchestrated by an actor (i.e., Model Architect) with a more formal manner in a precise process.

In this process, we introduce as a novel approach, a detailed design phase with interface consistency checking before the IVVQ (Integration, Verification, Validation, and Qualification) phase. The second desired characteristic is to create M&S common vocabulary and its integration to arKIitect systems engineering tool for capturing and sharing engineering domain knowledge between OEMs and model providers. To be able to facilitate editing of model characterization, we created a GUI based on MIC attributes. These techniques described in this paper allow M&S stakeholders' to collaborate quickly and easily.

In the literature, there are some similar works related to numerical model capturing, reuse, characterization and integration but to the best of our knowledge, the development of a systematic process and a complete and detailed M&S vocabulary was not exist.

To demonstrate the applicability of our proposed solution, engine-after treatment, crash and electric transmission models are tested. Engine-after treatment model is explained as a case study. During this case study observation, models' stakeholders (external/internal provider) have participated to the test scenario. Within model development process, the model and the system architects, characterize and create well-defined on-demand model requests. Based on this model request, the model provider selects or creates the model that (1) is appropriate for their desired simulation context and (2) represents the assumptions and limitations of the model. Thus, according to engineers' return of experience based on case study, the knowledge gap between model architect and provider is decreased by providing M&S common vocabulary. Also, knowledge capturing and understanding about numerical modeling is increased. The MIC is locally integrated to the company and tested by different engineering teams. Following the test results, we say that MIC's attributes are accurate and containing sufficient information for characterization different nature of models (0D reduced, and 1D, 2D and 3D).

MIC is applicable to another context such as aeronautic but it requires more work, and thus it is important to extend it to support different specific domains of interest. Model Development Process and MIC concepts will be used in next generation Company's multidisciplinary vehicle modeling strategy. Future works include (1) increasing the number of MIC tests with different engineering teams for testing its capacity (e.g., HVAC and Battery Aging Model are envisaged) and to extend its usage to support different specific domains of interest, (2) an extended validation protocol for proposed concepts in terms of value addition to company's current situation. (3) We would like to also complete the Vehicle Reference Architecture to be modeled by using mentioned tool and methods and finally (4) we would like to align of different views and viewpoints in the same tool.

A long-term vision is to integrate semantically rich domain model libraries and model of behavioral intention [35] concept to our MIC to be able to increase the probability to get the right model from supplier.



## Reference #5

- [1] G. Sirin, B. Yannou, E. Coatanéa and E. Landel, “Analysis of the simulation system in an automotive development project”. Int. Conf. of Complex Systems Design & Management CSDM, Paris, France, Dec, 12-14, 2012.
- [2] J.M. Branscomb, C.J.J. Paredis, J. Che, and M.J. Jennings, “Supporting Multidisciplinary Vehicle Analysis Using a Vehicle Reference Architecture Model in SysML”. Systems Engineering Research CSER, Atlanta, US-GA, March, 12-22, 2013.
- [3] G. Sirin, B. Yannou, E. Coatanéa and E. Landel, “Creating a Domain Ontology to Support the Numerical Models Exchange between Suppliers and Users in a Complex System Design”. ASME (IDETC/CIE), Portland, USA, Aug., 4-7, 2013
- [4] C.J.J. Paredis, A. Diaz-calderon, R. Sinha and P.K. Khosla, (2001, Apr). Composable models for simulation-based design. Engineering with Computers Journal, Vol.17, No. 2, p. 112-128.
- [5] L. Yilmaz. (2004). On the Need for Contextualized Introspective Models to Improve Reuse and Composability of Defense Simulations, JDMS Volume 1, Number 3.
- [6] R.J. Malak, and C.J.J. Paredis, (2007). Validating Behavioral Models for Reuse. Research in Engineering Design, Vol.18, No.3, p.111-128.
- [7] Systems Engineering Fundamentals, DOD Supplementary text prepared by the defense acquisition university press fort Belvoir, Virginia 22060-5565, USA, 2001,  
[http://123management.nl/0/070\\_methode/072\\_kwaliteit/Dod%20Systems%20Engineering.pdf](http://123management.nl/0/070_methode/072_kwaliteit/Dod%20Systems%20Engineering.pdf)
- [8] O. De Weck, “Feasibility of a 5x Speedup in System Development due to Meta Design”. ASME/DETC2012-70791, 2012.
- [9] D. Ward, S. Helton, and G. Polari, (2011). ROI Estimates from SAVI’s Feasibility Demonstration, Systems Engineering Conference.
- [10] G. Tassef, S.B. Brunnermeier, et S.A Martin. (1999). Interoperability cost analysis of the US automotive supply chain. Research Triangle Institute Final Report. RTI Project 7007-03,  
Available: [https://www.rti.org/pubs/US\\_Automotive.pdf](https://www.rti.org/pubs/US_Automotive.pdf)
- [11] C. Belton, “Vehicle Model Architecture for Vehicle System Control Design”. SAE World Congress & Exhibition, Detroit, Michigan, 2003.
- [12] E. H. Miller, “A note on reflector arrays,” IEEE Trans. Antennas Propagat., to be published.
- [13] G. Mocko, R.J. Malak, C.J.J. Paredis, and R. Peak, "A Knowledge Repository for Behavioral Models in Engineering Design". 24th ASME Computers and Information in Engineering Conference, Salt Lake City, UT, Sept, 2004.

- [14] AUTOSAR, [www.autosar.org](http://www.autosar.org).
- [15] Belton, “Vehicle Model Architecture for Vehicle System Control Design”. SAE World Congress & Exhibition, Detroit, Michigan, 2003.
- [16] M. Pratt, Introduction to ISO 10303—the STEP standard for product data exchange, *J. Comput. Inf. Sci. Eng.* 1 (1) (2001) 102.
- [17] W. Verhagen, R. Curran, Ontological modelling of the aerospace composite manufacturing domain, in: 18th ISPE International Conference on Concurrent Engineering, 2011, Advanced Concurrent Engineering, 2011, pp. 215–222.
- [18] S. Ahmed, S. Kim, K. Wallace, A methodology for creating ontologies for engineering design, in: Proceedings of the ASME IDETC/CIE Conference, Long Beach, CA, 2005.
- [19] Z. Li, M. Yang, K. Ramani, A methodology for engineering ontology acquisition and validation, *Artif. Intell. Eng. Des. Anal. Manuf*, Special Issue on Developing and Using Engineering Ontologies (23) (2009) 37–51.
- [20] I. Horváth, J. Vergeest, G. Kuczogi, Development and Application of Design Concept Ontologies for Contextual Conceptualization, Delft University of Technology, 1998.
- [21] B. Chandrasekaran, J. Josephson, V. Benjamins, What are ontologies, and why do we need them?, *IEEE Intell Syst. Appl.* 14 (1) (1999).
- [22] D. Fensel, C. Bussler, Y. Ding, V. Kartseva, M. Klein, M. Korotkiy, B. Omelayenko, R. Siebes, Semantic Web Application Areas, 2002. <<http://www.few.vu.nl/~ronny/work/NLDB02.pdf>> (retrieved 17.09.12).
- [23] I.R. Grosse, J.M. Milton–Benoit and J.C. Wileden (Jul, 2005) Ontologies for supporting simulation models. *AI EDAM*, Vol.19, No.1 p.1-18.
- [24] Noy, F. N. and McGuinness, (2001) *Ontology Development 101: A Guide to Creating Your First Ontology*. Stanford Knowledge Systems Laboratory Technical Report KSL-01-05 and Stanford Medical Informatics Technical Report SMI-2001-0880. Stanford, CA.
- [25] P. Failer. (2010). SAE AADL V2, An overview. Software Engineering Institute Carnegie Mellon University Pittsburgh, Available: [https://wiki.sei.cmu.edu/aadl/images/7/73/AADLV2Overview-AADLUserDay-Feb\\_2010.pdf](https://wiki.sei.cmu.edu/aadl/images/7/73/AADLV2Overview-AADLUserDay-Feb_2010.pdf)
- [26] B.P. Zeigler et al., The DEVS Environment for High-Performance Modeling and Simulation. *IEEE C S & E*, 1997. 4(3): p. 61-71.

- [27] S.R. Blattnig et al, Towards a Credibility Assessment of Models and Simulations. 49th AIAA/ASME/ASCE/AHS/ASC Structures, Structural Dynamics, and Materials, At Schaumburg, IL, 2008.
- [28] Delbecq, Andre L., and Van de Ven, Andrew H. (1971), "A Group Process Model for Problem Identification and Program Planning," *Journal of Applied Behavioral Science*, 7, 4.
- [29] D. Karnopp and R.C. Rosenberg. (1968). *Analysis and Simulation of multiport Systems*. The Bond Graph approach to physical systems dynamics, MIT Press.
- [30] S.D. Eppinger, and V. Salminen, "Patterns of Product Development Interactions". 13th International Conference on Engineering Design ICED, Aug., 21-23, Glasgow, Scotland, 2001.
- [31] Nasa Technical Standard (2008), Standard for models and simulations National Aeronautics and Space Administration Washington, DC 20546-0001, NASA-STD-7009.
- [32] S. Halbach, P. Sharer, S. Pagerit, C. Folkerts, A. Rousseau, "Model Architecture, Methods, and Interfaces for Efficient Math-Based Design and Simulation of Automotive Control Systems", Argonne National Laboratory, 2010.
- [33] V. Basili and H.D. Rombach. (1990). *Towards A Comprehensive Framework for Reuse: Model-based Reuse Characterization Schemes*. University of Maryland, CS-TR-2446, UMIACS-TR-90-47.
- [34] A. Van der Velden, P. Koch, S. Devanathan, J. Haan, D. Naehring and D. Fox, "Probabilistic Certificate of Correctness for Cyber Physical Systems", Volume 2: 32nd Computers and Information in Engineering Conference, Parts A and B Chicago, Illinois, USA, August 12–15, 2012.
- [35] F. Retho, H. Smaoui, J.C. Vannier, P. Dessante, A model-based method to support complex system design via systems interactions analysis. *Int. Conf. of Complex Systems Design & Management CSDM*, Paris, France, Dec, 12-14, 2013.
- [36] E. Brun and A.S. Saetre, Ambiguity Reduction in New Product Development Projects. *International Journal of Innovation Management* Vol. 12, No. 4 (Dec. 2008) pp. 573–596.
- [37] Weick, K (1995). *Sensemaking in Organizations*. Thousand Oaks, CA: Sage Publications

# 6

## Conduct Change: Tool Development and Deployment

Change management is a cyclic process, as an organization will always encounter the need for change. There are three phases in the Organizational Change Management Life Cycle which are Identify, Engage and Implement. The elements of change (processes, technology and people) and the phases of the Organizational Change Management Life Cycle are closely linked, and their intersection points must be carefully considered [1, 2 and 3].

**Process:** Business processes are defined by process maps, policies and procedures, and business rules that describe how work gets done. This drives the adoption of new technology.

**Technology:** Technology ensures greater organizational efficiency in implementing the changes. It is a means to process data with greater accuracy, dependability and speed.

**People:** Generally, organizations excel at designing new or improving existing processes. They also do well at identifying or developing technology to realize the power of new processes. However, most organizations fail to focus sufficient attention on the role people play in the processes and technology used to accomplish the desired organizational changes.

The general deployment process consists of several interrelated activities with possible transitions between process, technology and people. These activities can occur at the customer (Renault) side or at the supplier (model provider) side or both. Based on ITIL release [4] and deployment framework, new tool, process and role delegation is conducted in the company. The tool and mentioned methodology (see Chapter 4 and 5) is deployed to a part of the user base initially, and then this operation is repeated for subsequent parts of the user base via a scheduled rollout plan.

## 6.1 arKIitect© Systems Engineering (SE) Tool and its Customization

arKIitect© SE tool has been chosen to illustrate the proposed methodology. This tool has been chosen because it has a meta language definition system, a diagram definition system and modeling tool. The language is formed of a very compact syntax allowing to specify UML SysML diagrams and many others as needed for DSL design. One of the most powerful features offered by this type of tool is to have all the life cycle phases of the System Engineering process (RFLP). This means that this single model offers therefore traceability from the early requirements to the system architecture whereas most commercial tools only focus on one or two phases. While evaluating SysML, Renault also looks at other approaches that share the same type of data model but provide simplified and specialized views. The interest of a tool like arKIitect© is that it offers an intuitive interface and more flexible views that most SysML editors do. This tool developed by inspiring the architecture frameworks such as NAF, TOGAF etc that define all necessary and indispensable views that a project team must produce.

With arKIitect™, we can represent objects exchanging flows. We can easily build hierarchical systems by adding different graphical levels (see Fig. 6-1). It includes powerful filtering features that enable to tune the graphical representation and easily view or enter information. However, mentioned industrial tool (arKIitect) and others (Dassault and Siemens PLM tools) do not allow to design simulation model world. We would like to pull and transform the necessary system related information such as system requirements, functions and operations to design a simulation model in model world. Thus, the transition from system models (system world) to behavioral physic-based modelling (model world) should be created with a new module called “Simulation Model” which is developed first with Model Identity Card Ontology and supported with some consistency check rules. Thus, as illustrated in Fig. 6-2, we first create a new view for model architecture creation and model specification.

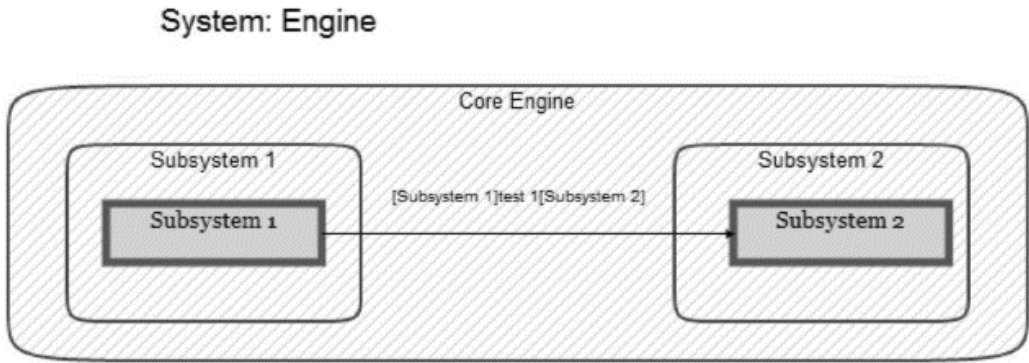

Fig. 6-1 Hierarchical representation of a system

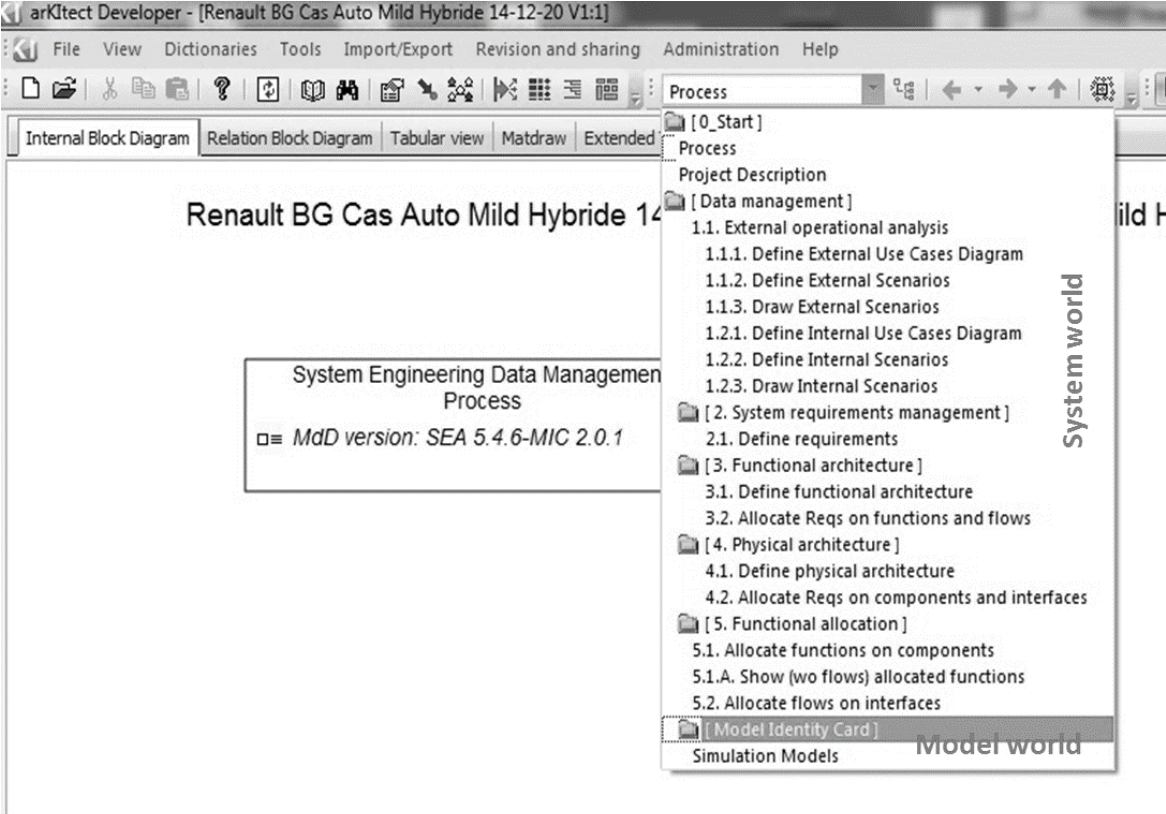

Fig. 6-2 Simulation model view creation

### 6.1.1 Model Identity Card (MIC) and arKitect Systems Engineering Tool Integration

Our primary foundation is based upon the concept that simulation models are knowledge-based abstractions of real systems. A system can be represented as a configuration of components or sub-systems that are connected to each other through well-defined interfaces. The configuration interface of a component object consists of ports, which define the intended interaction between a component and its environment; interactions consist of the exchange of energy, matter, or signals (information) (see Fig. 6-3). For example, the configuration interface of the motor has ports for the stator, the shaft of the rotor, and the electrical connectors. A system is a group of multi-domain / multi-physics components interacting together. Systems have structure, defined by parts and their composition. Systems have behavior, which involves inputs, processing and outputs of material, energy or information. On the other hand, the number and the diversity of the simulation models require another level of abstraction called meta-model that makes statements about the structure of different natures of models without making statements about their content.

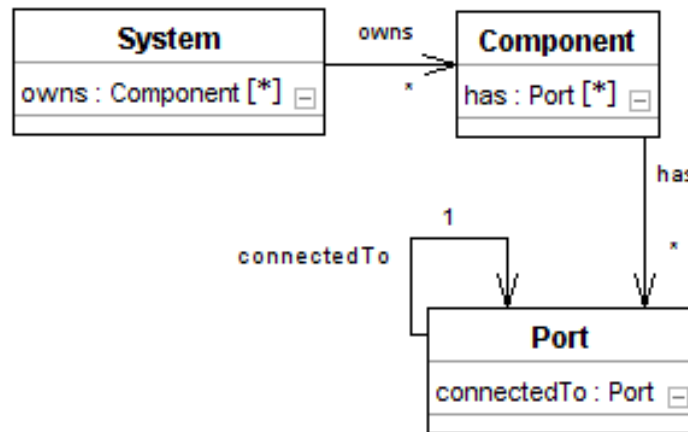

Fig. 6-3 System, Component and Port

The word **“mathematical or behavioral model”** is used to refer to a representation of our understanding of the conceptual structure and behavioral functioning of the **“system”**, in a way that facilitates simulation of the plausible behaviors of that system under various conditions (either historically observed or that might potentially occur), in support of generating improved understanding about the system or in support of decision making. Typical outputs from mathematical models in the aerospace and automotive industries are pressure, temperature, and flow of fuel etc.... Mathematical models attempt to recall the system in terms of performance or behavior and are therefore also called behavior models. The mathematical models can be classified and hierarchized in several different ways. The focus in the hierarchical classification below is on

typical fluid system simulation models, which often are dynamic, non-linear, and have continuous time and continuous states. A **simulation** is an execution of a model using input data to extract information from the model. A simulation is *an experiment* performed on a model. By analogy with an experiment in the real world on a system that needs atmospheric conditions and delivers measurement data, the model also needs inputs and delivers simulation data. The simulation enables the prediction of behavior of the system from a set of parameters and initial conditions.

As illustrated in Fig. 6-4, we defined different port nature such as Internal & External Parameters, Physical Variables (Input/Output) and Control Variables (Input/Output). AMESim model architecture graphical editor is used as a guide to be able to consider the causality notion.

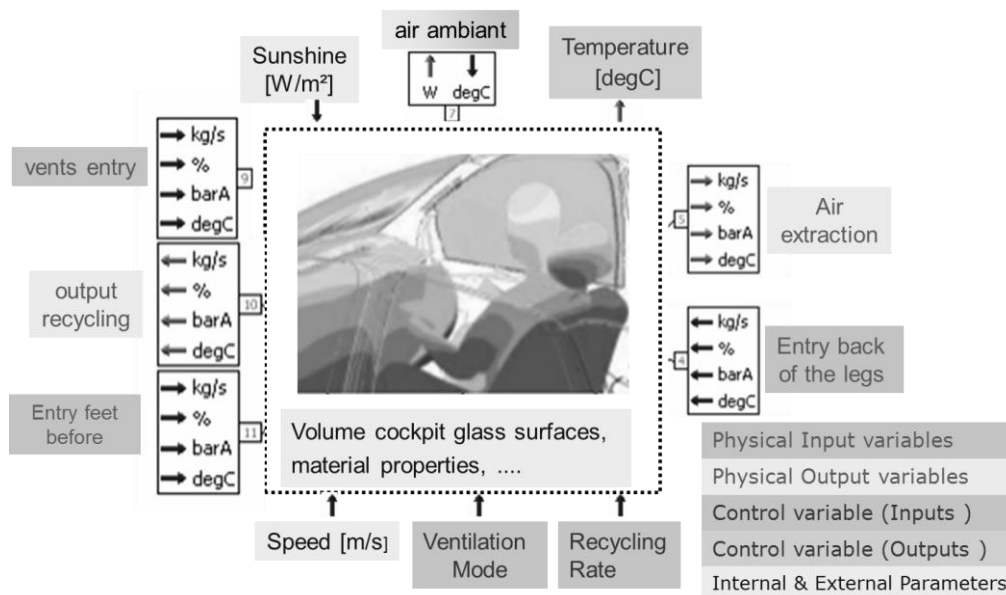

Fig. 6-4 Model and Interface Nature

The model architect characterizes each incoming and out-coming port of related submodels and their connections with each other. Each submodel has a MIC in which there is enough necessary information about the related model and its port connection with other models. Each port definition consists of Port Name, Port Nature, Direction, Domain, Sub-domain, variables, Units, Size, Min, Max values, and Resolution, Accuracy, etc (see Fig. 6-6). Once we define the incoming and outgoing ports and their connections with other submodels one by one, arKItech semiautomatically generates a block diagram (see Fig. 6-5).

The arrows may represent inputs, outputs, controls, mechanisms or calls for other.



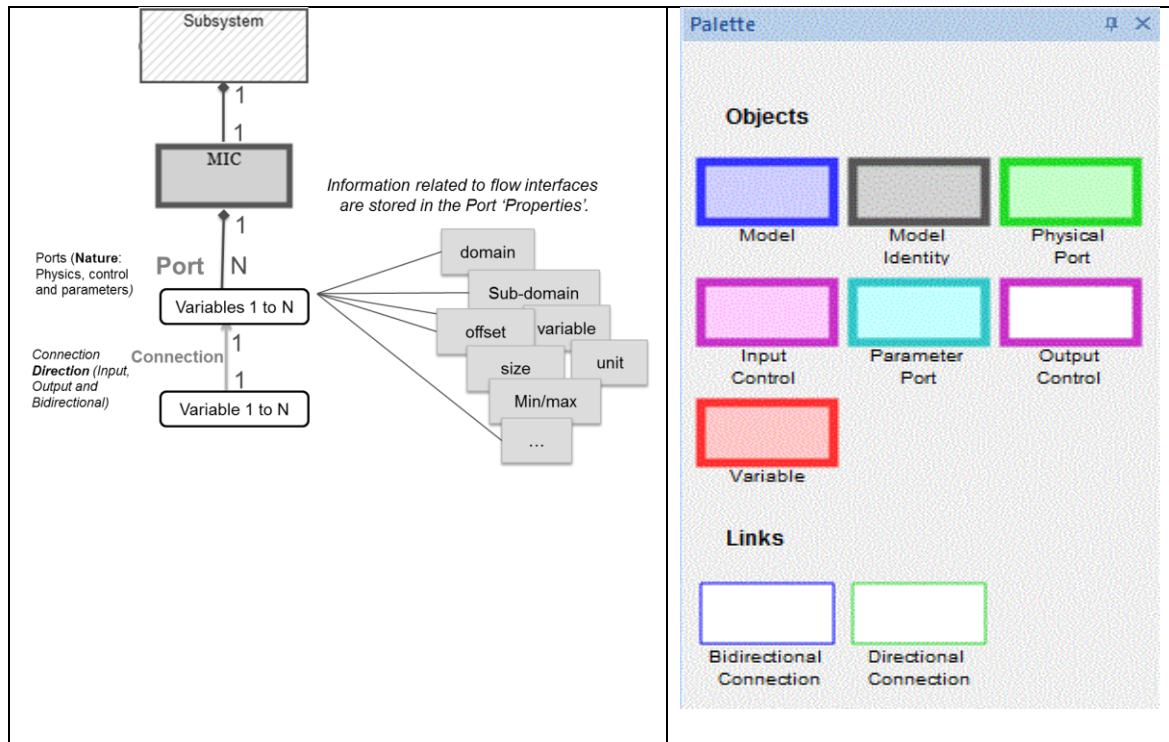

Fig. 6-5 MIC concept (left side) and created new objects in arKIitect desing tool (right side)

The semantics and the definition of the interfaces need to be accurate and complete because the communication within model components or between model components and outside environment have to be connected with well-defined interfaces. Interface does not contain any information about the internal behavior of the component. Instead, the interface exposes the key parameters whilst encapsulating the implementation of the model, which defines the internal behavior of the component (see Fig. 6-6).

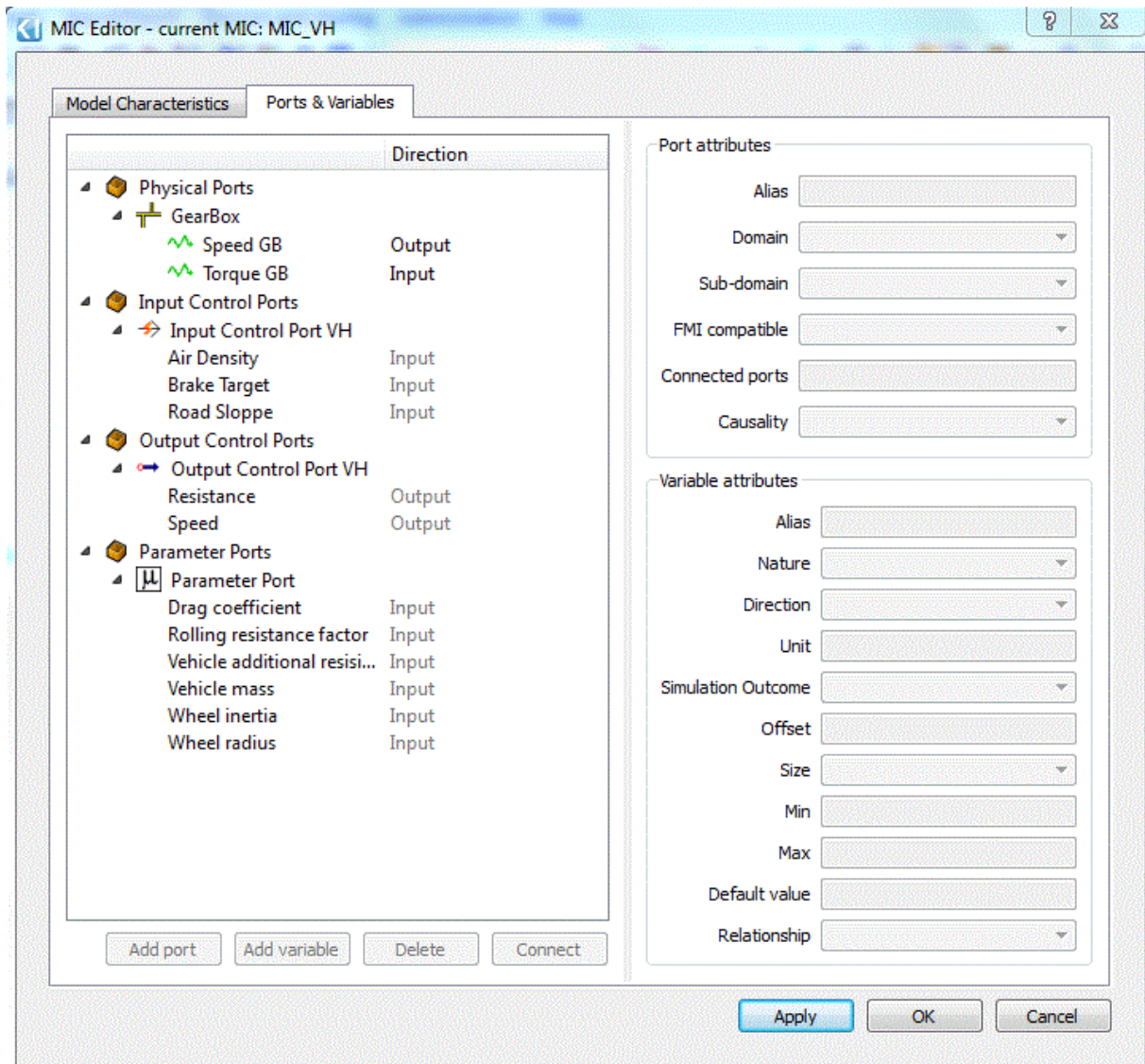

Fig. 6-6 MIC Port and Variable Specification

Each MIC can have several Ports of different Domains (Mechanical, Electrical, Hydraulic, Thermal...) which are presented in the same way (same appearance). Each Port can exchange in the 2 directions, based on the conventions. Each Port is composed of 1-4 Variables.

Variables represent Efforts (voltage, temperature, force, torque, pressure) & Flows (current, entropy, linear velocity, angular velocity, volumetric). Each Variable has a Direction (Input/Output regarding to its MIC). Links between Ports of different MICs is called Connection which represent all directional connections between the Variables of these Ports (Fig. 6-6).

As illustrated in Fig. 6-7, the model architect characterizes each incoming and out-coming port of related submodels and their connections with each other. Each submodel has a MIC in which there is enough necessary information about the related model and its port connection with other models. As an example, we characterize the “environment control system of an airplane cabin” submodel’s interface by using the MIC graphical user interface (GUI).

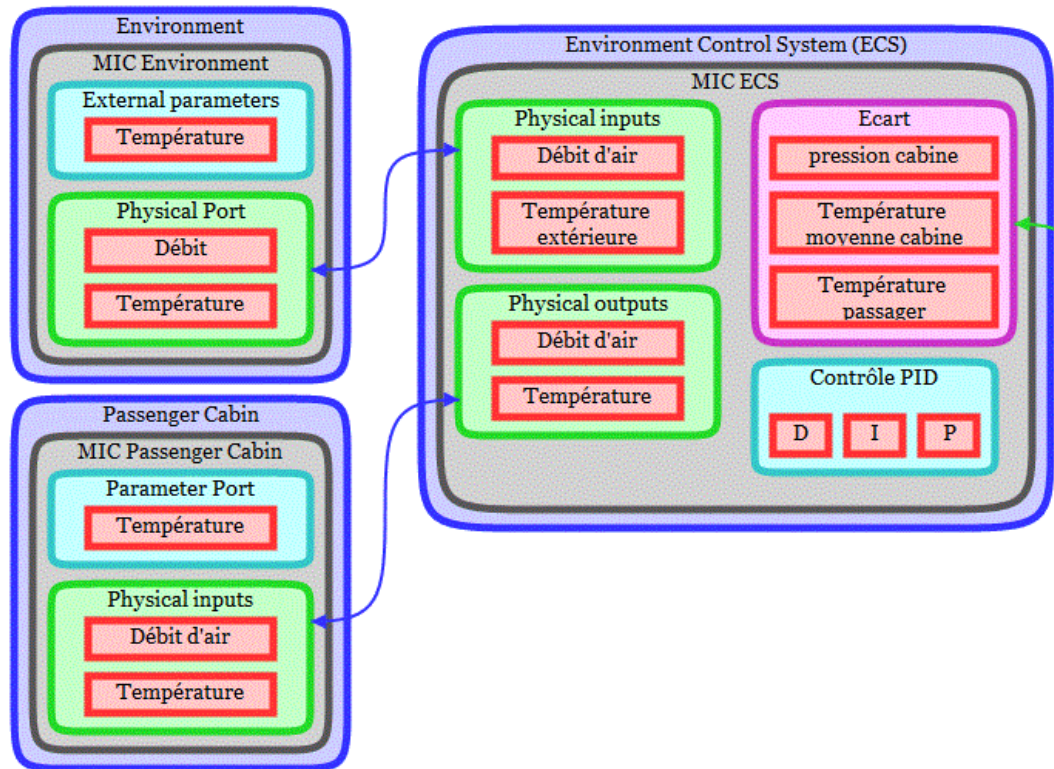

Fig. 6-7 Architecture created with defined graphical editor and MIC

## 6.2 Graphical User Interface (GUI) for Model Specification

The objective of MIC GUI is to simplify analysis models specification, sharing and reducing ambiguity and to reduce the amount of rework caused by interface inconsistency between domain models. MIC characterizes a model into 2 main classes: Model Characteristics with 4 sub classes (Object, Methods, Usage and Model Quality) (see Fig. 6-8) and ports and variables tab (see Fig. 6-9) that include the attributes of the model which are stored in the MIC Properties.

Fig. 6-8 MIC GUI for model specification

Below there are some definition of the attributes that are used in MIC GUI (see Fig. 6-8). For more information please see Appendix.

- **Model Dimension: (0 to 3D):**
  - **0D model** has no space dependency, has only a time dependency. Models with no time dependency are denoted as steady, steady state or stationary.
  - **1D model** includes one space dimension only. 1D steady state models lead to ordinary differential equations.

- **Chosen Method (Finite difference, elements, volumes; 0D)**
  - **Finite element method:** is a numerical technique for finding approximate solutions to boundary value problems for partial differential equations.
  - **Finite difference method:** is numerical methods for approximating the solutions to differential equations using finite difference equations to approximate derivatives.
  - **Finite volume method:** is a method for representing and evaluating partial differential equations in the form of algebraic equations.
  - **0D method**
- **Time Step (variable vs fixed)**
  - **Fixed-step solvers** solve the model at regular time intervals from the beginning to the end of the simulation.
  - **Variable-step solvers** vary the step size during the simulation, reducing the step size to increase accuracy when a model's states are changing rapidly and increasing the step size to avoid taking unnecessary steps when the model's states are changing slowly.
- **Linearity:**

**A linear model** uses parameters that are constant and do not vary throughout a simulation. This means that we can enter one fixed value for the parameter at the beginning of the simulation and it will remain the same throughout.

**A non-linear model** introduces dependent parameters that are allowed to vary throughout the course of a simulation run, and its use becomes necessary where interdependencies between parameters cannot be considered insignificant. Example of possible dependent parameters include is a temperature-dependent thermal conductivity
- **Model behavior (Continuous, Discrete, Mixed)**
  - The behavior of multidisciplinary systems is a combination of continuous time physic phenomena and events occurring at discrete space and time coordinate.

**Ex:** For high-fidelity simulation of such systems, hybrid modeling and simulation is required in which both continuous and discrete event phenomena can be represented. Many physical phenomena, such as rigid body motion, flow of electric currents, fluid flow, or heat flow, evolve as continuous functions of time and are therefore best modeled by a set of differential algebraic equations (DAEs).

  - Continuous variables described by differential equations.
  - Discrete events can occur that affect the continuously-changing variables.

- Some discrete-event simulation software will do combined discrete-continuous simulation as well.
- **Simulation Outcome (Static vs. Dynamic Model)**
  - **Static Model** is the one which describes relationships that do not change with respect to time.
  - **Dynamic models** are typically represented with differential equations.
- **Size (Matrix, Scalar, Vector)**
  - Number of inputs parameter allows to specify input signal names and dimensionality as well as the number of inputs. The following formats can be used to specify this parameter:
    - **Scalar:** Specifies the number of inputs to the output block. When this scalar is used, the block accepts signals of any dimensionality.
    - **Vector or Matrix:** The length of the vector specifies the number of inputs. Each element specifies the dimensionality of the corresponding input. A positive value specifies that the corresponding port can accept only vectors of that size. For example [2 3] specifies two input ports of size 2 and 3, respectively.
- **Scalability:** The ability of a distributed simulation to maintain time and spatial consistency as the number of entities and accompanying interactions increase.

### 6.3 Consistency Properties and Check

The overall “proof structure” is to verify that a particular consistency relationship exists between two abstractions of the two models. The consistency property desired is written in the Python script and integrated to the graphical editor by MIC metamodel. Mechanism can be broadly divided into two sections, the declarations for the abstract model structures to be checked and the declarations for the consistency property itself (see Fig. 6-9)

#### The viability rule:

This rule states the component-to-component possibilities of assembly. The rule exploits exclusively the information contained in the ports of the components. A basic definition of this rule is:

Only ports of the same type can be connected together:

- Two connected ports must have the same type or one must have a type parent of the other.
- Two connected ports must have opposite directions i.e. an output port must be connected to an input port and vice versa.

- A port must be connected at most to N ports, N being the port multiplicity.

**Interface rules:**

- Port Nature (mechanic, hydraulic, thermal etc...): only ports of the same type (nature) can be connected together
- Causality rule: only causal ports can be connected together
- Variable: Unit control (same units), sign convention (same direction) can be connected together

**Model Context Rules:**

- Compiler control between 2 connected models
- Type of model behavior: continue, discrete, mixed
- Tool version
- Time Step

	Compilability	ne computat	Scalability	Software	oftware versic	Time step
MicThermot	Yes	Elapsed tin	No	Amesim		hour
MicCooling	Yes	Real time	Yes	Amesim	V12	hour
MicAirext	Yes	Elapsed tin	No	Amesim		hour
MicClim	Yes	Elapsed tin	No	Amesim		hour
MicHvac	Yes	Elapsed tin	No	Amesim		hour
MicHabitacle	Yes	Elapsed tin	No	Amesim		hour
MicClimbox	Yes	Elapsed tin	No	Simulink		hour

Fig. 6-9 MIC Consistency Check

**Causality Check:**

- AMESim components can have ports with different types (mechanical, hydraulic, thermal...)
- Each port can exchange information in both directions (see Fig. 6-10):
  - Inputs (red)
  - Outputs (green)

Flux vs. Effort variables based on Power conservation

The inputs of the first connected port should correspond to the outputs of the second one = causality

- Only ports of the same type can be connected together

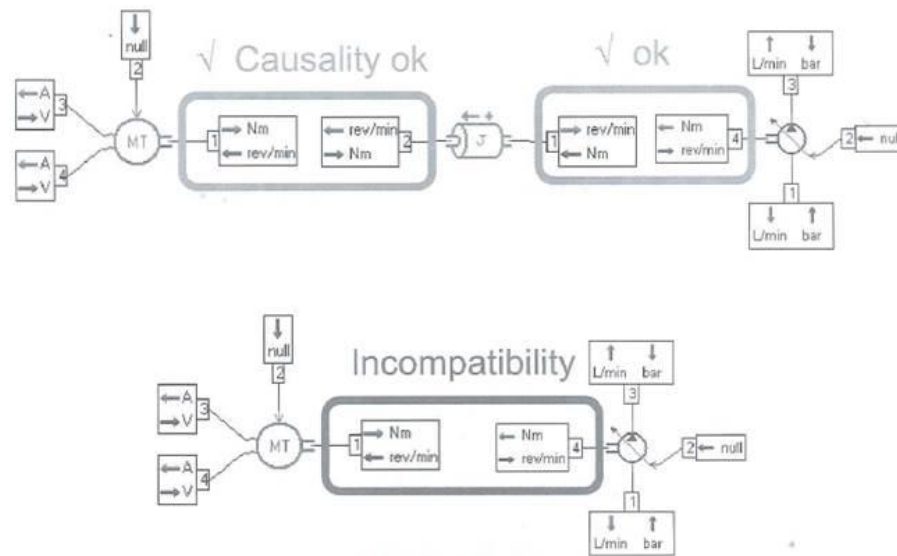

Fig. 6-10 Causality in Amesim Tool

#### 6.4 Organizational Change: Need for a new job description

To reduce the knowledge gap between system and model words and to support the new design activities that we have previously mentioned in Chapter 4 and 5, a new design actor named “**Model Architect**” is introduced. Each Model Architect has a multidisciplinary vision of a product and of simulation knowledge. He also has a deep understanding of the system-level requirements for the vehicle model, as well as how their models must interface with other domain models. There are multiple activities involved in the Model Architecture business cycle such as:

- understanding the system world requirements and interpreting and translating these requirements in model world,
- analyzing or evaluating and selecting the architecture,
- communicating and playing a transversal view between system architects and model providers.

These activities and proposed MIC meta-model are supported by a new design tool. An industrial tool is used to instantiate the MIC meta-model and a Graphical User Interface (GUI) is developed to create a semantically-rich model characterization support for the mentioned design actors.



Proposed new activities in the detailed model design phase and MIC concepts will be used in next generation OEM's multidisciplinary vehicle modeling strategy. Finally, the OEM that we worked with is creating a job description for the new design actor 'Model Architect' and is currently recruiting for this position.

**Reference #7**

- [1] S. Nurcan, C. Rolland. A multi-method for defining the organizational change. Journal of Information and Software Technology, Elsevier. Journal of Information and Software Technology, Elsevier. 45:2(2003), p. 61-82.
- [2] C. Rolland, S. Nurcan, G. Grosz. Enterprise Knowledge Development: the process view, Information and Management Journal, Elsevier 36(3), 1999, p.165-184.
- [3] S. Nurcan, C. Rolland. Using EKD-CMM electronic guide book for managing change in organisations, in Proceedings of the 9th European-Japanese Conference on Information Modelling and Knowledge Bases, Iwate, Japan, May 24-28, 1999, p.105-123.
- [4] G.Rasa *et al.* "Release and Deployment Management using ITIL", Global Journal of Computer Science and Technology, Vol.10 Issue 15 (Ver.1.0) December 2010

# 7

## **Conclusion, limits and research perspectives**

This thesis addresses the common needs of several software tool providers and industrial markets such as aerospace and automotive. It describes the methods, process and tool(s) that have been used to improve a successful collaboration between the industrial partners, and the modèle architecture design challenges that need to be explored within a multidisciplinary environment. Current inefficient way of working and lack of established process and design tools for supporting simulation model architecture design and collaborative development activity create some unnecessary iterations during simulation model integration phase. This is often responsible for increased product development lead-time and cost, schedule risk. To fulfill this need, the multidisciplinary simulation models need to be understandable and easy to create based on its architecture. Thus, it is necessary to maintain close links with the various disciplines and actors through clear information exchange in the early design stage.

164

Supporting Multidisciplinary Vehicle Modeling:  
Towards an Ontology-based Knowledge Sharing in Collaborative  
Model Based Systems Engineering Environment

In order to address this problem, this work aims to reduce late inconsistency detection by ensuring early stage collaborations between the different suppliers and OEM. Thus, this work integrates first a Detailed Model Design Phase to the current model development process and, second, the roles have been re-organized and delegated between design actors (Architect System and Model). The proposed detailed model design phase which is typically composed of the following steps:

**A System World Specification** which is made of:

- an operation scenario,
- a functional system architecture,
- a system analysis application plan with other systems (vehicle and sub systems level).

**A Model World Specification** which is made of:

- a structural formal vehicle architecture,
- a vehicle domain level models specification (e.g. model and its interfaces),
- a complete system level model architecture with negotiated domain model interfaces and related model specifications,
- an early certification (correctness control) before contracting suppliers - advanced checked options for detecting potential inconsistencies before IVVQ -.

These steps are supported by a new design tool and by an ontology based meta-model named “Model Identity Card (MIC)”. An industrial tool is used to instantiate the MIC meta-model and a Graphical User Interface (GUI) is developed to create a semantically-rich model characterization support for the mentioned design actors. MIC includes some important and refined characteristics of simulation model such as modeling assumptions and interfaces specifications. MIC in this case plays a role in the specification of such systems and improves the reliability of the systems by facilitating checking the match between the system requirements and the design solution. Another MIC objective is to simplify engineering knowledge capture and ambiguity reduction between design actors. MIC also helps to support a clear simulation model request creation and design artefact negotiation. Finally, MIC provides an interfaces correctness control for detecting and preventing interface mismatch problems between two domain models. To support the new activities previously mentioned at the detailed model design phase, a new design actor named “**Model Architect**” is introduced. Each Model Architect has a multidisciplinary vision of a product and of simulation knowledge. He also has a deep understanding of the system-level requirements for the vehicle model, as well as how their models must interface with other domain models.

This work proposes also a multi-view architectural method, aimed at reconciling the necessary high level and detailed design aspects and steps with the help of the mentioned actors. The design tools and mentioned activities perspectives (e.g. decisions, views and viewpoints) are structured by inspiration from Enterprise Architecture Frameworks (e.g. NAF, TOGAF, and DoDAF).

To demonstrate the applicability of our proposed solution, engine-after treatment, crash and electric transmission models are tested across automotive and aeronautic industries. The aim of this demonstration is to observe the significant improvement of current model design process in term of efficiency, interface mismatches reduction, and ambiguity and misunderstanding reduction. During this case study, some selected design actors (system architects and external/internal providers) have participated to the test scenarios. The objectives of validation of the proposed methods are twofold:

- (i) checking the scalability of MIC, i.e. the capacity to cover different natures of simulation models,
- (ii) qualitative observation to estimate the rate of model rework and ambiguity reduction

According to return of experience of the design actors who are involved in the case study and of our qualitative observations, the knowledge gap between the design actors is decreased by providing a MIC meta-model. (i) The MIC is partially integrated to the company and tested by different engineering teams. Following the test results, we can say that MIC's attributes are accurate and contain sufficient information for characterizing different natures of models (0D reduced, and 1D, 2D and 3D). This kind of test group experimentation is useful to be able to understand the proposed methods' functionality and capacity. Our aim is to make iterations with domain experts in terms of MIC and tool improvement until they succeed in meeting design requirements. The MIC is potentially a useful concept which contains sufficient information system to be modeled. MIC could possibly be applicable to another context such as aeronautics but it would require some work to extend it to support various specific domains of interest. (ii) Proposed early correctness control within a detailed model design phase aims to reduce the number of inconsistency based anomalies by a factor of 2. With the provided method, it would take approximately less than one staff hour of correctness check time for each defect found (e.g. current situation: inconsistency based rework creates on average, 2 or 3 supplementary staff work per project and 1 to 2 months of delay).

As a future consideration, proposed new activities in the detailed model design phase and MIC concepts will be used in next generation OEM's multidisciplinary vehicle modeling strategy. Finally, the OEM that we worked with is creating a job description for the new design actor 'Model Architect' and is currently recruiting for this position. A training roadmap was prepared for future Model Architects with the aim of introducing the new design tool and methodology.

In terms of future development stage, a MIC stand alone version will be shared with our external model providers for testing the MIC capacity. Another future consideration is that a Model of Intention (MoI) concept will be partially integrated to the detailed model design phase. MoI is a complementary method to MIC and allows to reduce the knowledge gap between Model Architect and Model Suppliers. MoI is an executable model and contains some observable parameters so as to be able to understand the requested models' expected behaviors for a given scenario. MIC and MoI are supposed to help also in choice of the most relevant simulation model available in OEM database.

## Personal Publications

### Journal papers

**Paper#1:** G. Sirin, L. Gasser, T. Welo, B. Yannou, and E. Landel, 2015. “Characteristics of Good Multidisciplinary Model Design Practice: Toward a Value-Added Thinking”, in preparation.

**Paper#2:** G. Sirin, F. Retho, M. Callot, P. Dessante, E. Landel, B. Yannou, J.C. Vannier, 2014. “Multidisciplinary Simulation Model Development: towards an inconsistency detection method during the design stage”. Submitted to Systems, Man and Cybernetics, Part A: Systems and Humans, IEEE Transactions.

**Paper#3:** G. Sirin., C.J.J. Paredis, B. Yannou, E. Landel, E. Coatanea, 2014. “A Model Identity Card to support model development process in a Collaborative Multidisciplinary Design Environment”. IEEE Systems Journal vol.PP, no.99, pp.1, 12.

**Paper#4 :** G. Sirin, B. Yannou, E. Landel, "Creating a Common Vocabulary to Support the Exchange of Numerical Models between Suppliers and Users in a Complex System Design", Special section on AFIS Doctoral Symposium: Systems Engineering Research Challenges in French Universities, Insight Journal of INCOSE 16/4, 30-32, December, 2013.

### Conference papers

- G. Sirin, B. Yannou, E. Coatanéa, and E. Landel, “Analysis of the simulation system in an automotive development project”, CSDM Complex Systems Design & Management Paris, France, 2012.
- G. Sirin, B. Yannou, E. Coatanéa, and E. Landel, “Discussion about Goal Oriented Requirement Elicitation Process into V model”, ICORD International Conference on Research into Design, Chennai, India, 2013.
- G. Sirin, B. Yannou, E. Coatanéa, and E. Landel, “Creating a Common Vocabulary to Support the Numerical Models Exchange Between Suppliers and Users in a Complex System Design”, IDETC/CIE, USA, 2013.
- G. Sirin, T. Welo, B. Yannou, and E. Landel, “Value Creation in Collaborative Analysis Model Development Processes”, IDETC/CIE, USA, 2014.





# Appendix

## TECHNICAL DEFINITION

- 1 Modeling and Simulation Terminology**
  - 1.1 System, Model and Simulation
  - 1.2 Model, Variables & Parameters Classification by Nature and Usage
  - 1.3 Causality and Model Development Tool
  - 1.4 Model Quality
    - 1.4.1 Input Pedigree – Uncertainties Quantification - History
    - 1.4.2 Validation & Robustness
    - 1.4.3 Verification
  
- 2 Model Identity Card (MIC)**
  - 2.1 MIC-FMI Standard Compatibility

This chapter is an overview of Model Identity Card and general M&S domain terminology to describe the different types of knowledge associated with models.

*This document is developed based on Amin El-Bakkali, Sören Steinkellner and some other researcher's works.*

## 1 MODELING AND SIMULATION TERMINOLOGY

This section provides an overview of model classification, simulation methods and their relation to engineering and vehicle model classification.

### 1.1 System, Model and Simulation

The word “**system**” will be used here to refer to a (generally complex) real world (usually physical) dynamical system, which can include natural as well as humanly engineered components.

**There are many reasons to simulate instead of setting up an experiment on a system in the real world.**

**The three main reasons are:**

- It is less expensive than perform experiments on real systems,

- It could be less dangerous. For example in aerospace development the pilot can practice a dangerous maneuver before performing it in the plane.
- The system may not yet exist, i.e. the model will act as prototype that is evaluated and tested.

**Other positive features that simulation provides are:**

- Variables not accessible in the real system can be observed in a simulation.
- It is easy to use and modify models and to change parameters and perform new simulations. With system design optimization many variants can be evaluated.
- The time scale of the system may be extended or shortened. For example, a pressure peak can be observed in detail or a flight of several hours can be simulated in minutes.

**The most important data flows in a model during simulation are (see Figure 2):**

- Parameters are constant during a simulation but can be changed in-between.
- Constants are not accessible for the simulation user.
- State Variables are quantities that can vary with time.
- Inputs are variables that affect the model.
- Outputs are variables that are observed.

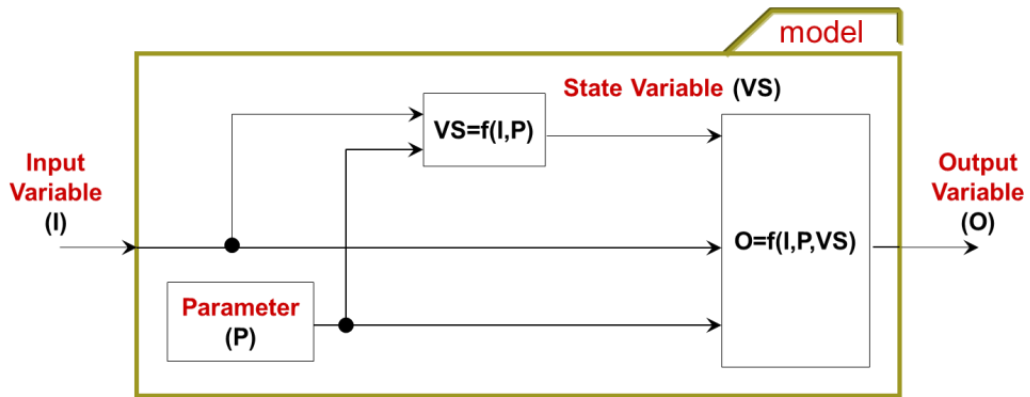

Figure 1 Model, white box

### Shock absorber

Relative displacements calculation based on applied force

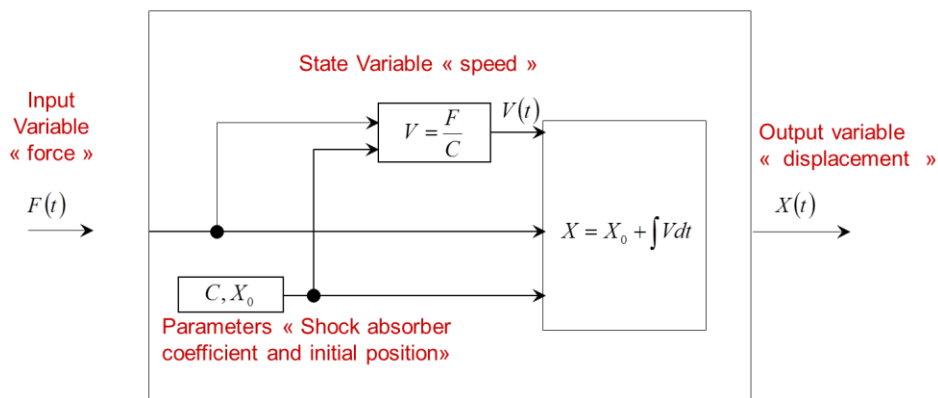

Figure 2 Model Parameters and Variables Example

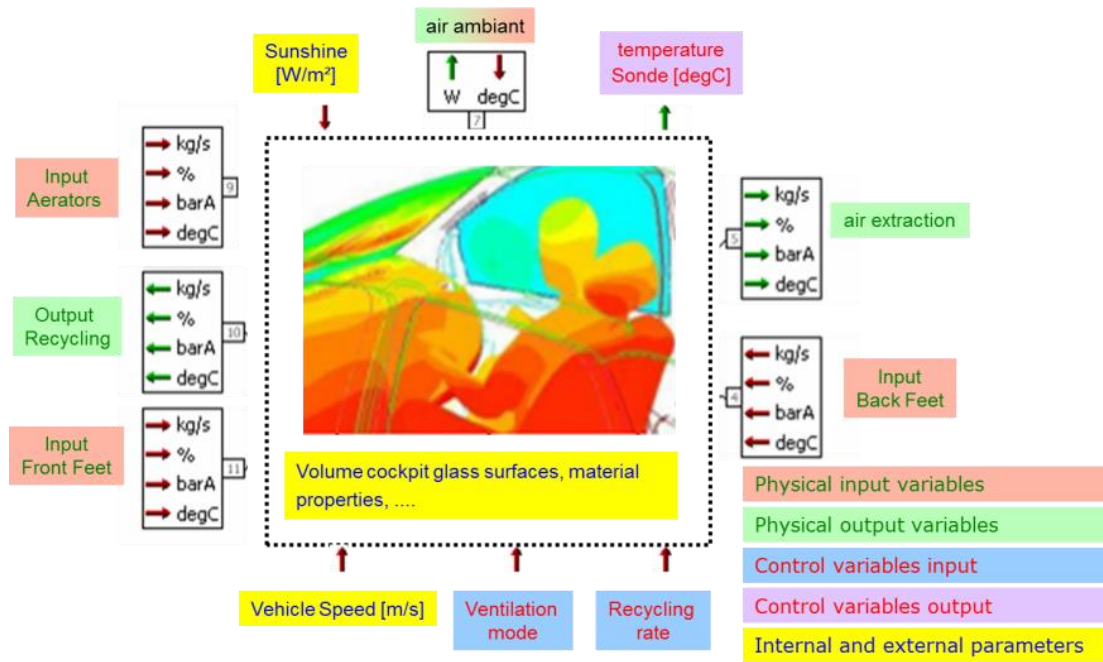

Figure 3 Input, Output and Control Variables

### State Variable

A state variable is a dynamically (i.e. time) varying characteristic of the system/model that represents the storage of mass/volume of the time varying quantity of interest within the system/model. A number of different state variables, taken together may be used to define the “state” of the system/model. Based on the conservation principle, the “state” (S) of the system/model is mathematically defined as being required to satisfy the equation  $dS(t)/dt = I(t) - O(t)$ , where  $I(t)$  and  $O(t)$  are the time varying inputs and outputs to the system/model respectively. It follows therefore that if the inputs and outputs have the units of mass/time (or volume/time, or concentration/time, etc.) that the state variables must have corresponding the units of mass (or volume or concentration etc., as appropriate). Dynamical models in use today are generally defined such that the state variable satisfies the Markov Property, which is that the state  $S(t)$  at time  $t$  contains all necessary information about the system needed to propagate the behavior of the system forward in time as new inputs become available, without the need to store/remember information about any previous (before time  $t$ ) inputs to the system. For example, in an automobile, the position, velocity and acceleration the car are state variables. In a thermodynamic system such as a water boiler, the heat stored in the water is a state variable.

**Control Variable**

A control variable is generally an input to the model/system or a variable/characteristic of the model/system which can be changed by the user/decision maker with the aim of modifying/controlling the behavior/response of the system. For example, in an automobile, the position of the accelerator pedal can be a control variable.

**Parameter**

A parameter is a characteristic of the model that represents some invariant property of the system, appears as a coefficient in the mathematical model equations, and has an influence on its input-state-output behavior. In environmental models it is usually considered to relate in a strong conceptual manner to some real property of the system. In a strict sense, a model parameter should be an invariant with respect to time. However, models are sometimes defined in such a way that the parameters are allowed to be time varying; if so, the form of variation must be precisely and externally specified before a model run is undertaken. One important function of the model parameters is to enable a set of model equations (or computer code) that describes the system in a generic way to be made specific to the particular system of interest. This can be done by adjusting the model parameters via a process called “model calibration” so that the input-state-output behavior of the model emulates/approximates the observed input-state-output behavior of the system. For example, in a model of an automobile, the mass of the automobile is a parameter. In a thermodynamic system such as a water boiler, the thermal conductivity of the boiler wall material is a parameter.

**!** Note that if a model parameter represents a property of the system that can (and may) be modified by the user/decision maker, then it can instead be considered to be a control/decision variable (e.g., the capacity of a man-made reservoir).

## 1.2 Model, Variables & Parameters Classification by Nature and Usage

The mathematical models can be classified and hierarchized in several different ways such as its nature, usage and dimension.

### 1.2.2 Simulation Output Classifications:

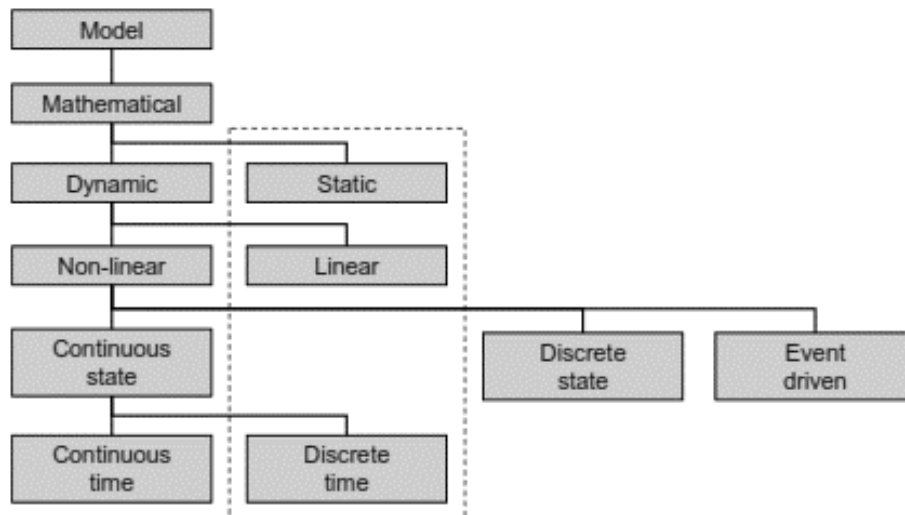

Figure 2 Simulation Output Classifications

#### Static vs. Dynamic Model

Static Model is the one which describes relationships that do not change with respect to time. In contrast to a static model, the output of a dynamic model can also be a function of the history of the models' inputs and not only a function of the current inputs. For example, the pressure in the aircraft fuel tank is a function of previous flight conditions. The pressure will be different if the aircraft is climbing, diving, or in level flight just before the observed time. Dynamic models are typically represented with differential equations. Setting the time derivative of the states to zero in a dynamic model will result in a static model.

#### Continuous vs. Discrete Time : Classification based on model's behavior

The behavior of multidisciplinary systems is a combination of continuous time physical phenomena and events occurring at discrete space and time coordinate. For high-fidelity simulation of such systems, hybrid modeling and simulation is required in which both continuous and discrete event phenomena can be represented. Many physical phenomena, such as rigid body motion, flow of electric currents, fluid flow, or

heat flow, evolve as continuous functions of time and are therefore best modeled by a set of differential algebraic equations (DAEs).

Physical events and digital components, on the other hand, generate outputs at discrete points in time and space; they are best modeled using discrete variables or impulse functions. Examples include rigid body collisions, data buses, and digital controllers. In addition, discrete event simulation is applied to a variety of other disciplines, including logistics, transportation, material handling, and military simulation. A good overview of the principles and industrial applications of discrete-event simulation can be found in [1]. Because mechatronic systems combine both continuous time phenomena and discrete events, they require mixed continuous-discrete models. Several simulation languages, including Modelica, support mixed systems modeling. These models also require advanced solvers that efficiently synchronize between DAE solving and discrete event propagation. Most commercial simulation software packages include this capability now.

### **Linear vs. Non-linear Systems:**

**A linear model** uses parameters that are constant and do not vary throughout a simulation. This means that we can enter one fixed value for the parameter at the beginning of the simulation and it will remain the same throughout.

**A non-linear model** introduces dependent parameters that are allowed to vary throughout the course of a simulation run, and its use becomes necessary where interdependencies between parameters cannot be considered insignificant. Examples of possible dependent parameters include:

- A temperature-dependent thermal conductivity

Table 1 Linear and Nonlinear Systems (adapted from Berkeley University Math Class Support) [6]

177

	<b>LINEAR SYSTEMS</b> $\dot{x}=Ax$	<b>NONLINEAR SYSTEMS</b> $\dot{x}=f(x)$
<b>EQUILIBIUM POINTS</b> A point where the system can stay forever without moving.	<b>UNIQUE</b> If A has rank n, then $x_e=0$ , otherwise the solution lies in the null space of A.	<b>MULTIPLE</b> $f(x_e)=0$ n nonlinear equations in n unknowns $0 \rightarrow +\infty$ solutions
<b>ESCAPE TIME</b>	$x \rightarrow +\infty$ as $t \rightarrow +\infty$	The state can go to infinity in finite time.
<b>STABILITY</b>	The equilibrium point is stable if all eigenvalues of A have negative real part, regardless of initial conditions.	About an equilibrium point: <ul style="list-style-type: none"> <li>• Dependent on IC</li> <li>• Local vs. Global stability important</li> <li>• Possibility of limit cycles</li> </ul> <b>LIMIT CYCLES</b> <ul style="list-style-type: none"> <li>• A unique, self-excited oscillation</li> <li>• A closed trajectory in the state space</li> <li>• Independent of IC</li> </ul>
<b>FORCED RESPONSE</b>	$\dot{x}=Ax+Bu$ <ul style="list-style-type: none"> <li>• The principle of superposition holds.</li> <li>• I/O stability <math>\rightarrow</math> bounded input, bounded output</li> <li>• Sinusoidal input <math>\rightarrow</math> sinusoidal output of same frequency</li> </ul>	$\dot{x}=f(x,u)$ <ul style="list-style-type: none"> <li>• The principle of superposition does not hold in general.</li> <li>• The I/O ratio is not unique in general, may also not be single valued.</li> </ul> <b>CHAOS</b> Complicated steady-state behavior, may exhibit randomness despite the deterministic nature of the system.

### Deterministic vs. Probabilistic Model

The simulation output of a deterministic model with a distinct set of input, model parameters, and model initialization will not differ from one simulation to another. In deterministic models all variables and parameters are functions of independent space and time variables. The independent variables are referred to by the usual notation  $x$ ,  $y$ ,  $z$  and  $t$ . In most models, especially in the relatively simple examples presented here, it is sufficient to formulate the problem considering only a subset of these four variables. Probabilistic models also include the probability distribution of the models' inputs and parameters. Extensive simulation of such models will result in the outputs of the model being given a probability distribution. Typical uncertain parameters are fluid properties and equipment performance degradation due to wear/aging. A



good representation of the probability distribution of the inputs and parameters in the model reflects probable measurement data distribution from aircraft or rig.

! **Combined discrete-continuous simulation**

- Continuous variables described by differential equations.
- Discrete events can occur that affect the continuously-changing variables.
- Some discrete-event simulation software will do combined discrete-continuous simulation as well.

A heterogeneous model is a model that consists of more than one model category, for example from a fuel system model with a continuous time equipment model connected to a discrete time control model.

Figure 5 classifies the variables and parameters based on its modifiable degrees and positioning in the model.

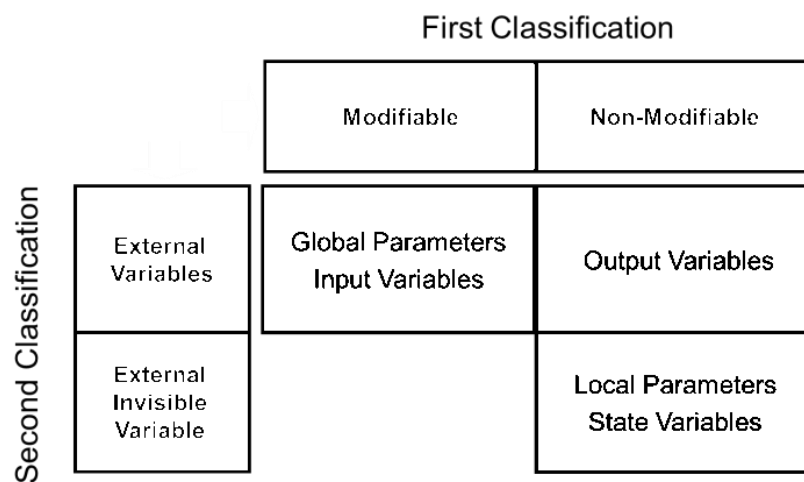

Figure 3 Variables & Parameters Classification

Example of global parameters: weather

**Model Dimension:**

Depending on the number of space dimensions, one speaks of 0D, 1D, 2D or 3D models. 0D models have no space dependency, only a time dependency. As  $t$  is the only independent variable, the analytical formulation leads to ordinary differential equations. These are differential equations, which depend on one variable only; in contrast to partial differential equations, where there are at least two independent variables. Models with no time dependency are denoted as steady, steady state or stationary. The corresponding terms for time dependent simulations are: unsteady or transient. A steady state is approached in real systems, if

the internal processes have time enough to adjust to constant outer conditions. It is a necessary condition for steady state that exterior processes or parameters do not change in time. Otherwise steady conditions cannot be reached.

1D model includes one space dimension only. 1D steady state models lead to ordinary differential equations.

- 2D model includes two space variables. One may distinguish between 2D horizontal and 2D vertical models. 3D models are quite complex. Numerical algorithms using the methods of Finite Differences, Finite Volumes or Finite Elements are the methods of choice for modeling in higher space dimensions, steady and unsteady.

Table 2 Model Classification par Hierarchy and Usage

	<b>Control World</b>	<b>Physical World</b>
<b>Environment</b>	<ul style="list-style-type: none"> <li>▪ Model of external communication</li> </ul>	<ul style="list-style-type: none"> <li>▪ Scenario Model</li> <li>▪ Traffic model</li> <li>▪ Infrastructure model</li> <li>▪ Test bed Model</li> <li>▪ Stimuli test model</li> </ul>
<b>Vehicle System</b>	<ul style="list-style-type: none"> <li>▪ Model of Control</li> <li>▪ Model of internal communication</li> <li>▪ Calculator Model</li> </ul>	<ul style="list-style-type: none"> <li>▪ Material Model</li> <li>▪ Component model</li> <li>▪ Organ Model</li> <li>▪ System Model</li> <li>▪ Vehicle Model</li> </ul>
<b>Humain</b>	<ul style="list-style-type: none"> <li>▪ Human Model</li> <li>▪ Passenger Model</li> </ul>	<ul style="list-style-type: none"> <li>▪ Driver model</li> </ul>

This classification serves as a support to build the system architecture to be modeled (**Erreur ! Source du renvoi introuvable.**).

Table 3 Model Classification Based on Model Nature

<b>Black Box Models</b>	<b>Gray Box Models</b>	<b>White Box Models</b>
Behavioral Model	Mesures and knowledge mixed models	Knowledge Model
Empirical Models	Half Physics or Empirical Models	Physical Models
Models made solely from experimental data. This is the most primitive form of model. They may have a predictive value in a range of restricted validity. <u>Example :</u> Emissions modeling engines = f (settings) by networks of neurons	Models which contain both equations from theory and empirical equations.  <u>Example :</u> Model of energy synthesis that mixes physical models (dynamic 0D) and empirical (emission maps)	Models derived from the analysis of physical phenomena.  <u>Example :</u> 3D modeling by solving the Navier Stokes flows

In a black box view model, the internal structure of a system is neglected and only its interaction over its system boundary to its context is considered this view is also called the interface of the system to its context (see Table 3). Depending on the form of interaction the interface of a system to its context can be separated into a static and dynamic aspect. In the static aspect it is described which events and values of interaction can occur in principle. In the dynamic aspects the system's interface behavior is described which shows the causal relationship between the sequences of actions provided by the actors of the context and the sequences of actions being the reactions of the system as exchanged and observed on the system's boundaries.

### 1.3 Causality and Model Development Tool

Historically, each technical domain has developed its own tools. This is a natural consequence of the requirements for a tool being just as high and specific to the product complexity in it. This is in order to achieve an efficient development environment. The increased complexity of the designed systems has put higher requirements on the tool's capability to resemble the system and still have a high level of abstraction in combination with a user friendly graphical interface (GUI).

Models easily become complex and unstructured without an appropriate tool. There are several modeling- and simulation tools on the market today that have reference libraries that describes the functionality of the component to ensure proper simulation. These are most often of the drag-and-drop type; this makes the modeling tool easy to use, thus minimizing the number of errors. Most simulation packages come with predefined libraries with sets of equations representing physical components. One of the major reasons for choosing a particular tool is whether a suitable component library already exists. Even so, it is not uncommon that some components may need to be tailored and added in order to simulate a specific system. When choosing a library, it is important to know to what levels of accuracy and bandwidth the components in the library are valid.

Causality is the property of cause and effect in the system and it is an important condition for the choice of modeling technique and tool. For physical systems with energy and mass flows, the causality is a question of modeling techniques/tools. In non-causal (or a causal) models, the causality is not explicitly stated, so the simulation tool has to sort the equations from model to the simulation code. When creating a causal model of a typical energy intensive system, the modeler has to choose what is considered to be a component's input and output. The bond graph modeling technique is a method that aids transformation from non-causal to causal models. The bond graph is an energy-based graphical technique for building mathematical models of dynamic systems. Thus, there are basically two representations, the signal flow/port approach using block diagrams suited to causal parts of the system and the power port approach, suitable for the non-causal parts.

The chosen approach should be based on the dominating causality characteristics of the system, but is sometimes an outcome of the tool available. The signal port approach clearly shows all variable couplings in the system. This is very useful for systems analysis and is therefore suitable for representing control systems and systems connected to them. However, a drawback is that the model may become complex and difficult to overview. In this case, power port modeling is more appropriate. In power port modeling, there are bi-directional nodes that contain the transfer of several variables. Power port is more compact and closely matches the real physical connection that by nature is bi-directional.

**Two examples of tools/languages for vehicle development are:**

- Modelica is an object-oriented language for modeling complex physical systems. Modelica is suitable for multi-domain modeling, for example modeling of mechatronic systems within vehicle applications. Such systems are composed of mechanical, electrical, and hydraulic subsystems, as well as control systems. Modelica uses equation-based modeling; the physical behavior of a model is described by differential, algebraic and discrete equations. Modelica models are acausal and use the power port technique. An M&S environment is needed to solve actual problems. The environment provides a customizable set of block libraries that let users design and simulate.
- Simulink from Mathworks and AMESim from LMS is also an environment for multi-domain M&S. The biggest difference compared to Modelica tools is that the models will be causal and use the signal flow technique. A causal block diagram is made up of connected operation blocks. The connections stand for signals, which are propagated from one block to the next. Blocks can be purely algebraic or may involve some notion of time such as delay or integration (see Figure 6 and 7).

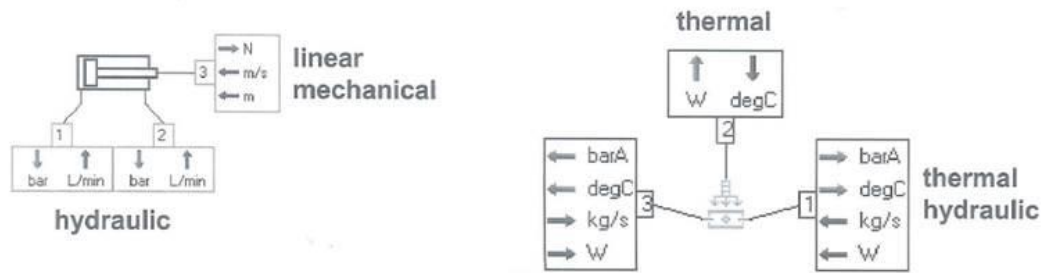

Figure 6 Multiple Regrouped Variables Representation in AMESim Tool

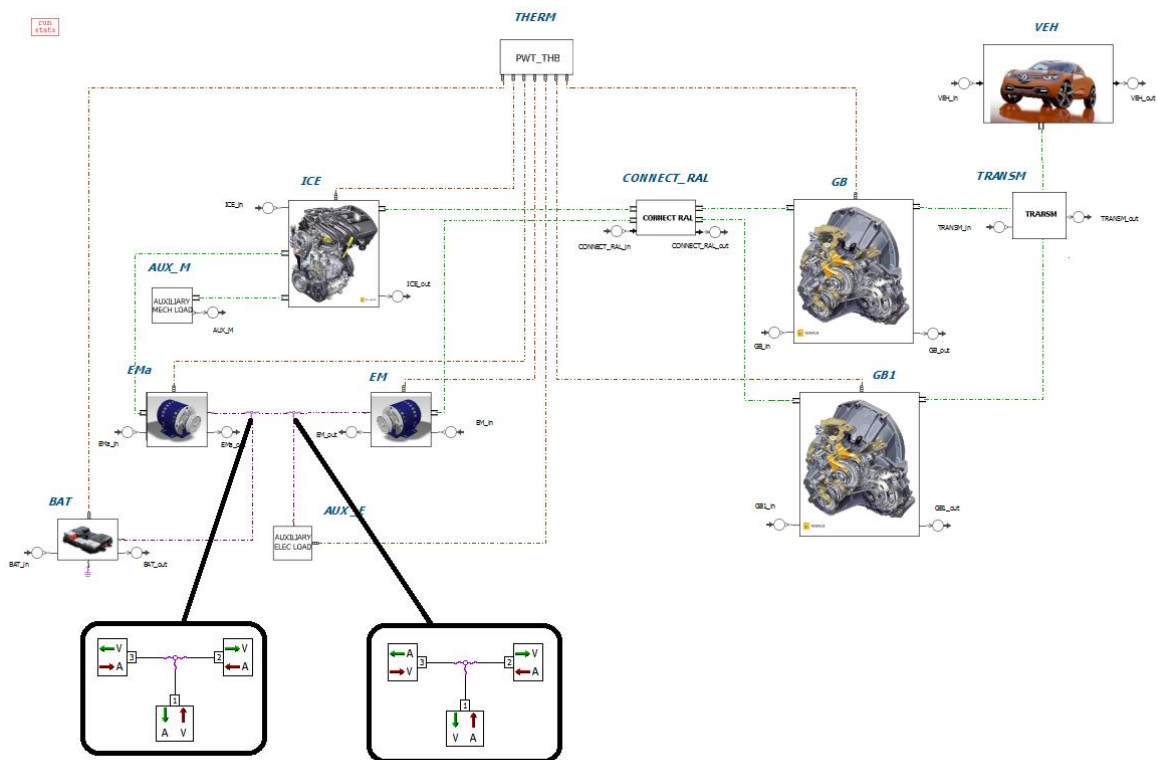

Figure 7 Causality in AMESim Tool

In the following table, effort and flow variables in some physical domains are listed.

Table 4 Physical Domain

Systems	Effort (e)	Flow (f)
Mechanical	Force (F)	Velocity (v)
	Torque ( $\mathcal{T}$ )	Angular velocity ( $\omega$ )
Electrical	Voltage (V)	Current (i)
Hydraulic	Pressure (P)	Volume flow rate (dQ/dt)
Thermal	Temperature (T)	Entropy change rate (ds/dt)
	Pressure (P)	Volume change rate (dV/dt)
Chemical	Chemical potential ( $\mu$ )	Mole flow rate (dN/dt)
	Enthalpy (h)	Mass flow rate (dm/dt)
Magnetic	Magneto-motive force ( $\epsilon_m$ )	Magnetic flux ( $\Phi$ )

### Verification and Validation (V&V)

Verification and validation (V&V) are two terms that are often mixed up. The general definitions of V&V are:

- Verification. Did I build the thing right? Is the computer implementation of the conceptual model correct?
- Validation. Did I build the right thing? Can the conceptual model be substituted, at least approximately for the real system?

### Definition of Verification:

Verification tasks are often independent of context and can often be objectively answered with a yes or a no, e.g. formal verification. With M&S tools, such Dymola and Simulink, the number of computer programming and implementation errors has been reduced. Model verification then primarily ensures that an error-free simulation language has been used, that the simulation language has been properly implemented on the computer, and the model programmed correctly in the simulation language [4].

- **Procedures for Verification**

- Structured programming
- Self-document
- Peer-review
- Consistency in input and output data

### **Definition of Validation**

Model validation, on the other hand, cannot be performed in early development phases such as the concept phase due to the need for system experiment data. However, sensitivity analyses can still be made that point out model component parameters that have a strong influence on the simulation result or compare the assumed uncertainty data influence with similar model accuracy experience. Later in the development process, when more knowledge and measurement data is available, model validation with measurement data can begin. Model validation is context dependent, e.g. for a specific simulation task a model can be validated in parts of the flight envelope for some model outputs. For another simulation task with its context a complete other model validation status can exist. In [4] a broader aspect and on a higher level has been taken concerning M&S result credibility. Eight factors have been defined with a five-level assessment of credibility for each factor, Verification Validation, Input Pedigree Results, Uncertainty, Results, Robustness, Use History M&S, Management, People, Qualifications. The approach clearly demonstrates the large number of factors that affect a model's credibility, which inevitably means that in the case of large models it is an extremely time-consuming task to make them credible.

To produce credible simulation results the simulated environment must be realistic and validated using accepted practices. Model validation should be performed at the lowest level that can be supported by test data in addition to the vehicle level to build confidence that the models can be used for vehicles other than the specific one(s) used for validation. Confidence in a model should be based on the accuracy of the model relative to test data, and the repeatability of the test data should be considered as well. For example, if a model produces results with 3% error versus test data, then conclusions from simulations can only be made when differences are greater than 3%.

### **Procedures**



- Standing to criticism/Peer review (Turing)
- Sensitivity analysis
- Extreme-condition testing
- Validation of Assumptions
- Consistency checks

### **MIC-FMI Standard Compatibility**

MIC and FMI interface specification compatibilities have been verified.

### **Classification of Interface Variables**

Variables exposed by the FMU are categorized in a slightly different way in FMI 2.0:

Attribute “causality” is an enumeration that defines the causality of the variable. Allowed values are:

parameter: An independent variable that must be constant during simulation.

input: The variable value can be provided from another model.

output: The variable value can be used by another model. The algebraic relationship to the inputs is defined in element Model Structure.

local: Local variable that is calculated from other variables. It is not allowed to use the variable value in another model

Attribute “variability” is an enumeration that defines the time dependency of the variable, in other words it defines the time instants when a variable can change its value. Allowed values are:

- constant: The value of the variable never changes.
- fixed: The value of the variable is fixed after initialization.
- tunable: The value of the variable is constant
- between externally triggered events due to changing variables with causality = "parameter" or "input" (see explanation below).
- discrete: The value of the variable is constant between internal events (= time, state, step events defined implicitly in the FMU).
- continuous: No restrictions on value changes.

## Terminology used in the manuscript [2-5]

**Adequacy:** The decision that the model fidelity is sufficient for the intended use.

**Uncertainty:** The extent to which a prediction may deviate from a future outcome.

**Uncertainty Quantification:** The process of characterizing all uncertainties in the model and experiment, and quantifying their effect on the simulation and experimental outcomes.

**Calibration:** The process of adjusting numerical or modeling parameters in the model to improve agreement with a referent.

**Contract:** a formal or informal specification of agreement that specifies the rights and obligations associated with a product.

**Value:** that which makes some party appreciate a product or service

**Change Management:** Change management processes are used to deliver a finalized and tested change into a preproduction environment along with a set of tools and/or procedures for migrating the change into the live production environment.

**Deployment:** The activity responsible for movement of approved releases of hardware, software, documentation, process etc. to test and production environments.

### Model Dimension

0D : Equation dans un volume défini sans localisation spatiales

1D : On dérive dans les équations suivant un axe dimensionnel

2D : On dérive dans les équations suivant deux axes dimensionnels

3D : On dérive dans les équations suivant les 3 axes dimensionnels

**Accuracy:** The difference between a parameter or variable (or a set of parameters or variables) within a model, simulation, or experiment and the true value or the assumed true value.

**Verification:** The process of determining that a model implementation accurately represents the developer's conceptual description of the model.

**Validation:** The process of determining the degree to which a model is an accurate representation of the real world from the perspective of the intended uses of the model.

**Ontology:** An ontology is an explicit specification of conceptualization of a domain. Thus, by the definition, an ontology is a set of concepts and their relationships.

**Conceptual model:** the collection of abstractions, assumptions and descriptions of physical processes representing the behavior of the reality of interest from which the mathematical model or validation experiments can be constructed

**Mathematical model:** the mathematical equations, boundary values, initial conditions and modeling data needed to describe the behavior of the conceptual model.

#### Reference #6

[1] H.V. Gupta, K.J. Beven and T. Wagener, 2005 “Model Calibration and Uncertainty Estimation”, in Encyclopedia of Hydrologic Sciences, 3 Volumes, John Wiley and Sons.

[2] S. Steinkellner, 2011, “Aircraft Vehicle Systems Modeling and Simulation under Uncertainty”, Linköping studies in science and technology thesis no 1497, Department of management and engineering division of machine design Linköpings universitet, Linköping 2011.

[3] Nasa Technical Standard (2008), Standard for models and simulations National Aeronautics and Space Administration Washington, DC 20546-0001, NASA-STD-7009.

[4] U.S. Dod. Verification, Validation and Accreditation Recommended Practice Guide (MSCO VV&A RPG) Glossary.

[5] IEEE Standard Glossary of Modeling and Simulation Terminology, IEEE Std 610.3-1989, vol., no., pp.0\_1, 1989 doi: 10.1109/IEEE STD.1989.94599.

[6] [http://www.me.berkeley.edu/ME237/2\\_general\\_properties.pdf](http://www.me.berkeley.edu/ME237/2_general_properties.pdf)