



HAL
open science

Utilisation des antifongiques chez le patient non neutropénique en réanimation

Sébastien Bailly

► **To cite this version:**

Sébastien Bailly. Utilisation des antifongiques chez le patient non neutropénique en réanimation. Applications [stat.AP]. Université Grenoble Alpes, 2015. Français. NNT: 2015GREAS013. tel-01294777

HAL Id: tel-01294777

<https://theses.hal.science/tel-01294777v1>

Submitted on 29 Mar 2016

HAL is a multi-disciplinary open access archive for the deposit and dissemination of scientific research documents, whether they are published or not. The documents may come from teaching and research institutions in France or abroad, or from public or private research centers.

L'archive ouverte pluridisciplinaire **HAL**, est destinée au dépôt et à la diffusion de documents scientifiques de niveau recherche, publiés ou non, émanant des établissements d'enseignement et de recherche français ou étrangers, des laboratoires publics ou privés.

UNIVERSITÉ GRENOBLE ALPES

THÈSE

Pour obtenir le grade de

DOCTEUR DE L'UNIVERSITÉ GRENOBLE ALPES

Spécialité : **Modèles, méthodes et algorithmes en biologie, santé et environnement**

Arrêté ministériel : 7 août 2006

Présentée par

Sébastien BAILLY

Thèse dirigée par **Jean-François TIMSIT**

préparée au sein de l'Institut Albert BONNIOT – UJF – INSERM
U823 – Equipe 11 : épidémiologie clinique des cancers des voies
aériennes et des patients de réanimation
dans l'École Doctorale Ingénierie pour la Santé, la Cognition,
l'Environnement

Utilisation des antifongiques chez le patient non neutropénique en réanimation

Thèse soutenue publiquement le **15 octobre 2015**,
devant le jury composé de :

Pr Bernard ALLAOUCHICHE (Membre)

Hospices Civils de Lyon et Université Lyon 1

Pr Pierre-Emmanuel CHARLES (Membre)

CHU de Dijon et Faculté de Dijon

Pr Muriel CORNET (Présidente)

CHU de Grenoble et Université Grenoble Alpes

Dr Philippe EGGIMANN (Rapporteur)

CHU Vaudois et Université de Lausanne

Pr Anne-Marie SCHOTT-PETHELAZ (Rapporteur)

Hospices Civils de Lyon et Université Lyon 1

Pr Jean-François TIMSIT (Membre)

Hôpital Bichat et Université Grenoble Alpes



Remerciements

J'adresse tous mes remerciements aux membres du jury :

A mon Directeur de thèse, Monsieur le Professeur Jean-François Timsit. Vous m'avez fait confiance pour mener à bien ce travail en me permettant d'aller à l'essentiel, de me dépasser et surtout vous avez su rendre passionnants ces travaux de recherche. J'aimerais aussi vous dire à quel point j'ai apprécié votre disponibilité et votre patience.

A Madame le Professeur Anne-Marie Schott pour avoir accepté d'être rapporteur de ma thèse. Je tiens à vous remercier tout particulièrement pour votre accueil dans votre service pour mon premier semestre d'internat. Grâce à vous j'ai pu conforter mon choix de parcours qui a aboutit à ce mémoire.

A Monsieur le Docteur Philippe Eggimann pour avoir accepté d'être rapporteur de ma thèse. Vos travaux de recherche ont été extrêmement précieux et m'ont énormément aidé dans la compréhension des problématiques cliniques des candidoses invasives.

A Madame le Professeur Muriel Cornet pour avoir accepté de participer à mon jury et pour votre soutien durant ma thèse et mes années d'internat.

A Monsieur le Professeur Bernard Allaouchiche ainsi qu'à Monsieur le Professeur Pierre-Emmanuel Charles de me faire l'honneur de participer à ce jury de thèse.

Tous mes remerciements aux personnes qui ont permis la réalisation de cette thèse :

A Monsieur le Professeur Hervé Pelloux qui, en me mettant en lien avec le Pr JF Timsit et en m'accueillant dans le service de Parasitologie et Mycologie du CHU de Grenoble durant mon internat a rendu possible ce travail et dans les meilleures conditions possibles.

A Madame le Docteur Danièle Maubon pour son soutien inconditionnel pour la réalisation des travaux de cette thèse. Ce fut un plaisir de travailler avec toi.

A Monsieur le Professeur Pierre Hainaut, Directeur de l'Institut Albert Bonniot, pour m'avoir donné les moyens de terminer ma thèse.

A Madame le Docteur Raphaëlle Germe pour votre écoute et votre disponibilité pour le montage de mon dossier de demande de bourse d'année recherche qui a pu aboutir et ainsi me dégager de tout souci d'ordre financier.

A Monsieur le Docteur Romain Pirracchio pour son aide, sa pédagogie sur les modèles structurels marginaux et les nouveaux estimateurs et surtout pour sa réactivité et sa disponibilité dans la relecture des articles.

Je remercie tous les co-auteurs pour leur aide et leur réactivité lors de la publication des articles.

Je remercie particulièrement Madame le Docteur Céline Feger pour sa relecture attentive de l'anglais et sa réactivité à toute épreuve.

Je tiens à remercier Stéphane Ruckly pour son aide et ses conseils précieux pour l'accès à la base de données et les scripts SAS.

A tous ceux qui m'ont aidé dans le recueil de données : Toufik Ariba et Eric Fernandez pour leur aide précieuse dans le recueil des données biologiques, le Dr Claire Chapuis et le Dr Luc Foroni pour les données pharmaceutiques, Madame Hélène Ghelfi et le Dr Jean-Charles Cartier pour les données cliniques.

Au Docteur Jean Iwaz pour son aide précieuse à Lyon puis à distance pour tous ses bons conseils de rédaction et de reformulation en anglais.

A toute l'équipe de IAME pour leur accueil à chaque venue sur Paris.

A Anne-Sophie, avec qui ce fut un plaisir de travailler et de mettre en application les méthodes statistiques. J'espère avoir été à la hauteur pour t'accompagner dans ton master.

Je tiens également à remercier ceux qui m'ont accompagné sur le chemin de la thèse :

A Pascal, cela fut un plaisir de te rencontrer et de découvrir avec toi l'épidémiologie clinique. Au plaisir de venir te rendre visite en Picardie, ou pour quelques randonnées !

A Guillaume, pour tous les souvenirs partagés ensemble. J'espère que nous pourrions retrouver du temps pour la suite.

A mes parents, pour votre soutien et votre générosité inconditionnels, sans vous rien n'aurait été possible.

A mon fils, Samuel pour toute la joie que tu me donnes à te voir grandir, découvrir, t'étonner et t'émerveiller sans cesse.

A Marie, pour ton soutien sans faille pendant tous ces moments parfois difficiles. Et plus simplement, parce que nous sommes toute la vie, mon amour.

Sommaire

Remerciements	2
Sommaire	5
Abréviations	6
Résumé	8
Abstract	9
Introduction	10
Première partie : État des lieux sur le traitement probabiliste des candidoses invasives	14
Publication N 1 : Empiric/pre-emptive anti-Candida therapy in non-neutropenic ICU patients	16
Deuxième partie : Exploration de données mycologiques longitudinales	23
I. Présentation des données	24
II. Effet du traitement antifongique sur la pression de sélection des espèces <i>Candida</i> en USI : analyse de séries temporelles	25
Publication N 2 : Impact of Antifungal Prescription on relative distribution and susceptibility of <i>Candida</i> spp – Trends Over 10 Years	27
Supplément électronique de la publication 2	56
III. Impact du traitement antifongique sur le diagnostic des candidémies : analyse de données répétées	61
Publication N 3 : Impact of systemic antifungal therapy on the detection of <i>Candida</i> spp. in blood cultures containing resins or selective media, in the clinical setting of candidemia	63
Supplément électronique de la publication 3	88
Troisième partie : Approche causale à partir de bases de données cliniques de haute qualité	95
I. Approche causale sur les données observationnelles	96
II. Impact de la désescalade précoce sur le pronostic des patients	98
Publication N°4 : Antifungal de-escalation was not associated with adverse outcome in critically ill patients treated for invasive candidiasis – Post-hoc analyses of the AmarCAND2 study data	99

Supplément électronique de la publication 4	111
III. Analyse causale sur données longitudinales.....	120
Publication N 5:What’s new to quantify causal effects from longitudinal cohort studies. A brief introduction to marginal structural models for intensivists.....	121
Supplément électronique de la publication 5	126
IV. Impact du traitement précoce sur le pronostic des patients	133
Publication N°6 : Failure of Empirical Systemic Antifungal Therapy in Mechanically- ventilated Critically Ill Patients	134
Supplément électronique de la publication 6	145
Conclusion.....	167
I. Apport de la thèse sur la prise en charge des candidoses invasives.....	168
II. Apport des méthodes statistiques sur l’exploration des données observationnelles ...	169
Les séries chronologiques	169
Les méthodes d’inférence causale	170
III. Perspectives sur les candidoses invasives	171
L’identification des patients à risque de candidose invasive	171
L’identification des effets liés aux USI	171
L’optimisation du diagnostic	171
IV. Perspectives statistiques	172
Références bibliographiques	173

Abréviations

AE : Bactect Plus Aerobic /F

ANA : Bactect Plus Anaerobic /F

ARD : Absolute risk difference

ARIMA : Autoregressive integration mobile average

ATE : Average treatment effect

ATT : Average treatment effect in the treated

BC : Blood cultures

CHU : Centre hospitalier universitaire

CI : Confidence interval

CMI : Concentration minimale inhibitrice

DDD : Defined daily doses

DE : De-escalation

DR : Double Robust

ELISA : Enzyme-linked immunosorbent assay

ESCMID : European society of clinical microbiology and infectious diseases

ESM : Electronic supplement material

FSV : Fungal-selective vials

HD : Hospital day

HR : Hazard ratio

I : Intermédiaire/Intermediate

IC : Invasive candidiasis

ICU : Intensive care unit

IDSA : Infectious diseases society of America

IMV : Invasive mechanical ventilation

IPTW : Inverse probability of treatment weighting

IQR : Interquartile range

MIC : Minimum inhibitory concentration

MSM : modèle structurel marginal

MY : Bactect Mycosis IC/F

OR : Odds ratio

PCR : Polymerase chain reaction

PR : Positivity rate

PS : Propensity score

R : Résistant/resistant

RCT : Randomized controlled trial

RR : Relative risk

RV : Resin vials

S : Sensible/Susceptible

SAPS : Simplified acute physiology score

SAT : Sytemic antifungal therapy

SOFA : Sepsis-related organ failure

TTP : Time to positivity

USI : Unité de soins intensifs

Résumé

Les levures du genre *Candida* figurent parmi les pathogènes majeurs isolés chez les patients en soins intensifs et sont responsables d'infections systémiques : les candidoses invasives. Le retard et le manque de fiabilité du diagnostic sont susceptibles d'aggraver l'état du patient et d'augmenter le risque de décès à court terme. Pour respecter les objectifs de traitement, les experts recommandent de traiter le plus précocement possible les patients à haut risque de candidose invasive. Cette attitude permet de proposer un traitement précoce aux malades atteints, mais peut entraîner un traitement inutile et coûteux et favoriser l'émergence de souches de moindre sensibilité aux antifongiques utilisés.

Ce travail applique des méthodes statistiques modernes à des données observationnelles longitudinales. Il étudie l'impact des traitements antifongiques systémiques sur la répartition des quatre principales espèces de *Candida* dans les différents prélèvements de patients en réanimation médicale, sur leur sensibilité à ces antifongiques, sur le diagnostic des candidémies ainsi que sur le pronostic des patients. Les analyses de séries de données temporelles à l'aide de modèles ARIMA (moyenne mobile autorégressive intégrée) ont confirmé l'impact négatif de l'utilisation des antifongiques sur la sensibilité des principales espèces de *Candida* ainsi que la modification de leur répartition sur une période de dix ans. L'utilisation de modèles hiérarchiques sur données répétées a montré que le traitement influence négativement la détection des levures et augmente le délai de positivité des hémocultures dans le diagnostic des candidémies. Enfin, l'utilisation des méthodes d'inférence causale a montré qu'un traitement antifongique préventif n'a pas d'impact sur le pronostic des patients non neutropéniques, non transplantés et qu'il est possible de commencer une désescalade précoce du traitement antifongique entre le premier et le cinquième jour après son initiation sans aggraver le pronostic.

Mots clés : traitement antifongique systémique ; unités de soins intensifs ; candidoses invasives ; inférence causale ; données observationnelles longitudinales ; modèles structurels marginaux.

Abstract

Candida species are among the main pathogens isolated from patients in intensive care units (ICUs) and are responsible for a serious systemic infection: invasive candidiasis. A late and unreliable diagnosis of invasive candidiasis aggravates the patient's status and increases the risk of short-term death. The current guidelines recommend an early treatment of patients with high risks of invasive candidiasis, even in absence of documented fungal infection. However, increased antifungal drug consumption is correlated with increased costs and the emergence of drug resistance whereas there is yet no consensus about the benefits of the probabilistic antifungal treatment.

The present work used modern statistical methods on longitudinal observational data. It investigated the impact of systemic antifungal treatment (SAT) on the distribution of the four *Candida* species most frequently isolated from ICU patients', their susceptibilities to SATs, the diagnosis of candidemia, and the prognosis of ICU patients. The use of autoregressive integrated moving average (ARIMA) models for time series confirmed the negative impact of SAT use on the susceptibilities of the four *Candida* species and on their relative distribution over a ten-year period. Hierarchical models for repeated measures showed that SAT has a negative impact on the diagnosis of candidemia: it decreases the rate of positive blood cultures and increases the time to positivity of these cultures. Finally, the use of causal inference models showed that early SAT has no impact on non-neutropenic, non-transplanted patient prognosis and that SAT de-escalation within 5 days after its initiation in critically ill patients is safe and does not influence the prognosis.

Keywords: systemic antifungal treatment, intensive care units, invasive candidiasis, causal inference, observational longitudinal data analysis, structural marginal models.

Introduction

Depuis les années 1990, le progrès médical a contribué à améliorer significativement l'espérance de vie des patients sévères, notamment en unités de soins intensifs (USI). [1] Cette amélioration est associée à une hausse des actes invasifs, des traitements immunosuppresseurs et des thérapies antibactériennes à large spectre et a entraîné une augmentation du nombre de patients à risque d'infections fongiques invasives.[2-4]

Les candidoses invasives, dues à des levures du genre *Candida*, constituent la première cause d'infections fongiques en milieu hospitalier observées chez l'homme. [5-8] Alors que ces infections étaient principalement identifiées chez les patients immunodéprimés, leur incidence a augmenté de façon importante ces trente dernières années chez les patients non immunodéprimés, [9] et plus particulièrement en USI.[1] Bien qu'il s'agisse d'un événement rare, dont l'incidence est estimée entre 2 à 10 cas pour 1000 patients admis en USI, [10] la mortalité attribuable est considérée comme étant élevée, avec des estimations variant de 30 à 60 % en fonction des situations cliniques, [11-15] faisant de ces germes l'un des pathogènes ayant le taux de mortalité attribuable le plus élevé. [16]

L'absence de spécificité clinique des candidoses invasives et le manque de fiabilité des méthodes biologiques rendent le diagnostic difficile et tardif, ce qui entraîne un retard de l'initiation d'un traitement antifongique adapté et aggrave le pronostic des patients. [17-19] Pour faire face au retard de diagnostic et limiter le risque d'aggravation du pronostic, des stratégies prophylactiques et probalistiques ont été mises en places. [20] L'apparition dans les années 2000 des échinocandines, famille de molécules antifongiques ayant une action fongicide à large spectre et n'entraînant pas d'effets indésirables ni d'interactions médicamenteuses importantes, [21] a modifié les pratiques. Ces molécules sont maintenant recommandées en première intention pour la prise en charge des candidoses invasives en USI par les principaux guides internationaux, et en traitement empirique chez les patients à risque de candidose invasive sans infection documentée.[22, 23]

Alors que ces traitements probabilistes représentent trois traitements antifongiques administrés sur quatre en USI, [20] leur bénéfice individuel, en l'absence de documentation mycologique de l'infection, reste discutable. [24, 25] Au risque d'un sur-traitement inutile des patients, s'ajoute une augmentation des coûts d'hospitalisation, car ces traitements font partie des médicaments onéreux, [26-28] et entraînent une sélection des espèces *Candida* résistantes pouvant conduire à des échecs cliniques.[29-31] Une des possibilités pour réduire la pression de sélection est de diminuer la durée du traitement en mettant en place une désescalade thérapeutique.[22, 23] Cette désescalade peut se faire en remplaçant la molécule initiale par du fluconazole par voie orale, ou en arrêtant le traitement. Cependant, il n'y a pas de consensus sur de telles stratégies, et aucune étude n'a évalué l'effet potentiel de la désescalade sur le pronostic des patients. [22, 23, 25]

Ce travail de thèse a pour objectif de mieux répondre aux problématiques soulevées par la prise en charge des candidoses invasives sur les patients sévères, non neutropéniques en USI. Pour cela, nous avons choisi d'explorer des données observationnelles en appliquant des méthodes statistiques innovantes, adaptées aux données évoluant dans le temps et permettant une approche causale.

La première partie est une revue non systématique de la littérature qui vient compléter cette introduction avec pour objectif de situer la problématique de la prise en charge des patients à haut risque de candidoses invasives sans infection prouvée.

À partir de là, nous explorerons, dans une deuxième partie, des bases de données mycologiques du centre hospitalier universitaire (CHU) de Grenoble, fusionnées avec des données cliniques et pharmaceutiques, d'une part pour évaluer la pression exercée dans le temps par la consommation des traitements antifongiques sur la sélection des espèces *Candida* au service de réanimation médicale et d'autre part pour estimer la valeur diagnostic des hémocultures dans le cas des candidémies, en présence de traitement antifongique.

Dans une troisième partie, nous nous intéresserons à des bases de données cliniques de haute qualité pour étudier l'impact de la désescalade précoce et du traitement empirique sur le pronostic à court terme des patients. L'objectif est d'utiliser des méthodes statistiques récentes permettant d'estimer l'effet causal moyen entre l'exposition et le pronostic. Nous verrons dans cette partie plus particulièrement les modèles structurels marginaux qui ont été développés au début des années 2000. [32] Ces méthodes, simples à mettre en œuvre d'un point de vue technique, reposent sur des hypothèses fortes et peuvent donner lieu à des résultats biaisés en cas de mauvaise application. Étant donné que ces méthodes présentent un intérêt particulier pour l'exploitation des données observationnelles en USI et que leur utilisation se développe dans la littérature médicale, nous avons proposé un article d'introduction pour les cliniciens.

**Première partie : État des lieux sur le
traitement probabiliste des candidoses invasives**

Cette première partie est une revue non systématique de la littérature qui complète l'introduction sous forme d'un article publié dans la revue en ligne F1000.

Après un rappel des principaux facteurs de risque de candidose invasive, dont la colonisation à *Candida* observée sur plusieurs sites qui joue un rôle clé, [10, 33] cet article fait le point sur les principales méthodes de diagnostic des candidoses invasives existantes et leurs limites. La difficulté de poser un diagnostic précis entraîne souvent un retard dans la mise en place d'un traitement antifongique adéquat qui est significativement associé à une hausse de la mortalité. [11, 19, 34] Pour réduire l'aggravation du pronostic, les recommandations internationales préconisent la prescription probabiliste de traitement antifongique.[22, 23] L'efficacité de ces stratégies préventives pour des patients sévères, à haut risque de candidose invasive, avec un choc septique, une colonisation extradigestive à *Candida* et de multiples défaillances d'organes n'a pas été clairement démontrée. Cet article explore les différentes études ayant exploré l'impact d'une stratégie probabiliste sur le pronostic des patients.

En conclusion, en l'absence de diagnostic fiable et précoce des candidoses invasives, il est nécessaire d'approfondir les connaissances sur le bénéfice attendu des thérapies antifongiques probabilistes des patients en ICU.

Publication N 1 : Empiric/pre-emptive anti-Candida therapy in non-neutropenic ICU patients

Timsit JF, Chemam S, Bailly S.

F1000prime Rep. — Publié

2015 ;7:21.

Empiric/pre-emptive anti-Candida therapy in non-neutropenic ICU patients

Jean-François Timsit^{1,2,3*}, Sarah Chemam³, and Sébastien Bailly^{1,2,4}

Addresses: ¹INSERM, IAME, UMR 1137, F-75018 Paris, France; ²Paris Diderot University, IAME, UMR 1137, Sorbonne Paris Cité, F-75018 Paris, France; ³AP-HP, Bichat Hospital, medical and infectious diseases ICU, F-75018 Paris, France; ⁴Joseph Fourier (Grenoble 1) University, Albert Bonniot institute, U 823, Grenoble, F-38000 France

* Corresponding author: Jean-François Timsit (jean-francois.timsit@bch.aphp.fr)

F1000Prime Reports 2015, 7:21 (doi:10.12703/P7-21)

All F1000Prime Reports articles are distributed under the terms of the Creative Commons Attribution-Non Commercial License (<http://creativecommons.org/licenses/by-nc/3.0/legalcode>), which permits non-commercial use, distribution, and reproduction in any medium, provided the original work is properly cited.

The electronic version of this article is the complete one and can be found at: <http://f1000.com/prime/reports/m/7/21>

Abstract

The potential of the systemic antifungal treatment of non-immunocompromised patients with sepsis, extra-digestive *Candida* colonization and multiple organ failure is unknown, although it represents three out of four antifungal treatments prescribed in intensive care units. It may allow an early treatment of invasive fungal infection at incubation phase, but exposes patients to unnecessary antifungal treatments with subsequent costs and antifungal selection pressure. As early diagnostic tests for invasive candidiasis are still considered insufficient, the potential of this strategy needs to be demonstrated by a randomized controlled trial. Such a trial is currently ongoing.

Candidiasis is a mortality risk factor

Candida is one of the most frequently recovered pathogens in patients with hospital acquired bloodstream infections [1–3], where it is associated with a mortality rate from 30 to more than 60% in case of septic shock [4–8].

Major risk factors for *Candida* colonization include length of intensive care unit (ICU) stay, use of parenteral nutrition, broad-spectrum and long-term antibiotics, central lines, and abdominal surgery. Importantly, a continuum exists between *Candida* colonization and candidemia [9–11]. Thus, a colonization index (number of colonized sites/number of sampled sites) of >0.5, with recovery of the same *Candida* species or genotypes in the colonized sites and bloodstream, has been set up and is associated with an increased risk of candidemia [11]. Studies conducted to develop a *Candida* score showed that factors associated with candidemia were surgery, multiple-site *Candida* colonization, severe sepsis, and parenteral nutrition [12]. Thus, *Candida* colonization, although not unique, is a reliable independent risk factor for candidemia [13–15]. Therefore, early systemic antifungal therapy (SAT) deserves consideration in ICU patients in whom they are increasingly used [16,17].

The diagnosis of candidemia is often difficult and delayed because the sensitivity of blood culture bottles (even in specific milieu) is not higher than 75% and decreased by previous antifungal therapy [18].

Non culture-based assays have been developed to improve the diagnosis of invasive candidiasis. These new tools have been mainly tested in hematological patients and in surgical ICUs. (1-3)- β -D-glucan is a cell wall component of *Candida* sp. and other fungi. It becomes detectable early during invasive candidiasis but may also rise in other fungal infections. Indeed, (1-3)- β -D-glucan rises in cases of aspergillosis, and *Pneumocystis jirovecii* infections, but also in rare infections, such as infection with *Fusarium* spp., *Acremonium* spp., *Sporothrix schenckii*, *Coccidioides immitis*, *Histoplasma capsulatum*, *Blastomyces dermatitidis*, *Trichosporon* spp. and *Saccharomyces cerevisiae*. Importantly, (1-3)- β -D-glucan is not found in Cryptococcosis or Zygomycetes infections (*Adsidia*, *Mucor*, *Rhizopus*). (1-3)- β -D-glucan remains detectable for more than one month after invasive candidiasis [19,20]. The cut off value proposed for hematological patients is 80 pg/ml but it appears to be higher in ICU patients [20,21].

False positive results have been reported in cases of dialysis with cellulose membrane, albumin perfusions, intravenous immunoglobulin administration, antibiotic therapy with coamoxiclav or Piperacillin-Tazobactam, and bacteremia [21]. The reported sensitivity and specificity of (1-3)- β -D-glucan is 57-97% and 56-93%, respectively. Given the low prevalence of invasive candidiasis in non-neutropenic patients, a negative test is adequate to rule out a diagnosis of infection [22]. In the recent study of the FUNGINOS group [23], in a selected population of surgical ICU patients, two consecutive measurements of (1-3)- β -D-glucan of more than 80 pg/ml were associated with a reasonable diagnostic value (positive predictive value of 72%, negative predictive value of 80%) that need to be confirmed in further study on other non-surgical ICU populations. Importantly, (1-3)- β -D-glucan positivity preceded the diagnosis of invasive candidiasis by 5 days in mean.

Mannan, a polysaccharidic antigen from *Candida* cell wall, is another potential diagnostic test. Both mannan antigen and anti-mannan antibodies could be measured using one enzyme-linked immunosorbent assay (ELISA) kit. Mannanemia is more specific than (1-3)- β -D-glucan but showed a lack of sensitivity in a recent study on candidemia [20]. The combination of both tests possesses an acceptable diagnostic value (86% specificity and 83% sensitivity) in a recent meta-analysis [24].

Finally, detection of *Candida* DNA using polymerase chain reaction (PCR) seems to be both sensitive and specific in the available literature but standardization of tests is lacking [25].

Early treatment of candidemia decreases mortality of ICU patients with septic shock

Delays in initiating appropriate treatment have been associated with increased mortality in patients with bloodstream infections [4,26]. Similar findings have been reported in patients with candidemia [26-29]. This is especially the case for critically ill patients with septic shock [8]. Importantly, the control of the infected source acts in synergy with the antifungal therapy. In a recent study, both a delay in antifungal treatment of more than 24 hours (odds ratio=5.99, $P=0.048$) and the absence of source control within the first 48 hours (odds ratio=2.99, $P=0.001$) were associated with the risk of death in the case of septic shock due to candidemia [7].

Overuse of antifungals modifies fungal ecosystem and promotes antifungal resistance

The usual risk factors described in the more recent predictive scores included variables that are frequent, and

lead us to treat 10-20% of the ICU patients [13,30]. More than two-thirds of these treatments are given without definitive proof of invasive fungal infections [30].

As an example, the colonization index's positive predictive value is less than 9% in the EPCAN study [14]. In medical ICU patients, 39% developed a colonization index of more than 0.5, while, in the same period, no invasive fungal infections were diagnosed [10].

New antifungal agents are well tolerated and over-treatment might be considered safe on an individual basis. However, new data from the US and Europe clearly demonstrate that the overuse of antifungal drugs contributes to both the emergence of *Candida* species that are known to be less sensitive to antifungal agents, as well as to the increased occurrence of sensitive *Candida* species with increased minimum inhibitory concentrations (MICs). Recently, Lortholary *et al.* reported that azole derivatives and candins pre-exposure increased the risk of fungemia due to species with higher MICs to the corresponding antifungal agents [31]. Pfaller *et al.* found an increase in rates of fluconazole-resistant *Candida glabrata* intermediate or resistant to candins over time, from less than 4% between 2000 and 2002 to more than 12% between 2008 and 2010 [32]. Dannaoui *et al.* reported 20 episodes of fungal infections caused by candidin-resistant *Candida* spp. that were harboring diverse and new resistance mutations [33]. For 12 patients, the initial isolates (low MICs, wild-type FKS gene) and the subsequent isolates (after caspofungin treatment, high MICs, FKS mutation) were genetically identical [33]. We also recently described a significant relationship between systemic antifungal therapy (SAT) consumption and MICs of colonizing and infecting fungi in ICU patients [34].

Finally, two studies clearly showed that the pre-exposure to candins was associated with episodes of *C. glabrata* septicemia with strains of reduced susceptibility to candins that harbored FKS mutation. Such strains were associated with a higher rate of clinical failure of echinocandin therapy [35,36].

Obviously, SAT should be used applying the same rules as for other antimicrobial agents. It must be effective and safe for the patient himself, and also for future patients.

Empiric/pre-emptive treatment of ICU patients has never proved to be effective

Regarding which benefits to expect from an empirical or pre-emptive SAT in critically ill non-immunocompromised patients, the current literature is inconclusive, and trials demonstrating the efficacy of SAT in

colonized patients with unresolved sepsis and organ dysfunction are warranted.

Empiric therapy is usually defined as a therapy instituted in patients with clinical signs suggestive of ongoing invasive infection (new systemic inflammatory response syndrome, organ failures), while pre-emptive therapy is given to patients with risk factors and one or more positive markers such as a rising colonization index or (1-3)- β -D-glucan elevation above a threshold value that remains to be determined in the ICU setting.

One may question the potential of empirical therapy of ICU patients with sepsis and risk factors of invasive fungal infection, and of pre-emptive therapy of ICU patients with a positive biomarker such as *Candida* colonization or (1-3)- β -D-glucan.

Regarding the so-called empirical therapy, no clear demonstration of efficacy has been published. In a randomized controlled double-blind trial, a high dose of fluconazole failed to reduce survival free of invasive fungal infection in medical-surgical ICU patients with non-resolving sepsis. In this study, *Candida* colonization was diagnosed at inclusion of patients in only a quarter of the cases [37]. The issue remains uncertain because the diagnosis of invasive fungal infection remains a challenge in ICU. In a one-day prevalence study, the authors declared 17% of nosocomial infections to be due to *Candida* spp. [38], but only 99/14,414 patients developed proven candidemia.

Candida colonization is a frequent event in ICU patients [14]. The colonization index, validated 20-years ago in long-term surgical ICU patients, has been broadly challenged. For instance, its positive predictive value is less than 9% in the EPCAN study [14]. Furthermore, in medical ICU patients, 39% developed a colonization index of more than 0.5, while, within the same period, no invasive fungal infections were diagnosed [10]. Colonization index remains an important way to characterize the dynamics of the colonization of ICU patients, which increases early in patients who will go on to develop invasive candidiasis, but its bedside practicality remains limited [39].

One before-and-after study showed decreased ICU-acquired candidemia rate when using a colonization index-based fluconazole therapy, but without any survival benefits [40].

Likewise, we are looking forward to having improved diagnostic strategies to increase the sensitivity, specificity and predictive values of the available tools, as well as

to reduce diagnostic delays. New tools such as assays to measure (1-3)- β -D-glucan levels provided promising results in ICU populations [23,41,42]. However, (1-3)- β -D-glucan is not specific to candidiasis, is higher than 80 pg/ml in many ICU patients without invasive candidiasis, and decreases slowly under effective treatment [19,43,44].

Over the last 15 years, several studies have evaluated the potential benefits from SAT in ICU patients overall [45–50], and in the subset of ICU patients with risk factors for candidemia or sepsis of unknown origin [37,40]. Pre-emptive SAT has been suggested for the sickest surgical ICU patients, most notably those with peritonitis [51]. More recently, an exploratory study compared the efficacy and safety of micafungin as a pre-emptive treatment of invasive candidiasis vs. placebo in high risk surgical subjects with intra-abdominal infections in a multicenter randomized control trial (INTENSE NCT NCT01122368). Results are available in [clinicaltrials.jp](http://www.clinicaltrials.jp) (<http://www.clinicaltrials.jp/user/display/file/9463-EC-0002%20synopsis.pdf?filed=983>). A total of 241 patients were analyzed in the full analysis set. In this study, the rate of independent data reviewing board-confirmed invasive fungal infection after inclusion was similar in the micafungin and placebo arms (8.9 vs. 11.1%). There was no difference in mortality, invasive fungal infection-free survival, and improvement of organ failures between the micafungin and placebo arms. Micafungin significantly reduced the colonization index.

In another multicenter, randomized, double-blind, placebo-controlled trial (MSG 01) Ostrosky-Zeichner *et al.* tested the use of caspofungin in 222 adults who were in the ICU for at least 3 days, were ventilated, received antibiotics, had a central line, and had 1 additional risk factor (parenteral nutrition, dialysis, surgery, pancreatitis, systemic steroids, or other immunosuppressive agents) [52]. The primary endpoint was the incidence of proven or probable invasive candidiasis. Unfortunately, in terms of trial protocol, patients with sepsis and with two consecutive (1-3)- β -D-glucan samples above 80 pg/ml were classified as probable cases of invasive candidiasis, which allowed the investigators to break the blind and to administer them pre-emptive therapy with caspofungin. The pre-emptive approach analysis included all patients who received the study drug, including those positive at baseline. The incidence of proven/probable invasive candidiasis in the placebo and caspofungin arms was 30.4% (31/102) and 18.8% (22/117) for the pre-emptive approach ($P=0.04$). There were no significant differences in the secondary endpoints of mortality, antifungal use, or length of stay.

Both studies give rise to comments. The rate of proven invasive candidiasis was low (6.9% and 11.1% in the

placebo arms of INTENSE and MSG-01 studies); it suggests that the targeted population is not fully understood and leads to suggestions that the studies are considerably underpowered. The decrease in the risk of probable infection in the MSG-01 study was not associated with an improvement of vital status or duration of ICU stay. This may be explained by the fact that (1-3)- β -D-glucan serum level above 80 pg/ml should not be considered an accurate biomarker of invasive candidiasis.

Patients that may possibly benefit from early (empiric or pre-emptive) antifungal treatment are those with a high risk of invasive candidiasis. Given the results of the study from Schuster *et al.* [37] and the work performed by the EPCAN groups [12,53], we postulated that the combination of multiple organ failure, sepsis of unknown origin and multiple colonization with *Candida* in mechanically ventilated patients for more than four days and receiving broad spectrum antibacterial agents, should select a population with a particularly high risk of life-threatening invasive candidiasis. The potential benefits ascribable to SAT in this population is currently being tested in the EMPIRICUS trial [54]. Results will be available in early 2015.

Conclusion

We consider that definite rules could not be derived for systemic antifungal therapy. We need to strongly encourage and promote studies able to improve diagnostic strategies, and randomized control trials further defining the efficacy of SAT in colonized patients with sepsis and multiple organ failures.

Pre-emptive treatment should be decided at bedside, after sampling at least two separate blood cultures with 10 ml volume of blood preferably on selective milieu, in view of the uncertainty involved. To contain the antifungal selection pressure that is starting to rise, we also propose considering "stopping rules" after 5 days when no proven invasive candidiasis occurs.

Until the development of accurate early diagnostic tests or the results from ongoing trials are available, a demonstration of a clinical benefit of treatment of such patients is warranted to solve uncertainties in the issue deciding antifungal treatment in ICU setting.

Abbreviations

ICU, intensive care unit; MIC, minimal inhibitory concentration; SAT, systemic antifungal therapy.

Disclosures

Jean-François Timsit's university received research grants from Astellas and Merck. Jean-François Timsit received

educational grants from Gilead and lectured in symposia organized by Astellas, Pfizer and Merck. Sébastien Bailly and Sarah Chemam declare that they have no disclosures.

Acknowledgments

We thank Dr Celine Feger (EmiBiotech™) for her review of the final version of the manuscript.

References

- Blumberg HM, Jarvis WR, Soucie JM, Edwards JE, Patterson JE, Pfaller MA, Rangel-Frausto MS, Rinaldi MG, Saiman L, Wiblin RT, Wenzel RP: Risk factors for candidal bloodstream infections in surgical intensive care unit patients: the NEMIS prospective multicenter study. *The National Epidemiology of Mycosis Survey. Clin Infect Dis* 2001, 33:177-86.
 - Rangel-Frausto MS, Wiblin T, Blumberg HM, Saiman L, Patterson J, Rinaldi M, Pfaller M, Edwards JE, Jarvis W, Dawson J, Wenzel RP: National epidemiology of mycoses survey (NEMIS): variations in rates of bloodstream infections due to *Candida* species in seven surgical intensive care units and six neonatal intensive care units. *Clin Infect Dis* 1999, 29:253-8.
 - Tabah A, Koulenti D, Laupland K, Misset B, Valles J, Bruzzi de Carvalho, Frederico, Paiva JA, Cakar N, Ma X, Eggimann P, Antonelli M, Bonten, Marc JM, Csomos A, Krueger WA, Mikstaki A, Lipman J, Depuydt P, Vesin A, Garrouste-Orgeas M, Zahar J, Blot S, Carlet J, Brun-Buisson C, Martin C, Rello J, Dimopoulos G, Timsit J: Characteristics and determinants of outcome of hospital-acquired bloodstream infections in intensive care units: the EURO-BACT International Cohort Study. *Intensive Care Med* 2012, 38:1930-45.
 - Garrouste-Orgeas M, Timsit JF, Tafflet M, Misset B, Zahar J, Soufir L, Lazard T, Jamali S, Mourvillier B, Cohen Y, Lasseigne A de, Azoulay E, Cheval C, Descorps-Declere A, Adrie C, Costa de Beauregard, Marie-Allette, Carlet J: Excess risk of death from intensive care unit-acquired nosocomial bloodstream infections: a reappraisal. *Clin Infect Dis* 2006, 42:1118-26.
 - Pittet D, Li N, Woolson RF, Wenzel RP: Microbiological factors influencing the outcome of nosocomial bloodstream infections: a 6-year validated, population-based model. *Clin Infect Dis* 1997, 24:1068-78.
 - Wisplinghoff H, Bischoff T, Tallent SM, Seifert H, Wenzel RP, Edmond MB: Nosocomial bloodstream infections in US hospitals: analysis of 24,179 cases from a prospective nationwide surveillance study. *Clin Infect Dis* 2004, 39:309-17.
- F1000Prime RECOMMENDED**
- Bassetti M, Righi E, Ansaldi F, Merelli M, Trucchi C, Cecilia T, Pascale G de, Diaz-Martin A, Luzzati R, Rosin C, Lagunes L, Treccarichi EM, Sanguinetti M, Posteraro B, Gamacho-Montero J, Sartor A, Rello J, Della Rocca G, Antonelli M, Tumbarello M: A multicenter study of septic shock due to candidemia: outcomes and predictors of mortality. *Intensive Care Med* 2014, 40:839-45.
- F1000Prime RECOMMENDED**
- Kollef M, Micek S, Hampton N, Doherty JA, Kumar A: Septic shock attributed to *Candida* infection: importance of empiric therapy and source control. *Clin Infect Dis* 2012, 54:1739-46.
- F1000Prime RECOMMENDED**
- Eggimann P, Garbino J, Pittet D: Epidemiology of *Candida* species infections in critically ill non-immunosuppressed patients. *Lancet Infect Dis* 2003, 3:685-702.
 - Charles PE, Dalle F, Aube H, Doise JM, Quenot JP, Aho LS, Chavanet P, Blettery B: *Candida* spp. colonization significance in critically ill

- medical patients: a prospective study. *Intensive Care Med* 2005, 31:393-400.
11. Pittet D, Monod M, Suter PM, Frenk E, Auckenthaler R: Candida colonization and subsequent infections in critically ill surgical patients. *Ann Surg* 1994, 220:751-8.
 12. León C, Alvarez-Lerma F, Ruiz-Santana S, León MA, Nolla J, Jordá R, Saavedra P, Palomar M: Fungal colonization and/or infection in non-neutropenic critically ill patients: results of the EPCAN observational study. *Eur J Clin Microbiol Infect Dis* 2009, 28:233-42.

F1000Prime
RECOMMENDED
 13. Eggimann P, Bille J, Marchetti O: Diagnosis of invasive candidiasis in the ICU. *Ann Intensive Care* 2011, 1:37.
 14. León C, Ruiz-Santana S, Saavedra P, Galván B, Blanco A, Castro C, Balasini C, Utande-Vázquez A, González de Molina, Francisco J, Blasco-Navalproto MA, López MJ, Charles PE, Martín E, Hernández-Viera MA: Usefulness of the "Candida score" for discriminating between Candida colonization and invasive candidiasis in non-neutropenic critically ill patients: a prospective multicenter study. *Crit Care Med* 2009, 37:1624-33.

F1000Prime
RECOMMENDED
 15. Ostrosky-Zeichner L: Issues in the design and interpretation of antifungal drug trials in the critically ill. *Curr Opin Infect Dis* 2009, 22:564-7.
 16. Marchetti O, Bille J, Flückiger U, Eggimann P, Ruef C, Garbino J, Calandra T, Glauser M, Täuber MG, Pittet D: Epidemiology of candidemia in Swiss tertiary care hospitals: secular trends, 1991-2000. *Clin Infect Dis* 2004, 38:311-20.

F1000Prime
RECOMMENDED
 17. San Miguel, Lucia Garcia, Cobo J, Otho E, Sánchez-Sousa A, Abaira V, Moreno S: Secular trends of candidemia in a large tertiary-care hospital from 1988 to 2000: emergence of Candida parapsilosis. *Infect Control Hosp Epidemiol* 2005, 26:548-52.

F1000Prime
RECOMMENDED
 18. Köck R, Eißing LC, Boschin MG, Ellger B, Horn D, Idelevich EA, Becker K: Evaluation of bactec mycosis IC/F and Plus Aerobic/ F blood culture bottles for detection of Candida in the presence of antifungal agents. *J Clin Microbiol* 2013, 51:3683-7.

F1000Prime
RECOMMENDED
 19. Jajjakul S, Vazquez JA, Swanson RN, Ostrosky-Zeichner L: (1,3)-β-D-glucan as a prognostic marker of treatment response in invasive candidiasis. *Clin Infect Dis* 2012, 55:521-6.

F1000Prime
RECOMMENDED
 20. Poissy J, Sendid B, Damiens S, Ichi Ishibashi K, François N, Kauv M, Favory R, Mathieu D, Poulain D: Presence of Candida cell wall derived polysaccharides in the sera of intensive care unit patients: relation with candidaemia and Candida colonisation. *Crit Care* 2014, 18:R135.

F1000Prime
RECOMMENDED
 21. León C, Ostrosky-Zeichner L, Schuster M: What's new in the clinical and diagnostic management of invasive candidiasis in critically ill patients. *Intensive Care Med* 2014, 40:808-19.

F1000Prime
RECOMMENDED
 22. Karageorgopoulos DE, Vouloumanou EK, Ntziora F, Michalopoulos A, Rafailidis PI, Falagas ME: β-D-glucan assay for the diagnosis of invasive fungal infections: a meta-analysis. *Clin Infect Dis* 2011, 52:750-70.

F1000Prime
RECOMMENDED
 23. Tissot F, Lamoth F, Hauser PM, Orasch C, Flückiger U, Siegmund M, Zimmerli S, Calandra T, Bille J, Eggimann P, Marchetti O: β-glucan antigenemia anticipates diagnosis of blood culture-negative intraabdominal candidiasis. *Am J Respir Crit Care Med* 2013, 188:1100-9.

F1000Prime
RECOMMENDED
 24. Mikulska M, Calandra T, Sanguinetti M, Poulain D, Viscoli C: The use of mannan antigen and anti-mannan antibodies in the diagnosis of invasive candidiasis: recommendations from the Third European Conference on Infections in Leukemia. *Crit Care* 2010, 14:R222.

F1000Prime
RECOMMENDED
 25. Nguyen MH, Wissel MC, Shields RK, Salomoni MA, Hao B, Press EG, Shields RM, Cheng S, Mitsani D, Vadnerkar A, Silveira FP, Kleboeker SB, Clancy CJ: Performance of Candida real-time polymerase chain reaction, β-D-glucan assay, and blood cultures in the diagnosis of invasive candidiasis. *Clin Infect Dis* 2012, 54:1240-8.

F1000Prime
RECOMMENDED
 26. Grim SA, Berger K, Teng C, Gupta S, Layden JE, Janda WM, Clark NM: Timing of susceptibility-based antifungal drug administration in patients with Candida bloodstream infection: correlation with outcomes. *J Antimicrob Chemother* 2012, 67:707-14.

F1000Prime
RECOMMENDED
 27. Garey KW, Rege M, Pal MP, Mingo DE, Suda KJ, Turpin RS, Bearden DT: Time to initiation of fluconazole therapy impacts mortality in patients with candidemia: a multi-institutional study. *Clin Infect Dis* 2006, 43:25-31.

F1000Prime
RECOMMENDED
 28. Labelle AJ, Micek ST, Roubinian N, Kollef MH: Treatment-related risk factors for hospital mortality in Candida bloodstream infections. *Crit Care Med* 2008, 36:2967-72.

F1000Prime
RECOMMENDED
 29. Morrell M, Fraser VJ, Kollef MH: Delaying the empiric treatment of candida bloodstream infection until positive blood culture results are obtained: a potential risk factor for hospital mortality. *Antimicrob Agents Chemother* 2005, 49:3640-5.

F1000Prime
RECOMMENDED
 30. Azoulay E, Garrouste M, Goldgran-Toledano D, Adrie C, Max A, Vesin A, Francois A, Zahar J, Cohen Y, Allaouchiche B, Schlemmer B, Timsit J: Increased nonbeneficial care in patients spending their birthday in the ICU. *Intensive Care Med* 2012, 38:1169-76.
 31. Lortholary O, Desnos-Ollivier M, Sibon K, Fontanet A, Bretagne S, Dromer F: Recent exposure to caspofungin or fluconazole influences the epidemiology of candidemia: a prospective multicenter study involving 2,441 patients. *Antimicrob Agents Chemother* 2011, 55:532-8.

F1000Prime
RECOMMENDED
 32. Pfaller MA, Castanheira M, Lockhart SR, Ahlquist AM, Messer SA, Jones RN: Frequency of decreased susceptibility and resistance to echinocandins among fluconazole-resistant bloodstream isolates of Candida glabrata. *J Clin Microbiol* 2012, 50:1199-203.

F1000Prime
RECOMMENDED
 33. Dannaoui E, Desnos-Ollivier M, Garcia-Hermoso D, Grenouillet F, Cassaing S, Baixench M, Bretagne S, Dromer F, Lortholary O: Candida spp. with acquired echinocandin resistance, France, 2004-2010. *In Emerging Infect Dis* 2012, 18:86-90.

F1000Prime
RECOMMENDED

34. Fournier P, Schwebel C, Maubon D, Vesin A, Lebeau B, Foroni L, Hamidfar-Roy R, Cornet M, Timsit J, Pelloux H: **Antifungal use influences Candida species distribution and susceptibility in the intensive care unit.** *J Antimicrob Chemother* 2011, **66**:2880-6.
35. Alexander BD, Johnson MD, Pfeiffer CD, Jiménez-Ortigosa C, Catania J, Booker R, Castanheira M, Messer SA, Perlin DS, Pfaller MA: **Increasing echinocandin resistance in *Candida glabrata*: clinical failure correlates with presence of FKS mutations and elevated minimum inhibitory concentrations.** *Clin Infect Dis* 2013, **56**:1724-32.
- F1000Prime RECOMMENDED**
36. Shields RK, Nguyen MH, Press EG, Updike CL, Clancy CJ: **Caspofungin MICs correlate with treatment outcomes among patients with *Candida glabrata* invasive candidiasis and prior echinocandin exposure.** *Antimicrob Agents Chemother* 2013, **57**:3528-35.
- F1000Prime RECOMMENDED**
37. Schuster MG, Edwards JE, Sobel JD, Darouiche RO, Karchmer AW, Hadley S, Slotman G, Panzer H, Biswas P, Rex JH: **Empirical fluconazole versus placebo for intensive care unit patients: a randomized trial.** *Ann Intern Med* 2008, **149**:83-90.
- F1000Prime RECOMMENDED**
38. Kett DH, Azoulay E, Echeverria PM, Vincent J: **Candida bloodstream infections in intensive care units: analysis of the extended prevalence of infection in intensive care unit study.** *Crit Care Med* 2011, **39**:665-70.
39. Eggimann P, Pittet D: **Candida colonization index and subsequent infection in critically ill surgical patients: 20 years later.** *Intensive Care Med* 2014, **40**:1429-48.
40. Piarroux R, Grenouillet F, Balvay P, Tran V, Blasco G, Millon L, Boillot A: **Assessment of preemptive treatment to prevent severe candidiasis in critically ill surgical patients.** *Crit Care Med* 2004, **32**:2443-9.
41. Posteraro B, Pascale G de, Tumbarello M, Torelli R, Pennisi MA, Bello G, Maviglia R, Fadda G, Sanguinetti M, Antonelli M: **Early diagnosis of candidemia in intensive care unit patients with sepsis: a prospective comparison of (1-3)- β -D-glucan assay, Candida score, and colonization index.** *Crit Care* 2011, **15**:R249.
42. Held J, Kohlberger I, Rappold E, Busse Grawitz A, Häcker G: **Comparison of (1-3)- β -D-glucan, mannan/anti-mannan antibodies, and Cand-Tec Candida antigen as serum biomarkers for candidemia.** *J Clin Microbiol* 2013, **51**:1158-64.
43. Sims CR, Jajakul S, Mohr J, Rodriguez J, Finkelman M, Ostrosky-Zeichner L: **Correlation of clinical outcomes with β -glucan levels in patients with invasive candidiasis.** *J Clin Microbiol* 2012, **50**:2104-6.
44. Clancy CJ, Nguyen MH: **Finding the "missing 50%" of invasive candidiasis: how nonculture diagnostics will improve understanding of disease spectrum and transform patient care.** *Clin Infect Dis* 2013, **56**:1284-92.
- F1000Prime RECOMMENDED**
45. Cruciani M, Lalla F de, Mengoli C: **Prophylaxis of *Candida* infections in adult trauma and surgical intensive care patients: a systematic review and meta-analysis.** *Intensive Care Med* 2005, **31**:1479-87.
46. Garbino J, Lew DP, Romand J, Hugonnet S, Auckenthaler R, Pittet D: **Prevention of severe *Candida* infections in nonneutropenic, high-risk, critically ill patients: a randomized, double-blind, placebo-controlled trial in patients treated by selective digestive decontamination.** *Intensive Care Med* 2002, **28**:1708-17.
47. Jacobs S, Price Evans, David A, Tariq M, Al Omar, Nasser Fawzan: **Fluconazole improves survival in septic shock: a randomized double-blind prospective study.** *Crit Care Med* 2003, **31**:1938-46.
48. Pelz RK, Hendrix CW, Swoboda SM, Diener-West M, Merz WG, Hammond J, Lipsett PA: **Double-blind placebo-controlled trial of fluconazole to prevent candidal infections in critically ill surgical patients.** *Ann Surg* 2001, **233**:542-8.
49. Playford EG, Webster AC, Sorrell TC, Craig JC: **Antifungal agents for preventing fungal infections in non-neutropenic critically ill and surgical patients: systematic review and meta-analysis of randomized clinical trials.** *J Antimicrob Chemother* 2006, **57**:628-38.
50. Shorr AF, Chung K, Jackson WL, Waterman PE, Kollef MH: **Fluconazole prophylaxis in critically ill surgical patients: a meta-analysis.** *Crit Care Med* 2005, **33**:1928-35; quiz 1936.
- F1000Prime RECOMMENDED**
51. Montravers P, Dupont H, Gauzit R, Veber B, Auboyer C, Blin P, Hennequin C, Marín C: **Candida as a risk factor for mortality in peritonitis.** *Crit Care Med* 2006, **34**:646-52.
52. Ostrosky-Zeichner L, Shoham S, Vazquez J, Reboli A, Betts R, Barron MA, Schuster M, Judson MA, Revanlar SG, Caeiro JP, Mangino JE, Mushatt D, Bedimo R, Freifeld A, Nguyen MH, Kauffman CA, Dismukes WE, Westfall AO, Deerman JB, Wood C, Sobel JD, Pappas PG: **MSG-01: A randomized, double-blind, placebo-controlled trial of caspofungin prophylaxis followed by preemptive therapy for invasive candidiasis in high-risk adults in the critical care setting.** *Clin Infect Dis* 2014, **58**:1219-26.
- F1000Prime RECOMMENDED**
53. León C, Ruiz-Santana S, Saavedra P, Almirante B, Nolla-Salas J, Alvarez-Lerma F, Garnacho-Montero J, León MA: **A bedside scoring system ("Candida score") for early antifungal treatment in nonneutropenic critically ill patients with *Candida* colonization.** *Crit Care Med* 2006, **34**:730-7.
- F1000Prime RECOMMENDED**
54. Timsit J, Azoulay E, Cornet M, Gangneux J, Julien V, Vésin A, Schir E, Wolff M: **EMPIRICUS micafungin versus placebo during nosocomial sepsis in *Candida* multi-colonized ICU patients with multiple organ failures: study protocol for a randomized controlled trial.** *Trials* 2013, **14**:399.

**Deuxième partie : Exploration de données
mycologiques longitudinales**

I. Présentation des données

Pour cette partie, nous avons privilégié une approche rétrospective à partir des informations disponibles dans les bases de trois systèmes d'information du CHU de Grenoble :

- Le système d'information du laboratoire de mycologie (Synergie software, Technidata, Meylan, France) qui rassemble les examens biologiques réalisés et comprend les données générales des patients et les données des prélèvements biologiques (date de prélèvement, type de prélèvement, résultats et espèces identifiées notamment). Cette base est couplée à l'automate d'hémoculture qui enregistre en continu le temps de positivité des flacons dans le logiciel BD EpiCenter™ (Beckton Dickinson, USA).
- La base de données de la pharmacie hospitalière (Opium) qui centralise les prescriptions réalisées par service et par patient. L'informatisation n'étant pas généralisée à tous les services, il a été nécessaire de compléter avec la lecture des dossiers patients.
- Les dossiers cliniques des patients qui sont enregistrés dans une plateforme commune accessible au sein du CHU de Grenoble (Critalnet) et recensent l'ensemble des éléments associés au parcours de soins des patients.

Les différentes données ont été fusionnées pour chaque patient dans deux bases de données longitudinales distinctes pour aborder deux questions concernant l'impact des pratiques de prescription des traitements antifongiques.

La première question traitée concerne l'effet de la consommation sur l'évolution de la pression de sélection des levures dans le service de réanimation médicale. La deuxième question porte sur l'effet du traitement antifongique sur la détection des levures dans les flacons d'hémocultures et sur le choix du type de flacon à privilégier.

II. Effet du traitement antifongique sur la pression de sélection des espèces

***Candida* en USI : analyse de séries temporelles**

En milieu hospitalier, 40 % des infections fongiques sont recensées en USI où elles représentent près de 20 % de l'ensemble des infections, [1, 7] entraînant une augmentation de la consommation en antifongiques dans le temps. Une des possibilités d'étudier l'effet de cette hausse sur la sélection des levures est d'exploiter des séries de mesures de l'évolution des prescriptions d'antifongiques mensuelles, de la distribution des différentes espèces de *Candida* et de leur sensibilité aux antifongiques évaluée par leurs concentrations minimales inhibitrices (CMI) mesurées par antifongigrammes.

Pour exploiter ces séries temporelles, définies par un ensemble d'observations indexées sur le temps à des intervalles réguliers, les méthodes d'analyse de variance supposant que les données observées correspondent à des réalisations indépendantes de variables aléatoires sont souvent utilisées quoique non adaptées. En effet, lorsque des données se suivent dans le temps, il est fort probable que les observations consécutives soient dépendantes les unes des autres. [35]

De même, les régressions multi variées, à partir du modèle linéaire généralisé, supposent que les termes d'erreurs aient la même variance dans le temps, soient indépendants les uns des autres et aient une distribution normale, ce qui n'est pas toujours le cas dans les séries temporelles. Enfin, les méthodes standards se basent sur des comparaisons de périodes assez longues, par exemple la comparaison de différentes années, qui ne prennent pas en compte les petites évolutions de consommation d'agent anti-infectieux ou de CMI observées. [36]

C'est pourquoi il est plus pertinent d'utiliser des méthodes adaptées à l'analyse de séries temporelles, notamment les modèles ARIMA. [37, 38] Ces modèles s'appuient sur l'information contenue dans les données en utilisant trois processus :

- Autorégressif (AR) qui suppose que la ou les observations précédentes déterminent la valeur de l'observation présente. Autrement dit, le modèle n'est pas déterminé par une valeur de référence, mais chaque point peut-être prédit par la somme pondérée d'un ensemble de points précédents à laquelle s'ajoute un terme aléatoire d'erreur.
- Intégration (I) qui permet de rendre la série stationnaire. En effet, les modèles ARIMA ne fonctionnent que sur des séries temporelles dont la moyenne est constante dans le temps. Si cela n'est pas observé naturellement, il est nécessaire de remplacer la série originale par une série intégrée dans laquelle toute tendance a été supprimée.
- Moyenne mobile (MA) qui suppose que chaque point est fonction des erreurs entachant les points précédents plus sa propre erreur. C'est-à-dire que la valeur de référence de la série n'est pas constante, mais varie d'une observation à l'autre.

La méthode développée par Box et Jenkins [35] explore chacun de ces processus pour définir le meilleur modèle ajustant les séries chronologiques étudiées. De plus, à l'aide d'une fonction de transfert, il est possible de déterminer s'il existe une corrélation dans le temps entre deux séries et de définir quel est le délai le plus significatif associé à cette corrélation. [36, 39] Une première étude réalisée sur le CHU de Grenoble avait établi un lien entre l'augmentation de la consommation d'antifongiques et l'évolution de la résistance des espèces *Candida* à ces molécules, malgré un faible recul pour la caspofungine. [30] En appliquant ces modèles sur une période plus longue, de dix ans, nous avons pu étudier l'impact de la consommation de cinq molécules : l'amphotéricine B, le voriconazole, le fluconazole, la caspofungine et la micafungine sur quatre espèces *Candida* : *C. albicans*, *C. glabrata*, *C. parapsilosis* et *C. tropicalis*

Cette étude a été présentée dans un article en cours de révision au Journal of Infection.

Publication N 2 : Impact of Antifungal Prescription on relative distribution and susceptibility of *Candida* spp – Trends Over 10 Years

Bailly S, Maubon D, Fournier P, Pelloux H, Schwebel C, Chapuis C, Foroni L, Cornet M,
Timsit JF.

Journal of Infection : en révision

Présentations orales :

- 43^{ème} congrès international de la Société de Réanimation en Langue Française 2015, Paris
- 27th annual congress European Society of Intensive Care Medicine, Barcelone 2014
- Journées de la recherche médicale 2014, Université Joseph Fourier, Grenoble

Résumé de l'article

Depuis 2003, de nouvelles molécules antifongiques ont été introduites pour la prise en charge des candidoses invasives en USI : les échinocandines. Ces molécules présentent un spectre d'action plus large pour les levures du genre *Candida* incluant les espèces *C. glabrata* et *C. krusei* et leur consommation a augmenté avec l'évolution des recommandations en faveur de ces traitements. Les pratiques de prescription des antifongiques ont été évaluées en réanimation médicale au CHU de Grenoble en 2010 sur une courte période et ont mis en évidence un lien entre la consommation d'antifongique et l'évolution des CMI.

L'objectif de cette étude est d'évaluer l'effet de la prescription d'antifongiques (amphotéricine B, fluconazole, voriconazole, caspofungine et micafungine) sur la sensibilité et la distribution des principales espèces *Candida* (*albicans*, *glabrata*, *parapsilosis* et *tropicalis*) au service de réanimation médicale de Grenoble de 2004 à 2013.

Pour cela, la consommation d'antifongique a été déterminée en nombre de doses journalières définies pour 1000 jours d'hospitalisation (DDD/HD). Les données concernant la distribution des espèces *Candida* et les CMI des antifongiques ont été recueillies sur la période d'étude. Les données temporelles ont été analysées à l'aide de modèles ARIMA.

Cette étude a montré que sur 2.403 espèces *Candida* isolées sur 5.360 patients, *C. albicans* est l'espèce majoritaire (53,1 %) suivie de *C. glabrata* (16,2 %), *C. parapsilosis* (7,9 %) puis *C. tropicalis* (7,5 %). Les principaux antifongiques prescrits sur le CHU sont les échinocandines avec une consommation mensuelle moyenne de 44.8 (± 19.2) DDD/HD. Cette consommation a augmenté significativement dans le temps, avec un minimum observé en 2004 à 17.9 DDD/HD et un maximum en 2013 de 71.3 DDD/HD. Sur la même période, il n'y a pas eu de variation significative de la consommation de fluconazole, avec une consommation mensuelle moyenne de 31.5 (± 11.6) DDD/HD.

Les analyses des séries temporelles ont montré une corrélation significative entre l'évolution de la consommation d'antifongique et la distribution des principales espèces *Candida*. De même, l'augmentation de la consommation d'antifongique est associée dans le temps à une augmentation des CMI de *C. parapsilosis*, *C. glabrata* et *C. albicans* pour la caspofungine et *C. glabrata* pour l'amphotéricine B.

Pour conclure, les antifongiques augmentent la pression de sélection sur les espèces *Candida* en USI. Le supplément électronique présenté à la suite de l'article montre l'évolution de la fréquence des espèces classées comme sensibles, intermédiaires ou résistantes aux différents antifongiques. Si les modifications observées n'ont pas d'impact clinique, les résultats soulignent tout de même la nécessité d'assurer un suivi des prescriptions dans le temps pour éviter l'émergence de phénomènes de résistance liés à la pression de sélection.

Title: Impact of Antifungal Prescription on relative distribution and susceptibility of *Candida* spp – Trends Over 10 Years

Running title: Impact of antifungal consumption on *Candida* spp.

Sébastien Bailly^{1,2,3} MsC sbailly@chu-grenoble.fr

Danièle Maubon^{2,4} MD PhD dmaubon@chu-grenoble.fr

Pierre Fournier² PharmD Pierre.FOURNIER@biomnis.com

Hervé Pelloux^{2,5} MD PhD hpelloux@chu-grenoble.fr

Carole Schwebel⁶ MD PhD cschwebel@chu-grenoble.fr

Claire Chapuis⁷ PharmD cchapuis1@chu-grenoble.fr

Luc Foroni⁷ PharmD lforoni@chu-grenoble.fr

Muriel Cornet^{2,4} MD PhD mcornet@chu-grenoble.fr

Jean-François Timsit^{3,8} MD PhD jean-francois.timsit@bch.aphp.fr

1: U823, Grenoble Alpes University, Rond-point de la Chantourne F-38700 La Tronche
France

2: Parasitology-Mycolology Laboratory, Institut de Biologie et de Pathologie, CHU de
Grenoble, Grenoble, France

3: UMR 1137 - IAME Team 5 – DeSCID : Decision SCiences in Infectious Diseases, control
and care Inserm/ Paris Diderot, Sorbonne Paris Cité University, 16 rue Henri Huchard Paris
F-75018, France

4: TIMC-IMAG-TheREx, UMR 5525 CNRS-UJF, Grenoble Alpes University, France , La
Tronche F-38700, France

5: UMR 5163 LAPM CNRS-UJF Grenoble Alpes University

6: Medical ICU, Grenoble University hospital, Boulevard de la Chantourne, F-38700 La Tronche, France

7: Pharmacy, Grenoble University hospital, Boulevard de la Chantourne, F-38700 La Tronche, France

8: Medical and Infectious Diseases ICU - Paris Diderot University / Bichat Hospital, 46 rue Henri Huchard, Paris F-75018 , France

Institution where the work was performed: Grenoble University hospital

Corresponding author

Pr Jean François TIMSIT

Université Paris Diderot / Hopital Bichat - Réanimation Médicale et des maladies infectieuses

46 rue Henri Huchard, Paris 75018

Phone +33 140 25 77 02

Fax +33 1 40 25 88 37

Email : jean-francois.timsit@bch.aphp.fr

Abstract

INTRODUCTION: The incidence of *Candida* spp. infections is worrisome, particularly in critically ill patients. Previous reports suggested that the increasing use of antifungal therapy might affect resistance profiles of invasive strains. The study objective was to describe the distribution resistance profiles of *Candida* spp. strains, and to correlate it with antifungal consumptions within one ICU.

METHOD: Antifungal drug consumption was measured as the number of defined daily doses per 1000 hospital days. The distribution of *Candida* spp. over a 10 year period (2004-13) and the MICs of antifungal drugs over 2007-13 were determined. Time series analyses were performed.

RESULTS. Of 2,403 identified *Candida* spp. from 5,360 patients, *C. albicans* predominated (53.1%), followed by *C. glabrata* (16.2%), *C. parapsilosis* (7.9%) and *C. tropicalis* (7.5%). *C. parapsilosis* increased from 5.7% in 2004 to 8.4% in 2013 (P=0.02). The increase in caspofungin use is correlated with the increase in caspofungin MICs of *C. parapsilosis* (P=0.01), *C. glabrata* (P=0.001) and *C. albicans* (P=0.02). Polyenes consumption correlated with an increase in amphotericin B MICs of *C. glabrata* (P=0.04).

CONCLUSION. Previous history of antifungal prescription within an ICU influences *Candida* species distribution and susceptibility profile to antifungal agents. The significant selective pressure exerted by caspofungin and amphotericin B on *C. glabrata* is a concern.

Introduction

Candida spp. strains are the most common causes of fungal infections, and the incidence of *Candida* spp. infections has risen over the last two decades. They account for up to 17% of all ICU-acquired infections and are associated with a high and worrisome increasing trend in mortality rate (1, 2). This increase is partly explained by the increased exposure of ICU patients to multiple-site *Candida* colonization along with invasive procedures (promoted by severe underlying illness, renal replacement therapy, prolonged antibacterial therapy, complicated abdominal surgery, parenteral nutrition, urinary catheter, intravascular lines) (3). The diagnosis of infected patients still relies mainly on blood or sterile-site cultures, although their lack of sensitivity results in detrimental delay in initiating targeted antifungal therapy (4, 5).

In an attempt to limit *Candida*-related mortality, appropriate treatment of proven infection should be started as early as possible. (6) This approach was extended to an increasing number of high risk patients with suspected candidiasis. (7, 8) Thus systemic antifungal treatments (SAT) are widely prescribed in ICU (9, 10) despite the controversies about the actual benefits of this strategy (11, 12). Concerns about misuse of SAT in ICU patients include possible increase of adverse effects, drug interactions and costs (5). In addition, previous studies suggested that antifungal exposure may favor the selection of acquired resistance among isolates recovered from both colonization and infection (5, 13). Indeed, recent reports established the rise of clinical failures associated with acquired resistance (4, 14, 15). Molecular resistance to echinocandins is mainly mediated by mutations in the *FKS* genes, which confer cross-resistance to all three echinocandins. *FKS* mutations are associated with clinical failure in patients receiving echinocandin treatments (15).

Over the past 15 years, antifungal drugs have been increasingly prescribed. However, the commonly used antifungal armamentarium is poor and targets actually only two main fungal

components (the membrane and the cell wall). Because global resistance emergence is a slower process on eukaryotes organisms, ecological impact of drug pressure have to be monitored on longer periods than for bacteria. Ecological changes on a wide period can be multifactorial. We previously reported limited data suggesting that antifungal use predisposes to select some *Candida* species and to increase their minimum inhibitory concentrations (MICs). (13)

The objective of this study was to describe both the distribution and the antifungal susceptibility profiles of *Candida* spp. isolates recovered from colonized and infected sites in ICU patients during a 10-year period. The correlation between antifungal consumptions and both *Candida* spp. distribution and susceptibility profiles was assessed using autoregressive integrated moving average (ARIMA) models and a transfer function. This method is well adapted to demonstrate temporal relationship between two time series such as consumption modification and ecological changes.

Methods

This is a retrospective study which was carried out in the Grenoble University Hospital ICU, France, between January 2004 and December 2013. This 18-bed ICU serves medical and surgical adult patients, including transplant recipients and patients with hematological and solid malignancies. It was an observational study based on anonymous monthly data. It was not necessary to obtain patient's consent and ethic approval.

Antifungal drug use

Data on antifungal drug use were extracted from the electronic database of the hospital pharmacy. Targeted antifungal drugs were polyenes (including amphotericin B and liposomal amphotericin B), caspofungin, micafungin, voriconazole and fluconazole. Regarding itraconazole, posaconazole, 5-fluorocytosine and anidulafungin, the levels of use in our ICU was considered too low during the study period to exert major effects.

We converted antifungal drug doses from milligrams to defined daily dose per 1000 hospital days (DDDs/1000HD), in accordance with the Guidelines for ATC classification and DDD assignment (WHO collaborating Centre for Drug Statistic Methodology; www.whocc.no).

The DDDs were 70 mg for amphotericin B, 210 mg for liposomal amphotericin B, 50 mg for caspofungin, 100 mg for micafungin, 400 mg for voriconazole and fluconazole. In a second step, we pooled the data for amphotericin B and liposomal amphotericin B to define overall polyene use.

Sampling and *Candida* spp. identification

All *Candida*-positive specimens from blood culture, respiratory tract, oropharyngeal tract, urine, stools, surgical site, and drains were considered (table 2). When multiple isolates were obtained from the same patient at the same time, all *Candida* spp. were included in the study but only the first isolate of a given species was considered in the analysis.

Specimens were inoculated onto CAN2 chromogenic isolation plates and/or Sabouraud chloramphenicol tubes (bioMérieux, Lyon, France) and incubated for 3-6 days at 35°C. The following rapid tests were used for identification: rapid assimilation or agglutination tests (Glabrata RTT, Bichro-Latex Albicans and Krusei-Color; Fumouze Diagnostics, Levallois-Perret, France) and api-ID32C (bioMérieux, Lyon, France). Blood samples were inoculated on Mycosis IC/F, Bactec Plus Aerobic/F, Bactec plus Anaerobic/F media and incubated up to 5 days in a Bactec 9240 automated system (Becton Dickinson Inc., Sparks, MS, USA).

Antifungal drug susceptibility

Yeast isolated from blood cultures, deep sites and normally sterile sites were tested routinely. For non-sterile sites (e.g. the lower respiratory tract and stools), the decision to perform antifungal drug susceptibility testing was based on the underlying disease and on the physician's request. The Etest[®] method (bioMérieux) was used during the 2007-2013 period. Fluconazole, amphotericin B, caspofungin and voriconazole Etest strips were placed on RPMI 1640 agar (AES, Reuz, France) and incubated at 35°C for 24h as recommended.

MICs were classified in subcategories (sensible (S), intermediate (I) and resistant (R)) for the four main species (*C. albicans*, *C. glabrata*, *C. parapsilosis* and *C. tropicalis*) following the

official EUCAST and CLSI recommendations (9, 15). (*Additional details on MICs subcategories are provided in the Supplemental Digital Content SDC1*).

Statistical analysis

For the most commonly isolated *Candida* spp. the monthly incidences and their changes over time were assessed using linear regression with correction for autocorrelation (AUTOREG procedure, SAS Inc. Cary, NC, USA). The Durbin-Watson statistic was used to identify significant autocorrelation terms. The same method was used to test linear trends in antifungal drug use over time. Fisher's test was performed to evaluate relationships between MIC subcategories and time periods; the Chi² test for trend was used when only two MIC categories were available.

The relationship between monthly antifungal drug use and 1) monthly median MIC of the same drug 2) proportion of *Candida* spp. were assessed using a dynamic regression model. In our study, this method consisted of modeling MIC or *Candida* spp. using the ARIMA model and adding drug consumption as an explanatory variable through a specific function (called 'transfer function'). ARIMA was designed to model a quantitative series over time by identifying the correlation with the past values of the same variable (AR stand for autoregressive) and abrupt changes in the recent past (MA stand for moving average). This method allowed us to determine the most likely time for the occurrence of the potential effect of antifungal drug use on the MIC or species proportions for each particular drug (16). The model-building process for each antifungal drug-*Candida* spp. pair involved four steps: (i) a linear interpolation for MIC missing values (ii) an ARIMA model was fitted to the MIC or species proportions series and to the drug-use series; (iii) the cross-correlations of the series were estimated to identify any significant and relevant delayed association over time; and (iv)

the drug-use series was entered in the MIC or strain proportions model using the transfer function in ARIMA (0,0,0) according to the lag found in step 2.

Series stationarity was tested (Dickey and Fuller test) and ensured by data differencing or transformation. The model yielding the lowest Akaike information criterion was chosen as the best model. Goodness-of-fit was assessed throughout model fitting using a white noise test of residuals and cross-correlation check of residuals.

Statistical analyses were performed using SAS 9.3 (SAS Inc).

Results

Patient population

During the 10-year period, 5,360 patients were included, among whom 1,712 had at least one specimen that yielded *Candida* spp. The mean number of ICU admission per year was 882 (SD 131 ; median 911), and the mean hospitalization days per year was 5823 (SD 572 ; median 5765). The mean simplified Acute Physiology score II (SAPS II) in the ICU per year was 45 (SD 1.65), the mean number of ICU death per year was 140 (SD 35) and the mean number of hospital death per year was 204 (SD 45).

Antifungal drug use

Table 1 reports the overall antifungal drug use during the study period. In 2013, micafungin was the most recently introduced (2010) and the most heavily used antifungal drug (38.8 DDDs/1000 HD), followed by fluconazole (37.7 DDDs/1000 HD), caspofungin (32.5 DDDs/1000HD), voriconazole (31.4 DDDs/1000 HD) and amphotericin B (19.1 DDDs/1000HD). Echinocandins use, including caspofungin and micafungin, increased significantly from 2004 to 2013 ($p < 0.0001$). There was a trend to a non-significant decrease of amphotericin B use ($p = 0.15$). The use of fluconazole, voriconazole remained unchanged over the whole study period ($p = 0.29$, and $p = 0.46$ respectively).

Distribution of *Candida* spp.

Table S1 in the Supplemental Digital Content reports the source of the samples and the culture results. Of the 42,873 samples collected during the study period, 8,362 (19.5%) yielded a *Candida* spp. Each species was counted only once per patient, which yielded a total of 2,403 *Candida* spp. isolates. Table 2 shows the distribution of *Candida* spp. *C. albicans* predominated (53 %), followed mainly by *C. glabrata* (22.2%), *C. parapsilosis* (7.9%), and

C. tropicalis (7.5%). The proportion of *C. parapsilosis* isolates increased significantly, from 5.7% (10/174) in 2004 to 8.4% (19/225) in 2013 ($p=0.02$). No changes occurred over time for the other *Candida* spp.

Correlations between antifungal drug use and *Candida* spp. distribution

We observed many significant correlations between previous use of antifungals and *Candida* spp. distribution (Table 3). The correlations were maximized for time lags varying from 2 to 7 months according to analyzes.

Antifungal susceptibility profiles

Table S2 in the Supplemental Digital Content reports the antifungal susceptibility data. The statistical analysis of drug susceptibility data for 2007-2013 was confined to the four most common species, namely, *C. albicans* (n=380), *C. glabrata* (n=107), *C. parapsilosis* (n=65) and *C. tropicalis* (n=49), resulting in 892 Etest determination. The proportion of *C. albicans* isolates showing fluconazole MICs between 0 and 0.5 mg/L increased significantly from 52% in 2007 to 90% in 2009 ($p<0.0001$) and stabilized thereafter. Resistant strains for fluconazole were found for *C. albicans* (2007: 3% and 2008: 1%), *C. glabrata* (2008: 13% and 2012: 11%) and *C. parapsilosis* (2007: 14% to 2012: 25%) without significant trend for the resistant phenomenon. Resistance to voriconazole was observed for two species: *C. albicans* (2007: 2% and 2008: 1%), *C. glabrata* (2008: 20%, 2012: 11% and 2013: 11%) without significant trend. All but one were susceptible to amphotericin B. No resistance to caspofungin was observed for the four *Candida* spp.

Correlations between antifungal drug use and *Candida* spp. MICs

Increased caspofungin use correlated significantly with increased caspofungin MIC values of *C. parapsilosis* isolates ($p=0.01$) 3 months later, and of *C. glabrata* isolates ($P=0.001$) 2 months later and of *C. albicans* ($p=0.02$) 7 months later (Table 4). As an example, Figure 1 shows the influence of high caspofungin use in periods 61 or 88 on predicted caspofungin MICs of *C. glabrata* in periods 63 or 90 (2 months later) (Figure S1 in the Supplemental Digital Content shows the influence of high caspofungin use on predicted caspofungin MICs of *C. parapsilosis*). Echinocandins (caspofungin and micafungin) consumption is significantly correlated with increased echinocandins MICs for *C. tropicalis* ($p=0.04$) two months later. Greater amphotericin B use significantly correlated with increased amphotericin B MICs for *C. glabrata* ($p=0.04$) 6 months later and there was a trend to a non significant increase of amphotericin B MICs for *C. albicans* 5 months later ($p=0.08$). Fluconazole consumption is significantly associated to a significant increase of fluconazole MICs for *C. tropicalis* 1 month later ($p=0.001$). No other significant correlations were found.

Discussion

The present study assessed the effect of antifungal drug use on the epidemiology and susceptibility of *Candida* spp. in ICU patients over ten years. The results confirm that history of antifungal use in ICUs influences both *Candida* species distribution and MICs of antifungal agents against major *Candida* spp. The observed effects of the drug exposure were drug- and species-dependent. In particular, echinocandins consumption was correlated with MICs rise in all the four species analyzed, except caspofungin and *C. tropicalis*. By contrast, significant selective pressures were exerted by amphotericin B only on *C. glabrata*, by fluconazole only on *C. tropicalis*, and by echinocandins on *C. parapsilosis*, *C. tropicalis* and *C. glabrata*. The latter effect confirms the findings of Fournier et al. over a shorter period regarding *C. parapsilosis* (13). These results are completely in accordance with other reports describing the emergence of *C. parapsilosis* and *C. glabrata* which are constantly gaining ground on *C. albicans* as responsible of candidemia (17), and the emergence of echinocandin-resistant *C. glabrata* strains (14, 18). Other recent studies have raised the question of the impact of antifungal use on emerging resistance, especially for echinocandins. Fekkar et al. described the emergence of 11 isolates of *Candida* spp. resistant to echinocandins during the year 2011, following ten years of increasing level of prescription of caspofungin (19). Our analysis comforts their hypothesis of the deleterious influence of overprescription on *Candida* spp. susceptibility profile.

The delays of these effects were also species-dependent; they were shorter in *C. glabrata*, *C. parapsilosis* and *C. tropicalis* than in *C. albicans*. The quick impact of echinocandins on *C. parapsilosis* susceptibility may be explained by the natural polymorphism in the target gene *FKS*. *C. glabrata* decreased rapidly its susceptibility to echinocandins, and this can be partly due to its haploid genome making it more prone to phenotypical changes after gene mutations. The *C. glabrata* MIC modification under amphotericin B confirms our previous observations,

although still unexplained (20). Multi-drug-resistant phenotypes in *C. glabrata* have recently been increasingly reported (21, 22); according to our result, a selective pressure of amphotericin B on *C. glabrata* might explain amphotericin B resistance emergence. This is an emerging concern because amphotericin B is commonly seen as the ‘last chance’ pan-species antifungal agent.

Results for *C. tropicalis* are concerning because they affect fluconazole and echinocandins, which are considered highly active against this species. *C. tropicalis* is frequently involved in invasive candidiasis in patients with malignancies, whilst these patients are commonly treated with these antifungals. Thus, specific attention should be paid to the susceptibility profile of this species subjected to drug pressure.

Impact of echinocandin use has also been highlighted on *C. albicans*. This result is important as this species has long been regarded as protected from resistance selection due to the very low prevalence of clinical resistant strains (15).

This study has not shown significant correlation between fluconazole and voriconazole consumption and MICs for the main *Candida* spp at the exception of the correlation between fluconazole consumption and MICs for *C. tropicalis* one month later. The later finding for *C. tropicalis* is surprising and needs to be confirmed by further studies. The lack of fluconazole and voriconazole impact on *C. glabrata* MICs is quite unexpected, owing to the intrinsic low azole susceptibility of this species. The currently low consumption of voriconazole in ICUs might explain its minor impact compared to that of other antifungals. Concerning the fluconazole, the absence of observed significant correlation might be explained by other parameters that were not taken into account in the ARIMA models.

The present study had several limitations. First, it is a retrospective study carried out in a single ICU; an extension to several ICUs will ensure a better understanding of the

determinants and extents of fungal resistance. Second, the ARIMA model used could have omitted several confounders, which might have biased the results and led to the observed associations. However, the determination coefficients for antifungal consumption and MIC suggest that a large part of MIC variability was explained by the model. A selection bias was also possible because not all *Candida* strains of all infection or colonization cases were submitted to the E-Test for assessment of susceptibility. Third, the MICs for caspofungin were assessed with routine caspofungin E-Test whereas these tests might have failed to detect non-susceptible isolates (9). In fact, after the recent recommendations (23), anidulafungin MICs was introduced in the study laboratory to assess yeast susceptibility to caspofungin, but the data were not available at the time of the present analysis.

Despite these limitations, results of this study confirmed that antifungal consumption can influence *Candida* spp. distribution and susceptibility profiles in ICUs where the impact of the emergence of resistance strain could lead therapeutic failure. Indeed, despite the fact that resistance among *Candida* strains is already known for several years (22), empirical SAT remain widely used by many ICU physicians, because of the high attributable mortality of *Candida* infections. Recent consensus guidelines all encourage the use of echinocandins as first-line therapy for candidemia with a poor encouragement for fluconazole step-down therapy (11, 24-26). In this context, particular attention should be paid by ICUs physicians to *C. glabrata* when empirical SAT is prescribed. This is particularly important when resistance to echinocandins and azole are detected in the same isolate (21). Currently, the multidrug resistance of *C. glabrata* is considered to be a threat to the effective empiric SAT of patients at risk for *Candida* bloodstream infection (27), especially where there is a shift in infection toward *C. glabrata*. (28)

Conclusion

Despite the new SAT and the new recommendations, prognostic of invasive *Candida* infection has not improved in ICU patients (2). This worrisome observation and our results highlight that effort to avoid the misuse of antifungal drugs is essential in intensive care units and comfort the recommendations for a better monitoring of the antifungal prescription, aiming to avoid resistance phenomenon without jeopardizing the efficacy of antifungal therapy .

List of abbreviations

ICU: intensive care unit

DDD: defined daily dose

HD: hospital days

MIC: minimum inhibitory concentration

SAT: systemic antifungal treatment

ARIMA: autoregressive integrated moving average

SD: standard deviation

Key messages

- We explored 10 years data for *Candida* spp. distribution and antifungal consumption.
- Increasing use of antifungal prescription influences MICs of antifungal agents.
- Increasing use of antifungal prescription influences distribution of *Candida* spp.
- Caspofungin and amphotericin B exerted a selective pressure on *C. glabrata*.

Conflict of Interest: M Cornet has received honoraria from Pfizer for educational presentations. JF Timsit: research grant from Merck, Astellas, 3M, Consultant for: Gilead, Merck, 3M, Astra-Zeneca, Give lecture in symposium for Pfizer, Novartis, Astellas, Merck. The other authors have no conflict of interest to declare.

Authors' contributions: SB, DM, PF, MC and JFT participated in the conception and design of study; DM, MC participated in the acquisition of biological data; CS, JFT participated in the acquisition of clinical data; CC, LF participated in the acquisition of pharmaceutical data; SB and JFT carried out the statistical analysis of the data; SB, DM, HP, MC and JFT participated to drafting and critical revisions of the manuscript. All authors read and approved the final manuscript.

Acknowledgements: the authors thank Dr Céline Feger (EMIBiotech), for her editorial assistance.

References

1. Vincent JL, Rello J, Marshall J, Silva E, Anzueto A, Martin CD, et al. International study of the prevalence and outcomes of infection in intensive care units. *Jama*. 2009 Dec 2;302(21):2323-9. PubMed PMID: 19952319. Epub 2009/12/03. eng.
2. Lortholary O, Renaudat C, Sitbon K, Madec Y, Denoed-Ndam L, Wolff M, et al. Worrying trends in incidence and mortality of candidemia in intensive care units (Paris area, 2002-2010). *Intensive care medicine*. 2014 Sep;40(9):1303-12. PubMed PMID: 25097069. Pubmed Central PMCID: 4147247. Epub 2014/08/07. eng.
3. Leon C, Ruiz-Santana S, Saavedra P, Galvan B, Blanco A, Castro C, et al. Usefulness of the "Candida score" for discriminating between Candida colonization and invasive candidiasis in non-neutropenic critically ill patients: a prospective multicenter study. *Crit Care Med*. 2009 May;37(5):1624-33. PubMed PMID: 19325481. Epub 2009/03/28. eng.
4. Shields RK, Nguyen MH, Press EG, Updike CL, Clancy CJ. Caspofungin MICs correlate with treatment outcomes among patients with *Candida glabrata* invasive candidiasis and prior echinocandin exposure. *Antimicrob Agents Chemother*. 2013 Aug;57(8):3528-35. PubMed PMID: 23669387. Pubmed Central PMCID: 3719767. Epub 2013/05/15. eng.
5. Leon C, Ostrosky-Zeichner L, Schuster M. What's new in the clinical and diagnostic management of invasive candidiasis in critically ill patients. *Intensive care medicine*. 2014 Jun;40(6):808-19. PubMed PMID: 24718642. Epub 2014/04/11. eng.
6. Corona A, Colombo R, Ascari A, Raimondi F. Antifungal therapy in the critically ill: in medio stat virtus; is a preemptive approach correct? *Crit Care Med*. 2012 Sep;40(9):2737-8; author reply 8-9. PubMed PMID: 22903113. Epub 2012/08/21. eng.
7. Freifeld AG, Bow EJ, Sepkowitz KA, Boeckh MJ, Ito JI, Mullen CA, et al. Clinical practice guideline for the use of antimicrobial agents in neutropenic patients with cancer: 2010 update by the infectious diseases society of america. *Clin Infect Dis*. 2011 Feb 15;52(4):e56-93. PubMed PMID: 21258094. Epub 2011/01/25. eng.
8. Bratzler DW, Dellinger EP, Olsen KM, Perl TM, Auwaerter PG, Bolon MK, et al. Clinical practice guidelines for antimicrobial prophylaxis in surgery. *Surg Infect (Larchmt)*. 2013 Feb;14(1):73-156. PubMed PMID: 23461695. Epub 2013/03/07. eng.
9. Arendrup MC, Dzajic E, Jensen RH, Johansen HK, Kjaeldgaard P, Knudsen JD, et al. Epidemiological changes with potential implication for antifungal prescription recommendations for fungaemia: data from a nationwide fungaemia surveillance programme. *Clin Microbiol Infect*. 2013 Aug;19(8):E343-53. PubMed PMID: 23607326. Epub 2013/04/24. eng.
10. Azoulay E, Dupont H, Tabah A, Lortholary O, Stahl J-P, Francois A, et al. Systemic antifungal therapy in critically ill patients without invasive fungal infection*. *Crit Care Med*. 2012 2012/03//;40(3):813-22.
11. Pappas PG, Kauffman CA, Andes D, Benjamin DK, Jr., Calandra TF, Edwards JE, Jr., et al. Clinical practice guidelines for the management of candidiasis: 2009 update by the Infectious Diseases Society of America. *Clin Infect Dis*. 2009 Mar 1;48(5):503-35. PubMed PMID: 19191635. Epub 2009/02/05. eng.
12. Schuster MG, Edwards JE, Jr., Sobel JD, Darouiche RO, Karchmer AW, Hadley S, et al. Empirical fluconazole versus placebo for intensive care unit patients: a randomized trial. *Ann Intern Med*. 2008 Jul 15;149(2):83-90. PubMed PMID: 18626047. Epub 2008/07/16. eng.
13. Fournier P, Schwebel C, Maubon D, Vesin A, Lebeau B, Foroni L, et al. Antifungal use influences *Candida* species distribution and susceptibility in the intensive care unit. *J Antimicrob Chemother*. 2011 Dec;66(12):2880-6. PubMed PMID: 21980066. Epub 2011/10/08. eng.
14. Alexander BD, Johnson MD, Pfeiffer CD, Jimenez-Ortigosa C, Catania J, Booker R, et al. Increasing echinocandin resistance in *Candida glabrata*: clinical failure correlates with presence of FKS mutations and elevated minimum inhibitory concentrations. *Clin Infect Dis*. 2013

Jun;56(12):1724-32. PubMed PMID: 23487382. Pubmed Central PMCID: 3658363. Epub 2013/03/15. eng.

15. Maubon D, Garnaud C, Calandra T, Sanglard D, Cornet M. Resistance of *Candida* spp. to antifungal drugs in the ICU: where are we now? *Intensive care medicine*. 2014 Sep;40(9):1241-55. PubMed PMID: 25091787. Epub 2014/08/06. eng.

16. Lopez-Lozano JM, Monnet DL, Yague A, Burgos A, Gonzalo N, Campillos P, et al. Modelling and forecasting antimicrobial resistance and its dynamic relationship to antimicrobial use: a time series analysis. *Int J Antimicrob Agents*. 2000 Feb;14(1):21-31. PubMed PMID: 10717497. Epub 2000/03/16. eng.

17. Guinea J. Global trends in the distribution of *Candida* species causing candidemia. *Clin Microbiol Infect*. 2014 Jun;20 Suppl 6:5-10. PubMed PMID: 24506442. Epub 2014/02/11. eng.

18. Shields RK, Nguyen MH, Press EG, Updike CL, Clancy CJ. Anidulafungin and micafungin MIC breakpoints are superior to that of caspofungin for identifying FKS mutant *Candida glabrata* strains and Echinocandin resistance. *Antimicrob Agents Chemother*. 2013 Dec;57(12):6361-5. PubMed PMID: 24060873. Pubmed Central PMCID: 3837909. Epub 2013/09/26. eng.

19. Fekkar A, Dannaoui E, Meyer I, Imbert S, Brossas JY, Uzunov M, et al. Emergence of echinocandin-resistant *Candida* spp. in a hospital setting: a consequence of 10 years of increasing use of antifungal therapy? *Eur J Clin Microbiol Infect Dis*. 2014 Sep;33(9):1489-96. PubMed PMID: 24715154. Epub 2014/04/10. eng.

20. Fournier C, Gaspar A, Boillot F, Villard J. Evaluation of a broth microdilution antifungal susceptibility test with a pH indicator: comparison with the broth macrodilution procedures. *J Antimicrob Chemother*. 1995 Mar;35(3):373-80. PubMed PMID: 7782253. Epub 1995/03/01. eng.

21. Krogh-Madsen M, Arendrup MC, Heslet L, Knudsen JD. Amphotericin B and caspofungin resistance in *Candida glabrata* isolates recovered from a critically ill patient. *Clin Infect Dis*. 2006 Apr 1;42(7):938-44. PubMed PMID: 16511756. Epub 2006/03/03. eng.

22. Ostrosky-Zeichner L. *Candida glabrata* and FKS mutations: witnessing the emergence of the true multidrug-resistant *Candida*. *Clin Infect Dis*. 2013 Jun;56(12):1733-4. PubMed PMID: 23487384. Epub 2013/03/15. eng.

23. Arendrup MC, Rodriguez-Tudela JL, Lass-Flörl C, Cuenca-Estrella M, Donnelly JP, Hope W. EUCAST technical note on anidulafungin. *Clin Microbiol Infect*. 2011 Nov;17(11):E18-20. PubMed PMID: 21923778. Epub 2011/09/20. eng.

24. Cornely OA, Bassetti M, Calandra T, Garbino J, Kullberg BJ, Lortholary O, et al. ESCMID* guideline for the diagnosis and management of *Candida* diseases 2012: non-neutropenic adult patients. *Clin Microbiol Infect*. 2012 Dec;18 Suppl 7:19-37. PubMed PMID: 23137135. Epub 2013/01/04. eng.

25. Leroux S, Ullmann AJ. Management and diagnostic guidelines for fungal diseases in infectious diseases and clinical microbiology: critical appraisal. *Clin Microbiol Infect*. 2013 Dec;19(12):1115-21. PubMed PMID: 24118188. Epub 2013/10/15. eng.

26. Maertens J, Marchetti O, Herbrecht R, Cornely OA, Fluckiger U, Frere P, et al. European guidelines for antifungal management in leukemia and hematopoietic stem cell transplant recipients: summary of the ECIL 3--2009 update. *Bone Marrow Transplant*. 2011 May;46(5):709-18. PubMed PMID: 20661235. Epub 2010/07/28. eng.

27. Pfaller MA, Castanheira M, Lockhart SR, Ahlquist AM, Messer SA, Jones RN. Frequency of decreased susceptibility and resistance to echinocandins among fluconazole-resistant bloodstream isolates of *Candida glabrata*. *J Clin Microbiol*. 2012 Apr;50(4):1199-203. PubMed PMID: 22278842. Pubmed Central PMCID: 3318516. Epub 2012/01/27. eng.

28. Andes DR, Safdar N, Baddley JW, Playford G, Reboli AC, Rex JH, et al. Impact of treatment strategy on outcomes in patients with candidemia and other forms of invasive candidiasis: a patient-level quantitative review of randomized trials. *Clin Infect Dis*. 2012 Apr;54(8):1110-22. PubMed PMID: 22412055. Epub 2012/03/14. eng.

Table 1 Overall antifungal drug use in mean defined daily doses per 1000 hospital days DDDs/1000HD (standard deviation) from 2004 to

December 2013

Drug	Drug use[DDDs / 1000 HD (SD)]												Pvalue ^c
	2004	2005	2006	2007	2008	2009	2010	2011	2012	2013			
Amphotericin B ^b	45.9 (47.1)	35.2 (26.3)	23.8 (22.4)	30.4 (28.4)	53.4 (50.5)	45.3 (33)	19 (16.4)	37.9 (46.1)	28.8 (31.6)	19.1 (13.8)	0.15		
Fluconazole	34 (23.5)	33.5 (30.2)	25.5 (14.7)	24.2 (18.1)	13.1 (11.9)	17.9 (15.9)	34 (15.8)	51.7 (18.6)	43.4 (24.3)	37.7 (18.9)	0.29		
Voriconazole	14.8 (34.8)	20.9 (17.9)	26.2 (37.7)	14.1 (22.5)	10.2 (19.6)	37.5 (21.2)	9.9 (12.2)	22.1 (18.7)	14.3 (15.9)	31.4 (24.2)	0.46		
Caspofungin	17.9 (19.3)	35.7 (35.7)	46.7 (31.4)	22.9 (25.7)	56.2 (25.5)	69.9 (40.1)	19.9 (15.4)	37.7 (22.6)	44.6 (20.1)	32.5 (25.6)	0.29		
Micafungin ^c						6.1 (9.2)	4.1 (12.2)	14.8 (21.4)	38.8 (35.2)	0.0001			
Echinocandins	17.9 (19.3)	35.7 (35.7)	46.7 (31.4)	22.9 (25.7)	56.2 (25.5)	69.9 (40.1)	26.0 (20.3)	41.7 (23.4)	59.4 (26.9)	71.3 (43.3)	<0.001		

^a P value of the autocorrelated error model (refers to a significant decrease or increase over time^e. ^b Includes liposomal amphotericin B. ^c No

available data before 2010 – DDD: Defined Daily Doses; HD: Hospitalisation Days SD: Standard Deviation

Table 2. Global *Candida* spp. distribution from January 2004 to December 2013

Organism	Number of isolates (%)													Total	P value ^a
	2004	2005	2006	2007	2008	2009	2010	2011	2012	2013	2013	2013			
<i>C. albicans</i>	100 (57.5)	147 (54)	144 (50.9)	136 (49.5)	125 (50)	136 (54.4)	132 (55.9)	116 (56)	123 (53.3)	115 (51.1)	1274 (53)	0.35			
<i>C. glabrata</i>	26 (14.9)	57 (21)	56 (19.8)	42 (15.3)	35 (13.9)	35 (13.7)	31 (13.1)	32 (15.3)	37 (16.1)	39 (17.3)	390 (22.2)	0.11			
<i>C. parapsilosis</i>	10 (5.7)	10 (3.7)	16 (5.7)	24 (8.7)	22 (8.8)	31 (12.4)	21 (8.9)	21 (10.1)	16 (7)	19 (8.4)	190 (7.9)	0.02			
<i>C. tropicalis</i>	13 (7.5)	16 (5.9)	23 (8.1)	22 (8)	15 (6)	22 (8.6)	16 (6.8)	16 (7.7)	17 (7.4)	21 (9.3)	181 (7.5)	0.50			
<i>C. kefyr</i>	10 (5.8)	14 (5.2)	15 (5.3)	14 (5.1)	20 (8)	9 (3.5)	12 (5.1)	8 (3.8)	15 (6.5)	15 (6.7)	132 (5.5)	0.37			
<i>C. krusei</i>	6 (3.5)	13 (4.8)	14 (5)	13 (4.7)	19 (7.6)	5 (2)	20 (8.5)	10 (4.8)	14 (6.1)	10 (4.4)	124 (5.2)	0.80			
Other <i>Candida</i> spp.	9 (5.2)	15 (5.5)	15 (5.3)	24 (8.7)	14 (5.6)	12 (4.7)	4 (1.7)	4 (1.9)	9 (3.9)	6 (2.7)	112 (4.7)				
All <i>Candida</i> spp.	174 (100)	272 (100)	283 (100)	275 (100)	250 (100)	250 (100)	236 (100)	207 (100)	231 (100)	225 (100)	2403				

^aP value of the autocorrelated error model (refers to a significant decrease or increase over time).

Table 3. Relationship between the monthly antifungal consumption and *Candida* spp. frequencies in subsequent months, based on ARIMA

models with transfer function

Drug	<i>C. albicans</i>	<i>C. glabrata</i>	<i>C. parapsilosis</i>	<i>C. tropicalis</i>	<i>C. krusei</i>	<i>C. kefyr</i>
Caspofungin						
β (SE)	-0.001 (0.0006)	-0.001 (0.0004)	0.0007 (0.0003)	-0.0003 (0.0003)	-0.0005 (0.0002)	-0.0002 (0.0003)
Time lag	6	7	7	2	7	7
Pvalue	0.03	0.01	0.02	0.27	0.04	0.38
Echinocandins ^a						
β (SE)	-0.001 (0.0005)	-0.0008 (0.0004)	0.0005 (0.0003)	-0.0001 (0.0003)	-0.0005 (0.0002)	-0.0002 (0.0003)
Time lag	6	5	6	2	7	7
Pvalue	0.009	0.03	0.048	0.62	0.01	0.31
Fluconazole						
β (SE)	0.0006 (0.0008)	-0.0008 (0.0006)	-0.001 (0.0004)	0.0007 (0.0004)	0.0002 (0.0003)	0.0002 (0.0004)
Time lag	5	5	4	9	7	2
Pvalue	0.45	0.16	0.005	0.08	0.58	0.55
Amphotericin B						
β (SE)	-0.001 (0.0005)	-0.0003 (0.0004)	-0.0002 (0.0003)	-0.0003 (0.0002)	0.0004 (0.0002)	0.0007 (0.0003)
Time lag	6	8	5	3	5	2
Pvalue	0.045	0.44	0.47	0.21	0.07	0.02
Voriconazole						
β (SE)	-0.002 (0.0007)*	0.0007 (0.0006)	0.0005 (0.0004)	0.0005 (0.0003)	-0.0008 (0.0003)	-0.0008 (0.0004)
Time lag	5	5	3	3	7	3
Pvalue	0.01	0.18	0.22	0.17	0.01	0.05

β (SE) is the estimate of the effect of antifungal use in previous months (time lag) on *Candida* species distribution for an antifungal, after inclusion in an ARIMA model designed to predict the MIC time series. A p value < 0.05 means there was a strong temporal correlation between antifungal consumption and *Candida* spp. MIC (according to the sign of β).

^aEchinocandins : caspofungin + micafungin – SE: Standard Error

Table 4. Relationship between the monthly antifungal consumption and *C. albicans*, *C. glabrata*, *C. parapsilosis* and *C. tropicalis* MICs in subsequent months, based on ARIMA models with transfer function

Drug	<i>C. albicans</i>	<i>C. glabrata</i>	<i>C. parapsilosis</i>	<i>C. tropicalis</i>
Caspofungin				
β (SE)	0.0002 (0.0001)	0.0009 (0.0003)	0.001 (0.0004)	0.0003 (0.0002)
Time lag	7	2	3	2
Pvalue	0.02	0.001	0.01	0.10
R ²	0.40	0.35	0.61	0.47
Echinocandins^a				
β (SE)	0.0002 (0.0001)	0.0008 (0.0003)	0.001 (0.0004)	0.00004 (0.00019)
Time lag	8	2	3	2
Pvalue	0.03	0.004	0.04	0.04
R ²	0.53	0.27	0.61	0.48
Fluconazole				
β (SE)	-0.004 (0.004)	-0.02 (0.01)	0.02 (0.02)	0.005 (0.0015)
Time lag	10	6	8	1
Pvalue	0.35	0.10	0.22	0.001
R ²	0.21	0.15	0.50	0.53
Amphotericin B				
β (SE)	0.0009 (0.0005)	0.002 (0.001)	0.001 (0.001)	0.001 (0.0009)
Time lag	5	6	3	4
Pvalue	0.08	0.04	0.29	0.23
R ²	0.23	0.27	0.21	0.50
Voriconazole				
β (SE)	-0.00004 (0.0001)	0.005 (0.004)	0.0005(0.0004)	0.0003 (0.0003)
Time lag	4	4	6	4
Pvalue	0.70	0.26	0.19	0.36
R ²	0.37	0.04	0.44	0.66

β (SE) is the estimate of the effect of antifungal use in previous months (time lag) on *Candida* MICs for an antifungal, after inclusion in an ARIMA model designed to predict the MIC time series

^aEchinocandins : caspofungin + micafungin

Figure 1: Monthly caspofungin consumption and predicted MICs of caspofungin for *C. glabrata*

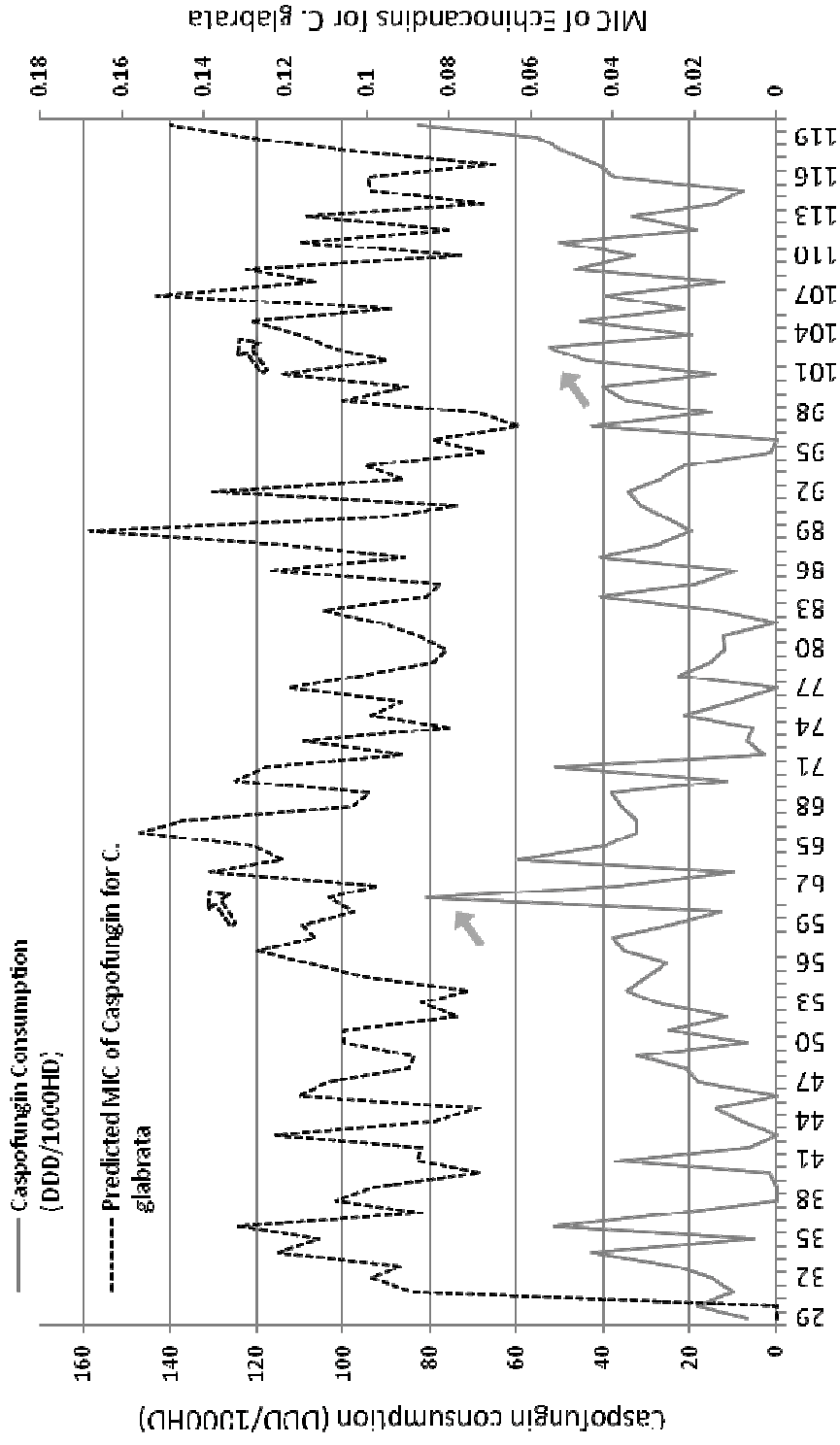

The predicted MICs of caspofungin for *C. glabrata* were obtained from an ARIMA (1,0,3) model for caspofungin consumption with a 3-month lag as an input variable (see statistical methods for details). The number on the x-axis are months (from 2007 until December 2013). The grey arrows underline periods of high caspofungin consumption, and the dotted-line arrows underline their impact on predicted *C. glabrata* caspofungin MIC

Supplément électronique de la publication 2

Impact of Antifungal Prescription on relative distribution and susceptibility of *Candida*
Species in one ICU - Trends Over 10 Years

S. Bailly, D. Maubon, P. Fournier, H. Pelloux, C. Schwebel, C. Chapuis, L. Foroni,
M. Cornet, J.F. Timsit

Corresponding author

Pr Jean François TIMSIT

UMR 1137 — IAME Team 5 – DeSCID : Decision SCiences in Infectious Diseases, control
and care Inserm/ Paris Diderot, Sorbonne Paris Cité University, 16 rue Henri Huchard Paris
F-75018, France

Medical and Infectious Diseases ICU - Paris Diderot University / Bichat Hospital, 46 rue
Henri Huchard, Paris F-75018 , France

Email : jean-francois.timsit@bch.aphp.fr

SDC1 : Details on MICs subcategories

The subcategories for MICs were : fluconazole, 0-0.5mg/L (S), 0.5-4 mg/L (I) and >4 mg/L (R) for *C. albicans*, *C. parapsilosis* and *C. tropicalis* and 0-32 mg/L (I) and >32 mg/L (R) for *C. glabrata*; amphotericin B, 0-1 (S) mg/L, >1 mg/L (R); voriconazole, 0-0.12 mg/L (S) 0.12-0.5 mg/L (I) and >0.5 mg/L (R) for *C. albicans*, *C. parapsilosis* and *C. tropicalis* and 0-0.25 mg/L (S), 0.25-0.5mg/L (I) and \geq 0.5 mg/L (R) for *C. glabrata*; and caspofungin, 0-0.25 mg/L (S), \geq 0.25-0.5 mg/L (I) and >0.5 mg/L (R) for *C. albicans*, and *C. tropicalis* and 0-0.125 mg/L (S), 0.125-0.25 mg/L (I) and >0.25 mg/L (R) for *C. glabrata*, 0-0.25mg/L (S), 0.25-4 (I) and >4 for *C. parapsilosis*.

Table S1. Number and sources of specimens, and frequency of isolation of *Candida* spp. in a French ICU, 2004-13

	Negative, n (%)	Positive, n (%)	Total
Blood culture	20520 (47.86)	196 (0.46)	20716
Respiratory tract	2900 (6.76)	2437 (5.68)	5337
Oropharyngeal	1486 (3.47)	2255 (5.26)	3741
Urine	2898 (6.76)	706 (1.65)	3604
Stool	1587 (3.70)	1594 (3.72)	3181
Surgical sites	2532 (5.91)	436 (1.02)	2968
Drains	1485 (3.46)	303 (0.71)	1788
Other	1103 (2.57)	435 (1.01)	1538
TOTAL	34511 (80.50)	8362 (19.50)	42873

Table S2. MICs of fluconazole, amphotericin B, caspofungin and voriconazole for *C. albicans*, *C. glabrata*, *C. parapsilosis* and *C. tropicalis* from 2007 to 2013

<i>Candida</i> species	Drug and MIC range (mg/L)	Number of isolates in the MIC range						
		2007 (n=58)	2008 (n=54)	2009 (n=65)	2010 (n=47)	2011 (n=60)	2012 (n=53)	2013 (n=43)
<i>C. albicans</i>	Fluconazole S* : 0 - 0.5	30 (52)	43 (80)	59 (90)	37 (79)	52 (87)	50 (94)	34 (79)
	I : 0.5 — 4	26 (45)	10 (19)	6 (9)	10 (21)	8 (13)	3 (6)	9 (21)
	R : >4	2 (3)	1 (1)					
Ampho B	S : 0 – 1	58 (100)	54 (100)	65 (100)	47 (100)	59(100)	53 (100)	43 (100)
Voriconazole	S : 0 - 0.12	53 (91)	52 (96)	65 (100)	43 (100)	50 (100)	53 (100)	43 (100)
	I : 0.12 – 0.5	4 (7)	1 (2)	-	-	-	-	-
	R : >0.5	1 (2)	1 (2)	-	-	-	-	-
Caspofungin	S : 0 – 0.25	56 (97)	54 (100)	65 (97)	47 (100)	60 (100)	53 (100)	43 (100)
	I : 0.25 – 0.5	2 (3)	-	2 (3)	-	-	-	-
<i>C. glabrata</i>		2007 (n=18)	2008 (n=15)	2009 (n=18)	2010 (n=13)	2011 (n=7)	2012 (n=19)	2013 (n=17)
Fluconazole	I : 0 – 32	18 (100)	13 (87)	18 (100)	13 (100)	7 (100)	17 (89)	17 (100)
	R : >32	-	2 (13)	-	-	-	2 (11)	-
Ampho B	S : 0 - 1	18 (100)	15 (100)	18 (100)	13 (100)	7 (100)	19 (100)	17 (76)
Voriconazole	S : 0 – 0.25	14 (78)	11 (73)	18 (100)	9 (75)	5 (71)	16 (84)	16 (94)
	I : 0.25 – 0.5	4 (22)	1 (7)		3 (25)	2 (29)	1 (5)	1 (5)
	R : >0.5	-	3 (20)	-	-	-	2 (11)	2 (11)
Caspofungin	S : 0 - 0.125	15 (83)	13 (87)	14 (78)	13 (100)	5 (71)	16 (84)	15 (88)
	I : 0.125 – 0.25	3 (17)	2 (13)	4 (22)	-	2 (29)	3 (16)	2 (12)
<i>C. parapsilosis</i>		2007 (n=7)	2008 (n=10)	2009 (n=17)	2010 (n=8)	2011 (n=12)	2012 (n=4)	2013 (n=7)
Fluconazole	S : 0 – 0.5	3 (43)	4 (40)	5 (29)	2 (25)	5 (42)	1 (25)	6 (86)
	I : 0.5 - 4	3 (43)	6 (60)	11 (65)	6 (75)	5 (42)	3 (75)	1 (14)
	R : >4	1 (14)	-	1 (6)	-	2 (16)	1 (25)	-
Ampho B	S : 0 – 1	7 (100)	10 (100)	17 (100)	7 (88)	12 (100)	4 (100)	7 (100)
	R : >1	-	-	-	1 (12)	-	-	-
Voriconazole	S : 0 - 0.12	5 (71)	9 (90)	14 (82)	5 (71)	8 (67)	2 (50)	7 (100)
	I : 0.12 - 0.5	2 (29)	1 (10)	3 (18)	2 (29)	4 (33)	2 (50)	-
Caspofungin	S : 0 - 0.25	2 (29)	2 (20)	3 (18)	-	10 (83)	1 (25)	6 (86)
	I : 0.25 – 4	5 (71)	8 (80)	14 (82)	8 (100)	2 (17)	3 (75)	1 (14)
<i>C. tropicalis</i>		2007 (n=10)	2008 (n=6)	2009 (n=8)	2010 (n=8)	2011 (n=5)	2012 (n=7)	2013 (n=5)
Fluconazole	S : 0 – 0.5	6 (60)	6 (100)	7 (88)	7 (88)	5 (100)	7 (100)	3 (60)
	I : 0.5 – 4	4 (40)	-	1 (12)	1 (12)	-	-	2 (40)
Ampho B	S : 0 – 1	10 (100)	6 (100)	8 (100)	8 (100)	5 (100)	7 (100)	5 (100)
Voriconazole	S : 0 - 0.12	9 (90)	5 (83)	8 (100)	8 (100)	5 (100)	7 (100)	5 (100)
	I : 0.12 – 0.5	1 (10)	1 (17)	-	-	-	-	-
Caspofungin	S : 0 - 0.25	10 (100)	6 (100)	8 (100)	8 (100)	5 (100)	6 (86)	5 (100)
	I : 0.25-0.5	-	-	-	-	-	1(14)	-

* S : Susceptible, I : Intermediate, R: Resistant strains – MIC: Minimum Inhibitory

Concentration – Ampho B : amphotericin B

Figure S1 : Monthly caspofungin consumption and observed and predicted MICs of caspofungin for *C. parapsilosis*.

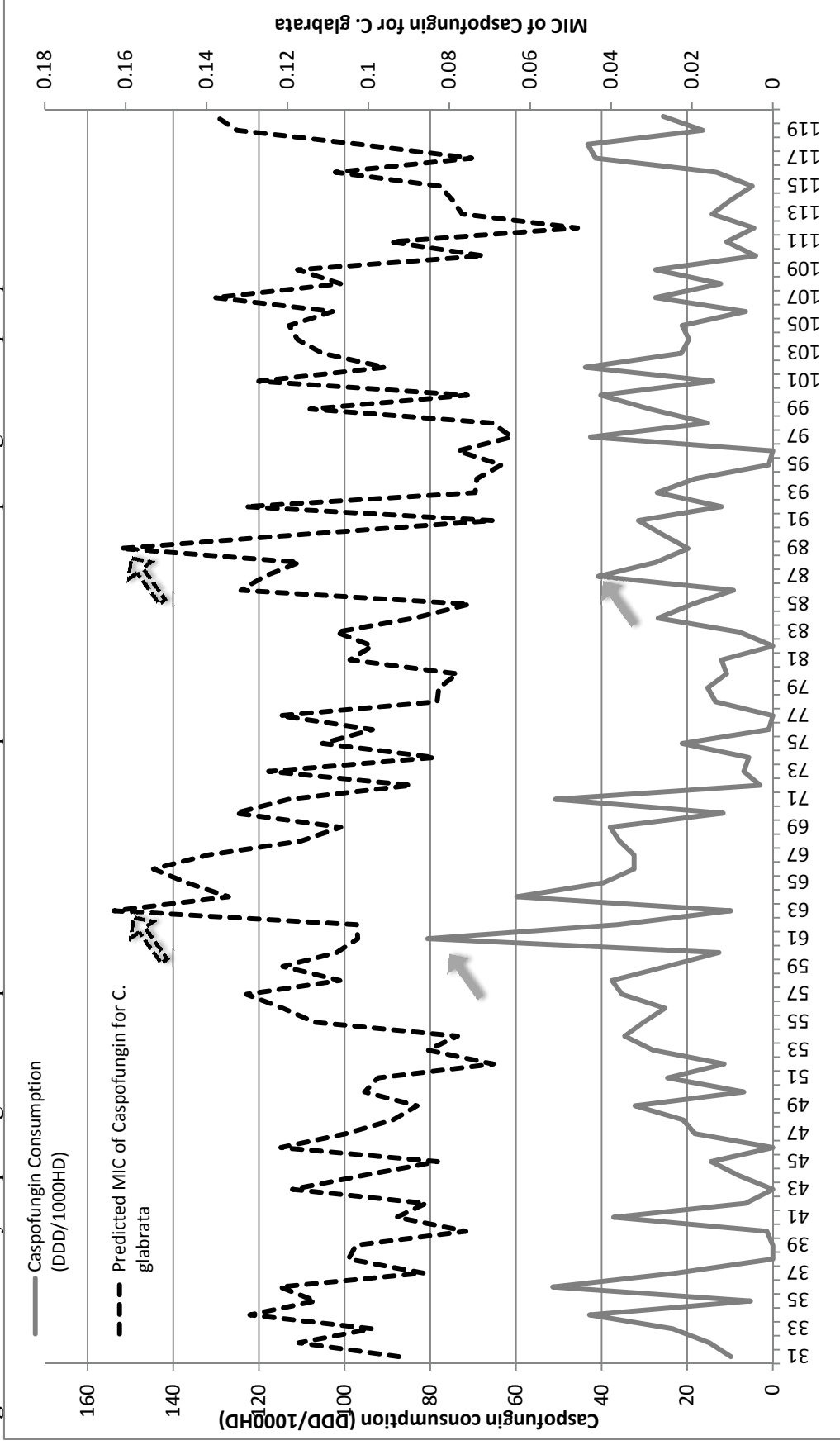

The predicted MICs of caspofungin for *C. parapsilosis* were obtained from an ARIMA (2,0,6) model for caspofungin consumption with a 3-month lag as an input variable (see statistical methods for detail). The number on the x-axis are months (from 2007 until December 2013). The grey arrows underline periods of high caspofungin consumption, and the dotted-line arrows underline their impact on predicted *C. parapsilosis* caspofungin MIC

III. Impact du traitement antifongique sur le diagnostic des candidémies : analyse de données répétées

Nous avons vu précédemment que le diagnostic des candidoses invasives est imparfait et souvent tardif. Dans le cas des candidémies, le diagnostic de référence est défini par l'observation d'un ou plusieurs flacons d'hémoculture positifs. [10, 40] Cependant leur sensibilité est faible, elle est estimée à 75 % dans le meilleur des cas. [41]

En routine, trois flacons peuvent être utilisés : deux flacons non sélectifs des levures, contenant des résines qui agglomèrent les agents anti-infectieux, dont les antifongiques, et un flacon sélectif des levures qui ne contient pas de résines adsorbantes. Des études *in vitro* ont montré que les performances de ces flacons sélectifs diminuent lorsqu'un traitement antifongique a été initié, [41, 42] mais il n'y a pas eu d'étude permettant de confirmer ces observations en situation clinique.

De plus, le choix du type de flacon d'hémoculture le plus approprié pour la détection et le suivi des candidémies n'est pas clair. La question reste posée de savoir si l'ajout d'un flacon sélectif des levures, entraînant un surcoût de sang prélevé, de matériel et de temps d'analyse, présente une réelle valeur ajoutée pour le diagnostic.

Pour répondre à ces questions, nous avons collecté les données nécessaires pour évaluer le taux de positivité, le temps de positivité et la concordance de l'ensemble des flacons d'hémocultures des patients candidémiques du CHU de Grenoble sur 4 ans.

Les données recueillies étaient longitudinales et présentaient une structure particulière : chaque patient pouvait avoir plusieurs jours de prélèvement, et chaque jour plusieurs flacons (avec ou sans résine) pouvaient être prélevés. Il s'agit d'une structure hiérarchique définie par un emboîtement de différents niveaux : le niveau flacon emboîté dans le niveau jour de

prélèvement et le niveau jour emboîté dans le niveau patient. Il s'agit également de mesures répétées, un patient pouvant être prélevé plusieurs jours de suite et avec plusieurs flacons chaque jour.

L'analyse de ces données par une méthode de régression logistique standard, implique que les observations d'un même patient sont indépendantes les unes des autres. Cela entraîne une sous-estimation de la variance liée à l'absence de prise en compte de l'effet groupe et à une inflation artificielle du nombre d'observations indépendantes aux niveaux les plus élevés (patient et jour de prélèvement). Cette approche conduit à une erreur de type I, c'est-à-dire au risque de conclure à un lien significatif entre un facteur d'exposition et la variable d'intérêt, alors que ce lien n'existe pas en réalité. [43, 44]

L'utilisation de modèles hiérarchiques permet d'analyser simultanément les variations interindividuelles au niveau flacon, ainsi qu'intragroupes (niveaux jour de prélèvement et patient).[45]

Ces modèles sont adaptés pour étudier l'impact de l'administration d'un traitement antifongique sur la détection des levures dans les flacons d'hémocultures chez des patients ayant une candidose invasive. Nous avons présenté les résultats de cette étude sous forme d'un article en cours de soumission.

Publication N 3 : Impact of systemic antifungal therapy on the detection of *Candida* spp. in blood cultures containing resins or selective media, in the clinical setting of candidemia

Bailly S, Garnault C, Cornet M, Pavese P, Hamidfar-Roy R, Foroni L, Boisset S, Timsit JF,
Maubon D

Soumis

Poster :

- 7th Trends in Medical Mycology 2015, Lisbon

Résumé de l'article

L'objectif de l'étude est d'évaluer, en situation clinique, l'impact d'un traitement antifongique systémique sur la détection des levures dans les flacons hémocultures.

125 patients ayant eu une candidémie au CHU de Grenoble sur 4 ans (2010 – 2013) ont été inclus de façon rétrospective. Nous avons comparé les résultats des flacons avec résine adsorbante (RV) de ceux des flacons sélectifs des levures (FSV) pour : le taux de positivité, le temps de positivité (TTP) et la concordance des flacons positifs, en utilisant pour chaque caractéristique une analyse multivariée avec un modèle hiérarchique à effets mixtes. Une analyse en sous-groupe a été réalisée pour les patients en USI.

Le taux de positivité des flacons est diminué par la présence de traitement antifongique ($p < 0.01$), une chirurgie abdominale ($p = 0.01$) et une hémodialyse ($p = 0.02$). Le traitement antifongique augmente significativement le TTP des deux types de flacons (RV et FSV). Si le TTP est semblable pour les deux types de flacons, l'effet du traitement antifongique est significativement plus élevé pour les flacons sans résines. Enfin, le traitement antifongique diminue le taux d'agrément observé entre les deux types de flacons.

Bien qu'il s'agisse d'une étude rétrospective monocentrique et que certains facteurs n'aient pas été pris en compte, comme le volume de prélèvement, les résultats montrent clairement que le traitement antifongique modifie le résultat et le temps de détection des deux types de flacons. Cela doit être pris en compte lors de l'analyse des résultats biologiques. De plus, cette étude a démontré l'intérêt d'associer des flacons avec résines et des flacons sans résines pour optimiser l'identification des levures, notamment en présence de traitement antifongique.

Impact of systemic antifungal therapy on the detection of *Candida* spp. in blood cultures in clinical cases of candidemia.

Sébastien Bailly,^{1,2,3} Cécile Garnaud^{1,4}, Muriel Cornet,^{1,4} Patricia Pavese,⁵ Rebecca Hamidfar-Roy,^{6,1} Luc Foroni,⁷ Sandrine Boisset,⁸ Jean-François Timsit,^{3,9} Danièle Maubon^{1,4}

1: Laboratoire de Parasitologie-Mycologie, Institut de Biologie et de Pathologie, CHU de Grenoble, Grenoble, France

2: U823, Université Grenoble Alpes, France

3: UMR 1137 - IAME Team 5 – DeSCID, Inserm/ Paris Diderot, Sorbonne Paris Cité University, Paris, France

4: Laboratoire TIMC-TheREx, UMR 5525 CNRS-UJF, Université Grenoble Alpes, France

5: Département des maladies infectieuses, CHU Grenoble, France

6: Réanimation médicale, CHU Grenoble, France

7: Pharmacie hospitalière, CHU Grenoble, France

8: Laboratoire de Bactériologie-Hygiène, Institut de Biologie et de Pathologie, Grenoble, France

9: Réanimation Médicale et des Maladies Infectieuses, Hôpital Bichat, Paris, France

Keywords: candidemia, blood culture, systemic antifungal therapy, diagnostic

Running title: Impact of systemic antifungals on blood culture

Corresponding author: Danièle Maubon, Laboratoire de Parasitologie-Mycologie, Institut de Biologie et de Pathologie, CHU de Grenoble, Grenoble, France. dmaubon@chu-grenoble.fr; daniele.maubon@ujf-grenoble.fr

Tel (+33) 4 76 76 54 90. Fax (+33) 4 76 76 52 28.

SYNOPSIS 243 words

Objectives

Candidemia diagnostic and follow-up still relies on blood cultures (BC). Here, we present a clinical study of the impact of systemic antifungal therapy (SAT) on yeast detection via BC.

Methods

Patients (n=125) experiencing candidemia at the Grenoble University Hospital, France were included in a four-year retrospective study. Resin aerobic and anaerobic (RV) and fungal-selective vials (FSV) were compared. The positivity rate (PR), the time to positivity (TTP), and agreement between vials were analyzed using multivariate hierarchical models adjusted by clinical characteristics.

Results

The PR was significantly decreased in patients with SAT ($p<0.01$), abdominal surgery ($p=0.01$), and hemodialysis ($p=0.02$). The SAT reduced the PR in both RV and FSV by a factor of 0.16 (95% CI: [0.08; 0.32]). The SAT increased the TTP of all vials (RV and FSV) by a factor of 1.76 ([1.30; 2.40]; $p<0.01$). The impact of SAT on the TTP was significantly higher in FSV than in RV (RR=1.76, [1.30; 2.40]), however, the TTP in FSV and RV remained comparable. Discordances of the PR between the vials were observed with and without SAT (37 and 58%, respectively), and SAT significantly decreased the agreement rate by a factor of 0.29 (CI: [0.12; 0.68]).

Conclusion

We showed a significant effect of SAT on BC results and a clear benefit to concomitantly collecting resins and selective vials especially in patients receiving SAT. Accounting for the presence of SAT in both the BC sampling protocol and the result analysis may improve patient management.

INTRODUCTION

Over the 20 past years, *Candida* spp. has become an increasingly common blood infection.¹ Candidemia has poor prognosis² and relatively high mortality in part because of delayed diagnosis.³⁻⁵ Unfortunately, there is no optimal tool currently available for a rapid and specific diagnosis. Despite their low sensitivity (around 50 and 75% when sampling recommendations are correctly followed), blood cultures (BC) remain the gold standard for candidemia diagnostic⁶ and are recommended in most guidelines.^{6,7} BC are also recommended for the monitoring of candidemia including the collection of at least one BC per day until they are negative.^{6,8} This follow up procedure is important because systemic antifungal therapy (SAT) should be maintained 14 days after the last positive blood culture and because the early switch from the first line echinocandin to an azole therapy is recommended in stable patients with negative BC.⁶⁻⁸ Currently, only an “automated validated BC” system is promoted and there are no clear recommendations on the most efficient blood culture sampling protocol in the guidelines.⁶ Also, it is not clear whether the use of a fungal-selective medium developed to enhance the retrieval of yeast from blood such as that proposed by Beckton-Dickinson (BACTEC Mycosis IC/F®, BD Diagnostics, Sparks, USA) is beneficial.

This selective medium contains antibiotics and lytic agents that lead to an enhanced positivity rate (PR) versus non-selective medium. This is especially true for *C. glabrata* detection and for polymicrobial (bacterial and yeast) infections.⁹⁻¹¹ Contrary to selective media, non-selective media contain adsorbing agents (resins or charcoal) that allow the capture of circulating antimicrobial compounds. Regarding yeast detection in BC vials, studies based on artificially spiked blood cultures showed somewhat conflicting results depending on the type of automated system and the *in vitro* protocol.¹² However, it is now well-known that the presence of antimicrobial compounds in BC vials alters the growth of the

pathogens and thus their detection by the automated system. Recent *in vitro* studies have shown that the presence of antifungal agents, and more specifically fungicidal agents as echinocandins, in spiked BC vials can significantly modify the rate and the time to positivity of vials without adsorbing agents.^{13,14} As empirical or preemptive SAT based on echinocandins is increasingly prescribed in patients for whom candidemia is suspected, the SAT may have a direct impact on the time to diagnostic and the initiation of the targeted antifungal therapy. In patients with documented candidemia, SAT may also modify the follow-up strategy currently based on BC monitoring. This should also be considered in the assessment of the time for an early step-down or the end of therapy.

Assessing the actual clinical diagnostic value of one type of BC vial is challenging because of the lack of comparative studies in real clinical situations of candidemia. Because candidemia is still a rare event in patients with sepsis, clinicians frequently prescribe non-selective aerobic and anaerobic resins vials (RV) before adding fungal selective vials (FSV). In the meantime, some patients may have already received SAT—this may further complicate the evaluation of the BC results. This raises the following questions: 1) does SAT alter the detection and time to detection in BC vials and, if so, does its effect vary according to the presence of resins? 2) What is the real added value of each type of vials in the clinical setting of candidemia when SAT is present or not? In this study, we addressed these questions in real clinical conditions by studying the ability of FSV and RV to detect candidemia, while considering the SAT received by the patients.

MATERIAL AND METHODS

Patients

This retrospective study was conducted from July 2010 to March 2014 at the Grenoble University Hospital in France. All patients experiencing candidemia -defined as at least one BC vial positive for *Candida* spp.- were included. Patients receiving SAT and hospitalized in the ICU were subject to sub-group analyses.

Blood culture systems

The Bactec Mycosis IC/F (MY) vial is a FSV developed to improve the recovery of fungi from blood. It contains antibiotic and lytic agents with no adsorbing resins.¹⁵ The Bactec Plus Aerobic/F (AE) and Bactec plus Anaerobic/ F (ANA) vials (gathered as 'resin' vials' - RV) contain inter-alia, nonionic adsorbing resins to neutralize antibiotics. For each vial, the recommended volume of inoculation was 8 to 10 ml blood. All vials were incubated in an automated system BACTEC FX (Becton Dickinson, USA). The maximum incubation time was 5 days (AE and ANA) and 6 days (MY).¹⁶ All blood cultures positive for yeasts were sub-cultured, and the strains were identified at the species level using assimilation tests (api-ID32C, bioMérieux Marcy l'Etoile, France), rapid identification tests (Glabrata RTT, Bichro-Latex Albicans, Krusei Color; Fumouze Diagnostics, Levallois-Perret, France) or mass spectrometry using MALDI-TOF technology (BRUKER DALTONIK GmbH, Bremen, Germany). We considered all three BC bottles available in the hospital (AE, ANA and MY). For each candidemia episode, the first positive vial and all subsequent vials until the last positive one were analyzed.

Data collection

Throughout the study, biological data (sample date, type of BC bottle, time to positivity (TTP), and species identification) were collected from the BD EpiCenter™ software (Beckton Dickinson, Le Pont de Claix, France) and from the Laboratory Information System (Synergie Software, Technidata, Meylan, France). For each patient with candidemia, information about SAT was collected including dates and duration of treatment and antifungal classes including azoles (“fungistatic”), echinocandins or polyens (“fungicidal”). Biological and pharmacological data were merged to determine the presence or the absence of antifungal compounds by the time BC was sampled. The following clinical information was collected (Charlson score, hospital unit, age, sex, broad spectrum antibacterial therapy, presence of a catheter, invasive mechanical ventilation, abdominal surgery, severe sepsis, and SAPSII score for ICU patients).

Statistical analysis

Positivity rate analysis

The PR was calculated for RV and FSV. After the first positive BC, each vial collected was considered within a 5-day interval. This 5-day interval was chosen because the positive and negative vials during this period were considered to belong to the same episode of candidemia. A multivariate hierarchical model was used to identify the factors associated with an increase or a decrease in the probability of having a positive result within this period. A negative BC belonging to a set with a positive BC was defined as a false-negative BC.

Time to positivity of resin and fungal selective vials

To assess the effect of SAT on TTP, each positive vial was considered. If a patient had a candidemia diagnosis by at least a positive BC, the negative BC collected the same day for the same patient were considered with a time to positivity (TTP) equal to the maximum incubation time of the study, i.e. 144 hours.

In patients who had more than one positive vial, the TTP of each vial was considered independently. A univariate analysis was performed using the non-parametric Kruskal-Wallis test. Among the RV, only the vial with the shorter TTP was considered. Moreover, to study patient variability and multiple sampling dates, we used a three-level hierarchical model for patient, sampling day and BC bottle. A negative binomial distribution was used to identify the factors associated with TTP. Finally, because SAT and vial types (RV and FSV) are assumed to have a common influence on TTP, an interaction term between SAT and vial types was introduced into the model.

Agreement between RV and FSV

Patients with one RV (AE or ANA) and one FSV vial set collected the same day were considered. A concordant result was defined when the RV and FSV give a positive result for the same species. To compare all three vials AE, ANA and MY individually, a complementary analysis was performed on triplets composed of the results of the three vials collected on the same day on the same patient. Univariate analyses were performed to assess the concordance between vials using: 1) McNemar test for the concordance between RV versus FSV; and 2) A Cochran Q test for the concordance between the three vials considered individually followed by McNemar post-hoc tests using a Bonferroni correction. A multivariate mixed model (including variables that led to a p value <0.20 in univariate analyses) was used to identify the factors that were significantly associated with the concordance. For the PR and TTP, two sub-group analyses were performed. The first focused specifically on ICU patients and studied clinical variables including the SAPSII. The second focused on SAT-treated patients to study both the impact of SAT type (fungistatic azoles versus fungicidal candins or polyenes) as well as the impact of the time elapsed from SAT initiation to positivity.

A normal distribution of the residuals was considered for the validity of each model. A p value of 0.05 was considered to be significant. Statistical analyses were performed using SAS v9.3 (SAS Institute Inc., Cary, NC, USA).

RESULTS

Characteristics of patients and vials

A total of 125 patients with candidemia were included: 72 were males (57.6%) and 64 (51.2%) were in the ICU when the candidemia was diagnosed. The median age was 61.5 years (IQR: 48-74); 37 patients (29.6%) underwent abdominal surgery and 43 patients (34.7%) developed severe sepsis. The median Charlson score was 6 (IQR: 4; 9), and the median SAPSII score was 47 (IQR: 42-55) for ICU patients. A more detailed description of the clinical conditions is given in Table 1.

Three hundred and eighty vials were studied: 216 RV (56.8%) and 164 FSV (43.2%). *Candida albicans* was the main identified species (37.4%) followed by *C. glabrata* (23%) and other fungal species (39.6%) (Table 2). The SAT was initiated before sampling in 142 cases (26.3%). It was mainly echinocandins (n=66, 12.2%) followed by azoles (n=53, 9.8%) and polyenes (n=23, 4.3%) (Table 2).

Positivity rate

After adjusting the clinical characteristics, the presence of SAT was significantly associated with a decrease in the probability of BC positivity ($p < 0.01$) (Table 3). Indeed, regardless of the type of vials, the SAT significantly decreased the PR by a factor of 0.16 (95% CI: [0.08; 0.32]) corresponding to a 6-fold increase in the number of false negative BC cases. Abdominal surgery and hemodialysis were also significantly associated with a decrease in the PR. There was a trend, although not significant, towards an increase in the PR of RV versus

FSV (OR: 1.14; 95% CI: [0.72; 1.79]) (Table 3). In ICU patients, similar trends were observed, but no clinical characteristics were associated with the PR (Table E1). In the SAT-treated patient sub-group, neither the type of antifungal treatment (fungicidal or fungistatic) nor the time elapsed from SAT initiation to positivity showed a significant effect on positivity (Table E1).

Time to positivity (TTP)

The univariate analysis showed that the TTP was similar between RV and FSV in both SAT and non-SAT sampled vials (Figure 1). However, the TTP was significantly higher in SAT sampled vials (41 h [23; 83]) versus non-SAT sampled vials (26 h [16; 46]; $p < 0.01$) (Figure 1).

In the multivariate analysis, the overall TTP in RV vials was prolonged by a factor of 1.15 [0.93; 1.42] compared to FSV. However, even if the TTP was systematically longer for each *Candida* species in the RV, this trend did not reach statistical significance ($p = 0.19$; Table E2). In the RV, ANA and AE were prolonged by a factor of 3.17 [2.58; 3.91] ($p < 0.01$) and 1.23 (95% CI; [1.01; 1.49] $p = 0.04$), respectively, (data not shown). According to the species involved, the TTP was significantly higher for *C. albicans* and *C. glabrata* versus other species ($p = 0.02$, RR=1.38 [1.06; 1.79] for *C. albicans* and $p = 0.05$, RR= 1.37 [1.00; 1.87] for *C. glabrata*). The impact of SAT on the TTP found in the univariate analysis was confirmed because the SAT increased the TTP of all vials (RV and FSV) by a factor of 1.76 ([1.30; 2.40]; $p < 0.01$). However, the impact of SAT on TTP was more important in the FSV than in the RV, due to a significant interaction between the vial types and SAT (see Table E2). Nevertheless, the FSV still had a comparable TTP to RV (Figure 1 and Table E3). When focusing on SAT-treated patients, the TTP was not significantly impacted by the type of *Candida* species, the type of SAT (fungicidal or fungistatic), or the time elapsed from SAT

initiation to positivity (Table E3A). When focusing on ICU patients, the previous effects seen for the type of BC vials, the SAT, and the interaction between SAT and BC types were confirmed—there was no effect of SAPSII on TTP (Table E3B).

Agreement rate analyses

We considered 133 combinations (133 FSV and 133 RV) from 82 patients (Figure 2). Agreement between RV and FSV was observed for 61 combinations (63%) in the untreated patients, and for 15 combinations (42%) in patients receiving SAT. For concordant results, the median TTP in SAT-treated patients was comparable between RV and FSV (45 hours (IQR: 26.5; 79.5) and 44 hours (IQR: 25.5; 144) ($p=0.80$)) as well as in untreated patients (30 hours (IQR: 19; 67.5) in RV and 25 hours (IQR: 19;42) in FSV) ($p=0.66$). Considering the discrepancies, in the absence of SAT, 16 (16%) and 20 (21%) vials were positive only for RV or only on FSV vials, respectively. In the presence of SAT, 13 (36%) and 8 (22%) vials were positive only for RV or FSV, respectively (Figure 2). In multivariate analysis, the SAT was significantly associated with a decrease of the agreement rate (OR: 0.29 [0.12; 0.68] $p<0.01$). When the three vials were considered independently, some candidemia diagnoses were achieved with only one of the three vials (Figure E1). A comparison of the paired results showed that the combination AE-MY vials reached the best PR (99%) for all but one species with or without SAT. Only *C. glabrata* was detected better by the ANA-MY combination with a 100% PR (Table E4 and E5).

DISCUSSION

We conducted a study based on routine clinical and biological data to evaluate the impact of SAT on the performances of different types of BC vials in patients with candidemia. To the best of our knowledge, this is the first study to analyze agreement rate analysis between resin vials (RV) and fungal selective vials (FSV) in the presence or absence of SAT. Using this

approach, we clearly showed that the concomitant sampling of RV or FSV is important for patient's care in all patients regardless of SAT. The benefit is even greater for patients receiving SAT. We noticed that the SAT influences the PR of BC independently of the vial type. Regarding the TTP, even if the impact of SAT was more substantial in the FSV than in the RV, the FSV still had a comparable TTP than RV. Knowing that in ICU patients as much as 75% of the SAT is considered empirical therapy for invasive candidiasis, our results support the recommendation of sampling BC on both RV and FSV, and whenever possible, before SAT prescription.^{17,18}

In the context of a suspected candidemia, BC sampling should be done daily. The addition of a supplementary vial can be problematic in terms of blood depletion and cost.⁶ Despite a high amount of published data comparing the performances of the currently available BC-automated system detection, the benefit of sampling both RV and FSV in the context of candidemia remains unclear to many clinicians.^{9,11,13,19-23} Recent results on *in vitro* simulated BC suggest that follow-up should be performed with non-selective media containing an adsorbent system rather than on selective media without adsorbing resins.^{13,14} In this study, we could not confirm that the RV were more efficient in the presence of fungicidal agents such as echinocandins.¹⁴ We did show that in real clinical settings, concurrent RV and FSV sampling benefits candidemia detection especially when SAT is ongoing. This discrepancy may be due to the fact that in real clinical settings, BCs are not sampled at the maximal concentration (C_{max}) of the SAT. Thus, the antifungal concentration may be subject to variations. A difference between the *in vivo* and *in vitro* metabolism of echinocandins can also be involved.

We found that there was no difference in terms of PR between RV and FSV. Because their collection is generally performed simultaneously, we chose to compile positive results from both aerobic and anaerobic vials (RV). Under these conditions we could not confirm the

superiority of the FSV to detect a higher amount of *C. glabrata*. This may be because both positive results for aerobic and anaerobic were combined as ‘resin’ vials or simply because previous conclusions were mostly the result of in vitro simulated BC that may not reflect real *C. glabrata* bloodstream infections. The SAT was significantly associated with a decrease in probability for BC positivity, but this was not related to the presence or the absence of resins in the vial. Thus, in terms of the BC positivity rate with or without SAT, the performance of RV and FSV were found equivalent in this study.

TTP is an important parameter because it can lead to quicker targeted SAT initiation which is beneficial for patients²⁴. In our study 27% of the vials (corresponding to 9.6% of patients) contained SAT by the time the BC was sampled, and we showed that the presence of SAT extended the global TTP by a factor 1.76 ([1.30; 2.40]; $p < 0.01$). TTP of *Candida* BC has also been proposed to help with species differentiation, especially for *C. glabrata* whose growth is slower.^{25,26} In this study, TTP was significantly increased for *C. glabrata* and for *C. albicans* too versus other species. Of note, TTP was also significantly higher for ANA vials than for AE or MY vials except for *C. glabrata*. This is the classical case because aerobic conditions are normally needed for yeast growth (data not shown). Others have suggested that TTP could be used to predict clinical outcomes.^{27,28} Kim et al. showed that the mortality rate at 6 weeks was significantly higher in a group with a TTP ≤ 24 h.²⁸ In their cohort, 8% of patients received SAT prior to a positive BC but the proportion of vials with SAT and the influence of SAT were unknown.

In this study, we considered that neither the results on PR nor the TTP were sufficient to reveal the clear benefit of one vial at the patient level. We looked forward to the agreement rate between the different types of vials (Fig. 2) and showed that both FSV and RV added value to candidemia diagnosis. Choosing between the two would lead to a loss of information for candidemia management (up to 36% in the presence of SAT). There may be several

hypotheses to explain the discordant results. First, the growth of *Candida* species can be different according to the media, but in our study discordance were not significantly related to species. Second, the SAT may also interfere with results. Indeed, we show that there is a significant increase in the discordant results in SAT patients in multivariate analysis. This suggests that the association of both RV and FSV is required in patients under SAT. Finally, in cases of an extremely low inoculum, discordance may only reflect the growth of yeasts in one vial. However, this will likely remain unusual because a blood concentration of 1 CFU/ml is sufficient to turn aerobic make the selective media positive.^{12,29} In Patel *et al.*, a higher rate of bacteremia was detected with 30 mL of blood versus 20 mL of blood, but this strategy did not enhance *Candida* identification rate.³⁰

In contrast to studies focusing on bacteremia, we found no evidence of any microbial or clinical determinant of time to positivity.³¹ Only abdominal surgery and hemodialysis patients correlated to lower positivity rates. For abdominal surgery, this may be the consequence of a lower rate of circulating yeast in the context of abdominal candidiasis. Hemodialysis is commonly associated with an increased risk of candidemia in patients,³² but our study showed a lower number of positive vial during this candidemic episode. We cannot explain this finding without additional study.

This study has several potential limitations. First, it was a retrospective study from a single, university-based population, and the number of patients with candidemia is restricted. Moreover, although local guidelines for BC sampling should be respected, we could not monitor the filling of each BC vial. This parameter can influence the BC result.³³ Monitoring systems measuring blood volume in the BC will probably become of paramount importance in the management of candidemia.³³ Finally, the sub-group analyses for SAT-treated patients are certainly under-powered due to the small sample size. These specific issues will need to be assessed in the future with larger populations. A comparative multi-centric study would also

be necessary to definitively address the benefit of sampling both RV and FSV to diagnose candidemia in the presence or absence of SAT.

CONCLUSION

Constant evaluation of BC performance is important because the incidence and mortality of candidemia are still growing despite new antifungals and guidelines.³⁴ With a practical clinical approach, we demonstrated that the SAT prescription significantly influences the result of the BC regardless of whether or not adsorbing resins are present in the BC. This should encourage clinicians to use only pertinent empirical SAT prescription and to sample BC before any SAT initiation. We also demonstrate that there is a clear added value to sampling with both RV and FSV because these results are often discordant. This added value is even more significant when patients are under SAT. Thus, a systematic sampling of both FSV and RV vials may improve not only the primary diagnostic but also the time needed for the step-down or end of therapy. When the species are identified, the association AE-MY is the best for all *Candida* sp. except for *C. glabrata* in which the ANA-MY gives the best positivity rate. The recommendations on candidemia diagnosis and follow-up should be clarified in a near future to help clinicians in their everyday practice.

Acknowledgments

We are grateful to Lucie Le Penec for the clinical and pharmacological data collection.

Funding

None

References

1. Enoch DA, Ludlam HA, Brown NM. Invasive fungal infections: a review of epidemiology and management options. *J Med Microbiol* 2006; **55**: 809–18.
2. Wisplinghoff H, Bischoff T, Tallent SM, *et al.* Nosocomial bloodstream infections in US hospitals: analysis of 24,179 cases from a prospective nationwide surveillance study. *Clin Infect Dis Off Publ Infect Dis Soc Am* 2004; **39**: 309–17.
3. Morrell M, Fraser VJ, Kollef MH. Delaying the empiric treatment of candida bloodstream infection until positive blood culture results are obtained: a potential risk factor for hospital mortality. *Antimicrob Agents Chemother* 2005; **49**: 3640–5.
4. Garey KW, Rege M, Pai MP, *et al.* Time to initiation of fluconazole therapy impacts mortality in patients with candidemia: a multi-institutional study. *Clin Infect Dis Off Publ Infect Dis Soc Am* 2006; **43**: 25–31.
5. Bassetti M, Righi E, Ansaldi F, *et al.* A multicenter study of septic shock due to candidemia: outcomes and predictors of mortality. *Intensive Care Med* 2014; **40**: 839–45.
6. Cuenca-Estrella M, Verweij PE, Arendrup MC, *et al.* diagnostic procedures-ESCMID* guideline for the diagnosis and management of *Candida* diseases 2012: diagnostic procedures: Diagnosis of *Candida* diseases. *Clin Microbiol Infect* 2012; **18**: 9–18.
7. Marchetti O, Lamoth F, Mikulska M, *et al.* ECIL recommendations for the use of biological markers for the diagnosis of invasive fungal diseases in leukemic patients and hematopoietic SCT recipients. *Bone Marrow Transplant* 2012; **47**: 846–54.
8. Pappas PG, Kauffman CA, Andes D, *et al.* Candida-Clinical Practice Guidelines for the Management of Candidiasis: 2009 Update by the Infectious Diseases Society of America. *Clin Infect Dis* 2009; **48**: 503–35.

9. Meyer M-H, Letscher-Bru V, Jaulhac B, *et al.* Comparison of Mycosis IC/F and Plus Aerobic/F Media for Diagnosis of Fungemia by the Bactec 9240 System. *J Clin Microbiol* 2004; **42**: 773–7.
10. Arendrup MC, Bruun B, Christensen JJ, *et al.* National surveillance of fungemia in Denmark (2004 to 2009). *J Clin Microbiol* 2011; **49**: 325–34.
11. Ericson E-L, Klingspor L, Ullberg M, *et al.* Clinical comparison of the Bactec Mycosis IC/F, BacT/Alert FA, and BacT/Alert FN blood culture vials for the detection of candidemia. *Diagn Microbiol Infect Dis* 2012; **73**: 153–6.
12. George BJ, Horvath LL, Hospenthal DR. Effect of Inoculum Size on Detection of *Candida* Growth by the BACTEC 9240 Automated Blood Culture System Using Aerobic and Anaerobic Media. *J Clin Microbiol* 2005; **43**: 433–5.
13. Jekarl DW, Lee S-Y, Lee S, *et al.* Comparison of the Bactec Fx Plus, Mycosis IC/F, Mycosis/F Lytic blood culture media and the BacT/Alert 3D FA media for detection of *Candida* species in seeded blood culture specimens containing therapeutic peak levels of fluconazole. *J Clin Lab Anal* 2012; **26**: 412–9.
14. Kock R, Eissing LC, Boschini MG, *et al.* Evaluation of Bactec Mycosis IC/F and Plus Aerobic/F Blood Culture Bottles for Detection of *Candida* in the Presence of Antifungal Agents. *J Clin Microbiol* 2013; **51**: 3683–7.
15. Fricker-Hidalgo H, Lebeau B, Pelloux H, *et al.* Use of the BACTEC 9240 System with Mycosis-IC/F Blood Culture Bottles for Detection of Fungemia. *J Clin Microbiol* 2004; **42**: 1855–6.
16. Bosshard PP. Incubation of fungal cultures: how long is long enough? *Mycoses* 2011; **54**: e539–45.

17. Bailly S, Bouadma L, Azoulay E, *et al.* Failure of empirical systemic antifungal therapy in mechanically ventilated critically ill patients. *Am J Respir Crit Care Med* 2015; **191**: 1139–46.
18. Azoulay E, Dupont H, Tabah A, *et al.* Systemic antifungal therapy in critically ill patients without invasive fungal infection. *Crit Care Med* 2012; **40**: 813–22.
19. Flayhart D, Borek AP, Wakefield T, *et al.* Comparison of BACTEC PLUS blood culture media to BacT/Alert FA blood culture media for detection of bacterial pathogens in samples containing therapeutic levels of antibiotics. *J Clin Microbiol* 2007; **45**: 816–21.
20. Horvath LL, George BJ, Murray CK, *et al.* Direct Comparison of the BACTEC 9240 and BacT/ALERT 3D automated blood culture systems for *Candida* growth detection. *J Clin Microbiol* 2004; **42**: 115–8.
21. Horvath LL, George BJ, Hospenthal DR. Detection of fifteen species of *Candida* in an automated blood culture system. *J Clin Microbiol* 2007; **45**: 3062–4.
22. Riedel S, Eisinger SW, Dam L, *et al.* Comparison of BD Bactec Plus Aerobic/F medium to VersaTREK Redox 1 blood culture medium for detection of *Candida* spp. in seeded blood culture specimens containing therapeutic levels of antifungal agents. *J Clin Microbiol* 2011; **49**: 1524–9.
23. Klingspor L, Muhammed SA, Ozenci V. Comparison of the two blood culture systems, Bactec 9240 and BacT/Alert 3D, in the detection of *Candida* spp. and bacteria with polymicrobial sepsis. *Eur J Clin Microbiol Infect Dis* 2012; **31**: 2983–7.
24. Taur Y, Cohen N, Dubnow S, *et al.* Effect of antifungal therapy timing on mortality in cancer patients with candidemia. *Antimicrob Agents Chemother* 2010; **54**: 184–90.
25. Huang L, Zhang YY, Sun LY. Time to positivity of blood culture can predict different *Candida* species instead of pathogen concentration in candidemia. *Eur J Clin Microbiol Infect Dis* 2013; **32**: 917–22.

26. Cobos-Trigueros N, Morata L, Torres J, *et al.* Usefulness of time-to-positivity in aerobic and anaerobic vials to predict the presence of *Candida glabrata* in patients with candidaemia. *J Antimicrob Chemother* 2013; **68**: 2839–41.
27. Nunes CZ, Marra AR, Edmond MB, *et al.* Time to blood culture positivity as a predictor of clinical outcome in patients with *Candida albicans* bloodstream infection. *BMC Infect Dis* 2013; **13**: 486.
28. Kim S-H, Yoon YK, Kim MJ, *et al.* Clinical impact of time to positivity for *Candida* species on mortality in patients with candidaemia. *J Antimicrob Chemother* 2013; **68**: 2890–7.
29. Fricker-Hidalgo H, Chazot F, Lebeau B, *et al.* Use of simulated blood cultures to compare a specific fungal medium with a standard microorganism medium for yeast detection. *Eur J Clin Microbiol Infect Dis* 1998; **17**: 113–6.
30. Patel R, Vetter EA, Harmsen WS, *et al.* Optimized pathogen detection with 30- compared to 20-milliliter blood culture draws. *J Clin Microbiol* 2011; **49**: 4047–51.
31. Martinez JA, Pozo L, Almela M, *et al.* Microbial and clinical determinants of time-to-positivity in patients with bacteraemia. *Clin Microbiol Infect* 2007; **13**: 709–16.
32. Chow JK, Golan Y, Ruthazer R, *et al.* Risk factors for *albicans* and non-*albicans* candidemia in the intensive care unit. *Crit Care Med* 2008; **36**: 1993–8.
33. Chang J, Park JS, Park S, *et al.* Impact of monitoring blood volume in the BD BACTEC™ FX blood culture system: virtual volume versus actual volume. *Diagn Microbiol Infect Dis* 2015; **81**: 89–93.
34. Lortholary O, Renaudat C, Sitbon K, *et al.* Worrisome trends in incidence and mortality of candidemia in intensive care units (Paris area, 2002-2010). *Intensive Care Med* 2014; **40**: 1303–12.

Table 1: Clinical characteristics of candidemia patients (N=125).

Variable	N (%)
Age (median, IQR)	61.5 [48; 74]
Gender (male)	72 (57.6)
Broad spectrum antibacterial therapy	92 (73.6)
Presence of catheter	66 (52.8)
Intensive care unit	64 (51.2)
SAPSII Score* (median, IQR)	47 [42; 55]
IMV on blood sample day	29 (23.4)
Abdominal surgery	37 (29.6)
Pancreatitis	4 (3.2)
Severe sepsis	43 (34.7)
Charlson score (median, IQR)	6 [4; 9]
Anticancer chemotherapy	40 (32.3)
Hemodialysis	14 (11.2)
Stem cell transplant	7 (5.6)
Solid organ transplant	8 (6.5)
Neutropenia	16 (12.9)
Diabetes	14 (11.3)
Diabetes organ damage	5 (4)
Myocardial infarction	9 (7.3)
Congestive_heart_failure	22 (17.7)
Cerebrovascular disease	10 (8.1)
Chronic pulmonary disease	32 (25.8)
Corticosteroid therapy	22 (17.6)
Moderate severe renal disease	15 (12.1)
Non metastatic tumor	29 (23.4)
Metastatic solid tumor	23 (18.5)
Moderate severe liver disease	22 (17.7)
AIDS	2 (1.6)

* SAPSII score: available only for ICU patients.

IMV: invasive mechanical ventilation

Table 2: Characteristics and time to positivity of the blood culture vials of the 125 patients with candidemia.

	RV		FSV	
	N (%)	TTP	N (%)	TTP
Number of vials	216	30 [19; 52]	164	26 [16; 60]
Candida species				
<i>C. albicans</i>	78 (36.1)	31.5 [21; 69]	65 (39.6)	25 [15; 40]
TTP				
<i>C. glabrata</i>	49 (22.7)	45 [27; 66]	38 (23.2)	40 [21; 86]
<i>C. tropicalis</i>	22 (10.2)	20 [10; 33]	20 (12.2)	20.75 [10; 39.5]
<i>C. lusitaniae</i>	15 (6.9)	21 [10; 30.5]	8 (4.9)	25 [16; 89]
<i>C. krusei</i>	11 (5.1)	32 [20; 144]	9 (5.5)	144 [32; 144]
<i>C. kefyr</i>	13 (6.0)	20 [17; 31]	7 (4.3)	14 [10; 20]
<i>C. parapsilosis</i>	6 (2.8)	20.5 [19; 22]	6 (3.4)	19.5 [16; 21]
Other <i>Candida</i> sp.	3 (1.4)	144 [144; 144]	4 (2.4)	30.5 [19; 62]
Other	19 (8.8)	28 [19; 41]	7 (4.3)	23 [13; 27]
Antifungal treatment	55 (25.5)		46 (28.1)	
Azoles	18 (8.4)		21 (12.8)	
Candins	29 (13.4)		18 (11.0)	
Polyenes	8 (3.7)		7 (4.3)	

AE: Bactec Plus Aerobic/F; ANA: Bactec plus Anaerobic/ F; MY: Bactec Mycosis IC/F

Data are expressed as N = number of strains (%) or median and interquartile range for TTP

TTP: Time to positivity (median, IQR)

Other: *Cryptococcus neoformans*, *Geotrichum capitum*, *Saccharomyces cerevisiae*, and non identified yeasts.

Table 3: Results of the multivariate mixed model for positivity

	OR [95% CI]	P value
Abdominal surgery	0.42 [0.23; 0.77]	0.01
Broad spectrum antibacterial therapy	0.57 [0.29; 1.12]	0.10
Hemodialysis	0.37 [0.16; 0.85]	0.02
Hospital unit: ICU	1.18 [0.64; 2.18]	0.59
Presence of a catheter	0.79 [0.45; 1.41]	0.43
Corticosteroid therapy	1.46 [0.71; 3.00]	0.31
Candida species		
<i>C. albicans</i>	0.86 [0.45; 1.63]	0.64
<i>C. glabrata</i>	1.55 [0.71; 3.38]	0.28
Other		
Systemic antifungal treatment	0.16 [0.08; 0.32]	<0.01
Resin vials (AE or ANA)*	1.14 [0.72; 1.79]	0.58
Interaction term: Resin x SAT	0.97 [0.41; 2.32]	0.95

OR>1 favor of positivity

*FSV was taken as reference.

Figure 1: Time to positivity: flow chart

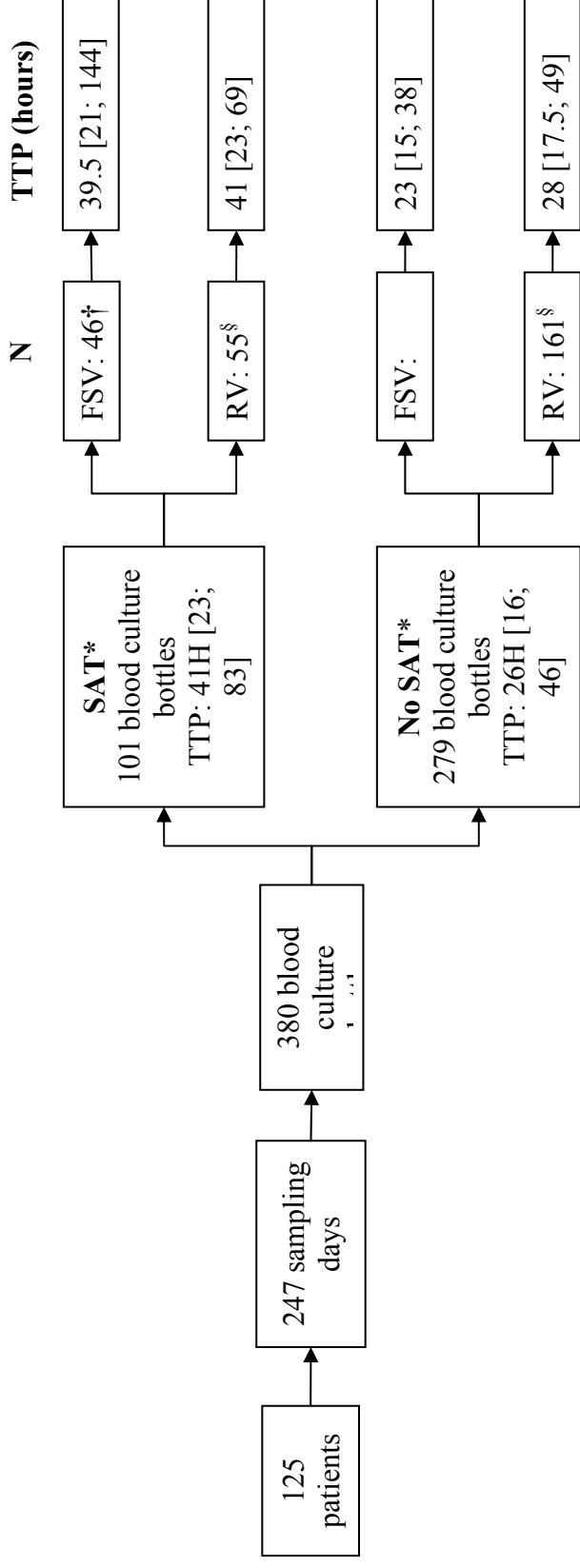

TTP: Time to positivity in hours (median, interquartile range); SAT: Systemic antifungal treatment; FSV: Fungal selective vial; RV: resin vials

* SAT/NoSAT 1) intra-group comparison: No significant differences were shown between RV and FSV vials for TTP in each SAT group. 2) inter-group comparison: SAT TTP was significantly higher than NoSAT TTP ($p < 0.01$)

[†] FSV inter-group comparison: SAT TTP was significantly higher than No SAT TTP for FSV ($p = 0.003$).

[§] RV inter-group comparison: SAT TTP was significantly higher than No SAT TTP for RV ($p = 0.02$).

Figure 2: Positive results for pairs composed of RV and FSV.

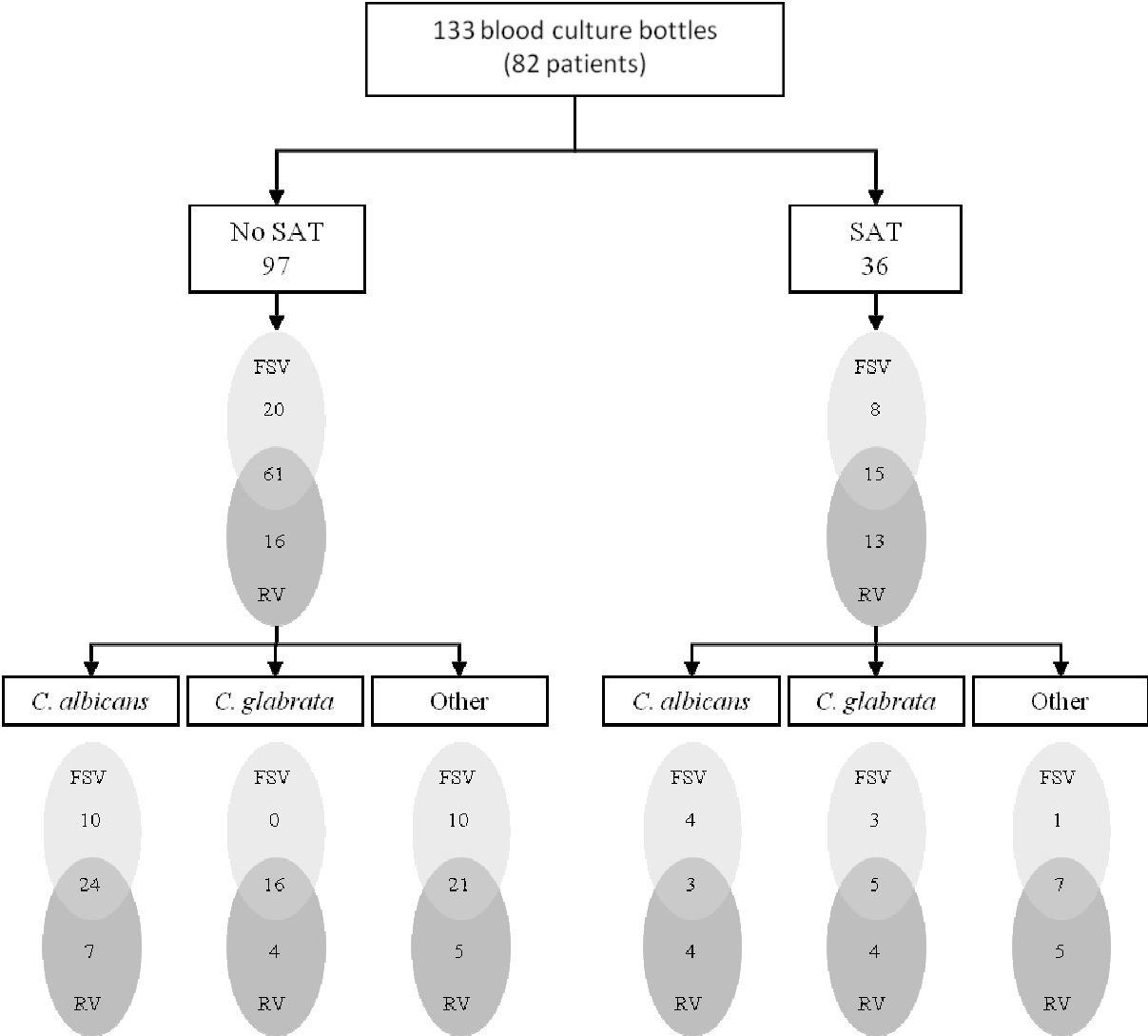

Venn diagrams showing the agreement rate analysis for the pairs composed of one fungal selective vial (FSV) and one resin vials (RV).

Supplément électronique de la publication 3

**Impact of systemic antifungal therapy on the detection of *Candida* spp. in blood cultures
in clinical cases of candidemia.**

Sébastien Bailly, Cécile Garnaud, Muriel Cornet, Patricia Pavese, Rebecca Hamidfar-Roy,

Luc Foroni, Sandrine Boisset, Jean-François Timsit, Danièle Maubon

Table E1: Results of the multivariate mixed model for positivity in sub-group analyses (ICU patients only or SAT treated patients only).

	ICU patients N vials = 338		SAT treated patients N vials = 168	
	OR [95 % CI]	P value	OR [95 % CI]	P value
Abdominal surgery	0.53 [0.25; 1.16]	0.11	0.56 [0.15; 2.12]	0.40
Broad spectrum antibacterial therapy	0.48 [0.16; 1.42]	0.19	0.54 [0.12; 2.40]	0.42
Hemodialysis	0.42 [0.17; 1.05]	0.07	0.42 [0.05; 3.26]	0.41
Hospital unit: ICU	-	-	-	-
Presence of a catheter	1.00 [0.45; 2.23]	1.00	0.69 [0.22; 2.16]	0.53
Corticosteroid therapy	1.74 [0.69; 4.41]	0.25	2.41 [0.62; 9.46]	0.21
Candida species				
<i>C. albicans</i>	0.81 [0.36; 1.83]	0.62	0.33 [0.09; 1.19]	0.10
<i>C. glabrata</i>	2.03 [0.70; 5.87]	0.19	0.46 [0.10; 2.09]	0.32
Other	ref			
Systemic antifungal treatment	0.19 [0.07; 0.52]	<.01	-	-
Resin vials (AE or ANA)*	1.05 [0.60; 1.82]	0.87	1.06 [0.47; 2.37]	0.88
Interaction term: Resin x SAT	0.95 [0.28; 3.28]	0.94	-	-
SAPS II score				
0	0.53 [0.22; 1.27]	0.16	-	-
1	0.42 [0.15; 1.18]	0.10	-	-
ref	ref		-	-
Type of SAT (Azole vs Fungicids)	-	-	0.74 [0.25; 2.22]	0.59
Interval from SAT initiation (days)				
[1; 2]	-	-	0.51 [0.14; 1.83]	0.31
[3; 5]	-	-	0.24 [0.06; 0.98]	0.05
>5	-	-	Ref	

OR>1 favor of positivity

Table E2: Results of the hierarchical model for time to positivity

	Relative risk [95 % CI]	pvalue
Abdominal surgery	0.98 [0.76; 1.27]	0.88
Broad spectrum antibacterial therapy	1.10 [0.85; 1.44]	0.46
Severe sepsis	1.05 [0.82; 1.34]	0.71
Invasive mechanical ventilation	1.38 [1.06; 1.78]	0.02
Presence of a catheter	1.09 [0.86; 1.38]	0.48
Charlson score		
0 – 4	1.13 [0.85; 1.49]	0.41
5 – 7	1.10 [0.84; 1.45]	0.50
8 - 16	Ref	
Delay from first positive (days)		
0	1.13 [0.89; 1.44]	0.31
1	0.56 [0.41; 0.76]	<.01
>2	Ref	
Fungal species		
<i>C. albicans</i>	1.38 [1.06; 1.79]	0.02
<i>C. glabrata</i>	1.37 [1.00; 1.87]	0.05
Other	Ref	
Type of blood culture bottle		
Resin vials	1.15 [0.93; 1.42]	0.19
FSV	Ref	
Antifungal treatment	1.76 [1.25; 2.5]	<.01
Interaction: SAT*RV	0.66 [0.45; 0.99]	0.04
Interaction: SAT*FSV	Ref	

RR>1: increase of TTP. RR<1 : decrease of TTP

Table E3A Results of the hierarchical model for sub-group analyses of time to positivity (SAT treated patients only).

	SAT treated patients N=168	
	RR [95 % CI]	pvalue
Abdominal surgery	0.93 [0.58; 1.50]	0.77
Broad spectrum antibacterial therapy	1.13 [0.68; 1.87]	0.65
Severe sepsis	1.10 [0.73; 1.66]	0.65
Invasive mechanical ventilation	1.04 [0.62; 1.77]	0.87
Presence of a catheter	1.39 [0.89; 2.17]	0.15
Charlson score		0.20
0 – 4	1.49 [0.94; 2.36]	
5 – 7	1.45 [0.88; 2.39]	
8 - 16	ref	.
Fungal species		0.20
<i>C. albicans</i>	1.50 [0.93; 2.42]	
<i>C. glabrata</i>	1.54 [0.92; 2.59]	
Other	ref	
Type of blood culture bottle		
Bactec aerobic	0.84 [0.63; 1.12]	0.25
Bactec anaerobic	1.95 [1.43; 2.66]	<.01
Mycosis	ref	
Type of SAT (Azole vs Fungicids)	1.14 [0.76; 1.72]	0.53
Interval from SAT initiation (days)		0.28
[1; 2]	0.69 [0.44; 1.09]	
[3; 5]	0.88 [0.56; 1.39]	
>5	Ref	

RR>1: increase of TTP. RR<1 : decrease of TTP

Table E3B Results of the hierarchical model for sub-group analyses of time to positivity (ICU patients only).

	ICU patients N=338	
	RR [95 % CI]	pvalue
Abdominal surgery	0.93 [0.71; 1.22]	0.59
Broad spectrum antibacterial therapy	0.87 [0.61; 1.24]	0.45
Severe sepsis	1.03 [0.79; 1.33]	0.84
Invasive mechanical ventilation	1.22 [0.95; 1.56]	0.11
Presence of a catheter	1.09 [0.83; 1.41]	0.54
Charlson score		0.97
0 – 4	0.96 [0.7; 1.33]	
5 – 7	1 [0.74; 1.35]	
8 - 16	Ref	
Delay from first positive (days)		<.01
0	1.14 [0.9; 1.44]	
1	0.67 [0.5; 0.9]	
>2	ref	
Fungal species		0.07
<i>C. albicans</i>	1.39 [1.05; 1.85]	
<i>C. glabrata</i>	1.27 [0.9; 1.8]	
Other	ref	
Type of blood culture bottle		<.01
Bactec aerobic	1.15 [0.91; 1.45]	
Bactec anaerobic	3.43 [2.66; 4.43]	
Mycosis	ref	
Antifungal treatment	1.92 [1.29; 2.85]	0.05
Interaction: SAT*AE	0.65 [0.41; 1.03]	0.07
Interaction: SAT*ANA	0.51 [0.31; 0.83]	<.01
Interaction: SAT*MY	Ref	
SAPS II score		0.67
0	1.08 [0.8; 1.47]	
1	1.17 [0.82; 1.66]	
ref		

RR>1: increase of TTP. RR<1 : decrease of TTP

Figure E1: Description of triplets of AE, ANA and MY flasks.

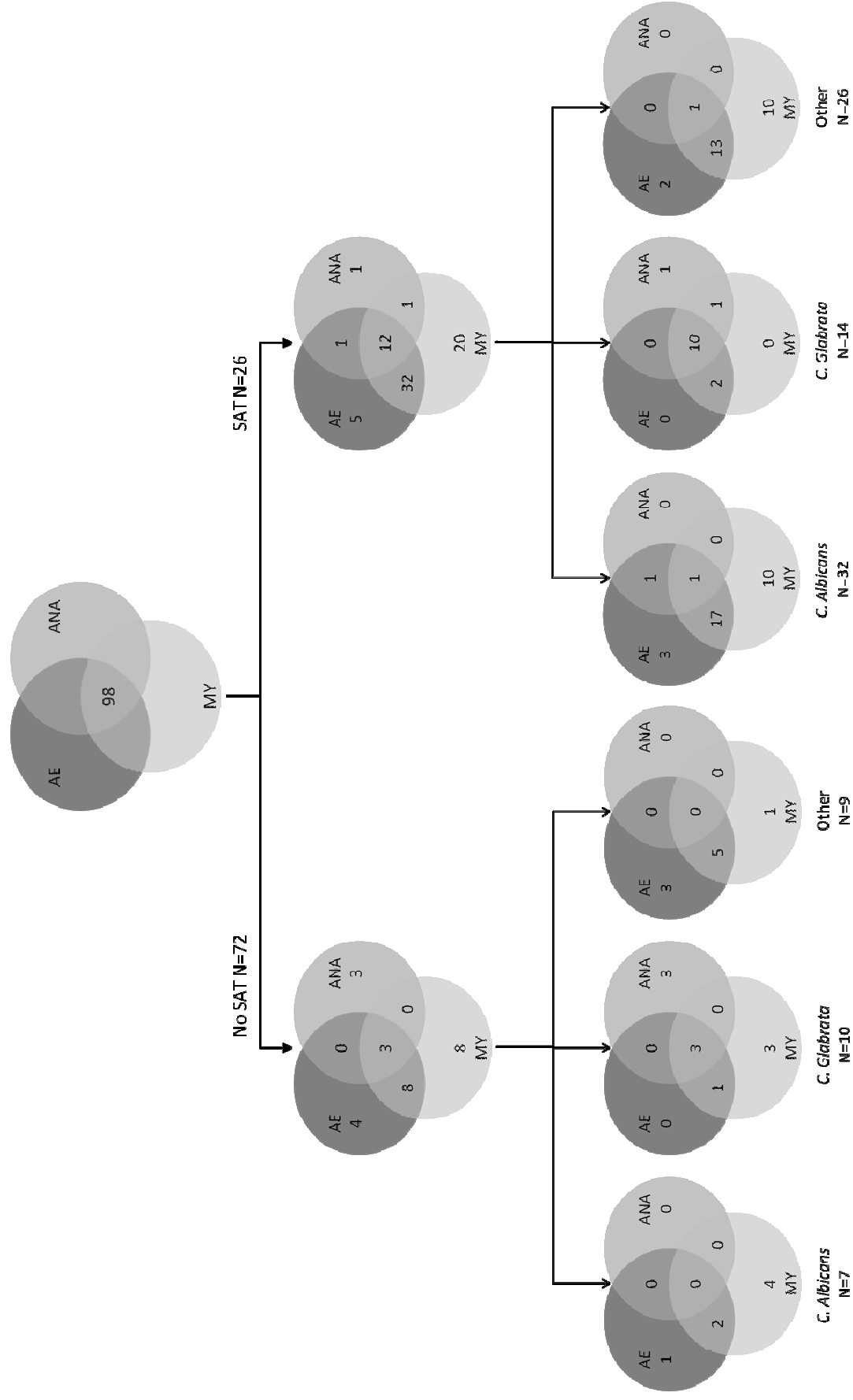

Table E4 Description of positivity rate in triplets according to flask combinations.

	Species	AE	MY	AE+ANA	AE+MY	ANA+MY	P value
SAT	All N=26	15 (58)	19 (73)	18 (69)	23 (88)	22 (85)	0.06
	<i>C. albicans</i> N=7	3 (43)	6 (86)	3 (43)	7 (100)	6 (86)	0.01
	<i>C. glabrata</i> N=10	4 (40)	7 (70)	7 (70)	7 (70)	10 (100)	<.01
No	All N=72	50 (68)	66 (90)	52 (71)	71 (99)	68 (93)	<.01
SAT	<i>C. albicans</i> N=32	22 (69)	28 (88)	22 (69)	32 (100)	29 (91)	<.01
	<i>C. glabrata</i> N= 14	12 (86)	13 (93)	14 (100)	13 (93)	14 (100)	<.01

N: number of positive sample (%) SAT: Systemic Antifungal Treatment – pvalue: Cochran Q

test

Table E5: Mcnemar post hoc tests in absence of SAT.

	No SAT	SAT
AE vs MY	<0.01	0.39
AE vs (AE+ANA)	0.50	0.25
AE vs (AE+MY)	<.01	<0.01
AE vs (ANA+MY)	<.01	0.12
MY vs (AE+ANA)	0.012	1
MY vs (AE+MY)	0.03	0.12
MY vs (ANA+MY)	0.50	0.25
AE+ANA vs (AE+MY)	<0.01	0.23
AE+ANA vs (ANA+MY)	<0.01	0.39
AE+MY vs (ANA+MY)	0.22	1

Pvalue threshold was 0.0167 after Bonferroni correction.

In presence or in absence of SAT, the combination AE + MY give the best positive rate for all species (88% for SAT and 99% for NoSAT) and for *C. albicans* (100%). For *C. glabrata*, the combination ANA + MY is more convenient with a positive rate of 100%.

After Bonferroni correction in presence of SAT, only combination AE+MY gave a significant higher PR (88%) than AE vials alone (58%). In the absence of SAT, MY vials alone and combination of AE+MY and ANA+MY vials have a significantly higher PR than AE vials alone; combination AE+ANA vials have a significantly PR rate than MY vials alone; and AE+MY or ANA+MY have a significantly higher PR than the combination of AE+ANA vials (resin vials).

**Troisième partie : Approche causale à partir de
bases de données cliniques de haute qualité**

I. Approche causale sur les données observationnelles

La notion de causalité est large et recouvre différentes définitions qui ont été explorées à l'origine par les philosophes, puis, depuis les années 1970, en épidémiologie avec le développement d'approches mathématiques. [46] Une des principales difficultés est de différencier une association entre deux événements d'une relation de causalité, et la confusion entre les deux est fréquente.[47, 48] En recherche clinique, la question qui intéresse le clinicien n'est pas de savoir si un facteur d'exposition, par exemple un traitement, est associé à un événement, par exemple la mortalité, mais s'il en est la cause.[49] C'est-à-dire que l'on cherche à savoir si, toutes choses égales par ailleurs, un traitement est responsable d'une modification, à la hausse ou à la baisse, du risque de décès.

L'essai clinique randomisé contrôlé est la méthode expérimentale présentant le plus haut niveau de preuve pour établir une relation de causalité entre un facteur d'exposition et un événement.[50] L'investigateur n'a pas d'influence sur les modalités d'affectation des patients dans un des groupes d'exposition au facteur étudié. Les caractéristiques des individus sont similaires dans chaque groupe, et, si une différence est observée, celle-ci ne peut être imputée qu'au hasard. Cela signifie que les patients sont alors interchangeables : le risque de l'événement dans le groupe A serait le même que celui du groupe B si tous les patients du groupe A avaient reçu le traitement attribué aux patients du groupe B. [51] Dans cette situation, si l'essai clinique est bien mené – c'est-à-dire en l'absence de perdus de vue, avec une observance totale, un maintien de l'aveugle et une puissance suffisante [51, 52] – la seule différence observable est imputable au facteur d'exposition et correspond à une estimation de l'effet causal moyen du traitement.

Cependant, il n'est pas toujours possible de réaliser un essai clinique car cela peut être inutile (par exemple pour évaluer l'efficacité de la réduction d'une fracture osseuse ou de la prescription de pénicilline en cas d'infection bactérienne), inapproprié (cas des effets

indésirables ou des événements rares, ou éloignés dans le futur), impossible (pour des raisons éthiques notamment) ou inadéquat. [53] Si les essais cliniques restent la meilleure approche pour les décisions nécessitant un haut niveau de preuve, ils ne représentent pas toujours le monde réel. [54] En effet, la randomisation implique une affectation aléatoire des patients dans les différents bras de traitement étudiés pour contrôler les différents facteurs de confusion, connus ou non. Pour que cela soit possible, il est souvent nécessaire de procéder à des exclusions de patients pour éviter d'éventuelles complications. Ce processus de sélection en amont restreint la population d'étude et ne permet pas de généraliser les résultats à l'ensemble de la population. [52, 53] De plus, les analyses expérimentales sont coûteuses et ne permettent de vérifier que peu d'hypothèses à la fois. Dans ces situations, les analyses sur des données observationnelles de haute qualité, prospectives ou rétrospectives, peuvent présenter une alternative pouvant donner des résultats proches de ceux de l'essai clinique randomisé. [53-55]

La principale problématique rencontrée dans les données observationnelles est que le facteur d'exposition n'est pas contrôlé par l'investigateur et que les caractéristiques des patients ne sont pas équilibrées entre les différents groupes à l'origine. Ainsi, du fait de l'absence d'interchangeabilité des patients, une différence de mortalité entre les deux groupes ne peut pas être attribuée seulement au facteur d'exposition, donc il n'est pas possible d'estimer directement l'effet causal. [51, 53] Une des possibilités est d'utiliser une méthode basée sur le score de propension, qui est la probabilité pour un individu de recevoir un traitement sachant un ensemble de covariables mesurées à un instant donné. [56] Lorsque les différences entre les groupes peuvent s'expliquer par les seules variables mesurées lors de l'inclusion dans l'étude, l'équilibre des groupes peut être rétabli après ajustement ou appariement sur le score de propension. Ceci permet de mesurer l'effet causal moyen d'un traitement chez les patients traités. Pour estimer cet effet dans l'ensemble de la population, c'est-à-dire pour répondre à la

question : « quelle serait la proportion d'événements observés si l'ensemble de la population était traité, ou à l'inverse, si l'ensemble de la population n'avait pas reçu le traitement? » il est possible d'utiliser un estimateur pondéré par l'inverse du score de propension ou IPTW (inverse probability of treatment weighing). [57] Ces méthodes, basées sur la théorie contre-factuelle, sont simples d'application, et sous réserve du respect des hypothèses initiales – identifiabilité du modèle ou positivité, présence de tous les facteurs de confusion (mesurés ou non) et pas de mauvaise spécification des modèles – elles permettent d'estimer une relation causale entre le traitement et l'événement d'intérêt.

II. Impact de la désescalade précoce sur le pronostic des patients

L'administration d'un traitement précoce chez un patient atteint de candidose invasive améliore significativement le pronostic. Cependant, si la candidose n'est pas prouvée, ou si le patient est stabilisé, la désescalade du traitement reste une pratique dont les recommandations divergent et dont l'impact sur le pronostic des patients à risque de candidose invasive n'a pas été établi. [23, 25] Nous avons choisi d'étudier l'effet de la désescalade précoce; c'est-à-dire dans les cinq jours après l'initiation du traitement, sur la mortalité à 30 jours des patients en USI en utilisant un estimateur IPTW double robuste (DR-IPTW). Deux modèles sont utilisés pour les méthodes basées sur un estimateur IPTW : un premier modèle permettant de calculer la probabilité d'être exposé et un deuxième modèle de régression sur le critère de jugement principal. L'estimation de l'effet causal moyen est correcte seulement si les deux modèles sont correctement spécifiés. L'intérêt d'utiliser un DR-IPTW est de combiner les deux régressions de telle façon que si l'un des deux modèles est mal spécifié, cela n'entraîne pas de biais dans l'estimation de l'effet causal moyen. [58]

Les résultats de cette étude ont été présentés sous forme d'article qui a été accepté dans la revue Intensive Care Medicine.

Publication N°4 : Antifungal de-escalation was not associated with adverse outcome in critically ill patients treated for invasive candidiasis – Post-hoc analyses of the AmarCAND2 study data

Bailly S, Leroy O, Montravers P, Constantin JM, Dupont H, Guillemot D, Lortholary O, Mira JP, Perrigault PF, Gangneux JP, Azoulay E, Timsit JF

Intensive Care Medicine : accepté

Présentation orale : 28th annual congress European Society of Intensive Care Medicine — Berlin 2015

Poster : 36th annual conference of the International Society for Clinical Biostatistics Utrecht 2015

Résumé de l'article

L'objectif de cette étude est de déterminer si la désescalade dans les cinq jours après l'initiation d'un traitement antifongique est associée avec une augmentation de la mortalité à 28 jours chez les patients adultes non neutropéniques en USI.

Les données sont issues d'une cohorte prospective multicentrique : AmarCand2 dans laquelle ont été inclus 835 patients provenant de 84 USI françaises ayant reçu un traitement antifongique systémique pour une candidose invasive documentée ou suspectée. Parmi ces patients, ceux qui étaient encore vivants cinq jours après l'initiation du traitement antifongique ont été sélectionnés et répartis en deux groupes : d'une part les patients ayant eu une désescalade entre l'initiation du traitement et le cinquième jour et d'autre part, les patients n'ayant pas eu de désescalade dans les cinq premiers jours. La désescalade est définie comme la transition d'une molécule fongicide (échinocandine ou amphotéricine B) vers le fluconazole ou un arrêt du traitement. L'effet causal moyen de la désescalade sur la mortalité à 28 jours a été estimé par l'utilisation d'un estimateur IPTW double robuste.

Sur les 647 patients vivants à 5 jours et inclus dans l'étude, 142 (22 %) ont eu une désescalade du traitement, et il n'a pas été mis en évidence d'effet délétère de la désescalade sur le pronostic des patients.

En conclusion, la désescalade précoce n'est pas liée au pronostic des patients et a été associée à une diminution de la consommation d'antifongiques. Cette étude est la première à montrer que la désescalade ne présente pas de danger pour une population de patients critiques en USI. Ainsi la désescalade d'un traitement antifongique vers le fluconazole peut être recommandée à des patients stabilisés, avec une hémoculture négative et une absence de localisation secondaire de candidose invasive.



Sébastien Bailly
Olivier Leroy
Philippe Montravers
Jean-Michel Constantin
Hervé Dupont
Didier Guillemot
Olivier Lortholary
Jean-Paul Mira
Pierre-François Perrigault
Jean-Pierre Gangneux
Elie Azoulay
Jean-François Timsit

Antifungal de-escalation was not associated with adverse outcome in critically ill patients treated for invasive candidiasis: post hoc analyses of the AmarCAND2 study data

Received: 1 July 2015
Accepted: 1 September 2015

© Springer-Verlag Berlin Heidelberg and ESICM 2015

Take-home message: Early de-escalation of systemic antifungal treatments is not consensual. A causal analysis based on a multicenter prospective cohort in 87 French ICUs has shown that antifungal de-escalation within a 5-day interval is safe in SAT-treated non-neutropenic adult intensive care unit patients.

Electronic supplementary material
The online version of this article (doi:10.1007/s00134-015-4053-1) contains supplementary material, which is available to authorized users.

S. Bailly (✉) · J.-F. Timsit
Inserm UMR 1137-IAME Team 5-DeSCID: Decision Sciences in Infectious Diseases, Control and Care INSERM/Paris Diderot, Sorbonne Paris Cité University, Paris, France
e-mail: sbailly@chu-grenoble.fr

J.-F. Timsit
e-mail: jean-francois.timsit@bch.aphp.fr
Tel.: +33 140 25 77 02

S. Bailly
Grenoble 1 University, U823, Rond-point de la Chantoume, 38700 La Tronche, France

O. Leroy
Medical ICU, Chatiliez Hospital, Tourcoing, France

P. Montravers
Paris Diderot Sorbonne Cite University, and Anaesthesiology and Critical Care Medicine, Bichat-Claude Bernard University Hospital, APHP, Paris, France

J.-M. Constantin
Perioperative Medicine Department, Clermont-Ferrand University Hospital, Clermont-Ferrand, France

H. Dupont
Surgical ICU, Amiens University Hospital, Amiens, France

D. Guillemot
Inserm UMR 1181 "Biostatistics, Biomathematics, Pharmacoepidemiology and Infectious Diseases" (B2PHI), 75015 Paris, France

O. Lortholary
University Paris Descartes, Necker Pasteur Center for Infectious Diseases, Necker Enfants-Malades Hospital, IHU Imagine, Paris, France

O. Lortholary
Pasteur Institute, National Reference Center for Invasive Mycoses and Antifungals, CNRS URA3012, Paris, France

J.-P. Mira
Medical ICU, Cochin University Hospital, APHP, Paris, France

J.-P. Mira
Paris Descartes, Sorbonne Paris Cité University, Paris, France

P.-F. Perrigault
Medical-Surgical ICU, Montpellier University Hospital, Montpellier, France

J.-P. Gangneux
Mycology, Rennes University Hospital, Rennes, France

E. Azoulay
Medical ICU, Saint-Louis University Hospital, Paris, France

J.-F. Timsit
Medical and Infectious Diseases ICU, Paris Diderot University/Bichat University Hospital, APHP, 46 rue Henri Huchard, Paris 75018, France

Abstract Purpose: Systemic antifungal therapy (SAT) of invasive candidiasis needs to be initiated immediately upon clinical suspicion. Controversies exist about adequate time and potential harm of antifungal de-escalation (DE) in documented and suspected candidiasis in ICU patients. Our objective was to investigate whether de-escalation within 5 days of antifungal initiation is associated with an increase of the 28-day mortality in SAT-treated non-neutropenic adult ICU patients. **Methods:** From the 835 non-neutropenic adults recruited in the multicenter prospective observational AmarCAND2 study, we selected the patients receiving systemic antifungal therapy for a documented or suspected invasive candidiasis in the ICU and who were still alive 5 days after SAT initiation. They were included into two groups according to the occurrence of observed SAT de-

escalation before day 6. The average causal SAT de-escalation effect on 28-day mortality was evaluated by using a double robust estimation. **Results:** Among the 647 included patients, early de-escalation at day 5 after antifungal initiation occurred in 142 patients (22 %), including 48 (34 %) patients whose SAT was stopped before day 6. After adjustment for the baseline confounders,

early SAT de-escalation was the solely factor not associated with increased 28-day mortality (RR 1.12, 95 % CI 0.76–1.66). **Conclusion:** In non-neutropenic critically ill adult patients with documented or suspected invasive candidiasis, SAT de-escalation within 5 days was not related to increased day-28 mortality but it was associated with decreased SAT consumption. These results

suggest for the first time that SAT de-escalation may be safe in these patients.

Keywords Antifungal · Intensive care unit · De-escalation · Invasive candidiasis · Causal inference · Sepsis · Outcome

Introduction

Candida species are one of the most frequently recovered pathogens in patients with hospital-acquired bloodstream infections and the most common cause of invasive fungal infection [1–3], which is associated with a mortality rate from 30 % to more than 60 % in the case of septic shock [4–8].

Early treatment of invasive candidiasis (IC) improves patients' prognosis [4, 6, 8, 9]. Given the poor sensitivity of blood culture to diagnose IC [10], guidelines recommend to initiate systemic antifungal therapy (SAT), mostly an echinocandin, for critically ill patients with risk factors for IC and no other known cause of fever. This approach is considered valid by many experts while waiting for further evidence. The general opinion is that the administration of SAT should be guided by the evaluation of risk factors, the use of clinical prediction rules, culture data from non-sterile sites, and biological markers [11].

Unfortunately, no diagnostic tests are available to firmly confirm or discard the diagnosis of IC in the absence of positive blood cultures or non-contaminated positive sample from a sterile site. Therefore the management of antifungal treatment in suspected non-proven invasive fungal infection is speculative.

A cross-sectional multicenter study showed that SAT was administered to 7.5 % of ICU patient-days, although two-thirds of them had no documented invasive fungal infection [12]. Possible consequences of these practices are an increase of cost and selection of more resistant yeasts [13, 14].

Similarly, the positive predictive value for IC of the prediction rules in a general ICU population was lower than 20 % in the most recent studies [15–17] and systematic pre-emptive strategies in such predetermined patients failed to improve patients' prognosis [15, 18].

Echinocandins are the first-line therapeutic option for IC, because of fungicidal activity, good tolerance, and a broad-spectrum activity [19, 20]. For IC, the European Society for Clinical Microbiology and Infectious Diseases (ESCMID) and Infectious Diseases Society of America (IDSA) guidelines recommend a de-escalation strategy (3 days in stabilized patients, as per IDSA, and 10 days overall, as per ESCMID) to limit the emergence of resistant strains and to

reduce treatment costs [19, 20]. However, the level of recommendation is poor because of the lack of available data. The safety of de-escalation in the case of proven candidiasis has been recently suggested by prospective non-comparative studies [21, 22], but no comparative study exists for proven or probable IC treated in the ICU.

The objective of this study is to investigate whether de-escalation or stopping of SAT within 5 days of initiation is associated with an increase in 28-day mortality in SAT-treated non-neutropenic adult ICU patients. We used a marginal structural model (MSM) to assess the causal relationship of de-escalation on day-28 prognosis using the prospective multicenter observational French study AmarCAND2.

Materials and methods

Study design

The patients were selected from AmarCAND2, a multicenter, prospective, observational study conducted in French ICUs during 1 year (2012–2013). The investigating centers were ICUs having managed at least one IC case within the past year and willing to participate in the study. Investigators enrolled patients according to the study protocol and managed them according to their own clinical judgment, independently from the sponsor. The Ethics Committee of the French Intensive Care Society and the French National Committee for Data Protection and Freedom of Information approved the study. Such an observational study does not require patients to sign an informed consent according to French regulations; however, written information was provided and oral consent was obtained from all participating patients whenever possible, or their family.

Patients

Investigators enrolled consecutive adult patients hospitalized in ICU and requiring SAT for documented or

suspected invasive *Candida* infection during their ICU stay. Patients receiving prophylactic SAT, those with neutropenia (absolute neutrophil count at most 500/mm³), those who had undergone solid organ transplant within the previous 15 days, or those receiving SAT for a mold infection were excluded.

Clinical and mycological data collection and definition

Data were collected for each patient using an electronic case report at study inclusion and throughout the study. The following data were collected: demographics data, severity scores (at inclusion, at SAT administration, at day 7 after SAT administration), clinical data at SAT administration, mycological data for confirmed invasive *Candida* infection, and information on the treatment. If the initial treatment was modified, the investigator was asked to record the date and reason(s) for the modification and information about the modification. At the end of the SAT, the following data were recorded: the SAT end date and the outcome of the *Candida* infection. The dates of ICU and hospital discharges were also collected, as was the vital status of all patients 28 days after the SAT initiation (alive, dead, or lost to follow-up after ICU discharge).

Studied population

AmarCAND2 patients who were still alive in the ICU at day 5 after the first SAT administration were included in the present study. Patients were divided into two groups according to the SAT strategy observed within 5 days following SAT initiation: (1) de-escalation group (DE) and (2) absence of de-escalation group (NoDE). SAT de-escalation was defined as either a switch from initial SAT drugs (except fluconazole) to fluconazole or termination of initial SAT drugs within 5 days following SAT initiation.

Study outcomes

The primary outcome was to evaluate whether SAT de-escalation within 5 days of SAT initiation was, or not, associated with the worsening of the 28-day mortality as compared to the mortality of adult non-neutropenic ICU patients who received SAT without any de-escalation. Subgroup analyses of the primary objective were performed for (1) patients with SAT de-escalation observed within 7 days after SAT initiation (allowing variation of SOFA score between SAT day and day 7 to be added in the model as an adjustment covariate); (2) patients who had a documented IC at day 5 (including a distinction between patients with *C. albicans* IC or patients with *C. non-albicans* IC); (3) patients who did not have a

documented IC at day 5; (4) Patients with echinocandins as initial SAT; (5) patients with fluconazole as initial SAT; (6) patients without secondary location for *Candida*; (7) ICUs belonging to large hospitals with more than 1040 hospitalization-beds. Secondary objectives were to evaluate (1) if stopping SAT before day 5 is, or not, associated with the worsening of the 28-day mortality as compared to the mortality of adult non-neutropenic ICU patients without proven invasive candidiasis at day 5 and whose SAT was not stopped; (2) to compare the effect of SAT de-escalation for adults ICU patients on (a) SOFA score at day 7; (b) the length of ICU stay; (c) the number of days alive after ICU discharge; (d) the duration of SAT administration; (e) the number of days alive after the end of SAT.

Statistical analysis

A descriptive analysis of the patient's characteristics was performed using median and interquartile range for quantitative data and frequencies and percent for qualitative data. The baseline characteristics of groups (DE vs. NoDE) were compared by means of the Chi-squared test for qualitative data and Mann-Whitney test for quantitative data. To estimate the average causal effect of DE on 28-day mortality, a double robust (DR) inverse probability of treatment weight (IPTW) estimator was used. The DR-IPTW estimator is an extension of the IPTW estimator [23]. The general principle of IPTW is to balance the distribution of baseline confounders across treatment groups, in order to reach the condition of a randomized controlled trial [24]. Two modeling steps are required. The first step is to model the treatment assignment, i.e., the propensity which is needed to compute the weights. The second step is to model the outcome as a function of the treatment in the weighted sample. When the treatment and the outcome are both binary, each modeling step usually relies on logistic regression models. Such regression models rely on strong assumptions about the underlying data distribution and may therefore be misspecified. DR-IPTW estimators were developed to prevent the consequence of model misspecification. This adaptation of the IPTW estimators guarantees consistency if only one of the two models is correctly specified and efficiency if they are both correctly specified [25]. The DR-IPTW estimator has a marginal interpretation, which corresponds to the average treatment effect, i.e., the difference in outcome had all patients being exposed to SAT de-escalation versus all patients being free from SAT de-escalation after adjustment for all measured confounders. The final results were expressed as relative risk (RR) for 28-day mortality between the two exposed pseudo-populations with bootstrapped standard errors and 95 % confidence intervals. Post hoc power analyses were performed for primary and secondary objectives. The

robustness of the results was confirmed by IPTW models. Statistical analyses were performed using SAS v9.3 (SAS Institute Inc., Cary, NC, USA). The SAS Macro developed by Funk et al. was used for the DR estimation [26]. A *p* value less than 0.05 was considered significant. Details on the power calculation are given in the Electronic Supplementary Material (ESM).

Results

Patient characteristics

From 835 patients enrolled in the AmarCAND2 study, 647 (77.5 %) who were still alive in the ICU 5 days after SAT initiation were included in the present study. Of the 647 included patients, 142 (22 %) experienced a SAT de-escalation or a SAT stop within 5 days of SAT initiation and 505 (78 %) were in the NoDE group (Fig. 1). Patients in the DE group were younger and had a shorter previous ICU stay but their SAPS II or SOFA scores at ICU admission were similar (Table 1). The rate of proven IC was not different between DE and NoDE groups (Table 2). Seven days after SAT initiation, SOFA score was not different between DE and NoDE groups (Table 3).

Initial SAT and SAT de-escalation

The use of echinocandins as first SAT was more frequent in the DE group (89 %) (Table 2). In the DE group, the median delay before SAT modification was 3 days (IQR

2; 4). A total of 94 patients (66 %) experienced a SAT de-escalation to fluconazole at a median dose of 800 mg (IQR 400; 800) and 48 patients (34 %) experienced a SAT stop within 5 days of initial SAT. Removal of a central catheter on the SAT initiation day was observed for 15 patients (58 %) in the DE group and for 23 patients (29 %) in the NoDE group (*p* < 0.01) (more details on removal of the possible source of infection are given Table E1 in ESM). The median duration of SAT was 11 days (IQR 7; 16) in the 323 remaining patients for whom the reason for SAT discontinuation was not recorded. Finally, antifungal prescriptions were defined into written procedures in 47 (61 %) ICUs and the de-escalation procedure was declared to follow international guidelines in 58 (75 %) ICUs. The existence of both types of procedures was not associated with the decision to de-escalate (Table 1).

Characteristics of patients with an invasive candidiasis at day 5

There was no difference between both groups regarding the characteristics of the patients and the evolution of the invasive candidiasis for the patients with an IC at day 5. In particular, the rates of clinical failure, or of death, were not different between DE and NoDE groups in both documented and non-documented IC (more details on the characteristics of the patients with an IC are given in Tables E2 and E3 in ESM).

Primary outcome

On the basis of the double robust estimation, the de-escalation strategy within 5 days had no significant impact on the 28-day mortality compared to non de-escalation strategy (relative risk 1.12, 95 % CI 0.76–1.66). Details on variables used for the double robust estimation are provided in Tables E4 and E5 in ESM. The sensitivity analysis of patients with a SAT de-escalation before day 7 gave similar results (RR 0.95 [0.66; 1.36]). Results remained unchanged in prespecified subgroups, more particularly for documented IC, non-documented IC, and first-line treatment with candins (Fig. 2). Moreover, subgroup analysis excluding suspected IC with *C. glabrata* or *C. krusei* showed no difference. The results using an IPTW estimator confirmed the double robust estimation model that we used (Table E6 in ESM).

Secondary outcomes

Early SAT de-escalation was associated with a decrease in the length of ICU stay (14 days [9; 28] vs. 19 days [11;

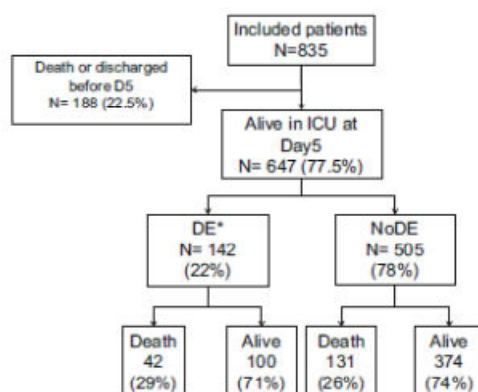

Fig. 1 Overall flow chart (primary objective). *SAT stop: *N* = 48. ICU intensive care unit, SAT systemic antifungal therapy, D5 day 5 after SAT initiation, DE SAT de-escalation group at day 5 included patients with a SAT de-escalation or a SAT stopping observed between D0 and D5 after SAT initiation, NoDE absence of SAT de-escalation at day 5, Death 28-day mortality

Table 1 Patient characteristics according to the de-escalation status at day 5 of systemic antifungal therapy ($N = 647$)

Characteristics	Systemic antifungal therapy group		<i>p</i> value
	De-escalation ($N = 142$)	No de-escalation ($N = 505$)	
Center characteristics*			
University hospital	33 (84.6)	125 (69.8)	0.78
Type of ICU			0.19
Medical	17 (12.0)	79 (15.6)	
Surgery	28 (19.7)	136 (26.9)	
Polyvalent	97 (68.3)	290 (26.9)	
Protocol for SAT prescription	86 (60.6)	275 (54.4)	0.57
Protocol for SAT de-escalation	39 (27.4)	179 (35.5)	0.14
Baseline characteristics			
Age	61.2 [51.5; 71.7]	63.7 [54.8; 73]	0.04
Sex (Male)	90 (63.4)	322 (63.8)	0.93
Body mass index	27.5 [22.9; 32.9]	25.9 [22.6; 30.4]	0.06
Previous duration of hospital stay (days)	2 [0; 9]	2 [0; 9]	0.91
Previous duration of ICU stay (days)	4 [0; 11]	5 [1; 13]	0.04
SAPS II score	48.5 [38; 58]	47 [36; 59]	0.52
SOFA score at ICU admission	8 [6; 11]	8 [5; 11]	0.35
Presence of comorbidities ^a	4 [2; 6]	4 [3; 6]	0.50
Immunosuppression	103 (72.5)	360 (71.3)	0.77
Corticosteroid therapy	4 (2.8)	23 (4.6)	0.36
AIDS	4 (2.8)	7 (1.4)	0.44
Other	14 (9.9)	53 (10.5)	0.83
Surgery just before or during ICU stay	95 (66.9)	330 (65.3)	0.73
Type of ICU admission			0.16
Medicine	61 (43)	234 (46.3)	
Elective surgery	8 (5.6)	44 (8.7)	
Emergency surgery	69 (48.6)	200 (39.6)	
Other (trauma, burn)	4 (2.8)	27 (5.3)	
At the initiation of the SAT in the ICU			
Body temperature	38 [37; 38.8]	38 [37; 38.5]	0.53
SOFA score	8 [5; 11]	8 [5; 10]	0.38
Septic shock	86 (60.6)	272 (53.9)	0.16
Severe sepsis	53 (37.3)	198 (39.2)	0.68
Invasive mechanical ventilation	117 (82.4)	417 (82.6)	0.96
Central venous catheter	141 (99.3)	488 (96.6)	0.09
Urinary catheterization	133 (93.7)	481 (95.2)	0.45
Hemodialysis or hemodiafiltration	39 (27.5)	165 (32.7)	0.24
Total parenteral nutrition	48 (33.8)	244 (48.3)	<0.01
Vasoactive drug	90 (63.4)	311 (61.6)	0.70
Antibacterial treatment	117 (82.4)	461 (91.3)	<0.01
Corticosteroid treatment	33 (23.2)	126 (25)	0.68
Red blood cell transfusion in ICU	67 (47.2)	297 (58.8)	0.01
Platelet transfusion in ICU	18 (12.7)	114 (22.6)	<0.01
Creatinine ($\mu\text{mol/L}$)	125 [70; 197]	105 [63; 178]	0.10

The results are given as n (%) or median \pm interquartile range [Q1; Q3]

p value: Chi-square test for qualitative variables, Mann-Whitney test for quantitative variables

ICU intensive care unit, SAT systemic antifungal therapy, SAPS simplified acute physiology score, SOFA sequential organ failure assessment, AIDS acquired immunodeficiency syndrome

* *p* value for center characteristics was obtained using an univariate hierarchical model

^a Comorbidities: myocardial infarction, congestive heart failure, peripheral venous disease, hemopathy, solid organ transplant, stroke, dementia, chronic obstructive pulmonary disease, peptic ulcer disease, diabetes (with or without organ damage), mild or severe chronic kidney disease, hemiplegia, solid tumor, mild or severe chronic liver disease

35] group $p < 0.01$), and a decrease in the SAT duration. The number of days alive without SAT at day 28 was higher in the DE group (14 days [5; 23]) than in the NoDE group (10 days [2; 17] $p < 0.01$). On the basis of the cost of echinocandin agents in France, we calculated

median costs in each DE group. It was 2835 € in the NoDE group (IQR 171; 7371) and 1743 € in the DE group (IQR 1134; 2382). The improvement of the SOFA score at day 7 was similar in both groups (Table 3). Clinical and microbiological failure rates were strictly

Table 2 Type of initial systemic antifungal therapy and invasive candidiasis according to patient group (*N* = 647)

Characteristics	systemic antifungal therapy group		<i>p</i> value
	De-escalation (<i>N</i> = 142)	No de-escalation (<i>N</i> = 505)	
Type of initial systemic antifungal therapy			<0.01
Amphotericin B	0 (0)	10 (2)	
Fluconazole	15 (10.6)	246 (48.7)	
Voriconazole	0 (0)	4 (0.8)	
Echinocandins	127 (89.4)	245 (48.5)	
At day 5 after SAT initiation			
Documented invasive candidiasis	70 (49.3)	206 (40.8)	0.07
Type of <i>Candida</i> infection			
Candidemia	32 (22.5)	82 (16.2)	0.08
Other invasive candidiasis	41 (28.9)	140 (27.7)	0.58
Deep-seated candidiasis	12 (8.5)	38 (7.5)	0.72
Complicated intra-abdominal infection	29 (20.4)	102 (20.2)	0.95
<i>Candida</i> species ^a			
<i>Candida albicans</i>	62 (43.7)	131 (25.9)	<0.01
<i>Candida non-albicans</i>	12 (8.5)	91 (18.0)	<0.01
<i>Candida glabrata</i>	6 (4.2)	47 (9.3)	0.05
<i>Candida parapsilosis</i>	1 (0.7)	15 (3.0)	0.12
<i>Candida krusei</i>	0 (0)	9 (1.8)	0.11
<i>Candida tropicalis</i>	3 (2.1)	10 (2.0)	0.92

SAT systemic antifungal therapy

^a Data only available for documented invasive candidiasis**Table 3** Results for the secondary outcome

Characteristics	Systemic antifungal therapy (SAT) group		<i>p</i> value
	De-escalation (<i>N</i> = 142)	No de-escalation (<i>N</i> = 505)	
SOFA score at day 7 after initial SAT	5 [3; 9]	5 [2; 9]	0.90
Delta SOFA score from SAT to day 7	2 [-1; 4]	2 [0; 4]	0.46
Length of ICU stay after initial SAT (days)	14 [9; 27]	19 [11; 35]	<0.01
Length of SAT administration (days)	12 [5; 16]	14 [8; 21]	<0.01
Number of days alive without SAT at day 28	13 [5; 23]	10 [1; 17]	<0.01
Number of days alive outside the ICU at day 28	3.5 [0; 17]	0 [0; 13]	0.03

SAT systemic antifungal therapy, ICU intensive care unit, SOFA sequential organ failure assessment

similar between DE and NoDE groups (Table E3 in ESM).

Post hoc power analysis

The sample size for the primary objective allowed us to conclude the non-inferiority of SAT de-escalation, in the case of an absolute risk difference of 9 % with a power of 0.8. Details of the post hoc power are given in Table E7 in ESM.

Discussion

Our causal analysis based on a large prospective observational multicenter study showed that SAT de-escalation in case of suspected or documented IC in non-neutropenic ICU patients occurred in only 22 % of the cases, and did

not impact day-28 mortality. DE led to a subsequent and significant decrease in the antifungal consumption. These results remained valid with different subgroups and were confirmed by sensitivity analysis.

Incidence of IC is increasing in ICU patients [27]. Despite the increasing amount of data on IC management, and the development of less toxic antifungal agents, the day-30 and early (before day 8) mortality rates are still increasing over time.

In order to save patients, physicians started antifungals early in case of severe sepsis or shock, without waiting for the definite proof of infection, as it is often delayed. This strategy naturally increased the number of SAT initiated in ICU and is certainly beneficial for ICU patients with documented fungal infections [12]. However, three out of four of the SAT are given without definite proof of fungal infection; this may lead to antifungal overuse with deleterious consequences [12]. Finally, the benefit of this empiric strategy has not been demonstrated in the general ICU

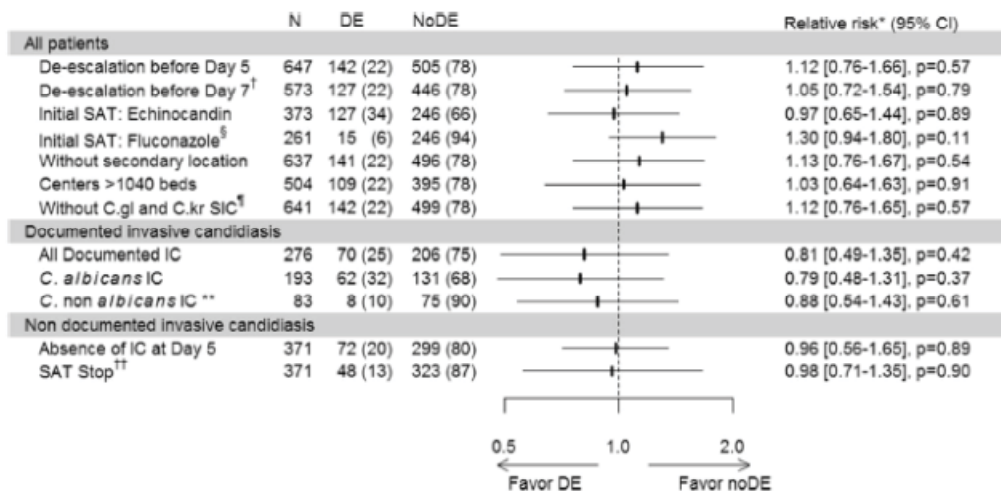

Fig. 2 Summary of results for primary and secondary outcomes. *DE* de-escalation, *NoDE* no de-escalation, *ICU* intensive care unit, *D5* day 5, *D7* day 7, *SAT* systemic antifungal treatment, *IC* invasive *Candida* infection. *RR relative risk. If RR < 1, de-escalation is protective for 28-day mortality. If RR > 1, de-escalation is not protective for 28-day mortality. [†]De-escalation was considered within 7 days after SAT initiation. The estimate was adjusted for SOFA score variation between the SAT start and

day 7. [§]Fluconazole: All patients in the DE group had only stop treatment. [¶]Exclusion of patients with suspected invasive candidiasis with *C. glabrata* and *C. krusei*. ***Candida* spp. for the 8 patients in the DE group were *C. glabrata* (N = 4), *C. tropicalis* (N = 2), *C. parapsilosis* (N = 1), and *C. lusitanae* (N = 1). ^{††}DE concerned only patients which switched from all initial SAT to SAT stop within 5 days

population [15, 18]. Furthermore, the overuse of antifungal agents is associated with increased MICs of *Candida* spp. to antifungal drugs [13, 28–31]. In addition, antifungal pre-exposure is associated with clinical [27] and microbiological failures [13, 32] and with breakthrough infections [29, 33]. Antifungal streamlining strategies are therefore fundamental to try to curb the trends.

In the ESCMID guidelines, step-down therapy is recommended only after 10 days for documented infection. In the IDSA guidelines, step-down therapy to fluconazole is considered reasonable for patients who have clinically improved after initial therapy with an echinocandin or polyenes and who are infected with a *Candida* spp. that is likely to be susceptible to fluconazole [20]. However, both the de-escalation rules for the most severe critically ill patients and the stopping rules for SAT started early without proven infection are not defined [19, 20].

For proven invasive candidiasis, three other studies already found that de-escalation is safe in the case of *Candida* spp. sensitive to fluconazole. In a small cost-effectiveness study, de-escalation to oral fluconazole was encouraged for candidemia. Of the 37 episodes of documented candidemia, 27 were commenced on an echinocandin or voriconazole and 19 (70.3 %) were de-escalated to fluconazole on the basis of the intravenous oral switch therapy (IVOST) policy after a mean of 4.6 days, with good results and important cost saving [34].

In the recent ACTION project performed by the Japanese Mycosis Group, clinical failure rate and

mortality rate were lower in patients with adherence to step-down oral therapy [22].

An open-label, non-comparative study evaluated an intravenous (i.v.) to oral step-down strategy. Patients with candidiasis were treated intravenously with anidulafungin. After 5 days of i.v. therapy, investigators had the option to step-down to oral azole therapy (fluconazole or voriconazole) if patients met prespecified criteria (ability to tolerate oral therapy; not febrile for more than 24 h; hemodynamically stable; not neutropenic; and documented clearance of *Candida* from the bloodstream). Of the 250 patients enrolled in the mITT population, 102 were switched to oral therapy after a median of 6 days, and clinical response relapse and mortality were similar between patients with early switch and the other patients [21].

Our results confirm previous observations that early de-escalation to azole is possible and safe. We also showed that empiric treatment could be safely stopped after 5 days of SAT therapy in the absence of proven invasive candidiasis.

De-escalation strategy is not explained by severity of organ dysfunction, shock, surgical type of admission, or by the use of other antimicrobial treatments. It occurred less frequently in older patients, for patients in ICU for a longer period of time, or those still under parenteral nutrition.

This study had several limitations. First, it was calibrated to reach a power of 80 % to show an absolute risk difference (ARD) of 9 % between both groups. The study is therefore underpowered to show a smaller ARD,

although still of important clinical relevance. The post hoc power analysis showed that the sample size necessary to reach a sufficient power for subgroup analysis or to show a smaller ARD would need thousands of patients enrolled. This would be unrealistic for a clinical trial.

Secondly, the causal model based on observational data was conducted under the unverifiable assumption of the absence of immeasurable confounders. In this study, there were no measurable time-dependent confounders during the SAT administration. This was a limitation, because SAT de-escalation could be related to the evolution of the patient's state of health during time.

As an example, the beta-D-glucan was not routinely measured within the AmarCAND2 study. However, the potential usefulness of repeated measurements of beta-D-glucan is only suggested in very particular subgroups of ICU patients with complicated abdominal surgery abdominal leakage or acute pancreatitis [35] and lack of specificity and sensitivity in the general ICU population [36].

Third, the reasons leading the investigators to stop SAT were not recorded, although it may have influenced the final results. However, the guidelines for de-escalation were equally followed between DE and NoDE groups.

Last, we cannot be sure that measured confounders occurring between SAT initiation and day 5 that were making physicians prone to de-escalate have been fully taken into account. However, neither the characteristics of the invasive candidiasis nor the SOFA at day 7 or the delta SOFA between SAT initiation and day 7 were different between groups. Furthermore, we analyzed de-escalation at day 7 as an exposure variable; it had no significant effect on the 28-day mortality.

We concluded that, in non-neutropenic critically ill adult patients with proven or suspected IC, SAT de-escalation within 5 days was associated with a decrease in antifungal consumption without apparent deleterious effect on day-28 mortality. De-escalation to fluconazole may be recommended for stabilized patients, with negative blood culture and absence of secondary location for

candidiasis. The latter has to be confirmed in randomized control trials.

Acknowledgments Members of the independent scientific committee: Olivier Leroy (MD, medical intensivist), Jean-François Timsit (MD, PhD, medical intensivist, epidemiologist), Jean-Pierre Gangneux (MD, PhD, mycologist), Elie Azoulay (MD, PhD, medical intensivist), Jean-Michel Constantin (MD, PhD, anesthesiologist and intensivist), Hervé Dupont (MD, PhD, anesthesiologist and intensivist), Olivier Lortholary (MD, PhD, infectious diseases specialist), Jean-Paul Mira (MD, PhD, medical intensivist), Philippe Montravers (MD, PhD, anesthesiologist and intensivist), Pierre-François Perrigault (MD, anesthesiologist and intensivist). Manuscript preparation: the authors thank Celine Feger (MD; EMIBiotech), who provided assistance in preparing and editing the manuscript and Romain Pirrachio (MD, PhD; University of California, San Francisco) who reviewed statistical analysis.

Compliance with ethical standards

Funding This work was supported by MSD France, which was the sponsor.

Conflicts of interest Authors had full access to the database, and the statistical analyses were conducted by an academic team: Biostatistics Unit, Lille University Hospital, Lille, France, which worked in full independence from MSD.EA has been a consultant to Astellas, Alexion, Cubist, Gilead, and MSD, and has benefited from grants to his research unit from Gilead and Pfizer. J-MC has been a consultant to MSD. HD has been a consultant to Astellas, Gilead, Cubist, Astrazeneca, Merck, and Pfizer. J-PG has been a consultant to Astellas, Gilead, Merck, and Pfizer. DG has benefited from grants of the Principality of Monaco to his research unit. O Leroy has been consultant to Astellas, Gilead, Merck, Novartis, Pfizer, and Sanofi. O Lortholary has been consultant to Gilead Sciences and Novartis and member of the speaker's bureau of Astellas, Basilea, Merck, Pfizer, and Sanofi. J-PM has been a consultant to Astellas, Gilead, MSD, and LFB. PM has been a consultant to Astra-Zeneca, Cubist, MSD, Pfizer, and TMC. P-FP has been a consultant to MSD and Pfizer. JFT has given lectures for symposiums set up by Astellas, Pfizer, MSD, 3M, Novartis, and Gilead; has benefited from unrestricted research grants to his research unit from 3M, MSD, and Astellas; and has been a consultant involved in scientific boards for MSD, 3M, and Bayer. SB has no conflict of interest.

References

1. Rangel-Frausto MS, Wiblin T, Blumberg HM, Saiman L, Patterson J, Rinaldi M, Pfaller M, Edwards JE, Jarvis W, Dawson J, Wenzel RP (1999) National epidemiology of mycoses survey (NEMIS): variations in rates of bloodstream infections due to *Candida* species in seven surgical intensive care units and six neonatal intensive care units. *Clin Infect Dis* 29:253–258
2. Tabah A, Koulenti D, Laupland K, Misset B, Valles J, Bruzzi de Carvalho F, Paiva JA, Cakar N, Ma X, Eggimann P, Antonelli M, Bonten MJM, Csomos A, Krueger WA, Mikstacki A, Lipman J, Depuydt P, Vesin A, Garrouste-Orgeas M, Zahar J-R, Blot S, Carlet J, Brun-Buisson C, Martin C, Rello J, Dimopoulos G, Timsit J-F (2012) Characteristics and determinants of outcome of hospital-acquired bloodstream infections in intensive care units: the EURO-BACT International Cohort Study. *Intensive Care Med* 38:1930–1945
3. Blumberg HM, Jarvis WR, Soucie JM, Edwards JE, Patterson JE, Pfaller MA, Rangel-Frausto MS, Rinaldi MG, Saiman L, Wiblin RT, Wenzel RP (2001) Risk factors for candidal bloodstream infections in surgical intensive care unit patients: the NEMIS Prospective Multicenter Study. *Clin Infect Dis* 33:177–186

4. Bassetti M, Righi E, Ansaldo F, Merelli M, Trucchi C, Cecilia T, De Pascale G, Diaz-Martin A, Luzzati R, Rosin C, Lagunes L, Trecarichi EM, Sanguinetti M, Posteraro B, Garnacho-Montero J, Sartor A, Rello J, Rocca GD, Antonelli M, Tumbarello M (2014) A multicenter study of septic shock due to candidemia: outcomes and predictors of mortality. *Intensive Care Med* 40:839–845
5. Garrouste-Orgeas M, Timsit JF, Tafflet M, Misset B, Zahar J-R, Soufir L, Lazard T, Jamali S, Mourvillier B, Cohen Y, De Lassence A, Azoulay E, Cheval C, Descorps-Declere A, Adrie C, Costa de Beauregard M-A, Carlet J, OUTCOMEREA Study Group (2006) Excess risk of death from intensive care unit-acquired nosocomial bloodstream infections: a reappraisal. *Clin Infect Dis* 42:1118–1126
6. Kollef M, Micek S, Hampton N, Doherty JA, Kumar A (2012) Septic shock attributed to *Candida* infection: importance of empiric therapy and source control. *Clin Infect Dis* 54:1739–1746
7. Pittet D, Li N, Woolson RF, Wenzel RP (1997) Microbiological factors influencing the outcome of nosocomial bloodstream infections: a 6-year validated, population-based model. *Clin Infect Dis* 24:1068–1078
8. Wisplinghoff H, Seifert H, Tallent SM, Bischoff T, Wenzel RP, Edmond MB (2003) Nosocomial bloodstream infections in pediatric patients in United States hospitals: epidemiology, clinical features and susceptibilities. *Pediatr Infect Dis J* 22:686–691
9. Grim SA, Berger K, Teng C, Gupta S, Layden JE, Janda WM, Clark NM (2012) Timing of susceptibility-based antifungal drug administration in patients with *Candida* bloodstream infection: correlation with outcomes. *J Antimicrob Chemother* 67:707–714
10. Köck R, Eißing LC, Bosch MG, Ellger B, Hom D, Idelevich EA, Becker K (2013) Evaluation of bactec mycosis IC/F and Plus Aerobic/F blood culture bottles for detection of *Candida* in the presence of antifungal agents. *J Clin Microbiol* 51:3683–3687
11. Eggimann P, Pittet D (2014) *Candida* colonization index and subsequent infection in critically ill surgical patients: 20 years later. *Intensive Care Med* 40:1429–1448
12. Azoulay E, Dupont H, Tabah A, Lortholary O, Stahl J-P, Français A, Martin C, Guidet B, Timsit J-F (2012) Systemic antifungal therapy in critically ill patients without invasive fungal infection. *Crit Care Med* 40:813–822
13. Alexander BD, Johnson MD, Pfeiffer CD, Jiménez-Ortigosa C, Catania J, Booker R, Castanheira M, Messer SA, Perlin DS, Pfaller MA (2013) Increasing echinocandin resistance in *Candida glabrata*: clinical failure correlates with presence of FKS mutations and elevated minimum inhibitory concentrations. *Clin Infect Dis* 56:1724–1732
14. Saraya T, Tanabe K, Araki K, Yonetani S, Makino H, Watanabe T, Tsujimoto N, Takata S, Kurai D, Ishii H, Miyazaki Y, Takizawa H, Goto H (2014) Breakthrough invasive *Candida glabrata* in patients on micafungin: a novel FKS gene conversion correlated with sequential elevation of MIC. *J Clin Microbiol* 52:2709–2712
15. Ostrosky-Zeichner L, Shoham S, Vazquez J, Reboli A, Betts R, Barron MA, Schuster M, Judson MA, Revankar SG, Caeiro JP, Mangino JE, Mushatt D, Bedimo R, Freifeld A, Nguyen MH, Kauffman CA, Dismukes WE, Westfall AO, Deerman JB, Wood C, Sobel JD, Pappas PG (2014) MSG-01: a randomized, double-blind, placebo-controlled trial of caspofungin prophylaxis followed by preemptive therapy for invasive candidiasis in high-risk adults in the critical care setting. *Clin Infect Dis* 58:1219–1226
16. León C, Ruiz-Santana S, Saavedra P, Galván B, Blanco A, Castro C, Balasini C, Utande-Vázquez A, González de Molina FJ, Blasco-Navalprota MA, López MJ, Charles PE, Martín E, Hernández-Viera MA, Cava Study Group (2009) Usefulness of the “Candida score” for discriminating between *Candida* colonization and invasive candidiasis in non-neutropenic critically ill patients: a prospective multicenter study. *Crit Care Med* 37:1624–1633
17. Ostrosky-Zeichner L, Sable C, Sobel J, Alexander BD, Donowitz G, Kan V, Kauffman CA, Kett D, Larsen RA, Morrison V, Nucci M, Pappas PG, Bradley ME, Major S, Zimmer L, Wallace D, Dismukes WE, Rex JH (2007) Multicenter retrospective development and validation of a clinical prediction rule for nosocomial invasive candidiasis in the intensive care setting. *Eur J Clin Microbiol Infect Dis* 26:271–276
18. Bailly S, Bouadma L, Azoulay E, Orgeas MG, Adrie C, Souweine B, Schwebel C, Maubon P, Hamidfar-Roy R, Darmon M, Wolff M, Comet M, Timsit J-F (2015) Failure of empirical systemic antifungal therapy in mechanically ventilated critically ill patients. *Am J Respir Crit Care Med* 191:1139–1146
19. Cornely OA, Bassetti M, Calandra T, Garbino J, Kullberg BJ, Lortholary O, Meersseman W, Akova M, Arendrup MC, Arikian-Akdagli S, Bille J, Castagnola E, Cuenca-Estrella M, Donnelly JP, Groll AH, Herbrecht R, Hope WW, Jensen HE, Lass-Flörl C, Petrikos G, Richardson MD, Roilides E, Verweij PE, Viscoli C, Ullmann AJ, ESCMID Fungal Infection Study Group (2012) ESCMID guideline for the diagnosis and management of *Candida* diseases 2012: non-neutropenic adult patients. *Clin Microbiol Infect* 18(Suppl 7):19–37
20. Pappas PG, Kauffman CA, Andes D, Benjamin DK, Calandra TF, Edwards JE, Filler SG, Fisher JF, Kullberg B-J, Ostrosky-Zeichner L, Reboli AC, Rex JH, Walsh TJ, Sobel JD, Infectious Diseases Society of America (2009) Clinical practice guidelines for the management of candidiasis: 2009 update by the Infectious Diseases Society of America. *Clin Infect Dis* 48:503–535
21. Vazquez J, Reboli AC, Pappas PG, Patterson TF, Reinhardt J, Chin-Hong P, Tobin E, Kett DH, Biswas P, Swanson R (2014) Evaluation of an early step-down strategy from intravenous anidulafungin to oral azole therapy for the treatment of candidemia and other forms of invasive candidiasis: results from an open-label trial. *BMC Infect Dis* 14:97
22. Takesue Y, Ueda T, Mikamo H, Oda S, Takakura S, Kitagawa Y, Kohno S, ACTIONs Project (2015) Management bundles for candidemia: the impact of compliance on clinical outcomes. *J Antimicrob Chemother* 70:587–593
23. Bang H, Robins JM (2005) Doubly robust estimation in missing data and causal inference models. *Biometrics* 61:962–973
24. Bailly S, Pirracchio R, Timsit JF (2015) What’s new in the quantification of causal effects from longitudinal cohort studies: a brief introduction to marginal structural models for intensivists. *Intensive Care Med*. doi: 10.1007/s00134-015-3919-6
25. Zhang M, Schaubel DE (2012) Contrasting treatment-specific survival using double-robust estimators. *Stat Med* 31:4255–4268
26. Funk MJ, Westreich D, Wiesen C, Stürmer T, Brookhart MA, Davidian M (2011) Doubly robust estimation of causal effects. *Am J Epidemiol* 173:761–767

27. Lortholary O, Renaudat C, Sthbon K, Madec Y, Denocud-Ndam L, Wolff M, Fontanet A, Bretagne S, Dromer F, French Mycosis Study Group (2014) Worrying trends in incidence and mortality of candidemia in intensive care units (Paris area, 2002–2010). *Intensive Care Med* 40:1303–1312
28. Andes D, Forrest A, Lepak A, Nett J, Marchillo K, Lincoln L (2006) Impact of antimicrobial dosing regimen on evolution of drug resistance in vivo: fluconazole and *Candida albicans*. *Antimicrob Agents Chemother* 50:2374–2383
29. Fekkar A, Dannaoui E, Meyer I, Imbert S, Brossas JY, Uzunov M, Mellon G, Nguyen S, Guillier E, Caumes E, Leblond V, Mazier D, Fievet MH, Datry A (2014) Emergence of echinocandin-resistant *Candida* spp. in a hospital setting: a consequence of 10 years of increasing use of antifungal therapy? *Eur J Clin Microbiol Infect Dis* 33:1489–1496
30. Khan Z, Ahmad S, Joseph L, Al-Obaid K (2014) Isolation of cholesterol-dependent, multidrug-resistant *Candida glabrata* strains from blood cultures of a candidemia patient in Kuwait. *BMC Infect Dis* 14:188
31. Lewis JS, Wiederhold NP, Wickes BL, Patterson TF, Jorgensen JH (2013) Rapid emergence of echinocandin resistance in *Candida glabrata* resulting in clinical and microbiologic failure. *Antimicrob Agents Chemother* 57:4559–4561
32. Shields RK, Nguyen MH, Press EG, Updike CL, Clancy CJ (2013) Caspofungin MICs correlate with treatment outcomes among patients with *Candida glabrata* invasive candidiasis and prior echinocandin exposure. *Antimicrob Agents Chemother* 57:3528–3535
33. Bizerra FC, Jimenez-Ortigosa C, Souza ACR, Breda GL, Queiroz-Telles F, Perlin DS, Colombo AL (2014) Breakthrough candidemia due to multidrug-resistant *Candida glabrata* during prophylaxis with a low dose of micafungin. *Antimicrob Agents Chemother* 58:2438–2440
34. Bal AM, Shankland GS, Scott G, Imtiaz T, Macaulay R, McGill M (2014) Antifungal step-down therapy based on hospital intravenous to oral switch policy and susceptibility testing in adult patients with candidaemia: a single centre experience. *Int J Clin Pract* 68:20–27
35. Tissot F, Lamothe F, Hauser PM, Orasch C, Flückiger U, Siegemund M, Zimmerli S, Calandra T, Bille J, Eggimann P, Marchetti O (2013) Beta-glucan antigenemia anticipates diagnosis of blood culture-negative intraabdominal candidiasis. *Am J Respir Crit Care Med* 188:1100–1109
36. Poissy J, Sendid B, Damiens S, Ichi Ishibashi K, François N, Kautz M, Favory R, Mathieu D, Poulain D (2014) Presence of *Candida* cell wall derived polysaccharides in the sera of intensive care unit patients: relation with candidaemia and *Candida* colonisation. *Crit Care* 18:R135

Supplément électronique de la publication 4

Antifungal de-escalation was not associated with adverse outcome in critically ill patients treated for invasive candidiasis – Post-hoc analyses of the AmarCAND2 study data

Sébastien Bailly, Olivier Leroy, Philippe Montravers, Jean-Michel Constantin, Hervé Dupont, Didier Guillemot, Olivier Lortholary, Jean-Paul Mira, Pierre-François Perrigault, Jean-Pierre Gangneux, Elie Azoulay, Jean-François Timsit.

ESM1: power calculation

Based on a 28-day mortality of 25% for patients who were still alive in ICU after 5 day, a non-inferiority margin of 10% will be considered as an acceptable hypothesis to conclude to the non-inferiority of SAT de-escalation on primary outcome. This margin corresponds to a power of 80% for an effective of 678 patients with a ratio of 1 patient of DE group for 3 patients of the NoDE group.

Table E1 : Removal of the possible source of infection

	SAT group		P value
	DE	NoDE	
	N=142	N=505	
At least one	45 (31.7)	177 (35)	0.65
Central catheter removal on SAT initiation day	15 (57.7)	23 (28.8)	<.01
Delay*	0 [0 ; 1]	1 [0 ; 3]	0.01
Arterial catheter removal	28 (62.2)	67 (38.3)	<.01
Delay	0 [0 ; 1]	1 [0 ; 3]	0.02
Dialysis catheter removal	11 (24.4)	32 (18.4)	0.36
Delay	1 [0 ; 2]	1 [0 ; 2]	0.95
Immediate removal of intravascular devices [†]	17 (12)	32 (6)	0.03
Foreign equipment removal	4 (2.8)	23 (4.6)	0.36
Delay	1.5 [0 ; 3]	0 [-1 ; 3]	0.47
Additional surgery	11 (7.7)	56 (11.1)	0.25
Delay	0 [0 ; 2]	0.5 [0 ; 3]	0.3
Percutaneous drainage	2 (1.4)	17 (3.4)	0.22
Delay	7 [2 ; 12]	1 [-1 ; 2]	0.14

*Delay: number of days after SAT initiation

[†] Immediate removal of intravascular devices: removal of the central catheter or the arterial catheter or the dialysis catheter on SAT day.

SAT: systemic antifungal therapy; DE: de-escalation group; NoDE: no de-escalation group

Missing values: 143 patients with a proven invasive candidiasis had no immediate removal of intravascular devices or other removal on SAT initiation day.

Table E2: Characteristics of the patients with a documented invasive candidiasis at day 5 (N=276)

	SAT group		P value
	DE N=70	NoDE N=206	
Secondary locations			0.26
0	67 (95.7)	188 (91.3)	
1*	1 (1.4)	9 (4.4)	
Number of positive blood samples after the initiation of SAT (missing=81)			0.36
0	32 (64)	95 (65.5)	
1	7 (14)	11 (7.6)	
≥2	11 (22)	39 (26.9)	
Median delay of positive blood culture (days)**	5 [3 ; 8]	5 [3 ; 15]	0.69
Probable <i>Candida</i> endophthalmitis (***)	2 (12.5)	3 (6.5)	0.45
Trans-esophageal echocardiography	17 (24.3)	52 (25.2)	0.87
Probable endocarditis	1 (5.9)****	6 (11.5)	0.50

(*) details of the secondary locations : DE group: endocarditis (1); NoDE group: ascitis (1); endocarditis (3); genital (1) ; eye (1); pleural (2) ; splenic (1).

(**) 8 patients in the DE group and 33 patients in the NoDE group had a known positive blood culture delay after the SAT.

(***) 16 patients in the DE group and 46 patients in the NoDE group underwent funduscopy.

(****) in this patient, de-escalation from caspofungin to fluconazole occurs two days after SAT initiation, related to the identification of *C. albicans*. Right-sided endocarditis was suspected on the basis of the culture of the pacemaker probe removed which culture yielded *Candida*.

SAT: systemic antifungal therapy; DE: de-escalation group; NoDE: no de-escalation group

Table E3 : Details on the evolution of invasive candidiasis on systemic antifungal therapy end

	Presence of IC day 5 (N=276)			Absence of invasive candidiasis at day 5*		
	DE N=70	NoDE N=206	Total	DE N=72	NoDE N=299	Total (N=371)
Clinical recovery	54 (77)	141 (68)	195 (71)	50 (69)	198 (66)	248 (67)
Deterioration of clinical condition due to IC	5 (7)	23 (11)	28 (10)	3 (4)	9 (3)	12 (3)
Death	1	14		1	4	
IC relapse	4	4		1	1	
Continuation of the fungemia	0	5		1	4	
Deterioration of clinical condition not due to IC	11 (16)	42 (20)	53 (19)	19 (26)	92 (31)	111 (30)
Death not due to the underlying illness	5	23		7	36	
Deterioration of the clinical status due to the underlying illness	5	8		10	43	
Limitation of life sustaining therapy for fatal underlying illness	1	1		1	2	
Discharge with treatment	0	10		1	11	

SAT: systemic antifungal therapy; DE: de-escalation group; NoDE: no de-escalation group; IC: invasive candidiasis

* 36 patients without documented candidiasis at D5 had a secondary documented invasive candidiasis after D5

Table E4 - Results of the weight model for the de-escalation effect (logistic regression model)

Parameter	HR* (95%CI)	P-value
Center variables		
Infectious diseases adviser in hospital	0.38[0.19 ; 0.76]	0.01
Systematic treatment of <i>Candida</i> colonization	0.84[0.54 ; 1.31]	0.44
De-escalation practiced following guideline	2.09[1.03 ; 4.24]	0.04
Microbiology laboratory in the hospital	1.35[0.59 ; 3.06]	0.48
Surgery ICU	0.55[0.3 ; 1.02]	0.06
Local antifungal protocol	0.93[0.55 ; 1.56]	0.78
Variables at ICU admission		
Type of admission (medicine)	0.57[0.35 ; 0.91]	0.02
Chronic disease	0.99[0.6 ; 1.64]	0.98
Age	0.99[0.97 ; 1]	0.15
Body Mass Index	1.01[0.98 ; 1.05]	0.35
Variables at SAT administration		
Echinocandins	10.65[5.64 ; 20.14]	<.01
Immediate removal of intravascular devices [†]	1.89[0.88 ; 4.08]	0.10
Duration of ICU stay before SAT administration (>5 days)	0.84[0.52 ; 1.38]	0.49
SOFA score		
[0 ; 5]	1.10[0.56 ; 2.19]	0.78
[6 ; 9]	0.69[0.40 ; 1.17]	0.17
>9	0[0 ; 0]	.
Septic shock	1.02[0.60 ; 1.75]	0.94
Total parenteral nutrition	0.46[0.29 ; 0.73]	<.01
Antibacterial therapy	0.46[0.24 ; 0.87]	0.02
Red blood cell transfusion in ICU	0.52[0.32 ; 0.84]	0.01
Creatinine (>103 µmol/L)	0.94[0.58 ; 1.50]	0.78
Documented candidemia (at Day 5)	0.77[0.43 ; 1.39]	0.39

*HR: Hazard ratio for SAT de-escalation. HR>1 increases the SAT de-escalation probability.

[†] Immediate removal of intravascular devices: removal of the central catheter or the arterial catheter or the dialysis catheter on SAT day.

SAT: systemic antifungal therapy; DE: de-escalation group; NoDE: no de-escalation group;

ICU: intensive care unit; SOFA: sequential organ failure assessment.

Table E5: Results of the final model for the de-escalation effect on 28-day mortality using a doubly-robust estimator

Parameter	De-escalation		No De-escalation	
	HR* (95%CI)	Pvalue	HR [†] (95%CI)	Pvalue
Center variables				
Microbiology laboratory (24/24)	0.61[0.30 ; 1.21]	0.11	0.26[0.08 ; 0.82]	0.02
Number of hospital bed (>1040)	0.59[0.37 ; 0.94]	0.02	0.57[0.21 ; 1.57]	0.28
Infectious disease adviser in ICU	0.59[0.36 ; 0.99]	0.04	0.35[0.13 ; 0.94]	0.04
Presence of a surgery ICU	0.60[0.34 ; 1.06]	0.07	1.86[0.53 ; 6.56]	0.34
Variables at ICU admission				
Duration of hospital stay before ICU admission (>1 day)	1.50[0.95 ; 2.35]	0.08	0.93[0.40 ; 2.17]	0.86
Surgery just before or during ICU stay	0.62[0.39 ; 0.99]	0.04	0.55[0.21 ; 1.49]	0.24
Presence of chronic diseases	1.75[1.02 ; 2.99]	0.03	3.8[1.32 ; 10.92]	0.01
SAPS II score	1.02[1.00 ; 1.03]	0.02	1.02[0.99 ; 1.05]	0.15
Variables at SAT administration				
Echinocandins	1.78[1.1 ; 2.88]	0.02	0.62[0.14 ; 2.71]	0.52
Immediate removal of intravascular devices [§]	1.85[0.77 ; 4.43]	0.99	1.89[0.43 ; 8.34]	0.40
Body temperature >38 °C	0.49[0.31 ; 0.79]	<.01	0.90[0.36 ; 2.25]	0.82
Septic shock	2.61[1.23 ; 5.50]	0.01	0.53[0.12 ; 2.31]	0.39
Hemodialysis	1.08[0.63 ; 1.84]	0.96	2.30[0.83 ; 6.36]	0.11
Vasoactive drug	0.69[0.32 ; 1.48]	0.39	1.61[0.38 ; 6.86]	0.52
Corticosteroid therapy	0.86[0.51 ; 1.45]	0.59	1.84[0.68 ; 4.98]	0.23
Red blood cell transfusion in ICU	1.13[0.69 ; 1.83]	0.42	0.74[0.29 ; 1.89]	0.53
Creatinine (>103 µmol/L)	1.07[0.66 ; 1.73]	0.68	1.03[0.37 ; 2.88]	0.96
Documented candidaemia at Day 5	1.20[0.65 ; 2.20]	0.21	1.04[0.30 ; 3.57]	0.95

*Hazard ratio in the DE group: risk for 28-day mortality if all patient had a SAT de-escalation before day 5 (a HR>1 increase the 28-day mortality)

† Hazard ratio in the NoDE group: risk for 28-day mortality if all patient had no SAT de-escalation before day 5 (a HR>1 increase the 28-day mortality)

§ Immediate removal of intravascular devices: removal of the central catheter or the arterial catheter or the dialysis catheter on SAT day.

SAT: systemic antifungal therapy; DE: de-escalation group; NoDE: no de-escalation group;

ICU: intensive care unit; SAPS: simplified acute physiology score.

Table E6: Results of the IPTW models for SAT de-escalation effect on 28-day mortality

Selected population	Group	HR* [95 % CI]	P-value
All patients	De-escalation before D5	1.17 [0.72 ; 1.91]	0.52
	De-escalation before D7	1.15 [0.66 ; 1.98]	0.62
	Initial SAT: echinocandins	0.92 [0.57 ; 1.49]	0.73
	Initial SAT: Fluconazole	2.24 [0.68 ; 7.36]	0.18
	Without secondary location	1.17 [0.73 ; 1.89]	0.51
	Hospital centers >1040 beds	1.20 [0.57 ; 2.52]	0.63
	Documented IC	Invasive candidiasis at D5	1.00 [0.48 ; 2.12]
<i>C. albicans</i> IC at Day5		0.74 [0.26 ; 2.06]	0.56
<i>C. non albicans</i> IC at D5		1.10 [0.19 ; 6.43]	0.92
Non documented IC	Absence of IC at D5	1.14 [0.62 ; 2.09]	0.67
	SAT stop at D5	0.65 [0.22 ; 1.93]	0.44

DE: De-escalation; ICU: intensive care unit; D5: day 5; D7: Day 7; SAT: Systemic

Antifungal Treatment; IC: invasive *Candida* infection

*HR: Hazard ratio. If HR>1: SAT de-escalation increase the risk of 28-day mortality. If

HR<1: SAT de-escalation decrease the risk of 28-day mortality.

Table E7 : Summary of post-hoc power analysis

Selected population	Group	N	DE	NoDE	Post-hoc power ARD [†]						
					5 %	6 %	7 %	8 %	9 %	10 %	11 %
All patients	De-escalation before D5	647	143 (22)	504 (78)	0.48	0.57	0.65	0.72	0.80	0.84	0.89
	De-escalation before D7	573	128 (22)	445 (78)	0.31	0.39	0.47	0.55	0.63	0.70	0.77
	Initial SAT: echinocandins	373	127 (34)	246 (66)	0.52	0.60	0.67	0.73	0.79	0.83	0.87
	Initial SAT: Fluconazole	261	16 (6)	245 (94)	0.15	0.18	0.20	0.23	0.26	0.30	0.33
	Without secondary locations	637	141 (22)	496 (78)	0.48	0.56	0.64	0.72	0.78	0.84	0.88
	Centers > 1040 beds	504	109 (22)	395 (78)	0.29	0.36	0.44	0.52	0.59	0.67	0.73
	Invasive candidiasis at D5	276	70 (25)	206 (75)	0.21	0.25	0.30	0.36	0.41	0.47	0.52
Documented IC	<i>C. albicans</i> IC at Day5	193	62 (32)	131 (68)	0.19	0.23	0.28	0.32	0.37	0.42	0.48
	<i>C. non albicans</i> IC at D5	83	8 (10)	75 (90)	0.10	0.11	0.12	0.13	0.15	0.16	0.18
	Absence of IC at D5	371	73 (20)	298 (80)	0.22	0.27	0.33	0.39	0.45	0.51	0.57
Non documented IC	SAT stop at D5	371	48 (13)	322 (87)	0.28	0.33	0.38	0.43	0.49	0.54	0.59

DE: De-escalation; NoDE: no de-escalation; ICU: intensive care unit; D5: day 5; D7: Day 7; SAT: Systemic Antifungal Treatment; IC: invasive

Candida infection

[†]ARD: Absolute Risk Difference

III. Analyse causale sur données longitudinales

Dans le cas où le traitement évolue au cours du temps et que le pronostic est impacté à la fois par l'histoire du traitement et par des facteurs de confusions dépendants du temps, l'approche IPTW utilisée précédemment ne suffit pas, car elle peut conduire à une estimation biaisée de l'estimateur final.[51, 59] Dans ces cas, il est nécessaire d'utiliser une approche plus adaptée, les modèles structurels marginaux, développés par Robins. [60] Si leur mise en œuvre est simple et peut se faire sur tous les logiciels statistiques avancés, ils reposent sur des hypothèses fortes telles que la positivité (ou l'identifiabilité), l'absence de mauvaise spécification des variables dans les modèles et l'absence de facteurs de confusion non mesurés. Une mauvaise prise en compte de ces hypothèses peut entraîner un biais de l'estimation finale ou un manque de précision important.[61]

Ces modèles sont de plus en plus utilisés dans la recherche médicale et se prêtent particulièrement aux problématiques des USI où la mise en place d'essais cliniques n'est pas toujours possible ou est limitée à un nombre restreint de patients. Afin de permettre une meilleure compréhension de ces modèles auprès des cliniciens, nous avons choisi de présenter un article court qui a été publié dans la revue Intensive Care Medicine. Cet article introduit également la méthode employée dans la partie suivante pour évaluer l'impact des traitements antifongiques sur le pronostic des patients.

Publication N 5:What's new to quantify causal effects from longitudinal cohort studies. A
brief introduction to marginal structural models for intensivists

Bailly S, Pirracchio R, Timsit JF.

Intensive Care Medicine : accepté

Juin 2015



S. Bailly
R. Pirracchio
J. F. Timsit

What's new in the quantification of causal effects from longitudinal cohort studies: a brief introduction to marginal structural models for intensivists

Received: 7 May 2015
Accepted: 9 June 2015

© Springer-Verlag Berlin Heidelberg and ESICM 2015

Electronic supplementary material The online version of this article (doi:10.1007/s00134-015-3919-6) contains supplementary material, which is available to authorized users.

S. Bailly
U823, Grenoble Alpes University, Rond-point de la Chantoume,
38700 La Tronche, France

S. Bailly (✉) · J. F. Timsit
UMR 1137, IAME Team 5, DeSCID: Decision Sciences in
Infectious Diseases, Control and Care Inserm/Paris Diderot,
Sorbonne Paris Cité University, 16 rue Henri Huchard,
75018 Paris, France
e-mail: sbailly@chu-grenoble.fr
Tel.: +33 140 25 77 02

R. Pirracchio
Department of Anesthesia and Perioperative Care, San Francisco
General Hospital and Trauma Center, University of California San
Francisco, San Francisco, CA, USA

R. Pirracchio
Division of Biostatistics, School of Public Health, University
of California at Berkeley, Berkeley, CA, USA

J. F. Timsit
Medical and Infectious Diseases ICU-Paris Diderot University/
Bichat Hospital, 46 rue Henri Huchard, 75018 Paris, France

When randomized controlled trials are not possible, observational longitudinal data may be the only option to quantify the impact of a treatment on an outcome [1]. As an illustration, we assessed the impact of empirical systemic antifungal therapy (SAT) on mortality in critically ill patients [2]. A regression may be used to model the

relationship between SAT and mortality, with adjustment on potential confounders. In many situations, the regression coefficient cannot be interpreted causally, particularly when SAT administration is a time-dependent variable [3–5]. Indeed, besides a direct causal effect, there may be several paths linking the treatment to the outcome through various confounders, i.e., variables associated with treatment allocation and with the outcome which may confound the association of interest. In this situation, the association measure provided by standard regression may differ from what clinicians often seek, which is a quantification of the direct causal effect between an exposure and an outcome. This situation may be illustrated by considering severe sepsis as a single confounder. Indeed, severe sepsis may trigger SAT while it also impacts mortality. Hence, SAT and mortality share a common cause, i.e., an indirect path linking SAT to mortality (Fig. E1 in the Electronic Supplementary Material). The standard approach based on logistic regression, for instance, may lead to a biased estimation of the causal effect of SAT on mortality because some time-dependent variables (i.e., septic shock) which may be affected by previous treatment history can in turn affect both further treatments and the outcome [3]. To overcome the limitation of standard regression approaches, new specific statistical methods have been developed to handle this type of bias and are often referred to as causal inference methods. They were first introduced in intensive care unit (ICU) literature by Bekaert et al. [6].

Let us consider ten ICU patients, three with and seven without severe sepsis (SS) at baseline, and suppose that SAT is administered to two patients with SS (67 %) and two patients without SS (29 %). To conclude about a causal relationship between treatment and mortality, the distribution of the confounders between the groups should be balanced. The propensity score (PS) may be used for this balance. In other words, with the use of the PS, a

Published online: 24 June 2015

difference in outcome between the treatment groups may be considered as causally related to the exposure [7]. PS matching estimators are usually used to estimate the average treatment effect in the treated (ATT) and answers to the question: “How would the outcomes of the treated individuals have differed had they received the control?” Nonetheless, this may not be the question of interest. When estimating the impact of SAT, the research question is rather: “What would be the outcome if all patients at risk were treated or if all remained untreated?” [8]. This is usually referred to as the average treatment effect (ATE). The PS may be also used to estimate the ATE through the inverse probability of treatment weight (IPTW) estimators [8]. The IPTW general concept is to weight each individual contribution by the inverse of his/her probability of receiving his/her treatment. The weights are calculated as $\frac{1}{PS}$ in treated individuals and $\frac{1}{1-PS}$ in the untreated individuals and are used to create a pseudo-population in which the exposure is independent of the measured confounders as illustrated in Fig. 1 [9, 10].

In the simple situation of a binary point treatment with non-time-varying confounders, and under a certain set of assumptions, one just has to compare the weighted outcome in the treated and the untreated to get an estimation of the causal effect of the exposure on the outcome in this pseudo-population. Hence, the first benefit of these new statistical approaches is that, under a set of assumptions, they may offer the possibility to estimate such causal quantities. However, the experimental situation is often more complex and may involve multiple time-point treatments and time-varying confounders. Marginal structural models (MSM) are a new class of statistical models developed by Robins [3] to handle this particular situation. Practically, MSMs refer to the regression of the outcome on the exposure in the pseudo-population [9]. In MSMs, IPTW estimators are used to estimate the parameter of interest (e.g., the causal risk difference, relative risk, or odds ratio). Specifically, the causal risk difference (i.e., the ATE) equals the slope of a weighted linear regression of the outcome on the exposure, using the weights as defined earlier. The added value of MSMs,

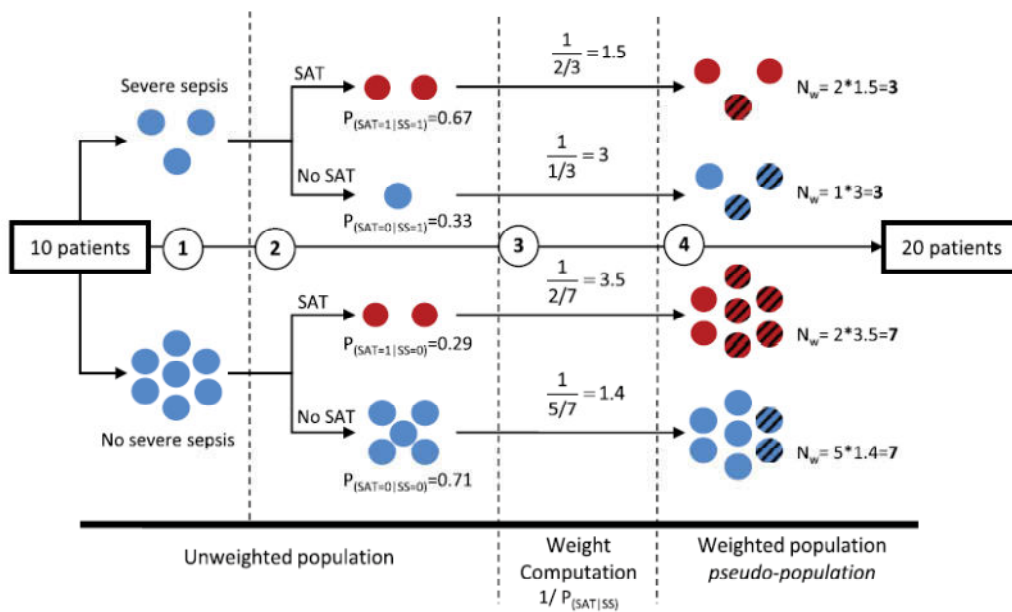

Fig. 1 Example of estimating the inverse probability of treatment weight. This example uses a virtual sample of ten patients. (1) The population may be divided into two groups according to the presence/absence of a severe sepsis (three versus seven). (2) In each subgroup, some patients are receiving SAT. For each individual in each subgroup, the probability of receiving his/her actual treatment ($P_{SAT|SS}$; i.e., probability of treatment given the presence/absence of SS) may be estimated from empirical proportions. (3) The inverse probability of treatment weight (IPTW) is computed from this probability and is equal to $1/P_{SAT|SS}$. The weight equals $1/PS$ when $SAT = 1$ and $1/(1 - PS)$ when $SAT = 0$. (4) These weights are used to build the pseudo-

population, where an individual with a low probability of SAT will be up-weighted and, conversely, an individual with a high probability of SAT will be down-weighted. The pseudo-population encompasses both factual and counterfactual observations. In this pseudo-population, the treated and untreated individuals are exchangeable and it is possible to compute directly the difference in mortality. If one death is observed in the treated group (one with severe sepsis and one without severe sepsis), the estimated number of death in the pseudo-population is 3.5 in the treated group and 4.4 in the untreated group ($3 + 1.4$). The relative risk for mortality is $(3.5/10)/(4.4/10) = 0.795$

as compared to the previously described PS-based methods, is that they can handle time-dependent confounders when classical PS methods account only for baseline confounders bias.

In case of longitudinal data, the treatment probability has to be updated at each time point [11, 12]. This means that the treatment probability at time t is estimated from the variables measured up to time t , including the exposure history. The probability of being treated at time t is in turn defined as the product of all the treatment probabilities up to time t . Thus, the weights derived at each time point are combined into single weights to estimate the impact of the entire treatment regimen.

Causal interpretation of the MSM parameters relies on some assumptions [3, 13]. First, for each combination of covariates, there must be treated and untreated individuals. When, for certain characteristics, there are only treated or untreated, the so-called positivity assumption is violated [3, 9]. This means that, in this stratum, the causal effect is not identifiable. In the present issue, Muriel et al. used an MSM with IPTW to estimate the causal effect of analgesic and/or sedative drugs on the failure of non-invasive positive-pressure ventilation [14]. Although this approach seems well suited for the topic, the results should be interpreted with particular caution because of the positivity assumption. The relatively small number of individuals in each treatment group defies the positivity assumption. This may explain the great variability in the final estimates (the wide confidence intervals). A second

causal assumption is known as the ignorability assumption. It refers to the absence of significant unmeasured confounder. Specifically, in the context of longitudinal studies, at each measurement time one must have available the history of all risk factors of the exposure that are also associated with the outcome (time-dependent confounding factors). While the first assumption is verifiable from the data, the second is often non-testable. Some basic SAS codes adapted to our example as well as details about the positivity assumption are provided in the Electronic Supplementary Material. Finally, to obtain unbiased causal estimates, the model for the conditional probability of exposure has to be correctly specified. Although MSMs are increasingly used in the medical literature and offer a new appealing alternative to standard regression methods, they need a very complex analytic strategy, especially because IPTW estimators can be very unstable and need strong assumptions to be adequately interpreted. Thus, the use of MSM for observational and longitudinal ICU data analysis often requires extensive statistical background. To overcome the risk of PS model misspecification, recent advances have been proposed. Double-robust estimators (e.g., augmented IPTW or targeted maximum likelihood estimators) [15] may represent the future of causal inference.

Compliance with ethical standards

Conflicts of interest Authors have no conflict of interest to declare.

References

1. Benson K, Hartz AJ (2000) A comparison of observational studies and randomized, controlled trials. *N Engl J Med* 342:1878–1886
2. Bailly S, Bouadma L, Azoulay E, Orgeas MG, Adrie C, Souweine B, Schwebel C, Maubon D, Hamidfar-Roy R, Darmon M, Wolff M, Comet M, Timsit JF (2015) Failure of empirical systemic antifungal therapy in mechanically ventilated critically ill patients. *Am J Respir Crit Care Med* 191:1139–1146
3. Robins JM, Hernan MA, Brumback B (2000) Marginal structural models and causal inference in epidemiology. *Epidemiology* 11:550–560
4. Resche-Rigon M, Pirracchio R, Robin M, De Latour RP, Sibon D, Ades L, Ribaud P, Ferman JP, Thieblemont C, Socie G, Chevret S (2012) Estimating the treatment effect from non-randomized studies: the example of reduced intensity conditioning allogeneic stem cell transplantation in hematological diseases. *BMC Blood Disord* 12:10
5. Gerhard T, Delaney JA, Cooper-Dehoff RM, Shuster J, Brumback BA, Johnson JA, Pepine CJ, Winterstein AG (2012) Comparing marginal structural models to standard methods for estimating treatment effects of antihypertensive combination therapy. *BMC Med Res Methodol* 12:119
6. Bekaert M, Timsit JF, Vansteelandt S, Depuydt P, Vesin A, Garrouste-Orgeas M, Decruyenaere J, Clec'h C, Azoulay E, Benoit D (2011) Attributable mortality of ventilator-associated pneumonia: a reappraisal using causal analysis. *Am J Respir Crit Care Med* 184:1133–1139
7. Rosenbaum PR, Rubin DB (1983) The central role of the propensity score in observational studies for causal effects. *Biometrika* 70:41–55
8. Pirracchio R, Carone M, Rigon MR, Caruana E, Mebazaa A, Chevret S (2013) Propensity score estimators for the average treatment effect and the average treatment effect on the treated may yield very different estimates. *Stat Methods Med Res*. doi: 10.1177/0962280213507034
9. Cole SR, Hernan MA (2008) Constructing inverse probability weights for marginal structural models. *Am J Epidemiol* 168:656–664
10. Hernan MA, Robins JM (2006) Estimating causal effects from epidemiological data. *J Epidemiol Community Health* 60:578–586
11. Hernan MA, Brumback B, Robins JM (2000) Marginal structural models to estimate the causal effect of zidovudine on the survival of HIV-positive men. *Epidemiology* 11:561–570

-
12. Do DP, Wang L, Elliott MR (2013) Investigating the relationship between neighborhood poverty and mortality risk: a marginal structural modeling approach. *Soc Sci Med* 91:58–66
 13. Yang S, Eaton CB, Lu J, Lapane KL (2014) Application of marginal structural models in pharmacoepidemiologic studies: a systematic review. *Pharmacoepidemiol Drug Saf* 23:560–571
 14. Muriel A, Penuelas O, Frutos-Vivar F, Arroliga A, Abreira V, Thille A, Brochard L, Nin N, Davies A, Amin P, Du B, Raymondos K, Rios F, Violi D, Maggiore S, Soares MA, Gonzalez M, Abroug F, Bulow H, Hurtado J, Kuiper M, Moreno R, Zeggwagh AA, Villagomez A, Jibaja M, Soto L, D'Empaire G, Matamis D, Koh Y, Anzueto A, Ferguson N, Esteban A (2015) Impact of sedation and analgesia during non-invasive positive pressure ventilation on outcome. A marginal structural model causal analysis. *Intensive Care Med*. doi: [10.1007/s00134-015-3854-6](https://doi.org/10.1007/s00134-015-3854-6)
 15. Munoz ID, van der Laan M (2012) Population intervention causal effects based on stochastic interventions. *Biometrics* 68:541–549

Supplément électronique de la publication 5

Electronic supplementary material

What's new to quantify causal effects from longitudinal cohort studies.

A gentle introduction to marginal structural models for intensivists

Bailly S., Pirracchio R., Timsit JF

Figure E1:

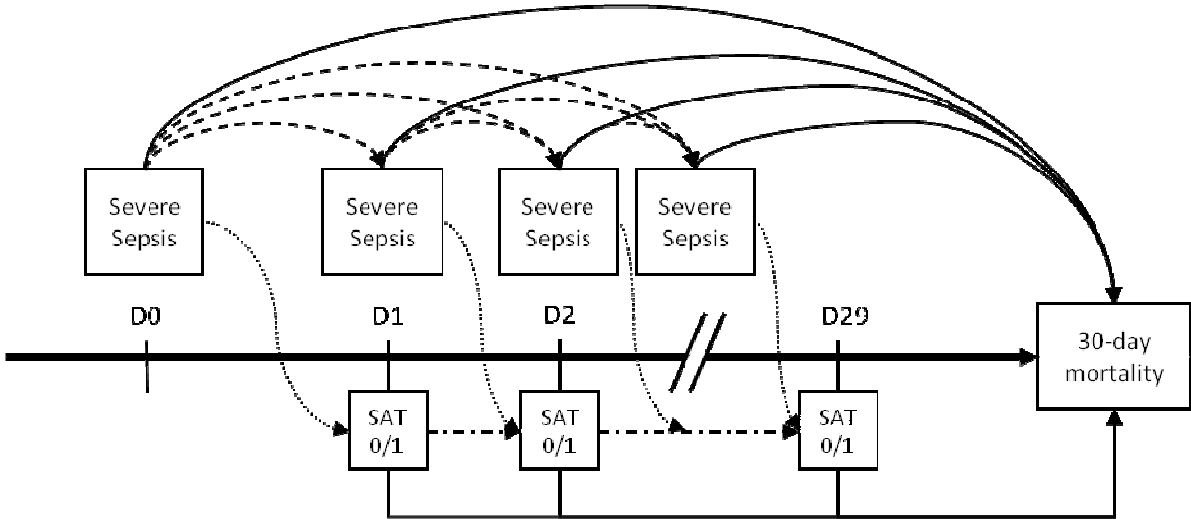

At inclusion (D0), the groups are unbalanced regarding severe sepsis (SS). The 30-day mortality is a function of SS at D0, but also of any SS occurring thereafter (time-dependent confounder) and of exposure to systemic antifungal therapy (SAT), which may change over time. The probability of receiving SAT is also a time-dependent covariate and may be a function of SS and of previous SAT exposure.

ESM SAS programming code for Figure 1

Example 1: SAS code to compute the odds ratio with one confounder in the case of a one-point treatment study (Figure 1).

1. Creation of the dataset

```
Data EXAMPLE;  
  input SS SAT DEATH;  
  datalines;  
0 1 1  
0 1 0  
0 0 1  
0 0 0  
0 0 0  
0 0 0  
0 0 0  
0 0 0  
1 1 0  
1 1 0  
1 0 1  
;
```

Variable description:

SS: severe sepsis (0 for not exposed and 1 for exposed)

SAT: systemic antifungal therapy (0 for not exposed and 1: exposed)

DEATH: 30-day mortality (0 for alive and 1 for dead)

2. Weight computation:

The weights are estimated in two steps.

First, the probability of receiving SAT is computed using a logistic regression (**PROC LOGISTIC**) where SAT is the response and SS the explanatory variable.

```
PROC LOGISTIC DATA= EXAMPLE descending noprint;  
model SAT=SS/link=logit;  
output out= WEIGHTS pred= PSAT;  
run;
```

The `descending` option is needed to model the probability that SAT = 1.

In the code, `link=logit` refers to a logit link between the response and the explanatory variables.

The output is a table called "Weights" that includes the probability of receiving SAT given SS ($P_{SAT=1|SS}$) for each patient. This probability is stored as a variable called "PSAT".

Second, weights are computed as follows: $1/P_{SAT=1|SS}$ in patients receiving SAT or $1/(1-P_{SAT=1|SS})$ in the others:

```
data WEIGHTS; set WEIGHTS;
if SAT=1 then IPTW=1/ PSAT;
if SAT=0 then IPTW=1/(1- PSAT);
run;
```

3. Odds ratio estimation

The **PROC GENMOD** uses a general estimating equation. It may be used to compute the odds ratios from a weighted dataset. Code `estimate` is used to choose the association measure, here, it is OR (to estimate a relative risk, the code option `link` must be changed from `logit` to `log`).

```
PROC GENMOD data = WEIGHTS descending;
model DEATH = SAT SS/ dist = binomial link = logit;
weight IPTW;
estimate 'Beta' SAT 1 -1/ exp;
run;
```

4. Multivariate analysis

As illustrated below in the extension for longitudinal data, the weighted regression may be adjusted for additional confounders.

ESM2 Extension to longitudinal data and the positivity assumption

Some changes are necessary to take into account multiple time-points:

1. Multiplication of the weights

To take into account the history of SAT up to time t , the weights up to time t are obtained by multiplying the weights derived from the PSs at time t by the weights obtained at each time point up to time $t-1$. As presented by Hernan et al in the SAS programming code for MSM Cox model [1], the steps for a longitudinal model are as follow:

Let us consider, besides SS_TD, three additional confounders: parenteral nutrition (PN_TD), multifocal *Candida* colonization (MCC_TD) and broad spectrum antibacterial therapy (BSAT_TD). We use suffix _TD to specify that these confounders are time-dependent. We use an additional variable to allow for time (TIME).

The probability of receiving SAT is estimated in the same way, by simply adding the additional confounders:

```
PROC LOGISTIC DATA= example descending noprint;
model SAT=SS_TD PN_TD MCC_TD BSAT_TD TIME/link=logit;
output out=WEIGHTS pred= PSAT;
run;
```

The weights are computed using a `retain` statement in a `DATA` step as follows:

```
DATA WEIGHTS ; set WEIGHTS ;

if first PATIENT then MULT=1;

retain MULT ;

If SAT=1 then MULT = MULT*PSAT;
If SAT=0 then MULT = MULT*(1-PSAT) ;

IPTW=1/MULT;

run;
```

Variable MULT is used to store the previous weight at each time for a given patient. The first day, for a new patient, MULT is initialized to 1 and takes the value of PSAT.

The second day, MULT multiplies PSAT at day 2 by PSAT at day 1 and so forth over the following days.

Finally, the weights are computed using MULT instead of PSAT as shown above.

2. Stabilization of the weights

To avoid an exponential growth of the initial population, the weight may be stabilized by replacing 1, at the numerator, by the probability of receiving SAT given the baseline covariates. Stabilization narrows the confidence intervals and therefore improves their coverage [2]. Further details on the SAS programming code are given by Hernan et al. [1] or Do et al. [3].

To implement MSMs in STATA, a detailed programming code may be found in a publication by Fewell et al. [4] or in an Electronic Supplement by Nandi et al. [5].

Finally for R application, two packages are available: *ipw* [6] and *ltmle* [7].

3. Positivity assumption

As previously stated, positivity is a key assumption in causal inference. A small sample size and a low or high treatment prevalence may violate the positivity assumption. When positivity is strongly violated, the causal parameter may not be identifiable from the data. When positivity is slightly violated, IPTW estimators may be biased and highly unstable [8, 9]. Positivity may be checked by looking at the distribution of the weights. The mean should be close to one and the range should be limited and have no outliers. [2]

ESM references

1. Hernan MA, Brumback B, Robins JM, (2000) Marginal structural models to estimate the causal effect of zidovudine on the survival of HIV-positive men. *Epidemiology* 11: 561-570
2. Cole SR, Hernan MA, (2008) Constructing inverse probability weights for marginal structural models. *Am J Epidemiol* 168: 656-664
3. Do DP, Wang L, Elliott MR, (2013) Investigating the relationship between neighborhood poverty and mortality risk: a marginal structural modeling approach. *Soc Sci Med* 91: 58-66
4. Fewell Z, Hernan MA, Wolfe F, Tilling K, Choi H, Sterne JAC, (2004) Controlling for time-dependent confounding using marginal structural models. *Stata Journal* 4: 402-420
5. Nandi A, Glymour MM, Kawachi I, VanderWeele TJ, (2012) Using marginal structural models to estimate the direct effect of adverse childhood social conditions on onset of heart disease, diabetes, and stroke. *Epidemiology* 23: 223-232
6. van der Wal WM, Geskus RB, (2011) IPW: An R package for inverse probability weighting. *Journal of Statistical Software* 43
7. Petersen M, Schwab J, Gruber S, Blaser N, Schomaker M, van der Laan M, (2014) Targeted Maximum Likelihood Estimation for Dynamic and Static Longitudinal Marginal Structural Working Models. *J Causal Inference* 2: 147-185
8. Platt RW, Delaney JA, Suissa S, (2012) The positivity assumption and marginal structural models: the example of warfarin use and risk of bleeding. *Eur J Epidemiol* 27: 77-83
9. Petersen ML, Porter KE, Gruber S, Wang Y, van der Laan MJ, (2012) Diagnosing and responding to violations in the positivity assumption. *Stat Methods Med Res* 21: 31-54

IV. Impact du traitement précoce sur le pronostic des patients

L'exploitation de la base de données longitudinales de haute qualité OutcomeRea® a permis d'étudier l'impact du traitement antifongique empirique sur le pronostic à 30 jours des patients sévères, non neutropéniques en USI à l'aide d'un modèle structurel marginal. Cette base de données présente l'avantage d'être multicentrique, prospective et longitudinale par un recueil journalier des données qui reflète l'évolution de l'état de santé et des soins effectués aux patients admis en USI durant leur séjour.

Dans le cas de l'administration d'un traitement antifongique, le fait de recevoir un traitement, un jour donné, dépend autant de l'état du patient à son entrée dans le service de réanimation (sévérité initiale, âge, sexe, traitement prophylactique préalable, etc.) que de l'évolution de son état ou des soins administrés au cours du temps (sévérité, nutrition parentérale, sepsis, présence de cathéter, etc.) comme nous l'avons vu dans l'article précédent. Les principaux facteurs de risques associés à une candidose invasive et à la mortalité précoce sont mesurés quotidiennement dans la base, ce qui permet de réduire le risque d'absence de facteurs de confusions importants pour utiliser un MSM. De plus, cette base est représentative de la population des patients en réanimation, et, à la différence d'un essai clinique, il sera possible d'extrapoler les résultats à l'ensemble des patients sévères non neutropéniques en réanimation.[62]

Les résultats de cette étude ont été publiés sous forme d'article dans *American Journal of Respiratory and Critical Care Medicine* (AJRCCM).

Publication N°6 : Failure of Empirical Systemic Antifungal Therapy in Mechanically-ventilated Critically Ill Patients

Bailly S, Bouadma L, Azoulay E, Garrouste-Orgeas M, Souweine B, Schwebel C, Maubon D, Hamidfar-Roy R, Darmon M, Wolff M, Cornet M, Timsit JF

American Journal of Respiratory and Critical Care Medicine : Publié le 15 mai 2015

Vol 191, Iss 10, pp 1139-1146

Présentations orales :

- 24th European Congress of Clinical Microbiology and Infectious Diseases 2014, Berlin
- Journées 2014 du Groupe De Recherche Statistique et Santé, Toulouse
- 42^{ème} congrès de la Société de Réanimation en Langue Française 2014, Paris

Poster :

- Journées de la recherche médicale 2014, Université Joseph Fourier, Grenoble

Résumé de l'article

Si les traitements antifongiques sont administrés majoritairement en absence de toute documentation d'infection fongique, il n'a pas été démontré d'effet bénéfique clair d'un traitement probabiliste. L'objectif de l'étude est d'estimer l'impact de l'administration d'un traitement antifongique empirique sur la mortalité à 30 jours ou sur la survenue d'une candidose invasive chez les patients à haut risque.

Pour cela les patients non-neutropéniques, n'ayant pas eu de transplantation d'organe, sans candidose invasive documentée les plus sévères, ont été inclus à partir de la base de données prospective OutcomeRea®.

Un modèle structurel marginal de Cox a été utilisé pour estimer l'effet causal moyen du traitement sur le pronostic en prenant en compte les facteurs de confusion dépendants du temps. Trois autres modèles ont été testés pour s'assurer de la fiabilité des résultats. Pour cela nous avons réalisé une étude cas-témoin appariée, un modèle cause-spécifique et un modèle utilisant un estimateur IPTW double robuste basé uniquement sur les variables initiales. Le choix de ces modèles ainsi que leurs résultats sont développés dans le supplément électronique de l'article.

Six analyses en sous-groupes ont été effectuées afin d'étudier l'effet d'un traitement antifongique précoce sur des populations présentant des risques plus importants :

- patients avec un *Candida* score supérieur à 2
- patients avec une colonisation multiple à *Candida* à l'inclusion
- type d'admission chirurgicale ou médicale
- chirurgie abdominale
- immunosuppression
- différents scores de gravité (SOFA)

Parmi 1491 patients inclus, 100 ont reçu un traitement antifongique empirique (6.7 %). Ces patients étaient plus sévères que les patients non traités, avec notamment un score SOFA et un

Candida score plus élevés et une proportion plus élevée de choc septique et de défaillances d'organes. Après ajustement sur les facteurs de confusions dépendants du temps, l'administration d'un traitement empirique ne montre pas d'effet positif sur le pronostic des patients (hazard ratio HR: 1.05 [0.56 ; 1.96]). Ce résultat a été confirmé par trois autres modèles. Les analyses de sous groupes n'ont pas mis en évidence d'impact significatif du traitement sur le pronostic. Il a seulement été observé une tendance non significative à l'amélioration du pronostic pour le sous-groupe de patient avec un score SOFA inférieur à 7.

Il s'agissait de la première étude multicentrique sur données observationnelles longitudinales basée sur une population importante de patients sévères en ICU. Après ajustement sur l'ensemble des facteurs de confusions initiaux et dépendants du temps, l'administration d'un traitement antifongique sans preuve de candidose invasive n'a pas d'incidence sur le pronostic à court terme des patients sévères en réanimation, non neutropéniques et non transplantés. Les études de puissances a posteriori ne permettent pas de conclure formellement à une absence d'effet du traitement, notamment dans les analyses en sous-groupes.

Toutefois, ce résultat renforce les doutes sur l'intérêt des traitements empiriques en absence de documentation de l'infection et confirme la nécessité d'affiner les règles de mise en place d'un traitement empirique.

Failure of Empirical Systemic Antifungal Therapy in Mechanically Ventilated Critically Ill Patients

Sébastien Bailly^{1,2}, Lila Bouadma³, Elie Azoulay⁴, Maité Garrouste Orgeas⁵, Christophe Adrie^{6,7}, Bertrand Souweine⁸, Carole Schwebel⁹, Danièle Maubon^{10,11}, Rebecca Hamidfar-Roy⁹, Michael Darmon¹², Michel Wolff⁹, Muriel Cornet^{10,11}, and Jean-François Timsit^{2,3}

¹Grenoble 1 University, U823, La Tronche, France; ²UMR 1137, IAME Team 5, DeSCID Inserm/Paris Diderot, Sorbonne Paris Cité University, Paris, France; ³Medical and Infectious Diseases ICU, Paris Diderot University/Bichat Hospital, Paris, France; ⁴Medical ICU, Saint-Louis University Hospital, Paris, France; ⁵Medical Surgical ICU, Saint-Joseph Hospital, Paris, France; ⁶Department of Physiology, Cochin University Hospital, APHP, Paris, France; ⁷Medical-Surgical ICU, Delafontaine Hospital, Saint-Denis, France; ⁸Medical ICU, Gabriel-Montpied University Hospital, Clermont-Ferrand, France; ⁹Medical ICU and ¹⁰Parasitology-Myology, Grenoble University Hospital, La Tronche, France; ¹¹TIMC-IMAG UMR 5525 Joseph Fourier University, La Tronche, France; and ¹²Medical ICU, Saint-Etienne University Hospital, Saint-Etienne, France

Abstract

Rationale: Systemic antifungal treatments are empirically administered to the sickest critically ill patients, often without documented invasive fungal infection.

Objectives: To estimate the impact of systemic antifungal treatment on 30-day survival of patients suspected to have invasive candidiasis.

Methods: All nonneutropenic, nontransplant recipients managed in five intensive care units intubated for at least 5 days, and free of invasive candidiasis, were included. To account for differences in patients' characteristics recorded daily before study end point, a causal model for longitudinal data was used to assess benefits from antifungal treatment. The composite primary end point was hospital mortality or occurrence of invasive candidiasis.

Measurements and Main Results: Among 1,491 patients, 100 (6.7%) received antifungal treatment for a suspected infection. Patients treated with antifungals were more severely ill than

untreated patients. Within the 30-day follow-up period, 363 (24.3%) patients died, and 22 (1.5%) exhibited documented invasive candidiasis. After adjustment on baseline and time-dependent confounders (underlying illness, severity, invasive procedures, *Candida* colonization), and using a marginal structural model for longitudinal data, treatment was not associated with a decreased risk of mortality or of occurrence of invasive candidiasis (hazard ratio, 1.05; 95% confidence interval, 0.56–1.96; $P = 0.91$).

Conclusions: This study failed to show outcome benefits for empirical systemic antifungal therapy in the sickest critically ill, nonneutropenic, nontransplanted patients. The *post hoc* power did not allow us to conclude to an absence of treatment effect especially for specific subgroups. Studies to refine indications for empirical treatment based on surrogate markers of invasive candidiasis are warranted.

Keywords: empirical treatment; antifungal; invasive candidiasis; intensive care unit; marginal structural model

Among the pathogens that are most frequently recovered from intensive care unit (ICU) patients with hospital-acquired bloodstream infections, the prevalence of

Candida spp. infections is ranked between 5.6 and 10% (1–5). Factors associated with invasive candidiasis (IC) are surgery, multiple-site *Candida* spp. colonization,

severe sepsis, and parenteral nutrition (6, 7). IC leads to increased mortality (8), and early initiation of antifungal therapy in ICU patients has been shown to be crucial

(Received in original form September 22, 2014; accepted in final form March 12, 2015)

Supported by Outcomera, a nonprofit organization. Unrestricted research and educational grants were received from academic organizations (Inserm and Ministry of Health) and private companies (Merck, 3M, Astellas, and Gilead).

Author Contributions: Literature search, S.B., J.-F.T., and E.A. Data analysis and interpretation, S.B., J.-F.T., E.A., D.M., and M.C. Writing, S.B., L.B., M.D., and J.-F.T. Critical review, L.B., E.A., M.G.O., C.A., B.S., C.S., D.M., R.H.-R., M.D., M.W., and M.C. Acquisition of the data, L.B., M.G.O., B.S., C.S., D.M., R.H.-R., M.C., and J.-F.T. Conception, hypothesis delineation, and design of the study, E.A., C.A., M.W., and J.-F.T.

Correspondence and requests for reprints should be addressed to Jean-François Timsit, M.D., Ph.D., Université Paris Diderot/Hôpital Bichat, Réanimation Médicale et des Maladies Infectieuses, UMR 1137, 46 rue Henri Huchard, Paris 75018, France. E-mail: jean-francois.timsit@bch.aphp.fr

This article has an online supplement, which is accessible from this issue's table of contents at www.atsjournals.org

Am J Respir Crit Care Med Vol 191, Iss 10, pp 1139–1146, May 15, 2015

Copyright © 2015 by the American Thoracic Society

Originally Published In Press as DOI: 10.1164/rccm.201409-1701OC on March 17, 2015

Internet address: www.atsjournals.org

At a Glance Commentary

Scientific Knowledge on the

Subject: There is no consensus about the effectiveness of empirical systemic antifungal treatment in the sickest critically ill, nonneutropenic, nontransplanted patients in intensive care units.

What This Study Adds to the

Field: Using a nonbiased method for longitudinal data analysis, this study shows that empirical systemic antifungal therapy failed to reduce mortality or invasive candidiasis in critically ill and mechanically ventilated patients.

to improve the prognosis of candidemia (9–11). Thus, the assessment of clinical risk predictive rules for IC is becoming critical (12). Although a continuum exists between *Candida* spp. colonization and IC (13), accurate biologic diagnostic tools are still lacking (7, 14–16).

To limit *Candida*-related mortality, empirical systemic antifungal treatment (SAT) has been proposed for ICU patients with risk factors for IC, particularly those with peritonitis (17–20). This strategy leads to an increase in the number of ICU patients who receive SAT (3). Indeed, Azoulay and coworkers (21, 22) showed that 7.5% of ICU patients receive SAT, among whom only one-third of treated patients presented a proved fungal infection and may expose to antifungal overuse. Results from a previously published trial do not support routine SAT in medical-surgical ICU patients with persistent sepsis (23). Thus, the actual benefit of SAT in ICU patients is not established (24). Because randomized clinical trials to assess the causal effect of SAT on death or IC are lacking, analysis of observational longitudinal studies may represent a suitable alternative.

Standard statistical methods are not appropriate in the case where time-dependant confounders have an impact on the exposure and the outcome (25). Time-dependent confounders can be observed for SAT administration and must be taken into account for the estimate of the treatment effect. A new class of statistical models, called marginal structural models

(MSM), was developed for causal inference on observational longitudinal data. In brief, these models allow one to estimate the causal treatment effect by the creation of a "pseudopopulation" where each patient is reweighted to balance on potential confounders and simulate randomization. By the mean of the "pseudopopulation," MSM can remove the bias because of time-dependant covariates that act as both confounders and mediators of the causal treatment effect and therefore manage selection bias (26).

The objective of this study was to assess a nonbiased effect of SAT on a composite primary end point constituted by 30-day death or IC in severely ill patients in ICU, using a large high-quality database and a new method based on Cox MSM with the inverse probability of treatment weight (IPTW) estimator.

Methods

Study Design and Data Source

We selected patients from five ICUs included in the French OutcomeRea group with prospectively recorded data regarding 30-day mortality, *Candida* spp. colonization, IC, and SAT administration. Methods for data collection and quality of the database have been described in detail elsewhere (27). In accordance with French law, the OutcomeRea database was declared to the Commission Nationale de l'Informatique et des Libertés (#999262). The objectives of this data collection were approved by the institutional review board (#5891) of the Clermont-Ferrand University Hospital (Clermont-Ferrand, France). Because the study did not modify patients' management and data were processed anonymously, the need for informed consent was waived.

Study Population

Patients older than 18 years and entered in the database from May 2004 to June 2012 were considered. To restrict the study to severely ill ICU patients, only patients with at least 5 days under invasive mechanical ventilation and without proved fungal infection on the fifth day were included. Exclusion criteria were as follows: neutropenia (<1,000 white blood cells per cubic millimeter), organ and stem cells transplantations, and decision to forego life-sustaining therapy before the fifth day

of invasive mechanical ventilation. Because *Candida* is the most common invasive fungal infection in the ICU (13), and fluconazole the most widely used SAT, we did not take into account samples positive to non-*Candida* invasive fungal infections.

Definitions

The observed data for each patient were the measurement on exposure defined by the use of any SAT, the composite primary outcome (30-d death or IC), and the confounders. The confounders were measured at baseline and daily from inclusion (fifth day of mechanical ventilation) to the end of the follow-up period (Figure 1). The time for patient's follow-up completion was defined as the time to failure (i.e., death or proved IC) and right-censored after 30 days. Follow-up was complete at 30 days.

Candida spp. colonization was considered multifocal when *Candida* spp. was simultaneously isolated from two noncontiguous foci as defined for *Candida* score (7, 28). Once a multisite colonization was detected, the patient was considered multicolonized until the end of the follow-up period. Proved IC was defined according to the modified European Organization for Research and Treatment of Cancer/ Diseases Mycoses Study Group criteria (definition for proved IC is provided in the online supplement ESM1) (17, 29).

Statistical Analysis

The primary outcome measure was death or proved IC. To assess the effect of SAT administration on outcome, we used an MSM that can be considered as an extension of the propensity-score matching allowing adjustment for time-dependent confounders (30). Theory and form of MSMs with IPTW estimator have been presented previously (30). A cause-specific model, a double robust estimator model, and a conditional logistic regression were performed to assess the sensibility of the results obtained by MSM (additional details on MSM methodology used and results obtained with the three other models are provided in the online supplement ESM2).

To assess the potential effect of SAT for subgroups of patients, sensitivity analysis was performed in six groups: (1) *Candida* score at inclusion greater than 2, (2) presence of a multicolonization for *Candida* at inclusion, (3) type of admission (surgery or medical), (4) abdominal

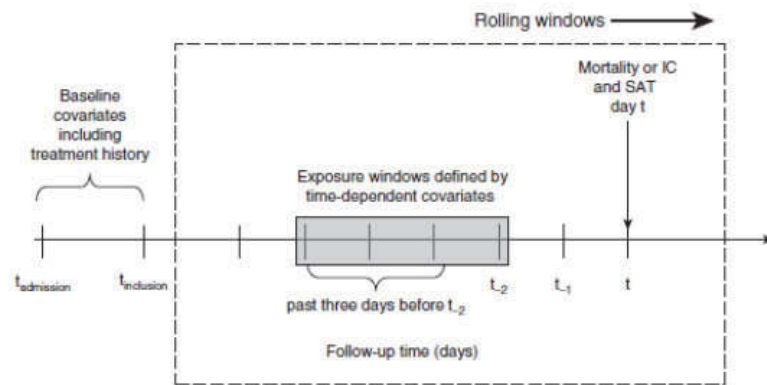

Figure 1. Marginal structural Cox model. Survival was modeled via a weighted logistic regression model for repeated measures using rolling windows (dashed box). For each subject day ending at time t , the probability of survival was modeled based on SAT on Day t , clinical and physiologic variables on Day $t-2$, or in the past 3 days before $t-2$. Adjustment was made for baseline characteristics defined at study inclusion or intensive care unit admission time ($t_{\text{admission}}$ or $t_{\text{inclusion}}$). Patient-days were weighted as described in the text. Windows were then rolled forward by 1 day to generate the next observation (large arrow). IC = invasive candidiasis; SAT = systemic antifungal treatment.

to 705 patient-days of antifungal therapy before outcome or Day 30. Fluconazole was administered for 61% of treated patients and echinocandins or polyenes for 39%. The proportion of dead or IC patients was significantly greater in the group of treated patients than in the group of untreated patients (Table 1). Both at admission and inclusion, treated patients had significantly higher *Candida* and SOFA scores than untreated patients. The maximum *Candida* score value for the ICU stay was significantly greater for treated patients (score of 4; interquartile range, 3–5). In addition, they presented more frequently with septic shock and multiple organ failure, immunosuppression, extracorporeal circulation, broad-spectrum antimicrobials including fluoroquinolone administration, and malnutrition (Table 1). These differences were also observed the day of initiation of the treatment (see Table E7 for additional data on treated patient’s characteristics).

surgery, (5) immunosuppression, and (6) terciles of sequential organ failure assessment (SOFA) score. These groups were defined before the statistical analysis. There was no correction for multiple testing.

Values of categorical variables are reported as numbers (%) and values of continuous variables as medians (quartiles 1 and 3). The Fisher exact test was used for categorical data and the Wilcoxon test for continuous data between treated and untreated groups. A P value of less than 0.05 was considered statistically significant. Data management and analysis was done with SAS 9.3 (SAS Institute Inc., Cary, NC). SAS code provided by Robins and coworkers (30) was adapted and used to fit the MSM for this study.

Results

Population

Among 11,035 patients admitted in the five selected ICUs of the OutcomeRea database, 1,491 patients were included in the study (Figure 2). During the follow-up period, 385 patients (25.8%) presented the outcome of interest: 22 (1.48%) had a proved IC and 363 (24.3%) died (see Tables E5 and E6 in the online supplement for additional details on IC occurrence).

SAT Administration

During their ICU stay, 100 patients (6.7%) received SAT for a median time of 5 days (interquartile range, 3–9) corresponding

SAT Administration Probability

Factors taken into account to predict SAT were (see online supplement) case-mix variables (sex, age, chronic diseases,

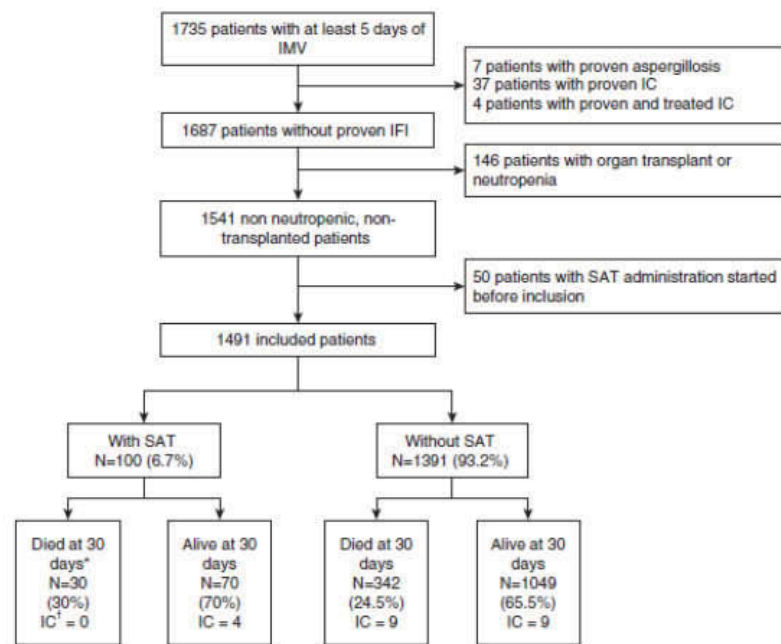

Figure 2. Flow chart of included patients with outcome: death and proved IC during the 30 follow-up days. IC = invasive candidiasis; IFI = invasive fungal infection; IMV = invasive mechanic ventilation; SAT = systemic antifungal treatment. *30-day status: alive or died; †patients with invasive candidiasis before 30 days.

Table 1. Baseline Characteristics for the Included Patients with Details for Patients Who Received SAT during the Follow-up Period

	All (n = 1,491)	SAT		P Value*
		Untreated (n = 1,391)	Treated (n = 100)	
Variables at ICU admission				
Age	65 (53–76)	65 (53–76)	63 (54–75)	0.65
Sex, male	950 (64)	898 (65)	52 (52)	0.01
Center				<0.01
A	745 (50)	679 (49)	66 (66)	
B	486 (33)	465 (33)	21 (21)	
C, D, E	260 (17)	247 (18)	13 (13)	
ICU admission				0.04
Medicine	1,251 (84)	1,167 (84)	84 (84)	
Elective surgery	85 (6)	84 (6)	1 (1)	
Emergency surgery	155 (10)	140 (10)	15 (15)	
Previous duration of hospital stay, d [†]	6 (5–8)	6 (5–8)	7 (6–11)	<0.01
Immunosuppression [‡]	121 (8)	107 (8)	14 (14)	0.03
Corticosteroid therapy >1 mo or >2 mg/kg	45 (3)	40 (3)	5 (5)	
Chemotherapy	57 (4)	49 (3)	8 (8)	
AIDS	17 (1)	15 (1)	2 (2)	
HIV not AIDS	7 (0)	6 (0)	1 (1)	
Other	2 (0)	2 (0)	0 (0)	
SAPS II	51 (40–63)	51 (40–63)	54 (39–62)	<0.01
Septic shock or multiple organ failure	427 (29)	389 (28)	38 (38)	0.04
Chronic disease	963 (65)	903 (65)	60 (60)	0.33
Extracorporeal circulation	17 (1)	13 (1)	4 (4)	0.02
Pancreatitis	18 (1)	16 (1)	2 (2)	0.34
Gastric or duodenal ulcer	27 (2)	24 (2)	3 (3)	0.42
Malnutrition	70 (5)	61 (4)	9 (9)	0.05
Cancer	238 (16)	219 (16)	19 (19)	0.40
Metastatic cancer	64 (4)	60 (4)	4 (4)	0.88
Malignant hemopathy	25 (2)	23 (1)	2 (2)	0.68
Variables at study inclusion (first 5 d of invasive mechanical ventilation)				
Candida score [§]	2 (1–3)	2 (1–3)	3 (2–4)	<0.01
Maximum Candida score during ICU stay	3 (2–4)	3 (2–4)	4 (3–5)	<0.01
SOFA	5 (2–8)	4 (2–8)	6 (3–11)	<0.01
Respiratory SOFA	0 (0–2)	0 (0–2)	0 (0–3)	<0.01
Coagulation SOFA	0 (0–1)	0 (0–1)	0 (0–2)	<0.01
Liver SOFA	0 (0–0)	0 (0–0)	0 (0–2)	<0.01
Cardiovascular SOFA	1 (0–3)	1 (0–3)	1 (0–4)	0.02
Central nervous system SOFA	1 (0–2)	1 (0–2)	1 (0–2)	0.54
Renal SOFA	0 (0–1)	0 (0–1)	0 (0–2)	<0.01
SAT history	29 (2)	13 (1)	16 (16)	<0.01
Broad-spectrum antibiotic therapy	499 (33)	438 (31)	61 (61)	<0.01
Fluoroquinolone administration	367 (25)	320 (23)	47 (47)	<0.01
Corticosteroid therapy history	534 (36)	480 (34)	54 (54)	<0.01
Presence of catheter	1,218 (82)	1,120 (80)	98 (98)	<0.01
Total parenteral nutrition	566 (38)	512 (37)	54 (54)	<0.01
Multifocal colonization	261 (17)	227 (16)	34 (34)	<0.01
History of severe sepsis [¶]	945 (63)	866 (62)	79 (79)	<0.01
Interest variables				
Total length of stay in ICU	14 (8–23)	13 (8–22)	25 (17–40)	<0.01
Duration of SAT administration**	5 (3–9)	—	5 (3–9)	
Type of SAT				
Azoles	61 (4)	—	61 (61)	
Candins or polyenes	39 (3)	—	39 (39)	
Deceased or proved IC at 30 d	385 (26)	351 (25)	34 (34)	0.06
Proven invasive candidiasis	22 (1)	18 (1)	4 (4)	0.05

Definition of abbreviations: IC = invasive candidiasis; ICU = intensive care unit; SAPS = simplified acute physiology score; SAT = systemic antifungal treatment; SOFA = sequential organ failure assessment.

Quantitative nonnormal variables are expressed as median (25–75th percentile), and binary variables are expressed as n (%).

Inclusion is defined as the fifth day of invasive mechanical ventilation.

*Wilcoxon test for quantitative variables and chi-square test for qualitative variables.

[†]Previous duration of hospitalization stay was greater than 30 days for 21 patients (1.4%), including two treated.

[‡]Immunosuppression concerned patients with long-term or high-dosage corticosteroid therapy, anticancer chemotherapy, AIDS, and non-AIDS immunodepression. Patients with aplasia and bone or organ transplant recipients were excluded. A patient can have several causes of immunosuppression.

[§]Candida score: from 781 patients with a Candida score less than 3 at inclusion, 278 (36%) have reached a Candida score greater than 3 (3 for 164 patients, 4 for 85 patients, 5 for 29 patients).

^{||}Presence of catheter included central vein catheter, arterial catheter, and Swan-Ganz catheter.

[¶]History of severe sepsis: from 546 patients that had no history of severe sepsis at inclusion, 107 had developed severe sepsis for the follow-up period.

**Duration of SAT administration: only treatments administered before IC or death before Day 30 were taken into account.

immunosuppression at admission, surgery at admission, SOFA score); therapy history between ICU admission and inclusion (antibiotic therapy, corticosteroid therapy); and time-dependent confounders, such as SOFA score, parenteral nutrition, broad-spectrum antibiotic therapy, corticosteroid, presence of hyperthermia, severe sepsis, multifocal colonization, and decision of limitation of life support (see Table E8 for additional data on risk factors for SAT).

SAT Administration and 30-Day Mortality or IC

Weighted population, which was defined by the inverse of the probability to receive SAT, was used in an MSM adjusted for baseline and time-dependent factors. SAT administration showed nonsignificant effect on mortality or IC risks (hazard ratio [HR], 1.05; 95% confidence interval [CI], 0.56–1.96). Results of double robust estimation, cause-specific models, and conditional logistic regression confirmed our primary results (see ESM3 and Tables E1–E4 for additional data on methods and results for these models). The results of sensitivity analysis did not show any significant association in any subgroup (Table 2).

Twenty-five percent of the 1,391 untreated patients and 34% of the 100 treated patients experienced the outcome death or IC at Day 30

(Table 1). According to these data, the *post hoc* power of the study was 65%.

Discussion

This is the first multicenter study based on observational longitudinal data of a large number of patients ($n = 1,491$) aiming to determine a causal effect of SAT on mortality or IC acquisition in severely ill ICU patients, provided all confounders were taken into account. After adjustment for baseline and time-dependent confounders through the use of a Cox MSM, results did not show that SAT administration without proved IC had an effect on the 30-day mortality or IC occurrence in nonneutropenic and nontransplanted ICU patients (HR, 1.05; 95% CI, 0.56–1.96). These results were robust in sensitivity analysis by using a weight truncate. However, subgroup analyses showed a nonsignificant trend for an improved IC-free survival at Day 30 in nonneutropenic and nontransplanted patients. In a *post hoc* analysis, a nonsignificant improvement of IC-free survival was also detected in the subgroup with a SOFA score below 7 at the fifth day of invasive mechanical ventilation (HR, 0.44; 95% CI, 0.15–1.34).

Literature, including the guidelines on the management of IC in ICU for nonimmunocompromised patients, contains expert consensus for SAT administration and early targeted treatment in proved IC in critically ill nonimmunocompromised patients (31, 32). Moreover, the Surviving Sepsis Guideline recommends an early empirical SAT that should be reassessed daily for potential deescalation (20). Indeed, randomized controlled trials (RCTs) have demonstrated that SAT is effective in case of proved invasive fungal infection, but these situations represent only 15–20% of the SAT prescribed in ICU (7, 21). In high-risk digestive surgery patients managed in ICUs with high annual incidence of candidemia (i.e., >1–2%), antifungal prophylaxis may be effective. However, regarding the so-called preemptive or empirical therapy, no clear demonstration of efficacy has been published so far (32). In a before–after design a study using colonization index-based fluconazole therapy showed a decreased rate of ICU-acquired candidemia, but no survival benefits (33). An RCT in critically ill patients with unresolved sepsis and risk factors for candidemia failed to demonstrate an impact of fluconazole on IC or mortality.

Using a large cohort of high-risk ICU patients, our study showed results that are

Table 2. Effect of SAT on 30-Day Mortality or Invasive Candidiasis on Different Subgroups (Sensitivity Analyses)

	Total ($n = 1,491$)	SAT ($n = 100$)	Death ($n = 363$)	IC ($n = 22$)	SAT Effect	
					HR (95% CI)	P Value
Type of admission						
Medicine	1,251 (84)	84 (84)	314 (86)	16 (73)	0.89 (0.44–1.83)	0.76
Surgery	240 (16)	16 (16)	49 (13)	6 (27)	2.86 (0.72–11.38)	0.14
Immunosuppression						
No	1,370 (92)	86 (86)	326 (90)	20 (91)	1.20 (0.59–2.45)	0.61
Yes	121 (8)	14 (14)	37 (10)	2 (9)	0.51 (0.18–1.47)	0.21
Abdominal surgery or pancreatitis						
No	1,413 (95)	91 (91)	352 (97)	18 (82)	1.05 (0.57–1.95)	0.88
Yes	78 (5)	9 (9)	11 (3)	4 (18)	3.92 (0.3–52.14)	0.3
SOFA at inclusion*						
0–6	994 (67)	55 (55)	177 (49)	11 (50)	0.44 (0.15–1.34)	0.15
7–23	497 (33)	45 (45)	186 (51)	11 (50)	1.49 (0.69–3.25)	0.31
Candida score at inclusion*						
0–2	781 (52)	38 (38)	198 (55)	5 (23)	1.48 (0.67–3.26)	0.33
3–5	710 (48)	62 (62)	165 (45)	17 (77)	0.78 (0.28–2.18)	0.87
Multifocal Candida colonization at inclusion*						
No	1,230 (83)	66 (66)	281 (77)	17 (77)	1.08 (0.32–3.61)	0.9
Yes	261 (17)	34 (34)	82 (23)	5 (23)	1.24 (0.60–2.55)	0.56

Definition of abbreviations: CI = confidence interval; HR = hazard ratio; IC = invasive candidiasis; SAT = systemic antifungal treatment; SOFA = sequential organ failure assessment.

Data are given as n (%) unless otherwise indicated.

*Inclusion is defined as the fifth day of invasive mechanical ventilation.

consistent with those previously published, thus confirming the absence of SAT effect on IC-free survival mortality at Day 30.

In a 1-day prevalence study, the intensivists declared 17% of nosocomial infections to be caused by *Candida* spp. However, only 99 of 14,414 patients developed proved candidemia (5). Furthermore, in medical ICU patients, 39% developed a colonization index of more than 0.5, whereas in the same period no IC was diagnosed (34).

The lack of impact of SAT in patients with the highest SOFA score may reflect other undiagnosed pathologies that have been missed or a late initiation of the SAT that is therefore ineffective. Also, it may be caused by the absence of actual IC. Indeed, *Candida* colonization or clinical scores (12, 28, 35) developed in ICU patients are associated with very good negative predictive value but very poor positive predictive value (7).

In our study, SAT without proved IC represented 705 patient-days of antifungal therapy and more than 60% of these treatments involved nonneutropenic nontransplanted patients studied. New data from the United States and Europe clearly demonstrated that overuse of antifungal drugs contributes to the emergence of *Candida* spp. that are less susceptible to antifungal agents, as well as to increased minimum inhibitory concentration (MICs) of normally susceptible *Candida* spp. (36). Recently, Lortholary and coworkers (37) reported that azoles and candins preexposure increased the risk of fungemia caused by species with higher MICs to the corresponding antifungal agents. We also described a significant correlation between SAT consumption and MICs of colonizing and infecting *Candida*

spp. in ICU patients (22). Moreover, *in vitro* resistant mutants of *Candida* spp. were recently associated with clinical treatment failures (38, 39).

This study used an innovative approach for the analysis of observational longitudinal surveys: a Cox MSM using IPTW estimator (40). Provided that all confounders are measured, this method is an alternate to approach causal inference in observational longitudinal studies where RCT methodology is not applicable. SAT administration is an adequate application for these models, because SAT is often empirically prescribed. Our study opens new opportunities to explore longitudinal databases in ICU to analyze outcomes depending on baseline and time-varying confounders and for which classical methods could present biases. Strong assumptions made for this model (positivity, no unmeasured confounder, and consistency) must be verified as recommended in the literature, as it was done here (41).

Some possible weaknesses of our results should be acknowledged. First, this study may have missed important predictors of SAT not recorded in the database. Although the estimation took into account all known predictors of SAT, other nonmeasured predictors of SAT may not have been considered. Moreover, despite the large number of patients studied, the estimated *post hoc* power should prompt to nuance the results, especially in specific subgroups. Further RCTs are needed to confirm our results, appropriately treat patients, and avoid antifungal misuse. Second, SAT was not homogenous because patients could have received either fluconazole, echinocandins, or polyenes. Echinocandins, currently recommended as initial SAT in

proved IC in unstable patients (24, 32), may have impacted more convincingly the disease-free survival. The effect of echinocandins therapy is currently evaluated through the EMPIRICUS trial, conducted in mechanically ventilated patients with a SOFA score greater than 3 with sepsis and multiple *Candida* spp. colonization (42).

Third, new biomarkers, such as 1,3- β -D-glucan (BD-glucan), may have been used to better select population that should benefit from SAT. A recent study (16) suggested that repeated measurements of BD glucan greater than 80 pg/ml could predict IC occurrence in surgical ICU patients. However, BD-glucan is not specific of candidiasis, is above the threshold of 80 pg/ml in many ICU patients without IC, and decreases slowly under effective treatment (43–45). The potential benefit of BD-glucan in rationalizing SAT is still missing or not convincing (18).

In conclusion, this study fails to show that systematic early antifungal treatment based on risk factors of IC influence the 30-day survival without proved IC in nonneutropenic, nontransplanted patients. A sufficiently powered RCT is needed to remove the doubts induced by a negative result in observational data analysis. To improve the efficacy of targeted antifungal therapy, maximal efforts should be done to increase the accuracy and precocity of IC diagnosis, including the identification of early biomarkers. ■

Author disclosures are available with the text of this article at www.atsjournals.org.

Acknowledgment: The authors thank Dr. Céline Feger (EMIBiotech) for her editorial assistance.

References

1. Tabah A, Koulenti D, Laupland K, Misset B, Valles J, Bruzzi de Carvalho F, Paiva JA, Cakar N, Ma X, Eggimann P, et al. Characteristics and determinants of outcome of hospital-acquired bloodstream infections in intensive care units: the EURO-BACT International Cohort Study. *Intensive Care Med* 2012;38:1930–1945.
2. Vincent JL, Rello J, Marshall J, Silva E, Anzueto A, Martin CD, Moreno R, Lipman J, Gomersall C, Sakr Y, et al.; EPIC II Group of Investigators. International study of the prevalence and outcomes of infection in intensive care units. *JAMA* 2009;302:2323–2329.
3. Marchetti O, Bille J, Fluckiger U, Eggimann P, Ruef C, Garbino J, Calandra T, Glauser MP, Tauber MG, Pittet D. Epidemiology of candidemia in Swiss tertiary care hospitals: secular trends, 1991–2000. *Clin Infect Dis* 2004;38:311–320.
4. Lortholary O, Renaudat C, Sitbon K, Madec Y, Denoeud-Ndam L, Wolff M, Fontanet A, Bretagne S, Dromer F; French Mycosis Study Group. Worsening trends in incidence and mortality of candidemia in intensive care units (Paris area, 2002–2010). *Intensive Care Med* 2014;40:1303–1312.
5. Kett DH, Azoulay E, Echeverria PM, Vincent JL; Extended Prevalence of Infection in ICU Study (EPIC II) Group of Investigators. *Candida* bloodstream infections in intensive care units: analysis of the extended prevalence of infection in intensive care unit study. *Crit Care Med* 2011;39:665–670.
6. León C, Alvarez-Lerma F, Ruiz-Santana S, León MA, Nolla J, Jordá R, Saavedra P, Palomar M; EPCAN Study Group. Fungal colonization and/or infection in non-neutropenic critically ill patients: results of the EPCAN observational study. *Eur J Clin Microbiol Infect Dis* 2009;28:233–242.
7. León C, Ruiz-Santana S, Saavedra P, Galván B, Blanco A, Castro C, Balasini C, Utande-Vázquez A, González de Molina FJ, Blasco-Navalproto MA, et al.; Cava Study Group. Usefulness of the “*Candida*

- score" for discriminating between *Candida* colonization and invasive candidiasis in non-neutropenic critically ill patients: a prospective multicenter study. *Crit Care Med* 2009;37:1624-1633.
8. Garrouste-Orgeas M, Timsit JF, Tafflet M, Misset B, Zahar JR, Soufir L, Lazard T, Jamali S, Mourvillier B, Cohen Y, et al.; OUTCOMEREA Study Group. Excess risk of death from intensive care unit-acquired nosocomial bloodstream infections: a reappraisal. *Clin Infect Dis* 2006;42:1118-1126.
 9. Grim SA, Berger K, Teng C, Gupta S, Layden JE, Janda WM, Clark NM. Timing of susceptibility-based antifungal drug administration in patients with *Candida* bloodstream infection: correlation with outcomes. *J Antimicrob Chemother* 2012;67:707-714.
 10. Bassetti M, Righi E, Ansaldo F, Merelli M, Trucchi C, De Pascale G, Diaz-Martin A, Luzzati R, Rosin C, Lagunes L, et al. A multicenter study of septic shock due to candidemia: outcomes and predictors of mortality. *Intensive Care Med* 2014;40:839-845.
 11. Koffel M, Micek S, Hampton N, Doherty JA, Kumar A. Septic shock attributed to *Candida* infection: importance of empiric therapy and source control. *Clin Infect Dis* 2012;54:1739-1746.
 12. Ostrosky-Zeichner L, Soble C, Sobel J, Alexander BD, Donowitz G, Kan V, Kauffman CA, Kett D, Larsen RA, Morrison V, et al. Multicenter retrospective development and validation of a clinical prediction rule for nosocomial invasive candidiasis in the intensive care setting. *Eur J Clin Microbiol Infect Dis* 2007;26:271-276.
 13. Eggimann P, Garbino J, Pittet D. Epidemiology of *Candida* species infections in critically ill non-immunosuppressed patients. *Lancet Infect Dis* 2003;3:685-702.
 14. Ostrosky-Zeichner L, Pappas PG. Invasive candidiasis in the intensive care unit. *Crit Care Med* 2006;34:857-863.
 15. Guery BP, Arendrup MC, Auzinger G, Azoulay E, Borges Sá M, Johnson EM, Müller E, Putensen C, Rotstein C, Sganga G, et al. Management of invasive candidiasis and candidemia in adult non-neutropenic intensive care unit patients: Part I. Epidemiology and diagnosis. *Intensive Care Med* 2009;35:55-62.
 16. Tissot F, Lamoth F, Hauser PM, Orasch C, Flückiger U, Slegemund M, Zimmerli S, Calandra T, Bille J, Eggimann P, et al.; Fungal Infection Network of Switzerland (FUNGINOS). β -Glucan antigenemia anticipates diagnosis of blood culture-negative intraabdominal candidiasis. *Am J Respir Crit Care Med* 2013;188:1100-1109.
 17. León C, Ostrosky-Zeichner L, Schuster M. What's new in the clinical and diagnostic management of invasive candidiasis in critically ill patients. *Intensive Care Med* 2014;40:808-819.
 18. Ostrosky-Zeichner L, Shoham S, Vazquez J, Reboli A, Betts R, Barron MA, Schuster M, Judson MA, Revankar SG, Caeiro JP, et al. MSG-01: a randomized, double-blind, placebo-controlled trial of caspofungin prophylaxis followed by preemptive therapy for invasive candidiasis in high-risk adults in the critical care setting. *Clin Infect Dis* 2014;58:1219-1226.
 19. Montravers P, Dupont H, Gauzit R, Veber B, Auboyer C, Blin P, Hennequin C, Martin C. *Candida* as a risk factor for mortality in peritonitis. *Crit Care Med* 2006;34:646-652.
 20. Dellinger RP, Levy MM, Rhodes A, Annane D, Gerlach H, Opal SM, Sevransky JE, Sprung CL, Douglas IS, Jaeschke R, et al.; Surviving Sepsis Campaign Guidelines Committee including the Pediatric Subgroup. Surviving sepsis campaign: international guidelines for management of severe sepsis and septic shock: 2012. *Crit Care Med* 2013;41:580-637.
 21. Azoulay E, Dupont H, Tabah A, Lortholary O, Stahl JP, Francois A, Martin C, Guidet B, Timsit JF. Systemic antifungal therapy in critically ill patients without invasive fungal infection. *Crit Care Med* 2012;40:813-822.
 22. Fournier P, Schwebel C, Maubon D, Vesin A, Lebeau B, Foroni L, Hamidfar-Roy R, Cornet M, Timsit JF, Pelloux H. Antifungal use influences *Candida* species distribution and susceptibility in the intensive care unit. *J Antimicrob Chemother* 2011;66:2880-2886.
 23. Schuster MG, Edwards JE Jr, Sobel JD, Darouiche RO, Karchmer AW, Hadley S, Slotman G, Panzer H, Biswas P, Rex JH. Empirical fluconazole versus placebo for intensive care unit patients: a randomized trial. *Ann Intern Med* 2008;149:83-90.
 24. Pappas PG, Kauffman CA, Andes D, Benjamin DK Jr, Calandra TF, Edwards JE Jr, Filler SG, Fisher JF, Kullberg BJ, Ostrosky-Zeichner L, et al. Clinical practice guidelines for the management of candidiasis: 2009 update by the Infectious Diseases Society of America. *Clin Infect Dis* 2009;48:503-535.
 25. Hernán MA, Brumback B, Robins JM. Marginal structural models to estimate the causal effect of zidovudine on the survival of HIV-positive men. *Epidemiology* 2000;11:561-570.
 26. Pirracchio R, Sprung CL, Payen D, Chevret S. Utility of time-dependent inverse-probability-of-treatment weights to analyze observational cohorts in the intensive care unit. *J Clin Epidemiol* 2011;64:1373-1382.
 27. Clec'h C, Alberti C, Vincent F, Garrouste-Orgeas M, de Lassence A, Toledano D, Azoulay E, Adrie C, Jamali S, Zaccaria I, et al. Tracheostomy does not improve the outcome of patients requiring prolonged mechanical ventilation: a propensity analysis. *Crit Care Med* 2007;35:132-138.
 28. León C, Ruiz-Santana S, Saavedra P, Almirante B, Nolla-Salas J, Alvarez-Lerma F, Gamacho-Montero J, León MA; EPCAN Study Group. A bedside scoring system ("Candida score") for early antifungal treatment in nonneutropenic critically ill patients with *Candida* colonization. *Crit Care Med* 2006;34:730-737.
 29. De Pauw B, Walsh TJ, Donnelly JP, Stevens DA, Edwards JE, Calandra T, Pappas PG, Maertens J, Lortholary O, Kauffman CA, et al. Revised definitions of invasive fungal disease from the European Organization for Research and Treatment of Cancer/Invasive Fungal Infections Cooperative Group and the National Institute of Allergy and Infectious Diseases Mycoses Study Group (EORTC/MSG) Consensus Group. *Clin Infect Dis* 2008;46:1813-1821.
 30. Robins JM, Hernán MA, Brumback B. Marginal structural models and causal inference in epidemiology. *Epidemiology* 2000;11:550-560.
 31. Deshpande A, Gaur S, Bal AM. Candidaemia in the non-neutropenic patient: a critique of the guidelines. *Int J Antimicrob Agents* 2013;42:294-300.
 32. Cornely OA, Bassetti M, Calandra T, Garbino J, Kullberg BJ, Lortholary O, Meersseman W, Akova M, Arendrup MC, Arikan-Akdagli S, et al. ESCMID guideline for the diagnosis and management of *Candida* diseases 2012: non-neutropenic adult patients. *Clin Microbiol Infect* 2012;18:19-37.
 33. Piarroux R, Grenouillet F, Balvay P, Tran V, Blasco G, Millon L, Bollot A. Assessment of preemptive treatment to prevent severe candidiasis in critically ill surgical patients. *Crit Care Med* 2004;32:2443-2449.
 34. Charles PE, Dalle F, Aube H, Doise JM, Quenot JP, Aho LS, Chavanet P, Blettery B. *Candida* spp. colonization significance in critically ill medical patients: a prospective study. *Intensive Care Med* 2005;31:393-400.
 35. Pittet D, Monod M, Suter PM, Frenk E, Auckenthaler R. *Candida* colonization and subsequent infections in critically ill surgical patients. *Ann Surg* 1994;220:751-758.
 36. Fekkar A, Dannaoui E, Meyer I, Imbert S, Brossas JY, Uzunov M, Mellon G, Nguyen S, Guiller E, Caumes E, et al. Emergence of echinocandin-resistant *Candida* spp. in a hospital setting: a consequence of 10 years of increasing use of antifungal therapy? *Eur J Clin Microbiol Infect Dis* 2014;33:1489-1496.
 37. Lortholary O, Desnos-Ollivier M, Sitbon K, Fontanet A, Bretagne S, Dromer F; French Mycosis Study Group. Recent exposure to caspofungin or fluconazole influences the epidemiology of candidemia: a prospective multicenter study involving 2,441 patients. *Antimicrob Agents Chemother* 2011;55:532-538.
 38. Alexander BD, Johnson MD, Pfeiffer CD, Jimenez-Ortigosa C, Catania J, Booker R, Castanheira M, Messer SA, Perlin DS, Pfaffer MA. Increasing echinocandin resistance in *Candida glabrata*: clinical failure correlates with presence of FKS mutations and elevated minimum inhibitory concentrations. *Clin Infect Dis* 2013;56:1724-1732.
 39. Shields RK, Nguyen MH, Press EG, Updike CL, Clancy CJ. Caspofungin MICs correlate with treatment outcomes among patients with *Candida glabrata* invasive candidiasis and prior echinocandin exposure. *Antimicrob Agents Chemother* 2013;57:3528-3535.

40. Cole SR, Hernán MA. Constructing inverse probability weights for marginal structural models. *Am J Epidemiol* 2008;168:656–664.
41. Yang S, Eaton CB, Lu J, Lapane KL. Application of marginal structural models in pharmacoepidemiologic studies: a systematic review. *Pharmacoepidemiol Drug Saf* 2014;23:560–571.
42. Timsit JF, Azoulay E, Cornet M, Gangneux JP, Jullien V, Vésin A, Schir E, Wolff M. EMPIRICUS micafungin versus placebo during nosocomial sepsis in *Candida* multi-colonized ICU patients with multiple organ failures: study protocol for a randomized controlled trial. *Trials* 2013;14:399.
43. Sims CR, Jajjakul S, Mohr J, Rodriguez J, Finkelman M, Ostrosky-Zeichner L. Correlation of clinical outcomes with β -glucan levels in patients with invasive candidiasis. *J Clin Microbiol* 2012;50:2104–2106.
44. Jajjakul S, Vazquez JA, Swanson RN, Ostrosky-Zeichner L. (1,3)- β -D-glucan as a prognostic marker of treatment response in invasive candidiasis. *Clin Infect Dis* 2012;55:521–526.
45. Clancy CJ, Nguyen MH. Finding the “missing 50%” of invasive candidiasis: how nonculture diagnostics will improve understanding of disease spectrum and transform patient care. *Clin Infect Dis* 2013; 56:1284–1292.

Supplément électronique de la publication 6

Failure of Empirical Systemic Antifungal Therapy in Mechanically-ventilated Critically Ill
Patients

Sebastien Bailly, Lila Bouadma, Elie Azoulay, Maité Garrouste Orgeas, Bertrand Souweine,
Carole Schwebel, Danièle Maubon, Rebecca Hamidfar-Roy, Michael Darmon, Michel Wolff,
Muriel Cornet, Jean-Francois Timsit

ESM1: Definition for proven invasive candidiasis

Proven invasive candidiasis include 1) candidemia defined as presence of *Candida* in one or more blood cultures; 2) intra-abdominal candidiasis defined on the basis of positive culture for *Candida* in the peritoneal fluid collected during operation; 3) Other candidiasis defined in this study by pleural candidiasis and candidiasis on surgery site or biopsy site, including histopathologic or cytopathologic examination of a needle aspiration or biopsy specimen from a normally sterile site, excluding mucous membranes showing yeast cells or recovery of a yeast by culture from a sample obtained by a sterile procedure (including a freshly [<24 h] placed drain) from a normally sterile site. (1, 2)

Introduction

A short introduction to the causal inference in observational data

As opposed to randomized clinical trials, in observational data studies, the exposure is not controlled by the investigator, and the characteristics (observed and unobserved confounders) of the patients in each study group are unbalanced at inclusion.

A key challenge for statistical analysis is that mortality difference between these groups cannot be totally attributed to empiric SAT administration, and causal inference seems impossible.

However if the difference between the two groups can be explained only by the characteristics measured at the time of inclusion, then it is possible to adjust for these baseline variables to balance the two groups (i.e. propensity-score based method).

This is not sufficient when the evolution of the general health status or care in the time contribute to the decision to treat. The decision to empirically treat a patient with SAT is time-dependent: one patient could be free from SAT the first day in ICU but treated later on, according to his clinical evolution.

Depending on the hypothetical model (Figure E1), the administration of SAT was assumed to be related to the patient's prior exposure to SAT and baseline covariates at inclusion such as risk factors of IC, severity score, age, or gender. These baseline covariates and SAT history were assumed to have an impact on other covariates which were time-dependent confounders for SAT probability and for the outcome.

Marginal structural modeling approaches are enable to assess what the effect of SAT on the primary composite endpoint (30-day death or IC) would have been, if all patients would have

remained SAT untreated or, alternatively, would have received SAT on a specific day by creating a pseudo-population. Cole et al have been defined a pseudo-population as the result of assigning to each patient a weight that is, informally, proportional to the participant's probability of receiving her own exposure history (SAT history in our case). (3)

Therefore it becomes possible to regress the primary composite outcome (30-day death or IC) on the empiric SAT exposition using a conventional regression model provided all confounders are taken into account. The parameters of such weighted model can be used to assess the average causal effect of exposure in the original study population. (3)

In this study we use a marginal structural model to assess the average causal effect of SAT on 30-day death or IC. To evaluate the robustness of the model, we have been developed three other methods: a double robust estimation of treatment effects, a cause-specific model and a matched-cohort design which were all developed in ESM3.

Methodology

Marginal structural model

MSM needed two steps: firstly, estimate individuals stabilized IPTWs. Weights are the inverse of the probability, for an individual, at a defined day, to receive his own antifungal treatment given baseline and time-dependant covariates. A pooled logistic regression model is used to estimate the antifungal treatment probability conditional on i) selected baseline covariates: age, sex, admission category (medical or surgery), immunosuppression (neutropenia, long-term, or high-dosage corticosteroid therapy, anticancer chemotherapy, AIDS), Day5 SOFA score, history of broad spectrum antibiotic therapy, corticosteroid therapy and antifungal treatment before Day5 and pre-existing chronic diseases; and ii) time-dependent covariates, as follows: a) variables measured two days before SAT administration: multifocal *Candida* colonization, parenteral nutrition, history of severe sepsis, therapeutic

limitation; b) variables measured in the last two days before SAT administration: hyperthermia, broad spectrum antibiotic therapy, corticosteroid therapy, presence of catheter or drain or Redon drain, and sedation; and c) the maximum SOFA score between Day-3 to Day-1.

Stabilized IPTWs have been shown to produce narrower confidence interval with better coverage rates than unstabilized weights.(4, 5) Secondly, these weights were introduced in a Cox proportional hazard model to estimate the effect of the antifungal treatment on the outcome. To check for positivity assumption, weights were truncated at the 1st and 99th percentiles as proposed by Cole et al. (3) To integrate the impact of the length of therapy on outcome, we included a binary variable that takes the 1 value after five days of SAT. The center was introduced as a fixed effect in the final model.

Patients discharged alive from the hospital before day 30 were considered free from TAF. A random sample of the patients discharged alive from ICU and referred to another hospital ward was selected to estimate the daily probability to receive SAT after ICU discharge. This probability of receiving SAT was affected to this patient's category and data were imputed from last day of ICU stay to the end of the follow-up period.

Checking the assumption of positivity

As highlighted by Cole and Hernan (3) and Petersen (6), the assumption of positivity should be checked in causal inference because treatment levels must vary within confounder strata. The examination of the distribution of the estimated weight was used for checking the positivity assumption and weight truncation was used to ensure that high weights have no impact on the final estimation.

Results

Positivity assumption

The examination of the distribution of the estimated weight shows that extremely high weights were not observed following the day of exposure and the mean of the stabilized weight is centered at 1 (figure E2). Table E1 shows the results of weight truncation, a truncation of the extreme weights (1 and 99 percentiles) concerns 187 individuals, which is 1% of all the computed weights.

Sensitivity analysis for the estimation of treatment effect

Results of the three models (ESM3) show a lack of SAT effect on mortality or invasive candidiasis: relative risk associated to the treatment effect was 0.94 [0.61;1.46] using a double robust estimator, the cause-specific hazard ratio was 0.88 [0.51;1.25] using a cause-specific model and hazard ratio was 1.39 [0.71 ; 2.71] using a conditional logistic regression.

Conclusion

The examination of the distribution of the estimated weights are in favor of a validation of the assumption of positivity and allow reporting a result with the weight truncated at the 1st and 99th percentiles according to the methodology proposed elsewhere. (3)

The three additional models are not completely comparable to the MSM because the DR estimation and the conditional logistic regression do not take into account the time-dependent covariates and because the cause-specific model cannot estimate a causal effect but only an association between exposure and outcome. The DR uses a propensity-based analysis which ensures a good matching of the two groups at baseline and reduces the risk of model misspecification. The matched-cohort is a simple and widely used method which allows computing odds ratio for SAT effect for exposed. The conditional logistic regression allows a post-hoc power computation. The cause-specific model uses a competing risk to compute a cause-specific hazard ratio. This is not the case of the assumption used in the MSM where

individuals are not considered as censored. The results of these models are close to those obtained with the MSM; this confirms the trend toward a failure of SAT in improving the prognosis of severe patients in ICU. The post-hoc power is equal to 65%.

ESM3: Methodology for sensitivity analysis for the estimation of the treatment effect

Double robust estimation of the treatment effect

This approach was developed by Funk and al. (7); it is an alternative to the standard propensity score (PS) approach of estimating the causal treatment effect that takes into account either the PS-based model misspecification or the outcome model misspecification. The DR estimation remains consistent even when an important confounder is omitted from one of the two models; however, in this case, the PS-based method can lead to a biased inference. (8) The weighting used for DR estimation creates two pseudo-populations of subjects that represent the expected treatment effect in the entire population when all the individuals are treated or all the individuals are untreated. (7) The DR has a marginal interpretation that corresponds to the average treatment effect. The baseline variables included in this model were: age, sex, history of antibiotic therapy, history of corticosteroid therapy, admission for surgery, SOFA score at inclusion, presence of chronic diseases, immunosuppression, multifocal colonization, use parenteral nutrition, severe sepsis, decision of limitation of life-support, hyperthermia.

Cause specific model

The cause-specific model is a common alternative to survival analysis for handling competing risks. This model allows a quantification of the cause-specific relative hazard, which is the association between the exposure and the outcome when the individuals with the competing event are censored. (9) One advantage of this model is to allow for time-dependent confounders in addition to the baseline confounders. The baseline covariates included were: age, sex, history of antibiotic therapy, history of corticosteroid therapy, admission for surgery, SOFA score at inclusion, and the presence of chronic diseases. The time-dependent covariates were: history of antibiotic therapy, history of corticosteroid therapy, immunosuppression, multifocal colonization, use of parenteral nutrition, severe sepsis, decision of limitation of life-support, hyperthermia, SOFA scores (into 6 components cardiac, hematologic, hepatic,

neurologic, renal, and respiratory). The competing event was "discharged alive before 30 days" and the outcome was "death or invasive candidiasis at 30 days".

Matched-cohort design

A conditional regression analysis for 1:10 matching in a nested exposed-unexposed study was performed to assess the effect of SAT on 30-day mortality. The final odds ratio assesses the additional risk related to SAT adjusted on confounders at Day-3 (Figure 3). (10) The exposed patients were matched with unexposed patients on the basis of the following criteria: sex, age, SOFA score at 5th IMV day, chronic disease, type of admission in ICU. To estimate odds ratio, the SAT effect was adjusted on severity score and confounders three day before the treatment day (SOFA score, broad spectrum antibiotic therapy, corticosteroid therapy, parenteral nutrition, severe sepsis, multiple colonization, hyperthermia, therapeutic limitation).

Results

Double robust estimator

The results for the two regression models for treatment probability are shown Table E2. The difference in risk between the two pseudo-populations is equal to -0.013 (95% CI: [-0.10;0.08]) and is not significantly different from zero. The relative risk associated with the treatment effect is equal to 0.94 [0.61;1.46] and indicates an absence of SAT effect on mortality or invasive candidiasis (p value = 0.79).

Cause-Specific model

The results for the cause-specific model are shown table E3. The cause-specific relative hazard regarding the outcome was 0.88 [0.51;1.25] and was not significantly different from 1 (p value = 0.49).

Matched-cohort design

The results for the conditional logistic regression (matched-cohort) are shown table E4. The hazard ratio of SAT on mortality or invasive candidiasis was 1.39 [0.71 ; 2.71] and was not significantly different from 1. The HR obtained here is in the same direction as the main result, and indicates an absence of SAT effect.

Table E1: Effect of Systemic Antifungal Treatment on outcome under progressive truncation of inverse probability weights.

Truncation percentiles	Estimated weight		Systemic Antifungal Treatment effect			
	Mean (SD)	Minimum / Maximum	Estimate	SE	HR [CI95%]	P value
0, 100	1(0.148)	0.12/6.44	0.1942	0.36	1.21[0.59;2.48]	0.59
1, 99	1(0.079)	0.39/1.49	0.0501	0.32	1.05[0.56;1.96]	0.87
5, 95	1(0.027)	0.9/1.09	0.0316	0.28	1.03[0.6;1.78]	0.91
10, 90	1(0.016)	0.95/1.04	0.0221	0.28	1.02[0.6;1.76]	0.94
25, 75	1(0.007)	0.98/1	0.0202	0.27	1.02[0.6;1.75]	0.94
50, 50	1(0)	1/1	0.0208	0.27	1.02[0.6;1.75]	0.94

SD: Standard Deviation – SE: Standard Error

Table E2 : Results of the logistic regression models for DR estimation

Parameter	SAT*		No SAT†	
	Estimate (SE)	Pvalue	Estimate (SE)	Pvalue
Intercept	-3.46 (0.33)	<.01	-3.34 (1.2)	<.01
Age (>65 years)	0.61 (0.18)	<.01	-0.18 (0.52)	0.73
Sex (male)	-0.03 (0.18)	0.86	-0.71 (0.57)	0.21
Antibiotic therapy history	-0.3 (0.18)	0.10	1.23 (0.58)	0.03
Corticosteroids therapy history	0.16 (0.18)	0.39	0.34 (0.54)	0.53
Surgery admission	-0.49 (0.25)	0.05	0.4 (0.73)	0.59
SOFA score at inclusion (per point)	0.23 (0.02)	<.01	0.08 (0.06)	0.13
Chronic underlying diseases	0.09 (0.19)	0.64	0.45 (0.65)	0.49
Immunosuppression	0.35 (0.33)	0.28	1.69 (0.87)	0.05
Multifocal colonization	0.34 (0.24)	0.15	0.34 (0.62)	0.58
Parenteral nutrition	0.11 (0.17)	0.52	-0.7 (0.57)	0.22
Severe sepsis	-0.5 (0.18)	<.01	0.37 (0.62)	0.55
Decision of limitation of life support	2.33 (0.18)	<.01	1.56 (0.59)	0.01
Temperature >38°C	-0.23 (0.17)	0.18	0.27 (0.61)	0.66

*Model of the predicted response among the exposed; †Model of the predicted response

among the unexposed. SAT : Systemic Antifungal Treatment; SE; Standard Error

Table E3: Results of the cause-specific model

Parameter	Death or Invasive candidiasis*				Discharge*				
	95% CI				95% CI				
	CSHR	Lower	Upper	Pvalue	CSHR	Lower	Upper	Pvalue	
Baseline confounders									
Age	1.70	1.45	1.93	<.01	0.77	0.65	0.89	<.01	
Sex (male)	0.99	0.77	1.21	0.94	0.86	0.73	0.98	0.02	
Antibiotic therapy history	0.94	0.69	1.19	0.63	0.93	0.78	1.08	0.36	
Corticosteroids therapy history	1.18	0.91	1.45	0.23	1.08	0.92	1.24	0.32	
Surgery admission	0.83	0.53	1.13	0.21	1.08	0.91	1.24	0.38	
SOFA score (per point)	1.08	1.05	1.11	<.01	0.96	0.94	0.98	<.01	
Chronic underlying disease	0.98	0.76	1.21	0.89	1.18	1.04	1.31	0.02	
Immunosuppression	0.96	0.59	1.33	0.84	1.10	0.85	1.35	0.45	
Time-dependent confounders									
Broad spectrum antibiotic therapy	1.17	0.92	1.42	0.21	0.89	0.73	1.04	0.13	
Corticosteroid therapy	1.05	0.77	1.32	0.73	0.81	0.65	0.98	0.02	
Temperature >38°C	0.73	0.52	0.94	<.01	0.83	0.71	0.96	<.01	
Decision of limitation of life support	4.71	4.48	4.93	<.01	0.74	0.50	0.99	0.02	
Multifocal colonization	1.01	0.78	1.24	0.91	0.80	0.66	0.94	<.01	
Parenteral nutrition	0.94	0.72	1.15	0.56	0.94	0.82	1.07	0.37	
Severe sepsis	0.53	0.29	0.76	<.01	0.86	0.72	1.00	0.03	
Cardiological SOFA score	1.17	1.08	1.27	<.01	0.74	0.67	0.81	<.01	
Hematology SOFA score	0.85	0.69	1.01	0.05	1.28	1.19	1.38	<.01	
Liver SOFA score	0.98	0.83	1.13	0.78	1.08	0.98	1.17	0.12	
Neurological SOFA score	1.18	1.09	1.27	<.01	0.78	0.73	0.84	<.01	
Renal SOFA score	1.07	0.97	1.17	0.16	0.93	0.86	0.99	0.02	
Respiratory SOFA score	1.08	0.99	1.17	0.10	1.04	0.99	1.09	0.14	
SAT effect	0.88	0.51	1.25	0.49	0.92	0.67	1.17	0.52	

*Competitive risks considered : Discharge alive; CSHR: Cause-Specific Hazard Ratio; CI:

Confidence interval

Table E4: Results of the matched-cohort based model

	Odds Ratio	95% Confidence interval		P value
		Lower	Upper	
SAT effect	1.39	0.712	2.708	0.33
Day-3 variables:				
SOFA score	1.40	1.06	1.83	0.02
Broad spectrum antibiotic therapy	1.42	0.80	2.51	0.23
Corticosteroid therapy	0.67	0.41	1.01	0.09
Parenteral nutrition	0.88	0.56	1.38	0.57
Severe sepsis	1.72	0.99	2.98	0.05
Multifocal colonization	0.70	0.43	1.14	0.15
Temperature >38°C	1.32	0.82	2.11	0.25
Decision of limitation of life support	0.52	0.28	0.95	0.03

Table E5: Details of invasive candidiasis (occurring before inclusion (n=41) or after inclusion (n=22)) in the population studied

	Blood culture	Pleural liquid	Peritoneal liquid	Surgery site and biopsy
After inclusion IC (N=22)				
<i>C. albicans</i>	8	1	2	4*
<i>C. glabrata</i>	-	1	-	-
<i>C. parapsilosis</i>	-	-	1	2*
<i>C. tropicalis</i>	1	-	-	1
<i>C. krusei</i>	1	-	-	
<i>Candida</i> spp	1	-	-	1
TOTAL	11	2	3	8
Before inclusion IC [†] (N= 41)				
<i>C. albicans</i>	9	2 [§]	4 ^l	11**
<i>C. glabrata</i>	4 [‡]	1 [§]	1	1
<i>C. parapsilosis</i>	2		1 ^l	
<i>C. tropicalis</i>	2 [‡]		1 ^l	
<i>C. krusei</i>			2 ^l	
<i>C. kefyr</i>	1			1**
<i>Candida</i> spp	1			1
TOTAL	19	2	7	13

*One patient had two identified *Candida* species (*C. albicans* and *C. parapsilosis*) on a biopsy.

[†] IC occurred before inclusion or was treated at inclusion day.

Patient with two identified species on a sample of [‡] blood culture (*C. albicans* and *C. tropicalis*), [§] Pleural liquid (*C. albicans* and *C. glabrata*), ^l Peritoneal liquid (*C. albicans* and *C. tropicalis* / *C. parapsilosis* and *C. krusei*) and ^{**} on biopsy (*C. albicans* and *C. kefyr*).

Table E6 : empirical SAT for the 22 proven invasive *Candida* infections

	Total	No SAT	SAT	SAT administration				
				Before IC			Within the first 48h*	
				FLU	AMB	ECH	AMB	ECH
<i>C. albicans</i>	14	6	8	1	2	1	1	3
<i>C. glabrata</i>	1	-	1	-	-	-	-	1
<i>C. parapsilosis</i>	3	3	-	-	-	-	-	-
<i>C. tropicalis</i>	2	1	1	-	-	-	-	1
<i>C. krusei</i>	1	-	1	-	-	-	-	1
<i>Candida</i> spp.	2	1	1	-	-	-	-	1

SAT : systemic antifungal treatment – FLU: Fluconazole – AMB: amphotericin B – ECH:

Echinocandins - * SAT was introduced within the first 48 hours after the diagnostic sample was drawn

Table E7: SAT treated patient's characteristics the day they received SAT (N=100).

	N(%) or Median (IQR)
Length of ICU stay from admission	21 (12 - 34)
SOFA	7 (4 - 9)
Candida score	4 (3 - 5)
Multisite colonization	70 (70)
Parenteral nutrition	64 (64)
History of severe sepsis	83 (83)
Catheter within the last three days	92 (92)
Antibiotic therapy within the last three days	55 (55)
Corticosteroids within the last three days	45 (45)
Hyperthermia within the last three days	45 (45)
Hypothermia within the last three days	45 (45)
Sedation within the last three days	79 (79)

SAT: Systemic Antifungal Treatment ; IQR : Inter Quartile Range

Table E8: Risk factors for SAT.

	OR [95% CI]	P value
Time of exposure	1.09 [1.06 ; 1.12]	<.01
Baseline confounders		
Center A	ref	<.01
Center B	3.46 [2.74 ; 4.35]	
Center C,D,E	1.87 [1.38 ; 2.55]	
Age (>65 years)	0.79 [0.67 ; 0.94]	<.01
Sex (male)	0.48 [0.40 ; 0.56]	<.01
Antibiotic therapy history	1.97 [1.62 ; 2.39]	<.01
Corticosteroids therapy history	1.24 [1.02 ; 1.50]	0.03
Surgery admission	1.37 [1.08 ; 1.74]	0.01
SOFA score at inclusion (per point)	0.98 [0.96 ; 1.00]	0.02
Chronic underlying diseases	0.66 [0.55 ; 0.80]	<.01
Immunosuppression	0.78 [0.59 ; 1.04]	0.09
Time-dependent confounders – max from Day minus1 to Day minus3		
Liver SOFA score (per point)	1.11 [0.99 ; 1.26]	0.08
Hematology SOFA score (per point)	1.07 [0.94 ; 1.22]	0.33
Cardiological SOFA score (per point)	1.10 [1.02 ; 1.19]	0.02
Renal SOFA score (per point)	1.19 [1.10 ; 1.29]	<.01
Respiratory SOFA score (per point)	1.00 [0.93 ; 1.08]	0.96
Neurological SOFA score (per point)	0.85 [0.78 ; 0.93]	<.01
Time-dependent confounders at D minus 2		
Severe sepsis	0.89 [0.70 ; 1.13]	0.34
Parenteral nutrition	2.05 [1.65 ; 2.55]	<.01
Multifocal colonization	3.78 [3.13 ; 4.56]	<.01
Decision of limitation of life support	1.74 [1.37 ; 2.21]	<.01
Time-dependent confounders In the past 3 days from D minus 2		
Broad spectrum antibiotic therapy	1.62 [1.35 ; 1.94]	<.01
Temperature >38°C	1.51 [1.27 ; 1.81]	<.01
Corticosteroid therapy	1.43 [1.19 ; 1.73]	<.01

* Patients with SAT history received SAT at least more than two day before inclusion, but not during the two previous days before inclusion.

SAT: Systemic Antifungal Treatment ; OR: Odds Ratio; CI: Confidence Interval

Figure E1: Directed acyclic graph of the SAT administration illustrating the links between baseline and time-dependent confounding and interest outcome. Solid line corresponds to the interest causal effect between SAT administration and outcome. Dashed arrows indicate the effects of the baseline and time-dependent confounders.

* IC: Invasive candidiasis

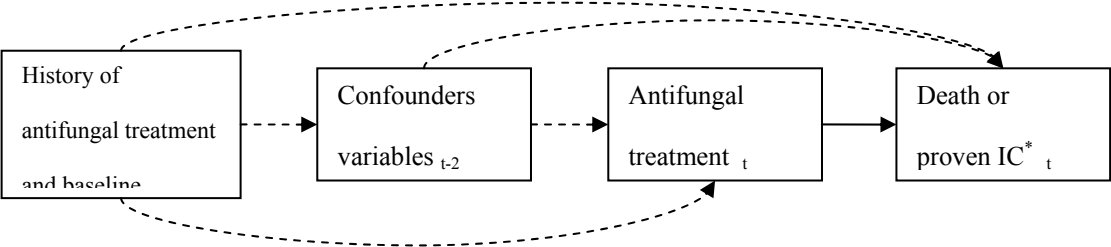

Figure E2: Distribution of stabilized weight following the day of exposure.

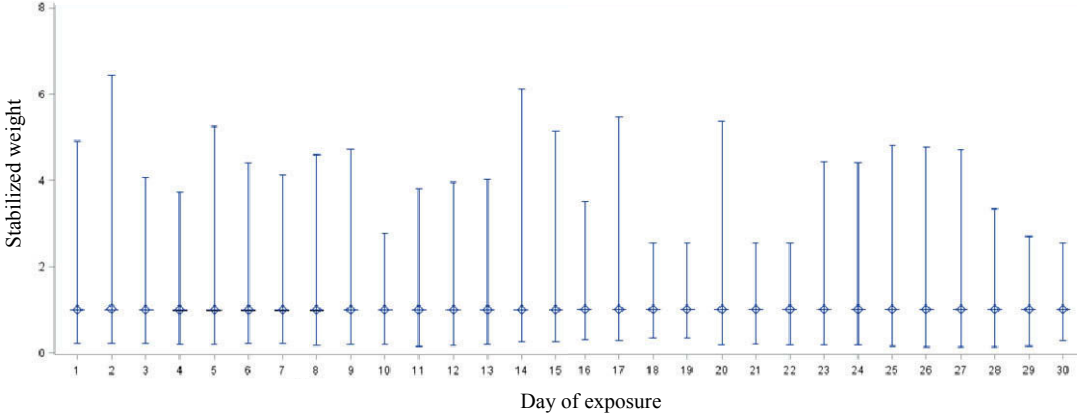
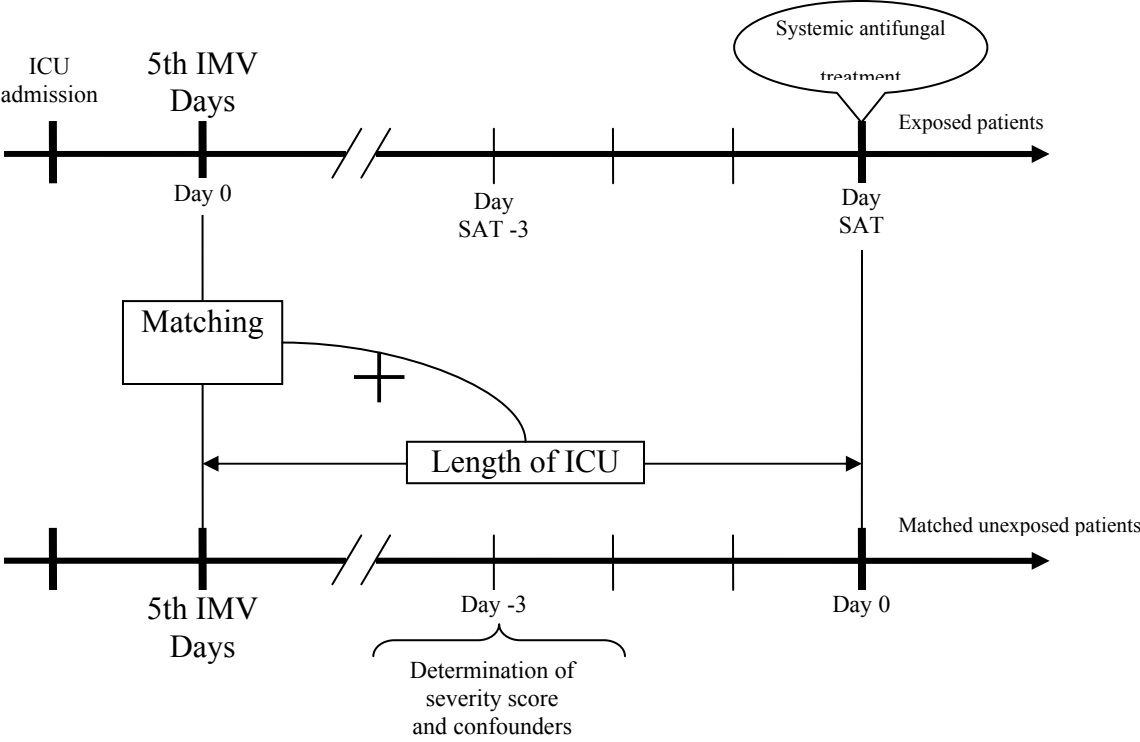

Figure E3: A chart illustrating the matching process for the matched-cohort design. SAT: systemic antifungal treatment; Day SAT: day of SAT administration in the exposed patient; Day 0: corresponding day of day SAT in the unexposed patient; ICU intensive care unit; IMV: invasive mechanic ventilation; Matching criteria: sex, age, SOFA score at 5th IMV day, chronic disease, type of admission in ICU.



ESM References

1. Leon C, Ostrosky-Zeichner L, Schuster M. What's new in the clinical and diagnostic management of invasive candidiasis in critically ill patients. *Intensive care medicine* 2014.
2. Tissot F, Lamoth F, Hauser PM, Orasch C, Fluckiger U, Siegemund M, Zimmerli S, Calandra T, Bille J, Eggimann P, Marchetti O. beta-glucan antigenemia anticipates diagnosis of blood culture-negative intraabdominal candidiasis. *American journal of respiratory and critical care medicine* 2013; 188: 1100-1109.
3. Cole SR, Hernan MA. Constructing inverse probability weights for marginal structural models. *Am J Epidemiol* 2008; 168: 656-664.
4. Robins JM, Hernan MA, Brumback B. Marginal structural models and causal inference in epidemiology. *Epidemiology* 2000; 11: 550-560.
5. Hernan MA, Brumback B, Robins JM. Marginal structural models to estimate the causal effect of zidovudine on the survival of HIV-positive men. *Epidemiology* 2000; 11: 561-570.
6. Petersen ML, Porter KE, Gruber S, Wang Y, van der Laan MJ. Diagnosing and responding to violations in the positivity assumption. *Stat Methods Med Res* 2012; 21: 31-54.
7. Funk MJ, Westreich D, Wiesen C, Sturmer T, Brookhart MA, Davidian M. Doubly Robust Estimation of Causal Effects. *American Journal of Epidemiology* 2011; 173: 761-767.
8. Lunceford JK, Davidian M. Stratification and weighting via the propensity score in estimation of causal treatment effects: a comparative study. *Stat Med* 2004; 23: 2937-2960.
9. Lau B, Cole SR, Gange SJ. Competing risk regression models for epidemiologic data. *American journal of epidemiology* 2009; 170: 244-256.
10. Nguile-Makao M, Zahar JR, Francais A, Tabah A, Garrouste-Orgeas M, Allaouchiche B, Goldgran-Toledano D, Azoulay E, Adrie C, Jamali S, Clec'h C, Souweine B, Timsit JF. Attributable mortality of ventilator-associated pneumonia: respective impact of main characteristics at ICU admission and VAP onset using conditional logistic regression and multi-state models. *Intensive Care Med* 2010; 36: 781-789.

Conclusion

I. Apport de la thèse sur la prise en charge des candidoses invasives

La prise en charge des candidoses invasives est une problématique d'actualité dans le système de soin et plus particulièrement en unité de soins intensifs. Ces infections sont responsables d'une aggravation du pronostic du patient, d'un prolongement du séjour d'hospitalisation et d'une augmentation conséquente des coûts de prise en charge des patients.

Les stratégies de traitement probabiliste mises en place pour diminuer l'impact des candidoses invasives entraînent une augmentation des coûts et induisent une pression de sélection des espèces *Candida* conduisant à la survenue d'échecs thérapeutiques liés à l'émergence de résistances et n'ont pas montré de bénéfice particulier sur le pronostic du patient.

Dans la première partie de la thèse, nous avons approfondi l'étude de l'impact des traitements antifongiques sur la distribution et la sensibilité des espèces *Candida* en USI, sur dix ans. Grâce à l'application des modèles ARIMA sur les séries temporelles, cette étude a permis de confirmer que l'utilisation croissante des échinocandines tendait à modifier la distribution des espèces et leur sensibilité. Les résultats observés soulignent l'importance d'optimiser la prescription des traitements antifongiques pour éviter d'accroître la pression de sélection en USI.

Dans la deuxième partie, nous avons montré que, quel que soit le type de flacon d'hémoculture utilisé, le traitement antifongique diminue le taux de positivité et augmente le temps de positivité. Ainsi, la mise en place d'un traitement précoce peut allonger la durée d'identification de l'espèce fongique, nécessaire à la détermination du traitement adéquat, mais peut également entraîner un sous-diagnostic de candidémie en cas d'absence de positivité du flacon. La combinaison de deux types de flacons d'hémoculture, avec et sans résines, apporte une réelle plus value dans la détection des espèces *Candida*, et devrait être privilégiée pour le suivi des patients ayant une candidose invasive.

La désescalade qui est une stratégie possible pour limiter la surconsommation de traitement antifongique n'avait pas fait l'objet d'étude comparative. En utilisant une méthode d'inférence causale adaptée, nous avons pu mettre en évidence que la mise en place d'une désescalade du traitement dans les cinq jours n'aggrave pas le pronostic du patient. Cela consolide le fait qu'une désescalade précoce peut être une alternative fiable, dans le cas où l'infection n'est pas documentée et que le patient est stabilisé. Des investigations plus poussées devront être faites pour des patients à haut risque de candidose invasive, notamment les patients chirurgicaux, pour confirmer la désescalade précoce dans la prise en charge des patients candidémiques en réanimation et modifier les recommandations dans ce sens.

Enfin, nous avons montré que l'administration d'un traitement antifongique empirique n'améliore pas le pronostic des patients. Cela confirme les différentes études réalisées, qui ne mettaient pas en évidence d'effet protecteur du traitement précoce et la nécessité de mieux cibler les patients pour lesquels une stratégie probabiliste sera la plus efficace.

II. Apport des méthodes statistiques sur l'exploration des données observationnelles

Les séries chronologiques

Les modèles ARIMA, et de manière plus générale les modèles sur séries chronologiques présentent l'intérêt d'exploiter les informations contenues dans les données pour pouvoir prédire leur propre évolution. Ces modèles ont montré leur intérêt dans la comparaison de deux séries temporelles pour l'étude de la pression de sélection exercée par les traitements antifongiques en USI. Ce qui aurait été possible, et que nous n'avons pas pu réaliser dans le cadre de cette thèse, est de comparer simultanément l'effet de plusieurs séries temporelles, comme les consommations en antibiotique ou les populations bactériennes. Enfin, une des applications envisageable de ces méthodes est le suivi continu, sous forme de tableau de bord, de la consommation d'antifongiques et des CMI, pour prédire l'évolution de la sensibilité des

différents germes et ainsi adapter au fur et à mesure les pratiques. Ce type d'analyse demande davantage de moyens pour être mise en œuvre en routine, mais illustre la puissance de ces outils.

Les méthodes d'inférence causale

Les méthodes d'inférence causale comme les modèles structurels marginaux avec un estimateur IPTW permettent d'exploiter des données observationnelles longitudinales pour estimer l'effet causal moyen. L'estimation obtenue est proche de celle d'un essai clinique randomisé, ce qui fait de ces méthodes une alternative de choix aux essais cliniques randomisés, lorsque ceux-ci ne sont pas possibles à mettre en place. Dans le cas d'une pathologie rare, telle que les candidoses invasives, les MSM permettent de tirer profit de grandes bases de données dans lesquelles le nombre d'événements est plus important, et qui sont plus représentatives de la réalité que ne l'est un essai clinique randomisé.

Ces méthodes n'ont pas vocation à remplacer les études expérimentales, qui resteront, malgré leurs limites, la meilleure stratégie pour déterminer un lien de causalité. Mais avec l'augmentation des données recueillies dans les différents CHU, les études pseudo-randomisées devraient se développer par la suite. Pour cela, la vulgarisation de ces méthodes a été réalisée pour assurer leur appropriation par les cliniciens. En effet, la mise en place de méthodes d'inférence causale nécessite une interaction forte entre le médecin qui maîtrise la connaissance clinique, et le statisticien qui doit s'assurer du bon respect des hypothèses sous-jacentes à ses modèles tout en étant en mesure de répondre à la question posée avec le biais le plus faible possible. Ces travaux ont été l'occasion de bien comprendre le fonctionnement des MSM, leur intérêt et leurs limites, permettant d'envisager de nouvelles applications dans le champ des USI.

III. Perspectives sur les candidoses invasives

L'identification des patients à risque de candidose invasive

Nous avons souligné dans les différentes parties de cette thèse la nécessité d'identifier plus précisément les patients à risque de développer une candidose invasive. Actuellement, les principaux scores cliniques existants sont essentiellement basés sur la colonisation multisite à *Candida*. [63, 64] L'utilisation de méthode de clustérisation sur la base AmarCand2 pourrait permettre d'établir les profils cliniques des patients recevant un traitement antifongique précoce, que ce soit pour une candidose documentée ou une candidose suspectée. Et parmi ces derniers, il sera intéressant d'explorer ce qui différencie les patients développant une candidose secondairement documentée des autres.

L'identification des effets liés aux USI

Il n'y a pas d'études qui se soit intéressée plus spécifiquement à la part des caractéristiques des USI dans la survenue des candidoses invasives. Une approche utilisant des modèles de fragilité, toujours en exploitant les données de la base AmarCand2, pourra contribuer à préciser les facteurs de risque de candidoses invasives.

L'optimisation du diagnostic

L'apport des méthodes statistiques sur données longitudinales peut permettre d'exploiter d'une autre façon les résultats des données biologiques. En effet, il a été montré que le 1-3- β -D-glucane est un marqueur non spécifique des candidoses invasives. Il pourrait être intéressant d'envisager une étude sur l'évolution de ces marqueurs dans le temps pour les patients ayant une candidose invasive prouvée en exploitant les données qui ont été recueillies dans le cadre de l'essai clinique Empiricus. [65]

IV. Perspectives statistiques

Nous avons utilisé la forme la plus simple des MSM avec des hypothèses concernant la prise en compte des risques compétitifs basées sur des probabilités estimées. D'autres méthodes ont été développées, utilisant des estimateurs doubles robustes plus élaborés et plus complexes qui minimisent le poids des hypothèses de positivité et de mauvaise spécification des variables des modèles. Cependant, il n'existe pas d'application clinique de ces méthodes en USI actuellement. La base OutcomeRea est un support privilégié pour mettre en pratique ces méthodes et en tirer les enseignements nécessaires à une plus large diffusion.

Par ailleurs, nous nous sommes posé un certain nombre de questions méthodologiques qui pourront être approfondies, notamment la prise en compte de traitements ayant plus de deux modalités, de traitements évoluant au cours du temps de façon dynamique, la prise en compte de différents niveaux de temps, de niveaux hiérarchiques. Certaines de ces questions ont pu être explorées dans le cas d'autres applications sur les problématiques néphrologiques ou hématologiques en réanimation.

Enfin, comme nous l'avons présenté précédemment, un des grands enjeux pour la suite est de pouvoir analyser de façon plus précise les données longitudinales, et notamment les profils de patients, cliniques ou biologiques, évoluant au cours du temps. Ces approches, déjà mises en pratiques dans le cas des modèles de trajectoires ou des modèles à croissance latente, permettent d'affiner l'information pour mieux comprendre les phénomènes sous-jacents des pathologies, que ce soit en réanimation ou dans d'autres domaines.

Références bibliographiques

1. Tortorano AM, Peman J, Bernhardt H, Klingspor L, Kibbler CC, Faure O, Biraghi E, Canton E, Zimmermann K, Seaton S, Grillot R, (2004) Epidemiology of candidaemia in Europe: results of 28-month European Confederation of Medical Mycology (ECMM) hospital-based surveillance study. *European journal of clinical microbiology & infectious diseases* : official publication of the European Society of Clinical Microbiology 23: 317-322
2. Fridkin SK, (2005) The changing face of fungal infections in health care settings. *Clin Infect Dis* 41: 1455-1460
3. Enoch DA, Ludlam HA, Brown NM, (2006) Invasive fungal infections: a review of epidemiology and management options. *J Med Microbiol* 55: 809-818
4. Marchetti O, Bille J, Fluckiger U, Eggimann P, Ruef C, Garbino J, Calandra T, Glauser MP, Tauber MG, Pittet D, (2004) Epidemiology of candidemia in Swiss tertiary care hospitals: secular trends, 1991-2000. *Clin Infect Dis* 38: 311-320
5. Beck-Sague C, Jarvis WR, (1993) Secular trends in the epidemiology of nosocomial fungal infections in the United States, 1980-1990. *National Nosocomial Infections Surveillance System. J Infect Dis* 167: 1247-1251
6. Fridkin SK, Jarvis WR, (1996) Epidemiology of nosocomial fungal infections. *Clin Microbiol Rev* 9: 499-511
7. Vincent JL, Rello J, Marshall J, Silva E, Anzueto A, Martin CD, Moreno R, Lipman J, Gomersall C, Sakr Y, Reinhart K, (2009) International study of the prevalence and outcomes of infection in intensive care units. *JAMA* 302: 2323-2329
8. Arendrup MC, Bruun B, Christensen JJ, Fuursted K, Johansen HK, Kjaeldgaard P, Knudsen JD, Kristensen L, Moller J, Nielsen L, Rosenvinge FS, Roder B, Schonheyder HC, Thomsen MK, Truberg K, (2011) National surveillance of fungemia in Denmark (2004 to 2009). *J Clin Microbiol* 49: 325-334
9. Eggimann P, Garbino J, Pittet D, (2003) Epidemiology of *Candida* species infections in critically ill non-immunosuppressed patients. *Lancet Infect Dis* 3: 685-702
10. Eggimann P, Bille J, Marchetti O, (2011) Diagnosis of invasive candidiasis in the ICU. *Ann Intensive Care* 1: 37
11. Garrouste-Orgeas M, Timsit JF, Tafflet M, Misset B, Zahar JR, Soufir L, Lazard T, Jamali S, Mourvillier B, Cohen Y, De Lassece A, Azoulay E, Cheval C, Descorps-Declere A, Adrie C, Costa de Beauregard MA, Carlet J, (2006) Excess risk of death from intensive care unit-acquired nosocomial bloodstream infections: a reappraisal. *Clin Infect Dis* 42: 1118-1126
12. Pittet D, Li N, Woolson RF, Wenzel RP, (1997) Microbiological factors influencing the outcome of nosocomial bloodstream infections: a 6-year validated, population-based model. *Clin Infect Dis* 24: 1068-1078
13. Wisplinghoff H, Bischoff T, Tallent SM, Seifert H, Wenzel RP, Edmond MB, (2004) Nosocomial bloodstream infections in US hospitals: analysis of 24,179 cases from a prospective nationwide surveillance study. *Clin Infect Dis* 39: 309-317
14. Lortholary O, Renaudat C, Sitbon K, Madec Y, Denoeud-Ndam L, Wolff M, Fontanet A, Bretagne S, Dromer F, (2014) Worrying trends in incidence and mortality of candidemia in intensive care units (Paris area, 2002-2010). *Intensive Care Med* 40: 1303-1312
15. Bitar D, Lortholary O, Le Strat Y, Nicolau J, Coignard B, Tattevin P, Che D, Dromer F, (2014) Population-based analysis of invasive fungal infections, France, 2001-2010. *Emerg Infect Dis* 20: 1149-1155
16. Harbarth S, Ferriere K, Hugonnet S, Ricou B, Suter P, Pittet D, (2002) Epidemiology and prognostic determinants of bloodstream infections in surgical intensive care. *Arch Surg* 137: 1353-1359; discussion 1359

17. Morrell M, Fraser VJ, Kollef MH, (2005) Delaying the empiric treatment of candida bloodstream infection until positive blood culture results are obtained: a potential risk factor for hospital mortality. *Antimicrob Agents Chemother* 49: 3640-3645
18. Garey KW, Rege M, Pai MP, Mingo DE, Suda KJ, Turpin RS, Bearden DT, (2006) Time to initiation of fluconazole therapy impacts mortality in patients with candidemia: a multi-institutional study. *Clin Infect Dis* 43: 25-31
19. Bassetti M, Righi E, Ansaldi F, Merelli M, Trucchi C, De Pascale G, Diaz-Martin A, Luzzati R, Rosin C, Lagunes L, Treçarichi EM, Sanguinetti M, Posteraro B, Garnacho-Montero J, Sartor A, Rello J, Rocca GD, Antonelli M, Tumbarello M, (2014) A multicenter study of septic shock due to candidemia: outcomes and predictors of mortality. *Intensive Care Med* 40: 839-845
20. Azoulay E, Dupont H, Tabah A, Lortholary O, Stahl JP, Francais A, Martin C, Guidet B, Timsit JF, (2012) Systemic antifungal therapy in critically ill patients without invasive fungal infection*. *Crit Care Med* 40: 813-822
21. Lewis RE, (2011) Current Concepts in Antifungal Pharmacology. *Mayo Clin Proc* 86: 805-817
22. Pappas PG, Kauffman CA, Andes D, Benjamin DK, Jr., Calandra TF, Edwards JE, Jr., Filler SG, Fisher JF, Kullberg BJ, Ostrosky-Zeichner L, Reboli AC, Rex JH, Walsh TJ, Sobel JD, (2009) Clinical practice guidelines for the management of candidiasis: 2009 update by the Infectious Diseases Society of America. *Clin Infect Dis* 48: 503-535
23. Cornely OA, Bassetti M, Calandra T, Garbino J, Kullberg BJ, Lortholary O, Meersseman W, Akova M, Arendrup MC, Arikian-Akdagli S, Bille J, Castagnola E, Cuenca-Estrella M, Donnelly JP, Groll AH, Herbrecht R, Hope WW, Jensen HE, Lass-Flörl C, Petrikos G, Richardson MD, Roilides E, Verweij PE, Viscoli C, Ullmann AJ, (2012) ESCMID* guideline for the diagnosis and management of *Candida* diseases 2012: non-neutropenic adult patients. *Clin Microbiol Infect* 18 Suppl 7: 19-37
24. Weiss E, Timsit JF, (2014) Management of invasive candidiasis in nonneutropenic ICU patients. *Ther Adv Infect Dis* 2: 105-115
25. Deshpande A, Gaur S, Bal AM, (2013) Candidaemia in the non-neutropenic patient: a critique of the guidelines. *Int J Antimicrob Agents* 42: 294-300
26. Munoz P, Valerio M, Vena A, Bouza E, (2015) Antifungal stewardship in daily practice and health economic implications. *Mycoses* 58 Suppl 2: 14-25
27. Zaoutis TE, Argon J, Chu J, Berlin JA, Walsh TJ, Feudtner C, (2005) The epidemiology and attributable outcomes of candidemia in adults and children hospitalized in the United States: a propensity analysis. *Clin Infect Dis* 41: 1232-1239
28. Hassan I, Powell G, Sidhu M, Hart WM, Denning DW, (2009) Excess mortality, length of stay and cost attributable to candidaemia. *J Infect* 59: 360-365
29. Fekkar A, Dannaoui E, Meyer I, Imbert S, Brossas JY, Uzunov M, Mellon G, Nguyen S, Guiller E, Caumes E, Leblond V, Mazier D, Fievet MH, Darty A, (2014) Emergence of echinocandin-resistant *Candida* spp. in a hospital setting: a consequence of 10 years of increasing use of antifungal therapy? *Eur J Clin Microbiol Infect Dis*
30. Fournier P, Schwebel C, Maubon D, Vesin A, Lebeau B, Foroni L, Hamidfar-Roy R, Cornet M, Timsit JF, Pelloux H, (2011) Antifungal use influences *Candida* species distribution and susceptibility in the intensive care unit. *The Journal of antimicrobial chemotherapy* 66: 2880-2886
31. Alexander BD, Johnson MD, Pfeiffer CD, Jimenez-Ortigosa C, Catania J, Booker R, Castanheira M, Messer SA, Perlin DS, Pfaller MA, (2013) Increasing echinocandin resistance in *Candida glabrata*: clinical failure correlates with presence of FKS

- mutations and elevated minimum inhibitory concentrations. *Clin Infect Dis* 56: 1724-1732
32. Robins JM, Hernan MA, Brumback B, (2000) Marginal structural models and causal inference in epidemiology. *Epidemiology* 11: 550-560
 33. Charles PE, Dalle F, Aube H, Doise JM, Quenot JP, Aho LS, Chavanet P, Blettery B, (2005) *Candida* spp. colonization significance in critically ill medical patients: a prospective study. *Intensive Care Med* 31: 393-400
 34. Grim SA, Berger K, Teng C, Gupta S, Layden JE, Janda WM, Clark NM, (2012) Timing of susceptibility-based antifungal drug administration in patients with *Candida* bloodstream infection: correlation with outcomes. *The Journal of antimicrobial chemotherapy* 67: 707-714
 35. Helfenstein U, (1996) Box-Jenkins modelling in medical research. *Stat Methods Med Res* 5: 3-22
 36. Lopez-Lozano JM, Monnet DL, Yague A, Burgos A, Gonzalo N, Campillos P, Saez M, (2000) Modelling and forecasting antimicrobial resistance and its dynamic relationship to antimicrobial use: a time series analysis. *Int J Antimicrob Agents* 14: 21-31
 37. Monnet DL, Lopez-Lozano JM, Campillos P, Burgos A, Yague A, Gonzalo N, (2001) Making sense of antimicrobial use and resistance surveillance data: application of ARIMA and transfer function models. *Clin Microbiol Infect* 7 Suppl 5: 29-36
 38. Harvey AC (1993) *Time Series Models: 2nd Edition*. The MIT Press, Cambridge, Mass
 39. Ph.D JCB, Ph.D DAD (2003) *SAS for Forecasting Time Series, Second Edition*. SAS Publishing, Cary, NC
 40. Leon C, Ostrosky-Zeichner L, Schuster M, (2014) What's new in the clinical and diagnostic management of invasive candidiasis in critically ill patients. *Intensive Care Med* 40: 808-819
 41. Kock R, Eissing LC, Boschini MG, Ellger B, Horn D, Idelevich EA, Becker K, (2013) Evaluation of bactec mycosis IC/F and Plus Aerobic/F blood culture bottles for detection of *Candida* in the presence of antifungal agents. *J Clin Microbiol* 51: 3683-3687
 42. Jekarl DW, Lee SY, Lee S, Park YJ, Lee J, Baek SM, An YJ, Ock SM, Lee MK, (2012) Comparison of the Bactec Fx Plus, Mycosis IC/F, Mycosis/F Lytic blood culture media and the BacT/Alert 3D FA media for detection of *Candida* species in seeded blood culture specimens containing therapeutic peak levels of fluconazole. *J Clin Lab Anal* 26: 412-419
 43. Austin PC, Tu JV, Alter DA, (2003) Comparing hierarchical modeling with traditional logistic regression analysis among patients hospitalized with acute myocardial infarction: should we be analyzing cardiovascular outcomes data differently? *Am Heart J* 145: 27-35
 44. Sullivan LM, Dukes KA, Losina E, (1999) Tutorial in biostatistics. An introduction to hierarchical linear modelling. *Stat Med* 18: 855-888
 45. Diez-Roux AV, (2000) Multilevel analysis in public health research. *Annu Rev Public Health* 21: 171-192
 46. Parascandola M, Weed DL, (2001) Causation in epidemiology. *J Epidemiol Community Health* 55: 905-912
 47. Hill AB, (1965) The Environment and Disease: Association or Causation? *Proc R Soc Med* 58: 295-300
 48. Phillips CV, Goodman KJ, (2004) The missed lessons of Sir Austin Bradford Hill. *Epidemiol Perspect Innov* 1: 3

49. Little RJ, Rubin DB, (2000) Causal effects in clinical and epidemiological studies via potential outcomes: concepts and analytical approaches. *Annu Rev Public Health* 21: 121-145
50. Black N, (1996) Why we need observational studies to evaluate the effectiveness of health care. *BMJ* 312: 1215-1218
51. Hernan M, (2004) A definition of causal effect for epidemiological research. *J Epidemiol Community Health* 58: 265-271
52. Port FK, (2000) Role of observational studies versus clinical trials in ESRD research. *Kidney Int* 57: S3-S6
53. Black N, (1996) Why we need observational studies to evaluate the effectiveness of health care. *Bmj* 312: 1215-1218
54. Dreyer NA, Tunis SR, Berger M, Ollendorf D, Mattox P, Gliklich R, (2010) Why observational studies should be among the tools used in comparative effectiveness research. *Health Aff (Millwood)* 29: 1818-1825
55. Benson K, Hartz AJ, (2000) A comparison of observational studies and randomized, controlled trials. *The New England journal of medicine* 342: 1878-1886
56. Rosenbaum PR, Rubin DB, (1983) The central role of the propensity score in observational studies for causal effects. *Biometrika* 70: 41-55
57. Pirracchio R, Carone M, Rigon MR, Caruana E, Mebazaa A, Chevret S, (2013) Propensity score estimators for the average treatment effect and the average treatment effect on the treated may yield very different estimates. *Stat Methods Med Res*
58. Funk MJ, Westreich D, Wiesen C, Sturmer T, Brookhart MA, Davidian M, (2011) Doubly Robust Estimation of Causal Effects. *American Journal of Epidemiology* 173: 761-767
59. Hernan MA, Robins JM, (2006) Estimating causal effects from epidemiological data. *J Epidemiol Community Health* 60: 578-586
60. Robins JM, (2008) Causal models for estimating the effects of weight gain on mortality. *Int J Obes (Lond)* 32 Suppl 3: S15-41
61. Cole SR, Hernán MA, (2008) Constructing Inverse Probability Weights for Marginal Structural Models. *American Journal of Epidemiology* 168: 656-664
62. Rothwell PM, (2005) External validity of randomised controlled trials: "to whom do the results of this trial apply?". *Lancet* 365: 82-93
63. Pittet D, Monod M, Suter PM, Frenk E, Auckenthaler R, (1994) Candida colonization and subsequent infections in critically ill surgical patients. *Ann Surg* 220: 751-758
64. Leon C, Ruiz-Santana S, Saavedra P, Almirante B, Nolla-Salas J, Alvarez-Lerma F, Garnacho-Montero J, Leon MA, (2006) A bedside scoring system ("Candida score") for early antifungal treatment in nonneutropenic critically ill patients with Candida colonization. *Crit Care Med* 34: 730-737
65. Timsit JF, Azoulay E, Cornet M, Gangneux JP, Jullien V, Vesin A, Schir E, Wolff M, (2013) EMPIRICUS micafungin versus placebo during nosocomial sepsis in Candida multi-colonized ICU patients with multiple organ failures: study protocol for a randomized controlled trial. *Trials* 14: 399