



**HAL**  
open science

# Schistosoma mansoni sirtuins : characterization of their role in schistosome energy metabolism

Alejandro Cabezas-Cruz

► **To cite this version:**

Alejandro Cabezas-Cruz. Schistosoma mansoni sirtuins : characterization of their role in schistosome energy metabolism. Human health and pathology. Université du Droit et de la Santé - Lille II, 2016. English. NNT : 2016LIL2S009 . tel-01400664

**HAL Id: tel-01400664**

**<https://theses.hal.science/tel-01400664>**

Submitted on 22 Nov 2016

**HAL** is a multi-disciplinary open access archive for the deposit and dissemination of scientific research documents, whether they are published or not. The documents may come from teaching and research institutions in France or abroad, or from public or private research centers.

L'archive ouverte pluridisciplinaire **HAL**, est destinée au dépôt et à la diffusion de documents scientifiques de niveau recherche, publiés ou non, émanant des établissements d'enseignement et de recherche français ou étrangers, des laboratoires publics ou privés.

UNIVERSITÉ DU DROIT ET DE LA SANTÉ  
École Doctoral Biologie - Santé  
Faculté des Sciences Pharmaceutiques et Biologiques de Lille

Order Number:

**DOCTORAL THESIS**

To obtain the degree of

**DOCTOR FROM THE UNIVERSITY OF LILLE II**

*Discipline: Biologie moléculaire et structurale, biochimie*

Presented by

**Alejandro CABEZAS-CRUZ**

9 September 2016

***Schistosoma mansoni* sirtuins: characterization of  
their role in schistosome energy metabolism.**

Composition of the Jury:

President: Professor El Moukhtar Aliouat

Rapporteurs: Professor A. G. M. Tielens

Professor Christoph Grunau

Examineur: Doctor James J. Valdés

Doctor Raymond Pierce

Centre d'Infection et d'Immunité de Lille (CIIL)  
Université Lille Nord de France INSERM U1019 – CNRS UMR 8204  
Institut Pasteur de Lille  
1 rue du Professor Calmette 59019 Lille Cedex France

# Acknowledgements

In first place I would like to thank my supervisor Dr. Raymond Pierce, Ray. I have several things to thank to Ray. Firstly, I would like to thank that Ray selected me as his student in 2013. Secondly, before starting this PhD, I did not know anything about Epigenetics or Schistosoma, Ray taught me the concepts, and he was an amazing help to discuss ideas and experiments on Schistosoma. As a result, I developed a passion for parasite epigenetics. Thirdly, Ray was really supportive about my other passion: ticks. He allowed me to reach my potential, and never stopped me or discouraged me in pursuing my second PhD.

Another key person in this PhD was Julien Lancelot, my friend. Without Julien, it would have been impossible for me to do all the experiments included in the thesis. I think Julien is the soul of the group. He was/is always eager to help everyone. He is the person that will put the interest of the group above his own interests, and that is something very valuable in a scientific team. Remarkably, he is always in good mood and is very enthusiastic about every new idea, therefore it was very easy for me to work with him. Thank you Julien !!!

I also want to thank Dr. Jamal Khalife, Jamal. My friend Jamal, that together with Ray, we share a passion for coffee ☺ This passion led us to every morning, while drinking coffee, share thoughts and ideas about science and life in general. In addition, Jamal always shared his gluten-free food reserves with me ☺ and importantly, he was the first in finding that I was in the list of INRA, when I had lost my hope.

My brother Jimi was also an important “structural” component of this thesis. He helped me to find out how the glucose was going through the schisto glucose transporters.

Thank you to all the group: Colette (for useful discussions), Steph (for technical assistance), Jacques (for technical assistance), Christine (for being so nice to me), Anne (for preparing nice cakes ☺) and the students Marion (for helping without limits), Astrid (for being my nice closest neighbor ☺), Thomas (for your playful way), Geraldine (for your smile), Bénédicte (for showing strength and hard work), Lucy (for showing strength) and Jordinelis (for having an immense hunger for learning). This was a favorable environment to learn and express my ideas.

Thank you to my family that even when far away, fuels my will.

Thank you Cami, my wife, for supporting my efforts.

Thank you to my daughters, Carmen Alicia, Carmen Sofia, Chloe and Clemence, which are an infinite source of motivation.

# Abstract

This thesis focuses on the metabolism of the parasite *Schistosoma mansoni*. During its life cycle, *S. mansoni* experiences drastic environmental changes that include: free-living stages in water and endoparasitism in invertebrate (i.e. snails) and vertebrate (i.e. mammals) hosts. In consequence, this parasite shows an amazing metabolic plasticity characterized by drastic metabolic switches from one stage to another. One of the more interesting is the switch from oxidative phosphorylation to aerobic glycolysis that occurs when the free-living stage, cercariae, infects the mammalian host. This switch is dependent on host glucose and is totally reversible when glucose concentration is low. Here, we study in details the evolution of the glucose transporters of *S. mansoni* as well as the potential role of histone modifying enzymes (i.e. sirtuins) in the regulation of the metabolic switch. The thesis is organized of three chapters.

**Chapter I** is a general **introduction** to genus schistosoma, its taxonomy and more prominent members, their epidemiology and current control strategies. We further introduce our current knowledge on the epigenetic machinery of these parasites as well as the sirtuin protein family.

In **Chapter II** we present the **results** of the thesis and this chapter is separated in two parts: (i) the evolution and molecular properties of glucose transporters in *S. mansoni*, (ii) and the role of Sirtuin 1 in the regulation of the mitochondrial metabolism of schistosomula, the mammalian stage of *S. mansoni*. We found that the glucose transporters from *S. mansoni*, SGTP1, SGTP2, SGTP3 and SGTP4 followed different evolutionary paths. Our results suggested that *S. mansoni* class I glucose transporters (SGTP2 and SGTP3) lost their capacity to transport glucose and that this function evolved independently in the Platyhelminthes-specific glucose transporters (SGTP1 and SGTP4).

Regarding the role of sirtuins in the regulation of glucose metabolism in *S. mansoni*, we found that at high concentrations of glucose, *S. mansoni* sirtuin 1 (SmSirt1) stimulate mitochondrial activity. Sirtuin 1 Inhibitors as well as *SmSirt1* gene knockdown, by RNA interference, reduce the mitochondrial activity of schistosomula. In addition, SmSirt1 is a repressor of pyruvate dehydrogenase kinase 1 (PDK1), a major regulator of mitochondrial activity. However, SmSirt1 did not appear to repress the *S. mansoni* glucose transporters. This is in agreement with our analysis of glucose transporter evolution because in mammals, Sirt1 regulates the expression of class I glucose transporters and our results showed that class I glucose transporters in *S. mansoni* do not transport glucose.

Finally, in **Chapter III** we make a general discussion of the main findings of the thesis.

# **RESUME DE THESE**

## Les schistosomes, une vue d'ensemble

La Schistosomiase humaine (également appelée schistosomose ou bilharziose) est causée par des trématodes du genre *Schistosoma*. Les premières traces archéologiques des humains infectés par *Schistosoma spp.* ont été trouvées dans des momies égyptiennes datées de 5200 ans avant JC (Kloos et David, 2002; Anastasiou et al., 2014). Selon des estimations, la schistosomiase affecte plus de 250 millions de personnes dans le monde (Chitsulo et al., 2004; King et al., 2005; Vos et al., 2012; Colley et al., 2014.), parmi lesquelles environ 280 000 personnes meurent chaque année dans les pays endémiques (King et al., 2005). Huit espèces de Schistosomes ont été recensées comme infectant les humains: *S. mansoni*, *S. haematobium*, *S. intercalatum*, *S. guineensis*, *S. mattheei*, *S. japonicum*, *S. mekongi*, *S. malayensis* (Standley et al 2012). Cependant, les espèces les plus fréquemment rencontrées chez l'homme sont *S. mansoni*, *S. haematobium*, *S. japonicum* et *S. mekongi* qui sont distribuées principalement en Afrique, en Amérique du Sud et en Asie (OMS; Colley et al., 2014). De manière intéressante, des espèces hôtes vertébrées définitives, autres que l'homme, peuvent contribuer à l'épidémiologie et à la persistance dans la nature des schistosomes (Standley et al., 2012). La pathologie induite par *S. mansoni* est principalement associée à la rétention des œufs du parasite dans les tissus (Foie, intestin principalement) qui induit une maladie débilitante chronique (Chitsulo et al., 2004). À l'heure actuelle, il n'y a pas de vaccin disponible et il n'existe qu'un seul médicament efficace, le Praziquantel (Fenwick et al., 2009).

Il est important de mentionner que la répartition actuelle des espèces de Schistosome en Afrique, Amérique du Sud et en Asie (Colley et al., 2014), est à ce jour, en cours d'évolution. Par exemple, *S. haematobium* a été récemment mis en évidence dans la région méditerranéenne, en particulier en Corse (Holtfreter et al., 2014; De Laval et al., 2014; Brunet et al., 2015). Cette constatation, ainsi que d'une décennie de cas indigènes à travers l'Europe, ont soulevé des préoccupations au sujet de la présence de la schistosomiase en Europe (de Laval et al., 2014). Ainsi, Laval et ses collègues (2014) ont décrit trois conditions épidémiologiques permettant l'évaluation du risque de schistosomiase en Europe méditerranéenne: (i) cette zone est écologiquement favorable aux escargots du genre *Bulinus* qui sont les hôtes intermédiaires des schistosomes affectant l'homme (*S. haematobium*, *S. intercalatum* et *S. guiniensis*) et les animaux (*S. bovis*, *S.*

*curassoni*, *S. mattheei*, *S. leiperi* et *S. margrebowiei*) (Kane et al., 2008), (ii) le réchauffement climatique crée des conditions favorables à la transmission locale de *Schistosoma* spp. (McCreech et al., 2015), et (iii) les mouvements de populations qui rassemblent des personnes infectées des régions endémiques vers la région européenne. Ces migrations de populations permettent également, compte tenu des conditions, l'établissement de chaînes de transmission de la pathologie dans ces régions.

Un autre exemple de changement de la répartition de *Schistosoma* spp. est celui de la Chine, où *S. japonicum* est la principale espèce de schistosome que l'on retrouve (Yang et al., 2014). Toutefois, la hausse de l'activité commerciale entre la Chine et l'Afrique a augmenté la fréquence et la détection de *S. mansoni* et *S. haematobium* chez les travailleurs chinois de retour de l'Afrique (Liang et al., 2013). Cette condition, ainsi que la présence d'habitats écologiques de *Biomphalaria straminea*, un hôte intermédiaire de *S. mansoni*, à Hong Kong (Wang et al., 2013; Liang et al., 2013) ainsi que le réchauffement climatique devrait augmenter la risque d'infections par *S. mansoni* dans la partie continentale chinoise (Liang et al., 2013).

Un autre facteur qui peut influencer sur la répartition actuelle des *Schistosoma* spp. est la capacité des espèces de schistosomes à s'hybrider entre elles. L'hybridation entre schistosomes influence l'épidémiologie de la maladie et optimise les caractéristiques phénotypiques en affectant la transmission, la morbidité et la sensibilité aux médicaments (Webster et al., 2013). Les deux principaux cas d'hybridation comprenant les schistosomes humains sont ceux entre *S. haematobium* et *S. bovis* et entre *S. mansoni* et *S. bovis* (Standley et al., 2012), mais l'hybridation de *S. haematobium* et *S. curassoni* a aussi été rapportée (Webster et al., 2013). En fait, certaines rapports études épidémiologiques, notamment en Corse (France) et au Bénin (Afrique) ont permis de mettre en évidence des hybrides entre *S. haematobium* / *S. bovis* (Moné et al., 2015, 2016). Au Sénégal, 88% des enfants diagnostiqués positifs présentent des infestations par des hybrides de *S. haematobium* / *S. curassoni* et *S. haematobium* / *S. bovis* (Webster et al., 2013). L'hybridation peut avoir un impact majeur sur l'évolution. Alors que l'hybridation peut entraîner une réduction de l'adaptabilité en raison de la stérilité en F1 et inviabilité, elle est en même temps une source de nouvelle variation génétique qui peut fournir la matière première pour la sélection naturelle et ainsi façonner l'évolution des traits écologiquement pertinents. Ainsi,

l'hybridation a le potentiel d'élargir la "surface de travail" pour la sélection en produisant toute une gamme de phénotypes potentiellement adaptatifs, allant d'un parent à l'autre et au-delà (King et al., 2015). En particulier, les patients infectés par des hybrides de schistosomes en Corse ont été affectés par une schistosomiase atypique (Moné et al., 2016).

### **Le contrôle de la schistosomiase, l'absence de traitements alternatifs**

Lors de la 65<sup>ème</sup> assemblée mondiale de la Santé qui a eu lieu le 26 mai 2012, l'Organisation Mondiale de la Santé (OMS) a lancé un appel à tous les pays endémique pour la schistosomiase dans le but d'éliminer cette maladie d'ici 2020. La pierre angulaire de cette proposition est l'accès massif aux médicaments schistosomicides dans les pays endémiques dont la population traitée est passée de 12 millions de personnes en 2006 à 32,6 millions de personnes en 2010. L'administration de médicament en masse (MDA) est une politique clé dans les stratégies actuelles de lutte contre la schistosomiase. Le Praziquantel (PZQ), une pyrazinoisoquinoléine, qui a été présenté comme un nouveau vermifuge en 1975, est le médicament de choix (Day et al., 1992; Fenwick et Jourdan, 2016). Ce médicament, dont le mécanisme d'action est mal connu, est actif contre toutes les espèces de schistosomes, peut être administré facilement par voie orale, permet un taux élevé de guérison et de réduction de l'excrétion des œufs, et n'est accompagné que de légers effets secondaires (Day et al., 1992; El-Bassiouni et al., 2007). En outre, le PZQ réduit les complications graves et fréquentes de la schistosomiase telles que la fibrose périportale et l'hépatomégalie dans le cas de la schistosomiase intestinale (Fenwick et Jourdan, 2016). Une hypothèse concernant le mode d'action du PZQ a été envisagée et il semble que la molécule joue un rôle sur les canaux calciques voltage dépendant en entraînant un afflux rapide des ions  $Ca^{2+}$ , une contraction musculaire dépendante du calcium ainsi qu'une paralysie (Day et al., 1992). Ces effets peuvent être médiés *via* l'interaction de cette drogue avec une sous-unité bêta d'un canal calcique (Kohn et al., 2001). Quel que soit le mécanisme d'action, les grands efforts financiers et politiques pour lutter contre la schistosomiase reposent actuellement sur le PZQ.

En raison de l'effort international, le niveau d'intensité de l'infection est en baisse dans les pays où la MDA s'est généralisée par rapport aux niveaux observés avant que les traitements ne soient offerts. En effet, l'élimination de la schistosomiase comme problème



majeur de santé publique est un objectif réalisable (Rollinson et al., 2013), mais elle peut prendre plus de temps que prévu initialement (Fenwick et Jourdan, 2016). Des exemples de programmes de lutte contre la schistosomiase réussies existent: Sainte-Lucie et d'autres îles des Caraïbes, le Brésil et le Venezuela pour *S. mansoni*; L'Arabie Saoudite et l'Egypte pour les espèces *S. mansoni* et *S. haematobium*; Maroc, Tunisie, Algérie, Maurice et la République islamique d'Iran pour *S. haematobium*; Le Japon et la République populaire de Chine pour *S. japonicum* (Rollinson et al., 2013).

Cependant, les prévisions à long terme, fondées sur la modélisation mathématique à partir de 2015, indiquent que la prévalence de l'infection peut être sensiblement réduite dans moins de 10 ans, mais seulement si la participation communautaire est supérieure à 70% et que la MDA est maintenue. Un risque important de la réapparition de l'infection augmente notamment dès que la MDA est suspendue (Gurarie et al., 2015). Cela conduit à un paradoxe : alors que l'arrêt de la MDA augmente la prévalence de la schistosomiase, le maintien de la MDA est très susceptible d'induire l'apparition d'une résistance des schistosomes au PZQ. Une situation analogue est représentée par "la crise de résistance aux antibiotiques" à laquelle l'humanité est confrontée aujourd'hui (Ventola, 2015). Cette crise de la résistance aux antimicrobiens a deux composantes principales: l'utilisation excessive et abusive de ces médicaments, et le manque de développement de nouveaux médicaments par l'industrie pharmaceutique (Ventola, 2015).

Les organismes résistants semblent être faiblement représentés au sein des populations de parasites et de microbes avant même que les antibiotiques commencent à être largement utilisés. Par exemple, des staphylocoques résistants à la pénicilline ont été détectés trois ans avant que cet antibiotique n'ait été introduit en 1943 (Ventola, 2015). Ensuite, les antimicrobiens suppriment les organismes sensibles aux médicaments, ouvrant la voie aux organismes résistants (Ventola, 2015). En dépit de l'évidence et/ou du sens commun, le PZQ continuera à être sur-utilisé (MDA), et nous devons donc nous attendre à l'émergence de souches de schistosomes résistantes. En effet, des isolats de schistosomes résistants au PZQ ont déjà été détectés (Doenhoff et al., 2008; Melman et al., 2009; Liang et al., 2010) et peuvent être induits aisément *in vitro* au laboratoire (Pinto-Almeida et al., 2015).

### **Phylogénie des Neodermata, la controverse se poursuit.**

Parmi les Platyhelminthes, l'ordre Neodermata est composé de trois classes: Monogenea, Digenea et Cestoda. Les schistosomes appartiennent à la classe Digenea. Cependant, de nouvelles données remettent en question la relation évolutive des groupes au sein du Neodermata (Egger et al., 2015; Laumer et al., 2015; Littlewood et Waeschenbach, 2015). Alors qu'une étude réalisée par Laumer et al. (2015) a montré que la classe Cestoda est étroitement liée à la classe Monogenea et non à Digenea comme on le pensait auparavant (Perkins et al., 2010), une autre étude par des collègues d'Egger (2015) a émis deux hypothèses alternatives pour expliquer la relation de la classe Monogenea avec Cestoda et Digenea: (A) La classe Cestoda est étroitement liée à Digenea et la classe Monogenea est basale ou (B), les deux clades de Monogenea (Monopisthocotylea et Polyopisthocotylea) ainsi que les classes Cestoda et Digenea sont monophylétiques. Ces deux études ont fournies trois hypothèses principales pour l'origine du parasitisme dans les Neodermata (Littlewood et Waeschenbach, 2015). La première hypothèse est différente de celle de Perkins et al. (2010), car elle propose que l'endoparasitisme a d'abord évolué et que l'ectoparasitisme serait un trait dérivé. La seconde hypothèse est en accord avec celle de Perkins et al. (2010). En effet, l'ectoparasitisme a évolué d'abord et l'endoparasitisme serait un trait dérivé. Cependant, la troisième hypothèse propose une nouvelle idée dans laquelle l'endoparasitisme et l'ectoparasitisme ont évolués indépendamment chez les Cestoda, les Trematoda et les Monogenea, respectivement. Dans tous les cas, au moins l'organisation des trois principales catégories de Neodermata n'ont pas subis de changements dramatiques et dans la classe Digenea : le genre *Schistosoma* se regroupe avec des espèces parasitaires importantes, telles que *Clonorchis sinensis* et *Fasciola hepatica*.

### **Cycle de vie de *S. mansoni***

Dans la nature, le cycle de vie de *S. mansoni* comprend des miracidiums ciliés vivant en liberté qui se développent dans l'eau après l'éclosion des oeufs et infectent leurs hôtes intermédiaires, les Mollusque du genre *Biomphalaria*. Dans l'escargot, le parasite subit une répllication asexuée par étapes comprenant des sporocystes mères, puis filles, et va finalement libérer des dizaines de milliers de cercaires dans l'eau, un processus qui prend entre 4 à 6 semaines. La cercaire est stade parasite vivant librement dans l'eau qui peut

pénétrer la peau intacte des hôtes humains, devenant un stade parasitaire juvénile, le schistosomule. Les cercaires peuvent rester infectieuses dans l'eau douce pendant 1 à 3 jours, mais ils épuisent leurs réserves d'énergie considérablement au bout de quelques heures (Lawson et Wilson, 1980). La transformation de la cercaire en schistosomule est caractérisée par une série de changements physiologiques, métaboliques et structurels (Stirewalt, 1974). Le schistosomule migre vers les poumons et en 5 à 7 semaines, se développe en un ver adulte qui va se localiser dans les veines mésentériques. L'activité principale des vers adultes est la reproduction. Un schistosome adulte femelle peut pondre entre 200 et 300 œufs par jour (Huang et al., 2012). Les schistosomes adultes peuvent vivre de 3 à 10 ans en moyenne, mais dans certains cas, ils peuvent survivre jusqu'à 40 ans (Warren et al., 1974; Chabasse et al., 1985; Hornstein et al., 1990). Ils sont appariés en permanence : la femelle se place dans le canal gynécophore du mâle. Afin de satisfaire à l'intense production d'œufs, le parasite doit adapter son métabolisme et, comme les tumeurs, devient un grand consommateur de glucose, sa production d'ATP étant essentiellement fournie par la glycolyse (Thompson et al., 1984).

### **Aperçu du métabolisme du glucose chez *S. mansoni***

Chez l'hôte définitif mammifère les vers de *S. mansoni* absorbent de grandes quantités de glucose. En effet, ils utilisent en 1 heure une quantité de glucose équivalente à un sixième, voire à un cinquième, de leur poids sec. En outre, plus de 80% du glucose métabolisé est converti en acide lactique. Les taux d'utilisation du glucose et de la production d'acide lactique par *S. mansoni* sont les mêmes dans des conditions d'aérobie ou d'anaérobie. En conséquence, *S. mansoni* est reconnu comme étant un fermenteur homolactiques (Bueding, 1950). Même si les schistosomes possèdent une ventouse buccale et un intestin fonctionnel, le glucose est ingéré par les parasites à travers leur tégument essentiellement par l'action de deux transporteurs du glucose (Skelly et al., 1998). De même, il a été proposé que le tégument du parasite constitue également une voie importante d'excrétion de l'acide lactique (Faghiri et al., 2010).

Remarquablement, alors que la glycolyse aérobie représente une voie métabolique majeure de stades de *S. mansoni* présents chez les mammifères, le métabolisme énergétique

des cercaires vivant en liberté, est presque, à l'inverse entièrement basé sur la phosphorylation oxydative (OXPHOS). Il a été démontré que lors de l'infection de l'hôte vertébré, le schistosomule de *S. mansoni* subit un changement métabolique vers la glycolyse rapide, qui dépend de la concentration de glucose externe et peut se produire en présence d'oxygène (Thompson et al., 1984; Horemans et al., 1992).

### **Des transporteurs de glucose chez *S. mansoni***

Deux transporteurs fonctionnels de glucose ont été décrits chez *S. mansoni*, SGTP1 et SGTP4 (Skelly et al., 1994) conduisant à l'idée que, comme pour les tumeurs, l'absorption de glucose peut être régulée à la hausse afin de satisfaire aux exigences de la voie d'augmentation de la glycolyse. En fait, les vers adultes utilisent de grandes quantités de glucose provenant de l'hôte. Ce processus est essentiel pour le schistosome, puisque la suppression de l'expression de SGTP1 et SGTP4 à la suite d'expérience d'ARN interférence (ARNi) porte atteinte à la capacité du parasite à importer du glucose et diminue considérablement sa viabilité (Krautz-Peterson et al., 2010; Da'dara et al., 2012). SGTP1 et SGTP4 ont été largement caractérisées et constituent la base moléculaire de l'absorption du glucose chez *S. mansoni* (Skelly et al., 1994; Zhong et al., 1995, Jiang et al., 1996, Skelly et al., 1998; Krautz-Peterson et al., 2010; Da'dara et al., 2012). Ces transporteurs partagent les caractéristiques moléculaires des transporteurs de glucose de mammifères (Joost et Thorens 2001 ; Augustin, 2010). Chez les schistosomules et les vers adultes, SGTP1 et SGTP4 sont localisés au niveau du tégument de *S. mansoni* (Skelly et al., 1998). SGTP4 est présent à l'intérieur des membranes bicouches doubles apicales, tandis que SGTP1 se trouve dans les membranes bicouches lipidiques basales à lipides uniques (Zhong et al., 1995; Jiang et al., 1996). SGTP4 semble être localisé uniquement au niveau du tégument, tandis que SGTP1 peut également être détecté dans le corps du ver, en particulier dans le muscle (Zhong et al., 1995). Le modèle actuel de transport du glucose dans les schistosomes est basé sur le fait que SGTP4 transporte le glucose de la circulation sanguine vers le tégument, tandis que SGTP1 transporte le glucose dans les tissus internes (Skelly et al., 1998). En accord avec les études antérieures sur le transport du glucose chez *S. mansoni* (Cornford et Oldendorf, 1979), SGTP1 et SGTP4 ont été décrits comme des transporteurs du D-glucose, mais pas de son isomère, le L-glucose, ce qui démontre que le transport de glucose chez les schistosomes

est stéréospécifique (Skelly et al., 1994). SGTP1 et SGTP4 ont une spécificité flexible pour les hexoses, comme l'indique la capacité du mannose, du maltose, du galactose, du fructose d'entrer en compétition avec le glucose pour leur absorption (Skelly et al., 1994). Le mannose est le concurrent le plus efficace pour l'absorption du glucose par SGTP1 et SGTP4, un résultat similaire à celui obtenu avec des schistosomes entiers (Uglem et Read, 1975). Les deux transporteurs sont complètement inhibés par des inhibiteurs de transporteurs de glucose tels que la cytochalasine B et la phlorétine, mais ils sont peu sensibles à la phlorizine, qui serait un inhibiteur spécifique du transport de glucose dépendant du sodium (Skelly et al., 1994). Enfin, l'affinité du glucose est plus élevée pour SGTP1 ( $K_m = 1,3 \text{ mM}$ ) que pour SGTP4 ( $K_m = 2 \text{ mM}$ ).

### **La glycolyse chez *S. mansoni***

Toutes les enzymes de la glycolyse sont présentes chez *S. mansoni*, *S. japonicum* et *S. haematobium* (You et al., 2014). Plusieurs de ces enzymes ont été caractérisées chez les schistosomes tels que l'hexokinase (Bueding et Mackinnon, 1955a; Tielens et al., 1994; Tielens, 1997), l'énolase (Ramajo-Hernández et al., 2007; De la Torre-Escudero et al., 2010), le triosephosphate (Yu et al., 2006; Da'dara et al., 2008), la glycéraldéhyde 3 phosphate déshydrogénase (Goudot-CROZEL et al., 1989; Charrier-Ferrara et al., 1992), la phosphofructokinase (Mansour et al., 2000), la phosphoglycérate kinase (Lee et al., 1995), et la phosphoglucose isomérase (Bueding et Mackinnon, 1955b). De manière remarquable, même si ces enzymes glycolytiques sont codées dans le génome de *S. mansoni*, elles montrent une cinétique différente par rapport à celle des hôtes vertébrés (Bueding et Mackinnon, 1955a, 1955b; Bueding et Mansour, 1957). Les différences principales concernent les concentrations de substrat optimales et les constantes de dissociation pour les enzymes du schistosome qui sont généralement plus élevées que ceux de l'hôte (Mansour et Bueding, 1953).

### **La lactate déshydrogénase de *S. mansoni***

Le gène codant pour une lactate déshydrogénase (LDH) a été séquencé et caractérisé chez *S. mansoni* (Guerra-SA et al., 1998). Les mesures du taux de réduction du pyruvate en

lactate a révélé des différences dans l'effet du pH sur l'activité de la LDH de *S. mansoni* par rapport à l'enzyme de mammifère. L'activité optimale de l'enzyme du ver est à un pH de 6,9 et celle de l'enzyme de mammifère à un pH de 7,8 (Mansour et Bueding, 1953). De même, la gamme optimale pour l'oxydation du lactate en pyruvate est comprise entre un pH de 8,2 et 8,9 pour l'enzyme du schistosomes et un pH compris entre 9,0 et 9,5 pour l'enzyme du mammifère (Mansour et Bueding, 1953). Les constantes de dissociation et les concentrations optimales de lactate sont identiques pour les deux enzymes. Ces deux valeurs sont, cependant, six et douze fois plus élevée pour les enzymes du ver en présence de pyruvate (Mansour et Bueding, 1953). Par ailleurs, il a été montré que l'activité enzymatique de la LDH du Schistosome est différente entre les souches sensibles et résistantes de *S. mansoni* (Doong et al., 1987). Fait intéressant, les transcrits codant pour la LDH de *S. mansoni* sont exprimés chez les stades larvaires avec des niveaux plus élevés chez les vers adultes (Guerra-Sá et al., 1998). Cependant, lors de l'infection de l'hôte vertébré, SGTP4 et la LDH se sont régulés à la hausse chez les schistosomules de 2 à 7 jours (Dillon et al., 2006), ce qui reflète sans doute une demande accrue de glucose ainsi qu'une augmentation de la production de lactate observée chez les schistosomes pendant leur développement chez l'hôte mammifère. Des résultats similaires ont été trouvés en utilisant des schistosomules de 3 jours (Parker-Manuel et al., 2011).

### **Le métabolisme mitochondrial de *S. mansoni***

Les premières études ont suggéré que *S. mansoni* présente un cycle tricarboxylique (TCA) couplé à la phosphorylation oxydative (OXPHOS) (Coles, 1972). En particulier, les cercaires, ont un métabolisme énergétique aérobie et dégradent leurs réserves de glycogène principalement en dioxyde de carbone, impliquant le TCA (Van Oordt et al., 1989). Dans l'eau, à la fois la tête et la queue des cercaires ont un métabolisme énergétique aérobie (Horemans et al., 1991). Le stade miracidium qui vie également librement dans l'eau est également connu pour consommer des quantités élevées d'oxygène et pour avoir un métabolisme aérobie (Bruce et al, 1971; Tielens et al., 1992). Le stade infectant les mollusques, le sporocyste, présente un métabolisme énergétique anaérobie facultatif (Tielens et al., 1992). En présence d'oxygène, les sporocystes tirent la majeure partie de leur énergie de la dégradation aérobie du glucose en dioxyde de carbone, mais dans des

conditions anaérobies, ils passent vers la production de lactate et de succinate (Tielens et al., 1992). Enfin, malgré le fait que leur métabolisme est principalement basé sur une aérobie glycolyse (GLY), produisant ainsi de grandes quantités de lactate, les stades de *S. mansoni* chez les mammifères absorbent également de l'oxygène et produisent de l'énergie grâce à l'OXPPOS (Coles, 1972). Lorsque les vers adultes étaient incubés en présence de cyanure, un inhibiteur de la cytochrome oxydase, l'absorption d'oxygène diminuait de 90% (Coles, 1972). Cette constatation a permis de suggérer la présence d'une cytochrome oxydase fonctionnelle chez le schistosome (Coles, 1972). D'autres études, utilisant différents inhibiteurs de cytochrome, ont également mis en évidence l'existence d'une chaîne respiratoire fonctionnelle chez *S. mansoni* (Magzoub et al., 1971). En outre, Coles (1972) a également conclu qu'environ un quart de l'énergie des vers adultes provenait de l'OXPPOS. La présence d'une OXPPOS fonctionnelle chez *S. mansoni* a été confirmée récemment (Huang et al., 2012).

### **Le contrôle épigénétique de la régulation des gènes chez les schistosomes.**

La découverte de la régulation épigénétique de l'expression des gènes a révolutionné notre compréhension de la façon dont fonctionnent les génomes et les approches pour le traitement de nombreuses pathologies. Les schistosomes sont des parasites métazoaires et en tant que tels, utilisent la plupart, sinon tous les mécanismes épigénétiques en jeu dans leurs hôtes vertébrés: variants d'histones, modification post-traductionnelle des histones, ARN non codant et, peut-être, méthylation de l'ADN.

### **Méthylation de l'ADN**

La méthylation de l'ADN comprend la méthylation ou l'hydroxyméthylation des résidus cytosine, principalement mais pas exclusivement au sein de dinucléotides CpG (Baubec et Schübeler, 2014). C'est une marque épigénétique importante associée à la répression génique. La présence de marques de méthylation d'ADN fonctionnelle dans les génomes de schistosomes est controversée. Les premiers travaux dans lesquels l'analyse par transfert de Southern a été réalisée pour les gènes sélectionnés après digestion avec des enzymes de restriction isoschizomères tolérants ou sensibles à la méthylcytosine (*HpaII* et *MspI*) n'ont

montré aucune différence dans les profils de restriction pour les ADN de *S. mansoni* adultes mâles ou femelles (Fantappié et al., 2001). En outre, l'endonucléase de restriction dépendante de la méthylcytosine *McrBC* n'a pas réussi à digérer l'ADN de *S. mansoni*. Cependant, une étude plus récente (Geyer et al., 2011), dans laquelle différentes méthodes plus sensibles, y compris la Gas Chromatography/Mass Spectrometry, des anticorps anti-méthylcytosine et du séquençage au bisulfite ciblé, ont été utilisées, a conclu que la méthylation des cytosines est bien présente et un intron répétitif hyperméthylé a été caractérisé dans un gène codant un facteur de transcription « *forkhead* ». La seule ADN méthyltransférase codée dans le génome du schistosome est *Dnmt2*. Les autres méthyltransférases habituellement associées à méthylation de l'ADN, les orthologues *Dnmt1* et *Dnmt3*, sont tous deux absents chez le schistosome. *Dnmt 2* n'a qu'une faible activité méthyltransférase sur l'ADN, mais possède une activité méthyltransférase solide vis-à-vis des tRNA<sup>Asp</sup> et d'autres ARNt (Goll et al., 2006). Le groupe diversifié d'espèces animales (y compris *S. mansoni* et *Drosophila melanogaster*) qui expriment seulement *Dnmt2* ont des niveaux de méthylation d'ADN très faibles (Kraus et Reuter, 2011). Cependant, *Dnmt2* conserve une certaine activité cytosine méthyltransférase (Hermann et al., 2003), et Geyer et coll. (2011) ont démontré que l'invalidation de transcrits *SmDnmt2* par siRNA a réduit les niveaux globaux de méthylecytosine dans le génome du schistosome. Ces auteurs ont en outre suggéré que la méthylation de cytosine est conservée à travers le phylum des Plathelminthes (Geyer et al., 2013). Face à cela, une étude approfondie (Raddatz et al., 2013) à l'aide d'un séquençage bisulfite du génome entier a montré qu'il manquait un motif de méthylation d'ADN détectable dans le génome de *S. mansoni*, même au niveau du locus "hyperméthylé" identifié par Geyer et al. (2011). Cependant, bien que ces résultats suggèrent fortement que le génome de *S. mansoni* est en fait non méthylé, la critique a été formulée que le stade du cycle de vie analysé, les vers adultes mâles, a le plus bas niveau de méthylation de l'ADN mesurée en utilisant une méthode ELISA (Geyer et al., 2013). Malgré cette controverse, les inhibiteurs de *Dnmt* ont été décrits comme affectant fortement les vers adultes, en particulier au niveau des organes reproducteurs, en affectant la morphologie des ovaires et en diminuant la ponte *in vitro* (Geyer et al., 2011). Que cela soit dû ou non à l'inhibition de la méthylation de l'ADN ou de l'ARNt, cela suggère que les inhibiteurs de *Dnmt*, tels que la 5-azacytidine, peuvent servir de bases pour le développement de précurseurs de nouveaux médicaments anti-schistosomes.



## **Les micro-ARN**

Les ARN non-codants (ncARN) comprennent de nombreuses classes différentes de transcrits qui ne codent pas pour des protéines, mais ont différents rôles dans la régulation de la transcription, la stabilité ou la traduction de gènes codant pour des protéines. Parmi ceux-ci, les micro-ARN (miARN) sont les mieux caractérisés et ce en fonction de leurs rôles fonctionnels et de leurs implications pathologiques, ainsi que des stratégies thérapeutiques les ciblant (Ling et al., 2013).

Une étude sur les séquences EST disponibles pour *S. mansoni* (Oliveira et al., 2011) a conclu que 10,3% des transcrits n'ont aucun potentiel codant pour une protéine et sont donc de possibles ncARNs. Cela suggère que le parasite peut utiliser les ncRNAs pour la régulation transcriptionnelle et translationnelle de ces gènes. En outre, la présence de protéines impliquées dans le traitement des miARN (Drosha, Dicer et Argonaute) (Oliveira et al., 2011) implique un rôle de la régulation par les miRNA du développement et la différenciation des schistosomes et explique l'efficacité du knockdown de transcription de l'ARNi et siRNA dans le parasite (Boyle et al., 2003). Chez *S. mansoni*, le séquençage d'une banque d'ADNc de petits ARN- a permis de mettre en évidence 211 nouveaux candidats de miRNA dont 11 ont été vérifiés par la suite par Northern blot (Simões et al., 2011). Il est à noter que les plathelminthes présentent une perte progressive de miARN conservés au cours de l'évolution (Fromm et al., 2013), peut-être dû à une simplification morphologique. Cependant, ils ont aussi acquis des ncRNAs spécifiques, y compris des siARN endogènes, qui sont exprimés de manière différentielle au cours du développement, notamment au cours de la différenciation sexuelle des vers femelles (Cai et al., 2011; Sun et al., 2014).

## **Modifications histones chez le Schistosome**

Une analyse *in silico* des prédictions de gènes au sein du génome de *S. mansoni* et de bibliothèques EST (Anderson et al., 2012) a montré que 21 des 29 gènes prédits codant pour des histones dans le génome sont exprimés, les autres gènes étant soit inexprimés ou soit ayant des séquences divergentes. De manière importante, les extrémités N-terminales des histones H3 et H4 du nucléosome sont hautement conservées, ce qui suggère

la conservation fonctionnelle des modifications d'histones trouvées sur les histones de mammifères. L'étude des marques d'histone et de leur rôle dans le développement et la différenciation du schistosome est encore à ses balbutiements, mais les études portant sur les inhibiteurs d'histone désacétylases (HDAC) et d'histones acétyltransférases (HAT) ont démontré l'importance de l'acétylation des histones et l'intérêt de ces enzymes en tant que cibles thérapeutiques potentielles. Les inhibiteurs d'HDAC(s), y compris la Trichostatine A (TSA), bloquent la transformation *in vitro* des miracidium de *S. mansoni* en sporocystes primaires d'une manière dose-dépendante (Azzi et al., 2009) et ceci en corrélation avec une augmentation de l'acétylation de l'histone H4. Plus récemment, les mêmes auteurs ont montré que les différences dans les niveaux d'acétylation de l'histone H3K9 sur les promoteurs des gènes codant pour les mucines polymorphes corrélaient avec leurs expressions différentielles dans des souches parasitaires compatibles ou incompatibles avec une souche donnée pour l'hôte intermédiaire, le mollusque d'eau douce *Biomphalaria glabrata*. Le traitement avec la TSA élimine ces différences d'expression spécifiques de la souche (Perrin et al., 2013).

L'inhibition des HAT(s) a également des conséquences sur le développement des schistosomes, en particulier dans la maturation des œufs. De plus, il a été montré que l'orthologue chez le schistosome de l'HAT GCN5 est capable d'acétyle l'H3 et l'H2A, et en particulier l'H3K14 (de Moraes Maciel et al., 2008). Par ailleurs, l'orthologue de l'HAT CBP/P300, SmCBP1 est capable d'acétyle principalement H4 (Bertin et al., 2006; Fantappié et al., 2008). L'inactivation par l'ARNi de l'une ou l'autre de ces HATs ou des deux chez les schistosomes adultes, réduit sensiblement les niveaux de transcription de la protéine de la coquille d'œuf, p14, et empêche ainsi, le développement des œufs. De plus, ces effets sont reproduits en traitant des couples de vers adultes avec un inhibiteur de HAT, le composé PU139 (Carneiro et al., 2014). Ces traitements produisent également des effets phénotypiques sur la ponte et le développement d'œufs qui ont été corrélés avec une diminution de l'acétylation de l'H3 et de l'H4. De plus, le PU139 entraîne une augmentation de la méthylation de l'H3K27, un marqueur de répression de la transcription, sur le promoteur proximal du gène codant la p14.

L'effet des inhibiteurs d'HDAC et d'HAT sur des schistosomes en culture suggère que ces enzymes sont des cibles thérapeutiques prometteuses pour le développement de nouveaux

médicament anti-schistosome. Ainsi, il a été montré que des inhibiteurs d'HDAC comme la TSA et l'Acide Valproïque induisent la mort de schistosomules et de vers adultes en culture de manière temps et dose-dépendant (Dubois et al., 2009). De plus, des expériences de TUNEL et la mise en place de dosage des caspases 3/7 ont permis de montrer que la mort des parasites est associée *in vitro* à l'induction de l'apoptose chez les schistosomules. Par ailleurs, d'un point de vue moléculaire, il a été décrit que la mort des parasites est corrélée à une augmentation globale de l'acétylation des histones H3 et H4. De plus, une augmentation significative de l'acétylation de l'histone H4 a été mise en évidence au niveau des promoteurs proximaux de différents gènes cibles des HDAC. Cette hyperacétylation induit par conséquent, une augmentation de la transcription de ces gènes cibles. Pour finir, plus récemment, des effets similaires ont été obtenus en utilisant des inhibiteurs d'HDAC de classe III, les sirtuines (Lancelot et al., 2013). En effet, il a été montré que la Salermide, un inhibiteur de Sirt1 et Sirt2 humaine est capable d'induire également la mort des parasites en culture *via* l'induction de l'apoptose. Pour finir, la Salermide induit également une altération morphologique marquée de l'appareil reproducteur de la femelle ver adulte, un arrêt de la ponte et la séparation des couples de vers adulte maintenus en culture.

### **Les sirtuines des schistosomes**

Les sirtuines forment une superfamille de protéine N-ε-acyl-lysine déacylases NAD<sup>+</sup>-dépendante conservées au cours de l'évolution. Elles sont impliquées dans divers processus cellulaires clés. Les sirtuines ont une structure générale globalement conservée avec un site catalytique formé par un canal hydrophobe entre le domaine Rossmann impliqué dans la liaison au NAD<sup>+</sup> et un petit domaine liant le Zn<sup>2+</sup>. Récemment, notre groupe a identifié cinq membres de la famille des sirtuines dans le génome de *S. mansoni* et a proposé leur utilisation comme cibles thérapeutique pour le développement de médicaments contre la schistosomiase (Pierce et al., 2012; Lancelot et al., 2013). Chez l'homme, les sirtuines sont au nombre de 7 (Sirt1-7) et présentent une structure de leur domaine catalytique très similaires entre elles. Néanmoins, ces enzymes présentent des localisations subcellulaires différentes ainsi que des spécificités de fonction et de substrat.

Chez les mammifères, SIRT1, SIRT6 et SIRT7 se localisent au niveau du noyau, SIRT3, SIRT4 et SIRT5 sont mitochondriales, tandis que SIRT2 est principalement cytoplasmique (Michishita et al., 2005). Cependant, SIRT2 et SIRT3 peuvent également se localiser au niveau du noyau. SIRT2 peut transiter vers le noyau lors de la mitose, où il peut agir comme une histone désacétylase sur les résidus H4K16 et H3K56 (Nord et Verdin, 2007; Vaquero et al., 2006) et SIRT3 peut se déplacer vers le noyau dans des conditions de stress cellulaire (Scher et al., 2007). En outre, l'activité de SIRT5 est détectable dans le cytoplasme (Park et al., 2013.) et Matsushita et al (Matsushita et al., 2011) ont identifié deux isoformes de SIRT5 humaine, avec une forme mitochondriale prédominante, plus courte et une isoforme plus longue localisée à la fois dans le cytoplasme et dans les mitochondries. Bien que à ce jour, les localisations subcellulaires des sirtuines de schistosomes n'aient pas été déterminées expérimentalement, la présence (ou l'absence) de séquences signal est indicative. Cependant, bien que SIRT6 et SIRT7 aient tous deux des signaux consensus d'exportation nucléaire, ils manquent le signal de localisation nucléaire, qui est présent à l'extrémité C-terminale de SIRT1 chez *S. mansoni*. En revanche, une séquence du peptide de ciblage mitochondrial est absente de SIRT5 chez le schistosome, mais est présente chez l'orthologue de *S. japonicum*, suggérant que les séquences des isoformes de *S. mansoni* (SIRT5, Lancelot et al., 2013) doivent être réexaminées.

Les membres de la famille des sirtuines sont impliqués dans des mécanismes tels que la détection des éléments nutritifs, la réparation de l'ADN et la régulation du métabolisme (Choi et Mostoslavsky, 2014). SIRT1 est régulée positivement par la restriction calorique, en réponse à des variations de concentration de son cofacteur le NAD<sup>+</sup> (Cantó et Auwerx 2011) et régule le métabolisme par la désacétylation d'une variété de protéines cibles, comprenant notamment PGC1 $\alpha$  et FoxO. Ainsi, Sirt1 module aussi bien la gluconéogenèse que la glycolyse. Sirt1 participe également à l'inhibition de l'induction de l'apoptose liée à l'âge qui se produit en réponse au stress (Brooks et Gu, 2009).

Cependant, Sirt1 n'est pas la seule sirtuine impliquée dans la régulation du métabolisme. Comme on pouvait s'y attendre, les sirtuines mitochondriales (SIRTs 3, 4 et 5) sont des acteurs essentiels dans le métabolisme énergétique (Ahn et al., 2008; Du et al., 2011; Park et al., 2013). Les sirtuines nucléaires, SIRTs 6 et 7, ont également été décrites récemment comme ayant un rôle essentiel dans la régulation du métabolisme. SIRT6 est

impliquée de manière critique dans la régulation du métabolisme du glucose. En effet, les souris SIRT6 KO développent une hypoglycémie fatale (Mostoslavsky et al., 2006). Cette sirtuine régule négativement la transcription dépendante de Hif-1 $\alpha$  par la désacétylation des résidus H3K9 présents sur les promoteurs de ses gènes cibles, qui comprennent ceux codant les transporteurs de glucose de classe 1, la lactate déshydrogénase (LDH) et la pyruvate kinase A-déshydrogénase 1 (Zhong et al., 2010). En absence de SIRT6 l'absorption du glucose est favorisée et la glycolyse aérobie (produisant du lactate), un phénotype associé à de nombreuses cellules cancéreuses, et connu sous le nom de « l'effet Warburg » (Warburg, 1956) est activée.

En plus de la régulation du métabolisme du glucose, les sirtuines régulent également la synthèse des lipides et leur utilisation, ce qui a notamment été montré par l'utilisation de modèles de knock-out de gènes. Dans un premier temps décrit comme activateur de la transcription, médiée par l'ARN polymérase I (Ford et al., 2006), il a été montré récemment que SIRT7 était impliquée dans le contrôle du métabolisme des lipides. Son activité histone déacétylase (sur les résidus H3K18) est impliquée dans la prévention de la stéatose hépatique (Shin et al., 2013) et des études chez la souris « knock-out » SIRT7 montrent son implication dans le contrôle du métabolisme lipidique du foie *via* la régulation de la voie ubiquitine-protéasome (Yoshizawa et al., 2014). En outre, une carence en SIRT7 conduit également à un dysfonctionnement mitochondrial, notamment une augmentation de la production de lactate, par l'intermédiaire de la désacétylation de GABP $\beta$ 1, un régulateur de gènes mitochondriaux codé par le noyau (Ryu et al., 2014). SIRT1 est impliquée dans le contrôle de l'utilisation hépatique des acides gras (Rodgers et Puigserver, 2007) et son ablation conduit également à une stéatose hépatique *in vivo* (Purushotham et al., 2009). De même, les souris invalidées pour le gène *sirt6* montrent une perte de graisse sous-cutanée (Mostoslavsky et al., 2006) et d'autres études (Choi et Mostoslavsky, 2014) révèlent son rôle en tant que régulateur de lipoprotéines de basse densité et de cholestérol. L'ensemble de ces données démontrent que Sirt6 est impliquée dans le métabolisme des lipides. L'inactivation du gène de *sirt3* conduit à l'hyperacétylation de nombreuses protéines mitochondriales. Parmi l'ensemble des cibles on retrouve une déshydrogénase acyl-CoA à longue chaîne, qui est impliquée dans l'oxydation des acides gras (Hirschev et al., 2010). Enfin, SIRT4 inhibe l'activité de la décarboxylase malonyl-CoA, permettant ainsi d'équilibrer

les niveaux mitochondriaux en malonyl-CoA et en acétyl-CoA réductase. Cette régulation induit par conséquent, la régulation de l'équilibre de l'oxydation dans la synthèse des acides gras (Laurent et al., 2013).

En plus de ces fonctions dans le métabolisme, les sirtuines ont également un rôle central dans la réparation de l'ADN. Par ailleurs, ces fonctions sont liées et peuvent être coordonnées (Choi et Mostoslavsky, 2014) étant donné que les dommages de l'ADN peuvent conduire à des changements métaboliques qui favorisent la défense anti-oxydante et la réparation de l'ADN (Cosentino et al., 2010). SIRT4, en inhibant le métabolisme de la glutamine mitochondriale, réachemine cet acide aminé en réponse aux dommages de l'ADN (Jeong et al., 2013). De plus, des embryons de souris délétés pour le gène *sirt1* montrent une réponse anormales vis-à-vis des dommages de l'ADN. Une étude récente (Scheibye-Knudsen et al., 2014) relie l'appauvrissement en  $\text{NAD}^+$  par l'enzyme poly-ADP-ribose polymérase de réparation chronique active d'ADN à l'inactivation de SIRT1 et sa cible PGC-1 $\alpha$  qui conduit à un défaut de mitochondries dans un modèle de souris de Cockayne syndrome B..

La conservation des sirtuines chez les plathelminthes suggère qu'ils remplissent un grand nombre des mêmes fonctions que chez les mammifères. Toutefois, certaines différences sont évidentes. Notamment l'absence de deux des sirtuines mitochondriales, SIRT3 et 4, chez *S. mansoni*, suggère que leurs fonctions peuvent avoir été prises par d'autres sirtuines, notamment par SIRT5. À l'appui de cette possibilité, au moins cinq isoformes d'épissage de SIRT5 ont été détectées comme des transcrits (Lancelot et al., 2013). Cependant, SIRT5 humaine n'a qu'une faible activité désacétylase (Du et al., 2011) et les activités enzymatique des différentes isoformes SIRT5 du schistosome restent à étudier. En outre, les domaines catalytiques des deux SIRT1 et 7 de *S. mansoni* contiennent de grandes insertions. Bien qu'il soit possible, il est peu probable que celles-ci affectent l'activité catalytique des enzymes. En effet, des insertions dans le domaine catalytique de l'HDAC8 de *S. mansoni* ont été décrites comme formant des boucles non structurées sur la surface de la protéine (Marek et al., 2013). On peut supposer que ces insertions fournissent des surfaces pour des interactions protéine-protéine spécifiques aux schistosomes, amenant de nouvelles fonctions aux sirtuines.

Chez *S. mansoni*, les sirtuines sont exprimées à tous les stades du cycle de vie, mais il existe de grandes variations dans les niveaux d'expression des transcrits, en particulier dans

le cas des sirtuines nucléaires, SIRT6 et SIRT7, qui sont fortement exprimées dans les stades larvaires, alors que les sirtuines nucléo-cytosolique, SIRT1 et SIRT2 montrent de plus faible variation d'expression. Le knockdown des transcrits de *sirt1* provoque des changements marqués au niveau des organes reproducteurs, notamment chez le ver femelle (Lancelot et al., 2013) où l'on remarque une augmentation anormale des ovocytes matures dans l'ovaire. Ce phénotype anormal est identique à celui obtenu après traitement des vers adultes avec la Salermide bien que ce dernier soit plus prononcé. Cette différence d'intensité au niveau du phénotype peut s'expliquer par le fait que la Salermide est un inhibiteur non sélectif de Sirt1 et 2 humaine et que dans ce cas l'inhibition de ces deux enzymes entraîne un phénotype plus marqué au niveau des organes reproducteurs. En outre, plusieurs inhibiteurs de sirtuines induisent le désappariement des couples de vers en culture et permettent de réduire significativement la ponte (Lancelot et al., 2013). Bien qu'à ce jour, nous n'ayons aucune donnée concernant les effets de l'inactivation de transcrits de sirtuines chez les schistosomules, les inhibiteurs de sirtuines, en particulier la Salermide, induisent facilement l'apoptose et la mort des larves à des concentrations de 10 et 20  $\mu$ M. L'abondance relative des transcrits de la sirtuine mitochondriale, *sirt5* et les deux sirtuines nucléaires *sirt6* et *sirt7* dans les stades larvaires infectieux (Lancelot et al., 2013) suggère que ceux-ci peuvent avoir un rôle crucial au cours du développement de schistosome et représentent donc des cibles sensibles à la chimiothérapie.

## **OBJECTIFS DE LA THESE**

Sur la base des éléments de preuve ci-dessus nous avons supposé que le changement métabolique que subit *S. mansoni* lors de l'infection de l'hôte mammifère se traduit par l'expression de gènes métaboliques qui sont réglementés au niveau épigénétique par les sirtuines. Pour tester cette hypothèse nous avons cherché à travailler sur deux grands objectifs:

- (1) L'identification et la caractérisation des gènes impliqués dans le métabolisme du glucose chez *S. mansoni*, avec un accent sur les transporteurs de glucose.
- (2) Etudier l'implication des sirtuines dans la régulation du changement métabolique de *S. mansoni* en présence de glucose, en mettant l'accent sur SmSIRT1 et SmSIRT6.

## RESULTATS

### **Objectif 1 : les transporteurs de glucose de *S. mansoni*.**

Deux protéines transporteuses de glucose du schistosome (SGTPs) nommées SGTP1 et SGTP4, ont été caractérisées fonctionnellement chez *S. mansoni* (Skelly et al., 1994; Krautz-Peterson et al., 2010). Ces deux protéines présentent une séquence très similaire (identité de 61%) et montrent une stéréospécificité pour le glucose, une spécificité flexible pour différents hexoses et une activité indépendante du sodium (Skelly et al., 1994). Les profils d'expression des protéines montrent que SGTP4 est exprimée au niveau du tégument externe des vers adultes, lequel interagit avec l'hôte (Skelly et al., 1996), tandis que SGTP1 est principalement localisée au niveau des membranes basales du tégument (Zhong et al., 1995). En outre, une analyse par Western blot a montré que SGTP1 est exprimée dans l'œuf, chez les sporocystes, les cercaires, les schistosomules, et chez les vers mâles et femelles adultes tandis que SGTP4 est seulement détectée chez les stades infectant des mammifères (schistosomules et adultes) (Skelly et al., 1996). Des études utilisant l'ARNi ont montré que les deux récepteurs SGTP1 et SGTP4 étaient indispensables pour l'absorption de glucose exogène chez les schistosomules *in vitro* et pour le développement du parasite *in vivo* (Krautz-Peterson et al., 2010).

Un troisième gène codant pour un transporteur de glucose, *sgtp2*, a également été identifié. Le cadre de lecture ouvert de *sgtp2* a été interrompu à ~ 260 pb en aval du premier codon ATG par une base manquante. L'addition hypothétique d'une base à cette position en aval conduit à la traduction d'un produit homologue à des transporteurs de glucose (Skelly et al., 1994). Des tests fonctionnels dans des ovocytes de *Xenopus* ont montré toutefois que ce récepteur hypothétique ne transporte pas de glucose (à 1 mM et 10 mM de substrat). En outre, les transcrits du gène *sgtp2* ne se trouvaient que chez les vers adultes femelles (Skelly et al., 1994) et cette observation suggère une fonction biologique spécifique de récepteur chez la femelle schistosome. De plus, un gène codant pour un quatrième transporteur de glucose, *sgtp3*, a également été identifié mais n'a pas été à ce jour caractérisé (Krautz-Peterson et al., 2010).



En modélisant la phase de l'infection chez l'hôte humain, nous avons montré que les profils de transcription des gènes codant pour ces transporteurs dans les schistosomules récemment transformé ont deux réponses opposées vis à vis d'une augmentation des concentrations de glucose. Concordante avec les profils de transcription, nos analyses phylogénétiques ont révélé que les transporteurs de glucose de *S. mansoni* appartiennent à deux groupes distincts, l'un associé à la classe I des transporteurs de glucose (SGTP2 et SGTP3) de vertébrés et d'insectes, et l'autre à une classe spécifique pour les parasites plathelminthes (SGTP1 et SGTP4). Pour étudier les trajectoires d'évolution des deux groupes et de leurs implications fonctionnelles, nous avons déterminé les taux d'évolution, les temps relatifs de divergence et l'organisation génomique. De plus nous avons effectué des analyses structurales utilisant les séquences des différents transporteur de glucose. Nous avons finalement utilisé les structures modélisées de ces transporteurs pour analyser biophysiquement (i) la dynamique des résidus clés au cours de liaison de glucose, (ii) la stabilité de glucose dans le site actif, et (iii) pour démontrer la diffusion du glucose. Les deux transporteurs de glucose spécifiques des platyhelminthes (SGTP1 et SGTP4), qui semblent être d'une origine plus récente que les deux autres, ont des taux d'évolution moléculaire plus lents, sont codés par des gènes pauvres en introns et sont capables de transporter du glucose. Fait intéressant, nos analyses concernant l'étude de la dynamiques moléculaires suggèrent que les transporteurs de glucose de classe I de *S. mansoni* (SGTP2 et SGTP3) ne sont pas en mesure de transporter le glucose. Nous avons conclu que les transporteurs de glucose de *S. mansoni* présentent différentes histoires évolutives. Nos résultats suggèrent que les transporteurs du glucose de *S. mansoni* de classe I ont perdu leur capacité de transport du glucose et que cette fonction a évolué de manière indépendante chez les transporteurs SGTP1 et SGTP4, spécifiques des platyhelminthes. Enfin, en tenant compte des différences dans la dynamique du transport du glucose de ces transporteurs par rapport à ceux de l'homme, nous concluons qu'ils peuvent constituer des cibles thérapeutiques intéressantes contre la schistosomiase.

## **Objectif 2 : l'implication des sirtuines dans la régulation du changement métabolique de *S. mansoni*.**

Des études précédentes ont montré que les vers adultes de *S. mansoni* étaient des fermenteurs homolactiques dans des conditions aérobies (Bueding, 1950). Cela est

surprenant, car à cette époque, il était surtout cru, à partir d'études dans les levures, que dans des conditions aérobies la fermentation du glucose serait inhibée par l'oxygène, à savoir «l'effet Pasteur» (Pasteur, 1861; Racker, 1974). En effet, il a été démontré plus tard que l'effet «Pasteur» ne se produit pas chez *S. mansoni* et que les vers produisent la même quantité d'acide lactique dans des conditions d'aérobic et d'anaérobic (Schiller et al., 1975; Bueding et Fisher, 1982). Au lieu de «l'effet Pasteur», ces parasites représentent un bon exemple de «l'effet Crabtree», à savoir, un processus dans lequel la présence de concentrations de glucose extérieures élevées induit un métabolisme fermentaire dans des conditions aérobies (Crabtree, 1928). Fait intéressant, semblable aux conclusions de Bueding (1950) chez *S. mansoni*, de nombreuses cellules cancéreuses obtiennent leur énergie à partir de la fermentation du pyruvate en acide lactique, même en présence d'un niveau adéquat d'oxygène, un phénomène appelé «effet Warburg» (Warburg et al., 1927 ; Warburg, 1956). La commutation métabolique dans les schistosomules s'est révélée être dépendante de la concentration de glucose externe (Horemans et al., 1992). Pour de faibles concentrations en glucose (0,05 mM), le profil métabolique demeure le même que chez les cercaires (en majorité de l'oxydation aérobic du glucose à travers la phosphorylation oxydative). Cependant, en présence de glucose 10 mM (ou 5 mM), la production de lactate est augmentée de 50 fois pendant les deux premières heures (Horemans et al., 1992). Pour évaluer l'effet de la concentration de glucose externe sur l'expression des gènes codant pour les récepteurs et les enzymes impliqués dans le métabolisme énergétique, nous avons développé un modèle dans lequel les schistosomules ont été incubés avec une faible concentration en glucose (0,05 mM, "Low Glucose" LG), puis cette concentration a été augmentée à 10 mM ("High Glucose" HG). À la suite de 3 heures d'incubation dans HG, l'expression de 16 gènes métaboliques a été mesurée par RT-PCR quantitative (qRT-PCR). Les transcrits de la lactate déshydrogénase (*sldhA*), pyruvate kinase déshydrogénase 1 (*spdk1*) et les transporteurs de glucose de classe I (*sgtp* et *sgtp3*) ont été significativement surexprimés lors de la transformation métabolique, tandis que les malate déshydrogénases mitochondrial (*smdh2*) et cytoplasmiques (*smdh1B* et *smdh1A*) ont été significativement régulés à la baisse. En revanche, le taux d'ARNm de la hexokinase (*shex*) n'a pas changé dans les conditions HG. Ceci est cohérent avec le fait que l'activité de SHEX est principalement régulée par le produit de la réaction (à savoir le glucose-6-phosphate) (Tielens et al., 1994; Tielens, 1997).

Chez les cercaires, la transition de OXPHOS à GLY dans les conditions HG se produit exclusivement dans la tête, et non pas dans la queue, qui maintient un métabolisme exclusivement basé sur l'OXPHOS (Horemans et al., 1991). Pour déterminer si le profil d'expression génique dans les conditions HG était spécifique des schistosomules, avec une augmentation de GLY, nous avons mesuré l'expression des mêmes gènes dans les queues de cercaires. La transcription des gènes codant les malate déshydrogénases (*smdh1A*, *smdh1B* et *smdh2*) ont été régulés à la hausse ainsi que les transcrits des gènes glycéraldéhyde-3-phosphate déshydrogénase (*sgapdh*) la *sl dhA* et les récepteurs de l'insuline (*smir1* et *smir2*). Cependant, *shex* et l'aquaporine de surface (*smaq*), un transporteur de lactate chez les schistosomes (Faghiri et al., 2005), ont été régulés à la baisse. Remarquablement, et de manière compatible avec un métabolisme basé exclusivement sur l'OXPHOS, la *spdk1* n'est que légèrement exprimée dans les queues de cercaires alors qu'elle est exprimée 3 fois plus chez les schistosomules incubés dans des conditions HG. La PDK1 est une kinase qui phosphoryle le complexe pyruvate-déshydrogénase (PDHC), inhibant ainsi la transformation du pyruvate en acétyl-CoA par le PDHC et réduisant par conséquent l'activité mitochondriale, le MTA (Gudi et al., 1995). Les profils d'expression opposées de *spdk1* dans les schistosomules HG et dans les queues de cercaires, suggèrent un rôle important de cette enzyme dans la régulation du MTA lors de la commutation métabolique chez *S. mansoni*.

Comme on pouvait s'y attendre, l'expression différentielle de gènes chez les schistosomules dans les conditions HG a été associée à une augmentation significative de la concentration en lactate extracellulaire. Il a été démontré que, dans des conditions HG, le glucose est principalement dégradé en lactate, mais du CO<sub>2</sub> a également été produit (Horemans et al., 1992), suggérant que, lors de la transformation métabolique, la respiration mitochondriale n'est pas inhibée. Par conséquent, nous avons mesuré l'activité mitochondriale (MTA) en utilisant une technique de dosage basée sur l'utilisation d'un indicateur l'Alamar blue (résazurine, AB). En accord avec des études précédentes (Protasio et al., 2013), la MTA a augmenté dans des conditions HG par rapport à LG. Cela suggère que, après la commutation métabolique, les schistosomules peuvent utiliser à la fois les mécanismes de GLY et OXPHOS pour obtenir de l'énergie.

Les résultats ci-dessus ont soutenu l'idée que, dans des conditions HG, la MTA est régulée adaptivement, probablement pour remplir des fonctions énergétiques dans des

environnements différents (à savoir HG et LG). Les sirtuines humaines 1 et 6 (SIRT1 et 6) sont des régulateurs du métabolisme cellulaire. SIRT1 est un régulateur connu du *Hypoxia Inducible Factor* (HIF), régulant à la fois l'activité de HIF-1 $\alpha$  et HIF-2 $\alpha$  (Dioum et al., 2009; Yoon et al., 2014). Ces facteurs de transcription sont impliqués dans la régulation de la transcription des gènes métaboliques tels que celui codant pour la PDK1 (Kim et al., 2006; Semenza, 2007; Park et al., 2013). SIRT1 est un régulateur positif de l'activité mitochondriale (Price et al., 2012). En addition, il a été récemment démontré que SIRT6 régule le passage à la glycolyse aérobie dans les cellules cancéreuses (Zhong et al., 2010; Sébastien et al., 2012). Par conséquent, nous avons testé: (i) si les sirtuines sont impliquées dans la régulation de l'expression des gènes codant pour les transporteurs de glucose, *spdk1* et *sl dhA* dans des conditions HG et (ii) si les sirtuines sont impliquées dans le commutateur MTA dans ces mêmes conditions. En premier lieu, nous avons mesuré les niveaux d'expression d'ARNm de *Smsirt1* et *Smsirt6* après 8h d'incubation dans des conditions HG, chez les schistosomules ainsi que dans les queues de cercaires. En effet, des rapports précédents ont identifié SIRT6 humain comme répresseur des gènes glycolytiques (Zhong et al., 2010; Sébastien et al., 2012) (Pierce et al., 2012). Nous avons trouvé des niveaux significativement élevés des transcrits de *Smsirt6* et *Smsirt1* dans les queues de cercaires compatibles avec leur métabolisme à base d'O<sub>2</sub>PHOS. Cependant, seulement *Smsirt1* a été régulée (de façon très modérée) à la hausse (1,4 fois) en schistosomules dans des conditions HG après 8h d'incubation.

Nous avons démontré en outre que l'expression des gènes codant la SLDHA et la SPDK1 est augmentée en présence de Sirtinol (un inhibiteur de SIRT1, 2 et 3), mais pas celui codant le transporteur de glucose SGPT1. Pour évaluer plus précisément le rôle des sirtuines dans la régulation de *sl dh* et *sp dk*, nous avons effectué l'interférence d'ARN (ARNi) en utilisant des ARN(s) double brins (ARNdb) spécifique *deSmsirt1* (Lancelot et al., 2013), et *Smsirt6*. Comme indiqué précédemment en utilisant cet ensemble d'ARNdb (Lancelot et al., 2013), nous avons obtenu une réduction d'environ 80% des transcrits de *Smsirt1* en schistosomules. Par contre, aucune réduction des transcrits de *Smsirt6* n'a été observée en utilisant des ARNdb spécifiques de SmSirt6 en schistosomules et nous n'avons donc pas été en mesure d'évaluer le rôle spécifique de cette sirtuine dans la régulation des enzymes clés métaboliques. Toutefois, les transcrits de *sp dk1* ont été surexprimés dans les schistosomules

et adultes vers traités avec des RNAidb *Smsirt1*. Aucun des autres gènes analysés ont vu leur expression significativement régulées par l'invalidation de *Smsirt1*. Au total, ces résultats suggèrent que SmSirt1 est un répresseur du gène *pdk1* chez *S. mansoni*. En outre, nous avons testé le rôle de *Smsirt1* dans l'activité mitochondriale. Dans des conditions de culture HG et galactose, le MTA des schistosomules était inhibé par la Salermide (autre inhibiteur de sirtuines) et le Sirtinol. En outre, l'invalidation de SmSirt1 a également diminué, de manière significative, le MTA après 48h d'incubation. En revanche, les inhibiteurs de sirtuines n'ont pas eu un effet significatif sur la production de lactate après 48h d'incubation.

## CONCLUSIONS ET PERSPECTIVES

Sur la base de nos résultats, nous avons conclu que: (i) les transporteurs de glucose de *S. mansoni* ont suivi des chemins différents pendant l'évolution : alors que les transporteurs SGTP2 et SGTP3 (de classe I) semble avoir perdu la fonction de transport du glucose, cette fonction a évolué indépendamment pour SGTP1 et SGTP4 ; (ii) la dynamique moléculaire de SGTP1 et SGTP4 pendant le transport du glucose est différente de celle de GLUT1 humaine. Cette différence pourrait être exploitée pour la conception de médicaments ; (iii) après la transformation métabolique dans des conditions HG, l'OXPPOS des schistosomules augmente ; (iv) SmSirt1 est un répresseur d'expression de la *spdk1* chez les schistosomules et les vers adultes, et (V) SmSirt1 est un régulateur positif de l'activité mitochondriale chez les schistosomules dans des conditions HG.

Nos résultats ouvrent de nouvelles frontières pour la recherche sur la régulation de l'aiguillage métabolique de *S. mansoni*, mais d'autres études doivent être entreprises pour compléter nos résultats et éclaircir les points suivants:

- (i) Si les différences de la dynamique moléculaire fonctionnelle entre les transporteurs de glucose de schistosomes et humains pourraient être exploitées pour la conception de médicaments anti-schistosomes,
- (ii) pour confirmer les résultats en ce qui concerne l'augmentation de OXPPOS après la transformation métabolique dans des conditions HG, d'autres études

doivent mesurer ce phénomène en utilisant des méthodes différentes que la méthode du dosage utilisant l'Alamar Bleu,

- (iii) pour tester le rôle de SPDK1 dans la régulation de la fonction mitochondriale dans des conditions HG, des différents inhibiteurs de SPDK1 devront être utilisés et des expériences d'invalidation de la SPDK1 en utilisant des ARNdb devront être mises en place.
- (iv) la relation entre l'activité mitochondriale et la production de lactate devrait également être évaluée.

## **Alejandro Cabezas-Cruz**

Alejandro Cabezas-Cruz, DVM, MSc

Date of Birth: 14.01.1983

Address: 77 rue Meurein, Appt 5, Residence Lyderic, 59800 Lille, France.

E-mail: [cabezasalejandrocruz@gmail.com](mailto:cabezasalejandrocruz@gmail.com)

Phone (mobile): +33 (0) 631 235 191

### **EDUCATION**

#### **– PhD in molecular and cellular aspects of biology: 10.2013 – Present**

Thesis: *Schistosoma mansoni* sirtuins: characterization of their role in schistosome energy metabolism.

University of Lille 2, Institute Pasteur Lille, Lille, France.

#### **– Master in Parasitology, MSc: 04.2012 – 09.2013**

Thesis: Cellular and molecular characterization of *Ehrlichia mineirensis* (UFMG-EV), a new organism isolated from *Rhipicephalus (Boophilus) microplus* ticks.

University of South Bohemia, České Budějovice, Czech Republic. **Honors Degree**

#### **– Doctor of Veterinary Medicine, DVM: 09.2001 – 06.2006**

Thesis: Development of murine models for the study of breast cancer.

Agricultural University of Havana (UNAH), Havana, Cuba. **Honors Degree**

### **PROFESSIONAL EXPERIENCE**

#### **– Berlin-Brandenburger Centrum für Regenerative Therapien (BCRT), Berlin, Germany. 2011**

Function: Internship in the laboratory of Dr. Sophie Van Linthout.

Topic: Cell culture and molecular biology.

#### **– Nuffield Department of Surgical Sciences (NDS), University of Oxford, United Kingdom. 2010**

Function: Internship in the laboratory of Prof. Pat Nuttall.

Topic: Functional characterization of tick molecules with immune modulator effect.

#### **– Center for Genetic Engineering and Biotechnology (CIGB). Cuba. 2006 – 2010**

Function: Researcher.

Topic: Development of recombinant vaccines against the cattle tick *Rhipicephalus microplus*.

#### **– Centre of Molecular immunology (CIM). Cuba. 2001 - 2006**

Function: Internship in the laboratory of Dr. Enrique Montero.

Topic: Immunology and animal models.

## PUBLICATIONS RELATED TO THE PRESENT THESIS

1. **Cabezas-Cruz A.**, et al. **2015**. Fast evolutionary rates associated with functional loss in class I glucose transporters of *Schistosoma mansoni*. **BMC Genomics**. 16(1):980.
2. Lancelot J., **Cabezas-Cruz A.**, et al. **2015**. Schistosome sirtuins as drug targets. **Future Medicinal Chemistry**. 7(6): 765-782.
3. **Cabezas-Cruz A.**, et al. **2014**. Epigenetic control of gene function in schistosomes: a source of therapeutic targets? **Frontiers in Genetics**. 5:317.

## OTHER PUBLICATIONS

2016

1. **Cabezas-Cruz A.**, et al. 2016. Mind the ticks when strolling through the park. **Frontiers for Young Minds**. In press
2. **Cabezas-Cruz A.**, Valdés J J., de la Fuente J. 2016. Control of vector-borne infectious diseases by human immunity against  $\alpha$ -Gal. **Expert Review of Vaccines**. 15(8):953-955.
3. **Cabezas-Cruz A.**, et al. 2016. *Anaplasma phagocytophilum* increases the levels of histone modifying enzymes to inhibit cell apoptosis and facilitate pathogen infection in the tick vector, *Ixodes scapularis*. **Epigenetics**. 11(4):303-319.
4. **Cabezas-Cruz A.**, et al. 2016. *Ehrlichia minasensis* sp. nov., a new species within the genus *Ehrlichia* isolated from the tick *Rhipicephalus microplus*. **International Journal of Systematic and Evolutionary Microbiology**. 66: 1426-1430.
5. Valdés J J\*, **Cabezas-Cruz A\***, et al. 2016. Substrate prediction of *Ixodes ricinus* salivary lipocalins differentially expressed during *Borrelia afzelii* infection. **Scientific Reports**. In press  
**\*Joint first authors.**
6. Tellier G., Lenne A., Cailliau-Maggio K., Cabezas-Cruz A., et al. 2016. Identification of *Plasmodium falciparum* translation initiation 1 eIF2 $\beta$  subunit: direct interaction with Protein Phosphatase type 1. **Frontiers in Microbiology**. 7:777.
7. de la Fuente J., Villar M., **Cabezas-Cruz A.**, et al. 2016. Tick-host-pathogen interactions: conflict and cooperation. **PLoS Pathogens**. 12(4): e1005488.
8. Estrada-Peña A., de la Fuente J., **Cabezas-Cruz A.** 2016. A comparison of the performance of regression models of *Amblyomma americanum* (L.) (Ixodidae) using life cycle or landscape data from administrative divisions. **Ticks and tick-borne diseases**. 7(4):624-30.
9. Ferrolho J., Antunes S., Santos A S., Velez R., Padre L., **Cabezas-Cruz A.**, et al. 2016. Detection and phylogenetic characterization of *Theileria* spp. and *Anaplasma marginale* in *Rhipicephalus bursa* in Portugal. **Ticks and tick-borne diseases**. 7(3): 443-448.
10. de la Fuente J., Villar M., Estrada-Peña A., **Cabezas-Cruz A.**, et al. 2016. *Anaplasma phagocytophilum* uses similar strategies to establish infection in tick vectors and vertebrate hosts. **Trends in Microbiology**. 24(3): 173-180.
11. Almazán C., González-Álvarez H., García-Fernández I., **Cabezas-Cruz A.**, et al. 2016. Molecular identification and characterization of *Anaplasma platys* and *Ehrlichia canis* in dogs in Mexico. **Ticks and tick-borne diseases**. 7(2):276-283.
12. Noda A A., Rodríguez I., Miranda J., Mattar S., **Cabezas-Cruz A.** 2016. First Report of Spotted Fever Group Rickettsia in Cuba. **Ticks and Tick-borne Diseases**. 7 (2016): 1057-1058.
13. Espinosa P J., Alberdi P., **Cabezas-Cruz A.**, et al. 2016. *Anaplasma phagocytophilum* manipulates host cell apoptosis by different mechanisms to establish infection. **Veterinary Sciences**. 3(15): vetsci3030015.
14. Villar M., López V., Ayllón N., **Cabezas-Cruz A.**, et al. 2016. The intracellular bacterium *Anaplasma phagocytophilum* selectively manipulates the levels of vertebrate host proteins in the tick vector *Ixodes scapularis*. **Parasites & Vectors**. In press



15. Estrada-Peña A., Sprong H., **Cabezas-Cruz A.**, de la Fuente J., Ramo A., Coipan E C. 2016. Nested coevolutionary networks shape the ecological relationships of ticks, hosts and the Lyme disease bacteria, *Borrelia burgdorferi*. ***Parasites & Vectors***. In press

2015

16. **Cabezas-Cruz A.**, et al. 2015. Regulation of the immune response to  $\alpha$ -gal and vector-borne diseases. ***Trends in Parasitology***. 31(10): 470-476.
17. **Cabezas-Cruz A** & de la Fuente J. 2015. *Anaplasma marginale* major surface protein 1a: a marker of strain diversity with implications for control of bovine anaplasmosis. ***Ticks and tick-borne diseases***. 6(2015):205-210.
18. **Cabezas-Cruz A.**, et al. 2015. Complete Genome Sequence of *Ehrlichia mineirensis*, a Novel Organism Closely Related to *Ehrlichia canis* with a New Host Association. ***Genome Announcement***. 3(1):e01450-14.
19. Tonk M\*, **Cabezas-Cruz A\***, et al. 2015. *Ixodes ricinus* defensins attack distantly-related pathogens. ***Developmental & Comparative Immunology***. 53(2):358-365.  
**\*Joint first authors.**
20. Alberdi P., Ayllón N., **Cabezas-Cruz A.**, et al. 2015. Infection of *Ixodes* spp. tick cells with different *Anaplasma phagocytophilum* isolates induces the inhibition of apoptotic cell death. ***Ticks and tick-borne diseases***. 6(6):758-767.
21. Tonk M., Knorr E., **Cabezas-Cruz A.**, et al. 2015. *Tribolium castaneum* defensins are primarily active against Gram-positive bacteria. ***Journal of invertebrate pathology***. 132: 208-215.
22. Kocan K M., de la Fuente J., **Cabezas-Cruz A.** 2015. The genus *Anaplasma*: New challenges after reorganization. ***Revue Scientifique et technique (International Office of Epizootics)***. 34(2):577-586.
23. Estrada-Peña A., de la Fuente J., Ostfeld R., **Cabezas-Cruz A.** 2015. Interactions between tick and transmitted pathogens evolved to minimise competition through nested and coherent networks. ***Scientific Reports***. 5: 10361.
24. Ayllón N., Villar M., Galindo R C., Kocan K M., Šíma R., López J., Vázquez J., Alberdi P., **Cabezas-Cruz A.**, et al. 2015. Systems Biology of Tissue-Specific Response to *Anaplasma phagocytophilum* Reveals Differentiated Apoptosis in the Tick Vector *Ixodes scapularis*. ***PLoS Genetics***. 11(3): e1005120.
25. Lis K., de Mera I G F., Popara M., Nieves A., **Cabezas-Cruz A.**, et al. 2015. Molecular and immunological characterization of three strains of *Anaplasma marginale* grown in cultured tick cells. ***Ticks and tick-borne diseases***. 6(2015):522-529.
26. de la Fuente J., Díez-Delgado I., Contreras M., Vicente J., **Cabezas-Cruz A.**, et al. 2015. Complete genome sequence of field isolates of *Mycobacterium bovis* and *Mycobacterium caprae*. ***Genome Announcement***. 3(3):e00247-15.
27. Baêta B A., Ribeiro Carla C D U., Teixeira R C., **Cabezas-Cruz A.**, et al. 2015. Characterization of two strains of *Anaplasma marginale* isolated from cattle in Rio de Janeiro, Brazil, after propagation in tick cell culture. ***Ticks and tick-borne diseases***. 6(2):141-145.
28. Ayllón N., Naranjo V., Hajdušek O., Villar M., Galindo R C., Kocan K M., Alberdi P., Šíma R., **Cabezas-Cruz A.**, et al. 2015. Nuclease Tudor-SN is involved in tick dsRNA-mediated RNA interference and feeding but not in defense against flaviviral or *Anaplasma phagocytophilum* rickettsial infection. ***PLoS ONE***. 10(7):e0133038.
29. Villar M., Ayllon N., Kocan K M., Bonzon-Kulichenko E., Alberdi P., Blouin E F., Weisheit S., Mateos-Hernandez L., **Cabezas-Cruz A.**, et al. 2015. Identification and characterization of *Anaplasma phagocytophilum* proteins involved in infection of the tick vector, *Ixodes scapularis*. ***PLoS ONE***. 10(9):e0137237.
30. Pinheiro-Silva R., Borges L., Coelho L P., **Cabezas-Cruz A.**, et al. 2015. Gene expression changes in the salivary glands of *Anopheles coluzzii* elicited by *Plasmodium berghei* infection. ***Parasites & Vectors***. 8:485.

31. de la Fuente J., Estrada-Peña A., **Cabezas-Cruz A.**, et al. 2015. Flying ticks: Anciently evolved associations that constitute a risk of infectious disease spread. *Parasites & Vectors*. 8:538.
32. de la Fuente J., Diez I., Contreras M., Vicente J., **Cabezas-Cruz A.**, et al. 2015. Comparative genomics of field isolates of *Mycobacterium bovis* and *M. caprae* provides evidence for possible correlates with bacterial viability and virulence. *PLoS Neglected Tropical Diseases*. 9(11):e0004232.
33. Almazán C., González-Álvarez H., García-Fernández I., **Cabezas-Cruz A.**, et al. 2015. Molecular identification and characterization of *Anaplasma platys* and *Ehrlichia canis* in dogs in Mexico. *Ticks and tick-borne diseases*. 2016;7(2):276-283.

## 2014

34. **Cabezas-Cruz A.**, et al. 2014. Cancer research meets tick vectors for infectious diseases. *THE LANCET Infectious Diseases*. 14(10): 916-917.
35. **Cabezas-Cruz A** & Valdés J J. 2014. Are ticks venomous animals? *Frontiers in Zoology*. 11: 47. **Highly accessed!**
36. **Cabezas-Cruz A.**, et al. 2014. The glycoprotein TRP36 of *Ehrlichia* sp. UFMG-EV and related cattle pathogen *Ehrlichia* sp. UFMT-BV evolved from a highly variable clade of *E. canis* under adaptive diversifying selection. *Parasites & Vectors*. 7:584.
37. Schwarz A\*, **Cabezas-Cruz A\***, et al. 2014. Understanding the evolutionary structural variability and target specificity of tick salivary peptides using next generation transcriptome data. *BMC evolutionary biology*. 14:4.  
**\*Joint first authors.**
38. Zwegarth E., **Cabezas-Cruz A.**, et al. 2014. *In vitro* culture and structural differences in the major immunoreactive protein gp36 of geographically distant *Ehrlichia canis* isolates. *Ticks and tick-borne diseases*. 5(4): 423–431.
39. Mutshembele A M., **Cabezas-Cruz A.**, et al. 2014. Epidemiology and evolution of genetic variability of *Anaplasma marginale* in South Africa. *Ticks and tick-borne diseases*. 5(6): 624-631.
40. Tonk M., **Cabezas-Cruz A.**, et al. 2014. Identification and partial characterisation of new members of the *Ixodes ricinus* defensin family. *Gene*. 540 (2): 146–152.
41. Silva J B., **Cabezas-Cruz A.**, et al. 2014. Infection of water buffalo in Rio de Janeiro Brazil with *Anaplasma marginale* strains also reported in cattle. *Veterinary Parasitology*. 205 (2014): 730–734.
42. Tonk M., **Cabezas-Cruz A.**, et al. 2014. Defensins from the tick *Ixodes scapularis* are effective against phytopathogenic fungi and the human bacterial pathogen *Listeria grayi*. *Parasites & Vectors*. 7: 554.
43. Silva J B., Fonseca A H., Barbosa J D., **Cabezas-Cruz A.**, et al. 2014. Low genetic diversity associated with low prevalence of *Anaplasma marginale* in water buffaloes in Marajó Island, Brazil. *Ticks and tick-borne diseases*. 5(6): 801-804.

## 2013

44. **Cabezas-Cruz A.**, et al. 2013. Functional and Immunological Relevance of *Anaplasma marginale* Major Surface Protein 1a Sequence and Structural Analysis. *PLoS ONE*. 8(6): e65243.
45. **Cabezas-Cruz A.**, et al. 2013. Ultrastructure of *Ehrlichia mineirensis*, a new member of the Ehrlichia genus. *Veterinary Microbiology*. 167(3–4): 455–458.
46. Pohl A E., **Cabezas-Cruz A.**, et al. 2013. Detection of genetic diversity of *Anaplasma marginale* isolates in Minas Gerais, Brazil. *Brazilian journal of veterinary parasitology*. 22(1):129–135.
47. Zwegarth E., Schöl H., Lis K., **Cabezas-Cruz A.**, et al. 2013. *In vitro* culture of a novel genotype of *Ehrlichia* sp. from Brazil. *Transboundary and Emerging Diseases*. 60 (Suppl. 2) 86–92.

48. Preston S G., Majtán J., Kouremenou C., Rysnik O., Burger L F., **Cabezas-Cruz A.**, et al. 2013. Novel immunomodulators from hard ticks selectively reprogramme human dendritic cell responses. *PLoS Pathogens*. 9(6): e1003450.

2012

49. **Cabezas-Cruz A.**, et al. 2012. New species of *Ehrlichia* isolated from *Rhipicephalus (Boophilus) microplus* shows an ortholog of the *E. canis* major immunogenic glycoprotein gp36 with a new sequence of tandem repeats. *Parasites & Vectors*. 5: 291.

#### **SELECTED POSTERS AND ORAL PRESENTATIONS**

- **Cabezas-Cruz A.**, et al. Effect of glucose on the structure and transcriptional regulation of glucose transporters in *Schistosoma mansoni*. Molecular and Cellular Biology of Helminths IX, Hydra, Greece, 2015. POSTER
- Lopez V., Alberti P., Villar M., **Cabezas-Cruz A.**, et al. Experimental infections of HL-60 cells with different strains of *Anaplasma phagocytophilum* isolated from humans, dogs and sheep. VIII International Conference on Ticks and Tick-borne Pathogens (TTP-8), Cape Town, South Africa, 2014. POSTER
- Mutshembele A M., Mtshali M S., Thekiso O M M., **Cabezas-Cruz A.**, et al. Epidemiology and evolution of genetic variability of *Anaplasma marginale* in South Africa. VIII International Conference on Ticks and Tick-borne Pathogens (TTP-8), Cape Town, South Africa, 2014. POSTER
- **Cabezas-Cruz A.**, et al. Cellular and molecular characterization of *Ehrlichia mineirensis*, a new tick-derived organism isolated from *Rhipicephalus (Boophilus) microplus*. 2 Workshop of ticks and tick-borne diseases, Berlin, Germany, 2013. ORAL PRESENTATION
- **Cabezas-Cruz A.**, et al. *Anaplasma marginale* major surface protein 1a (MSP1a): Strain classification with functional and immunological relevance. 2 Workshop of ticks and tick-borne diseases, Berlin, Germany, 2013. ORAL PRESENTATION
- **Cabezas-Cruz A.**, et al. Cellular and molecular characteristics of *Ehrlichia mineirensis*, a new tick-derived organism isolated from *Rhipicephalus (Boophilus) microplus*. International Symposium on Ectoparasites of Pets (ISEP) conference, Munich, Germany, 2013. POSTER

# Table of contents

<b>CHAPTER I Introduction .....</b>	<b>1</b>
Schistosoma.....	2
Schistosomes, ancient and deadly parasites.....	3
The epidemiology and distribution of human schistosomiasis are dynamic processes. ....	4
Control of Schistosomiasis, the lack of alternative therapeutics.....	8
Taxonomy of <i>S. mansoni</i> .....	11
Phylogeny of Neodermata, the controversy continues. ....	11
Life cycle of <i>S. mansoni</i> .....	15
Glucose metabolism in <i>Schistosoma mansoni</i> .....	17
Glucose metabolism in <i>S. mansoni</i> , an overview .....	18
Glucose transporters in <i>S. mansoni</i> .....	19
Glycolysis in <i>S. mansoni</i> .....	23
<i>Schistosoma mansoni</i> lactate dehydrogenase .....	27
Mitochondrial metabolism in <i>S. mansoni</i> .....	28
Glucose energetic balance .....	31
The pioneers of the metabolic switch.....	32
Cancer cells and the metabolic shift .....	33
The aerobic GLY and the metabolic needs of proliferating cells.....	33
Epigenetic control of gene regulation in schistosomes. ....	36
Abstract .....	39
Introduction.....	39
Epigenetic mechanisms as drug targets.....	41
DNA methylation .....	42
DNA methylation in schistosomes.....	43
Micro-RNAs.....	44
Schistosome miRNAs.....	45
Post-translational modifications of histones.....	46
Schistosome histone modifications.....	51

Schistosome histone modifying enzymes: which are the best targets? .....	52
Development of selective inhibitors as drugs: the challenges.....	54
Conclusions.....	57
Schistosome sirtuins.....	58
Abstract .....	60
Schistosomiasis: strategies for drug discovery.....	60
Why the boom in research on sirtuins? .....	61
Platyhelminthes present an evolutionarily conserved family of sirtuins.....	62
Sirtuin cellular functions.....	63
Sirtuin structure and catalysis .....	68
Sirtuins, cancer and schistosomes.....	70
Sirtuin inhibitors: scaffolds and strategies .....	72
Sirtuins as drug targets in parasites .....	74
Future perspectives.....	76
<b>HYPOTHESIS AND OBJECTIVES .....</b>	<b>77</b>
Hypothesis .....	78
Objectives.....	78
<b>CHAPTER II Results .....</b>	<b>79</b>
Schistosome glucose transporters. ....	80
Abstract .....	82
Glucose induces transcriptional changes in <i>S. mansoni</i> glucose transporter genes in schistosomula larvae .....	85
<i>S. mansoni</i> glucose transporters cluster separately and evolve at different rates.....	87
The rapidly-evolving glucose transporters SGTP2 and SGTP3 are encoded by intron-rich genes	90
<i>S. mansoni</i> glucose transporters show typical molecular signatures.....	92
The predicted tertiary structural conformations of <i>S. mansoni</i> glucose transporters are homologous to GLUT1 and Xyle .....	95
Residue dynamics reveal how glucose affects invariant residues of glucose transporters involved in binding.....	98
Biophysical properties of <i>S. mansoni</i> glucose transporters provide insights into glucose affinity .....	100
Methods .....	104

Role of sirtuins in the mitochondrial metabolism of <i>S. mansoni</i> .....	111
Abstract .....	113
Introduction.....	114
Results .....	115
High glucose concentration induces a gene expression reprogramming associated with increase lactate production and mitochondrial activity.....	115
High glucose activates mitochondrial activity after metabolic transformation.....	118
<i>SmSirt1</i> , but not <i>SmSirt6</i> , is upregulated upon metabolic transformation in schistosomula.....	120
<i>SmSirt1</i> is a repressor of <i>SPDK1</i> .....	122
<i>SmSirt1</i> is an activator of mitochondrial activity in <i>S. mansoni</i> .....	124
Discussion .....	125
Conclusions.....	127
Materials and methods .....	128
<b>CHAPTER III General discussion.....</b>	<b>132</b>
<b>CONCLUSIONS.....</b>	<b>137</b>
<b>PERSPECTIVES .....</b>	<b>139</b>
<b>REFERENCES.....</b>	<b>141</b>
<b>ANNEXES.....</b>	<b>175</b>

# Abbreviations

**ACP:** Acyl carrier protein

**ADP:** Adenosine diphosphate

**Asp:** Aspartate

**ATP:** Adenosine triphosphate

**aLRT:** Approximate likelihood ratio test

**Å:** Angstrom

**bp:** base pairs.

**CoA:** Coenzyme A

**CTP:** Cytidine triphosphate

**cDNA:** Complementary deoxyribonucleic acid

**dATP:** Deoxyadenosine triphosphate

**dCTP:** Deoxycytidine triphosphate

**dGTP:** Deoxyguanosine triphosphate

**DHF:** Dihydrofolate

**dTMP:** Deoxythymidine monophosphate

**dTTP:** Deoxythymidine triphosphate

**dUDP:** Deoxyuridine diphosphate

**dUMP:** Deoxyuridine monophosphate

**dUTP:** Deoxyuridine triphosphate

**FAD:** Flavin adenine dinucleotide

**FADH<sub>2</sub>:** Flavin adenine dinucleotide, reduced

**GMP:** Guanosine monophosphate

**GTP:** Guanosine triphosphate

**Glu:** Glutamate

**IDH1:** Isocitrate dehydrogenase 1

**IDH2:** Isocitrate dehydrogenase 2

**IMP:** Inosine monophosphate

**LRT:** Likelihood ratio test

**ML:** Maximum likelihood

**MP:** Maximum parsimony

**MEGA:** Molecular evolutionary genetics

**mM:** Millimolar

**mRNA:** messenger Ribonucleic acid

**NAD:** Nicotinamide adenine dinucleotide

**NADH:** Nicotinamide adenine dinucleotide, reduced

**NADP:** Nicotinamide adenine dinucleotide phosphate

**NADPH:** Nicotinamide adenine dinucleotide phosphate, reduced

**NJ:** Neighbor joining

**PCR:** Polymerase chain reaction

**PDB:** Protein data bank

**PELE:** Protein energy landscape exploration

**P:** Phosphate

**PDH:** Pyruvate dehydrogenase

**PRPP:** Phosphoribosyl pyrophosphate

**RT-PCR:** Real-Time PCR

**RACE PCR:** Rapid amplification of cDNA ends PCR

**RMSD:** Root mean square deviation analysis

**SH-like:** Shimodaira-Hasegawa-like

**SDH:** Succinate dehydrogenase

**THF:** Tetrahydrofolate

**UDP:** Uridine diphosphate

**UMP:** Uridine monophosphate

**UTP:** Uridine triphosphate

**α-KG:** α-Ketoglutarate

**μM:** Micromolar

# **CHAPTER I**

## **INTRODUCTION**





## Schistosoma

## Schistosomes, ancient and deadly parasites

Human schistosomiasis (also called bilharzia<sup>1</sup>) is caused by trematode flukes of the genus *Schistosoma*. The earliest archaeological records of humans infected with *Schistosoma* spp. were found in ancient Egyptian mummies dated to 5200 years BP<sup>2</sup> (Kloos and David, 2002; Anastasiou et al., 2014). However, a 6000 year old egg was discovered in pelvic sediment from a Tell Zeidan<sup>3</sup> farmer (Figure 1). Kloos and David (2002) suggested that the development of irrigation in the ancient Egypt may have provided conditions favorable for schistosomiasis. Since then, schistosomiasis has become the second (after malaria) most important parasitic disease affecting people worldwide. The most important species are *S. mansoni*, *S. haematobium*, *S. japonicum* and *S. mekongi* which are distributed mainly in Africa, South America and Asia (WHO<sup>4</sup>; Colley et al., 2014). The pathology of *S. mansoni* is mainly associated with the parasite's eggs which induce a chronic debilitating disease (Chitsulo et al., 2004). Currently, there is no vaccine available and only one effective drug, praziquantel<sup>5</sup> (Fenwick et al., 2009).

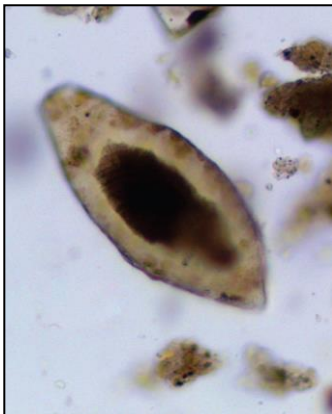

**Figure 1.** The ancient schistosome egg has a curved pole, a terminal spine at the opposite pole, a single wall, pale brown colouring, measured 132×56 µm and could be from *S. haematobium* or *S. intercalatum*. Picture from Anastasiou et al. (2014).

---

<sup>1</sup> Latin, former name of the genus *Schistosoma*, named after Theodor Maximilian Bilharz (1825–62), the German physician who discovered the parasite.

<sup>2</sup> Before Present (BP) years is a time scale used mainly in geology and other scientific disciplines to specify when events in the past occurred. Standard practice is to use 1 January 1950 as “Present”.

<sup>3</sup> Tell Zeidan is an archaeological site of the Ubaid culture in northern Syria.

<sup>4</sup> World Health Organization official website: <http://www.who.int/en/>

<sup>5</sup> Marketed as Biltricide.

**The epidemiology and distribution of human schistosomiasis are dynamic processes.**

According to conservative estimates, schistosomiasis affects more than 230 millions of people worldwide (Chitsulo et al., 2004; King et al., 2005; Vos et al., 2012; Colley et al., 2014), from which about 280 000 people die every year in endemic countries with this affection (King et al., 2005). Eight species of *Schistosoma* have been reported infecting humans (Table 1). Definitive vertebrate host species, other than human, may contribute to *Schistosoma* epidemiology and persistence in nature (Table 1).

**Table 1. The eight species of schistosome reported in humans (Standley et al., 2012).**

<i>Schistosoma</i> species	Distribution	Natural definitive host species (excluding humans)	Human public health importance
<i>S. mansoni</i>	Africa, Middle East, South America, Caribbean	Non-human primates (including apes), rodents, insectivores, artiodactylids (waterbuck), procyonids (raccoon)	High
<i>S. haematobium</i>	Africa, Middle East	Non-human primates (not apes)	High
<i>S. intercalatum</i>	Central Africa (D.R. Congo only)	Possibly rodents	Low
<i>S. guineensis</i>	West Africa (Lower Guinea)	Possibly rodents	Low
<i>S. mattheei</i>	Southern Africa	Non-human primates (not apes), artiodactylids (cattle, antelope)	Low
<i>S. japonicum</i>	East Asia (China, Philippines, Indonesia)	Non-human primates, artiodactylids (water buffalos in particular), carnivores, rodents, perissodactylids (horses)	High
<i>S. mekongi</i>	SE Asia (Vietnam, Cambodia, Laos, Thailand)	Carnivores (dogs), artiodactylids (pigs)	Moderate
<i>S. malayensis</i>	Malayan penisular	Rodents (van Mueller's rat)	Low

As shown in Figure 2, human schistosomiasis is a health burden mainly in countries in Africa, Asia and South America. However, recently *S. haematobium* was reported in the Mediterranean area, particularly in the island of Corsica, a French territory (Holtfreter et al., 2014; de Laval et al., 2014; Brunet et al., 2015). This finding, together with a decade of native cases around Europe, raised concerns regarding the presence of

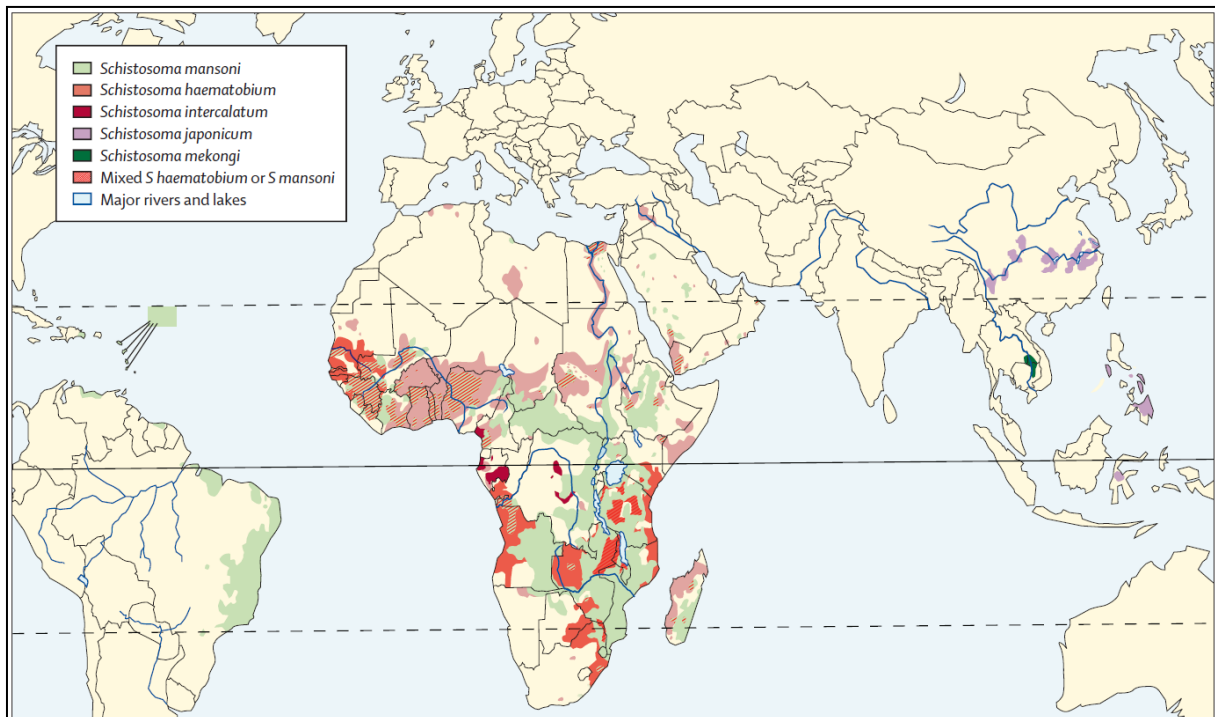
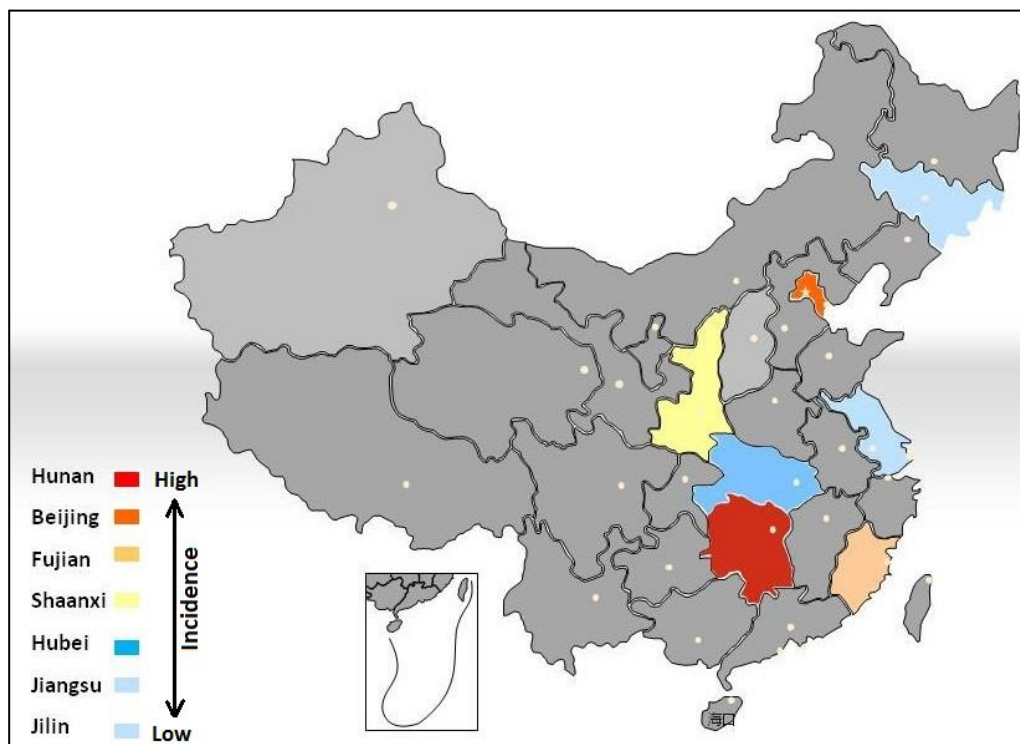

**Figure 2. Worldwide distribution of human schistosomiasis produced by the main species of *Schistosoma*. Figure from Colley et al., 2014.**

schistosomiasis in Europe (de Laval et al., 2014). Three epidemiological conditions were argued by de Laval and colleagues (2014) to be of special relevance in further assessing the risk of schistosomiasis in Mediterranean Europe: (i) this area is ecologically favorable to snails of the genus *Bulinus* which are the intermediate hosts of human (*S. haematobium*, *S. intercalatum* and *S. guiniensis*) and animal schistosomes (*S. bovis*, *S. curassoni*, *S. mattheei*, *S. leiperi* and *S. margrebowiei*) (Kane et al., 2008), (ii) climate warming creates favourable conditions for local transmission of *Schistosoma* spp. (McCreesh et al., 2015), and (iii) movement of people which brings infected individuals from endemic regions to the European region allowing, given the conditions, the establishment of transmission chains in these areas.

The presence of intermediate host snails, climatic change and population movements may also change the current pattern of *Schistosoma* spp. distribution. For example, *S. japonicum* is the main *Schistosoma* spp. in China (Yang et al., 2014). However, the rise of commercial activity between China and Africa has increased the occurrence and detection of *S. mansoni* and *S. haematobium* in Chinese workers returning from Africa (Liang et al., 2013). This condition, together with the presence of ecological habitats of *Biomphalaria straminea*,

an intermediate host of *S. mansoni*, in Hong Kong (Wang et al., 2013; Liang et al., 2013) and the global climate warming are expected to increase the risk of infections by *S. mansoni* in Chinese mainland (Liang et al., 2013). Notably, from 1981 when it was first found in Shenzhen City, Hong Kong, to 2013 the snail *B. straminea* has spread to northern regions such as Dongguan City and Huizhou City (Huang et al., 2014). As a consequence, an updated map of the presence of African schistosomiasis in China has been presented (Figure 3).



**Figure 3. Updated map of African schistosomiasis in China. Figure modified from Wang et al., 2013.**

Recently, McCreesh and colleagues (2015) modelled the impact of climate change on the geographical distribution of schistosomiasis by its effects on the suitability of freshwater bodies for hosting parasite and snail populations in Africa. They found that infection risk may increase by up to 20% over most of eastern Africa (mainly in Rwanda, Burundi, south-west Kenya and eastern Zambia) over the next 20 and 50 years. In addition, their predictions suggest that *S. mansoni* may become newly endemic in some areas. They concluded that this trend may reduce the impact of control and elimination programmes (McCreesh et al., 2015).

Hybridization between schistosomes influences disease epidemiology and enhances phenotypic characteristics affecting transmission, morbidity and drug sensitivity (Webster et al., 2013). Therefore, another factor to consider in the epidemiology of *Schistosoma* is the hybridization of species which increase the risk of emerging zoonotic schistosomes. The two main cases of hybridization that include the human schistosomes (Table 1) are those between *S. haematobium* and *S. bovis* and between *S. mansoni* and *S. bovis* (Standley et al., 2012), but also hybridization of *S. haematobium* and *S. curassoni* have been reported (Webster et al., 2013). In fact, some of the schistosomiasis reports in Corsica and Benin were associated to *S. haematobium/S. bovis* hybrids (Moné et al., 2015, 2016), and in Senegal, 88% of the children surveyed presented infections with hybrids of *S. haematobium/S. curassoni* or *S. haematobium/S. bovis* (Webster et al., 2013). Hybridization can have a major evolutionary impact. While it can result in lower average fitness due to F1 sterility and inviability, it is at the same time a rich source of new genetic variation which can provide the raw material for natural selection to shape the evolution of ecologically relevant traits. Thus, hybridization has the potential to broaden the “working surface” for selection by producing a whole range of potentially adaptive phenotypes, ranging from one parent to the other and beyond (King et al., 2015).

Finally, an important overlooked point in the epidemiology of Schistosomiasis are social and cultural factors. Some studies have shown the lack of appropriate knowledge regarding the presence, transmission and prevention of Schistosomiasis in endemic regions (Odhiambo et al., 2014; Rassi et al., 2016). A recent study highlighted the importance of individual and community perceptions in the epidemiology of Schistosomiasis (Rassi et al., 2016). For example, despite several rounds of mass drug administration in Mozambique, where schistosomiasis is highly endemic, only 9% of households with children reported that at least one of them received anti-schistosome treatment (Rassi et al., 2016). Another striking result was that among the people that were aware of the disease, only a very low proportion of them had the appropriate knowledge regarding acquisition (18%), transmission (26%) and prevention (13%) of schistosomiasis (Rassi et al., 2016). A high proportion of people in this study believed that schistosomiasis was transmitted through sexual contact. This type of study stresses the need for health education to achieve the success of schistosomiasis control programs.

## **Control of Schistosomiasis, the lack of alternative therapeutics**

In the Sixty-fifth World Health Assembly held on May 26 2012<sup>6</sup>, the World Health Organization (WHO) a call was launched for all countries endemic for schistosomiasis to eliminate this disease by 2020. The cornerstone of this proposal was the massive access to anti-schistosomal drugs in endemic countries with annual treatments increasing from 12 million people in 2006, to 32.6 million people in 2010. Mass drug administration (MDA) is a key policy in the current strategies to control schistosomiasis. Praziquantel (PZQ), a pyrazinoisoquinoline that was introduced as a novel anthelmintic in 1975, is the drug of choice (Day et al., 1992; Fenwick and Jourdan, 2016). This enigmatic antiparasitic, for which the mechanism of action is not known, is active against all *Schistosoma* species, can be administered easily, has high cure and egg reduction rates, with no or only mild side effects (Day et al., 1992; El-Bassiouni et al., 2007). In addition, PZQ reduces common serious complications of schistosomiasis such as periportal fibrosis and hepatomegaly in intestinal schistosomiasis (Fenwick and Jourdan, 2016). The initial effects of PZQ on the flukes include the rapid influx of Ca<sup>2+</sup> ions and calcium-dependent muscle contraction and paralysis (Day et al., 1992), and this may be mediated via its interaction with a calcium channel beta subunit (Kohn et al., 2001). Regardless of the mechanism of action, nowadays, the major financial and political efforts to tackle schistosomiasis rely on PZQ (Figure 4). Notably, Schistosomiasis Control Initiative (SCI) led by Professor Alan Fenwick at the Imperial College London, has provided proof of concept of that MDA is a suitable tool for the control of schistosomiasis in Sub-Saharan Africa. In addition to materials and diagnostic tools, this program has been a major educative step towards the effective control of schistosomiasis in this part of the world. Through SCI, 14 million African children are treated every year against schistosomiasis<sup>7</sup>.

---

<sup>6</sup> [http://www.who.int/neglected\\_diseases/mediacentre/WHA\\_65.21\\_Eng.pdf](http://www.who.int/neglected_diseases/mediacentre/WHA_65.21_Eng.pdf)

<sup>7</sup> Interview with Professor Alan Fenwick (<http://www.imperial.ac.uk/schistosomiasis-control-initiative/our-work/media/>)

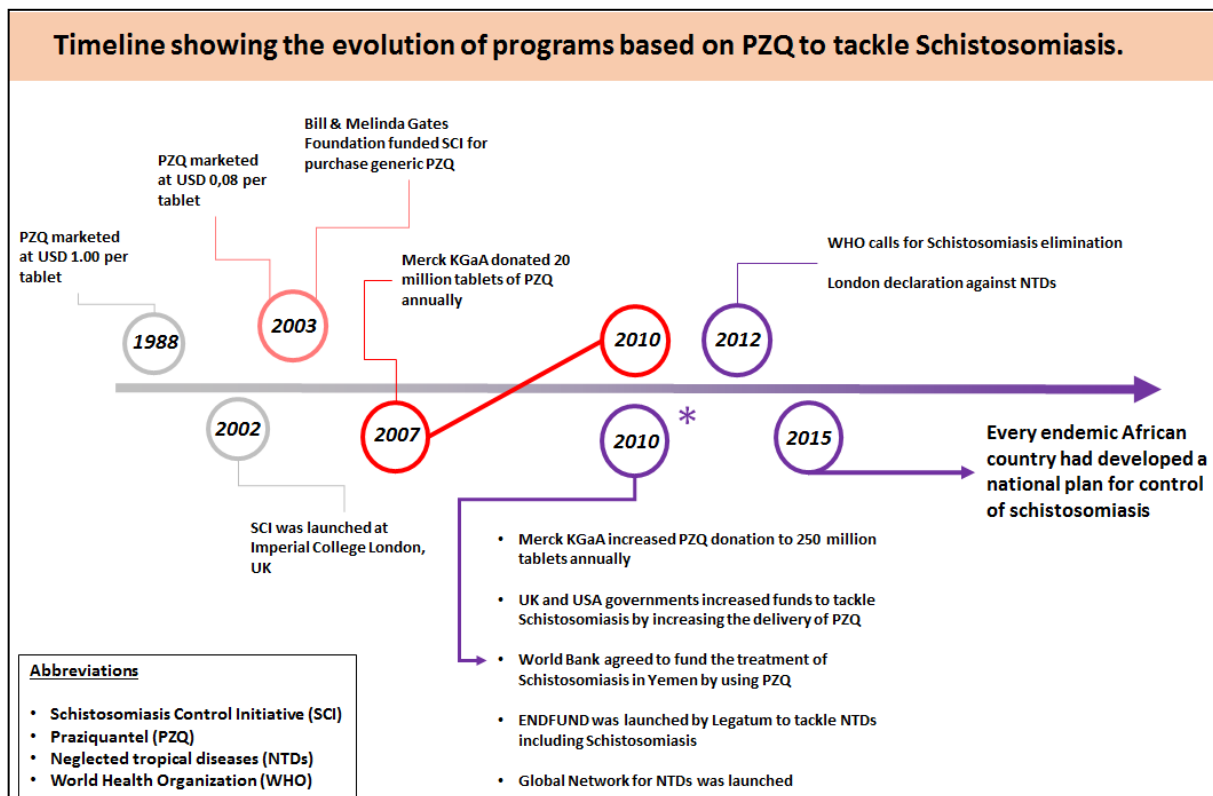

**Figure 4. Programs of control of schistosomiasis based on PZQ. After 2010 (asterisk) more international support was gathered for the control of schistosomiasis. Data obtained from Fenwick and Jourdan, 2016.**

As a result of the international efforts summarized in Figure 4, the intensity of infection is now very low compared with levels before treatments were offered. Indeed, elimination of schistosomiasis as a public health problem is an achievable goal (Rollinson et al., 2013), however it may take longer than initially thought (Fenwick and Jourdan, 2016). Examples of successful schistosomiasis control programmes include: St. Lucia and other Caribbean islands, Brazil and Venezuela for *S. mansoni*; Saudi Arabia and Egypt for both *S. mansoni* and *S. haematobium*; Morocco, Tunisia, Algeria, Mauritius and the Islamic Republic of Iran for *S. haematobium*; Japan and the People's Republic of China for *S. japonicum* (Rollinson et al., 2013).

However, long-term predictions based on mathematical modelling from 2015 indicates that infection prevalence can be substantially reduced within 10 years only if there is >70 % of community participation and sustained MDA. Notably, significant risk for re-emergence of infection increases as soon as MDA is suspended (Gurarie et al., 2015). This leads to a paradox, while stopping MDA increases the prevalence of schistosomiasis, sustained MDA is very likely to induce the emergence of PZQ resistance in Schistosomes. An



excellent example is “*The Antibiotic Resistance Crisis*” that humanity is facing nowadays (Ventola, 2015). An antimicrobial resistance crisis has two main components: the overuse and misuse of these medications and the lack of new drug development by the pharmaceutical industry (Ventola, 2015).

Resistant organisms appear to be within parasite and microbe populations at low frequency even before the antimicrobials start to be widely used. For example, Penicillin-Resistant *Staphylococcus* were detected three years before Penicillin was introduced in 1943 (Ventola, 2015). However, as a result of natural selection, antimicrobials remove drug-sensitive competitors, paving the way to resistant organisms (Ventola, 2015). While this is a quite straightforward thought, the overuse (MDA) of PZQ will continue, therefore we should expect the emergence of PZQ resistant strains of Schistosomes. In fact, PZQ-resistant isolates of *Schistosoma* have been already detected (Doenhoff et al., 2008; Melman et al., 2009; Liang et al., 2010) and can be induced readily in the laboratory (Pinto-Almeida et al., 2015).

New drugs are needed and several approaches are undergoing to this goal. In particular, our group target histone modifying enzymes of *S. mansoni* for drug discovery. In following subsections (*Epigenetic control of gene regulation in schistosomes* and *Schistosome sirtuins*)<sup>8</sup> this will be discussed in more details.

---

<sup>8</sup> *Epigenetic control of gene regulation in schistosomes* (from pag 35). *Schistosome sirtuins* (from pag 56)

## **Taxonomy of *S. mansoni***

The formal taxonomic classification of *S. mansoni* is as follow<sup>9</sup>:

<b>Kingdom</b>	<b>Animalia</b>
<b>Subkingdom</b>	<b>Bilateria</b>
<b>Infrakingdom</b>	<b>Protostomia</b>
<b>Superphylum</b>	<b>Platyzoa</b>
<b>Phylum</b>	<b>Platyhelminthes</b>
<b>Subphylum</b>	<b>Neodermata</b>
<b>Class</b>	<b>Trematoda</b>
<b>Subclass</b>	<b>Digenea</b>
<b>Order</b>	<b>Strigeatida</b>
<b>Family</b>	<b>Schistosomatidae</b>
<b>Genus</b>	<b>Schistosoma</b>
<b>Species</b>	<b><i>Schistosoma mansoni</i></b>

### **Phylogeny of Neodermata, the controversy continues.**

Within Platyhelminthes, Neodermata is composed for three classes: Monogenea, Digenea and Cestoda. Using a MLSA<sup>10</sup> approach that included 12 protein coding genes of the mitochondrial genomes of 32 Platyhelminthes, Perkins and colleagues (2010) resolved the phylogeny of Neodermata (Figure 5).

---

<sup>9</sup> Taken from the Integrated Taxonomic Information System (ITIS). Link: [http://www.itis.gov/servlet/SingleRpt/SingleRpt?search\\_topic=TSN&search\\_value=55320](http://www.itis.gov/servlet/SingleRpt/SingleRpt?search_topic=TSN&search_value=55320) (accessed 15-04-2016).

<sup>10</sup> Multilocus Sequence Analysis.

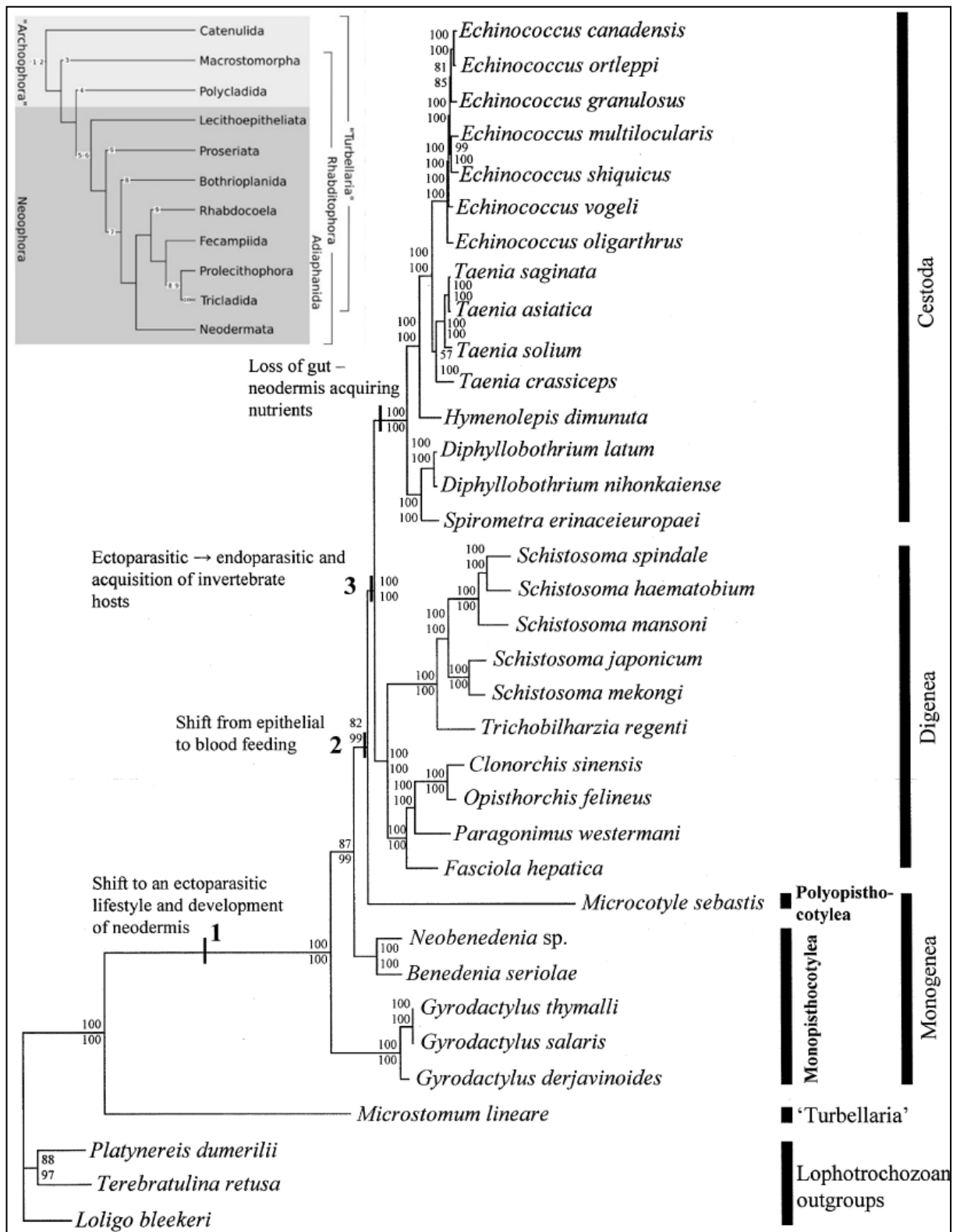
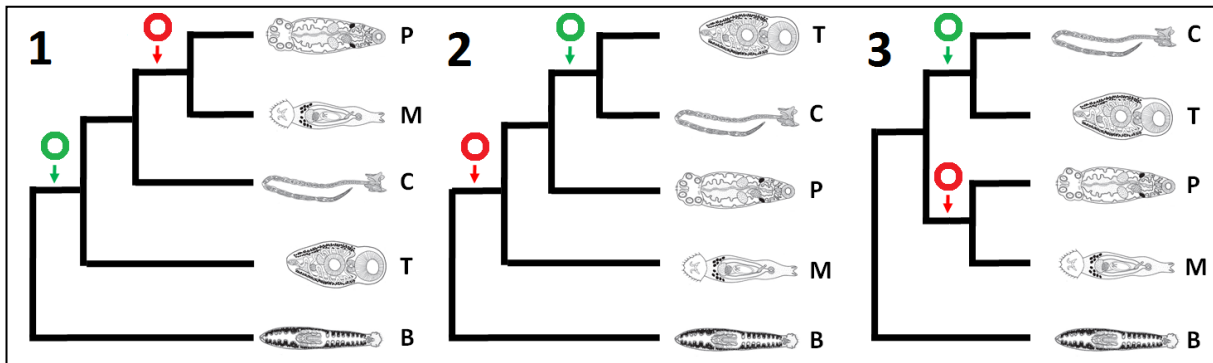

Figure 5. Phylogenetic relation of Platyhelminthes and the three classes of Neodermata. The phylogenetic relation of Platyhelminthes is shown including Neodermata (gray scale inset, figure from Martín-Durán and Egger, 2012). The phylogenetic relation of the three classes of Neodermata (Clade with point 1): Monogenea, Digenea and Cestoda is shown, figure from Perkins et al. (2010). Major evolutionary transitions in Neodermata towards a parasitic life-style are highlighted.

The analysis by Perkins et al. (2010) shows that Digenea and Cestoda are monophyletic and sister groups, but Monogenea is not monophyletic (Perkins et al., 2010). Generally speaking, Turbellaria are free-living flatworms, and Monogenea and Digenea+Cestoda are ectoparasites and endoparasites, respectively. Considering this, the phylogeny in Figure 5 provides a simple explanation for the shift from free-living to parasitism and the acquisition of multiple host life histories in Digenea+Cestoda. The phylogeny in Figure 5 suggests that the common ancestor of Neodermata (Point 1 in Figure 5) was a free-living turbellarian-like omnivore which adapted to ectoparasitism (Rohde, 1994; Perkins et al., 2010). The first and most essential morphological innovation to achieve this was the acquisition of attachment organs to maintain close contact with the host. The second parasitic evolutionary step was the shift from epithelium- to blood-feeding behavior (Point 2 in Figure 5). Finally, the adaptation to an endoparasitic life-style occurred (Point 3 in Figure 5). However, based on the analysis in Figure 5, the above evolutionary scenario makes several assumptions (i) that the turbellarian *Microstomum lineare* is the sister taxa of Neodermata, (ii) that Cestoda and Trematoda (Digenea+Aspidogastrea) form a monophyletic clade, (iii) and that Monogenea are basal to Cestoda and Trematoda.

However, recent studies have put things up-side down (Egger et al., 2015; Laumer et al., 2015). Firstly, both studies used strong phylogenetic approaches combined with transcriptomic data which produced MLSA including 1348/516 genes and 107000/132299 amino acid positions, respectively. Secondly, the two studies agreed that the sister taxon of Neodermata is a group of small flatworms called Bothrioplanida, which are predators of other invertebrates (Egger et al., 2015; Laumer et al., 2015; Littlewood and Waeschenbach, 2015). Thirdly, the study by Laumer et al. (2015) shows that the Cestoda are closely related to Monogenea and not to Digenea. Fourthly, Egger et al. (2015) obtained two alternative hypotheses (A/B) for the relation of Monogenea, Cestoda and Digenea: (A) Cestoda are closely related to Digenea, and Monogenea are basal to them and (B), the two clades of Monogenea (Monopisthocotylea and Polyopisthocotylea, see Figure 5) as well as Cestoda + Digenea are Monophyletic. As shown in Figure 6, these two studies have left three main hypotheses for the origin of parasitism in Neodermata (Littlewood and Waeschenbach, 2015). The first hypothesis (1 in Figure 6), is different to that of Perkins et al. (2010) because it proposes that endoparasitism evolved first and that ectoparasitism was a derived trait.



**Figure 6. Three main hypotheses for the origin of endoparasitism and ectoparasitism in Neodermata (1, 2 and 3). The position of Cestoda (C), Trematoda (T), Monopisthocotylea (M), Polyopisthocotylea (P) and Bothrioplanida (B) in each of the alternative hypothesis is shown. The hypothetical origin of endoparasitism and ectoparasitism in Neodermata is highlighted in green and red circles, respectively. Figure modified from Littlewood and Waeschenbach, 2015.**

The second hypothesis (2 in Figure 6), agrees with that of Perkins et al. (2010) in that ectoparasitism evolved first and endoparasitism was a derived trait. However, the third hypothesis (3 in Figure 6) proposes a new idea in which both endoparasitism and ectoparasitism evolved independently in Cestoda and Trematoda and Monogenea, respectively. Applying Occam's razor (i.e. *among competing hypotheses, the one with the fewest assumptions should be selected*) to the problem, I would argue that the hypothesis 3 implies that parasitism evolved two independent times, one as endoparasitism and the other as ectoparasitism. Suggesting that this major evolutionary transition (free-living to parasitism), occurred two times in Neodermata which I consider low probable. Thus, among these competing hypotheses, 1 or 2 seem as the most parsimonious. Choosing 1, would disregard previous studies that, as in 2, showed that Cestoda and Trematoda are sister taxa (Figure 5). Therefore, I consider the second hypothesis as the most probable. This second hypothesis also provides a more logic *continuum*: from free-living to ectoparasite (outside of the host body), and finally endoparasite (inside of the host body). In any case, at least the three main classes of Neodermata were saved from dramatic changes and in the class Digenea, the genus *Schistosoma* clusters together with important parasitic species such as *Clonorchis sinensis* and *Fasciola hepatica* (Figure 5).

Two major competing hypotheses have been proposed for the origin of *Schistosoma* (Agatsuma, 2003). The African origin was firstly proposed by Davis (1980, 1992). This

hypothesis proposes that *Schistosoma* originated in the super continent Gondwanaland, in the regions now forming Africa, South America, Antarctica, India, Arabia and Australia, and that after the fractionation of Gondwanaland they spread to Asia through the Indian plate (Agatsuma, 2003). However, recent molecular analyses have challenged the African origin of *Schistosoma*, and suggested an Asian origin (Agatsuma, 2003). This hypothesis proposes that the ancestral *Schistosoma* parasites existed first in Asia and that later moved into Africa, via migration and dispersal of definitive and snail intermediate hosts (Lawton et al., 2011). This hypothesis further proposes that schistosomes arrived to Africa 70 million years after the separation of the South American and African plates from Gondwanaland (Lawton et al., 2011).

### **Life cycle of *S. mansoni***

The life cycle of *S. mansoni* is depicted and resumed in Figure 7. In nature, the life cycle of *S. mansoni* includes free-living ciliated miracidia that develop in water after hatching from the eggs and infect the intermediate host, snails of the genus *Biomphalaria*. In the snail, the parasite undergoes asexual replication through mother and daughter sporocyst stages, eventually shedding tens of thousands of cercariae into the water, a process that takes from 4 to 6 weeks. The cercaria is a fork-tailed infective free-living stage that can penetrate the intact skin of human hosts becoming a juvenile parasitic stage, the schistosomula. Cercariae can remain infective in freshwater for 1–3 days, but deplete their energy reserves completely over a few hours (Lawson and Wilson, 1980). The transformation from cercariae to schistosomula is characterized by series of physiological, metabolic and structural changes (Stirewalt 1974). Schistosomula migrate to the lungs and within 5 to 7 weeks, develop into adult worms, which localized in the mesenteric veins. Adult schistosomes have sexual dimorphism. The main activity of adult worms is reproduction, one adult schistosome female can lay between 200 and 300 eggs per day (Huang et al., 2012). Adult schistosomes can live an average of 3–10 years, but in some cases as long as 40 years (Warren et al., 1974; Chabasse et al., 1985; Hornstein et al., 1990). They spend much of this time in a copula where the slender female is fitted into the gynaecophoric canal of the male. In order to carry out the intense egg production, the parasite needs to adapt its metabolism and like tumors

become high glucose consumer and the production of ATP will be basically based in glycolysis (Thompson et al., 1984).

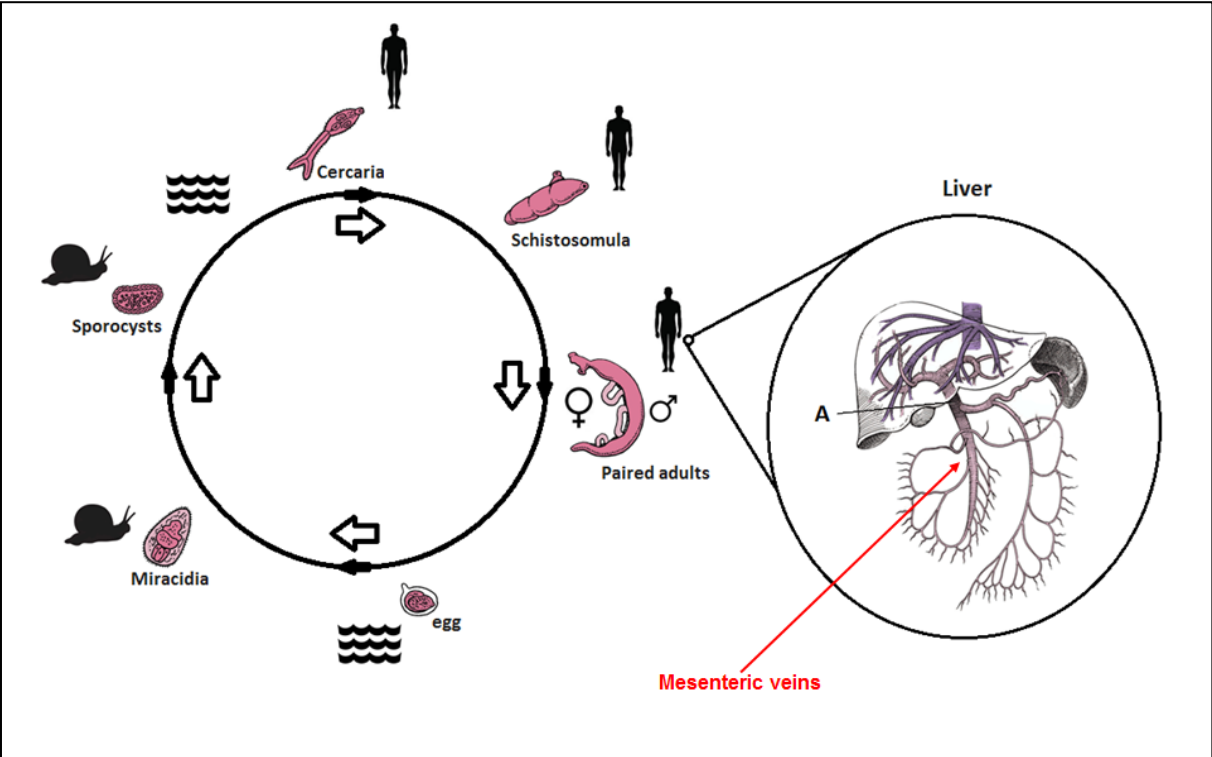
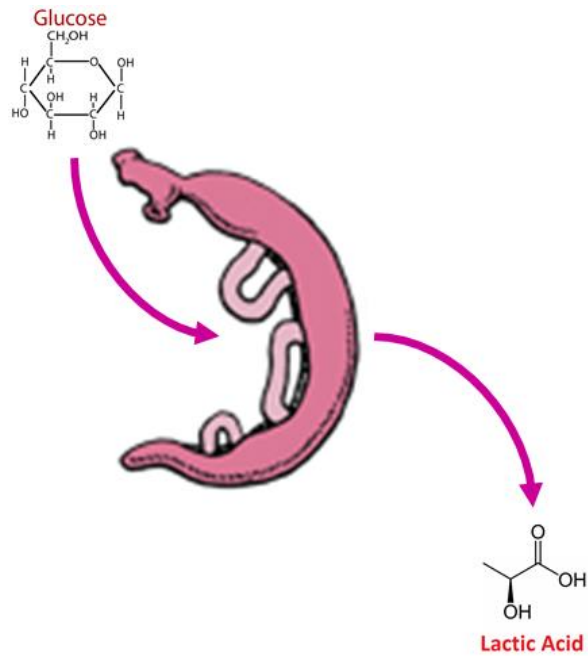

Figure 7. Life cycle of *S. mansoni*. The different stages of the life cycle of *S. mansoni* are shown.



## Glucose metabolism in *Schistosoma mansoni*



## **Glucose metabolism in *S. mansoni*, an overview**

It was early realized that mammalian stages of *S. mansoni* absorb copious quantities of glucose. In fact, *S. mansoni* utilizes in 1 hour an amount of glucose equivalent to one-sixth to one-fifth of its dry weight. In addition, over 80% of the metabolized glucose is converted to lactic acid. The rates of glucose utilization and of lactic acid production by *S. mansoni* are the same under aerobic and anaerobic conditions. In consequence, *S. mansoni* parasites are known as homolactic fermenters (Bueding, 1950). Despite the possession of a mouth and functional gut, glucose is taken up by the parasites across their tegument mainly through two glucose transporters (Skelly et al., 1998). Therefore, glucose transporters constitute the molecular basis of glucose uptake in *S. mansoni*. Likewise, it was proposed that the parasite's tegument also constitutes a major route of lactic acid excretion (Faghiri et al., 2010).

Remarkably, while aerobic glycolysis is a major metabolic pathway of mammalian stages of *S. mansoni*, the energetic metabolism of the free-living cercariae, is almost completely based on oxidative phosphorylation (OXPHOS). It was shown that early upon infection in the vertebrate host, *S. mansoni* schistosomula undergo a metabolic switch toward glycolysis which is dependent on external glucose concentration and most likely occurs exclusively in presence of oxygen (Thompson et al., 1984; Horemans et al., 1992).

In this section, glucose transporters and the major pathways of glucose degradation and their enzymatic components will be described. These pathways include glycolysis, the tricarboxylic cycle and OXPHOS. The particularities of these processes in *S. mansoni* will also be presented. In addition, for their importance in the understanding of metabolic switches in eukaryotic cells, three concepts will be introduced: “*Pasteur effect*”, “*Crabtree effect*” and “*Warburg effect*”. We conclude that *S. mansoni* has an exceptional metabolic plasticity, which may have evolved as a response to their cumbersome and challenging life cycle.

### Glucose transporters in *S. mansoni*

Few physiological parameters are more tightly and acutely regulated than blood glucose concentration. The transport of sugar across the cellular plasma membrane is performed by two families of transporters. Active transport occurs via symporters of the SLC5 gene family, while passive transport occurs via facilitative transporters of the SLC2 (GLUT) family (Vitavska and Wieczorek, 2013). A third family has been described and named the SLC45 gene family (Vitavska and Wieczorek, 2013).

From these three families, GLUT contains the main glucose transporters in human cells (Augustin, 2010). As shown in **Figure 8**, based on phylogenetic analysis three classes of GLUT can be distinguished: class I includes GLUT1-4 and GLUT14, class II includes GLUT5, 7, 9

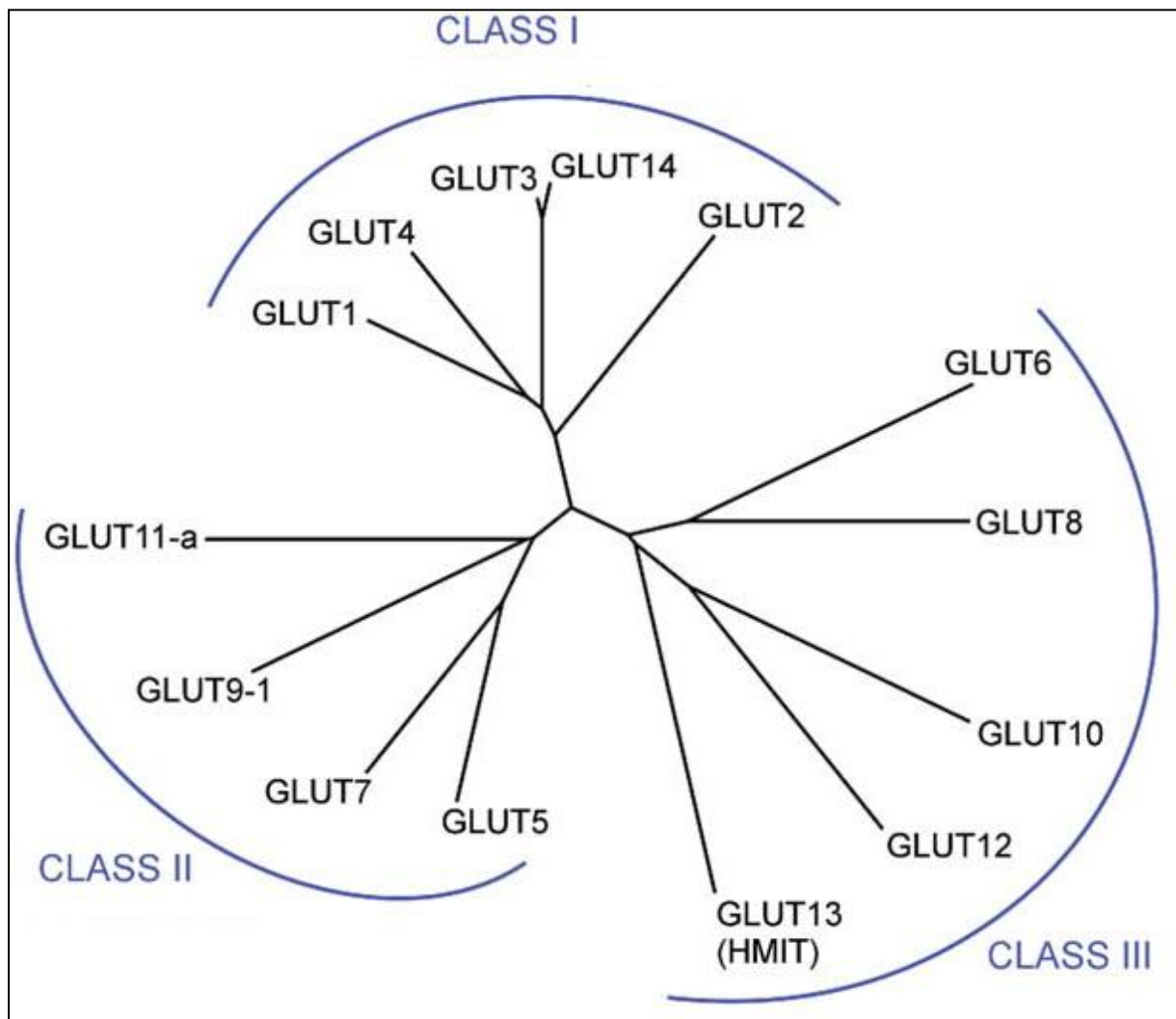

**Figure 8. Classification and members of the GLUT family of glucose transporters.**

and 11 and class III includes GLUT6, 8, 10, 12 and the proton driven myoinositol transporter GLUT13 (or HMIT) (Augustin, 2010). GLUT glucose transporters play specific and major roles in glucose homeostasis within the body. For instance, GLUT1 mediates glucose transport across the blood-brain barrier (Brockmann, 2009), the translocation of GLUT4 constitutes the rate limiting step in insulin controlled glucose uptake of skeletal and heart muscle as well as adipose tissue (Huang and Czech, 2007), and GLUT2 is a glucose sensor in insulin-secreting  $\beta$ -cells in the islets of Langerhans in the pancreas (Thorens, 2001).

At the molecular level, all 14 GLUT isoforms present the predicted 12 transmembrane helices (Augustin, 2010; Deng et al., 2014, 2015; Nomura et al., 2015). All family members harbor an N-linked glycosylation site. For class I and II family members, this is positioned in the first extracellular loop between transmembrane helices 1 and 2, whereas in class III family members the N-linked glycosylation site is located between transmembrane helices 9 and 10 (Augustin, 2010). Sequence comparisons between isoforms revealed conserved residues that have been termed sugar transporter signatures (Joost and Thorens, 2001). These residues participate in the substrate recognition by GLUT1 and other isoforms and include the QLS sequence in helix 7, the STSIF-motif in loop 7, tryptophan 388, and glutamine 161 positions in helix 5 (Augustin, 2010). These features are resumed in Figure 9.

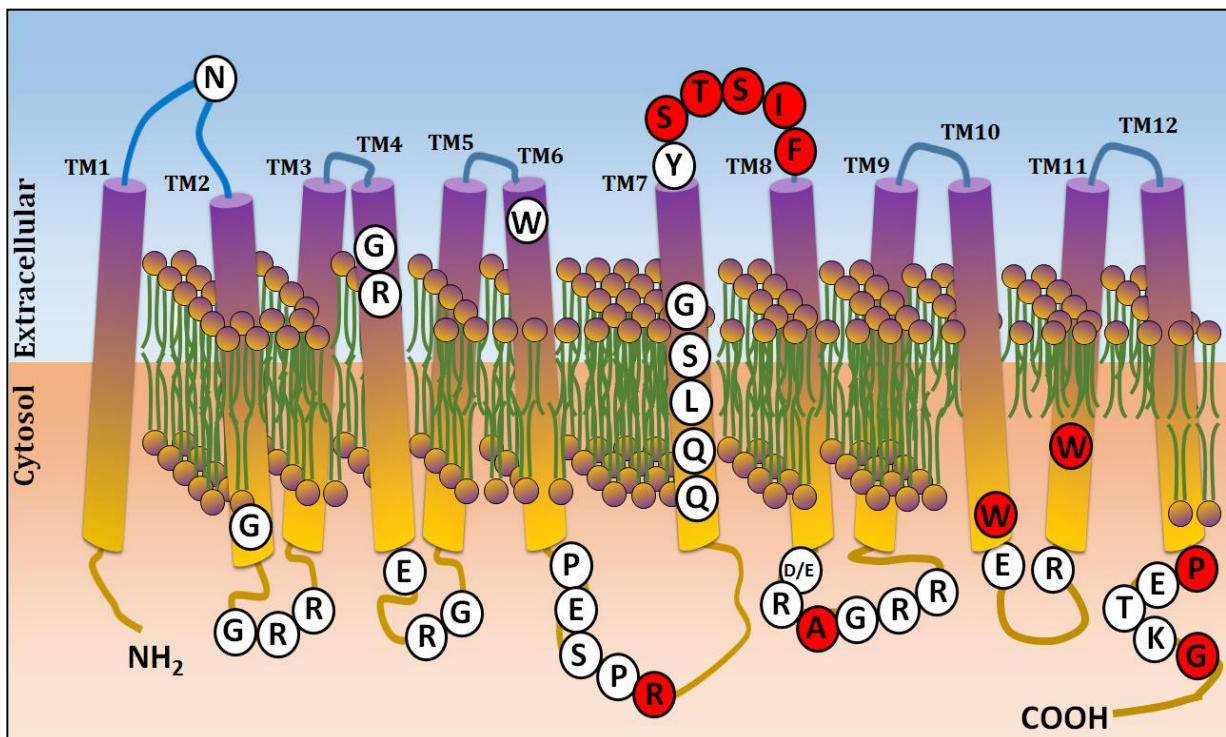
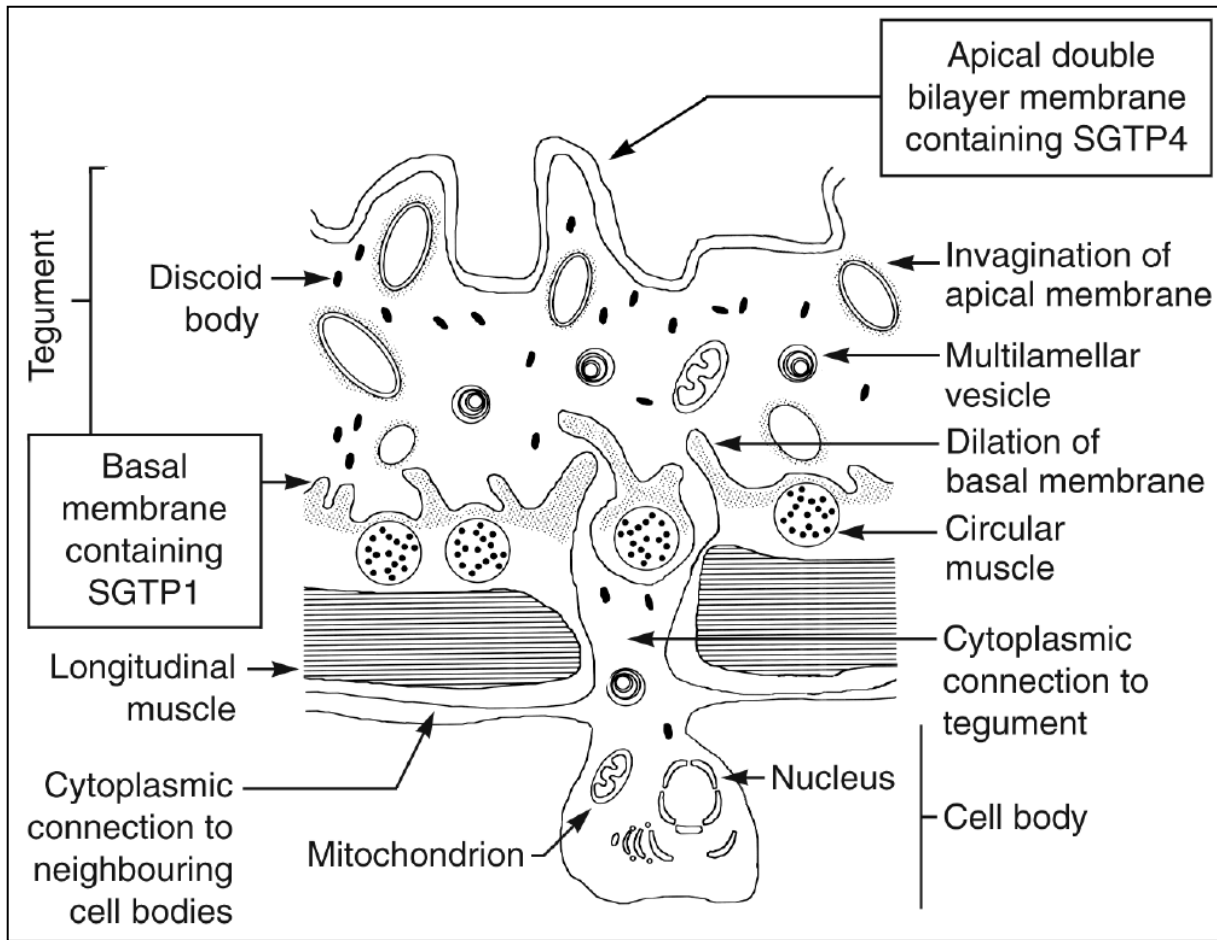

Figure 9. Sugar transporter signatures of class I/II glucose transporters. The 12 helices are

**buried within the cellular membrane and each one contains an extracellular (purple) and intracellular (yellow) faces. The asparagine (N) in the first extracellular loop is conserved in class I/II glucose transporters. This N is an N-linked glycosylation site. Some glycine (G) residues critical for structure stabilization in the GLUT family are shown. The glutamic acid (E) and arginine (R) residues implicated in conformational alterations and membrane topology of human GLUTs are also shown. The motif PESPR in the sixth intracellular loop between helix 6 and 7 is also shown. Data collected from (Joost and Thorens, 2001; Augustin, 2010).**

Two functional glucose transporters have been reported in *S. mansoni*, SGTP1 and SGTP4 (Skelly et al., 1994) leading to the idea that, like in tumors, glucose uptake can be upregulated in order to satisfy the requirements of the increased glycolytic pathway. In fact adult worms use large quantities of host glucose. Every five hours one adult worm uses an amount of glucose which is equivalent to its dry weight (Bueding, 1950). This process is essential to the *Schistosoma*, since the suppression of the expression of SGTP1 and SGTP4 using RNA interference (RNAi) impairs the parasite's ability to import glucose and severely decreases its viability (Krautz-Peterson et al., 2010; Da'dara et al., 2012). SGTP1 and SGTP4 have been extensively characterized and constitute the molecular basis of glucose uptake in *S. mansoni* (Skelly et al., 1994; Zhong et al., 1995; Jiang et al., 1996, Skelly et al., 1998; Krautz-Peterson et al., 2010; Da'dara et al., 2012). These transporters share the molecular features presented in Figure 9. However, there are amino acid substitutions (Figure 9, residues in red) in some of the key sugar transporter signatures that may lead to uncharacterized changes in activity compared to glucose transporters in other species.

In schistosomula and adult worms, these glucose transporters (SGTP1 and SGTP4) are localized on the tegument of *S. mansoni* (Skelly et al., 1998). Figure 10 shows that SGTP4 is present within the apical double bilayer membranes, while SGTP1 is found within the basal single lipid bilayer membranes (Zhong et al., 1995; Jiang et al., 1996). SGTP4 appears to be localized uniquely to the tegument, while SGTP1 can also be detected within the body of the worm, particularly in muscle (Zhong et al., 1995). The current model of glucose transport in schistosomes explains that SGTP4 transports glucose from the bloodstream into the tegument, while SGTP1 transports glucose into the inner tissues (Skelly et al., 1998).



**Figure 10. Diagrammatic representation of the structure of adult schistosome tegument and surrounding tissues. Figure from Skelly et al. (1998).**

In agreement with previous studies on glucose transport in *S. mansoni* (Cornford and Oldendorf, 1979), SGTP1 and SGTP4 were found to transport D-glucose, but not its isomer L-glucose, demonstrating that glucose transport in schistosomes is stereospecific (Skelly et al., 1994). SGTP1 and SGTP4 have relaxed specificity for hexoses, as indicated by the ability of mannose, maltose, galactose, and fructose to compete for glucose uptake (Skelly et al., 1994). Mannose was the most effective competitor of glucose uptake by both SGTP1 and SGTP4, a result similar to that obtained with whole schistosomes (Uglem and Read, 1975). Both transporters are completely inhibited by inhibitors of facilitated glucose transporters such as cytochalasin B and phloretin, but are weakly sensitive to phlorizin, reportedly a specific inhibitor of sodium-dependent glucose transport (Skelly et al., 1994). Finally, glucose affinity is higher for SGTP1 ( $K_m = 1.3\text{mM}$ ) than for SGTP4 ( $K_m = 2\text{mM}$ ).

## Glycolysis in *S. mansoni*

Glycolysis (GLY) is the metabolic pathway that converts one molecule of glucose ( $C_6H_{12}O_6$ ) into two molecules of pyruvate ( $CH_3COCOOH$ ). GLY is determined by a sequence of ten enzyme-catalyzed reactions. The enzymes and metabolic intermediates involved in this pathway are shown in Figure 11.

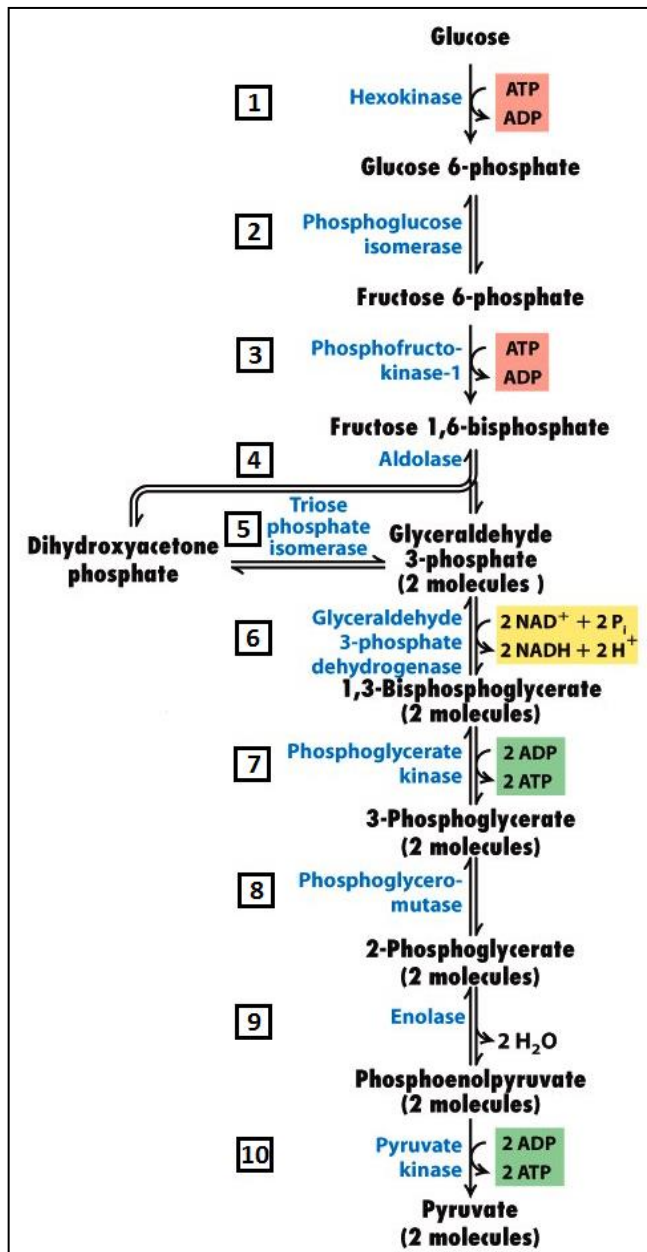

Figure 11. The figure displays the enzymes (numerals and names in blue) and metabolic intermediates (names in black) of the glycolytic pathway. The adenosine triphosphate (ATP) consumed (red boxes) or produced (green boxes) in each reaction are shown. The yellow box shows the production of two molecules of reduced nicotinamide adenine dinucleotide (NADH). Figure modified from Lodish et al. (2007).

The glycolytic enzymes include hexokinase (HK), phosphoglucose isomerase (PGI), phosphofructokinase (PFK), aldolase, triosephosphate isomerase (TPI), glyceraldehyde 3 phosphate dehydrogenase (GAPDH), phosphoglycerate kinase (PGK), phosphoglycerate mutase (PGM), enolase, and pyruvate kinase (PK). This pathway occurs in the cytoplasm and

its tightly controlled (Berg et al., 2002). The rate of conversion of glucose into pyruvate is regulated to meet two major cellular needs: (i) the production of ATP generated by the degradation of glucose, and (ii) the provision of building blocks for synthetic reactions (Berg et al., 2002; Lunt and Vander Heiden, 2011). In GLY, the major regulatory points are the reactions catalyzed by HK, PFK, and PK which are virtually irreversible (Berg et al., 2002).

All the enzymes of the glycolytic pathway in Figure 11 are present in *S. mansoni*, *S. japonicum* and *S. haematobium* (You et al., 2014). Several of these enzymes have been characterized in schistosomes such as HK (Bueding and Mackinnon, 1955a; Tielens et al., 1994; Tielens, 1997), enolase (Ramajo-Hernández et al., 2007; de la Torre-Escudero et al., 2010), TPI (Yu et al., 2006; Da'dara et al., 2008), G3PDH (Goudot-Crozel et al., 1989; Charrier-Ferrara et al., 1992), PFK (Mansour et al., 2000), PGK (Lee et al., 1995) and PGI (Bueding and Mackinnon, 1955b). Remarkably, although these glycolytic enzymes are present in the genome of *S. mansoni*, they show different kinetics compared to that of the vertebrate hosts (Bueding and Mackinnon, 1955a, 1955b; Bueding and Mansour, 1957). The main difference is that the optimal substrate concentrations and the dissociation constants for the enzymes of schistosomes are usually higher than those for the host (Mansour and Bueding, 1953). As shown in Figure 11, once glucose enters the cells through glucose transporters, HK catalyzes an important step of GLY where glucose is phosphorylated by ATP to glucose 6-phosphate (G6P), which cannot diffuse through the membrane, because of its negative charges. This step virtually traps extracellular glucose within the cells. Hexokinases can be found in most, if not all, organisms from archaea to mammals (Figure 12).

Because its sensitivity to product inhibition (G6P), in mammals, HK represents the first key regulatory point of GLY (Chen et al., 2014). However, yeast hexokinase is not inhibited by physiologically relevant levels of G6P (Chen et al., 2014). The *S. mansoni* HK has been well-characterized (Tielens et al., 1994; Shoemaker et al., 1995; Armstrong et al., 1996; Tielens, 1997), and it has high affinity for glucose ( $K_m \approx 60 \mu\text{M}$ ) and is inhibited by G6P and fructose 1,6-bisphosphate (Tielens et al., 1994). However, its sensitivity to inhibition by G6P is low (Tielens et al., 1994). Similar to HKs of *C. sinensis*, *Brugia malayi* and *Toxoplasma gondii*, *S. mansoni* HK can use glucose, fructose, and mannose as substrates (Tielens et al., 1994; Chen et al., 2014). The schistosomal hexokinase does not bind to mitochondria, consistent with its lack of a hydrophobic segment at the N-terminus which is required for binding of the mammalian HKs (Tielens et al., 1994).

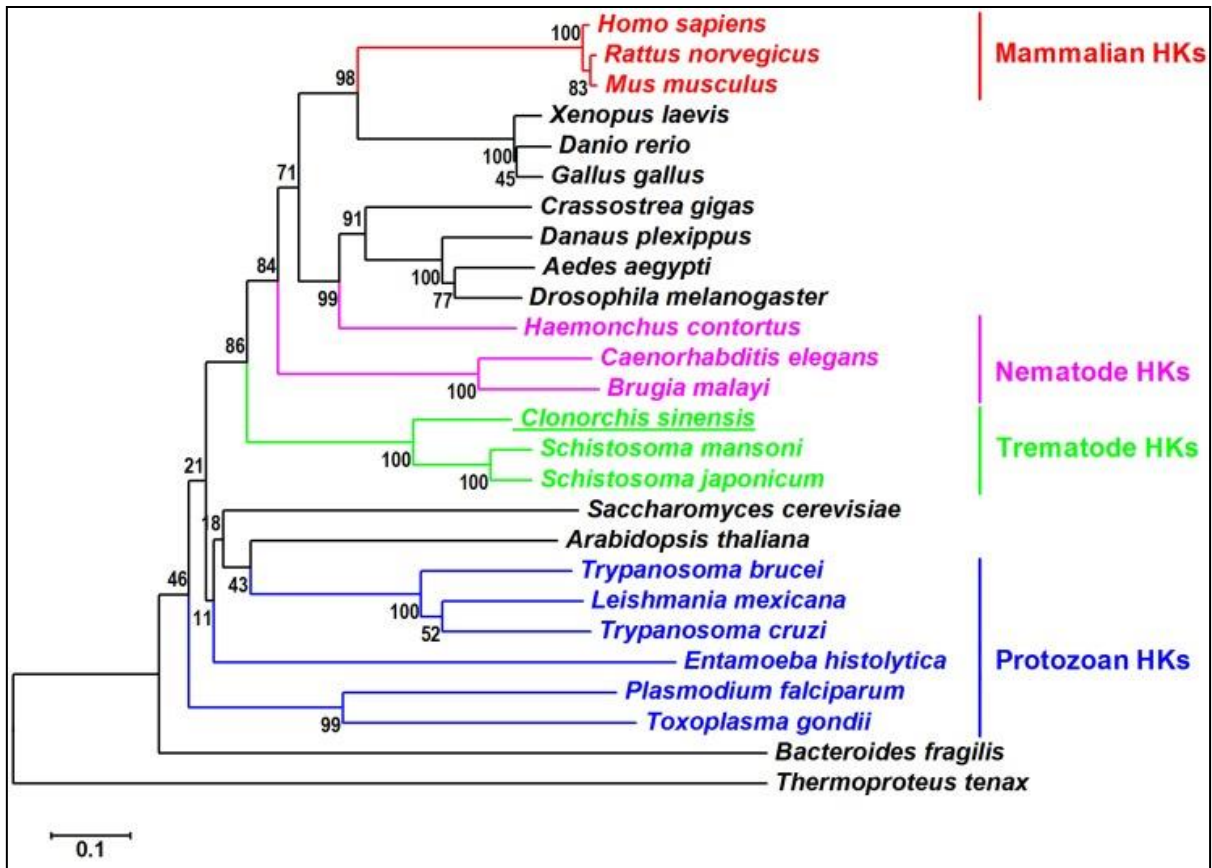

Figure 12. Distribution of HKs from archaea to mammals. Figure from Chen et al. (2014).

Phosphofructokinase is the most important control element in the mammalian glycolytic pathway (Berg et al., 2002). High levels of ATP allosterically inhibit this enzyme, thus lowering its affinity for fructose 6-phosphate (F6G). ATP elicits this effect by binding to a specific regulatory site that is distinct from the catalytic site. AMP reverses the inhibitory activity of ATP, therefore the activity of PFK is regulated by the ATP/AMP ratio. Thus, the activity of PFK increases when the ATP/AMP ratio is lowered (Berg et al., 2002). A fall in pH (i.e. an increase of  $H^+$ ) also inhibits phosphofructokinase activity which prevents the excessive formation of lactic acid (Berg et al., 2002). In 1957, Bueding and Mansour performed a series of experiments that led them to conclude that, similar to mammals, in *S. mansoni*, the rate of glycolysis is determined by the activity of PFK (Bueding and Mansour, 1957). These authors found differences in the activity of PFK from *S. mansoni* and rabbit muscle (Bueding and Mansour, 1957). When the activity of PFK from *S. mansoni* was compared to that of rabbit muscle, it was found to be more sensitive to inhibition by antimonials and to have less affinity for its substrate F6P and ATP (Bueding and Mansour, 1957). Interestingly, the optimum pH of *S. mansoni* PFK was slightly lower than that of rabbit



PFK (Bueding and Mansour, 1957). They concluded that significantly high intracellular concentrations of F6P and ATP are necessary to reduce the activity of schistosome PFK (Bueding and Mansour, 1957).

The gene encoding PFK was later isolated, cloned, expressed in insect cells and the enzyme was showed to be enzymatically active (Ding et al., 1994). *Schistosoma* PFK has 58% identity with its human ortholog (Ding et al., 1994). The enzymatic activity of pure recombinant PFK was similar to that reported with protein extracts (Bueding and Mansour, 1957; Su et al., 1996). In addition, fructose 2,6-bisphosphate was found, as in the mammalian enzyme, to be a potent activator of PFK by increasing its affinity for fructose 6-phosphate and diminishing the inhibitory effect of ATP (Su et al., 1996).

Pyruvate kinase, the enzyme catalyzing the third irreversible step in glycolysis, controls the outflow from this pathway. This final step yields ATP and pyruvate, a central metabolic intermediate that can be oxidized further or used as a building block (Berg et al., 2002). Several isozymic forms of PK encoded by different genes are present in mammals (i.e. L type predominates in liver, M type in muscle and brain). These two forms of PK have many properties in common. Both bind phosphoenolpyruvate cooperatively. Fructose 1,6-bisphosphate, the product of the preceding irreversible step in glycolysis, activates both isozymes to enable them to keep pace with the oncoming high flux of intermediates. ATP allosterically inhibits both the L and the M forms of PK to slow glycolysis when the energy charge is high. The PK from *S. mansoni* has been identified and characterized (Bueding and Saz, 1968; Brazier and Jaffe, 1973; Coles, 1973; Doong et al., 1987; Tielens et al., 1991). As expected *S. mansoni* PK was involved in the transformation of phosphoenolpyruvate to pyruvate (Tielens et al., 1991). In addition, while some glycolytic enzymes were affected in hycanthon<sup>11</sup>-resistant strains of *S. mansoni*, the activity of PK was not (Doong et al., 1987).

The pyruvate obtained from glucose by glycolysis has two fates: (i) be transformed into lactate by lactate dehydrogenase (LDH) in the cytoplasm or enter the mitochondria and be fully oxidized by the Tricarboxylic acid cycle (TCA) couple to OXPHOS.

---

<sup>11</sup> Hycanthon is the schistosomicide approved by the FDA in 1975. Hycanthon is shown to be an effective inhibitor of acetylcholinesterase (AChE) from *Schistosoma mansoni*.

### ***Schistosoma mansoni* lactate dehydrogenase**

An LDH gene has been sequenced and characterized in *S. mansoni* (Guerra-Sá et al., 1998). The cDNA was isolated from a directional cDNA library constructed with mRNA of *S. mansoni* adult worms (Guerra-Sá et al., 1998). The deduced translation product of 333 amino acids has high homology (>65% identity) with other LDH family proteins. The majority of the residues responsible for the substrate, coenzyme binding and catalysis sites are well conserved in *S. mansoni* LDH, however several indels<sup>12</sup> were observed when compared to other LDH enzymes, suggesting differences in activity (Guerra-Sá et al., 1998). In fact, measurements of the rate of reduction of pyruvate to lactate revealed differences in the effect of pH on the activity of the schistosome compared to mammalian LDH. The optimal activity of the worm enzyme was at pH 6.9 and that of the mammalian enzyme at pH 7.8 (Mansour and Bueding, 1953). Likewise, the optimal range for the oxidation of lactate to pyruvate was between pH 8.2 and 8.9 for the schistosome enzyme and between pH 9.0 and 9.5 for the mammalian enzyme (Mansour and Bueding, 1953). Dissociation constants and the optimal concentrations for lactate were identical for both enzymes. These two values were, however, six to twelve times higher for the worm enzymes in the presence of pyruvate (Mansour and Bueding, 1953). In addition, antibodies raised against rabbit LDH did not recognize or inhibit the activity of schistosome LDH (Mansour et al., 1954). The enzymatic activity of schistosoma LDH was also found to be different in susceptible vs. resistant strains of *S. mansoni* to hycanthone (Doong et al., 1987). Lactate dehydrogenase activity from the drug-resistant *S. mansoni* strains was not inhibited by hycanthone and showed three to five times greater  $K_m$  values than those from the drug-sensitive worms which were also inhibitable by hycanthone (Doong et al., 1987).

Interestingly, transcripts encoding *S. mansoni* LDH were expressed in larval schistosomes at higher levels than in adult worms (Guerra-Sá et al., 1998), and cercariae possess an active LDH (Coles et al., 1973). However, upon infection of the vertebrate host, SGTP4 and LDH were found to be upregulated in schistosomula after 2 days and 3 days of infection (Dillon et al., 2006; Parker-Manuel et al., 2011), presumably reflecting an increased demand for glucose as well as the increase in lactate production observed in the mammalian stages of the parasite.

---

<sup>12</sup> Insertions or deletions in DNA or amino acid sequences.

### Mitochondrial metabolism in *S. mansoni*

Under aerobic conditions, the pyruvate produced in the cytoplasm by PK is transported to the mitochondria where it is oxidatively decarboxylated by the pyruvate dehydrogenase complex (PDC) to form acetyl CoA. This irreversible reaction catalyzed by PDC, is the link between GLY and the TCA, also known as citric acid cycle or Krebs cycle. The TCA takes places in the mitochondrial matrix and its reactions are carried out by 8 enzymes that completely oxidize acetyl-CoA, into two molecules each of carbon dioxide and water (Berg et al., 2002). The enzymes and metabolic intermediates of TCA are shown in Figure 13.

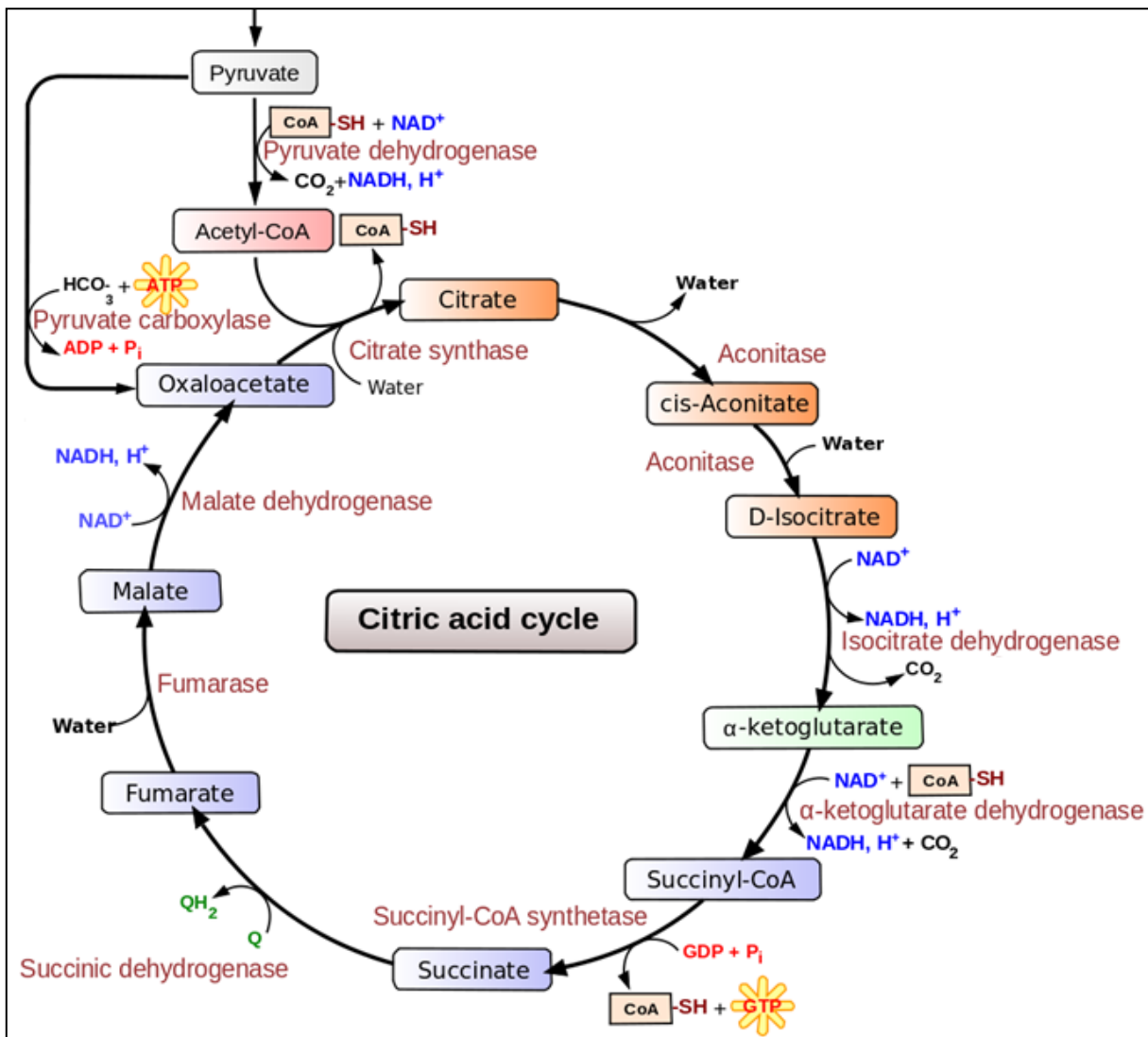
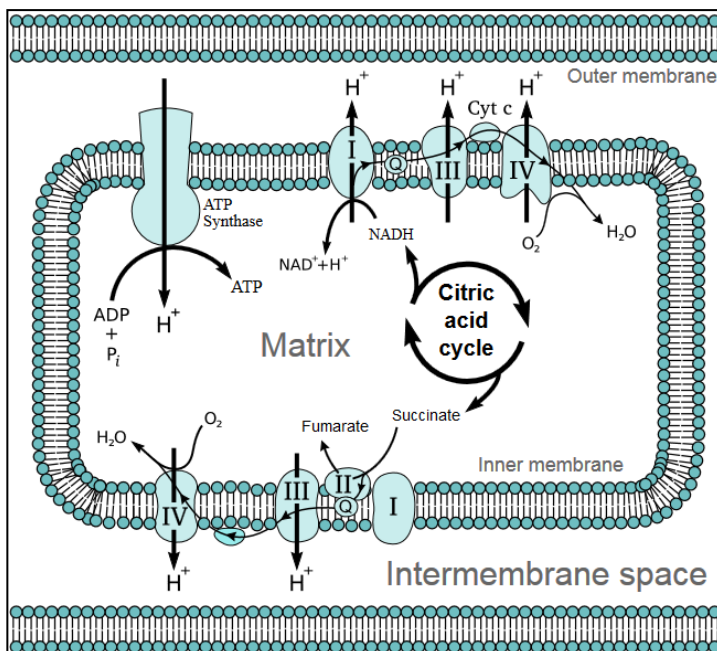

Figure 13. The figure displays the enzymes (red letters) and metabolic intermediates (boxes) of the citric acid cycle. The ATP consumed (red boxes) and guanosine triphosphate (GTP) produced are shown (yellow asterisks). The production of NADH in specific steps is also shown. Figure modified from wikipedia.<sup>13</sup>

<sup>13</sup> [https://en.wikipedia.org/wiki/Citric\\_acid\\_cycle#Overview](https://en.wikipedia.org/wiki/Citric_acid_cycle#Overview)

The reactions of the cycle also produce three molecules of NADH, one molecule of flavin adenine dinucleotide (FADH<sub>2</sub>), and one molecule of guanosine triphosphate (GTP). The NADH and FADH<sub>2</sub> generated by the TCA are in turn used by the OXPHOS pathway to generate energy-rich ATP (Berg et al., 2002). An important regulatory step of OXPHOS is the phosphorylation/dephosphorylation of PDC by pyruvate dehydrogenase kinase (PDK) and pyruvate dehydrogenase phosphatase (PDP), respectively. By phosphorylating and therefore inactivating PDC, PDK inhibits the entry of pyruvate into the TCA cycle. Because the TCA cycle is coupled to the electron-transport chain (ETC, also known as respiratory chain), regulation of the PDC by PDK is critical for the attenuation of mitochondrial respiration (Dupuy et al., 2015).

In OXPHOS, NADH and FADH<sub>2</sub> are used to reduce molecular oxygen to water. The reduction of molecular oxygen by NADH and FADH<sub>2</sub> occurs in a number of electron-transfer reactions that take place in the inner membrane of the mitochondria. The ETC couples this electron transfer with the transfer of protons across a membrane. This creates an electrochemical proton gradient that drives the synthesis of ATP by the enzyme ATP synthase. A graphic representation of this process is shown in Figure 14.



**Figure 14. Electron transport chain in the mitochondria coupled to the TCA. Figure from wikipedia.<sup>14</sup>**

Early studies suggested that *S. mansoni* present TCA coupled to OXPHOS (Coles, 1972). In particular, the cercaria, the free-living infective stage of *S. mansoni*, has an aerobic

<sup>14</sup> [https://en.wikipedia.org/wiki/Electron\\_transport\\_chain](https://en.wikipedia.org/wiki/Electron_transport_chain)

energy metabolism and degrades its glycogen reserves mainly to carbon dioxide, involving the TCA (Van Oordt et al., 1989). In water, both cercarial head and tail have aerobic energy metabolism (Horemans et al., 1991). The free-living stage miracidium is also known to consume high amounts of oxygen and to have an aerobic metabolism (Bruce et al., 1971; Tielens et al., 1992). The snail-infecting stage, the sporocyst, has a facultative anaerobic energy metabolism (Tielens et al., 1992). In the presence of oxygen, sporocysts derive most of their energy from the aerobic degradation of glucose to carbon dioxide, but under anaerobic conditions they switch towards lactate and succinate production (Tielens et al., 1992). Finally, despite the fact that their metabolism is mainly based on aerobic GLY, thus producing large amounts of lactate, mammalian stages of *S. mansoni* also take up oxygen and produce energy through OXPHOS (Coles, 1972). When adult worms were incubated in the presence of cyanide, an inhibitor of cytochrome oxidase, oxygen uptake decreased 90% (Coles, 1972). This suggested the presence of a functional cytochrome oxidase (Coles, 1972). Further studies, using different cytochrome inhibitors, supported the existence of a functional cytochrome system in *S. mansoni* (Magzoub et al., 1971). In addition, Coles (1972) also concluded that approximately one quarter of the energy in adult worms was derived from OXPHOS (Coles, 1972). The presence of a functional OXPHOS in *S. mansoni* has been recently confirmed (Huang et al., 2012).

Malate dehydrogenase (MDH), the last enzyme of the TCA (Figure 13), was isolated and characterized in adult *S. mansoni* (Rotmans, 1978; Bout et al., 1978). Two major isoenzymes of MDH have been reported in virtually all eukaryotic cells. One form is found in the mitochondria, while the other is present in the cytoplasm. MDH catalyzes the NAD/NADH-dependent interconversion of malate and oxaloacetate (Minárik et al., 2002). This is an important reaction that plays a major role in the malate/aspartate shuttle across the mitochondrial membrane, and in the TCA within the mitochondrial matrix (Minárik et al., 2002). Both mitochondrial and cytoplasmic forms of MDH were found in *S. mansoni*, and their isoelectric points were higher than their homologs in vertebrates (Rotmans, 1978). The  $K_m$  values showed that the affinities of mitochondrial and cytoplasmic MDHs for oxaloacetate and malate were similar and comparable with that of vertebrate MDHs (Rotmans, 1978).

## Glucose energetic balance

Cell maintenance needs a continuous inflow of energy; mostly in the form of ATP. A major source of cellular energy and new cell mass is glucose. Once in the cellular cytoplasm, glucose is metabolized via glycolysis to pyruvate. The two molecules of pyruvate produced as result of the degradation of one molecule of glucose can have two fates: (i) be oxidatively metabolized to  $\text{CO}_2$  in the tricarboxylic acid (TCA) cycle to produced large amounts of ATP through the process of OXPHOS or (ii) be fermented to organic acids or alcohols (e.g., lactate, acetate or ethanol). While the oxidation of glucose depends on oxygen, its fermentation does not. As shown in Figure 15, glucose fermentation is far less efficient than the TCA cycle coupled to OXPHOS. Indeed, only 2 molecules of ATP are produced per molecule of glucose during fermentation, whereas the TCA cycle coupled to OXPHOS can produce 36 molecules of ATP using the same amount of glucose (Lunt and Vander Heiden, 2011).

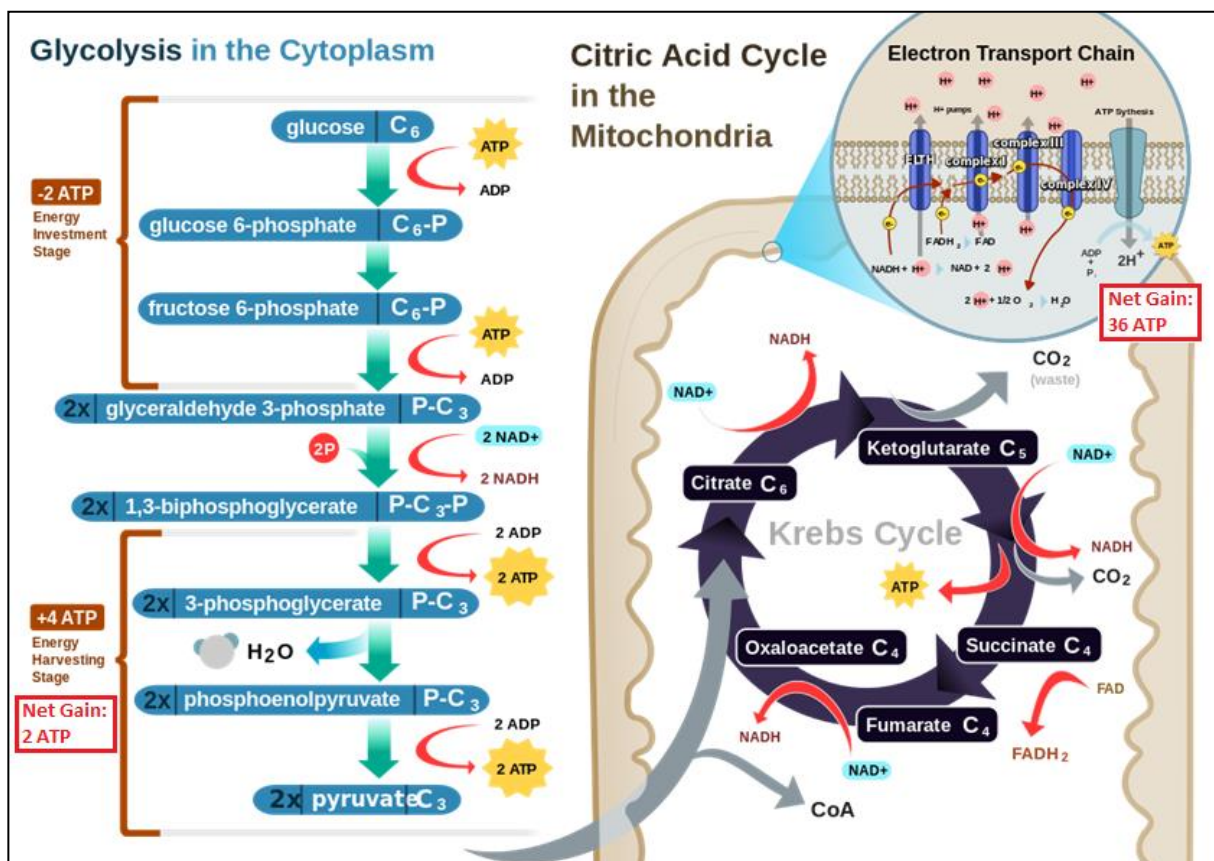

Figure 15. Net gain of ATP per molecule of glucose during fermentation and TCA coupled with OXPHOS. Figure modified from Wikipedia.<sup>15</sup>

<sup>15</sup> [https://en.wikipedia.org/wiki/Cellular\\_respiration](https://en.wikipedia.org/wiki/Cellular_respiration)

## The pioneers of the metabolic switch

Two scientists contributed significantly to the discovery of metabolic switches in eukaryotic cells: Louis Pasteur (Pasteur, 1861; Racker, 1974) and Herbert Grace Crabtree (Crabtree, 1928, 1929; De Deken, 1966). Louis Pasteur was the first to report that the utilization of glucose by yeast is much more rapid in the absence than in the presence of oxygen (Pasteur, 1861). As the oxygen level decreases, the generation of ATP shifts from OXPHOS in the mitochondria to the oxygen-independent pathway of GLY in the cytoplasm. Pasteur observed that "*If one gives it a quantity of free oxygen sufficient for its requirements of life ... it ceases to be a ferment*" (Racker, 1974). Thus, the "*Pasteur effect*" describes the inhibition of glucose utilization by the presence of oxygen and therefore that respiration could inhibit fermentation. Therefore, this process is reversible and dependent on the presence of oxygen. However, it was later noted that during exponential growth and in the presence of high concentrations of glucose, *Saccharomyces cerevisiae* ferments glucose to ethanol even in the presence of oxygen (Crabtree, 1928, 1929; De Deken, 1966). This process was also found to be reversible as in glucose-poor environments containing only nonfermentable carbon sources (e.g. mannose and galactose), *S. cerevisiae* relies mostly on OXPHOS to produce energy (De Deken, 1966; Lunt and Vander Heiden, 2011). Thus, the "*Crabtree effect*" describes the arrest of respiration and accelerated glycolysis by the availability of glucose, regardless of oxygen availability. Importantly, using fermentation, *S. cerevisiae* grow faster than using OXPHOS (Rolland et al., 2002). In addition, Slonimski (1956) found that respiration adaptation in *S. cerevisiae* is a function of glucose concentration. At low concentrations of glucose (below 6 mM), the rate of respiration increased as the concentration of glucose was increased, but at concentrations of glucose higher than 6 mM, the rate of respiration decreased as the concentration of glucose was increased. Simultaneously, as the concentration of glucose increased, the rate of aerobic fermentation also increased (Slonimski, 1956).

Despite decreased efficiency in ATP production, many fast-growing cells rely primarily on glucose fermentation during proliferation regardless of oxygen availability, a process hereafter referred as aerobic GLY (Lunt and Vander Heiden, 2011). Thus, similarly to *S. cerevisiae*, under certain circumstances, human and mouse lymphocytes, rat thymocytes, some parasites (e.g. blood-stage malaria and *S. mansoni*) and notably cancer cells, use aerobic GLY as their main source of energy.

### **Cancer cells and the metabolic shift**

It is currently widely accepted that one of the main malignant transformations observed in cancer cells is a shift from OXPHOS to Aerobic GLY (Gatenby and Gillies, 2004). It was Otto Heinrich Warburg who noted for first time that, even under normoxic conditions, tumor cells generate a high amount of energy by using the glycolytic pathway (with high production of lactic acid) and not OXPHOS (Warburg et al., 1927; Warburg, 1956; Lunt and Vander Heiden, 2011). Thus, similar to the “Crabtree effect”, the “Warburg effect” describes the inhibition of respiration and the increase of the glycolysis rate, regardless of oxygen availability. Remarkably, while both the *Pasteur* and *Crabtree effects* are reversible (metabolic switch), the *Warburg effect* is a pathological metabolic shift where apparently the reversibility is lost.

Therefore, once established, this glycolytic phenotype will be maintained unchanged by the tumor cells indicating that the glycolysis pathway is constitutively upregulated (Gatenby and Gillies, 2004). It is worth mentioning that this glycolytic shift is not absolute and instead represents a change from a baseline glycolytic rate of 10% (in normal cells) to over 50% (in tumor cells) (Denko, 2008). In this type of metabolism acquired by the transformed cells, glucose is used (over other substrates like fatty acids) almost exclusively to obtain energy. In correspondence several genes related with glucose uptake (glucose transporters: GLUT1 and GLUT3) (Bos et al., 2002) and glucose breakdown (phosphofruktokinase, aldolase and pyruvate dehydrogenase) are upregulated in cancer cells (Denko, 2008). In fact it has been shown *in vivo* that tumors are high glucose consumers (Gatenby and Gillies, 2004). Moreover, an increase in glucose uptake has been correlated with poor prognosis and increased tumour aggressiveness (Kunkel et al., 2003). Notably, regardless the metabolic shift, the tumor mitochondria are still functional and the capacity to produce ATP through OXPHOS is retained (Cairns et al., 2011).

### **The aerobic GLY and the metabolic needs of proliferating cells**

Despite the low efficiency of aerobic GLY in terms of net ATP production (2 ATP in aerobic GLY vs. 36 ATP in OXPHOS), aerobic GLY can generate more ATP than OXPHOS per unit of time (Pfeiffer et al., 2001). Therefore, aerobic GLY is an inefficient but faster pathway for ATP production. However, glycolysis is not a major contributor of ATP in most cells (Lunt and Vander Heiden, 2011). Instead, aerobic GLY has been suggested to be necessary to



maintain high levels of glycolytic intermediates to support anabolic reactions in proliferating cells (Lunt and Vander Heiden, 2011). Figure 16 shows the interconnections of metabolic pathways and how the glucose degraded through GLY may be associated to several anabolic pathways.

Intense egg production by female schistosomes (200-300/day/female) may be an explanation for the uptake of massive amounts of glucose and its degradation using aerobic GLY. Interestingly, most, if not all, of the glucose utilized by the female schistosome is transferred from the male partner via tegumentary-facilitated diffusion, free diffusion, or the combination of these two processes (Cornford, 1986). Therefore, male-to-female transfer may be a potentially rate-limiting step in glucose utilization by the female (Cornford et al., 1988), and thus egg production. This suggests that male and female metabolisms may be synchronized to achieve successful reproduction.

Importantly, in anaerobic and aerobic conditions, the amounts of lactate produced by adult worms were the same (Schiller et al., 1975; Bueding and Fisher, 1982). Strongly suggesting that in *S. mansoni*, the “Pasteur effect” does not occur. However, egg production was highly sensitive to oxygen concentration. Anaerobic conditions completely abolished the capacity of females to lay eggs (Schiller et al., 1975). This suggested that oxidative metabolism is required for egg production. Further studies, showed that mitochondrial oxygen consumption rates in females declined in the presence of OXPHOS inhibitors, and that mitochondrial respiration was higher in fecund vs. virgin females (Huang et al., 2012). In fact, OXPHOS inhibitors had a significant negative effect on female egg production, but no on worm survival. Interestingly, fatty acid depletion, fatty acid oxidation, OXPHOS and egg production were found to be related (Huang et al., 2012). Inhibition of fatty acid oxidation affected egg laying by females (Huang et al., 2012). An interesting link could be established between GLY and fatty acid oxidation. As observed in Figure 16, from the GLY intermediate dihydroxyacetone phosphate, triacylglycerol (TG) can be synthesized. This TG can be later transformed into fatty acids to be used in fatty acid oxidation and egg production. This is a tempting hypothesis on the connection between GLY and egg production in *S. mansoni*.

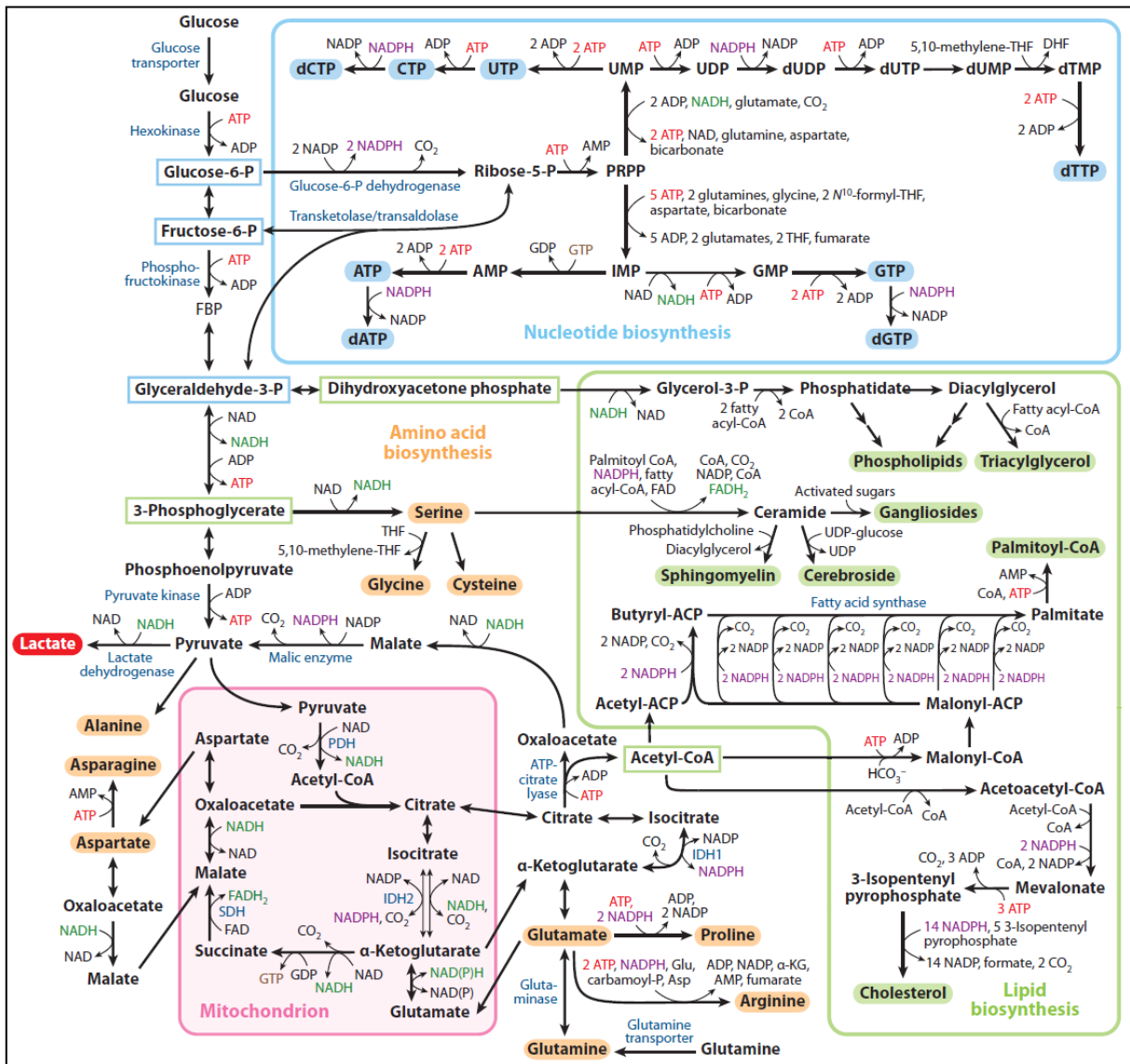
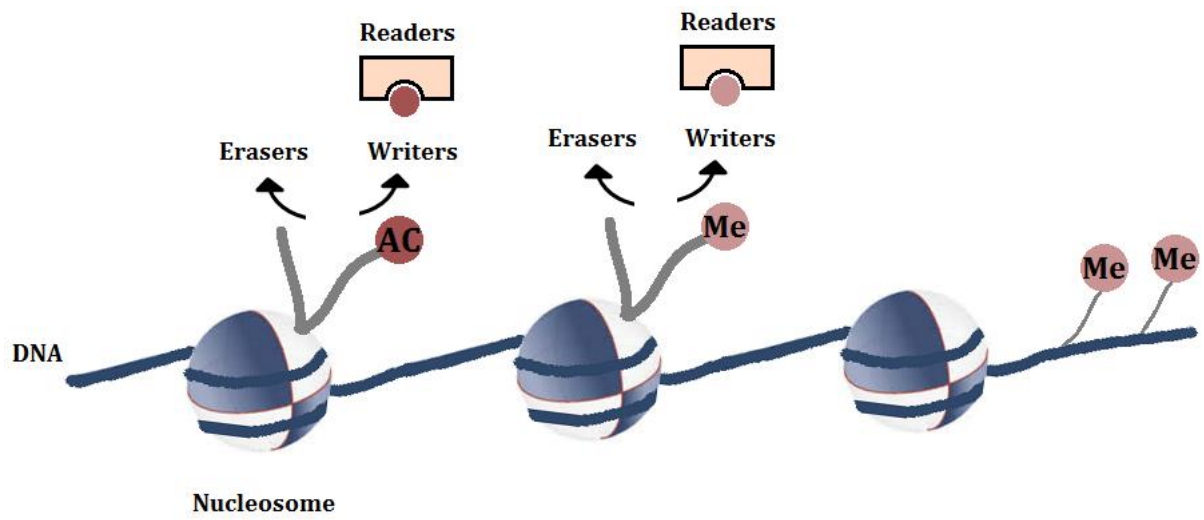

Figure 16. Metabolic pathways active in proliferating cells. The figure displays how glycolysis, OXPHOS, the pentose phosphate pathway, and glutamine metabolism contribute to biomass precursors. Enzymes that control critical steps and are important in cancer cells are shown (dark blue). Nucleotides, lipids and nonessential amino acids are highlighted in light blue, green, and orange, respectively. Key metabolites that serve as important precursors for biomass production are boxed. Abbreviations are as follows: Deoxyuridine triphosphate (dUTP), Flavin adenine dinucleotide (FAD), Flavin adenine dinucleotide, reduced (FADH<sub>2</sub>), Glutamate (Glu), Guanosine monophosphate (GMP), Guanosine triphosphate (GTP), Isocitrate dehydrogenase 1 (IDH1), Isocitrate dehydrogenase 2 (IDH2), Inosine monophosphate (IMP), Nicotinamide adenine dinucleotide (NAD), Nicotinamide adenine dinucleotide, reduced (NADH), Nicotinamide adenine dinucleotide phosphate (NADP), Nicotinamide adenine dinucleotide phosphate, reduced (NADPH), Phosphate (P), Pyruvate dehydrogenase (PDH), Phosphoribosyl pyrophosphate (PRPP), Succinate dehydrogenase (SDH), Tetrahydrofolate (THF), Uridine diphosphate (UDP), Uridine monophosphate (UMP), Uridine triphosphate (UTP), α-Ketoglutarate (α-KG), Acyl carrier protein (ACP), Adenosine diphosphate (ADP), Aspartate (Asp), Adenosine triphosphate (ATP), Coenzyme A (CoA), Cytidine triphosphate (CTP), Deoxyadenosine triphosphate (dATP), Deoxycytidine triphosphate (dCTP), Deoxyguanosine triphosphate (dGTP), Dihydrofolate (DHF), Deoxythymidine monophosphate (dTMP), Deoxythymidine triphosphate (dTTP), Deoxyuridine diphosphate (dUDP), Deoxyuridine monophosphate (dUMP). Figure from (Lunt and Vander Heiden, 2011).



## Epigenetic control of gene regulation in schistosomes

Most of our current knowledge on the regulation of glucose metabolism comes from cancer research. As mentioned before, cancer cells, like schistosomes, have a typical metabolism characterized by high glucose consumption and production of lactate. Recent studies have shown that the metabolism in cancer cells is largely regulated at the transcriptional level, where different chromatin organization stages are related to changes in expression of key metabolic genes (Sebastián et al., 2012). Therefore, current research efforts focus on the direct connections between metabolic changes and chromatin dynamics induced by post-translational modifications on histones (mainly methylation and acetylation). In consequence, in the following section we resume our current knowledge on schistosome epigenetics with emphasis on post-translational modifications of histones. In addition, for the relevance for the control of schistosomes, we present how this knowledge also provides new ways to treat schistosomiasis.

Histone acetylation and deacetylation are dynamic processes that play a key role in the regulation of metabolism in cancer cells. This modification is regulated through the activities of two large families of enzymes—the histone acetyltransferases and the histone deacetylases (HDACs). In particular, HDACs of the Sirtuin family were shown to participate in malignant transformation by regulating the expression of key glycolytic genes, such as class I glucose transporters, *LDH* and *PDK1*. Sirtuin family members were identified in schistosomes. Therefore, in the following sections, we also present our knowledge on this family of proteins as well as interesting results on their use as anti-schistome drug targets.

## Epigenetic control of gene function in schistosomes: a source of therapeutic targets?<sup>16</sup>

Alejandro Cabezas-Cruz<sup>1</sup>, Julien Lancelot<sup>1</sup>, Stéphanie Caby<sup>1</sup>, Guilherme Oliveira<sup>2</sup> and Raymond J. Pierce<sup>1\*</sup>

<sup>1</sup>Center for Infection and Immunity of Lille (CIIL), INSERM U1019 – CNRS UMR 8204, Université de Lille, Institut Pasteur de Lille, 1 rue Professeur Calmette, 59019 Lille Cedex, France.

<sup>2</sup>Genomics and Computational Biology Group, Center for Excellence in Bioinformatics, National Institute of Science and Technology in Tropical Diseases, Centro de Pesquisas René Rachou, Fundação Oswaldo Cruz, Belo Horizonte, Minas Gerais, Brazil

\*To whom correspondence should be addressed ([raymond.pierce@pasteur-lille.fr](mailto:raymond.pierce@pasteur-lille.fr))

---

<sup>16</sup> Published manuscript. Full reference as follow: Cabezas-Cruz A, Lancelot J, Caby S, Oliveira G, Pierce RJ. Epigenetic control of gene function in schistosomes: a source of therapeutic targets? Front Genet. 2014; 5:317. doi: 10.3389/fgene.2014.00317.

## **Abstract**

The discovery of the epigenetic regulation of gene expression has revolutionized both our understanding of how genomes function and approaches to the therapy of numerous pathologies. Schistosomes are metazoan parasites and as such utilize most, if not all the epigenetic mechanisms in play in their vertebrate hosts: histone variants, histone tail modifications, non-coding RNA and, perhaps, DNA methylation. Moreover, we are acquiring an increasing understanding of the ways in which these mechanisms come into play during the complex schistosome developmental program. In turn, interest in the actors involved in epigenetic mechanisms, particularly the enzymes that carry out epigenetic modifications of histones or nucleic acid, as therapeutic targets has been stimulated by the finding that their inhibitors exert profound effects, not only on survival, but also on the reproductive function of *Schistosoma mansoni*. Here, we review our current knowledge, and what we can infer, about the role of epigenetic mechanisms in schistosome development, differentiation and survival. We will consider which epigenetic actors can be targeted for drug discovery and what strategies can be employed to develop potent, selective inhibitors as drugs to cure schistosomiasis.

## **Introduction**

Schistosomiasis is caused by flatworm parasites of the genus *Schistosoma*, five species of which infect humans in 74 tropical and sub-tropical countries. It is estimated that more than 230 million people are infected, of which 90% are in sub-Saharan Africa (Colley et al., 2014 for review). Nearly thirty years after its introduction the treatment and control of schistosomiasis relies almost exclusively on praziquantel, the only drug effective against all schistosome species infecting humans. Its use has been and remains an unquestionable success story; mass treatments of school-age children in sub-Saharan Africa under the Schistosomiasis Control Initiative (Fenwick et al., 2009) hold the promise of a marked continent-wide reduction in disease morbidity and mortality. Nevertheless, the massive use of this drug may well lead to the selection of resistant/tolerant parasite strains. Episodes of drug tolerance have been reported (Doenhoff et al., 2008, Melman et al., 2009) and can be induced readily in the laboratory (Fallon and Doenhoff., 1994). In addition, changes to the local genetic polymorphism of parasites following treatment of the population have been

detected (Norton et al., 2010, Coeli et al., 2013), suggesting an effect of drug selection pressure. Although the precise mechanism of action of praziquantel in killing schistosomes is unknown, its initial effects include the rapid influx of Ca<sup>2+</sup> ions and calcium-dependent muscle contraction and paralysis (Day et al., 1992) and this may be mediated via its interaction with a calcium channel beta subunit (Kohn et al., 2001). However, resistance to praziquantel may be mediated by increased expression of the P-glycoprotein efflux pump, which is often involved in drug resistance mechanisms, following exposure to praziquantel (Messerli et al., 2009). Whether or not such reports are the harbingers of the development of resistance by schistosomes toward praziquantel, reliance on a single drug is patently untenable in the medium to long term.

Most of the current efforts to identify new drug leads for schistosomiasis and other neglected parasitic diseases rely on the screening of random compound libraries directly on the parasite maintained in culture (phenotypic screening). The recent publication of the genome sequences of a variety of parasites including the three main species of schistosomes that infect humans (Berriman et al., 2009, Zhou et al., 2009, Young et al., 2012) now means that approaches targeting specific gene products or pathways can be envisaged. These can include enzymes with activities specific to the parasite, or at least not found in the human host (e.g. Sayed et al., 2008), metabolic bottlenecks, or molecules that are targeted in other pathologies. For these a wide knowledge base and extensive libraries of inhibitors may already exist that can be exploited as starting points for the development of parasite-selective compounds. This type of approach also has the advantage that the molecular mechanism of action of a given compound, which is required for any new drug, is much easier to determine than with the random screening approach. However, both strategies are still used and both have proved fruitful sources of new drugs (Swinney and Anthony, 2011) although a more recent analysis of discovery of first-in-class drugs suggests a growing predominance of target-based approaches (Eder et al., 2014). Drug discovery is not a zero-sum game, but more a Nash equilibrium (Nash, 1950, Holt and Roth, 2004) in which the coexistence of strategies is not only possible but can also be highly productive.

Schistosomes are digenean parasites that successively infect freshwater snails (the intermediate host) and the vertebrate definitive host. They reproduce both asexually (within the snail host) and sexually (vertebrate host) and their life-cycle includes four distinct

morphological forms and separate sexes at the adult worm stage (Colley et al., 2014). The complexity of schistosome development and differentiation implies a tight control of gene transcription at all stages of the life-cycle and that epigenetic mechanisms are likely to play a crucial role in these processes, suggesting that they are viable drug targets. In other pathologies, but most intensively in cancer, the targeting of epigenetic processes is increasingly exploited. Indeed, two histone deacetylase (HDAC) inhibitors have already been approved for use and a number of other candidate drugs are undergoing clinical trials (Arrowsmith et al., 2012). Moreover, large libraries of compounds that affect epigenetic actors are available for testing against parasites. Here, we will consider which epigenetic mechanisms can be targeted in schistosomes and what methodologies can be used to develop parasite-selective drug leads.

### **Epigenetic mechanisms as drug targets**

The term “epigenetics” envelops a variety of heritable changes in gene expression that are linked to structural modifications of the chromatin, without changes to the DNA sequence. These include DNA methylation, reversible post-translational modifications of histones, histone variants, chromatin remodeling factors and non-coding RNAs. Viewed as potential targets, the most readily “druggable” are the enzymes that carry out DNA methylation and histone modifications, and increasingly, micro-RNAs (miRNAs) among the non-coding RNA categories (Figure 1).

The investigation of the role of epigenetic mechanisms in the control of gene transcription in schistosomes, and hence in biological processes like development and reproduction, is in its early stages. Nevertheless, the knowledge so far acquired, or inferred from the nature of schistosomes as invertebrate metazoan organisms and from a detailed analysis of the epigenetic actors encoded in their genomes, can be exploited to develop novel therapeutic strategies.



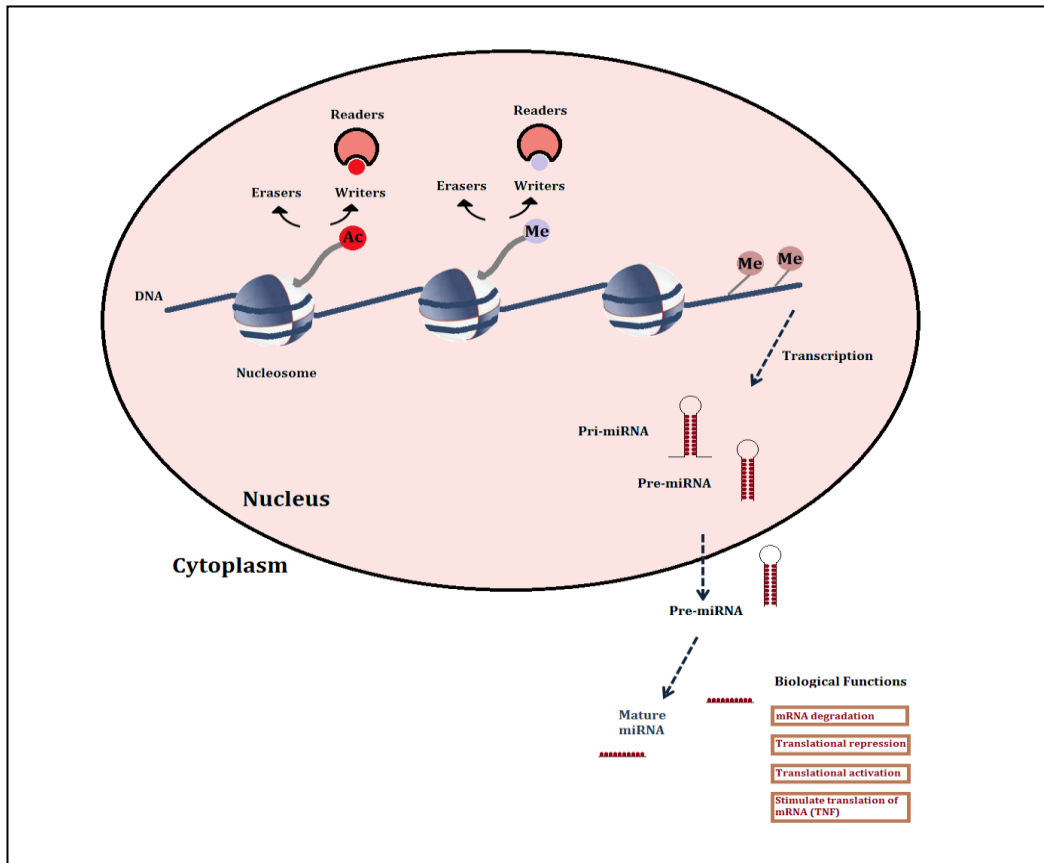

**Figure 1. Schematic representation of the major druggable epigenetic mechanisms. Histone modifications shown are limited to acetylation and methylation since the enzymes (writers and erasers) and recognition domains (readers: bromodomains) are the most studied for drug development. Also shown are DNA methylation and microRNAs.**

Moreover, insights into schistosome epigenetic mechanisms has been gained from studies aimed at developing such strategies, including for example the characterization of the actions of inhibitors of histone modifying enzymes, or from transcript knockdown studies. Here we will review the current state of knowledge of the epigenetic apparatus in schistosomes, including the still disputed significance of DNA methylation, the miRNA repertoire, the histone modifying enzyme complement and the potential for the development of novel drug treatments targeting these elements.

## DNA methylation

DNA methylation encompasses the methylation or hydroxymethylation of cytosine residues, mainly, but not exclusively within CpG dinucleotides (Baubec and Schübeler, 2014)

and is an important epigenetic mark associated with gene repression. In vertebrates three DNA methyltransferases (Dnmts) establish (Dnmt3a and Dnmt3b) and maintain (Dnmt1) DNA methylation marks. A further member of this family, Dnmt2 is primarily a tRNA methyltransferase with only weak DNA methyltransferase activity (Schaefer and Lyko, 2010). Disruption of DNA methylation patterns is present in a variety of diseases, particularly in cancer in which many oncogenic pathways lead to Dnmt1 overexpression, an overall DNA hypomethylation concomitant with hypermethylation of tumor suppressor genes at CpG islands in the promoter regions. Agents that provoke DNA demethylation, such as 5-azacytidine and 5-aza-2'-deoxycytidine (decitabine) have been approved for use in myelodysplastic syndrome (Yoo and Jones, 2006), but their mode of action is complex. It involves conversion to a triphosphate metabolite, incorporation into DNA provoking a DNA damage response and covalent trapping of Dnmt isoforms, followed by proteolysis of the Dnmts, demethylation and the reactivation of the hypermethylated genes (Stresemann and Lyko, 2008). The cytotoxicity of the 5-aza nucleosides and the lack of a direct inhibitory effect on Dnmts have led to the search for leads for new drug development. One example is laccic acid A, a recently developed direct DNA-competitive inhibitor of Dnmt1 (Fagan et al., 2013).

### **DNA methylation in schistosomes**

The presence of functional DNA methylation marks in schistosome genomes is controversial. Early work in which Southern blot analysis was carried out for selected genes after digestion with methylcytosine tolerant or sensitive restriction enzyme isoschizomers (*HpaII* and *MspI*) showed no differences in the restriction profiles for adult male or female *S. mansoni* DNA (Fantappiè et al., 2001). Moreover, the methylcytosine-dependent restriction endonuclease McrBC failed to digest *S. mansoni* DNA. However, a more recent study (Geyer et al., 2011) in which a variety of more sensitive methods including GC-MS, anti-methylcytosine antibodies and targeted bisulfite sequencing were used concluded that cytosine methylation was indeed present and a hypermethylated repetitive intron within a forkhead gene was characterized. The only DNA methyltransferase encoded in the schistosome genome is Dnmt2. The methyltransferases usually associated with DNA methylation; Dnmt1 and Dnmt3 orthologues are both absent. Dnmt 2 has only weak DNA

methyltransferase activity but has robust methyltransferase activity toward tRNA<sup>Asp</sup> and other tRNAs (Goll et al., 2006). The diverse group of animal species (including *S. mansoni* and *Drosophila melanogaster*) that express only Dnmt2 have very low DNA methylation levels (Kraus and Reuter, 2011). However, Dnmt2 does retain some cytosine methyltransferase activity (Hermann et al., 2003) and Geyer et al. (2011) showed that siRNA knockdown of SmDnmt2 transcripts reduced overall methylcytosine levels in the schistosome genome. These authors have further suggested that cytosine methylation is conserved throughout the phylum Platyhelminthes (Geyer et al., 2013). Against this, a comprehensive study (Raddatz et al., 2013) using whole-genome bisulfite sequencing showed that the *S. mansoni* genome lacked a detectable DNA methylation pattern, even at the “hypermethylated” locus identified by Geyer et al. (2011). Some clusters of incompletely converted cytosines were detected outside this region, but were consistent with bisulfite deamination artefacts (Warnecke et al., 2002). However, although these results strongly suggested that the *S. mansoni* genome is in fact unmethylated, the criticism has been levelled that the life-cycle stage analyzed, adult male worms, has the lowest level of DNA methylation measured using an ELISA method (Geyer et al., 2013). Notwithstanding this controversy, which will only be resolved by genome-wide bisulfite sequencing of other life-cycle stages, Dnmt inhibitors were found to strongly affect adult worms, particularly in terms of the morphology of the ovaries and *in vitro* egg-laying (Geyer et al., 2011). Whether or not this is due to the inhibition of DNA or tRNA methylation, it does suggest that Dnmt inhibitors such as 5-azacytidine may provide the basis for developing precursors of novel anti-schistosome drugs.

### **Micro-RNAs**

Non-coding (nc) RNAs include many different classes of transcripts that do not code for proteins, but have various regulatory roles in transcription, stability or translation of protein-coding genes. Of these, micro-RNAs (miRNAs) are the best characterized in terms of their functional roles and pathological implications, as well as therapeutic strategies targeting them (Ling et al., 2013). They are generated from long, capped and polyadenylated transcripts that are processed by a nuclear complex containing RNase III (Drosha: canonical pathway) or by the mRNA splicing machinery (non-canonical pathway) (Li and Rana, 2014 for review) into 60-100 nucleotide precursors that are then transported into the cytoplasm

where they are processed by the RNase Dicer into mature, double stranded miRNAs (Figure 1). Classically, miRNAs regulate transcript levels through binding to the 3'UTR regions of their target mRNAs, usually resulting in translational inhibition or mRNA destruction. However, it is now clear that miRNAs may have other mechanisms of action, for instance increasing translation via the recruitment of protein complexes to the mRNA or by binding proteins that block translation (Eiring et al., 2010). Different miRNAs have been shown to have either tumor-suppressive (e.g. miR-15a-miR-16-1 cluster) or oncogenic (miR-21, miR-17-miR-92 cluster, miR-155) properties. Indeed, miRNAs can drive cancer: miR 155 overexpression on its own provokes lymphoblastic leukemia or lymphoma in transgenic mice (Costinean et al., 2006). In cancer therapy, the upregulation of tumor-suppressive miRNAs has the advantage of simultaneously affecting a number of coding or non-coding genes that are targeted by the miRNA and that may be involved in the same or interacting pathways. A disadvantage is that a given miRNA may have different or even opposite effects in different cell types, depending on the expression patterns of its target genes. However, such considerations would be less of an obstacle in the therapy of parasitic diseases where it can be assumed that any disruption, positive or negative, of miRNA effects would be potentially deleterious to the parasite. Most current therapeutic strategies targeting miRNA in cancer are aimed at downregulating or blocking the function of oncogenic miRNA. One example consists in the use of antisense oligonucleotides, particularly those containing locked nucleic acids (LNA anti-miRs) which are bicyclic RNA analogues in a locked configuration. One such compound, an anti-viral, miravirsin, is in clinical trials for the treatment of hepatitis C viral infection (Janssen et al., 2013, Lieberman and Sarnow, 2013).

### **Schistosome miRNAs**

A survey of the available *S. mansoni* EST sequences (Oliveira et al., 2011) concluded that 10.3% (21,107 sequences) match the genome but have no protein coding potential and are therefore possible ncRNAs. This in turn suggests that the parasite may use a range of ncRNAs in transcriptional and translational regulation. Moreover, the presence of proteins involved in miRNA processing (Drosha, Dicer and Argonaute) (reviewed in Oliveira et al., 2011) supports a role for miRNA regulation of development and differentiation of schistosomes and explains the effectiveness of RNAi and siRNA knockdown of transcription

in the parasite (Boyle et al., 2003). Micro-RNAs were first identified in *S. japonicum* (Xue et al., 2008, Huang et al., 2009) in two separate studies that demonstrated the existence of a limited number of miRNA that are conserved in other organisms including humans and several hundred novel miRNAs. In the second study all the novel miRNAs (172) were identified by an inferred RNA hairpin and many were differentially expressed during the life-cycle (Huang et al., 2009). Deep sequencing studies (Hao et al., 2010, Wang et al., 2010) further showed the presence of large numbers of siRNAs derived from transposable elements, but also identified 38 novel *S. japonicum* miRNAs. In *S. mansoni*, the sequencing of a small-RNA cDNA library yielded 211 novel miRNA candidates of which 11 were further verified by Northern blotting (Simões et al., 2011). Therefore, although further work is necessary to validate the schistosome specific miRNAs and determine which of them are shared between schistosome species, it is clear that these miRNAs are potential therapeutic targets. It is of note that flatworms show a gradual loss of *conserved* miRNAs during evolution (Fromm et al., 2013), which is suggested to be due to morphological simplification. However, they have equally gained specific ncRNAs, including endogenous siRNAs, which are differentially expressed during development, notably during the sexual differentiation of female worms (Cai et al., 2011, Sun et al., 2014). A therapeutic strategy based on LNA anti-miRs would have the advantage of targeting parasite-specific sequences and hence avoiding off-target effects, but it is not yet known whether individual miRNAs could be valid therapeutic targets. There are several additional challenges associated with such a strategy (Ling et al., 2013), the main ones being to ensure bioavailability to the parasite and oral delivery, which would require a significant effort to investigate appropriate chemical substitutions.

### **Post-translational modifications of histones**

Histone post-translational modifications are currently under the most intensive study for drug development. The “writers” that add groups to histone N-terminal tails, “erasers” that remove them, or “readers” that recognize and bind them, are all potential therapeutic targets (Figure 1). The increasing variety of possible modifications includes phosphorylation, ubiquitinylation and sumoylation, but acetylation and methylation are the most abundant, most studied and their activity is mediated by the largest number of druggable proteins

(Arrowsmith et al., 2012). Gene regulation is effected by combinations of these histone marks, leading to the “histone code” hypothesis (Strahl and Allis, 2000) whereby different chromatin states are defined by specific repertoires of marks.

Histone acetylation is a dynamic process regulated by histone acetyltransferases (HAT) that use acetyl-CoA as a co-factor and transfer an acetyl residue to the  $\epsilon$ -amino group of lysines, particularly in the N-terminal tails of histones H3 and H4. The histone deacetylases (HDAC) that remove this mark belong to four classes in mammals. Classes I, II and IV have structurally-related catalytic domains and a  $Zn^{2+}$ -dependent catalytic mechanism (Gregoretti et al., 2004). The class III HDACs, or sirtuins, are phylogenetically unrelated and rely on  $NAD^+$  as a co-factor (Greiss and Gartner, 2009). Histone acetylation neutralizes the positive charge of the lysine, leading to a more relaxed structure permitting recruitment of the transcriptional machinery and in consequence is associated with transcriptional activation.

Histone methyl marks are written on lysine or arginine residues in histone tails by S-adenosylmethionine-dependent methyltransferases and erased by two classes of demethylase, the Jumonji family of demethylases that are 2-oxoglutarate-dependent, or the flavin-dependent lysine-specific demethylase 1 (KDM1/LSD1) and 2 (KDM2/LSD2). Unlike acetylation, a methyl group has no effect on the overall charge of the lysine or arginine residue that carries it and the effects of the mark are mediated by “reader” proteins that either compact the nucleosomes or form complexes with other regulatory proteins. Moreover, lysine residues can react with different reader domains depending on their position and degree (mono-, di- or tri-) of methylation and can consequently integrate signal platforms determining activation or repression of transcription (Badeaux and Shi, 2013).

The current list of inhibitors of “Histone Modifying Enzymes” (HMEs) approved for use in humans or in clinical trials reflects the initial concentration in this field on the HDACs as therapeutic targets. Of 18 such compounds, 17 are HDAC inhibitors (including the two approved compounds, Vorinostat and Romidepsin) and another is a sirtuin (Sirt) 1 inhibitor (Arrowsmith et al., 2012, West and Johnstone, 2014). Of the HDAC inhibitors in clinical trials some inhibit class I and II enzymes indiscriminately, whilst others are more selective. Romidepsin preferentially inhibits the class I HDACs 1, 2, 3 and 8, whilst Vorinostat inhibits the class II HDAC6 and HDAC8 only poorly (Arrowsmith et al., 2012). Selectivity for a given HDAC or class may be of therapeutic importance as these enzymes have different targets.

HDACs generally deacetylate both histones and other proteins. HDAC6 is not involved in epigenetic signaling at all but deacetylates tubulin and Hsp90 (Hubbert et al., 2002; Kovacs et al., 2005), while the only known HDAC8 substrate is SMC3, a component of the cohesin complex (Deardorff et al., 2012). HDAC inhibitors occupy the hydrophobic tunnel in the enzymes that accommodates the acetyllysine substrate and coordinate the zinc ion at the base of the tunnel, for example with a hydroxamate grouping as for Vorinostat. Selectivity can be based on differences between the make-up and architecture of the tunnel, or on the surface-accessible rim. However, within the cell HDACs are often part of multi-protein complexes that may alter substrate and inhibitor specificities compared to isolated recombinant proteins (Bantscheff, et al., 2011) and this remark is likely even more pertinent in the case of other HMEs.

Of the seven mammalian NAD<sup>+</sup>-dependent class III deacetylases, or sirtuins (Sirt) Sirts 1, 2, 3, 6 and 7 have been shown to possess deacetylase activity (Feldman et al., 2012), although Sirt6 is also a fatty acylase (Jiang et al., 2013). The other two sirtuins, 4 and 5 are both predominately mitochondrial. Sirt5 is a demalonylase and desuccinylase (Du et al., 2011) and has recently been shown to regulate a novel lysine modification, glutarylation (Tan et al., 2014). Sirt4 exhibits ADP-ribosyltransferase activity (Haigis et al., 2006). Sirtuin inhibitors have been developed against Sirts 1, 2 and 3 that couple the deacetylation reaction with the cleavage of NAD<sup>+</sup>, liberating free nicotinamide. Inhibitors can bind either to the conserved NAD<sup>+</sup>-binding C-pocket, like nicotinamide itself, or the acetyllysine peptide-binding cleft between the large and small domains of the enzyme (Yuan and Mamorstein, 2012), or both. In addition, since Sirt1 expression has been associated with increased lifespan and memory, allosteric activators such as resveratrol have been explored as therapeutic agents (Hubbard and Sinclair, 2014). Only one sirtuin inhibitor, selisistat, is currently in clinical trials, however, for Huntington's disease (Arrowsmith et al., 2012).

Histone acetyltransferases (HAT) generally lack obvious druggable sites and few selective inhibitors are currently available. The HAT catalytic domains have a conserved organization around a central fold where the acetyl-CoA cofactor binds. The peptide substrate binding site in the only solved structure is shallow and solvent accessible, reducing its capacity to be targeted by drugs (Arrowsmith et al., 2012). Among the inhibitors so far described are natural substances that promiscuously bind a variety of targets (Piaz et al.,

2011), or isothiazolone covalent modifiers (Ghizzoni et al., 2009). These latter include the more recently developed pyridoisothiazolones that effectively inhibit cancer cell proliferation (Furdas et al., 2011). However, a potent, selective inhibitor of the HAT EP300, C646, has been developed that binds at the cofactor pocket and has pro-apoptotic effects on prostate cancer cells (Bowers et al., 2010). This indicates that at least certain HATs are valid, standalone therapeutic targets, but effective screening may depend on the reconstitution of multi-protein complexes in which they are active in the cell and which may modulate their enzymatic activity (Arrowsmith et al., 2012).

The protein methyltransferases include both lysine (KMT) and arginine (PRMT) methyltransferases that are phylogenetically unrelated but share the requirement for S-adenosylmethionine as a cofactor and a cofactor binding site adjacent to the channel that binds the peptide substrate (Arrowsmith et al., 2012). Both these sites can be used to generate selective and potent inhibitors for both PRMTs and KMTs (Spannhoff et al., 2009, Dowden et al., 2010). However, in order to screen certain of the latter enzymes, the reconstitution of protein complexes is a prerequisite. The KMT component of the PRC2 transcription repression complex, EZH2, which methylates H3K27, is inactive on its own and minimally requires the presence of at least two members of the complex, EED and SUZ12 (Helin and Dhanak, 2013). High-throughput screening has been carried out on a complex additionally containing AEBP2 and RbAp48 proteins and has yielded highly selective inhibitors such as GSK126, which is a promising lead for the treatment of lymphoma (McCabe et al., 2012). Complex recomposition is not always necessary; the H3K79 methyltransferase DOT1L requires no partner proteins and a highly selective inhibitor, EPZ-5676, has been developed using a structure-guided strategy, with significant activity in a rat xenograft model of MLL-rearranged leukemia (Daigle et al., 2013).

Histone demethylases are under increasing scrutiny as drug targets (Hojfeldt et al., 2013). Two unrelated families of proteins exert demethylase activity, the LSD family and the JMJC domain-containing demethylases. In mammals the LSD (for Lysine-Specific Demethylase) family comprises only two members, but they share an amine oxidase-like domain with several metabolic enzymes in addition to a SWIRM (SW13, RSC8 and Moira) domain that is only found in some chromatin-associated enzymes. These enzymes use FAD as a cofactor that binds to one of two folded subdomains of the amine oxidase-like domain,



the other binding the substrate. However, substrate specificity may be regulated through interactions of the SWIRM domain with protein partners (Metzger et al., 2005). The conservation of the amine oxidase-like domain means that some inhibitors of monoamine oxidases, such as tranylcypromine also inhibit LSD1 (Schenk et al., 2012), however, selectivity for the latter can be improved in derivatives (Oryzon Genomics, 2010). One such inhibitor, ORY-1001, has greatly improved selectivity for LSD1 and is entering clinical trials (Maes et al., 2013). Few selective or potent inhibitors of JMJC (Jumonji C) demethylases have yet been reported. In these enzymes (31 family members in humans) the JMJC domain is catalytic and the enzymatic mechanism involves two cofactors, Fe(II) and 2-oxoglutarate, which are bound to it. Members of this family can demethylate mono-, di- or tri-methylated lysines. Most reported inhibitors contain metal chelating groups (analogous to HDAC inhibitors, but the latter are poor JMJC inhibitors) that compete with the 2-oxoglutarate cofactor. One remarkably selective inhibitor of JMJD3, an H3K27me<sub>3</sub>-specific demethylase, has been developed using a structure-guided approach (Kruidenier et al., 2012). This inhibitor, GSK-J1, interacts with critical amino acids involved in the binding of both the 2-oxoglutarate cofactor and the histone peptide substrate, and is competitive with the former but non-competitive with the latter. It is selective for both JMJD3 and Utx (a closely related JMJC demethylase active on the same substrate as JMJD3) but inactive against other members of the JMJC family. Moreover, GSK-J1 inhibits pro-inflammatory functions of human primary macrophages, indicating a possible therapeutic role. Moreover, a related JMJD3 inhibitor, GSK-J4, has recently been shown to have anti-tumorigenic activity against T-cell acute lymphoblastic leukaemia (Ntziachristos et al., 2014)

Of the “readers” of epigenetic marks, bromodomain proteins, which read acetylated lysine residues, have so far attracted the most attention as drug targets. Bromodomains are composed of a characteristic antiparallel bundle of four  $\alpha$ -helices that binds acetyllysine in a pocket at one extremity. They were first identified in the *Drosophila* gene *brahma*, hence the name, and in humans 61 bromodomains have been identified in 46 proteins, some containing more than one, and belong to eight distinct families (Hewings et al., 2012). Although the biological roles of most bromodomain proteins remain unknown, the connection of some of them with diseases such as cancer is becoming clearer (Arrowsmith et al., 2012, Filippakopoulos and Knapp, 2014). Small molecule inhibitors have been principally

been developed against the BET bromodomain family. A triazolobenzidine (Nicodeme et al., 2010) was initially isolated as an inducer of ApoA1 expression and a derivative with enhanced activity in a reporter gene assay was only subsequently shown to interact with the bromodomains of BET family members BRD2, 3 and 4 using a chemoproteomic approach (Chung et al., 2011). Following an observation that thieodiazepines could bind to BRD4 a structure-based approach led to the development of a novel thieno-triazolo-1'4-diazepine named JQ1 (Filippakopoulos et al., 2011). This molecule binds to the BRD4 acetyllysine site and has reduced activity against other BRDs, but little or none towards other bromodomains. JQ1 induced a differentiation phenotype and growth arrest in a cell line derived from human squamous carcinoma. Since these founder studies, further selective inhibitors of BET bromodomains have been identified and clinical trials are ongoing, notably for JQ1.

### **Schistosome histone modifications**

An *in silico* analysis of the schistosome genome predictions and EST libraries (Anderson et al., 2012) showed that 21 of the 29 histone genes predicted in the genome are expressed in *S. mansoni*, the remainder being either unexpressed or having divergent sequences. Importantly, the N-terminal tails of the nucleosomal histones H3 and H4 are highly conserved, suggesting the functional conservation of the histone marks found in mammalian histones. The study of histone marks and their role in schistosome development and differentiation is still in its infancy, but studies involving inhibitors of HDACs and HATs have demonstrated the importance of histone acetylation and the interest of these enzymes as potential therapeutic targets. HDAC inhibitors including Trichostatin A (TSA) blocked the *in vitro* transformation of *S. mansoni* miracidia into primary sporocysts in a dose-dependent manner (Azzi et al., 2009) and this correlated with an increase in histone H4 acetylation. More recently, the same authors showed that differences in the levels of histone H3K9 acetylation on the promoters of genes encoding polymorphic mucins correlated with their differential expression in parasite strains compatible or incompatible with a given strain of the intermediate host, the freshwater snail *Biomphalaria glabrata*. TSA treatment ablated these strain-specific differences in expression (Perrin et al., 2013).

Histone acetyltransferase inhibition also has developmental consequences in schistosomes, particularly in egg maturation. The schistosome orthologue of the HAT GCN5 has been shown to acetylate H3 and H2A, and in particular H3K14 (de Moraes Maciel et al., 2008) and the CBP/P300 orthologue SmCBP1 primarily acetylates H4 (Bertin et al., 2006, Fantappié et al., 2008). Knockdown of either or both of these HATs in adult schistosomes has been shown to markedly reduce the transcription levels of the major eggshell protein p14 and to affect egg development. Moreover, these effects are reproduced by treating adult worm pairs with an HAT inhibitor, PU139 (Carneiro et al., 2014). After both inhibitor treatment and RNAi to knock down transcripts of the HATs, the phenotypic effects on egg laying and development were correlated with decreased acetylation of H3 and H4, increased methylation at H3K27, a marker of transcriptional repression, on the p14 proximal promoter.

The effects of both HDAC and HAT inhibitors on schistosomes suggest that histone acetylation may be a legitimate therapeutic target and this was further supported by a preliminary study showing that HDAC inhibitors like TSA and valproic acid could induce time and dose-dependent death of schistosomes (adult worms or schistosomula larvae) in culture (Dubois et al., 2009). Parasite death was associated with the induction of apoptosis in schistosomula shown by both TUNEL staining and the activation of the effector caspases 3/7. Once more, the molecular basis of these effects was evidenced by a global increase in histone H3 and H4 acetylation and significantly increased H4 acetylation at the proximal promoters of HDAC target genes, correlated with an increase in their transcription. More recently, similar effects have been observed using inhibitors of the class III histone deacetylases, the sirtuins (Lancelot et al., 2013). Inhibitors of Sirtuins 1 and 2 such as salermide also induce apoptosis and death of schistosomula in culture. Moreover, salermide induces marked morphological alterations to the female worm genital apparatus, the arrest of egg-laying and the separation of worm pairs.

### **Schistosome histone modifying enzymes: which are the best targets?**

Schistosome HDACs and HATs are clearly potential drug targets, as are probably other HMEs, but there are several challenges that could potentially impede drug development:

- These enzymes are evolutionarily conserved, particularly their catalytic domains, and in order to avoid potential side effects, inhibitors that are selective for the schistosome enzyme have to be developed.
- If selective inhibitors can be developed, the targeted HME has to be essential to the parasite so that its inhibition is lethal. Many HMEs have overlapping specificities (Annex 1) and the inhibition of one may be compensated by another. However, in the case of enzymes methylating (EZH) or demethylating (Utx) H3K27, only one isoform is present in schistosomes (Annex 1), against two in humans, suggesting that these enzymes may represent particularly sensitive targets.

In consequence, for these particular therapeutic targets, an approach involving both target validation, notably by transcript knockdown (RNAi), and structural studies to determine specificities in the structure of the catalytic pocket, is essential.

The *S. mansoni* genome encodes 55 HMEs involved in protein acetylation/deacetylation or methylation/demethylation (Annex 1) (Pierce et al., 2012). Some of these, including the class I HDACs (Oger et al., 2008) and the sirtuins (Lancelot et al., 2013) have been cloned and characterized and preliminary choices of targets can be made based on their degree of sequence conservation. In addition, the human orthologues of several of these enzymes are known to function only as part of a multiprotein complex as is the case for the H3K27 methyltransferase EZH2 mentioned previously (McCabe et al., 2012). High-throughput screening of the human enzyme has been done, using a five protein complex, but the resources devoted to carry out such a strategy for the development of anti-cancer therapies are not available in the case of neglected tropical diseases. Therefore, although the schistosome orthologue of EZH2 is a unique target, its screening will pose difficulties and it is therefore preferable to target an enzyme that is active on its own (like the H3K79 methyltransferase DOT1L for example (Daigle et al., 2013)). In addition, certain HMEs are very large proteins (Annex 1) and although the production of truncated proteins containing the catalytic domain can be envisaged, this may affect both enzyme activity and the conformation of the catalytic pocket, limiting the relevance of screening or structural data.

These considerations reduce the choice of viable HME targets in schistosomes, but a large number remain. Two filters can be used to further limit the choice: the use of HME class inhibitors to determine whether enzyme families contain potential targets and

transcript knockdown using RNAi to validate individual HMEs as stand-alone therapeutic targets. RNAi is still the only available means to achieve targeted knockdown of gene function in schistosomes, but its efficacy is transcript-dependent and phenotypes are not always observed (Stefanić et al., 2010).

### **Development of selective inhibitors as drugs: the challenges**

An illustration of the strategy that can be employed to designate therapeutic targets is provided by the *S. mansoni* class I histone deacetylase 8 (SmHDAC8). Of the class I HDACs, SmHDAC8 was initially designated as a potential target for two reasons. First, transcript expression levels of SmHDAC8 are higher than those of SmHDAC1 and SmHDAC3 throughout the life cycle, notably in adult female worms (Oger et al., 2008). It is notable that HDAC 8 transcript levels are generally much lower than those of HDAC1 and 3 in normal human cells, but are markedly upregulated in some cancer cell lines and tissues (Nakagawa et al., 2007). Second, the analysis of the primary sequence of SmHDAC8 showed that it is less well conserved compared to its human orthologue than the other two class I enzymes. This is demonstrated by the sequence alignment and phylogenetic analysis shown in Figure 2.

The alignment shows that the essential residues for HDAC activity are conserved, but that the catalytic domain sequence contains insertions and substitutions that might indicate a change in architecture of the catalytic pocket, notably the replacement of a methionine (M274) in the human HDAC8 by a histidine (H292) in SmHDAC8 (Figure 2). The status of SmHDAC8 as a stand-alone therapeutic target was enhanced by the use of generic HDAC8 inhibitors (unpublished results) and particularly by transcript knockdown using RNA interference (Marek et al., 2013). The latter showed that treatment of schistosomula with double-stranded RNA, followed by their injection i.v. into mice and harvesting of surviving worms 35 days later, led to a reduced worm recovery compared to mice treated with dsRNA encoding green fluorescent protein as a control.

Whilst molecular modelling seemed to show that only the charge difference provided by His292 residue differentiated SmHDAC8 from its human counterpart, structural analysis by X-ray crystallography demonstrated a further important difference (Marek et al., 2013). In the schistosome enzyme, amino acid substitutions surrounding the catalytic pocket allow a

change in the configuration of the side chain of phenylalanine 151 (Figure 2). The side chain of the equivalent residue in human HDAC8, Phe152, adopts an obligatory flipped-in conformation that contributes to the narrow, hydrophobic tunnel accommodating the substrate or inhibitors. In contrast, in SmHDAC8 this side chain is free to adopt a flipped-out configuration, allowing the pocket to accommodate more bulky substrates or inhibitors.

This difference, together with the charge difference, allows the possibility of identifying selective inhibitors for the schistosome enzyme. Indeed, an *in silico* screen, based on the crystal structure of SmHDAC8 and involving the docking of a large number of potential inhibitors, led to the identification of an inhibitor, J1075 (Marek et al., 2013), which had greatly improved selectivity for SmHDAC8 compared to human class I and II HDACs. Moreover, this inhibitor caused dose and time-dependent death of schistosome larvae in culture via the induction of apoptosis. Optimization of this and other inhibitors identified by this strategy is ongoing, and further potential drug precursors have been identified (Stolfa et al., 2014). It is also notable that the structural specificities of the SmHDAC8 enzyme compared to the human orthologue are shared with HDAC8 in other flatworms, including other schistosome species, *Echinococcus* sp. and *Clonorchis sinensis* (Figure 2). Therefore, drugs effective against *S. mansoni* may well be applicable to these other species.

This example proves the concept that individual epigenetic enzymes can be valid therapeutic targets, and that, even though these enzymes generally have conserved catalytic domains, sufficient differences in structure can exist to allow the development of selective inhibitors that are drug precursors. It remains to be seen, however, whether these inhibitors can be made sufficiently selective to preclude potentially harmful side effects and whether they can be developed into drugs useable in a single oral dose in humans.

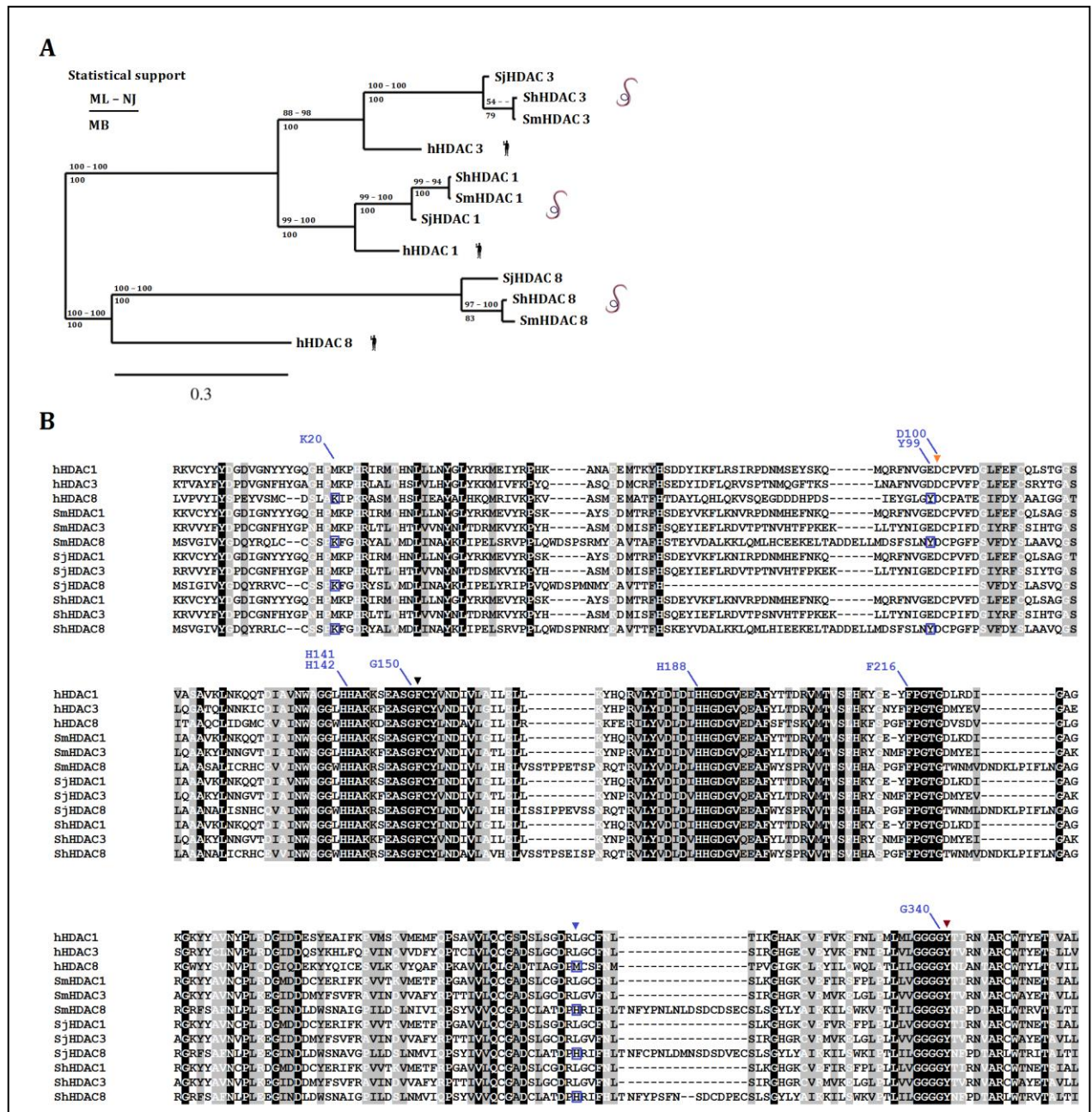

**Figure 2. Phylogenetic relationship amongst human and Schistosome class I HDACs.** Panel A displays a phylogenetic tree (consensus from maximum likelihood (ML), neighbor joining (NJ) and Mr Bayes (MB) methods) built using the amino acid sequences from the catalytic domains of class I HDACs (HDAC1, 3 and 8) present in *S. mansoni* (Sm), *S. japonicum* (Sj) and *S. haematobium* (Sh) and their human (h) orthologs. Panel B shows an amino acid sequence alignment constructed with MAFFT with the class I HDACs used above. Conserved (black background and white letters), conservative changes (gray background and black letters) and less conservative changes (gray background and white letters) in amino acid positions are highlighted. Black (F151) and brown (Y341) triangles show residues that despite being conserved present conformational differences between human and Schistosomes HDAC8 (Marek et al., 2013). The blue triangle shows the position of the replacement of a methionine (M274) in the human HDAC8 by a histidine (H292) in SmHDAC8 (boxed amino acids below blue triangle) (Marek et al., 2013). The flipped-out configuration of Y99 (blue line) in SmHDAC8 is essential for the specificity of the inhibitor J1075.

## Conclusions

Epigenetic processes provide a wealth of potential therapeutic targets for the development of novel therapies against schistosomiasis and other parasitic diseases. The most readily exploitable of these targets are the histone modifying enzymes, as well as perhaps Dnmt2, which lend themselves to target-based drug discovery strategies, necessary to ensure the development of parasite-selective drugs. A structure-based strategy has been initiated for *S. mansoni* HDAC8, involving the solution of the 3D structure of the catalytic domain and *in silico* docking of potential inhibitors. However, such enzymes can also be screened directly using random compound libraries and high-throughput methodologies using enzyme inhibition as the read-out. Moreover, the existing extensive libraries of HME inhibitors can be used for phenotypic screening of compound libraries for lethal effects on the parasite itself. In all these cases, since the molecular mechanism of action of the drug precursor is known, time will be saved in the process of optimizing selectivity.

The remaining potential targets discussed above, notably the histone modification readers, like bromodomain proteins, and miRNAs, require validation as effective targets and pose greater challenges for drug development. In order to identify the schistosome bromodomain proteins, an exhaustive analysis of the genomic data has still to be done. However, since both these proteins and miRNAs are under intensive investigation, particularly for the development of anti-cancer therapies, methodologies will be developed that could be exploited and adapted for the treatment of parasitic diseases.

Work on all the potential targets discussed here can benefit from the increasing knowledge base and compound libraries accrued, notably in the development of anti-cancer therapies. This “piggy-backing” approach (Dissous and Grevelding, 2010) holds great promise and can in part mitigate the relative lack of investment in efforts to improve the control and treatment of schistosomiasis and the other neglected parasitic diseases.



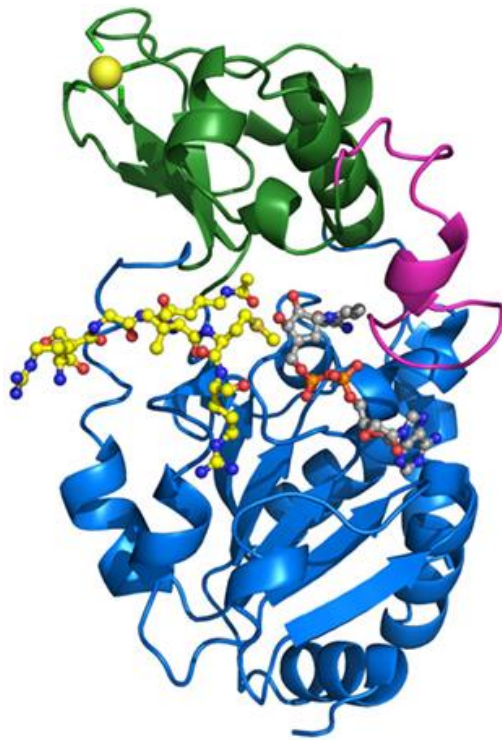

## Schistosome sirtuins

## Schistosome sirtuins as drug targets<sup>17</sup>

Julien Lancelot<sup>1</sup>, Alejandro Cabezas-Cruz<sup>1</sup>, Stéphanie Caby<sup>1</sup>, Martin Marek<sup>2</sup>, Johan Schultz<sup>3</sup>,  
Christophe Romier<sup>2</sup>, Wolfgang Sippl<sup>4</sup>, Manfred Jung<sup>5</sup>, Raymond J. Pierce<sup>1\*</sup>

<sup>1</sup>Center for Infection and Immunity of Lille (CIIL), INSERM U1019 – CNRS UMR 8204, Université de Lille, Institut Pasteur de Lille, 1 rue Professeur Calmette, 59019 Lille Cedex, France.

<sup>2</sup>Département de Biologie Structurale Intégrative, Institut de Génétique et Biologie Moléculaire et Cellulaire (IGBMC), Université de Strasbourg (UDS), CNRS, INSERM, 1 rue Laurent Fries, B.P. 10142, 67404 Illkirch Cedex

<sup>3</sup>Kancera AB, Karolinska Institutet Science Park, Banvaktsvägen 22, 171 48 Solna, Sweden.

<sup>4</sup>Institute of Pharmacy, Martin-Luther-Universität Halle-Wittenberg, Wolfgang-Langenbeck-Str. 4, 06120 Halle/Saale, Germany

<sup>5</sup>Institut für Pharmazeutische Wissenschaften, Albert-Ludwigs-Universität Freiburg, Albertstraße 25, 79104 Freiburg, Germany.

\*Corresponding author: Dr. Raymond J. Pierce, tel: (+33) 3-20-87-77-83, fax: (+33) 3-20-87-78-88, e-mail: raymond.pierce@pasteur-lille.fr

---

<sup>17</sup> Published manuscript. Full reference as follow: Lancelot J, Cabezas-Cruz A, Caby S, Marek M, Schultz J, Romier C, Sippl W, Jung M, Pierce RJ. Schistosome sirtuins as drug targets. Future Med Chem. 2015;7(6):765-82. doi: 10.4155/fmc.15.24.

## **Abstract**

The sirtuins form a superfamily of evolutionarily conserved NAD<sup>+</sup>-dependent protein N-ε-acyl-lysine (AcK) deacylases with roles in a variety of key cellular processes. Sirtuins have a broadly conserved overall structure with a catalytic site formed by a hydrophobic channel between the NAD<sup>+</sup>-binding Rossmann fold domain and a smaller Zn<sup>2+</sup>-binding domain. Schistosomes express five members of the sirtuin family and generic sirtuin inhibitors induce apoptosis and death in schistosome larvae, the disruption of adult worm pairs, inhibition of egg laying and damage to the male and female worm reproductive systems. Sirtuins in schistosomes and other parasitic flatworms present structural differences from their human orthologues that should allow the development of selective inhibitors that can be developed as drug leads.

## **Schistosomiasis: strategies for drug discovery**

The treatment and control of schistosomiasis currently relies entirely on the use of the only available drug, praziquantel. Despite the undoubted success of the programs of mass-treatment of school-age children in sub-Saharan Africa using this drug in reducing mortality and morbidity, notably through the Schistosomiasis Control Initiative (Fenwick et al., 2009), the potential for the development of resistance by the parasite (Doenhoff et al., 2008) means that the development of new drugs is an absolute priority. The annotated genome sequences for the three major species of schistosome infecting humans (Berriman et al., 2009; Zhou et al., 2009; Young et al., 2012) have provided an opportunity for the exploration of new strategies for drug discovery and we have chosen to pursue the targeting of schistosome epigenetic mechanisms (Cabezas-Cruz et al., 2014). The complex life-cycle of the schistosomes, involving two hosts and four morphologically distinct forms highlights the importance of a tight control of gene transcription during schistosome development, and the probable importance of epigenetic actors in this process. Moreover, these actors are increasingly targeted in other pathologies, notably in cancer, and the large libraries of compounds that have been identified can be exploited for testing against schistosomes, providing the basis for the development of lead compounds for anti-schistosome drug development. Here we focus on one family of such epigenetic actors, the sirtuins, and assess their potential as therapeutic targets in schistosomiasis.

## Why the boom in research on sirtuins?

Initially categorized as class III histone deacetylases (HDAC), sirtuins are NAD<sup>+</sup>-dependent protein N-ε-acyl-lysine (AcK) deacetylases that are phylogenetically and structurally distinct from the class I and II HDACs. Sirtuins are involved in a wide spectrum of biological functions: regulating transcriptional repression, cellular pathways, metabolism, aging, apoptosis and DNA damage responses (Herranz et al., 2010; Kaeberlein, 2010). They have also been linked to numerous human diseases (Libert et al., 2013). Notably, it is now clear that sirtuins can either promote or repress tumor development and the discovery of inhibitors and activators of these enzymes gives the possibility of controlled intervention in either context, ensuring that sirtuins constitute a hot spot of research in this field (Yuan et al., 2013). In the case of parasitic pathogens, certain sirtuins have been shown to be essential to the survival and/or development of these organisms, determining their interest as drug targets.

Recently, the sirtuin family has been phylogenetically and molecularly characterized among all the kingdoms of life, and they were found in all species of Bacteria, Archea, Protists, Plants, Fungi, Ecdysozoa, Choanozoa, Echinodermata, Radiata, Lophotrochozoa and Chordata (Greiss and Gartner, 2009). Importantly, from the structural point of view, sirtuins present a conserved and druggable NAD<sup>+</sup> and substrate pocket (Costantini et al., 2013), allowing the use of inhibitors, that have been characterized in one organism, in distantly related organisms. At the same time sirtuins are different enough (Costantini et al., 2013), to permit the design of species-specific inhibitors. All these properties make sirtuins ideal targets for drug discovery. Sirtuins have already been identified in important human and animal protozoan parasites (Religa and Waters, 2012) and recently they were described as “emerging anti-parasitic targets” (Zheng, 2013). However, in the literature, the sirtuins of important parasitic worms are underrepresented. Recently, our group identified members of the sirtuin family in the genome of the fluke *Schistosoma mansoni* and proposed their use as targets for anti-schistosomiasis drug development (Pierce et al., 2012; Lancelot et al., 2013). Herein, we review the structure, phylogeny and biological roles of sirtuins in relation to their interest as therapeutic targets in parasitic platyhelminths, and more particularly in schistosomes.

## Platyhelminthes present an evolutionarily conserved family of sirtuins

Sirtuins are grouped into four main classes that contain all the metazoan representatives of this family, while a fifth group contains sirtuins from gram positive bacteria and the gram negative, hyperthermophile bacterium *Thermotoga maritima* (Frye, 2000), although groups I and IV are further sub-divided and this organization was subsequently extended and consolidated (Greiss and Gartner, 2009). It appears that the seven sirtuins (Sirt1-7) present in metazoans arose very early during animal evolution and that because of the importance of their functions, they have been conserved in all branches of the phylogenetic tree (Greiss and Gartner, 2009). However, it is interesting to note that some organisms lack certain sirtuins, having only one or a few representatives of this family (Greiss and Gartner, 2009). The distribution of sirtuins in parasitic Platyhelminthes is a good example of this “selective lack of sirtuins” (Figure 1).

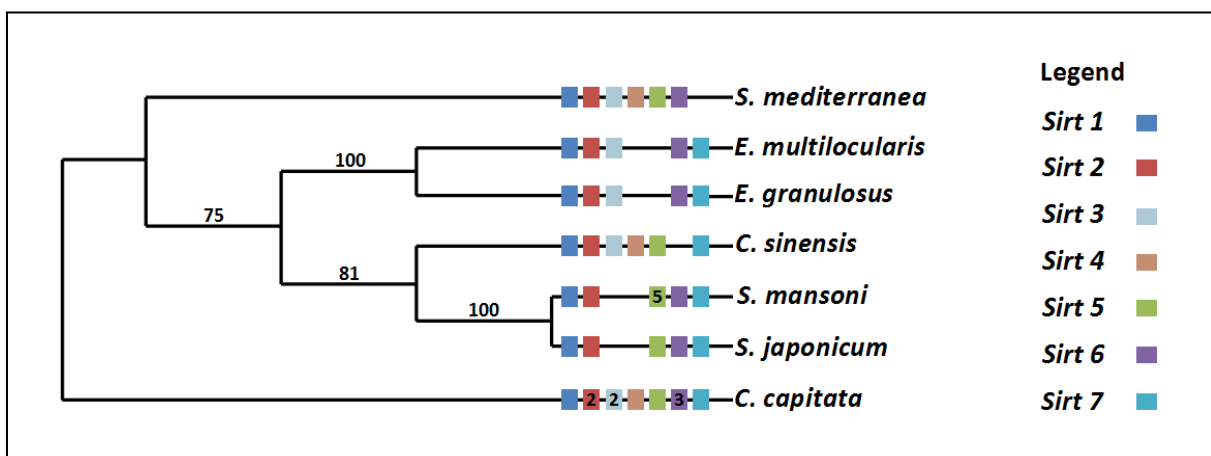

**Figure 1. Distribution of Sirtuins amongst phylogenetically related Platyhelminthes. The figure displays a maximum likelihood phylogenetic tree build using 18S rRNA gene from *S. mediterranea* (accession number: U31084), *E. multilocularis* (accession number: AB731634), *E. granulosus* (accession number: AB731639), *C. sinensis* (accession number: JF314770), *S. mansoni* (accession number: U65657), *S. japonicum* (accession number: AY157226) and *C. capitata* (accession number: U67323). The Sirtuins present in the different species are presented as coloured squares as shown in the legend of the figure. The values on the internal branches represent bootstrap values (1000 bootstrap replicates).**

For example *Schistosoma* spp lack Sirt3 and Sirt4; *Clonorchis sinensis*, the Chinese liver fluke, lacks Sirt6; and *Echinococcus* spp, lack Sirt4 and Sirt5. In sharp contrast, Sirt1 and Sirt2 seem to be ubiquitous. One could speculate that the parasitic life style would have made some

sirtuins unnecessary, however, *Schmidtea mediterranea*, a free living planarian lacks Sirt7. The presence of the seven sirtuins seems to be unrelated to the complexity of the organism. Thus, the seven sirtuins are present in at least one organism from Radiata (*Nematostella vectensis*, sea anemone) and Lophotrochozoa (*Capitella capitata*, a polychaete worm), although all ecdysozoan invertebrates seem to lack Sirt3. Most, but by no means all, vertebrates present the seven sirtuins. Exceptions are provided by the absence of Sirt1 and 7 in the zebrafish and of Sirt2 in the pufferfish *Tetraodon nigroviridis* (Greiss and Gartner, 2009). However, most unicellular organisms present only one or two sirtuins (Greiss and Gartner, 2009), and choanoflagellates (e.g. *Monosiga brevicollis*), considered to be the closest living relatives of metazoans (Cavalier-Smith, 1987), lack Sirt3 and Sirt5. It is considered that Sirt3 originated rather recently, as the Sirt3 group is present only in animal species, while Sirt5 is related to bacterial forms and is considered to be evolutionarily ancient (Greiss and Gartner, 2009). Thus sirtuins have been lost or gained in eukaryotic genomes across evolution.

### **Sirtuin cellular functions**

Sirtuins (Sirt1-7) share the highly conserved catalytic core but vary in subcellular localization, substrate specificity and function. In mammals Sirt1, Sirt6 and Sirt7 localize to the nucleus, Sirt3, Sirt4 and Sirt5 are mitochondrial, while Sirt2 is predominantly cytoplasmic (Michishita et al., 2005). However, both Sirt2 and Sirt3 can also localize to the nucleus. Sirt2 shuttles to the nucleus during mitosis, where it can act as a histone deacetylase on H4K16 and H3K56 (North and Verdin, 2007; Vaquero et al., 2006) and Sirt3 can shift to the nucleus under conditions of cellular stress (Scher et al., 2007). In addition, Sirt5 activity is detectable in the cytoplasm (Park et al., 2013) and Matsushita et al. (2011) identified two isoforms of human Sirt5, with a shorter, predominately mitochondrial form and a longer isoform located in both the cytoplasm and mitochondria.

Although the subcellular localizations of schistosome sirtuins have not been determined experimentally, the presence (or absence) of signal sequences is indicative (Figure 2).

However, although both Sirt 6 and Sirt7 have consensus nuclear export signals, they lack the nuclear localization signal, which is present at the C-terminal end of Sirt1 from *S.*

*mansoni*. The corresponding signal is absent from the predicted *Schistosoma japonicum* Sirt1 peptide sequence, but this is probably incomplete at the C-terminal end. In contrast, a mitochondrial targeting peptide sequence is absent from *S. mansoni* Sirt5, but present in the *S. japonicum* orthologue, suggesting that the sequences of the *S. mansoni* Sirt5 isoforms [16] should be reexamined.

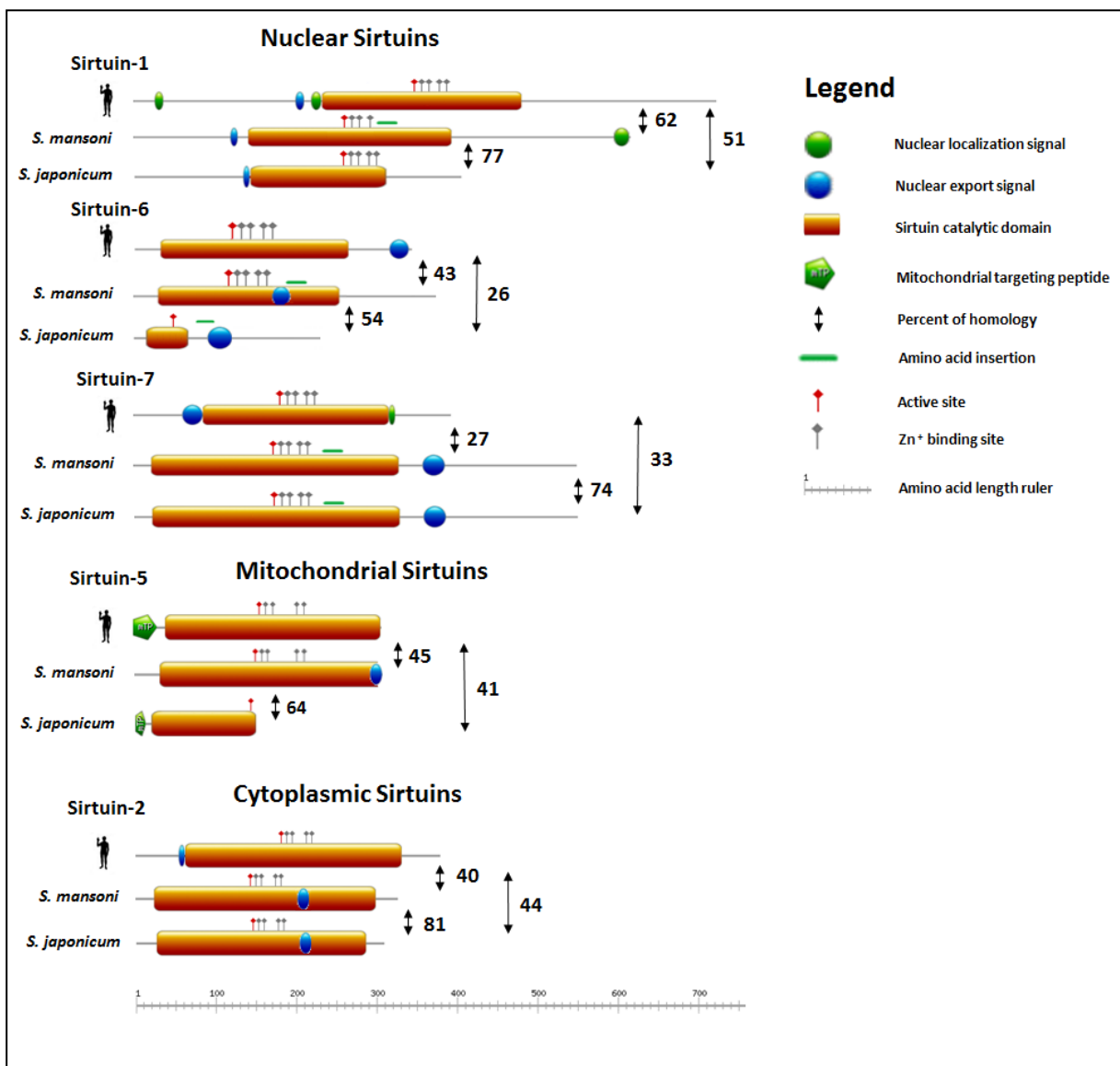

**Figure 2. Comparative diagram of human and Schistosome Sirtuins. Relevant domains of Schistosome sirtuins are highlighted and compared with the homologs in humans. Drawing was performed with the online tool MyDomains (PROSITE database, Sigrist et al., 2013).**

The substrates and functions of human sirtuins have been the subject of recent, extensive reviews (e.g. Yuan et al., 2013; Choi and Mostoslavsky, 2014) and here we will only present a brief overview. Since the discovery of the role of *Saccharomyces cerevisiae* Sir2 in

promoting longevity through increased gene dosage (Kaeberlein et al., 1999), followed by similar observations in *Caenorhabditis elegans* (Tissenbaum and Guarente, 2001) and *Drosophila melanogaster* (Wood et al., 2004) in relation to calorie restriction, (reviewed in Westphal et al., 2007; Guarente, 2013) the mechanisms by which this occurs have come under intense scrutiny. Sirtuin family members are involved in mechanisms such as nutrient sensing, DNA repair and the regulation of metabolism (Choi and Mostoslavsky, 2014). Sirt1 is upregulated by calorie restriction, responding to variations in the levels of its cofactor NAD<sup>+</sup> (Cantó and Auwerx, 2011), and regulates metabolism via the deacetylation of a variety of target proteins, including notably PGC1 $\alpha$  and FoxO, through which it modulates both gluconeogenesis and glycolysis. Sirt1 also participates in the resistance to age-related apoptosis that occurs in response to stress (Brooks and Gu, 2009).

However, Sirt1 is not alone in regulating metabolism. As would be expected, the mitochondrial sirtuins (Sirts 3, 4 and 5) are essential actors in energy metabolism. Sirt3 regulates energy homeostasis via the maintenance of basal ATP levels. Sirt3(-/-) mouse embryonic fibroblasts show a reduction in ATP levels and several components of the electron transport chain exhibit increased acetylation (Ahn et al., 2008). More recently it was shown that Sirt3 reversibly deacetylates the ATP synthase F1 proteins  $\alpha$ ,  $\beta$  and  $\gamma$  and oligomycin sensitivity-conferring protein in response to nutrient or exercise-induced stress (Vassilopoulos et al., 2014). Furthermore, Sirt3 regulates the TCA cycle enzyme isocitrate dehydrogenase 2, whilst deacetylation of pyruvate dehydrogenase E1 $\alpha$  subunit in response to nutrient stress allows metabolic flexibility by switching from oxidative phosphorylation to lactate production and utilization of fatty acids (Jing et al., 2013). Sirt4 inhibits glutamine entry to the TCA cycle via the inhibition of glutamate dehydrogenase activity by ADP-ribosylation. The third mitochondrial sirtuin, Sirt5, modulates glucose metabolism via the regulation of the activities of pyruvate and succinate dehydrogenases and mitochondrial respiration, but via its deacylase (desuccinylase and demalonylase), and not deacetylase, activity (Du et al., 2011; Park et al., 2013) (see below).

The nuclear sirtuins, Sirts 6 and 7, have also recently been shown to have essential roles in metabolism regulation. Sirt6 is critically involved in the regulation of glucose metabolism: Sirt6 KO mice develop a fatal hypoglycemia (Mostoslavsky et al., 2006). This sirtuin negatively regulates transcription dependent on Hif-1 $\alpha$  by deacetylating H3K9 on the



promoters of its target genes, which include glucose transporter 1, lactate dehydrogenase A and pyruvate dehydrogenase kinase 1 (Zhong et al., 2010). The effect of the absence of Sirt6 is to promote glucose uptake and aerobic glycolysis (producing lactate), a phenotype associated with many cancer cells and known as the “Warburg effect” (Warburg, 1956).

In common with cancer cells, during their development in the mammalian host, schistosomes undergo a metabolic transformation similar to the Warburg effect. The infective cercariae transform into schistosomula on penetrating the skin of a mammalian host, a biological transformation that is accompanied by both structural and physiological alterations. Notably, whilst the free-living cercariae have an aerobic metabolism, the schistosomula have a dominantly anaerobic metabolism, producing mainly lactate as the end-product of the degradation of glucose absorbed from the external medium (Horemans et al., 1992). This transformation seems to be entirely dependent on the presence of glucose since schistosomula maintain aerobic metabolism when cultured in the presence of only trace amounts of glucose, but switch to lactate production when glucose is added to the medium. The glucose dependent lactate fermentation metabolism is maintained during development into adult worms. We have shown that Sirt6 transcripts are highly expressed in cercariae and newly transformed schistosomula, but are approximately 70-fold downregulated in adult worms (Lancelot et al., 2013). We are currently investigating the role of *S. mansoni* Sirt6 in this metabolic switch and in the control of schistosome glucose metabolism.

In addition to regulation of glucose metabolism, sirtuins also regulate lipid synthesis and utilization, notably shown by the use of gene knockout models. Initially described as an activator of RNA polymerase I transcription (Ford et al., 2006), Sirt7 has also been shown recently to be involved in the control of lipid metabolism. Its histone (H3K18) deacetylase activity is involved in preventing fatty liver disease (Shin et al., 2013) and studies in Sirt7 knockout mice show its implication in controlling liver lipid metabolism via regulation of the ubiquitin-proteasome pathway (Yoshizawa et al., 2014). Moreover, Sirt7 deficiency also leads to mitochondrial dysfunction, including increased lactate production, via the deacetylation of GABP $\beta$ 1, a regulator of nuclear-encoded mitochondrial genes (Ryu et al., 2014). Sirt1 is involved in controlling hepatic fatty acid utilization (Rodgers and Puigserver, 2007) and its ablation also leads to hepatic steatosis *in vivo* (Purushotham et al., 2009).

Similarly, Sirt6 knockout mice indicate a role for lipid metabolism as they show a loss of subcutaneous fat (Mostoslavsky et al., 2006) and further studies (Choi and Mostoslavsky, 2014) reveal its role as a regulator of low-density lipoprotein and cholesterol. Sirt3 knockout leads to the hyperacetylation of many mitochondrial proteins, and its targets include long-chain acyl-CoA dehydrogenase which is involved in fatty acid oxidation (Hirschey et al., 2010). Finally, Sirt4 inhibits the activity of malonyl-CoA decarboxylase, which acts to balance mitochondrial levels of malonyl-CoA and acetyl-CoA, hence regulating the fatty acid oxidation/synthesis balance (Laurent et al., 2013).

In addition to these functions in metabolism, sirtuins also have a central role in DNA repair. Moreover, these functions are linked and may be coordinated (Choi and Mostoslavsky, 2014) since DNA damage can lead to metabolic changes that promote antioxidant defense and DNA repair (Cosentino et al., 2010). Sirt4, by inhibiting mitochondrial glutamine metabolism, reroutes this amino acid to the DNA damage response (Jeong et al., 2013). *Sirt1*-null mouse embryos show a defective DNA damage response and a deficiency in DNA repair. A recent study (Scheibye-Knudsen et al., 2014) links NAD<sup>+</sup> depletion by the chronically active DNA repair enzyme poly-ADP-ribose polymerase to inactivation of Sirt1 and its target PGC-1 $\alpha$  that leads to defective mitochondria in a mouse model of Cockayne Syndrome B. Although mitochondrial sirtuins Sirts 4 and 5 probably have no direct role in nuclear DNA repair, Sirt3 can locate to the nucleus under conditions of cellular stress where it modulates the expression of stress-related genes (Iwahara et al., 2012).

The conservation of the sirtuins in flatworms suggests that they fulfil many of the same functions as in mammals. However, some differences are evident. Notably the absence of two of the mitochondrial sirtuins, Sirt3 and 4, in *S. mansoni*, suggests that their functions may have been taken on by other sirtuins, notably by Sirt5. In support of this possibility, at least five splicing isoforms of Sirt5 were detected as transcripts (Lancelot et al., 2013). However, human Sirt5 has only low deacetylase activity (Du et al., 2011) and the activities of the schistosome Sirt5 isoforms remain to be characterized. In addition, the catalytic domains of both *S. mansoni* Sirt1 and 7 contain large insertions. Whilst it is possible, it is unlikely that these affect the catalytic activity of the enzymes; insertions in the catalytic domain of *S. mansoni* HDAC8 were shown to form unstructured loops on the surface of the

protein (Marek et al., 2013). We can speculate that these insertions provide surfaces for schistosome-specific protein-protein interactions, supporting novel functions.

### Sirtuin structure and catalysis

The crystal structures have been determined for Sirt2 (Finnin et al., 2001), Sirt3 (Jin et al., 2009), Sirt5 (Schuetz et al., 2007), Sirt6 (Pan et al., 2011) and the Sirt1 catalytic core domain (Zhao et al., 2013). All the complete structures contain a conserved catalytic core domain which is composed of a NAD<sup>+</sup>-binding Rossmann fold domain and a smaller Zn<sup>2+</sup>-binding domain that contains four highly conserved Cys residues. A model of the overall structure of sirtuins is shown in Figure 3.

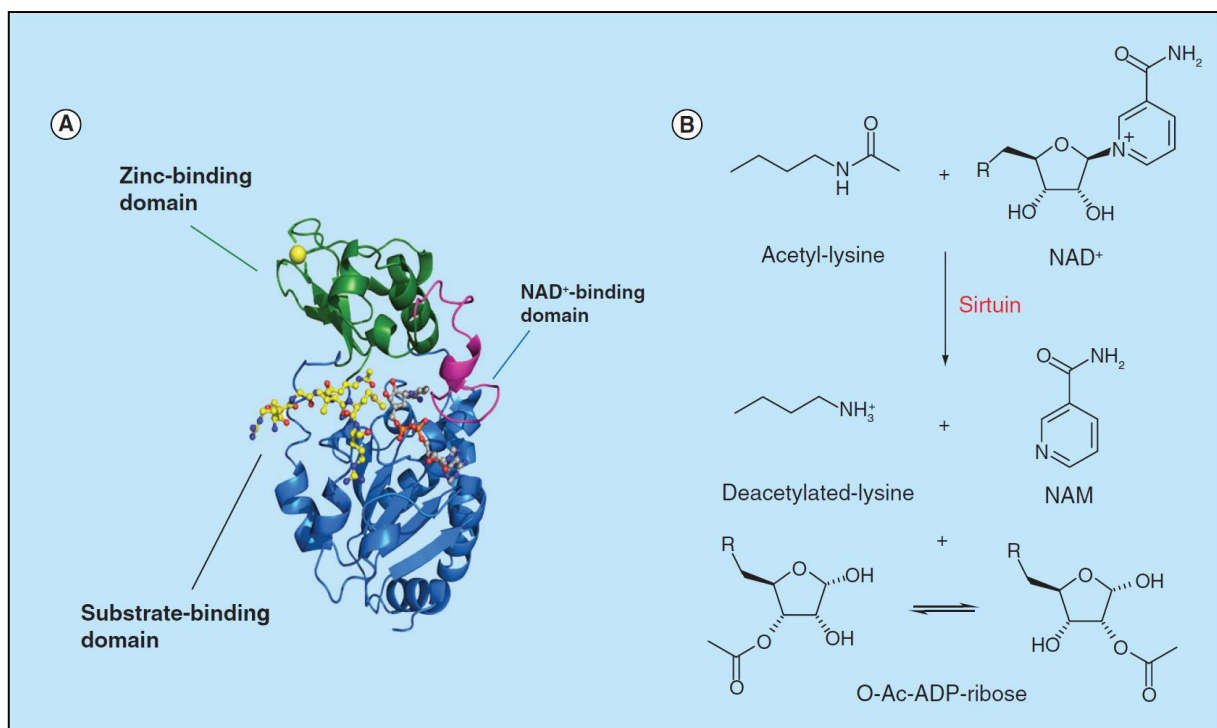

**Figure 3. Sirtuin structure and catalytic mechanism. A) Model of human Sirt1 showing the small Zn<sup>2+</sup>-binding domain and the larger Rossmann-fold domain including the NAD<sup>+</sup>-binding pocket. The acetylated peptide substrate is represented in the groove between the two domains. B) Simplified representation of the deacetylation reaction catalyzed by sirtuins.**

Schistosome sirtuins conform to this conserved overall structure, as do those of other helminths. Figure 4 shows the alignment of the catalytic core domain of Sirt1 from *S. mansoni* with those from human, from the trematode *C. sinensis*, two cestodes (*Echinococcus*) and another Lophotrochozoan, the annelid *C. capitata*.

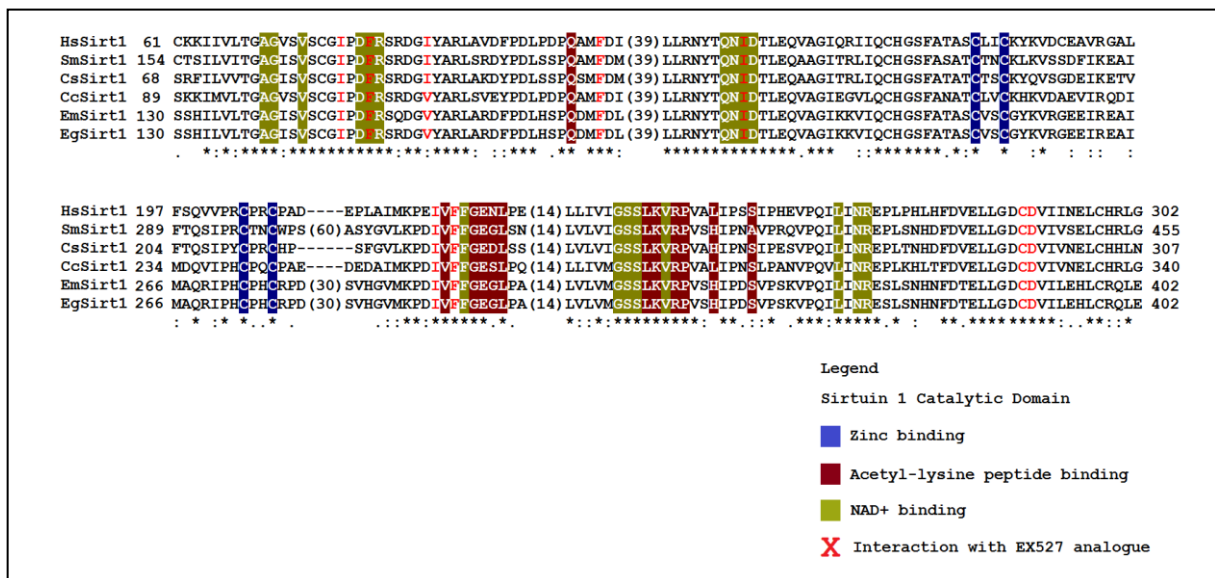

**Figure 4.** Alignment of the catalytic domains of Sirt1 from human (HsSirt1), *S. mansoni* (SmSirt1), another trematode, *Clonorchis sinensis* (CsSirt1), a non-parasitic lophotrochozoans, *Capitella capitata* (CcSirt1) and two cestodes *Echinococcus multilocularis* (EmSirt1) and *Echinococcus granulosus* (EgSirt1). Critical residues for zinc binding, peptide substrate binding and NAD<sup>+</sup> binding are shown. Residues involved in the binding of HsSirt1 to the inhibitor Ex527 (Gertz et al., 2013) are shown in red.

In all cases this domain shows extensive conservation, including the four Cys residues, albeit with large insertions in the case of the schistosome and *Echinococcus* sequences. The fact that these insertions are found only downstream to the active site and zinc ion binding residues (Figure 2), indicates that they probably do not affect the catalytic mechanism.

The catalytic site of sirtuins is formed by a hydrophobic channel at the interface of the large and small domains (Figure 3). The bound Zn<sup>2+</sup> ion, in contrast to that of class I, II and IV histone deacetylases, has no catalytic role, but is involved in structural maintenance. In the sirtuin catalytic mechanism, the acetyllysine side chain of the peptide substrate is brought into close proximity with the nicotinamide ribose of NAD<sup>+</sup>. Catalysis occurs in two stages (Figure 3): nicotinamide release and the formation of a bond between the acetyl

oxygen and C1', which yields an alkylimidate intermediate, followed by the formation of a second bicyclic intermediate and hydrolysis to yield the deacetylated peptide and 2'-O-acetyl-ADP-ribose.

Activities other than deacetylation have been described for sirtuins. ADP-ribosylation was described, notably in the case of Sirt4. For example, Sirt4 ADP-ribosylates GDH, suppressing its activity and repressing glutamate consumption (Haigis et al., 2006). However, for other sirtuins, the physiological significance of this activity has been called into question (Du et al., 2009), their ADP-ribosyltransferase activity being much weaker than their deacetylase activity. More recently, Sirt4 has been shown to exhibit a lipoamidase activity that regulates the pyruvate dehydrogenase complex (Mathias et al., 2014). Sirt5 has recently been characterized as a lysine demalonylase and desuccinylase (Du et al., 2011) and the latter modification has a regulatory role in glucose metabolism. Furthermore Sirt6, in addition to its transcriptional activity via the deacetylation of H3K9ac, has been shown to remove a long-chain fatty acyl group from lysine, regulating the secretion of TNF $\alpha$  (Jiang et al., 2013). Together, these latter activities invite a reassessment of sirtuins as protein deacylases, rather than simply as deacetylases.

### **Sirtuins, cancer and schistosomes**

We have previously pointed out several similarities between schistosomes and tumors and this convergence is also raised by Marek et al in this issue (Marek et al., 2015), so we will not labor the point here. Briefly, these are the cellular proliferation removed from control by the host, a degree of invisibility to the immune response and energy metabolism based on the consumption of large amounts of glucose and oxidative glycolysis producing lactate as the end-product (Pierce et al., 2012). We have already pointed out that schistosomes undergo a rapid switch from energy production based on oxidative phosphorylation in cercariae to glycolysis in schistosomula immediately after skin penetration, and this is stimulated by the presence of glucose in the external medium (Horemans et al., 1992). This metabolic switch is analogous to the Warburg effect noted in numerous tumors (Warburg, 1956). Sirtuins link the control of metabolism and DNA repair to tumorigenesis and it is probable that schistosome sirtuins fulfil similar functions to their human counterparts. It is therefore

relevant to cite some of the ways in which sirtuins are involved in the generation or suppression of cancers as an indication of their interest as therapeutic targets.

Of the mammalian sirtuins, only Sirt5 has not yet been found to be involved in cancer. For all the others, roles in both the promotion and the suppression of cancers have been described, probably depending on the cellular and molecular context (Roth and Chen, 2014). These considerations include possible differences in roles between mouse models and human tumors, the fact that the same sirtuins may behave differently in tumor initiation and in later stages and that they may fulfil distinct functions in different tissues (Yuan et al., 2013). Sirt1 is the most studied sirtuin in the development of cancer and its roles in metabolism, DNA damage repair and the regulation of cell survival mean that it is often an actor in tumor initiation and progression. In both breast and lung cancer Sirt1 is associated with the inactivation of hypermethylated in cancer 1 (HIC1) and of the p53 tumor suppressor pathway (through deacetylation of p53), decreased miR-200 $\alpha$  and is essential for oncogenic signaling by estrogen/estrogen receptor- $\alpha$ . Further, a model (Roth and Chen, 2014) has been proposed in which Sirt1 has a “bifurcated” role in cancer through genome maintenance. In normal cells it regulates high-fidelity DNA repair to promote genome stability, whereas in cancer cells it promotes low-fidelity DNA repair and cell survival. It is also crucial for the development of resistance to cancer drugs by various mechanisms including the facilitation of acquired resistance through genetic mutations (Wang and Chen, 2013). However, Sirt1 is also associated with tumor suppression, notably via the deacetylation and consequent deactivation hypoxia inducible factor 1 $\alpha$  (HIF1 $\alpha$ ), inhibiting the expression of genes targeted by this transcription factor (Lim et al., 2010).

On balance, although counter-examples exist in each case, the remaining sirtuins mainly seem to have roles in suppressing cancer. Sirt2 KO mice develop hepatocellular carcinoma (HCC) and Sirt 2 is downregulated in human HCC and breast cancer (Kim et al., 2011). Sirt3, through its roles in metabolism and regulating the oxidative stress response, is a mitochondrial tumor suppressor (Yuan et al., 2013, Kim et al., 2010, Finley et al., 2011). The expression of a single oncogene (Myc or Ras) in Sirt3(-/-) mouse embryonic fibroblasts results in in vitro transformation (Kim et al., 2010). Moreover, deletions of Sirt3 are present in 20% of all cancers (Roth and Chen, 2014). Sirt4 has recently been suggested to be a tumor suppressor (Jeong et al., 2013; Csibi et al., 2013) and its expression is reduced in human

cancers of the bladder, breast, colon, gastric system, ovary and thyroid (Yuan et al., 2013). Sirt6 is a tumor suppressor: it is downregulated in various human cancers and its depletion in a conditional mouse KO model leads to increases in the number, size and aggressiveness of tumors (Sebastián et al., 2012). Only Sirt7 seems to have predominantly tumor-promoting properties, via the deacetylation of H3K18, necessary for the maintenance of human cancer cell tumor phenotypes (Barber et al., 2012).

Whether sirtuins have roles as promoters or suppressors of tumors, their inhibition is likely to have profound effects on the viability of cancer cells. In the case of Sirt1 it has been argued (Yuan et al., 2013) that, since heterozygous knockout mice show little or no effect on development and physiology, and homozygous knockout phenotypes are much more severe in inbred than in outbred mouse strains, Sirt1 inhibitors are unlikely to have marked side-effects in humans, particularly as they would not be intended for prolonged use. Similarly, we can argue that inhibitors of parasite sirtuins, even if not completely selective vis-à-vis the human orthologues, could have significant effects on the parasite without affecting the human host. This is particularly probable since the aim is to develop novel agents that would be administered as a single dose.

### **Sirtuin inhibitors: scaffolds and strategies**

In view of their multiple cellular roles, notably in controlling metabolism and the DNA damage response, and their demonstrated activities as cancer promoters or repressors, sirtuins are considered as attractive drug targets in a number of pathologies. However, despite this, only one sirtuin inhibitor, Selisistat or SEN196 is currently in clinical trials for the treatment of Huntington's disease (Arrowsmith et al., 2012). Relatively few potent and/or selective compounds have so far been developed. Reasons for this include the pan-sirtuin inhibition often seen with sirtuin inhibitors, the fact that compounds targeting the NAD<sup>+</sup>-binding site can also interact with other enzymes that utilize NAD<sup>+</sup> (Wall et al., 1998; Slama and Simmons, 1989), the need for improved assays and for a better understanding of the inhibitory mechanisms of existing compounds (Schutkowski et al., 2014). Nevertheless, the potential for cancer therapy of sirtuin inhibitors has been demonstrated, for instance by the capacity of Sirtinol to induce apoptosis and autophagic cell death in the human breast cancer

cell line, MCF-7 (Wang et al., 2012) and the induction of cell death and p53 acetylation by Salermide, an inhibitor of Sirt1 and Sirt2, in the same cell line (Lara et al., 2009).

Sirtuin inhibitors and their specificities have been previously reviewed (e.g. Neugebauer et al., 2008; Cen, 2010) and **Annex 2** shows a list of some of them, many of which have been tested on schistosome larvae and adult worms in culture and shown to induce apoptosis and parasite death, or marked lesions, notably to the reproductive organs (Lancelot et al., 2013). Most show little selectivity when tested against Sirt1, 2 or 3 and this is a common feature of existing inhibitors. Moreover, even some of the best, recently developed inhibitors such as Ex-527 (Napper et al., 2005) and AGK2, which does show some selectivity for Sirt2 (**Annex 2** and Outeiro et al., 2007) show low potencies compared to typical drugs (Schutkowski et al., 2014). However, recent progress, both in assay development, kinetic characterization and analysis of structure-activity relationships, has meant that drug development based on sirtuin inhibitors has become more rational and effective.

One example of new structural insights into the action of sirtuin inhibitors is provided by the analysis of the binding of Ex-527 to the Sirt1 catalytic domain (Gertz et al., 2013). This showed that the inhibitor bound to the catalytic site, but that the binding extended into a proximal hydrophobic region. This analysis provided a basis for the development of analogues that would include extensions of the Ex-527 scaffold to reach sirtuin isoform-specific pockets (Gertz et al., 2013). Intriguingly, the residues involved in the binding of Ex-527 to human Sirt1 are well conserved in *S. mansoni* Sirt1, as well as in Sirt1 from other platyhelminth parasites (Figure 4), suggesting that this compound could form the basis for the development of parasite-specific inhibitors. An approach using tubulin-derived thioacetyllysine peptides (Kiviranta et al., 2009) allowed the identification of a compound with an IC<sub>50</sub> of 180 nM for Sirt1 and a 20-fold selectivity over Sirt2. Other structure-based approaches can now be used exploiting the specific deacetylation activities of Sirt5 and Sirt6. In the case of Sirt5 the modification of residues close to the catalytic site can be targeted (Suenkel et al., 2013; Roessler et al., 2014). The establishment of an assay for Sirt5 using a small labeled succinylated lysine derivative has led to the identification of thiobarbiturates as new inhibitors of this sirtuin (Maurer et al., 2012). Sirt6 has a long, specific hydrophobic



catalytic site pocket that should also allow the development of selective inhibitors (Jiang et al., 2013).

The schistosome sirtuins, whilst showing overall conservation of essential catalytic domain residues (Fig. 3 and Lancelot et al., 2013), also show significant differences. The solution of crystal structures of schistosome sirtuins bound to inhibitors would represent a significant advance for the development of selective inhibitors.

Nevertheless, the use of high-throughput screening of extensive compound libraries represents a complementary strategy that has recently been used with success to generate inhibitors of human Sirts 1, 2 and 3 that show nanomolar IC<sub>50</sub> inhibitory values, although they are not selective (Disch et al., 2013). It is to be expected that the application of both high-throughput and structure-based screening strategies will rapidly lead to the identification of both selective and potent sirtuin inhibitors. Indeed, in a recent study, we report the optimization of fluorescence-based assays for *S. mansoni* Sirt2 that allowed a pilot screen with inhibitors showing IC<sub>50</sub> values of less than 50 μM and docking studies rationalizing the binding of hits to the target using a homology model of the enzyme (Schiedel et al., 2015).

### **Sirtuins as drug targets in parasites**

The characterization of the biological roles of the sirtuins, particularly in metabolism, DNA damage repair and cell survival, the effects of the invalidation of sirtuin genes and/or transcripts in mouse models and the activities of sirtuin inhibitors all underline the status of sirtuins as drug targets in human pathologies, most obviously in cancer. But what about parasites, in general, and schistosomes in particular? A recent review (Religa and Waters, 2012) gives a thorough overview of the structure and functions of sirtuins from protozoan parasites and their potential as therapeutic targets, particularly in *Plasmodium falciparum* and *Leishmania*. Although the knockout of either of the *P. falciparum* sirtuin-encoding genes shows that neither is essential for parasite proliferation (Duraisingh et al., 2005; Tonkin et al., 2009), the roles of both sirtuins in the epigenetic control of the expression of the *var* genes, encoding variable surface antigens involved in the evasion of the host immune response, has been established. In the case of *Leishmania*, the sirtuin LiSIR2RP1 appears to

be essential since *LiSir2rp1*<sup>-/-</sup> parasites could only be obtained when the enzyme was expressed episomally (Vergnes et al., 2005a). Following the demonstration that Sirtinol was able to inhibit the growth of *Leishmania infantum* axenic amastigotes (Vergnes et al., 2005b), a more specific inhibitor, bisnaphthalimidopropyl (BNIP) has been developed that is selective for the parasite sirtuin LiSIR2RP1 compared to human Sirt1 (Tavares et al., 2010). Sirtuins are therefore targets of choice for anti-protozoan parasite drug development.

In *S. mansoni*, sirtuins are expressed at all life-cycle stages, but there are wide variations in the levels of transcripts, particularly in the case of the nuclear sirtuins, Sirt6 and Sirt7 (Figure 5), which are highly expressed in larval stages, whereas the nucleo-cytosolic sirtuins, Sirt1 and Sirt2 show less variation.

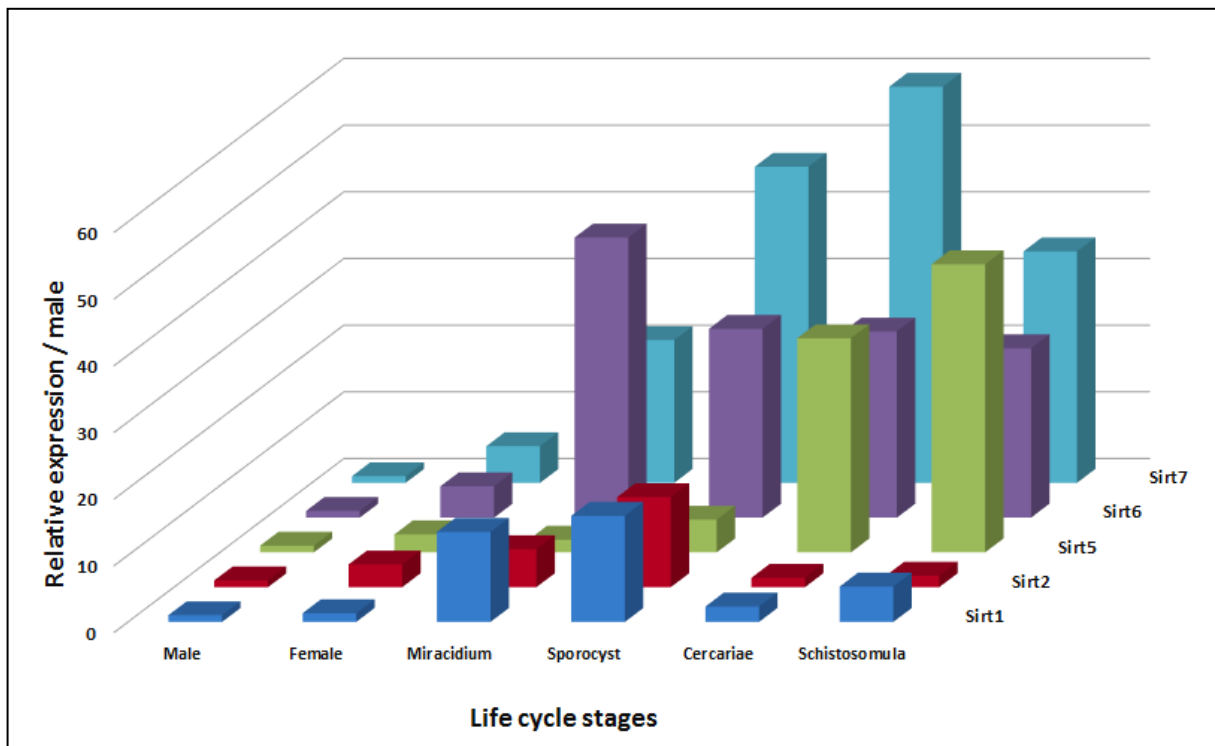

**Figure 5. Transcriptional regulation of sirtuins during the life-cycle of *S. mansoni*.** Levels of transcripts of the five *S. mansoni* sirtuins were measured in different life-cycle stages by quantitative RT-PCR (see Lancelot et al., 2013): male and female adult worms, miracidia, sporocysts, cercariae and schistosomula. Values are expressed relative to the levels in adult male worms.

The knockdown of Sirt1 transcripts causes marked changes to female worm reproductive organs (Lancelot et al., 2013) including an increase in mature oocytes in the ovaries. These changes are similar to those produced by treatment with the sirtuin inhibitor

Salermide, although these were more pronounced, possibly since Sirt2 would also be inhibited in this case. Moreover, several sirtuin inhibitors induced the unpairing of worm pairs in culture and significant reductions in egg laying (Lancelot et al., 2013). Although we have no data as yet concerning the effects of sirtuin transcript knockdown in the schistosomula larvae, sirtuin inhibitors, particularly Salermide, readily induce apoptosis and death of the larvae at 10 and 20  $\mu$ M concentrations. The relative abundance of transcripts of the mitochondrial sirtuin Sirt5 and the two nuclear sirtuins Sirt6 and Sirt7 in the infective larval stages (Lancelot et al., 2013) suggests that these may have crucial roles during schistosome development and therefore represent sensitive targets for chemotherapy.

### **Future perspectives**

Sirtuins are crucial regulators of cellular processes, two of which, energy metabolism and the DNA repair response, determine their potential importance as therapeutic targets. However, in the case of cancer, sirtuins can either promote or repress tumor development, and either inhibition or activation of their activity might be therapeutic or detrimental. This means that, for cancer therapy it is important that the sirtuin target and the clinical situation should be well defined. The need for individual sirtuin-selective inhibitors is manifest (Yuan et al., 2013). In the case of parasitic diseases, in contrast, it is evident that the inhibition of sirtuins is sufficient to cause detrimental effects to the parasite and that species selectivity and/or enhanced bioavailability to the parasitic organism is most important.

The differences in the catalytic domains of schistosome sirtuins compared to their human counterparts are likely to be sufficient to allow the development of selective inhibitors, but this requires verification by molecular modelling and, where possible, X-ray crystallographic studies. The study of the class I HDAC8 from *S. mansoni* (Marek et al., 2013) showed that the crystal structure was indispensable in order to detect all the differences in the architecture of the catalytic pocket of the enzyme, and this is likely to be even more critical for sirtuins in which two domains, the NAD<sup>+</sup>-binding domain and the peptide substrate-binding domain have to be considered. However, high-throughput screening of recombinant enzymes can also allow the detection of inhibitors with novel scaffolds and warheads that are selective. We are currently pursuing strategy involving both approaches, in the context of an EC-funded project (Pierce, 2014), aimed at developing new drugs against Neglected Parasitic Diseases, including schistosomiasis.

# **HYPOTHESIS AND OBJECTIVES**

# Hypothesis

The metabolic switch that *S. mansoni* undergoes in high concentrations of glucose is reflected in the expression of metabolic genes, which are regulated by sirtuins.

# Objectives

1. Identification and characterization of genes involved in glucose metabolism in *S. mansoni*, with emphasis on glucose transporters.
2. To test the implication of sirtuins in the regulation of the metabolic switch of *S. mansoni* in presence of glucose, with emphasis on SmSirt1 and SmSirt6.

# **CHAPTER II**

## **RESULTS**

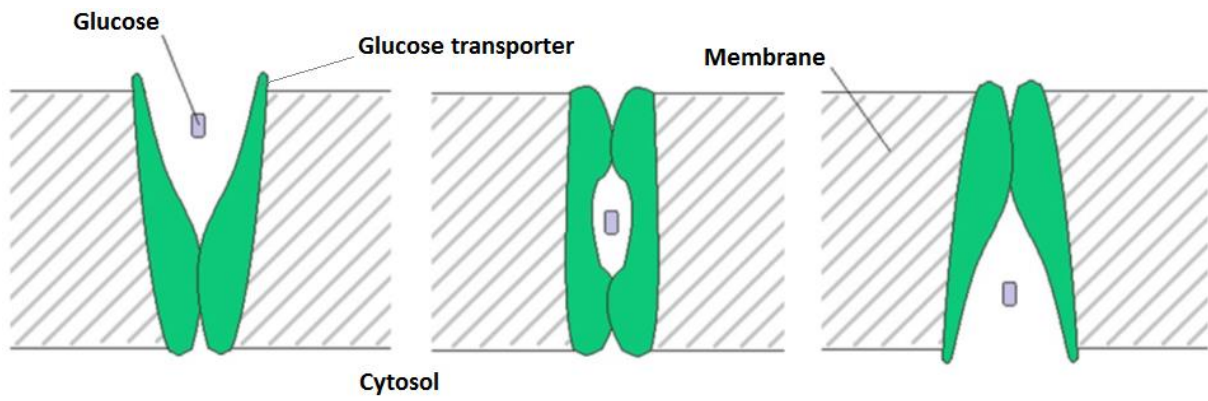

## Schistosome glucose transporters

**Fast evolutionary rates associated with functional loss in class I glucose transporters of *Schistosoma mansoni*<sup>18</sup>**

Alejandro Cabezas-Cruz<sup>a+</sup>, James J. Valdés<sup>b+</sup>, Julien Lancelot<sup>a</sup> and Raymond J. Pierce<sup>a\*</sup>.

<sup>a</sup> Univ. Lille, CNRS, Inserm, CHU Lille, Institut Pasteur de Lille, U1019 - UMR 8204 - CIIL - Centre d'Infection et d'Immunité de Lille, F-59000 Lille, France

<sup>b</sup> Institute of Parasitology, Biology Centre of the Academy of Sciences of the Czech Republic, 37005 České Budějovice, Czech Republic

+ *Joint first authorship*

**\*Corresponding author:** Dr. Raymond J. Pierce, tel: (+33) 3-20-87-77-83, fax: (+33) 3-20-87-78-88, e-mail: [raymond.pierce@pasteur-lille.fr](mailto:raymond.pierce@pasteur-lille.fr)

**Emails:**

Alejandro Cabezas-Cruz: [cabezasalejandrocruz@gmail.com](mailto:cabezasalejandrocruz@gmail.com)

James J. Valdés: [valdjj@gmail.com](mailto:valdjj@gmail.com)

Julien Lancelot: [julien.lancelot@pasteur-lille.fr](mailto:julien.lancelot@pasteur-lille.fr)

Raymond J. Pierce: [raymond.pierce@pasteur-lille.fr](mailto:raymond.pierce@pasteur-lille.fr)

---

<sup>18</sup> Published manuscript. Full reference as follow: Cabezas-Cruz A, Valdés JJ, Lancelot J, Pierce RJ. Fast evolutionary rates associated with functional loss in class I glucose transporters of *Schistosoma mansoni*. BMC Genomics. 2015;16:980.



## **Abstract**

### **Background:**

The trematode parasite, *Schistosoma mansoni*, has evolved to switch from oxidative phosphorylation to glycolysis in the presence of glucose immediately after invading the human host. This metabolic switch is dependent on extracellular glucose concentration. Four glucose transporters are encoded in the genome of *S. mansoni*, however, only two were shown to facilitate glucose diffusion.

### **Results:**

By modeling the phase of human host infection, we showed that transporter transcript expression profiles of recently transformed schistosomula have two opposing responses to increased glucose concentrations. Concurring with the transcription profiles, our phylogenetic analyses revealed that *S. mansoni* glucose transporters belong to two separate clusters, one associated with class I glucose transporters from vertebrates and insects, and the other specific to parasitic Platyhelminthes. To study the evolutionary paths of both groups and their functional implications, we determined evolutionary rates, relative divergence times, genomic organization and performed structural analyses with the protein sequences. We finally used the modelled structures of the *S. mansoni* glucose transporters to biophysically (i) analyze the dynamics of key residues during glucose binding, (ii) test glucose stability within the active site, and (iii) demonstrate glucose diffusion. The two *S. mansoni* Platyhelminthes-specific glucose transporters, which seem to be younger than the other two, exhibit slower rates of molecular evolution, are encoded by intron-poor genes, and transport glucose. Interestingly, our molecular dynamic analyses suggest that *S. mansoni* class I glucose transporters are not able to transport glucose.

### **Conclusions:**

The glucose transporter family in *S. mansoni* exhibit different evolutionary histories. Our results suggested that *S. mansoni* class I glucose transporters lost their capacity to transport glucose and that this function evolved independently in the Platyhelminthes-specific glucose transporters. Finally, taking into account the differences in the dynamics of glucose transport of the Platyhelminthes-specific transporters of *S. mansoni* compared to that of humans, we conclude that *S. mansoni* glucose transporters may be targets for rationally designed drugs against schistosomiasis.

Keywords: *Schistosoma mansoni*, glucose transporters, transcriptional regulation, phylogeny, biophysics

## Background

Upon contact with host mammalian skin, the free-living cercaria of *Schistosoma mansoni* undergoes dramatic biological (Stirewalt, 1974) and metabolic transformations (Horemans et al., 1992). The metabolic transformation is a switch from an oxidative metabolism to a glycolytic metabolism that is reversibly dependent on external glucose concentrations (Horemans et al., 1992). In the mammalian host, glucose transport is facilitated by diffusion through the *S. mansoni* tegument (Camacho and Agnew, 1995). Two closely related (61% identity) schistosome glucose transporter proteins (SGTPs) have been functionally characterized in *S. mansoni*, named SGTP1 and SGTP4 (Skelly et al., 1994; Krautz-Peterson et al., 2010). Both show stereospecificity for glucose, relaxed specificity for different hexoses and sodium-independent activity (Skelly et al., 1994). Differential protein expression profiles show that SGTP4 is expressed in the host-interactive outer tegument (Skelly et al., 1996), while SGTP1 is mainly located in the basal membranes of the tegument (Zhong et al., 1995). Furthermore, Western blot analysis showed that SGTP1 is expressed in the egg, sporocyst, cercaria, schistosomula, and in adult male and female worms, but SGTP4 is only detected in mammalian-stage parasites (schistosomula and adults) (Skelly et al., 1996). Studies using RNAi showed that both SGTP1 and SGTP4 were critical for exogenous glucose uptake in schistosomula *in vitro* and for parasite development *in vivo* (Krautz-Peterson et al., 2010).

A third glucose transporter gene, *sgtp2*, has also been identified. The *sgtp2* open reading frame was interrupted by a missing base ~260bp downstream the first initiator ATG codon. The hypothetical addition of a base at this downstream position resulted in a translation product homologous to glucose transporters (Skelly et al., 1994). Functional assays using *Xenopus* oocytes, however, showed that this hypothetical SGTP2 does not transport glucose (at 1mM and 10 mM of substrate). In addition, transcripts of the *sgtp2* gene were only found in adult females (Skelly et al., 1994), possibly due to a specific biological function at this stage. Although expressed sequence tags exist for all *S. mansoni* *sgtp* genes (Krautz-Peterson et al., 2010; You et al., 2014), a fourth glucose transporter, *sgtp3*, is rarely mentioned in the literature.

The human glucose transporter protein family is divided into three classes: class I comprises GLUT1 to GLUT4 and GLUT14; class II comprises GLUT5, GLUT7, GLUT9, and GLUT11; and, class III comprises GLUT6, GLUT8, GLUT10 and GLUT12 (Augustin, 2010). These three human glucose transporter classes are phylogenetically differentiated and show distinct molecular properties (Augustin, 2010). Among the human glucose transporters, GLUT1 and GLUT4 have been well studied and are transcriptionally upregulated under glucose deprivation conditions (Klip et al., 1994). In terms of primary amino acid sequence, SGTP1 and SGTP4 were reported to be homologous to human GLUT1 (Jiang et al., 1996), while SGTP2 is more similar to GLUT4 (Skelly et al., 1994).

Glucose transporters undergo conformational shifts during glucose diffusion (Deng et al., 2014). The resolved crystal structure of the proton symporter, Xyle, of *Escherichia coli* has a glucose-bound, occluded structural conformation towards the intracellular compartment (Sun et al., 2012). This occluded conformation disallows glucose diffusion into the cell. The crystal structure of human GLUT1, possesses a glucose-bound, open-inward structural conformation permitting glucose diffusion within the cell (Deng et al., 2014). Comparing these two homologous transporter structures, Deng et al. (2014) were able to hypothesize four intermediate conformational shifts during glucose binding and diffusion. Xyle and GLUT1 represent the two respective, intermediate and sequential, glucose-bound conformations. The other two are glucose-free that represent conformations before glucose binding and after glucose diffusion (Deng et al., 2014).

In this study, the evolution of *S. mansoni* glucose transporters is explored and the effects of glucose-induced transcriptional regulation of the encoded genes were determined. Our findings led us to investigate glucose stability and migration with *S. mansoni* glucose transporters using a publicly available, state-of-the-art algorithm. These results provide insights into the molecular properties, evolution and biophysics of glucose transport in trematodes. Unveiling the structural and dynamic differences in glucose transport by parasitic worms can establish the basis for the rational design of schistosome-specific glucose transporter inhibitors.

## **Results and Discussion**

## Glucose induces transcriptional changes in *S. mansoni* glucose transporter genes in schistosomula larvae

Regulation of nutrient transporters by nutrient availability is a well-known phenomenon in microorganisms, such as yeast (Forsberg and Ljungdahl, 2001) and bacteria (Di Palo et al., 2013). The regulation of mammalian transporters by their substrates, however, is less understood (Klip et al., 1994). Nevertheless, the effect of glucose on the transcriptional regulation of glucose transporters has been studied both *in vitro* and *in vivo* (Klip et al., 1994). From these studies it is clear that mRNA levels of class I glucose transporters *glut1* and *glut4*, the most extensively studied in this regard, change in response to the glucose concentration in the medium. As a consensus, *glut1* and *glut4* mRNA levels are higher under glucose deprivation conditions than in the presence of glucose (Klip et al., 1994). Despite extensive characterization of SGTP1 and SGTP4 from *S. mansoni* (Krautz-Peterson et al., 2010), no study on transcriptional regulation in response to glucose has been conducted. In addition, knowledge of the properties of SGTP2 and SGTP3 is limited.

Upon infection, changes in glucose concentration have been shown to be essential for *S. mansoni* (Horemans et al., 1992). Here we used an infection relevant model to evaluate the transcriptional regulation of the four glucose transporter genes from *S. mansoni* in presence of glucose. All glucose transporters were expressed in schistosomula 3h after mechanical transformation in the presence of 0.05mM glucose. A significant reduction in expression was observed after 8h incubation in glucose deprivation conditions ( $p\text{-value} < 0.01$ ). However, when the medium was supplemented with 10mM glucose we observed a significant change in expression pattern. While the transcriptional levels of *sgtp1* and *sgtp4* were downregulated ( $p\text{-value} < 0.025$ ), the transcriptional levels of *sgtp2* and *sgtp3* were upregulated ( $p\text{-value} < 0.025$ ) in the presence of 10mM glucose (Figure 1).

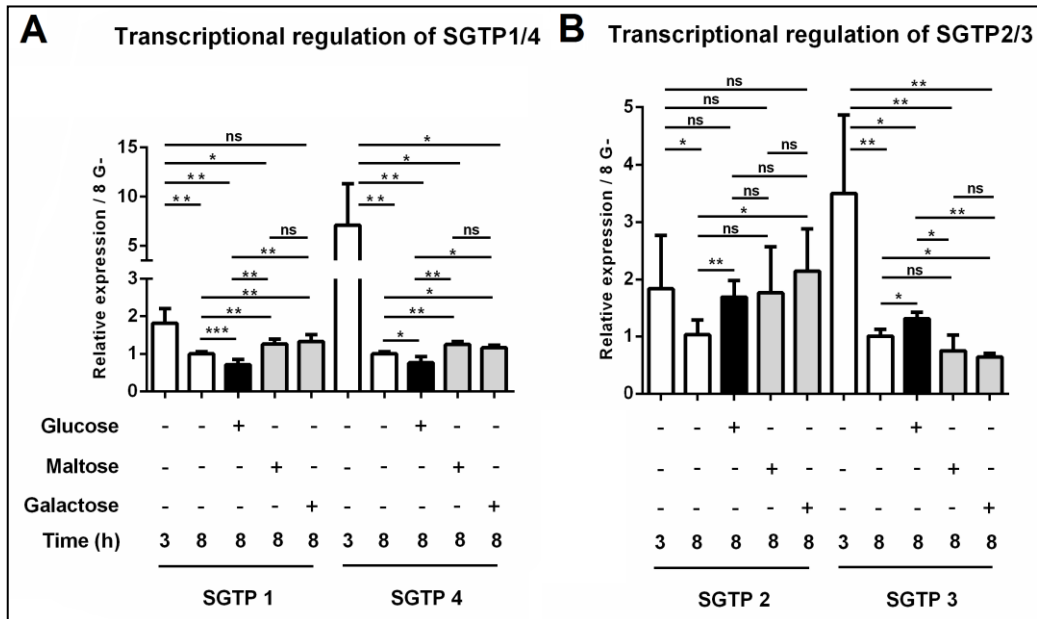

**Figure 1. Relative expression of *sgtp1*, *sgtp2*, *sgtp3* and *sgtp4* after transformation and adding glucose.** The relative expression of *sgtp1*, *sgtp4* (Panel A), *sgtp2* and *sgtp3* (Panel B) in schistosomula was determined using quantitative RT-PCR. Cercariae were mechanically transformed into schistosomula. A total of 10 000 schistosomula were incubated for 3h with traces of glucose (0.05mM). Subsequently, glucose, maltose and galactose were added to a final concentration of 10mM. After 8h of incubation, total RNA was extracted, cDNA was synthesized and quantitative RT-PCR was performed. Transcripts of *sgtp1* (*p*-value = 0.0006) and *sgtp4* (*p*-value = 0.02) were significantly downregulated after adding 10mM glucose, while *sgtp2* (*p*-value = 0.002) and *sgtp3* (*p*-value = 0.02) were significantly upregulated after adding 10mM glucose. Results shown are the means of three independent experiments. Gene expression data is presented relative to 8h with 0.05mM of glucose which was used as “calibrator sample”.

The downregulation of *sgtp1* and *sgtp4* transcripts was specific to glucose, as the addition of galactose or maltose to the medium resulted in a significant increase (*p*-value < 0.025) in the transcriptional levels of both genes (Figure 1).

Our results complement those obtained by Krautz-Peterson et al. (2010) since they showed that RNA interference (RNAi) of both SGTP1 and SGTP4 more strongly affected schistosomula when they were maintained in glucose-poor medium than in glucose-rich medium. In glucose deprivation conditions the parasite may increase the expression of these two glucose transporters to maximize the uptake of glucose. Thus, inhibiting the glucose transporters in glucose deprivation conditions will be more detrimental to the parasite than in the presence of glucose. The transcriptional expression levels of *sgtp2* significantly increased in the presence of galactose (*p*-value = 0.010), but not maltose (*p*-value = 0.163).

In contrast, the transcriptional expression levels of *sgtp3* significantly decreased in the presence of galactose ( $p$ -value = 0.004), but not maltose ( $p$ -value = 0.125). These observations suggest that the transcriptional regulation of *sgtp2* and *sgtp3* may not be glucose-specific.

### ***S. mansoni* glucose transporters cluster separately and evolve at different rates**

Maximum likelihood (ML), maximum parsimony (MP) and neighbor joining (NJ) analyses were performed to phylogenetically characterize the *S. mansoni* glucose transporters SGTP1, SGTP2, SGTP3 and SGTP4. Amino acid sequences from glucose and trehalose transporters from the taxonomic classes Insecta, Mammalia, Teleostei, Cestoda and Trematoda were included in the phylogenetic analyses. All phylogenetic trees had the same topology with each of the above methods. Therefore, only one topology (ML) is displayed (Figure 2).

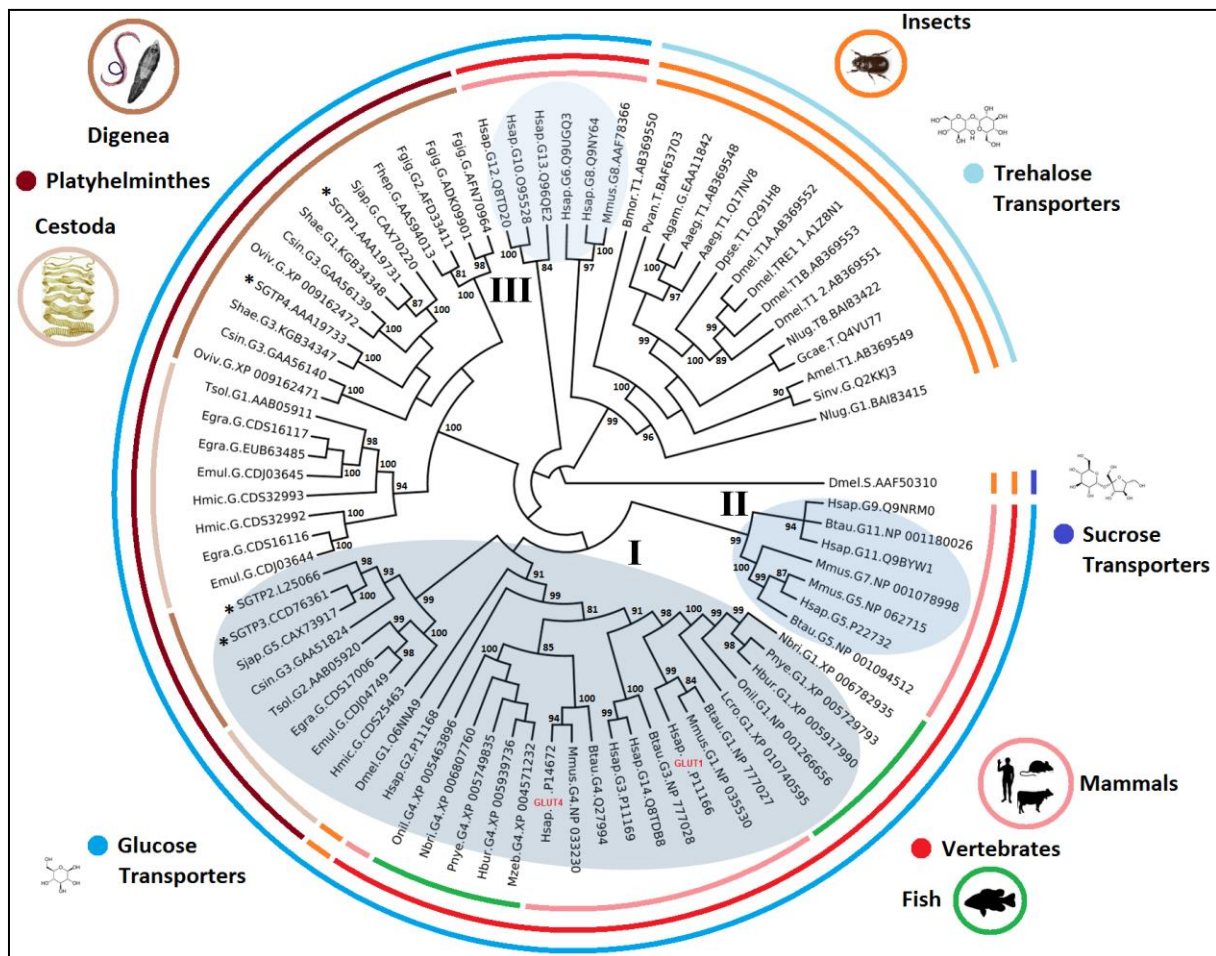

**Figure 2. Phylogeny of the trehalose and glucose transporter family.** The figure shows a phylogenetic tree of trehalose and glucose transporters from vertebrates, trematodes and insects. The topologies obtained with ML, MP and NJ methods were similar, and thus only

ML is displayed. Numbers on internal branches are the bootstrap values (only >80% are shown); the statistical support obtained with approximate likelihood ratio test (aLRT) was similar. Sequences are labeled with data collected from GenBank as name of species (four first letters), type of transporters (T: trehalose, G: glucose), number (if reported) of the sugar transporter and accession numbers. *S. mansoni* glucose transporters are indicated by asterisks. *Homo sapiens* GLUT1 and GLUT4 are highlighted in red. The classes of glucose transporters are numbered with roman numerals. *D. melanogaster* sucrose transporter was used as the outgroup. The labels for the species used are as follow: Mammals: *H. sapiens* (Hsap), *Mus musculus* (Mmus), *Bos Taurus* (Btau); Fish: *Oreochromis niloticus* (Onil), *Neolamprologus brichardi* (Nbri), *Haplochromis burtoni* (Hbur), *Pundamilia nyererei* (Pnye), *Larimichthys crocea* (Lcro), *Dicentrarchus labrax* (Dlab), *Maylandia zebra* (Mzeb); Insects: *Anopheles gambiae* (Agam), *Aedes aegypti* (Aaeg), *Apis mellifera* (Amel), *Bombyx mori* (Bmor), *Drosophila melanogaster* (Dmel), *Drosophila pseudoobscura pseudoobscura* (Dpse), *Gastric caeca* (Gcae), *Solenopsis Invicta* (Sinv); Cestodes: *Taenia solium* (Tsol), *Echinococcus granulosus* (Egra), *Echinococcus multilocularis* (Emul), *Hymenolepis microstoma* (Hmic), *Fasciola gigantica* (Fgig), *Fasciola hepatica* (Fhep); Flukes: *Clonorchis sinensis* (Csin), *S. haematobium* (Shae), *Opisthorchis viverrini* (Oviv), *S. japonicum* (Sjap).

Three classes of glucose transporters have been described in humans that form different phylogenetic clusters (Augustin, 2010). We found that *S. mansoni* SGTP2 and SGTP3 clustered together with vertebrate and *D. melanogaster* class I glucose transporters (Figure 2, roman numeral I), while SGTP1 and SGTP4 formed a Platyhelminthes-specific glucose transporter cluster. The phylogeny presented in Figure 2 is consistent with the monophyly of both Cestoda and Digenea (Perkins et al., 2010) since the two clusters containing glucose transporters from Platyhelminthes, cestodes and trematodes clustered separately (Figure 2). The phylogenetic analyses allowed us to classify SGTP2 and SGTP3 together with some glucose transporters from the flukes *S. japonicum*, *Clonorchis sinensis* and the cestodes *Taenia solium*, *Echinococcus granulosus*, *E. multilocularis* and *Hymenolepis microstoma* as class I glucose transporters. In particular, we found homologs of SGTP1, SGTP2, SGTP3 and SGTP4 in both *S. japonicum* and *S. haematobium* (Annex 3).

Mammalia, Platyhelminthes and Insecta shared a common ancestor circa 695 MYA (Douzery et al., 2004). The fact that class I glucose transporters included sequences from Platyhelminthes, insects and mammals suggested that this cluster is ancestral to the Platyhelminthes-specific cluster. To test this hypothesis we determined the relative divergence times for selected nodes in the 100 most parsimonious phylogenetic trees (see Materials and methods). Indeed, the results from this analysis showed that the cluster containing class I glucose transporters is older than the Platyhelminthes-specific cluster

(Figure 3A, node 2 vs. node 10) with  $p$ -value < 0.0001. In agreement with this, SGTP2 seems to be the oldest glucose transporter in *S. mansoni* (Figure 3B,  $p$ -value < 0.0001). The relative divergence time of SGTP3 and SGTP4 suggested that these phylogenetic events coincide in time, and they are recently evolved glucose transporters compared to SGTP2 and SGTP1. The phylogenetic position of SGTP3 and SGTP4 (Figure 2), and the relative divergence times (Figure 3B) of these genes support the idea that they originated from SGTP2 and SGTP1 respectively, possibly due to gene duplication.

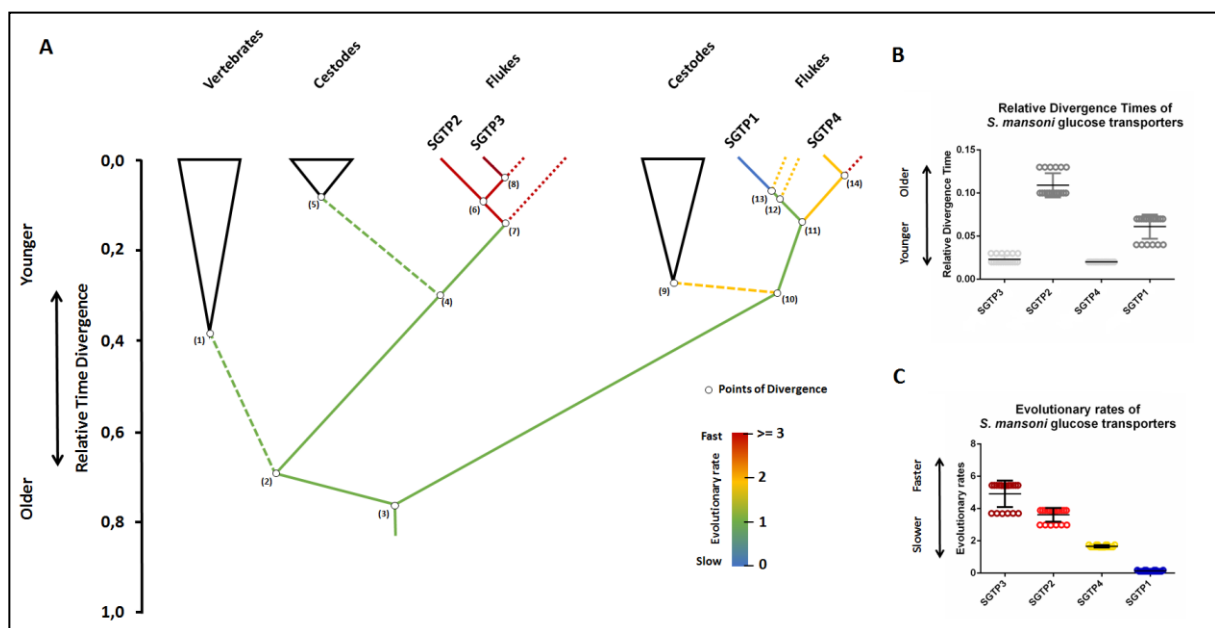

**Figure 3. Relative divergence times and evolutionary rates of *S. mansoni* glucose transporters.** The figure displays the relative divergence times of selected nodes from the ML tree topology in Figure 1. Class I glucose transporters (node 2) and Platyhelminthes-specific cluster of glucose transporters (node 10) (Panel A). Divergence times for selected branching points were calculated in the 100 most parsimonious trees using the ML method based on the LG model (see Materials and methods). Node 2 (average of relative time of divergence: 0.68, Std: 0.02) is older than node 10 (average of relative time of divergence: 0.28, Std: 0.009) with  $p$ -value < 0.0001. The colored scale shows the relative evolutionary rates among selected branches (Panels A and B). The evolutionary rate (evol rate) measured as the relative number of amino acid substitutions per site was calculated for selected nodes in the 100 most parsimonious trees using RelTime method (Tamura et al., 2012). The glucose transporters SGTP2 (average of evol rate: 3.6, Std: 0.42) and SGTP3 (average of evol rate: 4.9, Std: 0.81) evolved faster than SGTP1 (average of evol rate: 0.13, Std: 0.028) and SGTP4 (average of evol rate: 1.6, Std: 0.067) with a  $p$ -value < 0.0001 (Panel C).



Gene duplications were reported in glucose transporters from *Homo sapiens* and *Saccharomyces cerevisiae* (Brown et al., 1998; Wu and Freeze, 2002). After gene duplication, relaxation of selective constraints on duplicated genes has been observed, resulting in copies that evolve faster than their original orthologs (Robinson-Rechavi and Laudet, 2001; Nguyen et al., 2014). To test variations in evolutionary rates, we estimated these along branches of the glucose transporters phylogeny using the RelTime method (Tamura et al., 2012). Figure 3C shows that SGTP2 and SGTP3 evolved faster than SGTP1 and SGTP4 ( $p$ -value = 0.0001). In addition, SGTP3 and SGTP4 were found to evolve faster than SGTP2 and SGTP1, respectively with  $p$ -value < 0.0001.

We further compared the evolutionary rates of SGTP3/SGTP2 and SGTP4/SGTP1 using Tajima's relative rate test (Tajima, 1993). The  $\chi^2$  test statistic was 6.50 ( $p$ -value = 0.01079) for SGTP4/SGTP1 and 0 ( $p$ -value = 1.0000) for SGTP3/SGTP2. Thus, the null hypothesis of equal rates was rejected for SGTP4/SGTP1, but not for SGTP3/SGTP2. This suggests that Tajima's relative rate test may not be suited for distinguishing different rates of evolution in fast-evolving sequences like SGTP3/SGTP2 or simply that after divergence SGTP3 and SGTP2 evolved at the same rates. In agreement with the latter, other sequences from *S. japonicum* and *C. sinensis*, in the cluster where SGTP2 and SGTP3 are located, are also fast-evolving sequences (Figure 3). Interestingly, the transcriptional regulation of SGTP1 and SGTP4 compared with SGTP2 and SGTP3 in the presence of glucose (Figure 1) is in agreement with these phylogenetic and evolutionary observations.

### **The rapidly-evolving glucose transporters SGTP2 and SGTP3 are encoded by intron-rich genes**

The cDNA sequence encoding SGTP2 originally described by Skelly et al. (1994) was constructed from a cloned sequence by the insertion of a single nucleotide in order to restore the open reading frame. The authors speculated that *sgtp2* might therefore be an expressed pseudogene and not encoded as a functional protein. Comparison of the *sgtp2* (L25066) cDNA sequence to the genome sequence allowed the reconstruction of a "genomic" predicted cDNA sequence. Three base changes were found within the encoding region, one leading to an amino acid change (Asn88Lys). Since the cDNA sequence encodes a full-length protein reconstructed by assembling the exons of the genomic sequence, we

speculated that the missing nucleotide in the cDNA clone obtained by Skelly et al. (1994) might represent a cloning artifact. We therefore amplified the full-length coding sequence of SGTP2 from cDNA derived from adult worms and miracidia and sequenced the clones obtained. However, the examination of twenty such sequences failed to identify a single clone corresponding to the predicted genomic sequence (not shown). A number of these contain unspliced intronic sequences, whilst others contained short indels. None of the clones encoded a full-length SGTP2 protein sequence. We are therefore unable to verify our speculation concerning the status of the *sgtp2* gene as a pseudogene or a viable coding gene. One possibility is that the functional transcript might only be produced at specific stages during the life cycle. To compare the *sgtp2* gene organization and the potential structure and function of the SGTP2 protein, we used the transcript and protein sequence predicted by the genome. In contrast we confirmed that the sequence of SGTP3 predicted from the genome corresponds to viable transcripts present in adult worms. The transcript sequences were found to be identical to the genome prediction, but have a small deletion at the N-terminal end and to encode a further 86 amino acids at the C-terminal end. However, these sequence modifications have no effect on the core glucose transporter structure. The transcript sequence was submitted to GenBank [GenBank: KT895372].

The schistosome genome sequence and the derived exon/intron structure shown in Figure 4 and Annex 4 are aligned with published transcript sequences of SGTP1 and SGTP4, the transcript sequence of SGTP2 predicted from the genome, and the predicted transcript sequence of SGTP3. We analyzed the gene structure of human *glut1*, and collected that of *glut4* from the literature (Zhao and Keating, 2007), for comparison, since our phylogenetic analyses placed the human GLUT1 and GLUT4 within the same clade as SGTP2 and SGTP3. The analysis shows that the gene structures of *sgtp1* and *sgtp4* are similar to each other, but different from those of *sgtp2* and *sgtp3*, which are also similar to each other. Both *sgtp1* and *sgtp4* have 5 introns, four of which are large (>1 000bp), the size of the fifth was not evaluated due to missing sequence data. In contrast, *sgtp2* has 10 introns and *sgtp3* has 7 introns. Apart from the first intron of *sgtp2*, which is large and not conserved in *sgtp3*, the first introns of these two genes are small, between 31bp and 41bp, whereas the introns at the 3' end of both genes are large. Moreover, the sizes of exons 4 to 9 of *sgtp2* and 2 to 7 of *sgtp3* are identical and the positions of these introns with respect to the encoded amino acid

sequence of the corresponding proteins are conserved. Comparison of *sgtp1*, *sgtp4*, *sgtp2*, *sgtp3* and *glut1* genes (Annex 4) shows that 3 intron positions are perfectly conserved between all, and that the position of introns 1 and 2 is conserved between all but *sgtp3*. In addition, *glut1* shares an intron position (intron 5) with *sgtp2* (intron 6) and *sgtp3* (intron 4) that is not present in *sgtp1* or *sgtp4*. Overall, this analysis underlines the close relationship between *sgtp2* and *sgtp3*, and *sgtp1* and *sgtp4* that correlates well with our phylogenetic analysis.

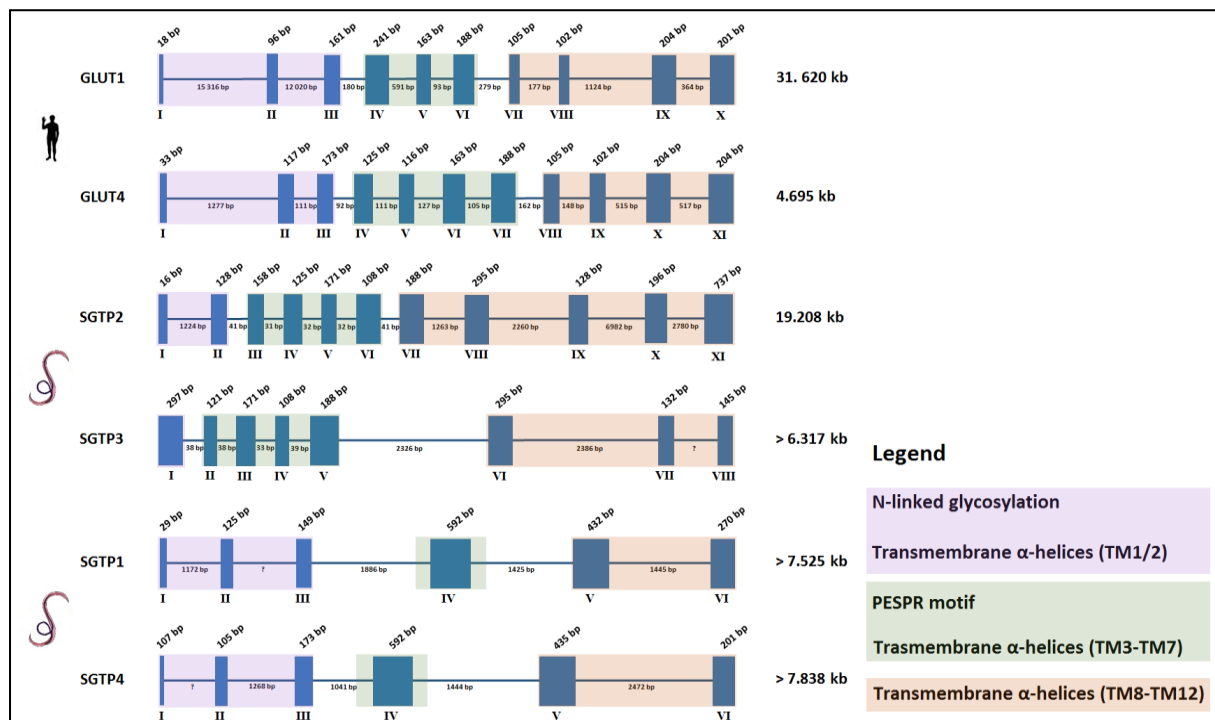
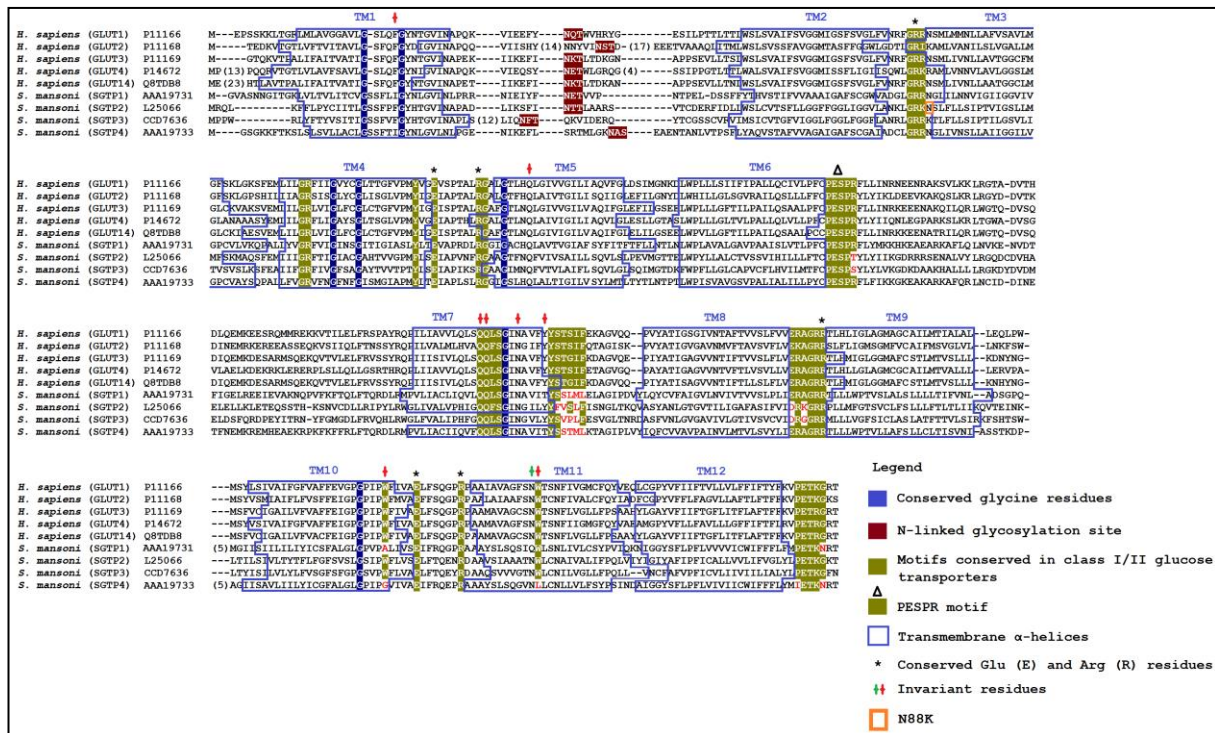

**Figure 4. Genomic organization of *S. mansoni* glucose transporters.** The genomic organization of the coding regions of *S. mansoni* glucose transporters is presented. The genomic organizations of human glucose transporters 1 (GLUT1) and 4 (GLUT4) are displayed for comparative purposes. Exons are represented by solid blue boxes and introns are represented by connecting lines. The sizes of exons and introns are shown in base pairs above and below the boxes and lines, respectively. Exons are numbered with Roman numerals beneath the boxes. Exons coding for different regions of the proteins are highlighted in purple, green and orange. Interrogation marks are showing intron positions where information is missing from genome sequences (see Annex 4 for complementary information).

### ***S. mansoni* glucose transporters show typical molecular signatures**

Despite SGTP1 and SGTP4 being clustered separately from class I and II glucose transporters, they share several molecular properties with these classes (Figure 5). Human class I glucose

transporters comprise GLUT1, GLUT2, GLUT3, GLUT4 and GLUT14 with GLUT1 being the first isoform cloned described by Mueckler et al. (1985). All members of GLUT family isolated from humans possess 12 transmembrane (TM)  $\alpha$ -helices (Augustin, 2010), structural patterns that are also present in some glucose transporters from Insecta (Kikuta et al., 2010). Using the TMHMM server we predicted the presence of the 12 TM  $\alpha$ -helices in SGTP1-4 and compared their positions with human class I glucose transporters (Figure 5). The positions of these TMs were conserved in the four glucose transporters from *S. mansoni*, except for the lack of TM7 in SGTP3. The only remarkable difference between the amino acid sequence of SGTP3 and the other glucose transporters at TM7 is the presence of two phenylalanine residues (Figure 5). However, the modelling analysis (see below) showed that SGTP3 has the typical 12 TM  $\alpha$ -helices. The discrepancy between TMHMM and modelling predictions regarding TMs in SGTP3 can only be solved through the experimental determination of the structure of this transporter. Probably due to differences in the algorithm used, the positions of our predicted TM differ slightly from those reported by Skelly et al. (1994) for SGTP1 and SGTP4. We then compared the sugar transporter signatures (Augustin, 2010; Joost and Thorens, 2001) of human and *S. mansoni* glucose transporters. Some glycine (Gly) residues critical for structure stabilization in the GLUT family (Mueckler et al., 1985) were also conserved in the TM  $\alpha$ -helices 1, 4, 5, 7 and 10 of *S. mansoni* glucose transporters (Figure 5). The glutamic acid (Glu) and arginine (Arg) residues implicated in conformational alteration (Schurmann et al., 1997) and membrane topology (Sato et al., 1999) in human GLUTs were also present in cytoplasmic loops 2, 4, 8, and 10 of *S. mansoni* glucose transporters (Figure 5).



**Figure 5. Alignment of members of glucose transporters class I.** Class I glucose transporters amino acid sequences from human (GLUT1-4 and GLUT-14) and *S. mansoni* (SGTP1, SGTP2, SGTP3 and SGTP4) were aligned using MAFFT. Relevant motifs among human class I/II glucose transporters and *S. mansoni* are highlighted. Annotation of relevant motifs was done using previous reports (Nguyen et al., 2014; Uldry and Thorens, 2004; Kanamori et al., 2010). The 12 transmembrane (TM) topologies, predicted using TMHMM Server v. 2.0 (Moller et al., 2001), are indicated. The positions of the invariant residues of Xyle (green) and GLUT1 (red) are marked. The substitution of Asn(N)88 by Lys(K)88 found in the genome for SGTP2 is boxed (orange). The number of amino acid insertions that resulted from the alignment are shown in brackets.

Some exclusive characteristics of class I/II glucose transporters in humans are conserved in *S. mansoni*. For example, the N-linked glycosylation site (Figure 5) in the first extracellular loop between TM1 and TM2 (Mueckler and Thorens, 2013) and the motif PESPR in the sixth intracellular loop between TM6 and TM7 (Figure 5). SGTP2 and SGTP3 showed an amino acid change in the last Arg of the motif PESPR to threonine (Thr) and serine (Ser), respectively. Despite the improbability of deducing substrate specificity or transport kinetics from the primary amino acid structure of class I glucose transporters, GLUT1, 3 and 4 are known to transport glucose, and not fructose, via a QLS sequence present in TM 7 (Seatter et al., 1998). This triad sequence has been implicated in substrate binding and is conserved in *S. mansoni* SGTP1, SGTP4 and SGTP3 (Figure 5), but not in SGTP2. In SGTP2 there is a substitution of leucine (Leu) by phenylalanine (Phe) and the same substitution was found in

the human GLUT2. Human GLUT2 has low affinity for glucose ( $K_m = 17\text{mM}$ ), which is uncommon among the known members of the GLUT family (Johnson et al., 1990), but has a high affinity for glucosamine ( $K_m \approx 0.8\text{mM}$ ) (Uldry et al., 2002). *S. mansoni* SGTP2 does not seem to transport glucose in *Xenopus* oocytes at 10mM glucose (Skelly et al., 1994), however, further studies should clarify whether this molecule shows a higher  $K_m$  for glucose or whether it has an affinity for glucosamine as does GLUT2. The presence of glucose transporters with different affinities for glucose is extremely important for the regulation of glucose uptake. For instance, under high glucose concentration conditions an increase in intracellular glucose reduces the glucose influx 50% in yeast cells expressing high-affinity glucose transporters (Teusink et al., 1998). Thus, by regulating the expression profile of the different glucose transporters with different kinetic properties, yeasts avoid affecting their glucose uptake, which is directly dependent on extracellular glucose concentration (Boles, 2002). Despite the fact that the hypothesis of glucose transporters with different affinities for glucose in *S. mansoni* is appealing and matches the expression profile in Figure 1, our biophysical analysis (below) suggests that neither SGTP2 nor SGTP3 transport glucose.

### **The predicted tertiary structural conformations of *S. mansoni* glucose transporters are homologous to GLUT1 and Xyle**

Upon substrate binding, the tertiary structure of most proteins undergoes conformational changes that coordinate their function. By comparing the structural differences of Xyle and GLUT1, Deng et al. (2014) were able to hypothesize on the conformational changes of glucose transporters during glucose binding and diffusion. This working model of glucose diffusion predicts that transporters prefer an outward (towards the extracellular), open, glucose-free conformation (i.e., the initial conformation). Glucose association (i.e., conformation of Xyle) and disassociation (i.e., conformation of GLUT1) trigger the migration of glucose towards an environment with a lower concentration – i.e., the intracellular compartment (Deng et al., 2014). The final conformation, glucose-free occluded (by the intracellular  $\alpha$ -helices), remains to be structurally resolved.

As proof of principle for our simulations, we submitted the modelled *S. mansoni* glucose transporters to the DALI server (Holm and Rosenström, 2010) to find homologous crystal structures with the best matching conformation. The crystal structures GLUT1 of *H.*

*sapiens* [PDB: 4PYP] and XylE of *E. coli* [PDB: 4GBZ] were among the top candidates. This provided two opportunities to control our simulations since, (i) glucose is not the substrate of XylE, it is a competitive inhibitor and (ii) XylE and GLUT1 are the two sequential intermediate structural conformations during glucose binding and diffusion, respectively (Deng et al., 2014). The conformational changes during binding occur mainly in TM  $\alpha$ -helices 1, 4, 7 and 10 that cause the occlusion by the intracellular  $\alpha$ -helices to open, thereby permitting diffusion (Deng et al., 2014). Root mean square deviation (RMSD) is frequently used in structural bioinformatics to measure the average distances between atoms from two or more protein structures. The superposition in Figure 6A graphically shows these overall structural differences – the RMSD between XylE [PDB: 4GBZ] and GLUT1 [PDB: 4PYP] is 3.2Å.

Figure 6B shows the predicted tertiary structures of *S. mansoni* glucose transporters SGTP1-SGTP4 and their structural similarity to GLUT1 and XylE. Both SGTP1 (RMSD 1.0Å) and SGTP4 (RMSD 1.3Å) are structurally homologous to XylE. SGTP2 (RMSD 2.3Å) and SGTP3 (RMSD 0.6Å) are structurally homologous to GLUT1. The higher RMSD for SGTP2 is mainly caused by differences in TM  $\alpha$ -helices 9 and 10, intracellular  $\alpha$ -helices and the C-terminus. These opposing conformations allow us to examine the stability of glucose within the active site of SGTP1 and SGTP4 and the inability of glucose migration (or diffusion) by SGTP2 and SGTP3.

**Figure 6. XylE and GLUT1 compared to the tertiary predicted structures of *S. mansoni* glucose transporters. Panel A (from left to right) shows the crystal structures of glucose transporters GLUT1 of *H. sapiens* [PDB: 4PYP] and XylE of *E. coli* [PDB: 4GBZ]. The transmembrane (TM)  $\alpha$ -helices (middle) are numbered (1-12) accordingly (IC = intracellular) with the  $\alpha$ -carbon backbone structural alignment of both crystal structures (GLUT1 = red and XylE = green; far right). Panel B shows the tertiary predicted structures of *S. mansoni* glucose transporters (left) with the structural alignment (right) of SGTP1 (blue) and SGTP4 (brown) with XylE of *E. coli* (green), and SGTP2 (magenta) and SGTP3 (cyan) with GLUT1 of *H. sapiens* (red). Structures are color-coded from the amino-terminus (N-ter; red) to the carboxyl-terminus (C-ter; blue). The structural alignment of the  $\alpha$ -carbon backbone was performed using the default tool of Schrodinger's Maestro program.**

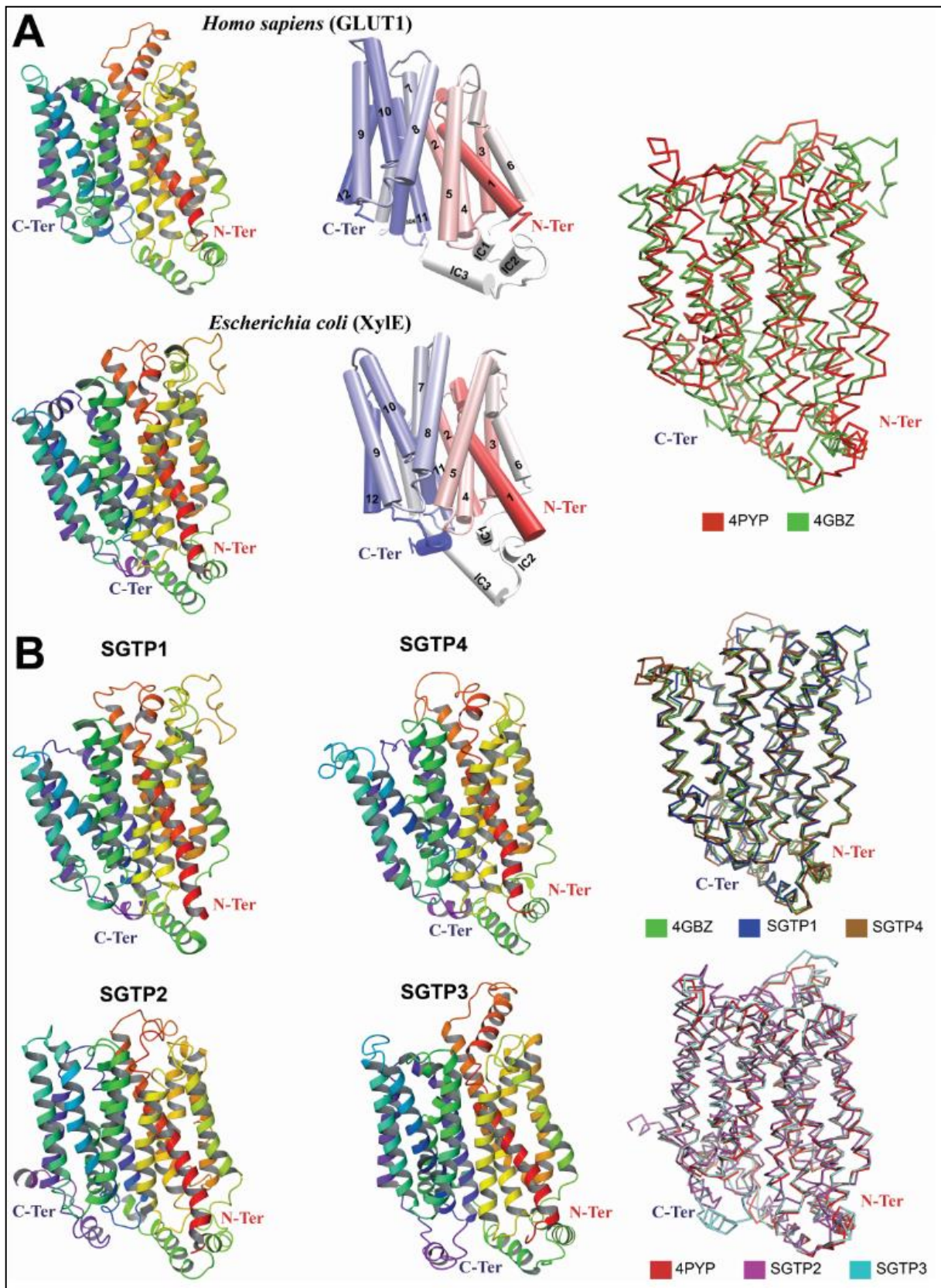



## **Residue dynamics reveal how glucose affects invariant residues of glucose transporters involved in binding**

The dynamics of key residues during substrate binding vary depending on the substrate and the protein. Since 1958, the key-lock theory to explain protein-substrate complexes has been revised by Koshland (1958) who proposed an induced-fit process. The induced-fit theory demonstrates that during protein-substrate interactions, conformational changes occur between both the protein and substrate to accommodate the complex. These molecular interactions subsequently cause the global conformational changes aforementioned in Figure 6. To understand how glucose will interact with key residues of glucose transporters, we performed an induced-fit docking simulation using the PELE server (see Materials and Methods).

Several conserved, invariant residues among glucose transporters (namely, GLUT1-GLUT4) were reported for Xyle that, when mutated to alanine (Ala), reduce the affinity of substrate binding (highlighted in Figure 5). These Xyle invariant residues are responsible for the competitive inhibitory properties of glucose (Sun et al., 2012) and showed altered conformations between Xyle and GLUT1 crystal structures. The differences in conformation between Xyle (green) and GLUT1 (red) invariant residues are clearly depicted in the structural representations of Figure 7. Large residue conformational shifts between Xyle and GLUT1 are seen in Gln161/168 (TM5), Tyr292/298 (TM7) and Trp388/392 (TM10). Both TM7 and TM10 are involved in the two sequential intermediate structural conformations during glucose binding (Deng et al., 2014). These homologous residues for SGTP1 and SGTP4 are, however, mutated – in TM7 as Tyr292/298Thr (SGTP1 and SGTP4), and in TM10 as Trp388/392Ala (SGTP1) and Trp388/392Gly (SGTP4) (Figure 5). To simplify matters we refer to the invariant residue positions in the order GLUT1/Xyle, hereafter.

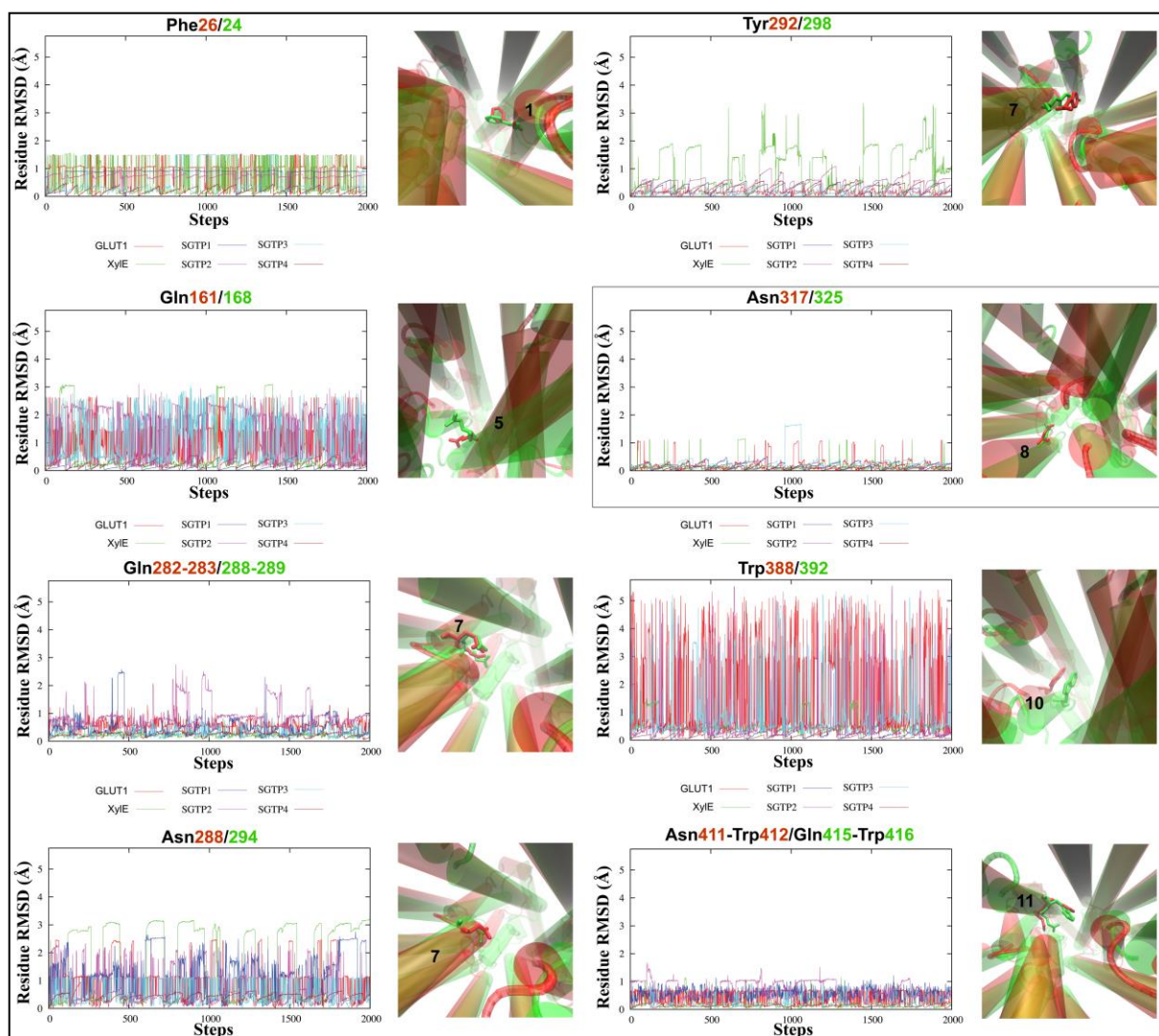

**Figure 7. Protein side chain dynamics during glucose induced-fit docking of XyIE, GLUT1 and *S. mansoni* glucose transporters. The line graphs depict the conformational changes of protein side chains in proximity to glucose for glucose transporters GLUT1 (red), XyIE (green), SGTP1 (blue), SGTP2 (magenta), SGTP3 (cyan) and SGTP4 (brown). The accepted PELE steps (x-axis) for all simulations were used to calculate the root mean square deviation (RMSD; given in Å) of side chain dynamics (y-axis) – see Materials and methods. Next to each line graph are the respective initial positions for each residue (sticks) of GLUT1 (red) and XyIE (green) crystal structures with the number indicating the parent TM  $\alpha$ -helix (tubes). The title of each line graph is color-coded respectively to GLUT1 and XyIE. The boxed-in panel is the negative control since it does not directly affect in substrate binding (Sun et al., 2012). (Note: The graphical structural representations are a bird’s-eye view of GLUT1 and XyIE.)**

The residue dynamics depicted in the line graphs of Figure 7 show that Gln161/168, Gln282-283/288-289, Asn288/294, Tyr292/298 and Trp388/392 undergo large conformational changes during induced-fit docking of glucose (compared with the dynamics of the negative control, Asn317/325 – see Figure 7 legend). Figure 7, however, shows that

these dynamics differ depending on the glucose transporter. XyleE and GLUT1 show high perturbations for Gln161/168 and Asn288/294, but have opposing dynamics for Tyr292/298 (XyleE) and Trp388/392 (GLUT1). The *S. mansoni* glucose transporter SGTP4 showed extremely low perturbations for all binding residues, perhaps due to its lower affinity for glucose compared with SGTP1 (Skelly et al., 1994). In contrast, SGTP2 possesses the most invariant residues with high perturbations, namely for Gln161/168, Gln282-283/288-289, Asn288/294 and Trp388/392. Both SGTP1 (Gln282-283/288-289 and Asn288/294) and SGTP3 (Gln161/168 and Trp388/392) only showed high perturbations for two invariant residues (Figure 7). There is a kink in TM7 that contributes to the coordination of the substrate in the active site of glucose transporters in the proximity of polar residues Gln282-283/288-289 and Asn288/294 and the aromatic residue, Tyr292/298 (Sun et al., 2012). The benzene ring of Tyr292/298 may act as “trapdoor” switch for glucose since it is thought to maintain the open-inward conformation of GLUT1 by interacting with TM4 (Deng et al., 2014).

### **Biophysical properties of *S. mansoni* glucose transporters provide insights into glucose affinity**

The induced-fit simulations revealed how invariant residues behave upon binding (since the algorithm constrains glucose migration within the active site), but what would happen if glucose were unconstrained? To answer this question, we simulated an unconstrained glucose migration starting from the active site. Due the importance of Tyr292/298 in maintaining the open-inward conformation of glucose transporters (Deng et al., 2014), we used it to triangulate glucose migration from its initial position in the active site. Annex 5 shows distinct glucose migration patterns for GLUT1 and XyleE. In accordance with the structural similarities (Figure 6), transcript expression (Figure 1) and evolution (Figure 2 and Figure 3), *S. mansoni* glucose transporters group together in glucose migration patterns showing that in SGTP2 and SGTP3 glucose migrates similarly to GLUT1, while SGTP1 and SGTP4 are similar to XyleE. These migration patterns seem to show glucose either slowly diffusing away from the active site (i.e., XyleE and SGTP4) or being ejected from it (i.e., GLUT1, SGTP2 and SGTP3). In SGTP1, however, glucose seems to stay within 10Å of the active site (Annex 5). This concentrated positioning within the active site agrees with the higher affinity that SGTP1 has for glucose compared with other SGTPs (Skelly et al., 1994).

In order to determine the biophysics of glucose affinity and the direction of migration patterns (towards the extracellular or intracellular compartments) we performed two types of analyses: (i) a cluster analysis to visualize the direction, and, (ii) an incorporation of 3D energy mapping of glucose migration to localize energy favorable clusters. Figure 8 shows that Xyle and GLUT1 possess conversely energy favorable glucose migration patterns. This is strictly caused by the structural conformation of these transporters since both are occluded by the extracellular TMs, but differ in the conformation of intracellular  $\alpha$ -helices (closed for Xyle and open for GLUT1). The open-inward conformation of GLUT1 is the characteristic that permits the diffusion of glucose within the cell. The distinct migration patterns and energy signatures of *S. mansoni* glucose transporters, however, may explain their individual response to glucose (Figure 8).

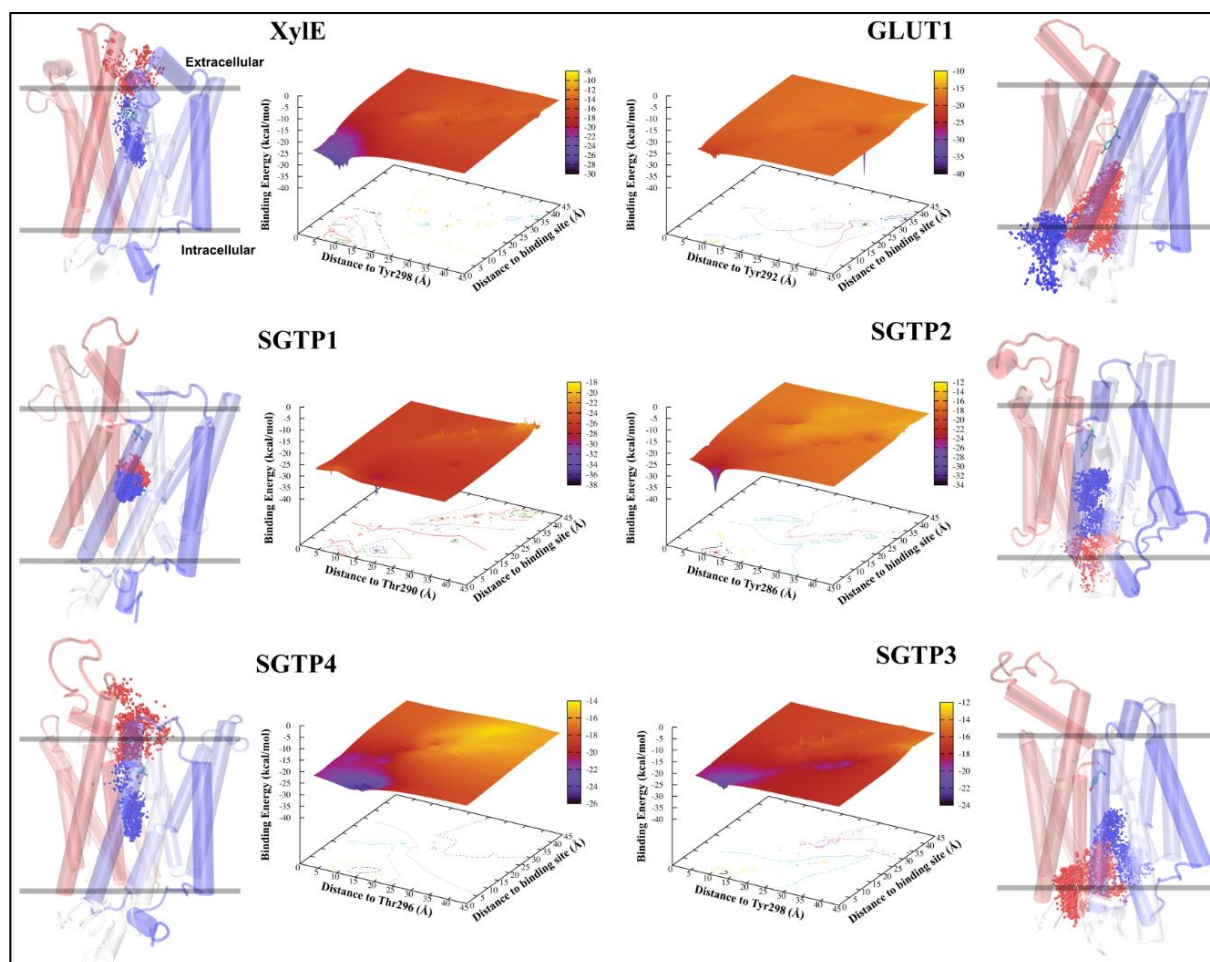

**Figure 8. Biophysics of glucose migration from the active sites of Xyle, GLUT1 and *S. mansoni* glucose transporters. All 3D plots show the mapping of glucose binding energy (kcal/mol; z-axis) compared to the triangulation of the glucose migratory distance (given in Å) from the Tyr292/298 homologous residue (x-axis) and the active site (y-axis) for GLUT1, Xyle, SGTP1, SGTP2, SGTP3 and SGTP4. The spectrum indicates the energy (kcal/mol) from a favorable glucose binding state (decreasing value; violet-blue) to an unfavorable binding**

state (increasing value; red-yellow). The contour base on the Cartesian coordinates is a 2D representation of the topology for the binding energy map. Next to each 3D plot are the graphical structural representations from the cluster analysis (see Materials and methods) depicting glucose migration from favorable binding energies (blue) to unfavorable ones (red). One oxygen atom (O5) was used to represent each glucose migration step away from the active site. The final position of Tyr292/298 is shown for each structure and each are color-coded from the N-ter (red) to the C-ter (blue). The lines indicating the position of the membrane is an approximation based on the position in Figure 5 – only for demonstration purposes.

Although SGTP2 and SGTP3 are structurally similar to GLUT1, the energy signatures for both are not comparable to GLUT1. The energy signature difference between SGTP2 and SGTP3 may be due to their slight structural deviations (as mentioned above and shown in Figure 6). Functional studies showed that SGTP2 does not transport glucose, even at 10mM concentration (Skelly et al., 1994). Our transcriptional analysis shows that SGTP2 and SGTP3 have opposing responses to glucose compared with SGTP1 and SGTP4 (Figure 1), and phylogenetically group together (Figure 2). These functional and evolutionary insights may explain glucose migration for SGTP2 and SGTP3 (Figure 8), since it migrates from an energy favorable state (i.e., the active site) to an unfavorable energy state (i.e., towards the intracellular compartment). Our results showed that transcriptional regulation of SGTP2 and SGTP3 respond differently to maltose and galactose than do SGTP1 and SGTP4 (Figure 1). All these results suggest that glucose is not the native substrate for SGTP2 and SGTP3, but may act as an inhibitor (as in Xyle) since both show energy favorable states within the active site (Figure 8).

Glucose affinity is higher for SGTP1 ( $K_m = 1.3\text{mM}$ ) than for SGTP4 ( $K_m = 2\text{mM}$ ) [4] and this affinity is clearly demonstrated in Figure 8. For SGTP4 glucose migrates from an energy favorable state (i.e., the active site) to an unfavorable energy state (i.e., towards the extracellular compartment). In contrast, glucose spends the majority of the simulation within the active site of SGTP1 with unfavorable energy states. We do see, however, that a smaller glucose cluster migrates towards the intracellular compartment with energy favorable states (Figure 8). This may be due to the similarity in structural conformation between SGTP1 and Xyle (with closed intracellular  $\alpha$ -helices), thereby impeding its diffusion by trapping glucose within the active site. The fact that SGTP1 differs from Xyle and SGTP4 in energy and migration patterns may be due to the fact that SGTP1 possesses a higher affinity for glucose

(Skelly et al., 1994) and that xylose, not glucose, is the native substrate for Xyle (Sun et al., 2012).

## Conclusions

SGTP2/3, not SGTP1/4, are relatively close to human GLUT1/4. This conclusion is based on our observations. The phylogenetic analysis shows that SGTP1/4 belong to a Platyhelminthes-specific glucose transporter class, while SGTP2/3 clearly belong to class I glucose transporters together with vertebrates and insect glucose transporters. Both SGTP2 and SGTP3 show a genome organization similar to that of GLUT1/4 and different to SGTP1/4. SGTP2 seems to be the ancestral glucose transporter in *S. mansoni* and GLUT1 is a structural homolog of SGTP2/3. Thus, the capacity of SGTP1/4 to transport glucose may have evolved independently, while SGTP2/3 apparently lost this capacity after the divergence from the last common ancestor with the other glucose transporters of class I. Overall, these observations may permit the development of specific inhibitors for *S. mansoni* glucose transporters.

A recent review (You et al., 2014) suggested that blocking glucose uptake, as the first step of glucose metabolism, represents an appealing strategy for developing drugs to produce starvation, energy supply deficiency, and mortality in parasitic worms. This is particularly necessary since praziquantel is currently the only treatment available for schistosomiasis and its massive use, notably in sub-Saharan Africa, has led to concerns about the potential for the development of resistance (Doenhoff et al., 2008). Glucosides, plant-derived compounds with glucose bound to a functional, non-sugar group (aglycone), have been shown to inhibit glucose diffusion in *S. mansoni* (Skelly et al., 1994; Uglem, 1975) and could therefore represent lead compounds for developing drugs targeting glucose transport. With the advent of computational biology, the ability to rationally design drugs for specific protein targets has greatly advanced. For example, using the *S. mansoni* glucose transporter structures, the aglycone could be altered to computationally test for stability and affinity of the designed glucoside(s). The top glucoside candidate(s) could then be experimentally analyzed for effectiveness. Since glucosides are non-transportable (Toggenburger et al., 1982) they could “trap” themselves in the active site to maintain the structural conformation similar to SGTP1 in Figure 8 – i.e., the glucose-bound, occluded conformation of Xyle. One of

the caveats of the PELE algorithm is that it cannot perform large protein conformational changes, as those described by Deng et al. (2014). Such simulations to rationally design drugs will benefit from other molecular dynamics software such as Desmond (Borhani and Shaw, 2012).

## **Methods**

### **Ethics statement**

All animal experimentation was conducted in accordance with the European Convention for the Protection of Vertebrate Animals used for Experimental and other Scientific Purposes (ETS No 123, revised Appendix A) and was approved by the committee for ethics in animal experimentation of the Nord-Pas de Calais region (Authorization No. AF/2009) and the Pasteur Institute of Lille (Agreement No. A59-35009).

### **Parasite material**

A Puerto Rican strain of *S. mansoni* was maintained in the laboratory using the snail, *Biomphalaria glabrata* as its intermediate host and the golden hamster, *Mesocricetus auratus* as a definitive host. Schistosomula were obtained by mechanical transformation from cercariae released from infected snails as previously reported (Ramalho-Pinto et al., 1974). Schistosomula were washed three times in serum and glucose-free DMEM medium (Life sciences, Carlsbad, USA) supplemented with traces of glucose (0.05mM) then incubated at 37°C, in an atmosphere of 5% CO<sub>2</sub>. After three hours of incubation, glucose, maltose or galactose were added to the medium at a concentration of 10mM each, and the schistosomula were incubated for another eight hours. A total of 10 000 parasites were used per condition and experiments were carried out in triplicate.

### **RNA isolation and quantitative RT-PCR**

Total RNA was isolated from the different stages of *S. mansoni* with TRIzol reagent (Invitrogen, Carlsbad, USA) according to the manufacturer's instructions. Complementary DNAs (cDNA) were obtained by reverse transcription of total RNA using the Thermoscript RT-

PCR System (Invitrogen, Carlsbad, USA). The cDNAs were then used as templates in triplicate assays for RT-PCR amplification using the KAPA SYBR FAST ABI Prism kit (Kapa Biosystems, Boston, USA), and ABI PRISM 7000 sequence detection system. We used previously reported primers for *S. mansoni* *sgtp1* and *sgtp4* (Krautz-Peterson et al., 2010). The primers for *sgtp2* and *sgtp3* were designed for this study: *sgtp2F* 5' TTTACCTTCGAGGGCAAGAT 3' and *sgtp2R* 5' CACCGCAAGTATGGAATACG 3', *sgtp3F* 5' GCAGCAACTCTCAGGAATCA 3' and *sgtp3R* 5'ACACAATAACCGCTCCAACC 3'. The ratios of relative expression were calculated using the  $2^{-\Delta\Delta Ct}$  ratio (Pfaffl, 2001) with *S. mansoni*  $\alpha$ -tubulin as the endogenous control gene (Lancelot et al., 2013). The statistical significance between groups was evaluated using the unpaired non-parametric Mann Whitney's test in the GraphPad 6 Prism program (GraphPad Software Inc.). Differences were considered significant when *p-value* < 0.05.

### **Phylogenetic analyses**

Sequences were collected from GenBank for phylogenetic analyses of sugar transporter proteins from mammals (3 species), fish (teleosts, 7 species), insects (8 species), cestodes (6 species) and flukes (4 species). A *Drosophila melanogaster* sucrose transporter was introduced as an outgroup. The species, sugar specificity and accession numbers of each sequence is provided in Figure 2. Glucose transporter amino acid sequences were aligned using MUSCLE (v3.7) configured for highest accuracy (Edgar, 2004) and non-aligned regions were removed with Gblocks (v 0.91b) (Castresana, 2000). Thus, the final alignment contained 333 gap-free amino acid positions. The best-fit model of the sequence evolution was selected based on Akaike Information Criterion (AIC), Corrected Akaike Information Criterion (cAIC) and Bayesian Information Criterion (BIC) implemented in Datamonkey (Delport et al., 2010). The LG model (Le and Gascuel, 2008), which had the lowest values of AIC, cAIC and BIC, was chosen for subsequent phylogenetic analyses. Maximum likelihood (ML), maximum parsimony (MP) and neighbor joining (NJ) methods, implemented in MEGA 6 (Tamura et al., 2013), were used to obtain the best tree topologies for each method. A proportion of Gamma distributed and invariants sites (G+I) were estimated in MEGA for each phylogenetic method. Reliability of internal branches was assessed using the bootstrapping method (1 000 bootstrap replicates) and the approximate likelihood ratio test (aLRT – SH-Like) implemented in MEGA and PhyML, respectively (Tamura et al., 2013; Anisimova and



Gascuel, 2006). Graphical representation and editing of the phylogenetic tree was performed with EvolView (Zhang et al., 2012).

### **Molecular Clock and evolutionary rates**

First, the likelihood ratio test (LRT) (Felsenstein, 1988) was used to test the molecular clock hypothesis (i.e., all tips of the tree are equidistant from the root of the tree) on the aforementioned phylogenetic trees (Tamura et al., 2013). The LRT rejected the null hypothesis of equal evolutionary rate throughout the tree at a 5% significance level ( $p$ -value = 0) for both topologies (ML and MP). Therefore, relative time divergence was determined (Wilke et al., 2009). Time trees were generated using the RelTime method (Tamura et al., 2012), as implemented in MEGA 6 (Tamura et al., 2013). RelTime is a useful method to estimate relative lineage-specific evolutionary rates and relative divergence times without requiring the pre-specification of statistical distribution of lineage rates and clock calibrations (Tamura et al., 2012). To calculate evolutionary rates, RelTime assumes that the elapsed time of two sister lineages from their most recent common ancestor is equal (Tamura et al., 2012). Divergence times for all branching points were calculated using the Maximum Likelihood method based on the LG model. The MP tree(s) were used to estimate the relative divergence times of glucose transporters in different taxa with special emphasis on *S. mansoni*. To account for statistical errors in our analysis, the 100 most parsimonious trees were searched using the Min-mini heuristic algorithm (Nei and Kumar, 2000), and the relative divergence times of the selected nodes was determined in all the trees. The Shapiro-Wilk normality test (Shapiro and Wilk, 1965) rejected normal distribution of the obtained relative divergence times ( $P < 0.0001$ ), therefore a paired Wilcoxon test was used to test whether the difference between divergence times of selected nodes were significant (Wilke et al., 2009). The GraphPad 6 Prism programme (GraphPad Software Inc.) was used to perform both Shapiro-Wilk and Wilcoxon tests. Evolutionary rates (measured as the relative number of amino acid substitutions per site) were calculated using the RelTime method (Tamura et al., 2012), implemented in MEGA 6 (Tamura et al., 2013). To further compare the evolutionary rates of SGTP3/SGTP2 and SGTP4/SGTP1 we used Tajima's relative rate test (Tajima, 1993). This method tests whether two sequences have equal rates of evolution using a third sequence as outgroup. The equality is tested using the chi-square ( $\chi^2$ ) test.

When the observed  $\chi^2$  is significantly higher ( $p$ -value < 0.05) than expected, the null hypothesis of equal rates can be rejected. Thus, to perform Tajima's relative rate test, Fhep.G.AAS94013 and Tsol.G2.AAB05920 sequences (see Figure 2) were used as outgroups to compare the rates of SGTP3/SGTP2 and SGTP4/SGTP1, respectively.

### **Analysis of genome organization and transcript variants**

The cDNA sequences of the four encoded *S. mansoni* glucose transporters were compared with genomic sequences available at the Wellcome Trust Sanger Institute Blast server ([http://www.sanger.ac.uk/cgi-bin/blast/submitblast/s\\_mansoni](http://www.sanger.ac.uk/cgi-bin/blast/submitblast/s_mansoni)) and GeneDB (<http://www.genedb.org/Homepage/Smansoni>). Intron-exon junctions were manually detected (5'GT and 3'AG) using sequence alignments constructed with Megalign (DNASar Inc.). For this analysis, the cDNA sequences for SGTP1 (GenBank: L25065), SGTP2 (GenBank: L25066) and SGTP4 (GenBank: L25067) published by Skelly et al. (1998) were used. In order to verify and complete the predicted transcript sequences of SGTP2, we carried out 5' and 3' RACE (GeneRacer kit, Invitrogen, Carlsbad, USA) using the oligonucleotides: *sgtp2F1* 5' GTAAAACACAATCAATGAGACAACCTG 3', *sgtp2R1* 5' GTAGAAAATAACTGGATAGATGACGA 3' and *sgtp2R2* 5' ATGGGAAATAAAACAAAATAGAACAA 3', based on the predicted sequence. In the case of SGTP3, a similar strategy was adopted, based on the sequence (Smp\_127200) predicted by genome annotation (Protasio et al., 2012). We carried out 5' and 3' RACE PCR using the oligonucleotides: *sgtp35.1* 5' CTGCCGCGCCACGTGACTTTATT 3', *sgtp35.2*, 5' TTGTTGGGATAGAAAGAAGGAAT 3', *smgtp33.1* 5' ATCTTGGGTTGGAGCGGTTATTGT 3', *smgtp33.2* 5' TCACTCAAGAATATAGGGATGC 3'. Subsequently, the full-length coding sequence was amplified using oligonucleotides: *smgtp3FL1* 5' CACTGACATGGACTGAAGGAGT 3', *smgtp3FL2* 5' TGCTACGAGTTTCTGCTTCTCATGC 3', *smgtp3FL3* 5' TTAATGATAGTACTGCACTGATTTA 3', *smgtp3FL4* 5' AGAATCGTTTTACCGGTATGATTGT 3'. Verification and the search for variants of the full-length coding sequences were carried out by PCR using the Advantage 2 Polymerase mix according to the manufacturer's instructions (Clontech, Mountain View, USA). PCR products were purified from agarose gels using the extraction kit Wizard SVGel and PCR clean-up system (Promega) and then inserted into pCR2.1-TOPO vector to chemically transform competent *E. coli* cells (One-Shot TOP10,

Invitrogen). Eurofins Genomics GmbH sequenced the clones. Analysis and alignment of the sequences were performed using the LASERGENE package (DNASStar).

### **Tertiary protein modelling**

To approximate an accurate tertiary model of the *S. mansoni* glucose transporters SGTP1, SGTP2, SGTP3 and SGTP4 we used several protein structure prediction servers, namely FOLDpro (Cheng and Baldi, 2006), I-TASSER (Zhang, 2008), 3D-Jigsaw (Bates et al., 2001), LOOPP (Vallat et al., 2009), Phyre2 (Kelley and Sternberg, 2009) and SwissModel (Zhang, 2008; Arnold et al., 2006). To assess the quality of the output models and to choose the top candidates we used Resprox (Berjanskii et al., 2012), Qmean (Benkert et al., 2009), ModFOLD (McGuffin et al., 2013). We then manually inspected the top three models of each SGTP to determine any unresolved secondary structures (i.e.,  $\alpha$ -helices).

The top candidate model structures were refined via minimization to remove steric clashes and optimization of the hydrogen-bond network by means of side chain sampling using the Schrödinger's Maestro Protein Preparation Wizard (Li et al., 2007). Briefly, the Protein Preparation Wizard analyzes the structure to build a cluster of hydrogen bonds and with the highest degree of sampling, the algorithm then performs 100 000 Monte Carlo orientations for each cluster. Based on the electrostatic and geometric scoring functions, the algorithm then determines an optimized structure. Glucose and the other glucose transporter crystal structures (see below) were also prepared and optimized in this manner.

### **Glucose induced-fit docking and migration**

For the biophysical simulations, namely induced-fit docking and substrate migration, we used the state-of-the-art Protein Energy Landscape Exploration server (PELE, Madadkar-Sobhani and Guallar, 2013). The PELE server provides ready-made scripts for substrate binding refinement (induced-fit docking) and unconstrained substrate binding site search (migration). The many uses of PELE can be accessed at <https://pele.bsc.es/pele.wt> and its algorithm is thoroughly explained in references (Borrelli et al., 2005; Madadkar-Sobhani and Guallar, 2013). Briefly, the PELE algorithm performs three stages. First, localized substrate perturbations are performed. Protein perturbations of the  $\alpha$ -carbon backbone are also

performed using an anisotropic network model (ANM) (Atilgan et al., 2001). Second, the amino acid side chains in proximity to the substrate are optimized using steric filters and a rotamer library (Jacobson et al., 2002). Finally, a truncated Newton minimizer and a surface generalized Born implicit solvent for minimization (Still et al., 1990) is used to achieve a local minimum after the initial perturbation. These three stages are performed for a number of steps and are analyzed in parallel with several computer-processing units. The results are a series of trajectories that represent protein side chain conformational changes and substrate migration. Based on the calculated energies of each step, a Monte Carlo Metropolis criterion implemented in PELE either accepts (if they are equal to and/or less than the initial energy) or rejects the steps (greater than the initial energy) (Borrelli et al., 2005). The energy is calculated by using a standard force field to describe the potential energy of a particular molecular system, known as the optimized potentials for liquid simulations (OPLS-2005) (Jorgensen and Tirado-Rives, 1988).

Several parameters were optimized from the ready-made scripts provided by the PELE server to facilitate sampling. For the substrate binding refinement (induced-fit docking), (i) *steric\_tr* ('100') and *tries* ('25') were reduced for the simulations to be less computationally expensive, (ii) translation (*tra\_r* '2') and rotation (*rot\_r* '0.3') of glucose were increased to permit more exploration of the active site, (iii) minimization radius (*mirad*) to allow minimization of the whole system, (iv) an ANM *type* to '4' was added and ANM *mode* changed to '5' for favorable protein perturbations; and, (v) an increased number of steps (1000) was used for sufficient overall sampling. For the unconstrained substrate binding site search (migration), (i) *waitfor* was increased to '4' to allow sufficient sampling of the active site, (ii) translation (*tra\_r*) was reduced to '4' to avoid large translation of glucose, (iii) an ANM *type* to '4' was added since the default ANM *mode* produced favorable protein perturbations; (iv) an increased number of steps (1000) was used for sufficient overall sampling; and, (v) a focused ANM (*anmrad* 15Å) and minimization (*mirad* 10Å) in proximity of the substrate was used for localized interpretation of glucose transport.

As proof of principle, we used two experimentally and structurally characterized glucose transporters: GLUT1 of *H. sapiens* [PDB: 4PYP] and XylE of *E. coli* [PDB: 4GBZ]. The xyz coordinates of glucose from the crystal structure of *E. coli* XylE were used as the starting position for all simulations (i.e., the active site of glucose transporters). The trajectories of

glucose induced-fit (>2 000) and migration (>10 000) produced by the PELE algorithm were viewed and analyzed using the Visual Molecular Dynamics program (VMD) (Humphrey et al., 1996). Clustering analyses of glucose migration was performed using VMD. The clustering parameters were set for '10' clusters with a 10Å cut-off distance for each cluster, since all simulations showed a concentrated glucose sampling of the active site (Annex 5). SGTP1 was set with a 5Å cut-off distance for each cluster since the majority of glucose exploration during the migration simulation was within the active site (Annex 5). All plots were generated using GNUPLOT (<http://gnuplot.sourceforge.net>).

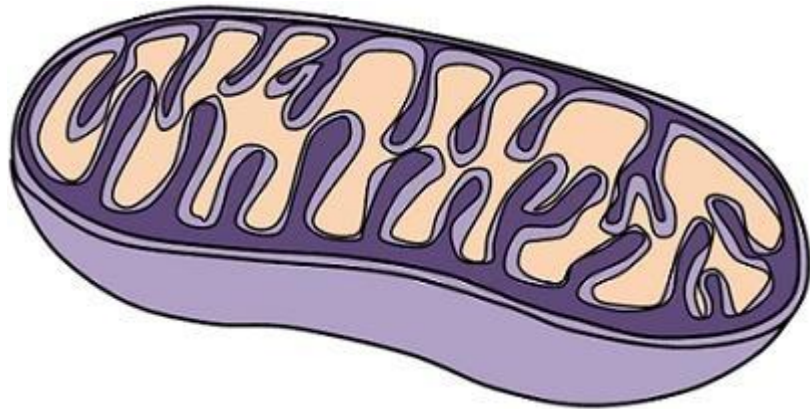

## **Role of sirtuins in the mitochondrial metabolism of *S. mansoni***

## **Role of sirtuins in the metabolism of *Schistosoma mansoni***

Alejandro Cabezas-Cruz<sup>1</sup>, Julien Lancelot<sup>1</sup>, Raymond J. Pierce<sup>1</sup>

<sup>1</sup> Univ. Lille, CNRS, Inserm, CHU Lille, Institut Pasteur de Lille, U1019 - UMR 8204 - CIIL -  
Centre d'Infection et d'Immunité de Lille, F-59000 Lille, France

## Abstract

Cercariae, the infective larvae of the human parasite *Schistosoma mansoni*, use oxidative phosphorylation as their main source of energy. However, upon infection, the transformed schistosomula switch to aerobic glycolysis with high production and secretion of lactate. This metabolic switch was shown to be completely reversible and dependent on the external levels of glucose. We show here that in high concentrations of glucose (HG, 10 mM), schistosomula undergo gene expression reprogramming. When schistosomula were exposed to HG, the glycolytic genes lactate dehydrogenase (*SLDHA*), pyruvate dehydrogenase kinase 1 (*SPDK1*) and class I glucose transporters (*SGTP2* and *SGTP3*) were upregulated, while genes related to mitochondrial function, i.e. malate dehydrogenases (*SMDH*) were downregulated. Interestingly, this gene expression profile in HG was associated with an increase in lactate production, but also with an increase in mitochondrial activity (MTA). We show that SmSirt1 is a positive regulator of MTA. First, SmSirt1 gene knockdown, using RNA interference, reduces MTA. Second, sirtuin inhibitors, such as salermide and sirtinol, also reduce MTA. We further show that SmSirt1 is a repressor of *SPDK1* gene expression in HG. We conclude that SmSirt1 enhances MTA in HG by repressing the expression of *SPDK1*.



## Introduction

Early studies showed that adult *Schistosoma mansoni* worms were homolactic fermenters in aerobic conditions (Bueding, 1950). This was surprising because at that time it was mostly believed, from studies in yeast, that under aerobic conditions the fermentation of glucose would be inhibited by oxygen, i.e. the “*Pasteur effect*” (Pasteur, 1861; Racker, 1974). In fact, it was later shown that the “*Pasteur effect*” does not occur in *S. mansoni*, and that these worms produce the same amount of lactic acid under aerobic and anaerobic conditions (Schiller et al., 1975; Bueding and Fisher, 1982). Instead of a “*Pasteur effect*”, *S. mansoni* parasites are a good example of the “*Crabtree effect*”, namely, a process in which the presence of high external glucose concentrations induces a fermentative metabolism in aerobic conditions (Crabtree, 1928). Interestingly, similar to the findings of Ernest Bueding (1950) in *S. mansoni*, many cancer cells were found to obtain their energy from the fermentation of pyruvate to lactic acid, even in the presence of adequate oxygen levels, a phenomenon named the “*Warburg effect*” (Warburg et al., 1927; Warburg, 1956).

Since then, the study of *S. mansoni* glucose metabolism has interested subsequent generations of parasitologists. Thus, it was later realized that upon transformation, cercariae, the free-living stage of *S. mansoni*, undergo a metabolic transition in which aerobic glycolysis and secretion of lactate becomes the main signature (Von Kruger et al., 1978). Later, in 1992, Horemans and colleagues, made a fundamental discovery: that the metabolic transition depends on external glucose concentration, is fully reversible and is uncoupled from the biological transformation of cercariae into schistosomula.

However, comparatively little attention has been paid to the respiratory capacity of transformed schistosomula and the role of mitochondria during the metabolic transition. Particularly, is there a mitochondrial switch in the presence of high glucose concentrations? And more importantly, how is this process regulated?

Much of what we know about regulation of “*Warburg effect*” comes from cancer biology. Remarkably, recent reports showed that this metabolic shift may be regulated at the epigenetic level in cancer cells. In particular, sirtuins, a family of NAD<sup>+</sup>-dependent protein N-ε-acyl-lysine (Ack) deacylases, has been found to regulate a wide range of cellular metabolic processes (Houtkooper et al., 2012; Chalkiadaki and Guarente, 2015). Particularly, Sirt1 regulates the expression of glycolytic genes by regulating the expression and activity of

the transcription factor HIF1 $\alpha$  (Lim et al., 2010), and stimulates mitochondrial metabolism and biogenesis (Cantó and Auwerx, 2012). In addition, human Sirt6 was found to be a tumor suppressor that regulates aerobic glycolysis in cancer cells (Sebastián et al., 2012). Consistent with this, Sirt6-deficient cells showed increased glucose uptake with upregulation of glycolysis and diminished mitochondrial respiration (Zhong et al., 2010). Our working hypothesis is that sirtuins may be master regulators of the metabolic switch in *S. mansoni*. Here we show (i) that after metabolic transformation in HG, the OXPHOS of schistosomula increases, (ii) that SmSirt1 is a repressor of SPDK1 expression in schistosomula and adult worms, and (iii) that SmSirt1 is a positive regulator of mitochondrial activity in schistosomula in HG.

## Results

### **High glucose concentration induces a gene expression reprogramming associated with increase lactate production and mitochondrial activity.**

The metabolic switch in schistosomula was shown to be dependent on external glucose concentration (Horemans et al., 1992). At low concentrations of glucose (0.05mM), the metabolic profile remained that of cercariae (major aerobic oxidation of glucose through OXPHOS), however, in the presence of glucose 10mM (or 5mM), the production of lactate increased 50-fold within the first 2 hours (Horemans et al., 1992). To assess the effect of external glucose concentration on metabolic gene expression, we developed a model (Figure 1A) in which schistosomula were incubated at low glucose concentrations (0.05 mM, LG) and then a high (10 mM, HG) concentration of glucose was added. Following 5 hours of incubation in HG, the expression of 16 metabolic genes was measured by quantitative real time PCR in these two conditions. Figure 1B shows that lactate dehydrogenase (*SLDHA*), pyruvate dehydrogenase kinase 1 (*SPDK1*) and class I glucose transporters (*SGTP2* and *SGTP3*) were significantly upregulated upon metabolic transformation, while mitochondrial (*SMDH2*) and cytoplasmic (*SMDH1B* & *SMDH1A*) malate dehydrogenases were significantly downregulated together with the rest of the genes. In contrast, the mRNA levels of hexokinase (*SHEX*) did not change in HG compared to LG. This is consistent with the observation that the activity of SHEX is mostly regulated by product (i.e. glucose 6-phosphate) availability (Tielens et al., 1994; Tielens, 1997).

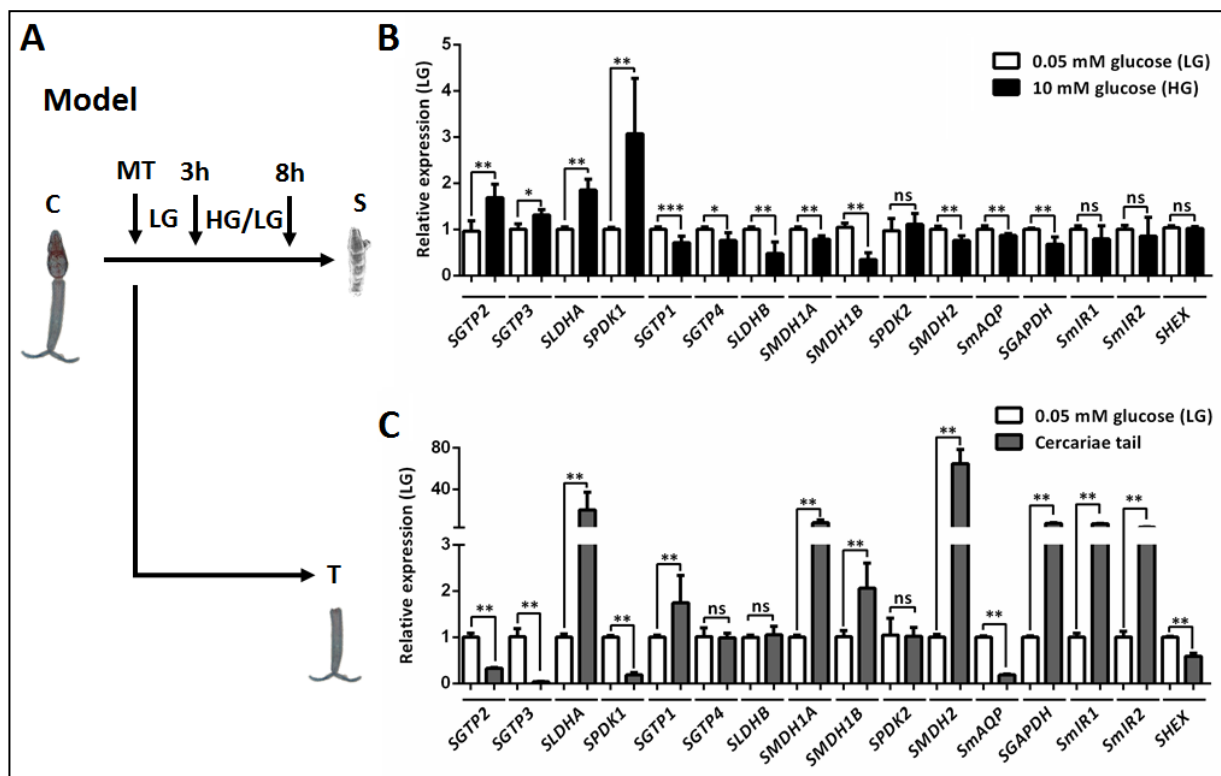
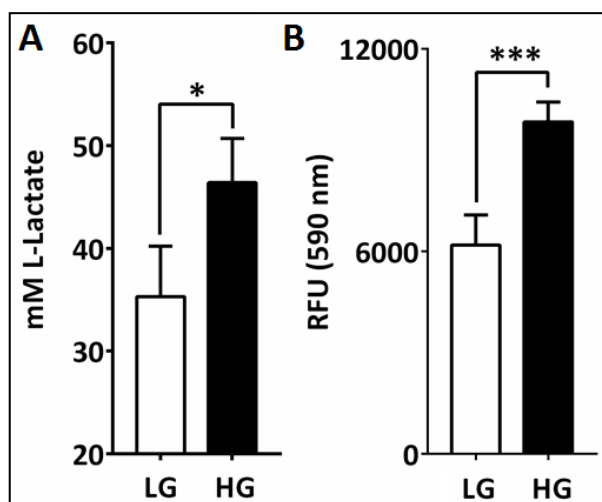

**Figure 1. Transcriptional reprogramming induced by high concentrations of glucose. Panel A.** The model. Cercariae were mechanically transformed and the resulting cercarial bodies were incubated for 3 hours (h) in DMEM medium, supplemented with 0.05 mM glucose (LG) to allow for biological transformation to schistosomula. Subsequently, 10mM glucose (HG) were added to the medium and the schistosomula were incubated for 5 hours to allow for full metabolic transformation, which occurs within the first 3h. 10 000 schistosomula were used per condition. **Panel B.** Change in gene expression pattern in presence of HG. Total RNA was extracted, cDNA synthesized and real time PCR was performed (primers in Annex 6). The abbreviation of genes is available in Annex 6. **Panel C.** Comparison of gene expression between cercariae tail and schistosomula in LG. The data presented is representative from three independent experiments.

In cercaria, the transition from OXPHOS to GLY in HG occurs exclusively in the head, and not in the tail, which has a metabolism based, exclusively, on OXPHOS (Horemans et al., 1991). To assess whether the pattern of gene expression in HG was typical for schistosomula with an increased GLY, we measured the same genes as above in cercariae tails (Figure 1C). Malate dehydrogenases genes (*SMDH1A*, *SMDH1B* and *SMDH2*) were upregulated as well as glyceraldehyde-3-phosphate dehydrogenase (*SGAPDH*), LDHA and Insulin receptors (*SmIR1* and *SmIR2*). However, *SHEX* and surface aquaporin (*SmaQP*), a lactate transporter in

*Schistosoma* (Faghiri et al., 2005), were downregulated. Remarkably, consistent with a metabolism based exclusively on OXPHOS, *SPDK1* was only marginally expressed in cercaria tails while it was 3-fold upregulated in schistosomula incubated in HG (Figure 1BC). PDK1 is a kinase that phosphorylates the pyruvate dehydrogenase complex (PDHC), inhibiting the transformation of pyruvate to acetyl-CoA by PDHC and therefore reduces mitochondrial activity (MTA) (Gudi et al., 1995). The opposed expression patterns of *SPDK1* in HG and cercaria tails, suggests a relevant role of *SPDK1* in the regulation of MTA during metabolic switch of *S. mansoni*.

As expected, the gene expression of schistosomula in HG was associated with a significant increase in extracellular lactate concentration (Figure 2A). It has been shown that in HG, glucose is mainly degraded to lactate, but CO<sub>2</sub> was also produced (Horemans et al., 1992), suggesting that upon metabolic transformation, mitochondrial respiration is not abolished. Therefore, we measured mitochondrial activity (MTA) using the Alamar blue Assay (AB). This assay uses an oxidized substrate (resazurin) that when reduced by the Complex IV (Cytochrome c Oxidase) of the respiratory chain, forms a red compound (resorufin) that is highly fluorescent (Springer et al., 1998). Thus, fluorescence intensity correlates with the reductive capacity of the mitochondria (Springer et al., 1998; Nakai et al., 2003; Zhang et al., 2004). This assay has been previously used to test MTA in *S. mansoni* (Protasio et al., 2013). In agreement with previous studies (Protasio et al., 2013), MTA increased in HG compared to LG (Figure 2B, right). This suggested that after the metabolic switch, schistosomula might use both GLY and OXPHOS to obtain energy.



**Figure 2. Panel A. Production of lactate increases in HG. Panel B. Mitochondrial activity, measured as Relative Fluorescence Units (RFU), increases in HG compared to**

LG.

### High glucose activates mitochondrial activity after metabolic transformation

To specifically address the link between glycolytic flow and MTA, we cultured schistosomula in 10 mM of either glucose or galactose (GAL) for 72 hours and measured MTA. Galactose forces the cells to use OXPHOS to obtain energy (Bustamente et al., 1977; Le Goffe et al., 1999; Rossignol et al., 2004; Weinberg et al., 2010; Chang et al., 2013). As shown in Figure 3, GAL increases MTA over time and this increase is comparable to that observed under LG conditions. Interestingly, the MTA in HG is significantly higher than that in LG and GAL. This result suggested that HG may increase the flow of pyruvate to the mitochondria, increasing its utilization by the TCA and therefore the reductive capacity of OXPHOS components.

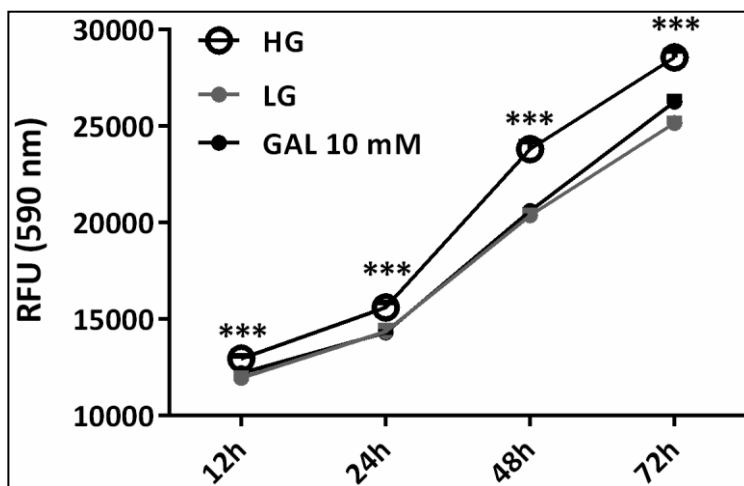
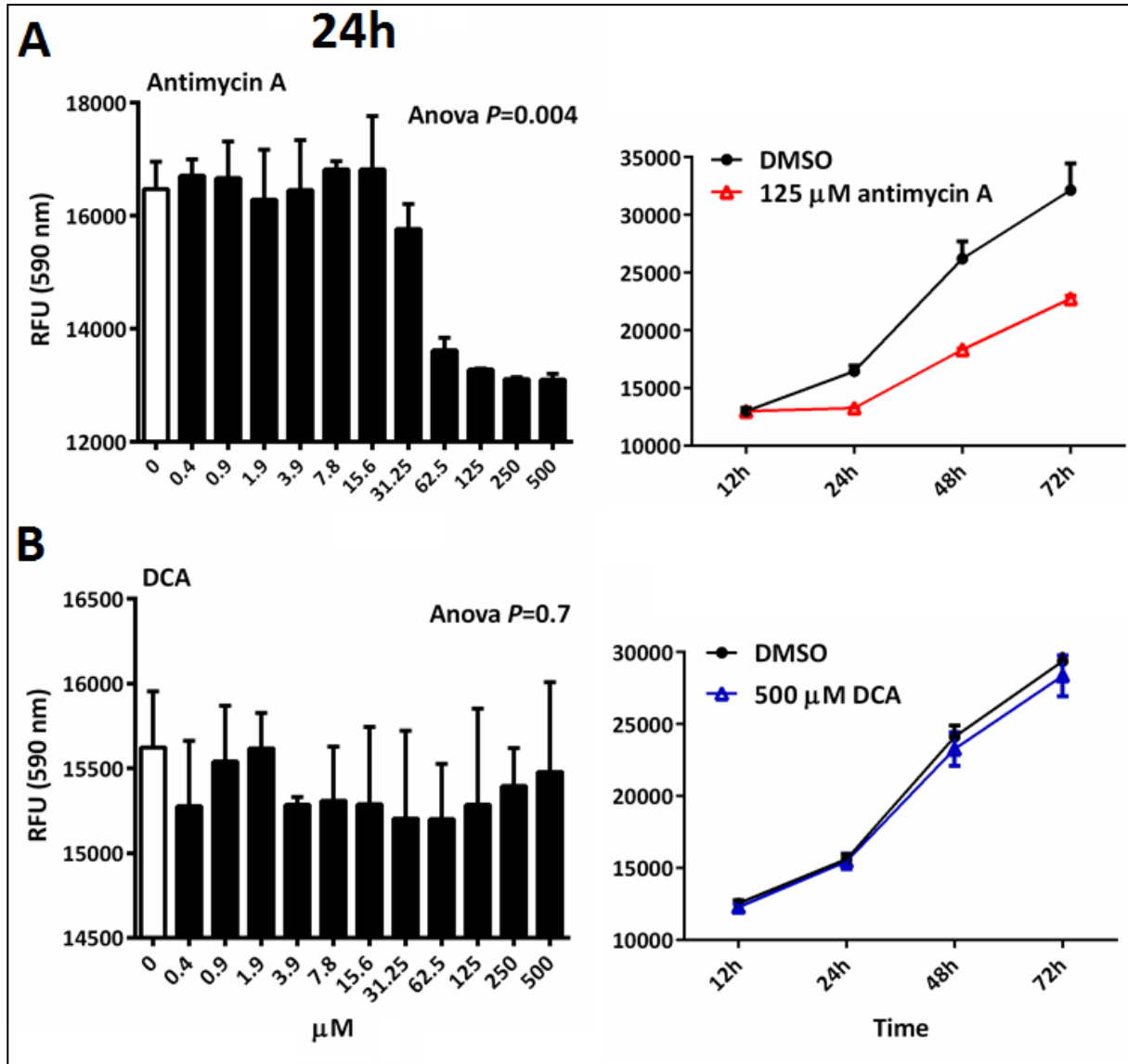

Figure 3. Increase in MTA in time. Schistosomula were incubated in presence of HG, LG and 10 mM galactose (GAL).

A key step in the mitochondrial metabolism of pyruvate, is its decarboxylation by the pyruvate dehydrogenase complex (PDC). Pyruvate dehydrogenase is inhibited by phosphorylation induced by PDK. If HG increases the utilization of pyruvate in the TCA, PDK should be inhibited at HG. Likewise, if at HG, pyruvate is being used in the TCA to produce redox potential, OXPHOS should be enhanced. To test these hypotheses, we incubated schistosomula in the presence of the PDK inhibitor, sodium dichloroacetate (DCA) and the complex III (cytochrome *bc1* complex) inhibitor antimycin A. Relatively low concentration (31.25  $\mu$ M) of antimycin A reduced MTA at HG. A maximum of MTA inhibition was reached at 125  $\mu$ M of antimycin A. The effect of 125  $\mu$ M antimycin A on MTA persisted for at least 72h after adding the inhibitor (Figure 4A). However, MTA did not change when increasing concentrations (0.4  $\mu$ M to 500  $\mu$ M) of DCA were added to the medium (Figure 4B). This result suggested that even when the *SPDK1* gene is upregulated upon metabolic

transformation (Figure 1A), the enzyme SPDK1 is not inhibiting the activity of PDC in HG. In contrast, the inhibition of OXPHOS by increasing concentrations of antimycin A, confirms the results above (Figure 3), suggesting that OXPHOS is enhanced by HG.



**Figure 4. Panel A. Increasing concentrations of antimycin A produce a significant decrease in MTA, starting at 31.25 μM (left). This decrease in MTA is more significant after 72h of incubation (right). Panel B. Increasing concentrations of sodium dichloroacetate (DCA) do not affect MTA (left), even after 72h of incubation (right).**

To test the effect of glucose flow on MTA, we cultured schistosomula in HG, 10 mM GAL and added Cytochalasin B (CytB), an inhibitor of glucose transporters (Basketter and Widdas, 1978) that was shown to inhibit *S. mansoni* glucose transporters SGTP1 and SGTP4 (Skelly et al., 1994) as well as to decrease glucose uptake of this parasite by 80% at 40μM (Krautz-

Peterson et al., 2010). Interestingly, the MTA of schistosomula incubated in HG and 40 $\mu$ M CytB, was higher than that of schistosomula incubated only in the presence of HG and GAL (Figure 5A). In contrast, the MTA of schistosomula incubated in GAL and CytB, was lower than that of schistosomula incubated only in the presence of HG and GAL (Figure 5A). In addition, compared to HG alone, the secretion of lactate was lower when schistosomula were incubated in the presence of CytB (Figure 5B). This result suggests that a compensatory mechanism may exist in schistosome mitochondria to counter for an energy deficit from glycolysis. This mechanism may increase MTA to compensate the decrease in the glucose flow and lactate production. However, when the cells rely only on OXPHOS, as in the presence of GAL, the MTA may be directly related to the glucose uptake (i.e. reduction in glucose uptake will reduce MTA).

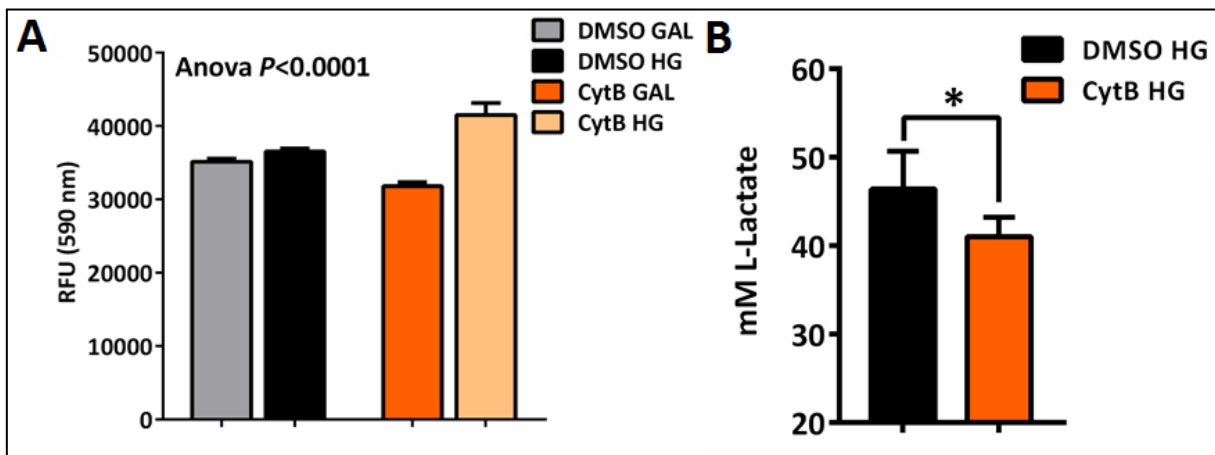

**Figure 5. Panel A. The glucose transporters inhibitor, cytochalasin B (CytB) increases the MTA in HG, but decreases it in GAL. Panel B. CytB decreases the production of lactate in HG.**

### ***SmSirt1*, but not *SmSirt6*, is upregulated upon metabolic transformation in schistosomula**

The above results supported the idea that in HG, MTA is regulated, probably to accomplish energetic functions in different environments (i.e. HG and LG). Human sirtuins 1 and 6 (Sirt1 and 6) are regulators of cellular metabolism. Sirtuin 1 is a known regulator of Hypoxia Inducible Factor (HIF), regulating the activity of both HIF-1 $\alpha$  and HIF-2 $\alpha$  activity (Dioum et al., 2009; Yoon et al., 2014). These transcription factors are involved in the transcriptional regulation of metabolic genes such as PDK1 (Kim et al., 2006; Semenza, 2007; Park et al., 2013). Sirtuin 1 is also a positive regulator of mitochondrial activity (Price et al., 2012). In

addition, Sirt6 was recently found to regulate the switch to aerobic glycolysis in cancer cells (Zhong et al., 2010; Sebastián et al., 2012).

Considering this, we tested: (i) whether sirtuins were involved in the regulation of the expression of glucose transporters, *SPDK1* and LDH in HG (Figure 1B), and (ii) whether sirtuins were involved in the MTA switch in HG (Figure 2). Firstly, we measured the mRNA expression levels of *SmSirt1* and *SmSirt6* after 8h in HG as well as in the cercaria tails (Figure 6). Consistent with previous reports where human Sirt6 was found to be a repressor of glycolytic genes (Zhong et al., 2010; Sebastián et al., 2012) and Sirt1 was found to enhance mitochondrial metabolism (Price et al., 2012), we found significant high levels of *SmSirt6* and *SmSirt1* in cercaria tails consistent with their OXPHOS-based metabolism. However, only *SmSirt1* was found to be upregulated (1.4-fold) in schistosomula in HG after 8h in cultured (Figure 6).

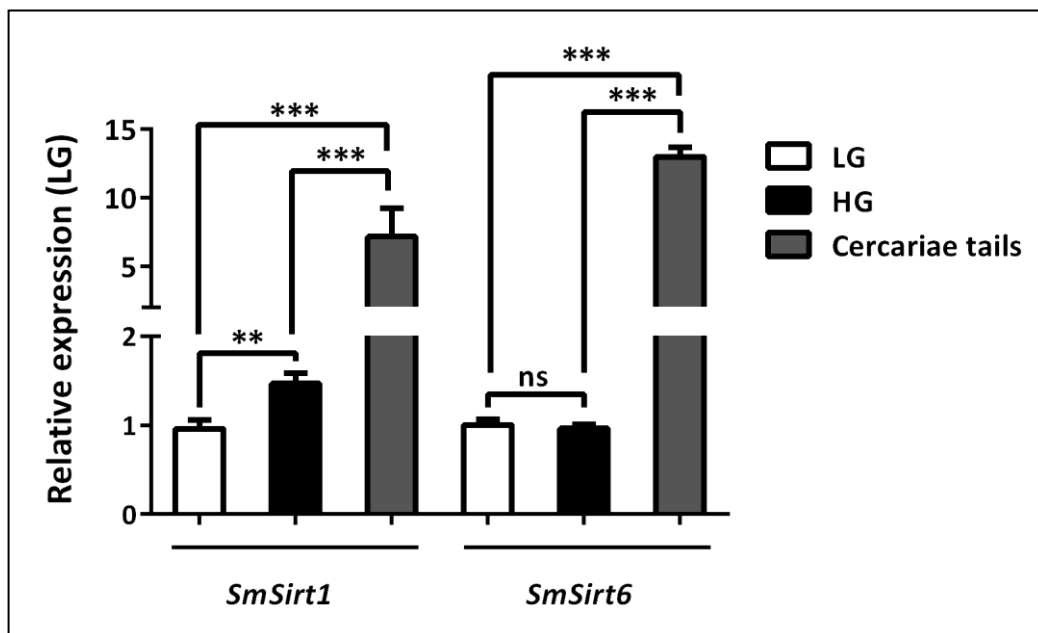
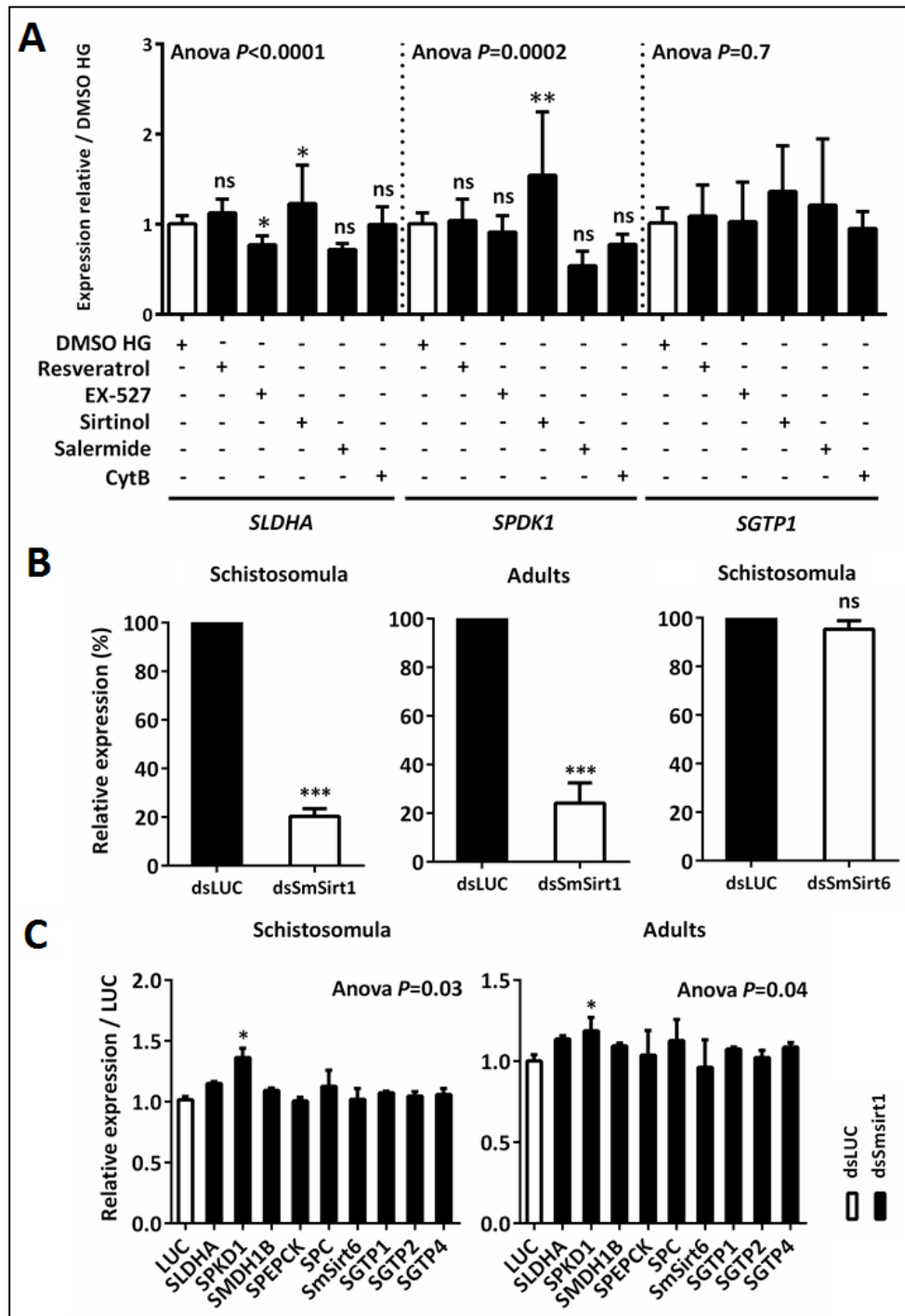

**Figure 6.** Expression of *SmSirt1* and *SmSirt6* was measured by real time PCR. Schistosomula were incubated as in Figure 1. In addition, the expression of these sirtuins was also measured in cercariae tails. Expression values in HG and cercariae tails are relative to LG.



### **SmSirt1 is a repressor of *SPDK1***

Sirtinol and Salermide are known inhibitors of human Sirt1 and Sirt2 (Hu et al., 2014). We have previously shown that sirtuin inhibitors Sirtinol and Salermide induced apoptosis and death of schistosomula, the separation of adult worm pairs, and a reduction in egg laying (Lancelot et al., 2013). Moreover, Salermide treatment led to a marked disruption of the morphology of ovaries and testes, changes that resembled those induced by transcriptional knockdown of SmSirt1 by RNA interference (Lancelot et al., 2013). EX-527 is also an inhibitor of human sirtuins, and is more selective for Sirt1 than for Sirt2 and Sirt3 (Gertz et al., 2013), but is also a potent inhibitor of Sirt6 *in vitro* (Kokkonen et al., 2014). A crystal structure of human Sirt1 in complex with EX-527 has been solved and the amino acid residues involved in the interaction protein-inhibitor were found (Gertz et al., 2013). An alignment of human and *S. mansoni* Sirt1 catalytic domains showed that the amino acid residues involved in the interaction between EX-527 and Sirt1 are conserved in SmSirt1 (Lancelot et al., 2015). To test the role of sirtuins in the regulation of the expression of *SPDK1*, *SGTP1* and *SLDH* upon metabolic transformation, we used the three sirtuin inhibitors above: Salermide, Sirtinol and EX-527. In addition, we used resveratrol, an indirect activator of sirtuin activity (Price et al., 2012). CytB was used as non-epigenetic inhibitor control. As shown in Figure 7A, in the presence of Sirtinol, the expression of *SLDHA* and *SPDK1* was upregulated, but not that of the glucose transporter *SGPT1*. (Figure 7A). To further evaluate the role of sirtuins in the regulation of *SLDH* and *SPDK*, we performed RNA interference (RNAi) using dsRNA specific to *SmSirt1* (Lancelot et al., 2013), and *SmSirt6*. As previously reported using this set of dsRNAs (Lancelot et al., 2013), we obtained a reduction of approx. 80% of *SmSirt1* transcripts in schistosomula (Figure 7B). However, no reduction was observed in *SmSirt6* transcripts using *SmSirt6*-specific dsRNAs in schistosomula. Therefore, only SmSirt1 was used in gene expression analysis using adult worms. Figure 7C shows that *SPDK1* transcripts were moderately, but significantly upregulated in dsSmSirt-treated schistosomula and adult worms. None of the other genes analyzed was significantly regulated (Figure 7C). Altogether, these results suggest that SmSirt1 is a repressor of *PDK1* in *S. mansoni*.



**Figure 7.** Panel A. Expression of glycolytic genes *SLDHA*, *SPDK1* and *SGTP1* of schistosomula in HG and in presence of sirtuin inhibitors (salermide, sirtinol, EX-527) and an activator (resveratrol). CytB was used as a non-epigenetic inhibitor. Only *SPDK1* and *SLDHA* levels increased significantly in the presence of sirtinol. EX-527 produced decrease in the expression of *SLDHA* compared to controls treated with DMSO. Panel B. RNAi led to a reduction of about 80% in the level of transcripts for *SmSirt1*, but not *SmSirt6*, in both schistosomula and adult worms, compared to controls knocked down for the irrelevant luciferase gene (LUC). Panel C. Schistosomula and adults knocked down for *SmSirt1* transcripts express significant higher levels of *SPDK1* transcripts. However, no significant change was observed in the other genes tested: *SLDHA*, *SGTP1*, 2 and 4, *SMDH1B*, *SPEPCK*, *SPC* and *SmSirt6*. Gene abbreviations are available in annex 4.

### SmSirt1 is an activator of mitochondrial activity in *S. mansoni*

Sirtuin 1 has been shown to stimulate the mitochondrial activity of mammalian cells (Price et al., 2012). In addition, the mitochondrial activation function of resveratrol was shown to be mediated by Sirt1 (Price et al., 2012). Therefore, we evaluated the effect of SmSirt1 on the mitochondrial activity of schistosomula. In both HG and GAL, salermide and sirtinol, but not EX-527 inhibited the MTA of schistosomula (Figure 8AB). In addition, *SmSirt1* knockdown also significantly decreased the MTA after 48h of incubation (Figure 8C). In contrast, sirtuin inhibitors did not have a significant effect on lactate production at 48h (Figure 8D).

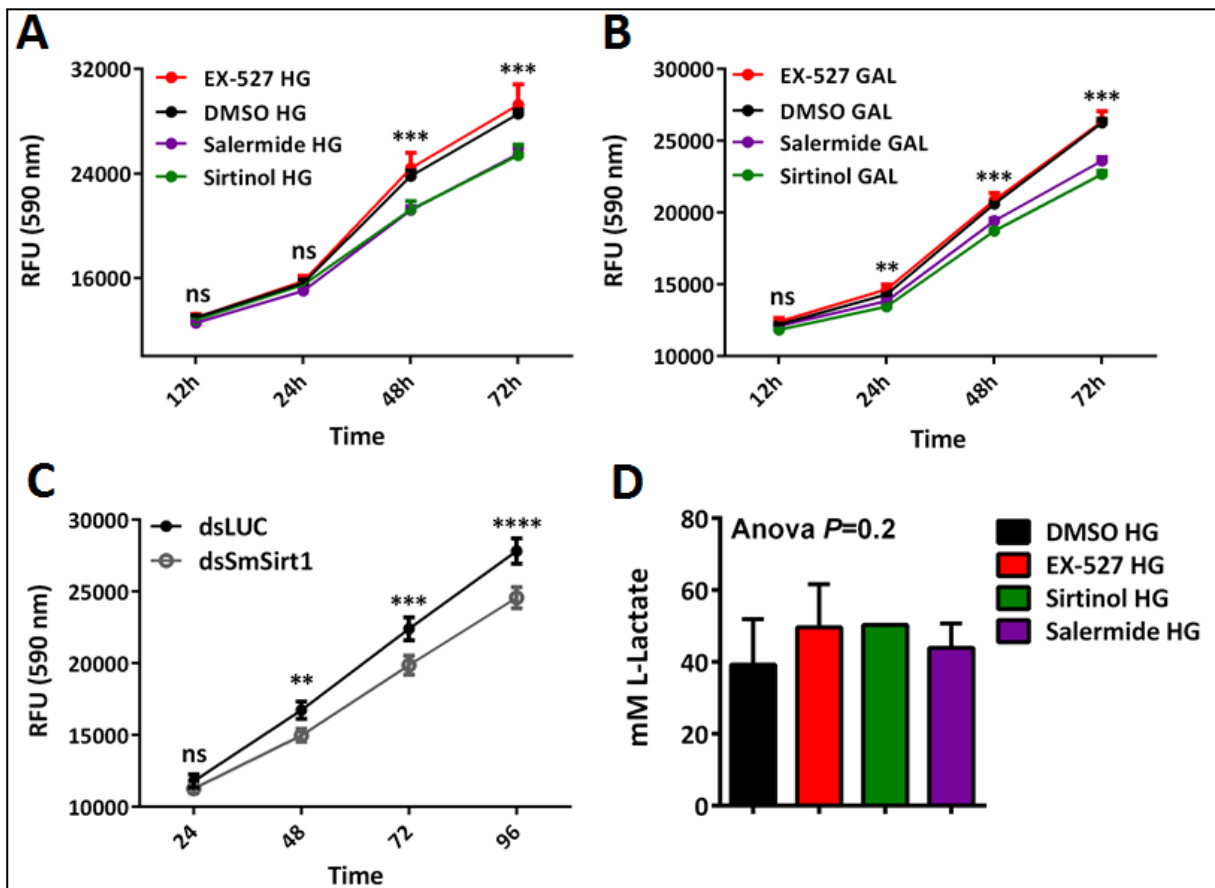

Figure 8. Panel AB. MTA of schistosomula in presence of sirtuin inhibitors and in HG (A) and GAL (B). Only salermide and sirtinol significantly decreased MTA in HG and GAL. Panel C. MTA of *SmSirt1*-knockdown schistosomula (dsSmSirt1) compared to that of the control dsLUC-treated schistosomula. Reduction in *SmSirt1* expression decreased the MTA from 48h. Panel D. To assess whether sirtuin inhibitors have an effect on lactate production, lactate concentration was measured at 48h. No significant effect was observed.

## Discussion

A great deal of attention has been paid to the metabolic switch of *S. mansoni*. Much of the research has focused on the increased aerobic glycolysis (GLY) of schistosomula at high glucose concentration (HG) and in particular on the increase in lactate production that these worms experience in HG conditions. The capacity for GLY is pervasive during the life cycle as it is present in most (if not all) of the life stages of *S. mansoni* such as miracidia (Tielens et al., 1992), sporocyst (Tielens et al., 1992), cercariae (only in the head, Horemans et al., 1991), schistosomula (Horemans et al., 1992) and adult worms (Bueding, 1950). In fact, the survival of *S. mansoni* remains the same in aerobic and anaerobic conditions as long as glucose is present (Schiller et al., 1975), confirming that glucose metabolism is essential for this parasite. Remarkably, at low glucose concentration (LG), the rate of CO<sub>2</sub> production increases (reflecting enhanced TCA), while the rate of lactate production decreases (reflecting diminished GLY). This process is totally reversible and dependent on external glucose concentration (Horemans et al., 1992). It is noteworthy that this dependence on HG to produce lactate may be regarded as a specific feature of schistosomes and not a requirement of energetic metabolism because for example in other worms, such as the nematode *Onchocerca lienalis*, the rate of lactate production is independent of the absence or presence of glucose (Dunn et al., 1988).

Here we showed that HG also induces an increase in OXPHOS measured as the reduction of resazurin by complex IV (Cytochrome c Oxidase) of the respiratory chain in the mitochondria. Interestingly, Horemans and colleagues (1992) showed that in HG, the amount of CO<sub>2</sub> decreased compared to LG. Our results, together with those of Horemans et al. (1992), suggest that in HG, the TCA cycle (where CO<sub>2</sub> is produced) may be diminished, while the OXPHOS may be enhanced. Under aerobic conditions such as that we used to perform our experiments, a contribution of OXPHOS to the energetic balance of the cells is expected. Likewise, in cancer cells under the “*Warburg effect*”, the contribution of OXPHOS to energy balance is substantial (Zheng, 2012).

It is noteworthy that in contrast to GLY, the OXPHOS pathway is not essential for schistosome survival, but to egg production in adult worms (Huang et al., 2012; Pearce and Huang, 2015). Our results showed that after infection in the mammalian host, schistosomula

may be able to use both GLY and OXPHOS to obtain energy or/and metabolic intermediates. In addition, the dramatic increase of *SPDK1* expression in presence of HG and the notable downregulation of this gene in cercariae tails, suggested that the OXPHOS of transformed schistosomula may be decreased relative to that of cercariae tail, where the metabolic switch does not occur (Horemans et al., 1991). The *PDK1* mRNA levels were previously reported to be upregulated (1.8-fold) in HG in pancreatic  $\beta$  cells of mice (Xu et al., 2006). An increase in PDK1 level and activity is expected to reduce the flow of pyruvate to the mitochondria and therefore regulate the mitochondrial metabolism.

However, increasing concentrations of DCA did not increase the mitochondrial activity, suggesting that SPDK1 may not be inhibiting SPDC in HG. Another explanation is that higher concentrations of DCA are needed to inhibit SPDK1 in *Schistosoma*. However, previous studies reported that 500 $\mu$ M (the maximal concentration we used) of DCA were sufficient to induce changes in mitochondrial metabolism (Bonnet et al., 2007). Further studies using other inhibitors of SPDK1, and *SPDK1* gene knockdown by RNAi, should clarify the role of SPDK1 in the mitochondrial function of *S. mansoni*.

Our results showed that the presence of HG induced a metabolic transcriptional reprogramming in schistosomula. This transcriptional reprogramming may be dependent on epigenetic regulation of gene expression. In agreement with this idea, it has been previously shown that the metabolic reprogramming of cancer cells is associated with gene expression regulation by histone modifying enzymes (Lim et al., 2010; Sebastián et al., 2012; Zhong et al., 2010). Particularly, in humans, Sirt1 regulates the expression of glycolytic genes (such as *GLUT1*, *LDHA* and *PDK1*) by regulating the expression and activity of the transcription factor HIF1 $\alpha$  (Lim et al., 2010). Two lines of evidence suggested that SmSirt1 may be a repressor of at least *SPDK1* in HG: (i) *SmSirt1* gene knockdown upregulated the expression of *SPDK1* in both schistosomula and adult worms, (ii) the inhibitors of sirtuins, sirtinol and salermide, upregulated the expression of *SPDK1* in schistosomula. The upregulation of *SPDK1* in HG may seem counterintuitive considering the repressing role of SmSirt1 on *SPDK1* in HG. However, by repressing *SPDK1* expression, SmSirt1 may contribute to the increase in OXPHOS that we observed in HG. Consistent with this role for SmSirt1, we found that the gene *SmSirt1* was upregulated in HG.

Finally, probably one of the main findings of the thesis is that SmSirt1 is a regulator of the mitochondrial activity in *S. mansoni*. That SmSirt1 is an activator of OXPHOS is supported by three lines of evidence: (i) *SmSirt1* gene knockdown decreased OXPHOS in schistosomula, (ii) the inhibitors of sirtuins sirtinol and salermide decreased OXPHOS in schistosomula. Currently, there is consensus in that Sirt1 is a regulator of mitochondrial metabolism (Bernier et al., 2011; Price et al., 2012; Andreux et al., 2013). However, in different models, Sirt1 was found to enhance (Price et al., 2012) or diminish (Bernier et al., 2011) mitochondrial metabolism. The role of Sirt1 in *S. mansoni* seems to be different to that of Sirt1 in murine embryonic fibroblast (MEF) cells (Bernier et al., 2011). In MEF, Sirt1 appears to be a negative regulator of mitochondria activity. In contrast with our results, Bernier and colleagues (2011) reported that *Sirt1* gene knock-out in mice increased mitochondrial metabolism, including OXPHOS (Complex I to IV) activity and ATP production. In addition, ectopic expression of Sirt1 in MEF, reduced ATP production. However, in agreement with a positive regulatory role of Sirt1 on mitochondrial activity, Sirt1 transgenic mouse expressing high level of Sirt1, present maximal respiration (Price et al., 2012). In addition, the activator of Sirt1, resveratrol, induces mitochondrial biogenesis and oxidative capacity. Importantly, the positive effects of resveratrol on mitochondrial metabolism are mediated by Sirt1 (Price et al., 2012). NAD<sup>+</sup> precursors, which are expected to improve the activity of Sirt1, led to SIRT1-dependent mitochondrial activation (Cantó et al., 2012; Cantó and Auwerx, 2012).

## Conclusions

A great deal of attention has been paid to the glycolytic capacity of *S. mansoni* in presence of HG that results in high lactate production and secretion. However, little is known regarding the role of mitochondria on the energetic metabolism of *S. mansoni* and how OXPHOS could balance energetic deficits during infection in the mammalian hosts. Here we showed that the metabolic switch of *S. mansoni* is associated to gene expression reprogramming, and that along with an increase in lactate production, OXPHOS is also enhanced in schistosomula in HG. We further showed evidence that SmSirt1 is a regulator of gene expression (i.e. *SPDK1*)

in *S. mansoni*, and that this sirtuin may be involved in the regulation of OXPHOS activity in this parasite.

## **Materials and methods**

### **Parasite material**

A Puerto Rican strain of *S. mansoni* was maintained in the laboratory using the snail, *Biomphalaria glabrata* as its intermediate host and the golden hamster, *Mesocricetus auratus* as a definitive host. Schistosomula were obtained by mechanical transformation from cercariae released from infected snails as previously reported (Ramalho-Pinto et al., 1974). Schistosomula were washed three times in serum and glucose-free DMEM medium (Life sciences, Carlsbad, USA) supplemented with traces of glucose (0.05mM) then incubated at 37°C, in an atmosphere of 5% CO<sub>2</sub>. After three hours of incubation, glucose or galactose were added to the medium at a concentration of 10mM each, and the schistosomula were incubated for another five hours. A total of 10 000 parasites were used per condition and experiments were carried out in triplicate.

### **RNA isolation and quantitative RT-PCR**

Total RNA was isolated from the different stages of *S. mansoni* with TRIzol reagent (Invitrogen, Carlsbad, USA) according to the manufacturer's instructions. Complementary DNAs (cDNA) were obtained by reverse transcription of total RNA using the ThermoScript RT-PCR System (Invitrogen, Carlsbad, USA). The cDNAs were then used as templates in triplicate assays for RT-PCR amplification using the KAPA SYBR FAST ABI Prism kit (Kapa Biosystems, Boston, USA), and ABI PRISM 7000 sequence detection system. We used previously reported primers for *S. mansoni* *sgtp1* and *sgtp4* (Krautz-Peterson et al., 2010). The primers of metabolic genes used in this study are shown in Annex 6. The ratios of relative expression were calculated using the  $2^{-\Delta\Delta C_t}$  ratio (Pfaffl, 2001) with *S. mansoni*  $\alpha$ -tubulin as the endogenous control gene (Lancelot et al., 2013). The statistical significance between groups was evaluated using the unpaired non-parametric Mann Whitney's test in the GraphPad 6

Prism program (GraphPad Software Inc.). Differences were considered significant when *p*-value < 0.05.

### **RNA interference in schistosomula and adult worms**

The design and generation of *SmSirt1*-dsRNA templates and adult worms transformation were previously reported (Lancelot et al., 2013). Briefly, two fragments of 500 bp *SmSirt1*-dsRNA templates were generated by PCR using gene targeted primers containing T7 promoter sequences. The same procedure was used to generate *SmSirt6*-dsRNA templates with the primers (forward FSirt6dsRNA3 5' CCCAACAAAGGAGTTTGTGGTT 3' / reverse RSirt6dsRNA3 5' AGCTTCCTCTGCAACACCG 3') designed for this study. A luciferase dsRNA template of equivalent size was generated similarly using the pGL3-basic plasmid (Promega) as template. dsRNA was prepared and purified using the Megascript RNAi kit (Ambion) according to the manufacturer's instructions. To deliver the dsRNA, 10 000 schistosomula were soaked into the medium containing 25 µg dsRNA, and 8 adult worms/group in 100 mL M199 medium containing 25 µg dsRNA, were electroporated in a 4 mm cuvette by applying a square wave with a single 20 ms impulse, at 125 V and at room temperature. Parasites were then transferred to 4 mL complete M199. After two days in culture, 2 mL of medium was removed and 2 mL of fresh complete M199 culture medium was added. Gene knockdown was monitored by qRT-PCR 5 days after dsRNA treatment as described above. Three independent experiments were carried out. The statistical significance of the level of *SmSirt1* transcript knockdown was evaluated using Student's t-test in the GraphPad Prism programme (GraphPad Software Inc.).

### **Inhibitors and resveratrol**

All inhibitors were added to the medium at the same time as 10mM glucose. So, that the metabolic switch occurred in the presence of the drug. Sirtuin inhibitors, Sirtinol and Salermide were used at 20µM final concentration as previously reported (Lancelot et al., 2013). EX-527, an inhibitor of sirtuins (Gertz et al., 2013), as well as resveratrol, an activator of sirtuin activity (Andreux et al., 2013; Hubbard and Sinclair, 2014), were used at 20µM final concentration. Glucose transporters inhibitor, Cytochalasin B was used at 40µM final



concentration as previously reported (Krautz-Peterson et al., 2010). Serial dilutions of respiratory chain complex III inhibitor, antimycin A (Dröse and Brandt, 2008), were prepared ranging from 0 to 500µM final concentration. Serial dilutions of pyruvate kinase 1 inhibitor, dichloroacetate DCA (Bonnet et al., 2007), were prepared ranging from 0 to 500µM final concentration.

### **Alamar blue assay for mitochondrial activity**

Alamar blue assay was previously used to test mitochondrial activity in *S. mansoni* schistosomula (Protasio et al., 2013). Alamar blue incorporates a colour indicator of metabolic activity of the mitochondrial function (Springer et al., 1998; Nakai et al., 2003; Zhang et al., 2004) and has been previously used to assess the viability of schistosomula (Mansour and Bickle, 2010). In order to assess metabolic activity of schistosomula, 100 schistosomula were placed on 96-well dark-bottom plates in a final volume of 200µl. Alamar blue (ThermoFisher, UK) was immediately added (20µl per well) and schistosomula were incubated for at least 3h prior measurement. Absorbance was measured at 530 and 590 wavelength excitation and emission, respectively, using the Infinite 200 PRO microplate reader (TECAN, Grödig, Austria). Data collection was performed using the Data Analysis Software Magellan (TECAN, Grödig, Austria). The absorbance values were reported as Relative Fluorescence Units (RFU). Mean blank RFU (RFU of wells with only medium) was subtracted from RFU of each experimental condition and corrected RFU was calculated. T-test and two-way Anova were used to evaluate the significance between mean absorbance at single-time points or multime measurements.

### **Lactate production assay**

Schistosomula were placed on 96-well plates in a final volume of 200µl per well. 100 Schistosomula were added per well. After 8h or 48h incubation time, 10µl of supernatant were extracted and used for L-lactate detection using the Glycolysis Cell-Based Assay Kit following the producer's recommendations (Cayman chemical, Ann Arbor, MI, USA). This kit is a colorimetric method for detecting extracellular L-lactate. The absorbance was read at 490nm using the Infinite 200 PRO microplate reader (TECAN, Grödig, Austria). Data

collection was performed using the Data Analysis Software Magellan (TECAN, Grödig, Austria). Mean blank absorbance (absorbance of wells with only medium) was subtracted from absorbance of each experimental condition and corrected absorbance was calculated. L-lactate concentration (mM) was then calculated as  $((\text{absorbance} - (\text{y-intercept of the standard curve})) / \text{slope of the standard curve}) \times 1$ . T-test and two-way Anova were used to evaluate the significance between mean absorbance at single-time points or multiple measurements.

# **CHAPTER III**

## **GENERAL DISCUSSION**

The particular results of the thesis were previously discussed within each section as follows: “Schistosome glucose transporters” (pages 84-104) and “Role of sirtuins in the mitochondrial metabolism of *S. mansoni*” (pages 125-127). Therefore, in this chapter, we will discuss briefly three major points: (i) why is SmSirt1 not a regulator of the expression of schistosome class I glucose transporters?, (ii) how our results of increased OXPHOS in HG (expressed as an increased in the reductive capacity of complex IV), complement those by Horemans et al. (1992) of decreased TCA (expressed as a decreased in the production of CO<sub>2</sub>) in HG, and (iii) the necessity to integrate the knowledge on GLY and OXPHOS to better understand schistosomes metabolism.

Sirtuins are major regulators of gene expression in eukaryotic cells, with both direct and indirect effects on transcriptional regulation (Dai and Faller, 2008). Notably, human sirtuins (i.e. Sirt1 and Sirt6) regulate cell metabolism by regulating the expression of major glycolytic genes (e.g. *PK1*, *GLUT1* and *LDHA*), which in turn regulate the glycolytic flow (Zhong et al., 2010; Sebastián et al., 2012; Lappas et al., 2012). However, we did not find evidence that SmSirt1 is a regulator of the expression of *SGTP1*. Firstly, the sirtuin activator Resveratrol, or sirtuin inhibitors (EX-527, Sirtinol and Salermide) did not affect significantly the expression of *SGTP1*. In addition, SmSirt1 knockdown in schistosomula did not affect the expression of this gene. In contrast, the expression of *SPDK1* was significantly affected by Salermide and SmSirt1 knockdown. *Schistosoma mansoni* *SGTP1* was previously shown to transport glucose and was suggested to be homolog of human GLUT1 (Skelly et al., 1994; Jiang et al., 1996). However, our phylogenetic analysis does not support the homology between *SGTP1* and GLUT1, nor the classification of *SGTP1* and *SGTP4* as class I glucose transporters (Cabezas-Cruz et al., 2015; see Chapter II of the present thesis). Rather, it appears that *SGTP1* and *SGTP4* are included in a group of platyhelminth-specific glucose transporters (Cabezas-Cruz et al., 2015). We found that *SGTP2* and *SGTP3*, which apparently do not transport glucose, are the class I glucose transporter homologs in *S. mansoni* (Skelly et al., 1994; Cabezas-Cruz et al., 2015). Considering this evolutionary disparity between human and schistosome glucose transporters, it is not surprising that SmSirt1 is not a regulator of *SGTP1* expression in *S. mansoni*.

When contrasting our results with those of Horemans et al. (1992), an interesting property emerges in the glucose metabolism of *S. mansoni*. This is, in HG, while the the TCA

decreases (i.e. evidenced by a decrease in the production of CO<sub>2</sub>, Horemans et al., 1992), the OXPHOS seems to increase compared to LG. This is contrary to the expectation that a reduction in the NADH produced by the TCA, will also reduce the OXPHOS and the ATP levels (Donohoe et al., 2011). For example, decreased TCA cycle function of mitochondria isolated from human colonocytes (cells of the colon), resulted in decreased NADH/NAD<sup>+</sup> ratio and diminished OXPHOS (Donohoe et al., 2011).

The synthesis (from isocitrate) and degradation (to succinate) of  $\alpha$ -ketoglutarate by isocitrate dehydrogenase and  $\alpha$ -ketoglutarate dehydrogenase, respectively, are associated with the production of both CO<sub>2</sub> and NADH in the TCA cycle. Therefore, a decrease in the activity of any of these two enzymes should be associated with a decrease in the production of both CO<sub>2</sub> and NADH. If the reduction of CO<sub>2</sub> production observed by Horemans et al. (1992) is caused by a reduction in the activity of isocitrate dehydrogenase and/or  $\alpha$ -ketoglutarate dehydrogenase, then we should expect a decrease in NADH and therefore a decrease in OXPHOS. However, the reactions catalyzed by malate dehydrogenase and succinate dehydrogenase also produce reduced intermediates (NADH and FADH<sub>2</sub>, respectively) that fuel the OXPHOS but do not produce CO<sub>2</sub>. Therefore, enhancement in the expression or/and activity of malate dehydrogenase and/or succinate dehydrogenase increases protonated substrates of the OXPHOS. The production of CO<sub>2</sub>-free NADH and FADH<sub>2</sub> could account for the increase in OXPHOS that we observed in HG. Interestingly, in HG we observed downregulation of both cytoplasmic and mitochondrial malate dehydrogenase genes (*SMDH1A*, *SMDH1B* and *SMDH2*). Although this finding cannot be taken as direct evidence of reduced activity of these enzymes in HG, the high levels of expression of these genes in cercarial tails is indicative.

Notably, succinate dehydrogenase (or succinate-coenzyme Q reductase or respiratory complex II) is the only enzyme that participates in both the TCA and OXPHOS. Complex II is not able to pump protons, but passes electrons to coenzyme Q. Coenzyme Q receives electrons from both Complex I (which accepts electrons from NADH) and complex II (which accepts electrons from succinate and FADH<sub>2</sub>). Subsequently, coenzyme Q passes electrons to complex III, which passes them to cytochrome c (cyt c), and cyt c passes electrons to Complex IV. Thus, through complex II, the TCA can fuel the OXPHOS based on FADH<sub>2</sub> and bypass the need for NADH produced by isocitrate dehydrogenase and/or  $\alpha$ -ketoglutarate

dehydrogenase. An alternative possibility is that oxaloacetate from GLY, enters the mitochondria via malate which is later reduced to succinate by a fumarate reductase activity of complex II, which is present in several helminths (Tielens, 1994), including *Ascaris suum* (Kita et al., 2002), and notably *S. mansoni* sporocysts (Van Hellemond et al., 1997).

Following our results and those by Horemans et al. (1992) we present a model to explain the mitochondrial metabolism of schistosomula in HG. The pyruvate produced in glycolysis is mainly diverted to lactate production, and the amount of pyruvate that enters the mitochondria is minimal. In consequence the TCA is not highly active and therefore the production of CO<sub>2</sub> diminishes compared to LG. This should be associated with a decrease in the activity of CO<sub>2</sub>-producing enzymes such as the pyruvate dehydrogenase complex, isocitrate dehydrogenase and  $\alpha$ -ketoglutarate dehydrogenase. On the other hand, the activity of complex II should be enhanced. It was recently shown that fatty acid oxidation is major contributor to TCA in *S. mansoni* (Huang et al., 2012; Pearce and Huang, 2015). Succinyl-CoA, the substrate of the enzyme succinyl-CoA synthase to produce succinate can be produced by  $\beta$ -oxidation. We propose that succinyl-CoA resulting from  $\beta$ -oxidation enters the TCA and enhances the activity of succinyl-CoA synthase and succinate dehydrogenase. This results in an increased capacity of complex II to fuel OXPHOS bypassing complex I and the need for NADH. In agreement with this model, the activity of isocitrate dehydrogenase in adult worms is only 6% of that reported for *S. mansoni* cercariae (Smith and Brown, 1977), and this was regarded as "*the largest difference between cercarial and adult enzymes*" (Coles, 1973).

A long-standing controversy in the study of cancer metabolism has been whether the glucose taken from the environment is exclusively degraded to lactic acid in the cytoplasm or whether part of it enters the mitochondria and contributes to OXPHOS (Garber, 2006; Jose et al., 2011). A similar controversy is evident in the literature on the metabolism of *S. mansoni* (McManus, 1989). Initially, it was demonstrated by Bueding (1950) that the predominant (if not exclusive) pathway of carbohydrate metabolism in schistosomes was GLY with high excretion of lactic acid. In my opinion this paper shaped the future research on *S. mansoni* metabolism because it provided, for parasitic helminths, the timely parallel to Otto Warburg's theory on cancer metabolism (i.e. *Warburg effect*). In consequence, as for the "*Warburg effect*" in cancer, the idea that "*adult schistosomes are homolactate*

*fermenters and derive no energy from oxidative metabolism*" has been the paradigm of *S. mansoni* metabolism since then. In contrast, Coles reported in 1972 that *S. mansoni* has a functional OXPHOS and it produces one quarter of the energy in adult worms. Currently, it is widely accepted that during the life cycle, *S. mansoni* uses GLY and OXPHOS in different proportions (Tielens, 1994). However, little is known about the contribution of OXPHOS to the energetic metabolism in mammalian stages of the parasite. More importantly, we do not know how GLY and OXPHOS are reciprocally regulated during infection in mammals. Remarkably, one study quantified in details the contribution of GLY and TCA to the metabolism of glucose during the infection of *S. mansoni* in hamsters (Van Oordt et al., 1988). In this study, it was noted that a distinction exists between the immediate transition after arrival to the host (and the new environment) and the long-term adaptations to it. Within the first 5 hours, the worms switched from a fully aerobic to a largely anaerobic energy metabolism (Van Oordt et al., 1988). Interestingly, the contribution of TCA to carbohydrate breakdown decreased from 6% (by 5h postinfection) to 2.5% (after 3 weeks postinfection). It would be interesting to test whether OXPHOS increases, decreases or does not change in time compared to our results at 8h from adding glucose to the medium.

Interesting insights on cell metabolism have been gained from the study of the interplay between GLY and OXPHOS in tumor cells (Jose et al., 2011). The schematic view of an absolute fermentative tumor (i.e. the "*Warburg effect*") is changing toward a mechanistic view in which OXPHOS and GLY components complement and regulate each other to provide the tumor with a remarkable metabolic plasticity. Definitely, the study of the metabolism in *S. mansoni* would benefit from such integrative approach. In addition, the contribution of different organs or tissues of the parasite to GLY or/and OXPHOS should be evaluated. For example, it was recently proposed that mature vitellocytes may be especially dependent of the use of OXPHOS.

# **CONCLUSIONS**



- 1. The glucose transporters of *Schistosoma mansoni* followed different evolutionary paths. While class I glucose transporters SGTP2 and SGTP3 appear to have lost the function of glucose transport, this function evolved independently in SGTP1 and SGTP4.**
- 2. The molecular dynamics of SGTP1 and SGTP4 while transporting glucose is different to that of human GLUT1. This difference can be exploited for drug design.**
- 3. After metabolic transformation in HG, the OXPHOS of schistosomula increases.**
- 4. SmSirt1 is a repressor of *SPDK1* expression in schistosomula and adult worms.**
- 5. SmSirt1 is a positive regulator of mitochondrial activity in schistosomula in HG.**

# **PERSPECTIVES**

- The differences of functional molecular dynamics between schistome and human glucose transporters should be exploited for anti-schistosomal drug design.
- Our results open new roads of research on the regulation of the metabolic switch in *S. mansoni*.
- To confirm the results regarding the increase of OXPHOS after metabolic transformation in HG, further studies should measure this phenomenon using methods different to the Alamar Blue assay.
- To test of role of SPDK1 in the regulation of mitochondrial function in HG, different SPDK1 inhibitors should be used as well as *SPDK1*-knockdown experiments using RNAi.
- The relationship between mitochondrial activity and lactate production should be evaluated.

# REFERENCES

## - A -

Agatsuma T. Origin and evolution of *Schistosoma japonicum*. *Parasitol Int.* 2003; 52(4):335-40.

Ahn BH, Kim HS, Song S, Lee IH, Liu J, Vassilopoulos A, Deng CX, Finkel T. A role for mitochondrial deacetylase Sirt3 in regulating energy homeostasis. *Proc Natl Acad Sci USA.* 2008; 105(38):4447-52.

Anastasiou E, Lorentz KO, Stein GJ, Mitchell PD. Prehistoric schistosomiasis parasite found in the Middle East. *Lancet Infect Dis.* 2014; 14(7):553-4.

Anderson L, Pierce RJ, Verjovski-Almeida S. *Schistosoma mansoni* histones: from transcription to chromatin regulation; an in silico analysis. *Mol Biochem Parasitol.* 2012; 183(2):105-14.

Andreux PA, Houtkooper RH, Auwerx J. Pharmacological approaches to restore mitochondrial function. *Nat Rev Drug Discov.* 2013; 12(6):465-83.

Anisimova M, Gascuel O. Approximate likelihood-ratio test for branches: A fast, accurate, and powerful alternative. *Syst Biol.* 2006; 55(4):539-52.

Armstrong RL, Wilson JE, Shoemaker CB. Purification and characterization of the hexokinase from *Schistosoma mansoni*, expressed in *Escherichia coli*. *Protein Expr Purif.* 1996; 8(3):374-80.

Arnold K, Bordoli L, Kopp J, Schwede T. The SWISS-MODEL Workspace: A web-based environment for protein structure homology modelling. *Bioinformatics.* 2006; 22(2):195-201.

Arrowsmith CH, Bountra C, Fish PV, Lee K, Schapira M. Epigenetic protein families: a new frontier for drug discovery. *Nat Rev Drug Discov.* 2012; 11(5):384-400.

Atilgan AR, Durell SR, Jernigan RL, Demirel MC, Keskin O, Bahar I. Anisotropy of Fluctuation Dynamics of Proteins with an Elastic Network Model. *Biophys J.* 2001; 80(1):505-15.

Augustin R. The protein family of glucose transport facilitators: It's not only about glucose after all. *IUBMB Life.* 2010; 62(5):315-33.

Azzi A, Cosseau C, Grunau C. *Schistosoma mansoni*: developmental arrest of miracidia treated with histone deacetylase inhibitors. *Exp Parasitol.* 2009; 121(3):288-91.

## - B -

Badeaux AI, Shi Y. Emerging roles for chromatin as a signal integration and storage platform. *Nat Rev Mol Cell Biol.* 2013; 14(4):211-24.

Bantscheff M, Hopf C, Savitski MM, Dittmann A, Grandi P, Michon AM, Schlegl J, Abraham Y, Becher I, Bergamini G, Boesche M, Delling M, Dümpelfeld B, Eberhard D, Huthmacher C, Mathieson T, PoECKel D, Reader V, Strunk K, Sweetman G, Kruse U, Neubauer G, Ramsden NG, Drewes G. Chemoproteomics profiling of HDAC inhibitors reveals selective targeting of HDAC complexes. *Nature Biotechnol.* 2011; 29(3):255-65.

Barber MF, Michishita-Kioi E, Xi Y, Tasselli L, Kioi M, Moqtaderi Z, Tennen RI, Paredes S, Young NL, Chen K, Struhl K, Garcia BA, Gozani O, Li W, Chua KF. SIRT7 links H3K18 deacetylation to maintenance of oncogenic transformation. *Nature.* 2012; 487(7405):114-8.

Bates P, Kelley L, MacCallum R, Sternberg M. Enhancement of Protein Modelling by Human Intervention in Applying the Automatic Programs 3D-JIGSAW and 3D-PSSM. *Proteins.* 2001; 5:39-46.

Baubec T, Schübeler D. Genomic patterns and context-specific interpretation of DNA methylation. *Genet Dev.* 2014; 25:85-92.

Benkert P, Künzli M, Schwede T. QMEAN server for protein model quality estimation. *Nucleic Acids Res.* 2009; 37(Web Server issue):W510-4.

Berg J M, Tymoczko J L, Stryer L. 2002. *Biochemistry*, 5th edition. New York: W H Freeman Press.

Berjanskii M, Zhou J, Liang Y, Lin G, Wishart D. Resolution-by-proxy: a simple measure for assessing and comparing the overall quality of NMR protein structures. *J Biomol NMR.* 2012; 53(3):167-80.

Bernier M, Paul RK, Martin-Montalvo A, Scheibye-Knudsen M, Song S, He HJ, Armour SM, Hubbard BP, Bohr VA, Wang L, Zong Y, Sinclair DA, de Cabo R. Negative regulation of STAT3 protein-mediated cellular respiration by SIRT1 protein. *J Biol Chem.* 2011; 286(22):19270-9.

Berriman M, Haas BJ, LoVerde PT, Wilson RA, Dillon GP, Cerqueira GC, Mashiyama ST, Al-Lazikani B, Andrade LF, Ashton PD, Aslett MA, Bartholomeu DC, Blandin G, Caffrey CR, Coghlan A, Coulson R, Day TA, Delcher A, DeMarco R, Djikeng A, Eyre T, Gamble JA, Ghedin E, Gu Y, Hertz-Fowler C, Hirai H, Hirai Y, Houston R, Ivens A, Johnston DA, Lacerda D, Macedo CD, McVeigh P, Ning Z, Oliveira G, Overington JP, Parkhill J, Pertea M, Pierce RJ, Protasio AV, Quail MA, Rajandream MA, Rogers J, Sajid M, Salzberg SL, Stanke M, Tivey AR, White O, Williams DL, Wortman J, Wu W, Zamanian M, Zerlotini A, Fraser-Liggett CM, Barrell BG, El-Sayed NM. The genome of the blood fluke *Schistosoma mansoni*. *Nature.* 2009; 460(7253):352-8.

Bertin B, Oger F, Cornette J, Caby S, Noël C, Capron M, Fantappie MR, Rumjanek FD, Pierce RJ. *Schistosoma mansoni* CBP/P300 has a conserved domain structure and interacts functionally with the nuclear receptor SmFtz-F1. *Mol Biochem Parasitol.* 2006; 146(2):180-91.

Boles E. 2002. Yeast as a model system for studying glucose transport. In Transmembrane transporters. New Jersey: John Wiley & Sons Press.

Bonnet S, Archer SL, Allalunis-Turner J, Haromy A, Beaulieu C, Thompson R, Lee CT, Lopaschuk GD, Puttagunta L, Bonnet S, Harry G, Hashimoto K, Porter CJ, Andrade MA, Thebaud B, Michelakis ED. A mitochondria-K<sup>+</sup> channel axis is suppressed in cancer and its normalization promotes apoptosis and inhibits cancer growth. *Cancer Cell*. 2007; 11(1):37-51.

Borhani D, Shaw D. The future of molecular dynamics simulations in drug discovery. *J Comput Aided Mol Des*. 2012; 26(1):15-26.

Borrelli K, Vitalis A, Alcantara R, Guallar V. PELE: Protein energy landscape exploration. A novel Monte Carlo based technique. *J Chem Theory Comput*. 2005; 1(6):1304-11.

Bos R, van Der Hoeven JJ, van Der Wall E, van Der Groep P, van Diest PJ, Comans EF, Joshi U, Semenza GL, Hoekstra OS, Lammertsma AA, Molthoff CF. Biologic correlates of (18)fluorodeoxyglucose uptake in human breast cancer measured by positron emission tomography. *J Clin Oncol*. 2002; 20(2):379-87.

Bout D, Dupas H, Capron M, Gazawi AE, Carlier Y, Delacourte A, Capron A. Purification, immunochemical and biological characterization of malate dehydrogenase of *Schistosoma mansoni*. *Immunochemistry*. 1978; 15(9):633-8.

Bowers EM, Yan G, Mukherjee C, Orry A, Wang L, Holbert MA, Crump NT, Hazzalin CA, Liszczak G, Yuan H, Larocca C, Saldanha SA, Abagyan R, Sun Y, Meyers DJ, Marmorstein R, Mahadevan LC, Alani RM, Cole PA. Virtual ligand screening of the p300/CBP histone acetyltransferase: identification of a selective small molecule inhibitor. *Chem Biol*. 2010; 17(5):471-82.

Boyle JP, Shoemaker CB, Yoshino TP. Using RNA interference to manipulate endogenous gene expression in *Schistosoma mansoni* sporocysts. *Mol Biochem Parasitol*. 2003; 128(2):205-15.

Brazier JB, Jaffe JJ. Two types of pyruvate kinase in schistosomes and filariae. *Comp Biochem Physiol B*. 1973; 44(1):145-55.

Brockmann K. The expanding phenotype of GLUT1-deficiency syndrome. *Brain Dev*. 2009; 31(7):545-52.

Brooks CL, Gu W. How does SIRT1 affect metabolism, senescence and cancer? *Nat Rev Cancer*. 2009; 9(2):123-8.

Brown C, Todd K, Rosenzweig R. Multiple duplications of yeast hexose transport genes in response to selection in a glucose-limited environment. *Mol Biol Evol*. 1998; 15(8):931-42.

Bruce JI, Ruff MD, Chiu JK, Howard L. *Schistosoma mansoni* and *Schistosoma japonicum*: oxygen uptake by miracidia. *Exp Parasitol*. 1971; 30(1):124-31.

Brunet J, Pfaff AW, Hansmann Y, Gregorowicz G, Pesson B, Abou-Bacar A, Candolfi E. An unusual case of hematuria in a French family returning from Corsica. *Int J Infect Dis.* 2015; 31:59-60.

Bueding E, Fisher J. Metabolic requirements of schistosomes. *J Parasitol.* 1982; 68(2):208-12.

Bueding E, Mackinnon JA. Hexokinases of *Schistosoma mansoni*. *J Biol Chem.* 1955a; 215(2):495-506.

Bueding E, Mackinnon JA. Studies of the phosphoglucose isomerase of *Schistosoma mansoni*. *J Biol Chem.* 1955b; 215(2):507-13.

Bueding E, Mansour JM. The relationship between inhibition of phosphofructokinase activity and the mode of action of trivalent organic antimonials on *Schistosoma mansoni*. *Br J Pharmacol Chemother.* 1957; 12(2):159-65.

Bueding E, Saz HJ. Pyruvate kinase and phosphoenolpyruvate carboxykinase activities of *Ascaris* muscle, *Hymenolepis diminuta* and *Schistosoma mansoni*. *Comp Biochem Physiol.* 1968; 24(2):511-8.

Bueding E. Carbohydrate metabolism of *Schistosoma mansoni*. *J Gen Physiol.* 1950; 33(5): 475–95.

## - C -

Cabezas-Cruz A, Lancelot J, Caby S, Oliveira G, Pierce RJ. Epigenetic control of gene function in schistosomes: a source of therapeutic targets? *Front Genet.* 2014; 5:317.

Cabezas-Cruz A, Valdés JJ, Lancelot J, Pierce RJ. Fast evolutionary rates associated with functional loss in class I glucose transporters of *Schistosoma mansoni*. *BMC Genomics.* 2015; 16:980.

Cai P, Hou N, Piao X, Liu S, Liu H, Yang F, Wang J, Jin Q, Wang H, Chen Q. Profiles of small non-coding RNAs in *Schistosoma japonicum* during development. *PLoS Negl Trop Dis.* 2011; 5(8):e1256.

Cairns R, Harris IS, Mak TW. Regulation of cancer cell metabolism. *Nat Rev Cancer.* 2011; 11(2):85-95.

Camacho M, Agnew A. Glucose uptake rates by *Schistosoma mansoni*, *S. haematobium*, and *S. bovis* adults using a flow in vitro culture system. *J Parasitol.* 1995; 81(4):637-40.

Cantó C, Auwerx J. NAD<sup>+</sup> as a signaling molecule modulating metabolism. *Cold Spring Harb Symp Quant Biol.* 2011; 76:291-8.

Cantó C, Auwerx J. Targeting sirtuin 1 to improve metabolism: all you need is NAD(+)? *Pharmacol Rev.* 2012; 64(1):166-87.



Cantó C, Houtkooper RH, Pirinen E, Youn DY, Oosterveer MH, Cen Y, Fernandez-Marcos PJ, Yamamoto H, Andreux PA, Cettour-Rose P, Gademann K, Rinsch C, Schoonjans K, Sauve AA, Auwerx J. The NAD(+) precursor nicotinamide riboside enhances oxidative metabolism and protects against high-fat diet-induced obesity. *Cell Metab.* 2012; 15(6):838-47.

Carneiro VC, de Abreu da Silva IC, Torres EJ, Caby S, Lancelot J, Vanderstraete M, Furdas SD, Jung M, Pierce RJ, Fantappiè MR. Epigenetic changes modulate schistosome egg formation and are a novel target for reducing transmission of schistosomiasis. *PLoS Pathog.* 2014; 10(5):e1004116.

Castresana J. Selection of conserved blocks from multiple alignments for their use in phylogenetic analysis. *Mol Biol Evol.* 2000; 17(4):540-52.

Cavalier-Smith T. 1987. *Evolutionary Biology of the Fungi: Symposium of the British Mycological Society.* Cambridge: Cambridge University Press.

Cen Y. Sirtuin inhibitors: the approach to affinity and selectivity. *Biochim Biophys Acta.* 2010; 1804(8): 1635-44.

Chabasse D, Bertrand G, Leroux JP, Gauthey N, Hocquet P. Developmental bilharziasis caused by *Schistosoma mansoni* discovered 37 years after infestation. *Bull Soc Pathol Exot.* 1985; 78(5):643-7.

Chalkiadaki A, Guarente L. The multifaceted functions of sirtuins in cancer. *Nat Rev Cancer.* 2015; 15(10):608-24.

Charrier-Ferrara S, Caillol D, Goudot-Crozel V. Complete sequence of the *Schistosoma mansoni* glyceraldehyde-3-phosphate dehydrogenase gene encoding a major surface antigen. *Mol Biochem Parasitol.* 1992; 56(2):339-43.

Chen T, Ning D, Sun H, Li R, Shang M, Li X, Wang X, Chen W, Liang C, Li W, Mao Q, Li Y, Deng C, Wang L, Wu Z, Huang Y, Xu J, Yu X. Sequence analysis and molecular characterization of *Clonorchis sinensis* hexokinase, an unusual trimeric 50-kDa glucose-6-phosphate-sensitive allosteric enzyme. *PLoS One.* 2014; 9(9):e107940.

Cheng J, Baldi P. A machine learning information retrieval approach to protein fold recognition. *Bioinformatics.* 2006; 22(12):1456-63.

Chitsulo L, Loverde P, Engels D. Schistosomiasis. *Nat Rev Microbiol.* 2004; 2(1):12-3.

Choi J-E, Mostoslavsky R. Sirtuins, metabolism and DNA repair. *Curr Opin Genet Dev.* 2014; 26:24-32.

Chung CW, Coste H, White JH, Mirguet O, Wilde J, Gosmini RL, Delves C, Magny SM, Woodward R, Hughes SA, Boursier EV, Flynn H, Bouillot AM, Bamborough P, Brusq JM, Gellibert FJ, Jones EJ, Riou AM, Homes P, Martin SL, Uings IJ, Toum J, Clement CA, Boullay AB, Grimley RL, Blandel FM, Prinjha RK, Lee K, Kirilovsky J, Nicodeme E. Discovery and characterization of small molecule inhibitors of the BET family bromodomains. *J Med Chem.* 2011; 54(11):3827-38.

- Coeli R, Baba EH, Araujo N, Coelho PM, Oliveira G. Praziquantel Treatment Decreases *Schistosoma mansoni* genetic diversity in experimental infections. PLoS Negl Trop Dis. 2103; 7(12):e2596.
- Coles GC. Oxidative phosphorylation in adult *Schistosoma mansoni*. Nature. 1972; 240(5382):488-9.
- Coles GC. Enzyme levels in cercariae and adult *Schistosoma mansoni*. Int J Parasitol. 1973; 3(4):505-10.
- Colley DG, Bustinduy AL, Secor WE, King CH. Human schistosomiasis. Lancet. 2014; 383(9936):2253-64.
- Cornford EM, Fitzpatrick AM, Quirk TL, Diep CP, Landaw EM. Tegumental glucose permeability in male and female *Schistosoma mansoni*. J Parasitol. 1988; 74(1):116-28.
- Cornford EM, Oldendorf WH. Transintegumental uptake of metabolic substrates in male and female *Schistosoma mansoni*. J Parasitol. 1979; 65(3):357-63.
- Cornford EM. Influence of mating on surface nutrient exchange in schistosomes. J Chem Ecol. 1986; 12(8):1777-96.
- Cosentino C, Grieco D, Costanzo V. ATM activates the pentose phosphate pathway promoting anti-oxidant defence and DNA repair. EMBO J. 2010; 30(3):546-55.
- Costantini S, Sharma A, Raucci R, Costantini M, Autiero I, Colonna G. Genealogy of an ancient protein family: the Sirtuins, a family of disordered members. BMC Evol Biol. 2013; 13:1-19.
- Costinean S, Zanesi N, Pekarsky Y, Tili E, Volinia S, Heerema N, Croce CM. Pre-B cell proliferation and lymphoblastic leukemia /high grade lymphoma in E $\mu$ -miR155 transgenic mice. Proc Natl Acad Sci USA. 2006; 103(18):7024-9.
- Crabtree HG. The carbohydrate metabolism of certain pathological overgrowths. Biochem J. 1928; 22(5):1289-98.
- Crabtree HG. Observations on the carbohydrate metabolism of tumors. Biochem. J. 1929; 23(3):536-45.
- Csibi A, Fendt SM, Li C, Poulogiannis G, Choo AY, Chapski DJ, Jeong SM, Dempsey JM, Parkhitko A, Morrison T, Henske EP, Haigis MC, Cantley LC, Stephanopoulos G, Yu J, Blenis J. The mTORC1 pathway stimulates glutamine metabolism and cell proliferation by repressing SIRT4. Cell. 2013; 153(4):840-54.

- D -

- Da'dara A, Krautz-Peterson G, Faghiri Z, Skelly PJ. Metabolite movement across the schistosome surface. J Helminthol. 2012; 86(2):141-7.

Da'dara A, Li YS, Xiong T, Zhou J, Williams GM, McManus DP, Feng Z, Yu XL, Gray DJ, Harn DA. DNA-based vaccines protect against zoonotic schistosomiasis in water buffalo. *Vaccine*. 2008; 26(29-30):3617-25.

Dai Y, Faller DV. Transcription Regulation by Class III Histone Deacetylases (HDACs)-Sirtuins. *Transl Oncogenomics*. 2008; 3:53-65.

Daigle SR, Olhava EJ, Therkelsen CA, Basavapathruni A, Jin L, Boriack-Sjodin PA, Allain CJ, Klaus CR, Raimondi A, Scott MP, Waters NJ, Chesworth R, Moyer MP, Copeland RA, Richon VM, Pollock RM. Potent inhibition of DOT1L as treatment for MLL-fusion leukemia. *Blood*. 2013; 122(6):1017-25.

Davis GM. Snail hosts of Asian *Schistosoma* infecting man: origin and coevolution. *Malacol Rev Suppl*. 1980; 2: 195–238.

Davis GM. Evolution of prosobranch snails transmitting Asian *Schistosoma*; coevolution with *Schistosoma*: a review. *Prog Clin Parasitol*. 1992; 3: 145–204.

Day TA, Bennet JL, Pax RA. Praziquantel: the enigmatic antiparasitic. *Parasitol Today*. 1992; 8:342-4.

De Deken RH. The Crabtree effect: a regulatory system in yeast. *J Gen Microbiol*. 1966; 44(2):149-56.

de la Torre-Escudero E, Manzano-Román R, Pérez-Sánchez R, Siles-Lucas M, Oleaga A. Cloning and characterization of a plasminogen-binding surface-associated enolase from *Schistosoma bovis*. *Vet Parasitol*. 2010; 173(1-2):76-84.

de Laval F, Savini H, Biance-Valero E, Simon F. Human schistosomiasis: an emerging threat for Europe. *Lancet*. 2014; 384(9948):1094-5.

de Moraes Maciel R, da Costa RF, de Oliveira FM, Rumjanek FD, Fantappiè MR. Protein acetylation sites mediated by *Schistosoma mansoni* GCN5. *Biochem Biophys Res Commun*. 2008; 370(1):53-6.

Deardorff MA, Bando M, Nakato R, Watrin E, Itoh T, Minamino M, Saitoh K, Komata M, Katou Y, Clark D, Cole KE, De Baere E, Decroos C, Di Donato N, Ernst S, Francey LJ, Gyftodimou Y, Hirashima K, Hullings M, Ishikawa Y, Jaulin C, Kaur M, Kiyono T, Lombardi PM, Magnaghi-Jaulin L, Mortier GR, Nozaki N, Petersen MB, Seimiya H, Siu VM, Suzuki Y, Takagaki K, Wilde JJ, Willems PJ, Prigent C, Gillessen-Kaesbach G, Christianson DW, Kaiser FJ, Jackson LG, Hirota T, Krantz ID, Shirahige K. HDAC8 mutations in Cornelia de Lange syndrome affect the cohesin acetylation cycle. *Nature*. 2012; 489(7415):313-7.

Delpont W, Poon A, Frost S, Kosakovsky P. Datamonkey 2010: a suite of phylogenetic analysis tools for evolutionary biology. *Bioinformatics*. 2010; 26(19):2455-7.

Deng D, Sun P, Yan C, Ke M, Jiang X, Xiong L, Ren W, Hirata K, Yamamoto M, Fan S, Yan N. Molecular basis of ligand recognition and transport by glucose transporters. *Nature*. 2015; 526(7573):391-6.

Deng D, Xu C, Sun P, Wu J, Yan C, Hu M, Yan N. Crystal structure of the human glucose transporter GLUT1. *Nature*. 2014; 510(7503):121-5.

Di Palo B, Ripa V, Santi I, Brettoni C, Muzzi A, Metruccio MM, Grifantini R, Telford JL, Paccani SR, Soriani M. Adaptive response of Group B streptococcus to high glucose conditions: new insights on the CovRS regulation network. *PLoS One*. 2013; 8(4):e61294.

Dillon GP, Feltwell T, Skelton JP, Ashton PD, Coulson PS, Quail MA, Nikolaidou-Katsaridou N, Wilson RA, Ivens AC. Microarray analysis identifies genes preferentially expressed in the lung schistosomulum of *Schistosoma mansoni*. *Int J Parasitol*. 2006; 36(1):1-8.

Ding J, Su JG, Mansour TE. Cloning and characterization of a cDNA encoding phosphofructokinase from *Schistosoma mansoni*. *Mol Biochem Parasitol*. 1994; 66(1):105-10.

Disch JS, Evindar G, Chiu CH, Blum CA, Dai H, Jin L, Schuman E, Lind KE, Belyanskaya SL, Deng J, Coppo F, Aquilani L, Graybill TL, Cuzzo JW, Lavu S, Mao C, Vlasuk GP, Perni RB. Discovery of thieno[3,2-d]pyrimidine-6-carboxamides as potent inhibitors of SIRT1, SIRT2, and SIRT3. *J Med Chem*. 2013; 56(9):3666-79.

Dissous C, Grevelding CG. Piggy-backing the concept of cancer drugs for schistosomiasis treatment: a tangible perspective? *Trends Parasitol*. 2010; 27(2):59-66.

Doenhoff M, Cioli D, Utzinger J. Praziquantel: mechanisms of action, resistance and new derivatives for schistosomiasis. *Curr Opin Infect Dis*. 2008; 21(6):659-67.

Donohoe DR, Garge N, Zhang X, Sun W, O'Connell TM, Bunger MK, Bultman SJ. The microbiome and butyrate regulate energy metabolism and autophagy in the mammalian colon. *Cell Metab*. 2011; 13(5):517-26.

Doong YC, Wong LJ, Bruce JI, Wong SS. Enzymatic differences between hycanthone-resistant and sensitive strains of *Schistosoma mansoni*. *Comp Biochem Physiol B*. 1987; 87(3):459-64.

Douzery E, Snell E, Baptiste E, Delsuc F, Philippe H. The timing of eukaryotic evolution: does a relaxed molecular clock reconcile proteins and fossils? *Proc Natl Acad Sci USA*. 2004; 101(43):15386-91.

Dowden J, Hong W, Parry RV, Pike RA, Ward SG. Toward the development of potent and selective bisubstrate inhibitors of protein arginine methyltransferases. *Bioorg Med Chem Lett*. 2010; 20(7):2103-5.

Dröse S, Brandt U. The mechanism of mitochondrial superoxide production by the cytochrome bc1 complex. *J Biol Chem*. 2008; 283(31):21649-54.

Du J, Jiang H, Lin H. Investigating the ADP-ribosyltransferase activity of sirtuins with NAD analogs and <sup>32</sup>P-NAD. *Biochemistry*. 2009; 48(13):2878-90.

Du J, Zhou Y, Su X, Yu JJ, Khan S, Jiang H, Kim J, Woo J, Kim JH, Choi BH, He B, Chen W, Zhang S, Cerione RA, Auwerx J, Hao Q, Lin H. Sirt5 is a NAD-dependent protein lysine demalonylase and desuccinylase. *Science*. 2011; 334(6057):806-9.

Dubois F, Caby S, Oger F, Cosseau C, Capron M, Grunau C, Dissous C, Pierce RJ. Histone deacetylase inhibitors induce apoptosis, histone hyperacetylation and up-regulation of gene expression in *Schistosoma mansoni*. Mol Biochem Parasitol. 2009; 168(1):7-15.

Dunn TS, Raines PS, Barrett J, Butterworth PE. Carbohydrate metabolism in *Onchocerca gutturosa* and *Onchocerca lienalis* (Nematoda: Filarioidea). Int J Parasitol. 1988; 18(1):21-6.

Dupuy F, Tabariès S, Andrzejewski S, Dong Z, Blagih J, Annis MG, Omeroglu A, Gao D, Leung S, Amir E, Clemons M, Aguilar-Mahecha A, Basik M, Vincent EE, St-Pierre J, Jones RG, Siegel PM. PDK1-Dependent Metabolic Reprogramming Dictates Metastatic Potential in Breast Cancer. Cell Metab. 2015; 22(4):577-89.

Duraisingh MT, Voss TS, Marty AJ, Duffy MF, Good RT, Thompson JK, Freitas-Junior LH, Scherf A, Crabb BS, Cowman AF. Heterochromatin silencing and locus repositioning linked to regulation of virulence genes in *Plasmodium falciparum*. Cell. 2005; 121(1):13-24.

## - E -

Eder J, Sedrani R, Wiesmann C. The discovery of first-in-class drugs: origins and evolution. Nat Rev Drug Discov. 2014; 13(8):577-87.

Edgar R. MUSCLE: multiple sequence alignment with high accuracy and high throughput. Nucleic Acids Res. 2004; 32(5):1792-7.

Egger B, Lapraz F, Tomiczek B, Müller S, Dessimoz C, Girstmair J, Škunca N, Rawlinson KA, Cameron CB, Beli E, Todaro MA, Gammoudi M, Noreña C, Telford MJ. A transcriptomic-phylogenomic analysis of the evolutionary relationships of flatworms. Curr Biol. 2015; 25(10):1347-53.

El-Bassiouni EA, Helmy MH, Saad EI, El-Nabi Kamel MA, Abdel-Meguid E, Hussein HS. Modulation of the antioxidant defence in different developmental stages of *Schistosoma mansoni* by praziquantel and artemether. Br J Biomed Sci. 2007; 64(4):168-74.

Eiring AM, Harb JG, Neviani P, Garton C, Oaks JJ, Spizzo R, Liu S, Schwind S, Santhanam R, Hickey CJ, Becker H, Chandler JC, Andino R, Cortes J, Hokland P, Huettner CS, Bhatia R, Roy DC, Liebhaber SA, Caligiuri MA, Marcucci G, Garzon R, Croce CM, Calin GA, Perrotti D. miR-328 functions as an RNA decoy to modulate hnRNP E2 regulation of mRNA translation in leukemic blasts. Cell. 2010; 140(5):652-65.

## - F -

Fagan RL, Cryderman DE, Kopelovich L, Wallrath LL, Brenner C. Laccaic acid A is a direct, DNA-competitive inhibitor of DNA methyltransferase 1. *J Biol Chem.* 2013; 288(33):23858-67.

Faghiri Z, Camargo SM, Huggel K, Forster IC, Ndegwa D, Verrey F, Skelly PJ. The tegument of the human parasitic worm *Schistosoma mansoni* as an excretory organ: the surface aquaporin SmAQP is a lactate transporter. *PLoS One.* 2010; 5(5):e10451.

Fallon PG, Doenhoff MJ. Drug-resistant schistosomiasis: resistance to praziquantel and oxamniquine induced in *Schistosoma mansoni* in mice is drug specific. *Am J Trop Med Hyg.* 1994; 51(1):83-8.

Fantappi  MR, Bastos de Oliveira FM, de Moraes Maciel R, Rumjanek FD, Wu W, Loverde PT. Cloning of SmNCoA-62, a novel nuclear receptor co-activator from *Schistosoma mansoni*: assembly of a complex with a SmRXR1/SmNR1 heterodimer, SmGCN5 and SmCBP1. *Int J Parasitol.* 2008; 38(10):1133-47.

Fantappi  MR, Gimba ER, Rumjanek FD. Lack of DNA methylation in *Schistosoma mansoni*. *Exp Parasitol.* 2001; 98(3):162-6.

Feldman JL, Dittenhafer-Reed KE, Denu JM. Sirtuin catalysis and regulation. *J Biol Chem.* 2012; 287(51):42419-27.

Felsenstein J. Phylogenies from molecular sequences: Inference and reliability. *Annu Rev Genet.* 1988; 22:521-565.

Fenwick A, Jourdan P. Schistosomiasis elimination by 2020 or 2030? *Int J Parasitol.* 2016. In press.

Fenwick A, Webster JP, Bosque-Oliva E, Blair L, Fleming FM, Zhang Y, Garba A, Stothard JR, Gabrielli AF, Clements AC, Kabatereine NB, Toure S, Dembele R, Nyandindi U, Mwansa J, Koukounari A. The Schistosomiasis Control Initiative (SCI): rationale, development and implementation from 2002-2008. *Parasitology.* 2009; 136(13):1719-30.

Filippakopoulos P, Knapp S. Targeting bromodomains: epigenetic readers of lysine acetylation. *Nat Rev Drug Discov.* 2014; 13(5):337-56.

Filippakopoulos P, Qi J, Picaud S, Shen Y, Smith WB, Fedorov O, Morse EM, Keates T, Hickman TT, Felletar I, Philpott M, Munro S, McKeown MR, Wang Y, Christie AL, West N, Cameron MJ, Schwartz B, Heightman TD, La Thangue N, French CA, Wiest O, Kung AL, Knapp S, Bradner JE. Selective inhibition of BET bromodomains. *Nature.* 2011; 468(7327):1067-73.

Finley LW, Carracedo A, Lee J, Souza A, Egia A, Zhang J, Teruya-Feldstein J, Moreira PI, Cardoso SM, Clish CB, Pandolfi PP, Haigis MC. SIRT3 opposes reprogramming of cancer cell metabolism through HIF1 alpha destabilization. *Cancer Cell.* 2011; 19(3):416-28.

Finnin MS, Donigian JR, Pavletich NP. Structure of the histone deacetylase SIRT2. *Nat Struct Biol.* 2001; 8(7):621-5.

Ford E, Voit R, Liszt G, Magin C, Grummt I, Guarente L. Mammalian Sir2 homolog SIRT7 is an activator of RNA polymerase I transcription. *Genes Dev.* 2006; 20(9):1075-80.

Forsberg H, Ljungdahl P. Sensors of extracellular nutrients in *Saccharomyces cerevisiae*. *Curr Genet.* 2001; 40(2):91-109.

Fromm B, Worren MM, Hahn C, Hovig E, Bachmann L. Substantial loss of conserved and gain of novel microRNA families in flatworms. *Mol Biol Evol.* 2013; 30(12):2619-28.

Frye RA. Phylogenetic classification of prokaryotic and eukaryotic Sir2-like proteins. *Biochem Biophys Res Commun.* 2000; 273(2):793-8.

Furdas SD, Shekfeh S, Bissinger EM, Wagner JM, Schlimme S, Valkov V, Hendzel M, Jung M, Sippl W. Synthesis and biological testing of novel pyridoisothiazolones as histone acetyltransferase inhibitors. *Bioorg Med Chem.* 2011; 19(12):3678-89.

## - G -

Garber K. Energy deregulation: licensing tumors to grow. *Science.* 2006; 312(5777):1158-9.

Gatenby RA, Gillies RJ. Why do cancers have high aerobic glycolysis? *Nat Rev Cancer.* 2004; 4(11):891-9.

Gertz M, Fischer F, Nguyen GT, Lakshminarasimhan M, Schutkowski M, Weyand M, Steegborn C. Ex-527 inhibits Sirtuins by exploiting their unique NAD<sup>+</sup>-dependent deacetylation mechanism. *Proc Natl Acad Sci USA.* 2013; 110(30):E2772-81.

Geyer KK, Chalmers IW, Mackintosh N, Hirst JE, Geoghegan R, Badets M, Brophy PM, Brehm K, Hoffmann KF. Cytosine methylation is a conserved epigenetic feature found throughout the phylum Platyhelminthes. *BMC Genomics.* 2013; 14:462.

Geyer KK, Rodríguez López CM, Chalmers IW, Munshi SE, Truscott M, Heald J, Wilkinson MJ, Hoffmann KF. Cytosine methylation regulates oviposition in the pathogenic blood fluke *Schistosoma mansoni*. *Nat Commun.* 2011; 2:424.

Ghizzoni M, Haisma HJ, Dekker FJ. Reactivity of isothiazolones and isothiazolone-1-oxides in the inhibition of PCAF histone acetyltransferase. *Eur J Med Chem.* 2009; 44(12):4855-61.

Goll MG, Kirpekar F, Maggert KA, Yoder JA, Hsieh CL, Zhang X, Golic KG, Jacobsen SE, Bestor TH. Methylation of tRNA Asp by the DNA methyltransferase homolog Dnmt2. *Science*. 2006; 311(5759):395-8.

Goudot-Crozel V, Caillol D, Djabali M, Dessein AJ. The major parasite surface antigen associated with human resistance to schistosomiasis is a 37-kD glyceraldehyde-P-dehydrogenase. *J Exp Med*. 1989; 170(6):2065-80.

Gregoretto IV, Lee YM, Goodson HV. Molecular evolution of the histone deacetylase family: functional implications of phylogenetic analysis. *J Mol Biol*. 2004; 338(1):17-31.

Greiss S, Gartner A. Sirtuin/Sir2 Phylogeny, Evolutionary Considerations and Structural Conservation. *Mol Cells*. 2009; 28(5):407-15.

Guarente L. Calorie restriction and sirtuins revisited. *Genes Dev*. 2013; 27(19):2072-85.

Guerra-Sá R, Franco GR, Pena SD, Rodrigues V. Lactate dehydrogenase: sequence and analysis of its expression during the life cycle of *Schistosoma mansoni*. *Mem Inst Oswaldo Cruz*. 1998; 93(Suppl 1):205-6.

Gurarie D, Yoon N, Li E, Ndeffo-Mbah M, Durham D, Phillips AE, Aurelio HO, Ferro J, Galvani AP, King CH. Modelling control of *Schistosoma haematobium* infection: predictions of the long-term impact of mass drug administration in Africa. *Parasit Vectors*. 2015; 8:529.

## - H -

Haigis MC, Mostoslavsky R, Haigis KM, Fahie K, Christodoulou DC, Murphy AJ, Valenzuela DM, Yancopoulos GD, Karow M, Blander G, Wolberger C, Prolla TA, Weindruch R, Alt FW, Guarente L. SIRT4 inhibits glutamate dehydrogenase and opposes the effects of calorie restriction in pancreatic beta cells. *Cell*. 2006; 126(5):941-54.

Hao L, Cai P, Jiang N, Wang H, Chen Q. Identification and characterization of microRNAs and endogenous siRNAs in *Schistosoma japonicum*. *BMC Genomics*. 2010; 11:55.

Helin K, Dhanak D. Chromatin proteins and modifications as drug targets. *Nature*. 2013; 502(7472):480-8.

Hermann A, Schmitt S, Jeltsch A. The human Dnmt2 has residual DNA-(cytosine-C5) methyltransferase activity. *J Biol Chem*. 2003; 278(34):31717-21.

Herranz D, Muñoz-Martin M, Cañamero M, Mulero F, Martinez-Pastor B, Fernandez-Capetillo O, Serrano M. Sirt1 improves healthy ageing and protects from metabolic syndrome-associated cancer. *Nat Commun*. 2010; 1:3.



Hewings DS, Rooney TP, Jennings LE, Hay DA, Schofield CJ, Brennan PE, Knapp S, Conway SJ. Progress in the development and application of small molecule inhibitors of bromodomain-acetyl-lysine interactions. *J Med Chem.* 2012; 55(22):9393-413.

Hirschey MD, Shimazu T, Goetzman E, Jing E, Schwer B, Lombard DB, Grueter CA, Harris C, Biddinger S, Ilkayeva OR, Stevens RD, Li Y, Saha AK, Ruderman NB, Bain JR, Newgard CB, Farese RV Jr, Alt FW, Kahn CR, Verdin E. SIRT3 regulates mitochondrial fatty-acid oxidation by reversible enzyme deacetylation. *Nature.* 2010; 464(7285):121-5.

Hojfeldt JW, Agger K, Helin K. Histone lysine demethylases as targets for anticancer therapy. *Nat Rev Drug Discov.* 2013; 12(12):917-30.

Holm L, Rosenström P. Dali server: conservation mapping in 3D. *Nucl Acids Res.* 2010; 38 (Web Server issue):545-549.

Holt CA, Roth AE. The Nash equilibrium: a perspective. *Proc Natl Acad Sci USA.* 2004; 101(12):3999-4002.

Holtfreter MC, Moné H, Müller-Stöver I, Mouahid G, Richter J. *Schistosoma haematobium* infections acquired in Corsica, France, August 2013. *Euro Surveill.* 2014; 19(22): 20821.

Horemans AM, Tielens AG, van den Bergh SG. The transition from an aerobic to an anaerobic energy metabolism in transforming *Schistosoma mansoni* cercariae occurs exclusively in the head. *Parasitology.* 1991; 102(2):259-65.

Horemans AM, Tielens AG, van den Bergh SG. The reversible effect on the energy metabolism of *Schistosoma mansoni* cercariae and schistosomula. *Mol Biochem Parasitol.* 1992; 51(1):73-9.

Hornstein L, Lederer G, Schechter J, Greenberg Z, Boem R, Bilguray B, Giladi L, Hamburger J. Persistent *Schistosoma mansoni* infection in Yemeni immigrants to Israel. *Isr J Med Sci.* 1990; 26(7):386-9.

Houtkooper RH, Pirinen E, Auwerx J. Sirtuins as regulators of metabolism and healthspan. *Nat Rev Mol Cell Biol.* 2012; 13(4):225-38.

Huang S, Czech MP. The GLUT4 glucose transporter. *Cell Metab.* 2007; 5(4): 237–52.

Huang SC, Freitas TC, Amiel E, Everts B, Pearce EL, Lok JB, Pearce EJ. Fatty acid oxidation is essential for egg production by the parasitic flatworm *Schistosoma mansoni*. *PLoS Pathog.* 2012; 8(10):e1002996.

Huang SY, Zhang QM, Li XH, Deng ZH. Distribution and schistosomiasis transmission risks of *Biomphalaria straminea* in inland China. *Zhongguo Xue Xi Chong Bing Fang Zhi Za Zhi.* 2014; 26(3):235-7.

Huang J, Hao P, Chen H, Hu W, Yan Q, Liu F, Han ZG. Genome-wide identification of *Schistosoma japonicum* microRNAs using a deep-sequencing approach. *PLoS One.* 2009; 4(12):e8206.

Hubbard BP, Sinclair DA. Small molecule SIRT1 activators for the treatment of aging and age-related diseases. *Trends Pharmacol Sci.* 2014; 35(3):146-54.

Hubbert C, Guardiola A, Shao R, Kawaguchi Y, Ito A, Nixon A, Yoshida M, Wang XF, Yao TP. HDAC6 is a microtubule-associated deacetylase. *Nature*. 2002; 417(6887):455-8.

Humphrey W, Dalke A, Schulten K. VMD - Visual Molecular Dynamics. *J Molec Graphics*. 1996; 14:33-38.

- I -

Iwahara T, Bonasio R, Narendra V, Reinberg D. SIRT3 functions in the nucleus in the control of stress-related gene expression. *Mol Cell Biol*. 2012; 32(24):5022-34.

- J -

Jacobson M, Friesner R, Xiang Z, Honig B. On the Role of the Crystal Environment in Determining Protein Side-chain Conformations. *J Mol Biol*. 2002; 320(3):597-608.

Janssen HL, Reesink HW, Lawitz EJ, Zeuzem S, Rodriguez-Torres M, Patel K, van der Meer AJ, Patick AK, Chen A, Zhou Y, Persson R, King BD, Kauppinen S, Levin AA, Hodges MR. Treatment of HCV infection by targeting microRNA. *N Engl J Med*. 2013; 368(18):1685-94.

Jeong SM, Xiao C, Finley LWS, Lahusen T, Souza AL, Pierce K, Li YH, Wang X, Laurent G, German NJ, Xu X, Li C, Wang RH, Lee J, Csibi A, Cerione R, Blenis J, Clish CB, Kimmelman A, Deng CX, Haigis MC. SIRT4 has tumor-suppressive activity and regulates the cellular metabolic response to DNA damage by inhibiting mitochondrial glutamate metabolism. *Cancer Cell*. 2013; 23(4):450-63.

Jiang H, Khan S, Wang Y, Charron G, He B, Sebastian C, Du J, Kim R, Ge E, Mostoslavsky R, Hang HC, Hao Q, Lin H. SIRT6 regulates TNF- $\alpha$  secretion through hydrolysis of long-chain fatty acyl lysine. *Nature*. 2013; 496(7443):110-3.

Jiang J, Skelly P, Shoemaker C, Caulfield J. *Schistosoma mansoni*: the glucose transport protein SGTP4 is present in tegumental multilamellar bodies, discoid bodies, and the surface lipid bilayers. *Exp Parasitol*. 1996; 82(2):201-10.

Jin L, Wei W, Jiang Y, Peng H, Cai J, Mao C, Dai H, Choy W, Bemis JE, Jirousek MR, Milne JC, Westphal CH, Perni RB. Crystal structures of human SIRT3 displaying substrate-induced conformational changes. *J Biol Chem*. 2009; 284(36):24394-405.

Jing E, O'Neill BT, Rardin MJ, Kleinriders A, Ilkeyeva OR, Ussar S, Bain JR, Lee KY, Verdin EM, Newgard CB, Gibson BW, Kahn CR. Sirt3 regulates metabolic flexibility of skeletal muscle through reversible enzymatic deacetylation. *Diabetes*. 2013; 62(10):3404-17.

Johnson J, Newgard C, Milburn J, Lodish H, Thorens B. The high Km glucose transporter of islets of Langerhans is functionally similar to the low affinity transporter of liver and has an identical primary sequence. *J Biol Chem*. 1990; 265(12):6548-51.

Joost HG, Thorens B. The extended GLUT-family of sugar/polyol transport facilitators: nomenclature, sequence characteristics, and potential function of its novel members. *Mol Membr Biol*. 2001; 18(4):247-56.

Jorgensen W, Tirado-Rives J. The OPLS [optimized potentials for liquid simulations] potential functions for proteins, energy minimizations for crystals of cyclic peptides and crambin. *J Am Chem Soc*. 1988; 110:1657-66.

Jose C, Bellance N, Rossignol R. Choosing between glycolysis and oxidative phosphorylation: a tumor's dilemma? *Biochim Biophys Acta*. 2011; 1807(6):552-61.

## - K -

Kaeberlein M, McVey M, Guarente L. The SIR2/3/4 complex and SIR2 alone promote longevity in *Saccharomyces cerevisiae* by two different mechanisms. *Genes Dev*. 1999; 13(19):2570-80.

Kaeberlein M. Lessons on longevity from budding yeast. *Nature*. 2010; 464(7288):513-9.

Kanamori Y, Saito A, Hagiwara-Komoda Y, Tanaka D, Mitsumasu K, Kikuta S, Watanabe M, Cornette R, Kikawada T, Okuda T. The trehalose transporter 1 gene sequence is conserved in insects and encodes proteins with different kinetic properties involved in trehalose import into peripheral tissues. *Insect Biochem Mol Biol*. 2010; 40(1):30-7.

Kane RA, Stothard JR, Emery AM, Rollinson D. Molecular characterization of freshwater snails in the genus *Bulinus*: a role for barcodes? *Parasit Vectors*. 2008; 1(1):15.

Kelley L, Sternberg M. Protein structure prediction on the Web: a case study using the Phyre server. *Nat Protocols*. 2009; 4(3):363-71.

Kikuta S, Kikawada T, Hagiwara-Komoda Y, Nakashima N and Noda H. Sugar transporter genes of the brown planthopper, *Nilaparvata lugens*: A facilitated glucose/fructose transporter. *Insect Biochem Mol Biol*. 2010; 40(11):805-13.

Kim HS, Patel K, Muldoon-Jacobs K, Bisht KS, Aykin-Burns N, Pennington JD, van der Meer R, Nguyen P, Savage J, Owens KM, Vassilopoulos A, Ozden O, Park SH, Singh KK, Abdulkadir SA, Spitz DR, Deng CX, Gius D. SIRT3 is a

mitochondria-localized tumor suppressor required for maintenance of mitochondrial integrity and metabolism during stress. *Cancer Cell*. 2010; 17(1):41-52.

Kim HS, Vassilopoulos A, Wang RH, Lahusen T, Xiao Z, Xu X, Li C, Veenstra TD, Li B, Yu H, Ji J, Wang XW, Park SH, Cha YI, Gius D, Deng CX. SIRT2 maintains genome integrity and suppresses tumorigenesis through regulating APC/C activity. *Cancer Cell*. 2011; 20(4):487-99.

King CH, Dickman K, Tisch DJ. Reassessment of the cost of chronic helminthic infection: a meta-analysis of disability-related outcomes in endemic schistosomiasis. *Lancet*. 2005; 365(9470):1561-9.

King KC, Stelkens RB, Webster JP, Smith DF, Brockhurst MA. Hybridization in Parasites: Consequences for Adaptive Evolution, Pathogenesis, and Public Health in a Changing World. *PLoS Pathog*. 2015; 11(9):e1005098.

Kita K, Hirawake H, Miyadera H, Amino H, Takeo S. Role of complex II in anaerobic respiration of the parasite mitochondria from *Ascaris suum* and *Plasmodium falciparum*. *Biochim Biophys Acta*. 2002; 1553(1-2):123-39.

Kiviranta PH, Suuronen T, Wallén EA, Leppänen J, Tervonen J, Kyrölenko S, Salminen A, Poso A, Jarho EM. N(epsilon)-thioacetyl-lysine-containing tri-, tetra- and pentapeptides as SIRT1 and SIRT2 inhibitors. *J Med Chem*. 2009; 52(7):2153-6.

Klip A, Tsakiridis T, Marette A, Ortiz P. Regulation of expression of glucose transporters by glucose: a review of studies in vivo and in cell cultures. *FASEB J*. 1994; 8(1):43-53.

Kloos H, David R. The paleoepidemiology of schistosomiasis in ancient Egypt. *Hum Ecol Rev*. 2002; 9: 14–25.

Kohn AB, Anderson PA, Roberts-Misterly JM, Greenberg RM. Schistosome calcium channel beta subunits. Unusual modulatory effects and potential role in the action of the antischistosomal drug praziquantel. *J Biol Chem*. 2001; 276(40):36873-6.

Koshland DE. Application of a theory of enzyme specificity to protein synthesis. *Proc Natl Acad Sci USA*. 1958; 44(2):98-104.

Kovacs JJ, Murphy PJ, Gaillard S, Zhao X, Wu JT, Nicchitta CV, Yoshida M, Toft DO, Pratt WB, Yao TP. HDAC6 regulates Hsp90 acetylation and chaperone-dependent activation of glucocorticoid receptor. *Mol Cell*. 2005; 18(5):601-7.

Kraus V, Reuter G. DNA methylation in *Drosophila* – a critical evaluation. *Prog Mol Biol Transf Sci*. 2011; 101:177-91.

Krautz-Peterson G, Simoes M, Faghiri Z, Ndegwa D, Oliveira G, Shoemaker CB, Skelly PJ. Suppressing glucose transporter gene expression in schistosomes impairs parasite feeding and decreases survival in the mammalian host. *PLoS Pathog*. 2010; 6(6):e1000932

Kruidenier L, Chung CW, Cheng Z, Liddle J, Che K, Joberty G, Bantscheff M, Bountra C, Bridges A, Diallo H, Eberhard D, Hutchinson S, Jones E, Katso R, Leveridge M, Mander PK, Mosley J, Ramirez-Molina C, Rowland P,

Schofield CJ, Sheppard RJ, Smith JE, Swales C, Tanner R, Thomas P, Tumber A, Drewes G, Oppermann U, Patel DJ, Lee K, Wilson DM. A selective jumonji H3K27 demethylase inhibitor modulates the proinflammatory macrophage response. *Nature*. 2012; 488(7411):404-8.

Kunkel M, Reichert TE, Benz P, Lehr HA, Jeong JH, Wieand S, Bartenstein P, Wagner W and Whiteside TL. Overexpression of Glut-1 and increased glucose metabolism in tumors are associated with a poor prognosis in patients with oral squamous cell carcinoma. *Cancer*. 2003; 97(4):1015-24.

- L -

Lancelot J, Caby S, Dubois-Abdesselem F, Vanderstraete M, Trolet J, Oliveira G, Bracher F, Jung M, Pierce RJ. *Schistosoma mansoni* Sirtuins: characterization and potential as chemotherapeutic targets. *PLoS Negl Trop Dis*. 2013; 7(9):e2428.

Lancelot J, Cabezas-Cruz A, Caby S, Marek M, Schultz J, Romier C, Sippl W, Jung M, Pierce RJ. Schistosome sirtuins as drug targets. *Future Med Chem*. 2015; 7(6):765-82.

Lappas M, Andrikopoulos S, Permezel M. Hypoxanthine-xanthine oxidase down-regulates GLUT1 transcription via SIRT1 resulting in decreased glucose uptake in human placenta. *J Endocrinol*. 2012; 213(1):49-57.

Lara E, Mai A, Calvanese V, Altucci L, Lopez-Nieva P, Martinez-Chantar ML, Varela-Rey M, Rotili D, Nebbioso A, Ropero S, Montoya G, Oyarzabal J, Velasco S, Serrano M, Witt M, Villar-Garea A, Imhof A, Mato JM, Esteller M, Fraga MF. Salermide, a Sirtuin inhibitor with a strong cancer-specific proapoptotic effect. *Oncogene*. 2009; 28(6):781-91.

Laumer CE, Hejnal A, Giribet G. Nuclear genomic signals of the 'microturbellarian' roots of platyhelminth evolutionary innovation. *Elife*. 2015; 4.

Laurent G, German NJ, Saha AK, de Boer VC, Davies M, Koves TR, Dephore N, Fischer F, Boanca G, Vaitheesvaran B, Lovitch SB, Sharpe AH, Kurland IJ, Steegborn C, Gygi SP, Muoio DM, Ruderman NB, Haigis MC. SIRT4 coordinates the balance between lipid synthesis and catabolism by repressing malonyl CoA decarboxylase. *Mol Cell*. 2013; 50(5):686-98.

Lawson JR, Wilson RA. The survival of the cercariae of *Schistosoma mansoni* in relation to water temperature and glycogen utilization. *Parasitology* 1980; 81(2):337-48.

Lawton SP, Hirai H, Ironside JE, Johnston DA, Rollinson D. Genomes and geography: genomic insights into the evolution and phylogeography of the genus *Schistosoma*. *Parasit Vectors*. 2011; 4:131.

Le S, Gascuel O. An improved general amino acid replacement matrix. *Mol Biol Evol*. 2008; 25(7):1307-20.

Lee KW, Thakur A, Karim AM, LoVerde PT. Immune response to *Schistosoma mansoni* phosphoglycerate kinase during natural and experimental infection: identification of a schistosome-specific B-cell epitope. *Infect Immun.* 1995; 63(11):4307-11.

Li X, Jacobson M, Zhu K, Zhao S, Friesner R. Assignment of polar states for protein amino acid residues using an interaction cluster decomposition algorithm and its application to high resolution protein structure modeling. *Proteins.* 2007; 66(4):824-37.

Li Z, Rana TM. Therapeutic targeting of microRNAs: current status and future challenges. *Nat Rev Drug Discov.* 2014; 13(8):622-38.

Liang YS, Wang W, Dai JR, Li HJ, Tao YH, Zhang JF, Li W, Zhu YC, Coles GC, Doenhoff MJ. Susceptibility to praziquantel of male and female cercariae of praziquantel-resistant and susceptible isolates of *Schistosoma mansoni*. *J Helminthol.* 2010; 84(2):202-7.

Liang YS, Wang W, Hong QB, Dai JR. Risk assessment and control measures for import of African schistosomiasis into China. *Zhongguo Xue Xi Chong Bing Fang Zhi Za Zhi.* 2013; 25(3):221-5.

Libert S, Guarente L. Metabolic and Neuropsychiatric Effects of Calorie Restriction and Sirtuins. *Annu. Rev Physiol.* 2013; 75:669–84.

Lieberman J, Sarnow P. Micromanaging hepatitis C virus. *N Engl J Med.* 2013; 368(18):1741-3.

Lim JH, Lee YM, Chun YS, Chen J, Kim JE, Park JW. Sirtuin1 modulates cellular responses to hypoxia by deacetylating hypoxia-inducible factor 1alpha. *Mol Cell.* 2010; 38(6):864-78.

Ling H, Fabbri M, Calin GA. MicroRNAs and other non-coding RNAs as targets for anticancer drug development. *Nat Rev Drug Discov.* 2013; 12(11):847-65.

Littlewood DT, Waeschenbach A. Evolution: a turn up for the worms. *Curr Biol.* 2015; 25(11):R457-60.

Lodish H, Berk A, Kaiser C A, Krieger M, Scott M P, Bretscher A, Ploegh H, Matsudaira P. 2007. *Molecular Cell Biology*, 6th Edition. New York: W H Freeman Press.

Lunt SY, Vander Heiden MG. Aerobic glycolysis: meeting the metabolic requirements of cell proliferation. *Annu Rev Cell Dev Biol.* 2011; 27:441-64.

## - M -

McManus DP. Carbohydrate and Energy Metabolism in Adult Schistosomes: A Reappraisal. In *Comparative Biochemistry of Parasitic Helminths* (Eds: Bennet EM, Behm C, Bryant C). 1989: pp 79-94

Madadkar-Sobhani A, Guallar V. PELE web server: atomistic study of biomolecular systems at your fingertips. *Nucleic Acids Res.* 2013; 41(Web Server issue):322-8.

Maes T, Tirapu I, Mascaro C, Ortega A, Estiarte A, Valls N. Preclinical characterization of a potent and selective inhibitor of the histone demethylase KDM1A for MLL leukemia. *J Clin Oncol.* 2013; 31:e13543.

Magzoub M, Maegraith BG, Fletcher KA. The oxidative metabolism of *Schistosoma mansoni* and the effects of antischistosomal drugs and cytochrome oxidase inhibitors. *Ann Trop Med Parasitol.* 1971; 65(1):31-44.

Mansour JM, McCrossan MV, Bickle QD, Mansour TE. *Schistosoma mansoni* phosphofructokinase: immunolocalization in the tegument and immunogenicity. *Parasitology.* 2000; 120(5):501-11.

Mansour NR, Bickle QD. Comparison of microscopy and Alamar blue reduction in a larval based assay for schistosome drug screening. *PLoS Negl Trop Dis.* 2010; 4(8):e795.

Mansour TE, Bueding E, Stavitsky AB. The effect of a specific antiserum on the activities of lactic dehydrogenase of mammalian muscle and of *Schistosoma mansoni*. *Br J Pharmacol Chemother.* 1954; 9(2):182-6.

Mansour TE, Bueding E. Kinetics of lactic dehydrogenases of *Schistosoma mansoni* and of rabbit muscle. *Br J Pharmacol Chemother.* 1953; 8(4):431-4.

Marek M, Kannan S, Hauser AT, Moraes Mourão M, Caby S, Cura V, Stolfa DA, Schmidtkunz K, Lancelot J, Andrade L, Renaud JP, Oliveira G, Sippl W, Jung M, Cavarelli J, Pierce RJ, Romier C. Structural basis for the inhibition of histone deacetylase 8 (HDAC8), a key epigenetic player in the blood fluke *Schistosoma mansoni*. *PLoS Pathog.* 2013; 9(9):e1003645.

Marek M, Oliveira G, Pierce RJ, Jung M, Sippl W, Romier C. Drugging the schistosome zinc-dependent HDACs: current progress and future perspectives. *Future Med Chem.* 2015;7(6):783-800.

Martín-Durán JM, Egger B. Developmental diversity in free-living flatworms. *Evodevo.* 2012; 3:7.

Mathias RA, Greco TM, Oberstein A, Budayeva HG, Chakrabarti R, Rowland EA, Kang Y, Shenk T, Cristea IM. Sirtuin 4 is a lipoamidase regulating pyruvate dehydrogenase complex activity. *Cell.* 2014; 159(7):1615-25.

Matsushita N, Yonashiro R, Ogata Y, Sugiura A, Nagashima S, Fukuda T, Inatome R, Yanagi S. Distinct regulation of mitochondrial localization and stability of two human Sirt5 isoforms. *Genes Cells.* 2011; 16(2):190-202.

Maurer B, Rumpf T, Scharfe M, Stolfa DA, Schmitt ML, He W, Verdin E, Sippl W, Jung M. Inhibitors of the NAD(+)-dependent protein desuccinylase and demalonylase Sirt5. *ACS Med Chem Lett.* 2012; 3(12):1050-3.

McCabe MT, Ott HM, Ganji G, Korenchuk S, Thompson C, Van Aller GS, Liu Y, Graves AP, Della Pietra A 3rd, Diaz E, LaFrance LV, Mellinger M, Duquenne C, Tian X, Kruger RG, McHugh CF, Brandt M, Miller WH, Dhanak D, Verma SK, Tummino PJ, Creasy CL. EZH2 inhibition as a therapeutic strategy for lymphoma with EZH2-activating mutations. *Nature.* 2012; 492(7427):108-12.

McCreesh N, Nikulin G, Booth M. Predicting the effects of climate change on *Schistosoma mansoni* transmission in eastern Africa. *Parasit Vectors*. 2015; 8:4.

McGuffin L, Buenavista M, Roche D. The ModFOLD4 server for the quality assessment of 3D protein models. *Nucleic Acids Res*. 2013; 41:368-72.

Melman SD, Steinauer ML, Cunningham C, Kubatko LS, Mwangi IN, Wynn NB, Mutuku MW, Karanja DM, Colley DG, Black CL, Secor WE, Mkoji GM, Loker ES. Reduced susceptibility to praziquantel among naturally occurring Kenyan isolates of *Schistosoma mansoni*. *PLoS Negl Trop Dis*. 2009; 3(8):e504.

Messerli SM, Kasinathan RS, Morgan W, Spranger S, Greenberg RM. *Schistosoma mansoni* P-glycoprotein levels increase in response to praziquantel exposure and correlate with reduced praziquantel susceptibility. *Mol Biochem Parasitol*. 2009; 167(1):54-9.

Metzger E, Wissmann M, Yin N, Müller JM, Schneider R, Peters AH, Günther T, Buettner R, Schüle R. LSD1 demethylates repressive histone marks to promote androgen-receptor-dependent transcription. *Nature*. 2005; 437(7057):436-9.

Michishita E, Park JY, Burneskis JM, Barrett JC, Horikawa I. Evolutionarily conserved and nonconserved cellular localizations and functions of human SIRT proteins. *Mol Biol Cell*. 2005; 16(10):4623-35.

Minárik P, Tomásková N, Kollárová M, Antalík M. Malate dehydrogenases--structure and function. *Gen Physiol Biophys*. 2002; 21(3):257-65.

Moller S, Croning M, Apweiler R. Evaluation of methods for the prediction of membrane spanning regions. *Bioinformatics*. 2001; 17:646-653.

Moné H, Holtfreter MC, Allienne JF, Mintsá-Nguéma R, Ibikounlé M, Boissier J, Berry A, Mitta G, Richter J, Mouahid G. Introgressive hybridizations of *Schistosoma haematobium* by *Schistosoma bovis* at the origin of the first case report of schistosomiasis in Corsica (France, Europe). *Parasitol Res*. 2015; 114(11):4127-33.

Moné H, Holtfreter MC, Mouahid G, Richter J. Difficulties in Schistosomiasis Assessment, Corsica, France. *Emerg Infect Dis*. 2016; 22(4):762-5.

Mostoslavsky R, Chua KF, Lombard DB, Pang WW, Fischer MR, Gellon L, Liu P, Mostoslavsky G, Franco S, Murphy MM, Mills KD, Patel P, Hsu JT, Hong AL, Ford E, Cheng HL, Kennedy C, Nunez N, Bronson R, Frendewey D, Auerbach W, Valenzuela D, Karow M, Hottiger MO, Hursting S, Barrett JC, Guarente L, Mulligan R, Demple B, Yancopoulos GD, Alt FW. Genomic instability and aging-like phenotype in the absence of mammalian SIRT6. *Cell*. 2006; 124(2):315-29.

Mueckler M, Caruso C, Baldwin S, Panico M, Blench I, Morris H, Allard W, Lienhard G, Lodish H. Sequence and structure of a human glucose transporter. *Science*. 1985; 229(4717):941-5.

Mueckler M, Thorens B. The SLC2 (GLUT) family of membrane transporters. *Mol Aspects Med*. 2013; 34(2-3):121-38.



## - N -

Nakagawa M, Oda Y, Eguchi T, Aishima S, Yao T, Hosoi F, Basaki Y, Ono M, Kuwano M, Tanaka M, Tsuneyoshi M. Expression profile of class I histone deacetylases in human cancer tissues. *Oncol Rep.* 2007; 18(4):769-74.

Nakai M, Mori A, Watanabe A, Mitsumoto Y. 1-methyl-4-phenylpyridinium (MPP+) decreases mitochondrial oxidation-reduction (REDOX) activity and membrane potential ( $\Delta\psi$ ) in rat striatum. *Exp Neurol.* 2003; 179(1):103-10.

Napper AD, Hixon J, McDonagh T, Keavey K, Pons JF, Barker J, Yau WT, Amouzegh P, Flegg A, Hamelin E, Thomas RJ, Kates M, Jones S, Navia MA, Saunders JO, DiStefano PS, Curtis R. Discovery of indoles as potent and selective inhibitors of the deacetylase SIRT1. *J Med Chem.* 2005; 48(25):8045-54.

Nash JF. Equilibrium points in N-person games. *Proc Natl Acad Sci USA.* 1950; 36(1):48-9.

Nei M, Kumar S. 2000. *Molecular evolution and Phylogenetics.* New York: Oxford University Press.

Neugebauer RC, Sippl W, Jung M. Inhibitors of NAD<sup>+</sup>-dependent histone deacetylases (sirtuins). *Curr Pharm. Des.* 2008; 14(6):562-73.

Nguyen BA, Strome B, Hua J, Desmond J, Gagnon-Arsenault I, Weiss E, Landry C, Moses A. Detecting functional divergence after gene duplication through evolutionary changes in posttranslational regulatory sequences. *PLoS Comput Biol.* 2014; 10(12):e1003977.

Nicodeme E, Jeffrey KL, Schaefer U, Beinke S, Dewell S, Chung CW, Chandwani R, Marazzi I, Wilson P, Coste H, White J, Kirilovsky J, Rice CM, Lora JM, Prinjha RK, Lee K, Tarakhovsky A. Suppression of inflammation by a synthetic histone mimic. *Nature.* 2010; 468(7327):1119-23.

Nomura N, Verdon G, Kang HJ, Shimamura T, Nomura Y, Sonoda Y, Hussien SA, Qureshi AA, Coincon M, Sato Y, Abe H, Nakada-Nakura Y, Hino T, Arakawa T, Kusano-Arai O, Iwanari H, Murata T, Kobayashi T, Hamakubo T, Kasahara M, Iwata S, Drew D. Structure and mechanism of the mammalian fructose transporter GLUT5. *Nature.* 2015; 526(7573):397-401.

North BJ, Verdin E. Interphase nucleo-cytoplasmic shuttling and localization of SIRT2 during mitosis. *PLoS One.* 2007; 2(8):e784.

Norton AJ, Gower CM, Lamberton PH, Webster BL, Lwambo NJ, Blair L, Fenwick A, Webster JP. Genetic consequences of mass human chemotherapy for *Schistosoma mansoni*: population structure pre- and post-praziquantel treatment in Tanzania. *Am J Trop Med Hyg.* 2010; 83(4):951-7.

Ntziachristos P, Tsirigos A, Welstead GG, Trimarchi T, Bakogianni S, Xu L, Loizou E, Holmfeldt L, Strikoudis A, King B, Mullenders J, Becksfort J, Nedjic J, Paietta E, Tallman MS, Rowe JM, Tonon G, Satoh T, Kruidenier L, Prinjha R, Akira S, Van Vlierberghe P, Ferrando AA, Jaenisch R, Mullighan CG, Aifantis I. Contrasting roles of histone 3 lysine 27 demethylases in acute lymphoblastic leukaemia. *Nature*. 2014; 514(7523):513-7.

- O -

Odhiambo GO, Musuva RM, Atuncha VO, Mutete ET, Odiere MR, Onyango RO, Alaii JA, Mwinzi PN. Low levels of awareness despite high prevalence of schistosomiasis among communities in Nyalenda informal settlement, Kisumu city, western Kenya. *PLoS Negl Trop Dis*. 2014; 8(4):e2784.

Oger F, Dubois F, Caby S, Noël C, Cornette J, Bertin B, Capron M, Pierce RJ. The class I histone deacetylases of the platyhelminth parasite *Schistosoma mansoni*. *Biochem Biophys Res Commun*. 2008; 377(4):1079-84.

Oliveira KC, Carvalho ML, Maracaja-Coutinho V, Kitajima JP, Verjovski-Almeida S. Non-coding RNAs in schistosomes: an unexplored world. *An Acad Bras Cienc*. 2011; 83(2):673-94.

Oryzon Genomics. 2010. Phenylcyclopropylamine derivatives and their medical use. WO/2010/084160.

Outeiro TF, Kontopoulos E, Altmann SM, Kufareva I, Strathearn KE, Amore AM, Volk CB, Maxwell MM, Rochet JC, McLean PJ, Young AB, Abagyan R, Feany MB, Hyman BT, Kazantsev AG. Sirtuin 2 inhibitors rescue alpha-synuclein-mediated toxicity in models of Parkinson's disease. *Science*. 2007; 317(5837):516-9.

- P -

Pan PW, Feldman JL, Devries MK, Dong A, Edwards AM, Denu JM. Structure and biochemical functions of SIRT6. *J Biol Chem*. 2011; 286(16):14575-87.

Park J, Chen Y, Tishkoff DX, Peng C, Tan M, Dai L, Xie Z, Zhang Y, Zwaans BM, Skinner ME, Lombard DB, Zhao Y. SIRT5 –mediated lysine desuccinylation impacts diverse metabolic pathways. *Mol Cell*. 2013; 50(6):919-30.

Parker-Manuel SJ, Ivens AC, Dillon GP, Wilson RA. Gene expression patterns in larval *Schistosoma mansoni* associated with infection of the mammalian host. *PLoS Negl Trop Dis*. 2011; 5(8):e1274.

Pasteur L. "Expériences et vues nouvelles sur la nature de fermentations". *C R Acad Sci*. 1861; 52:1260-4.

Pearce EJ, Huang SC. The metabolic control of schistosome egg production. *Cell Microbiol*. 2015; 17(6):796-801.

Perkins EM, Donnellan SC, Bertozzi T, Whittington ID. Closing the mitochondrial circle on paraphyly of the Monogenea (Platyhelminthes) infers evolution in the diet of parasitic flatworms. *Int J Parasitol.* 2010; 40(11):1237-45.

Perrin C, Lepesant JM, Roger E, Duval D, Fneich S, Thuillier V, Alliene JF, Mitta G, Grunau C, Cosseau C. *Schistosoma mansoni* mucin gene (SmPoMuc) expression: epigenetic control to shape adaptation to a new host. *PLoS Pathog.* 2013; 9:e1003571.

Pfaffl M. A new mathematical model for relative quantification in realtime RT-PCR. *Nucl Acids Res.* 2001; 29:e45.

Pfeiffer T, Schuster S, Bonhoeffer S. Cooperation and competition in the evolution of ATP-producing pathways. *Science.* 2001; 292(5516):504-7.

Piaz FD, Vassallo A, Rubio OC, Castellano S, Sbardella G, De Tommasi N. Chemical biology of histone acetyltransferase natural compounds modulators. *Mol Divers.* 2011; 15(2):401-16.

Pierce R, Dubois-Abdeselem F, Lancelot J, Andrade L and Oliveira G. Targeting Schistosome Histone Modifying Enzymes for Drug Development. *Curr Pharm Des.* 2012; 18(24):3567-78.

Pierce RJ. Anti-parasitic drug discovery. *Pan Europ Networks Sci Technol.* 2014; 11:192-3.

Pierce RJ, Dubois-Abdeselem F, Lancelot J, Andrade L, Oliveira G. Targeting schistosome histone modifying enzymes for drug development. *Curr Pharm Des.* 2012; 18(24):3567-78.

Pinto-Almeida A, Mendes T, Armada A, Belo S, Carrilho E, Viveiros M, Afonso A. The Role of Efflux Pumps in *Schistosoma mansoni* Praziquantel Resistant Phenotype. *PLoS One.* 2015; 10(10):e0140147.

Price NL, Gomes AP, Ling AJ, Duarte FV, Martin-Montalvo A, North BJ, Agarwal B, Ye L, Ramadori G, Teodoro JS, Hubbard BP, Varela AT, Davis JG, Varamini B, Hafner A, Moaddel R, Rolo AP, Coppari R, Palmeira CM, de Cabo R, Baur JA, Sinclair DA. SIRT1 is required for AMPK activation and the beneficial effects of resveratrol on mitochondrial function. *Cell Metab.* 2012; 15(5):675-90.

Protasio A, Tsai I, Babbage A, Nichol S, Hunt M, Aslett M, De Silva N, Velarde G, Anderson T, Clark R, Davidson C, Dillon G, Holroyd N, LoVerde P, Lloyd C, McQuillan J, Oliveira G, Otto T, Parker-Manuel S, Quail M, Wilson R, Zerlotini A, Dunne D, Berriman M. A systematically improved high quality genome and transcriptome of the human blood fluke *Schistosoma mansoni*. *PLoS Negl Trop Dis.* 2012; 6:e1455.

Purushotham A, Schug TT, Xu Q, Surapureddi S, Guo X, Li X. Hepatocyte-specific deletion of SIRT1 alters fatty acid metabolism and results in hepatic steatosis and inflammation. *Cell Metab.* 2009; 9(4):327-38.

- R -

- Racker E. History of the Pasteur effect and its pathobiology. *Mol Cell Biochem.* 1974; 5:17–23.
- Raddatz G, Guzzardo PM, Olova N, Fantappiè MR, Rampp M, Schaefer M, Reik W, Hannon GJ, Lyko F. Dnmt2-dependent methylomes lack defined DNA methylation patterns. *Proc Natl Acad Sci USA.* 2013; 110(21):8627–31.
- Ramajo-Hernández A, Pérez-Sánchez R, Ramajo-Martín V, Oleaga A. *Schistosoma bovis*: plasminogen binding in adults and the identification of plasminogen-binding proteins from the worm tegument. *Exp Parasitol.* 2007; 115(1):83-91.
- Ramalho-Pinto F, Gazzinelli G, Howells R, Mota-Santos T, Figueiredo E, Pellegrino J. *Schistosoma mansoni*: defined system for stepwise transformation of cercaria to schistosomule in vitro. *Exp Parasitol.* 1974; 36:360–72.
- Rassi C, Kajungu D, Martin S, Arroiz J, Tallant J, Zegers de Beyl C, Counihan H, Newell JN, Phillips A, Whitton J, Muloliwa AM, Graham K. Have You Heard of Schistosomiasis? Knowledge, Attitudes and Practices in Nampula Province, Mozambique. *PLoS Negl Trop Dis.* 2016; 10(3):e0004504.
- Religa A, Waters A. Sirtuins of parasitic protozoa: In search of function(s). *Mol Biochem Parasitol.* 2012; 185(2):71–88.
- Robinson-Rechavi M, Laudet V. Evolutionary rates of duplicate genes in fish and mammals. *Mol Biol Evol.* 2001; 18:681-3.
- Rodgers JT, Puigserver P. Fasting-dependent glucose and lipid metabolic response through hepatic sirtuin 1. *Proc. Natl. Acad. Sci. USA.* 2007; 104(31) :12861-6.
- Roessler C, Nowak T, Pannek M, Gertz M, Nguyen GT, Scharfe M, Born I, Sippl W, Steegborn C, Schutkowski M. Chemical probing of the human sirtuin 5 active site reveals its substrate acyl specificity and peptide-based inhibitors. *Angew Chem Int Ed Engl.* 2014; 53(40):10728-32.
- Rohde K. The origins of parasitism in the Platyhelminthes. *Int J Parasitol.* 1994; 24:1099–115.
- Rolland F, Winderickx J, Thevelein JM. Glucose-sensing and -signalling mechanisms in yeast. *FEMS Yeast Res.* 2002; 2:183–201
- Rollinson D, Knopp S, Levitz S, Stothard JR, Tchuem Tchuenté LA, Garba A, Mohammed KA, Schur N, Person B, Colley DG, Utzinger J. Time to set the agenda for schistosomiasis elimination. *Acta Trop.* 2013; 128(2):423-40.
- Roth M, Chen WY. Sorting out functions of sirtuins in cancer. *Oncogene.* 2014; 33(13):1609-20.
- Rotmans JP. *Schistosoma mansoni*: purification and characterization of malate dehydrogenases. *Exp Parasitol.* 1978; 46(1):31-48.

Ryu D, Jo YS, Lo Sasso G, Stein S, Zhang H, Perino A, Lee JU, Zeviani M, Romand R, Hottiger MO, Schoonjans K, Auwerx J. A SIRT7-dependent acetylation switch of GABP $\beta$ 1 controls mitochondrial function. *Cell Metab.* 2014; 20(5):856-69.

## - S -

Sato M, Mueckler M. A conserved amino acid motif (R-X-G-R-R) in the Glut1 glucose transporter is an important determinant of membrane topology. *J Biol Chem.* 1999; 274(35):24721-5.

Sayed AA, Simeonov A, Thomas CJ, Inglese J, Austin CP, Williams DL. Identification of oxadiazoles as new drug leads for the control of schistosomiasis. *Nat Med.* 2008; 14(4):407-12.

Schaefer M, Lyko F. Solving the Dnmt2 enigma. *Chromosoma.* 2010; 119(1):35-40.

Scheibye-Knudsen M, Mitchell SJ, Fang EF, Iyama T, Ward T, Wang J, Dunn CA, Singh N, Veith S, Hasan-Olive MM, Mangerich A, Wilson MA, Mattson MP, Bergersen LH, Cogger VC8, Warren A, Le Couteur DG, Moaddel R, Wilson DM 3rd, Croteau DL, de Cabo R, Bohr VA. A high fat diet and NAD(+) activate Sirt1 to rescue premature aging in Cockayne syndrome. *Cell Metab.* 2014; 20(5):840-55.

Schenk T, Chen WC, Göllner S, Howell L, Jin L, Hebestreit K, Klein HU, Popescu AC, Burnett A, Mills K, Casero RA Jr, Marton L, Woster P, Minden MD, Dugas M, Wang JC, Dick JE, Müller-Tidow C, Petrie K, Zelent A. Inhibition of the LSD1 (KDM1A) demethylase reactivates the all-*trans*-retinoic differentiation pathway in acute myeloid leukemia. *Nature Med.* 2012; 18(4):605-11.

Scher MB, Vaquero A, Reinberg D. SirT3 is a nuclear NAD<sup>+</sup>-dependent histone deacetylase that translocates to the mitochondria upon cellular stress. *Genes Dev.* 2007; 21(8):920-8.

Schiedel M, Marek M, Lancelot J, Karaman B, Almlöf I, Schultz J, Sippl W, Pierce RJ, Romier C, Jung M. Fluorescence-based screening assays for the NAD<sup>+</sup>-dependent histone deacetylase smSirt2 from *Schistosoma mansoni*. *J Biomol Screen.* 2015; 20(1):112-21.

Schiller EL, Bueding E, Turner VM, Fisher J. Aerobic and anaerobic carbohydrate metabolism and egg production of *Schistosoma mansoni* in vitro. *J Parasitol.* 1975; 61(3):385-9.

Schuetz A, Min J, Antoshenko T, Wang CL, Allali-Hassani A, Dong A, Loppnau P, Vedadi M, Bochkarev A, Sternglanz R, Plotnikov AN. Structural basis of inhibition of the human NAD<sup>+</sup>-dependent deacetylase SIRT5 by suramin. *Structure.* 2007; 15(3):377-89.

Schurmann A, Doege H, Ohnimus H, Monser V, Buchs A, Joost H. Role of conserved arginine and glutamate residues on the cytosolic surface of glucose transporters for transporter function. *Biochemistry*. 1997; 36(42):12897-902.

Schutkowski M, Fischer F, Roessler C, Steegborn C. New assays and approaches for discovery and design of Sirtuin modulators. *Expert Opin Drug Discov*. 2014; 9(2):183-99.

Seatter M, De la Rue S, Porter L, Gould G. QLS motif in transmembrane helix VII of the glucose transporter family interacts with the C-1 position of D-glucose and is involved in substrate selection at the exofacial binding site. *Biochemistry*. 1998; 37(5):1322-6.

Sebastián C, Zwaans BM, Silberman DM, Gymrek M, Goren A, Zhong L, Ram O, Truelove J, Guimaraes AR, Toiber D, Cosentino C, Greenson JK, MacDonald AI, McGlynn L, Maxwell F, Edwards J, Giacosa S, Guccione E, Weissleder R, Bernstein BE, Regev A, Shiels PG, Lombard DB, Mostoslavsky R. The histone deacetylase SIRT6 is a tumor suppressor that controls cancer metabolism. *Cell*. 2012; 151(6):1185-99.

Shapiro S, Wilk M. An analysis of variance test for normality (complete samples). *Biometrika*. 1965; 52:591–611.

Shin J, He M, Liu Y, Paredes S, Villanova L, Brown K, Qiu X, Nabavi N, Mohrin M, Wojnoonski K, Li P, Cheng HL, Murphy AJ, Valenzuela DM, Luo H, Kapahi P, Krauss R, Mostoslavsky R, Yancopoulos GD, Alt FW, Chua KF, Chen D. Sirt7 represses Myc activity to suppress ER stress and prevent fatty liver disease. *Cell Rep*. 2013; 5(3):654-65.

Shoemaker CB, Reynolds SR, Wei G, Tielens AG, Harn DA. *Schistosoma mansoni* hexokinase: cDNA cloning and immunogenicity studies. *Exp Parasitol*. 1995; 80(1):36-45.

Sigrist CJ, de Castro E, Cerutti L, Cuche BA, Hulo N, Bridge A, Bougueleret L, Xenarios I. New and continuing developments at PROSITE. *Nucleic Acids Res*. 2013; 41(Database issue):D344-7.

Simões MC, Lee J, Djikeng A, Cerqueira GC, Zerlotini A, da Silva-Pereira RA, Dalby AR, LoVerde P, El-Sayed NM, Oliveira G. Identification of *Schistosoma mansoni* microRNAs. *BMC Genomics*. 2011; 12:47.

Skelly P, Kim J, Cunningham J, Shoemaker CB. Cloning, characterization, and functional expression of cDNAs encoding glucose transporter proteins from the human parasite *Schistosoma mansoni*. *J Biol Chem*. 1994; 269(6):4247-53.

Skelly P, Shoemaker C. Rapid appearance and asymmetric distribution of glucose transporter SGTP4 at the apical surface of intramammalian-stage *Schistosoma mansoni*. *Proc Natl Acad Sci USA*. 1996; 93(8):3642-6.

Skelly PJ, Tielens AG, Shoemaker CB. Glucose Transport and Metabolism in Mammalian-stage Schistosomes. *Parasitol Today*. 1998; 14(10):402-6.

Slama JT, Simmons AM. Inhibition of NAD glycohydrolase and ADP-ribosyltransferases by carbocyclic analogues of oxidized nicotinamide adenine dinucleotide. *Biochemistry*. 1989; 28(19):7688-94.

Slonimski PP. Adaptation respiratoire: développement du système hémoprotéique induit par l'oxygène. Proc. 3rd int. Congr. Biochem. 1956; 242.

Smith TM, Brown JN. Tricarboxylic acid cycle enzyme activities in adult *Schistosoma mansoni* and *Schistosoma japonicum*. Trans R Soc Trop Med Hyg. 1977; 71(4):329-30

Spannhoff A, Hauser AT, Heinke R, Sippl W, Jung M. The emerging therapeutic potential of histone methyltransferase and demethylase inhibitors. ChemMedChem. 2009; 4(10):1568-82.

Springer JE, Azbill RD, Carlson SL. A rapid and sensitive assay for measuring mitochondrial metabolic activity in isolated neural tissue. Brain Res Brain Res Protoc. 1998; 2(4):259-63.

Standley CJ, Dobson AP, Stothard RJ. 2012 Out of Animals and Back Again: Schistosomiasis as a Zoonosis in Africa, Schistosomiasis. Croatia: InTech Publishing Group.

Stefanić S, Dvořák J, Horn M, Braschi S, Sojka D, Ruelas DS, Suzuki B, Lim KC, Hopkins SD, McKerrow JH, Caffrey CR. RNA interference in *Schistosoma mansoni* schistosomula: selectivity, sensitivity and operation for larger-scale screening. PLoS Negl Trop Dis. 2010; 4(10):e850.

Still W, Tempczyk A, Hawley R, Hendrickson T. Semi-analytical treatment of solvation for molecular mechanics and dynamics. J Am Chem Soc. 1990; 112:6127-6129.

Stirewalt MA. *Schistosoma mansoni*: cercaria to schistosomule. Adv Parasitol. 1974; 12:115-82.

Stolfa DA, Marek M, Lancelot J, Hauser AT, Walter A, Leproult E, Melesina J, Rumpf T, Wurtz JM, Cavarelli J, Sippl W, Pierce RJ, Romier C, Jung M. Molecular basis for the antiparasitic activity of a mercaptoacetamide derivative that inhibits histone deacetylase 8 (HDAC8) from the human pathogen *Schistosoma mansoni*. J Mol Biol. 2014; 426(20):3442-53.

Strahl B, Allis C. The language of covalent histone modifications. Nature. 2000; 403(6765):41-5.

Streseman C, Lyko F. Modes of action of the DNA methyltransferase inhibitors azacytidine and decitabine. Int J Cancer. 2008; 123(1):8-13

Su JG, Mansour JM, Mansour TE. Purification, kinetics and inhibition by antimonials of recombinant phosphofructokinase from *Schistosoma mansoni*. Mol Biochem Parasitol. 1996; 81(2):171-8.

Suenkel B, Fischer F, Steegborn C. Inhibition of the human deacylase Sirtuin 5 by the indole GW5074. Bioorg Med Chem Lett. 2013; 23(1):143-6.

Sun L, Zeng X, Yan C, Sun X, Gong X, Rao Y, Yan N. Crystal structure of a bacterial homologue of glucose transporters GLUT1-4. Nature. 2012; 490(7420):361-6.

Sun J, Wang S, Li C, Ren Y, Wang J. Novel expression profiles of microRNAs suggest that specific miRNAs regulate gene expression for the sexual maturation of female *Schistosoma japonicum* after pairing. Parasit Vectors. 2014; 7:177.

Swinney DC, Anthony J. How were new medicines discovered? *Nat Rev Drug Discov.* 2011; 10(7):507-19.

- T -

Tajima F. Simple methods for testing molecular clock hypothesis. *Genetics.* 1993; 135(2):599-607.

Tamura K, Battistuzzi F, Billing-Ross P, Murillo O, Filipski A, Kumar S. Estimating Divergence Times in Large Molecular Phylogenies. *Proc Natl Acad Sci USA.* 2012; 109(47):19333-8.

Tamura K, Stecher G, Peterson D, Filipski A, Kumar S. MEGA6: Molecular Evolutionary Genetics Analysis version 6.0. *Mol Biol Evol.* 2013; 30(12):2725-9.

Tan M, Peng C, Anderson KA, Chhoy P, Xie Z, Dai L, Park J, Chen Y, Huang H, Zhang Y, Ro J, Wagner GR, Green MF, Madsen AS, Schmiesing J, Peterson BS, Xu G, Ilkayeva OR, Muehlbauer MJ, Bralke T, Mühlhausen C, Backos DS, Olsen CA, McGuire PJ, Pletcher SD, Lombard DB, Hirschey MD, Zhao Y. Lysine glutarylation is a protein posttranslational modification regulated by SIRT5. *Cell Metab.* 2014; 19(4):605-17.

Tavares J, Ouaisi A, Kong Thoo Lin P, Loureiro I, Kaur S, Roy N, Cordeiro-da-Silva A. Bisnaphthalimidopropyl derivatives as inhibitors of Leishmania SIR2 related protein 1. *ChemMedChem.* 2010; 5(1):140-7.

Teusink B, Diderich J, Westerhoff H, van Dam K, Walsh M. Intracellular glucose concentration in derepressed yeast cells consuming glucose is high enough to reduce the glucose transport rate by 50%. *J Bacteriol.* 1998; 180(3):556-62.

Thompson DP, Morrison DD, Pax RA, Bennett JL. Changes in glucose metabolism and cyanide sensitivity in *Schistosoma mansoni* during development. *Mol Biochem Parasitol.* 1984; 13(1):39-51.

Thorens B. GLUT2 in pancreatic and extra-pancreatic glucodetection. *Mol Membr Biol.* 2001; 18(4):265–73.

Tielens AG, Horemans AM, Dunnewijk R, van der Meer P, van den Bergh SG. The facultative anaerobic energy metabolism of *Schistosoma mansoni* sporocysts. *Mol Biochem Parasitol.* 1992; 56(1):49-57.

Tielens AG, van den Heuvel JM, van Mazijk HJ, Wilson JE, Shoemaker CB. The 50-kDa glucose 6-phosphate-sensitive hexokinase of *Schistosoma mansoni*. *J Biol Chem.* 1994; 269(40):24736-41.

Tielens AG, Van der Meer P, van den Heuvel JM, van den Bergh SG. The enigmatic presence of all gluconeogenic enzymes in *Schistosoma mansoni* adults. *Parasitology.* 1991; 102(Pt 2):267-76.

Tielens AG. Energy generation in parasitic helminths. *Parasitol Today.* 1994; 10(9):346-52.

Tielens AG. Properties and function in metabolism of schistosomal hexokinase. *Biochem Soc Trans.* 1997; 25(1):127-31.



Tissenbaum HA, Guarente L. Increased dosage of a sir-2 gene extends lifespan in *Caenorhabditis elegans*. *Nature*. 2001; 410(6825):227-30.

Toggenburger G, Kessler M, and Semenza G. Phlorizin as a probe of the small-intestinal Na<sup>+</sup>, D-glucose cotransporter. A model. *Biochim Biophys Acta*. 1982; 688(2):557-71.

Tonkin CJ, Carret CK, Duraisingh MT, Voss TS, Ralph SA, Hommel M, Duffy MF, Silva LM, Scherf A, Ivens A, Speed TP, Beeson JG, Cowman AF. Sir2 paralogue cooperate to regulate virulence genes and antigenic variation in *Plasmodium falciparum*. *PLoS Biol*. 2009; 7(4):e84.

## - U -

Uglen GL, Read CP. Sugar transport and metabolism in *Schistosoma mansoni*. *J Parasitol*. 1975; 61(3):390-7.

Uldry M, Ibberson M, Hosokawa M, Thorens B. GLUT2 is a high affinity glucosamine transporter. *FEBS Lett*. 2002; 524(1-3):199-203.

Uldry M, Thorens B. The SLC2 family of facilitated hexose and polyol transporters. *Pflugers Arch*. 2004; 447(5):480-9.

## - V -

Vallat B, Pillardy J, Májek P, Meller J, Blom T, Cao B, Elber R. Building and assessing atomic models of proteins from structural templates: Learning and benchmarks. *Proteins*. 2009; 76(4):930-45.

Van Oordt BE, Tielens AG, van den Bergh SG. The energy metabolism of *Schistosoma mansoni* during its development in the hamster. *Parasitol Res*. 1988; 75(1):31-5.

Van Oordt BE, Tielens AG, Van den Bergh SG. Aerobic to anaerobic transition in the carbohydrate metabolism of *Schistosoma mansoni* cercariae during transformation in vitro. *Parasitology*. 1989; 98(Pt 3):409-15.

Van Hellemond JJ, Van Remoortere A, Tielens AG. *Schistosoma mansoni* sporocysts contain rhodoquinone and produce succinate by fumarate reduction. *Parasitology*. 1997; 115 (Pt 2):177-82.

Vaquero A, Scher MB, Lee DH, Sutton A, Cheng HL, Alt FW, Serrano L, Sternglanz R, Reinberg D. SirT2 is a histone deacetylase with preference for histone H4 Lys 16 during mitosis. *Genes Dev*. 2006; 20(10):1256-61.

Vassilopoulos A, Pennington JD, Andresson T, Rees DM, Bosley AD, Fearnley IM, Ham A, Flynn CR, Hill S, Rose KL, Kim HS, Deng CX, Walker JE, Gius D. SIRT3 deacetylates ATP synthase FA complex proteins in response to nutrient- and exercise-induced stress. *Antioxid. Redox Signal.* 2014; 21(4):551-64.

Ventola CL. The antibiotic resistance crisis: part 1: causes and threats. *Pharmacy and Therapeutics.* 2015; 40(4):277-83.

Vergnes B, Sereno D, Tavares J, Cordeiro-da-Silva A, Vanhille L, Madjidian-Sereno N, Depoix D, Monte-Alegre A, Ouaisi A. Targeted disruption of cytosolic SIR2 deacetylase discloses its essential role in *Leishmania* survival and proliferation. *Gene.* 2005a; 363:85-96.

Vergnes B, Vanhille L, Ouaisi A, Sereno D. Stage-specific antileishmanial activity of an inhibitor of SIR2 histone deacetylase. *Acta Trop.* 2005b; 94(2):107-15.

Vitavska O, Wiczorek H. The SLC45 gene family of putative sugar transporters. *Mol Aspects Med.* 2013; 34(2-3):655-60.

Vos T, Flaxman AD, Naghavi M, et al (more than 100 authors). Years lived with disability (YLDs) for 1160 sequelae of 289 diseases and injuries 1990–2010: a systematic analysis for the Global Burden of Disease Study 2010. *Lancet.* 2012; 380(9859):2163-96.

## - W -

Wall KA, Klis M, Kornet J, Coyle D, Amé JC, Jacobson MK, Slama JT. Inhibition of the intrinsic NAD<sup>+</sup> glycohydrolase activity of CD38 by carbocyclic NAD analogues. *Biochem J.* 1998; 335(Pt 3):631-6.

Wang J, Kim TH, Ahn MY, Lee J, Jung JH, Choi WS, Lee BM, Yoon KS, Yoon S, Kim HS. Sirtinol, a class III HDAC inhibitor, induces apoptotic and autophagic cell death in MCF-7 human breast cancer cells. *Int J Oncol.* 2012; 41(3):1101-9.

Wang W, Liang YS, Hong QB, Dai JR. African schistosomiasis in mainland China: risk of transmission and countermeasures to tackle the risk. *Parasit Vectors.* 2013; 6(1):249.

Wang Z, Chen W. Emerging roles of SIRT1 in cancer drug resistance. *Genes Cancer.* 2013; 4(3-4):82-90.

Wang Z, Xue X, Sun J, Luo R, Xu X, Jiang Y, Zhang Q, Pan W. An "in-depth" description of the small non-coding RNA population of *Schistosoma japonicum* schistosomulum. *PLoS Negl Trop Dis.* 2010; 4(2):e596.

Warburg O, Wind F, Negelein E. The metabolism of tumors in the body. *J General Physiol.* 1927; 8(6):519-30.

Warburg O. On the origin of cancer cells. *Science.* 1956; 123(3191):309–314

Warnecke PM, Stirzaker C, Song J, Grunau C, Melki JR, Clark SJ. Identification and resolution of artifacts in bisulfite sequencing. *Methods*. 2002; 27(2):101-7.

Warren KS, Mahmoud AA, Cummings P, Murphy DJ, Houser HB. *Schistosomiasis mansoni* in Yemeni in California: duration of infection, presence of disease, therapeutic management. *Am J Trop Med Hyg*. 1974; 23(5):902-9.

Webster BL, Diaw OT, Seye MM, Webster JP, Rollinson D. Introgressive hybridization of *Schistosoma haematobium* group species in Senegal: species barrier break down between ruminant and human schistosomes. *PLoS Negl Trop Dis*. 2013; 7(4):e2110.

West AC, Johnstone RW. New and emerging HDAC inhibitors for cancer treatment. *J Clin Invest*. 2014; 124(1):30-9.

Westphal CH, Dipp MA, Guarente L. A therapeutic role for sirtuins in diseases of aging? *Trends Biochem Sci*. 2007; 32(12):555-60.

Wilke T, Schultheiß R, Albrecht C. As time goes by: A simple fool's guide to molecular clock approaches in invertebrates. *Amer Malac Bull*. 2009; 27:25-45.

Wood JG, Rogina B, Lavu S, Howitz K, Helfand SL, Tatar M, Sinclair D. Sirtuin activators mimic caloric restriction and delay ageing in metazoans. *Nature*. 2004; 430(7000):686-9.

Wu X, Freeze H. GLUT14, a duplicon of GLUT3, is specifically expressed in testis as alternative splice forms. *Genomics*. 2002; 80(6):553-7.

**- X -**

Xu J, Han J, Epstein PN, Liu YQ. Regulation of PDK mRNA by high fatty acid and glucose in pancreatic islets. *Biochem Biophys Res Commun*. 2006; 344(3):827-33.

Xue X, Sun J, Zhang Q, Wang Z, Huang Y, Pan W. Identification and characterization of novel microRNAs from *Schistosoma japonicum*. *PLoS One*. 2008; 3(12):e4034.

**- Y -**

Yang GJ, Liu L, Zhu HR, Griffiths SM, Tanner M, Bergquist R, Utzinger J, Zhou XN. China's sustained drive to eliminate neglected tropical diseases. *Lancet Infect Dis*. 2014; 14(9):881-92.

Yoshizawa T, Karim MF, Sato Y, Senokuchi T, Miyata K, Fukuda T, Go C, Tasaki M, Uchimura K, Kadomatsu T, Tian Z, Smolka C, Sawa T, Takeya M, Tomizawa K, Ando Y, Araki E, Akaike T, Braun T, Oike Y, Bober E, Yamagata K. SIRT7 controls hepatic lipid metabolism by regulating the ubiquitin-proteasome pathway. *Cell Metab*. 2014; 19(4):712-21.

Yoo CB, Jones PA. Epigenetic therapy of cancer. Past, present, and future. *Nat Rev Drug Discov*. 2006; 5(1):37-50.

You H, Stephenson R, Gobert G, McManus D. Revisiting glucose uptake and metabolism in schistosomes: new molecular insights for improved schistosomiasis therapies. *Front Genet*. 2014; 5:176.

Young ND, Jex AR, Li B, Liu S, Yang L, Xiong Z, Li Y, Cantacessi C, Hall RS, Xu X, Chen F, Wu X, Zerlotini A, Oliveira G, Hofmann A, Zhang G, Fang X, Kang Y, Campbell BE, Loukas A, Ranganathan S, Rollinson D, Rinaldi G, Brindley PJ, Yang H, Wang J, Wang J, Gasser RB. Whole-genome sequence of *Schistosoma haematobium*. *Nat Genet*. 2012; 44(2):221-5.

Yu XL, He YK, Xiong T, Zhao YQ, Shi MZ, Zhou J, Liu ZC, Luo XS, Fu X, He HB, Harn DA, Li YS. Protective effects of co-immunization with SjCTPI-Hsp70 and interleukin-12 DNA vaccines against *Schistosoma japonicum* challenge infection in water buffalo. *Zhongguo Ji Sheng Chong Xue Yu Ji Sheng Chong Bing Za Zhi*. 2006; 24(6):433-6.

Yuan H, Su L, Chen WY. The emerging and diverse roles of sirtuins in cancer: a clinical perspective. *Onco Targets Ther*. 2013; 6:1399-416.

Yuan H, Mamorstein R. Structural basis for sirtuin activity and inhibition. *J Biol Chem*. 2012; 287(51):42428-35.

## - Z -

Zhang H, Gao S, Lercher M, Hu S, Chen W. EvolView, an online tool for visualizing, annotating and managing phylogenetic trees. *Nucleic Acids Res*. 2012; 40(Web Server issue):W569-72.

Zhang HX, Du GH, Zhang JT. Assay of mitochondrial functions by resazurin in vitro. *Acta Pharmacol Sin*. 2004; 25(3):385-9.

Zhang Y. I-TASSER server for protein 3D structure prediction. *BMC Bioinformatics*. 2008; 9:40.

Zhao F, Keating A. Functional properties and genomics of glucose transporters. *Curr Genomics*. 2007; 8(2):113-28.

Zhao X, Allison D, Condon B, Zhang F, Gheyi T, Zhang A, Ashok S, Russell M, MacEwan I, Qian Y, Jamison JA, Luz JG. The 2.5 Å crystal structure of the SIRT1 catalytic domain bound to nicotinamide adenine dinucleotide (NAD<sup>+</sup>) and an indole (EX527 analogue) reveals a novel mechanism of histone deacetylase inhibition. *J Med Chem.* 2013; 56(3):963-9.

Zheng J. Energy metabolism of cancer: Glycolysis versus oxidative phosphorylation (Review). *Oncol Lett.* 2012; 4(6):1151-1157.

Zheng W. Sirtuins as emerging anti-parasitic targets. *Eur J Med Chem.* 2013; 59:132-40.

Zhong C, Skelly P, Leaffer D, Cohn R, Caulfield J, Shoemaker C. Immunolocalization of a *Schistosoma mansoni* facilitated diffusion glucose transporter to the basal, but not the apical, membranes of the surface syncytium. *Parasitology.* 1995; 110(Pt4):383-394.

Zhong L, D'Urso A, Toiber D, Sebastian C, Henry RE, Vadysirisack DD, Guimaraes A, Marinelli B, Wikstrom JD, Nir T, Clish CB, Vaitheesvaran B, Iliopoulos O, Kurland I, Dor Y, Weissleder R, Shirihai OS, Ellisen LW, Espinosa JM, Mostoslavsky R. The histone deacetylase Sirt6 regulates glucose homeostasis via Hif1alpha. *Cell.* 2010; 140(2):280-93.

Zhou Y, Zheng H, Chen Y, Zhang L, Wang K, Guo J, Huang Z, Zhang B, Huang W, Jin K, Dou T, Hasegawa M, Wang L, Zhang Y, Zhou J, Tao L, Cao Z, Li Y, Vinar T, Brejova B, Brown D, Li M, Miller DJ, Blair D, Zhong Y, Chen Z, Liu F, Hu W, Wang ZQ, Zhang QH, Song HD, Chen S, Xu X, Xu B, Ju C, Huang Y, Brindley PJ, McManus DP, Feng Z, Han ZG, Lu G, Ren S, Wang Y, Gu W, Kang H, Chen J, Chen X, Chen S, Wang L, Yan J, Wang B, Lv X, Jin L, Wang B, Pu S, Zhang X, Zhang W, Hu Q, Zhu G, Wang J, Yu J, Wang J, Yang H, Ning Z, Beriman M, Wei CL, Ruan Y, Zhao G, Wang S, Liu F, Zhou Y, Wang ZQ, Lu G, Zheng H, Brindley PJ, McManus DP, Blair D, Zhang QH, Zhong Y, Wang S, Han ZG, Chen Z, Wang S, Han ZG, Chen Z. The *Schistosoma japonicum* genome reveals features of host-parasite interplay. *Nature.* 2009; 460(7253):345-51.

# **ANNEXES**

**Annex 1. Identity and characteristics of *Schistosoma mansoni* histone modifying enzymes (Cabezas-Cruz et al., 2014).**

HME type	Class	Closest human orthologue	Size (aa)	Substrate Specificity	Gene Id <sup>1</sup>
HDAC	I	HDAC1	517 *		Smp_005210
	I	HDAC3	418 *		Smp_093280
	I	HDAC8	440 *		Smp_091990
	II	HDAC4	291		Smp_191310
	II	HDAC5	701		Smp_069380
	II	HDAC6	1132		Smp_138770
	III (Sirtuin)	Sirt1	568 *	H1 - H3 -H4	Smp_138640
	III (Sirtuin)	Sirt2	337 *	H4K16	Smp_084140
	III (Sirtuin)	Sirt5	305 *		Smp_055090
	III (Sirtuin)	Sirt6	386 *	H3K9 - H3K56	Smp_134630
	III (Sirtuin)	Sirt7	517 *		Smp_024670
HAT	GNAT	GCN5 (KAT2A)	899 *	H3K9 - H3K14 - H3K18 H2B	Smp_070190
	GNAT	HAT1 (KAT1)	435	H4K5 - H4K12	Smp_178700
	MYST	Tip60 (KAT5)	463	H2AK5 - H3K14 - H4K5 - H4K8 - H4K12 - H4K16	Smp_053140
	MYST	MYST1 (KAT8)	496	H4K16	Smp_194520
	MYST	MYST2 (KAT7)	400	H4K5 - H4K8 - H4K12 - H3	Smp_171700
	MYST	MYST3 (KAT6A)	971	H3K14	Smp_131320
	CBP/p300	CBP/SmCBP1 (KAT3A)	2093 *	H2AK5 - H2BK15 - H3K14 - H3K18 - H4K5 - H4K8	Smp_105910
	CBP/p300	CBP/SmCBP2 (KAT3A)	1892	H2AK5 - H2BK15 - H3K14 - H3K18 - H4K5 - H4K8	Smp_127010
	TAFII250	TFIID subunit 1	2241	H3 - H4	Smp_166840
HMT	SET	EZH1	1026	H3K27	Smp_078900
	SET	MLL3 (KMT2C)	399	H3K4	Smp_070210
	SET	MLL3 (KMT2C)	1560	H3K4	Smp_138030
	SET	MLL1/4 (KMT2D)	3002	H3K4	Smp_144180
	SET	MLL5 (KMT2E)	751	H3K4	Smp_161010
	SET	C20orf11/MLL5/Ranbp9	1305		Smp_009980
	SET	NSD2/WHSC1	1746	H3K4 - H4K20	Smp_160700
	SET	NSD1/2 (KMT3B)	1343	H3K36 - H4K44	Smp_137060
	SET	SET8 (KMT5A)	409	H4K20	Smp_055310
	SET	SUV 39H2 (KMT1B)	586	H3K9	Smp_027300
	SET	SUV4-20H1 (KMT5C)	613	H4K20	Smp_062530
	SET	SETD2	1575	H3K36	Smp_133910
	SET	SETD1B	1720/1822	H3K4	Smp_140390
	SET	SETDB	918/1032		Smp_150850
	SET	SETMAR	250	H3K9	Smp_043580
	SET	SET/MYND4	782		Smp_000700
	SET	SET/MYND4	527		Smp_124950

	SET	SET/MYND5	423/429/433		Smp_121610
	DOT1	DOT1L (KMT4)		H3K79	Smp_165000
	PRMT	PRMT1	252/359/334	H4R3	Smp_029240
	PRMT	PRMT3	1564		Smp_127950
	PRMT	PRMT4/CARM1	737	H3R2 - H3R17 - H3R26	Smp_070340
	PRMT	PRMT5	630	H2A - H4	Smp_171150
	PRMT	PRMT7	755		Smp_025550
<b>HDM</b>	KDM1	LSD1A	1043		Smp_150560
	KDM1	LSD1A	916		Smp_160810
	KDM1	LSD1 (KDM1)	1073	H3K4 - H3K9	Smp_162940
	JmjC	JMJD1B (KDM3)	273	H3K9	Smp_161410
	JmjC	JMJD2C (KDM4C)	1136	H3K9 - H3K36	Smp_132170
	JmjC	JMJD4	809		Smp_147870
	JmjC	JMJD6	839		Smp_137240
	JmjC	JHDM1D (KDM7)	653	H3K36	Smp_127230
	JmjC	Jarid (KDM5)	2372	H3K4	Smp_156290
	JmjC	jarid (KDM5)	1639	H3K4	Smp_019170
	JmjC	UTX (KDM6A)	1137	H3K27	Smp_034000

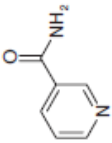
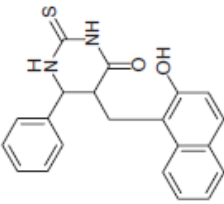
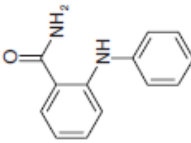
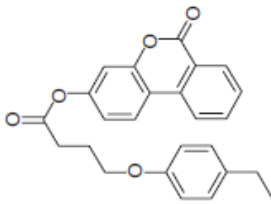

**Annex 2. Inhibition mechanism and IC<sub>50</sub> values of selected inhibitors of human sirtuins (Lancelot et al., 2015).**

Table 1. Inhibition mechanism and IC <sub>50</sub> values of selected inhibitors of human sirtuins.						
Compounds	Structures	Type of inhibition			IC <sub>50</sub> (μM)	
		NAD+	Acetyllysine substrate	hSirt1	hSirt2	hSirt3
Nicotinamide		Noncompetitive	Noncompetitive	25	100	n.d
Cambinol		Noncompetitive	Competitive	56	59	n.d
2-Anilino benzamide		Noncompetitive	Competitive	17	74	235
4-(4-ethyl-phenoxy)-butyric acid 6-oxo-6H-benzo [c] chromen-3-yl ester		Noncompetitive	Noncompetitive	6	97% inhibition at 50 μM	n.d

BIMs: Bisindolylmaleimide group of inhibitors; NAD: Nicotinamide adenine dinucleotide; n.d: Not determined.

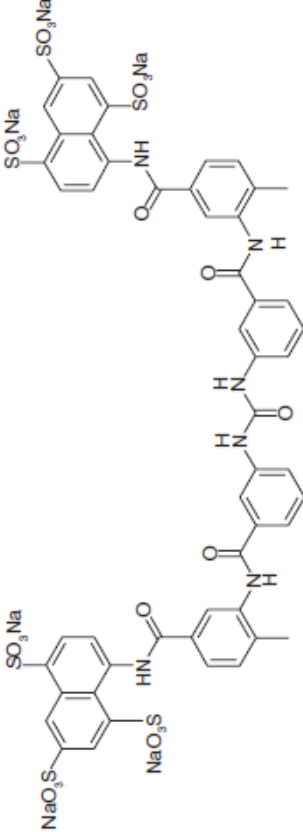
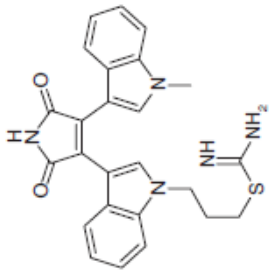
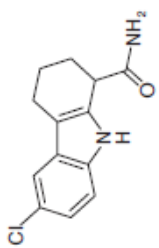
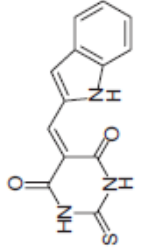
Table 1. Inhibition mechanism and IC <sub>50</sub> values of selected inhibitors of human sirtuins (cont.).						
Compounds	Structures	Type of inhibition			IC <sub>50</sub> (μM)	
		NAD+	Acetyllysine substrate	hSirt1	hSirt2	hSirt3
Suramin		Noncompetitive	n.d.	0.297	1.15	n.d.
Adenosine mimetics (BIMs)		Competitive	n.d.	3.5	0.8	n.d.
EX527		n.d.	n.d.	0.098	n.d.	n.d.
Thioibarbiturate		n.d.	n.d.	5.9	20.3	n.d.

BIMs: Bisindolylmaleimide group of inhibitors; NAD: Nicotinamide adenine dinucleotide; n.d.: Not determined.

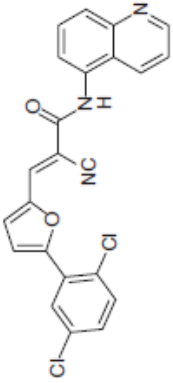
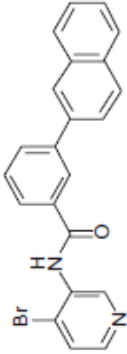
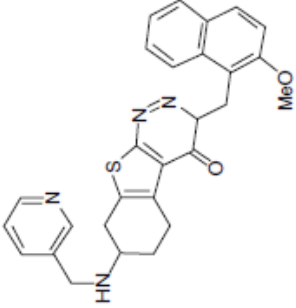
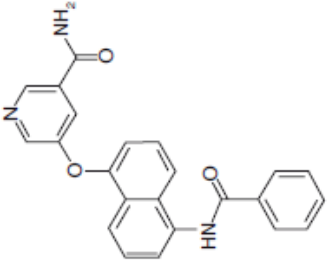
Table 1. Inhibition mechanism and IC <sub>50</sub> values of selected inhibitors of human sirtuins (cont.).						
Compounds	Structures	Type of inhibition			IC <sub>50</sub> (μM)	
		NAD+	Acetyllysine substrate	hSirt1	hSirt2	hSirt3
AGK2		n.d.	n.d.	>50	3.5	>50
Benzamide (17k)		n.d.	n.d.	>100	0.6	>100
ICL-SIRT078		Noncompetitive	Competitive	No inhibition at 100 μM	1.45	No inhibition at 100 μM
(5-benzamidonaphthalen-1/2-yloxy)-nicotinamide derivative		n.d.	Competitive	10.2	0.0483	44.2

BIMs: Bisindolylmaleimide group of inhibitors; NAD: Nicotinamide adenine dinucleotide; n.d: Not determined.

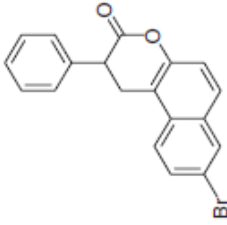
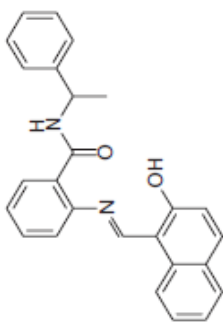
Table 1. Inhibition mechanism and IC <sub>50</sub> values of selected inhibitors of human sirtuins (cont.).						
Compounds	Structures	Type of inhibition			IC <sub>50</sub> (μM)	
		NAD+	Acetyllysine substrate	hSirt1	hSirt2	hSirt3
HR73		n.d.	n.d.	5	n.d.	n.d.
Sirtinol		n.d.	n.d.	131	38	n.d.

BIMs: Bisindolylmaleimide group of inhibitors; NAD: Nicotinamide adenine dinucleotide; n.d.: Not determined.

**Annex 3. Phylogeny of SGTP1, SGTP2, SGTP3 and SGTP4 homologs in *S. japonicum* and *S. haematobium*.** The figure shows a phylogenetic tree of the SGTP1, SGTP2, SGTP3 and SGTP4 homologs in *S. japonicum* (Sjap) and *S. haematobium* (Shae). The topology was obtained using the ML method. Numbers on internal branches are the bootstrap values. GenBank accession numbers of each sequence are included (Cabezas-Cruz et al., 2015).

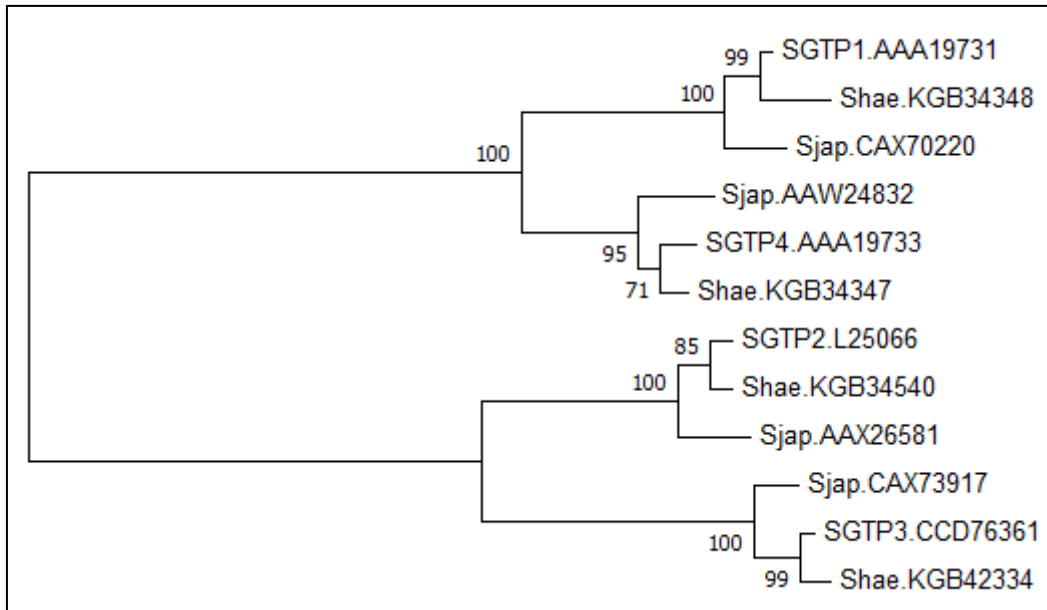

**Annex 4. Genomic structure and organization of *S. mansoni* glucose transporters (Cabezas-Cruz et al., 2015).**

<i>glut1</i>				<i>sgtp1</i>				<i>sgtp4</i>				<i>sgtp2</i>				<i>sgtp3</i>			
Exons	Size	Introns	Size	Exons	Size	Introns	Size	Exons	Size	Introns	Size	Exons	Size	Introns	Size	Exons	Size	Introns	Size
<b>1</b>	<b>18<sup>1</sup></b>	1	15316	<b>1</b>	<b>29</b>	1	1172	<b>1</b>	<b>107</b>	1	n.e.	<b>1</b>	<b>16</b>	1	1224	-	-		
<b>2</b>	<b>96</b>	2	12020	<b>2</b>	<b>125</b>	<b>2</b>	n.e.	<b>2</b>	<b>105</b>	2	1268	<b>2</b>	<b>128</b>	2	41	-	-		
<b>3</b>	<b>161<sup>2</sup></b>			<b>3</b>	<b>149</b>			<b>3</b>	<b>173</b>			<b>3</b>	<b>158</b>	3	31	<b>1</b>	<b>297</b>	1	38
		3	180									<b>4<sup>4</sup></b>	<b>125</b>			<b>2</b>	<b>121</b>		
4	241													4	32			2	38
		<b>4<sup>3</sup></b>	591									<b>5</b>	<b>171</b>	5	32	<b>3</b>	<b>171</b>	3	33
5	<b>163</b>	5	93			3	1886			3	1041	<b>6</b>	<b>108</b>	6	41	<b>4</b>	<b>108</b>	4	39
<b>6</b>	<b>188</b>	6	279	<b>4</b>	<b>592</b>			<b>4</b>	<b>592</b>			<b>7</b>	<b>188</b>			<b>5</b>	<b>188</b>		
7	105	7	177																
8	102													7	1263			5	2326
		8	1124			4	1425			4	1444	<b>8</b>	<b>295</b>	8	2260	<b>6</b>	<b>295</b>	6	2386
<b>9</b>	<b>204</b>			<b>5</b>	<b>432</b>			<b>5</b>	<b>435</b>			<b>9</b>	<b>128</b>	9	6982	<b>7</b>	<b>132</b>		
		9	364			5	1445			5	2472	10	196	10	2780			7	n.e.
10	201			6	1599			6	820			11	737			8	145		

Exon and intron sizes are in base pairs.

<sup>1</sup>In bold: Exons for which the exon-intron junction at the 3' end is conserved between different glucose transporter genes

<sup>2</sup>In blue: Exons for which the exon-intron junction at the 3' end is conserved among all selected glucose transporter genes.

<sup>3</sup>In red: Exons for which the exon-intron junction at the 3' end is conserved only between human *glut1*, *sgtp2* and *sgtp3*

<sup>4</sup>In green: Exons for which the exon-intron junction at the 3' end is conserved only between *sgtp2* and *sgtp3*

n.e.: Not evaluated (information missing from genome sequences).

**Annex 5. Glucose migration from the active site of Xyle, GLUT1 and *S. mansoni* glucose transporters.** The panels depict glucose migration Cartesian distances (given in Å) from the Tyr292/298 homologous residue (x-axis) and the active site (y-axis) for Xyle, GLUT1, SGTP1, SGTP2, SGTP3 and SGTP4 (Cabezas-Cruz et al., 2015).

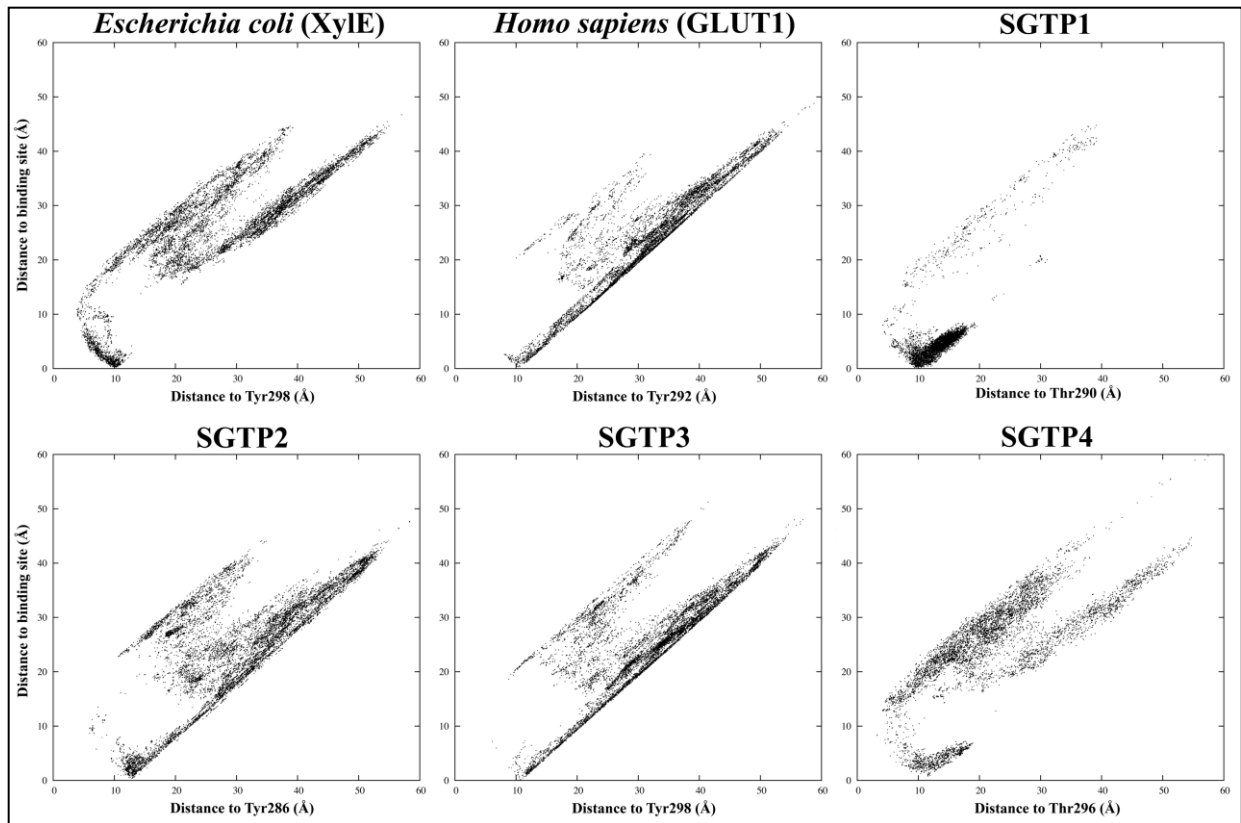

**Annex 6. Primers of metabolic genes from *Schistosoma mansoni*.**

Process/Enzyme	Abbreviation	Primers ID	Primers sequence (From 5' to 3')
<b>Glycolysis</b>			
Glyceraldehyde-3-phosphate dehydrogenase	<i>SGAPDH</i>	SGAPDHF	TGTACTTCGTGCAGCTTTCC
		SGAPDHR	CTGGAAATGTCCCATGAGTG
Glucose transporters	<i>SGTP1</i>	SGTP1F	CTGCAGCTTATCACTGAGTCAATC
		SGTP1R	CCACCGATGTTTTCTGTATAACAGGAT
Glucose transporters	<i>SGTP4</i>	SGTP4F	AGCCAAGGAGTTAACTTATTATGCAATTTATTG
		SGTP4R	TCCAACAGATAATAACGATAACTAAAAATGGTAAGAA
Lactate dehydrogenase A	<i>SLDHA</i>	SLDHAF	AGTAATTGGGACCGGAACAA
		SLDHAR	ACTCCAAACAGCAACTCG
Lactate dehydrogenase B	<i>SLDHB</i>	SLDHBF	TTTGCCTGCTGCTTCTAATG
		SLDHBR	AAATGCAATCGATGTTCCAA
Aquaporin	<i>SmAQP</i>	SmAQPf	GTGATTTAGGACCCAGACTCATGAT
		SmAQPR	GTTTGCTCCACTGAATGCTTTGTT
Hexokinase	<i>SHEX</i>	SHEXF	TATGCCTGTGAAATGGTCTG
		SHEXR	TCGAAGAATGCAGGCAATAC
<b>Oxidative phosphorylation</b>			
Malate dehydrogenase cytoplasmatic	<i>SMDH1A</i>	SMDH1AF	GACCACAATCGTGCTCAGTC
		SMDH1AR	TCGACAAATTGCGTATTGCT
Malate dehydrogenase cytoplasmatic	<i>SMDH1B</i>	SMDH1BF	GGAAAGAATTCACGGAATGG
		SMDH1BR	TTCGTTTGACCTCCAATTA
Malate dehydrogenase mitochondrial	<i>SMDH2</i>	SMDH2F	TAAAGGTGTTGCTGCTGACC
		SMDH2R	CATCCCTGCGGGAATAATAA
Pyruvate dehydrogenase kinase	<i>SPDK1</i>	SPDK1F	CAGGTTTACGGATGACGTTG
		SPDK1R	CAGACCACGATCCATCACTC
Pyruvate dehydrogenase kinase	<i>SPDK2</i>	SPDK2F	GCCAAGTTTCTTTGTGAGCA
		SPDK2R	GACCACATGATAGGCAGCAC
<b>Insulin pathway</b>			
Insulin receptor 1	<i>SmIR1</i>	SmIR1F	ACTGGAATGCCCTAACAACC
		SmIR1R	AGCTTGCTGAACATTGATCG
Insulin receptor 2	<i>SmIR2</i>	SmIR2F	ATGATAACGGCATTGCTCTG
		SmIR2R	TTCAGAATCCACGAAAGCTG