



**HAL**  
open science

# Economie écologique des ressources marines : Le cas de la pêche crevettière guyanaise

Bassirou Diop

► **To cite this version:**

Bassirou Diop. Economie écologique des ressources marines : Le cas de la pêche crevettière guyanaise. Economies et finances. Université de Guyane, 2016. Français. NNT : 2016YANE0007 . tel-01430060

**HAL Id: tel-01430060**

**<https://theses.hal.science/tel-01430060>**

Submitted on 9 Jan 2017

**HAL** is a multi-disciplinary open access archive for the deposit and dissemination of scientific research documents, whether they are published or not. The documents may come from teaching and research institutions in France or abroad, or from public or private research centers.

L'archive ouverte pluridisciplinaire **HAL**, est destinée au dépôt et à la diffusion de documents scientifiques de niveau recherche, publiés ou non, émanant des établissements d'enseignement et de recherche français ou étrangers, des laboratoires publics ou privés.



---

# UNIVERSITÉ DE GUYANE

Ecole Doctorale

“Diversités, santé et développement en Amazonie”

Thèse pour le doctorat en Sciences Économiques

Sous la direction de Monsieur Nicolas SANZ

Présentée par

**M. Bassirou Masseck DIOP**

---

## ÉCONOMIE ÉCOLOGIQUE DES RESSOURCES MARINES : LE CAS DE LA PÊCHERIE CREVETTIÈRE GUYANAISE

---

### JURY

M. SADEFO KAMDEM Jules	Professeur des Universités	LAMETA/Université de Guyane	Président du jury
M. THEBAUD Olivier	Chercheur HDR	UMR AMURE/Ifremer Brest	Rapporteur
M. VALLÉE Thomas	Professeur des Universités	IEMN-IAE/Université de Nantes	Rapporteur
M. DOYEN Luc	Directeur de recherche	CNRS/MNHN	Examineur
M. BLANCHARD Fabian	Chercheur HDR	UMR LEEISA/Ifremer Guyane	Examineur
M. SANZ Nicolas	Maitre de conférences	UMR LEEISA/Université de Guyane	Directeur de thèse







---

## Remerciements

*Je tiens tout d'abord à témoigner ma reconnaissance à mon directeur de thèse M. Nicolas Sanz, qui m'a encadré tout au long de ce travail. Il m'a fait partager son expérience et apporté son soutien au quotidien. Et il a su attiser en moi le goût pour la recherche et je ne pourrai jamais trouver les mots pour lui exprimer comme il se doit, ma gratitude. J'ai une pensée particulière pour M. Célimène, qui est celui sans qui le travail n'aurait pas vu le jour. Je remercie également M. Fabian Blanchard, pour son écoute attentive, pour ses conseils avisés et la disponibilité des données qui ont permis de mener ce travail à son terme. Je tiens également à témoigner ma reconnaissance à Jean Christophe Péreau et à Luc Doyen qui n'ont de cesse apporté leur point de vue sur mon travail, qui m'ont associé à leurs projets et m'ont permis de découvrir le milieu très convoité des colloques internationaux.*

*Je remercie les membres du jury particulièrement Messieurs Thébaud et Vallée, d'avoir accepté de rapporter cette thèse et de me donner l'occasion de prendre du recul sur le travail réalisé. Je remercie M. Sadefo pour son soutien indéfectible et d'avoir accepté de présider ma soutenance.*

*Je ne peux aussi oublier d'exprimer ma gratitude à l'Europe à travers le Fonds Social Européen, au Centre National d'Etudes Spatiales, ainsi qu'au ministère de l'Outre-Mer, car sans leurs contributions financières, ce travail ne verrait peut être pas le jour.*

*Je remercie particulièrement Tonton Pape, ainsi que sa famille, pour ses conseils et de me permettre de trancher dans mes moments de doute. Il sait toujours trouver les mots pour me soutenir, et me mettre en valeur.*

*Je ne pourrai ne pas remercier tous les membres du département SJE, avec une mention spéciale à M. Frédéric Bondil et à Mme Maude Elfort, car j'ai pu travailler avec beaucoup de sérénité au quotidien, à leur côté. Je remercie également M. Rosele Chim qui m'a donné l'opportunité de remettre les pieds à l'université.*

*Ensuite je dédie particulièrement ce travail à mon Grand-père Mame Palla qui malheureusement n'est plus là pour voir son aboutissement. Je tiens à lui dédier ce travail, car une manière d'honorer sa mémoire. Il m'a transmis depuis mon plus jeune âge, certaines valeurs dont la générosité et l'humilité. En effet il n'a de cesse répété qu'il fallait être généreux et humble car ce sont ces valeurs qui permettent de s'ouvrir facilement et d'être à l'écoute, afin de mieux apprendre des autres. Je ne fermerai pas la page sur lui avant de faire part d'un conseil, qu'il a très souvent répété : " il faut toujours aller jusqu'au bout dans les études". Et tant que j'aurai les moyens et les capacités je poursuivrai mon chemin en me rappelant ces sages paroles.*

*Enfin, Maman, Bara, Tonton Habib, Adja Tataye, la famille Cissé, ma famille et mes Amis, notamment de la soupe au marché, méritent également toute ma reconnaissance. En effet ils ont su avoir la patience nécessaire pour me supporter tout au long de ce programme. Certains d'entre eux ont pris le temps de me relire (Hélène, Milot, Pauline...). Je me suis senti soutenu, écouté et m'ont permis de toujours me rappeler l'essentiel.*

A Maman, et à la mémoire de Mame Palla.





## Résumé

L'objectif de cette thèse a été de comprendre le fonctionnement économique des pêcheries et de proposer des politiques de gestion des ressources halieutiques. L'attention a été portée essentiellement sur la pêche crevettière guyanaise. Une première analyse a été effectuée à partir d'une base de données historique. Les premiers constats ont été que cette pêche a été marquée par une forte diminution de son stock, de son effort, de sa production, ce qui a conduit à la fermeture de certaines entreprises. Les premiers résultats ont permis de comprendre que la production de cette pêche est fortement dépendante du stock et que la forte diminution de ce dernier n'est pas liée à la surpêche. En effet, malgré une baisse considérable de l'effort de pêche et du prélèvement, le stock a continué de s'effondrer, suggérant ainsi que d'autres facteurs peuvent être mis en cause. En particulier, la zone de pêche est caractérisée par un environnement amazonien avec une mangrove importante et de nombreux cours d'eau. L'intégration de la mangrove dans l'analyse, qui a pourtant connu une diminution de sa surface dans les années 90, n'a pas permis d'expliquer l'effondrement du stock observé. Cependant l'intégration d'autres facteurs comme le débit des fleuves et la température de surface de l'océan ont permis de mieux comprendre la chute du stock dans cette filière. La pêche crevettière guyanaise semble en effet fortement impactée par le changement global, notamment l'augmentation de la température des eaux dans les zones de prélèvement. De surcroît, le dernier chapitre suggère que certains phénomènes endogènes à la pêche, comme les effets de congestion entre les navires de pêche, rendent l'ensemble de la pêche plus sensible à des chocs exogènes technologiques, économiques ou biologiques, en amplifiant l'impact de ces derniers sur les décisions optimales des entreprises concernant l'effort de pêche. Afin de préserver la pêche crevettière en Guyane française, il apparaît donc essentiel d'essayer de limiter, dans la mesure du possible, les sources du changement climatique, au lieu de modifier profondément les pratiques économiques du secteur.

Mots clés : économie des ressources naturelles, gestion des pêcheries, environnement amazonien, changement global.



## Abstract

The objective of this thesis was to understand the economic behavior of fisheries and to propose resource management policies. The focus was mainly on the French Guiana shrimp fishery. First an initial analysis will be performed on a historical data basis. Initial findings have showed that this fishery was characterized by a strong decrease in its stock, its effort, its production and lead to the closure of some companies. The results have helped also to understand that the production in this fishery is highly dependent on stock and the decrease of the stock is not related to overfishing. Indeed, despite a considerable decline in fishing effort and production, the stock continued to slump suggesting that other factors may be involved. In particular the fishing zone is characterized by an Amazonian environment with significant mangrove and many rivers. The integration of mangrove in the analysis, which shows a decrease in its surface in the 90s did not explain the collapse of the stock. However, the integration of other factors such as rivers and sea surface temperatures have increased understanding of stock depletion in this sector. The French Guiana shrimp fishery is highly influenced by global change, notably increasing in temperature. Moreover, the last chapter suggests that some endogenous phenomena in the fishery, like the congestion effects between fishing vessels, make the whole fishery more sensitive to technology, exogenous economic or biological shocks, amplifying their impact on the optimal business decisions regarding fishing effort. In order to save the French Guiana shrimp fishery, it appears therefore crucial to try to limit the sources of climate change instead of deeply modifying economic practices in this sector, which may lead to misunderstandings by fishermen and local political conflicts.

Keywords : Natural resource economics ; Fisheries management ; Amazonian environment ; Global change.



---

## Avant propos

Ce projet de thèse entre dans le cadre d'un financement proposé par l'Ecole Doctorale de l'Université de Guyane sur des crédits émanant du Fonds Social Européen, co-financé par le Centre National d'Etudes Spatiales (CNES) et le Ministère de L'Outre-Mer (MOM). L'objectif principal de la thèse est donc d'étudier le fonctionnement économique des pêcheries, en particulier des pêcheries guyanaises, afin d'en améliorer la compréhension, de déterminer si celles-ci fonctionnent de façon efficiente et ainsi, d'identifier les conditions de leur développement futur. Ce travail se concentrera sur le marché du poisson guyanais et, plus particulièrement, sur celui de la crevette. Ainsi, les conditions techniques de l'activité de pêche seront analysées en détail. En outre, le comportement économique des entreprises locales sera étudié de façon approfondie. Ce travail vise à fournir à terme des outils d'aide à la décision aux professionnels de la pêche et aux responsables des activités qui lui sont associées. Les résultats obtenus, devraient également s'adresser aux gestionnaires des collectivités territoriales et de l'administration nationale afin de contribuer à la définition de stratégies pour le développement futur du secteur de la pêche.



---

## Productions scientifiques

### Articles de recherches

#### *Articles publiés dans des revues internationales avec comité de lecture*

a. Sanz, N., **Diop, B.**, Blanchard, F., and Lampert, L., (2016), “On the Influence of Environmental Factors :The French Guiana Shrimp Fishery”, *Environmental Economics and Policy Studies* In Press <http://doi.org/10.1007/s10018-016-0153-6>

#### *Documents de travail*

b. Sanz, N., **Diop, B.** (2014), “Fish Search and Equilibrium Conservation”, Document de Travail du Ceregmia HAL Id : hal-01228851, version 1.

c. **Diop, B.**, Sanz, N., Duplan, Y.J., Guene, EL., Blanchard, F., Doyen, L, Perea, J.C. (2015) “Global warming and the collapse of the French Guiana Shrimp Fishery”, Document de travail du Ceregmia HAL Id : hal-01243305, version 1.

d. **Diop, B.**, Sanz, N., Blanchard, F., Walker, R. (2016), “The role of mangrove for the French Guiana shrimp fishery”.

e. Sanz, N., **Diop, B.** (2016), “Optimal management of French Guiana shrimp fishery : a matching model”

### Participation à des conférences

**World Conference on Natural Resource Modeling 2014**, (8-11 Juillet à Vinius en Lituanie)

– “Fish Search and Equilibrium Conservation” (Présentation orale)

**Symposium “Gestion écosystémique et bio-économie des pêcheries guyanaises 2014** (25 Novembre à Cayenne)



- “On the Influence on Environmental Factors on Harvest :The French Guiana Shrimp Fishery” (Présentation orale)

**EAERE (European Association of Environmental and Resource Economists),  
(Helsinki pre-conference workshop 24 Juin 2015)**

- “Fish Search and Equilibrium Conservation” (Présentation orale)

**World Conference on Natural Resource Modeling 2015 (29 Juin – 01 Juillet  
à Bordeaux)**

- “On the Influence on Environmental Factors on Harvest : The French Guiana Shrimp Fishery” (Présentation orale)

**Workshop LiGA (Littoral de Guyane sous influence Amazonienne) (Cayenne  
24-28 Novembre 2015) “ Communautés, écosystèmes et territoires sous contraintes  
anthropiques et climatiques ”**

- “Global warming and the collapse of the French Guiana shrimp fishery” (Présentation orale)



# Table des matières

<b>1</b>	<b>Introduction générale</b>	<b>2</b>
1.1	Contexte général . . . . .	2
1.1.1	Situation de la pêche mondiale . . . . .	2
1.1.2	Politiques de gestion des ressources marines . . . . .	5
1.1.3	La pêche guyanaise . . . . .	9
1.2	Cas d'étude : La pêche crevette guyanaise . . . . .	11
1.2.1	Les spécificités . . . . .	11
1.2.2	Analyse de la pêche à l'aide du modèle Gordon-Schaefer . . . . .	14
1.2.3	Analyse en fonction de différents modes de fonctionnement théoriques	16
1.2.4	Application numérique . . . . .	19
1.2.5	Résultats par variable . . . . .	22
1.2.6	Synthèse . . . . .	26
1.3	Objectifs et méthodologie . . . . .	28
1.3.1	Prise en compte de facteurs environnementaux . . . . .	28
1.3.2	Un modèle dynamique . . . . .	32
1.3.3	La prise en compte des externalités de recherche : un modèle de pré- lèvement stochastique . . . . .	35
1.3.4	Structure de la thèse . . . . .	37
<b>2</b>	<b>The role of mangrove in the French Guiana shrimp fishery</b>	<b>42</b>
2.1	Introduction . . . . .	44
2.2	The French Guiana shrimp fishery . . . . .	46

## TABLE DES MATIÈRES

---

2.3	The model . . . . .	48
2.3.1	Open access . . . . .	50
2.3.2	Comparative static effect of fluctuation in mangrove area . . . . .	51
2.4	Empirical results . . . . .	53
2.5	Summary and conclusion . . . . .	56
2.6	Références bibliographiques . . . . .	60
 <b>3 On the Influence of Environmental Factors on Harvest : the French Guiana Shrimp Fishery Paradox</b>		<b>64</b>
3.1	Introduction . . . . .	66
3.2	Methods . . . . .	70
3.2.1	Variables and data set . . . . .	70
3.2.2	Cobb-Douglas (C-D) production function . . . . .	72
3.3	Results and discussion . . . . .	75
3.4	Conclusion . . . . .	82
3.5	Références bibliographiques . . . . .	84
 <b>4 Global warming and the collapse of the French Guiana shrimp fishery</b>		<b>89</b>
4.1	Introduction . . . . .	91
4.2	The French Guiana shrimp fishery . . . . .	93
4.3	The bio-economic model . . . . .	95
4.3.1	The dynamic model . . . . .	95
4.3.2	The production function . . . . .	96
4.3.3	The management strategy . . . . .	96
4.3.4	Climate scenarios . . . . .	98
4.4	Results . . . . .	98
4.5	Discussion . . . . .	100
4.6	Summary and conclusions . . . . .	104
4.7	Références bibliographiques . . . . .	112

<b>5</b>	<b>Endogenous catchability and congestion externalities between vessels in a search-matching model : Evidence from the French Guiana shrimp fishery</b>	<b>117</b>
5.1	Introduction . . . . .	119
5.2	The model . . . . .	122
5.2.1	Harvest and catchability technologies . . . . .	123
5.2.2	Steady state escapement . . . . .	125
5.3	Open access equilibrium . . . . .	126
5.3.1	Firms' decisions and equilibrium anthropic pressure . . . . .	126
5.3.2	Global outcome . . . . .	128
5.4	Maximum economic yield equilibrium . . . . .	132
5.5	Empirical analysis . . . . .	133
5.6	Conclusion . . . . .	134
<b>6</b>	<b>Conclusion générale</b>	<b>145</b>
6.1	Références bibliographiques . . . . .	151



---

---

## CHAPITRE I :

---

### INTRODUCTION GENERALE

#### Préambule

Cette thèse porte sur l'analyse et la gestion des ressources marines. Elle comporte des analyses théoriques et empiriques, appliquées à la pêche crevettière guyanaise. Elle s'organise de la manière suivante : le Chapitre 1, rédigé en français, fait état de la littérature, pose le cadre théorique et donne les outils méthodologiques qui vont permettre d'analyser cette pêche et de proposer ensuite une gestion alternative la concernant. Les quatre chapitres suivants constituent chacun un article où sont détaillés les cas d'étude, les méthodes, et les discussions autour des résultats obtenus. Les modèles sont abordés alternativement dans des cadres statiques ou dynamiques, déterministes ou stochastiques, en fonction de la problématique abordée.

# 1

## Introduction générale

### 1.1 Contexte général

#### 1.1.1 Situation de la pêche mondiale

Selon Flaaten (2010), la capture d'un poisson par un pêcheur peut sembler insignifiante si on imagine l'immensité de l'océan et toutes les ressources qu'il englobe. Cependant, toutes les captures de tous les pêcheurs à l'échelle mondiale ont conduit à la surexploitation et à la menace de disparition de nombreuses espèces marines. Ce qui a été le cas, à certaines périodes, par exemple, de la morue au Canada (Cohen *et al.*, 1990; Hutchings et Myers, 1994), du hareng dans les eaux islandaises et norvégiennes (Hamre, 1944), ou encore des anchois au Pérou dans les années 70 (Boerema et Gulland, 1973), malgré la relative petite part de capture de chaque pêcheur ou bateau. Cette vision de l'exploitation des ressources marines par les hommes pose le problème de l'allocation de ces ressources.

Depuis longtemps, l'exploitation des ressources issues de l'océan a été un enjeu capital pour les hommes. L'exploitation de ces ressources se fait de diverses manières, avec des rythmes variés et dans des contextes particuliers pour chaque région. Les ressources marines constituent un enjeu capital car elles permettent, d'une part, de générer des emplois et, d'autre part, de répondre à un besoin croissant d'alimentation pour les hommes. Les ressources marines constituent en effet une importante source d'alimentation pour les êtres



humains et dès lors leur exploitation constitue un enjeu social, économique et environnemental. Dans son rapport de 2016, la FAO (Organisation des Nations Unies pour l'Alimentation et l'Agriculture) considère que les ressources marines constituent une source importante d'aliments nutritifs et de protéines animales pour une grande part de la population mondiale (FAO, 2016). Elles procurent 20 % des apports en protéines animales de la population mondiale. De ce fait, le poisson et les produits de la pêche font partie des denrées alimentaires de base les plus échangées dans le monde. Le poisson et les produits de la pêche constituent par ailleurs un enjeu considérable car ils représentent une part majeure des échanges mondiaux.

Toutefois le rythme de croissance de la production mondiale de poisson est plus prononcé que celui de la population mondiale. En effet, un rapport de 2012 (FAO, 2012), précise que l'offre mondiale de poisson de consommation a progressé de manière spectaculaire depuis cinquante ans, avec un taux moyen de croissance de 3,2 % par an sur la période 1961-2009, soit un rythme supérieur à la croissance démographique mondiale annuelle, qui est de 1,7 % sur la même période. L'une des premières conséquences de cette situation est de faire passer la consommation par habitant d'une moyenne de 9.9 kg dans les années 60, à 18.4 kg en 2009. L'offre a atteint son niveau maximal en 1996, avec 86,4 millions de t., avant d'amorcer une baisse qui se poursuit depuis. Une alternative à la baisse de la production marine mondiale est l'aquaculture. Celle-ci a connu un développement impressionnant ces dernières années. La production mondiale de la pêche marine, relativement stable depuis la fin des années 80, s'est établie à 81.5 millions de t. en 2014, alors que celle de la production mondiale de l'aquaculture marine en constante évolution s'est établie à 26.7 millions de t. (FAO, 2016). Toutefois, en prenant en considération l'aquaculture dans son ensemble (marine et continentale), la production mondiale a contribué à hauteur de 44,1 % à la production totale de la pêche de capture et de l'aquaculture en 2014 et cette part est en constante augmentation.

De façon chiffrée, les estimations de stocks ont évolué d'une valeur précise, mais inexacte, de 22 millions de t. au début des années 50 (Thompson 1951), à des valeurs comprises entre 80 et 100 millions de t. validées par la FAO au début des années 70 (Gulland, 1972). Dans sa première évaluation qui date de 1974 (FAO, 1974), la FAO considérait que la proportion des

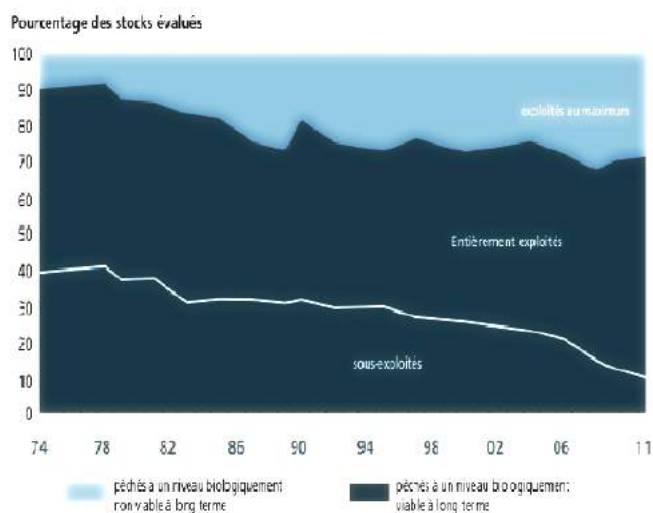

FIG. 1.1 – Evolution de l'état des stocks marins mondiaux (1974-2011) : source FAO (2014)

stocks qui ne sont pas pleinement exploités a progressivement baissé. Elle était de 40 % au début des années 70 et presque de 30 % au début des années 90. A l'inverse, le pourcentage des stocks surexploités a, quant à lui, augmenté, en particulier à la fin des années 70 et dans les années 80, passant de 10 % en 1974 à 26 % en 1989. Après 1990, le nombre de stocks surexploités a continué de progresser, bien qu'à un rythme moins soutenu. Ainsi, la proportion des stocks pleinement exploités, dont les captures sont en passe d'atteindre le niveau maximal durable, et pour lesquels il n'existe aucune possibilité d'accroissement de la production, est celle qui a le moins évolué. La proportion de stocks évalués et pêchés à un niveau biologiquement viable à long terme a baissé, passant de 90 % en 1974 à 71,2 % en 2011, après une légère remontée en 1990. Ainsi, il a été estimé qu'en 2011, 28,8 % des stocks de poissons étaient pêchés à un niveau biologiquement non viable à long terme qui dépassait le rendement maximal durable et, de ce fait, correspondait à une surexploitation. Sur le nombre total de stocks évalués en 2011, on a constaté que 61,3 % étaient exploités au maximum et que 9,9 % étaient sous-exploités (séparés par la ligne sur la Figure 1.1).

Toutefois, il est possible d'accroître la production à partir de ces stocks surexploités si

des plans efficaces de reconstitution des ressources sont mis en oeuvre. Le rétablissement durable d'une pleine productivité ne sera possible qu'après la mise en oeuvre de plans rigoureux de gestion, conformément au Plan d'application de Johannesburg adopté à l'issue du Sommet mondial pour le développement durable (Johannesburg, 2002). Ce plan recommandait de ramener les stocks à un niveau permettant d'obtenir un rendement maximal durable à l'horizon 2015, un objectif qui, selon toute vraisemblance, n'a pas été atteint. Quant aux stocks sous-exploités, ils sont en réalité exposés à une pression de pêche relativement faible et offrent donc des possibilités d'accroissement de la production. La proportion des stocks qui est sous-exploitée ne présente pas un potentiel de production très élevé, mais nécessite des plans de gestion appropriés pour éviter qu'une éventuelle augmentation du taux d'exploitation n'entraîne à nouveau une surexploitation. En effet, avec le rythme de surexploitation d'une grande majorité des espèces, celles qui ont moins de valeur commerciale aujourd'hui feront l'objet de convoitise dans les années à venir. La surexploitation des stocks a non seulement des conséquences écologiques défavorables, mais entraîne aussi une chute de la production qui n'est pas sans perturbation sur les plans économique et social. Une dizaine d'espèces principales représentent environ 30 % de la production mondiale marine. Si le rythme de surexploitation ne diminue pas, la situation mondiale des pêcheries risque de s'aggraver et d'avoir un impact négatif sur les productions futures.

La FAO préconise à cet effet de mettre en place des politiques de gestion, afin de préserver les ressources et d'assurer un rendement économique durable aux acteurs. Il convient ainsi de mettre en place des plans de gestion efficaces afin de reconstituer les stocks surexploités et de consolider la gestion des stocks qui connaissent un niveau biologique viable à long terme.

### 1.1.2 Politiques de gestion des ressources marines

L'examen des tentatives passées pour prédire l'avenir de la pêche offre la possibilité de sonder notre capacité à nous adapter à l'évolution des pêcheries et d'en tirer des conséquences. En effet beaucoup des prévisions faites par le passé ont été testées au cours du temps. Certaines des plus récentes doivent encore être testées à l'avenir comme le soulignent Garcia

and Grainger (2005).

Sous l'effet des techniques de pêche abusives et non réglementées ou du changement global, les captures et les stocks ont fortement diminué sur les 30 dernières années. Les ressources marines se faisant de plus en plus rares, une gestion plus rigoureuse des avantages collectifs qu'elles apportent apparaît nécessaire. En effet, la pêche doit concilier la nécessité de répondre aux besoins alimentaires et nutritionnels urgents d'une population en expansion, et le caractère limité, car épuisable, des ressources naturelles renouvelables.

La durabilité des pêches a été et reste le principal objectif de gestion. Traditionnellement, la gestion des pêches a privilégié l'optimisation de la productivité au niveau de l'espèce et l'approche la plus commune a consisté à éviter la surpêche du potentiel de croissance (caractérisée par une perte de tonnage du fait de la présence de juvéniles) et la surpêche du potentiel reproducteur (caractérisée par une diminution de l'abondance des stocks). Cette approche repose sur le fait que l'activité de pêche doit être fondée sur la durabilité et la stabilité. Il faut ainsi un équilibre entre l'activité de pêche et la capacité reproductive des ressources. Cette approche est connue sous la dénomination MSY (Maximum Sustainable Yields ou rendement maximal durable) qui était une cible bien établie pour la gestion des pêches et qui est incluse dans la Convention de 1982 des Nations Unies sur le droit de la mer (UNCLOS), qui stipule que les organismes de gestion des zones côtières devraient “... *maintenir ou rétablir les stocks des espèces exploitées à des niveaux permettant d'obtenir le rendement maximal durable, eu égard aux facteurs écologiques et économiques pertinents.*” (Cochrane, 2002). Les organismes de pêche sont tenus de mettre en place des mesures pour pratiquer une pêche durable. Les principales mesures pouvaient consister à mettre en place des réglementations concernant par exemple les mailles des filets, ou à sélectionner les engins de pêche, dans un premier temps. Ensuite les mesures ont consisté à mettre en place des moratoires, des quotas de captures ou encore des fermetures. A titre d'exemple, en 2010, le Pérou a connu une forte diminution de ses captures d'anchois, et la principale mesure prise à l'époque consistait en une instauration de périodes de fermeture de la pêche. En effet cette mesure est intervenue après une prise de conscience que les captures contenaient de nombreux juvéniles. Cette situation était attribuée à la survenue de l'épisode “la Niña”,

phénomène climatique qui se traduit par une arrivée de masses d'eau froide qui impacte le stock<sup>1</sup>. Cette mesure a porté ses fruits en 2011, année au cours de laquelle les captures d'anchois ont été supérieures à celles de 2009.

Depuis 1993, les pays ont considéré plusieurs mesures pour promouvoir l'approche écosystémique, en particulier dans le secteur des pêches. Le Code de conduite pour une pêche responsable ("le Code") a été adopté en 1995 par les pays membres de la FAO (FAO, 2003). Son rôle est défini de la manière suivante : "Le présent Code définit des principes et des normes internationales de comportement pour garantir des pratiques responsables en vue d'assurer effectivement la conservation, la gestion et le développement des ressources bio-aquatiques, dans le respect des écosystèmes et de la biodiversité." (FAO, 2011). Ces 20 dernières années, le "Code" a constitué une référence mondiale pour le développement durable des secteurs de la pêche et de l'aquaculture. Le "Code" a en effet pour objectif de parvenir au développement durable dans le contexte des pêches. Ainsi la politique de gestion a changé et tente de plus en plus de prendre en considération une approche écosystémique de la pêche (AEP), du fait de la médiocre performance des approches de gestion conventionnelles de la pêche. L'AEP est issue d'une volonté de conserver les ressources et de les gérer dans un même temps. Dans son rapport sur l'aménagement des pêches (FAO, 2003), l'organisation mondiale considère que l'AEP repose sur la reconnaissance de l'interdépendance entre le bien-être écologique et le bien-être humain. La gestion ne se limite plus à la seule ressource mais prend en considération tout son environnement.

Ainsi l'effondrement de la pêche à travers le monde suggère que de nouvelles approches de gestion des pêches sont nécessaires (Roughgarden, 1998). La gestion des pêches est confrontée à, et parfois confondue avec, la complexité des systèmes de pêche dans le monde réel.

---

<sup>1</sup>«La Niña» est le phénomène opposé de «El Niño» (qui signifie l'« Enfant Jésus » en espagnol) qui est utilisé par les pêcheurs en Equateur et au Pérou pour se référer à un courant océanique plus chaud que la normale, observé immédiatement après Noël. Les deux phénomènes sont réunis sous le titre de ENSO (El Niño-Southern Oscillation)

### **Nouvelles approches de gestion**

La théorie, selon laquelle la biomasse est donnée indéfiniment, se heurte à l'hypothèse irréaliste d'un environnement marin constant. Aujourd'hui, du fait du changement global, une telle hypothèse semble peu réaliste. Il semble donc nécessaire d'intégrer les facteurs environnementaux aux cadres du rendement économique maximum et du rendement maximal durable.

Une considération majeure pour la gestion des pêches est la réalité d'une incertitude liée à cette activité. Une des questions et préoccupations auxquelles l'AEP doit répondre est l'impact du changement climatique sur les écosystèmes marins. En effet selon Briones *et al.*, (2006), le changement climatique peut entraîner des ajustements environnementaux tels que des changements dans la configuration des précipitations et de la concentration en dioxyde de carbone atmosphérique et les changements dans les modèles de circulation de vent et de l'océan. Le plancton est en effet particulièrement sensible aux fluctuations de l'environnement et, de ce fait, la biomasse des petits pélagiques, qui se nourrissent généralement de plancton de courte durée, est fortement influencée par le changement climatique.

Jusqu'à présent, la recherche sur les conséquences économiques du changement climatique sur la pêche a été limitée et fragmentée. En général, les pays s'adaptent aux changements dans l'abondance de poissons, indépendamment des causes, à des échelles de temps très variables et de manière non coordonnée. Le changement climatique n'est pas un phénomène isolé, mais, dans une large mesure, la conséquence de l'action humaine sur l'ensemble de la terre, qui affecte le climat, l'utilisation des terres, l'exploitation des ressources et la pollution (Hannesson *et al.*, 2006). Ainsi il est important de prendre en considération cette dimension dans l'exploitation des ressources notamment marines. La gestion d'une pêcherie qui se base uniquement sur ses aspects biologique, économique ou encore technologique conduirait à des conclusions qui ne prendraient pas en compte les caractéristiques environnementales, pourtant déterminantes. En effet, des signes de l'influence des phénomènes environnementaux sur certaines espèces marines sont de plus en plus évidents. Le réchauffement climatique n'aurait pas seulement une incidence sur l'atmosphère, les plantes et les animaux, mais pourrait éga-

lement affecter la température des océans et des courants, et ainsi la vie végétale et animale marine. Prendre la mesure de ce phénomène serait susceptible d'améliorer l'efficacité de la gestion des ressources marines.

### 1.1.3 La pêche guyanaise

La Guyane possède un vaste plateau continental de près de 50 000 km<sup>2</sup> qui s'étend au large d'un littoral de 320 km de côtes vaseuses, rocheuses et sableuses. La proximité de la Guyane française avec l'estuaire de l'Amazonie se traduit par la présence d'un couloir de vase tout le long de la côte. Ces côtes sont couvertes à 80 % de mangroves. La Guyane bénéficie d'une Zone Economique Exclusive de 130 000 km<sup>2</sup>(<sup>2</sup>). Du fait de sa situation géographique, elle bénéficie d'une très grande biodiversité dans ses différents milieux naturels ainsi que de ressources abondantes, qui offrent de grandes possibilités d'exploitation.

La pêche est le troisième secteur économique de la Guyane. Elle emploie près de 760 personnes et représente près du tiers des recettes totales d'exportation de marchandises (hors activité spatiale) de la Guyane. Le rapport de l'Institut d'Emission Des Outre-Mer (IEDOM, 2015) chiffre les exportations de poissons à 1 473 t. (contre 1 275 t. en 2014), soit une sensible hausse de 15,6 % sur un an. Ces exportations représentent en valeur 8,2 millions € contre 6,9 millions € en 2014. Ces exportations sont constituées pour une grande partie de vivaneaux à destination de la Martinique. Ce ne fut pas toujours le cas, car les crevettes ont constitué dans le passé l'essentiel des exportations de produits de la mer en Guyane. Depuis la production a très fortement baissé du fait des chutes simultanées du stock et de l'effort de pêche.

Ainsi, trois ressources marines sont principalement exploitées en Guyane : le vivaneau, la crevette et le poisson blanc. Par ailleurs, on distingue trois types de pêche : une pêche artisanale, à savoir la pêche côtière, et deux pêcheries considérées comme étant industrielles, la pêche au vivaneau et la pêche à la crevette.

---

<sup>2</sup>La ZEE présente l'avantage d'une étendue sans obstacle au large et d'être formée sur toute sa superficie d'un plateau continental. Si la frontière des ZEE brésilienne et française à l'est a fait l'objet d'un accord dès 1981, la délimitation avec le Surinam, à l'ouest, n'a toujours pas abouti à ce jour. (*La Revue Maritime* N°477, 2006)

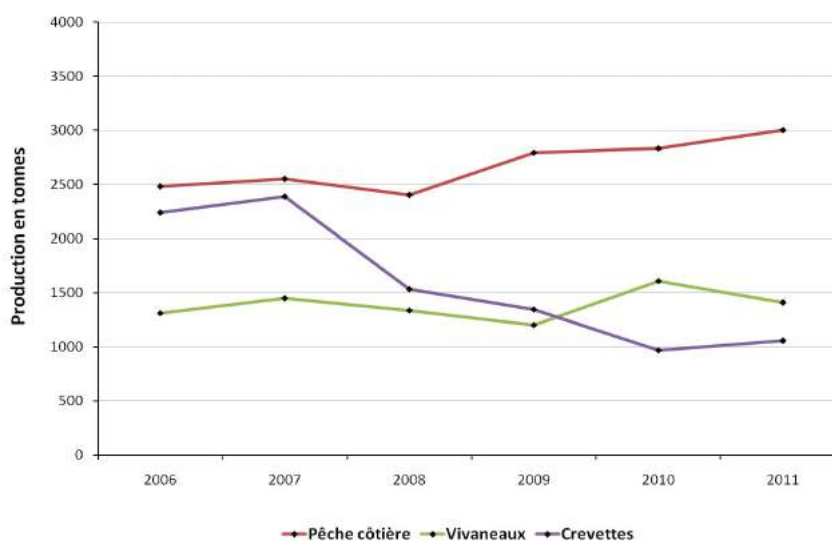

FIG. 1.2 – Historique de la production des trois types de pêche de Guyane française. Source : Ifremer Guyane.

La pêche côtière opère le long du littoral à des profondeurs de moins de 30 mètres. Elle est pratiquée par environ 200 navires artisanaux qui débarquent régulièrement une trentaine d'espèces différentes. Ces navires sont regroupés en quatre catégories selon Bellaïl et Dintheer (1992) : la pirogue, le canot créole, le canot créole amélioré, et la tapouille (voir Annexes, Figure 1.13). Cette pêche connaît une évolution croissante de sa production. Cependant, même si cette filière est caractérisée par une grande diversité, plusieurs recommandations ont été formulées pour améliorer sa durabilité, et notamment afin de diminuer les rejets dus à la faible sélectivité des techniques de pêche (Cissé *et al.*, 2014).

La pêche au vivaneau est pratiquée dans des fonds de 40 à 120 mètres. Le volume moyen annuel de production est de l'ordre de 1600 t. du fait d'une demande de plus en plus importante. La pêche au vivaneau est opérée par des navires vénézuéliens (voir Annexes, Figure 1.12) qui ont l'obligation de débarquer 75 % de leur production en Guyane. Les espèces qui sont principalement débarquées sont le vivaneau rouge et le vivaneau rayé. En 2012, ces navires étaient au nombre de 45 sous licences européennes, sans compter quelques navires antillais. Ces derniers ne font l'objet d'aucune obligation vis-à-vis de la Guyane. Cette pêche



est marquée par une relative constance de sa production. Depuis 1985, l'Ifremer a mis en place un système de suivi des débarquements de la pêcherie de vivaneaux pratiquée par les ligneurs vénézuéliens dans le but d'obtenir les données de base pour l'évaluation nécessaire du stock (Rivot *et al.*, 2000).

En ce qui concerne la pêche crevette, celle-ci est pratiquée dans des fonds de 30 à 100 mètres, à une distance située entre 22 et plus de 100 km des côtes. Elle comptait au début des années 90 plusieurs dizaines de chalutiers et n'en compte aujourd'hui qu'un peu plus d'une dizaine (Figure 1.4). Les débarquements sont passés de près de 4000 t. au début des années 90 à moins d'un millier de t. de nos jours. La pêche crevette a la particularité de connaître très peu de sélectivité dans ses prises. Cependant un dispositif de sélectivité appelé "TTED" (Trash and Turtle Device - Dispositif d'exclusion des tortues et détritiques, voir Figure 1.3) est devenu obligatoire depuis le 1er janvier 2010<sup>3</sup>. Les trois types de pêche de Guyane française ont connu des évolutions récentes très contrastées, marquées par un effondrement de la production crevette qui soulève un certain nombre d'interrogations quant à l'avenir de cette pêcherie (Figure 1.2).

## 1.2 Cas d'étude : La pêcherie crevette guyanaise

### 1.2.1 Les spécificités

La crevette demeure le produit le plus important en termes de valeur puisque, en 2010, elle a représenté approximativement 15 % de la valeur totale des produits halieutiques exportés dans le monde (FAO, 2012). La pêcherie crevette guyanaise n'échappe pas à cette règle, car l'essentiel de sa production est également exporté.

La pêcherie crevette guyanaise a débuté au début des années 60. Deux espèces sont principalement exploitées, le Brown et le Pink (respectivement *Farfantepenaeus subtilis* et *Farfantepenaeus brasiliensis*). L'ensemble de la flottille était constituée au départ de chalutiers floridiens ayant deux chaluts fonctionnant simultanément. Entre 1970 et 1990, la totalité de

---

<sup>3</sup>Le TTED est un système adaptable aux chaluts de pêche aux crevettes notamment, qui permet aux tortues marines prisonnières du filet de s'échapper.

## 1. INTRODUCTION GÉNÉRALE

---

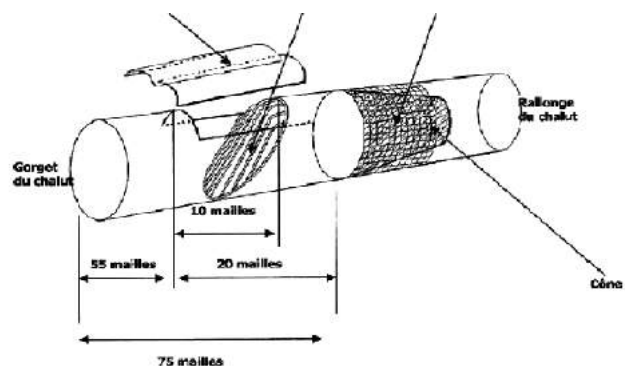

Système de grille adapté au chalut, avec une porte de sortie pour les tortues  
Détail du dispositif Flip-TED et BFD-FES. La Grille Nordmore peut remplacer le TED  
Grille ou TED comme Turtle Excluder Device (Source : IFREMER)

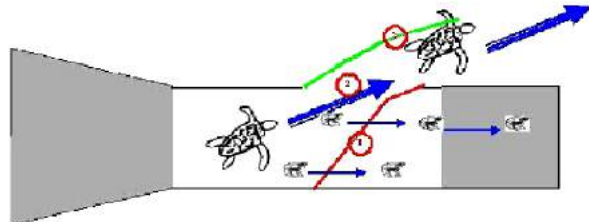

FIG. 1.3 – Dispositif TED de sélectivité (Source : Ifremer)

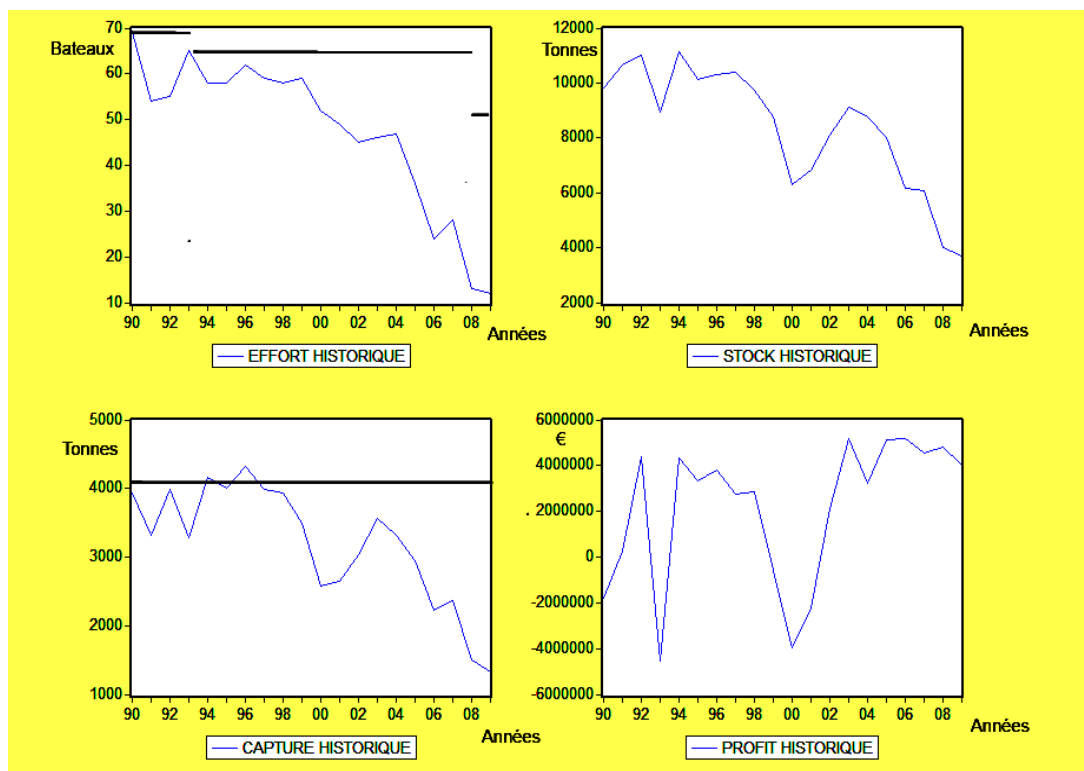

FIG. 1.4 – Historique de l’effort, du stock, de la capture et des profits de la pêcherie crevette de Guyane française

la flottille est progressivement devenue française. Depuis 1992, la flottille exploite la crevette sur le plateau continental. L'évaluation du stock fut réalisée par intervalle de deux années par un groupe de recherche rattaché à la FAO, Commission des Pêches pour l'Atlantique Centre-Ouest (COPACO) jusqu'en 1999. L'Ifremer a pris de son côté en charge les estimations à partir de 1980, permettant ainsi une meilleure connaissance de la population. Notre période d'étude s'étale de 1990 et 2009.

Le Tableau 1.1 fournit l'historique du stock, des débarquements, de l'effort (nombre de navires), et des profits. Ces valeurs historiques sont confrontées aux valeurs de trois régimes théoriques de gestion d'une pêcherie. Ces régimes alternatifs sont connus sous les noms de "rendement maximal durable" (MSY), d'"open access" (OA), et de "rendement économique maximal" (MEY). Ces confrontations permettent de déterminer quel régime illustre le mieux le fonctionnement de la pêcherie crevette guyanaise.

Le Figure 1.4 illustre les évolutions de l'effort, du stock, de la capture et du profit de la

pêcherie crevette guyanaise. Le quota imposé aux captures est de 4108 t. par an. Il fut instauré en 1983 et maintenu jusqu'en 2012. Le quota est symbolisé par le trait horizontal sur le graphique de l'évolution historique des captures. Le nombre de licences accordées était de 69 navires par an jusqu'en 1993. Ce nombre est passé à 63 en 1993 et s'est maintenu jusqu'en 2008 où il est passé à 49. Aujourd'hui on compte seulement une douzaine de navires en activité. Ces licences sont symbolisées par des segments sur le graphique de l'évolution historique de l'effort. Nous constatons que le nombre de licences proposées a toujours été supérieur au nombre de licences attribuées. Et le quota imposé n'a jamais été atteint sur la période étudiée. Ni les quotas, ni les licences n'ont constitué de facteur limitant dans cette pêcherie. Le stock, l'effort et la capture ont connu durant cette période des baisses simultanées. Cette situation invite de ce fait à une analyse plus approfondie de la pêcherie crevette guyanaise. Cette analyse passe dans un premier temps par une application du modèle de Gordon-Schaefer (Gordon, 1954; Schaefer, 1954, 1957) à cette pêcherie.

### 1.2.2 Analyse de la pêcherie à l'aide du modèle Gordon-Schaefer

Les économistes des ressources naturelles se sont intéressés aux pêcheries quand les ressources ont commencé à se faire rares, posant ainsi le problème de l'allocation de ces ressources. L'économie des ressources biologiques renouvelables est relativement récente, se situant autour des années 1950 dans le secteur de la pêcherie. Les modèles originaux étaient statiques et liaient de simples modèles de croissance de population à la production.

En économie, le travail et le capital (inputs) sont combinés pour produire (output). Ces deux facteurs sont entièrement consommés. Par ailleurs, il est possible de réguler l'un ou l'autre ou les deux à la fois pour augmenter ou diminuer la production. Ce qui n'est pas le cas en économie de la pêche. En effet, deux facteurs sont également utilisés dans l'industrie de la pêche : l'effort et le stock. L'effort, qui est représenté par le nombre de navires ou les jours passés en mer, peut en effet constituer un moyen de régulation dans cette industrie, tandis que le stock ne peut faire l'objet d'aucune mesure de régulation, du moins directement. Ce dernier facteur dépendant de la nature, il est affecté par l'ensemble des pêcheurs mais reste

incontrôlable. Aucun pêcheur ne peut savoir à l'avance la quantité qui sera disponible au moment de chacune de ses sorties.

Le modèle de Gordon (1954) comme celui de Clark (1990) est l'un des premiers modèles théoriques d'économie des pêches. Son but principal est d'examiner le résultat, en termes de production, de l'utilisation des ressources. Par la suite, les travaux de Gordon et de Schaefer (Gordon, 1954 ; Schaefer, 1954, 1957) ont conduit à un modèle simple qui décrit une pêcherie commerciale. Il y est représenté une fonction de production linéaire par rapport à l'effort et au stock, et homogène de degré deux. Ce modèle peut être spécifié de la manière suivante :

$$H = qEX \tag{1.1}$$

où  $H$  représente la capture,  $q$ , la capturabilité,  $E$ , l'effort de pêche, et  $X$ , le niveau du stock. Dans ce modèle, le stock croît suivant la fonction logistique de Verhulst (1838) :

$$F(X) = rX\left(1 - \frac{X}{K}\right) \tag{1.2}$$

où  $r$  et  $K$  sont des paramètres biologiques désignant respectivement le taux de croissance intrinsèque et la capacité de charge de l'habitat. La durabilité dans une pêcherie donnée implique que le niveau du stock soit constant, et que le prélèvement soit égal au recrutement. On dit alors que la ressource est exploitée sur la base d'un rendement durable. Ce qui se traduit par les égalités suivantes :

$$H = F(X) \tag{1.3}$$

$F(X)$  est fonction de la taille du stock et  $K$  peut être considérée également comme la biomasse moyenne inexploitée du stock (Figure 1.5). Ce rendement est calculé sur la base d'un stock obtenu dans des conditions représentées par la Figure 1.5. Il équivaut à la quantité maximale de poisson qui pourrait être prélevée pour un niveau de stock donné.

En substituant  $X$  dans l'équation (1.3) par son expression (1.1), on aboutit à l'expression

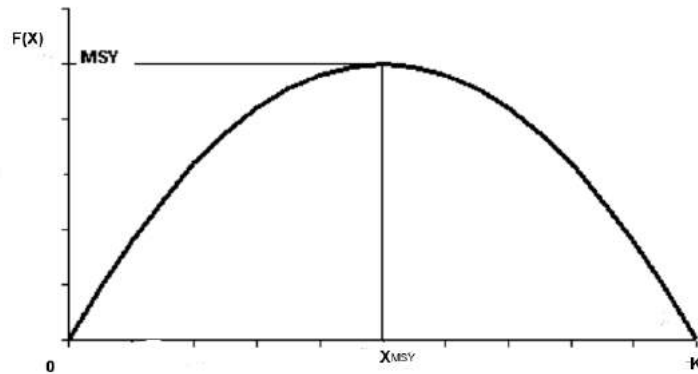

FIG. 1.5 – Courbe de croissance naturelle

suivante du prélèvement équilibré :

$$H(E) = qKE\left(1 - \frac{qE}{r}\right) \quad (1.4)$$

Les deux équations précédentes traduisent l'équilibre biologique, respectivement en fonction du stock et en fonction de l'effort de pêche. Ecrit autrement, on obtient :  $H/X = qE$ , ce qui correspond au prélèvement par unité de stock, et qui peut être comparé à  $r$ . Ainsi, si  $H/X > r$ , le stock est en diminution et inversement. Le modèle suppose donc que la capture par unité d'effort, encore appelée "capturabilité", est proportionnelle à la taille du stock.

$$\frac{H}{E} = qX \quad (1.5)$$

### 1.2.3 Analyse en fonction de différents modes de fonctionnement théoriques

Nous nous proposons dans cette sous-section d'analyser la pêcherie crevette guyanaise à l'aide de trois modes de gestion bien stabilisés dans la littérature. Le premier mode de gestion (MSY), basé sur des considérations purement biologiques, va d'abord être étudié.

Les deux autres modes de gestion alternatifs (open access et MEY), qui prennent à la fois en compte les aspects biologiques et économiques du prélèvement seront ensuite analysés.

### Rendement maximal durable (MSY)

Le rendement maximal durable constitue le principal mode de gestion des pêcheries depuis de nombreuses années. Les premières prédictions concernant les pêcheries se sont surtout focalisées sur les captures maximales à atteindre. Cet objectif ignore les aspects purement économiques. En effet, le MSY correspond à une situation qui n'implique pas forcément une durabilité économique mais seulement biologique. Certaines entreprises du secteur peuvent afficher des profits négatifs du fait de la mise en place de quotas.

La production maximale équilibrée est obtenue en maximisant la fonction de croissance naturelle du stock (Eq. 1.2), ce qui conduit à :

$$r - \frac{2rX}{K} = 0 \quad (1.6)$$

En isolant  $X$ , on obtient le niveau de stock qui correspond à la production maximale équilibrée :

$$X_{MSY} = \frac{K}{2} \quad (1.7)$$

Ensuite, en remplaçant  $X_{MSY}$  dans la fonction de croissance naturelle (Eq. 1.2), on obtient le niveau de production MSY :

$$H_{MSY} = \frac{rK}{4} \quad (1.8)$$

Le niveau d'effort correspondant au MSY est obtenu en égalisant les équations (1.1) et (1.8). En isolant  $E$ , nous obtenons l'équation suivante, qui correspond au niveau d'effort qui assure le rendement maximal durable :

$$E_{MSY} = \frac{r}{2q} \quad (1.9)$$

### Equilibre de libre entrée (open access)

L'équilibre d'open access est connu sous le nom d'équilibre bioéconomique ou bionomique (Gordon, 1954), et traduit une situation de libre entrée des entreprises dans la pêche. Cet équilibre est donc obtenu lorsque les profits réalisés par les entreprises de pêche sont égaux à zéro, le processus d'entrée des entreprises se poursuivant jusqu'à ce que l'effort de pêche atteigne son coût d'opportunité. La fonction de profit est donnée en supposant un prix de la production,  $p$ , et un coût de l'effort,  $c$ , constants, par l'expression suivante :

$$\Pi(E) = pH(E) - cE \quad (1.10)$$

En posant  $\Pi(E) = 0$ , et en isolant  $X$  dans l'équation (1.10), on obtient le niveau de stock d'OA :

$$X_{OA} = \frac{c}{pq} \quad (1.11)$$

L'expression de l'effort en OA est obtenue en isolant  $E$  à partir de l'équation (1.3) ; on obtient ainsi :

$$E_{OA} = \frac{r}{q} \left(1 - \frac{c}{pqK}\right) \quad (1.12)$$

Enfin, en substituant  $E$  par  $E_{OA}$  dans l'équation (1.4), on trouve l'expression du prélèvement, toujours en open access :

$$H_{OA} = \frac{cr}{pq} \left(1 - \frac{c}{pqK}\right) \quad (1.13)$$

### Rendement économique maximal (MEY)

L'équilibre MEY se distingue de l'équilibre OA en ce qu'il tient compte à la fois des aspects biologique et économique des activités halieutiques. Toutes les entreprises impliquées réalisent des profits positifs tout en préservant le stock. Dans ce cas de figure, la pêche est gérée de façon à obtenir la quantité d'effort qui donne la plus grande différence entre les recettes et les coûts. En dérivant dans un premier temps la fonction (1.10) par rapport à  $E$  et en posant la condition de premier ordre, nous obtenons le niveau d'effort correspondant



au rendement économique maximal :

$$E_{MEY} = \frac{r}{2q} \left(1 - \frac{c}{pqK}\right) \quad (1.14)$$

Ensuite, en remplaçant la valeur de  $E_{MEY}$  dans l'équation (1.3), on obtient le niveau de prélèvement correspondant au MEY :

$$H_{MEY} = \frac{rK}{4} \left[1 - \left(\frac{c}{pqK}\right)^2\right] \quad (1.15)$$

L'isolation de  $X$  dans l'équation (1.1) et les remplacements de  $E$  et  $H$  respectivement par  $E_{MEY}$  et  $H_{MEY}$  permettent d'obtenir l'expression du niveau du stock sous MEY :

$$X_{MEY} = \frac{K}{2} + \frac{c}{2pq} \quad (1.16)$$

Lorsque la pêcherie est gérée de façon optimale, l'effort se stabilise à un niveau qui maximise le rendement (Figure 1.6). En effet, dans le modèle Gordon-Schaefer statique, les recettes et les coûts sont fonction de l'effort de pêche. A l'équilibre bioéconomique, le chiffre d'affaires est égal au coût de la pêche. Ainsi le MEY correspond au volume des débarquements qui produirait la plus grande valeur ajoutée du secteur à long terme. Cependant si la pêcherie est non réglementée, exploitée par de nombreux acteurs concurrents, le niveau d'effort de pêche tend inévitablement vers  $E_{OA}$ , qui correspond à l'équilibre d'OA. Cet équilibre représente une situation de surexploitation selon Gordon (1954).

### 1.2.4 Application numérique

La fonction de prélèvement est donnée par l'équation (1.1) et la fonction de croissance naturelle par l'équation (1.2). En combinant les deux équations précédentes, nous obtenons à l'équilibre l'équation (1.4), qui peut être réécrite de la manière suivante :

$$H(E) = qKE - \frac{q^2K}{r}E^2 = b_1E + b_2E^2 \quad (1.17)$$

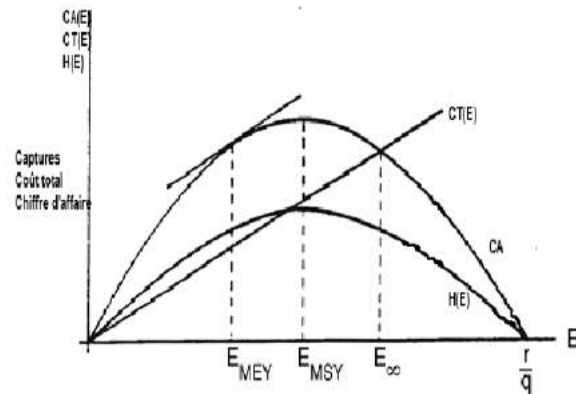

FIG. 1.6 – Recettes et coûts en fonction de l'effort de pêche

où  $b_1 = qK$ , et  $b_2 = \frac{-q^2K}{r}$ , sont les paramètres à estimer par la méthode des moindres carrés ordinaires. L'équation du prélèvement équilibré est estimée en utilisant les séries chronologiques fournies par l'Ifremer Guyane (Institut français pour la recherche marine) disponibles pour la période 1990-2009 (voir Tableau 1.1), qui portent sur le stock, l'effort et la production de la pêcherie crevette.

## 1. INTRODUCTION GÉNÉRALE

---

Tableau 1.1 Historique de la pêche crevette guyanaise

Années	Stock (t.)	Captures observées (t.)	Effort (Nombre de navires)	Profits
1990	9831	3926	69	-1782329
1991	10652	3313	54	240386
1992	11016	3987	55	4410845
1993	8929	3275	65	- 4558165
1994	11126	4156	58	4321822
1995	10120	4010	58	3329022
1996	10304	4323	62	3806458
1997	10409	3984	59	2739481
1998	9739	3940	58	2853022
1999	8765	3495	59	- 585719
2000	6302	2572	52	- 3972932
2001	6809	2651	49	- 2197509
2002	8120	3043	45	2119055
2003	9110	3557	46	5201514
2004	8778	3325	47	3211173
2005	8026	2943	36	5153724
2006	6173	2222	24	5203816
2007	6096	2369	28	4552452
2008	4000	1496	13	4807167
2009	3705	1323	12	4043508

Les résultats de l'estimation de l'équation du prélèvement équilibré sont donnés dans le Tableau 1.2. L'estimation des paramètres a conduit à résoudre un système de deux équations à trois inconnues mais les travaux de Martinet et Blanchard (2009) permettent de lever deux inconnues sur les trois. Ces deux inconnues sont constituées des paramètres biologiques, qui sont le taux de croissance intrinsèque  $r$  et la capacité de charge de l'habitat  $K$  ; les valeurs sont indiquées dans le Tableau 1.2. Nous en avons déduit la valeur de  $q$ , qui est une valeur

moyenne sur la période étudiée.

Les résultats dénotent une significativité globale du modèle, indiquée par la valeur du  $F$ -statistic de Fisher, et une significativité individuelle des paramètres estimés ( $T$  de Student). Les principaux tests d'hypothèses sur le modèle sont validés et permettent de poursuivre son analyse. Le modèle sera ainsi utilisé pour confronter les valeurs historiques des variables endogènes (stock, effort, capture et profit) aux variables simulées dans le cadre des différents modes de gestion que nous avons définis précédemment.

Tableau 1.2 : Estimation des paramètres de la fonction Gordon-Schaefer

		$H = b_1E + b_2E^2$
$b_1 = qK$		102 (0.000)
$b_2 = -\frac{q^2K}{r}$		-0.66 (0.002)
Number of observations	20	F statistic 27.21
$R^2$	0.78	$R^2$ adjusted 0.77
JB	3.48	Q-Stat 7.02
LM (ARCH)	2.04	DW 1.33
$K = 18500$ t. (Marinet et Blanchard, 2009)		$q = 0.006$
$i = 0.91$ (Marinet et Blanchard, 2009)		

Notes : p-values in parentheses ; all coefficients are statistically significant at the 5% level.

JB is the Jarque-Bera statistic of the normality test ; Q-Stat is the Ljung-Box statistic used in the correlation test ;

LM (Lagrange multiplier) corresponds to the heteroscedasticity test.

## 1.2.5 Résultats par variable

### Le stock

Le niveau de stock en MEY (Figure 1.7), c'est-à-dire celui qui permettrait de maximiser la rente, est plus élevé que dans tous les autres régimes de pêche. Le niveau baisse à partir

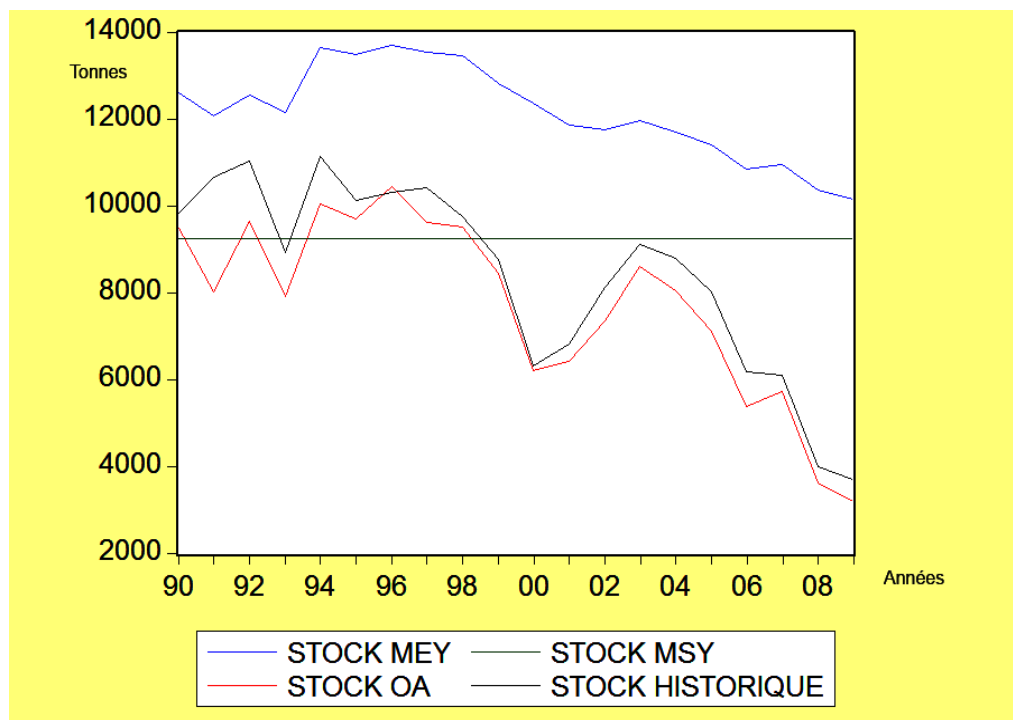

FIG. 1.7 – Les niveaux de stocks des différents régimes

de la fin des années 1990 pour se rapprocher du niveau qui assurerait le rendement maximal durable à la fin de notre période d'étude. Le niveau de stock historique varie autour du niveau de stock MSY entre 1990 et 1998 et finit par s'effondrer malgré une légère hausse en 2003. Enfin le niveau de stock en OA suit la même tendance que l'historique. Les valeurs en OA ont été obtenues en générant des coûts à partir de la condition de profit nul appliquée aux données historiques. Les coûts sont ainsi obtenus en isolant  $c$  dans l'équation (1.10). Les différentes valeurs d'équilibre d'open access sont consignées dans le Tableau 1.3 et celles du rendement économique maximal dans le Tableau 1.4.

### Les niveaux d'effort de pêche

Tandis que le niveau de stock sous MEY est plus important que celui observé sous MSY, l'effort de pêche qui permet de réaliser le MEY est moitié moins élevé que celui consenti sous OA (voir Figure 1.8). En réalité le niveau d'effort en OA est sans surprise le niveau d'effort le plus élevé parmi les quatre régimes de gestion. Le niveau d'effort en MEY est relativement croissant sur la période étudiée, variant de 40 à 60 navires, tandis que le niveau d'effort

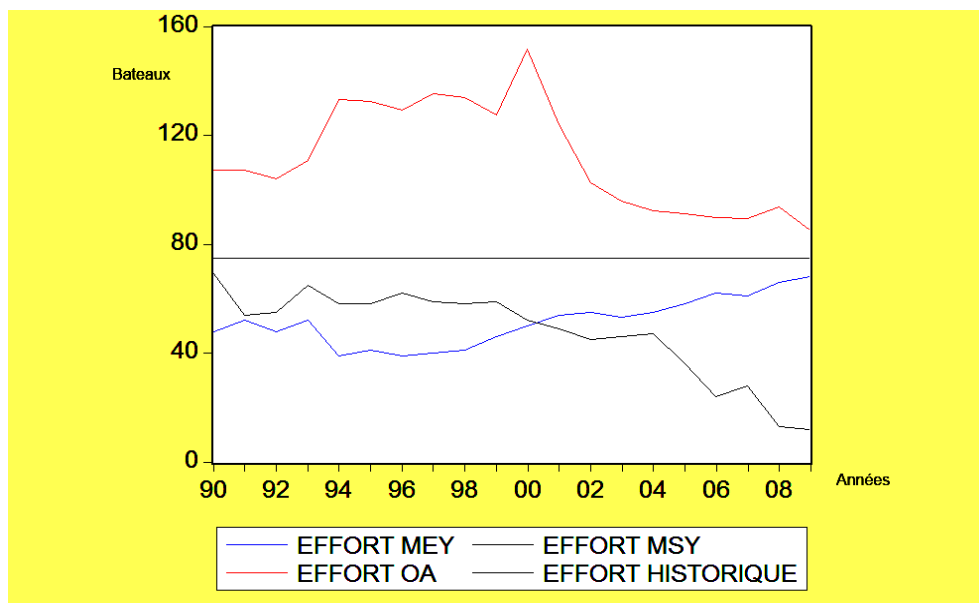

FIG. 1.8 – Les niveaux d’effort de pêche des différents régimes

historique connaît une tendance inverse, passant d’un peu plus de 60 navires à une dizaine de navires en 2009. Sur la période 1990-2000, le nombre historique de navires se situe au dessus du nombre de navires qui assurerait la rente maximale, et sur la période 2000-2009, le résultat inverse est obtenu. Le niveau d’effort historique n’a jamais pu atteindre le niveau qui assurerait le rendement maximal durable, qui se situe autour de 75 navires, c’est-à-dire au dessus du nombre des licences qui ont été accordées entre 1990 et 1993.

### Les niveaux de prélèvement

La Figure 1.9 représente l’évolution des captures historiques et de ce qu’auraient été les captures si la pêcherie avait été gérée sous un régime d’open access (OA), de maximisation de la rente (MEY) et de rendement maximal durable (MSY). On constate que le niveau de captures le plus bas est celui qui permet d’assurer la maximisation de la rente, et le niveau le plus fort, celui atteint sous OA. La pêcherie crevette guyanaise semble ainsi avoir plutôt fonctionné en OA. L’instauration de licences de pêche ainsi que la mise en place de quotas semblent ne jamais avoir été des outils de gestion efficaces. En effet, les quotas n’ont jamais été atteints et il y a eu toujours plus de licences de pêches proposées que de licences attribuées. Ces mesures n’ont donc pas été réellement contraignantes pour cette

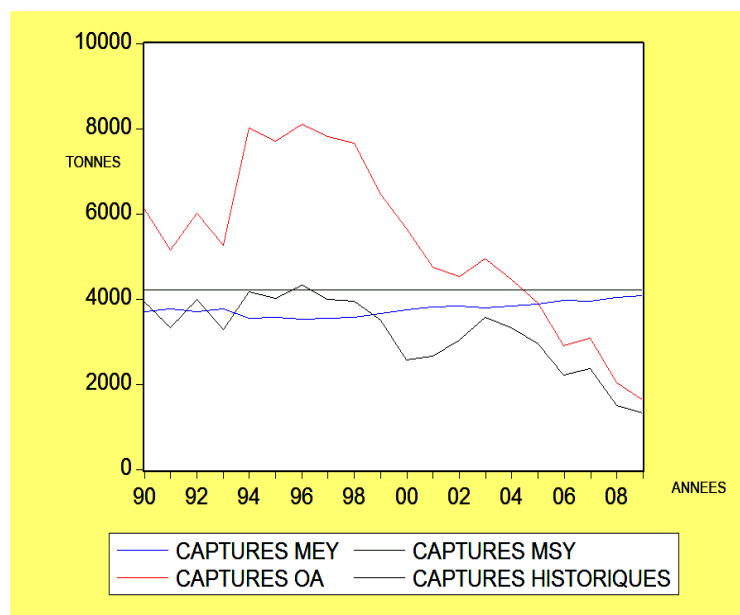

FIG. 1.9 – Les niveaux de prélèvement des différents régimes

pêcherie. Le niveau de captures qui assurerait la rente maximale est relativement stable sur la période étudiée, variant entre 3500 et 4000 t. Le niveau de captures historique se situe au dessus du niveau MEY durant la première décennie (1990-1999), et passe au dessous pendant la seconde décennie (2000-2009).

### Les niveaux de profits

Le niveau de profits le plus élevé est celui atteint sous MEY, par rapport à tous les autres régimes de gestion (Figure 1.10). Le niveau de profit historique est passé par des valeurs positives et négatives au cours de la période 1990-2009, et est resté très proche des niveaux de profit qui assurent le rendement maximal durable entre 1994 et 1997. Il redevient négatif entre 1999-2001 pour se stabiliser autour du profit MSY entre 2002 et 2009. Le niveau de profit qui satisfait le MSY se stabilise autour 3 500 000 €. Pour le calcul des profits, nous avons considéré un prix moyen de vente de 6.8€/kg et un coût moyen de 412 741€ par bateau.

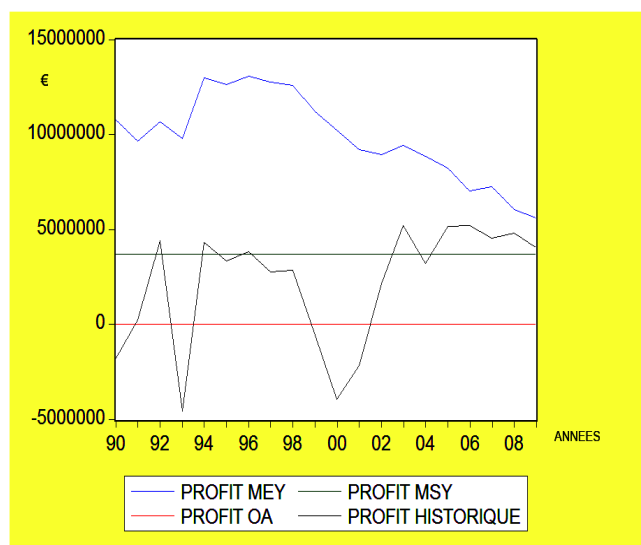

FIG. 1.10 – Les niveaux de profits des différents régimes

### 1.2.6 Synthèse

Trois modes de fonctionnement théoriques ont été confrontés à l'évolution historique de la pêcherie crevette guyanaise. Globalement, il existe une première période qui va de 1990 à 1998, durant laquelle la pêcherie se rapproche du rendement maximal durable, voire du rendement économique maximal, et une deuxième période, s'étalant de 1999 à 2009, où la pêcherie se trouve aussi bien en sous-exploitation biologique qu'économique.

Les résultats précédents permettent une meilleure compréhension du fonctionnement de la pêcherie crevette guyanaise et, dans une certaine mesure, d'évaluer les performances que cette pêcherie aurait atteintes si elle avait été gérée selon des modes de gestion alternatifs. Compte tenu du mode de fixation des quotas et des licences, la politique de gestion historique visait davantage une démarche purement biologique (politique de conservation) qu'une démarche de viabilité économique. Malgré cela, les objectifs semblent ne pas avoir été atteints et la situation de la pêcherie suggère que d'autres éléments doivent être pris en compte pour mieux en appréhender le fonctionnement. En particulier, le modèle de base utilisé dans ce premier chapitre ne suffit pas à expliquer l'évolution de la pêcherie dans la seconde phase de la période considérée. Nos résultats indiquent que si la pêcherie opérait en



## 1. INTRODUCTION GÉNÉRALE

---

open access, c'est le niveau d'effort soutenu qui conduirait à l'effondrement du stock.

Jusqu'à présent, les politiques de quotas ont été principalement mises en place sans prendre en considération l'évolution de l'environnement global de la pêche crevettière guyanaise. Seuls les aspects purement biologiques ont été intégrés aux analyses. Toutefois, les baisses concomitantes du stock, de l'effort de pêche et du prélèvement suggèrent que d'autres facteurs, autres que biologiques ou économiques, sont à l'origine des faits observés.

Tableau 1.3 : Valeurs d'équilibre d'open access entre 1990 et 2009

Year	Price (p) €/kg	Cost €/vessel	X <sub>OA</sub>	E <sub>OA</sub> (number of boats)	H <sub>OA</sub>	Profit
1990	8.34	474,533	9483	96	4051	0
1991	8.33	399,960	8000	105	3414	0
1992	8.09	467,461	9630	97	3990	0
1993	8.62	409,137	7910	104	3492	0
1994	10.35	623,400	10038	79	5321	0
1995	10.31	599,175	9685	82	5115	0
1996	10.06	630,280	10442	78	5380	0
1997	10.53	607,993	9623	81	5190	0
1998	10.43	595,568	9516	82	5084	0
1999	9.93	502,976	8442	93	4293	0
2000	11.8	439,849	6212	100	3754	0
2001	9.63	369,987	6403	108	3158	0
2002	7.98	351,929	7350	110	3004	0
2003	7.45	384,052	8591	107	3278	0
2004	7.19	346,674	8036	111	2959	0
2005	7.1	302,830	7108	116	2585	0
2006	6.99	225,098	5367	125	1921	0
2007	6.96	238,960	5722	123	2039	0
2008	7.28	157,838	3613	133	1347	0
2009	6.63	127,123	3195	136	1085	0

Table 1.4. Rendement économique maximal entre 1990 et 2009

Années	X <sub>MEY</sub>	E <sub>MEY</sub> (nombre de navires)	H <sub>MEY</sub>	Profit
1990	12601	48	3696	5117665
1991	12074	52	3777	3942827
1992	12551	48	3704	5060561
1993	12139	52	3767	4094787
1994	13652	39	3536	7642722
1995	13481	41	3562	7241586
1996	13701	39	3528	7756647
1997	13543	40	3552	7387601
1998	13455	41	3566	7181858
1999	12802	46	3666	5648647
2000	12356	50	3734	4603340
2001	11862	54	3809	3446510
2002	11735	55	3828	3147492
2003	11962	53	3794	3679409
2004	11698	55	3834	3060475
2005	11388	58	3881	2334472
2006	10839	62	3965	1047324
2007	10937	61	3950	1276862
2008	10364	66	4038	-66419
2009	10147	68	4071	-575022

## 1.3 Objectifs et méthodologie

### 1.3.1 Prise en compte de facteurs environnementaux

Depuis longtemps, l'exploitation des ressources issues de l'océan a été un enjeu capital pour les hommes. Les espèces exploitées sont variées et diffèrent d'une région à l'autre suivant les caractéristiques des écosystèmes. Certaines se développent et sont exploitées prin-

cipalement dans des zones tempérées alors que d'autres se développent dans des régions plus chaudes. Jusqu'à présent, la recherche sur les conséquences économiques du changement climatique sur la pêche a été limitée et fragmentée. En général, les pays s'adaptent aux changements dans l'abondance de poissons, indépendamment des causes, à des échelles de temps très variables et de manière non coordonnée. Ainsi il est important de prendre en considération cette dimension dans l'exploitation des ressources notamment marines.

La complexité de la dynamique des ressources et les limites d'observation posent des défis redoutables pour atteindre cet objectif qui est de prendre en considération les variables climatiques. De nombreuses approches intègrent les influences environnementales dans les modèles à une seule espèce. Depuis les travaux de Garcia et Lereste (1981), il est admis que la dynamique des crevettes tropicales est fortement influencée par des facteurs environnementaux. Les exemples les plus communs sont ceux qui incluent les variables climatiques pour améliorer l'ajustement d'un modèle, en modifiant les processus inclus dans la fonction de croissance naturelle du stock (Keyl et Wolff, 2008).

Les facteurs environnementaux peuvent être appréhendés de différentes manières dans la pêche. Ils peuvent être introduits directement dans la fonction de production ou intégrés à la fonction de croissance naturelle qui traduit la dynamique du stock.

Même si le modèle Gordon-Schaefer est adéquat pour l'analyse de certains types de pêche, les travaux théoriques montrent qu'il n'est pas approprié pour modéliser toutes les espèces, notamment celles qui se déplacent en banc. En effet, la fonction de Gordon-Schaefer est homogène de degré deux, et suppose de facto l'existence de rendements d'échelle croissants dans le processus de production, hypothèse a priori discutable pour nombre de pêcheries. En particulier, l'élasticité de la production par rapport à l'effort semble être sensiblement inférieure à l'unité et celle de la production par rapport au stock proche de zéro pour les espèces qui se déplacent en banc. Ainsi, Bjorndal (1987) propose d'utiliser une fonction de capture plus généralisée, de type Cobb-Douglas (Cobb and Douglas, 1928), où les élasticités de la capture par rapport au stock et à l'effort sont quelconques. Cette fonction prend la forme suivante :

$$H = qE^\alpha X^\beta \tag{1.18}$$

## 1. INTRODUCTION GÉNÉRALE

---

Dans l'équation (1.18),  $q$ ,  $E$ , et  $X$  désignent respectivement le coefficient de capturabilité, le niveau d'effort de pêche exprimé par exemple en nombre de jours en mer, et la taille du stock. Les paramètres  $\alpha$  et  $\beta$  représentent respectivement les élasticités de la capture par rapport à l'effort et par rapport au stock.

Les hypothèses sous-jacentes au modèle de Schaefer sont que la capture par unité d'effort est proportionnelle à la taille du stock à tous les niveaux de l'effort et du stock. Cependant, selon Clark (1976), ces deux hypothèses ne sont pas réalistes pour des pêcheries où les espèces se déplacent en banc, notamment les pélagiques, car cela suppose que les poissons se répartissent de façon homogène au niveau de l'océan, ce qui peut sembler peu réaliste. Ce type de modèle Cobb-Douglas met en lumière l'élasticité de la production par rapport au stock qui influe sur la sensibilité des coûts de capture à des changements dans la taille du stock. Lorsque cette élasticité est positive et proche de l'unité, une diminution du stock entraîne une forte augmentation des coûts unitaires de capture, ce qui représente un frein naturel à l'épuisement des stocks. Plus la valeur de cette élasticité sera faible, moins les coûts de prélèvement seront dépendants de l'évolution de la taille du stock. A l'extrême, lorsque cette élasticité est nulle, les coûts de prélèvement sont indépendants de la taille du stock et le stock peut être amené à disparaître sous un régime de fonctionnement open access par exemple (Bjorndal, 1988). Cependant la question de l'extinction totale des stocks est plus complexe et dépend aussi de la fonction de croissance naturelle (Clark, 1976).

La fonction généralisée Cobb-Douglas prend la forme suivante :

$$H = qE^\alpha X^\beta \exp(\lambda_1 D_1 + \lambda_2 D_2) \quad (1.19)$$

où  $D_1 = 1$ , lorsque les conditions de temps sont favorables, 0 sinon, et  $D_2 = 1$ , lorsque les conditions de temps ne sont pas favorables, et 0 sinon. Ces deux variables additionnelles sont considérées comme des variables indicatrices des conditions météorologiques. Elles ne peuvent prendre que les valeurs 0 ou 1. Les paramètres estimés  $\lambda_1$  et  $\lambda_2$  sont supposés avoir des signes positifs ou négatifs en fonction des résultats obtenus. Dans de bonnes conditions météorologiques, il y aura un impact positif dans la fonction de production, alors que dans

les périodes de mauvais temps ( $D_2 = 1$ ), il y aura un impact négatif. Ces variables peuvent ainsi être utilisées pour des phénomènes climatiques qui sont inverses.

La CPUE (Capture Par Unité d'Effort) peut aussi être utilisée pour tester la valeur prédictive de certaines variables environnementales et obtenir des modèles qui décrivent les relations entre captures et facteurs environnementaux. Des études ont montré que les variables environnementales ont eu une relation significative avec la CPUE dans certaines situations (Chifamba, 2000). Dans le cas de la pêche au Maquereau chilien, Peña-Torres *et al.* (2007) arrivent à la conclusion que le phénomène "El Niño" a eu un impact négatif sur le stock, sur les années courantes d'étude mais aussi sur les années précédentes. Le principe est d'introduire des variables dichotomiques plus connues sous le nom de variables muettes (dummy) et de les décaler dans le temps pour mesurer leurs effets. Dans le même contexte, les prises d'anchois dans le Pacifique Sud Est se sont réduites de moitié entre 2004 et 2010. Cette forte diminution est due à un effondrement du stock du fait de la survenue de l'épisode La Niña (FAO, 2012). "La Niña" est une arrivée de masse d'eau froide et "El Niño" est le phénomène inverse. Ces deux phénomènes naissent dans le Pacifique, sont dus à des fluctuations à grande échelle de la pression de l'air, et influencent tous les océans de la planète.

Une baisse des prélèvements malgré un niveau relativement constant de l'effort peut donner une indication sur l'état du stock, même s'il faut noter qu'un niveau d'effort constant combiné à une baisse de stock induit logiquement une augmentation des coûts unitaires de prélèvement. Cela aboutit généralement à une diminution du nombre d'embarcations ou du nombre d'heures passées en mer pour palier à l'augmentation des coûts. Il s'ensuit une politique de régulation de l'effort. Cette régulation se fait soit par la mise en place de quotas ou la diminution du nombre d'embarcations dans cette pêcherie. Ralph Turvey (1964) souligne que la régulation à partir du contrôle de l'effort de pêche est pertinente, car lorsque ce dernier décroît, le stock de poisson augmente, de même que l'âge moyen, le poids et la taille des poissons, ce qui facilite les captures, c'est-à-dire augmente la capture par unité d'effort.

Une autre manière d'aborder les facteurs environnementaux est de les intégrer dans la

fonction de croissance naturelle. En effet, il existe une large gamme de modèles qui sont utilisés pour l'évaluation des ressources marines et les prévisions pourraient être corrigées en tenant compte du changement climatique. L'intégration de variables environnementales se fait de plusieurs manières en fonction de l'impact du facteur que l'on veut mesurer. Pour un environnement marin aussi spécifique que celui de la Guyane française, la prise en compte de la mangrove, qui occupe 80 % du littoral, se fait à travers la capacité de charge de l'habitat, comme le décrit Barbier (1994). La prise en compte du débit des fleuves et de la température de surface de l'océan dans les zones de prélèvement peut se faire également à travers le stock, pour mesurer directement leur impact sur le stock et les décisions des agents économiques qui l'exploitent.

### 1.3.2 Un modèle dynamique

Le basculement du modèle statique au modèle dynamique s'est fait, non pas parce que le premier n'était plus adéquat, ni plus pertinent, mais parce que de nouveaux outils mathématiques ont permis le développement de modèles explicitement dynamiques. Scott (1955) pose les fondements de l'analyse dynamique des pêcheries, et considère que la gestion des ressources de la pêche peut être analysée à l'aide de la théorie moderne du capital. Sa tentative a été suivie par Gordon (1956) et par Crutchfield et Zellner (1962) avec une formulation du problème en termes de modèle mathématique dynamique. A la fin des années 60, la théorie du contrôle optimal devient l'outil standard en économie (Dorfman, 1969). Les premières applications remontent à Plourde (1970) et Quirk et Smith (1970). C'est dans les années 1970 que les modèles dynamiques ont commencé à se développer fortement, jusque dans les années 1980 (White, 2000).

Le modèle sera présenté dans un premier temps avec une dynamique simple, largement utilisée en économie de la pêche, et qui est souvent associée au nom de Schaefer. Plus récemment, Kamien et Schwartz (1991) en ont proposé une version dynamique. Considérons

$X = X(t)$  représentant la biomasse à l'instant  $t$ . On aura :

$$\frac{dX}{dt} = F(X) \quad (1.20)$$

Cette équation correspond à la fonction de recrutement net ou à la fonction de croissance naturelle. Il est supposé que  $F(X) > 0$ , pour  $0 < X < K$ ;  $F(0) = F(K) = 0$ , et  $F''(X) < 0$ , où  $K$  désigne la capacité de charge de l'habitat. Et lorsque le prélèvement est introduit, l'équation (1.20) devient :

$$\frac{dX}{dt} = F(X) - H(t) \quad (1.21)$$

où  $H(t) \geq 0$ , représente la capture et  $dX/dt$  peut être interprétée comme le taux d'investissement. La rente que génère la pêche est à chaque instant de temps :

$$\pi(X, H) = [p - c(X)]H(t) \quad (1.22)$$

où  $c(X)$  est le coût unitaire de pêche proportionnel à l'effort et de fait à la capture, et  $p$ , le prix de la capture. Nous avons  $c(E) = aE$ . Depuis l'équation (1.1), on déduit  $E = h/qX$ . Alors  $c(E) = ah/qX = c(h, X)$ . D'où l'on tire :  $c(X) = a/qX$ .

L'objectif est de maximiser le flux de profits futurs actualisés donnés par l'équation (1.22); la fonction objective est donc la suivante :

$$\max PV = \int_0^{\infty} \exp^{-\delta t} \pi [X(t), H(t)] dt \quad (1.23)$$

où  $\delta$  représente le taux d'actualisation.  $X(t)$  peut être considérée comme le capital naturel. Il est possible d'investir ou de désinvestir à chaque instant du temps en prélevant moins ou plus ( $H(t) < F(X), H(t) > F(X)$ ). Il s'agit ici de déterminer la taille optimale du stock  $X^*(t)$ , en d'autres termes la taille optimale de prélèvement  $H^*(t)$  se référant à l'équation d'équilibre biologique. On détermine dans ces conditions le prélèvement optimal  $H^*(t)$  avec pour objectif de trouver la valeur actualisée de la rente, sous les contraintes suivantes :  $X(t) > 0$ , et  $0 < H(t) < H^*(t)$ . Ni le prélèvement, ni la ressource ne peuvent être négatifs.

Nous posons un Hamiltonien :

$$\mathcal{H} = \exp^{-\delta t} [p - c(X)]H(t) + \mu(t)[F(X) - H(t)] \quad (1.24)$$

$$\mathcal{H} = \sigma(t)H(t) + \exp^{-\delta t} \mu(t)F(X) \quad (1.25)$$

où  $\mu(t)$  est le multiplicateur dynamique de Lagrange. Il peut être également considéré comme le prix implicite de la ressource. Ainsi ce problème est résolu avec le principe du maximum (Clark et Munro, 1982) :  $\sigma(t) = \exp^{-\delta t} [p - c(X) - \mu(t)]$ . La procédure pour résoudre un problème de contrôle optimal linéaire est telle qu'on détermine la solution singulière en posant :

$$\sigma(t) \equiv 0 \quad (1.26)$$

Pour un niveau optimal de stock, nous avons :

$$F'(X^*) - \frac{\partial \pi / \partial (X^*)}{\partial \pi / \partial (H)}_{\text{avec } H=F(X^*)} = \delta \quad (1.27)$$

C'est-à-dire :

$$F'(X^*) - \frac{c'(X)F(X^*)}{p - c(X^*)} = \delta \quad (1.28)$$

Ce même modèle peut être étendu en intégrant des variables environnementales dans la fonction de croissance naturelle. Plusieurs formes mathématiques sont utilisées pour cette fonction de croissance naturelle (Henderson and Tugwell 1979 ; Clark, 1990 ; Opsomer and Conrad 1994 ; Homans and Wilen 1997 ; Garza-Gil 1998 ; Hannesson 2006 ; Nostbakken 2008). En général, celle qui est souvent utilisée est la fonction logistique, et les autres formes fonctionnelles servent d'alternatives lorsque la logistique ne permet pas de bien ajuster le modèle. Celles qui sont les plus couramment utilisées sont les suivantes :

$$F(X) = aX \left(1 - \frac{X}{b}\right) \quad (1.29)$$

$$F(X) = X e^{a(1 - \frac{X}{b})} \quad (1.30)$$



$$F(X) = aX^b \tag{1.31}$$

$$F(X) = \frac{aX^b}{b + X} \tag{1.32}$$

$$F(X) = aX \ln\left(\frac{X}{b}\right) \tag{1.33}$$

La fonction (1.29) porte le nom de "logistique", et se présente sous une forme quadratique. Les fonctions (1.30), (1.31, 1.32, 1.33) portent respectivement les noms de Ricker, Cushing, Beverton-Holt, et Gompertz.

Par la suite, les paramètres  $a$  et  $b$  seront estimés à l'aide des techniques économétriques usuelles. Le modèle doté des paramètres les plus significatifs sera retenu. Le modèle dynamique permet en outre de faire des simulations pour déterminer les différentes trajectoires du stock en fonction des décisions prises, mais aussi des scénarios qui peuvent être envisagés, notamment concernant l'évolution de l'environnement de la pêcherie (rapidité du réchauffement climatique par exemple). Les scénarios peuvent être optimistes ou pessimistes suivant les projections faites concernant la variable environnementale introduite. Ce cadre d'analyse a été développé par Garza-Gil *et al.* (2011). Les résultats de ces auteurs indiquent que, si la température de surface de la mer dans l'Atlantique ibérique augmente dans le futur, les niveaux de biomasse et de capture deviendront plus faibles et le rendement économique diminuera. L'analyse des résultats a été effectuée en considérant plusieurs scénarios d'évolution de la température de surface.

### 1.3.3 La prise en compte des externalités de recherche : un modèle de prélèvement stochastique

Tous les modèles considérés jusqu'ici sont déterministes et supposent que les événements futurs sont connus de manière certaine. Ils ignorent volontairement de fait le caractère profondément aléatoire des activités de prélèvement halieutique. Les captures doivent toutefois la plupart du temps être réalisées dans des conditions d'incertitude comme le suggèrent Bjornald et Gordon (1998). L'incertitude est appréhendée dans notre cas d'étude en supposant que la capture n'est pas instantanée, qu'elle nécessite du temps et qu'elle est aléatoire. Ce

temps de recherche génère des coûts et a donc un impact sur les profits et donc les décisions des entreprises de pêche en termes d'effort et de prélèvement.

Afin de tenir compte des éléments stochastiques évoqués précédemment dans le traitement de notre problématique, nous adaptons le modèle de recherche et d'appariement de Pissarides (2000) développé pour analyser le marché du travail au cas des pêcheries (pour une synthèse, voir aussi Yashiv, 2006). Notre version du modèle apporte un éclairage nouveau sur le caractère potentiellement endogène de la capturabilité au sein des pêcheries, ainsi que sur le rôle crucial des externalités de congestion existant entre les navires de pêche. En outre, nous supposons que la capture par unité d'effort est endogène alors qu'elle est considérée comme exogène dans la majeure partie de la littérature sur les pêcheries.

En effet, la capture découle d'un processus de rencontres entre des navires de pêche d'une part, et des poissons d'autre part. Ainsi, une fonction d'appariement représente les rencontres aléatoires qui s'effectuent entre navires de pêche et poissons au sein de la pêcherie. L'effort de pêche global découle d'un processus de maximisation de leurs profits par les entreprises, fondé et explicité au niveau microéconomique. Le "taux d'évasion", à savoir le nombre de poissons non capturés rapporté à la totalité du stock, est lui déterminé par une condition d'équilibre biologique de long terme. Le cadre adopté implique que la pression anthropique (nombre de navires/nombres de poissons) et donc la capturabilité (qui est fonction de la pression anthropique) sont endogènes. Notre approche se démarque ainsi nettement de la majeure partie de la littérature qui considère ces dernières comme données, et permet d'expliquer l'évolution de la pêcherie sur la base de leurs variations. En outre, le modèle semble facilement extensible et devrait permettre, à terme, d'intégrer nombre de caractéristiques supplémentaires propres aux pêcheries. Enfin, il semble facilement estimable au plan économétrique et, partant, également aisément applicable à l'étude de l'exploitation des ressources naturelles en général.

### 1.3.4 Structure de la thèse

Le Chapitre 2 propose d'étudier le rôle potentiellement important de la mangrove sur l'évolution de la pêche crevettière de la Guyane française. En effet, la mangrove est un élément écologique prépondérant de cette région et est de ce fait susceptible, au travers des variations de sa superficie, d'influer sur le stock de crevettes. Nous proposons un cadre explicitement dynamique dans lequel la surface de la mangrove est explicitement intégrée à la capacité de charge de l'habitat dans la fonction de croissance naturelle du stock. Une fois une relation d'équilibre établie entre la surface de mangrove et la production, l'estimation des paramètres du modèle permet de déterminer si les variations de la surface de mangrove impactent positivement ou négativement la production et d'en quantifier les effets éventuels.

Le Chapitre 3 prolonge l'analyse précédente en explorant d'autres facteurs potentiellement explicatifs de l'évolution de la pêche crevettière guyanaise. Il propose ainsi d'inclure d'autres variables écologiques et climatiques dans l'analyse, comme le débit des fleuves, les phénomènes Niño et Niña, et la température de surface de l'océan, afin d'expliquer l'évolution du stock et de la production de crevettes. Certains de ces facteurs se révèlent être effectivement partiellement explicatifs de cette évolution. Le Chapitre 3 a fait l'objet d'une première publication dans la revue *Environmental Economics and Policy Studies*.

Le Chapitre 4 étend l'analyse à la prise en compte du changement climatique proprement dit. Il propose à nouveau un cadre dynamique au sein duquel plusieurs fonctions de croissance naturelle, augmentées de la température de surface des eaux de prélèvement, sont testées économétriquement, afin d'isoler celle qui ajuste le mieux les données observées. Le cadre permet ensuite d'étudier les conséquences de divers scénarios d'évolution de la température de surface des eaux sur les variables endogènes retenues jusqu'ici, en fonction des différents régimes de fonctionnement envisagés au Chapitre 1. Le Chapitre 4 a été présenté lors de la conférence du Groupement de Recherche du Littoral Guyanais sous influence Amazonienne (LiGA) mis en place par le CNRS (Centre National de Recherches Scientifiques) en novembre 2015. Il existe par ailleurs sous forme de document de travail du laboratoire Ceregmia (Centre d'Etude et de Recherche en Economie, Gestion, Modélisation et Informatique Appliquée) de

l'Université des Antilles.

Enfin, le Chapitre 5 a pour but de dépasser les limites des analyses précédentes, qui visent à expliquer l'évolution de la pêcherie crevette de Guyane française uniquement à partir des évolutions de son environnement biologique et écologique. Un cadre théorique stochastique est ainsi développé, dans lequel la capturabilité est supposée dépendre de la pression anthropique exercée par les entreprises de pêche sur le stock (ratio nombre de navires en campagne/stock non prélevé). Le cadre permet de mettre en évidence le rôle prépondérant des effets de congestion entre les navires de pêche. De telles externalités semblent en effet suffisamment fortes pour amplifier les chocs technologiques, biologiques ou économiques de faible ampleur subis par la pêcherie entre 1990 et 2009, et permettre de proposer une explication originale de son évolution sur cette période, fondée sur des mécanismes cette fois-ci endogènes. Ce dernier chapitre a été présenté à la conférence Natural Resource Modeling en juillet 2014, ainsi qu'à la conférence European Association of Environmental and Resource Economists en juin 2015. Il fait également l'objet d'un document de travail du laboratoire Ceregmia de l'Université des Antilles.

## Annexes



FIG. 1.11 – Flottille de crevettiers



FIG. 1.12 – Ligneurs vénézuéliens

## 1. INTRODUCTION GÉNÉRALE

---



FIG. 1.13 – Les quatre types de navires de la pêche côtière

---

---

**CHAPITRE II :**

---

**THE ROLE OF MANGROVE FOR THE FRENCH GUIANA SHRIMP  
FISHERY**

# The role of mangrove in the French Guiana shrimp fishery

<sup>a</sup>*Bassirou Diop*, <sup>b</sup>*Nicolas Sanz*, <sup>b</sup>*Fabian Blanchard*, <sup>c</sup>*Romain Walker*

<sup>a</sup>*Ceregmia, Université des Antilles; Campus de Schoelcher, BP 7209, 97275 Schoelcher Cédex, France.*

<sup>b</sup>*UMSR 3456, Laboratoire Ecologie, Evolution, Interactions des Ecosystèmes Amazoniens, CNRS, Université de Guyane, Ifremer.*

<sup>c</sup>*Université Paul Sabatier, 118 route de Narbonne, ECOLAB, Bâtiment 4R3, Toulouse cedex 9 31062, France.*

## Abstract

The mangroves play a vital role in the ecological balance. They provide marine ecosystem resources and are involved in its stabilization and in the coastal protection. They constitute the growth areas of many species that feed marine species and particularly shrimp. We develop a standard fishery model by integrating mangroves area into the analysis. The extended model shows that mangrove plays an important role in shrimp production and data related to it are well supported by the model. We analyze the effects of mangrove on open access of the French Guiana shrimp fishery and show that mangrove is not the only factor that plays a vital role in the French Guiana shrimp fishery.



## 2. THE ROLE OF MANGROVE IN THE FRENCH GUIANA SHRIMP FISHERY

---

*Keywords* : Mangrove ; Shrimp fishery ; Production function ; Open access

## 2.1 Introduction

Shrimp is nowadays the most consumed marine resource in the world. It represents the third export sector of the French Guiana and remains one of its main industrial sectors. However, the French Guyana shrimp fishery has encountered heavy difficulties in the past two decades. The globalization of the shrimp market, which has led to a decrease of 50% in real prices since 1997, and the long-term increase in fuel prices worldwide, though the 2007 crisis and its consecutive growth slow down has weakened this phenomenon, partly explain the economic problems the fishery has known. However, shrimp prices are now recovering on the US market. Facing this situation, some management rules were progressively adopted or reinforced starting from the creation of the Exclusive Economic Zone in 1977. A total allowable catch (TAC) system was implemented for both the brown and the pink shrimps in 1983 and the management of the fishery is now in compliance with the European legislation. Moreover, some spatial restrictions, forbidding trawling activities in specific coastal zones, were also imposed. The above measures have indeed led to the reduction of fishing effort and harvest levels. The number of active vessels has notably been diminished.

Indeed production has decreased from 3926 tons in 1990 to 1323 tons in 2009 (see Table A1.) and to less than 800 tons in 2015. Effort and biomass have followed the same trend in spite of restrictions and management rules.

The proximity between the French Guiana coast and the Amazon estuary results into the presence of a muddy corridor bounded by a red line (see Figure 2.1). The Fluid mud is transported along the coasts of the Guianas by a complex interaction of waves, and wind-generated coastal currents (Anthony *et al.*, 2010). This results in a coast partly covered by mangroves.

In French Guiana the mangroves stretch for 600 km<sup>2</sup> and colonize almost 75% of the coastline (Day *et al.*, 1987). Mangroves provide ecosystem services such as carbon sink, nursery, shoreline stabilization and protection and play a vital role in the ecological balance. In French Guiana, mangroves are still not threatened by human activities. However, knowing that 90% of the population live on the coastal area, the demographic growth (3 to 4%

## 2. THE ROLE OF MANGROVE IN THE FRENCH GUIANA SHRIMP FISHERY

---

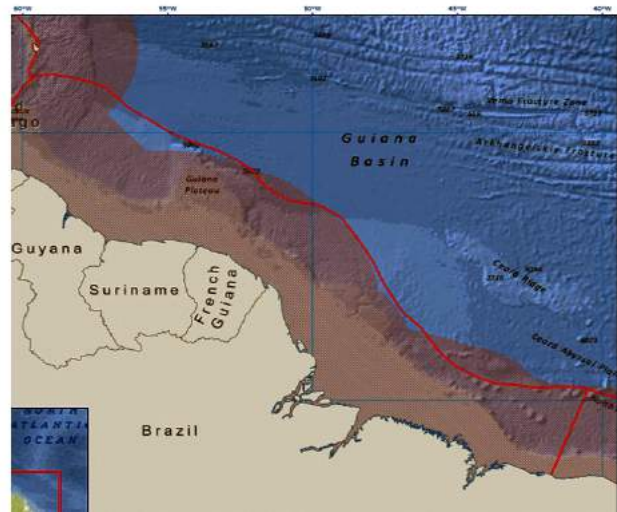

FIG. 2.1 – The Guianas-Brazil shrimping grounds

per year) jeopardizes this situation considering the potential future coastal anthropization. Moreover, large natural variations of the mangrove areas have been recently quantified in French Guiana and related to oceanographic phenomena (Walcker *et al.*, 2015). These large variations of the mangrove surface should allow us to detect the relationships between fishery productivity levels and mangrove surfaces. Moreover, mangroves entail sediments that come from the huge mud discharge of the Amazon River located close to the fishing zone. Indeed they are considered important nursery habitats for many marine species (Mumby *et al.*, 2004; Faunce and Serafy, 2006; Serafi *et al.*, 2015) and particularly for the shrimp.

Ecological dynamics of the fishery were investigated (Béné, 1997; Sanz *et al.*, 2016). Several environmental factors, acting as forcing factors were correlated to the fishery production. Actually increasing trends in sea surface temperatures were observed, explaining at least partially the decrease in the shrimp fishery production. It was shown that local rivers and the Amazon play also a role. However authors have shown the importance that mangrove plays as nursery habitat in the shrimp fishery production in various areas in Indian Ocean (Turner, 1977; Pauly and Ingles, 1986; Camacho and Bagarinao, 1987; Rönnbäck, 1999). This question was never been attacked in the Guiana continental shelf.

The main purpose of this paper is to suggest an approach for evaluating the impact

of mangroves on the shrimp production. A bioeconomic model is developed in which we firstly extend a standard fishery model by including the mangrove surface into the renewal resource of the shrimp, as Barbier and Strand (1998). We then analyze how losses and gain in mangrove area impact this fishery.

The French Guiana shrimp fishery is presented in Section 2. A extended bioeconomic model of fisheries in which we define linkages between the fishery and the mangrove is developed in section 3. Section 4 presents the main empirical results of the French Guiana fishery managed under open access completed with a comparative static effect of fluctuations in the mangroves area. The paper is summarised in a last section with a discussion and policy implications of our results.

## 2.2 The French Guiana shrimp fishery

Two shrimp species are mainly exploited in the French Guiana fishery, the brown and the pink shrimps (resp. *Farfantepenaeus subtilis* and *Farfantepenaeus brasiliensis*). The French Guiana shrimp fishery started in the late 1960's with the US fleet activity. All the vessels are floridian shrimp trawlers, each using two trawls at the same time. Japanese vessels also exploited shrimps, but the whole fleet became progressively French between 1970 and 1990. Over this period, the US-Japanese fleet increased up to 80 trawlers. Since 1992, the whole fleet is only composed with French trawlers targeting shrimps on the continental shelf. The stock assessment has been firstly performed each two years by a working group within the FAO institutional and international framework of the Western Central Atlantic Fishery Commission (WECAFC) up to 1999, and has then been undertaken by the Ifremer (French institute of research for the exploitation of the sea) for management advice since the 1980's, allowing for a strong knowledge of the population. The method used for assessment is the well-known "Virtual Population Analysis" (VPA), carried out on a monthly step basis which allows to obtain the recruit abundance as well as the spawning stock biomass and the fishing mortality.

Table A2.1 (see Appendix) shows series of the shrimp biomass, catches, effort and man-

## 2. THE ROLE OF MANGROVE IN THE FRENCH GUIANA SHRIMP FISHERY

---

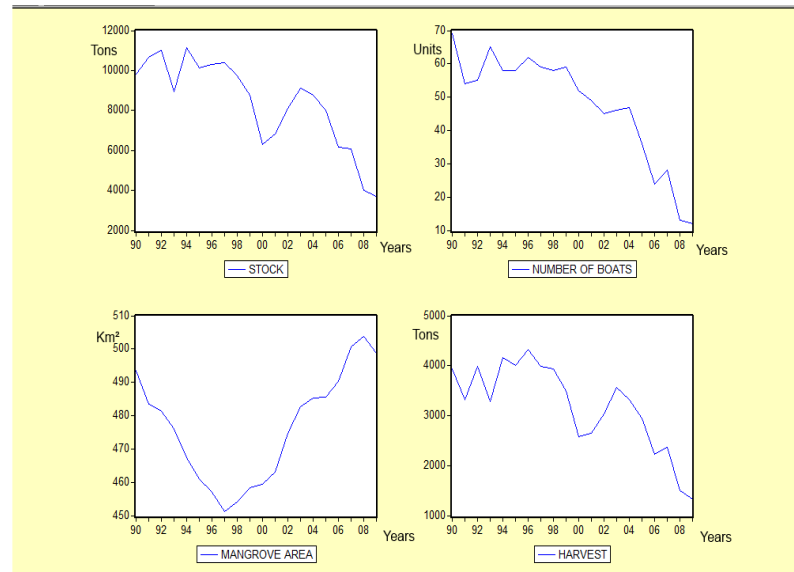

FIG. 2.2 – Historical path in French Guiana over 1990-2009 : Effort, Stock, Harvest levels, and Mangrove areas

groves areas for the period 1990-2009 obtained respectively from Ifremer and National Center for Scientific Research : CNRS (Walker *et al.*, 2015). Trends in series are shown in Figure 2.2. The biomass has steadily decreased over years though the effort and catch levels have followed quite the same trend. Yet, a total allowable catch (TAC) of 4108 tons for brown and pink shrimps has been adopted, of which 108 tons can be caught by neighboring countries (Surinam, Trinidad, Barbade). Compared to the historical catch, the TAC level has never been fully achieved. This TAC level has not been changed until 2011, facing the decline of the recruitment, and consequently of the spawning biomass, the TAC was reduced at 3317 tons in 2013 and at 3100 tons in 2014.

In 1991, a license system was introduced for both species. The main objective was initially to limit the number of vessels in order to protect the shrimp resource. Licenses are attributed without any fee. However, the license system did not seem to be in fact an active or efficient resource management tool. Indeed, the year abundance of shrimp is mainly correlated with recruitment but not with effort like *e.g.* the number of vessels or the number of days at sea.

The number of licenses was slightly reduced from 69 in 1991 to 63 in 1999, and to 49 in 2008, 40 in 2011 and 31 in 2014. During this period, the number of active shrimp trawlers was less than the number of licenses (less than half in 2006). The license system could have been a tool to adjust the number of vessels in order to improve economic results, but this objective was not explicitly addressed by the management system as the common fishery policy target is to reach the maximum sustainable yield (maximize the catches) and not the maximum economic yield (maximize the profit). Finally, there exist also some spatial restrictions : in order to limit the impact of trawling on juvenile shrimps and avoid conflicts with the coastal small-scale fishery, trawling is forbidden in coastal waters less than 30 meters deep. This rule is more restrictive than the spatial limitation applied to trawlers in European waters. All in all, the economic dynamics of the fishery has been characterized by a diminution of the fleet size, to concentrate the fishing activities on a reduced number of profitable vessels (around thirty).

## 2.3 The model

We consider changes in the biomass of a shrimp stock over time come from extended renewal resource dynamics, and harvesting. This can be explained by the following equation :

$$X_{t+1} - X_t = F(X_t, M_t) - H(X_t, E_t) \quad (2.1)$$

where  $X_t$  and  $X_{t+1}$  are respectively the total biomass at the period  $t$  and  $t+1$ ,  $M_t$  is the mangrove area in period  $t$ , and  $H_t$  is the total catch in period  $t$ , a function of the stock  $X_t$  in period  $t$ , and of the fishing effort in period  $t$ ,  $E_t$ . We assume here the number of participating vessels as effort units according to Bjørndal and Conrad (1987) who consider that is an appropriate measure of effort.

Assuming the mangroves as growth areas that feed shrimps and that play vital role in ecological balance, we extend the standard Gordon and Schaefer model (Gordon, 1954; Schaefer, 1954, 1957) to consider the impact of mangrove on the renewal resource dynamics

function through the carrying capacity (see Barbier, 1994, Barbier and Strand, 1998). The renewal resource dynamics of the biomass will be explained by discrete-time of the extended logistic growth function as follows :

$$F(X_t, M_t) = rX_t [K(M_t) - X_t] \quad (2.2)$$

where  $r$  is the intrinsic growth rate and  $K$  is the environment carrying capacity. The harvest in period  $t$  will be given by the following standard Schaefer production function :

$$H_t = qE_t X_t \quad (2.3)$$

where  $q$  represents the catchability coefficient.

Assuming a proportional and positive relationship between mangrove and carrying capacity ( $K(M_t) = \alpha M$ ) with  $\alpha > 0$ , and inserting Eq. (2.3) into Eq. (2.1), the stock dynamics equation becomes :

$$X_{t+1} - X_t = rX_t (\alpha M_t - X_t) - qE_t X_t \quad (2.4)$$

These equations describe the relationship between mangrove and the shrimp fishery. And we assume a steady-state condition which will be one of the long run equilibrium of our model. Furthermore the management of the French Guiana shrimp fishery is regulated through a quota of catches and a license system. We will consider in the next sections an open access equilibrium. These considerations will lead to analyze this fishery through the mangrove dynamics and to assess the economic consequences of variations in mangroves.

Smith (1969) views changes in fishing effort as determined by the level of profits. In the same way we suppose that fishing effort next period will fit in reaction the profit generated in current period (Clark, 1976 ; Conrad, 1995 ; Barbier and Starnd, 1998). With  $p$  the output price and  $c$  the cost per unit effort, the effort adjustment can be written as follows :

$$E_{t+1} - E_t = n[ph(X_t, E_t) - cE_t] \quad (2.5)$$

where  $n$  is a positive adjustment parameter scaled in effort.

### 2.3.1 Open access

In the following section the open access French Guiana shrimp fishery is studied using the Gordon-Schaefer model specification. The model allows for discussing the steady state equilibrium and is specified in discrete time. The equilibrium under open access fishery is known as the bioeconomic or bionomic equilibrium (Gordon, 1954) and can be obtained when profits are equal to zero, or harvest equal to renewal resource. Vessels will enter the fishery and entry will proceed until effort is earning its opportunity cost. In the long-run open access of the French Guiana shrimp fishery, we consider  $X_{t+1} = X_t = X$ ,  $E_{t+1} = E_t = E$  and  $M_{t+1} = M_t = M$ . Assuming a constant output price per unit harvested  $p$  and a constant cost per unit effort  $c$  the profit can be written as :

$$\pi_t = pH_t - cE_t \quad (2.6)$$

where  $p$  is the unit price of harvest and  $c$  the unit cost per vessel. Replacing  $H_t$  in (2.6) by (2.3), applying the free entry equilibrium condition under open access ( $\pi_t = 0$ ), and isolating  $X$ , enables to find the expressions for the open access stock level :

$$X_{OA} = \frac{c}{pq} \quad (2.7)$$

The expression of the stock depends only on economic and technological parameters. The stock level under open access will be even weaker than the shrimp has a high price, easily catchable and low cost. Applying the steady state equilibrium conditions ( $X_{t+1} = X_t = X$ ) to Eq. (2.1) and isolating  $E$  leads to the open access fishing effort level :

$$E_{OA} = \frac{r}{q}(\alpha M - X) \quad (2.8)$$



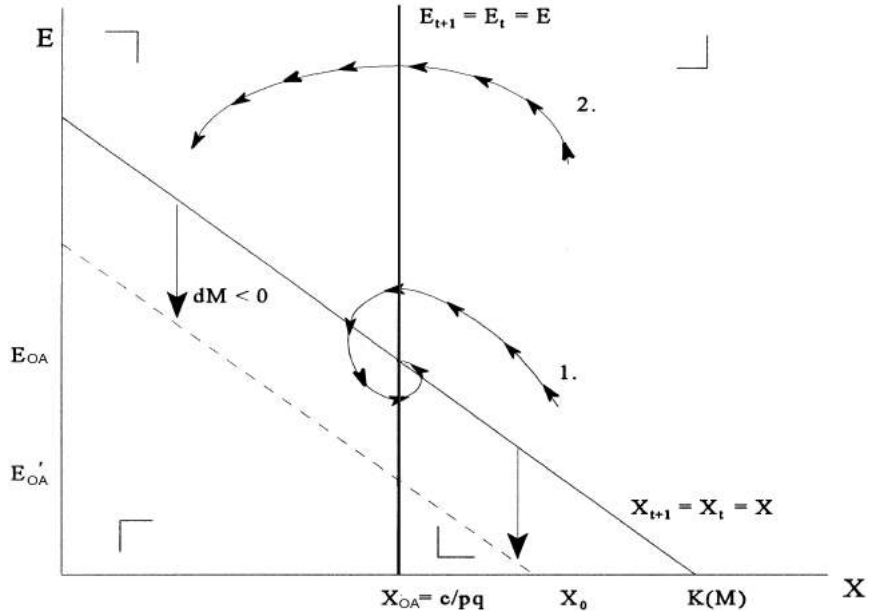

FIG. 2.3 – Effect of a change in mangrove area

Lastly, the expression of  $H_{OA}$  can be obtained by substituting Eq. (2.7) and (2.8) into Eq. (2.3) gives the expression of the open access harvest level :

$$H_{OA} = \frac{rc}{pq}(\alpha M - X) \quad (2.9)$$

### 2.3.2 Comparative static effect of fluctuation in mangrove area

Indeed from Equation (2.8) we obtain the comparative static effect of a change in the mangrove area on the equilibrium level of fishing effort,  $E_{OA}$  as follows :

$$E_{OA} = \frac{r}{q}(\alpha M - X_{OA})$$

$$qdE_{OA} - r(\alpha dM - dX_{OA}) = 0$$

or

$$\frac{dE_{OA}}{dM} = \frac{\alpha r}{q} > 0 \quad (2.10)$$

Equation (2.10) confirms that loss or gain of the mangrove area results respectively in lower or higher level equilibrium fishing effort. We can now derive the comparative static effect in the harvest and gross revenue of the fishery.

From Equation (2.3) we can write :

$$dH_{OA} = qX_{OA}dE_{OA} = \alpha r X_{OA}dM = \frac{\alpha r c}{pq}dM \quad (2.11)$$

We can easily derive change in gross revenue as follows :

$$pdH_{OA} = \frac{\alpha r c}{q}dM \quad (2.12)$$

We know  $\beta_1 = \alpha q$  and  $\beta_2 = -q^2/r$  and setting  $\beta_1/\beta_2 = -\alpha r/q$  we can rewrite Equations (2.11) and (2.12) as follows :

$$dH_{OA} = -\frac{c\beta_1}{p\beta_2}dM$$

$$pdH_{OA} = -\frac{c\beta_1}{\beta_2}dM$$

Equation (2.8) gives a relationship between effort, stock and mangrove area where the stock level is supposed constant in the long run equilibrium. Figure 2.3 draws the equilibrium conditions in  $(X, E)$  space. Since  $E_{t+1} = E_t = E$  the curve is a vertical line that intersects the abscissa axis at point  $X_{OA} = \frac{c}{pq}$ . And the  $X_{t+1} = X_t = X$  is a downward curve because of the negative relation between  $E$  and  $X$  in Equation (2.8). Two trajectories are represented, given an initial level of stock  $X_0$ . The first trajectory (1) converges towards open access  $(X_{OA}, E_{OA})$  equilibrium in spiral manner. The second trajectory (2) is rather unstable. It can corresponds to a high level of effort and can lead to a decline of the fishery. And a loss or a gain in mangrove area will impact directly the carrying capacity, and will shift up or down the  $X_{t+1} = X_t = X$  curve. The equilibrium  $X_{OA}$  will not change but this leads to a lower level of effort  $E'_{OA}$  and lower initial stock in long run equilibrium.

## 2.4 Empirical results

The steady state condition (assuming shrimp stock is constant  $X_{t+1} = X_t = X$  in the long run equilibrium) in the model allows for the relation between production, effort and mangrove. The relationship is as follows :

$$H_t = q\alpha E_t M_t - \frac{q^2}{r} E_t^2 = \beta_1 E_t M_t + \beta_2 E_t^2 \quad (2.13)$$

We first use ordinary least squares (OLS) to estimate the harvest production function (2.13) over the period 1990-2009. We use time series on shrimp harvest, effort and mangrove area. As we suppose that the French Guiana shrimp fishery operates during the studied period under open access, harvest and effort levels during that period satisfy both the open access equilibrium ( $\pi_t = 0$ ). We can thus derive the corresponding level of cost each year that satisfies  $\pi_t = 0$ . From Equation (2.6) we isolate  $c$  and obtain the following expression  $c = pH/E$  using historical data of the fishery. The cost levels are shown on Table A2 (see Appendix). The parameters  $\beta_1$  and  $\beta_2$  indicate values that are statistically significant at 5 % level. Significance level of coefficients denotes a good specification of the model and well supported data. Assumption of positive impact of mangrove on carrying capacity is strengthened by the positive sign of  $\beta_1$ . The marginal productivity are calculated based on the mean number of vessels (45.35 vessels), the mean annual harvest (3099 tons), and the mean mangrove area (474 km<sup>2</sup>). And output elasticity estimates are shown in Table 2.1.

## 2. THE ROLE OF MANGROVE IN THE FRENCH GUIANA SHRIMP FISHERY

---

Table 2.1 : Estimates of the relationship between shrimp harvest, effort and mangrove area

		$H = \beta_1 EM + \beta_2 E^2$	
$\beta_1 = q\alpha$		0.21	(0.000)
$\beta_2 = -\frac{q^2}{r}$		-0.66	(0.002)
Number of observations	20	F statistic	27.21
$R^2$	0.78	$R^2$ adjusted	0.76
JB	0.79	Q-Stat	4.73
LM (ARCH)	1.55	DW	1.36
Marginal productivity estimates (at means)			
$MP_M = \frac{\delta H}{\delta M} = \beta_1 E = 9.75$ tons/Km <sup>2</sup>		$MP_E = \frac{\delta H}{\delta E} = \beta_1 M + 2\beta_2 E = 42.19$ tons/boat	
Output elasticity estimates			
$\epsilon_{HM} = \frac{\delta H}{\delta M} * \frac{M}{H} = 1.49$		$\epsilon_{HE} = \frac{\delta H}{\delta E} * \frac{E}{H} = 0.61$	

Notes : p-values in parentheses ; all coefficients are statistically significant at the 5% level.

JB is the Jarque-Bera statistic of the normality test ; Q-Stat is the Ljung-Box statistic used in the correlation test ;

LM (Lagrange multiplier) is the one used in the heteroscedasticity test.

The results of our estimation show two coefficients and three bioeconomic parameters ( $\alpha$ ,  $q$ , and  $r$ ). We will not need to evaluate these parameters because a static comparative effects of change in mangrove area allows for simulating straightforward the marginal change in the mangrove area. The output elasticity for the mangrove area (1.49) indicate that a decline in the French Guiana mangroves has a more than proportionate impact on harvest in French Guiana shrimp fishery. However the impact of mangrove fluctuation during the 1990-2009 period was relatively small. Only 2% of the total surface of the mangrove was observed between 1990 and 2009. This situation suggests that the corresponding gain or loss in fishery harvest was about 3%. The positive output elasticity for effort (0.61) indicates the decrease in fishing effort over the period had a relative negative impact on shrimp harvest. As the number of vessels decreased by 80%, the corresponding loss in shrimp harvest was 48.8%.

## 2. THE ROLE OF MANGROVE IN THE FRENCH GUIANA SHRIMP FISHERY

Table 2.2 : Simulation results for the effects of mangrove on the OA equilibrium

Simulation estimates of marginal change in the mangrove area (dM)					
year	price (p) €/kg	Cost (c) €/vessel	dH <sub>OA</sub>	pdH <sub>OA</sub>	Change (%)
1990	8.34	474,533	12,795	106,710	0.32
1991	8.33	399,960	10,784	89,830	0.32
1992	8.09	467,461	12,604	101,966	0.31
1993	8.62	409,137	11,032	95,095	0.34
1994	10.35	623,400	16,809	173,973	0.40
1995	10.31	599,175	16,156	166,568	0.40
1996	10.06	630,280	16,995	170,969	0.39
1997	10.53	607,993	16,394	172,628	0.41
1998	10.43	595,568	16,059	167,495	0.40
1999	9.93	502,976	13,562	134,670	0.38
2000	11.08	439,849	11,860	131,408	0.46
2001	9.63	369,987	9,976	96,068	0.37
2002	7.98	351,929	9,489	75,722	0.31
2003	7.45	384,052	10,355	77,144	0.29
2004	7.19	346,674	9,347	66,363	0.28
2005	7.1	302,830	8,165	57,971	0.27
2006	6.99	225,098	6,069	42,422	0.27
2007	6.96	238,960	6,443	44,843	0.27
2008	7.28	157,838	4,256	30,983	0.28
2009	6.63	127,123	3,427	22,721	0.26
Mean	8.7	412,741	11,128	96,821	0.34

Simulation results (see Table 2.2) show on average over the 1990-2009 period that a

marginal decline in mangrove area leads to a loss of 11.128 tons of shrimp harvest and € 96,821 in revenues from the French Guiana fishery each year and it corresponds to 0.34% in the annual harvest. We can notice two phases of evolution of the mangrove area over the period studied. The first period 1990-1997 shows the mangrove area declining and the losses in terms of harvest varying between 10 and 16 tons on average. A second period 1998-2009 shows mangrove regains area and the losses in terms of harvest varying between 16 and 3 tons. Similarly we can also see that the losses in income are lower in this last period.

## 2.5 Summary and conclusion

In French Guiana the mangroves colonize almost 75% of the coastline. We investigate the connection between the mangroves and the shrimp fishery. For this we develop a model that shows how fluctuations in mangrove area can impact the production in the French Guiana shrimp fishery. We first extend an open access bioeconomic model by integrating the mangrove area in the natural growth function. We assume a proportional and positive relationship between mangrove and carrying capacity (Barbier and Starnd, 1998; Barbier, 2000), supported by the positive sign of the coefficient ( $\alpha > 0$ ) associated with. We estimated coefficients of the harvest production function. With the two parameters we derive the level of cost each year that satisfies the open access equilibrium. Finally we evaluate the static effect of mangrove area fluctuations in this fishery.

The mangrove fluctuates naturally and the decline observed over the period 1990-1997 may be caused by to the fluctuations in waves associated with the North Atlantic Oscillation (Walker *et al.*, 2015). Our results show that the financial losses increase when the mangrove decrease in surface and are smaller when the mangroves increase. This suggests that mangrove increase fishery resilience *i e* face to crisis, and mangrove protection slows the decline of the fishery according to our results. We reccommand therefore to preserve mangrove as possible as the fishery does not totally depend on the mangrove. Nevertheless it remains that the mangroves increase the robustness of the fishery from economic crises or else. Thus a special focus must be carried on the mangrove ecosystems as they are threatened by climate

change following Gilman *et al.* (2007) who consider that the relative sea-level rise may be the greatest threat to mangroves (see also Hoegh-Guldberg and Bruno, 2010 ; Alongi, 2008).

The extended model, integrating mangrove area, fitted quite well the data. It supports the hypothesis that the mangrove is important in the shrimp production and effort. Integrating mangrove area in the stock dynamic through the environment carrying capacity, can help to understand the mangrove influence in a fishery. The standard bionomic open access model (Gordon, 1954), allows for analyze the impacts of mangrove fluctuation on the French Guiana shrimp fishery.

The empirical results show first that the fluctuation in mangrove area leads to same fluctuations in production and revenue as harvest elasticity with respect to the mangrove is positive. Secondly they show that a decrease in effort will lead to a decrease in harvest. Indeed between 1990-2009 the effort level has decreased, like harvest level as the harvest elasticity with respect to the effort is positive. Historical mangrove area show losses between 1990 and 1997, and gains between 1998 and 2009 period. While the harvest levels decrease between 1998 and 2009, the increase of the mangrove area in the same period did not compensate for the loss of harvest.

The policy implications are not noticeable. If we assume the French Guiana shrimp fishery operating under open access, a mangrove protection or an increase in the mangrove area would not be sufficient to mitigate losses in this fishery. Indeed over the studied period, the losses first was immediately followed by gain in mangrove area, the effort levels continue to decrease and then harvest. The decrease in effort combined with a gain in mangrove would lead to stock recovery. Which was not the case in recent years. Our results imply that mangrove is not the only environmental factor to impact the French Guiana shrimp fishery. The role of mangroves has not been determinant in explaining the collapse of the shrimp stock in French Guiana. This suggests to take into account other factors that play more important role in this fishery (Sanz *et al.* 2016).

## Appendix

### Appendix A2.1 : The French Guiana shrimp fishery

Table A2.1 : The French Guiana shrimp fishery

Year	Biomass (tons)	Effort (boat number)	Observed catches (tons)	Mangrove area (km <sup>2</sup> )
1990	9831	69	3926	493.41
1991	10652	54	3313	483.39
1992	11016	55	3987	481.33
1993	8929	65	3275	475.91
1994	11126	58	4156	467.41
1995	10120	58	4010	461.08
1996	10304	62	4323	457.07
1997	10409	59	3984	451.18
1998	9739	58	3940	454.09
1999	8765	59	3495	458.22
2000	6302	52	2572	459.51
2001	6809	49	2651	463.20
2002	8120	45	3043	474.75
2003	9110	46	3557	482.52
2004	8778	47	3325	485.37
2005	8026	36	2943	485.51
2006	6173	24	2222	490.40
2007	6096	28	2369	500.60
2008	4000	13	1496	503.82
2009	3705	12	1323	498.53



## Appendix A2.2 : Results from open access

Table A2.2 : Results from Open Access

Year	Price (p) €/kg	Cost €/vessel = c/pH
1990	8.34	474,533
1991	8.33	399,960
1992	8.09	467,461
1993	8.62	409,137
1994	10.35	623,400
1995	10.31	599,175
1996	10.06	630,280
1997	10.53	607,993
1998	10.43	595,568
1999	9.93	502,976
2000	11.8	439,849
2001	9.63	369,987
2002	7.98	351,929
2003	7.45	384,052
2004	7.19	346,674
2005	7.1	302,830
2006	6.99	225,098
2007	6.96	238,960
2008	7.28	157,838
2009	6.63	127,123

## 2.6 Références bibliographiques

- Alongi, D. M. (2008), “Mangrove forests : resilience, protection from tsunamis, and responses to global climate change” *Estuarine, Coastal and Shelf Science*, 76(1), 1-13.
- Anthony, E. J., Gardel, A., Gratiot, N., Proisy, C., Allison, M. A., Dolique, F., Fromard, F. (2010), “The Amazon-influenced muddy coast of South America : A review of mud-bank–shoreline interactions”, *Earth-Science Reviews* 103(3), 99-121.
- Barbier, E. B. (1994), “Valuing environmental function : tropical wetlands”, *Land Economics* 70(2), 155-173.
- Barbier, E. B. (2000), “Valuing the environment as input : review of applications to mangrove-fishery linkages”, *Ecological Economics* 35(1), 47-61.
- Barbier, E. B., Strand, I. (1998), “Valuing mangrove-fishery linkages : a case study of Campeche, Mexico”, *Environmental Resource Economics* 12, 151-166.
- Béné, C. (1997), “Dynamique et adaptation d’un système-pêche face aux perturbations de son environnement. Analyses et modélisations dynamiques du couplage écologie-économie ; le cas de la pêcherie crevette guyanaise”, *Thèse de doctorat*.
- Bjørndal, T., Conrad, J. M. (1987), “The dynamics of an open access fishery”, *Canadian Journal of Economics* 1, 74-85.
- Camacho, A. S., Bagarinao, T. (1987), “The impact of fish pond development on the mangrove ecosystem in the Philippines”, *In : Mangroves of Asia and the Pacific : Status and Management, pp. 395–405. Technical Report of the UNDP/UNESCO Research and Training Pilot Programme on Mangrove Ecosystems in Asia and the Pacific*.
- Clark, C. (1976), *Mathematical Bioeconomic* New York : John Wiley and Sons.
- Conrad, J. M. (1995), “Bioeconomic Models of the Fishery”, in D. Bromley, ed., *Handbook of Environmental Economics*, Oxford : Basil Blackwell.
- Day, J.W., Conner, W., Ley-Lou, F., Day, R.H., Navarro, A.M. (1987) “The productivity and composition of mangrove forests, Laguna de Terminos, Mexico”, *Aquat Bot* 27, 267-284.

- Faunce, C. H., Serafy, J. E. (2006), "Mangroves as fish habitat : 50 years of field studies", *Marine Ecology Progress Series* 318, 1-18.
- Gilman, E. L., Ellison, J., Duke, N. C., Field, C. (2008), "Threats to mangroves from climate change and adaptation options : a review", *Aquatic botany* 89(2), 237-250.
- Gordon, H. (1954), "The economic theory of a common property", *Journal of Political Economy* 62(2), 124-142.
- Hoegh-Guldberg, O., & Bruno, J. F. (2010). The impact of climate change on the world's marine ecosystems. *Science*, 328(5985), 1523-1528.
- Homans, F. R., Wilen, J. E. (1997), "A model of regulated open access resource use", *Journal of Environmental Economics and Management* 32(1), 1-21.
- Mumby, P. J., Edwards, A. J., Arias-González, J. E., Lindeman, K. C., Blackwell, P. G., Gall, A., Gorczynska, M. I., Harborne, A. R., Pescod, C. L., Renken, H., Wabnitz, C. C., Llewellyn, G. (2004), "Mangroves enhance the biomass of coral reef fish communities in the Caribbean", *Nature* 427(6974), 533-536.
- Nøstbakken, L., Bjørndal, T. (2003), "Supply functions for North Sea herring", *Marine Resource Economics* 18, 345-361.
- Pauly, D., Ingles, J. (1986), "The relationship between shrimp yields and intertidal vegetation (mangrove) areas : a reassessment", *In IOC/FAO Workshop on Recruitment in Tropical Coastal Demersal Communities. UNESCO IOC Workshop Report Supplement* 44, 277-283.
- Rönnbäck, P. (1999), "The ecological basis for economic value of seafood production supported by mangrove ecosystems", *Ecological Economics* 29(2), 235-252.
- Sanz, N., Diop, B., Blanchard, F., Lampert, L. (2016), "On the influence of environmental factors on harvest : the French Guiana shrimp fishery paradox", *Environmental Economics and Policy Studies* 18(2), 1-15.
- Serafy, J. E., Shideler, G. S., Araújo, R. J., Nagelkerken, I. (2015), "Mangroves Enhance Reef Fish Abundance at the Caribbean Regional Scale", *PLoS ONE* 10(11) : e0142022. doi :10.1371/journal.pone.0142022

## 2. THE ROLE OF MANGROVE IN THE FRENCH GUIANA SHRIMP FISHERY

---

- Schaefer, M. (1954), "Some aspects of the dynamics of populations important to the management of commercial marine fisheries", *Bulletin of the Inter-American tropical tuna commission* 1, 25-26.
- Schaefer, M. (1957), "Some Considerations of Population Dynamics and Economics in Relation to the Management of the Commercial Marine Fisheries", *Journal of the Fisheries Research Board of Canada* 14, 669-681.
- Smith, V. L. (1969), "On models of commercial fishing", *Journal of political Economy* 77, 181-198.
- Turner, R. E. (1977), "Intertidal vegetation and commercial yields of penaeid shrimp", *Transactions of the American Fisheries Society* 106(5), 411-416.
- Walcker, R., Anthony, E. J., Cassou, C., Aller, R. C., Gardel, A., Proisy, C., Martinez, J. M., Fromard, F. (2015), "Fluctuations in the extent of mangroves driven by multi-decadal changes in North Atlantic waves", *Journal of Biogeography* 42, 2209-2219.

---

---

**CHAPITRE III :**

---

**ON THE INFLUENCE OF ENVIRONMENTAL FACTORS ON HARVEST :  
THE FRENCH GUIANA SHRIMP FISHERY PARADOX**

# On the Influence of Environmental Factors on Harvest : the French Guiana Shrimp Fishery Paradox

*Nicolas Sanz<sup>a</sup>, Bassirou Diop<sup>a</sup>, Fabian Blanchard<sup>b</sup>, Luis Lampert<sup>c</sup>*

*<sup>a</sup>CEREGMIA. Université des Antilles et de la Guyane, Campus de Troubiran, Pôle d'Enseignement Supérieur, 2091 route de Baduel - B.P. 792, 97337 Cayenne Cedex, France.*

*<sup>b</sup>Ifremer, Unité Biodiversité Halieutique de Guyane, BP 477, 97331 Cayenne, France.*

*<sup>c</sup>Ifremer, Centre Bretagne, ZI de la Pointe du Diable, CS 10070, 29280 Plouzane, France*

*Published in Environmental Economics and Policy Studies 18 (2016)*

## **Abstract**

The purpose of this paper is to investigate the environmental nature of the French Guiana shrimp fishery dynamics through an empirical analysis. In order to do so, we specify a global harvest production function, in which output depends on the number of days at sea and the stock level. In addition, we use some environmental variables representing the ‘El Niño’ and ‘la Niña’ phenomena, the sea surface temperature, and the flow of some amazonian rivers as instruments. This method enables us to correct the well known simultaneous bias between

### *3. ON THE INFLUENCE OF ENVIRONMENTAL FACTORS ON HARVEST : THE FRENCH GUIANA SHRIMP FISHERY PARADOX*

---

the harvest and the stock levels and to show that harvest is significantly dependent on the environmental factors analyzed, which may compromise the future of the French Guiana shrimp fishery in the context of climate change.

Keywords : Fisheries ; Harvest production function ; El Niño ; La Niña ; Amazonian rivers.

### 3.1 Introduction

Since the mid 90's, environmental issues have become central in the public debate (Dunlap *et al.*, 1991). Nowadays, next to the CO<sub>2</sub>'s emissions limitation and the management of water and wastes, the question of the safety of biodiversity also represents a crucial issue. Among all the numerous species the French Guiana entails, the shrimp constitutes a good example of a species being exploited for economic purposes that has almost totally collapsed in recent years (Lampert, 2011a)<sup>1</sup>.

The French Guiana coast's proximity of the Amazon estuary results in the presence of a muddy corridor bounded by a red line (see Figure 3.1). Two shrimp species are mainly exploited in the shrimp fisheries, the brown and the pink shrimps (resp. *Farfantepenaeus subtilis* and *Farfantepenaeus brasiliensis*). The *Farfantepenaeus subtilis* represents more than 85% of shrimp landings. The other species, fished farther offshore and eastern limit of their spatial distribution, represents the remainder. Currently the number of employees is about 135, and essentially foreign nationality (Guyana, Suriname, Brazil). The industry achieves a turnover amounted to € 6.52 millions and the weighted average price collected by the shrimp industry per kg thus came to € 6.91. The French Guiana shrimp fishery started in the late 60's with the US fleet activity. All the boats are Florida-style shrimp trawlers, each using two trawls at the same time. Japanese boats also exploited shrimps, but the whole fleet became progressively French between 1970 and 1990. Over this period, the US-Japanese fleet increased up to 80 trawlers. Since 1992, the whole fleet is only composed with french trawlers targeting shrimps on the continental shelf. The stock assessment has been firstly performed each two years by a working group within the institutional and international framework of the Western Central Atlantic Fishery Commission (WECAFC) up to 1999, and has then been undertaken by the Ifremer (French institute of research for the exploitation of the sea) for management advice since the eighties, allowing for a strong knowledge of the population. The method used for assessment is the well-known "Virtual Population Analysis" (VPA), carried out on a monthly step basis which allows to obtain the recruit abundance as well as

---

<sup>1</sup>The French Guiana constitutes one of the richest areas in terms of biodiversity in the world, the fourth as marine fish is concerned.



### 3. ON THE INFLUENCE OF ENVIRONMENTAL FACTORS ON HARVEST : THE FRENCH GUIANA SHRIMP FISHERY PARADOX

---

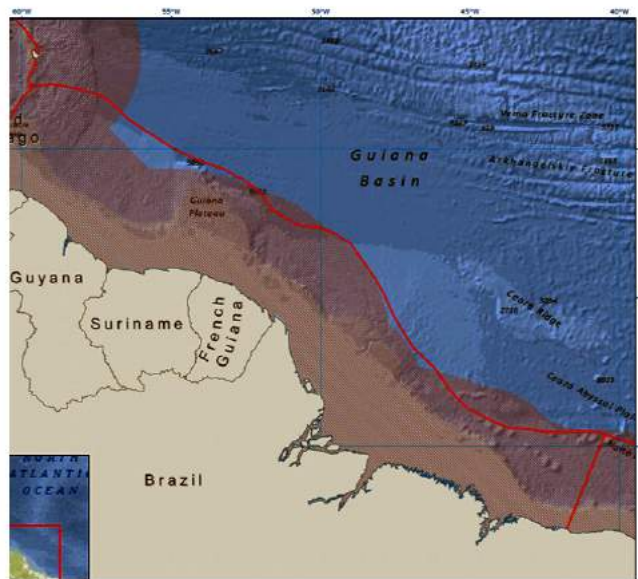

FIG. 3.1 – The Guianas-Brazil shrimping grounds

the spawning stock biomass and the fishing mortality.

One particular interest it presents is that its stock has steadily decreased over years though the effort and harvest levels have followed quite the same trend. Yet, some management rules and instruments have been progressively implemented or reinforced after the creation of the Exclusive Economic Zone. The management of the fishery is in compliance with European legislation. A total allowable catch (TAC) of 4108 tons/year (about 340 tons/month) (for brown and pink shrimps has been adopted in 1983, of which 108 t/year. can be caught by neighbouring countries (Surinam, Trinidad, Barbade). Compared to the historical catch, the TAC level has never been fully achieved. This TAC level has not been changed until 2011, despite the decreasing trends in biomass and landings. In 1991, a license system has been introduced for both species. The main objective was initially to limit the number of boats in order to protect the shrimp resource. Licenses are provided without fees. The main objective was initially to limit the number of boats to protect the shrimp resource. However, the license system did not seem to be in fact an active or efficient resource management tool. Indeed, the year abundance of shrimp is mainly correlated with recruitment but not with effort like *e.g.* the number of boats or the number of days at sea. The number

### 3. ON THE INFLUENCE OF ENVIRONMENTAL FACTORS ON HARVEST : THE FRENCH GUIANA SHRIMP FISHERY PARADOX

---

of licenses was slightly reduced from 69 in 1991 to 63 in 1999, and to 49 in 2010. During this period, the number of active shrimp trawlers was less than the number of licenses (less than half in 2006). The license system could have been a tool to adjust the number of boats in order to improve economic results, but this objective was not explicitly addressed by the management system. Finally, there exist also some spatial restrictions : in order to limit the impact of trawling on juvenile shrimps and avoid conflicts with the inshore small-scale fishery, trawling is forbidden in inshore waters less than 30 meters depth. This rule is more restrictive than the spatial limitation applied to trawlers in European waters. All in all, the economic dynamics of the fishery has been characterized by a diminution of the fleet size, to concentrate the fishing activities on a reduced number of profitable vessels. In addition it will be noted that the profitability has declined in this sector due to aquaculture growing globally. This results in lower prices for shrimp.

Nevertheless, despite this low effort level, the whole shrimp stock has strongly decreased between 1990 and 2009, which seems to constitute a paradox. Newfoundland are closed and most other major stocks have been heavily over-exploited despite extensive and intensive management efforts (Healey and Hennessey, 1998). Regulation may be incompatible or inadequate with the goal of making some fishery sustainable. This suggests that other factors, like environmental shocks, could explain the above statement. The French Guiana sea fishing area may be indeed affected by *e.g.* the large guianan rivers and some climatic phenomena like ‘El Niño’ and ‘La Niña’. The temperature, which can be considered as a general proxy of global climatic changes, may also play an important role here. Hence, a more efficient management of this fishery would consist in a bio-economic approach accounting for the environmental trends and the economic context, in accordance with the new framework of the ecosystem based fisheries management.

Knowledge of present biogeographical limits is thought to make possible to indentify sensitive species (Hart and Reynolds, 2002). Climate mapping is currently used to predict the future distributions of species. Actually bioclimatic models are used to assess potential changes in species distributions and to identify those species that may be most vulnerable to climate change. Ishimura *et al.* (2013) study a three agent game theoretic-bioeconomic

model of the Pacific Sardine stock's abundance and biomass distribution that accounts for decadal-scale climate change. These models attempt to match the current distribution of a species with a number of climatic variables, producing an envelope that describes the climate within a species current range. Then potential changes in distribution under various climate scenarios are estimated with the parameters of the envelope (Mooney, 1991 ; Rogers and Randolph 1993 ; Huntley, 1994 ; Mack, 1996 ; Beaumont and Hughes, 2002).

This method is based on the assumption that range and abundance are determined first and foremost by the physiological tolerances of individual organisms. Physiological tolerance can be defined as following. Species are adapted to a given range of environmental conditions defining its envelope, with an optimal environmental window, around the mean value of the range. Hence species abundance may follow some gaussian distribution within its envelope such as abundance declines towards the edges of the species range (Hengeveld and Haeck, 1982 ; Brown *et al.*, 1996 ; Maurer, 1999). Moreover because physiological tolerances limits are reached on these edges, species abundance may show there more rapid responses to small shifts in climate than near the midpoint of the range (Gaston, 1990 ; Lawton, 2000). In local communities, the mean abundance and temporal variability may then depend on the range position.

The purpose of this paper is thus in a first step to investigate the effects of some environmental phenomena on the working of the French Guiana shrimp fishery under a statistical view point. In order to do so, we propose an empirical analysis of a harvest production function where output depends on an effort variable (the number of days at sea) and the stock level. Besides, we introduce additional pure environmental variables to correct a specific simultaneous bias problem, which in turn enables to highlight the role that these variables play in improving the explanatory power of the model. We have chosen some variables about which data were available : the Niño and Niña phenomena, the sea surface temperature, and the flow of the Amazon, the Arouague, the Comte, the Maroni, and the Oyapock rivers. Output elasticities with respect to usual and environmental inputs are then analyzed in detail.

The paper is organized as follows. The second section introduces methods with variables'

description and production functional form. The third section summarizes the main results and discussion. And the last section entails some concluding remarks.

## 3.2 Methods

### 3.2.1 Variables and data set

Shrimp Landings and VPA calculations (Figure 3.2, first plate) : The whole shrimp production of French Guiana is landed at the Larivot port. We use the data obtained from the sampling carried out since 1989 by Ifremer. We determine the species (some pink royal shrimps – *Farfantepenaeus Brasiliensis* - are mixed with the brown shrimps *F. subtilis*) and sex each subject. Size distributions for males and females are different. The abundance values of the recruits and stock were monthly performed by age-based Virtual Population Analysis (VPA) in accord with Sparre and Venema (1998). The male and female were evaluated separately. The monthly length distributions (1989-2009) were split into 7 nominal age-groups (2 to 8 plus-group) for both males and females. A specific R package script was developed for this calculation because more than 200 cohorts have to be calculated simultaneously (Lampert, 2011a, 2011b). The VPA Ifremer calculations were performed with the local shrimps growth rates (Vendeville et al., 2008).

Sea surface temperatures (*SST*) (Figure 3.2, second plate) : The monthly sea surface temperatures (*SST*) were provided by the National Climatic Data Center (NCDC) database. This monthly one-degree global SST climatology was constructed using the analyses carried out by the Climate Prediction Center (CPC/NOAA). The one degree climatology and analyses derived from monthly Optimum Interpolation (OIv2). The area coverage of the data is 2°-9°N and 47°-59°W. The analysis used buoy and ship data sets, satellite SST data, and SST's simulated by sea-ice coverage. The OI.v2 analysis is described in Reynolds et al. (2002).

El Niño-La Niña index (Figure 3.2, third plate) : The Southern Oscillation Index, or SOI, gives an indication of the development and intensity of El Niño or La Niña events in

### 3. ON THE INFLUENCE OF ENVIRONMENTAL FACTORS ON HARVEST : THE FRENCH GUIANA SHRIMP FISHERY PARADOX

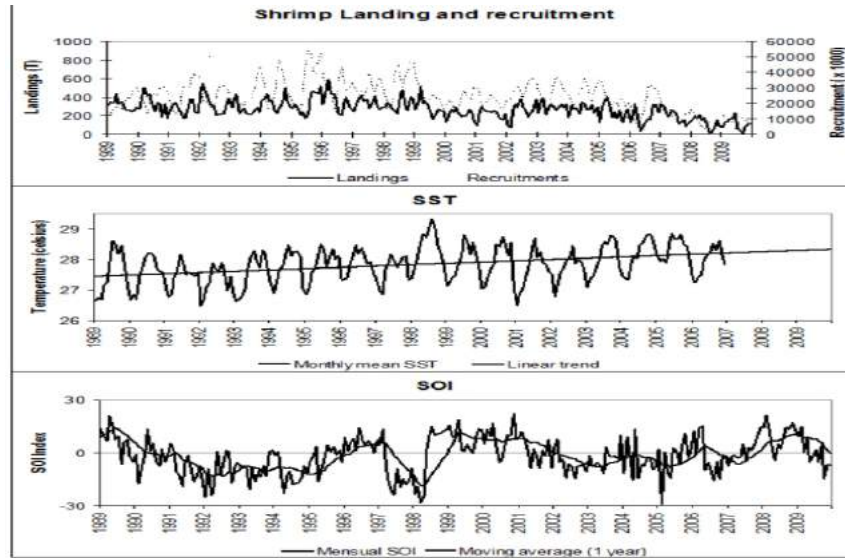

FIG. 3.2 – Monthly variations of the shrimp landing and recruitment, Sea Surface Temperature (SST) and SOI index

the Pacific Ocean. The SOI is calculated using the pressure differences between Tahiti and Darwin. There are several methods to calculate the SOI. The method used by the Australian Bureau of Meteorology is the Troup SOI which is the standardised anomaly of the Mean Sea Level Pressure difference between Tahiti and Darwin. It is calculated as follows :

$$- SOI=10*(Pdiff-Pdiffav)/SD(Pdiff)$$

where  $Pdiff$  = (average Tahiti MSLP for the month) - (average Darwin MSLP for the month),

$$- Pdiffav = \text{long term average of } Pdiff \text{ for the month in question}$$

$$- SD(Pdiff)= \text{long term standard deviation of } Pdiff \text{ for the month in question.}$$

Rivers flow (m<sup>3</sup>/seconde) (Figure 3.3) : The mensual means of the Amazon, Maroni and Oyapock rivers flows were loaded on the ORE HYBAM website. The Environmental Research Observatory (ORE) HYBAM (Geodynamical, hydrological and biogeochemical control of erosion/alteration and material transport in the Amazon basin) operates since 2003. In 2011, the ORE-HYBAM is a component of the GET (Geosciences Environnement Toulouse) (UMR 5563 CNRS / IRD UR 234 / UPS / CNES), Observatoire Midi-Pyrénées (OMP). The other local flow rivers were obtained by the guianian “direction de l’environnement, de

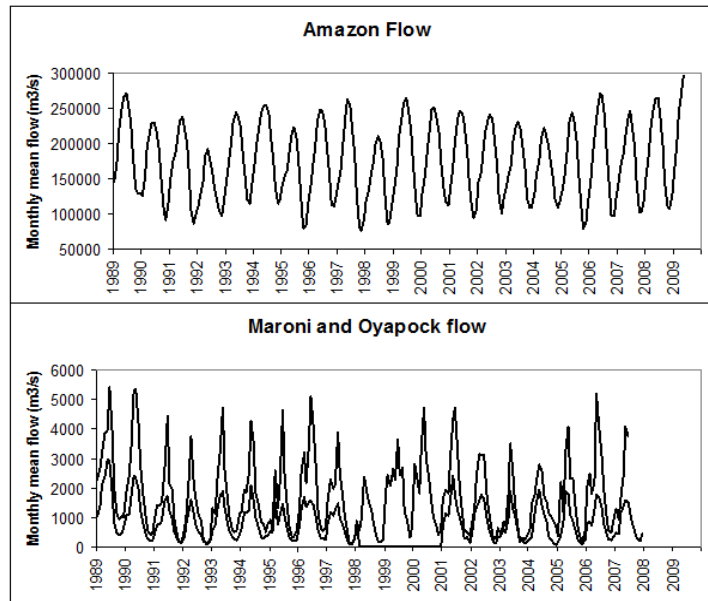

FIG. 3.3 – Mean monthly flow of the Amazon and main guianian rivers

l'aménagement et du logement" (DEAL). Figure 3.3 describes the same flow's trend ( $m^3/s$ ) between Amazon and the main guianan rivers.

### 3.2.2 Cobb-Douglas (C-D) production function

In fisheries economics, the most treated function is the Schaefer (1957) one, which is linear in both effort and stock size and homogeneous of degree two. According to these assumptions, catch per unit effort ( $H/E$ ) is proportional to stock size at all levels of effort and stock, and the distribution of fish is uniform (see Bjorndal, 1987). Whereas the use of such a function can be justified in a first step, its use is unrealistic for fisheries of schooling species (Clark, 1976, p. 235). Hence, we rather retain a more general Cobb-Douglas functional form. This function still implies that catch-input elasticities remain constant, *i.e.* independent of the scale of fishing operations or the fish stock's level. Besides, this kind of single species harvest functions enables to avoid the risks of misspecification, which could result from multi-species modelling (Peña *et al*, 2007). At last, inter-species biological interactions are still not well

### 3. ON THE INFLUENCE OF ENVIRONMENTAL FACTORS ON HARVEST : THE FRENCH GUIANA SHRIMP FISHERY PARADOX

---

identified in the fishing zone considered here. Moreover, the Cobb-Douglas function is very well-established in the literature on fishery economics (Bjorndal, 1987; Bjorndal, 1989; Bjorndal *et al.*, 1993), although other production functions integrating *e.g.* boats' capacity could also be considered (see Yagi and Managi, 2011). According to the Cobb-Douglas form retained here, the harvest is related to economic, biological, and environmental exogenous variables as follows :

$$H_t = qE_t^\alpha S_t^\beta \quad (3.1)$$

where  $q$ ,  $E_t$ , and  $S_t$  respectively denote the catchability coefficient, the fishing effort level expressed as the number of days at sea, and the stock size. The parameters  $\alpha$  and  $\beta$  respectively represent the elasticities of the harvest level with respect to effort and stock.

Times series data for the Guianan shrimp fisheries were obtained from the Ifremer. They are monthly) available from January 1990 to December 2009 involving  $N = 240$  observations. The data set includes details for whole fleet about harvest (the landed tonnage), inputs like the stock and the total number of days at sea (monthly operating days off shore), and the environmental factors as the rivers' flow, the sea surface temperature and the Niño and Niña indicators.

The *Stock* : the abundance values of the recruits and stock were monthly performed by age-based Virtual Population Analysis (VPA); see Section 3.2.1.

The *Harvest* variable to be explained corresponds to monthly landings of shrimp in tons for the whole fleet.

The *Effort* variable used for capturing the effects of fishing effort is a monthly number of total days during which the fleet is offshore. It includes the travelling time to the area where the fishing activities take place.

*Niño* and *Niña* variables describe the corresponding phenomena and are captured through the SOI ("Southern Oscillation Index") measure and used in the regression as dummies. This oscillation has its largest signature in and over the tropical Pacific and Indian oceans but it also affects oceanic and atmospheric conditions globally. The Niño yields a disruption of temperature in the tropical Pacific Ocean that has important weather and climate conse-

### 3. ON THE INFLUENCE OF ENVIRONMENTAL FACTORS ON HARVEST : THE FRENCH GUIANA SHRIMP FISHERY PARADOX

---

quences around the globe<sup>2</sup>. The Niño currents usually last for several months, resulting in the reduction of nutrients and a corresponding dissipation of fish stocks (Sun *et al.*, 2006). The Niña is opposite for this other phase of the SOI when sea surface temperatures in the central and eastern tropical Pacific are unusually low and when the trade winds are very intense. We suppose here that an oceanic episode of the Niño occurs when the SOI is lower than -8 and that an episode of the Niña occurs when the SOI is greater than 8. Besides, in order to take the persistence and the intensity of such phenomena into account, we have lagged the latter dummies of one year (12 months), which corresponds to the *Nino(-12)* and *Nina(-12)* additional variables.

The (sea surface) *Temperature* variable is measured in degrees celsius and is equal to the monthly mean during the estimated period. It is used in the regression as an instrumental variable.

Finally, in all regressions, we use the effort level as the exogenous variable and as instrumental variables that are correlated with the endogenous one (*Stock*). The instruments used are : the variables *juveniles* and *adults*, some pure environmental variables representing the *Niño* and the *Niña* phenomena, the SST, and those that denote the flow of the large rivers that are located in French Guiana. Among them, data are only available for the Arouague, the Comte, the Maroni, and the Oyapock. Next to the local rivers that are of interest since they are located close to the fishing zone, we also integrate to the analysis a very singular river due to its size, the Amazon. The flow of the above rivers has been evaluated in m<sup>3</sup>/sec.

The following logarithm of the Cobb-Douglas harvest function (3.1) will be estimated :

$$\ln H_t = \ln q + \alpha \ln E_t + \beta \ln S_t + \varepsilon_t \quad (3.2)$$

where  $\varepsilon_t$  denotes error terms.

---

<sup>2</sup>The term "El Niño" (meaning the "Christ Child" in Spanish) is used by fishermen in Ecuador and Peru to refer to a warmer than normal ocean current observed immediately after Christmas every few years.



### 3.3 Results and discussion

We first use ordinary least squares (OLS) to estimate the harvest production function. Results are presented in Table 3.2 (Model 1). Table 3.1 and Table 3.1a. show descriptive statistics for production inputs, output and instrumental variables.

Table 3.1 : Descriptive statistics for Stock, Effort, Harvest, Temperature

	Stock (tons)	Effort (days at sea)	Harvest (tons)	Temperature ( $\dot{C}$ )
Mean	730.88	1088.67	265.88	27.85
Median	734.21	1209	262.5	27.89
Maximum	1463.54	1842	586	29.33
Minimum	118.5	22	10	26.47
Std. D	253.51	381.82	104.85	0.57

Std. D : Standard deviation

Table 3.1a : Descriptive statistics for Amazon, Maroni, Oyapock, Arouague, and Comte rivers' flow

	Amazon (m <sup>3</sup> /s)	Maroni(m <sup>3</sup> /s)	Oyapock(m <sup>3</sup> /s)	Arouague (m <sup>3</sup> /s)	Comte (m <sup>3</sup> /s)
Mean	173 721	1760	861	303.4	103.9
Median	174 600	1524	755	290.54	88.30
Maximum	296 000	5438	2969	675.53	417.13
Minimum	76 390	100	76.81	74.19	9.35
Std. D	52 814	1277	616.56	149.50	74.50

Std. D : Standard deviation

### 3. ON THE INFLUENCE OF ENVIRONMENTAL FACTORS ON HARVEST : THE FRENCH GUIANA SHRIMP FISHERY PARADOX

---

Table 3.2 : Result from OLS estimation Eq.2 and TSLS estimation of the shrimp harvest function with Niño,  
Niña, the sea temperature and the rivers' flow as instrumental variables

Models	Instruments/Variable	Constant	Effort	Stock	N	Adjusted R <sup>2</sup>	F
1 (OLS)		-6.37 (-10.90)	0.46 (11.09)	0.65 (11.39)	240	0.80	502
2 (TSLS)	Niño	-7.43 (-12.30)	0.39 (9.42)	0.76 (12.83)	240	0.80	513
	Niño(-12)	-7.58 (-12.41)	0.39 (9.08)	0.77 (12.90)	240	0.81	505.7
3 (TSLS)	Niña	-7.43 (-12.30)	0.39 (9.41)	0.76 (12.84)	240	0.80	513
	Niña(-12)	-7.59 (-12.43)	0.39 (9.06)	0.77 (12.92)	240	0.81	505.8
4 (TSLS)	Temperature	-7.83 (-11.12)	0.25 (5.10)	0.86 (13.51)	240	0.66	237.72
5 (TSLS)	Amazon	-7.57 (-11.72)	0.33 (7.26)	0.80 (12.76)	240	0.76	392
6 (TSLS)	Aprouague	-7.81 (-11.53)	0.39 (8.40)	0.79 (11.80)	240	0.84	468
7 (TSLS)	Comte	-7.37 (-12.12)	0.40 (9.58)	0.75 (12.67)	240	0.80	507
8 (TSLS)	Maroni	-7.13 (-10.42)	0.24 (5.07)	0.81 (12.88)	240	0.67	238
9 (TSLS)	Oyapock	-7.47 (-9.55)	0.32 (5.77)	0.80 (10.11)	240	0.76	324

Notes : t-values in parentheses ; all coefficients are statistically significant at the 1% level.

Instrumental variables : Juveniles, Adults, Niño, Niña, Temperature ; Amazon, Aprouague, Comte, Maroni, Oyapock.

### 3. ON THE INFLUENCE OF ENVIRONMENTAL FACTORS ON HARVEST : THE FRENCH GUIANA SHRIMP FISHERY PARADOX

---

However, a Hausman test (Hausman, 1978) rejects the exogeneity of the *Stock* variable in the harvest function (3.1). The endogeneity of the fish stock is well known in the literature of fisheries. According to *e.g.* Peña-Torres *et al.* (2007) the endogeneity of the fish stock occurs for two reasons. Firstly, because catch affects biomass negatively. The second reason is linked to the assessment of the fish stock : Virtual Population Analysis (VPA). The VPA was introduced in fish stock assessment by Gulland, (1965). Indeed, the stock variable is calculated using this method which consists in reconstructing historical fish numbers at age using information on death of individuals each year. This death is usually partitioned into catch by fisheries and natural mortality. Then by construction the biomass estimates depend on the catch. A feasible solution for endogeneity problems is the use of lagged variables. Nonetheless, this strategy does not solve in a totally convincing way the issue of biomass endogeneity, as contemporaneous catch data is used to estimate current as well as past biomass values, when VPA stock assessment methodology is involved, as this is the case here. As Peña-Torres *et al.*, we use an instrumental variables regression which consists in two stage least squares (TSLS) estimation. The first stage of the estimation consists in making the variable *Stock* independent by regressing it on all the exogenous variables of the model (here, only *Effort*), and other instrumental variables. The order condition for identification, which says that there must be at least as many instruments as there are coefficients in equation, is here satisfied. The second stage corresponds to the estimation of Equation (3.2), while replacing the *Stock* variable by its fitted values found in the first stage regression. The results of the TSLS estimation are presented in Table 3.2. This method is of interest since it enables to evaluate the impact of the pure environmental variables on the stock during the first stage regression. We highlight the corresponding results in Table 3.3. In Table 3.3, the estimated effort and stock output elasticities for all models indicate values that are statistically significant at 5 % level. Comparison between Model 1 and Model 2-9 shows that the effort output elasticity is always higher in the OLS regression (46%) than in all the TSLS ones (about 35%, corresponding to the mean value of effort output elasticities), whereas the contrary is observed as the stock output elasticity is concerned. This suggests that the endogeneity problem related to the stock variable artificially increases the value of

### 3. ON THE INFLUENCE OF ENVIRONMENTAL FACTORS ON HARVEST : THE FRENCH GUIANA SHRIMP FISHERY PARADOX

---

the effort parameter and diminishes the stock parameter one.

All variables except the dummies for *Niño* and *Niña* refer to data transformed by natural logarithms. Coefficient estimates, *t*-values, the *Adjusted R*<sup>2</sup>, and the Fisher statistics (*F*) are indicated for all models. The number of observations is added to Table 2.

The overall explanatory power of all estimated models is high, with *Adjusted R*<sup>2</sup>s ranging from 0.67 to 0.84. Moreover, the individual significance level of most coefficients appears to be quite high, denoting a good specification of each model.

The effort output elasticity is significantly different from zero but much lower than one, which clearly indicates decreasing returns to effort within the shrimp's fishery.

The stock output elasticity is also significantly different from zero. This should have constituted a brake on the observed shrimp's stock depletion since such a positive value implies that harvesting costs depend on stock size. In this case, a fall in the stock size yields an increase in harvesting costs which leads to a decrease in the fishing effort level, and therefore constitutes a mechanical brake on stock depletion (see *e.g.* Bjorndal *et al.*, 1993). This brake phenomenon seems to have been at stake in the case of the French Guiana shrimp fishery where the fishermen have substantially decreased their effort level. Nevertheless, this has not prevented the stock from decreasing for a number of years. Our results therefore suggest that the observed shrimp stock collapse is not due to pure economical reasons, but rather to environmental ones in this model.

### 3. ON THE INFLUENCE OF ENVIRONMENTAL FACTORS ON HARVEST : THE FRENCH GUIANA SHRIMP FISHERY PARADOX

Table 3.3 : First stage OLS regression. Estimation of the stock with respect to the environmental variables

Environmental variable	Stock	T-student	Adjusted R <sup>2</sup>	F
2. Niño	0.10	(2.46)**	0.57	157.23
Niño(-12)	0.12	(2.97)**	0.57	155.57
3. Niña	-0.02	(-0.45)	0.55	150.88
Niña(-12)	-0.16	(-3.52)**	0.58	159.48
4. Temperature	-4.28	(-5.59)**	0.44	87.53
5. Amazon	-1.66	(-2.69)**	0.54	140.54
6. Arouague	-0.015	(-0.36)	0.59	124.17
7. Comte	0.05	(0.55)	0.55	149.44
8. Maroni	-0.04	(-2.28)**	0.41	79.19
9. Oyapock	-0.05	(-3.02)**	0.64	173.96

Notes : t-values in parentheses, \*\* : 99% of confidence. Only the coefficients of the environmental instruments are presented in the table.

However the first-stage regressions include the exogeneous variables in the harvest model

All in all, the stock output elasticity is higher than the effort one. This result is of particular interest since it clearly shows that, in the shrimp fishery of French Guiana, stock contributes to changes in harvest much more than effort.

Only the coefficient of the environmental instruments are presented in the Table 3. However the first-stage regressions include the exogeneous variables in the harvest model. Table 3.3 indicates that coefficient of dummy variable (*Niño*) is significantly different from zero (2.46). Moreover the lagged dummies of one year (12 months) *Niño(-12)* and *Niña(-12)* are also significant and show that intensity of its impact is higher several months later. Not surprisingly, as the Niño and Niña are opposite phenomena, the stock level is thus positively related to the Niño phenomenon and negatively to the Niña's one.

Niño and Niña climatic phenomena occur on a large scale and modify many environmental factors such as wind, air temperature, water temperature, rainfall, river flows and salinity, and probably also in the nursery area. In particular, as already said, the Niño corresponds

to an increase in temperature. However, Table 3.3 shows that its effect on stock is positive whereas the temperature's one is negative. Our results suggest therefore that the Niño's influence on stock seems to go through another channel than temperature. The Niño might indeed affect other important biological processes like sexual maturation, spawning, larvae migration, juvenile feeding and survival, that are not captured by the present analysis. Concerning the Niña, it can correspond to unfavourable local and/or regional hydro-climatic conditions inducing negative effects on the shrimp recruitment (Chaboud *et al.*, 2009). At last, the Niño and the Niña may have some impact on the water temperature, which may in turn influence the patterns of sea currents (Eide *et al.*, 2002).

Table 3.3 shows that the models that use the *Niño* and the *Niña* variables lagged twelve months generate even better results (higher *Adjusted R*<sup>2</sup>s and *t*-student statistics in both cases). The corresponding elasticities also appear to be higher, suggesting that both phenomena produce their effects on the shrimp's stock and harvest several months after their occurrence. Moreover, the *Adjusted R*<sup>2</sup> of the model that integrates the Niña's effects is even higher.

The results concerning the temperature seem particularly interesting since the corresponding coefficient appears to be the highest among all the environmental variables considered in this analysis. Furthermore, the model that uses temperature as an instrument also yields an high *Adjusted R*<sup>2</sup> (44% in table 3.3). Indeed, as mentioned by Garza-Gil *et al.* (2011), oscillations in temperature seem to have some repercussions on the fish's stock of the continental shelf species, to a greater or a lower degree. The negative temperature stock elasticity suggests that the current sea surface temperatures in French Guiana are probably above the optimal value that yields the highest recruitment.

Table 3.3 shows that impact of rivers'flow on the stock level, when it is significantly different from zero (*Amazon* and *Maroni and Oyapock*), is negative. It is well known that some groups of shrimps are more dependent on freshwater (estuarine extreme species) than others (oceanic-extreme species ; Kutkuhn, 1966). Shrimps reproduce offshore so that larval drift can be observed towards the coastline where the nurseries are located. Juveniles will grow there during several weeks. We can hypothesize that juveniles survival depends on

### 3. ON THE INFLUENCE OF ENVIRONMENTAL FACTORS ON HARVEST : THE FRENCH GUIANA SHRIMP FISHERY PARADOX

---

the quantity and the quality of the food brought by rivers. However, rivers bring a huge quantity of non-organic matter that could alter the feeding capacity of juveniles. Hence, there probably exists an optimal value for the rivers' flow. On the one hand, a high flow increases the number of survivals because of abundance of food and, on the other hand, a high flow reduces the survival because of too much particules in the water. The Amazon is the river that brings the highest quantity of suspended matter at the world's scale (on average around 4 tons of mud particules per second reach the French Guiana ; Gratiot *et al.*, 2008 ; Martinez *et al.*, 2009), which may partly explain the negative relationship between the stock and its flow. One can observe that the Maroni's effects are much weaker than those of the Amazon. Firstly, the flow of the Amazon is several orders of magnitude greater than the Maroni's one. Secondly, the North Brazil Current brings the Amazonian waters from the South East to the North West along the French Guiana coast and therefore pushes the Maroni's waters out of Guiana which weakens the influence of the latter on the stock. Beyond the flow of the rivers considered here, the change of vegetation of watersheds (inland) and nutrient flow to the Guiana-Brazil shrimp grounds may be another important factor affecting shrimp biomass. In order to study the above factors, the surface of the guianan mangrove should be directly integrated to the Cobb-Douglas production function next to the effort variable, as in Barbier (1998, 2000, 2003).

### 3.4 Conclusion

This paper shows that a Cobb-Douglas harvest production function is appropriate to describe the French Guiana shrimp fishery. The model relating the quantity of shrimp harvested to the number of days at sea and to the shrimp population seems to be well supported by the set of data used if augmented by some relevantly chosen environmental variables. The temperature of the sea surface in the fishing ground, the influence of the Niño and the Niña and the river's flow seem indeed to contribute to the explanation of changes in the shrimp's harvest. Among all, the sea temperature in the fishing ground appears to be the most influential. The increase of SST by global warming is significant in French Guiana area (about 0.65°C in 20 years). Nevertheless, there seems not to exist any order of importance between the other factors studied in this paper. However the impact of the Amazon is greater than the others rivers'one.

Our results concerning SOI effects also suggest that climatic change may influence stocks and harvest levels by the indirect effects in winds, waves, rains, suspended matter, sediments. More broadly, it may alter the configuration of ocean currents and, consequently, the most favourable regions for fishing (Arnason, 2003). This phenomenon can be small or large. The rivers' flow also tends to vary when climate changes. In particular, it rises during the rainy season (Callède *et al.*, 2004) and climatic predictions states that the length of this season will increase in the future. Our study highlights therefore some important effects the climatic change may have on the shrimp's stock through its influence on the flow of the big amazonian rivers. The potential increase in the long term trends in SST and the Amazon river flow may lead to a collapse of the stock.

In the French Guiana shrimp fishery, the regulation has been implemented through a system of licenses. Policymakers try to regulate the fishery through the control of the fishing effort level. However, the latter explains a much smaller proportion of the harvest variations than the stock (only 35%, see Table 2 where the mean value of effort output elasticities is about 35%). Moreover, our results suggest that the stock is very dependent on environmental factors. This explains why the impact of the above policy is quite weak. One may therefore



question the relevance or the effectiveness of such licenses that are even not always profitable.

Our paper ignores some other important features of shrimp fisheries that also depend very much on local conditions : mixing of water masses, water salinity, currents, nutrients, turbidity. The physical environment has been recognized as being the main factor driving the biological productivity and essentially influencing all processes in the sea. Other factors responsible for a great part of the observed variability in marine data are biological interactions and the anthropogenic impact (Daskalov, 1999). Which exact role do the above factors play is however very hard to precise. Further avenues of research may consist in explicitly integrating the above factors into the analysis. However, since the harvest production function used in this paper is found to be appropriate, a second step of the present work would consist in including explicitly other important instruments into the analysis like pure biological or ecological factors (*e.g.* nutrient flow from rivers). The guianan mangrove may also play a particularly important role and should thus be integrated to such an analysis.

### 3.5 Références bibliographiques

- Arnason, R. (2003), "Global warming and North Atlantic fisheries : attempting to assess the economic impact", Working paper presented at the FAME workshop, Copenhagen. ICES Oceanography Committee ICES CM 2006/OCC : 12 REF. ACFM, ACE, RMC.
- Baisre, J. A., Arboleya, Z. (2006), "Going against the flow : Effects of river damming in Cuban fisheries", *Fisheries Research* 81(23), 283-292.
- Barbier, E. B. (1998), "Valuing mangrove-fishery linkages—A case study of Campeche, Mexico", *Environmental and Resource Economics* 12(2), 151-166.
- Barbier, E. B. (2000), "Valuing the environment as input : review of applications to mangrove-fishery linkages" *Ecological Economics*, 35(1), 47-61.
- Barbier, E. B. (2003), "Habitat—fishery linkages and mangrove loss in Thailand", *Contemporary Economic Policy*, 21(1), 59-77.
- Beaumont, L.J., Hughes, L. (2002), "Potential changes in the distributions of latitudinally restricted Australian butterfly species in response to climate change". *Global Change Biology* 8, 954-971.
- Bjorndal, T. (1987), "Production Economics and Optimal Stock size in a North Atlantic Fishery", *Scandinavian Journal of Economics* 89, 145-64.
- Bjorndal, T. (1989), "Production in a Schooling Fishery : The case of the North Sea Herring Fishery", *Land Economics* 65(1), 49-56.
- Bjorndal, T., Conrad, D.V., Salvanes, K.G. (1993), "Stock Size, Harvesting Costs, and the Potential for Extinction : the Case of Sealing", *Land Economics* 69(2), 156-167.
- Bjorndal, T., Gordon, D.V. (1993), "The Opportunity Cost of Capital and Optimal Vessel Size in the Norwegian Fishing Fleet", *Land Economics* 69(1), 98-107.
- Brown, J.H., Stevens, G.C., Kaufman, D.M. (1996), "The geographic range : size, shape, boundaries, and internal structure". *Ann. Rev. Ecol. Syst.* 27, 597-623.
- Callède, J., Guyot, J.L., Ronchail, J., L'Hote, Y., Niel, H., De Olivera, E. (2004), "Evolution of the River Amazon's discharge at ébidos from 1903 to 1999", *Hydrological Sciences*

### 3. ON THE INFLUENCE OF ENVIRONMENTAL FACTORS ON HARVEST : THE FRENCH GUIANA SHRIMP FISHERY PARADOX

---

*Journal*, 49(1), 85-97.

Clark, C. W. (1976), “*Mathematical Bioeconomics : The Optimal Management of Renewable Resources*”, New York : John Wiley and Sons.

Chaboud, C., Thébaud, O. (2009), “18th World IMACS / MODSIM Congress”, Cairns, Australia 13-17 July 2009.

Daskalov, G. (1999), “Relating fish recruitment to stock biomass and physical environment in the Black Sea using generalized additive models”, *Fisheries Research* 41, 1–23.

Dunlap, R. E. (1991), “Trends in public opinion toward environmental issues : 1965 à 1990”, *Society & Natural Resources* 4(3), 285-312.

Eide, A., Heen, K. (2002), “Economic impacts of global warming : A study of the fishing industry in North Norway”, *Fisheries Research* 56(3), 261-274.

Garza-Gil, M. D., Torralba-Cano, J., Varela-Lafuente, M.M. (2011), “Evaluating the economic effects of climate change on the European sardine fishery”, *Regional Environmental Change* 11, 87-95.

Gaston, K. (1990), “Patterns in the geographical ranges of species”. *Biol. Rev.* 65, 105-129.

Gratiot, N., Anthony, E.J., Gardel, A., Gaucherel, C., Proisy, C., Wells, J.T. (2008), “Significant contribution of the 18.6 year tidal cycle to regional coastal changes”, *Nature Geoscience* 1, 169-172.

Gulland, J.A. (1965), “Estimation of mortality rates”, Appendix to Arctic Fisheries Working Group Report, ICES C.M. Doc N3.

Hart, P.J.B., Reynolds, J.D. (2002), “Banishing ignorance : underpinning fisheries with basic biology”, *Handbook of fish biology and fisheries* (Ed. by P. J. B. Hart and D. Reynolds), pp 1-12. Blackwell Science Ltd, Oxford.

Hausman, J.A. (1978), “Specification Tests in Econometrics”, *Econometrica* 46(6), 1251-1271.

Healey, M.C., Hennessey, T. (1998), “The paradox of fairness : The impact of escalating complexity on fishery management”, *Marine Policy* 22 (2) , pp. 109-118.

### 3. ON THE INFLUENCE OF ENVIRONMENTAL FACTORS ON HARVEST : THE FRENCH GUIANA SHRIMP FISHERY PARADOX

---

- Hengeveld, R., Haeck, J., (1982), "The distribution of abundance. I Measurements". *J. Biogeogr.* 9, 303-316.
- Huntley, B. (1994). "Plant species' response to climate change : implications for the conservation of European birds". *Ibis* 137, 127-138.
- Ishimura, G., Herrick, S., Sumaila, U.R. (2013), "Fishing games under climate variability : transboundary management of Pacific sardine in the California Current System", *Environmental Economics and Policy Studies* 15(2), 189-209.
- Kutkuhn, J.B. (1966), "Dynamics of a penaeid shrimp population and management implications", *Fishing Bulletin* 65, 313-338.
- Lampert, L. (2011a), "Etude de la crise de la pêche de la crevette en Guyane. Volume 1 : Effets de la pêche, hypothèses des causes", Rapport RST Ifremer/BIODIVHAL 2011-5, Cayenne, 52 p. annexe ; <http://archimer.ifremer.fr/doc/00075/18584/16137.pdf>
- Lampert, L. (2011b), "Mode d'emploi du script à R à pour le calcul par VPA du nombre de recrues de crevettes et de leur biomasse", Rapport RST Ifremer/BIODIVHAL 2011-1, Cayenne, 40 p. annexe ; <http://archimer.ifremer.fr/doc/00075/18615/16168.pdf>
- Lawton, J.H. (2000), "Community ecology in a changing world". Kinne O (Ed), Excellence in Ecology, 11, Ecology Institute, Oldendorf/Luhe, Germany.
- Mack, R.N. (1996). "Predicting the identity and fate of plant invaders : emergent and emerging approaches". *Biol. Cons.* 78, 107-121.
- Martinez, J.M., Guyot, J.L., Filizola, N., Sondag, F. (2009), "Increase in suspended sediment discharge of the Amazon River assessed by monitoring network and satellite data", *Catena* 79, 257-264.
- Maurer, B.A. (1999), "Untangling ecological complexity". *University of Chicago Press*, Chicago.
- Mooney, H.A. (1991), "Biological response to climate change : an agenda for research". *Ecol. Appl.* 1, 112-117.
- Peña-Torres, J., Agostini, C., Vergara, S. (2007), "Fish Stock Endogeneity in a Harvest

### 3. ON THE INFLUENCE OF ENVIRONMENTAL FACTORS ON HARVEST : THE FRENCH GUIANA SHRIMP FISHERY PARADOX

---

Function : ‘El Niño’ Effects on the Chilean Jack Mackerel Fishery”, *Revista de Analisis Economico* 22(2), 75-99.

Reynolds, R. W., Rayner, N. A., Smith, T. M., Stokes, D. C., Wang, W. (2002), “An Improved In Situ and Satellite SST Analysis for Climate”, *Journal of Climate* 15(13), 1609-1625.

Rogers, D.J., Randolph, S.E. (1993), “Distribution of tsetse and ticks in Africa : past, present and future”. *Parasit. Today* 9, 266-271.

Schaefer, M. B. (1957), “Some considerations of population dynamics and economics in relation to the management of marine fishes”, *Journal of the Fisheries Research Board of Canada* 14, 669-81.

Sparre, P., Venema, S.C. (1998), “Introduction to tropical fish stock assessment. Part 1 Manual”, Rev. 2. FAO. *Fish. Tech. Pap.* 306/1 (Rev. 2), Rome, FAO, 407 p.

Sun, C.-H., Chiang F.-S., Tsoa E., Chen M.-H. (2006), “The effects of El Niño on the mackerel purse-seine fishery harvests in Taiwan : An analysis integrating the barometric readings and sea surface temperature”, *Ecological Economics* 56(2), 268–279.

Vendeville, Ph., Rosé J., Viera A., and Blanchard F. (2008), “Durabilité des activités halieutiques et maintien de la biodiversité marine en Guyane”, Rapport IFOP-CPER. Cayenne : Ifremer, 316 p. annexe ; <http://archimer.ifremer.fr/doc/00085/19595/>.

Yagi, M., Managi, S. (2011), “Catch limits, capacity utilization and cost reduction in Japanese fishery management”, *Agriculture Economics* 42, 577-592.

---

---

**CHAPITRE IV :**

---

**GLOBAL WARMING AND THE COLLAPSE OF THE FRENCH GUIANA  
SHRMP FISHERY**

# Global warming and the collapse of the French Guiana shrimp fishery

<sup>a</sup>Bassirou Diop, <sup>b</sup>Nicolas Sanz, <sup>a</sup>Yves Jamont Duplan, <sup>a</sup>El Hadji Mama Guene, <sup>b</sup>Fabian Blanchard, <sup>c</sup>Luc Doyen, <sup>c</sup>Jean Christophe Pereau

<sup>a</sup>Ceregmia, Université des Antilles; Campus de Schoelcher, BP 7209, 97275 Schoelcher Cédex, France.

<sup>b</sup>UMRS 3456, Laboratoire Ecologie, Evolution, Interactions des Ecosystèmes Amazoniens (LEEISA), UG, CNRS, Ifremer, 97300 Cayenne, France

<sup>c</sup>GREThA, CNRS, Université de Bordeaux; Avenue Léon Duguit, Pessac, France.

*Working paper in Document du travail 201- CEREGMIA. <hal-01243305>.*

*Presented at Gdr Liga 2015 workshop*

## Abstract

This paper studies the biological and economic effects of global warming on the French Guiana shrimp fishery. To achieve this, a dynamic bio-economic model of the fishery accounting for the sea temperature is considered. The model is calibrated over historical data from 1993 to 2009. Different population dynamics and catch production functions are compared. Cobb-Douglas functions turns out to produce the best goodness of fit. Then a management

#### *4. GLOBAL WARMING AND THE COLLAPSE OF THE FRENCH GUIANA SHRIMP FISHERY*

---

scenario based on the optimization of the net present value derived from fishing is computed. The outcomes of this optimality scenario are investigated for status quo, MEY, closure scenarios with a sea surface temperature following the same trend of the last periods. Under the most likely scenario, the catches and profits respectively decrease and stock will collapse around 2100.

Keywords : Renewable resource ; Climate change ; Bio-economics ; Scenarios ; Optimality.



## 4.1 Introduction

Shrimp is nowadays the most consumed marine resource in the world. Its growing constitutes a major source of value for French Guiana. It represents the third export sector of the latter (25% of the total volume) and remains one of its main industrial sectors. However, the French Guyana shrimp fishery has faced many difficulties over the two last decades. The globalization of the shrimp market, which has led to a decrease of 50% in real prices since 1997, and the long-term increase in fuel prices worldwide, as well as the 2007 crisis, partly explain the economic problems of this fishery. Facing this situation, some management rules were progressively adopted or reinforced starting from the creation of the Exclusive Economic Zone in 1977. Besides, a total allowable catch (TAC) system was implemented for both the brown and the pink shrimps in 1983 and the management of the fishery is now in compliance with the European legislation. Moreover, some spatial restrictions, forbidding trawling activities in specific coastal zones, were also imposed. The above public policies have indeed led to the reduction of fishing effort and harvest levels. The number of active vessels has also been substantially diminished.

However, despite of the institutional changes mentioned above, the shrimp stock has steadily decreased between 1990 and 2009, mainly due to the fall of the recruitment of the two main species of shrimp targeted. This suggests that other factors, such as exogenous environmental shocks, may have a stronger influence on the French Guiana shrimp fishery than the economic factors *per se*. Hannesson *et al.*, (2006) provide strong evidence that fishing industries are very dependent on natural conditions. The French Guiana shrimp fishery might thus probably be affected by hydroclimatic modifications linked to global change (Chaboud and Thébaud, 2009). The sea temperature *per se* seems also to be the one that mostly affects the quality of offshore waters and thus the productivity of the local marine ecosystem (Sanz *et al.*, 2016). Climate change, and global warming in particular through its effect on the sea temperature, might therefore be the strongest driver of the strongest effects on the shrimp stock dynamics and harvest levels ( Cheung *et al.*, 2009 ; Brander, K. M., 2007).

But whereas there is increasing recognition that global warming affects the ecological

functioning of the marine ecosystems, its impact remains poorly understood (Barange, 2002). Research on its effects on fisheries has been limited and fragmented for a long time (Briones *et al.*, 2006) and its consequences on the economic outcomes of fisheries has been dealt with only over the last few years in the literature (Garza-Gil *et al.*, 2011). Until now, a majority of existing bioeconomic models still assume that environmental conditions in the marine ecosystem are constant, which rarely occurs in the real world, as underlined by Knowler (2002). Such an assumption has sometimes led to the misspecification of harvest controls, contributing to the diminished state of many exploited living marine resources (Keyl and Wolff, 2008 ; Stock *et al.*, 2011).

However, since a growing number of studies have identified strong responses of marine resources to climate variability over last years (*e.g.* Lehodey *et al.*, 2006), evidence for responses to anthropogenic climate change is now accumulating (Brander, 2010). As rapid and persistent rises in temperature are expected to arrive (Levitus *et al.*, 2000), there is a need to take this phenomenon into account systematically when building bioeconomic models. A more efficient management of the French Guiana shrimp fishery should thus rely on an integrated bioeconomic approach, accounting simultaneously for the local economic context and the environmental trends. Such an integrated approach is in line with the operationalization of the ecosystem based fisheries management (Doyen *et al.*, 2013, Thébaud *et al.*, 2013).

The aim of our paper is therefore to analyze the potential biological and economic effects that global warming may have on the French Guiana shrimp fishery. To do so, we adapt the modeling framework developed by Garza-Gil *et al.*, (2011), that consists in introducing a sea surface temperature variable into different renewable resource dynamics, making it possible to evaluate the impact of global warming on the shrimp stock dynamics in stylized manner<sup>1</sup>. We further estimate the shrimp harvest function using a Cobb-Douglas relationship. The bio-economic dynamic models are calibrated using data from the information system from Ifremer. We then define three scenarios (status quo, closure and MEY : Maximum Economic Yield) considered over a time horizon that extends to 2100 and we assume in each of them

---

<sup>1</sup>The temperature of waters may be considered as a general proxy of climate change in a first step ; the approach used here refers to the Extended Stock Assessment Models (ESAMs ; see Stock *et al.*, 2011).

that sea surface temperature rises at the same rate as over the period 1993-2009, *i.e.* about 0.025 °C per year.

The paper is organized as follows. Section 2 describes the French Guiana shrimp fishery and exemplifies the correlation between the sea surface temperature and the observed changes in the fish stock and harvest levels. Section 3 presents the bio-economic model used to determine the stock, harvest and profit levels that the French Guiana shrimp fishery would reach in the future if it were managed in a centralized manner, depending on three distinct scenarios regarding the trend of the sea surface temperature. Section 4 states the results of the simulations for the period 2010-2100 in detail. Finally section 5 provides a summary and concluding remarks.

## 4.2 The French Guiana shrimp fishery

Two shrimp species are mainly exploited in the French Guiana fishery, the brown and the pink shrimps (resp. *Farfantepenaeus subtilis* and *Farfantepenaeus brasiliensis*). The French Guiana shrimp fishery started in the late 1960's with the US fleet activity. All the vessels were floridian shrimp trawlers, each using two trawls at the same time. Japanese vessels also exploited shrimps, but the whole fleet became progressively French between 1970 and 1990. Over this period, the US-Japanese fleet increased up to 80 trawlers. Since 1992, the whole fleet is only composed with French trawlers targeting shrimps on the continental shelf. The stock assessment has been firstly performed each two years by a working group within the institutional and international framework of the Western Central Atlantic Fishery Commission (WECAFC) up to 1999, and has then been undertaken by the Ifremer (French institute of research for the exploitation of the sea) for management advice since the 1980's, allowing for a strong knowledge of the population. The method used for assessment is the well-known "Virtual Population Analysis" (VPA), carried out on a monthly step basis which allows to obtain the recruit abundance as well as the spawning stock biomass and the fishing mortality.

Table A4.1 (see Appendix) shows series of the shrimp biomass, catches, effort and sea

surface temperature for the period 1993-2009 obtained from Ifremer. The biomass has steadily decreased over years though the effort and catch levels have followed quite the same trend (see Figure 4.1). Yet, a total allowable catch (TAC) of 4108 tons for brown and pink shrimps has been adopted, of which 108 tons can be caught by neighboring countries (Surinam, Trinidad, Barbade). Compared to the historical catch, the TAC level has never been fully achieved. This TAC level has not been changed until 2011, despite the decreasing trends in biomass and landings. In 1991, a license system was introduced for both species. The main objective was initially to limit the number of vessels in order to protect the shrimp resource. Licenses are attributed without any fee. However, the license system did not seem to be in fact an active or efficient resource management tool. The number of licenses was slightly reduced from 69 in 1991 to 63 in 1999, and to 49 in 2010. During this period, the number of active shrimp trawlers was less than the number of licenses (less than half in 2006). The license system could have been a tool to adjust the number of vessels in order to improve economic results, but this objective was not explicitly addressed by the management system. Finally, there exist also some spatial restrictions : in order to limit the impact of trawling on juvenile shrimps and avoid conflicts with the coastal small-scale fishery, trawling is forbidden in coastal waters less than 30 meters deep. This rule is more restrictive than the spatial limitation applied to trawlers in European waters. All in all, the economic dynamics of the fishery has been characterized by a diminution of the fleet size, to concentrate the fishing activities on a reduced number of profitable vessels (around thirty).

Nevertheless, despite this low effort level, the whole shrimp biomass has strongly decreased between 1993 and 2009 (Lampert, 2011). Table 1 highlights the negative correlation between biomass, effort, catch on the one hand, and the sea surface temperature on the other hand. The French Guiana sea fishing area might be indeed affected by *e.g.* the temperature, which can be considered as a general proxy of global climatic change. The temperature increases between 1970 and 2004 on the Guiana coast. The difference between the average values of these two periods is  $0.65^{\circ}\text{C}$ , with an accentuation of this phenomenon by 1995 (Bernard, 2006).

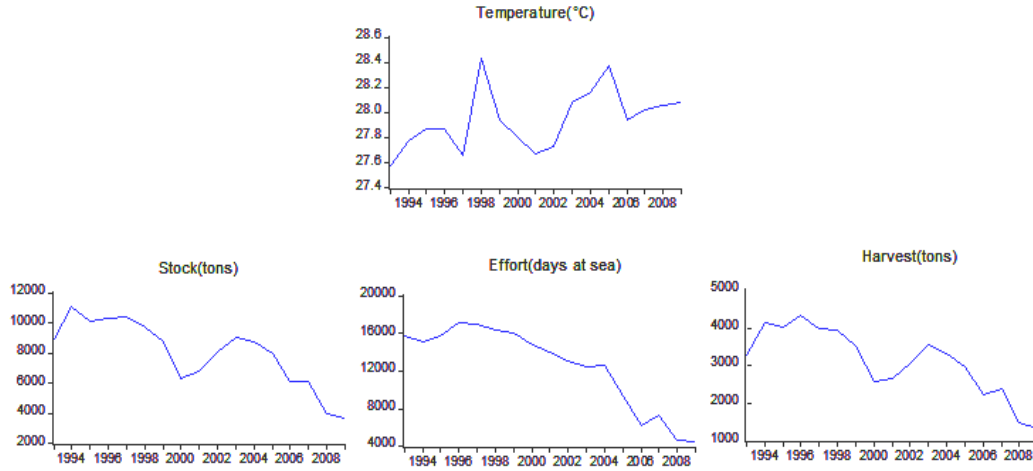

FIG. 4.1 – Historical path in French Guiana over 1993-2009 : sea surface temperature, shrimp stock, effort and harvest

## 4.3 The bio-economic model

### 4.3.1 The dynamic model

Before studying the effects of the increase in the sea temperature on the shrimp stock and harvest levels, and on the profit levels they generate, we have to determine which capture in a relevant way the renewal of the shrimp and its production process. We therefore firstly estimate four population dynamics that explicitly integrate the sea surface temperature. The logistic function is the most widely used in the economic literature. However, other functions may also be used when the logistic model results in non-significant parameters (Bjorndal, 1988 ; Clark, 1990 ; Opsomer and Conrad, 1994 ; Garza-Gil, 1998 ; Hannesson, 2006 ; Nostbakken, 2008 ; De Lara and Doyen, 2008) :

$$X_{t+1} = aX_t + bX_t^2 + cT_t - H_t \quad (4.1)$$

$$X_{t+1} = aX_t e^{bX_t + cT_t} - H_t \quad (4.2)$$

$$X_{t+1} = aX_t^b T_t^c - H_t \quad (4.3)$$

$$X_{t+1} = aX_t^{b+cT_t} - H_t \quad (4.4)$$

The above four functional forms are known as the logistic, the Ricker, the Cobb-Douglas, and the Cushing natural growth functions, respectively. The variable  $X$  denotes the fish stock biomass,  $t$ , the time (in year),  $H$  the harvest,  $a$ ,  $b$ , and  $c$ , the parameters that represent biological and environmental impacts, and  $T$ , the sea surface temperature. Since the Cobb-Douglas function best adjusts to the historical series, this is the one that will be used to describe the dynamic of the shrimp stock from now on.

### 4.3.2 The production function

Usually, the production function (Sanz *et al.*, 2016) used in the economic literature concerning fisheries is also of the Cobb-Douglas form :

$$H_t = \alpha X_t^{\beta_1} E_t^{\beta_2} \quad (4.5)$$

where  $\alpha$  denotes catchability, coefficients  $\beta_1$  and  $\beta_2$  represent respectively the elasticities of the catch level,  $H_t$ , with respect to the biomass,  $X_t$ , and the effort level,  $E_t^2$ . The effort level corresponds to the total number of days during which the fleet is offshore. It includes the travelling time to the area where the fishing activities take place.

### 4.3.3 The management strategy

If the French Guiana shrimp fishery was managed in a centralized manner in accordance with MEY (maximum economic yield) strategy as in Clark (1990), Doyen *et al.* (2013), the economic problem of the regulator would consist in choosing total optimal catches that would maximize the current value of the profit flow,  $pH_t - wE_t$ , generated by the production of shrimp, where  $p$ ,  $w$ , and  $H_t$ , represent respectively the unit price of harvest, the cost of effort, and the harvest level at time  $t$  respectively. The regulator's bio-economic program can

---

<sup>2</sup> $\beta_1 \neq \beta_2 \neq 1$ .

thus be written as :

$$Max_{H_t} \sum_{t=0}^{\infty} \delta^t (pH_t - wE_t) \quad (4.6)$$

$$\text{subject to } X_{t+1} = aX_t^b T_t^c - \alpha X_t^{\beta_1} E_t^{\beta_2}$$

$$X_t > 0, E_t \geq 0, X_o \text{ given}$$

$$0 \leq H_t \leq H$$

where  $\delta = 1/(1+r)$  stands for the discount factor and where  $r$  the discount rate is set at 3%. The solution of the above problem requires the use of optimum control theory (Kamien and Schwartz, 1991). At equilibrium, it can be proved (Conrad, 1999; De Lara and Doyen, 2008) the long-term balance in the renewable resource framework gives the optimal value of the shrimp biomass implicitly as follows :

$$\begin{aligned} \beta_1 A X^{-\frac{\beta_1+\beta_2}{\beta_2}} (aX^b T^c - X)^{\frac{1}{\beta_2}} + \\ \left[ p - A X^{-\frac{\beta_1}{\beta_2}} (aX^b T^c - X)^{\frac{(1-\beta_2)}{\beta_2}} \right] (abX^{b-1} T^c - 1) \\ - \delta \left[ p - A X^{-\frac{\beta_1}{\beta_2}} (aX^b T^c)^{\frac{(1-\beta_2)}{\beta_2}} \right] = 0 \quad (4.7) \end{aligned}$$

$$\text{where } A = \frac{w}{\alpha^{\frac{1}{\beta_2}} \beta_2}.$$

As can be seen, the formulation of the optimal value of the shrimp biomass depends on the sea surface temperature. Parameters  $\alpha, \beta_1, \beta_2, a, b, c$  are estimates of the production and the natural growth functions. The harvest level can be deduced from the biological constraint given by Eq. (4.3) and the effort level can be obtained from the technological constraint (4.5).

As far as corresponding profits are concerned, the unit price of landings,  $p$ , has been chosen equal to 6.60€/kg that includes a 1.30€/kg State subsidy that has been distributed to fishing firms since 1998, and the cost per unit of effort,  $w$ , is 1900€/day, which corresponds to the mean cost per day at sea.

#### 4.3.4 Climate scenarios

Each of the last three decades has been successively warmer at the Earth's surface than any preceding decade since 1850. The globally averaged combined land and ocean surface temperature show a warming of 0.85 [0.65 to 1.06] °C over the period 1880 to 2012 (IPCC, 2014 : Climate Change 2014). We are now in a position to analyze the effects of the rise in the sea surface temperature on the stock, the harvest and the profits of the French Guiana shrimp fishery.

Three management scenarios are considered over a time horizon that extends to 2100 and we consider two temperature scenarios. In the first case, we consider in each of the management scenarios that sea surface temperature rises at the same rate as over the period 1993-2009, *i.e.* about 0.025 °C per year, corresponding to a business as usual scenario. This would correspond to the highest scenario of the IPCC. The following expression denotes the evolution of the sea surface temperature  $T(t + 1) = T(t)(1 + 0.025)$  where  $T(2009) = 28.09$  °C (degree Celsius) corresponds to the value observed in 2009. In a second case, we consider a lower warming scenario, with temperatures staying at the level observed in 2009 (28.09°C), that would correspond to the lower scenario of the IPCC.

First a status quo scenario is considered corresponding to the maintenance of fishing intensity to a level observed in 2009 (4489 days at sea, see Table 1A). Secondly a closure scenario is considered and corresponding to closing of the fishery and where all fishing effort then harvest are set to zero. Finally we consider a MEY scenario where the effort level corresponding to the maximum economic yield is deducted from biological and technological constraint.

## 4.4 Results

We first estimate the four natural growth functions using the data shown in Table A4.1 (see Appendix). Results are presented in Table 4.2 for the Cobb-Douglas function, for which parameters are significant. The other functions, that did not fit the data, are presented in



#### 4. GLOBAL WARMING AND THE COLLAPSE OF THE FRENCH GUIANA SHRIMP FISHERY

---

table A4.2 (see Appendix).

Table 4.2 : Estimates of the Cobb-Douglas natural growth function

$X_{t+1} + h_t = aX_t^b T_t^c$	
$\ln(a)$	27.03 (0.023)
b	1.01 (0.000)
c	-8.07 (0.022)
$R^2$	0.89
$R^2$ adjusted	0.88
Standard Error of regression	0.105
JB	2.69
Q-Stat	6.38
LM (ARCH)	1.26
AIC	-1.50

Notes : p-values in parentheses ; all coefficients are statistically significant at the 5% level.

JB is the Jarque-Bera statistic of the normality test ; Q-Stat is the Ljung-Box statistic used in the correlation test ;

LM (Lagrange multiplier) is the one used in the heteroscedasticity test ; AIC (Akaike) is the statistic used in the prediction error model.

Table 4.3 presents the estimates regarding the French Guiana shrimp production function. The major statement is that the elasticity of harvest with respect to the stock is very close to one (0.91), making production mainly sensitive to the stock relative to fishing effort.

#### 4. GLOBAL WARMING AND THE COLLAPSE OF THE FRENCH GUIANA SHRIMP FISHERY

---

Table 4.3 : Estimates of the shrimp harvest function

---



---

$$H_t = \alpha X_t^{\beta_1} E_t^{\beta_2} = 0.27 X_t^{0.91} E_t^{0.11}$$

---

$\ln H_t = \ln \alpha + \beta_1 \ln(X_t) + \beta_2 \ln(E_t)$

$\ln H_t = -1.2(0.000) + 0.92 \ln(X_t)(0.000) + 0.11 \ln(E_t)(0.001)$

$R^2 = 0.99$

$R^2 \text{ adjusted} = 0.98$

Standard Error of regression = 0.035965

F-Stat = 719

DW = 1.63

JB = 0.09

---

Notes : p-values in parentheses ; all coefficients are statistically significant at the 5% level.

F-Stat and DW are respectively the Fisher and the Durbin-Watson statistics ;

JB is the Jarque-Bera statistic of the normality test.

We can now use the estimates of the natural growth and production functions to undertake the simulations that will give the trends for the stock, harvest, and profit levels until 2100. The numerical computations are performed with the software SCILAB 5.4.0. In the Cobb-Douglas case retained, the successful CUSUM test (Brown *et al.*, 1975), which is based on the cumulative sum of the recursive residuals and has been illustrated in Figure 4.5 of the Appendix, ensures the stability of the equation parameters over the period 1993-2009, allowing for robust forecasts over the period 2010-2100. The forecasts regarding the shrimp stock, fishing effort and harvest are drawn in Figures 4.2, 4.3. The accuracy of the regression is showed in Figure 4.4 where we can compare evolution between observed et adjusted values of catches.

## 4.5 Discussion

The situation is globally alarming in the long run because biomass, catch and rents are declining and jeopardized in every case at least by 2100.

#### 4. GLOBAL WARMING AND THE COLLAPSE OF THE FRENCH GUIANA SHRIMP FISHERY

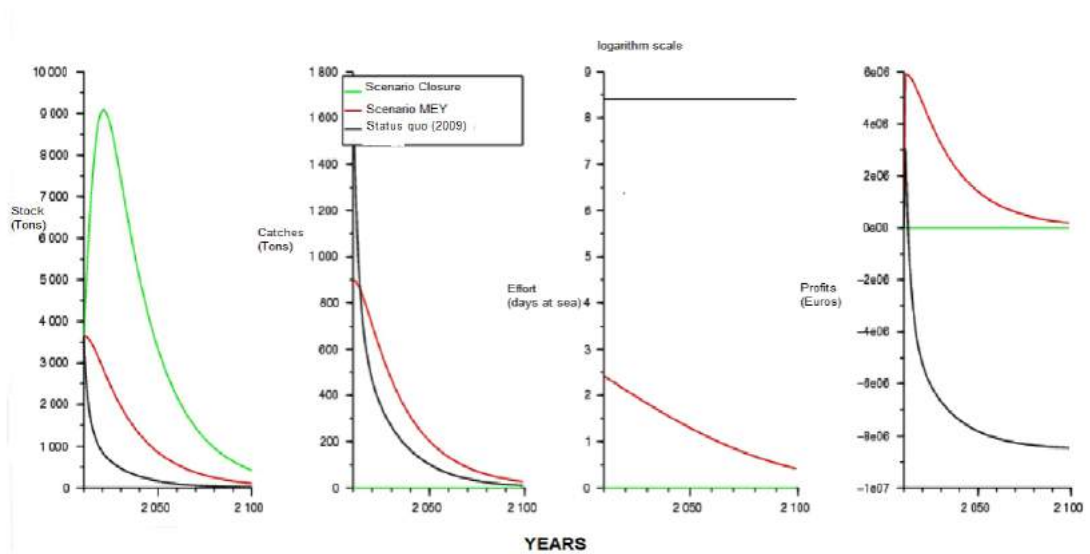

FIG. 4.2 – Highest scenario of the IPCC for Stock, Catches , Effort and Profits

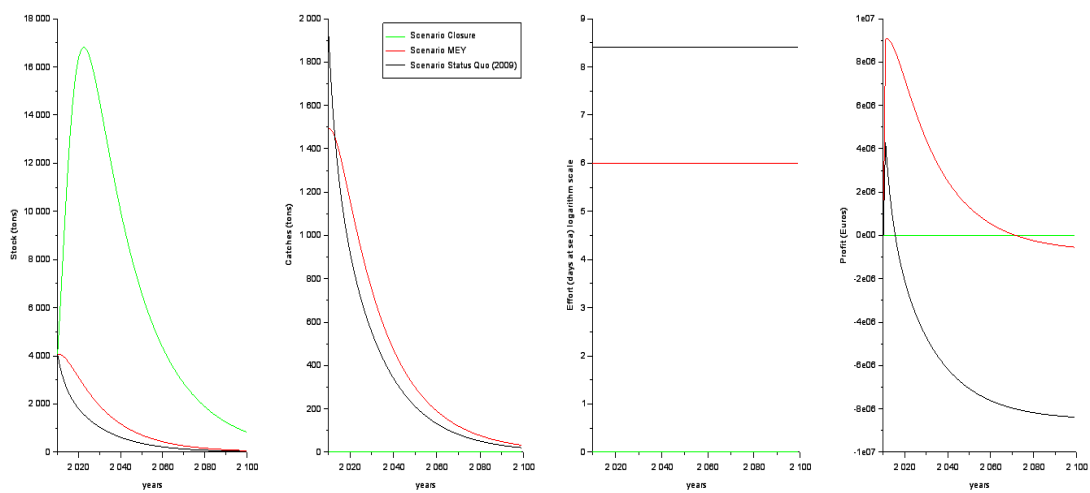

FIG. 4.3 – Lowest scenario of the IPCC for Stock, Catches , Effort and Profits

#### 4. GLOBAL WARMING AND THE COLLAPSE OF THE FRENCH GUIANA SHRIMP FISHERY

---

Fishing is detrimental to the stock : in particular current effort (status quo) is not viable for the stock ; Moreover, even a bio-economic management based on MEY that implies a very severe reduction of the effort and the catches is not enough to promote in the long run the sustainability of the stock and the catches.

Climate is the most detrimental driver because even with a closure of the fishery the erosion of the stock occurs again after 2050.

This would potentially condemn the whole viability of the fishery even if catch would restart after a long recovery of the biomass due to a temporary ban.

The observed fall in harvest may be due to either a decrease in the stock or in the effort level, or both of them. However, Table 4.2 indicates that in the French Guiana shrimp fishery, the stock-elasticity of harvest is 0.91, whereas the effort-elasticity of harvest is 0.11. Hence, harvest is mostly sensitive to the stock. This suggests that the rise in the sea surface temperature, through its direct effect on the stock (see Table 4.2), plays the main role in the fall of harvest. Numerical results in stock and harvest can be observed in Table 4.4 regarding a status quo scenario.

Our results indicate first that a Cobb-Douglas function, whose arguments are the stock and the sea surface temperature, constitutes the most appropriate model to illustrate the French Guiana shrimp natural growth. Secondly, they suggest that global warming has a substantial impact on the shrimp stock, and thus, on the harvest levels. This phenomenon can be mainly explained by the fact that in the case of the French Guiana shrimp fishery, harvest is mainly sensitive to the trend of the stock *per se*. Consequently, environmental factors, such as the sea surface temperature, seem to play a major role through their effects on the stock, on the trend of the production levels, and thus, on the overall profitability of the fishery. Besides, the fact that the stock-elasticity of harvest is close to one implies that global warming influences uppermost the harvest of the species, such as shrimp, for which the level of the stock is crucial.

The fall in the shrimp production and in its stock can be observed over time in French Guiana. Nevertheless, there are many potential causes for the observed collapse in fisheries. One potential source can be found in Bjorndal *et al.* (1993), who indicate that the stock-

output elasticity influences the sensitivity of harvesting costs. As the French Guiana shrimp fishery is very sensitive to changes in stock ( $\beta_1 = 0.92$ ; see Table 4.3), the decrease of the latter might represent a brake in its depletion process. However, the stock appears to follow the same negative trend. As stated in Sanz *et al.* (2016), the potential increase in the long term trends of sea surface temperature may lead to a collapse of the stock. Actually, recent works on the characterisation of the habitat of *Farfantepenaeus subtilis* have shown that the optimum surface temperatures observed within the distribution area of the species is between the minimum value of 27.07°C and the maximum value of 28.32°C (Kaschner *et al.*, 2015). Between 1993 and 2009, the observed period, the sea surface temperatures in French Guiana have encompassed two times the maximum optimal value, in 1998 and 2005. This is to say that as the habitat in French Guiana is then not optimal, the biological function may be decreased (growth, maturation, survival). Considering the projection period, this maximum optimal value is encompassed definitively in 2019. Hence, the decrease of the stock described and predicted here are consistent with.

All in all, the negative effect of the rise in the sea surface temperature on the stock is largely stronger than the positive effect of the fall in effort and harvest. This seems to reflect the prevalence of pure environmental phenomena over the economic factors *per se*. In order to save the French Guiana shrimp fishery, it appears therefore crucial to try to limit the sources of climate change instead of deeply modifying economic practices in the sector, which may lead to misunderstandings by fishermen and local political conflicts.

## 4.6 Summary and conclusions

This shrimp fishery in French Guiana exemplifies a situation of optimal extinction (Clark, 1973; Swanson, 1994).

In the long run, it is optimal in the bio-economic sense to close the fishery because of the joint conditions for the exploitation relying on both the dynamics of the stock, the technology, the cost of effort and the landing price.

The negative role played by climate is major in such a situation of optimal collapse. In other words, mitigation of emissions and climate warming is an important indirect goal for fishery management. In that respect, the case of tropical fisheries is especially challenging because few species have the ability to disperse to encounter environmental niche with future warmer temperature in these areas.

This study points out the need to adopt an ecosystem based management approach integrating environmental drivers such as habitat and climate.

As Stock *et al.* (2011) put forward, reliably predicting the impacts of future climate on living marine resources requires a good understanding of the mechanisms through which climate acts. More precisely, for living marine resources management strategies to be effective in a changing climate, the latter must consider how climate affects resource dynamics more directly. In this paper, a stock-growth model that explicitly integrates the sea surface temperature has been used to analyze the French Guiana shrimp fishery. The model parameters fit statistically actual values and the frame seems to be appropriate to describe quite accurately the evolution of the fishery. The estimates of the production and of the natural growth functions allow for simulated scenarios regarding the trend of the stock, depending on the evolution of the sea surface temperature. The three scenarios considered here confirm the final collapse of the shrimp fishery, whatever the hypothesis retained regarding the importance of the global warming process.

Our results strongly suggest that global warming, particularly through the rise in the surface temperature of local waters, has a major influence over the economic evolution the French Guiana shrimp fishery. The increase in the sea surface temperature, combined with a

#### *4. GLOBAL WARMING AND THE COLLAPSE OF THE FRENCH GUIANA SHRIMP FISHERY*

---

still potentially too strong fishing effort, results in a heavy fall in the shrimp stock. Harvest levels, which appear to be very sensitive to changes in the stock, collapse, leading to negative profits and a reduced number of fishing vessels. The most catastrophic scenario is the status quo where rent become negative before the beginning of 2020.

#### 4. GLOBAL WARMING AND THE COLLAPSE OF THE FRENCH GUIANA SHRIMP FISHERY

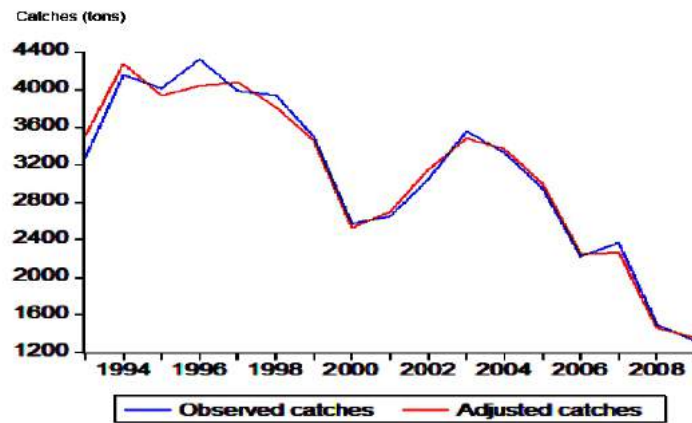

FIG. 4.4 – Observed catches vs adjusted catches

## Appendix

Table 4.1 : Correlations between shrimp biomass, catch, sea surface temperature and effort

Variables	Values				
	Biomass	Biomass t+1	Catches	Temperature	Effort
Biomass	1.00				
Biomass t+1	0.83	1.00			
Catches	0.98	0.81	1.00		
Temperature	-0.15	-0.42	-0.13	1.00	
Effort	0.84	0.80	0.87	-0.37	1



#### 4. GLOBAL WARMING AND THE COLLAPSE OF THE FRENCH GUIANA SHRIMP FISHERY

Table A4.1 : The French Guiana shrimp fishery

Year	Biomass (tons)	Total catches (tons)	Effort (days of fishing)	Sea surface temperature ( $^{\circ}C$ )
1993	8929	3275	15,682	27.57
1994	11126	4156	15,154	27.77
1995	10120	4010	15,723	27.87
1996	10303	4323	17,116	27.86
1997	10409	3984	16,992	27.66
1998	9739	3940	16,320	28.43
1999	8765	3495	16,013	27.94
2000	6302	2572	14,764	27.80
2001	6809	2651	14,026	27.67
2002	8120	3043	13,058	27.72
2003	9110	3557	12,504	28.08
2004	8778	3325	12,550	28.16
2005	8026	2943	9,266	28.37
2006	6173	2222	6,141	27.94
2007	6096	2369	7,278	28.02
2008	4000	1496	4,667	28.05
2009	3705	1323	4,489	28.09

Table A4.2 : Estimates of the Cushing, logistic, and Ricker natural growth functions

	$X_{t+1}+h_t = aX_t^{b+cT_t}$	$X_{t+1}+h_t = aX_t+bX_t^2+cT_t$	$X_{t+1}+h_t = aX_t e^{bX_t+cT_t}$
$a$		2.10 (0.055)	1.19 (0.105)
$\ln(a)$	0.13 (0.884)		6.80 (0.295)
$b$	1.89 (0.000)	-4.17E-05 (0.478)	-2.15E-05 (0.794)
$c$	-0.03 (0.024)	-104.48 (0.414)	-0.28 (0.027)
$R\acute{e}$	0.89	0.82	0.89
$R\acute{e}_{\text{adjusted}}$	0.87	0.80	0.87

Notes : p-values between brackets

#### 4. GLOBAL WARMING AND THE COLLAPSE OF THE FRENCH GUIANA SHRIMP FISHERY

---

Table 4. 4 : Numerical results from simulation (Status quo)

Table 4.4 : Numerical results from simulation (Status quo)

Years	Temperature ( $^{\circ}$ C)	Stock (tons)	Catches (tons)	Years	Temperature ( $^{\circ}$ C)	Stock (tons)	Catches (tons)
2010	28.09	3646.50	899.38	2030	28.59	1560.85	382.44
2011	28.12	3493.69	861.43	2031	28.62	1496.64	366.58
2012	28.14	3347.42	825.10	2032	28.64	1435.12	351.39
2013	28.17	3207.40	790.34	2033	28.67	1376.19	336.84
2014	28.19	3073.36	757.07	2034	28.69	1319.73	322.90
2015	28.22	2945.05	725.23	2035	28.73	1265.64	309.56
2016	28.24	2822.20	694.76	2036	28.74	1213.81	296.77
2017	8.27	2704.59	665.59	2037	28.77	1164.15	284.53
2018	28.29	2591.99	637.67	2038	28.79	1116.57	272.80
2019	28.32	2484.17	610.95	2039	28.82	1070.97	261.56
2020	28.34	2380.93	585.36	2040	28.84	1027.27	250.80
2021	28.37	2282.08	560.87	2041	28.87	985.40	240.48
2022	28.39	2187.42	537.43	2042	28.89	945.27	230.60
2023	28.42	2096.76	514.98	2043	28.92	906.80	221.14
2024	28.44	2009.95	493.50	2044	28.94	869.94	212.07
2025	28.47	1926.81	472.92	2045	28.97	834.61	203.38
2026	28.49	1847.17	453.22	2046	28.99	800.74	195.05
2027	28.52	1770.90	434.36	2047	29.02	768,28	187,07
2028	28.54	1697.85	416.30	2048	29.04	737,16	179,42
2029	28.57	1627.88	399.00	2049	29.07	707,33	172,10

#### 4. GLOBAL WARMING AND THE COLLAPSE OF THE FRENCH GUIANA SHRIMP FISHERY

---

Table 4.4 : Numerical results from simulation (Status quo)

Years	Temperature (°C)	Stock (tons)	Catches (tons)
2050	29.09	678,73	165,07
2051	29.12	651,31	158,34
2052	29.14	625,02	151,89
2053	29.17	599,82	145,71
2054	29.19	575,66	139,79
2055	29.22	552,49	134,11
2056	29.24	530,27	128,66
2057	29.27	508,97	123,44
2058	29.29	488,54	118,44
2059	29.32	468,94	113,64
2060	29.34	450,15	109,04
2061	29.37	432,13	104,64
2062	29.39	414,85	100,41
2063	29.42	398,27	96,36
2064	29.44	382,37	92,47
2065	29.47	367,12	88,75
2066	29.49	352,49	85,17
2067	29.52	338,45	81,75
2068	29.54	324,99	78,46
2069	29.57	312,07	75,31

Table 4.4 : Numerical results from simulation (Status quo)

Years	Temperature (°C)	Stock (tons)	Catches (tons)
2070	29.59	299,68	72,29
2071	29.62	287,79	69,39
2072	29.64	276,38	66,61
2073	29.67	265,43	63,94
2075	29.69	254,93	61,39
2075	29.72	244,85	58,93
2076	29.74	235,18	56,58
2077	29.77	225,89	54,32
2078	29.79	216,99	52,16
2079	29.82	208,44	50,08
2080	29.84	200,23	48,09
2081	29.87	192,36	46,18
2082	29.89	184,80	44,34
2083	29.92	177,55	42,58
2084	29.94	170,58	40,89
2085	29.97	163,90	39,27
2086	29.99	157,48	37,72
2087	30.02	151,32	36,23
2088	30.04	145,41	34,79
2089	30.07	139,73	33,42

4. GLOBAL WARMING AND THE COLLAPSE OF THE FRENCH GUIANA SHRIMP FISHERY

---

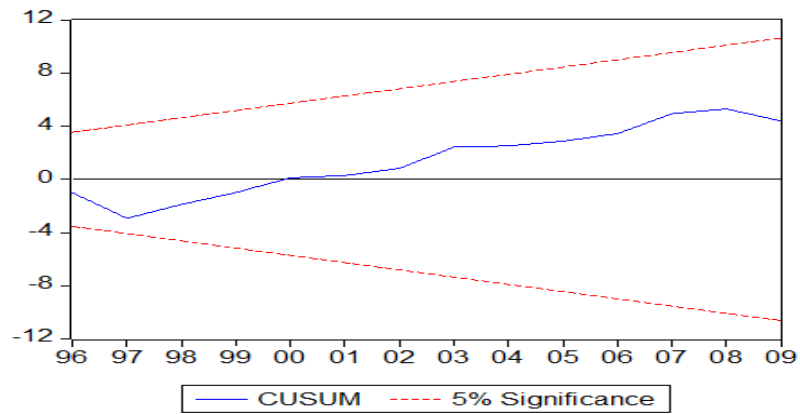

FIG. 4.5 – Cumulative Sum of the recursive residuals (CUSUM)

Table 4.4 : Numerical results from simulation (Status quo)

Years	Temperature ( $^{\circ}$ C)	Stock (tons)	Catches (tons)
2090	30.09	134,28	32,10
2091	30.12	129,04	30,83
2092	30.14	124,02	29,62
2093	30.17	119,19	28,45
2094	30.19	114,55	27,33
2095	30.22	110,10	26,26
20096	30.24	105,83	25,23
2097	30.27	101,73	24,24
2098	30.29	97,79	23,29
2099	30.32	94,00	22,38
2100	30.34	90,36	21,50

We can compare the results obtained from Table 4 with those from Table 3. Including sea surface temperature as an in input improve the explanatory capacity of each function even if it remains one function retained for our analysis.

#### 4. GLOBAL WARMING AND THE COLLAPSE OF THE FRENCH GUIANA SHRIMP FISHERY

---

Table A5.2 : Estimates of the logistic, Cushing, Ricker

	$X_{t+1}+H_t = aX_t+bX_t^2$	$X_{t+1}+H_t = aX_t^b$	$X_{t+1}+H_t = aX_t e^{bX_t}$
$a$	1.34 (0.000)		
$\ln(a)$		-0.07 (0.947)	0.08 (0.934)
$b$	1.40 $E-7$ (0.994)	1.04 (0.000)	1.02 (0.000)
$R^2$	0.82	0.84	0.86
$R^2$ adjusted	0.81	0.83	0.85
Standard Error of regression	1281	0.124	0.11
JB	0.27	0.48	0.60
Q-Stat	10.47	9.96	6.52
LM (ARCH)	2.07	0.86	0.54
AIC	17.26	-1.20	1.31

Notes : p-values in parentheses. Cobb-Douglas and Cushing are the same when sea surface temperature is not included

JB is the Jarque-Bera statistic of the normality test ; Q-Stat is the Ljung-Box statistic used in the correlation test ;

LM (Lagrange multiplier) is the one used in the heteroscedasticity test ; AIC (Akaike) is the statistic used in the prediction error model.

## 4.7 Références bibliographiques

- Barange, M. (2002), “Influence of climate variability and change on the structure, dynamics and exploitation of marine ecosystems”, *Issues in Environmental Science and Technology* 17, 57–82.
- Bernard, C. (2006), “Changement climatique, conséquences potentielles pour la biodiversité ichthyologique et pour la pêche côtière en Guyane française entre 1970 et 2005”, Mémoire de master 2, Geni, A. L., Université La Rochelle, IFREMER
- Brown, R. L., Durbin, J., Evans, J. M. (1975), “Techniques for Testing the Constancy of Regression Relationships Over Time”, *Journal of the Royal Statistical Society, Series B*, 37, 149-192.
- Bjørndal, Trond. (1988), “The Optimal Management of North Sea Herring”, *Journal of Environmental Economics and Management* 15, 9-29.
- Bjørndal, T., Conrad, D. V., Salvanes, K.G. (1993), “Stock Size, Harvesting Costs, and the Potential for Extinction : the Case of Sealing”, *Land Economics* 69(2), 156-167.
- Brander, K. (2010), “Impacts of climate change on fisheries”, *Journal of Marine Systems* 79(3), 389-402.
- Brander, K. M. (2007), “Global fish production and climate change”, *Proceedings of the National Academy of Sciences* 104(50), 19709-19714.
- Briones, R., Garces, L., Ahmed, M. (2005) “Climate change and small pelagic fisheries in developing Asia : the economic impact on fish producers and consumers”, In : *Climate Change and the Economics of the World's Fisheries* (eds R. Hannesson, M. Barange and S.F. Herrick Jr), Edward Elgar Publishing, Camberley, UK, 215-235.
- Chaboud, C., Thébaud, O. (2009), “18th World IMACS/MODSIM Congress”, Cairns, Australia 13–17 July  
2009. <http://archimer.ifremer.fr/doc/00243/35473/>
- Cheung, W. W., Lam, V. W., Sarmiento, J. L., Kearney, K., Watson, R., Pauly, D. (2009), “Projecting global marine biodiversity impacts under climate change scenarios”, *Fish*

- and *Fisheries* 10(3), 235-251.
- Clark, C. (1990), *Mathematical Bioeconomics. The Optimal Management of Renewable Resources*, 2nd edition, Wiley Interscience Publication, New York.
- Clark, C. W. (1973), "Profit maximization and the extinction of animal species", *The journal of political economy* 81(4), 950-961.
- Conrad, J. M. (1999), "The bioeconomics of marine sanctuaries", *Journal of Bioeconomics* 1(2), 205-217.
- De Lara, M., Doyen, L. (2008), *Sustainable management of natural resources : mathematical models and methods*. Springer Science & Business Media.
- Doyen, L., Cisse, A., Gourguet, S., Mouysset, L., Hardy, P. Y., Béné, C., Blanchard, F., Jiguet, F., Pereau, J. C., Thébaud, O. (2013), "Ecological-economic modelling for the sustainable management of biodiversity", *Computational Management Science* 10(4), 353-364.
- Garza-Gil, M. D., Torralba-Cano, J., Varela-Lafuente, M. M. (2011), "Evaluating the economic effects of climate change on the European sardine fishery", *Regional Environmental Change* 11, 87-95.
- Garza-Gil, M. D. (1998), "ITQ systems in multifleet fisheries", *Environmental and Resource Economics*, 11(1), 79-92.
- Hannesson, R., Barange, M., Herrick, S. J. (2006), *Climate Change and the Economics of the World's Fisheries*, Edward Elgar Publishing Limited, Cheltenham, UK.
- IPCC (2014), *Climate Change 2014 : Synthesis Report. Contribution of Working Groups I, II and III to the Fifth Assessment Report of the Intergovernmental Panel on Climate Change* [Core Writing Team, R.K. Pachauri and L.A. Meyer (eds.)]. IPCC, Geneva, Switzerland, 151 pp.
- Kamien, M., Schwartz, N. (1991), *Dynamic Optimization. The Calculus of Variation and Optimal Control in Economics and Management*, North Holland, New York.
- Keyl, F., Wolff, M. (2008), "Environmental variability and fisheries : what can models do ?", *Reviews in Fish Biology and Fisheries* 18(3), 273-299.

- Knowler, D. (2002), "A Review of Selected Bioeconomic Models with Environmental Influences in Fisheries", *Journal of Bioeconomics* 4, 163-181.
- Kaschner, K., Kesner-Reyes, K., Garilao, C., Rius-Barile, J., Rees, T., Froese, R. (2015), "AquaMaps : Predicted range maps for aquatic species" *World wide web electronic publication www.aquamaps.org* Version 08/2015.
- Lampert, L. (2011), *Etude de la crise de la pêche de la crevette en Guyane. Volume 1 : Effets de la pêcherie-hypothèses des causes*, Rapport RST Ifremer/Biodivhal 2011-5, Cayenne.
- Lehodey, P., Alheit, J., Barange, M., Baumgartner, T., Beaugrand, G., Drinkwater, K., Fromenting, J. M., Hareh, S. R., Ottersenf, G., Perryi, R. I., Royj, C., Van der Lingenk, C. D., Werner, F. (2006), "Climate variability, fish, and fisheries", *Journal of Climate* 19(20), 5009-5030.
- Levitus, S., Antonov, J. I., Boyer, T. P., Stephens, C. (2000), "Warming of the world ocean", *Science* 287, 2225-2229.
- Nostbakken, L. (2008), "Stochastic Modelling of the North Sea Herring Fishery under Alternative Management Regimes", *Marine Resource Economics* 23, 65-86.
- Sanz, N., Diop, B., Blanchard, F., Lampert, L. (2016), "On the influence of environmental factors on harvest : the French Guiana shrimp fishery paradox", *Environmental Economics and Policy Studies* 18(2), 1-15.
- Stock, Charles A., Alexander, Michael A., Bond, Nicholas A., Brander, Keith M., Cheung William, W. L., Curchitser, Enrique N., Delworth, Thomas L., Dunne, John P., Griffies, Stephen M., Haltuch, Melissa A., Hare, Jonathan A., Hollowed, Anne B., Lehodey, Patrick., Levin, Simon A., Link, Jason S., Rose, Kenneth A., Rykaczewski, Ryan R., Sarmiento, Jorge L., Stouffer, Ronald J., Schwing, Franklin B., Vecchi, Gabriel A., Werner, Francisco E. (2011), "On the use of IPCC-Class Models to Assess the Impact of Climate on Living Marine Resources", *Progress in Oceanography* 88(1-4), 1-27.
- Swanson, T. M. (1994), "The economics of extinction revisited and revised : a generalised framework for the analysis of the problems of endangered species and biodiversity



#### 4. GLOBAL WARMING AND THE COLLAPSE OF THE FRENCH GUIANA SHRIMP FISHERY

---

losses”, *Oxford Economic Papers* 46, 800-821.

Thébaud, O., Doyen, L., Innes, J., Lample, M., Macher, C., Mahevas, S., Mullon, C., Planque, B., Quaas, M., Smith, T., Vermard, Y. (2014), “Building ecological-economic models and scenarios of marine resource systems : Workshop report”. *Marine Policy* 43, 382-386.

---

---

**CHAPITRE V :**

---

**CONGESTION EFFECTS BETWEEN VESSELS IN A  
SEARCH-MATCHING MODEL : EVIDENCE FROM THE FRENCH  
GUIANA SHRIMP FISHERY**

5

# Endogenous catchability and congestion externalities between vessels in a search-matching model : Evidence from the French Guiana shrimp fishery

<sup>a</sup>Nicolas Sanz, <sup>b</sup>Bassirou Diop

<sup>a</sup>UMRS 3456, Laboratoire Ecologie, Evolution, Interactions des Ecosystèmes Amazoniens  
(LEEISA), Université de Guyane, CNRS, Ifremer, 97300 Cayenne, France

<sup>b</sup>Ceregmia-Université des Antilles, Campus de Schoelcher, BP 7209, 97275 Schoelcher  
Cedex, France

*Presented at World Conference on Natural Resource Modeling 2014 and EAERE 2015*

*Working paper in Document de travail du CEREGMIA 2015. <hal-01228851>*

## Abstract

This paper seeks to explain the simultaneous fall in activity and rise in profits in the

*5. ENDOGENOUS CATCHABILITY AND CONGESTION  
EXTERNALITIES BETWEEN VESSELS IN A SEARCH-MATCHING  
MODEL : EVIDENCE FROM THE FRENCH GUIANA SHRIMP FISHERY*

---

French Guiana shrimp fishery between 1990 and 2009. We develop a fishery version of the search-matching model in which catchability is endogenous, decreasing in the ratio empty vessels/escaped fish, that we call “anthropic pressure” and that is determined by profit maximization. We first estimate the stochastic harvest function of the model, that exhibits nearly constant returns-to-scale. This result allows in turn for showing that the decrease in equilibrium anthropic pressure and congestion between vessels, due to an exogenous reduction in shrimp natural growth, may be more than compensated by the consecutive rise in catchability, and lead to the observed fall in average harvesting costs and rise in profits. The model enables to confirm this result by evaluating actual catchability over the period studied. More broadly, we identify the condition under which a search-matching fishery, working under open access, may reach a maximum economic yield equilibrium, which corresponds to a very special case.

Keywords : fisheries ; matching ; search costs ; catchability.

## 5.1 Introduction

Shrimp is nowadays the most consumed and one of the most internationally traded fishery products in the world, representing 16 % of world fishery exports (FAO, 2008). Its growing constitutes a major source of value for French Guiana. It represents the third export sector of the latter (25% of the total volume) and remains one of its main industrial sectors. The French Guiana waters entail numerous species and the shrimp is one of the most exploited for economic purposes. Two slightly different species are mainly harvested in the French Guiana shrimp fishery (FGSF), the brown shrimp and the pink shrimp (resp. *Farfantepenaeus Subtilis* and *Frafantepenaeus Brasiliensis*). The *Subtilis* represents more than 85% of shrimp landings. The FGSF started in the late 60's with the US fleet activity. Since 1992 the whole fleet is only composed with french trawlers targeting shrimp on the continental shelf. However, the FGSF has faced strong difficulties during the two past decades. The shrimp stock, firms' fishing effort, and harvest levels have indeed steadily decreased over this period, though some management in compliance with the European legislation has been implemented. First, a total allowable catch (TAC) of 4108 tons/year was adopted in 1983, and never changed until 2011. Besides, some spatial restrictions in order to limit the impact of trawling on juvenile shrimp were implemented, and trawling is nowadays forbidden in inshore water less than 30 meters deep. Lastly, a license system was introduced in 1991 to limit the total size of the fleet, that has indeed steadily decreased from 70 vessels in 1990 to 12 vessels in 2009. Nevertheless, none of the above stock regulation policies have apparently succeeded in saving the shrimp stock. The TAC has almost never been reached and all in all, the FGSF seems to have on the whole worked under open access. The most striking fact is that the simultaneous marked fall in activity over the same period has not led to the corresponding expected decrease in the overall level of profits realized in the fishery (Fig. 5.1). Conversely, profits have globally remained positive over the same period, and have even increased during the last few years. Taking into account the recent fall in activity of the FGSF, the evolution of the rent generated by the latter constitutes therefore a kind of paradox that must be further understood and investigated.

5. ENDOGENOUS CATCHABILITY AND CONGESTION  
 EXTERNALITIES BETWEEN VESSELS IN A SEARCH-MATCHING  
 MODEL : EVIDENCE FROM THE FRENCH GUIANA SHRIMP FISHERY

---

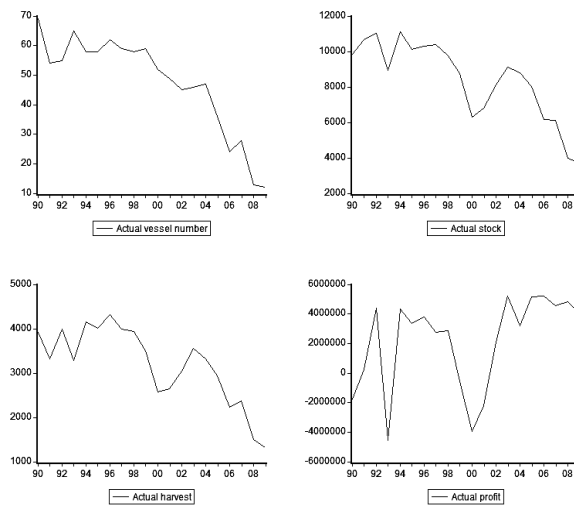

FIG. 5.1 – Actual stock, fishing effort, harvest, and profits levels in the FGSF between 1990 and 2009.

Since technical conditions of harvesting and nominal input and output prices have remained nearly unchanged in the FGSF between 1990 and 2009, the surprising rise in profits despite the above-mentioned evolution of the fishery over the same period, might only be explained by a fall in average harvesting costs and, more precisely, in the target search costs *per se*. The role of costs, and especially of search costs, has rarely been analyzed in detail in the literature about fisheries. Indeed, most canonical fishery models (Gordon, 1954; Schaefer, 1957; Clark and Munroe, 1982) are of deterministic nature and voluntarily neglect search activities, which prevents them from giving a realistic description of fish harvesting<sup>1</sup>. Reed (1978) considers a constant proportion of captured fish, that he calls the “rate of exploitation”. However, since fish distribution is often patchy within fishing areas, harvest may vary a lot over time. Unlike other natural resources where search is still important (such as oil exploration), fish harvest is even more complicated by the movement of fish, that must still be localized even if it is known to be present. The target detection process thus often represents the most time-consuming and therefore most costly activity when compared with catch *per se*. Next to the pure “fishing effort” cost, which encompasses notably vessel costs and crew

<sup>1</sup>See *e.g.* Munro (1992) for a survey on mathematical bioeconomic models of fisheries.

5. ENDOGENOUS CATCHABILITY AND CONGESTION  
EXTERNALITIES BETWEEN VESSELS IN A SEARCH-MATCHING  
MODEL : EVIDENCE FROM THE FRENCH GUIANA SHRIMP FISHERY

---

wages, fishing firms must often allocate specific resources to the acquisition of information concerning the location, size, and quality of fish. From the early 1980's, several works have undelined the fact that the corresponding spendings in fuel consumption, investments into detection materials and so on, often represent the major part of total costs (Mangel and Plant, 1985). Numerous examples of fisheries in which significant effort is devoted to the search activity itself are identified by Mangel and Clark (1983), although, in aquaculture or for some easily locatable species, search activities and their associated costs may be much lower (Bjorndal *et al.*, 1993). Among the rare studies on search activities *per se*, Mangel and Beder (1984) model search activities as stochastic Poisson processes and determine the optimal allocation of search effort between several historical fishing grounds, taking into account the stochastic fish distributions among them<sup>2</sup>.

In line with the works that consider the role of market imperfections in the analysis of fisheries (like *e.g.* Quaas, 2015, and Bertram and Quaas, 2016, in the case of imperfect substitutes among fishes), this paper seeks to explain the behavior of the FGSF during the two past decades from the target search/catch frictions that characterize most of harvesting activities. According to this approach, uncertainty and, more precisely, catch stochasticity, often implying the main costs for fishing firms, must for this reason be explicitly taken into account in the economic analysis of fisheries. In order to proceed, we adapt the search-matching framework proposed by Pissarides (2000) for the analysis of labor market search frictions between unemployed workers and firms, to the case of the catch process between vessels and targets. Hence in the present model, the catch of fish is also patchy and harvest per unit effort, *i.e.* "catchability", depends on the ratio number of empty vessels/number of escaped fish units, that we call "anthropic pressure". The number of empty vessels sent to sea, which represents search effort, is precisely microfounded since it is explicitly derived from profit maximizing behavior. This makes anthropic pressure and thus catchability endogenous, which constitutes an important departure of our model from the literature about fisheries, that usually takes it as given. Indeed, endogenous catchability makes it possible to highlight the role of congestion effects within fisheries. Moreover, since the search process

---

<sup>2</sup>See also McConnell *et al.* (1995) for a use of Poisson processes in the modelling of sportfishing.

is not instantaneous, at any moment in time, there always remain some escaped fish, which allows for determining the equilibrium level of escapement in the fishery, and highlighting the factors that influence it, *i.e.* to propose a novel framework for natural resource exploitation analysis. As we shall see, this framework highlights the sensitivity of several variables typical of fisheries such as the level of anthropic pressure, the levels of search effort and harvest chosen by firms, the state of stock conservation, the average duration of shrimp catch, and the size of the fleet, to economic, technological and biological changes. The theoretical model is developed under the open access (OA) and the maximum economic yield (MEY) regimes, that are then used to propose a new explanation concerning the evolution of the FGSF over the period 1990-2009.

The paper is organized as follows. Section 2 presents the basic search-matching model. Section 3 determines the equilibrium of the fishery when the latter evolves in an OA environment, where individual firms seek to maximize their profit in a decentralized manner. This section highlights the sensitivity of the OA search-matching fishery to changes in exogenous parameters in the long run and suggests a first theoretical explanation of the behavior of the FGSF between 1990 and 2009. Section 4 studies the behavior of the fishery when it is managed in a totally centralized and optimal way, and gives the condition for an OA search-matching fishery to reach a MEY equilibrium. Section 5 uses the results obtained in Sections 3 and 4 by interpreting the actual evolution of the FGSF in light of both theoretical regimes. Lastly, Section 6 summarizes the main findings of the paper and gives some concluding remarks.

## 5.2 The model

This first section gives a detailed description of the harvest process, *i.e.* the properties of the harvest function. Moreover, it estimates the parameters of the latter with help of data concerning the FGSF. It also presents the definition of equilibrium escapement of a given species in the steady state.

In this model, empty vessels search for fish in a situation of imperfect information about



the location of the latter. Production is not modelled as a continuous process with varying intensity, but as instantaneous, with searching for fish as time consuming. The fishery is made up of a fixed number,  $X$ , of fish units (individuals of any size, tons of fish, schools...), and  $V$  fishing firms, each firm having a single vessel, that is either empty, searching for fish, or filled. Thus, the variable  $V$ , that is determined endogenously in the present model, also corresponds to the total number of vessels present in the fishery, and to usual “fishing effort” in the literature about fisheries. We assume that once a unit of fish has been found by a vessel, it is instantaneously caught and removed from  $X$ . Thus, at any moment in time, the fish stock  $X$  is equal to the sum of the  $H$  found and thus harvested fish, and the  $U$  uncaught/escaped fish. The variable  $U$  may thus be interpreted as an indicator of the fish stock conservation state. We further assume that each vessel can load a single unit of fish. We assume that once they have caught a fish unit, vessels must unload it before being able to catch other units. The total number of vessels,  $V$ , is equal to the sum of the  $E$  empty vessels, that represent search effort, and the  $H$  filled vessels. Only escaped fish units and empty vessels take part to the harvest process and are randomly selected from the sets  $U$  and  $E$ , where  $U$  and  $E$  represent respectively the number of escaped fish units from the harvest, and the number of empty vessels. From now on, in line with the literature about fisheries (*e.g.* Reed, 1978),  $U$  and  $E$  will be respectively called “escapement” and “search effort”.

### 5.2.1 Harvest and catchability technologies

We assume that a harvest function,  $H$ , gives the number of meetings between vessels and fish units per unit time, as a function of the  $U$  escaped fish and the  $E$  empty vessels as follows :

$$H(E, U) = \omega U^\alpha E^\beta \quad (5.1)$$

where  $\omega$  denotes total factor productivity, and  $\alpha$  and  $\beta$ , the elasticities of harvest with respect to escapement and effort, respectively. We assume that  $H$  is increasing and concave in its two arguments (Clark, 1990). Empirical evidence from the data concerning the FGSEF suggest that returns-to-scale concerning  $H$  are around one. Table 1 shows the corresponding

5. ENDOGENOUS CATCHABILITY AND CONGESTION  
 EXTERNALITIES BETWEEN VESSELS IN A SEARCH-MATCHING  
 MODEL : EVIDENCE FROM THE FRENCH GUIANA SHRIMP FISHERY

---

results and indicates notably that the alternative hypothesis  $\alpha + \beta \neq 1$  is rejected<sup>3</sup>.

Tableau 5.1. Parameter estimates of the harvest function  
 for the FGSF between 1990 and 2009

$H = \omega U^\alpha E^\beta$	
$\omega$	4.48 (0.054)
$\alpha$	0.65 (0.000)
$\beta$	0.29 (0.0022)
Number of observations 20	
$R^2$ : 0.944	$R^2$ adjusted : 0.938
JB : 5.14	
LM (ARCH) : 1.78	DW : 1.51
Hypothesis test of $\alpha + \beta = 1$	Prob. : 0.31

Under a theoretical point of view, the constant returns-to-scale assumption adopted from the above empirical results is of particular interest, since it implies that the harvest function is homogeneous of degree one, which makes it possible to write the rate at which vessels catch fish units, *i.e.* the harvest level per unit effort or “catchability”, as :  $H(U, E)/E = H(U/E, 1) \equiv q(\theta)$ , where :

$$\theta = \frac{E}{U} \tag{5.2}$$

From (5.1) and (5.2), the function  $q(\theta)$  has thus the following form :

$$q(\theta) = \omega \theta^{-\alpha} \tag{5.3}$$

where, under the constant returns-to-scale assumption,  $\alpha = 1 - \beta$  stands here also for the elasticity of catchability with respect to anthropic pressure. Since it is equal to the number of empty vessels with respect to the number of escaped fish units, the variable  $\theta$  constitutes an appropriate indicator of the level of anthropic pressure that fishing firms apply on the

---

<sup>3</sup>As in Sanz *et al.* (2016), a problem of simultaneity bias may occur with the function  $H$  since empirically, the stock level may be evaluated on the basis of harvest. Here, the stock series has been corrected in order to avoid this possibility.

fish stock. Since, as we shall see,  $\theta$  will be determined by fishing firms' economic decisions, catchability will also be endogenous. This constitutes the major difference between our model and most of existing works about fisheries. Besides, Eq. (5.3) and the positive estimated value of  $\alpha$  found in the case of the FGFSF (Table 5.1) imply :  $q'(\theta) < 0$ . This means that an increase in anthropic pressure yields a decrease in catchability in this fishery. More precisely, if the ratio of empty searching vessels to escaped fish increases, the probability of finding fish for the average vessel,  $q(\theta) \delta t$ , decreases, and the probability of escaping for the average fish,  $\theta q(\theta) \delta t$ , increases, and conversely. This result suggests that, all in all, negative congestion externalities between vessels are stronger than positive participation externalities in the FGFSF. As we shall see later, the model allows for highlighting the central role played by congestion effects in the working of fisheries in general, and notably of the FGFSF.

### 5.2.2 Steady state escapement

In this subsection, we focus the analysis on fish conservation, *i.e.* on the determination of steady state escapement,  $U$ . According to the harvest function (5.1), the process that makes a unit of fish meet a vessel is Poisson with parameter  $H(U, E) / (U)^4$ . Still from the homogeneity property of the harvest function,  $H(U, E) / U = (E/U) H(U/E, 1)$ , thus we have :

$$\frac{H}{U} \equiv \theta q(\theta) \quad (5.4)$$

By construction,  $\theta q(\theta)$  indicates the rate (frequency) at which fish is caught by vessels<sup>5</sup>. Hence, the mean number of still uncaught fish that are captured by vessels during a small time interval is :  $H \delta t = \theta q(\theta) U \delta t$ , where  $\theta q(\theta) \delta t$  reads the fish's transition probability, and  $1 / [\theta q(\theta) \delta t]$ , the period at the end of which fish is being caught. The evolution of escapement is given by the difference between the number of new safe fish that arrive into the fishery, which corresponds to the fish stock's natural growth,  $B$ , and the portion of the fish stock

---

<sup>4</sup>The Poisson process is also applied by Clark and Mangel (1984) to animals searching for forage in order to study the role of information in their foraging strategies.

<sup>5</sup>For the sake of clarity, we assume here that found fish are systematically caught and therefore definitely eliminated from the stock. The possibility of discarding behavior by fishermen, although important, is left to later work. Moreover, bycatch phenomena are also voluntarily ignored here.

that is caught by vessels,  $H$ . Thus we have :  $\dot{U} = B - H$ . In the steady state,  $\dot{U} = 0$ , which implies :

$$H = B \quad (5.5)$$

Thus, in the steady state, vessels catch all new fish that arrives into the fishery. Inserting Eq. (5.5) into Eq. (5.4), and isolating  $U$ , yields :

$$U = \frac{B}{\theta q(\theta)} \quad (5.6)$$

Equation (5.6) is the stationary condition and the first key equation of the model. It indicates that, in the steady state, escapement is logically increasing with natural growth and is decreasing with the rate at which fish is being caught by vessels. As we shall see in the next section,  $\theta$  is determined by firms' economic decisions, which implies that  $U$  is also endogenous in the model.

### 5.3 Open access equilibrium

In this section, we assume that fishing activities are totally decentralized and that there is free entry and exit of firms into and out of the fishery.

#### 5.3.1 Firms' decisions and equilibrium anthropic pressure

This subsection is devoted to the determination of the equilibrium level of anthropic pressure,  $\theta$ , that firms set on the basis of pure economic considerations. In our setting, firms decide whether or not they send empty vessels to sea for searching fish. The process that changes the state of an empty vessel is Poisson with rate  $H(U, E) / (E) = H(U/E, 1)$ . Written differently :

$$\frac{H}{E} \equiv q(\theta) \quad (5.7)$$

In Eq. (5.7), since  $q'(\theta) < 0$ , the harvest level per unit effort/empty vessel is decreasing with the level of anthropic pressure at work inside the fishery. During a small time interval

5. ENDOGENOUS CATCHABILITY AND CONGESTION  
 EXTERNALITIES BETWEEN VESSELS IN A SEARCH-MATCHING  
 MODEL : EVIDENCE FROM THE FRENCH GUIANA SHRIMP FISHERY

---

$\delta t$ , an empty vessel catches fish at a rate (or frequency),  $q(\theta)$ , or with probability,  $q(\theta)\delta t$ , which implies that the mean duration (or “period”) during which a vessel remains empty is equal to  $1/q(\theta)$ . An empty vessel searching for fish costs  $S$  per unit time, and after having found fish, harvests the latter instantaneously. We assume that  $S$  integrates all the costs that are necessary to equip a vessel for a fishing campaign (crew wages, fuel...) <sup>6</sup>. Firms have a positive discount rate,  $r$ , and seek to maximize profits. They have full knowledge of the harvest process but do not coordinate their actions and take the catch probabilities as given. Let  $W_E$  and  $W_F$  be respectively the present-discounted value of expected profit from respectively an empty vessel and a filled vessel. After some calculations,  $W_E$  and  $W_F$  can be written as (see Appendix A) :

$$rW_E = -S + q(\theta)(-W_E + W_F) \quad (5.8)$$

$$rW_F = r(H + W_E) \quad (5.9)$$

In a perfect capital market, the valuation of their vessels by fishing firms is such that, whatever the state of the vessel (empty or filled), the capital cost,  $rW$ , is exactly equal to the rate of return on the vessel. In Eq. (5.8), an empty vessel costs  $S$  per unit time. The empty vessel catches fish and changes state according to a Poisson process with rate  $q(\theta)$ , yielding net return  $(-W_E + W_F)$ . In the steady state, since the vessel’s change in status from filled to empty is instantaneous,  $W_F$  is independent from the interest rate and is equal to the sum of the catch,  $H$ , and the present-discounted value of expected profit from an empty vessel,  $W_E$  <sup>7</sup>.

We assume that firms maximize profit by sending vessels to sea until the present-discounted value of the expected profit from the last engaged empty vessel is equal to zero ( $W_E = 0$ ).

This assumption ensures that all fish production opportunities are exploited by individual

---

<sup>6</sup>As Mangel and Clark (1983), we assume here that the search component of fishing operations is the most important stochastic consideration. What fishing firms can do about the uncertainties concerning weather or stock size and quality is negligible in comparison with what they can accomplish in the way of locating fish (see also Mangel and Plant, 1985, on this point).

<sup>7</sup>Here, the vessels owned by firms may be interpreted as assets. In financial economics, Eq. (5.8)-(5.9) are called “Capital Asset Pricing Market” (CAPM) equations. In a more general context, Scott (1955) suggested to treat stocks of natural resources as assets as well.

**5. ENDOGENOUS CATCHABILITY AND CONGESTION  
EXTERNALITIES BETWEEN VESSELS IN A SEARCH-MATCHING  
MODEL : EVIDENCE FROM THE FRENCH GUIANA SHRIMP FISHERY**

---

firms. Since each firm only owns a single vessel, it corresponds to a zero profit condition applied at the fishery global level, and thus represents an OA situation. Applying  $W_E = 0$  to Eq. (5.8), and isolating  $W_F$ , gives  $W_F = S/q(\theta)$  : in equilibrium, the number of vessels sent to sea by firms is such that expected profit from a filled vessel,  $W_F$ , is exactly equal to the expected cost of an empty vessel, *i.e.* the per unit time search cost,  $S$ , weighted by the rate at which fish is being caught,  $q(\theta)$ . Now, also setting  $W_E = 0$  in Eq. (5.9) leads to  $W_F = H$ . Still using  $W_E = 0$  in Eq. (5.8), dividing all terms by  $q(\theta)$ , and rearranging, leads to :  $H - S/q(\theta) = 0$ . In equilibrium, firms' instantaneous profit, net of average search cost ( $S/q(\theta)$ ), is equal to zero. Lastly, isolating  $q(\theta)$  gives implicitly the OA equilibrium value of anthropic pressure :

$$q(\theta_{OA}) = \frac{S}{H} \quad (5.10)$$

Eq. (5.10) is the second key equation of the model. Since  $q'(\theta) < 0$ , it indicates that equilibrium anthropic pressure is decreasing with search costs, and is increasing with harvest. Since it is derived from fishing firms' economic decisions, Eq. (5.10) constitutes the driving force of the model under OA, and implies that catchability is endogenous.

Lastly, the total number of vessels in the fishery is simply equal to the sum of empty and filled vessels. Since the number of filled vessels is equal to the captured portion of the fish stock, *i.e.* the difference between the stock and escaped fish, divided by harvest, we have :

$$V = E + \frac{X - U}{H} \quad (5.11)$$

Since as already seen  $E$ ,  $U$ , and  $H$ , are endogenously in this model, Eq. (5.10) indicates that total fishing effort is thus also determined endogenously and will depend on the technological, biological and economics conditions that characterize the fishery.

### 5.3.2 Global outcome

The model is made up of a system of five equations (5.3), (5.6), (5.11), (5.7), and (5.10), and five unknowns,  $\theta_{OA}$ ,  $H_{OA}$ ,  $E_{OA}$ ,  $U_{OA}$ , and  $v_{OA}$ , whose open access equilibrium values are

5. ENDOGENOUS CATCHABILITY AND CONGESTION  
 EXTERNALITIES BETWEEN VESSELS IN A SEARCH-MATCHING  
 MODEL : EVIDENCE FROM THE FRENCH GUIANA SHRIMP FISHERY

---

given by :

$$\theta_{OA} = \left( \frac{\omega B}{S} \right)^{\frac{1}{\alpha}} \quad (5.12)$$

$$U_{OA} = \left( \frac{B^{2\alpha-1} S^{1-\alpha}}{\omega} \right)^{\frac{1}{\alpha}} \quad (5.13)$$

$$E_{OA} = \frac{B^2}{S} \quad (5.14)$$

$$H_{OA} = B \quad (5.15)$$

$$V_{OA} = E_{OA} + \frac{X - U_{OA}}{H_{OA}} \quad (5.16)$$

The solving of the above system may be undertaken as follows. Using Eq. (5.3) to isolate  $\theta$  in Eq. (5.10), one finds the OA equilibrium value of anthropic pressure, which is given by Eq. (5.12). Besides, inserting Eq. (5.12) into the steady state escapement equation, Eq. (5.6), and isolating  $U$ , yields the expression of OA equilibrium escapement. Then, recalling the definition of anthropic pressure given by Eq. (5.2), isolating  $E$ , and replacing  $\theta$  and  $U$  respectively by Eq. (5.12) and (5.13), leads to equilibrium search effort under OA (Eq. (5.14)). Now, insertion of Eq. (5.13) and Eq. (5.14) into Eq. (5.1) and simplifying, allow for verifying the closing of the model by finding Eq. (5.15), which is the same as the steady state condition (Eq. (5.5)). Lastly, inserting Eq. (5.6) and Eq. (5.14) into Eq. (5.11) gives the OA equilibrium total number of vessels in the fishery, (Eq. (5.16)). The sign of the changes in the technological, economic and biological parameters on the endogenous variables of the model under OA are summarized in Table 5.2, in the case of the FGSF ( $\alpha = 0.65$ ) :

Table 5.2 : Sensitivity analysis of the OA equilibrium

	$\theta_{OA}$	$U_{OA}$	$E_{OA}$	$H_{OA}$	$V_{OA}$
$\omega$	+	-	0	0	+
$S$	-	+	-	0	-
$B$	+	+	+	+	+

The equilibrium of the fishery can be represented by the intersection of two curves, the Escapement Curve (EC) curve and the Search Effort (SE) curve, respectively given by Eq.

5. ENDOGENOUS CATCHABILITY AND CONGESTION  
 EXTERNALITIES BETWEEN VESSELS IN A SEARCH-MATCHING  
 MODEL : EVIDENCE FROM THE FRENCH GUIANA SHRIMP FISHERY

---

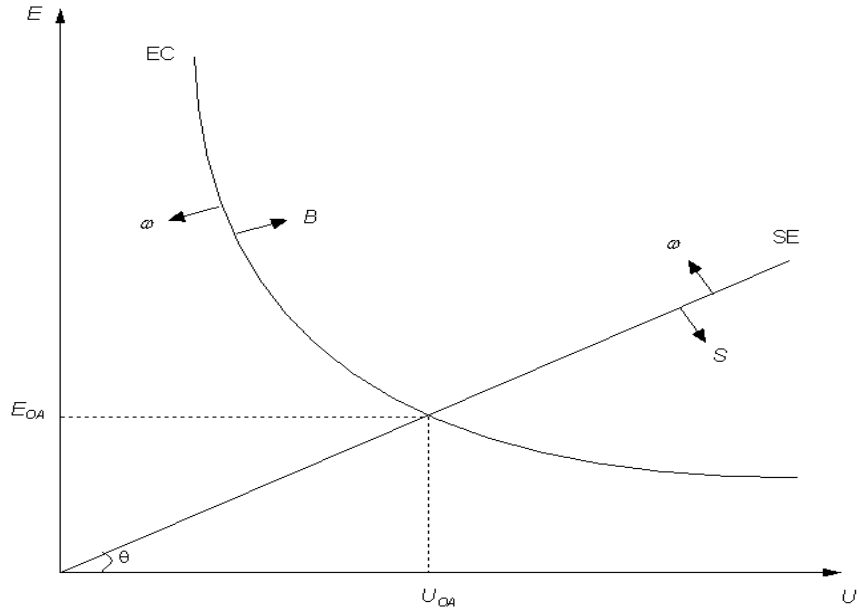

FIG. 5.2 – The open access search-matching fishery equilibrium

(5.6) and (5.10)<sup>8</sup>. The overall situation is depicted in Figure 5.2. As can be seen, the (ER) curve is decreasing and convex in the  $(U, E)$  space. As the number of empty vessels falls along the (ER) curve, the global harvest level decreases, which mechanically translates into a rise in escapement. In other words, the reduction in the number of empty vessels per stock unit,  $E$ , and the simultaneous rise in escapement,  $U$ , make anthropic pressure, and thus the probability for a fish to be caught by an empty vessel,  $\theta q(\theta)$ , decrease. Eq. (5.6) then indicates that for escapement to remain constant in the steady state, the number of empty vessels engaged into search must decrease. Conversely, a higher search effort corresponds to lower escapement. As far as the (SE) curve is concerned, Eq. (5.10) clearly indicates that it is linear in  $U$ , going through the origin in the  $(U, E)$  locus, with slope  $\theta$ . An increase in  $U$  leads to a reduction in  $\theta$  which makes catchability,  $q(\theta)$ , increase ( $q'(\theta) < 0$ ). This in turn makes the cost per unit search,  $S/q(\theta)$ , decrease, which induces firms to increase search effort,  $E$ .

---

<sup>8</sup>In the present example, the equations of the (SC) and (FE) curves can be respectively obtained by replacing  $\theta$  by  $E/U$  and isolating  $E$  in Eq. (5.6) and (5.10), which leads to  $E_{ER} = (B/\omega)^{1/(1-\rho)} U^{-\rho/(1-\rho)}$ , and  $E_{OA} = (\frac{\omega H}{S})^{1/\rho} U$ .



5. ENDOGENOUS CATCHABILITY AND CONGESTION  
 EXTERNALITIES BETWEEN VESSELS IN A SEARCH-MATCHING  
 MODEL : EVIDENCE FROM THE FRENCH GUIANA SHRIMP FISHERY

---

As far as the exogenous shocks that may affect the fishery are concerned, neither the evolution of the catchability parameter,  $\omega$ , nor changes in the search cost,  $S$ , explain the simultaneous falls in fishing effort, harvest and escapement in the FGSF between 1990 and 2009. Indeed, Table 5.2 indicates that a change in  $\omega$  has no effect on  $E$  and  $H$ , and has an ambiguous impact on  $U$ , whereas a variation in  $S$  lowers  $E$ , has no impact on  $H$ , and rises  $U$ . However, a reduction in the rate of natural growth per stock unit,  $B$ , leads simultaneously to the falls in  $E$ ,  $H$ , and  $U$ , observed empirically. An exogenous reduction in  $B$  induces vessels to decrease their harvest level in the steady state (Eq. (5.5)). The reduction in harvest implies that, for profits to remain null under OA, the average cost per unit search ( $S/q(\theta)$ ) must also decrease (Eq. (5.10)) which implies, for a given search cost,  $S$ , an increase in catchability,  $q(\theta)$ . This rise in catchability comes from the weakening of the congestion effects at work within the fishery and corresponds to a reduction in the level of anthropic pressure,  $\theta$  ( $q'(\theta) < 0$ ). It is worth noting here that the rise in catchability may even occur after a slight reduction in anthropic pressure, if the value of the elasticity of  $q(\theta)$  with respect to  $\theta$ , *i.e.*  $\alpha$ , is sufficiently high. As already shown, this is especially the case in the FGSF, where  $\alpha$  is near from one. From a reduction in  $H$ , coupled with a rise in  $q(\theta)$ , Eq. (5.7) implies an unambiguous reduction in  $E$ . Finally, since by definition  $U = E/\theta$ , the net effect on  $U$  remains theoretically ambiguous, since it depends on the value of  $\alpha$  (Eq. (5.6)). This statement can be confirmed by observing Figure 2, where a reduction in  $B$  is represented by the combined downward moves of the (ER) and (SE) curves, that lead to an unambiguous reduction in  $E$  but to an undetermined change in  $U$ . Nevertheless, in the case of the FGSF, a reduction in  $B$  leads to an unambiguous reduction in  $U$ . This result can be explained with help of the steady state constraint given by Eq. (5.6), which indicates that a fall in  $B$ , and thus in  $\theta$ , has an ambiguous impact on  $U$ . However, Eq. (5.12) clearly shows that a reduction in  $B$  is followed by a stronger reduction in  $\theta$  (since  $\alpha < 1$ ), so that  $U$  should increase in Eq. (5.13). The only additional mechanism that may lead to an overall reduction in  $U$  is thus necessary a stronger rise in catchability,  $q(\theta)$ , coming from the reduction in anthropic pressure and the congestion effects. In other words, after a negative change in the stock natural growth rate, the fall in the number of vessels that search for fish allow them to catch

fish (too?) much easier, which results all in all in a reduction in escapement.

## 5.4 Maximum economic yield equilibrium

In this section, we would like to study the case where the present search-matching fishery works under a Maximum economic yield (MEY) regime. In order to do so, we now assume that the fishery is managed in a totally centralized manner by, say, a regulator, that has a positive discount rate,  $r$ . We assume that the profit earned by the regulator is equal to the production yielded by a filled vessel,  $H$ , times the fraction of filled vessels present in the fishery. Since we assume that each vessel can load a single unit of fish, the fraction of filled vessels can be assimilated to the complementary of escapement,  $1 - U$ . The cost of an empty vessel,  $S$ , times the fraction of empty vessels,  $E$ , must be subtracted to earnings to get the net value of profit. From Eq. (5.6), we can express the objective function of the regulator with respect to  $\theta$  and  $U$  only :

$$\Omega = \int_0^{\infty} [H(X - U) - SE] e^{-rt} dt \quad (5.17)$$

Hence, the regulator maximizes  $\Omega$  with respect to  $\theta$ , subject to the constraint of the escapement rate dynamics, given by Eq. (5.6). Solving the program of the regulator leads to the following optimal values of the endogenous variables of the model (see Appendix B) :

$$\theta_{MEY} = \frac{(1 - \alpha) B}{(\alpha - r) S} \quad (5.18)$$

$$U_{MEY} = \left( \frac{\alpha - r}{1 - \alpha} S \right)^{1-\alpha} \frac{B^\alpha}{\omega} \quad (5.19)$$

$$E_{MEY} = \left[ \frac{1 - \alpha}{(\alpha - r) S} \right]^\alpha \frac{B^{1+\alpha}}{\omega} \quad (5.20)$$

$$H_{MEY} = B \quad (5.21)$$

$$V_{MEY} = E_{MEY} + \frac{X - U_{MEY}}{H_{MEY}} \quad (5.22)$$

The sign of the changes in the technological, technical, economic and biological parame-

5. ENDOGENOUS CATCHABILITY AND CONGESTION  
 EXTERNALITIES BETWEEN VESSELS IN A SEARCH-MATCHING  
 MODEL : EVIDENCE FROM THE FRENCH GUIANA SHRIMP FISHERY

---

ters on the endogenous variables of the model under MEY are summarized in Table 5.3, in the case of the FGSF ( $\alpha = 0.65$ ) :

Table 5.3 : Sensitivity analysis of the MEY equilibrium

	$\theta_{MEY}$	$U_{MEY}$	$E_{MEY}$	$H_{MEY}$	$V_{MEY}$
$\omega$	+	d	0	0	0
$S$	-	+	-	0	-
$B$	+	+	+	+	+

We are now in a position to determine under which condition the OA search-matching fishery works optimally or not. For instance, comparison of Eq. (5.12) with Eq. (5.18) (with no discount rate, *i.e.*  $r = 0$ , and  $\omega = 1$ ) shows that  $\theta_{OA} = \theta_{MEY}$  if and only if :

$$S = \left( \frac{1 - \alpha}{\alpha} \omega^{\frac{-1}{\alpha}} \right)^{\frac{\alpha}{1-\alpha}} B \quad (5.23)$$

In the case of the FGSF ( $\omega = 4.48$ ;  $\alpha = 0.65$ ), the OA fishery would reach the MEY by itself if the ratio  $S/B$  was negligible ( $4.3644 \times 10^{-3}$ ). Hence, since in the steady state,  $H = B$ , optimality would only be reached at very low average costs. Nevertheless, since  $B$  and  $S$  are empirically totally independently determined, the optimality condition given in Eq. (5.23) implies that an OA search-matching fishery almost never reaches the MEY equilibrium.

## 5.5 Empirical analysis

In order to plot the evolution of the most representative endogenous variables of the model, we follow Martinet and Blanchard (2009) by retaining the logistic-type function proposed by Verhulst (1838) and Pearl (1925) for describing the natural growth rate of the shrimp stock :

$$B(X, i, K) = iX \left( 1 - \frac{X}{K} \right) \quad (5.24)$$

where  $i$  represents the maximum relative growth or “intrinsic growth rate”, which is related to the studied species, and  $K$ , the carrying capacity, that depends on the characteristics of

the natural environment in which the species evolves, such as the size and the biological productivity of the habitat. Both parameters are assumed to be fixed and for a biological equilibrium to exist,  $K > X$  and  $i > 0$  must be verified. The values retained by the above authors for the French Guiana shrimp are :  $i = 0.91$ , and  $K = 18,5$ . Total fishing effort is drawn with help of Eq (5.16). As far as catchability is concerned (Eq. (5.3)), anthropic pressure,  $\theta$ , must be evaluated by assuming that vessels are searching for fish as long as they stay at sea. We thus use Ifremer data regarding the number of days at sea (soak length) as a proxy of the number of empty vessels,  $E$ . For escapement,  $U$ , we suppose that the latter is equal to the difference between annual shrimp stock and harvest levels, *i.e.* :  $U = X - H$ . Actual, OA and MEY fishing effort and catchability levels are thus plotted from Ifremer data between 1990 and 2009, respectively in Fig. 5.3 and 5.4.

First of all, Fig. 5.3 confirms that firms have decreased fishing effort between 1990 and 2009 in order to maintain profits. Fig. 5.4 confirms the preceding intuition by showing that the fall in fishing effort has allowed for a steady rise in actual catchability during the last decade. Vessels caught on average about 80 t. per year in 1990, and 140 t. in 2009. Besides, MEY fishing effort would always be higher than under OA : a regulator, seeking to maximize the rent of the fishery, would voluntarily choose a lower fleet size in order to benefits from lower congestion effects and higher catchability and profits. This explains why catchability under OA remained below MEY and actual levels during the last 12 years, competition preventing fishing firms from selecting a lower overall fleet size that would have allowed for achieving a higher catchability level (Fig. 5.4). This result also suggests that some cooperation failures between fishing firms in terms of search and fishing effort may be at work in fisheries like the FGSF.

## 5.6 Conclusion

As Bjorndal and Munro (2003) point out, “the economics of fisheries management under uncertainty is currently underdeveloped. Without question, much remains to be done”. The search-matching fishery model proposed in this paper seeks to fill the above gap by taking into

5. ENDOGENOUS CATCHABILITY AND CONGESTION  
 EXTERNALITIES BETWEEN VESSELS IN A SEARCH-MATCHING  
 MODEL : EVIDENCE FROM THE FRENCH GUIANA SHRIMP FISHERY

---

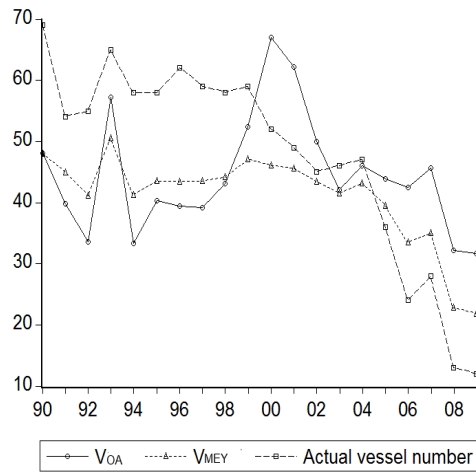

FIG. 5.3 – Evolution of fishing effort (total number of vessels) in the FGSF between 1990 and 2009

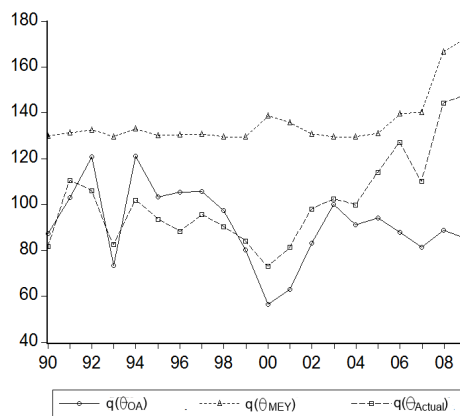

FIG. 5.4 – Evolution of actual, OA, and MEY catchability levels in the FGSF between 1990 and 2009.

5. ENDOGENOUS CATCHABILITY AND CONGESTION  
EXTERNALITIES BETWEEN VESSELS IN A SEARCH-MATCHING  
MODEL : EVIDENCE FROM THE FRENCH GUIANA SHRIMP FISHERY

---

account explicitly the fact that fish harvesting is most of the time a random activity. It first adapts search theory to the specific economic behavior of fishing firms. Its global properties are thus explicitly derived from precise microeconomic foundations. The model therefore exhibits the attractive properties of its original source, making it possible to study the effects of changes in exogenous parameters on some important endogenous variables that are proper to fisheries. Our results indicate that congestion effects between vessels and the resulting changes in catchability play a major role in explaining the parallel evolutions of the shrimp stock, search and fishing efforts, harvest, and profits. According to our model, the strong reduction in the FGSF fleet size to about 20 active vessels in 2016, undertaken to concentrate the fishing activities on a limited number of profitable vessels (Chaboud and Thébaud, 2009), might have considerably decreased congestion effects between fishing vessels and strongly weakened competition on catch. This seems to have in turn resulted into a substantial rise in catchability for the remaining vessels, that has more than compensated the fall in fishing effort and harvest, leading also finally to a reduction in the unharvested stock and a rise in profits. We then show that under a MEY regime, reinforcing congestion by choosing a higher number of fishing vessels may be beneficial in the long run because it may partially offsets the above phenomenon. Hence, our results appear to be compatible with those obtained by Huang and Smith (2014), who find a positive stock congestion externality on average, that increases the present value of fishery profits. This spillover reduces instantaneous profits, but dynamically also reduces effort and mediates the stock externality, producing a net long-run gain.

The present model is suitable for empirical analysis and thus for almost any kind of species, such as *e.g.* terrestrial animals. However, in order to capture other particular features of fisheries, it should be further extended into several directions. Among the numerous extensions that have already been realized in the past for the analysis of labour markets, some of them, like *e.g.* the endogenization and choice of optimal search effort by fishermen, could also be considered, in order to analyze the consequences of the strategic interactions between fishing vessels. Cooperation, like information sharing about the location of fish, might have an impact on the congestion effects studied here. Besides, the integration of bycatch and dis-

5. ENDOGENOUS CATCHABILITY AND CONGESTION  
EXTERNALITIES BETWEEN VESSELS IN A SEARCH-MATCHING  
MODEL : EVIDENCE FROM THE FRENCH GUIANA SHRIMP FISHERY

---

card behaviors into the present framework may also constitute a relevant avenue for future research. Broadly, the use of a search-matching model for the analysis of fisheries seems at least as natural as its application to *e.g.* labor markets. We thus hope that the framework proposed in this paper will help to improve the understanding of the working of fisheries and will constitute a convenient tool for the design of natural resource management policies.

## Appendix

### Appendix A : Fishing firms' choices and the Bellmann equations (in continuous time)

#### Method 1 (formal method)

The present-discounted values of expected profit from an empty and a filled vessels are respectively given by :

$$W_E = -S\varepsilon \int_0^T e^{-rt} dt + (H + W_E)\varepsilon (e^{-rT}) \quad (A1)$$

$$W_F = H - S\varepsilon \int_0^T e^{-rt} dt + W_F\varepsilon (e^{-rT}) \quad (A2)$$

where  $\varepsilon$  is the mathematical expectation. An empty vessel searching for fish costs  $S$  per unit time between 0 and  $T$ , where  $T$  is the date at which the vessel finds a fish unit.  $T$  is a random variable that follows a Poisson process, whose parameter is given by the rate at which vessels find fish units,  $q(\theta)$ . Still at date  $T$ , the vessel harvests a single fish unit and sell it in the market instantaneously, also earning the present-discounted of expected profit from an empty vessel,  $W_E$ . A firm with a filled vessel sells its fish unit in the market instantaneously, and then becomes empty, starting to search for fish between 0 and  $T$ , where  $T$  is a random variable that follows a Poisson process of parameter  $q(\theta)$ . At date  $T$ , the empty vessel finds a fish unit and recovers the status of a filled vessel, earning corresponding expected profit,  $W_F$ .

Let us start from calculating the integral entailed in Eq. (A1)-(A2), that become :

$$W_E = -S\varepsilon \int_0^T e^{-rt} dt + (H + W_E)\varepsilon (e^{-rT}) \quad (A3)$$

$$W_F = H - S\varepsilon \int_0^T e^{-rt} dt + W_F\varepsilon (e^{-rT}) \quad (A4)$$

Now, if  $T$  is a random variable that follows a Poisson process of parameter  $q$ , we have : ,



*5. ENDOGENOUS CATCHABILITY AND CONGESTION  
EXTERNALITIES BETWEEN VESSELS IN A SEARCH-MATCHING  
MODEL : EVIDENCE FROM THE FRENCH GUIANA SHRIMP FISHERY*

---

$\varepsilon (e^{-rT}) = \int_0^\infty qe^{-(r+q)T} dT$ . Thus, Eq. (A3)-(A4) become :

$$W_E = -S \int_0^\infty \left\{ \left[ -\frac{1}{r} e^{-rt} \right]_0^T \right\} qe^{-(r+q)T} dT + (H + W_E) \int_0^\infty qe^{-(r+q)T} dT \quad (A5)$$

$$W_F = H - S \int_0^\infty \left\{ \left[ -\frac{1}{r} e^{-rt} \right]_0^T \right\} qe^{-(r+q)T} dT + W_F \int_0^\infty qe^{-(r+q)T} dT \quad (A6)$$

After calculating the integrals and simplifying, one obtains :

$$W_E = -S \frac{1}{r+q} + (H + W_E) \frac{q}{r+q} \quad (A7)$$

$$W_F = H - S \frac{1}{r+q} + W_F \frac{q}{r+q} \quad (A8)$$

Lastly, solving for  $W_E$  and  $W_F$  leads to respectively Eq. (5.8)-(5.9).

### Method 2 (intuitive method)

According to the assumptions retained in our model, the present-discounted values of expected profit from an empty vessel and a filled vessel can be respectively written as :

$$W_E = \frac{1}{1+rdt} \{-Sdt + [1 - q(\theta) dt] W_E + q(\theta) dt W_F\} \quad (A9)$$

$$W_F = \frac{1}{1+rdt} (1 + W_E) \quad (A10)$$

At a discount rate  $r$ , an empty vessel costs  $S$  per unit time and go on yielding the expected value of an empty vessel,  $W_E$ , as long as it remains in this state with probability,  $1 - q(\theta) dt$ . With the complementary probability,  $q(\theta) dt$ , it finds a fish unit and yields the expected value from a filled vessel,  $W_F$ , to the firm. A firm with a filled vessel, loaded with one fish unit, becomes instantaneously empty and earns the expected profit associated with the state of an empty vessel,  $W_E$ . Multiplying all terms by  $(1 + rdt)$  and rearranging terms if  $dt$  tends to zero leads to Eq. (5.8)-(5.9) in the text.

## Appendix B : The regulator's program (in continuous time)

According to our model, the Hamiltonian corresponding to the regulator's profit maximization program is :

$$\mathcal{H} = e^{-rt} [H(X - U) - SE] + \mu \dot{U} \quad (\text{B1})$$

where  $\mu$  denotes the co-state variable. From the definition of anthropic pressure (Eq. (5.2)), the rate at which fish is being caught (Eq. (5.4)), and the steady state condition (5.6), the Hamiltonian can be re-written as :

$$\mathcal{H} = e^{-rt} [(1 - U) \theta q(\theta) U - S\theta U] + \mu \left[ U - \frac{B}{\theta q(\theta)} \right] \quad (\text{B2})$$

The optimality condition related to  $\theta$  reads :

$$\frac{\partial \mathcal{H}}{\partial \theta} = 0 \Leftrightarrow e^{-rt} \{U(1 - U)[q(\theta) + \theta q'(\theta)] - SU\} + \mu(-B) \left\{ -\frac{q(\theta) + \theta q'(\theta)}{[\theta q(\theta)]^2} \right\} = 0 \quad (\text{B3})$$

which, after some rearrangements and taking into account Eq. (5.5), leads to :

$$e^{-rt} [(\theta q(\theta) - B)(1 - \alpha) - S\theta] + \mu(1 - \alpha) = 0 \quad (\text{B4})$$

where  $\eta(\theta) = -q'(\theta)\theta/q(\theta)$  is the elasticity of the harvest function with respect to anthropic pressure. With the functional form retained for the catch technology (Eq. (5.3) in the text), it is immediate that :  $\eta(\theta) = \alpha$ . The optimality condition related to  $U$  is :

$$\frac{\partial \mathcal{H}}{\partial U} = -\dot{\mu} \quad (\text{B5})$$

Which, still from Eq. (B1) and Eq. (5.6) in the text, yields :

$$e^{-rt} [\theta q(\theta) - 2B - S\theta] + \mu = -\dot{\mu} \quad (\text{B6})$$

*5. ENDOGENOUS CATCHABILITY AND CONGESTION  
EXTERNALITIES BETWEEN VESSELS IN A SEARCH-MATCHING  
MODEL : EVIDENCE FROM THE FRENCH GUIANA SHRIMP FISHERY*

---

From Eq. (B4), one can calculate the derivative of  $\mu$  with respect to time :

$$\dot{\mu} = -re^{-rt} \left[ \frac{S\theta}{(1-\alpha)} - (\theta q(\theta) - B) \right] = -r\mu \quad (\text{B7})$$

Combination of Eq. (B6) and Eq. (B7) gives :

$$B(1+r) + S\theta \frac{r-\alpha}{1-\alpha} + r\theta q(\theta) = 0 \quad (\text{B8})$$

Now, solving Eq. (B8) for  $\theta$  gives Eq. (5.18) in the text. The optimal values of  $U_{MEY}$ ,  $E_{MEY}$ , and  $V_{MEY}$  can be found with the same method as in the OA case, which leads finally to the set of Eq. (5.18)-(5.22) in the text.

5. ENDOGENOUS CATCHABILITY AND CONGESTION  
EXTERNALITIES BETWEEN VESSELS IN A SEARCH-MATCHING  
MODEL : EVIDENCE FROM THE FRENCH GUIANA SHRIMP FISHERY

---

References

- Bertram C., Quaas M.F. (2016), “Biodiversity and Optimal Multi-species Ecosystem Management”, *Environmental Resource Economics*, forthcoming.
- Bjorndal, T., Conrad, J.M., Salvanes K.G. (1993), “Stock Size, Harvesting Costs, and the Potential for Extinction : The Case of Sealing”, *Land Economics* 69(2), 156-167.
- Bjorndal, T., Munro, G.R. (2003), “The economics of fisheries management : a survey”, in Tom Tietenberg and Henk Folmer (Eds.), *The International Yearbook of Environmental and Resource Economics 1998/1999 : A Survey of Current Issues*, Cheltenham, Edward Elgar, 153-188.
- Chaboud, C., Thébaud, O. (2009), “Bioeconomic model of the French Guyana shrimp fishery”, 18th World IMACS / MODSIM Congress, Cairns, Australia 13-17 July.
- Clark, C.W. (1990), *Mathematical Bioeconomics : The Optimal Management of Renewable Resources*, 2nd ed. (New York : Wiley).
- Clark, C.W., Mangel, M. (1984), “Foraging and flocking strategies : Information in an uncertain environment”, *The American Naturalist* 123(5), 626-641.
- Clark, C.W., Munro, G.R. (1982), “The Economics of Fishing and Modern Capital Theory : A Simplified Approach”, In L.J. Mirman and D.J. Spulber (eds) *Essays in the Economics of Renewable Resources*. North Holland.
- FAO, Food and Agriculture Organization of the United Nations (2008), “Global study of shrimp fisheries”, FAO fisheries technical papers 475.
- Gordon, H.S. (1954), “The economic theory of a common property resource : the fishery”, *Journal of Political Economy* 62, 124-142.
- Huang, L., Smith, M.D. (2014), “The dynamic efficiency costs of common-pool resource exploitation”, *The American Economic Review* 104(12), 4071-4103.
- Mangel, M., Beder, J.H. (1984), “Search and stock depletion : theory and applications”, *Canadian Journal of Fisheries and Aquatic Sciences*, forthcoming.

5. ENDOGENOUS CATCHABILITY AND CONGESTION  
EXTERNALITIES BETWEEN VESSELS IN A SEARCH-MATCHING  
MODEL : EVIDENCE FROM THE FRENCH GUIANA SHRIMP FISHERY

---

- Mangel, M., Clark, C.W. (1983), "Uncertainty, search, and information in fisheries", *Journal du Conseil / Conseil Permanent International pour l'Exploration de la Mer* 41, 93-103.
- Mangel, M., Plant, R.E. (1985), "Regulatory mechanisms and information processing in uncertain fisheries", *Marine Resource Economics* 1, 389-418.
- Martinet, V., Blanchard, F. (2009), "Fishery externalities and biodiversity : Trade-offs between the viability of shrimp trawling and the conservation of Frigatebirds in French Guiana", *Ecological Economics* 68, 2960-2968.
- McConnell, K.E., Strand, I.E., Blake-Hedges, L. (1995), "Random utility models of recreational fishing : catching fish using a poisson process", *Marine Resource Economics* 10, 247-261.
- Munro, G.R. (1992), "Mathematical bioeconomics and the evolution of modern fisheries economics", *Bulletin of Mathematical Biology* 54(2-3), 163-184.
- Pearl, R. (1925), *The Biology of Population Growth*, A. A. Knopf (Ed.), New York.
- Pissarides, C.A. (2000), *Equilibrium Unemployment Theory*, MIT Press (2nd ed.), Cambridge.
- Quaas M.F. (2015), "Sushi or Fish Fingers? Seafood Diversity, Collapsing Fish Stocks, and Multispecies Fishery Management", *Scandinavian Journal of Economics* 115(2), 381-422.
- Reed, W.J. (1978), "The steady state of a stochastic harvesting model", *Mathematical Biosciences* 41(3-4), 273-307.
- Sanz N., Diop B., Blanchard F., Lampert L. (2016), "On the influence of environmental factors on harvest : the French Guiana shrimp fishery paradox", *Environmental Economics and Policy Studies* 18(2), 1-15.
- Scott, A. (1955), "The Fishery : The Objectives of Sole Ownership", *Journal of Political Economy* 63(2), 116-124.
- Schaefer, M.B. (1957), "Some considerations of population dynamics and economics in relation to the management of marine fisheries", *Journal of the Fisheries Research Board of Canada* 14, 669-681.

5. ENDOGENOUS CATCHABILITY AND CONGESTION  
EXTERNALITIES BETWEEN VESSELS IN A SEARCH-MATCHING  
MODEL : EVIDENCE FROM THE FRENCH GUIANA SHRIMP FISHERY

---

Smith, V.L. (1969), “On Models of Commercial Fishing”, *Journal of Political Economy* 77(2), 181-198.

Verhulst, P.F. (1838), “Notice sur la loi que la population suit dans son accroissement”, *Correspondance Mathématique et Physique* 10, 113–117.

# 6

## Conclusion générale

L'objectif principal de ce travail est de comprendre le fonctionnement général des pêcheries et, plus particulièrement, celui de la pêcherie crevette de Guyane française. Le fonctionnement d'une pêcherie est très complexe en ce qu'il dépend de nombreux facteurs de nature biologique, écologique, géographique, économique, etc. Son étude nécessite donc de prendre en considération d'autres facteurs que ceux utilisés dans les modèles bioéconomiques traditionnels.

Il est unanimement reconnu que les ressources marines tendent à s'épuiser et que certaines espèces sont en voie d'extinction (Mullon *et al.*, 2005). Cette perte de biodiversité marine est très souvent associée à une surexploitation des ressources mais aussi, à des politiques de gestion des ressources parfois inappropriées. Certaines de ces politiques sont mises en place afin de préserver les ressources contre l'extinction pure et simple. Le Code de conduite, qui préconise de maintenir la mortalité par pêche au niveau, ou sous le niveau défini par le rendement constant maximum, et de veiller à ce que l'abondance du stock se situe également au moins à ce niveau, ne permet généralement pas de tenir compte des interactions écosystémiques (FAO, 2016). La mise en place de politiques de gestion qui tiennent compte des facteurs purement environnementaux constitue aujourd'hui une voie à suivre pour mieux comprendre les fluctuations des stocks de ressources issues des océans. La pêcherie crevette guyanaise a été marquée par un effondrement brutal de son stock ces dernières années. Malgré la baisse concomitante de l'effort de pêche et de la production, la ressource continue

## 6. CONCLUSION GÉNÉRALE

---

de s'effondrer. Cette situation a provoqué la fermeture de plusieurs entreprises évoluant dans cette filière. Des licences et des quotas mis en place, et jamais atteints, n'ont pas permis de stabiliser le stock pour lui permettre de se reconstituer.

Le premier chapitre montre que les modèles traditionnels ne suffisent pas à expliquer l'évolution de la pêche crevette guyanaise durant la période 1990-2009. Ainsi nous avons envisagé la possibilité selon laquelle un certain nombre de facteurs, environnementaux cette fois, étaient à l'oeuvre. Comme nous avons pu le voir, le débit de certains grands fleuves amazoniens ou des épisodes climatiques particuliers permettent, dans une certaine mesure, d'expliquer les faits observés. Concernant la mangrove, l'introduction explicite de sa surface dans le modèle du Chapitre 2 se justifie par le fait qu'elle occupe 80 % du littoral guyanais et qu'elle est connue pour être une zone de nurserie pour les crevettes (Robertson et Duke, 1987). Les résultats du chapitre 2 indiquent en effet que la mangrove, aux travers des variations de sa superficie, explique en partie l'évolution de la pêche crevette locale, notamment celle de sa production. La déforestation des écosystèmes de mangroves est notamment due au changement climatique, comme le soulignent Alongi (2008) et Gilman *et al.* (2008). Cependant, le rôle de la mangrove ne semble pas être déterminant. En effet, entre 1990 et 2009, en dépit du fait que les variations de sa surface ont été de faible ampleur, sa superficie a d'abord diminué pour augmenter par la suite. Si la mangrove avait joué un rôle important, l'augmentation de sa surface aurait permis de renforcer les effets positifs de la baisse de l'effort de pêche sur le stock et de reconstituer celui-ci, du moins en partie.

Le chapitre 3 permet, dans un premier temps, d'estimer la sensibilité de la production de crevettes par rapport au stock et à l'effort de pêche. Il apparaît en particulier que la pêche crevette guyanaise est fortement dépendante du stock. En effet, les résultats indiquent que l'élasticité de la capture par rapport au stock est positive et proche de l'unité. Ceci implique que même une faible diminution du stock dans cette filière entraîne une forte augmentation du coût unitaire de prélèvement et incite les professionnels du secteur à diminuer sensiblement leur effort de pêche. Comme on a pu le voir, l'effort de pêche diminue fortement également en effet sur la même période. Néanmoins, cette forte baisse de l'effort ne conduit pas au redressement du stock attendu. Les décideurs publics tentent de régle-



## 6. CONCLUSION GÉNÉRALE

---

menter la pêche à travers le contrôle du niveau de l'effort. Toutefois, ce dernier explique une proportion beaucoup plus faible des variations de la production que le stock. Ceci explique pourquoi l'impact de la réglementation ci-dessus est assez faible. On peut donc douter de la pertinence ou l'efficacité de ces licences.

Ceci nous a conduits à considérer d'autres facteurs environnementaux, comme le débit des fleuves, les épisodes comme "el Niño" ou "la Niña", et la température de surface. Nos résultats suggèrent que ces différents facteurs ont un impact non négligeable sur la pêcherie. En effet, une augmentation de la température de surface de l'océan ou une augmentation du débit de certains fleuves semblent provoquer une diminution de la taille du stock. Il en est de même en ce qui concerne la survenue des épisodes Niño ou Niña. L'augmentation potentielle dans les tendances à long terme de la température de surface de l'océan et le débit du fleuve Amazone peut conduire à un effondrement du stock. Toutefois, il apparaît que le facteur le plus déterminant est la température de surface des océans. Ce facteur s'est révélé en effet très important dans l'évolution de la pêcherie et nous a conduits à pousser notre analyse dans ce sens au Chapitre 4.

Ainsi, au Chapitre 4, considérons-nous plusieurs fonctions de croissance naturelle, toutes augmentées de la température de surface. Les résultats économétriques permettent dans un premier temps de retenir celle qui s'ajuste le mieux aux observations. Ensuite, considérant que la pêcherie est gérée de façon optimale, un premier scénario est envisagé, dans lequel la température de surface suit la même tendance que celle observée entre 1990 et 2009. Dans ce scénario, nous avons également envisagé des modes de fonctionnement théoriques alternatifs concernant la pêcherie, dont le statu quo, la fermeture totale. Les résultats nous montrent que malgré une probable fermeture de la pêcherie, le stock va d'abord se reconstituer avant de s'effondrer à nouveau autour de 2050. Par la suite un deuxième scénario, dans lequel nous supposons que la température va se stabiliser autour de sa valeur observée en 2009, est également envisagé. Les résultats apparaissent aussi alarmants que dans le scénario précédent. Ils suggèrent que les mesures qui devraient être prises pour préserver la ressource dépassent les cadres de gestion traditionnels. Cependant, de façon générale, la démarche qui consiste à intégrer le climat et les ressources naturelles dans un même cadre doit être entreprise avec

## 6. CONCLUSION GÉNÉRALE

---

précaution. En effet, nombre des corrélations entre les ressources marines et les variables climatiques qui ont été mises en évidence ces dernières années ont été contredites avec le temps (Myers, 1998). Cela limite l'intérêt des modèles concernés pour évaluer l'impact des changements globaux sur la dynamique des ressources. Ainsi, améliorer la compréhension des mécanismes des processus climatiques qui sous-tendent ces corrélations est nécessaire afin d'obtenir des prévisions plus fiables (Stock *et al.*, 2011).

Enfin, le chapitre 5 est une adaptation du modèle stochastique de recherche et d'appariement dans laquelle la capturabilité est endogène, ce qui constitue une différence majeure par rapport à la littérature existante sur le sujet (Sethi *et al.*, 2005 ; Singh *et al.*, 2006 ; Abbott et Wilen, 2011 ; Zhang et Smith, 2011). Les résultats indiquent qu'une diminution de la pression anthropique sur le stock non prélevé et de l'intensité des effets de congestion entre les navires peut être plus que compensée par la hausse consécutive de la capturabilité dans la pêche. Ces résultats permettent donc d'expliquer, dans une certaine mesure, les baisses simultanées de l'effort de pêche et du stock entre 1990 et 2009. Nous confirmons ces résultats en proposant une méthode d'évaluation de la durée moyenne de recherche de cibles sur la période étudiée, qui semble en effet baisser de façon continue sur la période, traduisant l'augmentation concomitante de la capturabilité.

Dans le cadre de cette étude, nous avons tenté d'apporter un diagnostic de la pêche crevette guyanaise. Dans la lignée de Howard *et al.* (2008), nous avons étendu des modèles déjà stabilisés dans la littérature en y intégrant des facteurs environnementaux. En outre, nous avons adapté un modèle qui a déjà fait ses preuves en économie du travail ou de la finance à l'économie des ressources naturelles, ce qui a permis de proposer une nouvelle approche stochastique innovante en économie des pêches. Les simulations et prévisions obtenues semblent réalistes et adaptées à la pêche étudiée. Toutefois, ces travaux ne portent que sur une seule espèce et ne prennent donc pas en considération les interactions de la crevette avec les autres espèces présentes dans son milieu. L'approche écosystémique des pêches (AEP) suggère de tenir compte, dans la gestion des pêches, des relations trophiques et du fonctionnement des écosystèmes aquatiques (FAO, 2014). Cependant, la non prise en compte des relations trophiques dans notre étude pourrait être comblée par un rapprochement de

## 6. CONCLUSION GÉNÉRALE

---

deux pêcheries industrielles existant en Guyane française : la crevette et le vivaneau. En particulier, Lampert (2011) émet dans son rapport l'hypothèse qu'en 2006 l'augmentation de juvéniles de vivaneaux a pu entamer de 30 % le recrutement de crevettes. De nouvelles études pourraient être conduites dans ce sens pour répondre aux recommandations de l'approche écosystémique des pêches, qui préconise d'analyser une pêcherie dans son ensemble, et notamment de prendre en considération les relations trophiques.

Les modèles économiques appliqués aux pêcheries se distinguent en général en fonction des caractéristiques suivantes : statiques ou dynamiques, théoriques ou empiriques, déterministes ou stochastiques. Les modèles statiques ont l'avantage de la simplicité et de permettre d'illustrer certains concepts de gestion. Cependant ils présentent quelques désavantages car la dynamique des ressources demeure par définition dynamique et le temps doit être pris en compte de manière explicite. Par ailleurs, les ressources subissent en permanence des chocs, ce qui rend difficile la prévision de leur évolution et incite à remplacer les modèles dynamiques déterministes par des modèles dynamiques stochastiques. Avec l'incertitude liée à l'environnement marin, les modèles devraient prendre en considération d'autres facteurs. Roughgarden et Smith (1996) notent que le problème central de la surpêche est exacerbé par l'incertitude dans la taille du stock et de sa dynamique. Ces auteurs attribuent ainsi l'effondrement de la pêche à l'incertitude dans les milieux marins, et soulignent qu'ignorer l'incertitude est susceptible de conduire à la surexploitation. Selon Sethi *et al.* (2005), il faut distinguer trois sources d'incertitude : la variabilité environnementale, qui influence la croissance des stocks ; l'erreur de mesure des stocks ; la mise en œuvre inexacte des quotas de capture. Ricker (1987) note qu'année après année, les différences dans les caractéristiques environnementales provoquent des fluctuations de la reproduction au moins aussi grandes que celles associées à des variations de la densité des stocks. C'est la raison pour laquelle il est souvent difficile de déterminer une relation entre le recrutement et la taille du stock à partir de l'observation directe des données biologiques. Les ressources affichent d'importantes variations au niveau du recrutement. Ce n'est donc pas une surprise que ces variations soient de plus en plus explicitement incluses dans les modèles économiques, comme annoncé par *e.g.* Lewis (1981) et Clark *et al.* (1985).

## 6. CONCLUSION GÉNÉRALE

---

Gérer aujourd'hui les pêcheries en se basant uniquement sur leurs caractéristiques biologiques, économiques et technologiques conduirait à des conclusions erronées du fait de la non prise en compte des spécificités environnementales du milieu dans lequel elles se développent. En effet, les signes de l'influence des phénomènes environnementaux sur certaines espèces sont de plus en plus évidents, même si les mécanismes à l'oeuvre doivent encore être analysés plus avant, et l'ampleur de cette influence quantifiée plus précisément. Négliger cette influence dans la mise en place de politique de régulation conduirait à des actions inefficaces pour préserver les ressources.

Nous espérons ainsi que ce travail permet une meilleure compréhension du fonctionnement de la pêche crevette de Guyane française et renforce l'idée selon laquelle certaines espèces étant directement menacées par le changement climatique, il faudrait intégrer systématiquement ce dernier dans l'analyse des pêcheries en général et la définition des politiques destinées à favoriser leur développement.

## 6.1 Références bibliographiques

- Abbott, J. K., Wilen, J. E. (2011), “Dissecting the tragedy : a spatial model of behavior in the commons”, *Journal of Environmental Economics and Management* 62(3), 386-401.
- Alongi, D. M. (2008), “Mangrove forests : resilience, protection from tsunamis, and responses to global climate change. Estuarine”, *Coastal and Shelf Science* 76(1), 1-13.
- Arnason, R. (2006), “Global warming, small pelagic fisheries and risk”, in *Climate change and the economics of the world’s fisheries*. Edward Elgard Northampton, Massachusetts, 1-3.
- Barbier, E. B. (1994), “Valuing environmental function : tropical wetlands”, *Land Economics* 70(2), 155-173.
- Barbier, E. B., Strand, I. (1998), “Valuing mangrove-fishery linkages : a case study of Campeche, Mexico”, *Environmental Resource Economics* 12, 151-166.
- Bjorndal, T. (1987), “Production Economics and Optimal Stock size in a North Atlantic Fishery”, *Scandinavian Journal of Economics* 89, 145-64.
- Bjorndal, Trond. (1988), “The Optimal Management of North Sea Herring”, *Journal of Environmental Economics and Management* 15, 9-29.
- Bjorndal, T. (1989), “Production in a Schooling Fishery : The case of the North Sea Herring Fishery”, *Land Economics* 65(1), 49-56.
- Bjorndal, T., Conrad, D.V., Salvanes, K.G. (1993), “Stock Size, Harvesting Costs, and the Potential for Extinction : the Case of Sealing”, *Land Economics* 69(2), 156-167.
- Bjorndal, T., Gordon, D.V. (1993), “The Opportunity Cost of Capital and Optimal Vessel Size in the Norwegian Fishing Fleet”, *Land Economics* 69(1), 98-107.
- Bjorndal, T., Munro, G. (1998), “The economics of fisheries management : a survey”, *International Yearbook of Environmental and Resource Economics*, 153-188.
- Boerema, L. K., Gulland, J. A. (1973), “Stock assessment of the Peruvian anchovy (*Engraulis ringens*) and management of the fishery”, *Journal of the Fisheries Board of Canada* 30(12), 2226-2235.

## 6. CONCLUSION GÉNÉRALE

---

- Briones, R., Garces, L., Ahmed, M. (2006), “8. Climate change and small pelagic fisheries in developing Asia : the economic impact on fish producers and consumers”, *Climate Change and the Economics of the World’s Fisheries : Examples Of Small Pelagic Stocks*, 215.
- Chifamba, P. C. (2000), ”The relationship of temperature and hydrological factors to catch per unit effort, condition and size of the freshwater sardine, *Limnothrissa miodon* (Boulenger), in Lake Kariba“, *Fisheries Research*, 45(3), 271-281.
- Cissé, A. A., Blanchard, F., Guyader, O. (2014), “Sustainability of tropical small-scale fisheries : Integrated assessment in French Guiana”, *Marine Policy* 44, 397-405.
- Clark, C. W. (1976), “*Mathematical Bioeconomics : The Optimal Management of Renewable Resources*”, New York : John Wiley and Sons.
- Clark, C. W. (1990), “Acoustic behavior of mysticete whales. In Sensory abilities of cetaceans”, (pp. 571-583), Springer US.
- Clark, C., Munro, G. R. (1982), “The economics of fishing and modern capital theory : a simplified approach”, in L. J. Mirman and D. F. Spulber(eds), *Essay in the Economics of Renewable resources*, Amsterdam, NL : North Holland, pp 31-54.
- Clark, C. W., Munro, G. R., Charles, A. T. (1985). “Fisheries, dynamics, and uncertainty”, *Progress in Natural Resource Economics* pp. 99-119.
- Cobb, C. W., Douglas, P. H. (1928), “A Theory of Production”, *American Economic Review* 18 (Supplement), 139–165.
- Cochrane, K. L. (2002), “The use of scientific information in the design of management strategies”. *A Fishery Manager’s Guidebook : Management measures and their application*, 95-130.
- Cohen, D. M., Inada, T., Iwamoto, T. et Scialabba, N. (1990), *Gadiform fishes of the world (order Gadiformes)*. FAO Species Catalogues, FAO Fisheries Synopsis 10(125) : 442pp.
- Crutchfield, J. A., and Zellner, A. (1962), “Economic Aspects of the Pacific Halibut Fishery”, *Fishery Industrial Research* Vol. I, No. 1, Washington : U.S. Department of the Interior.

## 6. CONCLUSION GÉNÉRALE

---

- Dorfman, R. (1969), “An economic interpretation of optimal control theory”, *American Economic Review* 59, 817-831.
- FAO (2016), *La situation mondiale des pêches et de l’aquaculture*, Contribuer à la sécurité alimentaire et à la nutrition de tous. Rome. 224 pages.
- FAO (2012), *The state of world fisheries and aquaculture*, State of World Fisheries and Aquaculture (FAO), Rome.
- FAO (2011), *Code de conduite pour une pêche responsable*. Rome. 91 pages.
- FAO (2003), *Aménagement des pêches. 2. L’approche écosystémique des pêches*. Directives techniques pour une pêche responsable, no 4, Suppl. 2. Rome.
- FAO-UN (1974), *Assessment of the world food situation present and future*. United Nations World Food Conference, Rome.
- Flaaten, Ola. (2010) *Fisheries Economics and Management*. Norwegian College of Fishery Science, 16.
- Garcia, S. M. Grainger, R. J. R. (2005), “Gloom and doom ? The future of marine capture fisheries”, *Philosophical Transactions of the Royal Society* 360, 21-46.
- Garcia, S., Le Reste, L. (1981) “Cycles vitaux, dynamique, exploitation et aménagement des stocks de crevettes pénelides côtières”. FAO, Document Technique Sur Les Pêches (203), Rome, 210 pages.
- Garza-Gil, M. (1998), “ITQ Systems in multifleet fisheries. An application for Iberoatlantic hake”, *Environmental and Resource Economics* 15, 93-106.
- Garza-Gil, M. D., Torralba-Cano, J., Varela-Lafuente, M. M. (2011), “Evaluating the economic effects of climate change on the European sardine fishery”, *Regional Environmental Change* 11, 87-95.
- Gilman, E. L., Ellison, J., Duke, N. C., Field, C. (2008), “Threats to mangroves from climate change and adaptation options : a review”, *Aquatic botany* 89(2), 237-250.
- Gordon, H. S. (1954), “*The Economic Theory of a Common-property Resource : the Fishery*”, *Journal of political economy*.

## 6. CONCLUSION GÉNÉRALE

---

- Gordon, H. S. (1956), “Obstacles to agreement on control in the fishing industry”, in *The Economics of Fisheries*, (R. Turvey and J. Wiseman, eds. (FAO, UN, Rome), pp. 65-72.
- Grafton, R. Q., Sandal, L. K., Steinshamn, S. I. (2000), “How to Improve the Management of Renewable Resources : The Case of Canada’s Northern Cod Fishery”. *American Journal of Agricultural Economics*, 82(3)570-580.
- Grafton, R. Q., Kompas, T., Hilborn, R. W. (2007), “Economics of Overexploitation Revisited”, *Science*, 318(5856) : 1601.
- Groupe d’experts intergouvernemental sur l’évolution du climat (2012) *Managing the Risks of Extreme Events and Disasters to Advance Climate Change Adaptation*. A Special Report of Working Groups I and II of the Intergovernmental Panel on Climate Change, sous la direction de C. B. Field, V. Barros, T.F. Stocker, D. Qin, D. J., Dokken, K. L. Ebi, M. D. Mastrandrea, K. J., Mach, G. K., Plattner, S. K., Allen, M., Tignor et P. M., Midgley, Cambridge (Royaume-Uni) et New York (États-Unis), Cambridge University Press, 582 pages.
- Gulland, J. A.(1970), “Summary, In : J.A. Gulland (compiler and editor), The Fish Resources of the Ocean. FAO” *Fish. Tech. Pap.* 97.
- Hamre, J. (1994), “Biodiversity and exploitation of the main fish stocks in the Norwegian-Barents Sea ecosystem”, *Biodiversity and Conservation*, 3(6), 473-492.
- Hannesson, R., Barange, M., Herrick, S. F. (2006), *Climate change and the economics of the world’s fisheries : examples of small pelagic stocks*. Edward Elgar Publishing.
- Henderson, J., Tugwell, M. (1979), “Exploitation of the lobster fishery : Some empirical results”, *Journal of Environmental Economics and Management* 6, 287-296.
- Hilborn, R. (2007), “Moving to Sustainability by Learning from Successful Fisheries”, *Ambio*, 36(4), 296-303.
- Homans, F., Wilen, J. (1997), “A model of regulated open access resource use”, *Journal of Environmental Economics and Management* 32, 1-21.



## 6. CONCLUSION GÉNÉRALE

---

- Howard, H.M., Link, J.S., Osgood, K.E., Gedamke, T., Watters, G.M., Polovina, J.J., Levin, P.S., Cyr, N., Aydin, K.Y., (2008), “Report of the NEMoW (National Ecosystem Modeling Workshop)”, NOAA Technical Memorandum NMFS-F/SPO-87, US Department of Commerce, Silver Spring, Maryland, 93 pp.
- Hutchings, J. A. et Myers, R.A. (1994), “What can be learned from the collapse of a renewable resource? Atlantic cod, *Gadus morhua*, of Newfoundland and Labrador”, *Canadian Journal of Fisheries and Aquatic Sciences* 51 : 2126-2146.
- IEDOM (2015), “Rapport annuel Guyane”, Juin 2016.
- Kamien, M. I., Schwartz, N. L. (1991), *Dynamic optimization : the calculus of variations and optimal control in economics and management*. Wilkinson, Maurice ed., Elsevier North Holland.
- Keyl, F., Wolff, M. (2008), “Environmental variability and fisheries : what can models do”, *Reviews in Fish Biology and Fisheries* 18, 273–299.
- Lampert, L. (2011a), “Etude de la crise de la pêche de la crevette en Guyane. Volume 1 : Effets de la pêcherie, hypothèses des causes”, Rapport RST Ifremer/BIODIVHAL 2011-5, Cayenne, 52 p. annexe ; [http ://archimer.ifremer.fr/doc/00075/18584/16137.pdf](http://archimer.ifremer.fr/doc/00075/18584/16137.pdf)
- Lewis, T. R. (1981), “Exploitation of a renewable resource under uncertainty”, *Canadian Journal of Economics* 14, 422-439.
- Martinet, V., Blanchard, F. (2009), “Fishery externalities and biodiversity : Trade-offs between the viability of shrimp trawling and the conservation of Frigatebirds in French Guiana”, *Ecological Economics* 68(12), 2960-2968.
- Mullon, C., Fréon, P., Cury, P. (2005), “The dynamics of collapse in world fisheries”, *Fish and Fisheries* 6(2), 111-120.
- Nostbakken, L. (2008), “Stochastic modelling of the North Sea Herring fishery under alternative management regimes”, *Marine Resource Economics* 23, 65-86.
- Opsomer, J. D., Conrad, J. M. (1994), “An open access analysis of the northern anchovy fishery”, *Journal of Environmental Economics and Management* 27, 21-37.

## 6. CONCLUSION GÉNÉRALE

---

- Peña-Torres, J., Agostini, C., Vergara, S. (2007), “Fish Stock Endogeneity in a Harvest Function : ‘El Niño’ Effects on the Chilean Jack Mackerel Fishery”, *Revista de Analisis Economico* 22(2), 75-99.
- Pissarides, C. A. (2000), *Equilibrium Unemployment Theory*, MIT Press (2nd ed.), Cambridge.
- Plourde, G. C. (1970), “A simple model of replenishible resource exploitation”, *American Economic Review* 60, 518-522.
- Quirk, J. P., Smith, V. L. (1970), “Dynamic Economic Models of Fishing”, in *Economics of Fisheries Management : A Symposium*, (A. D. Scott, ed.), University of British Columbia, Institute of Animal Resource Ecology, Vancouver, pp. 3-32.
- Ricker, W. E. (1987), “*Computation and interpretation of biological statistics of fish populations*”, Dept. of Fisheries and Oceans.
- Rivot, E., Charuau, A., Rose, J., Achoun, J. (2000), “La pêche du vivaneau rouge en Guyane. Un bilan de l’exploitation sous le régime vénézuélien, des techniques de capture à adapter et à développer”, <http://archimer.ifremer.fr/doc/00075/18614/>.
- Robertson, A. I., Duke, N. C. (1987), “Mangroves as nursery sites : comparisons of the abundance and species composition of fish and crustaceans in mangroves and other nearshore habitats in tropical Australia”, *Marine Biology* 96(2), 193-205.
- Roughgarden, J. (1998), “How to Manage Fisheries”, *Ecological Applications*, 8(1),160-164.
- Roughgarden, J., Smith, F. (1996), “Why fisheries collapse and what to do about it”, *Proceedings of the National Academy of Sciences USA* 93 : 5078-5083.
- Salz, P. (1986), “Policy Instruments for Development of Fisheries”, *Publication No. 5.74*, *The Hague : Agricultural Economics Research Institute*.
- Schaefer, M. B. (1957), “Some Considerations of Population Dynamics and Economics in Relation to the Management of the Commercial Marine Fisheries”, *Journal of the Fisheries Research Board of Canada*, 14(5), 669-681.
- Schaefer, M. (1954), “Some aspects of the dynamics of populations important to the management of commercial marine fisheries”, *Bulletin of the Inter-American tropical tuna*

## 6. CONCLUSION GÉNÉRALE

---

*commission 1* : 25–26.

- Scott, A. (1955), “The fishery : the objectives of sole ownership”, *The Journal of Political Economy*, 116-124.
- Sethi, G., Costello, C., Fisher, A., Hanemann, M., Karp, L. (2005), “Fishery management under multiple uncertainty”, *Journal of environmental economics and management* 50(2), 300-318.
- Singh, R., Weninger, Q., Doyle, M. (2006), “Fisheries management with stock growth uncertainty and costly capital adjustment”, *Journal of Environmental Economics and Management* 52(2), 582-599.
- Stock, Charles A., Alexander, Michael A., Bond, Nicholas A., Brander, Keith M., Cheung William, W. L., Curchitser, Enrique N., Delworth, Thomas L., Dunne, John P., Griffies, Stephen M., Haltuch, Melissa A., Hare, Jonathan A., Hollowed, Anne B., Lehodey, Patrick., Levin, Simon A., Link, Jason S., Rose, Kenneth A., Rykaczewski, Ryan R., Sarmiento, Jorge L., Stouffer, Ronald J., Schwing, Franklin B., Vecchi, Gabriel A., Werner, Francisco E. (2011), “On the use of IPCC-Class Models to Assess the Impact of Climate on Living Marine Resources”, *Progress in Oceanography* 88(1-4), 1-27.
- Thompson, H. (1951), “Latent fisheries resources and means for their development”, *In : Proc. U.N. Science Conference on Conservation and Utilization of Resources*, 7, 28-38.
- Unies, N. (2002), “Rapport du Sommet mondial pour le développement durable”, *Johannesburg*, 26, 9.
- Verhulst, P. F. (1838), “Notice sur la loi que la population suit dans son accroissement”, *Correspondance Mathématique et Physique* 10, 113–117.
- White, B. A. (2000), “Review of the Economics of Biological Natural Resources”, *Journal of Agricultural Economics*, 2000, 51(3), 419-462.
- Yashiv, E. (2006), “Evaluating the performance of the search and matching model”, *Contributions to Economic Analysis* 275, 509-550.
- Zhang, J. and Smith, M. D. (2011), “Estimation of a generalized fishery model : A twostage approach”, *Review of Economics and Statistics* 93(2), 690-699.



# Table des figures

1.1	Evolution de l'état des stocks marins mondiaux (1974-2011) : source FAO (2014)	4
1.2	Historique de la production des trois types de pêche de Guyane française. Source : Ifremer Guyane. . . . .	10
1.3	Dispositif TED de sélectivité (Source : Ifremer)	12
1.4	Historique de l'effort, du stock, de la capture et des profits de la pêcherie crevette de Guyane française . . . . .	13
1.5	Courbe de croissance naturelle . . . . .	16
1.6	Recettes et coûts en fonction de l'effort de pêche . . . . .	20
1.7	Les niveaux de stocks des différents régimes . . . . .	23
1.8	Les niveaux d'effort de pêche des différents régimes . . . . .	24
1.9	Les niveaux de prélèvement des différents régimes . . . . .	25
1.10	Les niveaux de profits des différents régimes . . . . .	26
1.11	Flottille de crevetiers . . . . .	39
1.12	Ligneurs vénézuéliens . . . . .	39
1.13	Les quatre types de navires de la pêche côtière . . . . .	40
2.1	The Gianas-Brazil shrimping grounds . . . . .	45
2.2	Historical path in French Guiana over 1990-2009 : Effort, Stock, Harvest levels, and Mangrove areas . . . . .	47
2.3	Effect of a change in mangrove area . . . . .	51
3.1	The Gianas-Brazil shrimping grounds . . . . .	67

3.2	Monthly variations of the shrimp landing and recruitment, Sea Surface Temperature (SST) and SOI index . . . . .	71
3.3	Mean monthly flow of the Amazon and main guianian rivers . . . . .	72
4.1	Historical path in French Guiana over 1993-2009 : sea surface temperature, shrimp stock, effort and harvest . . . . .	95
4.2	Highest scenario of the IPCC for Stock, Catches , Effort and Profits . . . . .	101
4.3	Lowest scenario of the IPCC for Stock, Catches , Effort and Profits . . . . .	101
4.4	Observed catches vs adjusted catches . . . . .	106
4.5	Cumulative Sum of the recursive residuals (CUSUM) . . . . .	110
5.1	Actual stock, fishing effort, harvest, and profits levels in the FGSE between 1990 and 2009. . . . .	120
5.2	The open access search-matching fishery equilibrium . . . . .	130
5.3	Evolution of fishing effort (total number of vessels) in the FGSE between 1990 and 2009 . . . . .	135
5.4	Evolution of actual, OA, and MEY catchability levels in the FGSE between 1990 and 2009. . . . .	135

# Liste des tableaux

1. Tableau 1.1 : Historique de la pêcherie crevettière guyanaise.
2. Tableau 1.2 : Estimations des paramètres.
3. Tableau 1.3 : Valeurs d'équilibre d'open access 1990-2009.
4. Table 1.4 : Rendement économique maximal 1990-2009.
5. Table 2.1 : Estimates of the relationship between shrimp harvest, effort and mangrove area.
6. Table 2.2 : Simulation results for the effects of mangrove on the OA equilibrium.
7. Table A2.1 : The French Guiana shrimp fishery.
8. Table A2.2 : Results from Open Access.
9. Table 3.1 : Descriptive statistics for Stock, Effort, Harvest, Temperature.
10. Table 3.1a : Descriptive statistics for Amazon, Maroni, Oyapock, Aprouague, and Comte rivers' flow.
11. Table 3. 2 : Result from OLS estimation Eq.2 and TSLS estimation of the shrimp harvest function with Niño, Niña, the sea temperature and the rivers'flow as instrumental variables.
12. Table 3.3 : First stage OLS regression. Estimation of the stock with respect to the environmental variables.
13. Table 4.2 : Estimates of the Cobb-Douglas natural growth function.

## *LISTE DES TABLEAUX*

---

14. Table 4.3 : Estimates of the shrimp harvest function.
15. Table 4.1 : Correlations between shrimp biomass, catch, sea surface temperature and effort.
16. Table A4.1 : The French Guiana shrimp fishery.
17. Table A4.2 : Estimates of the Cushing, logistic, and Ricker natural growth functions.
18. Table 4.4 : Numerical results from simulation (Status quo).
19. Table A4.2 : Estimates of the logistic, Cushing, Ricker.
20. Tableau 5.1. Parameter estimates of the harvest function for the FGSF over 1990-2009.
21. Table 5.2 : Sensitivity analysis of OA equilibrium.
22. Table 5.3 : Sensitivity analysis of the MEY equilibrium.