



**HAL**  
open science

# Mapping class groups, skein algebras and combinatorial quantization

Matthieu Faitg

► **To cite this version:**

Matthieu Faitg. Mapping class groups, skein algebras and combinatorial quantization. General Mathematics [math.GM]. Université Montpellier, 2019. English. NNT : 2019MONTTS023 . tel-02381323

**HAL Id: tel-02381323**

**<https://theses.hal.science/tel-02381323>**

Submitted on 26 Nov 2019

**HAL** is a multi-disciplinary open access archive for the deposit and dissemination of scientific research documents, whether they are published or not. The documents may come from teaching and research institutions in France or abroad, or from public or private research centers.

L'archive ouverte pluridisciplinaire **HAL**, est destinée au dépôt et à la diffusion de documents scientifiques de niveau recherche, publiés ou non, émanant des établissements d'enseignement et de recherche français ou étrangers, des laboratoires publics ou privés.

**THÈSE POUR OBTENIR LE GRADE DE DOCTEUR  
DE L'UNIVERSITÉ DE MONTPELLIER**

En Mathématiques et modélisation

École doctorale I2S - Information, Structures, Systèmes

Unité de recherche UMR 5149 - IMAG - Institut Montpellierain Alexander Grothendieck

**Groupes de difféotopie, algèbres d'écheveaux  
et quantification combinatoire**

Présentée par Matthieu FAITG

Le 16 septembre 2019

Sous la direction de Stéphane BASEILHAC et Philippe ROCHE

Devant le jury composé de

Stéphane BASEILHAC	Professeur	Université de Montpellier	Directeur
Damien CALAQUE	Professeur	Université de Montpellier	Examineur
François COSTANTINO	Professeur	Université de Toulouse III	Président du jury
Charles FROHMAN	Professeur	University of Iowa	Rapporteur
Azat GAINUTDINOV	Chargé de recherche	CNRS & Université de Tours	Rapporteur
David JORDAN	Professeur	University of Edinburgh	Examineur
Philippe ROCHE	Directeur de recherche	CNRS & Université de Montpellier	Co-directeur



**UNIVERSITÉ  
DE MONTPELLIER**

# Mapping class groups, skein algebras and combinatorial quantization

# Remerciements

Faire une thèse n'est pas une mince affaire et y parvenir nécessite le soutien d'un certain nombre de personnes, qu'il m'est agréable de remercier ici.

Je souhaite en premier lieu remercier sincèrement mes directeurs de thèse, Stéphane Baseilhac et Philippe Roche. Merci de m'avoir accordé votre confiance en me proposant ce sujet et merci pour votre disponibilité, votre compétence, vos conseils avisés, vos encouragements et votre grande sympathie. De façon générale, merci pour votre accompagnement de qualité pendant ces trois années.

Merci à Charles Frohman et Azat Gainutdinov d'avoir accepté d'être les rapporteurs de cette thèse, ainsi qu'à Damien Calaque, François Costantino et David Jordan d'avoir accepté d'en être les examinateurs. Un merci de plus à Azat pour ses nombreux commentaires et suggestions très utiles concernant mes prépublications et ce manuscrit de thèse.

Un grand merci collectif à tous les doctorants de l'IMAG (je ne prendrai pas le risque d'essayer de tous les citer) pour l'ambiance très amicale et la bonne humeur que vous avez fait régner; vous avez été un soutien très important. Plus généralement je remercie tous les membres de l'IMAG pour leur bienveillance ainsi que tous les personnels administratifs du bâtiment 9 pour leur efficacité.

Je remercie bien évidemment ma famille pour leur aide et leurs encouragements pendant toutes ces années, malgré la nature hautement mystérieuse de cette activité pour un regard extérieur. Enfin, j'ai une pensée particulière pour mes parents, qui nous ont quitté lors de ces années de thèse; c'est avec beaucoup d'émotion que je leur rend hommage et que je leur témoigne ma reconnaissance pour tout le soutien qu'ils m'ont apporté.

**Résumé.** Les algèbres  $\mathcal{L}_{g,n}(H)$  ont été introduites par Alekseev–Grosse–Schomerus et Buffenoir–Roche au milieu des années 1990, dans le cadre de la quantification combinatoire de l’espace de modules des  $G$ -connexions plates sur la surface  $\Sigma_{g,n}$  de genre  $g$  avec  $n$  disques ouverts enlevés. L’algèbre de Hopf  $H$ , appelée algèbre de jauge, était à l’origine le groupe quantique  $U_q(\mathfrak{g})$ , avec  $\mathfrak{g} = \text{Lie}(G)$ . Dans cette thèse nous appliquons les algèbres  $\mathcal{L}_{g,n}(H)$  à la topologie en basses dimensions (groupe de difféotopie et algèbres d’écheveaux des surfaces), sous l’hypothèse que  $H$  est une algèbre de Hopf de dimension finie, factorisable et enrubannée mais pas nécessairement semi-simple, l’exemple phare d’une telle algèbre de Hopf étant le groupe quantique restreint  $\bar{U}_q(\mathfrak{sl}_2)$  (où  $q$  est une racine  $2p$ -ième de l’unité).

D’abord, nous construisons en utilisant  $\mathcal{L}_{g,n}(H)$  une représentation projective des groupes de difféotopie de  $\Sigma_{g,0} \setminus D$  et de  $\Sigma_{g,0}$  (où  $D$  est un disque ouvert). Nous donnons des formules pour les représentations d’un ensemble de twists de Dehn qui engendre le groupe de difféotopie; en particulier ces formules nous permettent de montrer que notre représentation est équivalente à celle construite par Lyubashenko–Majid et Lyubashenko *via* des méthodes catégoriques. Pour le tore  $\Sigma_{1,0}$  avec l’algèbre de jauge  $\bar{U}_q(\mathfrak{sl}_2)$ , nous calculons explicitement la représentation de  $\text{SL}_2(\mathbb{Z})$  en utilisant une base convenable de l’espace de représentation et nous en déterminons la structure.

Ensuite, nous introduisons une description diagrammatique de  $\mathcal{L}_{g,n}(H)$  qui nous permet de définir de façon très naturelle l’application boucle de Wilson  $W$ . Cette application associe un élément de  $\mathcal{L}_{g,n}(H)$  à chaque entrelac dans  $(\Sigma_{g,n} \setminus D) \times [0, 1]$  qui est parallélisé, orienté et colorié par des  $H$ -modules. Quand l’algèbre de jauge est  $H = \bar{U}_q(\mathfrak{sl}_2)$ , nous utilisons  $W$  et les représentations de  $\mathcal{L}_{g,n}(H)$  pour construire des représentations des algèbres d’écheveaux  $\mathcal{S}_q(\Sigma_{g,n})$ . Pour le tore  $\Sigma_{1,0}$  nous étudions explicitement cette représentation.

**Abstract.** The algebras  $\mathcal{L}_{g,n}(H)$  have been introduced by Alekseev–Grosse–Schomerus and Buffenoir–Roche in the middle of the 1990’s, in the program of combinatorial quantization of the moduli space of flat  $G$ -connections over the surface  $\Sigma_{g,n}$  of genus  $g$  with  $n$  open disks removed. The Hopf algebra  $H$ , called gauge algebra, was originally the quantum group  $U_q(\mathfrak{g})$ , with  $\mathfrak{g} = \text{Lie}(G)$ . In this thesis we apply these algebras  $\mathcal{L}_{g,n}(H)$  to low-dimensional topology (mapping class groups and skein algebras of surfaces), under the assumption that  $H$  is a finite dimensional factorizable ribbon Hopf algebra which is not necessarily semisimple, the guiding example of such a Hopf algebra being the restricted quantum group  $\bar{U}_q(\mathfrak{sl}_2)$  (where  $q$  is a  $2p$ -th root of unity).

First, we construct from  $\mathcal{L}_{g,n}(H)$  a projective representation of the mapping class groups of  $\Sigma_{g,0} \setminus D$  and of  $\Sigma_{g,0}$  ( $D$  being an open disk). We provide formulas for the representations of Dehn twists generating the mapping class group; in particular these formulas allow us to show that our representation is equivalent to the one constructed by Lyubashenko–Majid and Lyubashenko *via* categorical methods. For the torus  $\Sigma_{1,0}$  with the gauge algebra  $\bar{U}_q(\mathfrak{sl}_2)$ , we compute explicitly the representation of  $\text{SL}_2(\mathbb{Z})$  using a suitable basis of the representation space and we determine the structure of this representation.

Second, we introduce a diagrammatic description of  $\mathcal{L}_{g,n}(H)$  which enables us to define in a very natural way the Wilson loop map  $W$ . This map associates an element of  $\mathcal{L}_{g,n}(H)$  to any link in  $(\Sigma_{g,n} \setminus D) \times [0, 1]$  which is framed, oriented and colored by  $H$ -modules. When the gauge algebra is  $H = \bar{U}_q(\mathfrak{sl}_2)$ , we use  $W$  and the representations of  $\mathcal{L}_{g,n}(H)$  to construct representations of the skein algebras  $\mathcal{S}_q(\Sigma_{g,n})$ . For the torus  $\Sigma_{1,0}$  we explicitly study this representation.

# Contents

<b>1</b>	<b>Introduction</b>	<b>7</b>
1.1	Introduction en français . . . . .	7
1.1.1	Quantification combinatoire . . . . .	7
1.1.2	Propriétés de $\mathcal{L}_{g,n}(H)$ , implémentation de la contrainte de platitude . . . . .	11
1.1.3	Représentations de groupes de difféotopie . . . . .	12
1.1.4	Équivalence avec la représentation de Lyubashenko . . . . .	14
1.1.5	Calcul graphique et théorie d'écheveau . . . . .	15
1.1.6	Perspectives . . . . .	16
1.2	Introduction in english . . . . .	18
1.2.1	Combinatorial quantization . . . . .	18
1.2.2	Properties of $\mathcal{L}_{g,n}(H)$ , implementation of the flatness constraint . . . . .	21
1.2.3	Representations of mapping class groups . . . . .	22
1.2.4	Equivalence with the Lyubashenko representation . . . . .	25
1.2.5	Graphical calculus and skein theory . . . . .	26
1.2.6	Perspectives . . . . .	27
<b>2</b>	<b>Notations and preliminaries</b>	<b>29</b>
2.1	General notations and conventions . . . . .	29
2.2	Matrices and tensors . . . . .	30
2.3	Braided Hopf algebras, factorizability, ribbon element . . . . .	32
2.4	Heisenberg double of $\mathcal{O}(H)$ . . . . .	36
2.5	Category $\text{mod}_l(H)$ , Reshetikhin–Turaev functor . . . . .	38
<b>3</b>	<b>The restricted quantum group <math>\bar{U}_q(\mathfrak{sl}_2)</math></b>	<b>41</b>
3.1	Properties of $\bar{U}_q$ . . . . .	42
3.1.1	Simple and projective $\bar{U}_q$ -modules . . . . .	42
3.1.2	Structure of the bimodule ${}_{\bar{U}_q}(\bar{U}_q)_{\bar{U}_q}$ and the center of $\bar{U}_q$ . . . . .	43
3.1.3	The braided extension of $\bar{U}_q$ . . . . .	46
3.1.4	Matrix coefficients for $\bar{U}_q$ . . . . .	47
3.2	Symmetric linear forms and the GTA basis . . . . .	49
3.3	Traces on projective $\bar{U}_q$ -modules and the GTA basis . . . . .	52
3.3.1	Correspondence between traces and symmetric linear forms . . . . .	52
3.3.2	Link with the GTA basis . . . . .	54
3.3.3	Symmetric linear form corresponding to the modified trace on $\text{Proj}_{\bar{U}_q}$ . . . . .	56
3.4	Multiplication rules in the GTA basis . . . . .	57
<b>4</b>	<b><math>\mathcal{L}_{0,1}(H)</math>, <math>\mathcal{L}_{1,0}(H)</math> and representation of the modular group <math>\text{SL}_2(\mathbb{Z})</math></b>	<b>63</b>
4.1	The loop algebra $\mathcal{L}_{0,1}(H)$ . . . . .	64
4.1.1	Definition of $\mathcal{L}_{0,1}(H)$ and $H$ -module-algebra structure . . . . .	64
4.1.2	Isomorphism $\mathcal{L}_{0,1}(H) \cong H$ . . . . .	67
4.2	The handle algebra $\mathcal{L}_{1,0}(H)$ . . . . .	69
4.2.1	Definition of $\mathcal{L}_{1,0}(H)$ and $H$ -module-algebra structure . . . . .	69

4.2.2	Isomorphism $\mathcal{L}_{1,0}(H) \cong \mathcal{H}(\mathcal{O}(H))$ . . . . .	72
4.2.3	Representation of $\mathcal{L}_{1,0}^{\text{inv}}(H)$ on $\text{SLF}(H)$ . . . . .	73
4.3	Projective representation of $\text{SL}_2(\mathbb{Z})$ . . . . .	78
4.3.1	Mapping class group of the torus . . . . .	78
4.3.2	Automorphisms $\tilde{\tau}_a$ and $\tilde{\tau}_b$ . . . . .	79
4.3.3	Projective representation of $\text{SL}_2(\mathbb{Z})$ on $\text{SLF}(H)$ . . . . .	80
4.3.4	Equivalence with the Lyubashenko-Majid representation . . . . .	83
4.4	The case of $H = \bar{U}_q(\mathfrak{sl}_2)$ . . . . .	85
4.4.1	Technical details . . . . .	85
4.4.2	$\mathcal{L}_{0,1}(\bar{U}_q)$ and $\mathcal{L}_{1,0}(\bar{U}_q)$ . . . . .	86
4.4.3	Explicit description of the $\text{SL}_2(\mathbb{Z})$ -projective representation . . . . .	88
4.4.4	A conjecture about the representation of $\mathcal{L}_{1,0}^{\text{inv}}(\bar{U}_q)$ on $\text{SLF}(\bar{U}_q)$ . . . . .	92
<b>5</b>	<b><math>\mathcal{L}_{g,n}(H)</math> and projective representations of mapping class groups</b>	<b>95</b>
5.1	Definition and properties of $\mathcal{L}_{g,n}(H)$ . . . . .	96
5.1.1	Braided tensor product and definition of $\mathcal{L}_{g,n}(H)$ . . . . .	96
5.1.2	The Alekseev isomorphism . . . . .	98
5.1.3	$\mathcal{L}_{g,n}(H)$ as an algebra of functions and LGFT . . . . .	99
5.2	Representation of $\mathcal{L}_{g,n}^{\text{inv}}(H)$ . . . . .	102
5.3	Projective representation of the mapping class group . . . . .	105
5.3.1	Mapping class group of $\Sigma_g$ . . . . .	106
5.3.2	Normalization of simple closed curves . . . . .	108
5.3.3	Lifting simple loops and mapping classes to $\mathcal{L}_{g,0}(H)$ . . . . .	111
5.3.4	Representation of the mapping class group . . . . .	115
5.3.5	Discussion for the case $n > 0$ . . . . .	117
5.3.6	Explicit formulas for the representation of some Dehn twists . . . . .	118
5.4	Equivalence with the Lyubashenko representation . . . . .	122
5.4.1	The Lyubashenko representation for $\text{mod}_l(H)$ . . . . .	122
5.4.2	Equivalence of the representations . . . . .	125
<b>6</b>	<b>Graphical calculus and relation to skein theory</b>	<b>129</b>
6.1	Diagrammatic description of $\mathcal{L}_{g,n}(H)$ . . . . .	130
6.2	The Wilson loop map . . . . .	137
6.3	Graphical calculus when $H = \bar{U}_q(\mathfrak{sl}_2)$ . . . . .	145
6.4	Representation of the skein algebra at roots of unity . . . . .	151
6.5	Explicit study of the representation of $\mathcal{S}_q(\Sigma_1)$ . . . . .	153
6.5.1	Structure of the representation . . . . .	153
6.5.2	Relationship with the skein representation . . . . .	156

# Chapter 1

## Introduction

### 1.1 Introduction en français

Soit  $\Sigma_{g,n}$  une surface compacte orientée de genre  $g$  avec  $n$  disques ouverts enlevés. “L’algèbre de graphe”  $\mathcal{L}_{g,n}$  a été introduite et étudiée par Alekseev [Ale94], Alekseev–Grosse–Schomerus [AGS95, AGS96] et Buffenoir–Roche [BR95, BR96] au milieu des années 1990, dans le cadre de la quantification combinatoire de l’espace de modules des connexions plates sur  $\Sigma_{g,n}$ . C’est une algèbre associative (non commutative) définie par générateurs et relations, les relations étant données sous une forme matricielle. Le thème principal de cette thèse est d’appliquer ces algèbres à la construction de représentations quantiques des groupes de difféotopie et des algèbres d’écheveaux des surfaces aux racines de l’unité.

Dans la section 1.1.1 ci-dessous, nous expliquons le contexte et les idées de la quantification combinatoire et la définition de l’algèbre  $\mathcal{L}_{g,n}$ . Puis de la section 1.1.2 à la section 1.1.5 nous énonçons et expliquons nos principaux résultats. Enfin, la section 1.1.6 contient des conjectures et problèmes qui peuvent être le point de départ d’autres travaux.

#### 1.1.1 Quantification combinatoire

Nous rappelons rapidement les principaux ingrédients de la quantification combinatoire. Soit  $G$  un groupe de Lie algébrique (généralement supposé connexe et simplement connexe, par exemple  $G = \mathrm{SL}_2(\mathbb{C})$ ) et  $\Sigma_{g,n}$  une surface compacte orientée de genre  $g$  avec  $n$  disques ouverts enlevés. On considère l’espace de modules des  $G$ -connexions plates  $\mathcal{M}_{g,n} = \mathcal{A}_f/\mathcal{G}$ , où  $\mathcal{A} = \Omega^1(\Sigma_{g,n}, \mathfrak{g})$  est identifié avec l’espace de toutes les  $G$ -connexions,  $\mathcal{A}_f$  est le sous-espace des connexions plates, et  $\mathcal{G} = C^\infty(\Sigma_{g,n}, G)$  est le groupe de jauge. Ces objets peuvent être décrits de façon discrète et combinatoire, en utilisant les holonomies le long des arêtes d’un graphe remplissant. Il s’agit d’un graphe orienté plongé sur  $\Sigma_{g,n}$  (ses sommets  $v \in V$  sont des points de  $\Sigma_{g,n}$  et ses arêtes  $e \in E$  sont des courbes simples orientées sur  $\Sigma_{g,n}$  qui relient deux sommets et qui ne se croisent pas entre elles) tel que  $\Sigma_{g,n} \setminus \Gamma$  est une réunion de disques ouverts. Soit  $\mathcal{A}_d = G^E$ . Un élément de  $\mathcal{A}_d$  est appelé une connexion discrète; il doit être pensé comme la collection  $(h_e)_{e \in E}$  des holonomies d’une connexion le long des arêtes de  $\Gamma$ . Si  $\gamma = (e_1, \dots, e_k)$  est un chemin dans  $\Gamma$ , on définit l’holonomie discrète d’une connexion discrète  $(h_e)_{e \in E}$  le long  $\gamma$  comme étant le produit  $h_{e_1} \dots h_{e_k}$ . Une connexion discrète est dite plate si son holonomie le long de toute face du graphe vaut 1. Ceci donne l’ensemble  $\mathcal{A}_{df} \subset \mathcal{A}_d$  des connexions discrètes plates. Enfin, le groupe de jauge  $\mathcal{G}$  agit par conjugaison sur l’holonomie le long d’une courbe d’une connexion dans  $\mathcal{A}$ . Ainsi, nous définissons le groupe de jauge discret comme étant  $\mathcal{G}_d = G^V$  et son action sur les connexions discrètes est  $(h_v)_{v \in V} \cdot (h_e)_{e \in E} = (h_e - h_e h_{e^+}^{-1})$ , où  $e^-$  est le point de départ de  $e$  et  $e^+$  est son point d’arrivée. Un résultat connu affirme que  $\mathcal{A}_{df}/\mathcal{G}_d \cong \mathrm{Hom}(\pi_1(\Sigma_{g,n}), G)/G$  (en principe le quotient est à considérer dans le cadre de la théorie géométrique des invariants (quotient GIT), mais ici la discussion est informelle). Donc cette construction est équivalente à la variété des caractères, qui est un modèle pour  $\mathcal{M}_{g,n}$ . Pour plus d’informations sur l’espace de modules et sa



description combinatoire, une référence accessible est [Lab13]. Cette description est aussi appelée une théorie de jauge discrète, cf. [BFK98a].

L'espace de modules  $\mathcal{A}_f/\mathcal{G}$  est muni de la structure de Poisson d'Atiyah–Bott–Goldman [AB83, Gol86], c'est-à-dire qu'on a un crochet de Poisson sur l'algèbre des fonctions  $\mathbb{C}[\mathcal{A}_f/\mathcal{G}] = \mathbb{C}[\mathcal{A}_f]^{\mathcal{G}}$ . La structure de Poisson correspondante sur la discrétisation  $\mathcal{A}_{df}/\mathcal{G}_d$  a été décrite par Fock–Rosly [FR93]; c'est un crochet de Poisson définit de façon matricielle sur l'algèbre des fonctions  $\mathbb{C}[\mathcal{A}_d]$  et qui induit un crochet de Poisson sur  $\mathbb{C}[\mathcal{A}_{df}]^{\mathcal{G}_d}$  (où le groupe de jauge agit à droite sur les fonctions de façon évidente). L'algèbre  $\mathcal{L}_{g,n}$  est une quantification de  $\mathbb{C}[\mathcal{A}_d]$ . Nous n'avons pas besoin de détailler plus ce fait puisque nous ne l'utilisons pas dans cette thèse. Dans la suite, nous expliquons simplement l'analogie entre  $\mathcal{L}_{g,n}$  et  $\mathbb{C}[\mathcal{A}_d]$ .

Ici nous utiliserons toujours le graphe  $\Gamma = \Gamma_{g,n} \subset \Sigma_{g,n}$  qui a un seul sommet et dont les arêtes forment un système de générateurs du groupe fondamental :

$$\Gamma_{g,n} = (\{\bullet\}, \{b_1, a_1, \dots, b_g, a_g, m_{g+1}, \dots, m_{g+n}\}).$$

Il est représenté ci-dessous :

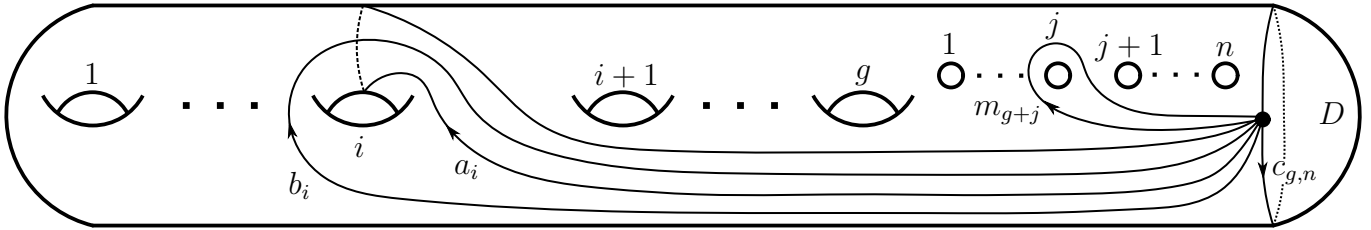

On a  $\Sigma_{g,n} \setminus \Gamma_{g,n} \cong D$ , où  $D$  est un disque ouvert. Ainsi, le voisinage tubulaire fermé de  $\Gamma_{g,n}$  est homéomorphe à  $\Sigma_{g,n} \setminus D$  :

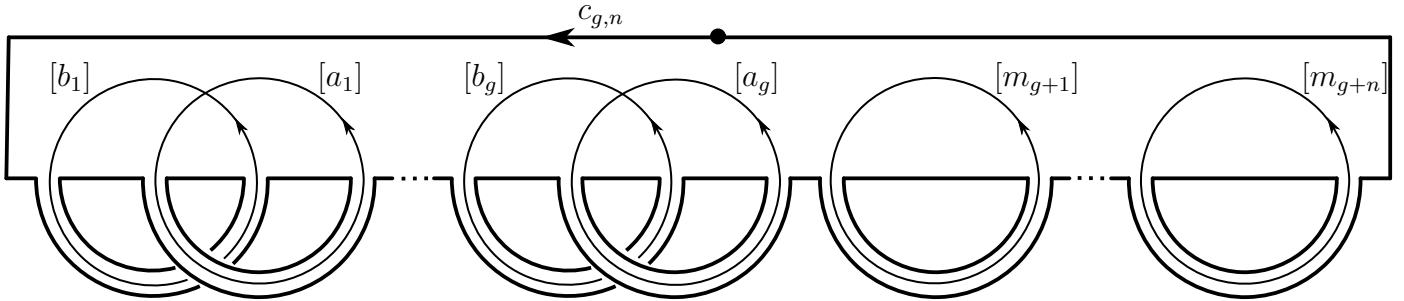

où  $[x]$  dénote la classe d'homotopie libre de  $x \in \pi_1(\Sigma_{g,n} \setminus D)$ . L'unique face du graphe  $\Gamma_{g,n}$  est la courbe induite par la suppression de  $D$  :

$$c_{g,n} = b_1 a_1^{-1} b_1^{-1} a_1 \dots b_g a_g^{-1} b_g^{-1} a_g m_{g+1} \dots m_{g+n}.$$

Avec ce choix de graphe, une connexion discrète  $A_d \in \mathcal{A}_d$  associe un élément de  $G$  à chaque générateur de  $\pi_1(\Sigma_{g,n} \setminus D)$ , et peut donc être identifiée avec une liste d'éléments de  $G$  :

$$A_d = (h_{b_1}, h_{a_1}, \dots, h_{b_g}, h_{a_g}, h_{m_{g+1}}, \dots, h_{m_{g+n}}) \in G^{2g+n}.$$

Une connexion discrète plate  $A_d \in \mathcal{A}_{df}$  associe un élément de  $G$  à chaque générateur de  $\pi_1(\Sigma_{g,n}) = \pi_1(\Sigma_{g,n} \setminus D) / \langle c_{g,n} \rangle$ . Il s'agit d'une liste  $(h_{b_1}, h_{a_1}, \dots, h_{b_g}, h_{a_g}, h_{m_{g+1}}, \dots, h_{m_{g+n}})$  d'éléments de  $G$  qui vérifie que

$$\text{Hol}(A_d, c_{g,n}) = h_{b_1} h_{a_1}^{-1} h_{b_1}^{-1} h_{a_1} \dots h_{b_g} h_{a_g}^{-1} h_{b_g}^{-1} h_{a_g} h_{m_{g+1}} \dots h_{m_{g+n}} = 1. \quad (1.1)$$

Le groupe de jauge discret est simplement  $\mathcal{G}_d = G$  (puisque  $V = \{\bullet\}$ ). L'action de  $h \in G$  sur une connexion discrète se fait par conjugaison :

$$\begin{aligned} & h \cdot (h_{b_1}, h_{a_1}, \dots, h_{b_g}, h_{a_g}, h_{m_{g+1}}, \dots, h_{m_{g+n}}) \\ &= (h h_{b_1} h^{-1}, h h_{a_1} h^{-1}, \dots, h h_{b_g} h^{-1}, h h_{a_g} h^{-1}, h h_{m_{g+1}} h^{-1}, \dots, h h_{m_{g+n}} h^{-1}). \end{aligned}$$

En d'autres termes :

$$\begin{aligned} \mathcal{A}_d &= \text{Hom}(\pi_1(\Sigma_{g,n} \setminus D), G), & \mathcal{A}_{df} &= \text{Hom}(\pi_1(\Sigma_{g,n}), G), \\ \mathcal{A}_d/\mathcal{G}_d &= \text{Hom}(\pi_1(\Sigma_{g,n} \setminus D), G)/G, & \mathcal{A}_{df}/\mathcal{G}_d &= \text{Hom}(\pi_1(\Sigma_{g,n}), G)/G, \end{aligned}$$

et on retrouve la variété des caractères.

Il est pertinent pour la suite de décrire l'algèbre commutative des fonctions  $\mathbb{C}[\mathcal{A}_d] = \mathbb{C}[G]^{\otimes(2g+n)}$  en termes de matrices (où  $\mathbb{C}[G]$  est l'algèbre des fonctions sur  $G$ ). Soit  $V$  une représentation (de dimension finie) de  $G$  avec une base  $(v_i)$  et une base duale  $(v^j)$ . On rappelle que les coefficients matriciels de  $V$  dans cette base sont  $T_j^i \in \mathbb{C}[G]$ , définis par  $T_j^i(h) = v^i(h \cdot v_j)$ . Ceci donne une matrice  $T$  qui a ses coefficients dans  $\mathbb{C}[G]$ . Les coefficients matriciels  $T_j^i$ , où  $V$  parcourt l'ensemble des  $G$ -modules de dimension finie, engendrent linéairement  $\mathbb{C}[G]$ . Définissons  $B(k), A(k), M(l) \in \text{Mat}_{\dim(V)}(\mathbb{C}[\mathcal{A}_d])$  par

$$\begin{aligned} B(k)_j^i(h_{b_1}, h_{a_1}, \dots, h_{b_g}, h_{a_g}, h_{m_{g+1}}, \dots, h_{m_{g+n}}) &= T_j^i(h_{b_k}), \\ A(k)_j^i(h_{b_1}, h_{a_1}, \dots, h_{b_g}, h_{a_g}, h_{m_{g+1}}, \dots, h_{m_{g+n}}) &= T_j^i(h_{a_k}), \\ M(l)_j^i(h_{b_1}, h_{a_1}, \dots, h_{b_g}, h_{a_g}, h_{m_{g+1}}, \dots, h_{m_{g+n}}) &= T_j^i(h_{m_l}). \end{aligned}$$

Les coefficients de ces matrices engendrent  $\mathbb{C}[\mathcal{A}_d]$  en tant qu'algèbre ( $V$  parcourant l'ensemble des  $G$ -modules de dimension finie). Le groupe de jauge  $G$  agit sur  $\mathbb{C}[\mathcal{A}_d]$  à droite :  $(f \cdot h)(x) = f(h \cdot x)$ . En termes de matrices, l'action se fait par conjugaison :

$$\forall h \in G, \quad U(k) \cdot h = {}^V U(k) {}^V h^{-1} \quad (1.2)$$

où  $h = T(h)$  est la représentation de  $h$  sur  $V$  et  $U$  est  $B, A$  ou  $M$ . Les fonctions invariantes forment une sous-algèbre,  $\mathbb{C}[\mathcal{A}_d/G] = \mathbb{C}[\mathcal{A}_d]^G$ , et sont appelées observables (classiques) dans le contexte des théories de jauge discrètes. On a ainsi décrit  $\mathbb{C}[\mathcal{A}_d]$  de façon matricielle.

Dans le but de quantifier la structure de Poisson de Fock–Rosly, Alekseev [Ale94], Alekseev–Grosse–Schomerus [AGS95, AGS96] et Buffenoir–Roche [BR95, BR96] ont remplacé le groupe de Lie  $G$  par un groupe quantique  $U_q(\mathfrak{g})$ , avec  $\mathfrak{g} = \text{Lie}(G)$  (mentionnons tout de suite que d'un point de vue purement algébrique on peut prendre n'importe quelle algèbre de Hopf enrubannée à la place de  $U_q(\mathfrak{g})$ ). Ils ont défini une algèbre associative (non-commutative)

$$\mathcal{L}_{g,n} = \mathbb{C}\langle B(k)_j^i, A(k)_j^i, M(l)_j^i \mid \text{relations } (\mathcal{R}) \rangle_{I,i,j,k,l}$$

qui est une déformation de  $\mathbb{C}[\mathcal{A}_d]$ , engendrée par les variables  $B(k)_j^i, A(k)_j^i, M(l)_j^i$  où  $I$  parcourt maintenant l'ensemble des  $U_q(\mathfrak{g})$ -modules de dimension finie. Les relations  $(\mathcal{R})$  sont données sous forme matricielle. Elles font intervenir la  $R$ -matrice de  $U_q(\mathfrak{g})$  et sont conçues de sorte que  $\mathcal{L}_{g,n}$  est un  $U_q(\mathfrak{g})$ -module-algèbre à droite pour l'action

$$\forall h \in U_q(\mathfrak{g}), \quad U(k) \cdot h = h' U(k) S(h'')$$

qui est l'analogue de (1.2),  $S$  étant l'antipode de  $U_q(\mathfrak{g})$ ,  $\Delta(h) = h' \otimes h''$  le coproduit et  $U = B, A$  ou  $M$ . En particulier, on a une sous-algèbre des éléments invariants  $\mathcal{L}_{g,n}^{\text{inv}}$ , qui est l'analogue de la sous-algèbre des observables classiques  $\mathbb{C}[\mathcal{A}_d]^G$ . Notons que  $\mathcal{L}_{g,n}$  est vraiment une algèbre quantique de fonctions, dans le sens qu'il est possible d'évaluer n'importe quel élément de  $\mathcal{L}_{g,n}$  sur une connexion discrète; ceci est discuté en détail dans les Remarques 4.1.9, 4.2.9 et dans la section 5.1.3.

Il est plus difficile de mettre en oeuvre l'analogue quantifié de la contrainte de platitude (1.1), à savoir que pour tout  $I$  :

$${}^I C_{g,n} = {}^I B(1) {}^I A(1)^{-1} {}^I B(1)^{-1} {}^I A(1) \dots {}^I B(g) {}^I A(g)^{-1} {}^I B(g)^{-1} {}^I A(g) {}^I M(g+1) \dots {}^I M(g+n) = \mathbb{I}_{\dim(I)}. \quad (1.3)$$

En effet, il n'est pas possible de considérer le quotient  $\mathcal{L}_{g,n}^{\text{inv}} / \langle ({}^I C_{g,n})_j^i - \delta_j^i \rangle_{I,i,j}$ , puisque les éléments  $({}^I C_{g,n})_j^i - \delta_j^i$  ne sont pas invariants. Il n'est pas non plus possible de quotienter toute l'algèbre  $\mathcal{L}_{g,n}$  (avant de se restreindre aux éléments invariants) car l'algèbre qui en résulte peut être réduite à  $0^1$ . La mise en oeuvre de la contrainte de platitude, qui donne lieu à "l'algèbre de modules" (qui est un analogue quantique de  $\mathbb{C}[\mathcal{A}_d/G]$ ), diffère selon les auteurs et leurs hypothèses sur l'algèbre de jauge. Par exemple :

- Dans [AGS95, AGS96, AS96a], l'algèbre de jauge n'est pas  $U_q(\mathfrak{g})$  mais plutôt une algèbre de Hopf modulaire (pensée comme une troncation semi-simple de  $U_q(\mathfrak{g})$ , où  $q$  est une racine de l'unité). Ils construisent des "projecteurs caractéristiques" grâce aux bonnes propriétés de la  $S$ -matrice dans le cadre modulaire et utilisent ces projecteurs pour définir l'algèbre de modules comme une sous-algèbre de  $\mathcal{L}_{g,n}^{\text{inv}}$  (c'est-à-dire le produit de  $\mathcal{L}_{g,n}^{\text{inv}}$  par ces projecteurs).
- Dans [BNR02], l'algèbre de jauge est  $U_q(\mathfrak{g})$  avec  $q$  générique. Ils considèrent toutes les matrices  ${}^I Y \in \mathcal{L}_{g,n} \otimes \text{End}_{\mathbb{C}}(I)$  (où  $I$  n'est pas fixé) qui satisfont  ${}^I Y \cdot h = {}^I h' Y S({}^I h'')$  (les produits de  ${}^I B(i), {}^I A(j), {}^I M(k)$  sont des exemples immédiats de telles matrices). La trace quantique  $\text{tr} \left( {}^I g Y ({}^I C_{g,n} - \mathbb{I}_{\dim(I)}) \right)$  (où  $g$  est l'élément pivot) est un élément invariant et on peut considérer l'idéal  $\mathcal{I} \subset \mathcal{L}_{g,n}^{\text{inv}}$  engendré par toutes ces traces quantiques. Alors ils définissent l'algèbre de modules comme étant  $\mathcal{L}_{g,n}^{\text{inv}} / \mathcal{I}$ . Cette construction est insuffisante quand l'algèbre de jauge n'est pas semi-simple car dans ce cas il y a des invariants qui ne peuvent pas s'écrire sous la forme  $\text{tr}({}^I g X)$ .
- Dans [MW15], l'algèbre de jauge  $K$  est de dimension finie et semi-simple pour la construction de l'algèbre de modules. Ils utilisent une cointégrale bilatère de  $H$  (appelée intégrale de Haar dans leur article, et dont l'existence est assurée par ces hypothèses sur  $K$ ) pour construire des projecteurs associés à chaque face du graphe  $\Gamma$ . Ils définissent alors l'algèbre de modules comme l'image de l'algèbre des observables par ces projecteurs (ceci donne une sous-algèbre de l'algèbre des observables, équivalente à celle de [AGS95, AGS96, AS96a]). Notons cependant que le formalisme de leur article (qui contient une axiomatisation et une étude des théories de jauge avec les algèbres de Hopf) est différent de celui utilisé ici.

Une définition possible de l'algèbre de modules sous nos hypothèses sur l'algèbre de jauge (qui n'incluent pas la semi-simplicité) est donnée dans la section 1.1.2 ci-dessous.

En plus des articles déjà mentionnés, ces algèbres de fonctions quantifiées et leurs généralisations apparaissent dans de nombreux travaux. Par exemple : [BFK98b] (définition d'une comultiplication sur les connexions (duale au produit dans  $\mathcal{L}_{g,n}$ , voir section 5.1.3), de l'holonomie et des boucles de Wilson au moyen de multitangles, qui sont des transformations agissant sur le graphe  $\Gamma$  et sur les connexions discrètes), [BZBJ18] (généralisation de  $\mathcal{L}_{g,n}$  dans un cadre catégorique avec l'homologie de factorisation), [AGPS18] (étude de  $\mathcal{L}_{1,0}$  avec la (super-) algèbre de jauge  $\bar{U}_q(\mathfrak{gl}(1|1))$  et de la représentation de  $\text{SL}_2(\mathbb{Z})$  associée), [GJS19] (variétés de caractères quantifiées aux racines de l'unité et définition de l'algèbre de modules *via* leur procédé de réduction Hamiltonienne quantique).

<sup>1</sup>Par exemple, sous nos hypothèses sur l'algèbre de jauge détaillées ci-dessous,  $\mathcal{L}_{1,0}(H)$  est isomorphe à une algèbre de matrices sur  $\mathbb{C}$  et son seul quotient possible est 0.

Comme nous l'avons déjà dit, la définition de  $\mathcal{L}_{g,n}$  est purement algébrique et n'importe quelle algèbre de Hopf enrubannée  $H$  peut jouer le rôle de l'algèbre de jauge; l'algèbre de graphe correspondante sera notée  $\mathcal{L}_{g,n}(H)$ . Dans cette thèse, nous supposons de plus que  $H$  est de dimension finie et factorisable, mais pas nécessairement semi-simple. L'exemple phare d'une telle algèbre de Hopf sera pour nous le groupe quantique restreint  $\bar{U}_q(\mathfrak{sl}_2)$ , noté  $\bar{U}_q$  dans la suite; le Chapitre 3 est dédié aux propriétés de  $\bar{U}_q$ .

Nous présentons maintenant nos principaux résultats en détail.

### 1.1.2 Propriétés de $\mathcal{L}_{g,n}(H)$ , implémentation de la contrainte de platitude

Sous nos hypothèses sur  $H$  (dimension finie, factorisable, enrubannée), l'algèbre de boucle  $\mathcal{L}_{0,1}(H)$  est isomorphe à  $H$  (Proposition 4.1.8), l'algèbre de anse  $\mathcal{L}_{1,0}(H)$  est isomorphe au double d'Heisenberg  $\mathcal{H}(\mathcal{O}(H))$  et donc à une algèbre de matrices sur  $\mathbb{C}$  (Proposition 4.2.8), et l'isomorphisme d'Alekseev reste vrai (Proposition 5.1.3) :

$$\mathcal{L}_{0,1}(H) \cong H, \quad \mathcal{L}_{1,0}(H) \cong \mathcal{H}(\mathcal{O}(H)) \cong \text{End}_{\mathbb{C}}(H^*), \quad \mathcal{L}_{g,n}(H) \cong \mathcal{L}_{1,0}(H)^{\otimes g} \otimes \mathcal{L}_{0,1}(H)^{\otimes n}.$$

Il s'ensuit que les représentations indécomposables de  $\mathcal{L}_{g,n}(H)$  sont de la forme

$$(H^*)^{\otimes g} \otimes I_1 \otimes \dots \otimes I_n$$

où  $H^*$  est l'unique représentation indécomposable (et simple) de  $\mathcal{H}(\mathcal{O}(H)) \cong \text{End}_{\mathbb{C}}(H^*)$  et  $I_1, \dots, I_n$  sont des représentations de  $H$ .

Comme nous ne supposons pas que  $H$  est semi-simple, les définitions de l'algèbre de modules mentionnées plus haut ne peuvent pas être utilisées. A la place, nous allons implémenter la contrainte de platitude au niveau des représentations : pour chaque représentation  $V$  de  $\mathcal{L}_{g,n}(H)$ , nous définissons un sous-espace  $\text{Inv}(V)$  par la condition que les matrices  $\overset{I}{C}_{g,n}$  agissent trivialement sur  $\text{Inv}(V)$  :

$$\text{Inv}(V) = \left\{ v \in V \mid \forall I, \overset{I}{C}_{g,n} \triangleright v = \mathbb{I}_{\dim(I)} v \right\}.$$

Notons que la relation qui définit  $\text{Inv}(V)$  correspond géométriquement à recoller le disque  $D$  à  $\Sigma_{g,n} \setminus D$  (puisque la boucle  $c_{g,n}$  qui engendre  $\ker(\pi_1(\Sigma_{g,n} \setminus D) \rightarrow \pi_1(\Sigma_{g,n}))$  est détruite).

En fait, le sous-espace  $\text{Inv}(V)$  est stable sous l'action de la sous-algèbre des éléments invariants  $\mathcal{L}_{g,n}^{\text{inv}}(H)$  :

**Théorème 5.2.6.** 1) Un élément  $x \in \mathcal{L}_{g,n}(H)$  est invariant sous l'action de l'algèbre de jauge  $H$  si, et seulement si, pour tout  $H$ -module  $I$ ,  $\overset{I}{C}_{g,n}x = x\overset{I}{C}_{g,n}$ .  
 2) Soit  $V$  une représentation de  $\mathcal{L}_{g,n}(H)$ . Alors  $\text{Inv}(V)$  est stable sous l'action des éléments invariants et fournit donc une représentation de  $\mathcal{L}_{g,n}^{\text{inv}}(H)$ .

Les matrices  $\overset{I}{C}_{g,n}$  utilisées dans ce théorème étaient déjà dans [Ale94] (avec  $H = U_q(\mathfrak{g})$ ,  $q$  générique), mais ici nous avons besoin de généraliser et d'adapter la construction des représentations des éléments invariants à nos hypothèses sur  $H$ .

Quand  $(g, n) = (1, 0)$ ,  $\mathcal{L}_{1,0}(H)$  est isomorphe à une algèbre de matrices et son unique représentation indécomposable (et simple) est  $H^*$ ; dans ce cas, nous avons une représentation de  $\mathcal{L}_{1,0}^{\text{inv}}(H)$  sur  $\text{Inv}(H^*) = \text{SLF}(H)$  (Théorème 4.2.13), où  $\text{SLF}(H)$  est l'algèbre des formes linéaires symétriques sur  $H$  :

$$\text{SLF}(H) = \{ \varphi \in H^* \mid \forall x, y \in H, \varphi(xy) = \varphi(yx) \}.$$

La définition de l'algèbre de modules dans [AGS95, AGS96, AS96a, BNR02] requiert de marquer les cercles de bord par des  $H$ -modules  $I_1, \dots, I_n$ . Alors  $V = (H^*)^{\otimes g} \otimes I_1 \otimes \dots \otimes I_n$  est une

représentation de  $\mathcal{L}_{g,n}(H)$ ; soit  $\rho_{\text{inv}}^V$  la représentation associée de  $\mathcal{L}_{g,n}^{\text{inv}}(H)$  sur  $\text{Inv}(V)$ . L'algèbre  $\rho_{\text{inv}}^V(\mathcal{L}_{g,n}^{\text{inv}}(H))$  implémente à la fois les contraintes d'invariance et de platitude. C'est donc un analogue quantique de  $\mathbb{C}[\mathcal{A}_{df}/G]$  et c'est le candidat naturel pour la définition de l'algèbre de modules sous nos hypothèses sur  $H$  :

$$\mathcal{M}_{g,n}(H, I_1, \dots, I_n) = \rho_{\text{inv}}^{(H^*)^{\otimes g} \otimes I_1 \otimes \dots \otimes I_n}(\mathcal{L}_{g,n}^{\text{inv}}(H)). \quad (1.4)$$

Cependant, nous n'aurons pas besoin de l'algèbre de modules dans cette thèse. À la place, l'objet important pour nos desseins est la représentation  $\text{Inv}(V)$  de  $\mathcal{L}_{g,n}^{\text{inv}}(H)$  (qui est aussi une représentation de l'algèbre de modules).

### 1.1.3 Représentations de groupes de difféotopie

Le groupe de difféotopie  $\text{MCG}(\Sigma_{g,n})$  agit sur  $\mathbb{C}[\text{Hom}(\pi_1(\Sigma_{g,n}), G)/G] = \mathbb{C}[\mathcal{A}_{df}/G]$ . Dans les Chapitres 4 (cas du tore) et 5 (cas général), nous construisons l'analogue de cette représentation (pour  $n = 0$ ) basé sur  $\mathcal{L}_{g,0}(H)$  et nous obtenons une représentation projective de  $\text{MCG}(\Sigma_{g,0} \setminus D)$  et surtout de  $\text{MCG}(\Sigma_{g,0})$ . Nous utilisons l'idée, proposée dans [AS96a], de remplacer les générateurs  $b_i, a_i, m_j$  de  $\pi_1(\Sigma_{g,0} \setminus D)$  par les matrices  $\overset{I}{B}(k), \overset{I}{A}(k), \overset{I}{M}(l)$  à coefficients dans  $\mathcal{L}_{g,0}(H)$ . De cette façon, chaque classe de difféotopie  $f \in \text{MCG}(\Sigma_{g,0} \setminus D)$  peut être vue comme un automorphisme de  $\mathcal{L}_{g,0}(H)$ , noté  $\tilde{f}$  et que nous appelons le relevé de  $f$ . En effet,  $f$  détermine un automorphisme de  $\pi_1(\Sigma_{g,0} \setminus D)$  et en remplaçant les (classes d'homotopie des) boucles par des matrices on définit  $\tilde{f}$  (à une normalisation près, cf. Définition (5.3.9)). Grâce aux isomorphismes de la section précédente

$$\mathcal{L}_{g,0}(H) \cong \mathcal{L}_{1,0}(H)^{\otimes g} \cong \mathcal{H}(\mathcal{O}(H))^{\otimes g} \cong \text{End}_{\mathbb{C}}((H^*)^{\otimes g}),$$

et on obtient que  $\mathcal{L}_{g,0}(H)$  est une algèbre de matrices, son unique représentation indécomposable (et simple) étant  $(H^*)^{\otimes g}$ . Il s'ensuit que tout automorphisme de  $\mathcal{L}_{g,0}(H)$  est intérieur; en particulier, à la classe de difféotopie  $f$  est associé un élément  $\hat{f} \in \mathcal{L}_{g,n}(H)$ , unique à scalaire près, et tel que  $\tilde{f}$  est la conjugaison par  $\hat{f}$ . Un tel élément  $\hat{f}$  est  $H$ -invariant (Corollaire (5.3.17)). En représentant les éléments  $\hat{f}$  sur  $(H^*)^{\otimes g}$  on obtient une représentation projective de  $\text{MCG}(\Sigma_{g,0} \setminus D)$  et en représentant les éléments  $\hat{f}$  sur  $\text{Inv}((H^*)^{\otimes g})$  on obtient une représentation projective de  $\text{MCG}(\Sigma_{g,0})$ , ce qui correspond au fait que le disque  $D$  est "recollé" dans  $\text{Inv}((H^*)^{\otimes g})$ .

Le cas du tore  $\Sigma_{1,0}$  est considéré en premier et à part car il mérite une attention particulière. Le résultat est énoncé comme suit :

**Théorème 4.3.7 (cas du tore).** 1) *L'affectation*

$$\tau_a \mapsto \rho(v_A^{-1}), \quad \tau_b \mapsto \rho(v_B^{-1})$$

où  $\rho$  est la représentation de  $\mathcal{L}_{1,0}(H)$  sur  $H^*$ , définit une représentation  $\theta_1^D$  de  $\text{MCG}(\Sigma_{1,0} \setminus D)$  sur  $H^*$ .

2) *L'affectation*

$$\tau_a \mapsto \rho_{\text{SLF}}(v_A^{-1}), \quad \tau_b \mapsto \rho_{\text{SLF}}(v_B^{-1})$$

où  $\rho_{\text{SLF}}$  est la représentation de  $\mathcal{L}_{1,0}^{\text{inv}}(H)$  sur  $\text{Inv}(H^*) = \text{SLF}(H)$ , définit une représentation projective  $\theta_1$  de  $\text{MCG}(\Sigma_{1,0}) = \text{SL}_2(\mathbb{Z})$  sur  $\text{SLF}(H)$ . Si de plus  $S(\psi) = \psi$  pour tout  $\psi \in \text{SLF}(H)$ , alors ceci définit en réalité une représentation projective de  $\text{PSL}_2(\mathbb{Z}) = \text{SL}_2(\mathbb{Z})/\{\pm \mathbb{I}_2\}$ .

Les éléments  $v_A^{-1}, v_B^{-1} \in \mathcal{L}_{1,0}^{\text{inv}}(H)$  qui apparaissent dans le théorème sont définis de la façon suivante.

Les coefficients  $(\overset{I}{A}_j^i)_{I,i,j}$  (resp.  $(\overset{I}{B}_j^i)_{I,i,j}$ ) engendrent une sous-algèbre de  $\mathcal{L}_{1,0}(H)$  isomorphe à  $\mathcal{L}_{0,1}(H)$ ,

qui est lui-même isomorphe à  $H$ . Donc on a un morphisme  $j_A : H \rightarrow \mathbb{C}\langle \overset{I}{A}_j^i \rangle_{I,i,j} \subset \mathcal{L}_{1,0}(H)$  (resp.

$j_B : H \rightarrow \mathbb{C}\langle \overset{I}{B}_j^i \rangle_{I,i,j} \subset \mathcal{L}_{1,0}(H)$ ), et on définit  $v_A^{-1} = j_A(v^{-1})$  (resp.  $v_B^{-1} = j_B(v^{-1})$ ) où  $v$  est l'élément

ruban de  $H$ . Ces éléments implémentent les relevés  $\tilde{\tau}_a, \tilde{\tau}_b$  des twists de Dehn  $\tau_a, \tau_b$  respectivement (voir Figure 4.2):  $v_A^{-1} = \hat{\tau}_a, v_B^{-1} = \hat{\tau}_b$  (Proposition 4.3.3). En combinant les Propositions 2.3.4 et 4.2.14, nous obtenons que les représentations de  $\tau_a$  et  $\tau_b$  sur  $\varphi \in H^*$  sont explicitement données par :

$$\begin{aligned}\theta_1^D(\tau_a)(\varphi) &= v_A^{-1} \triangleright \varphi = \varphi^{v^{-1}}, \\ \theta_1^D(\tau_b)(\varphi) &= v_B^{-1} \triangleright \varphi = \mu^l(v)^{-1} (\mu^l(g^{-1}v?) \varphi^v)^{v^{-1}}\end{aligned}\tag{1.5}$$

où pour tout  $\beta \in H^*$  et  $h \in H$ ,  $\beta^h \in H^*$  est défini par  $\beta^h(x) = \beta(hx)$ ,  $\mu^l \in H^*$  est l'intégrale à gauche de  $H$  et  $g$  est l'élément pivot (la forme linéaire  $\mu^l(v)^{-1} \mu^l(g^{-1}v?) : x \mapsto \mu^l(v)^{-1} \mu^l(g^{-1}vx)$  est reliée à l'inverse de l'élément ruban, cf. Proposition 2.3.4).

Pour une surface de genre quelconque  $\Sigma_{g,0}$ , le résultat est énoncé comme suit :

**Théorème 5.3.19 (cas général).** 1) *L'application*

$$\begin{aligned}\theta_g^D : \text{MCG}(\Sigma_{g,0} \setminus D) &\rightarrow \text{GL}((H^*)^{\otimes g}) \\ f &\mapsto \rho(\hat{f})\end{aligned}$$

où  $\rho$  est la représentation de  $\mathcal{L}_{g,0}(H)$  sur  $(H^*)^{\otimes g}$ , est une représentation projective.

2) *L'application*

$$\begin{aligned}\theta_g : \text{MCG}(\Sigma_{g,0}) &\rightarrow \text{GL}(\text{Inv}((H^*)^{\otimes g})) \\ f &\mapsto \rho_{\text{inv}}(\hat{f})\end{aligned}$$

où  $\rho_{\text{inv}}$  est la représentation de  $\mathcal{L}_{g,0}^{\text{inv}}(H)$  sur  $\text{Inv}((H^*)^{\otimes g})$ , est une représentation projective.

Un résultat similaire a été donné dans [AS96a] sous l'hypothèse que l'algèbre de jauge  $H$  est modulaire, l'espace de représentation étant l'algèbre de modules. Ainsi, notre travail fournit une preuve et généralise à un cadre non semi-simple leur résultat. Notons qu'on a une représentation projective car les éléments  $\hat{f}$  sont définis à un scalaire près. Notons aussi que  $\theta_g$  est juste une restriction de l'espace de représentation :

$$\forall f \in \text{MCG}(\Sigma_{g,0}), \quad \theta_g(f) = \theta_g^D(f)|_{\text{Inv}((H^*)^{\otimes g})}.$$

Le résultat est énoncé pour  $\Sigma_{g,0}$ , mais nous discutons son extension à une surface générale  $\Sigma_{g,n}$  dans la section 5.3.5.

Le relevé  $\tilde{\tau}_\gamma$  d'un twist de Dehn autour d'une courbe simple  $\gamma$  est implémenté par conjugaison par l'élément  $v_{\tilde{\gamma}}^{-1} \in \mathcal{L}_{g,n}(H)$ ; en d'autres termes,  $\hat{\tau}_\gamma = v_{\tilde{\gamma}}^{-1}$  (Proposition 5.3.16). Cet élément est défini comme ceci. Tout d'abord, exprimons  $\gamma$  en fonction des générateurs  $b_i, a_i, m_j$  de  $\pi_1(\Sigma_{g,n} \setminus D)$ .

Puis remplaçons  $b_i, a_i, m_j$  par les matrices  $\overset{I}{B}(i), \overset{I}{A}(i), \overset{I}{M}(j)$  (à une normalisation près par  $\overset{I}{v}^r$ ); ceci donne une matrice  $\overset{I}{\tilde{\gamma}}$ , appelée le relevé de  $\gamma$  (Definition 5.3.7). Enfin, les coefficients  $(\overset{I}{\tilde{\gamma}}_j^i)_{I,i,j}$  satisfont les relations qui définissent  $\mathcal{L}_{0,1}(H)$  (Proposition 5.3.14), qui est lui-même isomorphe à  $H$ . Ainsi,

nous avons un morphisme  $j_{\tilde{\gamma}} : H \rightarrow \mathbb{C}\langle \overset{I}{\tilde{\gamma}}_j^i \rangle_{I,i,j} \subset \mathcal{L}_{g,n}(H)$  et nous définissons  $v_{\tilde{\gamma}}^{-1} = j_{\tilde{\gamma}}(v^{-1})$ , où  $v$  est l'élément ruban de  $H$ . Grâce à ces éléments  $v_{\tilde{\gamma}}^{-1}$ , nous obtenons des formules pour les représentations des twists de Dehn autour des courbes fermées simples  $a_i, b_i, d_i, e_i$  (représentées dans la Figure 5.7) sur  $(H^*)^{\otimes g}$  :

**Théorème 5.3.22.** Soit  $\theta_g^D : \text{MCG}(\Sigma_{g,0} \setminus D) \rightarrow \text{PGL}((H^*)^{\otimes g})$  la représentation projective obtenue dans le Théorème 5.3.19. On a les formules suivantes :

$$\begin{aligned}\theta_g^D(\tau_{a_i})(\varphi_1 \otimes \dots \otimes \varphi_g) &= \varphi_1 \otimes \dots \otimes \varphi_{i-1} \otimes \theta_1^D(\tau_a)(\varphi_i) \otimes \varphi_{i+1} \otimes \dots \otimes \varphi_g, \\ \theta_g^D(\tau_{b_i})(\varphi_1 \otimes \dots \otimes \varphi_g) &= \varphi_1 \otimes \dots \otimes \varphi_{i-1} \otimes \theta_1^D(\tau_b)(\varphi_i) \otimes \varphi_{i+1} \otimes \dots \otimes \varphi_g, \\ \theta_g^D(\tau_{d_i})(\varphi_1 \otimes \dots \otimes \varphi_g) &= \varphi_1 \otimes \dots \otimes \varphi_{i-2} \otimes \varphi_{i-1} (S^{-1}(a_j) a_k ? b_k v''^{-1} b_j) \otimes \varphi_i (S^{-1}(a_l) S^{-1}(v'^{-1}) a_m ? b_m b_l) \\ &\quad \otimes \varphi_{i+1} \otimes \dots \otimes \varphi_g, \\ \theta_g^D(\tau_{e_i})(\varphi_1 \otimes \dots \otimes \varphi_g) &= \varphi_1 (S^{-1}(v^{(2i-2)-1}) ? v^{(2i-1)-1}) \otimes \dots \otimes \varphi_{i-1} (S^{-1}(v^{(2)-1}) ? v^{(3)-1}) \\ &\quad \otimes \varphi_i (S^{-1}(a_j) S^{-1}(v^{(1)-1}) a_k ? b_k b_j) \otimes \varphi_{i+1} \otimes \dots \otimes \varphi_g,\end{aligned}$$

avec  $i \geq 2$  pour les deux dernières égalités,  $R = a_j \otimes b_j \in H \otimes H$  est la  $R$ -matrice<sup>2</sup>, et les formules pour  $\theta_1^D(\tau_a), \theta_1^D(\tau_b)$  sont données dans (1.5) ci-dessus.

Pour le tore  $\Sigma_{1,0}$  et l'algèbre de jauge  $H = \bar{U}_q = \bar{U}_q(\mathfrak{sl}_2)$ , nous étudions explicitement la représentation projective de  $\mathrm{SL}_2(\mathbb{Z})$  sur  $\mathrm{SLF}(\bar{U}_q)$ .<sup>3</sup> Pour ce faire, nous avons besoin d'une base convenable de  $\mathrm{SLF}(\bar{U}_q)$ , qui est une algèbre de dimension  $3p - 1$ . Cette base est celle introduite dans [GT09] et [Ari10] et que nous appelons la base GTA; sa définition est rappelée en détail dans la section 3.2. Elle contient les caractères  $\chi_s^\epsilon$  des modules simples  $\mathcal{X}^\epsilon(s)$ , avec  $\epsilon \in \{\pm\}$  et  $1 \leq s \leq p$ ; ceci donne  $2p$  éléments. Les  $p - 1$  formes manquantes, notées  $G_s$  ( $1 \leq s \leq p - 1$ ), sont construites grâce aux propriétés des  $\bar{U}_q$ -modules projectifs  $\mathcal{P}^\epsilon(s)$ . Une propriété importante de cette base pour nos desseins est que ses règles de multiplication, déterminées dans le Théorème 3.4.1 (et indépendamment avant dans [GT09], voir les commentaires au début du Chapitre 3), sont simples. Cette particularité nous permet de calculer les formules suivantes :

**Théorème 4.4.6.** *Soit  $\theta_1 : \mathrm{SL}_2(\mathbb{Z}) \rightarrow \mathrm{PGL}(\bar{U}_q^*)$  la représentation projective obtenue dans le Théorème 4.3.7, avec l'algèbre de jauge  $\bar{U}_q = \bar{U}_q(\mathfrak{sl}_2)$ . Les représentations des twists de Dehn  $\tau_a$  et  $\tau_b$  sur la base GTA sont données par :*

$$\theta_1(\tau_a)(\chi_s^\epsilon) = v_{\mathcal{X}^\epsilon(s)}^{-1} \chi_s^\epsilon, \quad \theta_1(\tau_a)(G_{s'}) = v_{\mathcal{X}^+(s')}^{-1} G_{s'} - v_{\mathcal{X}^+(s')}^{-1} \hat{q} \left( \frac{p-s'}{[s']} \chi_{s'}^+ - \frac{s'}{[s']} \chi_{p-s'}^- \right)$$

et

$$\begin{aligned} \theta_1(\tau_b)(\chi_s^\epsilon) &= \xi \epsilon (-\epsilon)^{p-1} s q^{-(s^2-1)} \left( \sum_{\ell=1}^{p-1} (-1)^s (-\epsilon)^{p-\ell} (q^{\ell s} + q^{-\ell s}) (\chi_\ell^+ + \chi_{p-\ell}^-) + \chi_p^+ + (-\epsilon)^p (-1)^s \chi_p^- \right) \\ &\quad + \xi \epsilon (-1)^s q^{-(s^2-1)} \sum_{j=1}^{p-1} (-\epsilon)^{j+1} [j][js] G_j, \\ \theta_1(\tau_b)(G_{s'}) &= \xi (-1)^{s'} q^{-(s'^2-1)} \frac{\hat{q} p}{[s']} \sum_{j=1}^{p-1} (-1)^{j+1} [j][js'] \left( 2G_j - \hat{q} \frac{p-j}{[j]} \chi_j^+ + \hat{q} \frac{j}{[j]} \chi_{p-j}^- \right), \end{aligned}$$

avec  $\epsilon \in \{\pm\}$ ,  $0 \leq s \leq p$ ,  $1 \leq s' \leq p - 1$  et  $\xi^{-1} = \frac{1-i}{2\sqrt{p}} \frac{\hat{q}^{p-1}}{[p-1]!} (-1)^p q^{-(p-3)/2}$ .

De ces formules, on déduit la structure de la représentation :

**Théorème 4.4.9.** *Le sous-espace  $\mathcal{P} = \mathrm{vect}(\chi_s^+ + \chi_{p-s}^-, \chi_p^+, \chi_p^-)_{1 \leq s \leq p-1}$  des caractères des  $\bar{U}_q$ -modules projectifs, qui est de dimension  $p + 1$ , est stable sous l'action de  $\mathrm{SL}_2(\mathbb{Z})$  calculée dans le Théorème 4.4.6. De plus, il existe une représentation projective  $\mathcal{W}$  de  $\mathrm{SL}_2(\mathbb{Z})$ , de dimension  $p - 1$ , telle que*

$$\mathrm{SLF}(\bar{U}_q) = \mathcal{P} \oplus (\mathbb{C}^2 \otimes \mathcal{W})$$

où  $\mathbb{C}^2$  est la représentation naturelle de  $\mathrm{SL}_2(\mathbb{Z})$  (action par multiplication à gauche). Les formules pour l'action sur  $\mathcal{W}$  sont données dans (4.39).

### 1.1.4 Équivalence avec la représentation de Lyubashenko

En utilisant des méthodes catégoriques basées sur le coend d'une catégorie enrubannée, Lyubashenko-Majid [LM94] (cas du tore avec une catégorie de modules) et Lyubashenko [Lyu95b, Lyu96] (cas général) ont construit des représentations projectives de groupes de difféotopie. Nos hypothèses sur

<sup>2</sup>Nous utilisons la sommation implicite sur l'indice dans l'expression de  $R$ ; il ne faut pas confondre les composants  $a_j, b_j$  de la  $R$ -matrice et les boucles  $a_i, b_i \in \pi_1(\Sigma_{g,0} \setminus D)$ .

<sup>3</sup>Notons que l'algèbre de Hopf  $\bar{U}_q$  n'est pas tressée. Cependant, l'extension de  $\bar{U}_q$  par une racine carrée de  $K$  est enrubannée; de plus, la  $R$ -matrice et l'élément ruban satisfont de bonnes propriétés qui nous permettent d'appliquer le Théorème 4.3.7 avec  $H = \bar{U}_q$ . Voir sections 3.1.3, 4.4.1, 4.4.2.

$H$  nous permettent d'appliquer leurs constructions à la catégorie enrubbannée  $\text{mod}_l(H)$ , c'est-à-dire la catégorie des  $H$ -modules à gauche de dimension finie, et d'obtenir les formules correspondantes. Grâce aux formules de (1.5) et du Théorème 5.3.22, nous montrons que ces représentations sont équivalentes à celles construites ici :

**Théorème 4.3.10 (cas du tore).** *La représentation projective de  $\text{MCG}(\Sigma_1) = \text{SL}_2(\mathbb{Z})$  définie dans le Théorème 4.3.7 est équivalente à celle définie dans [LM94].*

Pour  $H = \bar{U}_q$ , la représentation de Lyubashenko-Majid de  $\text{SL}_2(\mathbb{Z})$  sur  $\mathcal{Z}(\bar{U}_q)$  a été étudiée explicitement dans [FGST06a] en relation avec la théorie conforme logarithmique des champs. En particulier, ils ont déterminé la structure de la représentation, et le Théorème 4.4.9 est en parfait accord avec leur résultat.

**Théorème 5.4.4 (cas général).** *Les représentations projectives de  $\text{MCG}(\Sigma_g \setminus D)$  et  $\text{MCG}(\Sigma_g)$  définies dans le Théorème 5.3.19 sont équivalentes à celles définies dans [Lyu95b, Lyu96].*

Cette équivalence est intéressante car la construction de la représentation projective dans le cadre de la quantification combinatoire utilise des techniques différentes du cadre de Lyubashenko–Majid et Lyubashenko, et est peut-être plus élémentaire puisque le point de départ est simplement d'imiter l'action du groupe de difféotopie sur le groupe fondamental au niveau de l'algèbre. De plus, bien que les représentations de groupes de difféotopie résultantes sont équivalentes, dans la quantification combinatoire nous avons aussi les algèbres d'observables  $\mathcal{L}_{g,n}^{\text{inv}}(H)$  et leurs représentations; ceci donne lieu à des représentations des algèbres d'écheveaux des surfaces (aux racines de l'unité), ce qui est un des sujets du Chapitre 6.

### 1.1.5 Calcul graphique et théorie d'écheveau

Dans le Chapitre 6, nous développons tout d'abord un calcul graphique pour  $\mathcal{L}_{g,n}(H)$  et nous reformulons les relations qui définissent  $\mathcal{L}_{g,n}(H)$  en termes de diagrammes. Puis nous utilisons ce calcul graphique pour définir l'application boucle de Wilson, qui associe un élément de  $\mathcal{L}_{g,n}(H)$  à chaque entrelac parallélisé, orienté et colorié (Définition 6.2.1 et Figure 6.3). Notre définition est complètement naturelle étant donné qu'elle est entièrement diagrammatique. Elle est équivalente mais différente de celles données dans [BR96] et [BFK98b]. Il n'est pas difficile de montrer que (entre autres) l'application boucle de Wilson prend ses valeurs dans l'algèbre des observables et surtout qu'elle est compatible avec le produit en pile de deux entrelacs (ces propriétés sont aussi dans [BR96] et [BFK98b] bien sûr, mais sont démontrées en utilisant leurs formalismes et définitions respectifs) :

**Théorème 6.2.7.** *L'application boucle de Wilson  $W$  est compatible avec le produit en pile :*

$$W(L_1 * L_2) = W(L_1)W(L_2).$$

Avec notre définition de  $W$ , la preuve de ce théorème est entièrement diagrammatique (Figure 6.7).

Quand l'algèbre de jauge est  $\bar{U}_q = \bar{U}_q(\mathfrak{sl}_2)$ , la boucle de Wilson est indépendante de l'orientation de l'entrelac et satisfait la relation d'écheveaux du crochet de Kauffman. Ces faits impliquent que nous avons une représentation de l'algèbre d'écheveaux du crochet de Kauffman  $\mathcal{S}_q(\Sigma_{g,n} \setminus D)$  sur n'importe quelle représentation  $V$  de  $\mathcal{L}_{g,n}(\bar{U}_q)$  et si nous nous restreignons à  $\text{Inv}(V)$ , nous obtenons une représentation de  $\mathcal{S}_q(\Sigma_{g,n})$ , grâce au fait que le disque  $D$  est "recolle" dans  $\text{Inv}(V)$ . La dernière partie de cette affirmation est énoncée et prouvée pour  $n = 0$  dans le théorème ci-dessous, mais est probablement vraie pour tout  $g, n$ .

**Théorème 6.4.1.** *1. Soit  $\rho : \mathcal{L}_{g,n}(\bar{U}_q) \rightarrow \text{End}_{\mathbb{C}}(V)$  une représentation (avec  $V = (\bar{U}_q^*)^{\otimes g} \otimes I_1 \otimes \dots \otimes I_n$ , où  $I_1, \dots, I_n$  sont des représentations de  $\bar{U}_q$ ). L'application*

$$\begin{aligned} \mathcal{S}_q(\Sigma_{g,n} \setminus D) &\rightarrow \text{End}_{\mathbb{C}}(V) \\ L &\mapsto \rho(W(L)) \end{aligned}$$



est une représentation de  $\mathcal{S}_q(\Sigma_{g,n} \setminus D)$ .

2. Supposons  $n = 0$  et soit  $\rho_{\text{inv}}$  la représentation de  $\mathcal{L}_{g,0}^{\text{inv}}(\bar{U}_q)$  sur  $\text{Inv}((\bar{U}_q^*)^{\otimes g})$ . L'application

$$\begin{aligned} \mathcal{S}_q(\Sigma_{g,0}) &\rightarrow \text{End}_{\mathbb{C}}(\text{Inv}((\bar{U}_q^*)^{\otimes g})) \\ L &\mapsto \rho_{\text{inv}}(W(L^\circ)) \end{aligned}$$

est bien définie et est une représentation de  $\mathcal{S}_q(\Sigma_{g,0})$ .

Dans le théorème,  $L^\circ$  est n'importe quel entrelac dans  $(\Sigma_{g,0} \setminus D) \times [0, 1]$  tel que  $(j \times \text{id})(L^\circ) = L$ , où  $j : \Sigma_{g,0} \setminus D \rightarrow \Sigma_{g,0}$  est l'injection canonique.

Pour le tore  $\Sigma_{1,0}$ , nous étudions explicitement cette représentation sur  $\text{SLF}(\bar{U}_q)$ , en utilisant encore la base GTA et ses règles de multiplication. Il suffit de considérer l'action des boucles  $a, b$  puisqu'elles engendrent l'image de l'application boucle de Wilson (Proposition 6.3.5). Les sous-espaces

$$\mathcal{P} = \text{vect}(\chi_s^+ + \chi_{p-s}^-, \chi_p^+, \chi_p^-)_{1 \leq s \leq p-1}, \quad \mathcal{U} = \text{vect}(\chi_s^+)_{1 \leq s \leq p-1}, \quad \mathcal{V} = \text{vect}(G_s)_{1 \leq s \leq p-1}$$

déterminent la structure de cette représentation. De plus, nous avons une représentation naturelle de  $\mathcal{S}_q(\Sigma_{1,0})$  sur le module d'écheveaux  $\mathcal{S}_q(H_1)$ , où  $H_1$  est un corps à anses de genre 1 (*i.e.* un anneau épaisi). Le module d'écheveaux réduit  $\mathcal{S}_q^{\text{red}}(H_1)$  est isomorphe à un facteur de composition de  $\text{SLF}(\bar{U}_q)$ :

**Propositions 6.5.2 et 6.5.5.**  $J_1 = \mathcal{P} \subset J_2 = \text{vect}(\mathcal{P} \cup \mathcal{U}) \subset J_3 = \text{vect}(\mathcal{P} \cup \mathcal{U} \cup \mathcal{V})$  est une série de composition de  $\text{SLF}(\bar{U}_q)$  sous l'action de  $\mathcal{S}_q(\Sigma_{1,0})$ . Cette représentation est indécomposable et sa structure est schématisée par le diagramme suivant :

$$\begin{array}{ccc} \mathcal{U} & & \mathcal{V} \\ & \searrow^{W_B} & \swarrow_{W_A, W_B} \\ & \mathcal{P} & \end{array}$$

De plus, les  $\mathcal{S}_q(\Sigma_{1,0})$ -modules  $\mathcal{S}_q^{\text{red}}(H_1)$  et  $\bar{\mathcal{U}} = J_2/J_1$  sont isomorphes.

Nous conjecturons que la dernière affirmation est vraie en genre quelconque, c'est-à-dire que  $\mathcal{S}_q^{\text{red}}(H_g)$  est un facteur de composition de  $\text{Inv}((\bar{U}_q)^{\otimes g})$  sous l'action de  $\mathcal{S}_q(\Sigma_{g,0})$  (Conjecture 6.5.6).

## 1.1.6 Perspectives

Plusieurs questions et problèmes basés sur cette thèse peuvent faire l'objet de travaux supplémentaires, en particulier lorsque l'algèbre de jauge est  $\bar{U}_q = \bar{U}_q(\mathfrak{sl}_2)$ .

Le premier groupe de questions concerne la description de l'algèbre des observables  $\mathcal{L}_{g,n}^{\text{inv}}(\bar{U}_q)$ . C'est un fait général (Proposition 6.2.9) que la valeur de la boucle de Wilson d'une courbe fermée simple  $x \in \pi_1(\Sigma_{g,n} \setminus D)$  coloriée par  $I$  est la trace quantique de son relevé :

$$\overset{I}{W}(x) = \text{tr}(K^{p+1} \overset{I}{\tilde{x}}),$$

où le relevé  $\overset{I}{\tilde{x}}$  (Définition 5.3.7) est défini en remplaçant les générateurs de  $\pi_1(\Sigma_{g,n} \setminus D)$  par des matrices dans l'expression de  $x$  via la correspondance  $\overset{I}{B}(i) \leftrightarrow b_i$ ,  $\overset{I}{A}(j) \leftrightarrow a_j$ ,  $\overset{I}{M}(k) \leftrightarrow m_k$ , à une normalisation près. Ces éléments sont des "observables semi-simples" car ils se scindent sur les extensions :

$$0 \rightarrow I \rightarrow V \rightarrow J \rightarrow 0 \text{ exacte} \implies \overset{V}{W}(x) = \overset{I}{W}(x) + \overset{J}{W}(x).$$

Dans la section 6.3, tous les entrelacs sont coloriés par la représentation fondamentale  $\mathcal{X}^+(2)$ :

$$W(x) = \text{tr}(K^{p+1} \overset{\mathcal{X}^+(2)}{\tilde{x}}),$$

C'est suffisant pour retrouver tous les  $W(x)$  (où les  $\mathcal{X}^\epsilon(s)$  sont les  $\bar{U}_q$ -modules simples) grâce aux formules (qui sont des conséquences de la Proposition 5.3.14 et de (3.31)) :

$$W(x) W(x) = W(x)^{\mathcal{X}^\epsilon(s)} = W(x)^{\mathcal{X}^\epsilon(s-1)} + W(x)^{\mathcal{X}^\epsilon(s+1)}, \quad W(x) W(x) = 2 W(x)^{\mathcal{X}^\epsilon(p)} = 2 W(x)^{\mathcal{X}^\epsilon(p-1)} + 2 W(x)^{\mathcal{X}^\epsilon(1)}.$$

En revanche, c'est insuffisant pour retrouver tous les observables. En effet, il y a aussi des observables non semi-simples basés sur les pseudo-traces  $G_s$  (voir (3.24)) :

$$V^s(x) = \text{tr}(\sigma_s K^{\mathcal{P}^+(s)} \tilde{x}^{\mathcal{P}^+(s)}) + \text{tr}(\sigma_{p-s} K^{\mathcal{P}^-(p-s)} \tilde{x}^{\mathcal{P}^-(p-s)}) \quad (1 \leq s \leq p-1).$$

Ce  $V^s$  est un analogue non semi-simple de l'application boucle de Wilson  $W$  et n'est défini que sur les boucles simples pour le moment. Ceci nous amène aux problèmes suivants (qui peuvent avoir une solution ou pas) :

- Définir  $V^s(L)$  pour n'importe quel entrelac orienté parallélisé  $L \in (\Sigma_{g,n} \setminus D) \times [0, 1]$ .
- Déterminer les relations d'écheveau satisfaites par l'application  $V^s$ .
- Est-ce que la collection des observables  $W(x), V^s(x)$  (pour  $1 \leq s \leq p-1$  et  $x$  une boucle simple)<sup>4</sup> engendre l'algèbre  $\mathcal{L}_{g,n}^{\text{inv}}(\bar{U}_q)$  ? Plus généralement, décrire aussi précisément que possible  $\mathcal{L}_{g,n}^{\text{inv}}(\bar{U}_q)$ .

Le dernier point est probablement très difficile. À la place, on peut recoller le disque  $D$  en étudiant la représentation de  $\mathcal{L}_{g,n}^{\text{inv}}(\bar{U}_q)$  sur  $\text{Inv}(V)$ , où  $V = (\bar{U}_q^*)^{\otimes g} \otimes I_1 \otimes \dots \otimes I_n$ . Ceci pourrait être un premier pas pour comprendre la structure de l'algèbre de modules  $\mathcal{M}_{g,n}(H, I_1, \dots, I_n)$  telle que définie en (1.4). Ces questions sont encore très difficiles et il vaut mieux se restreindre à  $n = 0$  afin d'éviter le choix de  $I_1, \dots, I_n$ . La section 4.4.4 contient des remarques sur le cas  $(g, n) = (1, 0)$ . La première difficulté de ce type de questions en genre supérieur est que nous ne connaissons pas de base de  $\text{Inv}((\bar{U}_q^*)^{\otimes g})$  qui généraliserait la base GTA de  $\text{SLF}(\bar{U}_q) = \text{Inv}(U_q^*)$ .

- Déterminer une base "convenable" de  $\text{Inv}((\bar{U}_q^*)^{\otimes g})$ .
- Déterminer la structure de la représentation de  $\mathcal{L}_{g,0}^{\text{inv}}(\bar{U}_q)$  sur  $\text{Inv}((\bar{U}_q^*)^{\otimes g})$  et déduire des conséquences sur la structure de l'algèbre de modules  $\mathcal{M}_{g,0}(H)$ .

La partie semi-simple de  $\mathcal{L}_{g,n}^{\text{inv}}(\bar{U}_q)$  mérite cependant une attention particulière puisque c'est l'image par  $W$  (avec tous les entrelacs coloriés par  $\mathcal{X}^+(2)$ ) de l'algèbre d'écheveaux  $\mathcal{S}_q(\Sigma_{g,n} \setminus D)$ . De plus,  $\text{Inv}((\bar{U}_q^*)^{\otimes g})$  est une représentation de  $\mathcal{S}_q(\Sigma_{g,0})$ . Pour  $g = 1$ , la structure de cette représentation est déterminée dans la Proposition 6.5.2, et dans la Proposition 6.5.5 il est montré qu'elle contient la représentation naturelle de  $\mathcal{S}_q(\Sigma_{1,0})$  sur  $\mathcal{S}_q^{\text{red}}(H_1)$  en tant que facteur de composition.

- Déterminer la structure de la représentation de  $\mathcal{S}_q(\Sigma_{g,0})$  sur  $\text{Inv}((\bar{U}_q^*)^{\otimes g})$ .
- Prouver que la représentation naturelle de  $\mathcal{S}_q(\Sigma_{g,0})$  sur  $\mathcal{S}_q^{\text{red}}(H_g)$  est un facteur de composition de la représentation de  $\mathcal{S}_q(\Sigma_{g,0})$  sur  $\text{Inv}((\bar{U}_q^*)^{\otimes g})$  (Conjecture 6.5.6).

Un autre problème est de généraliser le Théorème 4.4.9 en genre supérieur :

- Déterminer la structure de la représentation projective de  $\text{MCG}(\Sigma_{g,0})$  sur  $\text{Inv}((\bar{U}_q^*)^{\otimes g})$ .

<sup>4</sup>Nous pouvons prendre  $s = 1$  grâce à la relation  $W(x)V^s(x) = \frac{[s-1]}{[s]}V^{s-1}(x) + \frac{[s+1]}{[s]}V^{s+1}(x)$ , qui est due à la Proposition 5.3.14 et au Théorème 3.4.1.

Enfin, on peut essayer de généraliser les algèbres  $\mathcal{L}_{g,n}$  dans un contexte catégorique. Ceci peut avoir plusieurs sens. On sait que  $\mathcal{L}_{0,1}(H)$  est un coend (Proposition 5.4.3); en utilisant ceci, on peut partir d'une catégorie enrubannée avec coend  $K$  et tout réécrire de façon catégorique grâce à la propriété universelle du coend (par exemple,  $\mathcal{L}_{1,0}(H)$  serait  $K \otimes K$  et son produit serait décrit par un morphisme qui factorise une certaine famille dinaturelle). Nous pouvons aussi essayer de catégorifier  $\mathcal{L}_{g,n}$  (par exemple avec l'algèbre de jauge  $U_q(\mathfrak{sl}_2)$ ,  $q$  générique), ce qui signifie qu'on cherche une catégorie monoïdale  $\mathcal{C}_{g,n}$  telle que  $K_0(\mathcal{C}_{g,n}) \cong \mathcal{L}_{g,n}$ ; il serait intéressant de voir ce qui joue le rôle de l'algèbre des observables dans une telle catégorification.

## 1.2 Introduction in english

Let  $\Sigma_{g,n}$  be a compact oriented surface of genus  $g$  with  $n$  open disks removed. The “graph algebra”  $\mathcal{L}_{g,n}$  has been introduced and studied by Alekseev [Ale94], Alekseev–Grosse–Schomerus [AGS95, AGS96] and Buffenoir–Roche [BR95, BR96] in the middle of the 1990's, in the program of the combinatorial quantization of the moduli space of flat connections over  $\Sigma_{g,n}$ . It is an associative (non-commutative) algebra defined by generators and relations, the relations being given in a matrix form. The main theme of this thesis is to apply these algebras to the construction of quantum representations of mapping class groups and of skein algebras of surfaces at roots of unity.

In section 1.2.1 below we explain the context underlying the combinatorial quantization and the definition of the algebra  $\mathcal{L}_{g,n}$ . Then from section 1.2.2 to section 1.2.5 we state and explain our main results. Finally, the section 1.2.6 contains conjectures and problems that can serve as a starting point for further work.

### 1.2.1 Combinatorial quantization

Let us recall quickly the main ingredients of combinatorial quantization. Let  $G$  be an algebraic Lie group (generally assumed connected and simply-connected, *e.g.*  $G = \mathrm{SL}_2(\mathbb{C})$ ) and  $\Sigma_{g,n}$  be a compact oriented surface of genus  $g$  with  $n$  open disks removed. We consider the moduli space of flat  $G$ -connections  $\mathcal{M}_{g,n} = \mathcal{A}_f/\mathcal{G}$ , where  $\mathcal{A} = \Omega^1(\Sigma_{g,n}, \mathfrak{g})$  is identified with the space of all  $G$ -connections,  $\mathcal{A}_f$  is the subspace of flat  $G$ -connections, and  $\mathcal{G} = C^\infty(\Sigma_{g,n}, G)$  is the gauge group. These objects can be described in a discrete and combinatorial way, using holonomies along the edges of a filling graph  $\Gamma = (V, E)$ . This is an embedded oriented graph on  $\Sigma_{g,n}$  (its vertices  $v \in V$  are points of  $\Sigma_{g,n}$  and its edges  $e \in E$  are simple oriented curves on  $\Sigma_{g,n}$  between two vertices which do not intersect pairwise) such that  $\Sigma_{g,n} \setminus \Gamma$  is a union of open disks. Let  $\mathcal{A}_d = G^E$ . Call an element of  $\mathcal{A}_d$  a discrete connection; it is to be thought as the collection  $(h_e)_{e \in E}$  of holonomies of a connection along the edges of  $\Gamma$ . If  $\gamma = (e_1, \dots, e_k)$  is a path in  $\Gamma$ , we define the discrete holonomy of a discrete connection  $(h_e)_{e \in E}$  along  $\gamma$  as the product  $h_{e_1} \dots h_{e_k}$ . A discrete connection is called flat if its holonomy along any face of the graph is 1. This gives a set  $\mathcal{A}_{df} \subset \mathcal{A}_d$  of flat discrete connections. Finally, the gauge group  $\mathcal{G}$  acts by conjugation on the holonomy along a curve of a connection in  $\mathcal{A}$ . Hence, we define the discrete gauge group to be  $\mathcal{G}_d = G^V$  and its action on discrete connections is  $(h_v)_{v \in V} \cdot (h_e)_{e \in E} = (h_e h_{e^+}^{-1})$ , where  $e^-$  is the source of  $e$  and  $e^+$  its target. It is a result that  $\mathcal{A}_{df}/\mathcal{G}_d \cong \mathrm{Hom}(\pi_1(\Sigma_{g,n}), G)/G$  (usually the quotient is in the sense of geometric invariant theory but our discussion is informal). Hence, this construction is equivalent to the character variety, which is a model for  $\mathcal{M}_{g,n}$ . For more informations about the moduli space and its combinatorial description, an accessible reference is [Lab13]. This description is also called a lattice gauge field theory, see *e.g.* [BFK98a].

The moduli space  $\mathcal{A}_f/\mathcal{G}$  carries the Atiyah–Bott–Goldman Poisson structure [AB83, Gol86], namely a Poisson bracket on the algebra of functions  $\mathbb{C}[\mathcal{A}_f/\mathcal{G}] = \mathbb{C}[\mathcal{A}_f]^{\mathcal{G}}$ . The corresponding Poisson structure on the discretization  $\mathcal{A}_{df}/\mathcal{G}_d$  has been described by Fock–Rosly [FR93]; this is a Poisson bracket defined in a matrix way on the algebra of functions  $\mathbb{C}[\mathcal{A}_d]$  and which induces a Poisson bracket on  $\mathbb{C}[\mathcal{A}_{df}]^{\mathcal{G}_d}$  (the gauge group acts on functions on the right in the obvious way). The algebra  $\mathcal{L}_{g,n}$  is

a quantization of  $\mathbb{C}[\mathcal{A}_d]$ . We will not need to discuss this fact for the purposes of that thesis. Instead, in the sequel, we simply explain the analogy between  $\mathcal{L}_{g,n}$  and  $\mathbb{C}[\mathcal{A}_d]$ .

Here we always take the graph  $\Gamma = \Gamma_{g,n} \subset \Sigma_{g,n}$  with one vertex and whose edges represent a generating system of the fundamental group:

$$\Gamma_{g,n} = (\{\bullet\}, \{b_1, a_1, \dots, b_g, a_g, m_{g+1}, \dots, m_{g+n}\}).$$

It is represented below:

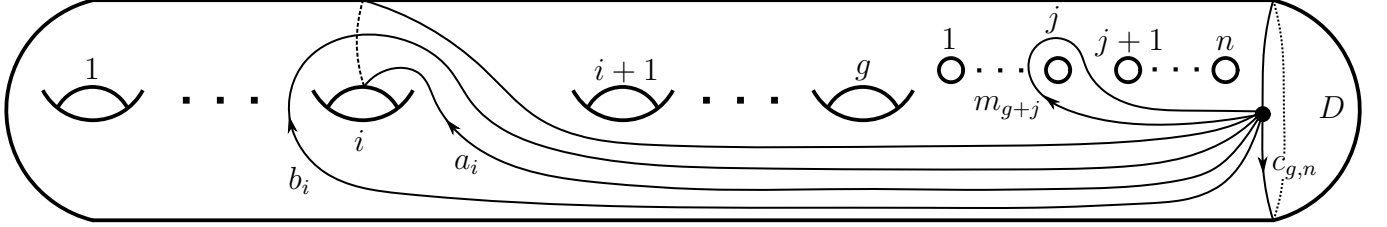

It holds  $\Sigma_{g,n} \setminus \Gamma_{g,n} \cong D$ , where  $D$  is an open disk. Hence, the closed tubular neighborhood of  $\Gamma_{g,n}$  is homeomorphic to  $\Sigma_{g,n} \setminus D$ :

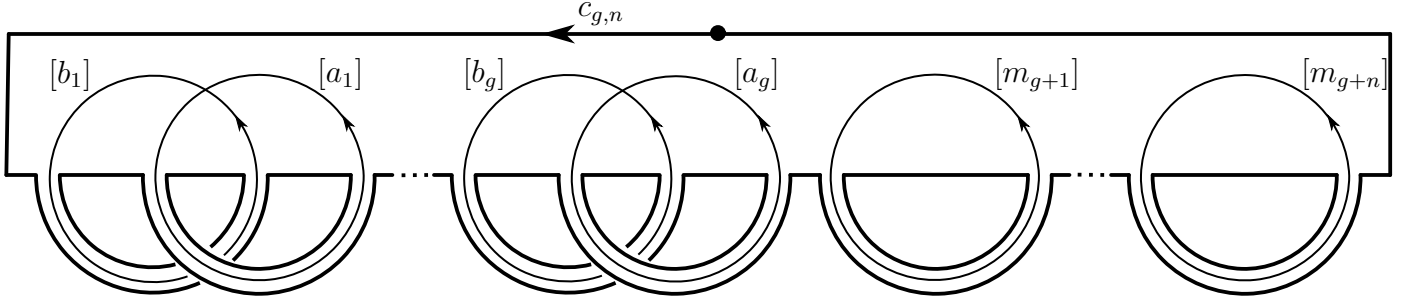

where  $[x]$  denotes the free homotopy class of  $x \in \pi_1(\Sigma_{g,n} \setminus D)$ . The unique face of the graph  $\Gamma_{g,n}$  is the curve induced by the deletion of  $D$ :

$$c_{g,n} = b_1 a_1^{-1} b_1^{-1} a_1 \dots b_g a_g^{-1} b_g^{-1} a_g m_{g+1} \dots m_{g+n}.$$

With this choice of graph, a discrete connection  $A_d \in \mathcal{A}_d$  assigns an element of  $G$  to each generator of  $\pi_1(\Sigma_{g,n} \setminus D)$ , and can thus be identified with a tuple

$$A_d = (h_{b_1}, h_{a_1}, \dots, h_{b_g}, h_{a_g}, h_{m_{g+1}}, \dots, h_{m_{g+n}}) \in G^{2g+n}.$$

A flat discrete connection  $A_d \in \mathcal{A}_{df}$  assigns an element of  $G$  to each generator of  $\pi_1(\Sigma_{g,n}) = \pi_1(\Sigma_{g,n} \setminus D) / \langle c_{g,n} \rangle$ . It is given by a tuple  $(h_{b_1}, h_{a_1}, \dots, h_{b_g}, h_{a_g}, h_{m_{g+1}}, \dots, h_{m_{g+n}})$  such that

$$\text{Hol}(A_d, c_{g,n}) = h_{b_1} h_{a_1}^{-1} h_{b_1}^{-1} h_{a_1} \dots h_{b_g} h_{a_g}^{-1} h_{b_g}^{-1} h_{a_g} h_{m_{g+1}} \dots h_{m_{g+n}} = 1. \quad (1.6)$$

The discrete gauge group is just  $\mathcal{G}_d = G$  (since  $V = \{\bullet\}$ ). The action of  $h \in G$  on a discrete connection is by conjugation:

$$\begin{aligned} & h \cdot (h_{b_1}, h_{a_1}, \dots, h_{b_g}, h_{a_g}, h_{m_{g+1}}, \dots, h_{m_{g+n}}) \\ &= (h h_{b_1} h^{-1}, h h_{a_1} h^{-1}, \dots, h h_{b_g} h^{-1}, h h_{a_g} h^{-1}, h h_{m_{g+1}} h^{-1}, \dots, h h_{m_{g+n}} h^{-1}). \end{aligned}$$

In other words

$$\begin{aligned} \mathcal{A}_d &= \text{Hom}(\pi_1(\Sigma_{g,n} \setminus D), G), & \mathcal{A}_{df} &= \text{Hom}(\pi_1(\Sigma_{g,n}), G), \\ \mathcal{A}_d / \mathcal{G}_d &= \text{Hom}(\pi_1(\Sigma_{g,n} \setminus D), G) / G, & \mathcal{A}_{df} / \mathcal{G}_d &= \text{Hom}(\pi_1(\Sigma_{g,n}), G) / G, \end{aligned}$$

and we recover the character variety.

For our purposes, it is worthwhile to describe the commutative algebra of functions  $\mathbb{C}[\mathcal{A}_d] = \mathbb{C}[G]^{\otimes(2g+n)}$  in terms of matrices (where  $\mathbb{C}[G]$  is the algebra of functions on  $G$ ). Let  $V$  be a (finite dimensional) representation of  $G$  with basis  $(v_i)$  and dual basis  $(v^j)$ . Recall that the matrix coefficients of  $V$  in that basis are  $T_j^i \in \mathbb{C}[G]$ , defined by  $T_j^i(h) = v^i(h \cdot v_j)$ . This gives a matrix  $T$  with coefficients in  $\mathbb{C}[G]$ . The matrix coefficients  $T_j^i$ , where  $V$  runs in the set of finite dimensional  $G$ -modules, span linearly  $\mathbb{C}[G]$ . Define  $B(k), A(k), M(l) \in \text{Mat}_{\dim(V)}(\mathbb{C}[\mathcal{A}_d])$  by

$$\begin{aligned} B(k)_j^i(h_{b_1}, h_{a_1}, \dots, h_{b_g}, h_{a_g}, h_{m_{g+1}}, \dots, h_{m_{g+n}}) &= T_j^i(h_{b_k}), \\ A(k)_j^i(h_{b_1}, h_{a_1}, \dots, h_{b_g}, h_{a_g}, h_{m_{g+1}}, \dots, h_{m_{g+n}}) &= T_j^i(h_{a_k}), \\ M(l)_j^i(h_{b_1}, h_{a_1}, \dots, h_{b_g}, h_{a_g}, h_{m_{g+1}}, \dots, h_{m_{g+n}}) &= T_j^i(h_{m_l}). \end{aligned}$$

The coefficients of these matrices span  $\mathbb{C}[\mathcal{A}_d]$  as an algebra ( $V$  running in the set of finite dimensional  $G$ -modules). The gauge group  $G$  acts on  $\mathbb{C}[\mathcal{A}_d]$  on the right:  $(f \cdot h)(x) = f(h \cdot x)$ . In terms of matrices, the action is by conjugation:

$$\forall h \in G, \quad U(k) \cdot h = {}^V U(k) {}^V h^{-1} \quad (1.7)$$

where  $h = T(h)$  is the representation of  $h$  on  $V$  and  $U$  is  $B, A$  or  $M$ . The invariant functions form a subalgebra,  $\mathbb{C}[\mathcal{A}_d/G] = \mathbb{C}[\mathcal{A}_d]^G$ , and are called (classical) observables in the context of lattice gauge field theory. This is the matrix description of  $\mathbb{C}[\mathcal{A}_d]$ .

In order to quantize the Fock–Rosly Poisson structure, Alekseev [Ale94], Alekseev–Grosse–Schomerus [AGS95, AGS96] and Buffenoir–Roche [BR95, BR96] replaced the Lie group  $G$  by a quantum group  $U_q(\mathfrak{g})$ , with  $\mathfrak{g} = \text{Lie}(G)$  (but from a purely algebraic point of view we can take any ribbon Hopf algebra instead of  $U_q(\mathfrak{g})$ ). They defined an associative (non-commutative) algebra

$$\mathcal{L}_{g,n} = \mathbb{C}\langle B(k)_j^i, A(k)_j^i, M(l)_j^i \mid \text{relations } (\mathcal{R}) \rangle_{I,i,j,k,l}$$

which is a deformation of  $\mathbb{C}[\mathcal{A}_d]$ , generated by variables  $B(k)_j^i, A(k)_j^i, M(l)_j^i$  where  $I$  now runs in the set of finite dimensional  $U_q(\mathfrak{g})$ -modules. The defining relations  $(\mathcal{R})$  are given in a matrix form. They involve the  $R$ -matrix of  $U_q(\mathfrak{g})$  and are designed so that  $\mathcal{L}_{g,n}$  is a right  $U_q(\mathfrak{g})$ -module-algebra for the action

$$\forall h \in U_q(\mathfrak{g}), \quad U(k) \cdot h = h' U(k) S(h'')$$

which is the analogue of (1.7),  $S$  being the antipode of  $U_q(\mathfrak{g})$ ,  $\Delta(h) = h' \otimes h''$  the coproduct and  $U = B, A$  ou  $M$ . In particular, we have a subalgebra of invariant elements  $\mathcal{L}_{g,n}^{\text{inv}}$ , which is the analogue of the algebra of classical observables  $\mathbb{C}[\mathcal{A}_d]^G$ . Note that  $\mathcal{L}_{g,n}$  really is a quantum algebra of functions, in the sense that it is possible to evaluate any element of  $\mathcal{L}_{g,n}$  on a discrete connection; this is discussed in detail in Remarks 4.1.9, 4.2.9 and in section 5.1.3.

It is more difficult to implement the quantized analogue of the flatness constraint (1.6), namely for all  $I$ :

$$C_{g,n}^I = B(1)A(1)^{-1}B(1)^{-1}A(1) \dots B(g)A(g)^{-1}B(g)^{-1}A(g)M(g+1) \dots M(g+n) = \mathbb{I}_{\dim(I)}. \quad (1.8)$$

Indeed, it is not possible to consider the quotient  $\mathcal{L}_{g,n}^{\text{inv}} / \langle (C_{g,n}^I)_j^i - \delta_j^i \rangle_{I,i,j}$  since the elements  $(C_{g,n}^I)_j^i - \delta_j^i$  are not invariant. It is also not possible to quotient the whole algebra  $\mathcal{L}_{g,n}$  (before taking the invariant

elements) because the resulting algebra may be equal to  $0^5$ . The implementation of the flatness constraint, giving rise to the “moduli algebra” (which is a quantum analogue of  $\mathbb{C}[\mathcal{A}_{df}/G]$ ), differs depending on the authors and their assumptions on the gauge algebra. For instance:

- In [AGS95, AGS96, AS96a], the gauge algebra is not  $U_q(\mathfrak{g})$  but rather a modular Hopf algebra (thought of as a semisimple truncation of  $U_q(\mathfrak{g})$ , where  $q$  is a root of unity). They construct “characteristic projectors” thanks to the nice properties of the  $S$ -matrix in the modular setting and use these projectors to define the moduli algebra as a subalgebra of  $\mathcal{L}_{g,n}^{\text{inv}}$  (namely the product of  $\mathcal{L}_{g,n}^{\text{inv}}$  by these projectors).
- In [BNR02], the gauge algebra is  $U_q(\mathfrak{g})$  with  $q$  generic. They consider all the matrices  ${}^I Y \in \mathcal{L}_{g,n} \otimes \text{End}_{\mathbb{C}}(I)$  (where  $I$  is not fixed) satisfying  ${}^I Y \cdot h = {}^I h' Y S({}^I h'')$  (products of  ${}^I B(i), {}^I A(j), {}^I M(k)$  are obvious examples of such matrices). The quantum trace  $\text{tr} \left( {}^I g Y ({}^I C_{g,n} - \mathbb{I}_{\dim(I)}) \right)$  ( $g$  being the pivotal element) is an invariant element and we can consider the ideal  $\mathcal{I} \subset \mathcal{L}_{g,n}^{\text{inv}}$  generated by all these quantum traces. Then they define the moduli algebra as the quotient  $\mathcal{L}_{g,n}^{\text{inv}}/\mathcal{I}$ . This construction is not sufficient when the gauge algebra is not semisimple because in this case there are invariants which cannot be written as  $\text{tr}({}^I g X)$ .
- In [MW15], the gauge algebra  $K$  is assumed finite dimensional and semisimple for the construction of the moduli algebra. They use a two-sided cointegral of  $H$  (called Haar integral in their paper, and whose existence is guaranteed by these assumptions on  $K$ ) to construct projectors associated to each face of the graph  $\Gamma$ . Then they define the moduli algebra as the image of the algebra of observables by these projectors (this gives a subalgebra of the algebra of observables, equivalent to the one of [AGS95, AGS96, AS96a]). Note however that the formalism of their paper (which contains an axiomatisation and study of Hopf algebra gauge theory) is different from the one used here.

A possible definition of the moduli algebra under our assumptions on the gauge algebra (which do not include semisimplicity) is given in section 1.2.2 below.

In addition to the papers already mentionned, these quantized algebras of functions and their generalizations appear in various works. For instance: [BFK98b] (definition of a comultiplication on the connections (dual to the product in  $\mathcal{L}_{g,n}$ , see section 5.1.3), of the holonomy and of the Wilson loops by means of multitangles, which are transformations acting on the graph  $\Gamma$  and on the discrete connections), [BZBJ18] (generalization of  $\mathcal{L}_{g,n}$  in a categorical setting using factorization homology), [AGPS18] (study of  $\mathcal{L}_{1,0}$  with the gauge (super-) algebra  $\bar{U}_q(\mathfrak{gl}(1|1))$  and of the associated representation of  $\text{SL}_2(\mathbb{Z})$ ), [GJS19] (quantized character varieties at roots of unity and definition of the moduli algebra *via* their process of quantum Hamiltonian reduction).

As already said, the definition of  $\mathcal{L}_{g,n}$  is purely algebraic and any ribbon Hopf algebra  $H$  can play the role of the gauge algebra; the corresponding graph algebra will be denoted  $\mathcal{L}_{g,n}(H)$ . In that thesis, we assume furthermore that  $H$  is finite dimensional and factorizable, but not necessarily semisimple. For us, the guiding example of such a Hopf algebra will be the restricted quantum group  $\bar{U}_q(\mathfrak{sl}_2)$ , denoted  $\bar{U}_q$  in the sequel; Chapter 3 is devoted to the properties of  $\bar{U}_q$ .

We now discuss our main results in detail.

## 1.2.2 Properties of $\mathcal{L}_{g,n}(H)$ , implementation of the flatness constraint

Under our assumptions on  $H$  (finite dimensional, factorizable, ribbon), the loop algebra  $\mathcal{L}_{0,1}(H)$  is isomorphic to  $H$  (Proposition 4.1.8), the handle algebra  $\mathcal{L}_{1,0}(H)$  is isomorphic to the Heisenberg dou-

<sup>5</sup>For instance, under our assumptions on the gauge algebra stated below,  $\mathcal{L}_{1,0}(H)$  is isomorphic to a matrix algebra over  $\mathbb{C}$  and its only possible quotient is 0.

ble  $\mathcal{H}(\mathcal{O}(H))$  and thus to a matrix algebra over  $\mathbb{C}$  (Proposition 4.2.8), and the Alekseev isomorphism remains valid (Proposition 5.1.3):

$$\mathcal{L}_{0,1}(H) \cong H, \quad \mathcal{L}_{1,0}(H) \cong \mathcal{H}(\mathcal{O}(H)) \cong \text{End}_{\mathbb{C}}(H^*), \quad \mathcal{L}_{g,n}(H) \cong \mathcal{L}_{1,0}(H)^{\otimes g} \otimes \mathcal{L}_{0,1}(H)^{\otimes n}.$$

It follows that the indecomposable representations of  $\mathcal{L}_{g,n}(H)$  have the form

$$(H^*)^{\otimes g} \otimes I_1 \otimes \dots \otimes I_n$$

where  $H^*$  is the only indecomposable (and simple) representation of  $\mathcal{H}(\mathcal{O}(H)) \cong \text{End}_{\mathbb{C}}(H^*)$  and  $I_1, \dots, I_n$  are representations of  $H$ .

Since we do not assume that  $H$  is semisimple, the definitions of the moduli algebra mentioned above cannot be used. Instead, we will implement the flatness constraint (1.8) at the level of the representations: for each representation  $V$  of  $\mathcal{L}_{g,n}(H)$ , we define a subspace  $\text{Inv}(V)$  by the requirement that the matrices  $\overset{I}{C}_{g,n}$  act trivially on  $\text{Inv}(V)$ :

$$\text{Inv}(V) = \left\{ v \in V \mid \forall I, \overset{I}{C}_{g,n} \triangleright v = \mathbb{I}_{\dim(I)} v \right\}.$$

Note that the defining relation of  $\text{Inv}(V)$  corresponds geometrically to gluing back the disc  $D$  to  $\Sigma_{g,n} \setminus D$  (since the loop  $c_{g,n}$  generating  $\ker(\pi_1(\Sigma_{g,n} \setminus D) \rightarrow \pi_1(\Sigma_{g,n}))$  is killed).

In fact, the subspace  $\text{Inv}(V)$  is stable under the action of the subalgebra of invariant elements  $\mathcal{L}_{g,n}^{\text{inv}}(H)$ :

**Theorem 5.2.6.** 1) An element  $x \in \mathcal{L}_{g,n}(H)$  is invariant under the action of the gauge algebra  $H$  if, and only if, for every  $H$ -module  $I$ ,  $\overset{I}{C}_{g,n}x = x\overset{I}{C}_{g,n}$ .  
 2) Let  $V$  be a representation of  $\mathcal{L}_{g,n}(H)$ . Then  $\text{Inv}(V)$  is stable under the action of invariant elements and thus provides a representation of  $\mathcal{L}_{g,n}^{\text{inv}}(H)$ .

The matrices  $\overset{I}{C}_{g,n}$  used in that theorem already appeared in [Ale94] (with  $H = U_q(\mathfrak{g})$ ,  $q$  generic), but here we need to generalize and adapt the construction of the representations of the invariant elements to our assumptions on  $H$ .

When  $(g, n) = (1, 0)$ ,  $\mathcal{L}_{1,0}(H)$  is isomorphic to a matrix algebra and its unique indecomposable (and simple) representation is  $H^*$ ; in that case, we have a representation of  $\mathcal{L}_{1,0}^{\text{inv}}(H)$  on  $\text{Inv}(H^*) = \text{SLF}(H)$  (Theorem 4.2.13), where  $\text{SLF}(H)$  is the algebra of symmetric linear forms on  $H$ :

$$\text{SLF}(H) = \{ \varphi \in H^* \mid \forall x, y \in H, \varphi(xy) = \varphi(yx) \}.$$

The definition of the moduli algebra in [AGS95, AGS96, AS96a, BNR02] requires to label the boundary circles by  $H$ -modules  $I_1, \dots, I_n$ . Then  $V = (H^*)^{\otimes g} \otimes I_1 \otimes \dots \otimes I_n$  is a representation of  $\mathcal{L}_{g,n}(H)$ ; let  $\rho_{\text{inv}}^V$  be the corresponding representation of  $\mathcal{L}_{g,n}^{\text{inv}}(H)$  on  $\text{Inv}(V)$ . The algebra  $\rho_{\text{inv}}^V(\mathcal{L}_{g,n}^{\text{inv}}(H))$  both implements the invariant and flatness constraints. Hence it is a quantum analogue of  $\mathbb{C}[\mathcal{A}_{df}/G]$  and is the natural candidate for the definition of the moduli algebra under our assumptions on  $H$ :

$$\mathcal{M}_{g,n}(H, I_1, \dots, I_n) = \rho_{\text{inv}}^{(H^*)^{\otimes g} \otimes I_1 \otimes \dots \otimes I_n}(\mathcal{L}_{g,n}^{\text{inv}}(H)). \quad (1.9)$$

However, we will not need the moduli algebra in this thesis. The important object for our purposes is instead the representation  $\text{Inv}(V)$  of  $\mathcal{L}_{g,n}^{\text{inv}}(H)$  (which is also a representation of the moduli algebra).

### 1.2.3 Representations of mapping class groups

The mapping class group  $\text{MCG}(\Sigma_{g,n})$  acts on  $\mathbb{C}[\text{Hom}(\pi_1(\Sigma_{g,n}), G)/G] = \mathbb{C}[\mathcal{A}_{df}/G]$ . In Chapters 4 (case of the torus) and 5 (general case), we construct the analogue of this representation (for

$n = 0$ ) based on  $\mathcal{L}_{g,0}(H)$  and we get a projective representation of  $\text{MCG}(\Sigma_{g,0} \setminus D)$  and above all of  $\text{MCG}(\Sigma_{g,0})$ . We use the idea, proposed in [AS96a], of replacing the generators  $b_i, a_i, m_j$  of  $\pi_1(\Sigma_{g,0} \setminus D)$  by the matrices  $\overset{I}{B}(k), \overset{I}{A}(k), \overset{I}{M}(l)$  with coefficients in  $\mathcal{L}_{g,0}(H)$ . In that way, each mapping class  $f \in \text{MCG}(\Sigma_{g,0} \setminus D)$  can be seen as an automorphism of  $\mathcal{L}_{g,0}(H)$ , denoted by  $\tilde{f}$  and which we call the lift of  $f$ . Indeed,  $f$  determines an automorphism of  $\pi_1(\Sigma_{g,0} \setminus D)$  and replacing (homotopy classes of) loops by matrices defines  $\tilde{f}$  (up to some normalization, see Definition (5.3.9)). Thanks to the isomorphisms of the previous section

$$\mathcal{L}_{g,0}(H) \cong \mathcal{L}_{1,0}(H)^{\otimes g} \cong \mathcal{H}(\mathcal{O}(H))^{\otimes g} \cong \text{End}_{\mathbb{C}}((H^*)^{\otimes g})$$

and hence  $\mathcal{L}_{g,0}(H)$  is a matrix algebra, its unique indecomposable (and simple) representation being  $(H^*)^{\otimes g}$ . It follows that each automorphism of  $\mathcal{L}_{g,0}(H)$  is inner; in particular, to the mapping class  $f$  is associated an element  $\hat{f} \in \mathcal{L}_{g,n}(H)$ , unique up to scalar, and such that  $\tilde{f}$  is the conjugation by  $\hat{f}$ . Such an element  $\hat{f}$  is  $H$ -invariant (Corollary (5.3.17)). Representing the elements  $\hat{f}$  on  $(H^*)^{\otimes g}$  gives a projective representation of  $\text{MCG}(\Sigma_{g,0} \setminus D)$  and representing the elements  $\hat{f}$  on  $\text{Inv}((H^*)^{\otimes g})$  gives a projective representation of  $\text{MCG}(\Sigma_{g,0})$ , which corresponds to the fact that the disk  $D$  is “glued back” in  $\text{Inv}((H^*)^{\otimes g})$ .

The case of the torus  $\Sigma_{1,0}$  is considered first because it deserves particular interest. The result is stated as follows:

**Theorem 4.3.7 (case of the torus).** 1) *The assignment*

$$\tau_a \mapsto \rho(v_A^{-1}), \quad \tau_b \mapsto \rho(v_B^{-1})$$

where  $\rho$  is the representation of  $\mathcal{L}_{1,0}(H)$  on  $H^*$ , defines a representation  $\theta_1^D$  of  $\text{MCG}(\Sigma_{1,0} \setminus D)$  on  $H^*$ .

2) *The assignment*

$$\tau_a \mapsto \rho_{\text{SLF}}(v_A^{-1}), \quad \tau_b \mapsto \rho_{\text{SLF}}(v_B^{-1})$$

where  $\rho_{\text{SLF}}$  is the representation of  $\mathcal{L}_{1,0}^{\text{inv}}(H)$  on  $\text{Inv}(H^*) = \text{SLF}(H)$ , defines a projective representation  $\theta_1$  of  $\text{MCG}(\Sigma_{1,0}) = \text{SL}_2(\mathbb{Z})$  on  $\text{SLF}(H)$ . If moreover  $S(\psi) = \psi$  for all  $\psi \in \text{SLF}(H)$ , then this defines actually a projective representation of  $\text{PSL}_2(\mathbb{Z}) = \text{SL}_2(\mathbb{Z})/\{\pm\mathbb{I}_2\}$ .

The elements  $v_A^{-1}, v_B^{-1} \in \mathcal{L}_{1,0}^{\text{inv}}(H)$  appearing in the theorem are defined as follows. The coefficients  $(\overset{I}{A}_j^i)_{I,i,j}$  (resp.  $(\overset{I}{B}_j^i)_{I,i,j}$ ) generate a subalgebra of  $\mathcal{L}_{1,0}(H)$  isomorphic to  $\mathcal{L}_{0,1}(H)$ , which is itself isomorphic to  $H$ . Hence we have a morphism  $j_A : H \rightarrow \mathbb{C}\langle \overset{I}{A}_j^i \rangle_{I,i,j} \subset \mathcal{L}_{1,0}(H)$  (resp.  $j_B : H \rightarrow \mathbb{C}\langle \overset{I}{B}_j^i \rangle_{I,i,j} \subset \mathcal{L}_{1,0}(H)$ ), and we define  $v_A^{-1} = j_A(v^{-1})$  (resp.  $v_B^{-1} = j_B(v^{-1})$ ) where  $v$  is the ribbon element of  $H$ . These elements implements the lifts  $\tilde{\tau}_a, \tilde{\tau}_b$  of the Dehn twists  $\tau_a, \tau_b$  respectively (see Figure 4.2):  $v_A^{-1} = \hat{\tau}_a, v_B^{-1} = \hat{\tau}_b$  (Proposition 4.3.3). Combining Propositions 2.3.4 and 4.2.14, we get that the representations of  $\tau_a$  and  $\tau_b$  on  $\varphi \in H^*$  are explicitly given by:

$$\begin{aligned} \theta_1^D(\tau_a)(\varphi) &= v_A^{-1} \triangleright \varphi = \varphi^{v^{-1}}, \\ \theta_1^D(\tau_b)(\varphi) &= v_B^{-1} \triangleright \varphi = \mu^l(v)^{-1} (\mu^l(g^{-1}v?) \varphi^v)^{v^{-1}} \end{aligned} \tag{1.10}$$

where for any  $\beta \in H^*$  and  $h \in H$ ,  $\beta^h \in H^*$  is defined by  $\beta^h(x) = \beta(hx)$ ,  $\mu^l \in H^*$  is the left integral of  $H$  and  $g$  is the pivotal element (the linear form  $\mu^l(v)^{-1} \mu^l(g^{-1}v?) : x \mapsto \mu^l(v)^{-1} \mu^l(g^{-1}vx)$  is related to the inverse of the ribbon element, see Proposition 2.3.4).

For a surface of arbitrary genus  $\Sigma_{g,0}$ , the result is stated as follows:

**Theorem 5.3.19 (general case).** 1) *The map*

$$\begin{aligned} \theta_g^D : \text{MCG}(\Sigma_{g,0} \setminus D) &\rightarrow \text{GL}((H^*)^{\otimes g}) \\ f &\mapsto \rho(\hat{f}) \end{aligned}$$



where  $\rho$  is the representation of  $\mathcal{L}_{g,0}(H)$  on  $(H^*)^{\otimes g}$ , is a projective representation.

2) The map

$$\begin{aligned} \theta_g : \text{MCG}(\Sigma_{g,0}) &\rightarrow \text{GL}(\text{Inv}((H^*)^{\otimes g})) \\ f &\mapsto \rho_{\text{inv}}(\widehat{f}) \end{aligned}$$

where  $\rho_{\text{inv}}$  is the representation of  $\mathcal{L}_{g,0}^{\text{inv}}(H)$  on  $\text{Inv}((H^*)^{\otimes g})$ , is a projective representation.

A similar result was given in [AS96a] under the assumption that the gauge algebra  $H$  is modular, the representation space being the moduli algebra. Thus our work provides a proof and generalizes their result to a non-semisimple setting. Note that we have a projective representation because the elements  $\widehat{f}$  are defined only up to scalar. Also note that  $\theta_g$  is just a restriction of the representation space:

$$\forall f \in \text{MCG}(\Sigma_{g,0}), \quad \theta_g(f) = \theta_g^D(f) \Big|_{\text{Inv}((H^*)^{\otimes g})}.$$

The result is stated for  $\Sigma_{g,0}$ , but we discuss its extension to a general surface  $\Sigma_{g,n}$  in section 5.3.5.

The lift  $\widetilde{\tau}_\gamma$  of a Dehn twist about a simple closed curve  $\gamma$  is implemented by conjugation by an element  $v_{\widetilde{\gamma}}^{-1} \in \mathcal{L}_{g,n}(H)$ ; in other words,  $\widehat{\tau}_\gamma = v_{\widetilde{\gamma}}^{-1}$  (Proposition 5.3.16). This element is defined as follows. First, express  $\gamma$  in terms of the generators  $b_i, a_i, m_j$  of  $\pi_1(\Sigma_{g,n} \setminus D)$ . Then replace  $b_i, a_i, m_j$  by the matrices  $\overset{I}{B}(i), \overset{I}{A}(i), \overset{I}{M}(j)$  (up to some normalization by  $\overset{I}{v}^x$ ); this gives a matrix  $\overset{I}{\widetilde{\gamma}}$ , called the lift of  $\gamma$  (Definition 5.3.7). Finally, the coefficients  $(\overset{I}{\widetilde{\gamma}}_j^i)_{I,i,j}$  satisfy the defining relations of  $\mathcal{L}_{0,1}(H)$  (Proposition 5.3.14), which is itself isomorphic to  $H$ . Hence we have a morphism  $j_{\widetilde{\gamma}} : H \rightarrow \mathbb{C}\langle \overset{I}{\widetilde{\gamma}}_j^i \rangle_{I,i,j} \subset \mathcal{L}_{g,n}(H)$  and we define  $v_{\widetilde{\gamma}}^{-1} = j_{\widetilde{\gamma}}(v^{-1})$ , where  $v$  is the ribbon element of  $H$ . Thanks to these elements  $v_{\widetilde{\gamma}}^{-1}$ , we obtain formulas for the representations of the Dehn twists about the simple closed curves  $a_i, b_i, d_i, e_i$  (depicted in Figure 5.7) on  $(H^*)^{\otimes g}$ :

**Theorem 5.3.22.** *Let  $\theta_g^D : \text{MCG}(\Sigma_{g,0} \setminus D) \rightarrow \text{PGL}((H^*)^{\otimes g})$  be the projective representation obtained in Theorem 5.3.19. The following formulas hold:*

$$\begin{aligned} \theta_g^D(\tau_{a_i})(\varphi_1 \otimes \dots \otimes \varphi_g) &= \varphi_1 \otimes \dots \otimes \varphi_{i-1} \otimes \theta_1^D(\tau_a)(\varphi_i) \otimes \varphi_{i+1} \otimes \dots \otimes \varphi_g, \\ \theta_g^D(\tau_{b_i})(\varphi_1 \otimes \dots \otimes \varphi_g) &= \varphi_1 \otimes \dots \otimes \varphi_{i-1} \otimes \theta_1^D(\tau_b)(\varphi_i) \otimes \varphi_{i+1} \otimes \dots \otimes \varphi_g, \\ \theta_g^D(\tau_{d_i})(\varphi_1 \otimes \dots \otimes \varphi_g) &= \varphi_1 \otimes \dots \otimes \varphi_{i-2} \otimes \varphi_{i-1} (S^{-1}(a_j) a_k ? b_k v''^{-1} b_j) \otimes \varphi_i (S^{-1}(a_l) S^{-1}(v'^{-1}) a_m ? b_m b_l) \\ &\quad \otimes \varphi_{i+1} \otimes \dots \otimes \varphi_g, \\ \theta_g^D(\tau_{e_i})(\varphi_1 \otimes \dots \otimes \varphi_g) &= \varphi_1 (S^{-1}(v^{(2i-2)-1}) ? v^{(2i-1)-1}) \otimes \dots \otimes \varphi_{i-1} (S^{-1}(v^{(2)-1}) ? v^{(3)-1}) \\ &\quad \otimes \varphi_i (S^{-1}(a_j) S^{-1}(v^{(1)-1}) a_k ? b_k b_j) \otimes \varphi_{i+1} \otimes \dots \otimes \varphi_g, \end{aligned}$$

with  $i \geq 2$  for the two last equalities,  $R = a_j \otimes b_j \in H \otimes H$  is the  $R$ -matrix<sup>6</sup>, and the formulas for  $\theta_1^D(\tau_a), \theta_1^D(\tau_b)$  are given in (1.10) above.

For the torus  $\Sigma_{1,0}$  and the gauge algebra  $H = \bar{U}_q = \bar{U}_q(\mathfrak{sl}_2)$ , we explicitly study the projective representation of  $\text{SL}_2(\mathbb{Z})$  on  $\text{SLF}(\bar{U}_q)$ .<sup>7</sup> To do so, we need a suitable basis of  $\text{SLF}(\bar{U}_q)$ , which is a  $(3p-1)$ -dimensional algebra. This basis is the one introduced in [GT09] and [Ari10], which we call the GTA basis; its definition is recalled in detail in section 3.2. It contains the characters  $\chi_s^\epsilon$  of the simple modules  $\mathcal{X}^\epsilon(s)$ , with  $\epsilon \in \{\pm\}$  and  $1 \leq s \leq p$ ; this gives  $2p$  elements. The missing  $p-1$  forms  $G_s$  ( $1 \leq s \leq p-1$ ) are constructed thanks to the properties of the  $\bar{U}_q$ -projective modules  $\mathcal{P}^\epsilon(s)$ . An important property of this basis for our purposes is that its multiplication rules, determined in Theorem 3.4.1 (and independently before in [GT09], see the comments at the beginning of Chapter 3), are simple. This feature allows us to compute the following formulas:

<sup>6</sup>We use implicit summation on the index in the expression of  $R$ ; do not confuse the components  $a_j, b_j$  of the  $R$ -matrix and the loops  $a_i, b_i \in \pi_1(\Sigma_{g,0} \setminus D)$ .

<sup>7</sup>We mention that the Hopf algebra  $\bar{U}_q$  is not braided. But the extension of  $\bar{U}_q$  by a square root of  $K$  is ribbon; moreover, the  $R$ -matrix and the ribbon element satisfy nice properties which allow us to apply Theorem 4.3.7 with  $H = \bar{U}_q$ . See sections 3.1.3, 4.4.1, 4.4.2.

**Theorem 4.4.6.** *Let  $\theta_1 : \mathrm{SL}_2(\mathbb{Z}) \rightarrow \mathrm{PGL}(\bar{U}_q^*)$  be the projective representation obtained in Theorem 4.3.7, with gauge algebra  $\bar{U}_q = \bar{U}_q(\mathfrak{sl}_2)$ . The representations of the Dehn twists  $\tau_a$  and  $\tau_b$  on the GTA basis are given by:*

$$\theta_1(\tau_a)(\chi_s^\epsilon) = v_{\mathcal{X}^\epsilon(s)}^{-1} \chi_s^\epsilon, \quad \theta_1(\tau_a)(G_{s'}) = v_{\mathcal{X}^+(s')}^{-1} G_{s'} - v_{\mathcal{X}^+(s')}^{-1} \hat{q} \left( \frac{p-s'}{[s']} \chi_{s'}^+ - \frac{s'}{[s']} \chi_{p-s'}^- \right)$$

and

$$\begin{aligned} \theta_1(\tau_b)(\chi_s^\epsilon) &= \xi \epsilon (-\epsilon)^{p-1} s q^{-(s^2-1)} \left( \sum_{\ell=1}^{p-1} (-1)^s (-\epsilon)^{p-\ell} (q^{\ell s} + q^{-\ell s}) (\chi_\ell^+ + \chi_{p-\ell}^-) + \chi_p^+ + (-\epsilon)^p (-1)^s \chi_p^- \right) \\ &\quad + \xi \epsilon (-1)^s q^{-(s^2-1)} \sum_{j=1}^{p-1} (-\epsilon)^{j+1} [j][js] G_j, \end{aligned}$$

$$\theta_1(\tau_b)(G_{s'}) = \xi (-1)^{s'} q^{-(s'^2-1)} \frac{\hat{q} p}{[s']} \sum_{j=1}^{p-1} (-1)^{j+1} [j][js'] \left( 2G_j - \hat{q} \frac{p-j}{[j]} \chi_j^+ + \hat{q} \frac{j}{[j]} \chi_{p-j}^- \right),$$

with  $\epsilon \in \{\pm\}$ ,  $0 \leq s \leq p$ ,  $1 \leq s' \leq p-1$  and  $\xi^{-1} = \frac{1-i}{2\sqrt{p}} \frac{\hat{q}^{p-1}}{[p-1]!} (-1)^p q^{-(p-3)/2}$ .

From these formulas, we deduce the structure of the representation:

**Theorem 4.4.9.** *The  $(p+1)$ -dimensional subspace  $\mathcal{P} = \mathrm{vect}(\chi_s^+ + \chi_{p-s}^-, \chi_p^+, \chi_p^-)_{1 \leq s \leq p-1}$  of the characters of the projective  $\bar{U}_q$ -modules is stable under the  $\mathrm{SL}_2(\mathbb{Z})$ -action of Theorem 4.4.6. Moreover, there exists a  $(p-1)$ -dimensional projective representation  $\mathcal{W}$  of  $\mathrm{SL}_2(\mathbb{Z})$  such that*

$$\mathrm{SLF}(\bar{U}_q) = \mathcal{P} \oplus (\mathbb{C}^2 \otimes \mathcal{W})$$

where  $\mathbb{C}^2$  is the natural representation of  $\mathrm{SL}_2(\mathbb{Z})$  (action by left multiplication). The formulas for the action on  $\mathcal{W}$  are given in (4.39).

## 1.2.4 Equivalence with the Lyubashenko representation

Using categorical methods based on the coend of a ribbon category, Lyubashenko-Majid [LM94] (case of the torus and with a category of modules) and Lyubashenko [Lyu95b, Lyu96] (general case) constructed projective representations of mapping class groups. Our assumptions on  $H$  allow us to apply their constructions to the ribbon category  $\mathrm{mod}_l(H)$ , namely the category of finite dimensional left  $H$ -modules, and to obtain the corresponding formulas. Thanks to the formulas of (1.10) and Theorem 5.3.22, we show that these representations are equivalent to those constructed here:

**Theorem 4.3.10 (case of the torus).** *The projective representation of  $\mathrm{MCG}(\Sigma_1) = \mathrm{SL}_2(\mathbb{Z})$  defined in Theorem 4.3.7 is equivalent to that defined in [LM94].*

For  $H = \bar{U}_q$ , the Lyubashenko-Majid representation of  $\mathrm{SL}_2(\mathbb{Z})$  on  $\mathcal{Z}(\bar{U}_q)$  was studied explicitly in [FGST06a] in relation to logarithmic conformal field theory. In particular, they determined the structure of that representation, and Theorem 4.4.9 is in perfect agreement with their result.

**Theorem 5.4.4 (general case).** *The projective representations of  $\mathrm{MCG}(\Sigma_g \setminus D)$  and  $\mathrm{MCG}(\Sigma_g)$  defined in Theorem 5.3.19 are equivalent to those defined in [Lyu95b, Lyu96].*

This equivalence is interesting because the construction of the projective representation of the mapping class group in the combinatorial quantization setting uses different techniques than in the Lyubashenko-Majid and Lyubashenko settings, and is perhaps more elementary since the starting point is simply to mimic the action of the mapping class group on the fundamental group at the level of the algebra. Moreover, even though the resulting representations of mapping class groups are equivalent, in the combinatorial quantization setting we also have the algebras of observables  $\mathcal{L}_{g,n}^{\mathrm{inv}}(H)$  and their representations; they give rise to representations of the skein algebras of surfaces (at roots of unity), which is one of the subjects of Chapter 6.

## 1.2.5 Graphical calculus and skein theory

In Chapter 6, we first develop a graphical calculus for  $\mathcal{L}_{g,n}(H)$  and we reformulate the defining relations of  $\mathcal{L}_{g,n}(H)$  in terms of diagrams. Then we use this graphical calculus to define the Wilson loop map, which assigns an element of  $\mathcal{L}_{g,n}(H)$  to any colored oriented framed link (Definition 6.2.1 and Figure 6.3). Our definition is completely natural since it is entirely diagrammatic. It is equivalent but different from the ones of [BR96] and [BFK98b]. It is not difficult to show that (among other things) the Wilson loop map take values in the algebra of observables and above all that it is compatible with the stack product of two links (these properties are also in [BR96] and [BFK98b] of course, but are proved by using their respective formalisms and definitions):

**Theorem 6.2.7.** *The Wilson loop map  $W$  is compatible with the stack product:*

$$W(L_1 * L_2) = W(L_1)W(L_2).$$

With our definition of  $W$ , the proof of that theorem is purely diagrammatic (Figure 6.7).

When the gauge algebra is  $\bar{U}_q = \bar{U}_q(\mathfrak{sl}_2)$ , the Wilson loop map is independent of the orientation of the link and satisfies the Kauffman bracket skein relation. These facts imply that we have a representation of the Kauffman bracket skein algebra  $\mathcal{S}_q(\Sigma_{g,n} \setminus D)$  on any representation  $V$  of  $\mathcal{L}_{g,n}(\bar{U}_q)$  and, if we restrict to  $\text{Inv}(V)$ , we obtain a representation of  $\mathcal{S}_q(\Sigma_{g,n})$ , due to the fact that the disk  $D$  is “glued back” in  $\text{Inv}(V)$ . The last part of the claim is stated and proved for  $n = 0$  in the theorem below, but is probably true for any  $g, n$ .

**Theorem 6.4.1.** *1. Let  $\rho : \mathcal{L}_{g,n}(\bar{U}_q) \rightarrow \text{End}_{\mathbb{C}}(V)$  be a representation (with  $V = (\bar{U}_q^*)^{\otimes g} \otimes I_1 \otimes \dots \otimes I_n$ , where  $I_1, \dots, I_n$  are representations of  $\bar{U}_q$ ). The map*

$$\begin{aligned} \mathcal{S}_q(\Sigma_{g,n} \setminus D) &\rightarrow \text{End}_{\mathbb{C}}(V) \\ L &\mapsto \rho(W(L)) \end{aligned}$$

*is a representation of  $\mathcal{S}_q(\Sigma_{g,n} \setminus D)$ .*

*2. Assume  $n = 0$  and let  $\rho_{\text{inv}}$  be the representation of  $\mathcal{L}_{g,0}^{\text{inv}}(\bar{U}_q)$  on  $\text{Inv}((\bar{U}_q^*)^{\otimes g})$ . The map*

$$\begin{aligned} \mathcal{S}_q(\Sigma_{g,0}) &\rightarrow \text{End}_{\mathbb{C}}(\text{Inv}((\bar{U}_q^*)^{\otimes g})) \\ L &\mapsto \rho_{\text{inv}}(W(L^\circ)) \end{aligned}$$

*is well-defined and is a representation of  $\mathcal{S}_q(\Sigma_{g,0})$ .*

In the theorem,  $L^\circ$  is any link in  $(\Sigma_{g,0} \setminus D) \times [0, 1]$  such that  $(j \times \text{id})(L^\circ) = L$ , where  $j : \Sigma_{g,0} \setminus D \rightarrow \Sigma_{g,0}$  is the canonical injection.

For the torus  $\Sigma_{1,0}$ , we explicitly study this representation on  $\text{SLF}(\bar{U}_q)$ , using again the GTA basis and its multiplication rules. It suffices to consider the action of the loops  $a, b$  since they generate the image of the Wilson loop map (Proposition 6.3.5). The subspaces

$$\mathcal{P} = \text{vect}(\chi_s^+ + \chi_{p-s}^-, \chi_p^+, \chi_p^-)_{1 \leq s \leq p-1}, \quad \mathcal{U} = \text{vect}(\chi_s^+)_{1 \leq s \leq p-1}, \quad \mathcal{V} = \text{vect}(G_s)_{1 \leq s \leq p-1}$$

determine the structure of the representation. Moreover, we have a natural representation of  $\mathcal{S}_q(\Sigma_{1,0})$  on the skein module  $\mathcal{S}_q(H_1)$ , where  $H_1$  is a genus 1 handlebody (*i.e.* a thickened annulus). The reduced skein module  $\mathcal{S}_q^{\text{red}}(H_1)$  is isomorphic to a composition factor of  $\text{SLF}(\bar{U}_q)$ :

**Propositions 6.5.2 and 6.5.5.**  *$J_1 = \mathcal{P} \subset J_2 = \text{vect}(\mathcal{P} \cup \mathcal{U}) \subset J_3 = \text{vect}(\mathcal{P} \cup \mathcal{U} \cup \mathcal{V})$  is a composition series of  $\text{SLF}(\bar{U}_q)$  under the action of  $\mathcal{S}_q(\Sigma_{1,0})$ . This representation is indecomposable and its structure is schematized by the following diagram:*

$$\begin{array}{ccc} \mathcal{U} & & \mathcal{V} \\ & \searrow^{W_B} & \swarrow_{W_A, W_B} \\ & \mathcal{P} & \end{array}$$

*Moreover, the  $\mathcal{S}_q(\Sigma_{1,0})$ -modules  $\mathcal{S}_q^{\text{red}}(H_1)$  and  $\bar{\mathcal{U}} = J_2/J_1$  are isomorphic.*

We conjecture that the last claim is true in any genus, namely that  $\mathcal{S}_q^{\text{red}}(H_g)$  is a composition factor of  $\text{Inv}((\bar{U}_q^*)^{\otimes g})$  under the action of  $\mathcal{S}_q(\Sigma_{g,0})$  (Conjecture 6.5.6).

## 1.2.6 Perspectives

Several questions and problems based upon this thesis can be investigated in further work, especially when the gauge algebra is  $\bar{U}_q = \bar{U}_q(\mathfrak{sl}_2)$ .

The first set of questions is about the description of the algebra of observables  $\mathcal{L}_{g,n}^{\text{inv}}(\bar{U}_q)$ . It is a general fact (Proposition 6.2.9) that the value of the Wilson loop map around a simple loop  $x \in \pi_1(\Sigma_{g,n} \setminus D)$  colored by  $I$  is the quantum trace of its lift:

$$\overset{I}{W}(x) = \text{tr}(K^{p+1} \overset{I}{\tilde{x}}),$$

where the lift  $\overset{I}{\tilde{x}}$  (Definition 5.3.7) is defined by replacing generators of  $\pi_1(\Sigma_{g,n} \setminus D)$  by matrices in the expression of  $x$  via the correspondence  $B(i) \leftrightarrow b_i$ ,  $A(j) \leftrightarrow a_j$ ,  $M(k) \leftrightarrow m_k$ , up to some normalization. These elements are “semisimple observables” since they split on extensions:

$$0 \rightarrow I \rightarrow V \rightarrow J \rightarrow 0 \text{ exact} \implies \overset{V}{W}(x) = \overset{I}{W}(x) + \overset{J}{W}(x).$$

In section 6.3, all the links are colored by the fundamental representation  $\mathcal{X}^+(2)$ :

$$W(x) = \text{tr}(K^{p+1} \overset{\mathcal{X}^+(2)}{\tilde{x}}),$$

This is enough to recover all the  $\overset{\mathcal{X}^\epsilon(s)}{W}(x)$  (where the  $\mathcal{X}^\epsilon(s)$  are the simple  $\bar{U}_q$ -modules) thanks to the formulas (which follows from Proposition 5.3.14 and (3.31)):

$$\overset{\mathcal{X}^\epsilon(s)}{W}(x) \overset{\mathcal{X}^\epsilon(s-1)}{W}(x) = \overset{\mathcal{X}^\epsilon(s-1)}{W}(x) + \overset{\mathcal{X}^\epsilon(s+1)}{W}(x), \quad \overset{\mathcal{X}^\epsilon(p)}{W}(x) \overset{\mathcal{X}^\epsilon(p-1)}{W}(x) = 2 \overset{\mathcal{X}^\epsilon(p-1)}{W}(x) + 2 \overset{\mathcal{X}^{-\epsilon}(1)}{W}(x).$$

However, this is insufficient to recover all the observables. Indeed, there are also non-semisimple observables based on the pseudo-traces  $G_s$  (see (3.24)):

$$V^s(x) = \text{tr}(\overset{\mathcal{P}^+(s)}{\sigma_s} K^{p+1} \overset{\mathcal{P}^+(s)}{\tilde{x}}) + \text{tr}(\overset{\mathcal{P}^-(p-s)}{\sigma_{p-s}} K^{p+1} \overset{\mathcal{P}^-(p-s)}{\tilde{x}}) \quad (1 \leq s \leq p-1).$$

This  $V^s$  is a non-semisimple analogue of the Wilson loop map  $W$  and is defined only on simple loops for the moment. This leads to the following problems (which may be solvable or not):

- Define  $V^s(L)$  for any oriented framed link  $L \in (\Sigma_{g,n} \setminus D) \times [0, 1]$ .
- Determine skein relations satisfied by the map  $V^s$ .
- Does the collection of observables  $W(x), V^s(x)$  (for  $1 \leq s \leq p-1$  and  $x$  a simple loop)<sup>8</sup> generates the algebra  $\mathcal{L}_{g,n}^{\text{inv}}(\bar{U}_q)$ ? More generally, describe as precisely as possible  $\mathcal{L}_{g,n}^{\text{inv}}(\bar{U}_q)$ .

The last item is probably very difficult. Instead, we can glue back the disk  $D$  by studying the representation of  $\mathcal{L}_{g,n}^{\text{inv}}(\bar{U}_q)$  on  $\text{Inv}(V)$ , where  $V = (\bar{U}_q^*)^{\otimes g} \otimes I_1 \otimes \dots \otimes I_n$ . This would be a first step to understand the structure of the moduli algebra  $\mathcal{M}_{g,n}(H, I_1, \dots, I_n)$  defined in (1.9). These questions are still very difficult and it is better to restrict to  $n = 0$  in order to avoid the choices of  $I_1, \dots, I_n$ . Section 4.4.4 contains remarks about the case  $(g, n) = (1, 0)$ . The first difficulty for this kind of questions in higher genus is that we do not know a basis of  $\text{Inv}((\bar{U}_q^*)^{\otimes g})$  which would generalize the GTA basis of  $\text{SLF}(\bar{U}_q) = \text{Inv}(U_q^*)$ .

<sup>8</sup>We can take  $s = 1$  thanks to the relation  $W(x)V^s(x) = \frac{[s-1]}{[s]}V^{s-1}(x) + \frac{[s+1]}{[s]}V^{s+1}(x)$ , which follows from Proposition 5.3.14 and Theorem 3.4.1.

- Determine a “suitable basis” of  $\text{Inv}((\bar{U}_q^*)^{\otimes g})$ .
- Determine the structure of the representation of  $\mathcal{L}_{g,0}^{\text{inv}}(\bar{U}_q)$  on  $\text{Inv}((\bar{U}_q^*)^{\otimes g})$  and deduce consequences about the structure of the moduli algebra  $\mathcal{M}_{g,0}(H)$ .

The semisimple part of  $\mathcal{L}_{g,n}^{\text{inv}}(\bar{U}_q)$  deserves however a special interest since it is the image by  $W$  (with all the links colored by  $\mathcal{X}^+(2)$ ) of the Kauffman bracket skein algebra  $\mathcal{S}_q(\Sigma_{g,n} \setminus D)$ . Moreover,  $\text{Inv}((\bar{U}_q^*)^{\otimes g})$  is a representation of  $\mathcal{S}_q(\Sigma_{g,0})$ . For  $g = 1$ , the structure of this representation is determined in Proposition 6.5.2 and it is shown in Proposition 6.5.5 that it contains the natural representation of  $\mathcal{S}_q(\Sigma_{1,0})$  on  $\mathcal{S}_q^{\text{red}}(H_1)$  as a composition factor.

- Determine the structure of the representation of  $\mathcal{S}_q(\Sigma_{g,0})$  on  $\text{Inv}((\bar{U}_q^*)^{\otimes g})$ .
- Prove that the natural representation of  $\mathcal{S}_q(\Sigma_{g,0})$  on  $\mathcal{S}_q^{\text{red}}(H_g)$  is a composition factor of the representation of  $\mathcal{S}_q(\Sigma_{g,0})$  on  $\text{Inv}((\bar{U}_q^*)^{\otimes g})$  (Conjecture 6.5.6).

Another problem is to generalize Theorem 4.4.9 in higher genus:

- Determine the structure of the projective representation of  $\text{MCG}(\Sigma_{g,0})$  on  $\text{Inv}((\bar{U}_q^*)^{\otimes g})$ .

Finally, we can try to generalize the algebras  $\mathcal{L}_{g,n}$  in a categorical setting. This can have different meanings. We know that  $\mathcal{L}_{0,1}(H)$  is a coend (Proposition 5.4.3); using this, we can start with a ribbon category with coend  $K$  and rewrite all in categorical terms using the universal property of the coend (for instance,  $\mathcal{L}_{1,0}(H)$  would be  $K \otimes K$  and its product would be described as a morphism which factorizes a certain dinatural family). We can also try to categorify  $\mathcal{L}_{g,n}$  (for instance with gauge algebra  $U_q(\mathfrak{sl}_2)$ ,  $q$  generic), which means finding a monoidal category  $\mathcal{C}_{g,n}$  such that  $K_0(\mathcal{C}_{g,n}) \cong \mathcal{L}_{g,n}$ ; it would be interesting to see what plays the role of the algebra of observables in such a categorification.

# Chapter 2

## Notations and preliminaries

In this chapter, we set the notations and collect important facts which will be intensively used in the subsequent chapters. We assume that the reader is familiar with the basic notions about Hopf algebras, knot theory and tensor categories explained for instance in the three first parts of [Kas95].

### 2.1 General notations and conventions

In order to simplify notations, we will use implicit summations. First, we use Einstein's notation for the computations involving indices: when an index variable appears twice in a litteral expression, one time in upper position and one time in lower position, it implicitly means summation over all the values of the index. Second, we use Sweedler's notation (see [Kas95, Not. III.1.6]) without summation sign for coproducts, that is we write

$$\begin{aligned}\Delta(x) &= x' \otimes x'', \quad \Delta^{(2)}(x) = (\Delta \otimes \text{id}) \circ \Delta(x) = (\text{id} \otimes \Delta) \circ \Delta(x) = x' \otimes x'' \otimes x''', \quad \dots, \\ \Delta^{(n)}(x) &= x^{(1)} \otimes \dots \otimes x^{(n+1)}.\end{aligned}$$

We write the universal  $R$ -matrix as  $R = a_i \otimes b_i$  with implicit summation on  $i$  and define  $R' = b_i \otimes a_i$ . We also denote  $RR' = X_i \otimes Y_i$ ,  $(RR')^{-1} = \bar{X}_i \otimes \bar{Y}_i$ .

The symbol “?” will mean a variable in functional constructions. For instance if  $H$  is a finite dimensional Hopf algebra and  $\varphi, \psi \in H^*$ ,  $a, b \in H$ , then for all  $x, y \in H$ ,  $\varphi(a?) : x \mapsto \varphi(ax)$ ,  $\varphi(?) \otimes \psi(b?) : x \otimes y \mapsto \varphi(xa)\psi(by)$  and  $\varphi(?)\psi(b?) : x \mapsto \varphi(x'a)\psi(bx'')$  (thanks to the dual Hopf algebra structure on  $H^*$ , see section 2.3). We will often use the notation  $\varphi^a$  as a shorthand for  $\varphi(a?)$ .

All the algebras under consideration in this text are finite dimensional  $\mathbb{C}$ -algebras. If  $A$  is a finite dimensional  $\mathbb{C}$ -algebra,  $V$  is a finite dimensional  $A$ -module and  $x \in A$ , we denote by  $\overset{V}{x} \in \text{End}_{\mathbb{C}}(V)$  the representation of  $x$  on the module  $V$ . Hence, if  $(v_i)$  is a basis of  $V$ , we have

$$xv_j = \overset{V_j}{x}_j v_i. \tag{2.1}$$

More generally, if  $X \in A^{\otimes n}$  and if  $V_1, \dots, V_n$  are  $A$ -modules, we denote by  $\overset{V_1 \dots V_n}{X}$  the representation of  $X$  on  $V_1 \otimes \dots \otimes V_n$ .

As in [CR62], we will use the abbreviation PIM for Principal Indecomposable Module. Recall that the PIMs  $P_i$  are the indecomposable direct summands of the regular representation of  $A$ :

$${}_A A = n_1 P_1 \oplus \dots \oplus n_k P_k$$

where the integer  $n_i > 0$  is the multiplicity of  $P_i$  in that decomposition. Since we assume that  $A$  is finite dimensional, it is well-known (see *e.g.* [CR62]) that every finite dimensional projective module is a direct sum of PIMs. Hence the projective cover of any finite dimensional module is a direct sum of PIMs, and it follows that any finite dimensional module is a quotient of a direct sum of PIMs.

We will work only with finite dimensional modules and “module” will implicitly mean “finite dimensional left module”. When we use right modules we explicitly mention it at each time. The *socle* of  $V$ , denoted by  $\text{Soc}(V)$  is the largest semi-simple submodule of  $V$ . The *top* of  $V$ , denoted by  $\text{Top}(V)$ , is  $V/\text{Rad}(V)$ , where  $\text{Rad}(V)$  is the Jacobson radical of  $V$ . See [CR62, Chap. IV and VIII] for background material about representation theory.

For  $q \in \mathbb{C} \setminus \{-1, 0, 1\}$ , we define the  $q$ -integer  $[n]$  (with  $n \in \mathbb{Z}$ ) and the  $q$ -factorial  $[m]!$  (with  $m \in \mathbb{N}$ ) by:

$$[n] = \frac{q^n - q^{-n}}{q - q^{-1}}, \quad [0]! = 1, \quad [m]! = [1][2] \dots [m] \text{ for } m \geq 1.$$

We will denote  $\hat{q} = q - q^{-1}$  to shorten formulas. In what follows  $q$  is a primitive  $2p$ -root of unity (where  $p$  is a fixed integer  $\geq 2$ ), say  $q = e^{i\pi/p}$ . Observe that in this case  $[n] = \frac{\sin(n\pi/p)}{\sin(\pi/p)}$ ,  $[p] = 0$  and  $[p - n] = [n]$ .

As usual  $\delta_{s,t}$  or  $\delta_t^s$  is the Kronecker symbol and  $\mathbb{I}_n$  is the identity matrix of size  $n$ .

The letter  $H$  will always denote a finite dimensional, factorizable, ribbon Hopf algebra (over  $\mathbb{C}$ ). More notations are defined in the next two sections.

We denote by  $\Sigma_{g,n}$  the compact oriented surface of genus  $g$  with  $n$  open disks removed.

## 2.2 Matrices and tensors

Let  $A$  be a finite dimensional associative algebra. We denote by  $\text{Mat}_n(A)$  the algebra of  $n \times n$ -matrices with coefficients in  $A$ :

$$\text{Mat}_n(A) = A \otimes \text{Mat}_n(\mathbb{C}).$$

Every  $M \in \text{Mat}_m(A)$  is written as  $M = \sum_{i,j} M_j^i \otimes E_j^i$ , where  $E_j^i$  is the matrix with 1 at the intersection of the  $i$ -th row and the  $j$ -th column and 0 elsewhere. More generally, every  $L \in A \otimes \text{Mat}_{m_1}(\mathbb{C}) \otimes \dots \otimes \text{Mat}_{m_l}(\mathbb{C})$  can be written as

$$L = \sum_{i_1, j_1, \dots, i_l, j_l} L_{j_1 \dots j_l}^{i_1 \dots i_l} \otimes E_{j_1}^{i_1} \otimes \dots \otimes E_{j_l}^{i_l}$$

and the elements  $L_{j_1 \dots j_l}^{i_1 \dots i_l} \in A$  are called the coefficients of  $L$ . If  $f : A \rightarrow B$  (with  $B$  an algebra) is a morphism we define  $f(L) \in B \otimes \text{Mat}_{m_1}(\mathbb{C}) \otimes \dots \otimes \text{Mat}_{m_l}(\mathbb{C})$  component-by-component:

$$f(L) = \sum_{i_1, j_1, \dots, i_l, j_l} f(L_{j_1 \dots j_l}^{i_1 \dots i_l}) \otimes E_{j_1}^{i_1} \otimes \dots \otimes E_{j_l}^{i_l}$$

or equivalently  $f(L)_{j_1 \dots j_l}^{i_1 \dots i_l} = f(L_{j_1 \dots j_l}^{i_1 \dots i_l})$ .

Let  $M \in A \otimes \text{Mat}_m(\mathbb{C})$ ,  $N \in A \otimes \text{Mat}_n(\mathbb{C})$ . We embed  $M, N$  in  $A \otimes \text{Mat}_m(\mathbb{C}) \otimes \text{Mat}_n(\mathbb{C}) = \text{Mat}_{mn}(A)$  by

$$M_1 = \sum_{i,j} M_j^i \otimes E_j^i \otimes \mathbb{I}_n, \quad N_2 = \sum_{i,j} N_j^i \otimes \mathbb{I}_m \otimes E_j^i$$

where  $\mathbb{I}_k = \sum_{i=1}^k E_i^i$  is the identity matrix of size  $k$ . This can also be written as

$$(M_1)_{bd}^{ac} = M_b^a \delta_d^c, \quad (N_2)_{bd}^{ac} = \delta_b^a N_d^c$$

(where  $\delta_j^i$  is the Kronecker symbol), or also

$$M_1 = M \otimes \mathbb{I}_n, \quad N_2 = \mathbb{I}_m \otimes N$$

where  $\otimes$  is the Kronecker product. Note that  $M_1 N_2$  (resp.  $N_2 M_1$ ) contains all the possible products of coefficients of  $M$  (resp. of  $N$ ) by coefficients of  $N$  (resp. of  $M$ ):  $(M_1 N_2)_{j\ell}^{ik} = M_j^i N_\ell^k$  (resp.  $(N_2 M_1)_{j\ell}^{ik} = N_\ell^k M_j^i$ ). In particular,  $M_1 N_2 = N_2 M_1$  if and only if the coefficients of  $M$  commute with those of  $N$ .

Example 2.2.1. Let  $M, N \in \text{Mat}_2(A)$ :

$$M = \begin{pmatrix} m_1^1 & m_2^1 \\ m_1^2 & m_2^2 \end{pmatrix}, \quad N = \begin{pmatrix} n_1^1 & n_2^1 \\ n_1^2 & n_2^2 \end{pmatrix}.$$

Then

$$M_1 = \begin{pmatrix} m_1^1 \mathbb{I}_2 & m_2^1 \mathbb{I}_2 \\ m_1^2 \mathbb{I}_2 & m_2^2 \mathbb{I}_2 \end{pmatrix} = \begin{pmatrix} m_1^1 & 0 & m_2^1 & 0 \\ 0 & m_1^1 & 0 & m_2^1 \\ m_1^2 & 0 & m_2^2 & 0 \\ 0 & m_1^2 & 0 & m_2^2 \end{pmatrix}, \quad N_2 = \begin{pmatrix} N & 0 \\ 0 & N \end{pmatrix} = \begin{pmatrix} n_1^1 & n_2^1 & 0 & 0 \\ n_1^2 & n_2^2 & 0 & 0 \\ 0 & 0 & n_1^1 & n_2^1 \\ 0 & 0 & n_1^2 & n_2^2 \end{pmatrix}$$

and

$$M_1 N_2 = \begin{pmatrix} m_1^1 n_1^1 & m_1^1 n_2^1 & m_2^1 n_1^1 & m_2^1 n_2^1 \\ m_1^1 n_1^2 & m_1^1 n_2^2 & m_2^1 n_1^2 & m_2^1 n_2^2 \\ m_1^2 n_1^1 & m_1^2 n_2^1 & m_2^2 n_1^1 & m_2^2 n_2^1 \\ m_1^2 n_1^2 & m_1^2 n_2^2 & m_2^2 n_1^2 & m_2^2 n_2^2 \end{pmatrix}, \quad N_2 M_1 = \begin{pmatrix} n_1^1 m_1^1 & n_2^1 m_1^1 & n_1^1 m_2^1 & n_2^1 m_2^1 \\ n_1^2 m_1^1 & n_2^2 m_1^1 & n_1^2 m_2^1 & n_2^2 m_2^1 \\ n_1^1 m_1^2 & n_2^1 m_1^2 & n_1^1 m_2^2 & n_2^1 m_2^2 \\ n_1^2 m_1^2 & n_2^2 m_1^2 & n_1^2 m_2^2 & n_2^2 m_2^2 \end{pmatrix}.$$

△

This is obviously generalized to more general embeddings. For instance,  $L \in A \otimes \text{Mat}_n(\mathbb{C})^{\otimes 2}$  can be embedded in  $A \otimes \text{Mat}_n(\mathbb{C})^{\otimes 2}$  in two ways:

$$(L_{12})_{bd}^{ac} = L_{bd}^{ac}, \quad (L_{21})_{bd}^{ac} = L_{db}^{ca}$$

and can be embedded in  $A \otimes \text{Mat}_n(\mathbb{C})^{\otimes 3}$  in several ways, *e.g.*

$$(L_{12})_{bdf}^{ace} = L_{bd}^{ac} \delta_f^e, \quad (L_{13})_{bdf}^{ace} = L_{bf}^{ae} \delta_d^c, \quad (L_{32})_{bdf}^{ace} = L_{fd}^{ec} \delta_b^a \quad \dots$$

Note that  $(R')_{12}^{IJ} = (R)_{21}^{JI}$ , where  $R = a_i \otimes b_i \in H^{\otimes 2}$  and  $R' = b_i \otimes a_i$ .

Recall that we use Einstein's notation for the computations involving indices. For instance if  $X, Y \in A \otimes \text{Mat}_n(\mathbb{C})$ ,  $L, M \in \text{Mat}_n(\mathbb{C})^{\otimes 2} \otimes A$  and  $N \in \text{Mat}_n(\mathbb{C})^{\otimes 3} \otimes A$ , then

$$(XY)_b^a = X_i^a Y_b^i, \quad (X_1 M_{12})_{bd}^{ac} = X_i^a M_{bd}^{ic}, \quad (L_{32} M_{13} N_{312})_{bdf}^{ace} = L_{ij}^{ec} M_{kl}^{ai} N_{fbd}^{lkj}.$$

We will extensively use matrices which are labelled by finite dimensional representations of  $A$ . Such matrices will be denoted by  $\overset{V}{M}$ ,  $V$  being a finite dimensional  $A$ -module. The matrix  $\overset{V}{M}$  will be an element of  $\text{Mat}_{\dim(V)}(B)$ , where  $B$  is some algebra, but since we want to record that it is associated with the  $A$ -module  $V$ , it is better to consider it as an element of  $B \otimes \text{End}_{\mathbb{C}}(V)$ .

An important example of such matrices labelled by modules is provided by representation morphisms. Indeed, let  $V$  be  $A$ -module; then by definition we have a map  $\overset{V}{T} : A \rightarrow \text{End}_{\mathbb{C}}(V)$ :

$$\overset{V}{T}(x) = \overset{V}{x} \tag{2.2}$$

where we denote by  $\overset{V}{x}$  the representation of  $x \in A$  on  $V$ . In other words, if  $(v_i)$  is a basis of  $V$  and  $(v^i)$  is its dual basis, then

$$\overset{V}{T}_j^i = v^i(? \cdot v_j) : A \rightarrow \mathbb{C} \\ x \mapsto v^i(x \cdot v_j)$$

Hence  $\overset{V}{T}$  is a matrix with coefficients in  $A^*$ :  $\overset{V}{T} \in A^* \otimes \text{End}_{\mathbb{C}}(V)$ . The linear form  $\overset{V}{T}_j^i$  is called a matrix coefficient associated to the  $A$ -module  $V$ . By definition, if  $f : V \rightarrow W$  is an  $A$ -morphism it holds

$$\overset{W}{T} f = f \overset{V}{T} \tag{2.3}$$



where we identify  $f$  with its matrix. We call this relation the naturality of the (family of) matrices  $\overset{V}{T}$ . Also note that if  $V$  is a submodule or a quotient of  $W$ , then  $\overset{V}{T}$  is a submatrix of  $\overset{W}{T}$  and thus the matrix coefficients of  $V$  are contained in those of  $W$ . If  $A$  is a Hopf algebra, then  $\overset{V}{T}$  is a matrix with coefficients in the dual Hopf algebra  $\mathcal{O}(A)$ , see (2.15).

The algebra  $A$  being finite dimensional, its dual  $A^*$  is generated as a vector space by the matrix coefficients of the PIMs. Indeed, let  $(x_1, \dots, x_n)$  be a basis of  $A$  with  $x_1 = 1$ , let  $(x^1, \dots, x^n) \subset A^*$  be the dual basis and let  ${}_A A$  be the regular representation. It is readily seen that  $\overset{A A}{T}_1^i(x_j) = \delta_{i,j}$  and thus  $\overset{A A}{T}_1^i = x^i$ . Since the PIMs are the direct summands of  ${}_A A$ , the claim is proved. Note however that the matrix coefficients of the PIMs do not form a basis of  $A^*$  in general. Indeed, even if we fix a family  $(P_\alpha)$  representing each isomorphism class of PIMs, it is possible for  $P_\alpha$  and  $P_\beta$  to have a composition factor  $S$  in common. In this case, both  $\overset{P_\alpha}{T}$  and  $\overset{P_\beta}{T}$  contain  $\overset{S}{T}$  as submatrix. This is what happens for  $A = \bar{U}_q(\mathfrak{sl}_2)$ , see (3.22). In the semi-simple case this phenomenon does not occur.

If  $A$  is a Hopf algebra with pivotal element  $g$  (see section 2.3),  $V$  is an  $A$ -module and  $\overset{V}{M} \in B \otimes \text{End}_{\mathbb{C}}(V)$  (where  $B$  is some algebra), the quantum trace of  $\overset{V}{M}$  is

$$\text{tr}_q(\overset{V}{M}) = \text{tr}(g \overset{V}{M}) \in B.$$

## 2.3 Braided Hopf algebras, factorizability, ribbon element

In all this thesis,  $H$  is a finite dimensional, factorizable, ribbon Hopf algebra. We recall the meaning of these assumptions and for further use we record some properties of such algebras.

Let  $H = (H, \cdot, 1, \Delta, \varepsilon, S, R)$  be a braided Hopf algebra with universal  $R$ -matrix  $R = a_i \otimes b_i$  (see e.g. [Kas95, Chap. VIII]). Recall that:

$$R \Delta = \Delta^{\text{op}} R, \tag{2.4}$$

$$(\Delta \otimes \text{id})(R) = R_{13} R_{23}, \quad (\text{id} \otimes \Delta)(R) = R_{13} R_{12}. \tag{2.5}$$

$$(S \otimes \text{id})(R) = (\text{id} \otimes S^{-1})(R) = R^{-1}, \quad (S \otimes S)(R) = R. \tag{2.6}$$

$$R_{12} R_{13} R_{23} = R_{23} R_{13} R_{12} \tag{2.7}$$

with  $R_{12} = a_i \otimes b_i \otimes 1$ ,  $R_{13} = a_i \otimes 1 \otimes b_i$ ,  $R_{23} = 1 \otimes a_i \otimes b_i \in H^{\otimes 3}$ . The relation (2.7) is called the (quantum) Yang-Baxter equation.

Consider

$$\begin{aligned} \Psi : H^* &\rightarrow H \\ \beta &\mapsto (\beta \otimes \text{id})(RR') \end{aligned}$$

where  $R' = b_i \otimes a_i$ . We say that  $H$  is factorizable if  $\Psi$  is an isomorphism of vector spaces. Since we assume that  $H$  is finite dimensional, we can restrict  $\beta$  to be a matrix coefficient  $\overset{I}{T}_j^i$  of some  $H$ -module  $I$ , by the remarks of section 2.2.

Define  $R^{(+)} = R$ ,  $R^{(-)} = (R')^{-1}$ , and let

$$\overset{I}{L}^{(\pm)} = (\overset{I}{T} \otimes \text{id})(R^{(\pm)}) = (a_i^{(\pm)}) b_i^{(\pm)} \in \text{Mat}_{\dim(I)}(H) \tag{2.8}$$

where  $R^{(\pm)} = a_i^{(\pm)} \otimes b_i^{(\pm)}$  (note that  $(a_i^{(\pm)}) b_i^{(\pm)}$  is the matrix obtained by multiplying each coefficient (which is a scalar) of the matrix  $(a_i^{(\pm)})$  by the element  $b_i \in H$ ). Recall that  $R^{(-)}$  is also a universal

$R$ -matrix and in particular it satisfies the properties (2.4)–(2.7) above. We use the letters  $I, J, \dots$  for modules over  $H$ . Note that

$$L^{(\pm)-1} = S^{-1}(L^{(\pm)}) = (a_i^{(\pm)}) S^{-1}(b_i^{(\pm)}).$$

If  $H$  is factorizable, the coefficients of the matrices  $L^{(\pm)}$  generate  $H$  as an algebra, since  $(T \otimes \text{id})(RR') = L^{(+)}L^{(-)-1}$ . These matrices satisfy nice properties which are consequences of (2.5) and (2.7):

$$\begin{aligned} L_1^{(\epsilon)} L_2^{(\sigma)} &= L_{12}^{I \otimes J}, \\ R_{12}^{IJ(\epsilon)} L_1^{(\epsilon)} L_2^{(\sigma)} &= L_2^{(\sigma)} L_1^{(\epsilon)} R_{12}^{IJ(\epsilon)} \quad \forall \epsilon, \sigma \in \{\pm\}, \\ R_{12}^{IJ(\epsilon)} L_1^{(\sigma)} L_2^{(\sigma)} &= L_2^{(\sigma)} L_1^{(\sigma)} R_{12}^{IJ(\epsilon)} \quad \forall \epsilon, \sigma \in \{\pm\}, \\ \Delta(L^{(\epsilon)} a_b) &= L^{(\epsilon)} a_b \otimes L^{(\epsilon)} a_i, \quad \varepsilon(L^{(\epsilon)}) = \mathbb{I}_{\dim(I)}. \end{aligned} \tag{2.9}$$

For instance, here is a proof of the first equality with  $\epsilon = +$ :

$$L_{12}^{I \otimes J(+)} = (L_{12}^{I \otimes J})_{12} b_i = (a_i \otimes a_j)_{12} b_i b_j = (a_i)_1 (a_j)_2 b_i b_j = (a_i)_1 b_i (a_j)_2 b_j = L_1^{(+)} L_2^{(+)}$$

where we used (2.5); note that these are equalities between matrices in  $\text{Mat}_{\dim(I)}(\mathbb{C}) \otimes \text{Mat}_{\dim(J)}(\mathbb{C}) \otimes H$  which imply equalities among the coefficients. If the representations  $I$  and  $J$  are fixed and arbitrary, we will simply write these relations as:

$$L_{12}^{(\epsilon)} = L_1^{(\epsilon)} L_2^{(\epsilon)}, \quad R_{12}^{(\epsilon)} L_1^{(\epsilon)} L_2^{(\sigma)} = L_2^{(\sigma)} L_1^{(\epsilon)} R_{12}^{(\epsilon)}, \quad R_{12}^{(\epsilon)} L_1^{(\sigma)} L_2^{(\sigma)} = L_2^{(\sigma)} L_1^{(\sigma)} R_{12}^{(\epsilon)},$$

the space 1 (resp. 2) corresponding implicitly to the evaluation in the representation  $I$  (resp.  $J$ ).

*Remark 2.3.1.* The set of generators  $(L^{(\pm)})_j^i$  is not at all minimal. However, in practice, due to the fusion relation (the first relation in (2.9)) we can restrict  $I$  to belong to a set  $\mathcal{G}$  of well-chosen  $H$ -modules which generate every other module by tensor products, in the sense that every  $H$ -module is isomorphic to a submodule or a quotient of a tensor product of elements of  $\mathcal{G}$ . For instance, in the case of  $H = \bar{U}_q(\mathfrak{sl}_2)$ , we can restrict  $I$  to be the fundamental representation  $\mathcal{X}^+(2)$ . Also see Remark 2.3.2 and section 3.1.4.  $\triangle$

Recall that the *Drinfeld element*  $u$  and its inverse are:

$$u = S(b_i) a_i = b_i S^{-1}(a_i) \quad \text{and} \quad u^{-1} = S^{-2}(b_i) a_i = S^{-1}(b_i) S(a_i) = b_i S^2(a_i). \tag{2.10}$$

We assume that  $H$  contains a ribbon element  $v$ . It satisfies:

$$v \text{ is central and invertible,} \quad \Delta(v) = (R'R)^{-1} v \otimes v, \quad S(v) = v, \quad \varepsilon(v) = 1, \quad v^2 = uS(u). \tag{2.11}$$

The two last equalities can be deduced easily from the others. A ribbon element is in general not unique. A ribbon Hopf algebra  $(H, R, v)$  is a braided Hopf algebra  $(H, R)$  together with a ribbon element  $v$ .

We say that  $g \in H$  is a *pivotal element* if:

$$\Delta(g) = g \otimes g \quad \text{and} \quad \forall x \in H, \quad S^2(x) = gxg^{-1}. \tag{2.12}$$

Note that  $g$  is invertible since it is grouplike:  $S(g) = g^{-1}$ . A pivotal element is in general not unique. But in a ribbon Hopf algebra  $(H, R, v)$  there is a canonical choice:

$$g = uv^{-1}. \tag{2.13}$$

We will always take this canonical pivotal element  $g$  in the sequel.

The canonical Hopf algebra structure on  $H^*$  is defined by:

$$(\varphi\psi)(x) = (\varphi \otimes \psi)(\Delta(x)), \quad 1_{H^*} = \varepsilon, \quad \Delta(\varphi)(x \otimes y) = \varphi(xy), \quad \varepsilon(\varphi) = \varphi(1), \quad S(\varphi) = \varphi \circ S. \quad (2.14)$$

with  $\varphi, \psi \in H^*$  and  $x, y \in H$ . When it is endowed with this structure,  $H^*$  is called dual Hopf algebra, and denoted  $\mathcal{O}(H)$  in the sequel. Recall that  $H^*$  is generated as a vector space by the matrix coefficients  $\overset{I}{T}_j^i$  (see section 2.2). In terms of these elements, the structure of  $\mathcal{O}(H)$  is:

$$\overset{I}{T}_1 \overset{J}{T}_2 = \overset{I \otimes J}{T}_{12}, \quad \eta(1) = \overset{\mathbb{C}}{T}, \quad \Delta(\overset{I}{T}_b^a) = \overset{I}{T}_i^a \otimes \overset{I}{T}_b^i, \quad \varepsilon(\overset{I}{T}) = \mathbb{I}_{\dim(I)}, \quad S(\overset{I}{T}) = \overset{I}{T}^{-1}, \quad (2.15)$$

where  $\mathbb{C}$  is the trivial representation. For instance, here are proofs of the first and last equalities (with  $h \in H$ ):

$$\begin{aligned} \left( \overset{I \otimes J}{T}_{12} \right)(h) &= \left( \overset{I \otimes J}{h} \right)_{12} = (h' \otimes h'')_{12} = (h')_1 (h'')_2 = \overset{I}{T}_1(h') \overset{J}{T}_2(h'') = \left( \overset{I}{T}_1 \overset{J}{T}_2 \right)(h), \\ \left( S(\overset{I}{T}) \overset{I}{T} \right)(h) &= S(\overset{I}{T})(h') \overset{I}{T}(h'') = \overset{I}{T}(S(h')) \overset{I}{T}(h'') = \overset{I}{T}(S(h')h'') = \varepsilon(h) \overset{I}{T}(1) = \varepsilon(h) \mathbb{I}_{\dim(I)}. \end{aligned}$$

Note that

$$S(\overset{I}{T}) = {}^t \overset{I^*}{T} \quad (2.16)$$

where  ${}^t$  is the transpose. Indeed, let  $(v_i)$  be a basis of  $I$  and  $(v^j)$  be the dual basis. Denote  $v_j^* = v^j$ . Then by (2.1), we have  $\langle xv^j, v_i \rangle = \langle xv_j^*, v_i \rangle = \overset{I^*}{x}_j^k \langle v_k^*, v_i \rangle = \overset{I^*}{x}_j^i$ . But using (2.36) we also get  $\langle xv^j, v_i \rangle = \langle v^j, S(x)v_i \rangle = S(x)_i^k \langle v^j, v_k \rangle = S(x)_i^j$ . This shows that  $\overset{I^*}{x} = {}^t S(x)$  as desired. Recall the well-known exchange relation

$$\overset{IJ}{R}_{12} \overset{I}{T}_1 \overset{J}{T}_2 = \overset{J}{T}_2 \overset{I}{T}_1 \overset{IJ}{R}_{12}, \quad (2.17)$$

which is simply due to (2.15), (2.35) below and (2.3):

$$\overset{IJ}{R} \overset{I}{T}_1 \overset{J}{T}_2 = P_{IJ} c_{I,J} \overset{I \otimes J}{T} = P_{IJ} \overset{J \otimes I}{T} c_{I,J} = P_{IJ} \overset{J}{T}_1 \overset{I}{T}_2 P_{IJ} \overset{IJ}{R} = \overset{J}{T}_2 \overset{I}{T}_1 \overset{IJ}{R}$$

where  $P_{IJ}$  is the flip tensor  $P_{IJ}(x \otimes y) = y \otimes x$  or  $(P_{IJ})_{bd}^{ac} = \delta_d^a \delta_b^c$ . As before, if the representations  $I$  and  $J$  are fixed and arbitrary, we will simply write

$$T_{12} = T_1 T_2 \quad \text{and} \quad R_{12} T_1 T_2 = T_2 T_1 R_{12}.$$

*Remark 2.3.2.* Exactly as for the matrices  $\overset{I}{L}^{(\pm)}$ , the set of generators  $\overset{I}{T}_j^i$  is not at all minimal. Due to the fusion relation of (2.15), we have the same comments that in Remark 2.3.1 (see section 3.1.4, where this is discussed in detail for  $H = \bar{U}_q(\mathfrak{sl}_2)$ ).  $\triangle$

We denote by  $\mathcal{Z}(H)$  the subalgebra of central elements of  $H$  and by  $\text{SLF}(H) \subset \mathcal{O}(H)$  the subalgebra of symmetric linear forms on  $H$ :

$$\text{SLF}(H) = \{ \varphi \in H^* \mid \forall x, y \in H, \quad \varphi(xy) = \varphi(yx) \}.$$

$\text{SLF}(H)$  is a subalgebra because the coproduct is a morphism of algebras:

$$\varphi\psi(xy) = \varphi((xy)') \psi((xy)'') = \varphi(x'y') \psi(x''y'') = \varphi(y'x') \psi(y''x'') = \varphi((yx)') \psi((yx)'') = \varphi\psi(yx).$$

Consider the following map, called Drinfeld morphism:

$$\begin{aligned} \mathcal{D}: H^* &\rightarrow H \\ \varphi &\mapsto (\varphi \otimes \text{id})((g \otimes 1)RR') = \varphi(g a_i b_j) b_i a_j \end{aligned} \quad (2.18)$$

where  $g$  is the pivotal element (2.12).

**Lemma 2.3.3.** *If  $H$  is factorizable,  $\mathcal{D} : H^* \rightarrow H$  is an isomorphism of vector spaces and it provides an isomorphism of algebras*

$$\mathcal{D} : \text{SLF}(H) \xrightarrow{\sim} \mathcal{Z}(H).$$

*In particular,  $\text{SLF}(H)$  is a commutative algebra.*

*Proof.*  $\mathcal{D}$  is an isomorphism by assumption since  $g$  is invertible. Consider the following actions of  $H$  on itself and on  $H^*$ :

$$h \diamond a = h'' a S^{-1}(h'), \quad h \diamond \varphi = \varphi(S(h'')?h').$$

It is easy to see that

$$a \in \mathcal{Z}(H) \iff \forall h \in H, h \diamond a = \varepsilon(h)a, \quad \varphi \in \text{SLF}(H) \iff \forall h \in H, h \diamond \varphi = \varepsilon(h)\varphi.$$

Moreover, using (2.4), we get that  $\mathcal{D}$  intertwines these actions:

$$\begin{aligned} \mathcal{D}(h \diamond \varphi) &= \mathcal{D}(\varphi(S(h'')?h')) = \varphi(S(h'')g a_i b_j h') b_i a_j = \varphi(S(h^{(4)})g a_i b_j h''') b_i a_j h'' S^{-1}(h') \\ &= \varphi(S(h^{(4)})g a_i h'' b_j) b_i h''' a_j S^{-1}(h') = \varphi(S(h^{(4)})g h''' a_i b_j) h'' b_i a_j S^{-1}(h') \\ &= \varphi(g a_i b_j) h'' b_i a_j S^{-1}(h') = h \diamond \mathcal{D}(\varphi) \end{aligned}$$

Hence,  $\mathcal{D}$  brings symmetric linear forms to central elements. To show that it is a morphism of algebras, we use (2.14), (2.12) and (2.5):

$$\begin{aligned} \mathcal{D}(\varphi\psi) &= \varphi\psi(g a_i b_j) b_i a_j = \varphi(g a'_i b'_j) \psi(g a''_i b''_j) b_i a_j = \varphi(g a_i b_l) \psi(g a_k b_j) b_i b_k a_j a_l \\ &= \varphi(g a_i b_l) b_i \mathcal{D}(\psi) a_l = \varphi(g a_i b_l) b_i a_l \mathcal{D}(\psi) = \mathcal{D}(\varphi) \mathcal{D}(\psi) \end{aligned}$$

since  $\mathcal{D}(\psi)$  is central. □

Recall that a *left integral* (resp. *right integral*) is a non-zero linear form  $\mu^l$  (resp.  $\mu^r$ ) on  $H$  which satisfies:

$$\forall x \in H, \quad (\text{id} \otimes \mu^l) \circ \Delta(x) = \mu^l(x)1 \quad (\text{resp. } (\mu^r \otimes \text{id}) \circ \Delta(x) = \mu^r(x)1). \quad (2.19)$$

Since  $H$  is finite dimensional, this is equivalent to:

$$\forall \psi \in \mathcal{O}(H), \quad \psi \mu^l = \varepsilon(\psi) \mu^l \quad (\text{resp. } \mu^r \psi = \varepsilon(\psi) \mu^r). \quad (2.20)$$

It is well-known that left and right integrals always exist if  $H$  is finite dimensional. Moreover, they are unique up to scalar. We fix  $\mu^l$ . Then  $\mu^l \circ S^{-1}$  is a right integral, and we choose

$$\mu^r = \mu^l \circ S^{-1}. \quad (2.21)$$

Integrals will be important for our purposes because they are related to the ribbon element, as explained in the following proposition (the points 2. and 3. are well-known thanks to results of Radford, see *e.g.* [Rad11]).

**Proposition 2.3.4.** *Let  $\varphi_v, \varphi_{v^{-1}} \in H^*$  defined by:*

$$\varphi_v = \mu^l(v^{-1})^{-1} \mu^l(g^{-1}v^{-1}?), \quad \varphi_{v^{-1}} = \mu^l(v)^{-1} \mu^l(g^{-1}v?).$$

*Then:*

$$\mathcal{D}(\varphi_v) = v, \quad \mathcal{D}(\varphi_{v^{-1}}) = v^{-1}.$$

*It follows that:*

$$\begin{aligned} 1. \quad & \varphi_v, \varphi_{v^{-1}} \in \text{SLF}(H), \\ 2. \quad & \forall x, y \in H, \quad \mu^r(gxy) = \mu^r(gyx), \quad \mu^l(g^{-1}xy) = \mu^l(g^{-1}yx), \end{aligned} \quad (2.22)$$

$$3. \quad \forall x, y \in H, \quad \mu^r(xy) = \mu^r(S^2(y)x), \quad \mu^l(xy) = \mu^l(S^{-2}(y)x). \quad (2.23)$$

*Proof.* Consider the following computation, where we use (2.11) and (2.19):

$$\begin{aligned} \mathcal{D}(\mu^l(g^{-1}v^{-1} ?)) &= \langle \mu^l(g^{-1}v^{-1} ?) \otimes \text{id}, (g \otimes 1)RR' \rangle = \langle \mu^l(g^{-1}v^{-1} ?) \otimes \text{id}, gv(v^{-1})'' \otimes v(v^{-1})' \rangle \\ &= \mu^l((v^{-1})'') v(v^{-1})' = \mu^l(v^{-1})v. \end{aligned}$$

Since  $H$  is factorizable, the map  $\mathcal{D}$  is an isomorphism of vector spaces. The left integral  $\mu^l$  is non-zero, so  $\mu^l(g^{-1}v^{-1} ?)$  is non-zero either. Since  $\mathcal{D}$  is an isomorphism, it follows that  $\mathcal{D}(\mu^l(g^{-1}v^{-1} ?)) = \mu^l(v^{-1})v \neq 0$ , and thus  $\mu^l(v^{-1}) \neq 0$ . Hence the formula for  $\varphi_v$  is well defined. Moreover, we have the restriction  $\mathcal{D} : \text{SLF}(H) \xrightarrow{\sim} \mathcal{Z}(H)$ , so since  $v \in \mathcal{Z}(H)$ , we get that  $\varphi_v \in \text{SLF}(H)$ . This allows us to deduce the properties stated about  $\mu^l$ . Using (2.21), we obtain the properties 1, 2 and 3 for  $\mu^r$ . We can now proceed with the computation for  $\varphi_{v^{-1}}$ :

$$\begin{aligned} \mathcal{D}(\mu^l(g^{-1}v ?)) &= \langle \mu^l(g^{-1}v ?) \otimes \text{id}, (g \otimes 1)RR' \rangle = \mu^l(va_i b_j) b_i a_j \\ &= \mu^r(vS(b_j)S(a_i)) b_i a_j = \mu^r(vS(a_i)S^{-1}(b_j)) b_i a_j \\ &= \langle \mu^r \otimes \text{id}, (v \otimes 1)(R'R)^{-1} \rangle = \mu^r(v') v'' v^{-1} = \mu^r(v)v^{-1} = \mu^l(v)v^{-1} \end{aligned}$$

where we used (2.21), the property 3 previously shown and (2.11). We conclude as before.  $\square$

Let us record an useful formula:

$$\forall h \in H, \forall \varphi \in \mathcal{O}(H), \quad \mu^r(h?)\varphi = \mu^r(h'?)\varphi(S^{-1}(h'')). \quad (2.24)$$

Indeed, thanks to (2.19)

$$\begin{aligned} \langle \mu^r(h?)\psi, x \rangle &= \mu^r(hx')\psi(x'') = \mu^r(h'x')\psi(S^{-1}(h''')h''x'') = \psi(S^{-1}(h''')\mu^r(h'x')h''x'') \\ &= \psi(S^{-1}(h'')\mu^r((h'x)')(h'x'')) = \mu^r(h'x)\psi(S^{-1}(h'')). \end{aligned}$$

Finally, it holds (see Lemma 4.3.8)

$$\mu^l = \mu^r(g^2?). \quad (2.25)$$

## 2.4 Heisenberg double of $\mathcal{O}(H)$

The Heisenberg double of  $\mathcal{O}(H)$ , denoted by  $\mathcal{H}(\mathcal{O}(H))$ , is the vector space  $\mathcal{O}(H) \otimes H$  endowed with the product

$$(\varphi \otimes h)(\psi \otimes k) = \varphi\psi(?h') \otimes h''k$$

where  $\psi(?y) \in \mathcal{O}(H)$  is defined by  $\psi(?y)(x) = \psi(xy)$  (for  $x \in H$ ) and  $\varphi\psi(?y)$  is the product of  $\varphi$  and  $\psi(?y)$  in  $\mathcal{O}(H)$ :  $\langle \varphi\psi(?y), x \rangle = \varphi(x')\psi(x''y)$ . See *e.g.* [Mon93, 4.1.10]. Let us identify  $\psi \otimes 1 \in \mathcal{H}(\mathcal{O}(H))$  with  $\psi \in \mathcal{O}(H)$  and  $\varepsilon \otimes h \in \mathcal{H}(\mathcal{O}(H))$  with  $h \in H$ . Then we have  $\varphi \otimes h = (\varphi \otimes 1)(\varepsilon \otimes h) = \varphi h$  and the structure of algebra on  $\mathcal{H}(\mathcal{O}(H))$  is entirely defined by the following exchange relation:

$$h\psi = \psi(?h')h''. \quad (2.26)$$

There is a faithful representation  $\triangleright$  of  $\mathcal{H}(\mathcal{O}(H))$  on  $\mathcal{O}(H)$  (see [Mon93, Lem. 9.4.2]) defined by

$$\psi \triangleright \varphi = \psi\varphi, \quad h \triangleright \varphi = \varphi(?h). \quad (2.27)$$

Hence we have an injective morphism  $\rho : \mathcal{H}(\mathcal{O}(H)) \rightarrow \text{End}_{\mathbb{C}}(H^*)$ ; by equality of the dimensions, it follows that

$$\mathcal{H}(\mathcal{O}(H)) \cong \text{End}_{\mathbb{C}}(H^*). \quad (2.28)$$

In other words,  $\mathcal{H}(\mathcal{O}(H))$  is isomorphic to a matrix algebra. In particular, the elements of  $\mathcal{H}(\mathcal{O}(H))$  can be defined by their action on  $\mathcal{O}(H)$  under  $\triangleright$ .

In terms of matrix coefficients,  $\mathcal{H}(\mathcal{O}(H))$  is generated as an algebra by  $T_j^I$  and  $L_j^{(\pm)I}$  for  $I$  running in the set of finite dimensional  $H$ -modules. This set of generators is of course not at all minimal and in practice we can restrict to well-chosen representations, as explained in Remarks 2.3.1 and 2.3.2. With these generators, the exchange relation is

$$L_1^{(\pm)J} T_2^I = T_2^J L_1^{(\pm)I} R_{12}^{IJ(\pm)} \quad (2.29)$$

Indeed, using (2.8), (2.26), (2.5) and obvious commutation relations:

$$\begin{aligned} L_1^{(\pm)J} T_2^I &= (a_i^{(\pm)})_1 b_i^{(\pm)J} T_2^I = (a_i^{(\pm)})_1 T_2^J (b_i^{(\pm)})_2 b_i^{(\pm)I} = (a_i^{(\pm)} a_j^{(\pm)})_1 T_2^J (b_j^{(\pm)})_2 b_i^{(\pm)I} \\ &= (a_i^{(\pm)})_1 (a_j^{(\pm)})_1 T_2^J (b_j^{(\pm)})_2 b_i^{(\pm)I} = T_2^J (a_i^{(\pm)})_1 b_i^{(\pm)I} (a_j^{(\pm)})_1 (b_j^{(\pm)})_2 = T_2^J L_1^{(\pm)I} R_{12}^{IJ(\pm)} \end{aligned}$$

where  $R^{(\pm)} = a_i^{(\pm)} \otimes b_i^{(\pm)}$ . Similarly, the representation  $\triangleright$  is

$$T_1^I \triangleright T_2^J = T_{12}^{I \otimes J}, \quad L_1^{(\pm)I} \triangleright T_2^J = (a_i^{(\pm)})_1 b_i^{(\pm)I} \triangleright T_2^J = (a_i^{(\pm)})_1 T_2^J (b_i^{(\pm)})_2 = T_2^J R_{12}^{IJ(\pm)}. \quad (2.30)$$

For  $h \in H$ , let  $\tilde{h} \in \mathcal{H}(\mathcal{O}(H))$  be defined by

$$\tilde{h} \triangleright \varphi = \varphi(S^{-1}(h)). \quad (2.31)$$

It is easy to see that

$$\forall g \in H, \forall \psi \in \mathcal{O}(H), \quad \tilde{g}\tilde{h} = \widetilde{gh}, \quad g\tilde{h} = \tilde{h}g, \quad \tilde{h}\psi = \psi(S^{-1}(h)). \quad (2.32)$$

Applying this to the matrices  $L^{(\pm)}$  of generators of  $H$ , we define

$$\tilde{L}^{(+)} = a_i \tilde{b}_i, \quad \tilde{L}^{(-)} = S^{-1}(b_i) \tilde{a}_i \in \text{Mat}_{\dim(I)}(\mathcal{H}(\mathcal{O}(H))) \quad (2.33)$$

or equivalently

$$\tilde{L}_1^{(\pm)} \triangleright T_2^J = R_{12}^{(\pm)-1} T_2^J.$$

Using the standard properties of the  $R$ -matrix, it is not difficult to show the following relations:

$$\begin{aligned} \tilde{L}_1^{(\epsilon)} \tilde{L}_2^{(\sigma)} &= \tilde{L}_{12}^{(\epsilon \otimes \sigma)}, & \tilde{L}_1^{(\epsilon)J} \tilde{L}_2^{(\sigma)I} &= \tilde{L}_2^{(\sigma)I} \tilde{L}_1^{(\epsilon)J}, & R_{12}^{IJ(\epsilon)} \tilde{L}_1^{(\epsilon)J} T_2^I &= T_2^I \tilde{L}_1^{(\epsilon)I}, \\ R_{12}^{IJ(\epsilon)} \tilde{L}_1^{(\epsilon)I} \tilde{L}_2^{(\sigma)J} &= \tilde{L}_2^{(\sigma)J} \tilde{L}_1^{(\epsilon)I} R_{12}^{IJ(\epsilon)} \quad \forall \epsilon, \sigma \in \{\pm\}, & R_{12}^{IJ(\sigma)} \tilde{L}_1^{(\sigma)J} \tilde{L}_2^{(\epsilon)I} &= \tilde{L}_2^{(\epsilon)I} \tilde{L}_1^{(\sigma)J} R_{12}^{IJ(\sigma)} \quad \forall \epsilon, \sigma \in \{\pm\}. \end{aligned} \quad (2.34)$$

For instance, here is a proof of the fourth equality with  $\epsilon = +, \sigma = -$ :

$$\begin{aligned} R_{12}^{IJ(+)} \tilde{L}_1^{(+)} \tilde{L}_2^{(-)} &= (a_i)_1 (b_i)_2 (a_j)_1 \tilde{b}_j S^{-1}(b_k)_2 \tilde{a}_k = (a_i a_j)_1 (b_i S^{-1}(b_k))_2 \widetilde{b_j a_k} \\ &= (a_j a_i)_1 (S^{-1}(b_k) b_i)_2 \widetilde{a_k b_j} = S^{-1}(b_k)_2 \tilde{a}_k (a_j)_1 \tilde{b}_j (a_i)_1 (b_i)_2 = \tilde{L}_2^{(-)I} \tilde{L}_1^{(+)} R_{12}^{IJ(+)}. \end{aligned}$$

We simply used a Yang-Baxter relation:

$$a_i a_j \otimes b_i S^{-1}(b_k) \otimes b_j a_k = R_{12} R_{13} R_{32}^{-1} = R_{32}^{-1} R_{13} R_{12} = a_j a_i \otimes S^{-1}(b_k) b_i \otimes a_k b_j.$$

## 2.5 Category $\text{mod}_l(H)$ , Reshetikhin–Turaev functor

Let  $H$  be as above, with  $R$ -matrix  $R = a_i \otimes b_i$ , ribbon element  $v$  and pivotal element  $g = uv^{-1}$ . We recall the ribbon structure of  $\text{mod}_l(H)$ , the category of finite dimensional left  $H$ -modules. The notations and conventions are those of [Kas95, Chap. XIV]. The objects of  $\text{mod}_l(H)$  will be denoted by  $I, J, \dots$  as previously. The unit object is  $\mathbb{C}$ ; its  $H$ -module structure is given by  $h \cdot z = \varepsilon(h)z$ .

The braiding  $c_{I,J}$  and twist  $\theta_I$  are defined by

$$\begin{aligned} c_{I,J} : I \otimes J &\rightarrow J \otimes I & \theta_I : I &\rightarrow I \\ x \otimes y &\mapsto P_{IJ}^{IJ} R(x \otimes y) = b_i y \otimes a_i x & x &\mapsto v^{-1} x \end{aligned} \quad (2.35)$$

where  $P_{IJ} : I \otimes J \rightarrow J \otimes I$  is the flip map  $P_{IJ}(x \otimes y) = y \otimes x$ . Note that  $c_{I,J}^{-1}(y \otimes x) = S(a_i)x \otimes b_i y$ .

The dual  $I^*$  of the  $H$ -module  $I$  is defined by

$$\forall h \in H, \quad \forall \varphi \in I^*, \quad h\varphi = \varphi(S(h)?). \quad (2.36)$$

The duality morphisms are defined by

$$\begin{aligned} b_I : \mathbb{C} &\rightarrow I \otimes I^* & d_I : I^* \otimes I &\rightarrow \mathbb{C} \\ 1 &\mapsto v_i \otimes v^i & \varphi \otimes x &\mapsto \varphi(x) \end{aligned}$$

and

$$\begin{aligned} b'_I : \mathbb{C} &\rightarrow I^* \otimes I & d'_I : I \otimes I^* &\rightarrow \mathbb{C} \\ 1 &\mapsto v^i \otimes g^{-1}v_i & x \otimes \varphi &\mapsto \varphi(gx) \end{aligned}$$

The name ‘‘ribbon category’’ comes from the well-known fact ([RT90], see also [KM91] and [Kas95, XIV.5.1]) that there is a tensor functor  $F_{\text{RT}} : \mathcal{RG}_H \rightarrow \text{mod}_l(H)$ , where  $\mathcal{RG}_H$  is the category of  $\text{mod}_l(H)$ -colored ribbon graphs. We call  $F_{\text{RT}}$  the Reshetikhin–Turaev functor; it takes the following values:

$$\begin{aligned} F_{\text{RT}}\left( \begin{array}{c} I \\ \downarrow \\ I \end{array} \right) &= \text{id}_I, & F_{\text{RT}}\left( \begin{array}{c} \uparrow \\ I \end{array} \right) &= \text{id}_{I^*}, & F_{\text{RT}}\left( \begin{array}{c} J \\ \downarrow \\ \boxed{f} \\ \downarrow \\ I \end{array} \right) &= (f : I \rightarrow J), \\ F_{\text{RT}}\left( \begin{array}{c} K \\ \downarrow \\ \boxed{g} \\ \downarrow \\ \boxed{f} \\ \downarrow \\ I \end{array} \right) &= (g \circ f : I \rightarrow K), & F_{\text{RT}}\left( \begin{array}{c} J \downarrow \quad L \\ \boxed{f} \quad \boxed{g} \\ \downarrow \quad \downarrow \\ I \quad K \end{array} \right) &= (f \otimes g : I \otimes K \rightarrow J \otimes L), \\ F_{\text{RT}}\left( \begin{array}{c} J \quad I \\ \searrow \quad \swarrow \\ \swarrow \quad \searrow \end{array} \right) &= (c_{I,J} : I \otimes J \rightarrow J \otimes I), & F_{\text{RT}}\left( \begin{array}{c} I \quad J \\ \searrow \quad \swarrow \\ \swarrow \quad \searrow \end{array} \right) &= (c_{I,J}^{-1} : J \otimes I \rightarrow I \otimes J), \\ F_{\text{RT}}\left( \begin{array}{c} I \\ \curvearrowright \end{array} \right) &= (d_I : I^* \otimes I \rightarrow \mathbb{C}), & F_{\text{RT}}\left( \begin{array}{c} I \\ \curvearrowright \end{array} \right) &= (d'_I : I \otimes I^* \rightarrow \mathbb{C}), \\ F_{\text{RT}}\left( \begin{array}{c} I \\ \curvearrowleft \end{array} \right) &= (b_I : \mathbb{C} \rightarrow I \otimes I^*), & F_{\text{RT}}\left( \begin{array}{c} I \\ \curvearrowleft \end{array} \right) &= (b'_I : \mathbb{C} \rightarrow I^* \otimes I), \\ F_{\text{RT}}\left( \begin{array}{c} I \\ \downarrow \\ \circlearrowleft \end{array} \right) &= F_{\text{RT}}\left( \begin{array}{c} I \\ \downarrow \\ \circlearrowright \end{array} \right) &= (\theta_I : I \rightarrow I), & F_{\text{RT}}\left( \begin{array}{c} I \\ \downarrow \\ \circlearrowleft \end{array} \right) &= F_{\text{RT}}\left( \begin{array}{c} I \\ \downarrow \\ \circlearrowright \end{array} \right) &= (\theta_I^{-1} : I \rightarrow I). \end{aligned}$$

In the sequel we will identify a colored ribbon graph with its evaluation through  $F_{\text{RT}}$ . Note that we read diagrams from bottom to top.

We record some facts about duality in a ribbon category and more specifically in  $\text{mod}_l(H)$ . First, the duality  $*$  is a contravariant functor. Indeed, recall that the transpose of  $f : I \rightarrow J$  is  $f^* : J^* \rightarrow I^*$ , defined by

$$f^* = (\text{id}_{I^*} \otimes d'_J) \circ (\text{id}_{I^*} \otimes f \otimes \text{id}_{J^*}) \circ (b'_I \otimes \text{id}_{J^*}) = (d_J \otimes \text{id}_{I^*}) \circ (\text{id}_{J^*} \otimes f \otimes \text{id}_{I^*}) \circ (\text{id}_{J^*} \otimes b_I).$$

This is represented diagrammatically as follows:

$$f^* = \begin{array}{c} \uparrow \\ \text{---} \\ \downarrow J \\ \boxed{f} \\ \uparrow I \\ \text{---} \\ \downarrow \end{array} = \begin{array}{c} \text{---} \\ \downarrow J \\ \boxed{f} \\ \uparrow I \\ \text{---} \\ \downarrow \end{array}$$

In  $\text{mod}_l(H)$ ,  $f^*$  is simply the usual transpose:  $f^*(\varphi) = \varphi \circ f$ . The families  $(d_I)$ ,  $(d'_I)$ ,  $(b_I)$ ,  $(b'_I)$  satisfy:

$$\begin{aligned} d_J \circ (\text{id}_{J^*} \otimes f) &= d_I \circ (f^* \otimes \text{id}_I), & d'_J \circ (f \otimes \text{id}_{J^*}) &= d'_I \circ (\text{id}_I \otimes f^*), \\ (f \otimes \text{id}_{J^*}) \circ b_I &= (\text{id}_J \otimes f^*) \circ b_J, & (\text{id}_{I^*} \otimes f) \circ b'_I &= (f^* \otimes \text{id}_J) \circ b'_J. \end{aligned} \quad (2.37)$$

This is represented diagrammatically as follows:

$$\begin{array}{cc} \begin{array}{c} \text{---} \\ \downarrow J \\ \boxed{f} \\ \downarrow I \\ \text{---} \end{array} = \begin{array}{c} \boxed{f^*} \\ \uparrow J \\ \downarrow I \\ \text{---} \end{array} & \begin{array}{c} \boxed{f} \\ \downarrow I \\ \text{---} \\ \downarrow J \\ \text{---} \end{array} = \begin{array}{c} \text{---} \\ \downarrow I \\ \text{---} \\ \downarrow J \\ \boxed{f^*} \\ \uparrow J \\ \text{---} \end{array} \\ \begin{array}{c} \downarrow J \\ \boxed{f} \\ \uparrow I \\ \text{---} \end{array} = \begin{array}{c} \text{---} \\ \downarrow J \\ \text{---} \\ \uparrow I \\ \boxed{f^*} \\ \uparrow J \\ \text{---} \end{array} & \begin{array}{c} \text{---} \\ \uparrow I \\ \text{---} \\ \downarrow J \\ \boxed{f} \\ \uparrow I \\ \text{---} \end{array} = \begin{array}{c} \text{---} \\ \uparrow I \\ \text{---} \\ \downarrow J \\ \boxed{f^*} \\ \uparrow J \\ \text{---} \end{array} \end{array}$$

Let

$$e_I : \begin{array}{l} I^{**} \xrightarrow{\sim} I \\ \langle ?, x \rangle \mapsto g^{-1}x \end{array} \quad (2.38)$$

be the identification with the bidual, where  $\langle ?, ? \rangle = d_I : I^* \otimes I \rightarrow \mathbb{C}$  is the duality pairing. The morphism  $e_I$  and its inverse can be written in terms of duality morphisms:

$$\begin{aligned} e_I &= (\text{id}_I \otimes d'_{I^*}) \circ (b_I \otimes \text{id}_{I^{**}}) = (d_{I^*} \otimes \text{id}_I) \circ (\text{id}_{I^{**}} \otimes b'_I), \\ e_I^{-1} &= (\text{id}_{I^{**}} \otimes d_I) \circ (b'_{I^*} \otimes \text{id}_I) = (d'_I \otimes \text{id}_{I^{**}}) \circ (\text{id}_I \otimes b_{I^*}). \end{aligned}$$

This is represented diagrammatically as follows:

$$e_I = \begin{array}{c} \text{---} \\ \downarrow I^* \\ \boxed{\text{id}_{I^*}} \\ \uparrow I \\ \text{---} \end{array} = \begin{array}{c} \text{---} \\ \downarrow I^* \\ \boxed{\text{id}_{I^*}} \\ \uparrow I \\ \text{---} \end{array} \quad e_I^{-1} = \begin{array}{c} \text{---} \\ \downarrow I \\ \boxed{\text{id}_{I^*}} \\ \uparrow I^* \\ \text{---} \end{array} = \begin{array}{c} \text{---} \\ \downarrow I \\ \boxed{\text{id}_{I^*}} \\ \uparrow I^* \\ \text{---} \end{array}$$

The family of morphisms  $(e_I)$  is natural:

$$f \circ e_I = e_J \circ f^{**}$$

and satisfies the following property:

$$e_{I^*} = (e_I^{-1})^*. \quad (2.39)$$

This last equality is easy to see diagrammatically:





# Chapter 3

## The restricted quantum group $\bar{U}_q(\mathfrak{sl}_2)$

The restricted quantum group  $\bar{U}_q(\mathfrak{sl}_2)$  is an important example of a factorizable and ribbon<sup>1</sup> finite dimensional Hopf algebra. This algebra is interesting because it is sufficiently simple and well-studied to allow us to carry explicit computations when we use it as a gauge algebra in the combinatorial quantization (see sections 4.4 and 6.3). Moreover, its  $R$ -matrix satisfies the Jones skein relation when evaluated in the fundamental representation. We will use this property to construct representations of skein algebras, thanks to the Wilson loop map, in Chapter 6.

Note that the aim of this chapter is to collect technical properties which will be used when applying the general constructions of the subsequent chapters to the (important) example of  $\bar{U}_q(\mathfrak{sl}_2)$ ; the reader can skip this chapter at the first reading and just refer to it from the sections 4.4, 6.3, 6.4, 6.5.

We first recall the definition of  $\bar{U}_q = \bar{U}_q(\mathfrak{sl}_2)$  and explain some facts about its structure, its representation theory and its matrix coefficients. The material of sections 3.1.1, 3.1.2, 3.1.3 comes from [FGST06a] (it is also recalled in detail in [Iba15]).

Then we define the GTA basis of  $\text{SLF}(\bar{U}_q)$  (symmetric linear forms on  $\bar{U}_q$ ), introduced in [GT09] and in [Ari10]. This basis will be a crucial tool when studying explicitly the representations of  $\text{SL}_2(\mathbb{Z})$  and of  $\mathcal{S}_q(\Sigma_{1,0})$  on  $\text{SLF}(\bar{U}_q)$  (sections 4.4.3 and 6.5). A key property of this basis is that its multiplication rules, determined in section 3.4, are simple. I mention that such multiplication rules were already given in [GT09], but I was not aware of the existence of their paper when preparing this work (in [GT09] they work in the space of  $q$ -characters  $\text{qCh}(\bar{U}_q)$ , which is isomorphic as an algebra to  $\text{SLF}(\bar{U}_q)$  by the shift of the pivotal element; ; also note that they use a normalized version of  $G_s$ ). It turns out that our proofs are different. In [GT09], they use the fact that the multiplication in the canonical basis of  $\mathcal{Z}(\bar{U}_q)$  is very simple. They first express the image of their basis of  $\text{qCh}(\bar{U}_q)$  (which is the GTA basis shifted by the inverse of the pivotal element) through the Radford mapping in the canonical basis of  $\mathcal{Z}(\bar{U}_q)$ . This gives a basis of  $\mathcal{Z}(\bar{U}_q)$  called the Radford basis. Then they use the  $\mathcal{S}$ -transformation of the  $\text{SL}_2(\mathbb{Z})$  representation on  $\mathcal{Z}(\bar{U}_q)$  to express the Drinfeld basis (which is the image of their basis of  $\text{qCh}(\bar{U}_q)$  by the Drinfeld map) in the Radford basis. This gives the multiplication rules in the Drinfeld basis. Since the Drinfeld map is an isomorphism of algebras between  $\text{qCh}(\bar{U}_q)$  and  $\mathcal{Z}(\bar{U}_q)$ , this gives also the multiplication rules in the GTA basis. Here we directly work in  $\text{SLF}(\bar{U}_q)$ . We take advantage of the decomposition rules for tensor products to see that there are not many coefficients to determine, and then we compute these coefficients by using the evaluation on suitable elements of  $\bar{U}_q$ .

Section 3.3 is a digression on the link between the GTA basis and traces on projective  $\bar{U}_q$ -modules. We also compute the decomposition of  $\mu^r(K^{p+1}?)$  (right integral shifted by the pivotal element) in the GTA basis (to be used in the proof of Theorem 4.4.6). A particular trace on projectives  $\bar{U}_q$ -modules is the modified trace computed in [BBGe17], and we observe that  $\mu^r(K^{p+1}?)$  is the symmetric linear

---

<sup>1</sup>These two properties are an abuse of terminology due to the subtlety that the  $R$ -matrix belongs to an extension of  $\bar{U}_q(\mathfrak{sl}_2)$  by a square root  $K^{1/2}$ . But this square root does not appear in the double braiding  $RR'$  nor in the ribbon element  $v$ , see section 3.1.3.

form corresponding to the modified trace. This last fact is not specific to  $\bar{U}_q$ : it has been proved under general assumptions (which cover the case of  $\bar{U}_q$ ) in [BBGa18] that there is a unique (up to scalar) modified trace on the ideal of finite-dimensional projective  $H$ -modules and that the corresponding symmetric linear form is the right integral shifted by the pivotal element.

The material of this chapter is mainly the content of [Fai18a]. However, the present chapter contains more details and comments.

### 3.1 Properties of $\bar{U}_q$

Let  $q = e^{i\pi/p}$  be a primitive root of unity of order  $2p$ , with  $p \geq 2$ . Recall that  $\bar{U}_q(\mathfrak{sl}_2)$ , the *restricted quantum group* associated to  $\mathfrak{sl}_2(\mathbb{C})$ , is the  $\mathbb{C}$ -algebra generated by  $E, F, K$  together with the relations

$$E^p = F^p = 0, \quad K^{2p} = 1, \quad KE = q^2EK, \quad KF = q^{-2}FK, \quad EF = FE + \frac{K - K^{-1}}{q - q^{-1}}.$$

It will be simply denoted by  $\bar{U}_q$  in the sequel. It is a  $2p^3$ -dimensional Hopf algebra, with comultiplication  $\Delta$ , counit  $\varepsilon$  and antipode  $S$  given by the following formulas:

$$\begin{aligned} \Delta(E) &= 1 \otimes E + E \otimes K, & \Delta(F) &= F \otimes 1 + K^{-1} \otimes F, & \Delta(K) &= K \otimes K, \\ \varepsilon(E) &= 0, & \varepsilon(F) &= 0, & \varepsilon(K) &= 1, \\ S(E) &= -EK^{-1}, & S(F) &= -KF, & S(K) &= K^{-1}. \end{aligned}$$

The monomials  $E^m F^n K^l$  with  $0 \leq m, n \leq p-1$ ,  $0 \leq l \leq 2p-1$ , form a basis of  $\bar{U}_q$ , usually referred as the PBW-basis. Recall the formula (see [Kas95, Prop. VII.1.3]):

$$\Delta(E^m F^n K^l) = \sum_{i=0}^m \sum_{j=0}^n q^{i(m-i)+j(n-j)-2(m-i)(n-j)} \begin{bmatrix} m \\ i \end{bmatrix} \begin{bmatrix} n \\ j \end{bmatrix} E^{m-i} F^j K^{l+j-n} \otimes E^i F^{n-j} K^{l+m-i} \quad (3.1)$$

where the  $q$ -binomial coefficients are defined by  $\begin{bmatrix} a \\ b \end{bmatrix} = \frac{[a]!}{[b]![a-b]!}$  for  $a \geq b$ .

Since  $K$  is annihilated by the polynomial  $X^{2p} - 1$ , which has simple roots over  $\mathbb{C}$ , the action of  $K$  is diagonalizable on each  $\bar{U}_q$ -module, and the eigenvalues are  $2p$ -roots of unity.

The elements  $K$  and  $K^{p+1}$  both satisfy the properties of a pivotal element, see (2.12). In the sequel and as in [FGST06a], we always take  $K^{p+1}$  for the pivotal element of  $\bar{U}_q$ :

$$g = K^{p+1}. \quad (3.2)$$

Due to the Hopf algebra structure on  $\bar{U}_q$ , its category of modules is a monoidal category with duals. It is not braided (see [KS11]).

#### 3.1.1 Simple and projective $\bar{U}_q$ -modules

The finite dimensional representations of  $\bar{U}_q$  are classified ([Sut94] and [FGST06b]). Two types of modules are important for our purposes: the simple modules and the projective modules. As in [FGST06a] (see also [Iba15]), we denote the simple modules by  $\mathcal{X}^\alpha(s)$ , with  $\alpha \in \{\pm\}$ ,  $1 \leq s \leq p$ .  $\mathcal{X}^+(2)$  is called the fundamental representation. The modules  $\mathcal{X}^\pm(p)$  are simple and projective simultaneously. The other indecomposable projective modules are not simple. We denote them by  $\mathcal{P}^\alpha(s)$  with  $\alpha \in \{\pm\}$ ,  $1 \leq s \leq p-1$ .

The module  $\mathcal{X}^\alpha(s)$  admits a *canonical basis*  $(v_i)_{0 \leq i \leq s-1}$  such that

$$Kv_i = \alpha q^{s-1-2i} v_i, \quad Ev_0 = 0, \quad Ev_i = \alpha [i][s-i] v_{i-1}, \quad Fv_i = v_{i+1}, \quad Fv_{s-1} = 0. \quad (3.3)$$

The module  $\mathcal{P}^\alpha(s)$  admits a *standard basis*  $(b_i, x_j, y_k, a_l)_{\substack{0 \leq i, l \leq s-1 \\ 0 \leq j, k \leq p-s-1}}$  such that

$$\begin{aligned}
 Kb_i &= \alpha q^{s-1-2i} b_i, & Eb_i &= \alpha[i][s-i]b_{i-1} + a_{i-1}, & Fb_i &= b_{i+1}, \\
 Kx_j &= -\alpha q^{p-s-1-2j} x_j, & Eb_0 &= x_{p-s-1}, & Fb_{s-1} &= y_0, \\
 Ky_k &= -\alpha q^{p-s-1-2k} y_k, & Ex_j &= -\alpha[j][p-s-j]x_{j-1}, & Fx_j &= x_{j+1}, \\
 Ka_l &= \alpha q^{s-1-2l} a_l, & Ex_0 &= 0, & Fx_{p-s-1} &= a_0, \\
 & & Ey_k &= -\alpha[k][p-s-k]y_{k-1}, & Fy_k &= y_{k+1}, \\
 & & Ey_0 &= a_{s-1}, & Fy_{p-s-1} &= 0, \\
 & & Ea_l &= \alpha[l][s-l]a_{l-1}, & Fa_l &= a_{l+1}, \\
 & & Ea_0 &= 0, & Fa_{s-1} &= 0.
 \end{aligned} \tag{3.4}$$

Note that such a basis is not unique up to scalar since we can replace  $b_i$  by  $b_i + \lambda a_i$  (with  $\lambda \in \mathbb{C}$ ) without changing the action.

In terms of composition factors, the structure of  $\mathcal{P}^\alpha(s)$  can be schematically represented as follows (with the basis vectors corresponding to each factor and the action of  $E$  and  $F$ ):

$$\begin{array}{ccc}
 \text{Top}(\mathcal{P}^\alpha(s)) \cong \mathcal{X}^\alpha(s), (b_i)_{0 \leq i \leq s-1} & & \\
 \swarrow E & \downarrow E & \searrow F \\
 (x_j)_{0 \leq j \leq p-s-1}, \mathcal{X}^{-\alpha}(p-s) & & \mathcal{X}^{-\alpha}(p-s), (y_k)_{0 \leq k \leq p-s-1} \\
 \searrow F & & \swarrow E \\
 \text{Soc}(\mathcal{P}^\alpha(s)) \cong \mathcal{X}^\alpha(s), (a_l)_{0 \leq l \leq s-1} & & 
 \end{array} \tag{3.5}$$

If we need to emphasize the module in which we are working, we will use the following notations:  $v_i^\alpha(s)$  for the canonical basis of  $\mathcal{X}^\alpha(s)$  and  $b_i^\alpha(s)$ ,  $x_j^\alpha(s)$ ,  $y_k^\alpha(s)$ ,  $a_l^\alpha(s)$  for a standard basis of  $\mathcal{P}^\alpha(s)$  (these are the notations used in [Ari10]).

Let us recall the  $\bar{U}_q$ -morphisms between these modules. Observe that  $\mathcal{X}^\alpha(s)$  is  $\bar{U}_q$ -generated by  $v_0^\alpha(s)$  and  $\mathcal{P}^\alpha(s)$  is  $\bar{U}_q$ -generated by  $b_0^\alpha(s)$ , so the images of these vectors suffice to define  $\bar{U}_q$ -morphisms.  $\mathcal{X}^\alpha(s)$  is simple, so by Schur's lemma  $\text{End}_{\bar{U}_q}(\mathcal{X}^\alpha(s)) = \mathbb{C}\text{Id}$ . Since

$$\mathcal{X}^\alpha(s) \cong \text{Top}(\mathcal{P}^\alpha(s)) \cong \text{Soc}(\mathcal{P}^\alpha(s))$$

there exist injection and projection maps defined by:

$$\begin{array}{ccc}
 \mathcal{X}^\alpha(s) & \hookrightarrow & \mathcal{P}^\alpha(s) \\
 v_0^\alpha(s) & \mapsto & a_0^\alpha(s)
 \end{array} \quad \text{and} \quad \begin{array}{ccc}
 \mathcal{P}^\alpha(s) & \twoheadrightarrow & \mathcal{X}^\alpha(s) \\
 b_0^\alpha(s) & \mapsto & v_0^\alpha(s).
 \end{array}$$

We have  $\text{End}_{\bar{U}_q}(\mathcal{P}^\alpha(s)) = \mathbb{C}\text{Id} \oplus \mathbb{C}p_s^\alpha$  and  $\text{Hom}_{\bar{U}_q}(\mathcal{P}^\alpha(s), \mathcal{P}^{-\alpha}(p-s)) = \mathbb{C}P_s^\alpha \oplus \mathbb{C}\bar{P}_s^\alpha$ , where:

$$p_s^\alpha(b_0^\alpha(s)) = a_0^\alpha(s), \quad P_s^\alpha(b_0^\alpha(s)) = x_0^{-\alpha}(p-s), \quad \bar{P}_s^\alpha(b_0^\alpha(s)) = y_0^{-\alpha}(p-s). \tag{3.6}$$

The other Hom-spaces involving only simple modules and indecomposable projective modules are null.

### 3.1.2 Structure of the bimodule $\bar{U}_q(\bar{U}_q)_{\bar{U}_q}$ and the center of $\bar{U}_q$

Recall that if  $M$  is a left module (over any  $k$ -algebra  $A$ ), then  $M^* = \text{Hom}_{\mathbb{C}}(M, k)$  is endowed with a *right*  $A$ -module structure, given by:

$$\forall a \in A, \forall \varphi \in M^*, \varphi a = \varphi(a \cdot)$$

where  $\cdot$  is the place of the variable. We denote by  $R^*(M)$  the so-defined right module. Note that if we define  $R^*(f)$  as the transpose of  $f$ , then  $R^*$  becomes a contravariant functor. If  $A$  is a Hopf algebra, one must be aware not to confuse  $R^*(M)$  with the categorical dual  $M^*$ , which is a left module on which  $A$  acts by:

$$\forall a \in A, \forall \varphi \in M^*, a\varphi = \varphi(S(a) \cdot).$$

**Lemma 3.1.1.** *The right  $\bar{U}_q$ -module  $R^*(\mathcal{X}^\alpha(s))$  admits a basis  $(\bar{v}_i)_{0 \leq i \leq s-1}$  such that*

$$\bar{v}_i K = \alpha q^{1-s+2i} \bar{v}_i, \quad \bar{v}_i E = \alpha [i][s-i] \bar{v}_{i-1}, \quad \bar{v}_0 E = 0, \quad v_i F = \bar{v}_{i+1}, \quad \bar{v}_{s-1} F = 0.$$

*The right  $\bar{U}_q$ -module  $R^*(\mathcal{P}^\alpha(s))$  admits a basis  $(\bar{b}_i, \bar{x}_j, \bar{y}_k, \bar{a}_l)_{\substack{0 \leq i, l \leq s-1 \\ 0 \leq j, k \leq p-s-1}}$  such that*

$$\begin{aligned} \bar{b}_i K &= \alpha q^{1-s+2i} \bar{b}_i, & \bar{b}_i E &= \bar{a}_{i-1} + \alpha [i][s-i] \bar{b}_{i-1}, & \bar{b}_i F &= \bar{b}_{i+1}, \\ \bar{x}_j K &= -\alpha q^{-p+s+1+2j} \bar{x}_j, & \bar{x}_j E &= -\alpha [j][p-s-j] \bar{x}_{j-1}, & \bar{x}_j F &= \bar{x}_{j+1}, \\ \bar{y}_k K &= -\alpha q^{-p+s+1+2k} \bar{y}_k, & \bar{y}_k E &= -\alpha [k][p-s-k] \bar{y}_{k-1}, & \bar{y}_k F &= \bar{y}_{k+1}, \\ \bar{a}_l K &= \alpha q^{1-s+2l} \bar{a}_l, & \bar{a}_l E &= \alpha [l][s-l] \bar{a}_{l-1}, & \bar{a}_l F &= \bar{a}_{l+1}, \end{aligned}$$

$$\begin{aligned} \bar{b}_0 E &= \bar{x}_{p-s-1}, & \bar{b}_{s-1} F &= \bar{y}_0, \\ \bar{x}_0 E &= 0, & \bar{x}_{p-s-1} F &= \bar{a}_0, \\ \bar{y}_0 E &= \bar{a}_{s-1}, & \bar{y}_{p-s-1} F &= 0, \\ \bar{a}_0 E &= 0, & \bar{a}_{s-1} F &= 0. \end{aligned}$$

Such basis will be termed respectively the *canonical basis* and a *standard basis* in the sequel.

*Proof.* Let  $(v^i)_{0 \leq i \leq s-1}$  be the basis dual to the canonical basis given in (3.3). Then  $\bar{v}_i = v^{s-1-i}$  gives the desired result. Similarly, let  $(b^i, x^j, y^k, a^l)_{\substack{0 \leq i, l \leq s-1 \\ 0 \leq j, k \leq p-s-1}}$  be the basis dual to a standard basis given in (3.4). Then

$$\bar{b}_i = a^{s-1-i}, \quad \bar{x}_j = y^{p-s-1-j}, \quad \bar{y}_k = x^{p-s-1-k}, \quad \bar{a}_l = b^{s-1-l}$$

gives the desired result.  $\square$

We denote by  $\bar{v}_q(\bar{U}_q)_{\bar{v}_q}$  the regular bimodule, where the left and right actions are respectively the left and right multiplication of  $\bar{U}_q$  on itself. Recall that a block of  $\bar{v}_q(\bar{U}_q)_{\bar{v}_q}$  is just an indecomposable two-sided ideal (see [CR62, Section 55]). The block decomposition of  $\bar{U}_q$  is (see [FGST06a])

$$\bar{v}_q(\bar{U}_q)_{\bar{v}_q} = \bigoplus_{s=0}^p Q(s)$$

where the structure of each block  $Q(s)$  as a left  $\bar{U}_q$ -module is:

$$\begin{aligned} Q(0) &\cong p\mathcal{X}^-(p), & Q(p) &\cong p\mathcal{X}^+(p), \\ Q(s) &\cong s\mathcal{P}^+(s) \oplus (p-s)\mathcal{P}^-(p-s) & \text{for } 1 \leq s \leq p-1 \end{aligned} \quad (3.7)$$

and the structure of each block as a right  $\bar{U}_q$ -module is:

$$\begin{aligned} Q(0) &\cong pR^*(\mathcal{X}^-(p)), & Q(p) &\cong pR^*(\mathcal{X}^+(p)), \\ Q(s) &\cong sR^*(\mathcal{P}^+(s)) \oplus (p-s)R^*(\mathcal{P}^-(p-s)) & \text{for } 1 \leq s \leq p-1. \end{aligned}$$

The following proposition is a reformulation of [FGST06a, Prop. 4.4.2] (see also [Iba15, Th. II.1.4]). It will be used for the proof of Theorem 3.3.4.

**Proposition 3.1.2.** *For  $1 \leq s \leq p-1$ , the block  $Q(s)$  admits a basis*

$$(B_{ab}^{++}(s), X_{cd}^{-+}(s), Y_{ef}^{+-}(s), A_{gh}^{++}(s), B_{ij}^{--}(s), X_{kl}^{+-}(s), Y_{mn}^{+-}(s), A_{or}^{--}(s))$$

*with  $0 \leq a, b, d, f, g, h, k, m \leq s-1$ ,  $0 \leq c, e, i, j, l, n, o, r \leq p-s-1$ , such that*

1.  $\forall 0 \leq j \leq s-1$ ,  $(B_{ij}^{++}(s), X_{kj}^{-+}(s), Y_{lj}^{+-}(s), A_{mj}^{++}(s))_{\substack{0 \leq i, m \leq s-1 \\ 0 \leq k, l \leq p-s-1}}$  is a standard basis of  $\mathcal{P}^+(s)$  for the left action.
2.  $\forall 0 \leq j \leq p-s-1$ ,  $(B_{ij}^{--}(s), X_{kj}^{+-}(s), Y_{lj}^{+-}(s), A_{mj}^{--}(s))_{\substack{0 \leq k, l \leq s-1 \\ 0 \leq i, m \leq p-s-1}}$  is a standard basis of  $\mathcal{P}^-(p-s)$  for the left action.

3.  $\forall 0 \leq i \leq s-1$ ,  $(B_{ij}^{++}(s), X_{ik}^{+-}(s), Y_{il}^{-+}(s), A_{im}^{++}(s))_{\substack{0 \leq j, m \leq s-1 \\ 0 \leq k, l \leq p-s-1}}$  is a standard basis of  $R^*(\mathcal{P}^+(s))$  for the right action.
4.  $\forall 0 \leq i \leq p-s-1$ ,  $(B_{ij}^{--}(s), X_{ik}^{+-}(s), Y_{il}^{-+}(s), A_{im}^{--}(s))_{\substack{0 \leq k, l \leq s-1 \\ 0 \leq j, m \leq p-s-1}}$  is a standard basis of  $R^*(\mathcal{P}^-(p-s))$  for the right action.

The block  $Q(0)$  admits a basis  $(A_{ij}^{--}(0))_{0 \leq i, j \leq p-1}$  such that

1.  $\forall 0 \leq j \leq p-1$ ,  $(A_{ij}^{--}(0))_{0 \leq i \leq p-1}$  is a standard basis of  $\mathcal{X}^-(p)$  for the left action.
2.  $\forall 0 \leq i \leq p-1$ ,  $(A_{ij}^{--}(0))_{0 \leq j \leq p-1}$  is a standard basis of  $R^*(\mathcal{X}^-(p))$  for the right action.

The block  $Q(p)$  admits a basis  $(A_{ij}^{++}(p))_{0 \leq i, j \leq p-1}$  such that

1.  $\forall 0 \leq j \leq p-1$ ,  $(A_{ij}^{++}(p))_{0 \leq i \leq p-1}$  is a standard basis of  $\mathcal{X}^+(p)$  for the left action.
2.  $\forall 0 \leq i \leq p-1$ ,  $(A_{ij}^{++}(p))_{0 \leq j \leq p-1}$  is a standard basis of  $R^*(\mathcal{X}^+(p))$  for the right action.

As in [FGST06a], the structure of  $Q(s)$  in terms of composition factors can be schematically represented as follows (each vertex represents a composition factor and is labelled by the basis vectors of this factor):

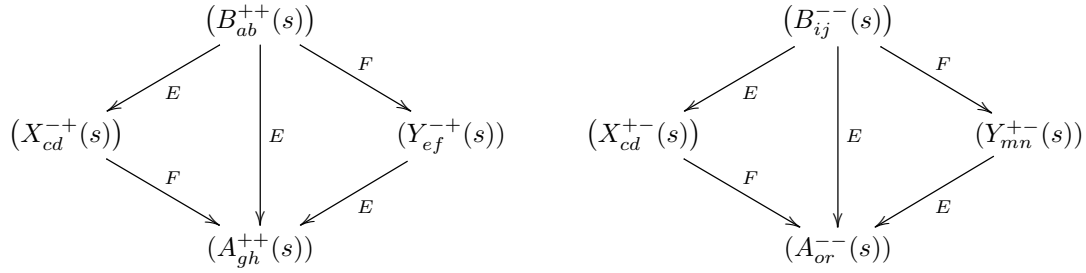

for the left action, and

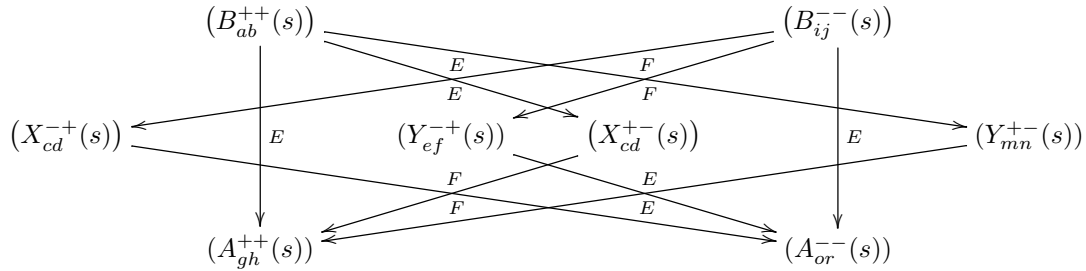

for the right action.

The knowledge of the structure of the bimodule  $\bar{U}_q(\bar{U}_q)_{\bar{U}_q}$  allows us to determine the center of  $\bar{U}_q$ . Indeed, each central element determines a bimodule endomorphism and conversely. Recall from [FGST06a] that  $\mathcal{Z}(\bar{U}_q)$  is a  $(3p-1)$ -dimensional algebra with basis elements  $e_s$  ( $0 \leq s \leq p$ ) and  $w_t^\pm$  ( $1 \leq t \leq p-1$ ). The element  $e_s$  is just the unit of the block  $Q(s)$ , thus by (3.7) and (3.5) the action of  $e_s$  on the simple and the projective modules is given by

$$\begin{aligned}
 \text{For } s=0, & \quad e_0 v_0^+(t) = 0, & \quad e_0 v_0^-(t) = \delta_{t,p} v_0^-(p), & \quad e_0 b_0^\pm(t) = 0, \\
 \text{For } 1 \leq s \leq p-1, & \quad e_s v_0^+(t) = \delta_{s,t} v_0^+(s), & \quad e_s v_0^-(t) = \delta_{p-s,t} v_0^-(p-s), & \\
 & \quad e_s b_0^+(t) = \delta_{s,t} b_0^+(s), & \quad e_s b_0^-(t) = \delta_{t,p-s} b_0^-(p-s), & \\
 \text{For } s=p, & \quad e_p v_0^+(t) = \delta_{t,p} v_0^+(p), & \quad e_p v_0^-(t) = 0, & \quad e_p b_0^\pm(t) = 0
 \end{aligned} \tag{3.8}$$

while for the elements  $w_s^\pm$ :

$$\begin{aligned}
 w_s^+ v_0^\pm(t) &= 0, & w_s^+ b_0^+(t) &= \delta_{s,t} a_0^+(s), & w_s^+ b_0^-(t) &= 0, \\
 w_s^- v_0^\pm(t) &= 0, & w_s^- b_0^+(t) &= 0, & w_s^- b_0^-(t) &= \delta_{t,p-s} a_0^-(p-s).
 \end{aligned} \tag{3.9}$$

Observe that

$$\begin{aligned} \mathcal{P}^+(s) & & \mathcal{P}^-(p-s) \\ w_s^+ &= p_s^+, & w_s^- &= p_{p-s}^-. \end{aligned}$$

The action of the central elements on  $\mathcal{P}^\alpha(s)$  is enough to recover their action on every module, using projective covers. From these formulas, we deduce the multiplication rules of these elements:

$$e_s e_t = \delta_{s,t} e_s, \quad e_s w_t^\pm = \delta_{s,t} w_s^\pm, \quad w_s^\pm w_t^\pm = 0. \quad (3.10)$$

Let us mention that the idempotents  $e_s$  are not primitive: there exists primitive orthogonal idempotents  $e_{s,i}$  such that  $e_s = \sum_i e_{s,i}$ , see [Ari10].

**Definition 3.1.3.** *The basis  $\{e_s, w_t^\pm\}$  ( $0 \leq s \leq p$ ,  $1 \leq t \leq p-1$ ) will be called the canonical basis of  $\mathcal{Z}(\bar{U}_q)$ .*

If  $z$  is a central element and  $S$  is a simple module, we know by Schur lemma that  $\overset{S}{z} = z_S \text{id}_S$  for some scalar  $z_S \in \mathbb{C}$ . For a simple  $\bar{U}_q$ -module, we see thanks to (3.8) and (3.9) that the scalars  $z_{\mathcal{X}^\alpha(s)}$  satisfy a symmetry property:

$$\forall 1 \leq s \leq p-1, \quad z_{\mathcal{X}^+(s)} = z_{\mathcal{X}^-(p-s)}. \quad (3.11)$$

We will sometimes use the convention  $z_{\mathcal{X}^+(0)} = z_{\mathcal{X}^-(p)}$  to unify formulas.

An important and useful central element of  $\bar{U}_q$  is the Casimir element  $C$ , defined by

$$C = FE + \frac{qK + q^{-1}K^{-1}}{(q - q^{-1})^2} \quad (3.12)$$

Since  $Cb_0^\alpha(s) = a_0^\alpha(s) + \alpha \frac{q^s + q^{-s}}{(q - q^{-1})^2} b_0^\alpha(s)$ , we get that the expression of  $C$  in the canonical basis of  $\mathcal{Z}(\bar{U}_q)$  is

$$C = \sum_{j=0}^p \frac{q^j + q^{-j}}{(q - q^{-1})^2} e_j + \sum_{k=1}^{p-1} (w_k^+ + w_k^-). \quad (3.13)$$

Moreover, thanks to [FGST06a, Formula (D.7)], we know that the subalgebra of  $\mathcal{Z}(\bar{U}_q)$  generated by  $C$  is

$$\mathbb{C}\langle C \rangle = \text{vect}(e_s, w_t^+ + w_t^-)_{0 \leq s \leq p, 1 \leq t \leq p-1}. \quad (3.14)$$

This means that any of the elements  $e_s, w_t^+ + w_t^-$  can be written as a polynomial in  $C$ .

### 3.1.3 The braided extension of $\bar{U}_q$

The Hopf algebra  $\bar{U}_q$  is not braided. Indeed, for  $p > 2$ , one can find (see [KS11]) two  $\bar{U}_q$ -modules  $V, W$  such that  $V \otimes W$  and  $W \otimes V$  are not isomorphic, which immediately implies that  $\bar{U}_q$  cannot contain a  $R$ -matrix; the remaining case  $p = 2$  is considered in [GR17a] where it is shown directly that there is no  $R$ -matrix either. However,  $\bar{U}_q$  is very close to be braided, since its extension by a square root of  $K$  is braided. Let  $\bar{U}_q^{1/2}$  be this extension; the universal  $R$ -matrix  $R \in \bar{U}_q^{1/2} \otimes \bar{U}_q^{1/2}$  is given by

$$R = q^{H \otimes H/2} \sum_{m=0}^{p-1} \frac{\hat{q}^m}{[m]!} q^{m(m-1)/2} E^m \otimes F^m, \quad \text{with} \quad q^{H \otimes H/2} = \frac{1}{4p} \sum_{n,j=0}^{4p-1} q^{-nj/2} K^{n/2} \otimes K^{j/2} \quad (3.15)$$

where  $q^{1/2}$  is a fixed square root of  $q$ . We use the notation  $q^{H \otimes H/2}$  because  $q^{H \otimes H/2} v \otimes w = q^{ab/2}$  if  $K^{1/2} v = q^{a/2} v$  and  $K^{1/2} w = q^{b/2} w$ ; also recall the notation  $\hat{q} = q - q^{-1}$ .

Even if  $R \notin \bar{U}_q \otimes \bar{U}_q$ , the  $R$ -matrix satisfies the important property that  $RR' \in \bar{U}_q \otimes \bar{U}_q$ . Its value is

$$RR' = \frac{1}{2p} \sum_{m,n=0}^{p-1} \sum_{i,j=0}^{2p-1} \frac{\hat{q}^{m+n}}{[m]![n]!} q^{\frac{m(m-1)}{2} + \frac{n(n-1)}{2} - m^2 + m(i-j) - ij} E^m K^i F^n \otimes F^m K^j E^n. \quad (3.16)$$

with  $\hat{q} = q - q^{-1}$ . From this expression, we see that the map

$$\begin{aligned} \Psi : \bar{U}_q^* &\rightarrow \bar{U}_q \\ \beta &\mapsto (\beta \otimes \text{id})(RR') \end{aligned}$$

is an isomorphism of vector spaces. Thus by abuse of terminology we will say that  $\bar{U}_q$  is factorizable (this is an abuse of terminology since the usual definition of factorizability requires braiding (*i.e.* existence of a  $R$ -matrix) and  $\bar{U}_q$  is not braided). Note that the extension  $\bar{U}_q^{1/2}$  is not factorizable since  $K^{1/2}$  does not appear in the expression of  $RR'$ .

The Drinfeld element  $u = S(b_i)a_i$  (with  $R = a_i \otimes b_i$ ) also belongs to  $\bar{U}_q$  (the square root of  $K$  does not appear in its expression). Moreover,  $\bar{U}_q$  contains two possible ribbon elements, namely elements  $v \in \bar{U}_q$  which satisfy (2.11). Here we take

$$v = \frac{1-i}{2\sqrt{p}} \sum_{m=0}^{p-1} \sum_{j=0}^{2p-1} \frac{\hat{q}^m}{[m]!} q^{-\frac{m}{2} - mj + \frac{(j+p+1)^2}{2}} F^m K^j E^m.$$

With this choice of  $v$ , it holds (see (2.13))

$$g = uv^{-1} = K^{p+1}.$$

The choice of the other possible ribbon element would have led to  $g = uv^{-1} = K$ , but from the beginning we have decided to take  $K^{p+1}$  as pivotal element, which forces the choice of  $v$ . The element  $v$  is central and invertible; its expression in the canonical basis of  $\mathcal{Z}(\bar{U}_q)$  is

$$\begin{aligned} v &= \sum_{s=0}^p v_{\mathcal{X}^+(s)} e_s + \hat{q} \sum_{s=1}^{p-1} v_{\mathcal{X}^+(s)} \left( \frac{p-s}{[s]} w_s^+ - \frac{s}{[s]} w_s^- \right), \\ v^{-1} &= \sum_{s=0}^p v_{\mathcal{X}^+(s)}^{-1} e_s - \hat{q} \sum_{s=1}^{p-1} v_{\mathcal{X}^+(s)}^{-1} \left( \frac{p-s}{[s]} w_s^+ - \frac{s}{[s]} w_s^- \right). \end{aligned} \tag{3.17}$$

with  $\hat{q} = q - q^{-1}$ . The scalar  $v_{\mathcal{X}^\alpha(s)}$  is defined by  $v_{\mathcal{X}^\alpha(s)} = v_{\mathcal{X}^\alpha(s)} \text{id}$ , its value is

$$v_{\mathcal{X}^+(s)} = v_{\mathcal{X}^-(p-s)} = (-1)^{s-1} q^{-\frac{(s^2-1)}{2}}. \tag{3.18}$$

and  $v_{\mathcal{X}^+(0)}$  is just a notation for  $v_{\mathcal{X}^-(p)}$  used to unify the formula.

### 3.1.4 Matrix coefficients for $\bar{U}_q$

This section is an example and will not be used in the rest of the text. The aim is to explain how one can restrict to well-chosen representations when he deals with algebras defined by means of matrix coefficients (which is the case of all the algebras considered in this text). Here we will exhibit a (well-known) minimal set of matrix coefficients which generate  $\mathcal{O}(\bar{U}_q)$  and give a presentation by generators and relations of this algebra based on these matrix coefficients. The reasoning is more interesting than the result because the method presented here can be applied to the algebra  $\mathcal{L}_{0,1}(\bar{U}_q)$  and then to  $\mathcal{L}_{g,n}(\bar{U}_q)$  (see section 4.4.2).

The decomposition formulas for tensor products of simple modules and projective modules are given in [KS11]. First, since

$$\mathcal{X}^+(2) \otimes \mathcal{X}^+(s) \cong \mathcal{X}^+(s-1) \oplus \mathcal{X}^+(s+1)$$

for  $2 \leq s \leq p-1$ , we see that  $\mathcal{X}^+(p) = \mathcal{P}^+(p)$  is a direct summand of  $\mathcal{X}^+(2)^{\otimes(p-1)}$ . Second, since

$$\mathcal{X}^+(2) \otimes \mathcal{X}^+(p) \cong \mathcal{P}^+(p-1), \quad \mathcal{X}^+(2) \otimes \mathcal{P}^+(s) \cong \mathcal{P}^+(s-1) \oplus \mathcal{P}^+(s+1), \quad \mathcal{X}^+(2) \otimes \mathcal{P}^+(1) \cong 2\mathcal{X}^-(p) \oplus \mathcal{P}^+(2)$$



for  $2 \leq s \leq p-1$ , we see that  $\mathcal{P}^+(j)$  is a direct summand of  $\mathcal{X}^+(2)^{\otimes 2p-j-1}$ , and that  $\mathcal{X}^-(p) = \mathcal{P}^-(p)$  is a direct summand of  $\mathcal{X}^+(2)^{\otimes 2p-1}$ . Finally, since

$$\mathcal{X}^+(2) \otimes \mathcal{X}^-(p) \cong \mathcal{P}^-(p-1), \quad \mathcal{X}^+(2) \otimes \mathcal{P}^-(s) \cong \mathcal{P}^-(s-1) \oplus \mathcal{P}^-(s+1)$$

for  $2 \leq s \leq p-1$ , we see that  $\mathcal{P}^-(j)$  is a direct summand of  $\mathcal{X}^+(2)^{\otimes 3p-j-1}$ . It follows that every PIM  $P$  is a direct summand of some tensor power  $\mathcal{X}^+(2)^{\otimes n}$ , and that  $T$  is a submatrix of  $T^{\mathcal{X}^+(2)^{\otimes n}}$ . Hence the coefficients  $\left( T^{\mathcal{X}^+(2)^{\otimes n}} \right)_{j_1, \dots, j_n}^{i_1, \dots, i_n}$  linearly span  $\mathcal{O}(\bar{U}_q)$ . But thanks to the fusion relation (2.15) of the matrices  $T$ , it holds:

$$\left( T^{\mathcal{X}^+(2)^{\otimes n}} \right)_{j_1 \dots j_n}^{i_1 \dots i_n} = \left( T^{\mathcal{X}^+(2)} \right)_{j_1}^{i_1} \dots \left( T^{\mathcal{X}^+(2)} \right)_{j_n}^{i_n} \quad (3.19)$$

and this shows that the matrix coefficients  $\left( T^{\mathcal{X}^+(2)} \right)_j^i$  generate  $\mathcal{O}(\bar{U}_q)$  as an algebra.

We denote

$$T^{\mathcal{X}^+(2)} = \begin{pmatrix} a & b \\ c & d \end{pmatrix}.$$

Let us seek relations between these generators. All the relations are implied by the existence of certain well-chosen morphisms. First, one has the exchange relation (2.17) (which comes from the existence of the braiding isomorphism  $c : \mathcal{X}^+(2)^{\otimes 2} \rightarrow \mathcal{X}^+(2)^{\otimes 2}$ ). The  $R$ -matrix (3.15) evaluated in  $\mathcal{X}^+(2)^{\otimes 2}$  is

$$q^{-1/2} \begin{pmatrix} q & 0 & 0 & 0 \\ 0 & 1 & \hat{q} & 0 \\ 0 & 0 & 1 & 0 \\ 0 & 0 & 0 & q \end{pmatrix}$$

(with  $\hat{q} = q - q^{-1}$ ) and relation (2.17) is equivalent to

$$ba = qab, \quad db = qbd, \quad ca = qac, \quad dc = qcd, \quad bc = cb, \quad ad - da = (q^{-1} - q)bc.$$

Second, since  $\mathcal{X}^+(2)^{\otimes 2} \cong \mathcal{X}^+(1) \oplus \mathcal{X}^+(3)$ , there exists a unique (up to scalar) morphism  $\Phi : \mathbb{C} = \mathcal{X}^+(1) \rightarrow \mathcal{X}^+(2)^{\otimes 2}$ ; it is given by  $\Phi(1) = qv_0 \otimes v_1 - v_1 \otimes v_0$ . By naturality (2.3) and fusion (2.15), we have  $T_1^{\mathcal{X}^+(2)\mathcal{X}^+(2)} T_2^{\mathcal{X}^+(2)^{\otimes 2}} \Phi = T^{\mathbb{C}} \Phi = \Phi T = \Phi$ . This gives just one new relation, the quantum determinant:

$$ad - q^{-1}bc = 1. \quad (3.20)$$

Next, since  $\mathcal{P}^+(p-1)$  is a direct summand of  $\mathcal{X}^+(2)^{\otimes p}$ , there exists<sup>2</sup> an injection  $f : \mathcal{P}^+(p-1) \rightarrow \mathcal{X}^+(2)^{\otimes p}$ . For instance, one can check that the assignment

$$f(b_0^+(p-1)) = v_0^{\otimes (p-1)} \otimes v_1$$

does the job, and we have  $f(x_0^+(p-1)) = v_0^{\otimes p}$ ,  $f(y_0^+(p-1)) = \lambda v_1^{\otimes p}$  for some  $\lambda (\neq 0$  since  $f$  is injective). Endowing the tensor basis of  $\mathcal{X}^+(2)^{\otimes p}$  with the lexicographic order and using (3.19) above and (3.22) below, we get that the matrices under consideration have the following shapes:

<sup>2</sup>Such a morphism is far from unique. Indeed, using the decomposition rules recalled above, one can show that  $\mathcal{X}^+(2)^{\otimes p} \cong W \oplus (p-2)\mathcal{X}^+(p-1) \oplus \mathcal{P}^+(p-1)$ , and thanks to the description of Hom-spaces in section 3.1.1, we get that  $\dim(\text{Hom}_{\bar{U}_q}(\mathcal{P}^+(p-1), \mathcal{X}^+(2)^{\otimes p})) = p$ .

$$f = \begin{pmatrix} (b_i) & x_0 & y_0 & (a_j) \\ \mathbf{0} & 1 & 0 & \mathbf{0} \\ * & \mathbf{0} & \mathbf{0} & * \\ \mathbf{0} & 0 & \lambda & \mathbf{0} \end{pmatrix} \begin{matrix} v_0^{\otimes p} \\ \vdots \\ v_1^{\otimes p} \end{matrix} \quad \mathcal{X}^{+(2)\otimes p} T = \begin{pmatrix} v_0^{\otimes p} & \dots & v_1^{\otimes p} \\ a^p & * & b^p \\ * & * & * \\ c^p & * & d^p \end{pmatrix} \begin{matrix} v_0^{\otimes p} \\ \vdots \\ v_1^{\otimes p} \end{matrix}$$

$$\mathcal{P}^{+(p-1)} T = \begin{pmatrix} (b_i) & x_0 & y_0 & (a_j) \\ \mathcal{X}^{+(p-1)} T & \mathbf{0} & \mathbf{0} & \mathbf{0} \\ A_{p-1}^+ & \mathcal{X}^{-(1)} T & \mathbf{0} & \mathbf{0} \\ B_{p-1}^+ & \mathbf{0} & \mathcal{X}^{-(1)} T & \mathbf{0} \\ H_{p-1}^+ & D_{p-1}^+ & C_{p-1}^+ & \mathcal{X}^{+(p-1)} T \end{pmatrix} \begin{matrix} (b_i) \\ x_0 \\ y_0 \\ (a_j) \end{matrix}$$

To obtain the blocks of  $\mathbf{0}$ 's in the matrix of  $f$ , just compare the weights of the elements. The relation  $\mathcal{P}^{+(p-1)} T = \mathcal{X}^{+(2)\otimes p} T f$  implies  $b^p = c^p = 0$ . Finally,  $\mathcal{P}^-(p-1)$  is a direct summand of  $\mathcal{X}^+(2)^{\otimes 2p}$ , and it is not difficult to check that the assignments

$$f_1(b_0^-(p-1)) = v_0^{\otimes(2p-1)} \otimes v_1, \quad f_2(b_{p-2}^-(p-1)) = v_0 \otimes v_1^{\otimes(2p-1)}$$

define injective morphisms  $f_1, f_2 : \mathcal{P}^-(p-1) \rightarrow \mathcal{X}^+(2)^{\otimes 2p}$ , and we have  $f_1(x_0^-(p-1)) = v_0^{\otimes 2p}$ ,  $f_2(y_0^-(p-1)) = v_1^{\otimes 2p}$ . One can compute as above that the relation  $f_1 \mathcal{P}^{-(p-1)} T = \mathcal{X}^{+(2)\otimes 2p} T f_1$  (resp.  $f_2 \mathcal{P}^{-(p-1)} T = \mathcal{X}^{+(2)\otimes 2p} T f_2$ ) implies  $a^{2p} = 1$  (resp.  $d^{2p} = 1$ ), where  $1 = \varepsilon = \mathcal{X}^{+(1)} T$ . We then arrive to the following Proposition, which is certainly well-known.

**Proposition 3.1.4.** *The algebra  $\mathcal{O}(\bar{U}_q)$  admits the following presentation:*

$$\langle b, c, d \mid db = qbd, \quad dc = qcd, \quad bc = cb, \quad b^p = c^p = 0, \quad d^{2p} = 1 \rangle$$

*Proof.* Note first that the generator  $a$  is not required. Indeed since  $d$  is invertible, we have  $a = d^{-1} + q^{-1}bcd^{-1}$ . Let  $A$  be the algebra defined by this presentation. Then by the computations above, we have a surjection  $p : A \rightarrow \mathcal{O}(\bar{U}_q)$  and thus  $\dim(\mathcal{O}(\bar{U}_q)) \leq \dim(A)$ . But it is clear that any element of  $A$  is a linear combination of monomials  $b^i c^j d^k$  with  $0 \leq i, j \leq p-1$ ,  $0 \leq k \leq 2p-1$ . Hence  $\dim(A) \leq 2p^3 = \dim(\mathcal{O}(\bar{U}_q))$  and  $p$  is an isomorphism.  $\square$

## 3.2 Symmetric linear forms and the GTA basis

Let

$$\text{SLF}(\bar{U}_q) = \{\varphi \in \bar{U}_q^* \mid \forall x, y \in \bar{U}_q, \varphi(xy) = \varphi(yx)\}.$$

From the general comments of section 2.3,  $\text{SLF}(\bar{U}_q)$  is a subalgebra of  $\mathcal{O}(\bar{U}_q)$ .  $\mathcal{O}(\bar{U}_q)$  is more precisely a Hopf algebra, but  $\text{SLF}(\bar{U}_q)$  is not a sub-coalgebra of  $\mathcal{O}(\bar{U}_q)$ , see Remark 3.2.5 below; it is however stable by the antipode  $S$ .

Since  $\bar{U}_q$  is factorizable (in the generalized sense of section 3.1.3), we know thanks to Lemma 2.3.3 that

$$\dim(\text{SLF}(\bar{U}_q)) = \dim(\mathcal{Z}(\bar{U}_q)) = 3p - 1.$$

An interesting basis of  $\text{SLF}(\bar{U}_q)$  was found by Gainutdinov and Tipunin in [GT09] and by Arike in [Ari10]. To be precise, a basis of the space  $\text{qCh}(\bar{U}_q)$  of  $q$ -characters is constructed in [GT09], but the shift by the pivotal element  $g = K^{p+1}$  provides an isomorphism

$$\text{qCh}(\bar{U}_q) \xrightarrow{\sim} \text{SLF}(\bar{U}_q), \quad \psi \mapsto \psi(g \cdot).$$

This basis is built from the simple and the projective modules. First, define  $2p$  linear forms<sup>3</sup>  $\chi_s^\alpha$ ,  $\alpha \in \{\pm\}$ ,  $1 \leq s \leq p$ , by:

$$\chi_s^\alpha = \text{tr} \begin{pmatrix} \mathcal{X}^{\alpha(s)} \\ T \end{pmatrix}. \quad (3.21)$$

They are obviously symmetric. Observe that  $\chi_1^+ = \varepsilon$  is the unit for the algebra structure on  $\text{SLF}(\bar{U}_q)$  described above. To construct the  $p-1$  missing linear forms, observe with the help of (3.5) that the matrix of the action on  $\mathcal{P}^\alpha(s)$  has the following block form in a standard basis:

$$\mathcal{P}^\alpha(s) T = \begin{pmatrix} (b_i) & (x_j) & (y_k) & (a_l) \\ \mathcal{X}^{\alpha(s)} T & \mathbf{0} & \mathbf{0} & \mathbf{0} \\ A_s^\alpha & \mathcal{X}^{-\alpha(p-s)} T & \mathbf{0} & \mathbf{0} \\ B_s^\alpha & \mathbf{0} & \mathcal{X}^{-\alpha(p-s)} T & \mathbf{0} \\ H_s^\alpha & D_s^\alpha & C_s^\alpha & \mathcal{X}^{\alpha(s)} T \end{pmatrix} \begin{pmatrix} (b_i) \\ (x_j) \\ (y_k) \\ (a_l) \end{pmatrix}. \quad (3.22)$$

It is not difficult to see that these matrices satisfy the following symmetries:

$$A_{p-s}^- = C_s^+, \quad B_{p-s}^- = D_s^+, \quad D_{p-s}^- = B_s^+, \quad C_{p-s}^- = A_s^+.$$

By computing the matrices  $(xy) = \begin{pmatrix} \mathcal{P}^+(s) \\ x & y \end{pmatrix} = \begin{pmatrix} \mathcal{P}^+(s) & \mathcal{P}^+(s) \\ x & y \end{pmatrix}$  and  $(xy) = \begin{pmatrix} \mathcal{P}^-(p-s) \\ x & y \end{pmatrix} = \begin{pmatrix} \mathcal{P}^-(p-s) & \mathcal{P}^-(p-s) \\ x & y \end{pmatrix}$ , these symmetries allow us to see that the linear form  $G_s$  ( $1 \leq s \leq p-1$ ) defined by

$$G_s = \text{tr}(H_s^+) + \text{tr}(H_{p-s}^-) \quad (3.23)$$

is a symmetric linear form. This can also be written as

$$G_s = \text{tr} \begin{pmatrix} \mathcal{P}^+(s) \\ \sigma_s & T \end{pmatrix} + \text{tr} \begin{pmatrix} \mathcal{P}^-(p-s) \\ \sigma_{p-s} & T \end{pmatrix} \quad (3.24)$$

where  $\sigma_j : \mathcal{P}^\alpha(s) \rightarrow \mathcal{P}^\alpha(s)$  is the linear map (which is not a  $\bar{U}_q$ -morphism) sending  $\text{Soc}(\mathcal{P}^\alpha(s))$  to  $\text{Top}(\mathcal{P}^\alpha(s))$  (see (3.5)):

$$\sigma_s = \begin{pmatrix} (b_i) & (x_j) & (y_k) & (a_l) \\ \mathbf{0} & \mathbf{0} & \mathbf{0} & \mathbb{I}_j \\ \mathbf{0} & \mathbf{0} & \mathbf{0} & \mathbf{0} \\ \mathbf{0} & \mathbf{0} & \mathbf{0} & \mathbf{0} \\ \mathbf{0} & \mathbf{0} & \mathbf{0} & \mathbf{0} \end{pmatrix} \begin{pmatrix} (b_i) \\ (x_j) \\ (y_k) \\ (a_l) \end{pmatrix}.$$

It is instructive for our purposes to see a proof that these symmetric linear forms are linearly independent. Let us begin by introducing important elements for  $0 \leq n \leq p-1$  (they are discrete Fourier transforms of  $(K^l)_{0 \leq l \leq 2p-1}$ ):

$$\Phi_n^\alpha = \frac{1}{2p} \sum_{l=0}^{2p-1} (\alpha q^{-n})^l K^l.$$

The following easy lemma shows that these elements allow one to select vectors which have a given weight, and this turns out to be very useful.

<sup>3</sup>The correspondence of notations with [Ari10] is:  $T_s^+ = \chi_s^+$ ,  $T_s^- = \chi_{p-s}^-$ . The letter  $T$  is here reserved for the matrices  $\overset{V}{T}$  described above.

**Lemma 3.2.1.** 1) Let  $M$  be a left  $\bar{U}_q$ -module, and let  $m_i^+(s)$  be a vector of weight  $q^{s-1-2i}$ ,  $m_i^-(p-s)$  be a vector of weight  $-q^{(p-s)-1-2i} = q^{-s-1-2i}$ ,  $m_i^-(s)$  be a vector of weight  $-q^{s-1-2i}$ ,  $m_i^+(p-s)$  be a vector of weight  $q^{(p-s)-1-2i} = -q^{-s-1-2i}$ . Then:

$$\begin{aligned}\Phi_{s-1}^+ m_i^+(s) &= \delta_{i,0} m_0^+(s), & \Phi_{s-1}^+ m_i^-(p-s) &= 0, \\ \Phi_{s-1}^- m_i^-(s) &= \delta_{i,0} m_0^-(s), & \Phi_{s-1}^- m_i^+(p-s) &= 0.\end{aligned}$$

2) Let  $N$  be a right  $\bar{U}_q$ -module, and let  $n_i^+(s)$  be a vector of weight  $q^{1-s+2i}$ ,  $n_i^-(p-s)$  be a vector of weight  $-q^{1-(p-s)+2i} = q^{1+s+2i}$ ,  $n_i^-(s)$  be a vector of weight  $-q^{1-s+2i}$ ,  $n_i^+(p-s)$  be a vector of weight  $q^{1-(p-s)+2i} = -q^{1+s+2i}$ . Then:

$$\begin{aligned}n_i^+(s)\Phi_{s-1}^+ &= \delta_{i,s-1} n_{s-1}^+(s), & n_i^-(p-s)\Phi_{s-1}^+ &= 0, \\ n_i^-(s)\Phi_{s-1}^- &= \delta_{i,s-1} n_{s-1}^-(s), & n_i^+(p-s)\Phi_{s-1}^- &= 0.\end{aligned}$$

*Proof.* It follows from easy computations with sums of roots of unity.  $\square$

We can now state the key observation.

**Proposition 3.2.2.** Let

$$\varphi = \sum_{s=1}^p (\lambda_s^+ \chi_s^+ + \lambda_s^- \chi_s^-) + \sum_{s'=1}^{p-1} \mu_{s'} G_{s'} \in \text{SLF}(\bar{U}_q).$$

Then:

$$\lambda_s^+ = \varphi(\Phi_{s-1}^+ e_s), \quad \lambda_s^- = \varphi(\Phi_{s-1}^- e_{p-s}), \quad \mu_{s'} = \frac{\varphi(w_{s'}^+)}{s'} = \frac{\varphi(w_{s'}^-)}{p-s'}.$$

*Proof.* It is a corollary of (3.8) and (3.9). Indeed, we have:

$$\begin{aligned}\mathcal{X}^{+(s)} T(e_t) &= \delta_{s,t} I_s, & \mathcal{X}^{+(s)} T(w_t^\pm) &= 0, & \mathcal{X}^{-(s)} T(e_t) &= \delta_{s,p-t} I_s, \\ \mathcal{X}^{-(s)} T(w_t^\pm) &= 0, & H_s^\pm(e_t) &= 0, & H_s^+(w_s^+) &= \delta_{s,t} I_s, \\ H_s^+(w_t^-) &= 0, & H_{p-s}^-(w_t^+) &= 0, & H_{p-s}^-(w_t^-) &= \delta_{s,t} I_{p-s}.\end{aligned}\tag{3.25}$$

This gives the formula for  $\mu_s$ . The formulas for  $\lambda_s^\pm$  follow from this and Lemma 3.2.1.  $\square$

If we have  $\sum_{s=1}^p (\lambda_s^+ \chi_s^+ + \lambda_s^- \chi_s^-) + \sum_{s'=1}^{p-1} \mu_{s'} G_{s'} = 0$ , we can evaluate the left-hand side on the elements appearing in Proposition 3.2.2 to get that all the coefficients are equal to 0. Thus we have a free family of cardinal  $3p-1$ , hence a basis of  $\text{SLF}(\bar{U}_q)$ .

**Theorem 3.2.3.** The symmetric linear forms  $\chi_s^\pm$  ( $1 \leq s \leq p$ ) and  $G_{s'}$  ( $1 \leq s' \leq p-1$ ) form a basis of  $\text{SLF}(\bar{U}_q)$ .

**Definition 3.2.4.** The basis of Theorem 3.2.3 will be called the GTA basis (for Gainutdinov, Tipunin, Arike).

*Remark 3.2.5.* Let  $\varphi \in \text{SLF}(\bar{U}_q)$ . It is easy to see that  $\varphi(K^j E^n F^m) = 0$  if  $n \neq m$ . From this we deduce that  $\text{SLF}(\bar{U}_q)$  is not a sub-coalgebra of  $\bar{U}_q^*$ . Indeed, write  $\Delta(\chi_2^+) = \sum_i \varphi_i \otimes \psi_i$ , and assume that  $\varphi_i, \psi_i \in \text{SLF}(\bar{U}_q)$ . Then  $1 = \chi_2^+(EF) = \sum_i \varphi_i(E)\psi_i(F) = 0$ , a contradiction.  $\triangle$

*Remark 3.2.6.* If we choose a basis of  $\mathcal{Z}(\bar{U}_q)$ , then its dual basis can not be entirely contained in  $\text{SLF}(\bar{U}_q)$ . Indeed, let  $\varphi = \sum_{s=0}^p \lambda_s^\pm \chi_s^\pm + \sum_{s=1}^{p-1} \mu_s G_s \in \text{SLF}(\bar{U}_q)$ . Then  $\varphi(w_s^+) = s\mu_s$ ,  $\varphi(w_s^-) = (p-s)\mu_s$ , and we see that there does not exist  $\varphi \in \text{SLF}(\bar{U}_q)$  such that  $\varphi(w_s^+) = 1$ ,  $\varphi(w_s^-) = 0$ . Hence,  $\text{SLF}(\bar{U}_q) \subset \bar{U}_q^*$  is not the dual of  $\mathcal{Z}(\bar{U}_q) \subset \bar{U}_q$ .  $\triangle$

We have an obvious action of  $\mathcal{Z}(\bar{U}_q)$  on  $\text{SLF}(\bar{U}_q)$ :

$$\forall z \in \mathcal{Z}(\bar{U}_q), \forall \varphi \in \text{SLF}(\bar{U}_q), \quad \varphi^z = \varphi(z?). \quad (3.26)$$

For further use, we record the values of this action with the canonical basis of  $\mathcal{Z}(\bar{U}_q)$  and the GTA basis of  $\text{SLF}(\bar{U}_q)$ :

$$\begin{aligned} (\chi_s^+)^{et} &= \delta_{s,t} \chi_s^+, & (\chi_s^-)^{et} &= \delta_{p-s,t} \chi_s^-, & G_s^{et} &= \delta_{s,t} G_s \\ (\chi_s^+)^{w_t^\pm} &= 0, & (\chi_s^-)^{w_t^\pm} &= 0, & G_s^{w_t^+} &= \delta_{s,t} \chi_s^+, & G_s^{w_t^-} &= \delta_{s,t} \chi_{p-s}^-. \end{aligned} \quad (3.27)$$

This is just a consequence of (3.25).

### 3.3 Traces on projective $\bar{U}_q$ -modules and the GTA basis

The material of this section is independent of the rest of the text and will not be used elsewhere (except for the equality (3.29)).

#### 3.3.1 Correspondence between traces and symmetric linear forms

Let  $A$  be a finite dimensional  $k$ -algebra. We have an anti-isomorphism of algebras:

$$A \rightarrow \text{End}_A(A), \quad a \mapsto \rho_a \text{ defined by } \rho_a(x) = xa.$$

Observe that the right action of  $A$  naturally appears. Let  $t$  be a trace on  $A$ , that is, an element of  $\text{SLF}(\text{End}_A(A))$ . Then:

$$t(\rho_{ab}) = t(\rho_b \circ \rho_a) = t(\rho_a \circ \rho_b) = t(\rho_{ba}).$$

So we get an isomorphism of vector spaces

$$\begin{aligned} \{\text{Traces on } \text{End}_A(A)\} &= \text{SLF}(\text{End}_A(A)) \rightarrow \text{SLF}(A) \\ t &\mapsto \varphi^t \text{ defined by } \varphi^t(a) = t(\rho_a). \end{aligned}$$

whose inverse is:

$$\begin{aligned} \text{SLF}(A) &\rightarrow \{\text{Traces on } \text{End}_A(A)\} = \text{SLF}(\text{End}_A(A)) \\ \varphi &\mapsto t^\varphi \text{ defined by } t^\varphi(\rho_a) = \varphi(a). \end{aligned}$$

In the case of  $A = \bar{U}_q$ , we can express  $\varphi^t$  in the GTA basis, which will be the object of the next section.

Let  $\text{Proj}_A$  be the full subcategory of the category of finite dimensional  $A$ -modules whose objects are the projective  $A$ -modules.

**Definition 3.3.1.** A trace on  $\text{Proj}_A$  is a family of linear maps  $t = (t_U : \text{End}_A(U) \rightarrow k)_{U \in \text{Proj}_A}$  such that

$$\forall f \in \text{Hom}_A(U, V), \forall g \in \text{Hom}_A(V, U), \quad t_V(g \circ f) = t_U(f \circ g).$$

We denote by  $\mathcal{T}_{\text{Proj}_A}$  the vector space of traces on  $\text{Proj}_A$ .

This cyclic property of traces on  $\text{Proj}_A$  is one of the axioms of the so-called modified traces, defined for instance in [GKP11]. Note that this definition could be restated in the following way (and could be generalized to other abelian full subcategories than  $\text{Proj}_A$ ).

**Lemma 3.3.2.** Let  $t = (t_U : \text{End}_A(U) \rightarrow k)_{U \in \text{Proj}_A}$  be a family of linear maps. Then  $t$  is a trace on  $\text{Proj}_A$  if and only if:

- $\forall f, g \in \text{End}_A(U), \quad t_U(g \circ f) = t_U(f \circ g),$

- $t_{U \oplus V}(f) = t_U(p_U \circ f \circ i_U) + t_V(p_V \circ f \circ i_V)$ , where  $p_U, p_V$  are the canonical projection maps and  $i_U, i_V$  are the canonical injection maps.

*Proof.* If  $t$  is a trace and  $f \in \text{End}_A(U \oplus V)$ , we have:

$$t_{U \oplus V}(f) = t_{U \oplus V}((i_U p_U + i_V p_V)f) = t_U(p_U f i_U) + t_V(p_V f i_V).$$

Conversely, let  $f : U \rightarrow V$ ,  $g : V \rightarrow U$ . Define  $F = i_V f p_U$ ,  $G = i_U g p_V$ . Then  $FG = i_V f g p_V$  and  $GF = i_U g f p_U$ . We have  $p_U G F i_U = gf$ ,  $p_V G F i_V = 0$ ,  $p_U F G i_U = 0$ ,  $p_V F G i_V = fg$ , thus:

$$t_V(fg) = t_{U \oplus V}(FG) = t_{U \oplus V}(GF) = t_U(gf).$$

This shows the equivalence.  $\square$

Now, consider:

$$\begin{aligned} \Pi_A : \quad \mathcal{T}_{\text{Proj}_A} &\rightarrow \text{SLF}(\text{End}_A(A)) \xrightarrow{\sim} \text{SLF}(A) \\ t = (t_U)_{U \in \text{Ob}(\text{Proj}_A)} &\mapsto t_A \mapsto \varphi^t \text{ defined by } \varphi^t(a) = t_A(\rho_a). \end{aligned}$$

**Theorem 3.3.3.** *The map  $\Pi_A$  is an isomorphism. In other words,  $t_A$  entirely characterizes  $t = (t_U)$ .*

*Proof.* For all the facts concerning PIMs (Principal Indecomposable Modules) and idempotents in finite dimensional  $k$ -algebras, we refer to [CR62, Chap. VIII]. We first show that  $\Pi_A$  is surjective. Let:

$$1 = e_1 + \dots + e_n$$

be a decomposition of the unit into primitive orthogonal idempotents ( $e_i e_j = \delta_{i,j} e_i$ ). Then the PIMs of  $A$  are isomorphic to the left ideals  $Ae_i$  (possibly with multiplicity). We have isomorphisms of vector spaces:

$$\text{Hom}_A(Ae_i, Ae_j) \xrightarrow{\sim} e_i Ae_j, \quad f \mapsto f(e_i).$$

For every  $\varphi \in \text{SLF}(A)$ , define  $t_{Ae_i}^\varphi$  by:

$$t_{Ae_i}^\varphi(f) = \varphi(f(e_i)).$$

Let  $f : Ae_i \rightarrow Ae_j$ ,  $g : Ae_j \rightarrow Ae_i$ , and put  $f(e_i) = e_i a_f e_j$ ,  $g(e_j) = e_j a_g e_i$ . Then using the idempotence of the  $e_i$ 's and the symmetry of  $\varphi$  we get:

$$t_{Ae_i}^\varphi(g \circ f) = \varphi(g \circ f(e_i)) = \varphi((e_i a_f e_j)(e_j a_g e_i)) = \varphi((e_j a_g e_i)(e_i a_f e_j)) = \varphi(f \circ g(e_j)) = t_{Ae_j}^\varphi(f \circ g).$$

We know that every projective module is isomorphic to a direct sum of PIMs, so we extend  $t^\varphi$  to  $\text{Proj}_A$  by the following formula:

$$t_{\bigoplus_l A_l}(f) = \sum_l t_{Ae_l}(i_l \circ f \circ p_l)$$

where  $p_l$  and  $i_l$  are the canonical injection and projection maps. By Lemma 3.3.2, this defines a trace on  $\text{Proj}_A$ . We then show that  $\Pi_A(t^\varphi) = \varphi$ , proving surjectivity:

$$\begin{aligned} \Pi_A(t^\varphi)(a) &= t_A^\varphi(\rho_a) = \sum_{j=1}^n t_{Ae_j}^\varphi(p_j \circ \rho_a \circ i_j) = \sum_{j=1}^n \varphi(p_j \circ \rho_a(e_j)) = \sum_{j=1}^n \varphi(p_{Ae_j}(e_j a)) \\ &= \sum_{j,k=1}^n \varphi(p_{Ae_j}(e_j a e_k)) = \sum_{j=1}^n \varphi(e_j a e_j) = \sum_{j=1}^n \varphi(a e_j) = \varphi(a). \end{aligned}$$

Note that we used that the  $e_j$ 's are idempotents and that  $a = \sum_{j=1}^n a e_j$ . We now show injectivity. Assume that  $\Pi_A(t) = 0$ . Then:

$$\forall a \in A, \quad t_A(\rho_a) = \sum_{j=1}^n t_{Ae_j}(p_j \circ \rho_a \circ i_j) = 0.$$

Let  $f : Ae_j \rightarrow Ae_j$ , with  $f(e_j) = e_j a_f e_j$ . Since  $\rho_{f(e_j)}(e_l) = \delta_{j,l} e_j a_f e_j$ , we have  $p_j \circ \rho_{f(e_j)} \circ i_j = f$  and  $p_l \circ \rho_{f(e_j)} \circ i_l = 0$  if  $l \neq j$ . Hence:

$$t_{Ae_j}(f) = t_A(\rho_{f(e_j)}) = 0.$$

Then  $t_{Ae_j} = 0$  for each  $j$ , so that  $t = 0$ .  $\square$

### 3.3.2 Link with the GTA basis

We leave the general case and focus on  $A = \bar{U}_q$ . The following theorem expresses  $\Pi_{\bar{U}_q}$  in the GTA basis.

**Theorem 3.3.4.** *Let  $t = (t_U)_{U \in \text{Proj}_{\bar{U}_q}}$  be a trace on  $\text{Proj}_{\bar{U}_q}$ . Then:*

$$\Pi_{\bar{U}_q}(t) = t_{\mathcal{X}^+(p)}(\text{Id})\chi_p^+ + t_{\mathcal{X}^-(p)}(\text{Id})\chi_p^- + \sum_{s=1}^{p-1} (t_{\mathcal{P}^+(s)}(\text{Id})\chi_s^+ + t_{\mathcal{P}^-(s)}(\text{Id})\chi_s^- + t_{\mathcal{P}^+(s)}(p_s^+)G_s).$$

*Proof.* First of all, we write the decomposition of the left regular representation of  $\bar{U}_q$ , assigning an index to the multiple factors:

$$\bar{U}_q = \bigoplus_{s=1}^{p-1} \left( \bigoplus_{j=0}^{s-1} \mathcal{P}_j^+(s) \oplus \mathcal{P}_j^-(s) \right) \oplus \bigoplus_{j=0}^{p-1} \mathcal{X}_j^+(p) \oplus \mathcal{X}_j^-(p).$$

Thus, since  $t$  is a trace:

$$\begin{aligned} t_{\bar{U}_q}(\rho_a) &= \sum_{s=1}^{p-1} \left( \sum_{j=0}^{s-1} t_{\mathcal{P}_j^+(s)} \left( p_{\mathcal{P}_j^+(s)} \circ \rho_a \circ i_{\mathcal{P}_j^+(s)} \right) + t_{\mathcal{P}_j^-(s)} \left( p_{\mathcal{P}_j^-(s)} \circ \rho_a \circ i_{\mathcal{P}_j^-(s)} \right) \right) \\ &\quad + \sum_{j=0}^{p-1} t_{\mathcal{X}_j^+(p)} \left( p_{\mathcal{X}_j^+(p)} \circ \rho_a \circ i_{\mathcal{X}_j^+(p)} \right) + t_{\mathcal{X}_j^-(p)} \left( p_{\mathcal{X}_j^-(p)} \circ \rho_a \circ i_{\mathcal{X}_j^-(p)} \right). \end{aligned}$$

Consider the following composite maps for  $1 \leq s \leq p-1$  (note that the blocks appear because  $\rho_a$  is the right multiplication by  $a$ ):

$$\begin{aligned} h_{s,j,a}^+ &: \mathcal{P}^+(s) \xrightarrow{I_{s,j}^+} \mathcal{P}_j^+(s) \xrightarrow{i_{\mathcal{P}_j^+(s)}} Q(s) \xrightarrow{\rho_a} Q(s) \xrightarrow{p_{\mathcal{P}_j^+(s)}} \mathcal{P}_j^+(s) \xrightarrow{(I_{s,j}^+)^{-1}} \mathcal{P}^+(s), \\ h_{s,j,a}^- &: \mathcal{P}^-(s) \xrightarrow{I_{s,j}^-} \mathcal{P}_j^-(s) \xrightarrow{i_{\mathcal{P}_j^-(s)}} Q(p-s) \xrightarrow{\rho_a} Q(p-s) \xrightarrow{p_{\mathcal{P}_j^-(s)}} \mathcal{P}_j^-(s) \xrightarrow{(I_{s,j}^-)^{-1}} \mathcal{P}^-(s), \end{aligned}$$

where  $I_{s,j}^+$  and  $I_{s,j}^-$  are the isomorphisms defined by (see Proposition 3.1.2):

$$\begin{aligned} I_{s,j}^+(b_i^+(s)) &= B_{ij}^{++}(s), \quad I_{s,j}^+(x_i^+(s)) = X_{ij}^{-+}(s), \quad I_{s,j}^+(y_i^+(s)) = Y_{ij}^{-+}(s), \quad I_{s,j}^+(a_i^+(s)) = A_{ij}^{++}(s), \\ I_{s,j}^-(b_i^-(s)) &= B_{ij}^{--}(p-s), \quad I_{s,j}^-(x_i^-(s)) = X_{ij}^{+-}(p-s), \quad I_{s,j}^-(y_i^-(s)) = Y_{ij}^{+-}(p-s), \\ I_{s,j}^-(a_i^-(s)) &= A_{ij}^{--}(p-s). \end{aligned}$$

For  $s = p$ , consider:

$$\begin{aligned} h_{p,j,a}^+ &: \mathcal{X}^+(p) \xrightarrow{I_{p,j}^+} \mathcal{X}_j^+(p) \xrightarrow{i_{\mathcal{X}_j^+(p)}} Q(p) \xrightarrow{\rho_a} Q(p) \xrightarrow{p_{\mathcal{X}_j^+(p)}} \mathcal{X}_j^+(p) \xrightarrow{(I_{p,j}^+)^{-1}} \mathcal{X}^+(p), \\ h_{p,j,a}^- &: \mathcal{X}^-(p) \xrightarrow{I_{p,j}^-} \mathcal{X}_j^-(p) \xrightarrow{i_{\mathcal{X}_j^-(p)}} Q(0) \xrightarrow{\rho_a} Q(0) \xrightarrow{p_{\mathcal{X}_j^-(p)}} \mathcal{X}_j^-(p) \xrightarrow{(I_{p,j}^-)^{-1}} \mathcal{X}^-(p) \end{aligned}$$

where  $I_{p,j}^+$  and  $I_{p,j}^-$  are the isomorphisms defined by (see Proposition 3.1.2):

$$I_{p,j}^+(v_i^+(p)) = A_{ij}^{++}(p) \quad \text{and} \quad I_{p,j}^-(v_i^-(p)) = A_{ij}^{--}(0).$$

Then for  $1 \leq s \leq p-1$ :

$$t_{\mathcal{P}_j^\alpha(s)} \left( p_{\mathcal{P}_j^\alpha(s)} \circ \rho_a \circ i_{\mathcal{P}_j^\alpha(s)} \right) = t_{\mathcal{P}^\alpha(s)}(h_{s,j,a}^\alpha)$$

and for  $s = p$ :

$$t_{\mathcal{X}_j^\alpha(p)} \left( p_{\mathcal{X}_j^\alpha(p)} \circ \rho_a \circ i_{\mathcal{X}_j^\alpha(p)} \right) = t_{\mathcal{X}^\alpha(p)}(h_{p,j,a}^\alpha).$$

We must determine the endomorphism  $h_{s,j,a}^\alpha$  when  $a$  is replaced by the elements given in Proposition 3.2.2. Using (3.9), we get:

$$\forall s' \neq s, \forall j, h_{s',j,w_s^+}^\pm = 0 \quad \text{and} \quad h_{s,j,w_s^+}^- = 0$$

and:

$$\forall j, h_{s,j,w_s^+}^+ = p_s^+.$$

Since this does not depend on  $j$  and since the block  $Q(s)$  contains  $s$  copies of  $\mathcal{P}^+(s)$ , we find that  $t_{\bar{U}_q}(\rho_{w_s^+}) = st_{\mathcal{P}^+(s)}(p_s^+)$ . So by Proposition 3.2.2, the coefficient of  $G_s$  is  $t_{\mathcal{P}^+(s)}(p_s^+)$ .

Next, assume that  $1 \leq s \leq p-1$ , and let us compute  $h_{s',j,\Phi_{s-1}^+ e_s}^\alpha$ . By (3.8), we see that

$$\forall s' \notin \{s, p-s\}, \forall j, h_{s',j,\Phi_{s-1}^+ e_s}^\pm = 0 \quad \text{and} \quad \forall j, h_{s,j,\Phi_{s-1}^+ e_s}^- = 0, h_{p-s,j,\Phi_{s-1}^+ e_s}^+ = 0.$$

Then, Proposition 3.1.2 together with Lemma 3.2.1 gives:

$$\forall j, h_{p-s,j,\Phi_{s-1}^+ e_s}^- = 0 \quad \text{and} \quad \forall 0 \leq j \leq s-2, h_{s,j,\Phi_{s-1}^+ e_s}^+ = 0 \quad \text{and} \quad h_{s,s-1,\Phi_{s-1}^+ e_s}^+ = \text{Id}.$$

It follows that  $t_{\bar{U}_q}(\rho_{\Phi_{s-1}^+ e_s}) = t_{\mathcal{P}^+(s)}(\text{Id})$ . So by Proposition 3.2.2, the coefficient of  $\chi_s^+$  is  $t_{\mathcal{P}^+(s)}(\text{Id})$ .

We now consider  $h_{s',j,\Phi_{s-1}^- e_{p-s}}^\pm$ . This time, (3.8) shows that

$$\forall s' \notin \{s, p-s\}, \forall j, h_{s',j,\Phi_{s-1}^- e_{p-s}}^\pm = 0 \quad \text{and} \quad \forall j, h_{p-s,j,\Phi_{s-1}^- e_{p-s}}^- = 0, h_{s,j,\Phi_{s-1}^- e_{p-s}}^+ = 0.$$

Then, Proposition 3.1.2 together with Lemma 3.2.1 gives:

$$\forall j, h_{p-s,j,\Phi_{s-1}^- e_{p-s}}^+ = 0 \quad \text{and} \quad \forall 0 \leq j \leq s-2, h_{s,j,\Phi_{s-1}^- e_{p-s}}^- = 0 \quad \text{and} \quad h_{s,s-1,\Phi_{s-1}^- e_{p-s}}^- = \text{Id}.$$

It follows that  $t_{\bar{U}_q}(\rho_{\Phi_{s-1}^- e_{p-s}}) = t_{\mathcal{P}^-(s)}(\text{Id})$ . So by Proposition 3.2.2, the coefficient of  $\chi_s^-$  is  $t_{\mathcal{P}^-(s)}(\text{Id})$ .

Finally, in the case where  $s = p$ :

$$\forall s' \neq p, \forall j, h_{s',j,\Phi_{p-1}^+ e_p}^\pm = 0 \quad \text{and} \quad h_{p,j,\Phi_{p-1}^+ e_p}^- = 0.$$

Then, Proposition 3.1.2 together with Lemma 3.2.1 gives:

$$\forall 0 \leq j \leq p-2, h_{p,j,\Phi_{p-1}^+ e_p}^+ = 0 \quad \text{and} \quad h_{p,p-1,\Phi_{p-1}^+ e_p}^+ = \text{Id}.$$

It follows that  $t_{\bar{U}_q}(\rho_{\Phi_{p-1}^+ e_p}) = t_{\mathcal{X}^+(p)}(\text{Id})$ . So by Proposition 3.2.2, the coefficient of  $\chi_p^+$  is  $t_{\mathcal{X}^+(p)}(\text{Id})$ .

One similarly gets the coefficient of  $\chi_p^-$ .  $\square$

By Proposition 3.2.2, the coefficient of  $G_s$  is also given by:  $\frac{1}{p-s} t_{\bar{U}_q}(\rho_{w_s^-})$ . Taking back the notations of the proof above, we see using (3.9) that

$$\forall s' \neq p-s, \forall j, h_{s',j,w_s^-}^\pm = 0 \quad \text{and} \quad h_{p-s,j,w_s^-}^+ = 0$$

and:

$$\forall j, h_{p-s,j,w_s^-}^- = p_{p-s}^-.$$

Since this does not depend on  $j$  and since the block  $Q(s)$  contains  $p-s$  copies of  $\mathcal{P}^-(p-s)$ , we find that  $t_{\bar{U}_q}(\rho_{w_s^-}) = (p-s)t_{\mathcal{P}^-(p-s)}(p_{p-s}^-)$ . So by Proposition 3.2.2, the coefficient of  $G_s$  is  $t_{\mathcal{P}^-(p-s)}(p_{p-s}^-)$ .

We thus have:

$$t_{\mathcal{P}^-(p-s)}(p_{p-s}^-) = t_{\mathcal{P}^+(s)}(p_s^+). \quad (3.28)$$

Note that there is an elementary way to see this. Indeed, the morphisms  $P_s^+$  and  $\bar{P}_{p-s}^-$  defined in (3.6) satisfy:

$$\bar{P}_{p-s}^- \circ P_s^+ = p_s^+, \quad P_s^+ \circ \bar{P}_{p-s}^- = p_{p-s}^-.$$

Hence, we recover (3.28) by property of the traces. From this, we deduce the following corollary.



**Corollary 3.3.5.** *Let*

$$\varphi = \sum_{s=1}^p (\lambda_s^+ \chi_s^+ + \lambda_s^- \chi_s^-) + \sum_{s'=1}^{p-1} \mu_{s'} G_{s'} \in \text{SLF}(\bar{U}_q).$$

Then the trace  $t^\varphi = \Pi_{\bar{U}_q}^{-1}(\varphi)$  associated to  $\varphi$  is given by:

$$t_{\mathcal{X}^\pm(p)}^\varphi(\text{Id}) = \lambda_p^\pm, \quad t_{\mathcal{P}^\pm(s)}^\varphi(\text{Id}) = \lambda_s^\pm, \quad t_{\mathcal{P}^+(s')}^\varphi(p_{s'}^+) = t_{\mathcal{P}^-(p-s')}^\varphi(p_{p-s'}^-) = \mu_{s'}.$$

### 3.3.3 Symmetric linear form corresponding to the modified trace on $\text{Proj}_{\bar{U}_q}$

Let  $H$  be a finite dimensional Hopf algebra. Let us recall that a *modified trace*  $\mathfrak{t}$  on  $\text{Proj}_H$  is a trace which satisfies the additional property that for  $U \in \text{Proj}_H$ , for each  $H$ -module  $V$  and for  $f \in \text{End}_H(U \otimes V)$  we have:

$$\mathfrak{t}_{U \otimes V}(f) = \mathfrak{t}_U(\text{tr}_R(f))$$

where  $\text{tr}_R = \text{Id} \otimes \text{tr}_q$  is the right partial quantum trace (see [GKP11, (3.2.2)]). These modified traces are actively studied, having for motivation the construction of invariants in low dimensional topology. We refer to [GKP11] for the general theory in a categorical framework which encapsulates the case of  $\text{Proj}_H$ .

In [BBGe17], it is shown that there exists a unique up to scalar modified trace  $\mathfrak{t} = (\mathfrak{t}_U)$  on  $\text{Proj}_{\bar{U}_q}$ . Uniqueness comes from the fact that  $\mathcal{X}^+(p)$  is both a simple and a projective module. The values of this trace are given by:

$$\begin{aligned} \mathfrak{t}_{\mathcal{X}^+(p)}(\text{Id}) &= (-1)^{p-1}, & \mathfrak{t}_{\mathcal{X}^-(p)}(\text{Id}) &= 1, & \mathfrak{t}_{\mathcal{P}^+(s)}(\text{Id}) &= (-1)^s (q^s + q^{-s}), \\ \mathfrak{t}_{\mathcal{P}^-(s)}(\text{Id}) &= (-1)^{p-s-1} (q^s + q^{-s}), & \mathfrak{t}_{\mathcal{P}^+(s)}(p_s^+) &= (-1)^s [s]^2, & \mathfrak{t}_{\mathcal{P}^-(s)}(p_s^-) &= \mathfrak{t}_{\mathcal{P}^+(p-s)}(p_{p-s}^+). \end{aligned}$$

Let  $H$  be a finite dimensional unimodular pivotal Hopf algebra with pivotal element  $g$  and let  $\mu^r \in H^*$  be a right integral on  $H$ , which means that

$$\forall x \in H, \quad (\mu^r \otimes \text{Id})(\Delta(x)) = \mu(x)1.$$

Recall from (2.22) that  $\mu^r(g \cdot)$  is a symmetric linear form. In the recent paper [BBGa18], it is shown that modified traces on  $\text{Proj}_H$  are unique up to scalar, and that the corresponding symmetric linear forms are scalar multiples of  $\mu^r(g \cdot)$ . Here, we show how Theorem 3.3.4 and computations made in [GT09] (see also [Ari10]) and [FGST06a] quickly allow us to recover this result in the case of  $H = \bar{U}_q$ . First, recall that right integrals  $\mu_\zeta^r$  of  $\bar{U}_q$  are given by:

$$\mu_\zeta^r(F^m E^n K^j) = \zeta \delta_{m,p-1} \delta_{n,p-1} \delta_{j,p+1},$$

where  $\zeta$  is an arbitrary scalar. Hence:

$$\mu_\zeta^r(K^{p+1} F^m E^n K^j) = \zeta \delta_{m,p-1} \delta_{n,p-1} \delta_{j,0}.$$

Using formulas given in [GT09] (see also [Ari10]<sup>4</sup>), we have ( $1 \leq s \leq p-1$ ):

$$\begin{aligned} e_0 &= \frac{(-1)^{p-1}}{2p[p-1]!^2} \sum_{t=0}^{p-1} \sum_{l=0}^{2p-1} q^{-(-2t-1)l} F^{p-1} E^{p-1} K^l + (\text{terms of lower degree in } E \text{ and } F), \\ e_s &= \alpha_s \sum_{t=0}^{p-1} \sum_{l=0}^{2p-1} q^{-(s-2t-1)l} F^{p-1} E^{p-1} K^l + (\text{terms of lower degree in } E \text{ and } F), \\ e_p &= \frac{1}{2p[p-1]!^2} \sum_{t=0}^{p-1} \sum_{l=0}^{2p-1} q^{-(p-2t-1)l} F^{p-1} E^{p-1} K^l + (\text{terms of lower degree in } E \text{ and } F), \end{aligned}$$

<sup>4</sup>In notations of [Ari10], we have  $e_s = \sum_{t=1}^s e^+(s, t) + \sum_{u=1}^{p-s} e^-(p-s, u)$ .

where  $\alpha_s$  is given in the last page of [Ari10] as:

$$\alpha_s = -\frac{(-1)^{p-s-1}}{2p[p-s-1]!^2[s-1]!^2} \left( \sum_{l=1}^{s-1} \frac{1}{[l][s-l]} - \sum_{l=1}^{p-s-1} \frac{1}{[l][p-s-l]} \right).$$

In order to simplify this, it is observed in [Mur17, Proof of Proposition 2], that

$$\sum_{l=1}^{s-1} \frac{1}{[l][s-l]} - \sum_{l=1}^{p-s-1} \frac{1}{[l][p-s-l]} = \frac{-(q^s + q^{-s})}{[s]^2}.$$

So, since:

$$[p-s-1]!^2[s-1]!^2 = \frac{[p-1]!^2}{[s]^2},$$

we get:

$$\alpha_s = \frac{(-1)^{p-s-1}}{2p[p-1]!^2} (q^s + q^{-s}).$$

Using formulas given in [FGST06a] (see also [Iba15, Prop. II.3.19]), we have:

$$\begin{aligned} w_s^+ &= \frac{(-1)^{p-s-1}}{2p[p-1]!^2} [s]^2 s F^{p-1} E^{p-1} + (\text{other monomials}), \\ w_s^- &= \frac{(-1)^{p-s-1}}{2p[p-1]!^2} [s]^2 (p-s) F^{p-1} E^{p-1} + (\text{other monomials}). \end{aligned}$$

We now use Proposition 3.2.2 to get the coefficients of  $\mu_\zeta^r(K^{p+1}.)$  in the GTA basis. For instance:

$$\begin{aligned} \frac{\mu_\zeta^r(K^{p+1}w_s^+)}{s} &= \zeta \frac{(-1)^{p-s-1}}{2p[p-1]!^2} [s]^2, \\ \mu_\zeta^r(K^{p+1}\Phi_{s-1}^+ e_s) &= \frac{\alpha_s}{2p} \mu_\zeta^r \left( K^{p+1} F^{p-1} E^{p-1} \sum_{t=0}^{p-1} \sum_{l,j=0}^{2p-1} q^{-(s-1)(l+j)+2tl} K^{l+j} \right) \\ &= \zeta \frac{\alpha_s}{2p} \sum_{t=0}^{p-1} \sum_{l=0}^{2p-1} q^{2tl} = \zeta \alpha_s. \end{aligned}$$

Choose the normalization factor to be  $\zeta = (-1)^{p-1} 2p[p-1]!^2$ , and let  $\mu^r$  be the so-normalized integral. Then:

$$\begin{aligned} \mu^r(K^{p+1}.) &= (-1)^{p-1} \chi_p^+ + \chi_p^- + \sum_{s=1}^{p-1} \left( (-1)^s (q^s + q^{-s}) \chi_s^+ + (-1)^{p-s-1} (q^s + q^{-s}) \chi_s^- \right. \\ &\quad \left. + (-1)^s [s]^2 G_s \right). \end{aligned} \tag{3.29}$$

By Theorem 3.3.4, we recover  $\Pi_{\bar{U}_q}(\mathbf{t}) = \mu^r(K^{p+1}.)$ .

### 3.4 Multiplication rules in the GTA basis

We mentioned in section 3.2 that  $\text{SLF}(\bar{U}_q)$  is a commutative algebra. In this section, we address the problem of the decomposition in the GTA basis of the product of two elements in this basis. The resulting formulas are surprisingly simple.

Let us start by recalling some facts. For every  $\bar{U}_q$ -module  $V$ , we define the character of  $V$  as (see (2.2) for the definition of  $\bar{T}$ ):

$$\chi^V = \text{tr}(\bar{T}^V).$$

This splits on extensions:

$$0 \rightarrow V \rightarrow M \rightarrow W \rightarrow 0 \text{ exact} \implies \chi^M = \chi^V + \chi^W.$$

Due to the fact that  $\bar{U}_q$  is finite dimensional, every finite dimensional  $\bar{U}_q$ -module has a composition series (*i.e.* is constructed by successive extensions by simple modules). It follows that every  $\chi^V$  can be written as a linear combination of the  $\chi_s^\alpha = \chi^{\mathcal{X}^\alpha(s)}$ . Moreover, we see by definition of the product on  $\bar{U}_q^*$  that

$$\begin{matrix} V \otimes W \\ T \end{matrix} = \begin{matrix} V \\ T_1 \end{matrix} \begin{matrix} W \\ T_2 \end{matrix} \quad (3.30)$$

where  $\begin{matrix} V \\ T_1 \end{matrix} = \begin{matrix} V \\ T \end{matrix} \otimes I_{\dim(W)}$  and  $\begin{matrix} W \\ T_2 \end{matrix} = I_{\dim(V)} \otimes \begin{matrix} W \\ T \end{matrix}$ . Thus  $\chi^{V \otimes W} = \chi^V \chi^W$ . Hence multiplying two  $\chi$ 's is equivalent to tensoring two simples modules and finding the decomposition into simple factors. This means that

$$\text{vect}(\chi_s^\alpha)_{\alpha \in \{\pm\}, 1 \leq s \leq p} \xrightarrow{\sim} \mathfrak{G}(\bar{U}_q) \otimes_{\mathbb{Z}} \mathbb{C}, \quad \chi^I \mapsto [I]$$

where  $\mathfrak{G}(\bar{U}_q)$  is the Grothendieck ring of  $\bar{U}_q$ . By [FGST06a], we know the structure of  $\mathfrak{G}(\bar{U}_q)$ . Recall the decomposition formulas (with  $2 \leq s \leq p-1$ ):

$$\mathcal{X}^-(1) \otimes \mathcal{X}^\alpha(s) \cong \mathcal{X}^{-\alpha}(s), \quad \mathcal{X}^+(2) \otimes \mathcal{X}^\alpha(s) \cong \mathcal{X}^\alpha(s-1) \oplus \mathcal{X}^\alpha(s+1), \quad \mathcal{X}^+(2) \otimes \mathcal{X}^\alpha(p) \cong \mathcal{P}^\alpha(p-1)$$

so that

$$\chi_1^- \chi_s^\alpha = \chi_s^{-\alpha}, \quad \chi_2^+ \chi_s^\alpha = \chi_{s-1}^\alpha + \chi_{s+1}^\alpha, \quad \chi_2^+ \chi_p^\alpha = 2\chi_{p-1}^\alpha + 2\chi_1^{-\alpha}. \quad (3.31)$$

We see in particular that  $\chi_2^+$  generates the subalgebra  $\text{vect}(\chi_s^\alpha)_{\alpha \in \{\pm\}, 1 \leq s \leq p}$ . The  $\chi_s^\alpha$  are expressed as Chebyshev polynomials of  $\chi_2^+$ , see [FGST06a, section 3.3] for details.

**Theorem 3.4.1.** *The multiplication rules in the GTA basis are entirely determined by (3.31) and by the following formulas:*

$$\chi_2^+ G_1 = [2]G_2, \quad (3.32)$$

$$\chi_2^+ G_s = \frac{[s-1]}{[s]} G_{s-1} + \frac{[s+1]}{[s]} G_{s+1} \text{ for } 2 \leq s \leq p-2, \quad (3.33)$$

$$\chi_2^+ G_{p-1} = [2]G_{p-2}, \quad (3.34)$$

$$\chi_1^- G_s = -G_{p-s} \text{ for all } s, \quad (3.35)$$

$$G_s G_t = 0 \text{ for all } s, t. \quad (3.36)$$

Before giving the proof, let us deduce a few consequences.

**Corollary 3.4.2.** *For all  $1 \leq s \leq p-1$  we have:*

$$G_s = \frac{1}{[s]} \chi_s^+ G_1, \quad \chi_p^+ G_1 = 0.$$

It follows that  $(\chi_s^+ + \chi_{p-s}^-)G_t = 0$ , and that  $\mathcal{P} = \text{vect}(\chi_s^+ + \chi_{p-s}^-, \chi_p^+, \chi_p^-)_{1 \leq s \leq p-1}$  is an ideal of  $\text{SLF}(\bar{U}_q)$ .

*Proof of Corollary 3.4.2.* The formulas for  $\chi_s^+ G_1$  are proved by induction using  $\chi_{s+1}^+ = \chi_s^+ \chi_2^+ - \chi_{s-1}^+$  together with formula (3.33). We deduce:

$$(\chi_s^+ + \chi_{p-s}^-)G_t = \frac{\chi_t^+}{[t]} (\chi_s^+ G_1 + \chi_{p-s}^- G_1) = \frac{\chi_t^+}{[t]} ([s]G_s + [s]\chi_1^- G_{p-s}) = 0.$$

It is straightforward that  $\mathcal{P}$  is stable by multiplication by  $\chi_2^+$ , so it is an ideal.  $\square$

*Remark 3.4.3.* We have  $\chi^{\mathcal{P}^\alpha(s)} = 2(\chi_s^\alpha + \chi_{p-s}^{-\alpha})$  for  $1 \leq s \leq p-1$ . Thus  $\mathcal{P}$  is generated by characters of the projective modules. It is well-known that if  $H$  is a finite dimensional Hopf algebra, then the full subcategory of finite dimensional projective  $H$ -modules is a tensor ideal. Thus we can deduce without any computation that  $\mathcal{P}$  is stable under the multiplication by every  $\chi^I$ .  $\triangle$

We now proceed with the proof of the theorem. Observe that we cannot apply Proposition 3.2.2 to show it since we do not know expressions of  $\Delta(e_s)$  and  $\Delta(w_s^\pm)$  which are easy to evaluate in the GTA basis. Recall ([KS11], see also [Iba15]) the following fusion rules:

$$\mathcal{X}^-(1) \otimes \mathcal{P}^\alpha(s) \cong \mathcal{P}^{-\alpha}(s) \quad \text{for all } s, \quad (3.37)$$

$$\mathcal{X}^+(2) \otimes \mathcal{P}^\alpha(1) \cong 2\mathcal{X}^{-\alpha}(p) \oplus \mathcal{P}^\alpha(2), \quad (3.38)$$

$$\mathcal{X}^+(2) \otimes \mathcal{P}^\alpha(s) \cong \mathcal{P}^\alpha(s-1) \oplus \mathcal{P}^\alpha(s+1) \quad \text{for } 2 \leq s \leq p-1, \quad (3.39)$$

$$\mathcal{X}^+(2) \otimes \mathcal{P}^\alpha(p-1) \cong 2\mathcal{X}^\alpha(p) \oplus \mathcal{P}^\alpha(p-2). \quad (3.40)$$

They imply the following key lemma.

**Lemma 3.4.4.** *There exist scalars  $\gamma_s, \beta_s, \lambda_s, \eta_s, \delta_s$  such that*

$$\begin{aligned} \chi_2^+ G_s &= \beta_s G_{s-1} + \gamma_s G_{s+1} + \lambda_s (\chi_{s-1}^+ + \chi_{p-s+1}^- - \chi_{s+1}^+ - \chi_{p-s-1}^-) \quad (\text{for } 2 \leq s \leq p-2), \\ \chi_2^+ G_1 &= \gamma_1 G_2 + \lambda_1 (\chi_p^- - \chi_2^+ - \chi_{p-2}^-), \quad \chi_2^+ G_{p-1} = \beta_{p-1} G_{p-2} + \lambda_{p-1} (\chi_{p-2}^+ + \chi_2^- - \chi_p^+), \\ \chi_1^- G_s &= \eta_s G_{p-s} + \delta_s (\chi_{p-s}^+ + \chi_s^-). \end{aligned}$$

*Proof.* Let us fix  $2 \leq s \leq p-2$ ; by (3.21), (3.23), (3.30) and (3.39) we have:

$$\begin{aligned} \chi_2^+ G_s &\in \text{vect} \left( \begin{array}{cc} \mathcal{X}^+(2) & \mathcal{P}^+(s) \\ T_{ij} & \cdot T_{kl} \end{array}, \begin{array}{cc} \mathcal{X}^+(2) & \mathcal{P}^-(p-s) \\ T_{ij} & \cdot T_{kl} \end{array} \right)_{ijkl} = \text{vect} \left( \begin{array}{cc} \mathcal{X}^+(2) \otimes \mathcal{P}^+(s) & \mathcal{X}^+(2) \otimes \mathcal{P}^-(p-s) \\ T_{ijkl} & , T_{ijkl} \end{array} \right)_{ijkl} \\ &= \text{vect} \left( \begin{array}{cccc} \mathcal{P}^+(s-1) & \mathcal{P}^+(s+1) & \mathcal{P}^-(p-s+1) & \mathcal{P}^-(p-s-1) \\ T_{ij} & , T_{ij} & , T_{ij} & , T_{ij} \end{array} \right)_{ij} \end{aligned}$$

where  $T_{ij}^V$  is the matrix element at the  $i$ -th row and  $j$ -th column of the representation matrix  $T^V$  and  $T_{ijkl}^{V \otimes W}$  is the matrix element at the  $(i, j)$ -th row and  $(k, l)$ -th column of the representation matrix  $T^{V \otimes W}$ . Hence, since  $\chi_2^+ G_s$  is symmetric, it is necessarily of the form

$$\chi_2^+ G_s = \beta_s G_{s-1} + \gamma_s G_{s+1} + z_1 \chi_{s-1}^+ + z_2 \chi_{s+1}^+ + z_3 \chi_{p-s+1}^- + z_4 \chi_{p-s-1}^-.$$

Evaluating this equality on  $K$  and  $K^2$ , we find (since  $G_t(K^l) = 0$  for all  $t$  and  $l$ ):

$$[s-1](z_1 - z_3) + [s+1](z_2 - z_4) = 0, \quad [s-1]_{q^2}(z_1 - z_3) + [s+1]_{q^2}(z_2 - z_4) = 0,$$

with  $[n]_{q^2} = \frac{q^{2n} - q^{-2n}}{q^2 - q^{-2}}$ . The determinant of this linear system with unknowns  $z_1 - z_3, z_2 - z_4$  is  $\frac{2 \sin((s-1)\pi/p) \sin((s+1)\pi/p)}{\sin(\pi/p) \sin(2\pi/p)} (\cos((s+1)\pi/p) - \cos((s-1)\pi/p)) \neq 0$ . Hence  $z_1 = z_3, z_2 = z_4$ . Moreover, evaluating the above equality on 1, we find  $p(z_1 + z_2) = 0$ . Letting  $\lambda_s = z_1$ , the result follows. The other formulas are obtained in a similar way using (3.37), (3.38) and (3.40).  $\square$

We will use the Casimir element  $C$  (see (3.12)) to make computations easier. Observe that, due to (3.13) and (3.27), we have

$$\forall x \in \bar{U}_q, \quad \chi_s^\alpha(Cx) = \alpha c_s \chi_s^\alpha(x), \quad G_s(Cx) = c_s G_s(x) + (\chi_s^+ + \chi_{p-s}^-)(x). \quad (3.41)$$

where  $c_s = \frac{q^s + q^{-s}}{(q - q^{-1})^2}$ . Then by induction we get  $G_s(C^n) = n p c_s^{n-1}$  for  $n \geq 1$ . We will also denote  $c_K = \frac{qK + q^{-1}K^{-1}}{(q - q^{-1})^2}$ .

*Proof of Theorem 3.4.1.*

• *Formula (3.33).* We first evaluate the corresponding formula of Lemma 3.4.4 on  $FE$ . It holds  $G_t(FE) = G_t(C) = p$ ,  $(\chi_t^+ + \chi_{p-t}^-)(FE) = (\chi_t^+ + \chi_{p-t}^-)(C) = pc_t$  for all  $t$  and  $\chi_2^+ G_s(FE) = \chi_2^+(K^{-1})G_s(FE) = [2]p$ . Thus we get:

$$\beta_s + \gamma_s + (c_{s-1} - c_{s+1})\lambda_s = \beta_s + \gamma_s - [s]\lambda_s = [2]. \quad (3.42)$$

Next, we evaluate the formula of Lemma 3.4.4 on  $(FE)^2$ . On the one hand,

$$\begin{aligned} (\chi_2^+ G_s)((FE)^2) &= \chi_2^+(K^{-2})G_s((FE)^2) = \chi_2^+(K^{-2})G_s(C^2 - 2Cc_K + c_K^2) \\ &= \chi_2^+(K^{-2})G_s(C^2) = 2p(q^2 + q^{-2})c_s. \end{aligned}$$

For the first equality, we used that  $\varphi(E^i F^j K^l) = \delta_{i,j} \varphi(E^i F^i K^l)$  for all  $\varphi \in \text{SLF}(\bar{U}_q)$ , that  $G_s(K^l) = 0$  and that  $G_s(FEK^l) = 0$  for  $1 \leq l \leq p-1$ . The third equality is due to (3.41) and to the fact that  $(\chi_s^+ + \chi_{p-s}^-)(K^l) = 0$  for  $1 \leq l \leq p-1$ . On the other hand, using again the Casimir element,

$$\begin{aligned} &\beta_s G_{s-1}((FE)^2) + \gamma_s G_{s+1}((FE)^2) + \lambda_s (\chi_{s-1}^+ + \chi_{p-s+1}^- - \chi_{s+1}^+ - \chi_{p-s-1}^-)((FE)^2) \\ &= \beta_s G_{s-1}(C^2) + \gamma_s G_{s+1}(C^2) + \lambda_s (\chi_{s-1}^+ + \chi_{p-s+1}^- - \chi_{s+1}^+ - \chi_{p-s-1}^-)(C^2) \\ &= 2pc_{s-1}\beta_s + 2pc_{s+1}\gamma_s + p(c_{s-1}^2 - c_{s+1}^2)\lambda_s. \end{aligned}$$

Since  $c_{s-1}^2 - c_{s+1}^2 = -(q + q^{-1})c_s[s]$ , we get

$$2c_{s-1}\beta_s + 2c_{s+1}\gamma_s - (q + q^{-1})c_s[s]\lambda_s = 2(q^2 + q^{-2})c_s. \quad (3.43)$$

In order to get a third linear equation between  $\beta_s$ ,  $\gamma_s$  and  $\lambda_s$ , we use evaluation on  $E^{p-1}F^{p-1}$ . This has the advantage to annihilate all the  $\chi_t^\alpha$  appearing in the formula of Lemma 3.4.4. First:

$$\begin{aligned} E^{p-1}F^{p-1}b_0^\alpha(s) &= E^{p-1}y_{p-s-1}^\alpha(s) = (-\alpha)^{p-s-1}[p-s-1]!^2 E^s y_0^\alpha(s) \\ &= (-\alpha)^{p-s-1} \alpha^{s-1} [p-s-1]!^2 [s-1]!^2 a_0^\alpha(s) \\ &= (-\alpha)^{p-s-1} \alpha^{s-1} \frac{[p-1]!^2}{[s]^2} a_0^\alpha(s) \end{aligned} \quad (3.44)$$

and  $E^{p-1}F^{p-1}$  annihilates all the other basis vectors. Hence:

$$G_s(E^{p-1}F^{p-1}) = 2(-1)^{p-s-1} \frac{[p-1]!^2}{[s]^2}.$$

Next by (3.1), we have:

$$\chi_2^+ \otimes \text{Id}(\Delta(E^{p-1}F^{p-1})) = -[2]E^{p-1}F^{p-1} - q^2 E^{p-2}F^{p-2}K.$$

As in (3.44), we find:

$$\begin{aligned} E^{p-2}F^{p-2}Kb_0^\alpha(s) &= (-\alpha)^{p-s} \alpha^s q^{s-1} \frac{[p-1]!^2}{[s+1][s]^2} a_0^\alpha(s), \\ E^{p-2}F^{p-2}Kb_1^\alpha(s) &= (-\alpha)^{p-s-1} \alpha^{s-1} q^{s-3} \frac{[p-1]!^2}{[s-1][s]^2} a_1^\alpha(s) \end{aligned}$$

and all the others basis vectors are annihilated. Hence:

$$G_s(E^{p-2}F^{p-2}K) = 2(-1)^{p-s-1} \frac{[p-1]!^2}{[s]^2} \frac{q^{-2}[2]}{[s-1][s+1]}.$$

We obtain:

$$\chi_2^+ \otimes G_s(\Delta(E^{p-1}F^{p-1})) = 2(-1)^{p-s} [p-1]!^2 \frac{[2]}{[s-1][s+1]}$$

and thus:

$$\frac{\beta_s}{[s-1]^2} + \frac{\gamma_s}{[s+1]^2} = \frac{[2]}{[s-1][s+1]}. \quad (3.45)$$

As a result, we have a linear system (3.42)–(3.43)–(3.45) between  $\beta_s$ ,  $\gamma_s$  and  $\lambda_s$ . It is easy to check that  $\beta_s = \frac{[s-1]}{[s]}$ ,  $\gamma_s = \frac{[s+1]}{[s]}$ ,  $\lambda_s = 0$  is a solution. Moreover this solution is unique. Indeed, a straightforward computation reveals that

$$\det \begin{pmatrix} 1 & 1 & -[s] \\ 2c_{s-1} & 2c_{s+1} & -(q+q^{-1})c_s[s] \\ \frac{1}{[s-1]^2} & \frac{1}{[s+1]^2} & 0 \end{pmatrix} = \frac{[s]^2}{[s-1]^2} + \frac{[s]^2}{[s+1]^2} > 0.$$

• *Formulas (3.32) and (3.35).* Evaluating as above the corresponding formulas of Lemma 3.4.4 on  $FE$  and  $(FE)^2$ , one gets linear systems with non-zero determinants. It is then easy to see that  $\beta_1 = [2]$ ,  $\lambda_1 = 0$  and  $\eta_s = -1$ ,  $\delta_s = 0$  are the unique solutions of each of these two systems.

• *Formula (3.34).* It can be deduced from the formulas already shown:

$$\chi_2^+ G_{p-1} = -\chi_2^+ \chi_1^- G_1 = -\chi_1^- [2] G_2 = [2] G_{p-2}.$$

• *Formula (3.36).* Recall the isomorphism of algebras  $\mathcal{D}$  defined in (2.18). Taking into account that  $\varphi(K^i F^m E^n) = 0$  if  $n \neq m$  for any  $\varphi \in \text{SLF}(\bar{U}_q)$  and that  $G_s(K^i) = 0$  for all  $i$ , and making use of the expression of  $RR'$  given in (3.16), we get:

$$\begin{aligned} \mathcal{D}(G_s) &= \sum_{n=0}^{p-1} \sum_{j=0}^{2p-1} \left( \sum_{i=0}^{2p-1} \frac{(q-q^{-1})^n}{[n]!^2} q^{n(j-i-1)-ij} G_s(K^{p+i+1} E^n F^n) \right) K^j F^n E^n \\ &= \sum_{n=1}^{p-1} \sum_{j=0}^{2p-1} \lambda_{j,n} K^j F^n E^n \end{aligned}$$

for some coefficients  $\lambda_{j,n}$  (observe that  $n \geq 1$ ). From this it follows that for all  $\alpha \in \{\pm\}$  and  $1 \leq r \leq p-1$ :  $\mathcal{D}(G_s) b_0^\alpha(r) \in \mathbb{C} a_0^\alpha(r)$ . By (3.8), we deduce that  $\mathcal{D}(G_s) \in \text{vect}(w_r^\pm)_{1 \leq r \leq p-1}$  for all  $s$ . Thus  $\mathcal{D}(G_s G_t) = 0$ , thanks to (3.10).  $\square$



# Chapter 4

## $\mathcal{L}_{0,1}(H)$ , $\mathcal{L}_{1,0}(H)$ and representation of the modular group $\mathrm{SL}_2(\mathbb{Z})$

In this chapter, we focus on the surfaces

$$\Sigma_{0,1}^\circ = \Sigma_{0,1} \setminus D, \quad \Sigma_{1,0}^\circ = \Sigma_{1,0} \setminus D$$

where  $D$  is an embedded open disk, and on the associated algebras  $\mathcal{L}_{0,1}(H)$  and  $\mathcal{L}_{1,0}(H)$ . These algebras deserve a particular interest and are a necessary preliminary step because they are the building blocks of  $\mathcal{L}_{g,n}(H)$  (we will see what does this means in Definition 5.1.1).

Figures 4.1 and 4.2 are the pictures that one should always keep in mind. We see  $\Sigma_{0,1}^\circ$  and  $\Sigma_{1,0}^\circ$  as thickenings (*i.e.* tubular neighborhoods) of the embedded oriented graphs  $\Gamma_{0,1} = (\{\bullet\}, \{m\})$  and  $\Gamma_{1,0} = (\{\bullet\}, \{b, a\})$  whose vertex is the basepoint and whose edges are the generators of the fundamental group represented below. To get the second view from the first in Figure 4.2<sup>1</sup>, retract to a tubular neighborhood of the loops  $b$  and  $a$ . Note that with this choice of generators, the boundary loop of  $\Sigma_{1,0}^\circ$  is expressed as

$$c = ba^{-1}b^{-1}a. \tag{4.1}$$

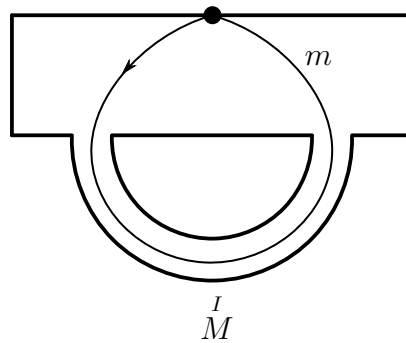

Figure 4.1: Surface  $\Sigma_{0,1}^\circ$  with basepoint, canonical loop and matrices of generators.

To each generating loop, or equivalently to each handle, is associated a family of matrices, indexed by the  $H$ -modules and whose coefficients are generators of the algebra. The defining relations are given in Definitions 4.1.1 and 4.2.1, following [AGS95, BR95, AGS96]. The difference with these original papers is that we directly restrict to the canonical graphs  $\Gamma_{0,1}$  and  $\Gamma_{1,0}$  and that we do not use Clebsch-Gordan operators to write the fusion relation; indeed, these operators have good properties in the semisimple case only and computations are simpler without using them. Also, the

<sup>1</sup>Compared to the Figure 1 of [Fai18b], we have done a 180°-rotation around the horizontal axis of  $\mathbb{R}^3$ , in order to have the handles at the bottom of the Figure. The reason of this change comes from the definition of the graphical calculus and the Wilson loop map in Chapter 6.



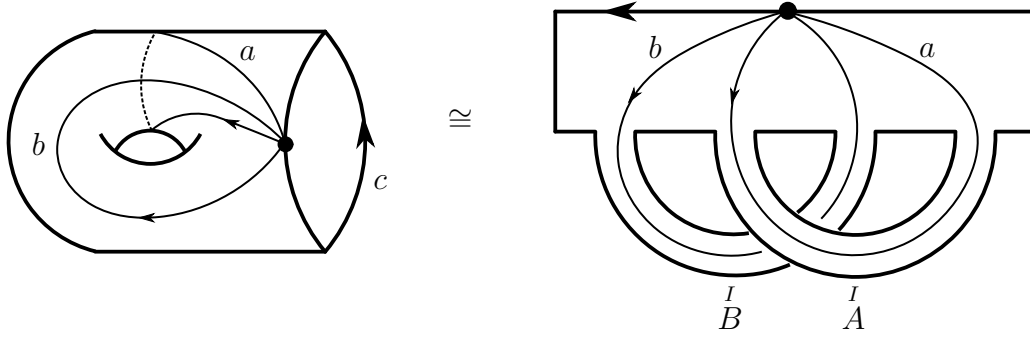

Figure 4.2: Two views of the surface  $\Sigma_{1,0}^\circ$ , with basepoint, canonical loops and matrices of generators.

relations may vary from one paper to another due to different choice of  $R$ -matrices ( $R'^{-1}$  instead of  $R$ ) or different labellings of the matrices associated to loops.

The main results of this chapter are

- The representation of the algebra of invariant elements  $\mathcal{L}_{1,0}^{\mathrm{inv}}(H)$  on  $\mathrm{SLF}(H)$  (Theorem 4.2.13).  
Note that the matrices  $\overset{I}{C}$  (which correspond to the boundary of  $\Sigma_{1,0}^\circ$ , see (4.1)) used for the proof of that Theorem already appeared in [Ale94] (with  $H = U_q(\mathfrak{g})$ ), but here we need to generalize and adapt the construction of the representation to our assumptions on  $H$ .
- The construction of a projective representation of  $\mathrm{SL}_2(\mathbb{Z})$  (mapping class group of the torus  $\Sigma_{1,0}$ ) on  $\mathrm{SLF}(H)$  (Theorem 4.3.7). This complete and generalize to a non-semisimple setting the idea of Alekseev–Schomerus [AS96a].
- The equivalence of the representation of  $\mathrm{SL}_2(\mathbb{Z})$  with the one constructed by Lyubashenko–Majid in [LM94] (Theorem 4.3.10).
- The explicit description of the representation of  $\mathrm{SL}_2(\mathbb{Z})$  when  $H = \bar{U}_q(\mathfrak{sl}_2)$  (Theorems 4.4.6 and 4.4.9).

The material of this chapter is mainly the content of [Fai18b]. However here we give more details and comments.

## 4.1 The loop algebra $\mathcal{L}_{0,1}(H)$

We assume that  $H$  is a finite dimensional factorizable Hopf algebra. The ribbon assumption is not needed in this section.

### 4.1.1 Definition of $\mathcal{L}_{0,1}(H)$ and $H$ -module-algebra structure

Let  $T(H^*)$  be the tensor algebra of  $H^*$ , which by definition is linearly spanned by all the formal products  $\varphi_1 \cdots \varphi_n$  (with  $n \geq 0$  and  $\varphi_i \in H^*$ ) modulo the obvious multilinear relations. There is a canonical injection  $j : H^* \rightarrow T(H^*)$  and we define  $\overset{I}{M} = j(\overset{I}{T})$ , i.e.  $\overset{I}{M}_b^a = j(\overset{I}{T}_b^a)$ .

**Definition 4.1.1.** *The loop algebra  $\mathcal{L}_{0,1}(H)$  is the quotient of  $T(H^*)$  by the following fusion relations:*

$$\overset{I \otimes J}{M}_{12} = \overset{I}{M}_1(\overset{IJ}{R'})_{12} \overset{J}{M}_2(\overset{IJ}{R}'^{-1})_{12}$$

for all finite dimensional  $H$ -modules  $I, J$ .

The right hand-side of the fusion relation in Definition 4.1.1 above is the one of [BNR02, Def 1]; the one of [AGS96, Def 12] and [AS96a, eq (3.11)] is different, due to different choices of the action of  $H$  on  $\mathcal{L}_{0,1}(H)$  and to particular normalization of Clebsch-Gordan operators. Moreover, in the papers [AGS96, AS96a, BNR02] the matrix  $\overset{I \otimes J}{M}$  did not appeared, instead it was always decomposed as a sum of the matrices of the irreducible direct summands of  $I \otimes J$  thanks to Clebsch-Gordan operators, which is relevant in the semisimple case only; in [Sch98],  $I$  and  $J$  are restricted to the regular representation and the matrix  $\overset{I \otimes J}{M}$  is denoted by  $\Delta_a(M)$  (the relation is again different due to different choices). In the semisimple setting, the algebras resulting from each of these definitions are isomorphic.

Note that the fusion relation is a relation between matrices in  $\mathcal{L}_{0,1}(H) \otimes \text{Mat}_{\dim(I)}(\mathbb{C}) \otimes \text{Mat}_{\dim(J)}(\mathbb{C})$  (for all finite dimensional  $I, J$ ) which implies relations among elements of  $\mathcal{L}_{0,1}(H)$  (the coefficients of these matrices). Explicitly, in terms of matrix coefficients it is written as

$$\forall I, J, a, b, c, d, \quad \overset{I \otimes J}{M}_{bd}^{ac} = M_i^a(R) \overset{IJ}{(R')}_{jk}^{ic} M_l^k(R) \overset{IJ}{(R^{-1})}_{bd}^{jl},$$

see the definition of the subscripts 1 and 2 in section 2.2. If the two representations  $I$  and  $J$  are fixed and arbitrary, we can simply write

$$M_{12} = M_1 R_{21} M_2 R_{21}^{-1}. \quad (4.2)$$

Moreover, one can check that  $\overset{(I \otimes J) \otimes K}{M} = \overset{I \otimes (J \otimes K)}{M}$  holds thanks to the Yang-Baxter equation.

Note that if  $f : I \rightarrow J$  is a  $H$ -morphism it holds

$$\overset{J}{M} f = f \overset{I}{M} \quad (4.3)$$

where we identify  $f$  with its matrix (indeed, by (2.3),  $f \overset{I}{M} = f \bar{j}(\overset{I}{T}) = \bar{j}(f \overset{I}{T}) = \bar{j}(\overset{J}{T} f) = \bar{j}(\overset{J}{T}) f = \overset{J}{M} f$  where  $\bar{j}$  is the linear map  $H^* \rightarrow \text{T}(H^*) \rightarrow \mathcal{L}_{0,1}(H)$ ). We call this relation the naturality of the (family of) matrices  $\overset{I}{M}$ .

*Remark 4.1.2.* If  $I$  is a submodule or a quotient of  $J$ , then  $\overset{I}{M}$  is a submatrix of  $\overset{J}{M}$  thanks to (4.3). Let  $\mathcal{G}$  be a set of  $H$ -modules which generate  $\text{mod}_l(H)$  by tensor products, in the sense that every  $H$ -module is isomorphic to a submodule or a quotient of a tensor product of elements of  $\mathcal{G}$ . Then by the fusion relation, we see that every matrix coefficient  $\overset{I}{M}_j^i$  is a linear combination of matrix coefficients of the modules in  $\mathcal{G}$ . In practice, we restrict ourselves to such a well-chosen set  $\mathcal{G}$  to obtain presentations of  $\mathcal{L}_{0,1}(H)$  with no many generators. For instance, if  $H = \bar{U}_q(\mathfrak{sl}_2)$ , we take  $\mathcal{G} = \{\mathcal{X}^+(2)\}$ , see section 4.4.2.  $\triangle$

We have an useful analogue of relation (2.17).

**Proposition 4.1.3.** *The following exchange relation holds in  $\mathcal{L}_{0,1}(H)$ :*

$$\overset{IJ}{R}_{12} \overset{I}{M}_1 \overset{IJ}{(R')}_{12} \overset{J}{M}_2 = \overset{J}{M}_2 \overset{IJ}{R}_{12} \overset{I}{M}_1 \overset{IJ}{(R')}_{12}.$$

This relation is called the *reflection equation*. It can be written in a shortened way if the representations  $I$  and  $J$  are fixed and arbitrary:

$$R_{12} M_1 R_{21} M_2 = M_2 R_{12} M_1 R_{21}. \quad (4.4)$$

*Proof.* We have the braiding isomorphism  $c_{I,J} = P \overset{IJ}{R} : I \otimes J \rightarrow J \otimes I$  where  $P$  is the flip tensor  $P(x \otimes y) = y \otimes x$ . Hence:

$$\begin{aligned} \overset{IJ}{R}_{12} \overset{I}{M}_1 (\overset{IJ}{R}')_{12} \overset{J}{M}_2 (\overset{IJ}{R}')_{12}^{-1} &= \overset{IJ}{R} \overset{I \otimes J}{M} = P c_{I,J} \overset{I \otimes J}{M} = P \overset{J \otimes I}{M} c_{I,J} = P_{12} \overset{J}{M}_1 (\overset{JI}{R}')_{12} \overset{I}{M}_2 (\overset{JI}{R}')_{12}^{-1} P_{12} \overset{IJ}{R}_{12} \\ &= \overset{J}{M}_2 (\overset{JI}{R}')_{21} \overset{I}{M}_1 (\overset{JI}{R}')_{21}^{-1} \overset{IJ}{R}_{12} = \overset{J}{M}_2 \overset{IJ}{R}_{12} \overset{I}{M}_1. \end{aligned}$$

We simply used the fusion relation, the naturality (4.3) and  $P_{12}(\overset{JI}{R}')_{12} P_{12} = (\overset{JI}{R}')_{21} = \overset{IJ}{R}_{12}$ .  $\square$

Consider the following right action  $\cdot$  of  $H$  on  $\mathcal{L}_{0,1}(H)$ , which is the analogue of the right action of the gauge group on the functions:

$$\overset{I}{M} \cdot h = \overset{I}{h'} \overset{I}{M} \overset{I}{S}(h''). \quad (4.5)$$

As in [BR95], one can equivalently work with the corresponding left coaction  $\Omega : \mathcal{L}_{0,1}(H) \rightarrow \mathcal{O}(H) \otimes \mathcal{L}_{0,1}(H)$  defined by

$$\Omega(\overset{I}{M}_b^a) = \overset{I}{T}_i^a S(\overset{I}{T}_b^j) \otimes \overset{I}{M}_j^i$$

so that we recover  $\cdot$  by evaluation:  $x \cdot h = (\langle \cdot, h \rangle \otimes \mathrm{id}) \circ \Omega(x)$ . If we view  $\mathcal{O}(H)$  and  $\mathcal{L}_{0,1}(H)$  as subalgebras of  $\mathcal{O}(H) \otimes \mathcal{L}_{0,1}(H)$  in the canonical way, then  $\Omega$  is simply written as  $\Omega(\overset{I}{M}) = \overset{I}{T} \overset{I}{M} S(\overset{I}{T})$ .

**Proposition 4.1.4.** *The right action  $\cdot$  is a  $H$ -module-algebra structure on  $\mathcal{L}_{0,1}(H)$ . Equivalently,  $\Omega$  is a left  $\mathcal{O}(H)$ -comodule-algebra structure on  $\mathcal{L}_{0,1}(H)$ .*

*Proof.* One must show for instance that  $\Omega$  is a morphism of algebras (*i.e.* that it preserves the fusion relation), as in [BR95]. With the shortened notation explained before, the computation is as follows:

$$\begin{aligned} \Omega(M)_{12} &= T_{12} M_{12} S(T_{12}) && \text{(definition)} \\ &= T_1 T_2 M_1 R_{21} M_2 R_{21}^{-1} S(T)_2 S(T)_1 && \text{(eq. (2.15) and (4.2))} \\ &= T_1 M_1 T_2 R_{21} M_2 R_{21}^{-1} S(T)_2 S(T)_1 && \text{(commuting elements in tensor product algebra)} \\ &= T_1 M_1 T_2 R_{21} M_2 S(T)_1 S(T)_2 R_{21}^{-1} && \text{(eq. (2.17))} \\ &= T_1 M_1 T_2 R_{21} S(T)_1 M_2 S(T)_2 R_{21}^{-1} && \text{(commuting elements in tensor product algebra)} \\ &= T_1 M_1 S(T)_1 R_{21} T_2 M_2 S(T)_2 R_{21}^{-1} && \text{(eq. (2.17))} \\ &= \Omega(M)_1 R_{21} \Omega(M)_2 R_{21}^{-1} && \text{(definition).} \end{aligned}$$

$\square$

We say that an element  $x \in \mathcal{L}_{0,1}(H)$  is invariant if for all  $h \in H$ ,  $x \cdot h = \varepsilon(h)x$  (or equivalently,  $\Omega(x) = \varepsilon \otimes x$ ) and we denote by  $\mathcal{L}_{0,1}^{\mathrm{inv}}(H)$  the subalgebra of invariant elements of  $\mathcal{L}_{0,1}(H)$  (also called ‘‘observables’’).

*Example 4.1.5.* For any representation  $I$ , the element

$$\overset{I}{W} = \mathrm{tr}_q(\overset{I}{M}) = \mathrm{tr}(\overset{I}{g} \overset{I}{M}) \quad (4.6)$$

is invariant:

$$\mathrm{tr}(\overset{I}{g} \overset{I}{M}) \cdot h = \mathrm{tr}(\overset{I}{g} \overset{I}{h'} \overset{I}{M} \overset{I}{S}(h'')) = \mathrm{tr}(\overset{I}{g} \overset{I}{S}^{-1}(h'') \overset{I}{h'} \overset{I}{M}) = \varepsilon(h) \mathrm{tr}(\overset{I}{g} \overset{I}{M}).$$

However, this splits on extensions:

$$0 \rightarrow I \rightarrow K \rightarrow J \rightarrow 0 \text{ exact} \implies \overset{K}{W} = \overset{I}{W} + \overset{J}{W}$$

and in general (when  $H$  is non-semisimple), the span of the  $\overset{I}{W}$ 's is strictly smaller than the subalgebra of invariant elements.  $\triangle$

### 4.1.2 Isomorphism $\mathcal{L}_{0,1}(H) \cong H$

Recall the right adjoint action of  $H$  on itself defined by  $a \cdot h = S(h')ah''$  with  $a, h \in H$ , whose invariant elements are the central elements of  $H$ .

**Proposition 4.1.6.** *If we endow  $H$  with the right adjoint action, the following map is a morphism of (right)  $H$ -module-algebras:*

$$\begin{aligned} \Psi_{0,1} : \mathcal{L}_{0,1}(H) &\rightarrow H \\ M &\mapsto (T \otimes \text{id})(RR') = L^{(+)}L^{(-)-1}. \end{aligned}$$

In particular,  $\Psi_{0,1}$  brings invariant elements to central elements.

*Proof.* Using the relations of (2.9)<sup>2</sup>, we check that  $\Psi_{0,1}$  preserves the relation of Definition 4.1.1:

$$\begin{aligned} \Psi_{0,1}(M)_1 R_{21} \Psi_{0,1}(M)_2 R_{21}^{-1} &= L_1^{(+)} L_1^{(-)-1} R_{21} L_2^{(+)} L_2^{(-)-1} R_{21}^{-1} = L_1^{(+)} L_2^{(+)} R_{21} L_1^{(-)-1} L_2^{(-)-1} R_{21}^{-1} \\ &= L_1^{(+)} L_2^{(+)} L_2^{(-)-1} L_1^{(-)-1} = L_{12}^{(+)} L_{12}^{(-)-1} = \Psi_{0,1}(M)_{12}. \end{aligned}$$

For the  $H$ -linearity:

$$\begin{aligned} \Psi_{0,1}(h' M S(h'')) &= (T \otimes \text{id})(h' \otimes 1 R R' S(h'') \otimes 1) \\ &= (T \otimes \text{id})(h' \otimes 1 R R' S(h)''' \otimes S(h)'' h''''') \\ &= (T \otimes \text{id})(h' S(h)''' \otimes S(h)'' R R' 1 \otimes h''''') \\ &= (T \otimes \text{id})(1 \otimes S(h') R R' 1 \otimes h'') = S(h') \Psi_{0,1}(M) h''. \end{aligned}$$

We used the basic properties of  $S$  and the fact that  $\Delta^{\text{op}}R = R\Delta$ , with  $\Delta^{\text{op}}(h) = h'' \otimes h'$ .  $\square$

We call  $\Psi_{0,1}$  the *Reshetikhin – Semenov-Tian-Shansky – Drinfeld morphism* (RSD morphism for short) [RS88, Dri89]. The difference with the morphism  $\Psi$  of section 2.3 is that the source spaces are different.

Write  $\mathbb{T}(H^*) = \bigoplus_{n \in \mathbb{N}} \mathbb{T}_n(H^*)$ , where  $\mathbb{T}_n(H^*)$  is the subspace generated by all the products  $\psi_1 \cdots \psi_n$ , with  $\psi_i \in H^*$  for each  $i$ .

**Lemma 4.1.7.** *Each element of  $\mathbb{T}(H^*)$  is equivalent modulo the fusion relation of  $\mathcal{L}_{0,1}(H)$  to an element of  $\mathbb{T}_1(H^*)$ . It follows that  $\dim(\mathcal{L}_{0,1}(H)) \leq \dim(H^*)$ .*

*Proof.* It suffices to show that the product of two elements of  $\mathbb{T}_1(H^*)$  is equivalent to a linear combination of elements of  $\mathbb{T}_1(H^*)$ , and the result follows by induction. We can restrict to matrix coefficients since they linearly span  $H^*$ . If we write  $R = a_i \otimes b_i$ , then the fusion relation is rewritten as:

$$M_{12}^{I \otimes J}(R')_{12} = (a_i)_2 M_1^I M_2^J(b_i)_1$$

<sup>2</sup>More precisely, we use relations easily implied by (2.9). For instance for the second equality, we used the relation  $L_1^{(-)-1} R_{21} L_2^{(+)} = L_2^{(+)} R_{21} L_1^{(-)-1}$ , which is obtained as follows: exchanging  $I$  and  $J$  in the second relation of (2.9) we have  $R_{12}^{JI} L_1^{(+)} L_2^{(-)} = L_2^{(-)} L_1^{(+)} R_{12}^{JI}$  and then applying the flip map  $P : H \otimes \text{End}_{\mathbb{C}}(J) \otimes \text{End}_{\mathbb{C}}(I) \rightarrow H \otimes \text{End}_{\mathbb{C}}(I) \otimes \text{End}_{\mathbb{C}}(J)$  we get  $R_{21}^{JI} L_2^{(+)} L_1^{(-)} = L_1^{(-)} L_2^{(+)} R_{21}^{JI}$  which is written

$R_{21} L_2^{(+)} L_1^{(-)} = L_1^{(-)} L_2^{(+)} R_{21}$  in the shortened notation. Recall that in the shortened notation the index 1 (resp. 2) implicitly means evaluation in a representation  $I$  (resp.  $J$ ) (thus  $R_{21}$  means  $R_{21}^{JI} = (R')_{12}^{JI}$ ). More generally, any permutation of the indices in defining relations is allowed when one does computations with the shortened notation. We will no longer give such details in subsequent computations.

Using  $a_j a_i \otimes b_i S(b_j) = 1 \otimes 1$ , we get:

$${}^I M_1 {}^J M_2 = (a_i)_2 {}^J M_{12} (R')_{12} S(b_i)_1 {}^I M_1 \quad (4.7)$$

and this give the result since  ${}^I M_1 {}^J M_2$  contains all the possible products between the coefficients of  ${}^I M$  and those of  ${}^J M$ .  $\square$

**Proposition 4.1.8.** *Recall that we assume that  $H$  is a finite dimensional factorizable Hopf algebra. Then the RSD morphism  $\Psi_{0,1}$  gives an isomorphism of  $H$ -module-algebras  $\mathcal{L}_{0,1}(H) \cong H$ . It follows that  $\mathcal{L}_{0,1}^{\mathrm{inv}}(H) \cong \mathcal{Z}(H)$ .*

*Proof.* Since  $H$  is factorizable,  $\Psi_{0,1}$  is surjective. Hence  $\dim(\mathcal{L}_{0,1}(H)) \geq \dim(H)$ . But by Lemma 4.1.7,  $\dim(\mathcal{L}_{0,1}(H)) \leq \dim(H^*) = \dim(H)$ . Thus  $\dim(\mathcal{L}_{0,1}(H)) = \dim(H)$ .  $\square$

Let us point out obvious consequences. First, the matrices  ${}^I M$  are invertible since  $RR'$  is invertible. Second, this theorem allows us to identify  $\mathcal{L}_{0,1}(H)$  with  $H$  via  ${}^I M = {}^I L^{(+)} {}^I L^{(-)-1}$ , where the matrices  $L^{(\pm)}$  are defined in (2.8). We will always work with this identification in the sequel.

*Remark 4.1.9.* Due to Proposition 4.1.8, there is an isomorphism of vector spaces  $f : \mathcal{L}_{0,1}(H) \rightarrow H^*$  given by  ${}^I M_j^i \mapsto {}^I T_j^i$ . We define a  $H$ -module-algebra structure on  $H^*$ , denoted by  $\mathcal{F}_{0,1}(H)$  and with product  $*$ , by requiring  $f$  to be an isomorphism of (right)  $H$ -module-algebras. The right  $H$ -action is

$$\varphi \cdot h = \varphi(h' ? S(h'')).$$

Using (4.7), (2.15) and obvious commutation relations we have

$$\begin{aligned} {}^I T_\beta^\alpha * {}^I T_\delta^\gamma &= f \left( ({}^I M_1 {}^J M_2)_{\beta\delta}^{\alpha\gamma} \right) = f \left( (a_i)_2 {}^J M_{12} (R')_{12} S(b_i)_1 \right)_{\beta\delta}^{\alpha\gamma} = \left( (a_i)_2 {}^J T_{12} (b_j)_1 S(b_i)_1 (a_j)_2 \right)_{\beta\delta}^{\alpha\gamma} \\ &= \left( ({}^I T b_j S(b_i))_1 (a_i {}^J T a_j)_2 \right)_{\beta\delta}^{\alpha\gamma} = {}^I T_\beta^\alpha (? b_j S(b_i)) {}^I T_\delta^\gamma (a_i ? a_j). \end{aligned}$$

In other words,

$$\varphi * \psi = \varphi(? b_j S(b_i)) \psi(a_i ? a_j), \quad x_m \mapsto \varphi(x'_m b_j S(b_i)) \psi(a_i x''_m a_j). \quad (4.8)$$

This is the product of the functions  $\varphi, \psi \in \mathcal{F}_{0,1}(H)$  and its evaluation on the discrete connection which assigns  $x_m \in H$  to the loop  $m$ , see Figure 4.3 and the Introduction.  $\triangle$

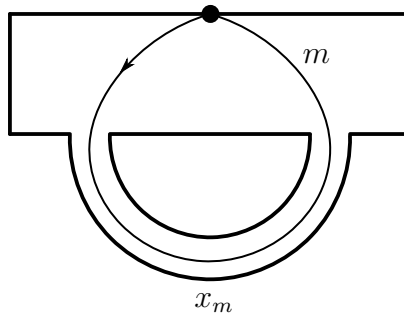

Figure 4.3: A discrete connection  $x_m \in H$  on  $\Sigma_{0,1}^0$ .

Recall that we denote by  $\text{SLF}(H)$  the space of symmetric linear forms on  $H$ :

$$\text{SLF}(H) = \{\psi \in H^* \mid \forall x, y \in H, \psi(xy) = \psi(yx)\}$$

and that  $\text{SLF}(H)$  is obviously a subalgebra of  $\mathcal{O}(H)$ . Also recall from section 2.3 the Drinfeld morphism

$$\begin{aligned} \mathcal{D}: H^* &\rightarrow H \\ \psi &\mapsto (\psi \otimes \text{id})((g \otimes 1)RR') = \psi(ga_i b_j) b_i a_j. \end{aligned}$$

By Lemma 2.3.3,  $\mathcal{D}$  induces an isomorphism of algebras between  $\text{SLF}(H)$  and  $\mathcal{Z}(H)$ . Hence  $\text{SLF}(H) \cong \mathcal{Z}(H) = \mathcal{L}_{0,1}^{\text{inv}}(H)$ .

*Example 4.1.10.* Consider the invariant elements of Example 4.1.5; then it holds by definition

$$\mathcal{D}(\chi^I) = \Psi_{0,1}(\overset{I}{W}), \quad (4.9)$$

where  $\chi^I = \text{tr}(\overset{I}{T})$  is the character of the representation  $I$ . Due to (2.15), we have  $\chi^{I \otimes J} = \chi^I \chi^J$  and hence the same fusion rule applies to the observables  $\overset{I}{W}$ :

$$\overset{I \otimes J}{W} = \overset{I}{W} \overset{J}{W}.$$

This implies that the span of the  $\overset{I}{W}$ 's is a subalgebra of  $\mathcal{L}_{0,1}^{\text{inv}}(H)$  (in general strictly smaller, see for instance (4.31)).  $\triangle$

Let us fix a notation. Every  $\psi \in H^*$  can be written as  $\psi = \sum_{i,j,I} \lambda_{ij}^I \overset{I}{T}_j^i$  with  $\lambda_{ij}^I \in \mathbb{C}$ . In order to avoid the indices, define for each  $I$  a matrix  $\Lambda_I \in \text{Mat}_{\dim(I)}(\mathbb{C})$  by  $(\Lambda_I)_j^i = \lambda_{ji}^I$ . Then  $\psi$  can be expressed as:

$$\psi = \sum_I \text{tr}(\Lambda_I \overset{I}{T}).$$

We record these observations as a lemma.

**Lemma 4.1.11.** *Every  $x \in \mathcal{L}_{0,1}(H)$  can be expressed as:*

$$x = \sum_I \text{tr}(\Lambda_I \overset{I}{g} \overset{I}{M})$$

*such that  $\mathcal{D}^{-1}(x) = \sum_I \text{tr}(\Lambda_I \overset{I}{T})$ . Moreover, if  $x \in \mathcal{L}_{0,1}^{\text{inv}}(H)$ , then  $\mathcal{D}^{-1}(x) \in \text{SLF}(H)$ .*

*Remark 4.1.12.* Let us stress that, due to non-semi-simplicity, this way of writing elements of  $\mathcal{L}_{0,1}(H)$  and of  $\text{SLF}(H)$  is in general not unique, see the comments in section 2.2.  $\triangle$

## 4.2 The handle algebra $\mathcal{L}_{1,0}(H)$

We assume that  $H$  is a finite dimensional factorizable ribbon Hopf algebra. Note however that the ribbon assumption is not needed in sections 4.2.1 and 4.2.2.

### 4.2.1 Definition of $\mathcal{L}_{1,0}(H)$ and $H$ -module-algebra structure

Consider the free product  $\mathcal{L}_{0,1}(H) * \mathcal{L}_{0,1}(H)$ , and let  $j_1$  (resp.  $j_2$ ) be the canonical injection in the first (resp. second) copy of  $\mathcal{L}_{0,1}(H)$ . We define  $\overset{I}{B} = j_1(\overset{I}{M})$  and  $\overset{I}{A} = j_2(\overset{I}{M})$ .

**Definition 4.2.1.** The handle algebra  $\mathcal{L}_{1,0}(H)$  is the quotient of  $\mathcal{L}_{0,1}(H) * \mathcal{L}_{0,1}(H)$  by the following exchange relations:

$${}^{IJ}R_{12} {}^I B_1 ({}^{IJ}R')_{12} {}^J A_2 = A_2 {}^J R_{12} {}^I B_1 {}^{IJ}R_{12}^{-1}$$

for all finite dimensional  $H$ -modules  $I, J$ .

The exchange relation above is the same as in [BNR02, Def 1] except that  $A$  and  $B$  are switched; the one of [AGS96, Def 12] and [AS96a, eq (3.14)] is different, due to a different choice of the action of  $H$  on  $\mathcal{L}_{1,0}(H)$ . In the semisimple setting, the algebras resulting from each of these definitions are isomorphic.

The exchange relation is a relation between matrices in  $\mathcal{L}_{1,0}(H) \otimes \mathrm{Mat}_{\dim(I)}(\mathbb{C}) \otimes \mathrm{Mat}_{\dim(J)}(\mathbb{C})$  (for all finite dimensional  $I, J$ ) which implies relations among elements of  $\mathcal{L}_{1,0}(H)$  (the coefficients of these matrices), namely

$$\forall I, J, a, b, c, d, \quad {}^{IJ}R_{ij}^{ac} {}^I B_k^i ({}^{IJ}R')_{bl}^{kj} {}^J A_d^l = A_i^c {}^J R_{jk}^{ai} {}^I B_l^j ({}^{IJ}R^{-1})_{bd}^{lk}.$$

Like the other relations before, the  $\mathcal{L}_{1,0}(H)$ -exchange relation can be written more simply as:

$$R_{12} B_1 R_{21} A_2 = A_2 R_{12} B_1 R_{12}^{-1}. \quad (4.10)$$

By (4.3), if  $f : I \rightarrow J$  is a morphism it holds

$${}^J B f = f {}^I B, \quad {}^J A f = f {}^I A \quad (4.11)$$

where we identify  $f$  with its matrix. We call this relation the naturality of the (families of) matrices  ${}^I B, {}^I A$ . Also note that the content of Remark 4.1.2 also applies to  $\mathcal{L}_{1,0}(H)$ : in practice, we can restrict to a set  $\mathcal{G}$  of well-chosen  $H$ -modules and when we write  ${}^I B$  and  ${}^I A$ , we can assume that  $I \in \mathcal{G}$ . For instance, if  $H = \bar{U}_q(\mathfrak{sl}_2)$ , we take  $\mathcal{G} = \{\mathcal{X}^+(2)\}$ , see section 4.4.2.

Similarly to  $\mathcal{L}_{0,1}(H)$ , consider the following right action of  $H$  on  $\mathcal{L}_{1,0}(H)$ , which is the analogue of the action of the gauge group on the functions:

$${}^I B \cdot h = h' {}^I B S({}^I h''), \quad {}^I A \cdot h = h' {}^I A S({}^I h''). \quad (4.12)$$

As above and like in [BR95], it is equivalent to work with the corresponding left coaction  $\Omega : \mathcal{L}_{1,0}(H) \rightarrow \mathcal{O}(H) \otimes \mathcal{L}_{1,0}(H)$  defined by

$$\Omega({}^I B) = {}^I T {}^I B S({}^I T), \quad \Omega({}^I A) = {}^I T {}^I A S({}^I T).$$

**Proposition 4.2.2.** The right action  $\cdot$  is a  $H$ -module-algebra structure on  $\mathcal{L}_{1,0}(H)$ . Equivalently,  $\Omega$  is a left  $\mathcal{O}(H)$ -comodule-algebra structure on  $\mathcal{L}_{1,0}(H)$ .

*Proof.* One must show that  $\Omega$  is an algebra morphism, as in [BR95]. This amounts to check that  $\Omega$  is compatible with the exchange relation, which is similar to the proof of Proposition 4.1.4 and is left to the reader.  $\square$

We denote by  $\mathcal{L}_{1,0}^{\mathrm{inv}}(H)$  the subalgebra of invariant elements of  $\mathcal{L}_{1,0}(H)$  (also called ‘‘observables’’). For instance, the elements

$$\mathrm{tr}_{12} \left( {}^{I \otimes J} g_{12} \Phi {}^I A_1 ({}^{IJ}R')_{12} {}^J B_2 {}^{IJ} R_{12} \right) \quad (4.13)$$

with  $\Phi \in \mathrm{End}_H(I \otimes J)$  and  $\mathrm{tr}_{12} = \mathrm{tr} \otimes \mathrm{tr}$ , are invariant.

**Notation.** Let  $\overset{I}{N} = \overset{I}{v}^m \overset{I}{N}_1^{n_1} \dots \overset{I}{N}_l^{n_l} \in \text{Mat}_{\dim(I)}(\mathcal{L}_{1,0}(H))$ , where  $m, n_i \in \mathbb{Z}$  and each  $N_i$  is  $A$  or  $B$ . By definition of the right action of  $H$  on  $\mathcal{L}_{1,0}(H)$ , we have a morphism of  $H$ -modules

$$j_N : \begin{array}{ccc} \mathcal{L}_{0,1}(H) & \rightarrow & \mathcal{L}_{1,0}(H) \\ \overset{I}{M} & \mapsto & \overset{I}{N} \end{array} .$$

Let  $x \in \mathcal{L}_{0,1}(H)$ , we introduce the notation

$$x_N = j_N(x). \quad (4.14)$$

Since we identify  $\mathcal{L}_{0,1}(H)$  with  $H$  through  $\Psi_{0,1}$  we also use this notation when  $x \in H$ :  $x_N = \Psi_{0,1}^{-1}(x)_N$ . Note that if  $x \in \mathcal{L}_{0,1}^{\text{inv}}(H) \cong \mathcal{Z}(H)$ , then  $x_N \in \mathcal{L}_{1,0}^{\text{inv}}(H)$ . The following lemma is an obvious fact.

**Lemma 4.2.3.** *If  $N$  satisfies the fusion relation of  $\mathcal{L}_{0,1}(H)$ ,  $\overset{I \otimes J}{N}_{12} = \overset{I}{N}(i)_1 \overset{IJ}{(R')}_{12} \overset{J}{N}(i)_2 \overset{IJ}{(R')}_{12}^{-1}$ , then  $j_N$  is a morphism of  $H$ -module-algebras:  $(xy)_N = x_N y_N$ .*

Note that we allow  $\overset{I}{v}^m$  in the formula of  $\overset{I}{N}$  due to the fusion relation. Indeed, a suitable product of matrices  $\overset{I}{A}^{\pm 1}, \overset{I}{B}^{\pm 1}$  satisfies the fusion relation when it is correctly normalized by some power of  $v$ , see e.g. (4.26), (4.27) and Proposition 4.3.2.

*Example 4.2.4.* Taking back the elements introduced in Example 4.1.5, we have

$$\overset{I}{W}_A = \text{tr}_q(\overset{I}{A}), \quad \overset{I}{W}_B = \text{tr}_q(\overset{I}{B}), \quad \overset{I}{W}_{vB^{-1}A} = \text{tr}_q(\overset{I}{v} \overset{I}{B}^{-1} \overset{I}{A}), \dots \quad (4.15)$$

These are invariant elements of  $\mathcal{L}_{1,0}(H)$ . △

*Remark 4.2.5.* Recall from remark 4.1.12 that the matrix coefficients do not form a basis of  $\mathcal{L}_{0,1}(H)$ . They just linearly span this space. However, the maps  $j_{wA^{m_1}B^{n_1} \dots A^{m_k}B^{n_k}}$  are well-defined. Indeed, first observe that

$$\begin{aligned} j_B : \mathcal{L}_{0,1}(H) &\xrightarrow{j_1} \mathcal{L}_{0,1}(H) * \mathcal{L}_{0,1}(H) \xrightarrow{\pi} \mathcal{L}_{1,0}(H) \\ j_A : \mathcal{L}_{0,1}(H) &\xrightarrow{j_2} \mathcal{L}_{0,1}(H) * \mathcal{L}_{0,1}(H) \xrightarrow{\pi} \mathcal{L}_{1,0}(H) \end{aligned}$$

are well-defined. Let us show for instance that the map  $j_{A^{-1}B^{-1}A}$  is well-defined. Assume that  $\lambda_b^a \overset{I}{T}_a^b = 0$ . Applying the coproduct in  $\mathcal{O}(H)$  twice and tensoring with  $\text{id}_H$ , we get:

$$\lambda_b^a \overset{I}{T}_k^b \otimes \text{id}_H \otimes \overset{I}{T}_l^k \otimes \text{id}_H \otimes \overset{I}{T}_a^l \otimes \text{id}_H = 0.$$

We evaluate this on  $(RR')^{-1} \otimes (RR')^{-1} \otimes RR'$ :

$$\lambda_b^a (\overset{I}{M}^{-1})_k^b \otimes (\overset{I}{M}^{-1})_l^k \otimes \overset{I}{M}_a^l = 0.$$

Finally, we apply the map  $j_A \otimes j_B \otimes j_A$  and multiplication in  $\mathcal{L}_{1,0}(H)$ :

$$\lambda_b^a (\overset{I}{A}^{-1} \overset{I}{B}^{-1} \overset{I}{A})_a^b = 0$$

as desired. A similar proof can be used to show that all the other maps defined by means of matrix coefficients (like  $\Psi_{1,0}$  or  $\alpha, \beta$  below etc..) are well-defined. △



### 4.2.2 Isomorphism $\mathcal{L}_{1,0}(H) \cong \mathcal{H}(\mathcal{O}(H))$

Recall that the definition and properties of the Heisenberg double  $\mathcal{H}(\mathcal{O}(H))$  are summarized in section 2.4.

**Proposition 4.2.6.** *The following map is a morphism of algebras:*

$$\begin{aligned} \Psi_{1,0} : \mathcal{L}_{1,0}(H) &\rightarrow \mathcal{H}(\mathcal{O}(H)) \\ \overset{I}{B} &\mapsto \overset{I}{L}^{(+)} \overset{I}{T} \overset{I}{L}^{(-)-1}, \\ \overset{I}{A} &\mapsto \overset{I}{L}^{(+)} \overset{I}{L}^{(-)-1} \end{aligned}$$

*Proof.* We have to check that the fusion and exchange relations are compatible with  $\Psi_{1,0}$ . Observe that the restriction of  $\Psi_{1,0}$  to the first copy of  $\mathcal{L}_{0,1}(H) \subset \mathcal{L}_{1,0}(H)$  is just the RSD morphism  $\Psi_{0,1}$ , thus  $\Psi_{1,0}$  is compatible with the fusion relation over  $A$ . For the fusion relation over  $B$ , we have:

$$\begin{aligned} \Psi_{1,0}(B)_{12} &= L_{12}^{(+)} T_{12} L_{12}^{(-)-1} && \text{(definition)} \\ &= L_1^{(+)} L_2^{(+)} T_1 T_2 L_2^{(-)-1} L_1^{(-)-1} && \text{(eq. (2.9) and (2.15))} \\ &= L_1^{(+)} T_1 L_2^{(+)} R_{21} T_2 L_2^{(-)-1} L_1^{(-)-1} && \text{(Lemma 2.29)} \\ &= L_1^{(+)} T_1 L_2^{(+)} R_{21} T_2 R_{21} L_1^{(-)-1} L_2^{(-)-1} R_{21}^{-1} && \text{(eq. (2.9))} \\ &= L_1^{(+)} T_1 L_2^{(+)} R_{21} L_1^{(-)-1} T_2 L_2^{(-)-1} R_{21}^{-1} && \text{(Lemma 2.29)} \\ &= L_1^{(+)} T_1 L_1^{(-)-1} R_{21} L_2^{(+)} T_2 L_2^{(-)-1} R_{21}^{-1} && \text{(eq. (2.9))} \\ &= \Psi_{1,0}(B)_1 R_{21} \Psi_{1,0}(B)_2 R_{21}^{-1} && \text{(definition).} \end{aligned}$$

The same kind of computation allows one to show that  $\Psi_{1,0}$  is compatible with the  $\mathcal{L}_{1,0}$ -exchange relation.  $\square$

We wish to show that  $\Psi_{1,0}$  is an isomorphism.

**Lemma 4.2.7.** *Every element in  $\mathcal{L}_{1,0}(H)$  can be written as  $\sum_i (x_i)_B (y_i)_A$  with  $x_i, y_i \in \mathcal{L}_{0,1}(H)$ . It follows that  $\dim(\mathcal{L}_{1,0}(H)) \leq \dim(\mathcal{L}_{0,1}(H))^2 = \dim(H)^2$ .*

*Proof.* This is the same proof as in Lemma 4.1.7. It suffices to show that an element like  $y_A x_B$  can be expressed as  $\sum_i (x_i)_B (y_i)_A$ . The exchange relation can be rewritten as:

$$\overset{I}{A}_1 \overset{J}{B}_2 = (a_i)_2 \overset{J}{R}'_{12} \overset{IJ}{B}_2 \overset{J}{R}_{12} \overset{I}{A}_1 \overset{IJ}{R}'_{12} \overset{I}{S}(b_i)_1. \quad (4.16)$$

and the result follows since  $\overset{I}{A}_1 \overset{J}{B}_2$  contains all the possible products between the coefficients of  $\overset{I}{A}$  and those of  $\overset{J}{B}$ .  $\square$

**Proposition 4.2.8.** *Recall that we assume that  $H$  is a finite dimensional factorizable Hopf algebra.  $\Psi_{1,0}$  gives an isomorphism of algebras  $\mathcal{L}_{1,0}(H) \cong \mathcal{H}(\mathcal{O}(H))$ . It follows that  $\mathcal{L}_{1,0}(H)$  is a matrix algebra:  $\mathcal{L}_{1,0}(H) \cong \mathrm{Mat}_{\dim(H)}(\mathbb{C})$  and in particular has trivial center.*

*Proof.* Observe that  $\Psi_{1,0} \circ j_A = i_H \circ \Psi_{0,1}$  where  $i_H : H \rightarrow \mathcal{H}(\mathcal{O}(H))$  is the canonical inclusion. Since  $\Psi_{0,1}$  is an isomorphism, there exist matrices  $\overset{I}{A}^{(\pm)}$  such that

$$\Psi_{1,0}(\overset{I}{A}^{(\pm)}) = \overset{I}{L}^{(\pm)} \in \mathrm{Mat}_{\dim(I)}(\mathcal{H}(\mathcal{O}(H))).$$

Moreover, we have:

$$\Psi_{1,0}(\overset{I}{A}^{(+)-1} \overset{I}{B} \overset{I}{A}^{(-)}) = \overset{I}{T} \in \mathrm{Mat}_{\dim(I)}(\mathcal{H}(\mathcal{O}(H))).$$

Thus  $\Psi_{1,0}$  is surjective, and hence  $\dim(\mathcal{L}_{1,0}(H)) \geq \dim(\mathcal{H}(\mathcal{O}(H))) = \dim(H)^2$ . This together with Lemma 4.2.7 gives  $\dim(\mathcal{L}_{1,0}(H)) = \dim(\mathcal{H}(\mathcal{O}(H)))$ . The last claim is a general fact, see (2.28).  $\square$

*Remark 4.2.9.* Due to Proposition 4.2.8, there is an isomorphism of vector spaces  $f : \mathcal{L}_{1,0}(H) \rightarrow H^* \otimes H^*$  given by  $\overset{I}{B}_j^i \overset{J}{A}_l^k \mapsto \overset{I}{T}_j^i \otimes \overset{J}{T}_l^k$ . We define a  $H$ -module-algebra structure on  $H^* \otimes H^*$ , denoted by  $\mathcal{F}_{1,0}(H)$  and with product  $*$ , by requiring  $f$  to be an isomorphism of (right)  $H$ -module-algebras. The right  $H$ -action is

$$(\varphi \otimes \psi) \cdot h = \varphi(h' ? S(h'')) \otimes \psi(h''' ? S(h^{(4)})).$$

For  $\varphi \in H^*$ , let  $\varphi_b = \varphi \otimes \varepsilon$  and  $\varphi_a = \varepsilon \otimes \varphi$ . It is clear that

$$\varphi_b * \psi_a = \varphi \otimes \psi, \quad \varphi_a * \psi_a = (\varphi * \psi)_a, \quad \varphi_b * \psi_b = (\varphi * \psi)_b \quad (4.17)$$

(recall the algebra  $\mathcal{F}_{0,1}(H)$  defined in Remark 4.1.9). Moreover, using (4.16):

$$\begin{aligned} (\overset{I}{T}_\beta^\alpha)_a * (\overset{J}{T}_\delta^\gamma)_b &= f \left( \overset{I}{A}_1 \overset{J}{B}_2 \right)_{\beta\delta}^{\alpha\gamma} = f \left( (a_i)_2 (R')_{12} \overset{J}{B}_2 \overset{IJ}{R}_{12} \overset{I}{A}_1 (R')_{12} \overset{I}{S}(b_i)_1 \right)_{\beta\delta}^{\alpha\gamma} \\ &= f \left( \overset{J}{a}_i \overset{J}{a}_j \overset{J}{B} \overset{J}{b}_k \overset{J}{a}_l \right)_\delta^\gamma f \left( \overset{I}{b}_j \overset{I}{a}_k \overset{I}{A} \overset{I}{b}_l \overset{I}{S}(b_i) \right)_\beta^\alpha = \overset{J}{T}_\delta^\gamma(a_i a_j ? b_k a_l) \otimes \overset{I}{T}_\beta^\alpha(b_j a_k ? b_l S(b_i)) \end{aligned}$$

and it follows that

$$\varphi_a * \psi_b = \psi(a_i a_j ? b_k a_l)_b * \varphi(b_j a_k ? b_l S(b_i))_a. \quad (4.18)$$

Combining (4.17) and (4.18), we obtain the general formula:

$$\begin{aligned} (\varphi_1 \otimes \psi_1) * (\varphi_2 \otimes \psi_2) &= \varphi_1(? b_m S(b_n)) \varphi_2(a_i a_j a_n ? a_m b_k a_l) \otimes \psi_1(b_j a_k ? b_o S(b_p) b_l S(b_i)) \psi_2(a_p ? a_o), \\ x_b \otimes x_a &\mapsto \varphi_1(x'_b b_m S(b_n)) \varphi_2(a_i a_j a_n x''_b a_m b_k a_l) \otimes \psi_1(b_j a_k x'_a b_o S(b_p) b_l S(b_i)) \psi_2(a_p x''_a a_o). \end{aligned}$$

This is the product of the functions  $\varphi_1 \otimes \psi_1, \varphi_2 \otimes \psi_2 \in \mathcal{F}_{1,0}(H)$  and its evaluation on the discrete connection which assigns  $x_b$  to the loop  $b$  and  $x_a$  to the loop  $a$ , see Figure 4.4 and the Introduction.  $\triangle$

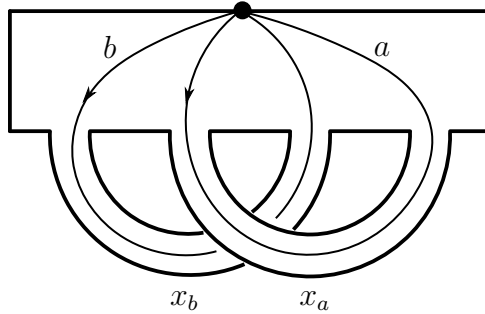

Figure 4.4: A discrete connection  $x_b \otimes x_a \in H^{\otimes 2}$  on  $\Sigma_{1,0}^\circ$ .

### 4.2.3 Representation of $\mathcal{L}_{1,0}^{\text{inv}}(H)$ on $\text{SLF}(H)$

In this section we construct representations of the subalgebra of invariants  $\mathcal{L}_{1,0}^{\text{inv}}(H)$ . This will be extended to any  $g, n$  in the next chapter.

Recall from (2.27) that there is a faithful representation  $\triangleright$  of  $\mathcal{H}(\mathcal{O}(H))$  on  $\mathcal{O}(H)$ . Using the isomorphism  $\Psi_{1,0}$ , we get a representation of  $\mathcal{L}_{1,0}(H)$  on  $\mathcal{O}(H)$ , still denoted  $\triangleright$ :

$$\forall x \in \mathcal{L}_{1,0}(H), \forall \psi \in \mathcal{O}(H), \quad x \triangleright \psi = \Psi_{1,0}(x) \triangleright \psi. \quad (4.19)$$

Using (2.29), it is easy to get:

$$\overset{I}{A}_1 \triangleright \overset{J}{T}_2 = \overset{J}{T}_2 (R R')_{12} \quad \text{and} \quad \overset{I}{B}_1 \triangleright \overset{J}{T}_2 = (a_i)_1 \overset{I \otimes J}{T}_{12}(b_i)_{12} (R')_{12} = (a_i a_j)_1 \overset{I \otimes J}{T}_{12}(b_j)_1 (b_i)_2 (R')_{12} \quad (4.20)$$

where as usual  $R = a_i \otimes b_i$  and the last equality is obtained using (2.5).

Let us define matrices (see section 2.4 for the definition of  $\tilde{L}^{(\pm)}$ )

$${}^I C = v^2 {}^I B {}^I A^{-1} {}^I B^{-1} {}^I A, \quad {}^I C^{(\pm)} = \Psi_{1,0}^{-1} ({}^I \tilde{L}^{(\pm)} \tilde{L}^{(\pm)}) \quad (4.21)$$

Observe that geometrically,  ${}^I C$  corresponds to the boundary of the surface  $\Sigma_{1,0}^0$ , see (4.1) and Figure 4.2.

**Lemma 4.2.10.** *It holds:*

$${}^I C = {}^I C^{(+)} {}^I C^{(-)-1}.$$

Moreover, the matrices  ${}^I C$  satisfy the fusion relation of  $\mathcal{L}_{0,1}(H)$ :

$${}^{I \otimes J} C_{12} = {}^I C_1 ({}^I R')_{12} {}^J C_2 ({}^I R')_{12}^{-1}.$$

*Proof.* We have

$$\Psi_{1,0} \left( v^2 {}^I B {}^I A^{-1} {}^I B^{-1} {}^I A \right) = {}^I L^{(+)} \left( v^2 {}^I T {}^I L^{(+)-1} {}^I L^{(-)} S({}^I T) \right) {}^I L^{(-)-1}.$$

Let us simplify the middle term. It is equal to:

$$\begin{aligned} v^2 {}^I T S({}^I a_i) S^{-1}({}^I b_j) b_i a_j S({}^I T) &= v^2 {}^I T S({}^I a_i) S^{-1}({}^I b_j) S({}^I a'_j) S({}^I b'_i) S({}^I T) b''_i a''_j \\ &= v^2 {}^I T S({}^I a_i a_k) S^{-1}({}^I b_j b_\ell) S({}^I a_j) S({}^I b_k) S({}^I T) b_i a_\ell = {}^I T S({}^I b_\ell a_i) S({}^I T) a_\ell b_i. \end{aligned}$$

The first equality is the exchange relation (2.26) in  $\mathcal{H}(\mathcal{O}(H))$  and the second follows from the properties of the  $R$ -matrix. The third equality is obtained as follows: denoting  $m : H \otimes H \rightarrow H$  the multiplication, we can write

$$\begin{aligned} v^2 S(a_i a_k) S^{-1}(b_\ell) S^{-1}(b_j) S(a_j) S(b_k) \otimes b_i a_\ell &= v S(a_i a_k) S^{-1}(b_k b_\ell) g^{-1} \otimes b_i a_\ell \\ &= v S(a_k a_i) S^{-1}(b_\ell b_k) g^{-1} \otimes a_\ell b_i = v S(a_i) S(S^{-2}(b_k) a_k) S^{-1}(b_\ell) g^{-1} \otimes a_\ell b_i = S(a_i) S(b_\ell) \otimes a_\ell b_i. \end{aligned}$$

For the second equality, we used the Yang-Baxter relation  $R_{13} R_{12} R_{32} = R_{32} R_{12} R_{13}$ ; the others equalities follows from (2.10) and the standard properties for  $g$  and  $v$ . Now, we have:

$${}^I T_1 S({}^I b_\ell a_i)_1 S({}^I T)_1 a_\ell b_i \triangleright {}^J T_2 = {}^I T_1 S({}^I b_\ell a_i)_1 S({}^I T)_1 {}^J T_2 (a_\ell b_i)_2 = S({}^I b_\ell a_i)_1 ({}^J a_\ell b_i)_2 {}^J T_2 = ({}^I a_i b_\ell)_1 \tilde{b}_i \tilde{a}_\ell \triangleright {}^J T_2.$$

For the second equality, we used that for any  $h \in H$ :

$$\langle S({}^I b_\ell a_i)_1 S({}^I T)_1 {}^J T_2 (a_\ell b_i)_2, h \rangle = S(h' b_\ell a_i)_1 (h'' a_\ell b_i)_2 = S({}^I b_\ell a_i h')_1 ({}^J a_\ell b_i h'')_2 = \langle S({}^I T)_1 S({}^I b_\ell a_i)_1 ({}^J a_\ell b_i)_2 {}^J T_2, h \rangle.$$

Since  $\triangleright$  is faithful, we finally get

$$v^2 {}^I T S({}^I a_i) S^{-1}({}^I b_j) b_i a_j S({}^I T) = ({}^I a_\ell b_i) \tilde{b}_\ell \tilde{a}_i = \tilde{L}^{(+)} \tilde{L}^{(-)-1}.$$

Hence

$$\Psi_{1,0} ({}^I C) = {}^I L^{(+)} \tilde{L}^{(+)} ({}^I L^{(-)} \tilde{L}^{(-)})^{-1} = \Psi_{1,0} ({}^I C^{(+)} {}^I C^{(-)-1})$$

as desired. Now, consider the morphism of algebras

$$\begin{aligned} f : H &\rightarrow \mathcal{H}(\mathcal{O}(H)) \\ h &\mapsto \tilde{h}' h'' \end{aligned}$$

and observe that

$$\Psi_{1,0}(C^{(+)}) = a_i^I \widetilde{b}'_i b''_i, \quad \Psi_{1,0}(C^{(-)}) = S^{-1}(b_i) \widetilde{a}'_i a''_i, \quad \Psi_{1,0}(C) = X_i^I \widetilde{Y}'_i Y''_i, \quad (4.22)$$

where  $X_i \otimes Y_i = RR'$ . Then we have a morphism

$$\begin{array}{ccccccc} \mathcal{L}_{0,1}(H) & \xrightarrow{\Psi_{0,1}} & H & \xrightarrow{f} & \mathcal{H}(\mathcal{O}(H)) & \xrightarrow{\Psi_{1,0}^{-1}} & \mathcal{L}_{1,0}(H) \\ M & \xrightarrow{I} & X_i Y_i & \xrightarrow{I} & X_i \widetilde{Y}'_i Y''_i & \xrightarrow{I} & C. \end{array}$$

It follows that  $C$  satisfies the fusion relation. Alternatively, one can write  $\Psi_{1,0}(C) = L^{(+)} \widetilde{L}^{(+)} \widetilde{L}^{(-)-1} L^{(-)-1}$  and check the fusion relation directly using (2.9) and (2.34).  $\square$

Thanks to Lemmas 4.2.3 and 4.2.10, we have a morphism

$$j_C : \begin{array}{ccc} \mathcal{L}_{0,1}(H) & \rightarrow & \mathcal{L}_{1,0}(H) \\ M & \xrightarrow{I} & C \end{array}.$$

The previous proof shows that  $j_C = \Psi_{1,0}^{-1} \circ f \circ \Psi_{0,1}$ . Moreover, the algebra generated by the coefficients  $C^{(\pm)i}_j$  equals the vector space generated by the coefficients  $C^i_j$ :

$$\mathbb{C}\langle C^{(\pm)i}_j \rangle_{I,i,j} = \text{vect}(C^i_j)_{I,i,j}.$$

Indeed, since  $H$  is factorisable, it is generated as an algebra by the coefficients  $L^{(\pm)i}_j = (a_i^{(\pm)})_j^i b_l^{(\pm)}$  and as a vector space by the coefficients  $(X_l)_j^i Y_l$ . The claim follows from  $C^{(\pm)i}_j = j_C(a_i^{(\pm)})_j^i b_l^{(\pm)}$  and  $C^i_j = j_C((X_l)_j^i Y_l)$ .

**Lemma 4.2.11.** *It holds*

$$C_1^{(\pm)} U_2^J C_1^{(\pm)-1} = R_{12}^{(\pm)-1} U_2^J R_{12}^{(\pm)}$$

where  $U$  is  $A$  or  $B$ .

*Proof.* We use the isomorphism  $\Psi_{1,0}$  together with relations (2.9), (2.29) and (2.34):

$$\begin{aligned} \Psi_{1,0}\left(C_1^{(\pm)} A_2 C_1^{(\pm)-1}\right) &= L_1^{(\pm)} \widetilde{L}_1^{(\pm)} L_2^{(+)} L_2^{(-)-1} \widetilde{L}_1^{(\pm)-1} L_1^{(\pm)-1} = L_1^{(\pm)} L_2^{(+)} L_2^{(-)-1} L_1^{(\pm)-1} \\ &= R_{12}^{(\pm)-1} L_2^{(+)} L_1^{(\pm)} R_{12}^{(\pm)} L_2^{(-)-1} L_1^{(\pm)-1} = R_{12}^{(\pm)-1} L_2^{(+)} L_2^{(-)-1} R_{12}^{(\pm)} \\ &= \Psi_{1,0}\left(R_{12}^{(\pm)-1} A_2 R_{12}^{(\pm)}\right) \end{aligned}$$

and

$$\begin{aligned} \Psi_{1,0}\left(C_1^{(\pm)} B_2 C_1^{(\pm)-1}\right) &= L_1^{(\pm)} \widetilde{L}_1^{(\pm)} L_2^{(+)} T_2 L_2^{(-)-1} \widetilde{L}_1^{(\pm)-1} L_1^{(\pm)-1} = L_1^{(\pm)} L_2^{(+)} \widetilde{L}_1^{(\pm)} T_2 \widetilde{L}_1^{(\pm)-1} L_2^{(-)-1} L_1^{(\pm)-1} \\ &= L_1^{(\pm)} L_2^{(+)} R_{12}^{(\pm)-1} T_2 L_2^{(-)-1} L_1^{(\pm)-1} = R_{12}^{(\pm)-1} L_2^{(+)} L_1^{(\pm)} T_2 L_2^{(-)-1} L_1^{(\pm)-1} \\ &= R_{12}^{(\pm)-1} L_2^{(+)} T_2 L_1^{(\pm)} R_{12}^{(\pm)} L_2^{(-)-1} L_1^{(\pm)-1} = R_{12}^{(\pm)-1} L_2^{(+)} T_2 L_2^{(-)-1} R_{12}^{(\pm)} \\ &= \Psi_{1,0}\left(R_{12}^{(\pm)-1} B_2 R_{12}^{(\pm)}\right). \end{aligned}$$

The subscript 1 (resp. 2) implicitly means evaluation in a representation  $I$  (resp.  $J$ ).  $\square$

Thanks to Lemma 4.2.3, we can define an action of  $H$  (identified with  $\mathcal{L}_{0,1}(H)$  through  $\Psi_{0,1}$ ) on  $H^*$  by

$$h \cdot \varphi = h_C \triangleright \varphi. \quad (4.23)$$

**Lemma 4.2.12.** *The action (4.23) of  $H$  on  $H^*$  is*

$$h \cdot \varphi = \varphi(S^{-1}(h')?h'').$$

It follows that we have the equivalence

$$\varphi \in \mathrm{SLF}(H) \iff \overset{I}{C} \triangleright \varphi = \mathbb{I}_{\dim(I)} \varphi.$$

*Proof.* Since  $H$  is factorizable, we can assume that  $h = (\overset{I}{X}_i)_b^a Y_i$ , where  $RR' = X_i \otimes Y_i$ . Due to (4.19) and (4.22), we obtain

$$h \cdot \varphi = (\overset{I}{X}_i)_b^a (Y_i)_C \triangleright \varphi = \overset{I}{C}_b^a \triangleright \varphi = (\overset{I}{X}_i)_b^a \widetilde{Y'_i Y''_i} \triangleright \varphi = \varphi \left( (\overset{I}{X}_i)_b^a S^{-1}(Y'_i)?Y''_i \right) = \varphi(S^{-1}(h')?h'')$$

as desired. Next, it is easy to see that  $\varphi \in \mathrm{SLF}(H)$  if, and only if,  $h \cdot \varphi = \varepsilon(h)\varphi$  for all  $h \in H$ . Applying this to  $h = (\overset{I}{X}_i)_b^a Y_i$  and using that  $X_i \varepsilon(Y_i) = 1$ , we find that  $\varphi \in \mathrm{SLF}(H)$  if, and only if,  $\overset{I}{C}_b^a \triangleright \varphi = \delta_b^a \varphi$  for all  $I, a, b$ .  $\square$

It follows from this lemma that, in the case of the torus,  $\mathrm{SLF}(H)$  implements the flatness constraint (1.8) discussed in the Introduction.

**Theorem 4.2.13.** 1) *An element  $x \in \mathcal{L}_{1,0}(H)$  is invariant under the action of  $H$  (or equivalently under the coaction  $\Omega$  of  $\mathcal{O}(H)$ ) if, and only if, for every  $H$ -module  $I$ ,  $\overset{I}{C}x = x\overset{I}{C}$ .*  
 2) *The restriction of  $\triangleright$  to  $\mathcal{L}_{1,0}^{\mathrm{inv}}(H)$  leaves the subspace  $\mathrm{SLF}(H) \subset H^*$  stable:*

$$\forall x \in \mathcal{L}_{1,0}^{\mathrm{inv}}(H), \forall \psi \in \mathrm{SLF}(H), x \triangleright \psi \in \mathrm{SLF}(H).$$

Hence, we have a representation of  $\mathcal{L}_{1,0}^{\mathrm{inv}}(H)$  on  $\mathrm{SLF}(H)$ . We denote it  $\rho_{\mathrm{SLF}}$ .

*Proof.* 1) Letting  $U$  be  $A$  or  $B$ ,  $R^{(\pm)} = a_i^{(\pm)} \otimes b_i^{(\pm)}$  and using Lemma 4.2.11, we have that the right action  $\cdot$  of  $H$  on  $\mathcal{L}_{1,0}(H)$  satisfies:

$$\begin{aligned} \overset{J}{U}_2 \cdot \overset{I}{L}_1^{(\pm)-1} &= \overset{J}{U}_2 \cdot S^{-1}(b_i^{(\pm)})(a_i^{(\pm)})_1 = S^{-1}(b_i^{(\pm)'})_2 \overset{J}{U}_2 (b_i^{(\pm)'})_2 (a_i^{(\pm)})_1 \\ &= S^{-1}(b_i^{(\pm)})_2 \overset{J}{U}_2 (b_j^{(\pm)})_2 (a_i^{(\pm)} a_j^{(\pm)})_1 = \overset{IJ}{R}_{12}^{(\pm)-1} \overset{J}{U}_2 \overset{IJ}{R}_{12}^{(\pm)} = \overset{I}{C}_1^{(\pm)} \overset{J}{U}_2 \overset{I}{C}_1^{(\pm)-1}. \end{aligned}$$

We have thus shown that

$$(\overset{J}{U})_d^c \cdot S^{-1}(\overset{I}{L}^{(\pm)})_b^a = (\overset{I}{C}^{(\pm)})_i^a (\overset{J}{U})_d^c (\overset{I}{C}^{(\pm)-1})_b^i$$

or in other words

$$\forall x \in \mathcal{L}_{1,0}(H), x \cdot S^{-1}(\overset{I}{L}^{(\pm)}) = \overset{I}{C}^{(\pm)} x \overset{I}{C}^{(\pm)-1}$$

Since  $H$  is factorizable, the elements  $S^{-1}(\overset{I}{L}^{(\pm)})_b^a$  generate  $H$  as an algebra. Hence the previous equation shows that  $x$  is an invariant element if, and only if, it commutes with the coefficients of the matrices  $\overset{I}{C}^{(\pm)}$ . As remarked above, the algebra generated by the coefficients  $\overset{I}{C}^{(\pm)i}$  equals the algebra generated by the coefficients  $\overset{I}{C}_j^i$ . Hence, an element is invariant if, and only if, it commutes with the

coefficients of the matrices  $\overset{I}{C}$ .

2) Let  $x \in \mathcal{L}_{1,0}^{\text{inv}}(H)$  and  $\varphi \in \text{SLF}(H)$ , then

$$\overset{I}{C} \triangleright (x \triangleright \varphi) = (\overset{I}{C}x) \triangleright \varphi = (x\overset{I}{C}) \triangleright \varphi = x \triangleright (\overset{I}{C} \triangleright \varphi) = \mathbb{I}_{\dim(I)}(x \triangleright \varphi)$$

and it follows that  $x \triangleright \varphi \in \text{SLF}(H)$  thanks to Lemma 4.2.12.  $\square$

We now need to determine explicit formulas for the representation of particular types of invariant elements that will appear in the proof of the modular identities in section 4.3. If  $\psi \in H^*$  and  $a \in H$ , we define:

$$\psi^a = \psi(a?)$$

where  $\psi(a?) : x \mapsto \psi(ax)$ . This defines a right representation of  $H$  on  $H^*$ . Obviously, if  $z \in \mathcal{Z}(H)$  and  $\psi \in \text{SLF}(H)$  then  $\psi^z \in \text{SLF}(H)$ .

Recall that  $z_A = j_A(z)$  (resp.  $z_B = j_B(z)$ ) is the image of  $z \in \mathcal{L}_{0,1}(H)$  by the map  $j_A(\overset{I}{M}) = \overset{I}{A}$  (resp.  $j_B(\overset{I}{M}) = \overset{I}{B}$ ). See (4.14) for the general definition.

**Proposition 4.2.14.** *Let  $z \in \mathcal{L}_{0,1}^{\text{inv}}(H) = \mathcal{Z}(H)$  and let  $\psi \in \text{SLF}(H)$ . Then:*

$$z_A \triangleright \psi = \psi^z \quad \text{and} \quad z_B \triangleright \psi = (\mathcal{D}^{-1}(z)\psi^v)^{v^{-1}}$$

where  $\mathcal{D}$  is the isomorphism defined in (2.18).

*Proof.* The first relation is obvious. For the second formula, we write  $z_B = \sum_I \text{tr}(\Lambda_I \overset{I}{g} \overset{I}{B})$  with  $\mathcal{D}^{-1}(z) = \sum_I \text{tr}(\Lambda_I \overset{I}{T}) \in \text{SLF}(H)$  by Lemma 4.1.11. We also write  $\psi = \sum_J \text{tr}(\Theta_J \overset{J}{T})$ . Then, using (4.20):

$$\begin{aligned} z_B \triangleright \psi &= \sum_{I,J} \text{tr}_{12} \left( (\Lambda_I)_1 (\Theta_J)_2 \overset{I}{g}_1 \overset{I}{B}_1 \triangleright \overset{J}{T}_2 \right) \\ &= \sum_{I,J} \text{tr}_{12} \left( (\Lambda_I)_1 (\Theta_J)_2 \overset{I}{g}_1 (a_i a_j)_1 \overset{I \otimes J}{T}_{12} (b_j)_1 (b_i)_2 (R')_{12} \right) \\ &= \mathcal{D}^{-1}(z) (g a_i a_j ? b_j b_k) \psi(? b_i a_k) = \mathcal{D}^{-1}(z) (? b_j b_k S^2(a_i a_j) g) \psi(? b_i a_k) \end{aligned}$$

with  $\text{tr}_{12} = \text{tr} \otimes \text{tr}$ ,  $R = a_i \otimes b_i$ . Thanks to the Yang-Baxter equation, we have:

$$b_j b_k \otimes a_i a_j \otimes b_i a_k = R_{23} R_{21} R_{31} = R_{31} R_{21} R_{23} = b_i b_j \otimes a_j a_k \otimes a_i b_k.$$

It follows that:

$$\begin{aligned} z_B \triangleright \psi &= \mathcal{D}^{-1}(z) (? b_i b_j S^2(a_j a_k) g) \psi(? a_i b_k) \\ &= \mathcal{D}^{-1}(z) (? v^{-1} b_i a_k) \psi(? a_i b_k) = \mathcal{D}^{-1}(z) (? (v^{-1})') \psi(? v(v^{-1})'') \end{aligned}$$

where we used (2.10), (2.13) and (2.11). Hence for  $x \in H$ :

$$(z_B \triangleright \psi)(x) = \mathcal{D}^{-1}(z) ((v^{-1})' x') \psi(v(v^{-1})'' x'') = (\mathcal{D}^{-1}(z) \psi^v)(v^{-1}x) = (\mathcal{D}^{-1}(z) \psi^v)^{v^{-1}}(x)$$

as desired.  $\square$

**Lemma 4.2.15.** *Let  $z \in \mathcal{L}_{0,1}^{\text{inv}}(H) = \mathcal{Z}(H)$  and let  $\psi \in \text{SLF}(H)$ . Then:*

$$z_{B^{-1}} \triangleright \psi = (S(\mathcal{D}^{-1}(z)) \psi^v)^{v^{-1}}.$$

*It follows that if  $S(\psi) = \psi$  for all  $\psi \in \text{SLF}(H)$ , then  $\rho_{\text{SLF}}(z_{B^{-1}}) = \rho_{\text{SLF}}(z_B)$ .*

*Proof.* This proof is quite similar to that of the previous proposition. Using the fact that  $\Psi_{1,0}(\overset{I}{B}^{-1}) = \overset{I}{L}^{(-)} S(\overset{I}{T}) \overset{I}{L}^{(+)-1}$  together with Lemma 2.29 and formulas (2.16), (2.6) and (2.5), it is not too difficult to show that

$$\overset{I}{B}_1^{-1} \triangleright \overset{J}{T}_2 = {}^{t\otimes \mathrm{id}} \left( \begin{array}{c} \overset{I^*}{(a_i)_1} \quad \overset{I^* \otimes J}{T_{12}} \quad \overset{I^*}{(a_j S^{-2}(b_j b_k))_1} \quad \overset{J}{(a_k b_i)_2} \end{array} \right)$$

where  ${}^{t\otimes \mathrm{id}}$  means transpose on the first tensorand. Write  $z_{B^{-1}} = \sum_I \mathrm{tr}(\Lambda_I \overset{I}{g} \overset{I}{B}^{-1})$  with  $\mathcal{D}^{-1}(z) = \sum_I \mathrm{tr}(\Lambda_I \overset{I}{T}) \in \mathrm{SLF}(H)$  by Lemma 4.1.11, and  $\psi = \sum_J \mathrm{tr}(\Theta_J \overset{J}{T})$ . Observe using (2.16) that:

$$S(\mathcal{D}^{-1}(z)) = \sum_I \mathrm{tr} \left( \Lambda_I S(\overset{I}{T}) \right) = \sum_I \mathrm{tr} \left( {}^t \Lambda_I \overset{I^*}{T} \right).$$

Using the fact that  $S(g) = g^{-1}$  and (2.16), we thus get:

$$\begin{aligned} z_{B^{-1}} \triangleright \psi &= \sum_{I,J} \mathrm{tr}_{12} \left( \begin{array}{c} (\Lambda_I \overset{I}{g})_1 (\Theta_J)_2 \quad {}^{t\otimes \mathrm{id}} \left( \begin{array}{c} \overset{I^*}{(a_i)_1} \quad \overset{I^* \otimes J}{T_{12}} \quad \overset{I^*}{(a_j S^{-2}(b_j b_k))_1} \quad \overset{J}{(a_k b_i)_2} \end{array} \right) \end{array} \right) \\ &= \sum_{I,J} \mathrm{tr}_{12} \left( \begin{array}{c} ({}^t \Lambda_I)_1 (\Theta_J)_2 \quad \overset{I^*}{(a_i)_1} \quad \overset{I^* \otimes J}{T_{12}} \quad \overset{I^*}{(a_j S^{-2}(b_j b_k) g^{-1})_1} \quad \overset{J}{(a_k b_i)_2} \end{array} \right) \\ &= S(\mathcal{D}^{-1}(z)) (a_i ? a_j S^{-2}(b_j b_k) g^{-1}) \psi(? a_k b_i) \\ &= S(\mathcal{D}^{-1}(z)) (? a_j S^{-2}(b_j b_k) g^{-1} a_i) \psi(? a_k b_i) = S(\mathcal{D}^{-1}(z)) (? (v^{-1})') \psi(? v(v^{-1})''). \end{aligned}$$

For the last equality we used (2.10), (2.13) and (2.11). Hence we get as in the previous proof  $z_{B^{-1}} \triangleright \psi = (S(\mathcal{D}^{-1}(z)) \psi^v)^{v^{-1}}$ .  $\square$

### 4.3 Projective representation of $\mathrm{SL}_2(\mathbb{Z})$

As previously,  $H$  is a finite dimensional factorizable ribbon Hopf algebra.

#### 4.3.1 Mapping class group of the torus

First, recall the general definition (see [FM12]).

**Definition 4.3.1.** *If  $S$  is a compact oriented surface, we denote by  $\mathrm{MCG}(S)$  its mapping class group, that is the group of isotopy classes of orientation preserving homeomorphisms of  $S$  which fix the boundary pointwise.*

For this chapter we focus on the torus  $\Sigma_{1,0} = S^1 \times S^1$ . Let  $\Sigma_{1,0}^\circ = \Sigma_{1,0} \setminus D$ , where  $D$  is an embedded open disk. The surface  $\Sigma_{1,0}^\circ$  together with the canonical curves  $a$  and  $b$  are represented in Figure 4.2. The groups  $\mathrm{MCG}(\Sigma_{1,0}^\circ)$  and  $\mathrm{MCG}(\Sigma_{1,0})$  are generated by the Dehn twists  $\tau_a, \tau_b$  about the free homotopy classes of the curves  $a$  and  $b$ . It is well-known (see [FM12]) that

$$\begin{aligned} \mathrm{MCG}(\Sigma_{1,0}^\circ) &= B_3 = \langle \tau_a, \tau_b \mid \tau_a \tau_b \tau_a = \tau_b \tau_a \tau_b \rangle, \\ \mathrm{MCG}(\Sigma_{1,0}) &= \mathrm{SL}_2(\mathbb{Z}) = \langle \tau_a, \tau_b \mid \tau_a \tau_b \tau_a = \tau_b \tau_a \tau_b, (\tau_a \tau_b)^6 = 1 \rangle. \end{aligned}$$

This presentation is not the usual one of  $\mathrm{SL}_2(\mathbb{Z})$ , which is:

$$\mathrm{SL}_2(\mathbb{Z}) = \langle s, t \mid (st)^3 = s^2, s^4 = 1 \rangle.$$

The link between the two presentations is  $s = \tau_a^{-1} \tau_b^{-1} \tau_a^{-1}$ ,  $t = \tau_a$ .

Recall that if we have two simple closed curves  $\gamma, x$  then  $\tau_\gamma(x)$  is obtained as follows: at each intersection point between  $x$  and  $\gamma$ , resolve the intersection by plugging a copy of  $\gamma$  into  $x$ , in such a way that  $x$  turns left into the copy of  $\gamma$ :

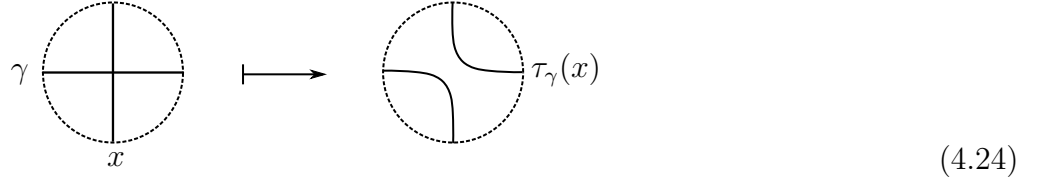

Since  $MCG(\Sigma_{1,0}^\circ)$  fixes the boundary, it fixes the basepoint (see Figure 4.2) and hence we have an action of  $MCG(\Sigma_{1,0}^\circ)$  on  $\pi_1(\Sigma_{1,0}^\circ)$ . The actions of the Dehn twists  $\tau_a$  and  $\tau_b$  are given by:

$$\tau_a(a) = a, \quad \tau_a(b) = ba \quad \text{and} \quad \tau_b(a) = b^{-1}a, \quad \tau_b(b) = b. \quad (4.25)$$

For instance, the action of  $\tau_a$  on  $b$  is depicted by:

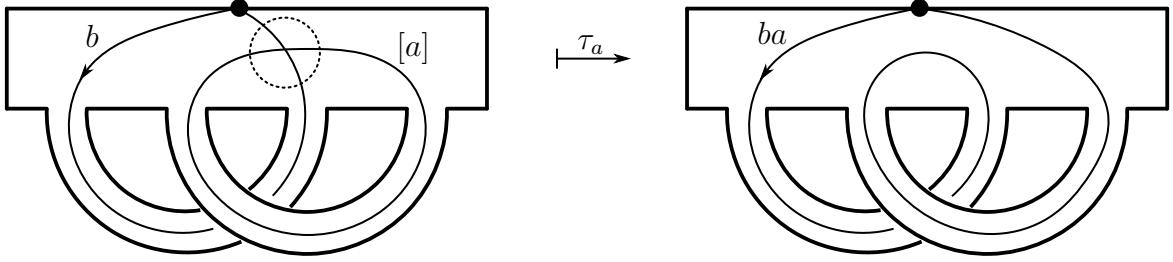

### 4.3.2 Automorphisms $\tilde{\tau}_a$ and $\tilde{\tau}_b$

The fundamental idea, proposed in [AS96a] and [AS96b], is to lift the action of the Dehn twists of  $MCG(\Sigma_{g,n} \setminus D)$  on  $\pi_1(\Sigma_{g,n} \setminus D)$  at the level of the algebra  $\mathcal{L}_{g,n}(H)$ . Let us be more precise. In  $\pi_1(\Sigma_{1,0}^\circ)$  we have the two canonical curves  $a$  and  $b$ , while in  $\mathcal{L}_{1,0}(H)$  we have the matrices  $\overset{I}{A}$  and  $\overset{I}{B}$ . Using (4.25), let us try to define two morphisms  $f_a, f_b : \mathcal{L}_{1,0}(H) \rightarrow \mathcal{L}_{1,0}(H)$  by the same formulas:

$$\begin{aligned} f_a(\overset{I}{A}) &= \overset{I}{A}, & f_a(\overset{I}{B}) &= \overset{I}{B}\overset{I}{A} \\ f_b(\overset{I}{A}) &= \overset{I}{B}^{-1}\overset{I}{A}, & f_b(\overset{I}{B}) &= \overset{I}{B}. \end{aligned}$$

Let us see the behavior of these mappings under the fusion and exchange relations. For the exchange relation, no problem arises:

$$\begin{aligned} R_{12} f_a(B)_1 R_{21} f_a(A)_2 &= R_{12} B_1 A_1 R_{21} A_2 && \text{(definition)} \\ &= R_{12} B_1 R_{21} A_2 R_{12} A_1 R_{12}^{-1} && \text{(eq. (4.4))} \\ &= A_2 R_{12} B_1 A_1 R_{12}^{-1} && \text{(eq. (4.10))} \\ &= f_a(A)_2 R_{12} f_a(B)_1 R_{12}^{-1} && \text{(definition)} \end{aligned}$$

and a similar computation holds for  $f_b$ . The fusion relation is almost satisfied:

$$\begin{aligned} f_a(B)_{12} &= B_{12} A_{12} && \text{(definition)} \\ &= \Delta(v)_{12} B_{12} v_1^{-1} v_2^{-1} R_{21} R_{12} A_{12} && \text{(trick)} \\ &= \Delta(v)_{12} B_1 R_{21} B_2 R_{21}^{-1} v_1^{-1} v_2^{-1} R_{21} R_{12} A_1 R_{21} A_2 R_{21}^{-1} && \text{(eq. (4.2))} \\ &= \Delta(v)_{12} v_1^{-1} v_2^{-1} B_1 R_{21} B_2 R_{12} A_1 R_{21} A_2 R_{21}^{-1} && \text{(v is central)} \\ &= \Delta(v)_{12} v_1^{-1} v_2^{-1} B_1 A_1 R_{21} B_2 A_2 R_{21}^{-1} && \text{(eq. (4.10))} \\ &= \Delta(v)_{12} v_1^{-1} v_2^{-1} f_a(B)_1 R_{21} f_a(B)_2 R_{21}^{-1} && \text{(definition)} \end{aligned} \quad (4.26)$$

and we get similarly:

$$f_b(A)_{12} = B_{12}^{-1} A_{12} = \Delta(v^{-1})_{12} v_1 v_2 f_b(A)_1 R_{21} f_b(A)_2 R_{21}^{-1}. \quad (4.27)$$



From this we conclude that the elements  ${}^I v^{-1} B A$  and  ${}^I v B^{-1} A$  satisfy the relation (4.2). Since  $v$  is central, we see that the exchange relation still holds with these elements. We thus have found the morphisms which lift  $\tau_a$  and  $\tau_b$ ; we denote them by  $\tilde{\tau}_a$  and  $\tilde{\tau}_b$  respectively (these morphisms appeared first in [AS96a, Lem. 2] and [AS96b, eqs (4.1), (4.2)]).

**Proposition 4.3.2.** *We have two automorphisms  $\tilde{\tau}_a, \tilde{\tau}_b$  of  $\mathcal{L}_{1,0}(H)$  defined by:*

$$\begin{aligned}\tilde{\tau}_a({}^I A) &= {}^I A, & \tilde{\tau}_a({}^I B) &= {}^I v^{-1} B A \\ \tilde{\tau}_b({}^I A) &= {}^I v B^{-1} A, & \tilde{\tau}_b({}^I B) &= {}^I B.\end{aligned}$$

Moreover, these automorphisms are inner: there exist  $\hat{\tau}_a, \hat{\tau}_b \in \mathcal{L}_{1,0}(H)$  unique up to scalar such that

$$\forall x \in \mathcal{L}_{1,0}(H), \quad \tilde{\tau}_a(x) = \hat{\tau}_a x \hat{\tau}_a^{-1}, \quad \tilde{\tau}_b(x) = \hat{\tau}_b x \hat{\tau}_b^{-1}.$$

*Proof.* By Proposition 4.2.8,  $\mathcal{L}_{1,0}(H)$  is a matrix algebra. Hence, by the Skolem-Noether theorem, every automorphism of  $\mathcal{L}_{1,0}(H)$  is inner.  $\square$

A natural question is then to find explicitly the elements  $\hat{\tau}_a, \hat{\tau}_b$ . The answer is amazingly simple (it has been given in [AS96a, eq (9.7)] for the modular case; there they express these elements as linear combinations of traces which form a basis in the modular case only). Recall the notation (4.14).

**Proposition 4.3.3.** *Up to scalar,  $\hat{\tau}_a = v_A^{-1} \in \mathcal{L}_{1,0}^{\mathrm{inv}}(H)$  and  $\hat{\tau}_b = v_B^{-1} \in \mathcal{L}_{1,0}^{\mathrm{inv}}(H)$ .*

*Proof.* We must show that:

$$v_A^{-1} A = A v_A^{-1}, \quad v_A^{-1} B = {}^I v^{-1} B A v_A^{-1} \quad \text{and} \quad v_B^{-1} A = {}^I v B^{-1} A v_B^{-1}, \quad v_B^{-1} B = B v_B^{-1}.$$

It is obvious that  $v_A^{-1}$  (resp.  $v_B^{-1}$ ) commutes with the matrices  $A$  (resp.  $B$ ) since it is central in  $j_A(\mathcal{L}_{0,1}(H))$  (resp. in  $j_B(\mathcal{L}_{0,1}(H))$ ). Let us show the other commutation relation for  $v_A^{-1}$ . We use the isomorphism  $\Psi_{1,0}$ . Observe that  $\Psi_{1,0}(x_A) = x$  for all  $x \in H$ . Hence, using the exchange relation of Definition 2.26 and (2.11), we have:

$$\begin{aligned}\Psi_{1,0}(v_A^{-1} B) &= {}^I L^{(+)} v^{-1} {}^I T L^{(-)-1} = {}^I L^{(+)} T (?v'^{-1}) v''^{-1} {}^I L^{(-)-1} = {}^I L^{(+)} T (v')^{-1} v''^{-1} {}^I L^{(-)-1} \\ &= {}^I L^{(+)} T {}^I v^{-1} b_i a_j v^{-1} a_i b_j {}^I L^{(-)-1} = {}^I v^{-1} {}^I L^{(+)} T {}^I b_i a_i {}^I a_j b_j {}^I L^{(-)-1} v^{-1} \\ &= {}^I v^{-1} {}^I L^{(+)} T {}^I L^{(-)-1} {}^I L^{(+)} L^{(-)-1} v^{-1} = \Psi_{1,0}({}^I v^{-1} B A v_A^{-1})\end{aligned}$$

as desired. We now apply the morphism  $\tilde{\tau}_a^{-1} \circ \tilde{\tau}_b^{-1}$  to the equality  $v_A^{-1} B = {}^I v^{-1} B A v_A^{-1}$ :

$$\tilde{\tau}_a^{-1} \circ \tilde{\tau}_b^{-1}(v_A^{-1} B) = {}^I v v_B^{-1} B A^{-1} = \tilde{\tau}_a^{-1} \circ \tilde{\tau}_b^{-1}({}^I v^{-1} B A v_A^{-1}) = {}^I B A^{-1} B v_B^{-1}.$$

Using that  $v_B$  and  $B$  commute, we easily get the desired equality.  $\square$

### 4.3.3 Projective representation of $\mathrm{SL}_2(\mathbb{Z})$ on $\mathrm{SLF}(H)$

Observe that

$$\tau_a \tau_b \tau_a = \tau_b \tau_a \tau_b, \quad (\tau_a \tau_b)^6 \neq \mathrm{id} \quad \text{in } \pi_1(\Sigma_{1,0}^\circ).$$

Since  $\tau_a(c) = \tau_b(c) = c$  where  $c = b a^{-1} b^{-1} a$  is the boundary loop induced by the deletion of the open disk  $D$ ,  $\tau_a$  and  $\tau_b$  are well-defined in  $\pi_1(\Sigma_{1,0}) = \pi_1(\Sigma_{1,0}^\circ) / \langle c \rangle$ , and we have

$$\tau_a \tau_b \tau_a = \tau_b \tau_a \tau_b, \quad (\tau_a \tau_b)^6 = \mathrm{id} \quad \text{in } \pi_1(\Sigma_{1,0}).$$

Recall that  $\mathcal{L}_{1,0}(H)$  is associated to  $\Sigma_{1,0}^\circ$ , and it is easy to check that

$$\tilde{\tau}_a \tilde{\tau}_b \tilde{\tau}_a = \tilde{\tau}_b \tilde{\tau}_a \tilde{\tau}_b, \quad (\tilde{\tau}_a \tilde{\tau}_b)^6 \neq \mathrm{id} \quad \text{in } \mathcal{L}_{1,0}(H).$$

It follows from Propositions 4.3.2 and 4.3.3 that

$$v_A^{-1} v_B^{-1} v_A^{-1} \sim v_B^{-1} v_A^{-1} v_B^{-1}, \quad (v_A^{-1} v_B^{-1})^6 \not\sim 1 \quad \text{in } \mathcal{L}_{1,0}(H)$$

where  $\sim$  means equality up to scalar (we will see that  $\sim$  is actually  $=$  for the braid relation). Hence, if we want a representation of  $\mathrm{MCG}(\Sigma_{1,0})$  based on the elements  $v_A^{-1}$  and  $v_B^{-1}$ , we have to glue back the disc  $D$ . Recall that the matrices  $\overset{I}{C}$  corresponding to the boundary circle are killed on  $\mathrm{SLF}(H)$  (Lemma 4.2.12). Hence, it is natural to think that representing  $v_A^{-1}$  and  $v_B^{-1}$  on  $\mathrm{SLF}(H)$  (see Theorem 4.2.13) will provide a projective representation of  $\mathrm{MCG}(\Sigma_{1,0})$ :

$$\rho_{\mathrm{SLF}}(v_A^{-1} v_B^{-1} v_A^{-1}) \sim \rho_{\mathrm{SLF}}(v_B^{-1} v_A^{-1} v_B^{-1}), \quad \rho_{\mathrm{SLF}}(v_A^{-1} v_B^{-1})^6 \sim 1.$$

We will show that this indeed holds.

Recall from Proposition 2.3.4 the symmetric linear forms

$$\varphi_v = \mu^l(v^{-1})^{-1} \mu^l(g^{-1}v^{-1}?), \quad \varphi_{v^{-1}} = \mu^l(v)^{-1} \mu^l(g^{-1}v?).$$

satisfying  $\mathcal{D}(\varphi_{v^{\pm 1}}) = v^{\pm 1}$ . Due to the fact that  $\varphi_{v^{-1}} = \varphi_v^{-1}$  (since  $\mathcal{D}$  is an isomorphism of algebras), we see that

$$\varphi_{v^{-1}} \varphi_{v^{-1}}^{v^{-2}} = \frac{\mu^l(v^{-1})}{\mu^l(v)} \varepsilon. \quad (4.28)$$

where  $\beta^h = \beta(h?)$  for all  $\beta \in H^*$ ,  $h \in H$ . By Proposition 4.2.14, the actions of  $v_A^{-1}$  and  $v_B^{-1}$  on  $\mathrm{SLF}(H)$  are:

$$\forall \psi \in \mathrm{SLF}(H), \quad v_A^{-1} \triangleright \psi = \psi^{v^{-1}} = \psi(v^{-1}?) \quad \text{and} \quad v_B^{-1} \triangleright \psi = (\varphi_{v^{-1}} \psi^v)^{v^{-1}}. \quad (4.29)$$

**Lemma 4.3.4.**  $\varphi_{v^{-1}} \varphi_{v^{-1}}^{v^{-1}} = \varphi_{v^{-1}}^{v^{-1}}$ .

*Proof.* For  $x \in H$ :

$$\begin{aligned} \langle \varphi_{v^{-1}} \varphi_{v^{-1}}^{v^{-1}}, x \rangle &= \mu^l(v)^{-2} \mu^l(vg^{-1}x') \mu^l(g^{-1}x'') = \mu^l(v)^{-2} \langle \mu^l(v?) \mu^l, g^{-1}x \rangle \\ &= \mu^l(v)^{-1} \mu^l(g^{-1}x) = \varphi_{v^{-1}}^{v^{-1}}(x). \end{aligned}$$

We simply used (2.20). □

This lemma has an important consequence.

**Proposition 4.3.5.** *The following braid relation holds in  $\mathcal{L}_{1,0}(H)$ :*

$$v_A^{-1} v_B^{-1} v_A^{-1} = v_B^{-1} v_A^{-1} v_B^{-1}.$$

*Proof.* The morphisms  $\tilde{\tau}_a$  and  $\tilde{\tau}_b$  satisfy the braid relation  $\tilde{\tau}_a \tilde{\tau}_b \tilde{\tau}_a = \tilde{\tau}_b \tilde{\tau}_a \tilde{\tau}_b$ . Hence by Proposition 4.3.3 and since  $\mathcal{Z}(\mathcal{L}_{1,0}(H)) \cong \mathbb{C}$ , we have:  $\lambda v_A^{-1} v_B^{-1} v_A^{-1} = v_B^{-1} v_A^{-1} v_B^{-1}$  for some  $\lambda \in \mathbb{C}$ . We evaluate on the counit:

$$\begin{aligned} \lambda v_A^{-1} v_B^{-1} v_A^{-1} \triangleright \varepsilon &= \lambda v_A^{-1} v_B^{-1} \triangleright \varepsilon = \lambda v_A^{-1} \triangleright \varphi_{v^{-1}}^{v^{-1}} = \lambda \varphi_{v^{-1}}^{v^{-2}} \\ v_B^{-1} v_A^{-1} v_B^{-1} \triangleright \varepsilon &= v_B^{-1} v_A^{-1} \triangleright \varphi_{v^{-1}}^{v^{-1}} = v_B \triangleright \varphi_{v^{-1}}^{v^{-2}} = \left( \varphi_{v^{-1}} \varphi_{v^{-1}}^{v^{-1}} \right)^{v^{-1}} = \left( \varphi_{v^{-1}}^{v^{-1}} \right)^{v^{-1}} = \varphi_{v^{-1}}^{v^{-2}}. \end{aligned}$$

We used  $\varepsilon(v?) = \varepsilon(v)\varepsilon = \varepsilon$  and Lemma 4.3.4. It follows that  $\lambda = 1$ . □

Consider  $\widehat{\omega} = v_A^{-1} v_B^{-1} v_A^{-1} \in \mathcal{L}_{1,0}(H)$ , which implements the automorphism  $\omega = \widetilde{\tau}_a \widetilde{\tau}_b \widetilde{\tau}_a$ :  $\omega(x) = \widehat{\omega} x \widehat{\omega}^{-1}$ . The key observation is the following lemma.

**Lemma 4.3.6.** *For all  $\psi \in \mathrm{SLF}(H)$ :*

$$\widehat{\omega}^2 \triangleright \psi = \frac{\mu^l(v^{-1})}{\mu^l(v)} S(\psi).$$

*Proof.* First, we show the formula for  $\psi = \varepsilon$ :

$$\widehat{\omega}^2 \triangleright \varepsilon = (v_A^{-1} v_B^{-1} v_A^{-1})^2 \triangleright \varepsilon = v_A^{-1} v_B^{-1} v_A^{-1} \triangleright \varphi_{v^{-1}}^{v^{-2}} = v_A^{-1} \triangleright (\varphi_{v^{-1}} \varphi_{v^{-1}}^{v^{-2}})^{v^{-1}} = \frac{\mu^l(v^{-1})}{\mu^l(v)} v_A^{-1} \triangleright \varepsilon^{v^{-1}} = \frac{\mu^l(v^{-1})}{\mu^l(v)} \varepsilon$$

where we used (4.29) and (4.28). Second, note that  $\omega(A) = v^2 A^{-1} B^{-1} A = B^{-1} C$  and  $\omega(B) = A$ . It follows that, for every  $z \in \mathcal{Z}(H) = \mathcal{L}_{0,1}^{\mathrm{inv}}(H)$ ,  $\omega^2(z_B) = \omega(z_A) = z_{B^{-1}C}$  and thus

$$\widehat{\omega}^2 z_B = z_{B^{-1}C} \widehat{\omega}^2.$$

Observe by Proposition 4.2.14 that for every  $\psi \in \mathrm{SLF}(H)$  we have  $\psi = \mathcal{D}(\psi^v)_B \triangleright \varepsilon$ . Hence, we get

$$\begin{aligned} \widehat{\omega}^2 \triangleright \psi &= \widehat{\omega}^2 \mathcal{D}(\psi^v)_B \triangleright \varepsilon = \mathcal{D}(\psi^v)_{B^{-1}C} \widehat{\omega}^2 \triangleright \varepsilon = \frac{\mu^l(v^{-1})}{\mu^l(v)} \mathcal{D}(\psi^v)_{B^{-1}C} \triangleright \varepsilon = \frac{\mu^l(v^{-1})}{\mu^l(v)} \mathcal{D}(\psi^v)_{B^{-1}} \triangleright \varepsilon \\ &= \frac{\mu^l(v^{-1})}{\mu^l(v)} S(\psi^v)^{v^{-1}} = \frac{\mu^l(v^{-1})}{\mu^l(v)} S(\psi). \end{aligned}$$

We simply used Lemmas 4.2.12 and 4.2.15. Also recall that if  $\varphi \in \mathrm{SLF}(H)$  then

$$z_{B^{-1}C} \triangleright \varphi = \sum_I \mathrm{tr} \left( \Lambda_I g^I B^{-1} C \triangleright \varphi \right) = \sum_I \mathrm{tr} \left( \Lambda_I g^I B^{-1} \triangleright \varphi \right) = z_{B^{-1}} \triangleright \varphi,$$

with the notation of Lemma 4.1.11. □

Recall that the group  $\mathrm{PSL}_2(\mathbb{Z}) = \mathrm{SL}_2(\mathbb{Z}) / \{\pm \mathbb{I}_2\}$  admits the following presentations:

$$\mathrm{PSL}_2(\mathbb{Z}) = \langle \tau_a, \tau_b \mid \tau_a \tau_b \tau_a = \tau_b \tau_a \tau_b, (\tau_a \tau_b)^3 = 1 \rangle = \langle s, t \mid (st)^3 = 1, s^2 = 1 \rangle.$$

We denote by  $\rho$  the representation of  $\mathcal{L}_{0,1}(H)$  on  $H^*$  and by  $\rho_{\mathrm{SLF}}$  the representation of  $\mathcal{L}_{0,1}^{\mathrm{inv}}(H)$  on  $\mathrm{SLF}(H)$ .

**Theorem 4.3.7.** *Recall that we assume that  $H$  is a finite dimensional factorizable ribbon Hopf algebra.*

1) *The assignment*

$$\tau_a \mapsto \rho(v_A^{-1}), \quad \tau_b \mapsto \rho(v_B^{-1})$$

*defines a representation  $\theta_1^\circ$  of  $\mathrm{MCG}(\Sigma_{1,0}^\circ) = B_3$  on  $H^*$ .*

2) *The assignment*

$$\tau_a \mapsto \rho_{\mathrm{SLF}}(v_A^{-1}), \quad \tau_b \mapsto \rho_{\mathrm{SLF}}(v_B^{-1})$$

*defines a projective representation  $\theta_1$  of  $\mathrm{MCG}(\Sigma_{1,0}) = \mathrm{SL}_2(\mathbb{Z})$  on  $\mathrm{SLF}(H)$ . If moreover  $S(\psi) = \psi$  for all  $\psi \in \mathrm{SLF}(H)$ , then this defines actually a projective representation of  $\mathrm{PSL}_2(\mathbb{Z})$ .*

*Proof.* By Proposition 4.3.5, we know that the braid relation is satisfied in  $\mathcal{L}_{1,0}(H)$ , thus the first claim holds. By Lemma 4.3.6, we have:

$$(v_A^{-1} v_B^{-1})^3 \triangleright \psi = \widehat{\omega}^2 \triangleright \psi = \frac{\mu^l(v^{-1})}{\mu^l(v)} S(\psi).$$

If  $S_{|\mathrm{SLF}(H)} = \mathrm{id}$ , then

$$\rho_{\mathrm{SLF}}(v_A^{-1} v_B^{-1})^3 = \frac{\mu^l(v^{-1})}{\mu^l(v)} \mathrm{id}.$$

Otherwise,

$$(v_A^{-1} v_B^{-1})^6 \triangleright \psi = \frac{\mu^l(v^{-1})}{\mu^l(v)} \widehat{\omega}^2 \triangleright S(\psi) = \frac{\mu^l(v^{-1})^2}{\mu^l(v)^2} S^2(\psi) = \frac{\mu^l(v^{-1})^2}{\mu^l(v)^2} \psi(g^{-1}) = \frac{\mu^l(v^{-1})^2}{\mu^l(v)^2} \psi.$$

□

Observe that the quantity  $\frac{\mu^l(v^{-1})}{\mu^l(v)}$  does not depend on the choice of  $\mu^l$  since it is unique up to scalar.

#### 4.3.4 Equivalence with the Lyubashenko-Majid representation

Recall that  $H$  is a finite dimensional factorizable ribbon Hopf algebra. Under this assumption, two operators  $\mathcal{S}, \mathcal{T} : H \rightarrow H$  are defined in [LM94]:

$$\mathcal{S}(x) = (\mathrm{id} \otimes \mu^l)(R^{-1}(1 \otimes x)R'^{-1}), \quad \mathcal{T}(x) = v^{-1}x.$$

It is shown that they are invertible and satisfy  $(\mathcal{S}\mathcal{T})^3 = \lambda \mathcal{S}^2$ ,  $\mathcal{S}^2 = S^{-1}$ , with  $\lambda \in \mathbb{C} \setminus \{0\}$ . We warn the reader that in [LM94], they consider the *inverse* of the ribbon element (see the bottom of the third page of their paper). That is why there is  $v^{-1}$  in the formula for  $\mathcal{T}$ .

Now we introduce two maps. The first is

$$\begin{aligned} \chi : H^* &\rightarrow H \\ \beta &\mapsto (\beta \otimes \mathrm{id})(R'R) \end{aligned}$$

while the second is

$$\begin{aligned} \gamma : H &\rightarrow H^* \\ x &\mapsto \mu^r(S(x)). \end{aligned}$$

The map  $\chi$  is a slight variant of the map  $\Psi$  of section 2.3 and is called Drinfeld morphism in [FGST06a]. The map  $\gamma$  is denoted  $\widehat{\phi}^{-1}$  in [FGST06a] and is the inverse of the Radford map ( $\widehat{\phi}(\varphi) = \varphi(c')c''$ , where  $c$  is the two-sided cointegral of  $H$ ; see [Rad94, Rad11]). Consider the space of left  $q$ -characters:

$$\mathrm{Ch}^l(H) = \{ \beta \in H^* \mid \forall x, y \in H, \beta(xy) = \beta(S^2(y)x) \}.$$

These maps satisfy the following restrictions:

$$\chi : \mathrm{Ch}^l(H) \longrightarrow \mathcal{Z}(H), \quad \gamma : \mathcal{Z}(H) \longrightarrow \mathrm{Ch}^l(H).$$

This is due to the fact (observed by Drinfeld [Dri89] and Radford [Rad94] respectively) that they intertwine the adjoint and the coadjoint actions (for the first the computation is analogous to that of the proof of Proposition 4.1.6, while the second is immediate by Proposition 2.3.4).

It is not too difficult to show (see e.g. [Iba15, Remark IV.1.2]) that

$$\forall z \in \mathcal{Z}(H), \quad \mathcal{S}(z) = \chi \circ \gamma(z).$$

It follows that  $\mathcal{Z}(H)$  is stable under  $\mathcal{S}$  and  $\mathcal{T}$ . But since  $S^2$  is inner, we have  $\mathcal{S}^4(z) = S^{-2}(z) = z$  for each  $z \in \mathcal{Z}(H)$ . Thus there exists a projective representation  $\rho_{\mathrm{LM}}$  of  $\mathrm{SL}_2(\mathbb{Z})$  on  $\mathcal{Z}(H)$ , defined by:

$$\rho_{\mathrm{LM}}(s) = \mathcal{S}_{|\mathcal{Z}(H)}, \quad \rho_{\mathrm{LM}}(t) = \mathcal{T}_{|\mathcal{Z}(H)}.$$

The left  $q$ -characters are nothing more than shifted symmetric linear forms. More precisely, we have an isomorphism of algebras:

$$\begin{aligned} (g^{-1})^* : \mathrm{SLF}(H) &\rightarrow \mathrm{Ch}^l(H) \\ \psi &\mapsto \psi(g^{-1}). \end{aligned}$$

Let us define shifted versions of  $\chi$  and of  $\gamma$ :

$$\chi_{g^{-1}} = \chi \circ (g^{-1})^* : \mathrm{SLF}(H) \xrightarrow{\cong} \mathcal{Z}(H), \quad \gamma_g = g^* \circ \gamma : \mathcal{Z}(H) \xrightarrow{\cong} \mathrm{SLF}(H).$$

The equality  $\mathcal{S} = \chi_{g^{-1}} \circ \gamma_g$  still holds, but we have now  $\mathrm{SLF}(H)$  instead of  $\mathrm{Ch}^l(H)$ .

We will need the following relation between left and right integrals.

**Lemma 4.3.8.** *Under our assumptions  $H$  is unibalanced, which means that  $\mu^l = \mu^r(g^2?)$ .*

*Proof.* The terminology “unibalanced” is picked from [BBGa18], where some facts about integrals and cointegrals are recalled. Recall (see e.g. [EGNO15, Prop. 8.10.10]) that a finite dimensional factorizable Hopf algebra is unimodular, which means that there exists  $c \in \mathcal{Z}(H)$ , called two-sided cointegral, such that  $xc = \varepsilon(x)c$  for all  $x \in H$ . Let  $a \in H$  be the comodulus of  $\mu^r$ :  $\psi\mu^r = \psi(a)\mu^r$  for all  $\psi \in \mathcal{O}(H)$  (see e.g. [BBGa18, eq. 4.9]). By a result of Drinfeld (see [Mon93, Prop. 10.1.14], but be aware that in this book the notations and conventions for  $a$  and  $g$  are different from those we use), we know that:

$$uS(u)^{-1} = a(\mathbf{a} \otimes \mathrm{id})(R)$$

where  $\mathbf{a} \in H^*$  is the modulus of the left cointegral  $c^l$  of  $H$ . Here, since  $c = c^l$  is two-sided, we have  $\mathbf{a} = \varepsilon$ . Thus  $g^2 = u^2v^{-2} = uS(u)^{-1} = a$  by (2.11) and (2.13). We deduce that

$$\mu^l = \mu^r \circ S = \mu^r(a?) = \mu^r(g^2?)$$

where the second equality is [BBGa18, Prop. 4.7]. □

**Lemma 4.3.9.** *It holds:*

$$\rho_{\mathrm{SLF}}(v_A^2 v_B) = \mu^l(v^{-1})^{-1} \gamma_g \circ \chi_{g^{-1}}.$$

*Proof.* We compute each side of the equality. On the one hand:

$$\gamma_g \circ \chi_{g^{-1}}(\psi) = \gamma_g((\psi \otimes \mathrm{id})(g^{-1}(v^{-1})'v \otimes (v^{-1})''v)) = \psi(g^{-1}(v^{-1})'v) \mu^r(gS((v^{-1})''v)?)$$

whereas on the other hand:

$$\begin{aligned} v_A^2 v_B \triangleright \psi &= (\varphi_v \psi^v)^v = \mu^l(v^{-1})^{-1} (\mu^r(gv^{-1}?) \psi^v)^v \\ &= \mu^l(v^{-1})^{-1} [\mu^r(g(v^{-1})'?) \psi(vg^{-1}S^{-1}((v^{-1})''))]^v \\ &= \mu^l(v^{-1})^{-1} \mu^r(gvS((v^{-1})'')?) \psi(vg^{-1}(v^{-1})') \end{aligned}$$

as desired. We used the formulas (which are analogous to (4.29))

$$v_A \triangleright \psi = \psi^v = \psi(v?), \quad v_B \triangleright \psi = \mu^l(v^{-1})^{-1} (\mu^l(g^{-1}v^{-1}?) \psi^v)^{v^{-1}}$$

together with Lemma 4.3.8, the property (2.24) and the equality  $(v^{-1})' \otimes S^{-1}((v^{-1})'') = S((v^{-1})'') \otimes (v^{-1})'$  which is due to  $S(v) = v$ . □

The link between the two presentations of  $\mathrm{SL}_2(\mathbb{Z})$  is  $s = \tau_a^{-1} \tau_b^{-1} \tau_a^{-1}$ ,  $t = \tau_a$ . Hence we define two operators  $\mathcal{S}', \mathcal{T}' : \mathrm{SLF}(H) \rightarrow \mathrm{SLF}(H)$  by:

$$\mathcal{S}' = \theta_1(s) = \rho_{\mathrm{SLF}}(v_A v_B v_A), \quad \mathcal{T}' = \theta_1(t) = \rho_{\mathrm{SLF}}(v_A^{-1}).$$

**Theorem 4.3.10.** *Recall that we assume that  $H$  is a finite dimensional factorizable ribbon Hopf algebra. Then the projective representation  $\theta_1$  of Theorem 4.3.7 is equivalent to  $\rho_{\mathrm{LM}}$ .*

*Proof.* Consider the following isomorphism of vector spaces:

$$\begin{aligned} f = \rho_{\text{SLF}}(v_A^{-1}) \circ \gamma_g : \mathcal{Z}(H) &\rightarrow \text{SLF}(H) \\ z &\mapsto \gamma_g(z)^{v^{-1}} = \mu^r(gv^{-1}S(z)?) . \end{aligned}$$

By Lemma 4.3.9:

$$\mathcal{S}' = \mu^l(v^{-1})^{-1} \rho_{\text{SLF}}(v_A^{-1}) \circ \gamma_g \circ \chi_{g^{-1}} \circ \rho_{\text{SLF}}(v_A).$$

Thus:

$$f \circ \mathcal{S} = \rho_{\text{SLF}}(v_A^{-1}) \circ \gamma_g \circ \chi_{g^{-1}} \circ \gamma_g = \mu^l(v^{-1}) \mathcal{S}' \circ f.$$

Next,

$$f \circ \mathcal{T}(z) = f(v^{-1}z) = \gamma_g(z)^{v^{-2}} = \rho_{\text{SLF}}(v_A^{-1}) \left( \gamma_g(z)^{v^{-1}} \right) = \mathcal{T}' \circ f(z)$$

Then  $f$  is an intertwiner of projective representations.  $\square$

## 4.4 The case of $H = \bar{U}_q(\mathfrak{sl}_2)$

Let  $q$  be a primitive root of unity of order  $2p$ , with  $p \geq 2$ . We now work in some detail the case of  $H = \bar{U}_q = \bar{U}_q(\mathfrak{sl}_2)$ , the restricted quantum group associated to  $\mathfrak{sl}_2(\mathbb{C})$ . We take back all the notations and results from Chapter 3. In particular, to explicitly describe the representation of  $\text{SL}_2(\mathbb{Z})$ , we will use the GTA basis of  $\text{SLF}(\bar{U}_q)$  introduced in section 3.2.

### 4.4.1 Technical details

In principle, since  $\bar{U}_q$  is not braided (see section 3.1.3), it is not clear that the previous definitions and results remain valid. In practice, the universal  $R$ -matrix simply belongs to the extension  $\bar{U}_q^{1/2}$  of  $\bar{U}_q$  by a square root of  $K$ , and although some computations occur in the extension, the final result always belongs to  $\bar{U}_q$ . The important things are that the  $M$ -matrix  $RR'$  belongs to  $\bar{U}_q^{\otimes 2}$ , that the ribbon element  $v$  belongs to  $\bar{U}_q$  and that  $\bar{U}_q$  is factorizable (recall that this last claim is an abuse of terminology since  $\bar{U}_q$  is not braided, see details in section 3.1.3).

In order to define  $\mathcal{L}_{0,1}(\bar{U}_q)$  and  $\mathcal{L}_{1,0}(\bar{U}_q)$  we introduce some terminology. Let  $I$  be a  $\bar{U}_q^{1/2}$ -module. Since  $\bar{U}_q \subset \bar{U}_q^{1/2}$ ,  $I$  determines a  $\bar{U}_q$ -module, which we denote  $I|_{\bar{U}_q}$ . We say that a  $\bar{U}_q$ -module  $J$  is *liftable* if there exists a  $\bar{U}_q^{1/2}$ -module  $\tilde{J}$  such that  $\tilde{J}|_{\bar{U}_q} = J$ . Not every  $\bar{U}_q$ -module is liftable. Indeed, if it was the case, this would imply that  $V \otimes W \cong W \otimes V$  (since  $\bar{U}_q^{1/2}$  is braided) for every  $\bar{U}_q$ -modules  $V, W$ , which is false: a counter-example is given in [KS11]. However, the simple modules and the PIMs are liftable, which is enough for us. It suffices to define the action of  $K^{1/2}$  on these modules. Take back the notations of section 3.1.1 for the canonical basis of modules. For the simple module  $\mathcal{X}^\epsilon(s)$  ( $\epsilon \in \{\pm\}$ ), there are two choices for  $\epsilon^{1/2}$ , and so the two possible lifts are defined by

$$K^{1/2}v_j = \epsilon^{1/2}q^{(s-1-2j)/2}v_j$$

and the action of  $E$  and  $F$  is unchanged. Similarly, the two possible lifts of the PIM  $\mathcal{P}^\epsilon(s)$  are defined by

$$\begin{aligned} K^{1/2}b_0 &= \epsilon^{1/2}q^{(s-1)/2}b_0, & K^{1/2}x_0 &= (\epsilon^{1/2}q^{p/2})q^{(p-s-1)/2}x_0 \\ K^{1/2}y_0 &= (-\epsilon^{1/2}q^{p/2})q^{(p-s-1)/2}y_0, & K^{1/2}a_0 &= \epsilon^{1/2}q^{(s-1)/2}a_0 \end{aligned}$$

and the action of  $E$  and  $F$  is unchanged.

Let  $\tilde{\mathcal{C}}^-$  be the 1-dimensional  $\bar{U}_q^{1/2}$ -module with basis  $v$  defined by  $Ev = Fv = 0$ ,  $K^{1/2}v = -v$  (which is a lift of  $\mathcal{X}^+(1) = \mathbb{C}$ ). If  $\tilde{I}$  is a lift of a simple module or a PIM  $I$ , then we have seen that the only possible lift of  $I$  are  $\tilde{I}^+ = \tilde{I}$  and  $\tilde{I}^- = \tilde{I} \otimes \tilde{\mathcal{C}}^-$ . Moreover, using (2.5), we get equalities which will be used in the next section:

$$\begin{aligned} \begin{pmatrix} \tilde{I}^- \tilde{J} \\ \tilde{R} \end{pmatrix}_{12} &= \begin{pmatrix} \tilde{I}^+ \tilde{J} \\ \tilde{R} \end{pmatrix}_{12} \begin{pmatrix} \tilde{J} \\ K^p \end{pmatrix}_2, & \begin{pmatrix} \tilde{I} \tilde{J}^- \\ \tilde{R} \end{pmatrix}_{12} &= \begin{pmatrix} \tilde{I} \tilde{J}^+ \\ \tilde{R} \end{pmatrix}_{12} \begin{pmatrix} \tilde{I} \\ K^p \end{pmatrix}_1 \\ \begin{pmatrix} \tilde{I}^- \tilde{J} \\ \tilde{R}' \end{pmatrix}_{12} &= \begin{pmatrix} \tilde{I}^+ \tilde{J} \\ \tilde{R}' \end{pmatrix}_{12} \begin{pmatrix} \tilde{J} \\ K^p \end{pmatrix}_2, & \begin{pmatrix} \tilde{I} \tilde{J}^- \\ \tilde{R}' \end{pmatrix}_{12} &= \begin{pmatrix} \tilde{I} \tilde{J}^+ \\ \tilde{R}' \end{pmatrix}_{12} \begin{pmatrix} \tilde{I} \\ K^p \end{pmatrix}_1. \end{aligned} \tag{4.30}$$

### 4.4.2 $\mathcal{L}_{0,1}(\bar{U}_q)$ and $\mathcal{L}_{1,0}(\bar{U}_q)$

We define  $\mathcal{L}_{0,1}(\bar{U}_q)$  as the quotient of  $T(\bar{U}_q^*)$  by the fusion relation

$$M_{12}^{I \otimes J} = M_1^I \tilde{I} \tilde{J} M_2^J \tilde{I} \tilde{J}^{-1}$$

where  $I, J$  are simple modules or PIMs and  $\tilde{I}, \tilde{J}$  are lifts of  $I$  and  $J$ . From (4.30) and the fact that  $K^p$  is central, we see that this does not depend on the choice of  $\tilde{I}$  and  $\tilde{J}$ . As we saw in section 2.2, the matrix coefficients of the PIMs linearly span  $\mathcal{L}_{0,1}(H)$ , thus we can restrict to them in the definition. However, it is important to have the matrices associated to simple modules and more precisely to  $\mathcal{X}^+(2)$ , as we shall see below. All the results of section 4.1 remain true for  $\mathcal{L}_{0,1}(\bar{U}_q)$ . In particular,  $\Psi_{0,1}$  is an isomorphism since  $\bar{U}_q$  is factorizable.

We now describe  $\mathcal{L}_{0,1}(\bar{U}_q)$  by generators and relations. Let

$$M = \begin{matrix} \mathcal{X}^+(2) \\ M \end{matrix} = \begin{pmatrix} a & b \\ c & d \end{pmatrix} \quad \text{and} \quad \tilde{R} = \begin{matrix} \tilde{\mathcal{X}}^+(2) \\ R \end{matrix} = q^{-1/2} \begin{pmatrix} q & 0 & 0 & 0 \\ 0 & 1 & \hat{q} & 0 \\ 0 & 0 & 1 & 0 \\ 0 & 0 & 0 & q \end{pmatrix}$$

where  $\tilde{\mathcal{X}}^+(2)$  is the lift of  $\mathcal{X}^+(2)$  defined by  $K^{1/2}v_0 = q^{1/2}v_0$ . Using the same reasoning as in section 3.1.4, we know that the coefficients of  $M^{(n)}$  ( $n \in \mathbb{N}$ ) linearly span  $\mathcal{L}_{0,1}(\bar{U}_q)$ . But thanks to the fusion relation, each such coefficient is a linear combination of products of the elements  $a, b, c, d$ :

$$\begin{pmatrix} \mathcal{X}^+(2)^{\otimes n} \\ M \end{pmatrix}_{j_1, \dots, j_n}^{i_1, \dots, i_n} = \lambda_{(j_1, \dots, j_n)_{k_1, \dots, k_n}}^{(i_1, \dots, i_n)_{l_1, \dots, l_n}} \begin{pmatrix} \mathcal{X}^+(2) \\ M \end{pmatrix}_{l_1}^{k_1} \dots \begin{pmatrix} \mathcal{X}^+(2) \\ M \end{pmatrix}_{l_n}^{k_n},$$

which is the analogue of (3.19). It follows that  $a, b, c, d$  generate  $\mathcal{L}_{0,1}(\bar{U}_q)$ . Let us determine relations between these elements. First, we have the reflection equation, which comes from the existence of the braiding morphism  $c : \mathcal{X}^+(2)^{\otimes 2} \rightarrow \mathcal{X}^+(2)^{\otimes 2}$ :

$$\tilde{R}_{12} M_1 \tilde{R}_{21} M_2 = M_2 \tilde{R}_{12} M_1 \tilde{R}_{21}.$$

This equation is equivalent to the following exchange relations:

$$\begin{aligned} da &= ad, & db &= q^2 bd, & dc &= q^{-2} cd, \\ ba &= ab + q^{-1} \hat{q} bd, & cb &= bc + q^{-1} \hat{q} (da - d^2), & ca &= ac - q^{-1} \hat{q} dc. \end{aligned}$$

with  $\hat{q} = q - q^{-1}$ . Second, since  $\mathcal{X}^+(2)^{\otimes 2} \cong \mathcal{X}^+(1) \oplus \mathcal{X}^+(3)^3$ , there exists a unique (up to scalar) morphism  $\Phi : \mathbb{C} = \mathcal{X}^+(1) \rightarrow \mathcal{X}^+(2)^{\otimes 2}$ . It is easily computed:

$$\Phi(1) = qv_0 \otimes v_1 - v_1 \otimes v_0.$$

By fusion and naturality (4.3), we have

$$M_1 \tilde{R}_{21} M_2 \tilde{R}_{21}^{-1} \Phi = \begin{matrix} \mathcal{X}^+(2)^{\otimes 2} \\ M_{12} \end{matrix} \Phi = \begin{matrix} \mathbb{C} \\ \Phi M \end{matrix} = \Phi.$$

This gives just one new relation, which is the analogue of the quantum determinant (3.20):

$$ad - q^2 bc = 1.$$

Finally, let us compute the RSD isomorphism on  $M$ :

$$\Psi_{0,1} \begin{pmatrix} a & b \\ c & d \end{pmatrix} = \begin{matrix} \tilde{\mathcal{X}}^+(2) \\ L^{(+)} \end{matrix} \begin{matrix} \tilde{\mathcal{X}}^+(2) \\ L^{(-)-1} \end{matrix} = \begin{pmatrix} K^{1/2} & \hat{q} K^{1/2} F \\ 0 & K^{-1/2} \end{pmatrix} \begin{pmatrix} K^{1/2} & 0 \\ \hat{q} K^{-1/2} E & K^{-1/2} \end{pmatrix} = \begin{pmatrix} K + q^{-1} \hat{q}^2 FE & q^{-1} \hat{q} F \\ \hat{q} K^{-1} E & K^{-1} \end{pmatrix}.$$

We deduce the relations  $b^p = c^p = 0$  and  $d^{2p} = 1$  from the defining relations of  $\bar{U}_q$ .

<sup>3</sup>This decomposition does not hold if  $p = 2$ : in that case, we have  $\mathcal{X}^+(2)^{\otimes 2} \cong \mathcal{P}^+(1)$ . But there is still the morphism  $\Psi : \mathbb{C} \rightarrow \mathcal{X}^+(2)^{\otimes 2}$  which corresponds to sending  $\mathbb{C} = \mathcal{X}^+(1)$  in  $\mathrm{Soc}(\mathcal{P}^+(1))$ .

**Theorem 4.4.1.** *The algebra  $\mathcal{L}_{0,1}(\bar{U}_q)$  admits the following presentation:*

$$\left\langle a, b, c, d \left| \begin{array}{lll} da = ad, & db = q^2bd, & dc = q^{-2}cd \\ ba = ab + q^{-1}\hat{q}bd, & cb = bc + q^{-1}\hat{q}(da - d^2), & ca = ac - q^{-1}\hat{q}dc \\ ad - q^2bc = 1, & b^p = c^p = 0, & d^{2p} = 1 \end{array} \right. \right\rangle.$$

A basis is given by the monomials  $b^i c^j d^k$  with  $0 \leq i, j \leq p-1$ ,  $0 \leq k \leq 2p-1$ .

*Proof.* Let  $A$  be the algebra defined by this presentation. It is readily seen that  $a = d^{-1} + q^2bcd^{-1}$  and that the monomials  $b^i c^j d^k$  with  $0 \leq i, j \leq p-1$ ,  $0 \leq k \leq 2p-1$  linearly span  $A$ . Thus  $\dim(A) \leq 2p^3$ . But we know that  $2p^3 = \dim(\bar{U}_q) = \dim(\mathcal{L}_{0,1}(\bar{U}_q))$  since the monomials  $E^i F^j K^\ell$  with  $0 \leq i, j \leq p-1$ ,  $0 \leq \ell \leq 2p-1$  form the PBW basis of  $\bar{U}_q$ . It follows that  $\dim(A) \leq \dim(\mathcal{L}_{0,1}(\bar{U}_q))$ . Since these relations are satisfied in  $\mathcal{L}_{0,1}(\bar{U}_q)$ , there exists a surjection  $p : A \rightarrow \mathcal{L}_{0,1}(\bar{U}_q)$ . Thus  $\dim(A) \geq \dim(\mathcal{L}_{0,1}(\bar{U}_q))$ , and the theorem is proved.  $\square$

*Remark 4.4.2.* It is possible to get the relations  $b^p = c^p = 0$ ,  $d^{2p} = 1$  by fusion and naturality, as it was done in section 3.1.4. The big difference is that the fusion relation of  $\mathcal{L}_{0,1}(\bar{U}_q)$  is more complicated than the fusion relation of  $\mathcal{O}(\bar{U}_q)$  and consequently the matrices  $M^{\mathcal{X}^+(2)^{\otimes n}}$  are much more complicated than the matrices  $T^{\mathcal{X}^+(2)^{\otimes n}}$ . First one must show by induction *via* tedious matrix reasonings that

$$M^{\mathcal{X}^+(2)^{\otimes n}} = \begin{pmatrix} v_0^{\otimes p} & \dots & v_1^{\otimes p} \\ * & * & \lambda_n b^n \\ * & * & * \\ \mu_n c^n & * & d^n \end{pmatrix} \begin{matrix} v_0^{\otimes p} \\ \vdots \\ v_1^{\otimes p} \end{matrix}$$

where  $\lambda_n, \mu_n$  are non-zero scalars. Then one can take back the reasoning of section 3.1.4: the morphism  $f : \mathcal{P}^+(p-1) \rightarrow \mathcal{X}^+(2)^{\otimes p}$  will imply  $b^p = c^p = 0$  and the morphism  $f_2$  will imply  $d^{2p} = 1$ . In contrast, the relation  $a^{2p} = 1$  is not true in  $\mathcal{L}_{0,1}(\bar{U}_q)$ .  $\triangle$

*Remark 4.4.3.* Theorem 4.4.1 indicates that  $\mathcal{L}_{0,1}(\bar{U}_q)$  is a restricted version (*i.e.* a finite dimensional quotient by monomial central elements) of  $\mathcal{L}_{0,1}(U_q)^{\text{spe}}$ , the specialization at our root of unity  $q$  of the algebra  $\mathcal{L}_{0,1}(U_q)$ . A complete study of the algebra  $\mathcal{L}_{0,1}(U_q)^{\text{spe}}$  will appear in [BaR].  $\triangle$

Applying the isomorphism of algebras  $\mathcal{D}$  defined in (2.18) to the GTA basis of  $\text{SLF}(\bar{U}_q)$  (defined in section 3.2), we get a basis of  $\mathcal{Z}(\bar{U}_q) = \mathcal{L}_{0,1}^{\text{inv}}(\bar{U}_q)$ . We introduce notations for these basis elements<sup>4</sup>:

$$W^{\mathcal{X}^\epsilon(s)} = \mathcal{D}(\chi_s^\epsilon), \quad V^{s'} = \mathcal{D}(G_{s'}) \quad (4.31)$$

with  $1 \leq s \leq p$ ,  $\epsilon \in \{\pm\}$  and  $1 \leq s' \leq p-1$ . They satisfy the same multiplication rules than the elements of the GTA basis, see Theorem 3.4.1. Unwinding the definitions, this reads

$$\begin{aligned} W^{\mathcal{X}^\epsilon(s)} &= (\chi_s^\epsilon \otimes \text{id})((K^{p+1} \otimes 1)RR') \cong \text{tr}(K^{p+1} M^{\mathcal{X}^\epsilon(s) \mathcal{X}^\epsilon(s)}) \\ V^s &= (G_s \otimes \text{id})((K^{p+1} \otimes 1)RR') \cong \text{tr}(\sigma_s^{\mathcal{P}^+(s) \mathcal{P}^+(s)} K^{p+1} M^{\mathcal{P}^+(s) \mathcal{P}^+(s)}) + \text{tr}(\sigma_{p-s}^{\mathcal{P}^-(p-s) \mathcal{P}^-(p-s)} K^{p+1} M^{\mathcal{P}^-(p-s) \mathcal{P}^-(p-s)}) \end{aligned} \quad (4.32)$$

since we choose  $K^{p+1}$  as pivotal element and where  $\cong$  is the identification  $\mathcal{L}_{0,1}(\bar{U}_q) = \bar{U}_q$  *via*  $\Psi_{0,1}$  (recall that usually we use this identification without mention). In particular, the expression (3.16) of  $RR'$  allows us to compute that

$$W^{\mathcal{X}^+(2)} = -qa - q^{-1}d = \mathcal{D}(\chi_2^+) = -\hat{q}^2 FE - qK - q^{-1}K^{-1} = -\hat{q}^2 C \quad (4.33)$$

<sup>4</sup>The elements  $\chi(s)$  defined in [GT09] correspond to  $[s]V^s$  here



where  $C$  is the Casimir element (3.12).

Similarly, we define  $\mathcal{L}_{1,0}(\bar{U}_q)$  as the quotient of  $\mathcal{L}_{0,1}(\bar{U}_q) * \mathcal{L}_{0,1}(\bar{U}_q)$  by the exchange relations:

$$\tilde{I}\tilde{J} \begin{matrix} I \\ R_{12}B_1(R')_{12}A_2 \end{matrix} = A_2R_{12}B_1(R^{-1})_{12} \begin{matrix} \tilde{I}\tilde{J} \\ J \end{matrix}$$

where  $I, J$  are simple modules or PIMs and  $\tilde{I}, \tilde{J}$  are liftings of  $I$  and  $J$ . From (4.30), we see again that this does not depend on the choice of  $\tilde{I}$  and  $\tilde{J}$ . The coefficients of  $\begin{matrix} \mathcal{X}^+(2) \\ A \end{matrix}$  and of  $\begin{matrix} \mathcal{X}^+(2) \\ B \end{matrix}$ :

$$A = \begin{pmatrix} a_1 & b_1 \\ c_1 & d_1 \end{pmatrix}, \quad B = \begin{pmatrix} a_2 & b_2 \\ c_2 & d_2 \end{pmatrix}$$

generate  $\mathcal{L}_{1,0}(\bar{U}_q)$ . Using the commutation relations of the Heisenberg double, it is easy to show that  $\Psi_{1,0}$  indeed takes values in  $\mathcal{H}(\mathcal{O}(\bar{U}_q))$  (the square root of  $K$  does not appear). In order to obtain a presentation of  $\mathcal{L}_{1,0}(\bar{U}_q)$ , one can again restrict to  $I = J = \mathcal{X}^+(2)$  and write down the corresponding exchange relations together with the relations coming from the fact that the variables  $a_i, b_i, c_i, d_i$  ( $i = 1, 2$ ) generate a copy of  $\mathcal{L}_{0,1}(\bar{U}_q)$ . We do not give this presentation of  $\mathcal{L}_{1,0}(\bar{U}_q)$  since it is quite cumbersome and we will not use it in this work. Let us just mention that the monomials

$$b_1^i c_1^j d_1^k b_2^l c_2^m d_2^n, \quad 0 \leq i, j, l, m \leq p-1, \quad 0 \leq k, n \leq 2p-1 \quad (4.34)$$

form a basis. Indeed, they are a generating set thanks to the exchange relations and to the restriction relations  $b_1^p = c_1^p = b_2^p = c_2^p = 0, d_1^{2p} = d_2^{2p} = 1$ ; moreover, the number of such monomials is  $4p^6 = \dim(\mathcal{L}_{1,0}(\bar{U}_q))$ . The generators  $a_1, a_2$  do not appear in the monomial basis because they can be expressed as  $a_1 = d_1^{-1} + q^2 b_1 c_1 d_1^{-1}, a_2 = d_2^{-1} + q^2 b_2 c_2 d_2^{-1}$ .

In view of the next section, let us precise that by definition (see (4.14) and (4.32)) we have

$$W_X^{\mathcal{X}^c(s)} = \mathrm{tr}(K^{\mathcal{X}^c(s)+1} X^{\mathcal{X}^c(s)}), \quad V_X^s = \mathrm{tr}(\sigma_s K^{\mathcal{P}^+(s)+1} X^{\mathcal{P}^+(s)}) + \mathrm{tr}(\sigma_{p-s} K^{\mathcal{P}^-(p-s)+1} X^{\mathcal{P}^-(p-s)}), \quad (4.35)$$

where  $X$  is any product of the matrices  $B, A$  with some normalization by  $v^r$ , for instance  $X = A, X = B, X = vB^{-1}A$ .

### 4.4.3 Explicit description of the $\mathrm{SL}_2(\mathbb{Z})$ -projective representation

Note that it can be shown directly that  $\bar{U}_q$  is unimodular and unibalanced, see for instance [Iba15, Cor. II.2.8] (also note that in [BBGa18] it is shown that all the simply laced restricted quantum groups at roots of unity are unibalanced).

**Proposition 4.4.4.** *For all  $z \in \mathcal{Z}(\bar{U}_q)$ ,  $S(z) = z$  and for all  $\psi \in \mathrm{SLF}(\bar{U}_q)$ ,  $S(\psi) = \psi$ . It follows that in the case of  $\bar{U}_q$ ,  $\rho_{\mathrm{SLF}}$  is in fact a projective representation of  $\mathrm{PSL}_2(\mathbb{Z})$ .*

*Proof.* By [FGST06a, Appendix D], the canonical central elements are expressed as  $e_s = P_s(C)$ ,  $w_s^\pm = \pi_s^\pm Q_s(C)$  where  $P_s$  and  $Q_s$  are polynomials,  $C$  is the Casimir element (3.12) and  $\pi_s^\pm$  are discrete Fourier transforms of  $(K^j)_{0 \leq j \leq 2p-1}$ . It is easy to check that  $S(C) = C$  and that  $S(\pi_s^\pm) = \pi_s^\pm$ , thus  $S(e_s) = e_s$  and  $S(w_s^\pm) = w_s^\pm$ . Next, let  $\psi \in \mathrm{SLF}(\bar{U}_q)$ . Since  $\gamma_g$  is an isomorphism, we can write  $\psi = \gamma_g(z) = \mu^r(gS(z))$  with  $z \in \mathcal{Z}(\bar{U}_q)$ . Then:

$$S(\psi) = S(\mu^r(gz)) = \mu^r \circ S(?zg^{-1}) = \mu^l(g^{-1}z?) = \mu^r(gz?) = \psi.$$

We used that  $S(z) = z$ , Proposition 2.3.4 and the fact that  $\bar{U}_q$  is unibalanced.  $\square$

We want to determine the action of  $\theta_1(\tau_a) = \rho_{\mathrm{SLF}}(v_A^{-1})$  and  $\theta_1(\tau_b) = \rho_{\mathrm{SLF}}(v_B^{-1})$  on the GTA basis. For this, we will need the expression (3.17) of  $v^{\pm 1}$  in the canonical basis of  $\mathcal{Z}(\bar{U}_q)$ , the formulas (3.27) for the action (3.26) of  $\mathcal{Z}(\bar{U}_q)$  on  $\mathrm{SLF}(\bar{U}_q)$ , the multiplication rules in the GTA basis (Theorem 3.4.1) and the following lemma (in which we use the notation (4.14)).

**Lemma 4.4.5.** *Let  $z \in \mathcal{L}_{0,1}^{\text{inv}}(H) = \mathcal{Z}(H)$  and let  $\psi \in \text{SLF}(H)$ . Then:*

$$z_{v_B^{-1}A} \triangleright \psi = S(\mathcal{D}^{-1}(z)) \psi.$$

*Proof.* The proof is analogous to those of the two similar results in section 4.2.3 and is thus left to the reader. Note that this lemma is not specific to the case of  $\bar{U}_q$ .  $\square$

**Theorem 4.4.6.** *Let  $\theta_1 : \text{SL}_2(\mathbb{Z}) \rightarrow \text{PGL}(\bar{U}_q^*)$  be the projective representation obtained in Theorem 4.3.7, with gauge algebra  $\bar{U}_q = \bar{U}_q(\mathfrak{sl}_2)$ . The representations of the Dehn twists  $\tau_a$  and  $\tau_b$  on the GTA basis are given by:*

$$\theta_1(\tau_a)(\chi_s^\epsilon) = v_{\chi^\epsilon(s)}^{-1} \chi_s^\epsilon, \quad \theta_1(\tau_a)(G_{s'}) = v_{\chi^+(s')}^{-1} G_{s'} - v_{\chi^+(s')}^{-1} \hat{q} \left( \frac{p-s'}{[s']} \chi_{s'}^+ - \frac{s'}{[s']} \chi_{p-s'}^- \right)$$

and

$$\begin{aligned} \theta_1(\tau_b)(\chi_s^\epsilon) &= \xi \epsilon (-\epsilon)^{p-1} s q^{-(s^2-1)} \left( \sum_{\ell=1}^{p-1} (-1)^s (-\epsilon)^{p-\ell} (q^{\ell s} + q^{-\ell s}) (\chi_\ell^+ + \chi_{p-\ell}^-) + \chi_p^+ + (-\epsilon)^p (-1)^s \chi_p^- \right) \\ &\quad + \xi \epsilon (-1)^s q^{-(s^2-1)} \sum_{j=1}^{p-1} (-\epsilon)^{j+1} [j][js] G_j, \end{aligned}$$

$$\theta_1(\tau_b)(G_{s'}) = \xi (-1)^{s'} q^{-(s'^2-1)} \frac{\hat{q} p}{[s']} \sum_{j=1}^{p-1} (-1)^{j+1} [j][js'] \left( 2G_j - \hat{q} \frac{p-j}{[j]} \chi_j^+ + \hat{q} \frac{j}{[j]} \chi_{p-j}^- \right),$$

with  $\epsilon \in \{\pm\}$ ,  $0 \leq s \leq p$ ,  $1 \leq s' \leq p-1$  and  $\xi^{-1} = \frac{1-i}{2\sqrt{p}} \frac{\hat{q}^{p-1}}{[p-1]!} (-1)^p q^{-(p-3)/2}$ .

*Proof.* The formulas for  $\theta_1(\tau_a) = \rho_{\text{SLF}}(v_A^{-1})$  are easily deduced from Proposition 4.2.14, (3.17) and (3.27). Computing the action of  $\theta_1(\tau_b) = \rho_{\text{SLF}}(v_B^{-1})$  is more difficult. We will use the commutation relations of  $v_B^{-1}$  with the  $A, B$ -matrices, namely

$$v_B^{-1} \overset{I}{A} = \overset{I}{v} \overset{I}{B}^{-1} \overset{I}{A} v_B^{-1}, \quad v_B^{-1} \overset{I}{B} = \overset{I}{B} v_B^{-1} \quad (4.36)$$

to compute the action of  $v_B^{-1}$  by induction. The multiplication rules of the GTA basis (Theorem 3.4.1) will be used several times. Let us denote

$$v_B^{-1} \triangleright \chi_s^\epsilon = \sum_{\sigma \in \{\pm\}} \sum_{\ell=1}^p \lambda_\ell^\sigma(\epsilon, s) \chi_\ell^\sigma + \sum_{j=1}^{p-1} \delta_j(\epsilon, s) G_j.$$

Taking the quantum trace of relation (4.36) provides  $v_B^{-1} \overset{\mathcal{X}^+(2)}{W}_A = \overset{\mathcal{X}^+(2)}{W}_{v_B^{-1}A} v_B^{-1}$  (recall (4.35)). On the one hand, we obtain by (4.33), (3.13) and (3.27):

$$v_B^{-1} \overset{\mathcal{X}^+(2)}{W}_A \triangleright \chi_s^\epsilon = v_B^{-1} \triangleright \chi_s^\epsilon (-\hat{q}^2 C?) = \sum_{\substack{\ell=1 \\ \sigma \in \{\pm\}}}^p -\epsilon (q^s + q^{-s}) \lambda_\ell^\sigma(\epsilon, s) \chi_\ell^\sigma + \sum_{j=1}^{p-1} -\epsilon (q^s + q^{-s}) \delta_j(\epsilon, s) G_j.$$

On the other hand, we use Lemma 4.4.5 together with (4.31) and the multiplication rules:

$$\begin{aligned} \overset{\mathcal{X}^+(2)}{W}_{v_B^{-1}A} v_B^{-1} \triangleright \chi_s^\epsilon &= \sum_{\sigma \in \{\pm\}} \sum_{\ell=1}^p \lambda_\ell^\sigma(\epsilon, s) \chi_2^+ \chi_\ell^\sigma + \sum_{j=1}^{p-1} \delta_j(\epsilon, s) \chi_2^+ G_j \\ &= \sum_{\sigma \in \{\pm\}} (\lambda_2^\sigma(\epsilon, s) + 2\lambda_p^{-\sigma}(\epsilon, s)) \chi_1^\sigma + \sum_{\ell=2}^{p-2} (\lambda_{s-1}^\sigma(\epsilon, s) + \lambda_{s+1}^\sigma(\epsilon, s)) \chi_\ell^\sigma + (\lambda_{p-2}^\sigma(\epsilon, s) + 2\lambda_p^\sigma(\epsilon, s)) \chi_{p-1}^\sigma \\ &\quad + \lambda_{p-1}^\sigma(\epsilon, s) \chi_p^\sigma + \frac{\delta_2(\epsilon, s)}{[2]} G_1 + \sum_{j=2}^{p-2} [j] \left( \frac{\delta_{j-1}(\epsilon, s)}{[j-1]} + \frac{\delta_{j+1}(\epsilon, s)}{[j+1]} \right) G_j + \frac{\delta_{p-2}(\epsilon, s)}{[2]} G_{p-1}. \end{aligned}$$

This gives recurrence equations between the coefficients which are easily solved:

$$v_B^{-1} \triangleright \chi_s^\epsilon = \lambda(\epsilon, s) \left( \sum_{\ell=1}^{p-1} (-1)^s (-\epsilon)^{p-\ell} (q^{\ell s} + q^{-\ell s}) (\chi_\ell^+ + \chi_{p-\ell}^-) + \chi_p^+ + (-\epsilon)^p (-1)^s \chi_p^- \right) \\ + \delta(\epsilon, s) \sum_{j=1}^{p-1} (-\epsilon)^{j+1} \frac{[j][j s]}{[s]} G_j.$$

The coefficients  $\lambda(\epsilon, s) = \lambda_p^+(\epsilon, s)$  and  $\delta(\epsilon, s) = \delta_1(\epsilon, s)$  are still unknown. In order to compute them by induction, we use the relation  $v_B^{-1} W_B^{\mathcal{X}^+(2)} = W_B^{\mathcal{X}^+(2)} v_B^{-1}$ , which is another consequence of (4.36) (and of (4.35)). Before, note that

$$W_B^{\mathcal{X}^+(2)} \triangleright \chi_s^\epsilon = (\chi_2^+(\chi_s^\epsilon)^v)^{v^{-1}} = \frac{v_{\mathcal{X}^\epsilon(s)}}{v_{\mathcal{X}^\epsilon(s-1)}} \chi_{s-1}^\epsilon + \frac{v_{\mathcal{X}^\epsilon(s)}}{v_{\mathcal{X}^\epsilon(s+1)}} \chi_{s+1}^\epsilon = -\epsilon q^{-s+\frac{1}{2}} \chi_{s-1}^\epsilon - \epsilon q^{s+\frac{1}{2}} \chi_{s+1}^\epsilon.$$

with  $1 \leq s \leq p-1$  and the convention that  $\chi_0^\pm = 0$ . It follows that

$$v_B^{-1} \triangleright \chi_{s+1}^\epsilon = -\epsilon q^{-s-\frac{1}{2}} W_B^{\mathcal{X}^+(2)} \triangleright (v_B^{-1} \triangleright \chi_s^\epsilon) - q^{-2s} v_B^{-1} \triangleright \chi_{s-1}^\epsilon. \quad (4.37)$$

Due to (3.17), (3.27) and the multiplication rules, we have

$$W_B^{\mathcal{X}^+(2)} \triangleright (v_B^{-1} \triangleright \chi_s^\epsilon) = (\chi_2^+(v_B^{-1} \triangleright \chi_s^\epsilon)^v)^{v^{-1}} = \frac{v_{\mathcal{X}^+(p-1)}}{v_{\mathcal{X}^+(p)}} (\lambda_{p-1}^+(\epsilon, s) + \hat{q} \delta_{p-1}(\epsilon, s)) \chi_p^+ + \frac{v_{\mathcal{X}^+(2)}}{[2]} \delta_2(\epsilon, s) G_1 + \dots$$

where the dots (...) mean the remaining of the linear combination in the GTA basis. After replacing by the values found previously and inserting in relation (4.37), this yields

$$\lambda(\epsilon, s+1) \chi_p^+ + \delta(\epsilon, s+1) G_1 + \dots \\ = (q^{-(s+1)} (q^s + q^{-s}) \lambda(\epsilon, s) - q^{-2s} \lambda(\epsilon, s-1) + (-\epsilon)^{p-1} (-1)^{s-1} \hat{q} q^{-(s+1)} \delta(\epsilon, s)) \chi_p^+ \\ + (-q^{-(s+2)} (q^s + q^{-s}) \delta(\epsilon, s) - q^{-2s} \delta(\epsilon, s-1)) G_1 + \dots$$

These are recurrence equations. It just remains to determine the first values  $\lambda(\epsilon, 1)$ ,  $\delta(\epsilon, 1)$ . Observe that, since  $\bar{U}_q$  is unbalanced:

$$v_B^{-1} \triangleright \chi_1^+ = (\varphi_{v^{-1}}(\chi_1^+)^v)^{v^{-1}} = \mu^l(v)^{-1} \mu^l(K^{p-1} v^?)^{v^{-1}} = \mu^l(v)^{-1} \mu^r(K^{p+1}?). \quad (4.38)$$

In (3.29), the decomposition of  $\mu^r(K^{p+1}?)$  in the GTA is given (when  $\mu^r$  is suitably normalized). Thanks to this, we obtain

$$v_B^{-1} \triangleright \chi_1^+ = \lambda(+, 1) \chi_p^+ + \delta(+, 1) G_1 + \dots = \xi (-1)^{p-1} \chi_p^+ - \xi G_1 + \dots$$

and

$$v_B^{-1} \triangleright \chi_1^- = v_{\mathcal{X}^-(1)} v_B^{-1} W_B^{\mathcal{X}^-(1)} \triangleright \chi_1^+ = v_{\mathcal{X}^-(1)} W_B^{\mathcal{X}^-(1)} \triangleright v_B^{-1} \triangleright \chi_1^+ = v_{\mathcal{X}^-(1)} (\chi_1^- (v_B^{-1} \triangleright \chi_1^+)^v)^{v^{-1}} \\ = -\xi \chi_p^+ + \xi G_1 + \dots = \lambda(-, 1) \chi_p^+ + \delta(-, 1) G_1 + \dots$$

The scalar  $\xi$  does not depend on the choice of  $\mu^r$  thanks to the factor  $\mu^l(v)^{-1} = \mu^l \circ S(v)^{-1} = \mu^r(v)^{-1}$  in (4.38). Using the formulas [FGST06a] for  $\mu^r$  and  $v$  in the PBW basis to compute  $\mu^r(v)$  gives the value of  $\xi$ . We are now in position to solve the recurrence equations. It is easy to check that the solutions are

$$\delta(\epsilon, s) = \xi \epsilon (-1)^s q^{-(s^2-1)} [s], \quad \lambda(\epsilon, s) = \xi \epsilon (-\epsilon)^{p-1} s q^{-(s^2-1)}.$$

We now proceed with the proof of the formula for  $G_{s'}$ . Relation (4.36) implies  $v_B^{-1}V_B^1 = V_B^1v_B^{-1}$  (see (4.35)). By (3.17), (3.27) and the multiplication rules, we have on the one hand:

$$v_B^{-1}V_B^1 \triangleright \chi_s^+ = v_B^{-1} \triangleright (G_1(\chi_s^+)^v)^{v^{-1}} = [s]v_B^{-1} \triangleright G_s - \hat{q}(p-s)v_B^{-1} \triangleright \chi_s^+ + \hat{q}s v_B^{-1} \triangleright \chi_{p-s}^-$$

whereas on the other hand:

$$V_B^1v_B^{-1} \triangleright \chi_s^+ = (G_1(v_B^{-1} \triangleright \chi_s^+)^v)^{v^{-1}} = \hat{q}p \sum_{j=1}^{p-1} \delta_j(+, s) \left( G_j - \hat{q} \frac{p-j}{[j]} \chi_j^+ + \hat{q} \frac{j}{[j]} \chi_{p-j}^- \right).$$

Equalizing both sides and inserting the previously found values, we obtain the desired formula.  $\square$

*Remark 4.4.7.* The guiding principle of the previous computations was that the multiplication of two symmetric linear forms in the GTA basis is easy when one of them is  $\chi_2^+$ ,  $\chi_1^-$  or  $G_1$  (see Theorem 3.4.1), and that all the formulas can be derived from  $v_B^{-1} \triangleright \chi_1^+$  using only such products.  $\triangle$

Recall that the standard representation  $\mathbb{C}^2$  of  $\mathrm{SL}_2(\mathbb{Z}) = \mathrm{MCG}(\Sigma_{1,0})$  is defined by

$$\tau_a \mapsto \begin{pmatrix} 1 & 0 \\ -1 & 1 \end{pmatrix}, \quad \tau_b \mapsto \begin{pmatrix} 1 & 1 \\ 0 & 1 \end{pmatrix}.$$

**Lemma 4.4.8.** *Let  $V$  be a (projective) representation of  $\mathrm{SL}_2(\mathbb{Z})$  which admits a basis  $(x_s, y_s)$  such that*

$$\begin{aligned} \tau_a x_s &= \sum_{\ell} a_{\ell}(s) x_{\ell}, & \tau_b x_s &= \sum_{\ell} b_{\ell}(s) (x_{\ell} + y_{\ell}) \\ \tau_a y_s &= \sum_{\ell} a_{\ell}(s) (y_{\ell} - x_{\ell}), & \tau_b y_s &= \sum_{\ell} b_{\ell}(s) y_{\ell}. \end{aligned}$$

*Then there exists a (projective) representation  $W$  of  $\mathrm{SL}_2(\mathbb{Z})$  such that  $V \cong \mathbb{C}^2 \otimes W$ . More precisely,  $W$  admits a basis  $(w_s)$  such that*

$$\tau_a w_s = \sum_{\ell} a_{\ell}(s) w_{\ell}, \quad \tau_b w_s = \sum_{\ell} b_{\ell}(s) w_{\ell}.$$

*Proof.* It is easy to check that the formulas for  $\tau_a w_s$  and  $\tau_b w_s$  indeed define a  $\mathrm{SL}_2(\mathbb{Z})$ -representation on  $W$ . Let  $(e_1, e_2)$  be the canonical basis of  $\mathbb{C}^2$ . Then

$$e_1 \otimes w_s \mapsto y_s, \quad e_2 \otimes w_s \mapsto x_s$$

is an isomorphism which intertwines the  $\mathrm{SL}_2(\mathbb{Z})$ -action.  $\square$

**Theorem 4.4.9.** *The  $(p+1)$ -dimensional subspace  $\mathcal{P} = \mathrm{vect}(\chi_s^+ + \chi_{p-s}^-, \chi_p^+, \chi_p^-)_{1 \leq s \leq p-1}$  is stable under the  $\mathrm{SL}_2(\mathbb{Z})$ -action of Theorem 4.4.6. Moreover, there exists a  $(p-1)$ -dimensional projective representation  $\mathcal{W}$  of  $\mathrm{SL}_2(\mathbb{Z})$  such that*

$$\mathrm{SLF}(\bar{U}_q) = \mathcal{P} \oplus (\mathbb{C}^2 \otimes \mathcal{W}).$$

*Proof.* By Corollary 3.4.2,  $\mathcal{P}$  is an ideal of  $\mathrm{SLF}(\bar{U}_q)$ . It is easy to see that  $\mathcal{P}$  is moreover stable under the action (3.27) of  $\mathcal{Z}(\bar{U}_q)$ . Thus we deduce without any computation that  $\mathcal{P}$  is  $\mathrm{SL}_2(\mathbb{Z})$ -stable. Next, in view of the formulas in Theorem 4.4.6, it is natural to define

$$x_s = \hat{q} \frac{p-s}{[s]} \chi_s^+ - \hat{q} \frac{s}{[s]} \chi_{p-s}^-, \quad y_s = G_s - x_s.$$

Then:

$$\begin{aligned} \theta_1(\tau_a)(x_s) &= v_{\mathcal{X}^+(s)}^{-1} x_s, & \theta_1(\tau_b)(x_s) &= \xi(-1)^s q^{-(s^2-1)} \frac{\hat{q}p}{[s]} \sum_{j=1}^{p-1} (-1)^{j+1} [j][js] (x_j + y_j) \\ \theta_1(\tau_a)(y_s) &= v_{\mathcal{X}^+(s)}^{-1} (y_s - x_s), & \theta_1(\tau_b)(y_s) &= \xi(-1)^s q^{-(s^2-1)} \frac{\hat{q}p}{[s]} \sum_{j=1}^{p-1} (-1)^{j+1} [j][js] y_j. \end{aligned}$$

The result follows from Lemma 4.4.8. □

We precise that, explicitly, the projective representation  $\mathcal{W}$  has a basis  $(w_s)_{1 \leq s \leq p-1}$  such that

$$\tau_a w_s = v_{\chi^+(s)}^{-1} w_s, \quad \tau_b w_s = \xi(-1)^s q^{-(s^2-1)} \frac{\hat{q}p}{[s]} \sum_{j=1}^{p-1} (-1)^{j+1} [j][js] w_j. \quad (4.39)$$

The structure of the Lyubashenko-Majid representation on  $\mathcal{Z}(\bar{U}_q)$ , which by Theorem 4.3.10 is equivalent to the one constructed here, was described in [FGST06a] in relation to logarithmic conformal field theory. Theorem 4.4.9 is in perfect agreement with their result.

*Remark 4.4.10.* The subspace  $\mathcal{P}$  appearing in Theorem 4.4.9 is spanned as a vector space by the characters of the projective  $\bar{U}_q$ -modules. Indeed, since the characters split on extensions, we have  $\chi^{\mathcal{P}^+(s)} = \chi^{\mathcal{P}^-(s)} = 2(\chi_s^+ + \chi_{p-s}^-)$  for  $1 \leq s \leq p-1$  and the simple projective modules  $\mathcal{X}^\pm(p) = \mathcal{P}^\pm(p)$  give  $\chi_p^\pm$ .

#### 4.4.4 A conjecture about the representation of $\mathcal{L}_{1,0}^{\mathrm{inv}}(\bar{U}_q)$ on $\mathrm{SLF}(\bar{U}_q)$

Another natural (but harder) question is to determine the structure of  $\mathrm{SLF}(\bar{U}_q)$  under the action of  $\mathcal{L}_{1,0}^{\mathrm{inv}}(\bar{U}_q)$ <sup>5</sup>. As mentioned in the proof of Theorem 4.4.9, the subspace  $\mathcal{P} = \mathrm{vect}(\chi_s^+ + \chi_{p-s}^-, \chi_p^\pm)_{1 \leq s \leq p-1}$  is quite “stable”. We propose the following conjecture.

**Conjecture 4.4.11.**  $\mathcal{P}$  is a  $\mathcal{L}_{1,0}^{\mathrm{inv}}(\bar{U}_q)$ -submodule of  $\mathrm{SLF}(\bar{U}_q)$ .

In order to prove this conjecture one needs to find a basis or a generating set of  $\mathcal{L}_{1,0}^{\mathrm{inv}}(\bar{U}_q)$ , and then to show that  $\mathcal{P}$  is stable under the action of the basis elements (or of the generating elements). Both tasks are difficult.

Recall that since  $\mathcal{P}$  is an ideal of  $\mathrm{SLF}(\bar{U}_q)$  which is stable under the action (3.27) of  $\mathcal{Z}(\bar{U}_q)$ , it follows from the formulas of Proposition 4.2.14 and Lemma 4.4.5 that  $\mathcal{P}$  is stable under the representations of  $z_A$ ,  $z_B$  and  $z_{B^{-1}A}$  for all  $z \in \mathcal{Z}(\bar{U}_q) = \mathcal{L}_{0,1}^{\mathrm{inv}}(\bar{U}_q)$ . Also recall the wide family of invariants given in (4.13); we can try to test the conjecture with them. A long computation (which is not specific to  $\bar{U}_q$ ) shows that

$$\mathrm{tr}_{12} \left( \begin{array}{ccc} I \otimes J & I & IJ \\ g_{12} \Phi_{12} A_1 & (R')_{12} & B_2 R_{12} \end{array} \right) \triangleright \chi^K = v_J \mathrm{tr}_{13} \left( \begin{array}{cc} I \otimes K & I \otimes K^{-1} \\ T_{13} & v_{13}^{-1} s_{IJ,K}(\Phi)_{13} \end{array} \right)$$

where  $\chi^K$  is the character of  $K$ ,  $v = v_J \mathrm{id}$  (note that we may assume that  $I, J, K$  are simple modules) and

$$s_{IJ,K}(\Phi) = \mathrm{tr}_2 \left( \begin{array}{cc} J & JK \\ g_2 R_{23} \Phi_{12} & (R')_{23} \end{array} \right).$$

Proving that  $\mathcal{P}$  is stable under the action of these invariants amounts to show symmetry properties between  $s_{IJ, \mathcal{X}^+(s)}$  and  $s_{IJ, \mathcal{X}^-(p-s)}$  for all simple  $\bar{U}_q$ -modules  $I, J$ . We have checked that it is true if  $\Phi = \mathrm{id}_{I \otimes J}$  (in this case  $s_{IJ,K}(\mathrm{id}_{I \otimes J}) = s_{J,K} \mathrm{id}_{I \otimes K}$ , where  $s_{J,K}$  is the usual  $S$ -matrix) for all simple modules  $I, J$ , and also that it holds for  $I = J = \mathcal{X}^+(2)$  with every  $\Phi$ .

**Proposition 4.4.12.** 1)  $\mathrm{SLF}(\bar{U}_q)$  is indecomposable as a  $\mathcal{L}_{1,0}^{\mathrm{inv}}(\bar{U}_q)$ -module.

2) Assume that Conjecture 4.4.11 holds. Then the  $\mathcal{L}_{1,0}^{\mathrm{inv}}(\bar{U}_q)$ -modules  $\mathcal{P}$  and  $\mathrm{SLF}(\bar{U}_q)/\mathcal{P}$  are simple. It follows that  $\mathrm{SLF}(\bar{U}_q)$  has length 2 as a  $\mathcal{L}_{1,0}^{\mathrm{inv}}(\bar{U}_q)$ -module.

<sup>5</sup>A weakened version of this problem will be solved in section 6.5.1, where we determine the structure of  $\mathrm{SLF}(\bar{U}_q)$  under the action of the subalgebra  $\mathbb{C}\langle W_A, W_B \rangle \subsetneq \mathcal{L}_{1,0}^{\mathrm{inv}}(\bar{U}_q)$ ; this subalgebra generated by  $W_A$  and  $W_B$  is the image of the skein algebra of the torus  $\mathcal{S}_q(\Sigma_1)$  by the Wilson loop map  $W$ , which will be defined in Chapter 6.

*Proof.* These are basically consequences of (3.27) and of the multiplication rules in the GTA basis (Theorem 3.4.1). To avoid particular cases, let  $\chi_0^\epsilon = 0$ ,  $\chi_{p+1}^\epsilon = \chi_1^{-\epsilon}$ ,  $\chi_{-1}^\epsilon = \chi_{p-1}^{-\epsilon}$  and  $e_{-1} = e_{p+1} = 0$ . 1) Observe that  $\text{SLF}(\bar{U}_q)$  is generated by  $\chi_1^+ = \varepsilon$  as a  $\mathcal{L}_{1,0}^{\text{inv}}(\bar{U}_q)$ -module: this is a general fact which follows immediately from Lemma 4.4.5. Explicitly:

$$W_{vB^{-1}A}^{\mathcal{X}^\epsilon(s)} \triangleright \chi_1^+ = \chi_s^\epsilon \chi_1^+ = \chi_s^\epsilon, \quad V_{vB^{-1}A}^s \triangleright \chi_1^+ = G_s \chi_1^+ = G_s.$$

Write  $\text{SLF}(\bar{U}_q) = U_1 \oplus U_2$ . At least one of the two subspaces  $U_1, U_2$  necessarily contains an element of the form  $u = G_1 + \sum_{i \neq 1} \lambda_i G_i + \sum_{j, \epsilon} \eta_j^\epsilon \chi_j^\epsilon$ ; assume that it is  $U_1$ . Then  $(w_1^+)_A \triangleright u = \chi_1^+ \in U_1$  thanks to (3.27). It follows that  $U_1 = \text{SLF}(\bar{U}_q)$  and  $U_2 = \{0\}$ , as desired.

2) Let  $0 \neq U \subset \mathcal{P}$  be a submodule, and let  $v = \sum_{j=0}^p \lambda_j (\chi_j^+ + \chi_{p-j}^-) \in U$  with  $\lambda_s \neq 0$  for some  $s$ . Then using Proposition 4.2.14 and (3.27), we get  $(e_s)_A \triangleright v = \lambda_s (\chi_s^+ + \chi_{p-s}^-)$ , and thus  $\chi_s^+ + \chi_{p-s}^- \in U$ .

Apply  $W_{vB^{-1}A}^{\mathcal{X}^+(2)}$  (we use Lemma 4.4.5 and Proposition 4.4.4):

$$W_{vB^{-1}A}^{\mathcal{X}^+(2)} \triangleright (\chi_s^+ + \chi_{p-s}^-) = \chi_2^+ (\chi_s^+ + \chi_{p-s}^-) = (\chi_{s-1}^+ + \chi_{p-s+1}^-) + (\chi_{s+1}^+ + \chi_{p-s-1}^-).$$

Hence:

$$\begin{aligned} (e_{s-1})_A W_{vB^{-1}A}^{\mathcal{X}^+(2)} \triangleright (\chi_s^+ + \chi_{p-s}^-) &= \chi_{s-1}^+ + \chi_{p-s+1}^- \\ (e_{s+1})_A W_{vB^{-1}A}^{\mathcal{X}^+(2)} \triangleright (\chi_s^+ + \chi_{p-s}^-) &= \chi_{s+1}^+ + \chi_{p-s-1}^-. \end{aligned}$$

It follows that  $\chi_{s-1}^+ + \chi_{p-s+1}^-$ ,  $\chi_{s+1}^+ + \chi_{p-s-1}^- \in U$ . Continuing like this, one gets step by step that all the basis vectors belong to  $U$ , hence  $U = \mathcal{P}$ .

Next, let  $\bar{G}_s$  and  $\bar{\chi}_s^+$  be the classes of  $G_s$  and  $\chi_s^+$  modulo  $\mathcal{P}$  (with  $\bar{\chi}_0^+ = \bar{\chi}_p^+ = 0$ ). Let  $0 \neq U \subset \text{SLF}(\bar{U}_q)/\mathcal{P}$  be a submodule and  $w = \sum_{j=1}^{p-1} \nu_j \bar{G}_j + \sigma_j \bar{\chi}_j^+ \in U$  be non-zero. If all the  $\nu_j$  are 0, then there exists  $\sigma_s \neq 0$  and  $(e_s)_A \triangleright w = \sigma_s \bar{\chi}_s^+ \in U$ . If one of the  $\nu_j$ , say  $\nu_s$ , is non-zero, then  $(w_s^+)_A \triangleright w = \nu_s \bar{\chi}_s^+ \in U$ . In both cases we get  $\bar{\chi}_s^+ \in U$ . Now we proceed as previously:

$$(e_{s-1})_A W_{vB^{-1}A}^{\mathcal{X}^+(2)} \triangleright \bar{\chi}_s^+ = \bar{\chi}_{s-1}^+, \quad (e_{s+1})_A W_{vB^{-1}A}^{\mathcal{X}^+(2)} \triangleright \bar{\chi}_s^+ = \bar{\chi}_{s+1}^+.$$

Thus we get step by step that  $\bar{\chi}_j^+ \in U$  for all  $j$ . Apply  $V_{vB^{-1}A}^1$  and use Corollary 3.4.2:

$$V_{vB^{-1}A}^1 \triangleright \bar{\chi}_j^+ = G_1 \chi_j^+ + \mathcal{P} = [j]G_j + \mathcal{P}.$$

It follows that  $\bar{G}_j \in U$  for all  $j$ , and thus  $U = \text{SLF}(\bar{U}_q)/\mathcal{P}$  as desired.  $\square$

*Remark 4.4.13.* As suggested to me by A. Gainutdinov, we can extend Conjecture 4.4.11 to any finite dimensional, factorizable, ribbon Hopf algebra  $H$ . Let  $\mathcal{P}_H = \text{vect}(\chi^P)_{P \in \text{Proj}(H)} \subset \text{SLF}(H)$ , where  $\text{Proj}(H) \subset \text{mod}_l(H)$  is the subcategory (in fact, the ideal) of finite dimensional projective  $H$ -modules and  $\chi^P = \text{tr}(\overset{P}{T})$  is the character of  $P$  (we can restrict  $P$  to be some PIM).

**Generalized Conjecture 4.4.11.**  $\mathcal{P}_H$  is a  $\mathcal{L}_{1,0}^{\text{inv}}(H)$ -submodule of  $\text{SLF}(H)$ .

Note that it is known that  $\mathcal{P}_H$  is stable under the Lyubashenko-Majid  $\text{SL}_2(\mathbb{Z})$ -action ([CW08], also see [GR17b]). Hence, by Theorem 4.3.10,  $\mathcal{P}_H$  is stable under the action of  $v_A^{-1}$  and  $v_B^{-1}$ .



# Chapter 5

## $\mathcal{L}_{g,n}(H)$ and projective representations of mapping class groups

Let  $\Sigma_{g,n}$  be the compact oriented surface of genus  $g$  with  $n$  open disks removed. Let  $D \subset \Sigma_{g,n}$  be an open disk, then we define  $\Sigma_{g,n}^\circ = \Sigma_{g,n} \setminus D$ . Of course,  $\Sigma_{g,n}^\circ = \Sigma_{g,n+1}$ , but the boundary circle  $c_{g,n}$  induced by the deletion of  $D$  plays a particular role since we put a basepoint on it, see Figure 5.1. In this chapter, we consider the algebra  $\mathcal{L}_{g,n}(H)$  associated to  $\Sigma_{g,n}^\circ$  (as everywhere in this thesis,  $H$  denotes a finite dimensional, factorizable, ribbon Hopf algebra).

Figure 5.2 is the picture that one should always keep in mind<sup>1</sup>. In this picture, we see  $\Sigma_{g,n}$  as a thickening (*i.e.* tubular neighborhood) of the embedded oriented graph

$$\Gamma_{g,n} = (\{\bullet\}, \{b_1, a_1, \dots, b_g, a_g, m_{g+1}, \dots, m_{g+n}\})$$

where the loops  $b_i, a_i, m_j$  generating the free group  $\pi_1(\Sigma_{g,n}^\circ)$  are represented in Figure 5.1. Note that with these generators, the loop  $c_{g,n}$  induced by the deletion of the disc  $D$  is expressed as

$$c_{g,n} = b_1 a_1^{-1} b_1^{-1} a_1 \dots b_g a_g^{-1} b_g^{-1} a_g m_{g+1} \dots m_{g+n}. \quad (5.1)$$

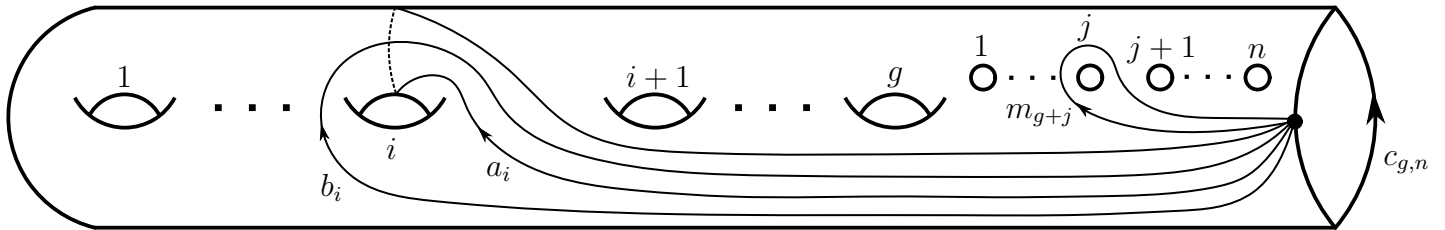

Figure 5.1: Surface  $\Sigma_{g,n}^\circ$  with basepoint  $(\bullet)$  and generators for  $\pi_1(\Sigma_{g,n}^\circ)$ .

To each generating loop, or equivalently to each handle, is associated a family of matrices, indexed by the  $H$ -modules and whose coefficients are generators of the algebra  $\mathcal{L}_{g,n}(H)$ . The defining relations are given in (5.6), following [AGS95, BR95, AGS96] (modulo the same remarks that in the introduction of Chapter 4). We define  $\mathcal{L}_{g,n}(H)$  as a braided tensor product, as in [AS96b]. This has the advantage to show immediately that  $\mathcal{L}_{g,n}(H)$  is a  $H$ -module-algebra and to emphasize the role of the two building blocks of the theory, namely  $\mathcal{L}_{0,1}(H)$  and  $\mathcal{L}_{1,0}(H)$ .

The main results of this chapter are

- The construction of a representation  $\text{Inv}(V)$  of the algebra of invariant elements  $\mathcal{L}_{g,n}^{\text{inv}}(H)$  for any representation  $V$  of  $\mathcal{L}_{g,n}(H)$  (Theorem 5.2.6). Note that the matrices  $\overset{I}{C}_{g,n}$  (which correspond

<sup>1</sup>Compared to the Figure 1 of [Fai18c], we have done a 180°-rotation around the horizontal axis of  $\mathbb{R}^3$ , in order to have the handles at the bottom of the Figure. The reason of this change comes from the definition of the graphical calculus and the Wilson loop map in Chapter 6.



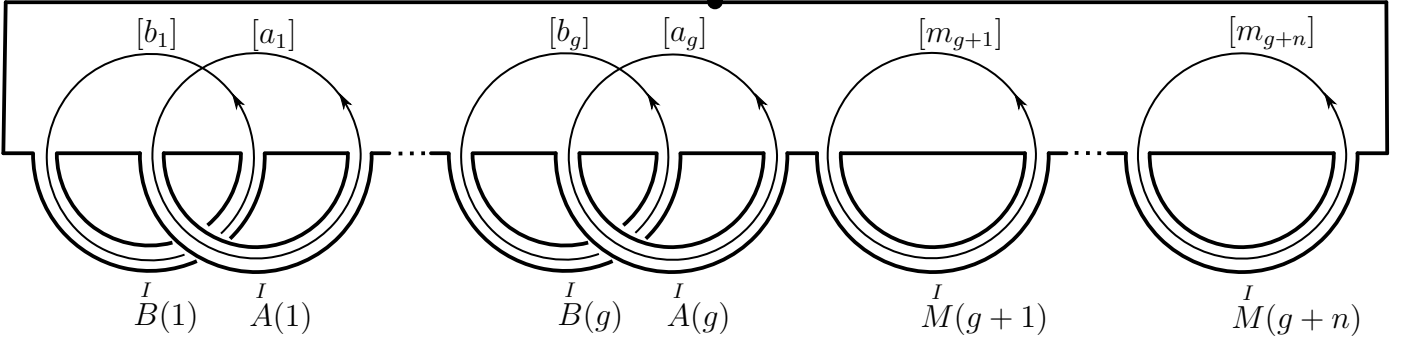

Figure 5.2:  $\Sigma_{g,n}^o$  represented as a thickened graph and matrices of generators of  $\mathcal{L}_{g,n}(H)$ .

to the loop  $c_{g,n}$ , see (4.1)) used for the proof of that theorem already appeared in [Ale94] (with  $H = U_q(\mathfrak{g})$ ), but here we need to generalize and adapt the construction of the representation to our assumptions on  $H$ .

- The construction of a projective representation of the mapping class group of  $\Sigma_g = \Sigma_{g,0}$  on  $\text{Inv}((H^*)^{\otimes g})$  (Theorem 5.3.19). This implements and generalizes to a non-semisimple setting an idea of Alekseev–Schomerus [AS96a, Section 9].
- The explicit formulas for the representation of the Dehn twists about the circles depicted in Figure 5.7 (Theorem 5.3.22).
- The equivalence of the representation of Theorem 5.3.19 with the one constructed by Lyubashenko using categorical techniques in [Lyu95b, Lyu96] (Theorem 5.4.4).

Most of the material presented in this chapter is the content of [Fai18c]. Here we added section 5.1.3 to explain how  $\mathcal{L}_{g,n}(H)$  is related to the work of [BFK98a, BFK98b]. We also added section 5.3.2 in which we define the normalization of a simple closed curve and this allows us to define the lift of any simple loop in section 5.3.3 (the difference with [Fai18c] is explained in Remark 5.3.13).

## 5.1 Definition and properties of $\mathcal{L}_{g,n}(H)$

### 5.1.1 Braided tensor product and definition of $\mathcal{L}_{g,n}(H)$

Let  $\text{mod}_r(H)$  be the category of finite dimensional right  $H$ -modules (or, equivalently, of finite dimensional left  $\mathcal{O}(H)$ -comodules). The braiding in  $\text{mod}_r(H)$  is given by:

$$\begin{aligned} c_{I,J} : I \otimes J &\rightarrow J \otimes I \\ v \otimes w &\mapsto w \cdot a_i \otimes v \cdot b_i \end{aligned}$$

with  $R = a_i \otimes b_i$ . Let  $(A, m_A, 1_A)$  and  $(B, m_B, 1_B)$  be two algebras in  $\text{mod}_r(H)$  (that is,  $H$ -module-algebras), and define:

$$\begin{aligned} m_{A \tilde{\otimes} B} &= (m_A \otimes m_B) \circ (\text{id}_A \otimes c_{B,A} \otimes \text{id}_B) : (A \otimes B) \otimes (A \otimes B) \rightarrow A \otimes B, \\ 1_{A \tilde{\otimes} B} &= 1_A \otimes 1_B : \mathbb{C} \rightarrow A \otimes B. \end{aligned}$$

This endows  $A \otimes B$  with a structure of algebra in  $\text{mod}_r(H)$ , denoted  $A \tilde{\otimes} B$  and called braided tensor product of  $A$  and  $B$  (see [Maj95, Lemma 9.2.12]). Note that  $\tilde{\otimes}$  is associative.

There are two canonical algebra embeddings  $j_A, j_B : A, B \hookrightarrow A \tilde{\otimes} B$  respectively defined by  $j_A(x) = x \otimes 1_B$ ,  $j_B(y) = 1_A \otimes y$ . We identify  $x \in A$  (resp.  $y \in B$ ) with  $j_A(x) \in A \tilde{\otimes} B$  (resp.  $j_B(y)$ ). Under these identifications, the multiplication rule in  $A \tilde{\otimes} B$  is entirely given by:

$$\forall x \in A, \forall y \in B, \quad xy = (x \cdot a_i)(y \cdot b_i). \quad (5.2)$$

Since  $\mathcal{L}_{0,1}(H)$  and  $\mathcal{L}_{1,0}(H)$  are algebras in  $\text{mod}_r(H)$ , we can apply the braided tensor product to them.

**Definition 5.1.1.**  $\mathcal{L}_{g,n}(H)$  is the  $H$ -module-algebra  $\mathcal{L}_{1,0}(H)^{\otimes g} \otimes \mathcal{L}_{0,1}(H)^{\otimes n}$ .

It is essential to keep in mind that the  $H$ -module-algebra  $\mathcal{L}_{g,n}(H)$  is associated with the surface  $\Sigma_{g,n}^o = \Sigma_{g,n} \setminus D$ ; in order to make this precise we now define the matrices introduced in Figure 5.2. There are canonical algebra embeddings  $j_i : \mathcal{L}_{1,0}(H) \hookrightarrow \mathcal{L}_{g,n}(H)$  for  $1 \leq i \leq g$  and  $j_i : \mathcal{L}_{0,1}(H) \hookrightarrow \mathcal{L}_{g,n}(H)$  for  $g+1 \leq i \leq g+n$ , given by  $j_i(x) = 1^{\otimes i-1} \otimes x \otimes 1^{\otimes g+n-i}$ . Define

$${}^I A(i) = j_i({}^I A), \quad {}^I B(i) = j_i({}^I B) \quad \text{for } 1 \leq i \leq g \quad \text{and} \quad {}^I M(i) = j_i({}^I M) \quad \text{for } g+1 \leq i \leq g+n.$$

The right action of  $H$  on  $\mathcal{L}_{g,n}(H)$  (or equivalently the left coaction  $\Omega$  of  $\mathcal{O}(H)$ ) is of course

$${}^I U(i) \cdot h = h' {}^I U(i) S(h'') \quad (\text{or equivalently } \Omega({}^I U(i)) = {}^I T U(i) S({}^I T)) \quad (5.3)$$

where  $U$  is  $B$ ,  $A$  or  $M$ . By (4.3) and (4.11), if  $f : I \rightarrow J$  is a morphism of  $H$ -modules it holds

$${}^J B(i) f = f {}^I B(i), \quad {}^J A(i) f = f {}^I A(i), \quad {}^J M(j) f = f {}^I M(j) \quad (5.4)$$

for all  $i, j$ , where we identify  $f$  with its matrix. We call this relation the naturality of the (families of) matrices  ${}^I B(i), {}^I A(i), {}^I M(j)$ .

Relation (5.2) indicates that  $\mathcal{L}_{g,n}(H)$  is an exchange algebra. Let us write the exchange relations in a matrix form. Let  $U, V$  be  $B$  or  $A$  or  $M$ . Then, by definition of the right action and by (5.2):

$${}^J V(j) {}^I U(i)_1 = ({}^I a'_k)_1 {}^I U(i)_1 S({}^I a''_k)_1 ({}^J b'_k)_2 {}^J V(j)_2 S({}^J b''_k)_2 = ({}^I a_l)_1 {}^{IJ} R_{12} {}^I U(i)_1 {}^{IJ} R_{12}^{-1} {}^J V(j)_2 {}^{IJ} R_{12} S({}^J b_l)_2 \quad (5.5)$$

where for the second equality we applied properties of the  $R$ -matrix and obvious commutation relations in  $\text{End}_{\mathbb{C}}(I) \otimes \text{End}_{\mathbb{C}}(J) \otimes \mathcal{L}_{g,n}(H)$ . Using that  $a_m a_l \otimes S(b_l) b_m = 1 \otimes 1$  together with obvious commutation relations, we obtain the desired exchange relation:

$${}^{IJ} R_{12} {}^I U(i)_1 {}^{IJ} R_{12}^{-1} {}^J V(j)_2 = {}^J V(j)_2 {}^{IJ} R_{12} {}^I U(i)_1 {}^{IJ} R_{12}^{-1}.$$

To sum up, the presentation of  $\mathcal{L}_{g,n}(H)$  by generators and relations is:

$$\begin{cases} {}^{I \otimes J} U(i)_{12} = {}^I U(i)_1 ({}^I R')_{12} {}^J U(i)_2 ({}^I R')_{12}^{-1} & \text{for } 1 \leq i \leq g+n \\ {}^{IJ} R_{12} {}^I U(i)_1 {}^{IJ} R_{12}^{-1} {}^J V(j)_2 = {}^J V(j)_2 {}^{IJ} R_{12} {}^I U(i)_1 {}^{IJ} R_{12}^{-1} & \text{for } 1 \leq i < j \leq g+n \\ {}^{IJ} R_{12} {}^I B(i)_1 ({}^I R')_{12} {}^J A(i)_2 = {}^J A(i)_2 {}^{IJ} R_{12} {}^I B(i)_1 {}^{IJ} R_{12}^{-1} & \text{for } 1 \leq i \leq g \end{cases} \quad (5.6)$$

where  $U(i)$  (resp.  $V(i)$ ) is  $A(i)$  or  $B(i)$  if  $1 \leq i \leq g$  and is  $M(i)$  if  $g+1 \leq i \leq g+n$ . These are relations between matrices in  $\mathcal{L}_{g,n}(H) \otimes \text{Mat}_{\dim(I)}(\mathbb{C}) \otimes \text{Mat}_{\dim(J)}(\mathbb{C})$  (for all finite dimensional  $I, J$ ) which imply relations among elements of  $\mathcal{L}_{g,n}(H)$  (the coefficients of these matrices). Such a presentation was first introduced in [Ale94] and [AGS95]. Recall that the first line of relations is the  $\mathcal{L}_{0,1}(H)$ -fusion relation on each loop, the second line is the exchange relation of the braided tensor product and the third line is the  $\mathcal{L}_{1,0}(H)$ -exchange-relation. These are the same relations as in [BNR02], except that  $A(i)$  and  $B(i)$  are switched for all  $1 \leq i \leq g$ ; the ones of [AGS96, Def 12] and [AS96a, eqs (3.11)–(3.21)] are different, due to a different choice of the action of  $H$  on  $\mathcal{L}_{1,0}(H)$ , but yield the same algebra when  $H$  is semisimple. Thanks to these relations, we see that a generic element in  $\mathcal{L}_{g,n}(H)$  is a linear combination of elements of the form

$${}^{I_1} B(1)_{j_1}^{i_1} {}^{I_2} A(1)_{j_2}^{i_2} \cdots {}^{I_{2g-1}} B(g)_{j_{2g-1}}^{i_{2g-1}} {}^{I_{2g}} A(g)_{j_{2g}}^{i_{2g}} {}^{I_{2g+1}} M(g+1)_{j_{2g+1}}^{i_{2g+1}} \cdots {}^{I_{2g+n}} M(g+n)_{j_{2g+n}}^{i_{2g+n}}.$$

Note that the content of Remark 4.1.2 also applies to  $\mathcal{L}_{g,n}(H)$ : in practice, we can assume that the representations labelling the matrices belong to a set  $\mathcal{G}$  of well-chosen  $H$ -modules. For instance, if  $H = \bar{U}_q(\mathfrak{sl}_2)$ , we take  $\mathcal{G} = \{\mathcal{X}^+(2)\}$ .

**Notation.** Let  $\overset{I}{N} = \overset{I}{v}^m \overset{I}{N}_1^{n_1} \dots \overset{I}{N}_l^{n_l} \in \text{Mat}_{\dim(I)}(\mathcal{L}_{g,n}(H))$ , where  $m, n_i \in \mathbb{Z}$  and each  $N_i$  is one of the  $A(j), B(j), M(k)$  for some  $j$  or  $k$ . By definition of the right action on  $\mathcal{L}_{g,n}(H)$ , we have a morphism of  $H$ -modules

$$j_N : \begin{array}{ccc} \mathcal{L}_{0,1}(H) & \rightarrow & \mathcal{L}_{g,n}(H) \\ \overset{I}{M} & \mapsto & \overset{I}{N} \end{array} . \quad (5.7)$$

Let  $x \in \mathcal{L}_{0,1}(H)$ , then we denote

$$x_N = j_N(x). \quad (5.8)$$

Since we identify  $\mathcal{L}_{0,1}(H)$  with  $H$  we also use this notation when  $x \in H$ . Note that if  $x \in \mathcal{L}_{0,1}^{\text{inv}}(H) \cong \mathcal{Z}(H)$ , then  $x_N \in \mathcal{L}_{g,n}^{\text{inv}}(H)$ . The following lemma is an obvious fact.

**Lemma 5.1.2.** *If  $N$  satisfies the fusion relation of  $\mathcal{L}_{0,1}(H)$ ,  $\overset{I \otimes J}{N}_{12} = \overset{I}{N}(i)_1 \overset{IJ}{(R')}_{12} \overset{J}{N}(i)_2 \overset{IJ}{(R')}_{12}^{-1}$ , then  $j_N$  is a morphism of  $H$ -module-algebras:  $(xy)_N = x_N y_N$ .*

See e.g. (5.13) for an application of this lemma.

## 5.1.2 The Alekseev isomorphism

Consider the tensor product algebra  $\mathcal{L}_{1,0}(H)^{\otimes g} \otimes \mathcal{L}_{0,1}(H)^{\otimes n}$ . We have canonical algebra embeddings  $j_i : \mathcal{L}_{1,0}(H) \hookrightarrow \mathcal{L}_{1,0}(H)^{\otimes g} \otimes \mathcal{L}_{0,1}(H)^{\otimes n}$  for  $1 \leq i \leq g$  and  $j_i : \mathcal{L}_{0,1}(H) \hookrightarrow \mathcal{L}_{1,0}(H)^{\otimes g} \otimes \mathcal{L}_{0,1}(H)^{\otimes n}$  for  $g+1 \leq i \leq g+n$ , defined by  $j_i(x) = 1^{\otimes i-1} \otimes x \otimes 1^{\otimes g+n-i}$ . Define  $\underline{A}(i) = j_i(\underline{A})$ ,  $\underline{B}(i) = j_i(\underline{B})$  for  $1 \leq i \leq g$  and  $\underline{M}(i) = j_i(\underline{M})$  for  $g+1 \leq i \leq g+n$ . We underline these matrices to avoid confusion with prior matrices having coefficients in  $\mathcal{L}_{g,n}(H)$ . By definition, the exchange relation between copies in  $\mathcal{L}_{1,0}(H)^{\otimes g} \otimes \mathcal{L}_{0,1}(H)^{\otimes n}$  is simply

$$\underline{U}(i)_1 \underline{V}(j)_2 = \underline{V}(j)_2 \underline{U}(i)_1$$

where  $i \neq j$ ,  $\underline{U}(i), \underline{V}(i)$  is  $\underline{A}(i)$  or  $\underline{B}(i)$  if  $1 \leq i \leq g$  and is  $\underline{M}(i)$  if  $g+1 \leq i \leq g+n$ .

The next result is due to Alekseev (see [Ale94]). Consider the matrices  $\overset{I}{M}^{(-)} = \Psi_{0,1}^{-1}(\overset{I}{L}^{(-)})$  and  $\overset{I}{C}^{(-)} = \Psi_{1,0}^{-1}(\overset{I}{L}^{(-)} \overset{I}{\tilde{L}}^{(-)})$  (recall (2.8) and (2.33)). Let

$$\begin{array}{ccc} \overset{I}{\Lambda}_1 = \mathbb{I}_{\dim(I)}, & \overset{I}{\Lambda}_i = \overset{I}{C}^{(-)}(1) \dots \overset{I}{C}^{(-)}(i-1) & \text{for } 2 \leq i \leq g+1, \\ \overset{I}{\Gamma}_{g+1} = \overset{I}{\Lambda}_{g+1}, & \overset{I}{\Gamma}_i = \overset{I}{\Lambda}_{g+1} \overset{I}{M}^{(-)}(g+1) \dots \overset{I}{M}^{(-)}(i-1) & \text{for } g+2 \leq i \leq g+n. \end{array} \quad (5.9)$$

be matrices with coefficients in  $\mathcal{L}_{1,0}(H)^{\otimes g} \otimes \mathcal{L}_{0,1}(H)^{\otimes n}$  (with  $\mathbb{I}_s$  the identity matrix of size  $s$ ).

**Proposition 5.1.3.** *The map*

$$\begin{array}{ccc} \alpha_{g,n} : \mathcal{L}_{g,n}(H) = \mathcal{L}_{1,0}(H)^{\otimes g} \tilde{\otimes} \tilde{\mathcal{L}}_{0,1}(H)^{\otimes n} & \rightarrow & \mathcal{L}_{1,0}(H)^{\otimes g} \otimes \mathcal{L}_{0,1}(H)^{\otimes n} \\ \overset{I}{A}(i) & \mapsto & \overset{I}{\Lambda}_i \overset{I}{A}(i) \overset{I}{\Lambda}_i^{-1} \quad \text{for } 1 \leq i \leq g \\ \overset{I}{B}(i) & \mapsto & \overset{I}{\Lambda}_i \overset{I}{B}(i) \overset{I}{\Lambda}_i^{-1} \quad \text{for } 1 \leq i \leq g \\ \overset{I}{M}(i) & \mapsto & \overset{I}{\Gamma}_i \overset{I}{M}(i) \overset{I}{\Gamma}_i^{-1} \quad \text{for } g+1 \leq i \leq g+n \end{array}$$

is an isomorphism of algebras, which we call the Alekseev isomorphism.

*Proof.* In order to show that it is a morphism of algebras, one must check using various exchange relations that the defining relations (5.6) of  $\mathcal{L}_{g,n}(H)$  are preserved under  $\alpha_{g,n}$ . This is a straightforward but tedious task and we will not give the details. Let us prove that  $\alpha_{g,n}$  is bijective. We first show that  $\alpha_{g,0}$  is surjective for all  $g$  by induction. For  $g = 1$ ,  $\alpha_{1,0}$  is the identity. For  $g \geq 2$ , we embed  $\mathcal{L}_{g-1,0}(H)$  in  $\mathcal{L}_{g,0}(H)$  in an obvious way by  $\overset{I}{A}(i) \mapsto \overset{I}{A}(i)$  and  $\overset{I}{B}(i) \mapsto \overset{I}{B}(i)$  for  $1 \leq i \leq g-1$ . Then the restriction of  $\alpha_{g,0}$  to  $\mathcal{L}_{g-1,0}(H)$  is  $\alpha_{g-1,0}$ , and by induction we assume that  $\alpha_{g-1,0}(\mathcal{L}_{g-1,0}(H)) = \mathcal{L}_{1,0}(H)^{\otimes g-1}$ . Since  $\overset{I}{\Lambda}_i \in \text{Mat}_{\dim(I)}(\mathcal{L}_{1,0}(H)^{\otimes i-1} \otimes \mathbb{C}^{\otimes g+1-i})$ , there exists matrices  $\overset{I}{\mathcal{N}}_i$  ( $1 \leq i \leq g$ ) such that  $\alpha_{g,0}(\overset{I}{\mathcal{N}}_i) = \overset{I}{\Lambda}_i$ . Then  $\alpha_{g,0}(\overset{I}{\mathcal{N}}_i^{-1} \overset{I}{U}(i) \overset{I}{\mathcal{N}}_i) = \overset{I}{U}(i)$ , with  $U = A$  or  $B$  and  $\alpha_{g,0}$  is surjective. Similarly, for  $g$  fixed and  $n \geq 1$ , we can embed  $\mathcal{L}_{g,n-1}(H)$  into  $\mathcal{L}_{g,n}(H)$  and reproduce the same reasoning. Hence  $\alpha_{g,n}$  is surjective for all  $g, n$ . Since the domain and the range of  $\alpha_{g,n}$  have the same dimension, it is an isomorphism.  $\square$

We generalize the isomorphisms  $\Psi_{0,1}$  and  $\Psi_{1,0}$  by

$$\Psi_{g,n} = (\Psi_{1,0}^{\otimes g} \otimes \Psi_{0,1}^{\otimes n}) \circ \alpha_{g,n} : \mathcal{L}_{g,n}(H) \xrightarrow{\sim} \mathcal{H}(\mathcal{O}(H))^{\otimes g} \otimes H^{\otimes n}. \quad (5.10)$$

In particular  $\mathcal{L}_{g,0}(H)$  is a matrix algebra, since  $\mathcal{H}(\mathcal{O}(H))$  is.

Thanks to  $\Psi_{g,n}$ , the representation theory of  $\mathcal{L}_{g,n}(H)$  is entirely determined by the representation theory of  $H$ . Indeed, the only indecomposable (and simple) representation of  $\mathcal{H}(\mathcal{O}(H)) \cong \text{End}_{\mathbb{C}}(H^*)$  is  $H^*$ , thus it follows that the indecomposable representations of  $\mathcal{L}_{g,n}(H)$  are of the form

$$(H^*)^{\otimes g} \otimes I_1 \otimes \dots \otimes I_n$$

where  $I_1, \dots, I_n$  are indecomposable representations of  $H$ . We will denote the action of  $\mathcal{L}_{g,n}(H)$  on  $(H^*)^{\otimes g} \otimes I_1 \otimes \dots \otimes I_n$  by  $\triangleright$ , namely:

$$x \triangleright (\varphi_1 \otimes \dots \otimes \varphi_g \otimes v_1 \otimes \dots \otimes v_n) = \Psi_{g,n}(x) \cdot (\varphi_1 \otimes \dots \otimes \varphi_g \otimes v_1 \otimes \dots \otimes v_n) \quad (5.11)$$

for  $x \in \mathcal{L}_{g,n}(H)$ , where  $\cdot$  is the action component-by-component of  $\Psi_{g,n}(x)$  on  $(H^*)^{\otimes g} \otimes I_1 \otimes \dots \otimes I_n$ .

### 5.1.3 $\mathcal{L}_{g,n}(H)$ as an algebra of functions and LGFT

In this section, we discuss the fact that  $\mathcal{L}_{g,n}(H)$  is the algebra of gauge fields of a lattice gauge field theory (LGFT) as defined in [BFK98a, BFK98b]; this is independent of the rest of the text and will not be used elsewhere.

First, we describe  $\mathcal{L}_{g,n}(H)$  as an algebra of functions. Let  $E_{g,n} = \{b_1, a_1, \dots, b_g, a_g, m_{g+1}, \dots, m_{g+n}\}^2$  and let  $\mathcal{F}_{g,n}(H)$  be the vector space  $\bigotimes_{e \in E_{g,n}} H_e^*$ , where  $H_e^*$  is a copy of  $H^*$  labelled by  $e$ . For  $e \in E_{g,n}$  and  $\varphi \in H^*$ , define an element  $\varphi_e \in \mathcal{F}_{g,n}(H)$  by

$$\varphi_e \left( \bigotimes_{a \in E} x_a \right) = \varphi(x_e) \prod_{a \in E_{g,n} \setminus \{e\}} \varepsilon(x_a).$$

Consider the linear map  $f : \mathcal{L}_{g,n}(H) \rightarrow \mathcal{F}_{g,n}(H)$  defined by

$$\overset{I_1}{B}(1)_{j_1}^{i_1} \overset{I_2}{A}(1)_{j_2}^{i_2} \dots \overset{I_{2g-1}}{B}(g)_{j_{2g-1}}^{i_{2g-1}} \overset{I_{2g}}{A}(g)_{j_{2g}}^{i_{2g}} \overset{I_{2g+1}}{M}(g+1)_{j_{2g+1}}^{i_{2g+1}} \dots \overset{I_{2g+n}}{M}(g+n)_{j_{2g+n}}^{i_{2g+n}} \mapsto \overset{I_1}{T}_{j_1}^{i_1} \otimes \dots \otimes \overset{I_{2g+n}}{T}_{j_{2g+n}}^{i_{2g+n}}.$$

Thanks to the Alekseev isomorphism,  $\dim(\mathcal{L}_{g,n}(H)) = \dim(\mathcal{F}_{g,n}(H))$ , and thus  $f$  is an isomorphism of vector spaces. We define a structure of right  $H$ -module-algebra (with product denoted by  $*$ ) on  $\mathcal{F}_{g,n}(H)$  by requiring  $f$  to be an isomorphism of right  $H$ -module-algebras.

<sup>2</sup>We endow  $E_{g,n}$  with the total order  $b_1 < a_1 < \dots < b_g < a_g < m_{g+1} < \dots < m_{g+n}$ .

**Proposition 5.1.4.** *The right  $H$ -module-algebra  $\mathcal{F}_{g,n}(H)$  is generated by the elements  $\varphi_e$ , with  $\varphi \in H^*$  and  $e \in E_{g,n}$ . These elements satisfy*

1.  $\varphi_e \cdot h = \varphi(h' ? S(h''))_e$  (with  $h \in H$ ),
2.  $(\varphi_1)_{b_1} * (\varphi_2)_{a_1} * \dots * (\varphi_{2g-1})_{b_g} * (\varphi_{2g})_{a_g} * (\varphi_{2g+1})_{m_{g+1}} * \dots * (\varphi_{2g+n})_{m_{g+n}} = \varphi_1 \otimes \dots \otimes \varphi_{2g+n}$ ,
3.  $\varphi_{v_\beta} * \psi_{u_\alpha} = \psi(s_i s_j ? S(s_k) s_l)_{u_\alpha} * \varphi(t_j t_k ? t_l S(t_i))_{v_\beta}$  where  $u, v$  are  $a$  or  $b$  or  $m$  and  $\alpha < \beta$ ,
4.  $\varphi_{a_i} * \psi_{b_i} = \psi(s_i s_j ? t_k s_l)_{b_i} * \varphi(t_j s_k ? t_l S(t_i))_{a_i}$  for all  $1 \leq i \leq g$ ,
5.  $\varphi_e * \psi_e = [\varphi(? t_j S(t_i)) \psi(s_i ? s_j)]_e$  for all  $e \in E_{g,n}$ ,

where exceptionally we denote  $R = s_i \otimes t_i$  to avoid confusion between the usual notation  $R = a_i \otimes b_i$  and the loops  $a_i$  and  $b_i$ . These formulas allow one to compute the product of any two elements in  $\mathcal{F}_{g,n}(H)$ .

*Proof.* Since  $\overset{C}{U}(i) = 1$  for any  $U = A, B, M$  and  $1 \leq i \leq 2g + n$ , we have

$$f(\overset{I}{B}(i)_k^j) = (\overset{I}{T}_k^j)_{b_i}, \quad f(\overset{I}{A}(i)_k^j) = (\overset{I}{T}_k^j)_{a_i}, \quad f(\overset{I}{M}(i)_k^j) = (\overset{I}{T}_k^j)_{m_i}.$$

This implies the first claim and the first and second equalities (recall that any  $\varphi \in H^*$  is a linear combination of matrix coefficients  $\overset{I}{T}_j^i$ ). For the third equality, (5.5) gives

$$\begin{aligned} (\overset{J}{T}_b^a)_{v_\beta} * (\overset{I}{T}_d^c)_{u_\alpha} &= f\left(\overset{J}{V}(\beta)_1 \overset{I}{U}(\alpha)_2\right)_{bd}^{ac} = f\left(\overset{I}{(s_i)_2} \overset{IJ}{R_{21}} \overset{I}{U}(\alpha)_2 \overset{IJ}{R_{21}^{-1}} \overset{J}{V}(\beta)_1 \overset{IJ}{R_{21}} \overset{J}{S}(t_i)_1\right)_{bd}^{ac} \\ &= f\left(\overset{I}{s_i} \overset{I}{s_j} \overset{I}{U}(\alpha) \overset{I}{S}(s_k) \overset{I}{s_l}\right)_d^c f\left(\overset{J}{t_j} \overset{J}{t_k} \overset{J}{V}(\beta) \overset{J}{t_l} \overset{J}{S}(t_i)\right)_b^a = \overset{I}{T}_d^c(s_i s_j ? S(s_k) s_l)_{u_\alpha} * \overset{J}{T}_b^a(t_j t_k ? t_l S(t_i))_{v_\beta} \end{aligned}$$

as desired. The fourth and fifth equalities are (4.8) and (4.18).  $\square$

Now, let  $\Gamma = (V, E)$  be a filling graph of  $\Sigma_{g,n}$  (an embedded oriented graph such that  $\Sigma_{g,n} \setminus \Gamma$  is a union of open discs). Recall (see [BFK98a, BFK98b] for the precise definitions) that a lattice gauge field theory on  $\Gamma$  consists of

- a space of (discrete) connections  $\mathcal{A}_\Gamma = \bigotimes_{e \in E} H_e$ ,
- a space of gauge fields  $\mathbb{C}[\mathcal{A}_\Gamma] = \bigotimes_{e \in E} H_e^*$  (functions on  $\mathcal{A}_\Gamma$ ),
- a gauge algebra  $\mathcal{G}_\Gamma = \bigotimes_{v \in V} H_v$ .

In [BFK98a, BFK98b], an action of  $\mathcal{G}_\Gamma$  on  $\mathcal{A}_\Gamma$  as well as a  $H$ -equivariant comultiplication  $\nabla : \mathcal{A}_\Gamma \rightarrow \mathcal{A}_\Gamma^{\otimes 2}$  are defined. Dualizing this, we get a structure of (right)  $H$ -module-algebra (with product denoted by  $\star$ ) on  $\mathbb{C}[\mathcal{A}_\Gamma]$ :

$$\forall h \in H, \quad \forall \varphi, \psi \in \mathbb{C}[\mathcal{A}_\Gamma], \quad \varphi \cdot h = \varphi(h \cdot ?), \quad \varphi \star \psi = (\varphi \otimes \psi) \circ \nabla.$$

Here we take the most natural graph

$$\Gamma_{g,n} = (V = \{\bullet\}, E_{g,n} = \{b_1, a_1, \dots, b_g, a_g, m_{g+1}, \dots, m_{g+n}\}),$$

(see Figure 5.3) and we denote  $\mathcal{A}_{\Gamma_{g,n}} = \mathcal{A}_{g,n}$ ,  $\mathcal{G}_{\Gamma_{g,n}} = H$ . With this choice, a discrete connection is

$$h_{b_1} \otimes h_{a_1} \otimes \dots \otimes h_{b_g} \otimes h_{a_g} \otimes h_{m_{g+1}} \otimes \dots \otimes h_{m_{g+n}} \in \mathcal{A}_{g,n}.$$

We will consider the examples of  $\Sigma_{0,1}$  and  $\Sigma_{1,0}$ , write down the  $H$ -action and the product in  $\mathbb{C}[\mathcal{A}_{g,n}]$  and observe that it is isomorphic to  $\mathcal{F}_{g,n}(H)$  (and hence to  $\mathcal{L}_{g,n}(H)$ ). We use the rules given in [BFK98a] without explanation.

For  $\Sigma_{0,1}$ , we have the graph at the left below (with ciliation and cyclic order, see [BFK98a] and the references therein):

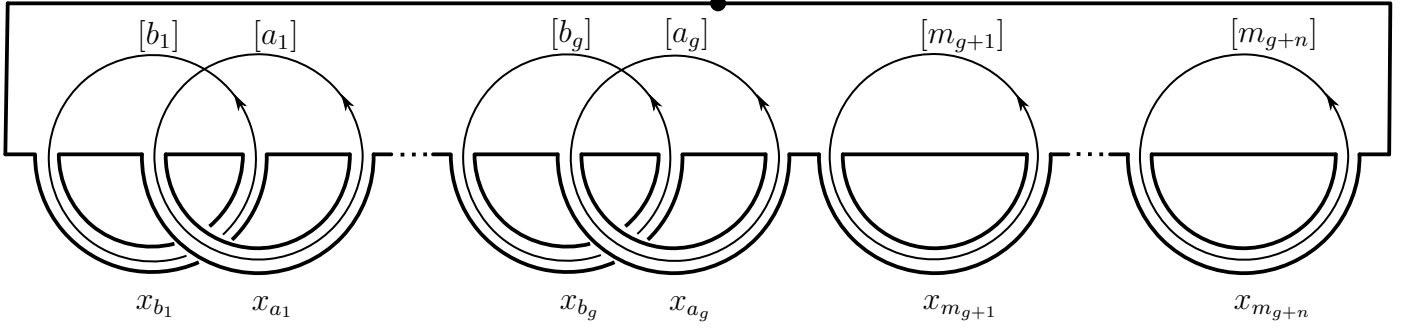
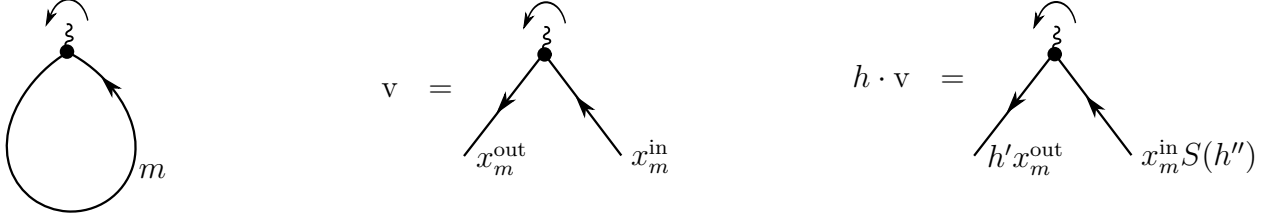
 Figure 5.3: Surface  $\Sigma_{g,n}^o$  viewed as a thickening of  $\Gamma_{g,n}$ , canonical loops and a discrete connection.

A connection is an assignment of an element of  $H$  to each edge (the holonomy of that edge), so here a connection is simply  $x_m$ . To compute the action of  $H$  on  $x_m$ , we determine the action on the vertex  $v$  as represented above. Then, gluing  $x_m^{\text{out}} \sim x_m^{\text{in}}$ , we get  $h \cdot x_m = h' x_m S(h'')$ . Hence the right action on  $\varphi \in \mathbb{C}[\mathcal{A}_{0,1}]$  is  $\varphi \cdot h = \varphi(h' S(h''))$ . To compute  $\nabla$ , we consider the operator  $F_v : H^{\otimes 2} \rightarrow H^{\otimes 4}$  associated to the vertex  $v$ :

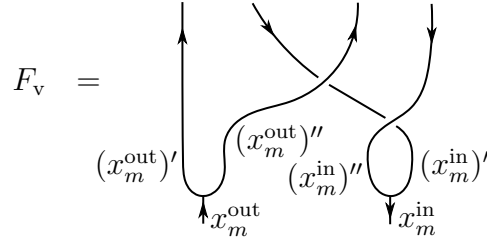

Evaluating the tangle<sup>3</sup> yields  $F_v(x_m^{\text{out}} \otimes x_m^{\text{in}}) = (x_m^{\text{out}})' \otimes (x_m^{\text{in}})' b_i S(b_j) \otimes a_j (x_m^{\text{out}})'' \otimes (x_m^{\text{in}})'' a_i$ . Then, gluing  $x_m^{\text{out}} \sim x_m^{\text{in}}$ , we get  $\nabla(x_m) = x_m' b_i S(b_j) \otimes a_j x_m'' a_i$  and thus

$$\varphi \star \psi = \varphi(? b_i S(b_j)) \psi(a_j ? a_i).$$

We see that  $\mathbb{C}[\mathcal{A}_{0,1}] = \mathcal{F}_{0,1}(H)$  (see Remark 4.1.9).

For  $\Sigma_{1,0}$ , we have the graph at the left below:

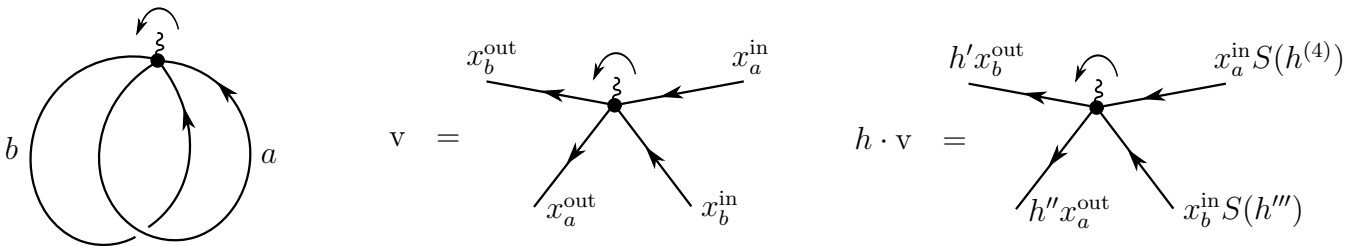

Here a connection is  $x_b \otimes x_a \in H^{\otimes 2}$ . Gluing  $x_b^{\text{out}} \sim x_b^{\text{in}}$  and  $x_a^{\text{out}} \sim x_a^{\text{in}}$  in the action on the vertex, we get that the left action of  $H$  on  $\mathcal{A}_{1,0}$  is  $h \cdot (x_b \otimes x_a) = h' x_b S(h''') \otimes h'' x_a S(h^{(4)})$ . Hence the right action of  $H$  on  $\varphi \otimes \psi \in \mathbb{C}[\mathcal{A}_{1,0}]$  is

$$(\varphi \otimes \psi) \cdot h = \varphi(h' S(h''')) \otimes \psi(h'' S(h^{(4)}))$$

To compute  $\nabla$ , we consider the operator  $F_v : H^{\otimes 4} \rightarrow H^{\otimes 8}$  associated to the vertex  $v$ :

<sup>3</sup>We point out a misprint in [BFK98a, Fig. 11]: the second and third crossings are inverted.

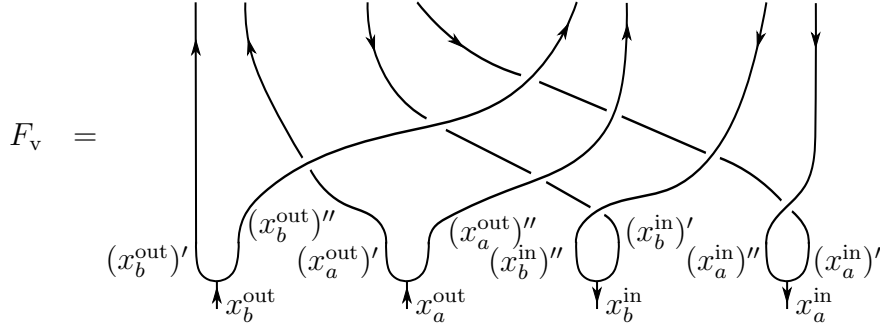

Evaluating the tangle yields

$$F_v(x_b^{\text{out}} \otimes x_a^{\text{out}} \otimes x_b^{\text{in}} \otimes x_a^{\text{in}}) = (x_b^{\text{out}})' \otimes b_k(x_a^{\text{out}})' \otimes (x_b^{\text{in}})'b_i S(b_l)S(b_n) \otimes (x_a^{\text{in}})'b_j b_m S(b_o)S(b_p) \\ \otimes a_p a_n a_k (x_b^{\text{out}})'' \otimes a_o a_l (x_a^{\text{out}})'' \otimes (x_b^{\text{in}})'' a_i a_m \otimes (x_a^{\text{in}})'' a_j.$$

Then, gluing  $x_b^{\text{out}} \sim x_b^{\text{in}}$  and  $x_a^{\text{out}} \sim x_a^{\text{in}}$ , we get

$$\nabla(x_b \otimes x_a) = x_b' b_i S(b_l)S(b_n) \otimes b_k x_a' b_j b_m S(b_o)S(b_p) \otimes a_p a_n a_k x_b'' a_i a_m \otimes a_o a_l x_a'' a_j$$

and thus

$$(\varphi_1 \otimes \psi_1) \star (\varphi_2 \otimes \psi_2) = \varphi_1(?b_i S(b_l)S(b_n)) \varphi_2(a_p a_n a_k ?a_i a_m) \otimes \psi_1(b_k ?b_j b_m S(b_o)S(b_p)) \psi_2(a_o a_l ?a_j)$$

Recall that we defined  $\varphi_b = \varphi \otimes \varepsilon$  and  $\varphi_a = \varepsilon \otimes \varphi$ . We have

$$\varphi_b \star \psi_a = \varphi(?S(b_i)) \otimes \psi(a_i?) = \varphi(?S(b_i))_b \star \psi(a_i?)_a$$

and this suggests to consider

$$\begin{aligned} \eta: \mathbb{C}[\mathcal{A}_{1,0}] &\rightarrow \mathcal{F}_{1,0}(H) \\ \varphi \otimes \psi &\mapsto \varphi(?b_i) \otimes \psi(a_i?) \end{aligned}$$

A straightforward computation using (2.5) and (2.7) shows that  $\eta$  is indeed an isomorphism of  $H$ -modules-algebras (see Remark 4.2.9). The  $H$ -module-algebras  $\mathbb{C}[\mathcal{A}_{g,n}]$  and  $\mathcal{F}_{g,n}(H)$  are isomorphic for any  $g, n$ . The example of  $\Sigma_{1,0}^1$  is generalized as follows: for each crossing in the graph  $\Gamma_{g,n}$  use an  $R$ -matrix as above to define the isomorphism.

## 5.2 Representation of $\mathcal{L}_{g,n}^{\text{inv}}(H)$

An element  $x \in \mathcal{L}_{g,n}(H)$  is called *invariant* if  $x \cdot h = \varepsilon(h)x$  for all  $h \in H$ , or equivalently, if  $\Omega(x) = \varepsilon \otimes x$ . Such elements are also called ‘‘observables’’. In this section we construct representations of the subalgebra of invariant elements  $\mathcal{L}_{g,n}^{\text{inv}}(H)$ .

Recall from section 4.2.3 that the matrices

$${}^I C = {}^I v^2 {}^I B {}^I A^{-1} {}^I B^{-1} {}^I A, \quad {}^I C^{(\pm)} = \Psi_{1,0}^{-1}({}^I L^{(\pm)} \tilde{{}^I L}^{(\pm)}) \in \text{Mat}_{\dim(I)}(\mathcal{L}_{1,0}(H))$$

satisfy the decomposition  ${}^I C = {}^I C^{(+)} {}^I C^{(-)-1}$  and allow for a simple characterization of the invariant elements. We generalize this to any  $g, n$ . For  $i \leq g$ , let  ${}^I C(i)$  be the embedding of  ${}^I C$  previously defined on the  $i$ -th copy of  $\mathcal{L}_{1,0}(H)$  in  $\mathcal{L}_{g,n}(H)$ :  ${}^I C(i) = {}^I v^2 {}^I B(i) {}^I A^{-1}(i) {}^I B^{-1}(i) {}^I A(i)$ .

**Definition 5.2.1.**  ${}^I C_{g,n} = {}^I C(1) \dots {}^I C(g) {}^I M(g+1) \dots {}^I M(g+n) \in \text{Mat}_{\dim(I)}(\mathcal{L}_{g,n}(H))$ .

In particular  $\overset{I}{C}_{1,0} = \overset{I}{C}$ . Geometrically (see (5.1) and Figure 5.2), for each  $I$  the matrix  $\overset{I}{C}_{g,n}$  corresponds to the boundary circle induced by the removal of the disk  $D$  in  $\Sigma_{g,n}$ .

There is a decomposition analogous to Lemma 4.2.10. Indeed, let

$$\overset{I}{C}_{g,n}^{(\pm)} = \alpha_{g,n}^{-1} \left( \overset{I}{C}^{(\pm)}(1) \dots \overset{I}{C}^{(\pm)}(g) \overset{I}{M}^{(\pm)}(g+1) \dots \overset{I}{M}^{(\pm)}(g+n) \right) \in \text{Mat}_{\dim(I)}(\mathcal{L}_{g,n}(H)),$$

where  $\overset{I}{C}^{(\pm)} = \Psi_{1,0}^{-1}(\overset{I}{L}^{(\pm)} \widetilde{\overset{I}{L}}^{(\pm)})$  and  $\overset{I}{M}^{(\pm)} = \Psi_{0,1}^{-1}(\overset{I}{L}^{(\pm)})$  (recall (2.8) and (2.33)).

**Proposition 5.2.2.** *The following equality holds in  $\mathcal{L}_{g,n}(H)$ :*

$$\overset{I}{C}_{g,n} = \overset{I}{C}_{g,n}^{(+)} \overset{I}{C}_{g,n}^{(-)-1}.$$

Moreover, the matrices  $\overset{I}{C}_{g,n}$  satisfy the fusion relation of  $\mathcal{L}_{0,1}(H)$ :

$$\overset{I \otimes J}{(C_{g,n})}_{12} = \overset{I}{(C_{g,n})}_1 \overset{IJ}{(R')}_{12} \overset{J}{(C_{g,n})}_2 \overset{IJ}{(R'^{-1})}_{12}.$$

*Proof.* The first claim is a simple consequence of the definition of  $\alpha_{g,n}$  and of Lemma 4.2.10. The fusion relation is a consequence of a more general fact which is easy to show, namely: if  $i_1 < \dots < i_k$  and if  $\overset{I}{X}^1(i_1), \dots, \overset{I}{X}^k(i_k)$  are matrices satisfying the fusion relation of  $\mathcal{L}_{0,1}(H)$ , then their product  $\overset{I}{X}^1(i_1) \dots \overset{I}{X}^k(i_k)$  also satisfies the fusion relation of  $\mathcal{L}_{0,1}(H)$ .  $\square$

The image of these matrices have simple expressions in  $\mathcal{H}(\mathcal{O}(H))^{\otimes g} \otimes H^{\otimes n}$ :

**Lemma 5.2.3.** *It holds*

$$\begin{aligned} \Psi_{g,n}(\overset{I}{C}_{g,n}^{(+)}) &= a_i \widetilde{b_i^{(2g-1+n)}} b_i^{(2g+n)} \otimes \dots \otimes \widetilde{b_i^{(1+n)}} b_i^{(2+n)} \otimes b_i^{(n)} \otimes \dots \otimes b_i^{(1)} \\ \Psi_{g,n}(\overset{I}{C}_{g,n}^{(-)}) &= S^{-1}(b_i) a_i^{(2g-1+n)} a_i^{(2g+n)} \otimes \dots \otimes a_i^{(1+n)} a_i^{(2+n)} \otimes a_i^{(n)} \otimes \dots \otimes a_i^{(1)} \\ \Psi_{g,n}(\overset{I}{C}_{g,n}) &= \overset{I}{X}_i \widetilde{Y_i^{(2g-1+n)}} Y_i^{(2g+n)} \otimes \dots \otimes \widetilde{Y_i^{(1+n)}} Y_i^{(2+n)} \otimes Y_i^{(n)} \otimes \dots \otimes Y_i^{(1)} \end{aligned}$$

where  $X_i \otimes Y_i = RR'$  and the superscripts mean iterated coproduct.

*Proof.* As an immediate consequence of quasitriangularity, we have for all  $n \geq 2$

$$(\text{id} \otimes \Delta^{(n-1)})(R) = a_i \otimes b_i^{(1)} \otimes \dots \otimes b_i^{(n)} = a_{i_1} \dots a_{i_n} \otimes b_{i_n} \otimes \dots \otimes b_{i_1}.$$

with implicit summation on  $i_1, \dots, i_n$ . It follows that

$$\begin{aligned} \Psi_{g,n}(\overset{I}{C}_{g,n}^{(+)}) &= \overset{I}{L}^{(+)}(1) \widetilde{\overset{I}{L}}^{(+)}(1) \dots \overset{I}{L}^{(+)}(g) \widetilde{\overset{I}{L}}^{(+)}(g) \overset{I}{L}^{(+)}(g+1) \dots \overset{I}{L}^{(+)}(g+n) \\ &= a_{i_1} \dots a_{i_{2g+n}} \widetilde{b_{i_2} b_{i_1}} \otimes \dots \otimes \widetilde{b_{i_{2g}} b_{i_{2g-1}}} \otimes b_{i_{2g+1}} \otimes \dots \otimes b_{i_{2g+n}} \\ &= a_i \widetilde{b_i^{(2g-1+n)}} b_i^{(2g+n)} \otimes \dots \otimes \widetilde{b_i^{(1+n)}} b_i^{(2+n)} \otimes b_i^{(n)} \otimes \dots \otimes b_i^{(1)} \end{aligned}$$

as desired. The second is shown similarly since  $R'^{-1}$  is also an universal  $R$ -matrix. The third is an immediate consequence.  $\square$



Lemma 5.2.3 indicates that the algebra generated by the coefficients  $C_j^{(\pm)i}$  equals the vector space generated by the coefficients  $C_j^i$ :

$$\mathbb{C}\langle C_j^{(\pm)i} \rangle_{I,i,j} = \text{vect}\langle C_j^i \rangle_{I,i,j}. \quad (5.12)$$

The matrices  $C_{g,n}^I$  satisfying the fusion relation of  $\mathcal{L}_{0,1}(H)$ , we can apply Lemma 5.1.2 and define a representation of  $H$  on  $V = (H^*)^{\otimes g} \otimes I_1 \otimes \dots \otimes I_n$  by

$$h \cdot v = h_{C_{g,n}} \triangleright v. \quad (5.13)$$

Recall that

$$\begin{array}{ccc} H & \xrightarrow{\Psi_{0,1}^{-1}} & \mathcal{L}_{0,1}(H) & \xrightarrow{j_{C_{g,n}}} & \mathcal{L}_{g,n}(H) \\ \binom{I}{X_i} Y_i & \longmapsto & M & \longmapsto & C_{g,n}^I \end{array}$$

Since  $H$  is factorizable, each  $h \in H$  is a linear combination of coefficients of the matrices  $L^{(+)} L^{(-)-1} = \binom{I}{X_i} Y_i$  and thus  $h_{C_{g,n}} = j_{C_{g,n}} \circ \Psi_{0,1}^{-1}(h)$  is a linear combination of coefficients of the matrices  $C_{g,n}^I$ . It follows from Lemma 5.2.3 that the action (5.13) is explicitly given by

$$\begin{aligned} & h \cdot \varphi_1 \otimes \dots \otimes \varphi_g \otimes v_1 \otimes \dots \otimes v_n \\ &= \varphi_1(S^{-1}(h^{(2g-1+n)})?h^{(2g+n)}) \otimes \dots \otimes \varphi_g(S^{-1}(h^{(1+n)})?h^{(2+n)}) \otimes h^{(n)}v_1 \otimes \dots \otimes h^{(1)}v_n. \end{aligned} \quad (5.14)$$

As in the case of  $\mathcal{L}_{1,0}(H)$ , the matrices  $C_{g,n}^I$  allow one to give a simple characterization of the invariant elements of  $\mathcal{L}_{g,n}(H)$  and to construct representations of them. We begin with a technical lemma.

**Lemma 5.2.4.** *It holds*

$$\binom{I}{C_{g,n}^{(\pm)}}_1 \binom{J}{U(i)}_2 \binom{I}{C_{g,n}^{(\pm)}}_1^{-1} = \binom{IJ}{R_{12}^{(\pm)}}_1^{-1} \binom{J}{U(i)}_2 \binom{IJ}{R_{12}^{(\pm)}}_2$$

where  $U$  is  $A$ ,  $B$  or  $M$ .

*Proof.* The case  $(g, n) = (1, 0)$  is Lemma 4.2.11. The case  $(g, n) = (0, 1)$  is easy with (2.9). Similarly, thanks to (2.9), (2.29) and (2.34), we obtain

$$\binom{IJ}{R_{12}^{(\pm)}}_1 \binom{I}{C_1^{(\pm)}}_1 \binom{J}{C_2^{(-)}}_2 = \binom{J}{C_2^{(-)}}_2 \binom{I}{C_1^{(\pm)}}_1 \binom{IJ}{R_{12}^{(\pm)}}_2, \quad \binom{IJ}{R_{12}^{(\pm)}}_1 \binom{I}{M_1^{(\pm)}}_1 \binom{J}{M_2^{(-)}}_2 = \binom{J}{M_2^{(-)}}_2 \binom{I}{M_1^{(\pm)}}_1 \binom{IJ}{R_{12}^{(\pm)}}_2.$$

Using these preliminary facts, we can carry out the general computation. For instance, for  $i \leq g$

$$\begin{aligned} & \alpha_{g,n} \left( \binom{I}{C_{g,n}^{(\pm)}}_1 \binom{J}{U(i)}_2 \binom{I}{C_{g,n}^{(\pm)}}_1^{-1} \right) \\ &= \underline{C}^{(\pm)}(1)_1 \dots \underline{C}^{(\pm)}(i)_1 \underline{C}^{(-)}(1)_2 \dots \underline{C}^{(-)}(i-1)_2 \underline{U}(i)_2 \underline{C}^{(-)}(i-1)_2^{-1} \dots \underline{C}^{(-)}(1)_2^{-1} \underline{C}^{(\pm)}(i)_1^{-1} \dots \underline{C}^{(\pm)}(1)_1^{-1} \\ &= \underline{C}^{(\pm)}(1)_1 \underline{C}^{(-)}(1)_2 \dots \underline{C}^{(\pm)}(i-1)_1 \underline{C}^{(-)}(i-1)_2 \underline{C}^{(\pm)}(i)_1 \underline{U}(i)_2 \underline{C}^{(\pm)}(i)_1^{-1} \underline{C}^{(-)}(i-1)_2^{-1} \underline{C}^{(\pm)}(i-1)_1^{-1} \dots \\ & \quad \underline{C}^{(-)}(1)_2^{-1} \underline{C}^{(\pm)}(1)_1^{-1} \\ &= \underline{C}^{(\pm)}(1)_1 \underline{C}^{(-)}(1)_2 \dots \underline{C}^{(\pm)}(i-1)_1 \underline{C}^{(-)}(i-1)_2 \binom{IJ}{R_{12}^{(\pm)}}_1^{-1} \underline{U}(i)_2 \binom{IJ}{R_{12}^{(\pm)}}_2 \underline{C}^{(-)}(i-1)_2^{-1} \underline{C}^{(\pm)}(i-1)_1^{-1} \dots \\ & \quad \underline{C}^{(-)}(1)_2^{-1} \underline{C}^{(\pm)}(1)_1^{-1} \\ &= \binom{IJ}{R_{12}^{(\pm)}}_1^{-1} \underline{C}^{(-)}(1)_2 \underline{C}^{(\pm)}(1)_1 \dots \underline{C}^{(-)}(i-1)_2 \underline{C}^{(\pm)}(i-1)_1 \underline{U}(i)_2 \underline{C}^{(\pm)}(i-1)_1^{-1} \underline{C}^{(-)}(i-1)_2^{-1} \dots \\ & \quad \underline{C}^{(\pm)}(1)_1^{-1} \underline{C}^{(-)}(1)_2^{-1} \binom{IJ}{R_{12}^{(\pm)}}_2 \\ &= \binom{IJ}{R_{12}^{(\pm)}}_1^{-1} \underline{C}^{(-)}(1)_2 \dots \underline{C}^{(-)}(i-1)_2 \underline{U}(i)_2 \underline{C}^{(-)}(i-1)_2^{-1} \dots \underline{C}^{(-)}(1)_2^{-1} \binom{IJ}{R_{12}^{(\pm)}}_2 = \alpha_{g,n} \left( \binom{IJ}{R_{12}^{(\pm)}}_1^{-1} \binom{J}{U(i)}_2 \binom{IJ}{R_{12}^{(\pm)}}_2 \right). \end{aligned}$$

The case  $i > g$  is treated in a similar way. □

For  $(V, \triangleright)$  a representation of  $\mathcal{L}_{g,n}(H)$ , let

$$\text{Inv}(V) = \left\{ v \in V \mid \forall I, {}^I C_{g,n} \triangleright v = \mathbb{I}_{\dim(I)} v \right\} = \{v \in V \mid \forall h \in H, h \cdot v = \varepsilon(h)v\} \quad (5.15)$$

where  $\mathbb{I}_k$  is the identity matrix of size  $k$ , and the action  $\cdot$  of  $H$  on  $V$  is defined in (5.13) and (5.14). This subspace  $\text{Inv}(V)$  implements the flatness constraint (1.8) discussed in the Introduction.

*Remark 5.2.5.* For  $(g, n) = (1, 0)$ ,  $\text{Inv}(H^*) = \text{SLF}(H)$  thanks to Lemma 4.2.12.  $\triangle$

**Theorem 5.2.6.** 1) An element  $x \in \mathcal{L}_{g,n}(H)$  is invariant under the action of  $H$  (or equivalently under the coaction  $\Omega$  of  $\mathcal{O}(H)$ ) if, and only if, for every  $H$ -module  $I$ ,  ${}^I C_{g,n} x = x {}^I C_{g,n}$ .  
2) Let  $V$  be a representation of  $\mathcal{L}_{g,n}(H)$ . Then  $\text{Inv}(V)$  is stable under the action of invariant elements and thus provides a representation of  $\mathcal{L}_{g,n}^{\text{inv}}(H)$ .

*Proof.* 1) Letting  $U$  be  $A(i), B(i)$  or  $M(j)$ ,  $R^{(\pm)} = a_i^{(\pm)} \otimes b_i^{(\pm)}$  and using Lemma 5.2.4, we have that the right action  $\cdot$  of  $H$  on  $\mathcal{L}_{1,0}(H)$  satisfies:

$$\begin{aligned} U_2 \cdot L_1^{(\pm)-1} &= U_2 \cdot S^{-1}(b_i^{(\pm)})(a_i^{(\pm)})_1 = S^{-1}(b_i^{(\pm)})_2 U_2 (b_i^{(\pm)})_2 (a_i^{(\pm)})_1 \\ &= S^{-1}(b_i^{(\pm)})_2 U_2 (b_j^{(\pm)})_2 (a_i^{(\pm)} a_j^{(\pm)})_1 = {}^{IJ} R_{12}^{(\pm)-1} U_2 {}^{IJ} R_{12}^{(\pm)} = ({}^I C_{g,n}^{(\pm)})_1 U_2 ({}^I C_{g,n}^{(\pm)-1})_1. \end{aligned}$$

We have thus shown that

$$(U)_d^c \cdot S^{-1}(L)_b^{(\pm)a} = ({}^I C_{g,n}^{(\pm)})_i^a (U)_d^c ({}^I C_{g,n}^{(\pm)-1})_b^i$$

or in other words

$$\forall x \in \mathcal{L}_{g,n}(H), \quad x \cdot S^{-1}(L^{(\pm)}) = {}^I C_{g,n}^{(\pm)} x {}^I C_{g,n}^{(\pm)-1}$$

Since  $H$  is factorizable, the elements  $S^{-1}(L^{(\pm)})_b^a$  generate  $H$  as an algebra. Hence the previous equation shows that  $x$  is an invariant element if, and only if, it commutes with the coefficients of the matrices  ${}^I C_{g,n}^{(\pm)}$ . As remarked in (5.12), the algebra generated by the coefficients  $({}^I C_{g,n}^{(\pm)})_j^i$  equals the algebra generated by the coefficients  $({}^I C_{g,n})_j^i$ . Hence, an element is invariant if, and only if, it commutes with the coefficients of the matrices  ${}^I C_{g,n}$ .

2) Let  $x \in \mathcal{L}_{g,n}^{\text{inv}}(H)$  and  $v \in \text{Inv}(V)$ , then

$${}^I C_{g,n} \triangleright (x \triangleright v) = ({}^I C_{g,n} x) \triangleright v = (x {}^I C_{g,n}) \triangleright v = x \triangleright ({}^I C_{g,n} \triangleright v) = \mathbb{I}_{\dim(I)}(x \triangleright v)$$

and thus  $x \triangleright v \in \text{Inv}(V)$  by definition.  $\square$

## 5.3 Projective representation of the mapping class group

Recall that the mapping class group  $\text{MCG}(\Sigma_{g,n})$  is the group of all isotopy classes of orientation-preserving homeomorphisms which fix the boundary pointwise.

For simplicity we will mainly consider the case of  $\Sigma_g$  ( $n = 0$ )<sup>4</sup>. The particular features in this case are that the presentation of the mapping class group is easier and that the associated algebra  $\mathcal{L}_{g,0}(H) \cong \mathcal{H}(\mathcal{O}(H))^{\otimes g}$  is isomorphic to a matrix algebra. We discuss the extension of the construction to the case of  $n > 0$  in subsection 5.3.5.

<sup>4</sup>except in section 5.3.2 and at the beggining of section 5.3.3 were we deal with the general case ( $n \geq 0$ ).

### 5.3.1 Mapping class group of $\Sigma_g$

We begin with some terminology. A curve on  $\Sigma_g^\circ$  is called *simple* if it does not contain self-crossings (up to free homotopy). A simple closed curve (not necessarily oriented) on a surface up to free homotopy is simply called a *circle*. Elements of  $\pi_1(\Sigma_g^\circ)$  (oriented based curves up to homotopy) are called *loops*. We say that a loop is *simple* if it does not contain self-crossing (up to homotopy). If  $\gamma \in \pi_1(\Sigma_g^\circ)$ , we denote by  $[\gamma]$  the free homotopy class of  $\gamma$ . For  $\alpha$  a circle, recall that we denote by  $\tau_\alpha$  the Dehn twist about  $\alpha$  (see [FM12]). If  $\gamma \in \pi_1(\Sigma_g^\circ)$ , then  $\tau_\gamma$  is a shorthand for  $\tau_{[\gamma]}$ , thus defined as follows: consider a circle  $\gamma'$  freely homotopic to  $\gamma$  and which does not intersect the boundary circle  $c_g = \partial(\Sigma_g^\circ)$ , then  $\tau_\gamma = \tau_{\gamma'}$ . Of course all these notions make sense for  $\Sigma_{g,n}$  as well.

Recall that we take the loops  $b_i, a_i$  ( $1 \leq i \leq g$ ) represented in Figure 5.4 as generators for the free group  $\pi_1(\Sigma_g^\circ)$ . With these generators, the boundary circle  $c_g$  has the following expression:

$$c_g = b_1 a_1^{-1} b_1^{-1} a_1 \dots b_g a_g^{-1} b_g^{-1} a_g.$$

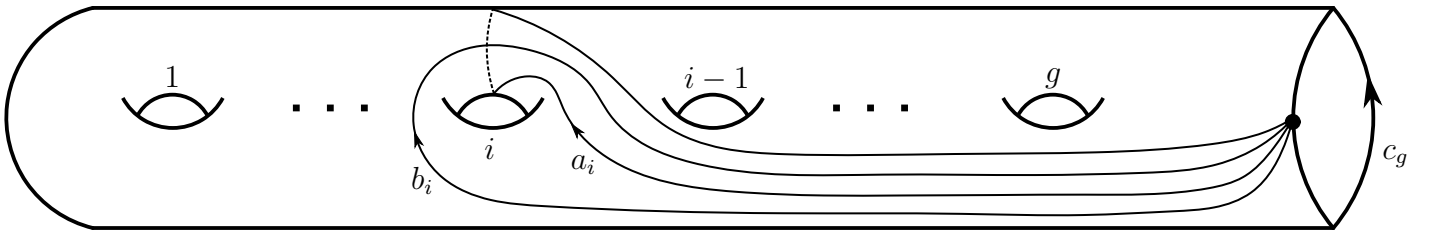

Figure 5.4: Surface  $\Sigma_g^\circ$  with basepoint ( $\bullet$ ), generators for  $\pi_1(\Sigma_g^\circ)$  and boundary circle  $c_g$ .

Retracting  $\Sigma_g^\circ$  to a tubular neighborhood of the loops  $b_i$  and  $a_i$ , we get Figure 5.5. In other words,  $\Sigma_g^\circ$  is homeomorphic to the thickening of the embedded oriented graph  $\Gamma_{g,0}$  with vertex  $\bullet$  and with edges  $b_i$  and  $a_i$ .

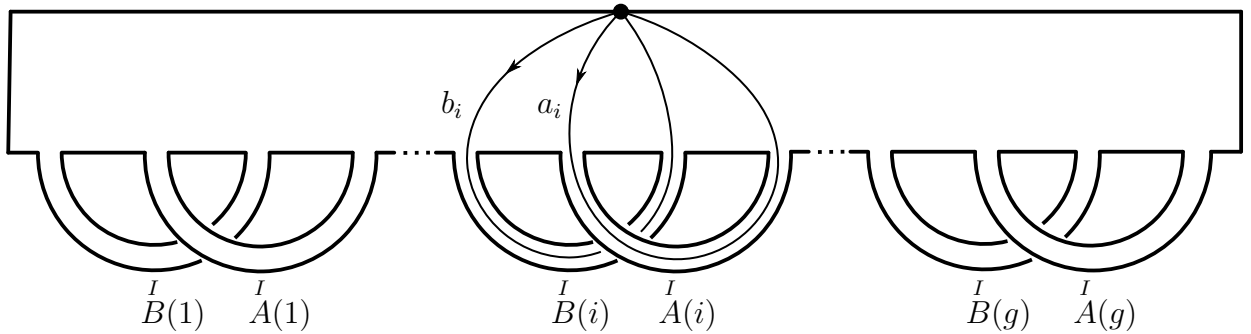

Figure 5.5: Surface  $\Sigma_g^\circ$  viewed as a thickening of the graph  $\Gamma_{g,0}$ , and matrices of generators of  $\mathcal{L}_{g,0}(H)$ .

An important notion for the sequel is that of a positively oriented simple loop.

**Definition 5.3.1.** *We say that a loop in  $\pi_1(\Sigma_g^\circ)$  (or more generally in  $\pi_1(\Sigma_{g,n}^\circ)$ ) is positively oriented if its orientation is counterclockwise, as indicated in Figure 5.6<sup>5</sup>; we say that it is negatively oriented if it is not positively oriented.*

Note that it is possible to have two simple loops  $x_+, x_- \in \pi_1(\Sigma_{g,n}^\circ)$  such that  $x_+$  is positively oriented,  $x_-$  is negatively oriented and  $[x_+] = [x_-]$ . For instance in  $\Sigma_1^\circ$  take  $x_+ = ba^{-1}b^{-1}$  and  $x_- = a^{-1}$ . Thus it makes no sense to say that a circle is positively or negatively oriented. Also recall that a simple loop

<sup>5</sup>Compared to the Figure 5 of [Fai18c], we have done a 180°-rotation around the horizontal axis of  $\mathbb{R}^3$ , in order to have the handles of  $\Sigma_{g,n}^\circ$  at the bottom of the Figure. The reason of this change comes from the definition of the graphical calculus and the Wilson loop map in Chapter 6.

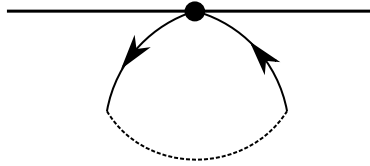

Figure 5.6: A positively oriented loop near the basepoint fixed in Figure 5.2 or 5.5.

or a circle is *non-separating* if it does not cut the surface into two connected components, otherwise it is called *separating*. All these properties (simple, non-separating, positively oriented) are preserved under the action of Dehn twists on the loops, hence they are preserved under the action of  $\text{MCG}(\Sigma_g^\circ)$  on the loops.

In addition to the generating loops  $b_i$  and  $a_i$ , we define the following loops on  $\Sigma_g^\circ$ :

$$\begin{aligned} d_1 &= b_1 a_1^{-1} b_1^{-1}, & d_i &= a_{i-1} b_i a_i^{-1} b_i^{-1} \quad \text{for } 2 \leq i \leq g, \\ e_1 &= b_1 a_1^{-1} b_1^{-1}, & e_i &= b_1 a_1^{-1} b_1^{-1} a_1 \dots b_{i-1} a_{i-1}^{-1} b_{i-1}^{-1} a_{i-1} b_i a_i^{-1} b_i^{-1} \quad \text{for } 2 \leq i \leq g, \\ s_i &= b_1 a_1^{-1} b_1^{-1} a_1 \dots b_i a_i^{-1} b_i^{-1} a_i \quad \text{for } 1 \leq i \leq g. \end{aligned} \quad (5.16)$$

The loops  $b_i, a_i, d_i, e_i$  are simple, non-separating and positively oriented; their free homotopy class are depicted in Figure 5.7.

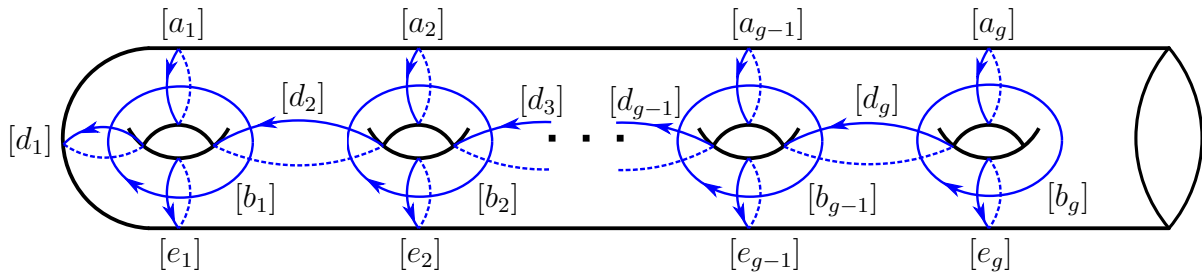

Figure 5.7: A canonical set of non-separating curves on the surface  $\Sigma_g^\circ$ .

The loops  $s_i$  are simple, separating and positively oriented; their free homotopy class are depicted in Figure 5.8. Note that  $s_g = c_g$ .

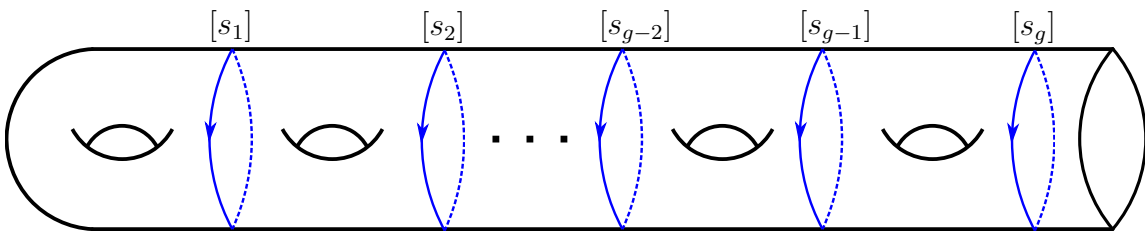

Figure 5.8: Canonical separating curves on the surface  $\Sigma_g^\circ$ .

The Dehn twists  $\tau_{e_2}, \tau_{b_i}, \tau_{d_i}$  are called the Humphries generators. There exists presentations of  $\text{MCG}(\Sigma_g)$  and  $\text{MCG}(\Sigma_g^\circ)$  due to Wajnryb [Waj83] (also see [FM12, Sect. 5.2.1]):  $\text{MCG}(\Sigma_g^\circ)$  is generated by the Humphries generators together with four families of relations called disjointness relations, braid relations, 3-chain relation and lantern relation, see [FM12, Theorem 5.3] (the correspondence of notations with [FM12, Figure 5.7] is  $c_0 = [e_2]$ ,  $c_{2j} = [b_j]$ ,  $c_{2j-1} = [d_j]$ ). The presentation of  $\text{MCG}(\Sigma_g)$  is obtained as the quotient of  $\text{MCG}(\Sigma_g^\circ)$  by the hyperelliptic relation:

$$\left( \tau_{b_g} \tau_{d_g} \dots \tau_{b_1} \tau_{d_1} \tau_{d_1} \tau_{b_1} \dots \tau_{d_g} \tau_{b_g} \right) w = w \left( \tau_{b_g} \tau_{d_g} \dots \tau_{b_1} \tau_{d_1} \tau_{d_1} \tau_{b_1} \dots \tau_{d_g} \tau_{b_g} \right) \quad (5.17)$$

where  $w$  is any word in the Humphries generators which equals  $\tau_{a_g}$ .

Since the mapping class group fixes the boundary pointwise, the basepoint is fixed and we can consider the action of  $\text{MCG}(\Sigma_g^\circ)$  on  $\pi_1(\Sigma_g^\circ)$ . The actions of the Humphries generators on the fundamental group are easily computed (see (4.24)). We just indicate the non-trivial actions:

$$\begin{aligned} \tau_{e_2}(a_1) &= e_2^{-1}a_1e_2, \quad \tau_{e_2}(b_1) = e_2^{-1}b_1e_2, \quad \tau_{e_2}(b_2) = e_2^{-1}b_2, \\ \tau_{b_i}(a_i) &= b_i^{-1}a_i, \\ \tau_{a_1}(b_1) &= b_1a_1 \quad (\text{note that } [a_1] = [d_1^{-1}]), \\ \tau_{d_i}(a_{i-1}) &= d_i^{-1}a_{i-1}d_i, \quad \tau_{d_i}(b_{i-1}) = b_{i-1}d_i, \quad \tau_{d_i}(b_i) = d_i^{-1}b_i \quad (\text{with } i \geq 2). \end{aligned} \tag{5.18}$$

### 5.3.2 Normalization of simple closed curves

In this section, we associate an integer to any oriented circle and to any simple loop in  $\pi_1(\Sigma_{g,n}^\circ)$  (we define this integer for the general case  $n \geq 0$ ). To define these quantities, we use the view of  $\Sigma_{g,n}^\circ$  depicted in Figure 5.2. Note that it is not the assignment defined in [AS96a, Section 9] (it gives different values). This comes from the fact that their normalizations by powers of  $v$  of particular product of matrices (see section 5.3.3) differ from ours. This is maybe due to their normalization of Clebsch-Gordan operators (which are not used here since they are defined in the semi-simple case only).

Let  $\gamma \subset \Sigma_{g,n}^\circ$  be an oriented circle (which is not isotopic to a point). Using isotopy, we may assume that the handles of Figure 5.2 contain only bunches of parallel strands. Since  $\gamma$  is simple, the ‘‘rectangle’’ in Figure 5.2 can contain only vertical strands, caps  $\cap$  and cups  $\cup$ . We choose the following preferred direction on  $\Sigma_{g,n}^\circ$ :

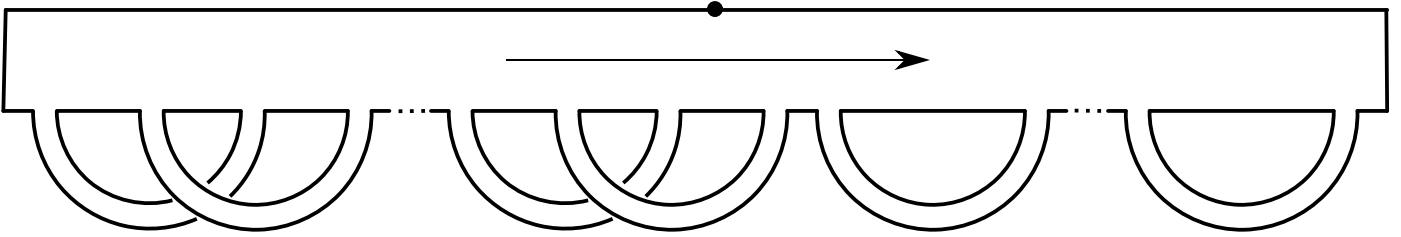

We define  $N_U(\gamma)$  as the number of cups and strands-in-handle which run against this preferred direction; similarly, we define  $N_\cap(\gamma)$  as the number of caps which run against this preferred direction. More precisely,  $N_U(\gamma)$  (resp.  $N_\cap(\gamma)$ ) is the number of pieces of  $\gamma$  which look like the following:

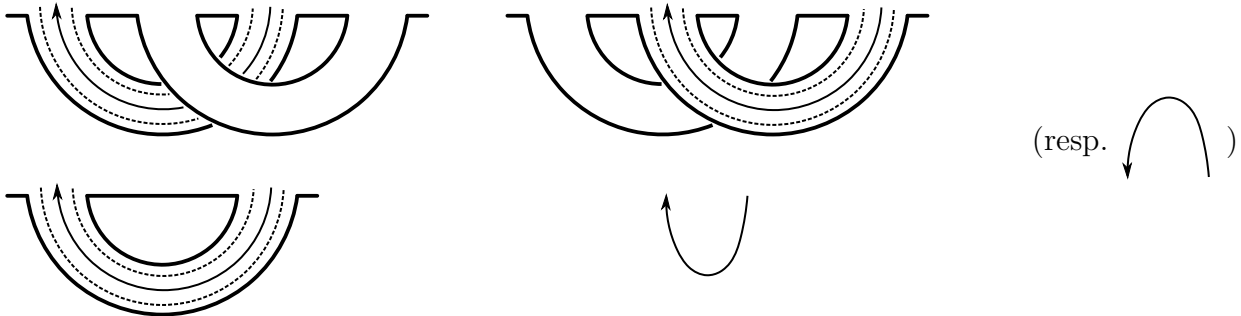

If  $x \in \pi_1(\Sigma_{g,n}^\circ)$  is a non-trivial loop, we define  $N_U(x)$  and  $N_\cap(x)$  by the same formula (we stress that the junction of the loop at the basepoint is not considered as a cap).

**Definition 5.3.2.** Let  $\eta$  be an oriented circle  $\subset \Sigma_{g,n}^\circ$  or a loop  $\in \pi_1(\Sigma_{g,n}^\circ)$ . The normalization of  $\eta$  is  $N(\eta) = N_U(\eta) - N_\cap(\eta) \in \mathbb{Z}$ .

It is clear that  $N(\eta)$  does not depend of the homotopy class of  $\eta$ . Note that if  $x \in \pi_1(\Sigma_{g,n}^\circ)$ , we have

$$N(x) = \begin{cases} N([x]) + 1 & \text{if } x \text{ is positively oriented} \\ N([x]) & \text{if } x \text{ is negatively oriented} \end{cases} \tag{5.19}$$

Also observe that if  $\gamma$  is an oriented circle, then

$$N(\gamma^{-1}) = -N(\gamma) \quad (5.20)$$

where  $\gamma^{-1}$  is  $\gamma$  with the opposite orientation.

*Example 5.3.3.* Consider the oriented circle  $\gamma$  and the loop  $x$  depicted below:

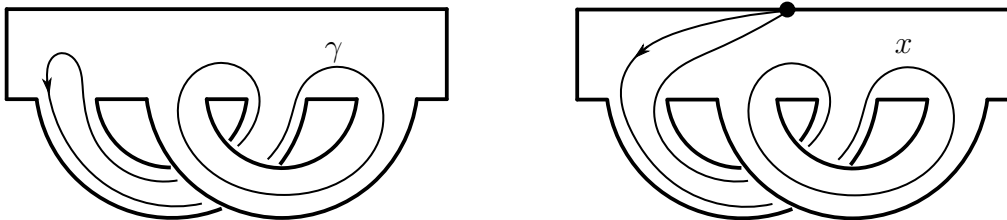

We have  $N_U(\gamma) = 2$  and  $N_\cap(\gamma) = 1$ , thus  $N(\gamma) = 1$ . For  $x = ba^{-1}b^{-1}$ , we have  $N_U(x) = 2$  and  $N_\cap(x) = 0$ , thus  $N(x) = 2$ .  $\triangle$

We can define  $N$  in a different manner. Consider the following figure:

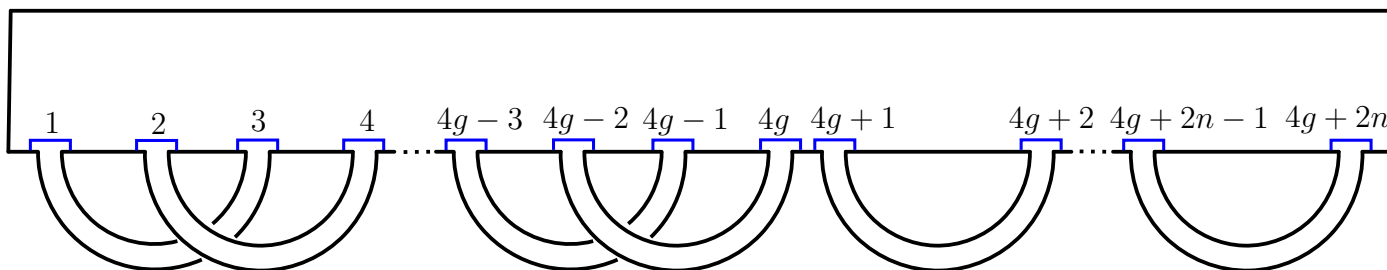

The extremities of each handle are endowed with the blue lines, which we call “gates”, numbered from 1 to  $4g+2n$ . First, let  $x \in \pi_1(\Sigma_{g,n}^\circ)$  be a simple loop. Starting from the basepoint and following  $x$  along its orientation, we meet a first gate numbered  $g_1$ , then a second gate numbered  $g_2$  and so on. This provides a sequence  $g(x) = (g_1, \dots, g_{2k})$  and we have

$$N(x) = \sum_{i=1}^k \delta(g_{2i-1} > g_{2i}) - \sum_{i=1}^{k-1} \delta(g_{2i} \geq g_{2i+1}),$$

where  $\delta(a > b)$  (resp.  $\delta(a \geq b)$ ) is 1 if  $a > b$  (resp.  $a \geq b$ ) and 0 otherwise. Now, if  $\gamma$  is a circle, we do not have a canonical starting point. Instead, choose a point where  $\gamma$  meets one of the gates to *enter* in a handle, numbered  $g_1$ , and follow  $\gamma$  along its orientation. This gives a sequence as previously except that we meet  $g_1$  two times, at the beginning and at the end. In other words,  $g(\gamma) = (g_1, \dots, g_{2k}, g_{2k+1} = g_1)$ , and we have

$$N(\gamma) = \sum_{i=1}^k \delta(g_{2i-1} > g_{2i}) - \sum_{i=1}^k \delta(g_{2i} \geq g_{2i+1}).$$

It is clear that this quantity does not depend on the choice of the starting point.

*Example 5.3.4.* Take back the cases of Example 5.3.3. For the circle  $\gamma$ , we put the starting point at the left of the gate 1. Then we obtain  $g(\gamma) = (1, 3, 4, 2, 3, 1, 1)$  and we recover  $N(\gamma) = 1$ . We might as well have started from the left of the gate 3 or from the gate 4. For the loop  $x$ ,  $g(x) = (1, 3, 4, 2, 3, 1)$  and we recover  $N(x) = 2$ .  $\triangle$

Let  $\omega$  be the algebraic intersection form of simple curves (simple loops or oriented circles); recall that  $\omega(\alpha, \beta)$  is the sum of the indices of the intersection points of  $\alpha$  and  $\beta$ , as follows:



**Lemma 5.3.5.** *Let  $\gamma$  be a circle endowed with an arbitrary orientation and let  $x \in \pi_1(\Sigma_{g,n}^{\circ})$  be a simple loop; it holds*

$$N(\tau_{\gamma}(x)) = N(x) + \omega(x, \gamma)N(\gamma).$$

*This formula is also true if  $x$  is an oriented circle.*

*Proof.* Let  $p_1, \dots, p_k$  be the intersection points between  $x$  and  $\gamma$ . By the method for computing the action of a Dehn twist on a simple closed curve (see (4.24)), it is clear that  $N(\tau_{\gamma}(x)) = N(x) + \epsilon_1 N(\gamma) + \dots + \epsilon_k N(\gamma)$ , with  $\epsilon_i = \pm 1$ . Moreover, it is not difficult to check that each  $\epsilon_i$  indeed is the index of the intersection point  $p_i$ , as defined above. For instance, assume that the intersection looks like in the figure below

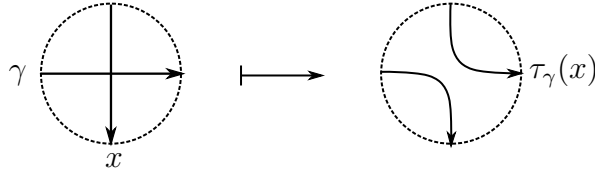

We see that in the resulting curve we follow a copy of  $\gamma$  in the sense of its orientation. Hence, the contribution of this operation to the final result is  $+N(\gamma)$ . And indeed we have  $\omega(x, \gamma) = -\omega(\gamma, x) = +1$ .  $\square$

Now, let  $\pi_1^v(\Sigma_{g,n}^{\circ})$  be the group  $\mathbb{Z} \times \pi_1(\Sigma_{g,n}^{\circ})$ . The elements of  $\pi_1^v(\Sigma_{g,n}^{\circ})$  are of the form  $v^n x$ , where  $x \in \pi_1(\Sigma_{g,n}^{\circ})$  and  $v$  is a formal element commuting with  $\pi_1(\Sigma_{g,n}^{\circ})$ .

For the remaining of this section, we restrict to  $n = 0$  (see however the discussion in section 5.3.5). We define group automorphisms  $\tau_{e_2}^v, \tau_{b_i}^v, \tau_{d_i}^v : \pi_1^v(\Sigma_g^{\circ}) \rightarrow \pi_1^v(\Sigma_g^{\circ})$  which are normalized versions of (5.18):

$$\begin{aligned} \tau_{e_2}^v(v) &= v, & \tau_{b_i}^v(v) &= v, & \tau_{a_1}^v(v) &= v, & \tau_{d_i}^v(v) &= v, \\ \tau_{e_2}^v(a_1) &= e_2^{-1} a_1 e_2, & \tau_{e_2}^v(b_1) &= e_2^{-1} b_1 e_2, & \tau_{e_2}^v(b_2) &= v^{-3} e_2^{-1} b_2, \\ \tau_{b_i}^v(a_i) &= v b_i^{-1} a_i, \\ \tau_{a_1}^v(b_1) &= v^{-1} b_1 a_1 \quad (\text{recall that } [a_1] = [d_1^{-1}]), \\ \tau_{d_i}^v(a_{i-1}) &= d_i^{-1} a_{i-1} d_i, & \tau_{d_i}^v(b_{i-1}) &= v b_{i-1} d_i, & \tau_{d_i}^v(b_i) &= v^{-1} d_i^{-1} b_i \quad (\text{with } i \geq 2). \end{aligned} \tag{5.21}$$

We just indicate the values on the generators of  $\pi_1(\Sigma_g^{\circ})$  which are not fixed. Note that we have defined these group automorphisms in the following way:

$$\tau_y^v(u_i) = v^{N(\tau_y(u_i))} \tau_y(u_i) = v^{\omega(u_i, [y])N([y])} \tau_y(u_i) \tag{5.22}$$

where  $u_i$  is  $b_i$  or  $a_i$  and  $y$  is  $e_2, b_i$  or  $d_i$ <sup>6</sup>.

**Proposition 5.3.6.** *1) The assignment*

$$\tau_{e_2} \mapsto \tau_{e_2}^v, \quad \tau_{b_i} \mapsto \tau_{b_i}^v, \quad \tau_{d_i} \mapsto \tau_{d_i}^v$$

*extends to a morphism of groups  $\text{MCG}(\Sigma_g^{\circ}) \rightarrow \text{Aut}(\pi_1^v(\Sigma_g^{\circ}))$ .*

*2) For  $f \in \text{MCG}(\Sigma_g^{\circ})$ , denote by  $f^v : \pi_1^v(\Sigma_g^{\circ}) \rightarrow \pi_1^v(\Sigma_g^{\circ})$  the image of  $f$  by this morphism. Then for all simple loop  $x \in \pi_1(\Sigma_g^{\circ})$ , it holds*

$$f^v(v^{N(x)} x) = v^{N(f(x))} f(x). \tag{5.23}$$

<sup>6</sup>We recall from section 5.3.1 that if  $y \in \pi_1(\Sigma_g^{\circ})$ , then  $\tau_y$  is a shorthand for  $\tau_{[y]}$  and in this case  $y$  must be considered as a circle.

*Proof.* Thanks to Lemma 5.3.5 and to (5.22), we see that

$$\tau_{y_1}^v \circ \tau_{y_2}^v (v^{N(x)}x) = v^{N(\tau_{y_1} \circ \tau_{y_2}(x))} \tau_{y_1} \circ \tau_{y_2}(x) \quad (5.24)$$

for all  $x \in \pi_1(\Sigma_g^o)$ , where  $y_1, y_2$  are  $e_2, b_i$  or  $d_i$ . Let  $\tau_{y_1}^{\epsilon_1} \dots \tau_{y_k}^{\epsilon_k} = \text{id}$  be a relation in  $\text{MCG}(\Sigma_g^o)$  (where each  $y_j$  is  $e_2, b_i$  or  $d_i$  and  $\epsilon_j \in \mathbb{Z}$ ), then we have  $\tau_{y_1}^{\epsilon_1} \dots \tau_{y_k}^{\epsilon_k}(u_i) = u_i$  for each  $u_i = a_i$  or  $b_i$ . It follows that  $(\tau_{y_1}^v)^{\epsilon_1} \dots (\tau_{y_k}^v)^{\epsilon_k}(u_i) = v^{N(u_i)}u_i = u_i$  and thus  $(\tau_{y_1}^v)^{\epsilon_1} \dots (\tau_{y_k}^v)^{\epsilon_k}(u_i) = \text{id}$ . Alternatively, one can check tediously that the assignment preserve the Wajnryb relations. The second claim follows from (5.24) and the fact that  $\tau_{e_2}, \tau_{b_i}, \tau_{d_i}$  generate  $\text{MCG}(\Sigma_g^o)$ .  $\square$

### 5.3.3 Lifting simple loops and mapping classes to $\mathcal{L}_{g,0}(H)$

We define the lift of a simple loop in the general case ( $n \geq 0$ ). In the group  $\pi_1^v(\Sigma_{g,n}^o)$  defined in the previous section, we have the loops  $b_i, a_i, m_j$  and the formal variable  $v$ , while in  $\mathcal{L}_{g,n}(H)$  we have the matrices  $\overset{I}{B}(i), \overset{I}{A}(i), \overset{I}{M}(j)$  and  $\overset{I}{v}$ . Hence for each  $H$ -module  $I$ , we have an evaluation map  $\text{ev}_I : \pi_1^v(\Sigma_{g,n}^o) \rightarrow \mathcal{L}_{g,n}(H) \otimes \text{End}_{\mathbb{C}}(I)$  defined by

$$b_i \mapsto \overset{I}{B}(i), \quad a_i \mapsto \overset{I}{A}(i), \quad m_j \mapsto \overset{I}{M}(j), \quad v \mapsto \overset{I}{v}, \quad \text{ev}_I(xy) = \text{ev}_I(x)\text{ev}_I(y).$$

This observation together with the normalization introduced in section 5.3.2 will allow us to define the *lift* of a simple loop for any  $g, n$  and the *lift* of a homeomorphism for  $n = 0$  (see however the discussion in section 5.3.5).

**Definition 5.3.7.** *Let  $x \in \pi_1(\Sigma_{g,n}^o)$  be a positively oriented simple loop. The lift of  $x$  (in the representation  $I$ ) is*

$$\overset{I}{\tilde{x}} = \text{ev}_I(v^{N(x)}x).$$

*Let  $x \in \pi_1(\Sigma_{g,n}^o)$  be a negatively oriented simple loop. The lift of  $x$  (in the representation  $I$ ) is*

$$\overset{I}{\tilde{x}} = \left( \overset{I}{x^{-1}} \right)^{-1}.$$

In Remark 6.2.10, we will see why we must distinguish the positively oriented case from the negatively oriented case in the definition of the lift. Of course,  $\overset{I}{\tilde{b}}_i = \overset{I}{B}(i), \overset{I}{\tilde{a}}_i = \overset{I}{A}(i), \overset{I}{\tilde{m}}_j = \overset{I}{M}(j)$  since  $N(b_i) = N(a_i) = N(m_j) = 0$ .

Until now, we restrict to  $n = 0$ . For the loops of (5.16), we have ( $1 \leq i \leq g$ ):

$$\begin{aligned} \overset{I}{\tilde{d}}_i &= \text{ev}_I(v^2 d_i) = \overset{I}{v}^2 \overset{I}{A}(i-1) \overset{I}{B}(i) \overset{I}{A}(i)^{-1} \overset{I}{B}(i)^{-1}, \\ \overset{I}{\tilde{e}}_i &= \text{ev}_I(v^{2i} e_i) = \overset{I}{v}^{2i} \overset{I}{B}(1) \overset{I}{A}(1)^{-1} \overset{I}{B}(1)^{-1} \overset{I}{A}(1) \dots \overset{I}{B}(i-1) \overset{I}{A}(i-1)^{-1} \overset{I}{B}(i-1)^{-1} \overset{I}{A}(i-1) \overset{I}{B}(i) \overset{I}{A}(i)^{-1} \overset{I}{B}(i)^{-1}, \\ \overset{I}{\tilde{s}}_i &= \text{ev}_I(v^{2i} s_i) = \overset{I}{v}^{2i} \overset{I}{B}(1) \overset{I}{A}(1)^{-1} \overset{I}{B}(1)^{-1} \overset{I}{A}(1) \dots \overset{I}{B}(i) \overset{I}{A}(i)^{-1} \overset{I}{B}(i)^{-1} \overset{I}{A}(i). \end{aligned}$$

We note that these lifts satisfy the  $\mathcal{L}_{0,1}(H)$ -fusion relation:

$$\overset{I \otimes J}{\tilde{d}}_i = \overset{I}{\tilde{d}}_i \overset{IJ}{(R')_{12}} \overset{J}{\tilde{d}}_i \overset{IJ}{(R')_{12}}^{-1}, \quad \overset{I \otimes J}{\tilde{e}}_i = \overset{I}{\tilde{e}}_i \overset{IJ}{(R')_{12}} \overset{J}{\tilde{e}}_i \overset{IJ}{(R')_{12}}^{-1}, \quad \overset{I \otimes J}{\tilde{s}}_i = \overset{I}{\tilde{s}}_i \overset{IJ}{(R')_{12}} \overset{J}{\tilde{s}}_i \overset{IJ}{(R')_{12}}^{-1}. \quad (5.25)$$

To check this easily, observe that  $\overset{I}{\tilde{d}}_i = \overset{I}{A}(i-1) \overset{I}{C}_{1,0} \overset{I}{A}(i)^{-1}$ ,  $\overset{I}{\tilde{e}}_i = \overset{I}{C}_{i,0} \overset{I}{A}(i)^{-1}$  and use Lemma 4.2.10 and relations (5.6) to write the fusion and reorder the matrices, which is a straightforward computation.



Now, we define maps  $\widetilde{\tau}_{e_2}, \widetilde{\tau}_{b_i}, \widetilde{\tau}_{d_i} : \mathcal{L}_{g,0}(H) \rightarrow \mathcal{L}_{g,0}(H)$  which lift the action (5.18) of the Humphries generators on the fundamental group by the following formulas (recall (5.21)):

$$\widetilde{\tau}_{e_2}(\text{ev}_I(u_j)) = \text{ev}_I(\tau_{e_2}^v(u_j)), \quad \widetilde{\tau}_{b_i}(\text{ev}_I(u_j)) = \text{ev}_I(\tau_{b_i}^v(u_j)), \quad \widetilde{\tau}_{d_i}(\text{ev}_I(u_j)) = \text{ev}_I(\tau_{d_i}^v(u_j)) \quad (5.26)$$

where  $u_j$  is  $a_j$  or  $b_j$ . Thanks to (5.23) and the fact that  $N(u_j) = 0$ , this can also be written as

$$\widetilde{\tau}_{e_2}(\widetilde{u}_j) = \widetilde{\tau}_{e_2}(u_j), \quad \widetilde{\tau}_{b_i}(\widetilde{u}_j) = \widetilde{\tau}_{b_i}(u_j), \quad \widetilde{\tau}_{d_i}(\widetilde{u}_j) = \widetilde{\tau}_{d_i}(u_j).$$

More explicitly:

$$\begin{aligned} \widetilde{\tau}_{e_2}(A(1)) &= \widetilde{e}_2^{-1} A(1) \widetilde{e}_2, & \widetilde{\tau}_{e_2}(B(1)) &= \widetilde{e}_2^{-1} B(1) \widetilde{e}_2, & \widetilde{\tau}_{e_2}(B(2)) &= \widetilde{v} \widetilde{e}_2^{-1} B(2), \\ \widetilde{\tau}_{b_i}(A(i)) &= \widetilde{v} B(i)^{-1} A(i), \\ \widetilde{\tau}_{a_1}(B(1)) &= \widetilde{v}^{-1} B(1) A(1) \quad (\text{recall that } [a_1] = [d_1^{-1}]), \\ \widetilde{\tau}_{d_j}(A(j-1)) &= \widetilde{d}_j^{-1} A(j-1) \widetilde{d}_j, & \widetilde{\tau}_{d_j}(B(j-1)) &= \widetilde{v}^{-1} B(j-1) \widetilde{d}_j, & \widetilde{\tau}_{d_j}(B(j)) &= \widetilde{v} \widetilde{d}_j^{-1} B(j), \end{aligned} \quad (5.27)$$

for  $j \geq 2$ , and the other matrices are fixed.

**Proposition 5.3.8.** 1) The maps  $\widetilde{\tau}_{e_2}, \widetilde{\tau}_{b_i}, \widetilde{\tau}_{d_i}$  are automorphisms of  $\mathcal{L}_{g,0}(H)$ .

2) The assignment

$$\tau_{e_2} \mapsto \widetilde{\tau}_{e_2}, \quad \tau_{b_i} \mapsto \widetilde{\tau}_{b_i}, \quad \tau_{d_i} \mapsto \widetilde{\tau}_{d_i}$$

extends to a morphism of groups  $\text{MCG}(\Sigma_g^0) \rightarrow \text{Aut}(\mathcal{L}_{g,0}(H))$ .

*Proof.* 1) We have to check that these maps are compatible with the defining relations (5.6). This relies on straightforward but tedious computations. For instance, let us show that  $\widetilde{\tau}_{d_j}(B(j-1))$  satisfies the fusion relation. First, it is easy to establish the following exchange relation:

$$R' B(j-1)_2 R (\widetilde{d}_j)_1 R' = (\widetilde{d}_j)_1 R' B(j-1)_2.$$

Hence, using (5.25),

$$\begin{aligned} \widetilde{v}^{-1} B(j-1) \widetilde{d}_j &= B(j-1) \widetilde{v}^{-1} \widetilde{d}_j = B(j-1) R' R \widetilde{v}_1^{-1} \widetilde{v}_2^{-1} \widetilde{d}_j \\ &= \widetilde{v}_1^{-1} \widetilde{v}_2^{-1} B(j-1)_1 R' B(j-1)_2 R (\widetilde{d}_j)_1 R' (\widetilde{d}_j)_2 R'^{-1} \\ &= \left( \widetilde{v}^{-1} B(j-1) (\widetilde{d}_j) \right)_1 R' \left( \widetilde{v}^{-1} B(j-1) (\widetilde{d}_j) \right)_2 R'^{-1}. \end{aligned}$$

This computation reveals the role of the power of  $v$  which appears in  $\widetilde{\tau}_{d_j}(B(j-1))$ : it replaces  $R'^{-1}$  by  $R$  and allows us to apply the previously established exchange relation. We used (2.11) and the fact that  $\widetilde{v}^K U(k) = U(k) \widetilde{v}^K$  where  $U$  is  $B$  or  $A$ . Note that the normalizations by powers of  $v$  have no importance when one checks the compatibility with the other defining relations of  $\mathcal{L}_{g,0}(H)$ , they are only used for the fusion relation.

2) This is obvious thanks to Proposition 5.3.6 and (5.26).  $\square$

**Definition 5.3.9.** The lift of an element  $f \in \text{MCG}(\Sigma_g^0)$ , denoted by  $\widetilde{f}$ , is its image by the morphism of Proposition 5.3.8.

Due to (5.26), it holds  $\widetilde{f} \circ \text{ev}_I = \text{ev}_I \circ f^v$ . In other words,  $f^v$  and  $\widetilde{f}$  are formally identical. Moreover, we have the following lemma which is an expected fact.

**Lemma 5.3.10.** *If  $x \in \pi_1(\Sigma_g^\circ)$  is a simple loop it holds*

$$\widetilde{f}(\widetilde{x}) = \widetilde{f(x)}.$$

*Proof.* If  $x$  is positively oriented, so is  $f(x)$  and we have

$$\widetilde{f}(\widetilde{x}) = \widetilde{f}(\text{ev}_I(v^{N(x)}x)) = \text{ev}_I(f^v(v^{N(x)}x)) = \text{ev}_I(v^{N(f(x))}f(x)) = \widetilde{f(x)}$$

thanks to (5.3.6) and (5.23). If  $x$  is negatively oriented, so is  $f(x)$  and we have

$$\widetilde{f}(\widetilde{x}) = \widetilde{f}(\widetilde{x^{-1}^{-1}}) = \widetilde{f(x^{-1})}^{-1} = \widetilde{f(x)}^{-1} = \widetilde{f(x)}.$$

□

If  $\gamma_1, \gamma_2$  are circles on a surface which have the same topological type<sup>7</sup>, there exists a homeomorphism  $f$  such that  $f(\gamma_1)$  is freely homotopic to  $\gamma_2$  (see e.g. [FM12, Sect. 1.3.1]). Here we need to consider fixed-point homotopies. We say that two simple loops  $x_1, x_2 \in \pi_1(\Sigma_g^\circ)$  have the same topological type if the circles  $[x_1], [x_2]$  have the same topological type.

**Lemma 5.3.11.** *Let  $x_1, x_2$  be positively oriented simple loops in  $\pi_1(\Sigma_g^\circ)$  which have the same topological type, then there exists  $f \in \text{MCG}(\Sigma_g^\circ)$  such that  $f(x_1) = x_2$  in  $\pi_1(\Sigma_g^\circ)$ .*

*Proof.* As mentioned, we already know that there exists  $\eta \in \text{MCG}(\Sigma_g^\circ)$  such that  $\eta(x_1) = x'_2 = \alpha^\varepsilon x_2^{\pm 1} \alpha^{-\varepsilon}$  in  $\pi_1(\Sigma_g^\circ)$  for some loop  $\alpha$  and some  $\varepsilon \in \{\pm 1\}$ .  $x'_2$  is positively oriented, non-separating and simple since  $x_1$  is, and thus we can assume that  $\alpha$  is simple and does not intersect  $x_2$  (except at the basepoint). There are six possible configurations for the loops  $\alpha$  and  $x_2$  in a neighbourhood of the basepoint:

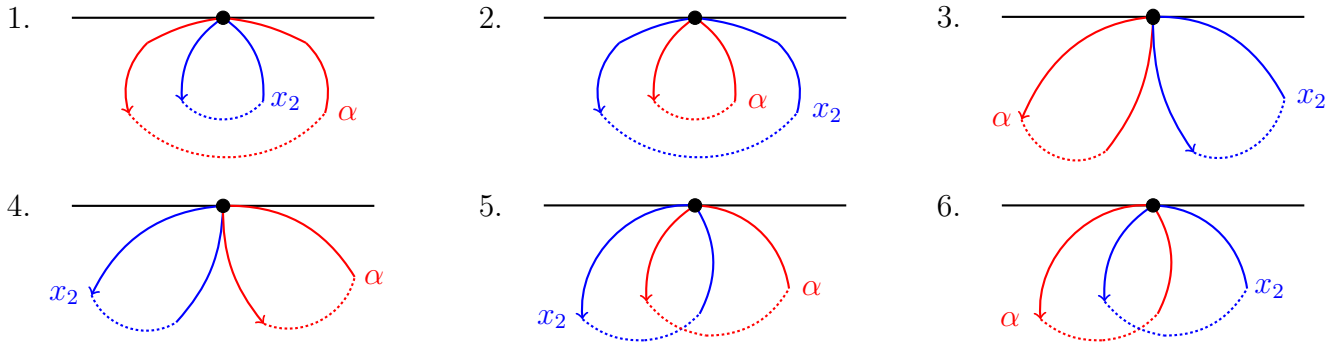

In case 1,  $x'_2 = \alpha x_2 \alpha^{-1}$ , and then  $\tau_\alpha(x'_2) = \alpha^{-1} x'_2 \alpha = x_2$ . Case 2 is impossible because none of the four possible loops  $\alpha^\varepsilon x_2^{\pm 1} \alpha^{-\varepsilon}$  is simple. In case 3,  $x'_2 = \alpha x_2 \alpha^{-1}$ . For  $\beta = \alpha x_2$ , we have  $\tau_\beta(\alpha) = \beta^{-1} \alpha \beta$ ,  $\tau_\beta(x_2) = \beta^{-1} x_2 \beta$ , and thus  $\tau_\beta(x'_2) = x_2$ . In case 4,  $x'_2 = \alpha^{-1} x_2 \alpha$ . For  $\delta = x_2 \alpha$ , we get similarly to case 3 that  $\tau_\delta^{-1}(x'_2) = \delta x'_2 \delta^{-1} = x_2$ . In case 5,  $x'_2 = \alpha^{-1} x_2^{-1} \alpha$ . Observe that  $\tau_\alpha(x_2) = x_2 \alpha$ ,  $\tau_{x_2}(\alpha) = x_2^{-1} \alpha$ , and then

$$\tau_\alpha^{-1} \tau_{x_2}^{-2} \tau_\alpha^{-1} (\alpha^{-1} x_2^{-1} \alpha) = \tau_\alpha^{-1} \tau_{x_2}^{-2} (x_2^{-1} \alpha) = \tau_\alpha^{-1} (x_2 \alpha) = x_2.$$

In case 6,  $x'_2 = \alpha x_2^{-1} \alpha^{-1}$ , and we get similarly to case 5 that  $\tau_\alpha \tau_{x_2}^2 \tau_\alpha (x'_2) = x_2$ . □

*Example 5.3.12.* We have

$$\tau_{b_i} \tau_{a_i} (b_i) = a_i, \quad \tau_{d_i}^{-1} \tau_{b_{i-1}}^{-1} (d_i) = b_{i-1}, \quad \tau_{y_i}^{-1} \tau_{a_i}^{-1} \tau_{b_{i-1}}^{-1} \tau_{y_i}^{-1} (a_i) = b_{i-1}, \quad \tau_{y_2}^{-1} \tau_{b_1}^{-1} \tau_{e_2} \tau_{y_2} (e_2) = b_1$$

where  $y_i = a_{i-1} b_i$ . This allows to transform any of the loops  $a_i, b_i, d_i, e_2$  into  $a_1$ . △

<sup>7</sup>Two circles  $\gamma_1, \gamma_2$  on a surface  $S$  are said to have the same topological type if the cut surfaces  $S_{\gamma_1}, S_{\gamma_2}$  are the same (up to homeomorphism), see [FM12, p. 38].

*Remark 5.3.13.* In [Fai18c], Lemma 5.3.11 was the starting point to define the lift of non-separating positively oriented simple loops. More precisely, we first defined the lifts of the Humphries generators and checked that they satisfy the Wajnryb relations. This defines the lift of every  $f \in \text{MCG}(\Sigma_g^o)$ .

Then we declared that the lift of  $a_1$  (in the representation  $I$ ) is  $\overset{I}{A}(1)$  and that the lift of a non-separating positively oriented simple loop  $x \in \pi_1(\Sigma_g^o)$  is  $\widetilde{f}(\overset{I}{A}(1))$  where  $f$  is such that  $x = f(a_1)$ .

For this, it was necessary to show that  $f(a_1) = g(a_1)$  implies  $\widetilde{f}(\overset{I}{A}(1)) = \widetilde{g}(\overset{I}{A}(1))$ , which was done in [Fai18c, Lemma 5.5]. This had the advantage to be shorter than the construction presented here since it does not require to define the normalization  $N$ . However, it is less general because it is not adapted to non-separating loops.  $\triangle$

Lemma 5.3.11 has the following important consequence.

**Proposition 5.3.14.** *Let  $x \in \pi_1(\Sigma_g^o)$  be a positively oriented simple loop. Then the lift of  $x$  satisfies the fusion relation of  $\mathcal{L}_{0,1}(H)$ :*

$$\overset{I \otimes J}{\widetilde{x}} = \overset{I}{\widetilde{x}_1} \overset{IJ}{R'} \overset{J}{\widetilde{x}_2} \overset{IJ}{R'^{-1}}.$$

It follows that there exists a morphism of  $H$ -module-algebras  $j_{\widetilde{x}} : \mathcal{L}_{0,1}(H) \rightarrow \mathcal{L}_{g,0}(H)$  given by  $\overset{I}{M} \mapsto \overset{I}{\widetilde{x}}$ .

*Proof.* There are  $g + 1$  possible topological types for loops in  $\Sigma_g^o$ . The more simple positively oriented loops representing each topological type are  $a_1, s_1, \dots, s_g$  (whose cut surfaces are respectively  $\Sigma_{g,3}, \Sigma_{1,1} \sqcup \Sigma_{g-1,2}, \dots, \Sigma_{g,1} \sqcup \Sigma_{0,2}$ , see Figures 5.7 and 5.8). These particular loops satisfy the fusion relation. This is obviously true for  $\widetilde{a}_1 = \overset{I}{A}(1)$ . For  $\widetilde{s}_i$ , observe that  $\overset{I}{\widetilde{s}_i} = j(\overset{I}{C_{i,0}})$ , where  $\overset{I}{C_{i,0}}$  is defined in section 5.2 and  $j : \mathcal{L}_{i,0}(H) \rightarrow \mathcal{L}_{g,0}(H)$  is the obvious embedding. Since by Proposition 5.2.2,  $C_{i,0}$  satisfies the fusion relation, so does  $\widetilde{s}_i$ . By Lemma 5.3.11, there exists  $f \in \text{MCG}(\Sigma_g^o)$  such that  $f(x)$  is  $a_1$  or  $s_1 \dots$  or  $s_g$  and hence by Lemma 5.3.10:

$$\overset{I \otimes J}{\widetilde{x}} = f^{-1}(\overset{I \otimes J}{f(x)}) = \widetilde{f}^{-1}\left(\overset{I \otimes J}{f(x)}\right) = \widetilde{f}^{-1}\left(\overset{I}{f(x)_1} \overset{IJ}{R'} \overset{J}{f(x)_2} \overset{IJ}{R'^{-1}}\right) = \overset{I}{\widetilde{x}_1} \overset{IJ}{R'} \overset{J}{\widetilde{x}_2} \overset{IJ}{R'^{-1}},$$

as desired.  $\square$

Recall that  $\mathcal{L}_{g,0}(H) \cong \text{End}_{\mathbb{C}}((H^*)^{\otimes g})$  is a matrix algebra. By the Skolem-Noether theorem, every automorphism of  $\mathcal{L}_{g,0}(H)$  is inner. Hence to each  $f \in \text{MCG}(\Sigma_g^o)$  is associated an element  $\widehat{f} \in \mathcal{L}_{g,0}(H)$ , unique up to scalar, such that

$$\forall x \in \mathcal{L}_{g,0}(H), \quad \widetilde{f}(x) = \widehat{f} x \widehat{f}^{-1}. \quad (5.28)$$

We will determine the elements  $\widehat{\tau}_\gamma$  associated to Dehn twists about non-separating circles and use this to show that  $\widehat{f} \in \mathcal{L}_{g,0}^{\text{inv}}(H)$ .

**Lemma 5.3.15.** *We have  $\widehat{\tau}_{a_1} = v_{A(1)}^{-1}$ . In other words:*

$$\forall x \in \mathcal{L}_{g,0}(H), \quad \widetilde{\tau}_{a_1}(x) = v_{A(1)}^{-1} x v_{A(1)}.$$

*Proof.* We have  $v_{A(1)}^{-1} \overset{I}{A}(1) = \overset{I}{A}(1) v_{A(1)}^{-1} = \widetilde{\tau}_{a_1}(\overset{I}{A}(1)) v_{A(1)}^{-1}$ . Indeed, since  $v^{-1}$  is central in  $H$ ,  $v_{A(1)}^{-1}$  is central in the subalgebra generated by the coefficients of the matrices  $\overset{I}{A}(1)$ . Next, let  $j_1 : \mathcal{H}(\mathcal{O}(H)) \rightarrow \mathcal{H}(\mathcal{O}(H))^{\otimes g}$  be the canonical embedding on the first copy. Observe that for all  $x \in H$ ,  $\Psi_{g,0}(x_{A(1)}) = j_1(x)$ . Then:

$$\begin{aligned} \Psi_{g,0}(v_{A(1)}^{-1} \overset{I}{B}(1)) &= j_1(v^{-1} \overset{I}{L}^{(+)} \overset{I}{T} \overset{I}{L}^{(-) - 1}) = j_1(\overset{I}{L}^{(+)} \overset{I}{T} (v'^{-1}) v''^{-1} \overset{I}{L}^{(-) - 1}) \\ &= j_1(\overset{I}{L}^{(+)} \overset{I}{T} \overset{I}{v}^{-1} \overset{I}{b}_i \overset{I}{a}_j \overset{I}{a}_i \overset{I}{b}_j v^{-1} \overset{I}{L}^{(-) - 1}) = j_1(\overset{I}{v}^{-1} \overset{I}{L}^{(+)} \overset{I}{T} \overset{I}{L}^{(-) - 1} \overset{I}{L}^{(+)} \overset{I}{L}^{(-) - 1} v^{-1}) \\ &= \Psi_{g,0}(\overset{I}{v}^{-1} \overset{I}{B}(1) \overset{I}{A}(1) v_{A(1)}^{-1}) = \Psi_{g,0}(\widetilde{\tau}_{a_1}(\overset{I}{B}(1)) v_{A(1)}^{-1}). \end{aligned}$$

We used the exchange relation (2.26) of  $\mathcal{H}(\mathcal{O}(H))$  together with (2.11) and the definition of the matrices  $\overset{I}{L}^{(\pm)}$ . Finally, recall the matrices (5.9) which occur in the definition of the Alekseev isomorphism. The same argument as in the proof of Lemma 5.2.3 shows that

$$\Psi_{1,0}^{\otimes g}(\overset{I}{\Lambda}_i) = S^{-1}(b_\ell) \widetilde{a_\ell^{(2i-1)}} a_\ell^{(2i)} \otimes \dots \otimes \widetilde{a_\ell^{(1)}} b_\ell^{(2)}.$$

From this we see that  $j_1(v^{-1})$  commutes with  $\Psi_{1,0}^{\otimes g}(\overset{I}{\Lambda}_i)$ . Eventually it follows that  $\Psi_{g,0}(v_{A(1)}^{-1})$  commutes with  $\Psi_{g,0}(\overset{I}{U}(i)) = \Psi_{g,0}\left(\widetilde{\tau_{a_1}}(\overset{I}{U}(i))\right)$ , where  $U$  is  $A$  or  $B$ .  $\square$

Recall the notation (5.8). If  $\gamma$  is a simple loop,  $\widetilde{\gamma}$  satisfies the fusion relation and thus  $(v^{-1})_{\widetilde{\gamma}} = (v_{\widetilde{\gamma}})^{-1}$ .

**Proposition 5.3.16.** *For any non-separating circle  $\gamma$  on  $\Sigma_g^o$ , we have  $\widehat{\tau}_\gamma = v_{\widetilde{\gamma}}^{-1}$ . In other words:*

$$\forall x \in \mathcal{L}_{g,0}(H), \quad \widetilde{\tau}_\gamma(x) = v_{\widetilde{\gamma}}^{-1} x v_{\widetilde{\gamma}}.$$

If  $\gamma, \delta \in \pi_1(\Sigma_g^o)$  are positively oriented non-separating simple loops such that  $[\gamma] = [\delta]$ , then  $v_{\widetilde{\gamma}}$  is proportional to  $v_{\widetilde{\delta}}$ .

*Proof.* We represent the circle  $[\gamma]$  by a positively oriented, non-separating simple loop  $\gamma \in \pi_1(\Sigma_g^o)$ . Let  $f \in \text{MCG}(\Sigma_g^o)$  be such that  $f(a_1) = \gamma$ , then

$$\widetilde{\tau}_\gamma = \widetilde{\tau_{f(a_1)}} = \widetilde{f \tau_{a_1} f^{-1}} = \widetilde{f} \widetilde{\tau_{a_1}} \widetilde{f}^{-1}.$$

Hence, by Lemma 5.3.15,

$$\forall x \in \mathcal{L}_{g,0}(H), \quad \widetilde{\tau}_\gamma(\widetilde{f}(x)) = \widetilde{f}(\widetilde{\tau_{a_1}}(x)) = \widetilde{f}(v_{A(1)}^{-1} x v_{A(1)}) = v_{\widetilde{\gamma}}^{-1} \widetilde{f}(x) v_{\widetilde{\gamma}}.$$

Replacing  $x$  by  $\widetilde{f}^{-1}(x)$ , we get the result. The second claim follows from a similar reasoning together with the fact that  $\tau_\gamma$  depends only of the free homotopy class of  $\gamma$ .  $\square$

An analogous result in the modular setting has been given in [AS96a, eq (9.7)]. The notation  $v_{\widetilde{\gamma}}^{-1}$  does not appear in their work; instead, they express this element as a linear combination of traces which form a basis in the modular case only.

**Corollary 5.3.17.** *For all  $f \in \text{MCG}(\Sigma_g^o)$ , it holds  $\widehat{f} \in \mathcal{L}_{g,0}^{\text{inv}}(H)$ .*

*Proof.* Let  $\gamma$  be a positively oriented, non-separating simple loop. Then  $\widetilde{\gamma}$  satisfies the fusion relation of  $\mathcal{L}_{0,1}(H)$ , and thus  $j_{\widetilde{\gamma}}$  is a morphism of  $H$ -module-algebras (Lemma 5.1.2). Hence, since  $v^{-1} \in \mathcal{Z}(H) = \mathcal{L}_{0,1}^{\text{inv}}(H)$ , we have  $v_{\widetilde{\gamma}}^{-1} \in \mathcal{L}_{g,0}^{\text{inv}}(H)$ . In particular, the statement is true for the Humphries generators thanks to Proposition 5.3.16 and thus for any  $f$ .  $\square$

### 5.3.4 Representation of the mapping class group

The only additional fact needed is the following lemma.

**Lemma 5.3.18.** *It holds:  $v_{A(g)}^{-1} = v_{A(g)^{-1}}$ .*

*Proof.* Denote as usual  $X_i \otimes Y_i = RR'$ ,  $\overline{X}_i \otimes \overline{Y}_i = (RR')^{-1}$  and let  $\mu^l$  be the left integral on  $H$  (unique up to scalar). We have:

$$\mu^l(vX_i)Y_i = \mu^l(v)v^{-1} = \mu^l(v\overline{X}_i)\overline{Y}_i.$$

The first equality is shown in the proof of Proposition 2.3.4 while the second is easy using (2.11) and (2.19). Let us write  $\mu^l(v)^{-1}\mu^l(v?) = \sum_{i,j,I} c_{I,i}^j T_j^I$  with  $c_{I,i}^j \in \mathbb{C}$ . Then, using the identification  $\overset{I}{M} = (\overset{I}{X}_i)Y_i$  between  $\mathcal{L}_{0,1}(H)$  and  $H$ , the fact that  $\overset{I}{M}^{-1} = (\overset{I}{X}_i)\bar{Y}_i$  and the equalities above, we get

$$v_{A(g)}^{-1} = j_{A(g)} \left( \sum_{i,j,I} c_{I,i}^j \overset{I}{M}_j^i \right) = j_{A(g)} \left( \sum_{i,j,I} c_{I,i}^j (\overset{I}{M}^{-1})_j^i \right) = j_{A(g)^{-1}} \left( \sum_{i,j,I} c_{I,i}^j \overset{I}{M}_j^i \right) = v_{A(g)^{-1}}^{-1}$$

where the morphisms  $j_\bullet$  are defined at the end of subsection 5.1.1. We used that  $j_{A(g)}$  is a morphism of algebras (see Lemma 5.1.2).  $\square$

It is clear that the lemma holds for the lift of any positively oriented, non-separating simple loop, but we do not need this.

Recall that we have a representation of  $\mathcal{L}_{g,0}(H)$  on  $(H^*)^{\otimes g}$ , let us denote it  $\rho$ . We also have the associated representation of  $\mathcal{L}_{g,0}^{\text{inv}}(H)$  on  $\text{Inv}((H^*)^{\otimes g})$ , let us denote it  $\rho_{\text{inv}}$ . Also recall that the elements  $\widehat{f}$  are defined in (5.28). We can now state the representation of the mapping class groups  $\text{MCG}(\Sigma_g^\circ)$  and  $\text{MCG}(\Sigma_g)$ . An analogous result was announced in [AS96a] under the assumption that the gauge algebra is modular.

**Theorem 5.3.19.** 1) *The map*

$$\begin{aligned} \theta_g^\circ : \text{MCG}(\Sigma_g^\circ) &\rightarrow \text{GL}((H^*)^{\otimes g}) \\ f &\mapsto \rho(\widehat{f}) \end{aligned}$$

is a projective representation.

2) *The map*

$$\begin{aligned} \theta_g : \text{MCG}(\Sigma_g) &\rightarrow \text{GL}(\text{Inv}((H^*)^{\otimes g})) \\ f &\mapsto \rho_{\text{inv}}(\widehat{f}) \end{aligned}$$

is a projective representation.

*Proof.* 1) This is an immediate consequence of Proposition 5.3.8.

2) We must show that the hyperelliptic relation (5.17) is projectively satisfied. The word  $w$  can be constructed as follows: take  $f \in \text{MCG}(\Sigma_g^\circ)$  such that  $f(a_1) = a_g$  and express it as a word in the Humphries generators  $f = \tau_{\gamma_1} \dots \tau_{\gamma_n}$ . Then  $\tau_{a_g} = f\tau_{a_1}f^{-1}$  and  $w = \tau_{\gamma_1} \dots \tau_{\gamma_n}\tau_{a_1}\tau_{\gamma_n}^{-1} \dots \tau_{\gamma_1}^{-1}$ . The automorphism  $\widetilde{\tau}_{a_g}$  is implemented by conjugation by  $\widehat{f}v_{A(1)}^{-1}\widehat{f}^{-1}$  and also by conjugation by  $v_{A(g)}^{-1}$  (Proposition 5.3.16). Hence,  $\widehat{f}v_{A(1)}^{-1}\widehat{f}^{-1} \sim v_{A(g)}^{-1}$ , where  $\sim$  means proportional. Now, let  $h = \tau_{b_g}\tau_{d_g} \dots \tau_{b_1}\tau_{d_1}\tau_{d_1}\tau_{b_1} \dots \tau_{d_g}\tau_{b_g}$ . A computation gives  $\widetilde{h}(A(g)) = \overset{I}{A}(g)^{-1}\overset{I}{C}_{g,0}$ . Thus

$$\widehat{h}\widehat{f}v_{A(1)}^{-1}\widehat{f}^{-1}\widehat{h}^{-1} \sim \widehat{h}v_{A(g)}^{-1}\widehat{h}^{-1} = \widetilde{h}(v_{A(g)}^{-1}) = v_{A(g)^{-1}C_{g,0}}^{-1}.$$

By definition of  $\text{Inv}((H^*)^{\otimes g})$  and Lemma 5.3.18, we have

$$\rho_{\text{inv}}(v_{A(g)^{-1}C_{g,0}}^{-1}) = \rho_{\text{inv}}(v_{A(g)^{-1}}^{-1}) = \rho_{\text{inv}}(v_{A(g)}^{-1}).$$

It follows that  $\rho_{\text{inv}}(\widehat{h}(\widehat{f}v_{A(1)}^{-1}\widehat{f}^{-1})\widehat{h}^{-1}) \sim \rho_{\text{inv}}(\widehat{f}v_{A(1)}^{-1}\widehat{f}^{-1})$ . This shows that the map is well-defined since  $\text{MCG}(\Sigma_g)$  is the quotient of  $\text{MCG}(\Sigma_g^\circ)$  by the hyperelliptic relation and that it is a projective representation.  $\square$

Note that, as in the case of the torus (see discussion at the beginning of section 4.3.3), the representation  $\text{Inv}((H^*)^{\otimes g})$  allowed us to glue back the disc  $D$ , and hence to obtain a representation of  $\text{MCG}(\Sigma_g)$  (and not just of  $\text{MCG}(\Sigma_g^\circ)$ ).

*Remark 5.3.20.* I think undoubtedly that, when  $H$  is modular, the projective representation of Theorem 5.3.19 is equivalent to the one of [AS96a, Th. 28]. Let  $\mathcal{M}_{g,0}^{\text{AS}}(H)$  be the moduli algebra of [AS96a] (whose construction holds under the assumption that  $H$  is modular). In [AS96a, Th.

28], each Dehn twist is mapped to an element of  $\mathcal{M}_{g,0}^{\text{AS}}(H)$ : 
$$\begin{array}{ccc} \text{MCG}(\Sigma_g) & \rightarrow & \mathcal{M}_{g,0}^{\text{AS}}(H) \\ \tau_\gamma & \mapsto & \hat{h}(\gamma) \end{array}$$
 and these

elements  $\hat{h}(\gamma)$  (which implement the lift of  $\tau_\gamma$  by conjugation in the moduli algebra) are claimed to satisfy the relations of  $\text{MCG}(\Sigma_g)$  up to scalar. Recall that in (1.9) we proposed to take the image of the representation  $\rho_{\text{inv}}$  as a generalization  $\mathcal{M}_{g,0}^{\text{gen}}(H)$  of the moduli algebra  $\mathcal{M}_{g,0}^{\text{AS}}(H)$  in the non-

modular setting. With this definition, we have a map 
$$\begin{array}{ccc} \text{MCG}(\Sigma_g) & \rightarrow & \mathcal{M}_{g,0}^{\text{gen}}(H) \\ \tau_\gamma & \mapsto & \rho_{\text{inv}}(v_\gamma^{-1}) \end{array}$$
 which satisfies the relations of  $\text{MCG}(\Sigma_g)$  up to scalar. If the algebras  $\mathcal{M}_{g,0}^{\text{AS}}(H)$  and  $\mathcal{M}_{g,0}^{\text{gen}}(H)$  are isomorphic when  $H$  is modular, then the representations of  $\text{MCG}(\Sigma_g)$  are equivalent in this case. This remark can of course be generalized to any  $\Sigma_{g,n}$ .  $\triangle$

### 5.3.5 Discussion for the case $n > 0$

Let us consider the general case  $n > 0$ , see Figure 5.1. Denote  $\Sigma_{g,n}^\circ = \Sigma_{g,n} \setminus D$ , where  $D$  is an embedded open disk.

The only difference is that, in general,  $\mathcal{L}_{g,n}(H)$  is not a matrix algebra and we cannot claim directly the existence and unicity up to scalar of the elements  $\hat{f}$ . Nevertheless, we now propose (without proofs) a program to extend the previous construction which should not be difficult to apply.

The first task is to define the lifting homomorphism  $\text{MCG}(\Sigma_{g,n}^\circ) \rightarrow \text{Aut}(\mathcal{L}_{g,n}(H))$  generalizing Definition 5.3.9:

- Consider a generating set  $g_1, \dots, g_k$  of  $\text{MCG}(\Sigma_{g,n}^\circ)$  and compute the action of these generators on  $\pi_1(\Sigma_{g,n}^\circ)$ .
- As in (5.21), define the morphisms  $g_i^v \in \text{Aut}(\pi_1^v(\Sigma_{g,n}^\circ))$  by the formula

$$\forall x \in \{b_1, a_1, \dots, b_g, a_g, m_{g+1}, \dots, m_{g+n}\}, \quad g_i^v(x) = v^{N(g_i(x))} g_i(x).$$

It is clear that Proposition 5.3.6 is not at all specific to the case  $n = 0$  and remains true for any  $n$ . In particular, the assignment  $g_i \mapsto g_i^v$  extends to a morphism of groups  $\text{MCG}(\Sigma_{g,n}^\circ) \rightarrow \text{Aut}(\pi_1^v(\Sigma_{g,n}^\circ))$ .

- The lift of a simple loop is defined for any  $g, n$ , see Definition 5.3.7. Using this, define the lifts  $\tilde{g}_1, \dots, \tilde{g}_k$  of the generators  $g_1, \dots, g_k$  by the same formula as in 5.26:

$$\forall x \in \{b_1, a_1, \dots, b_g, a_g, m_{g+1}, \dots, m_{g+n}\}, \quad \tilde{g}_i(\text{ev}_I(x)) = \text{ev}_I(g_i^v(x))$$

which can also be written as

$$\forall x \in \{b_1, a_1, \dots, b_g, a_g, m_{g+1}, \dots, m_{g+n}\}, \quad \tilde{g}_i(\tilde{x}) = \widetilde{g_i(x)}.$$

Then one must show that each  $\tilde{g}_i$  preserves the defining relations of  $\mathcal{L}_{g,n}(H)$ , and it will follow that the assignment  $g_i \mapsto \tilde{g}_i$  extends to a morphism of groups  $\text{MCG}(\Sigma_{g,n}^\circ) \rightarrow \text{Aut}(\mathcal{L}_{g,n}(H))$ , which to a mapping class  $f$  associates its *lift*  $\tilde{f}$ .

Now, we will associate a (not unique) element  $\hat{f}$  to each mapping class  $f$  such that  $\tilde{f}(x) = \hat{f}x\hat{f}^{-1}$  for all  $x \in \mathcal{L}_{g,n}(H)$ . We assume  $g > 1$  because in this case there is a generating set of  $\text{MCG}(\Sigma_{g,n}^\circ)$  which consists only of Dehn twists, see [FM12, Figure 4.10]; hence  $g_i = \tau_{c_i}$  for each  $i$ , where  $c_i \in \pi_1(\Sigma_{g,n}^\circ)$  is a non-separating, positively oriented simple loop.

- Lemma 5.3.11 still holds. In particular, since the loop  $c_i$  is non-separating for each  $i$ , it has the same topological type than  $a_1$  and there exists  $f_i \in \text{MCG}(\Sigma_{g,n}^\circ)$  such that  $f_i(a_1) = c_i$ . Note that it

is possible to find the  $f_i$ 's explicitly as in Example 5.3.12, without invoking Lemma 5.3.11, and this is sufficient for the sequel.

- Lemma 5.3.15 remains true for  $n > 0$ . By reproducing the proof of Proposition 5.3.16 with the  $f_i$ 's, we get that  $\tilde{\tau}_{c_i}(x) = v_{\tilde{c}_i}^{-1} x v_{\tilde{c}_i}$ . Since the  $\tau_{c_i}$  are a generating set, it follows that for each  $f \in \text{MCG}(\Sigma_{g,n}^o)$ , there exists an invertible element  $\hat{f} \in \mathcal{L}_{g,n}^{\text{inv}}(H)$  such that  $\tilde{f}(x) = \hat{f}x\hat{f}^{-1}$ . The elements  $\hat{f}$  are unique only up to an invertible central invariant element of  $\mathcal{L}_{g,n}(H)$ ; in particular  $\widehat{f\hat{g}} = z\hat{f}\hat{g}$  for some  $z \in \mathcal{Z}(\mathcal{L}_{g,n}(H))$ .

- Since  $\mathcal{Z}(\mathcal{H}(\mathcal{O}(H))^{\otimes g}) \cong \mathbb{C}$ , we have for all  $z \in \mathcal{Z}(\mathcal{L}_{g,n}(H))$ :

$$\Psi_{g,n}(z) = 1 \otimes \dots \otimes 1 \otimes z_1 \otimes \dots \otimes z_n \in \mathcal{H}(\mathcal{O}(H))^{\otimes g} \otimes H^{\otimes n} \quad (5.29)$$

with  $z_i \in \mathcal{Z}(H)$ . Let

$$\rho^{g,S_1,\dots,S_n} : \mathcal{L}_{g,n}(H) \rightarrow \text{End}_{\mathbb{C}}(V(g, S_1, \dots, S_n))$$

be a representation, with  $V(g, S_1, \dots, S_n) = (H^*)^{\otimes g} \otimes S_1 \otimes \dots \otimes S_n$  and where  $S_1, \dots, S_n$  are *simple*  $H$ -modules. Due to (5.29) and to Schur lemma, we see that the representation of  $z \in \mathcal{Z}(\mathcal{L}_{g,n}(H))$  on  $V(g, S_1, \dots, S_n)$  is a scalar  $\lambda_z \text{id}_{V(g, S_1, \dots, S_n)}$ . Hence, the element  $\rho^{g,S_1,\dots,S_n}(\hat{f})$  is unique up to scalar. Define

$$\begin{aligned} \theta_{g,S_1,\dots,S_n}^o : \text{MCG}(\Sigma_{g,n}^o) &\rightarrow \text{GL}(V(g, S_1, \dots, S_n)) \\ f &\mapsto \rho^{g,S_1,\dots,S_n}(\hat{f}) \end{aligned} .$$

This is a projective representation:

$$\theta_{g,S_1,\dots,S_n}^o(fg) \sim \rho^{g,S_1,\dots,S_n}(\widehat{f\hat{g}}) = \rho^{g,S_1,\dots,S_n}(z\hat{f}\hat{g}) \sim \rho^{g,S_1,\dots,S_n}(\hat{f})\rho^{g,S_1,\dots,S_n}(\hat{g}) \sim \theta_{g,S_1,\dots,S_n}^o(f)\theta_{g,S_1,\dots,S_n}^o(g),$$

where  $\sim$  means equality up to scalar. Hence,  $\theta_{g,S_1,\dots,S_n}^o$  generalizes the projective representation  $\theta_g^o$  of the first part of Theorem 5.3.19 (when  $S_1, \dots, S_n$  are simple  $H$ -modules). Let  $\rho_{\text{inv}}^{g,S_1,\dots,S_n}$  be the representation of  $\mathcal{L}_{g,n}^{\text{inv}}(H)$  on  $\text{Inv}(V(g, S_1, \dots, S_n))$ . The statement generalizing the second part of Theorem 5.3.19 is the following:

**Statement (to be proved).** *Let  $S_1, \dots, S_n$  be simple  $H$ -modules. The map*

$$\begin{aligned} \theta_{g,S_1,\dots,S_n} : \text{MCG}(\Sigma_{g,n}) &\rightarrow \text{GL}(\text{Inv}(V(g, S_1, \dots, S_n))) \\ f &\mapsto \rho_{\text{inv}}^{g,S_1,\dots,S_n}(\hat{f}) \end{aligned}$$

*is a projective representation.*

To prove this, one must use a presentation of  $\text{MCG}(\Sigma_{g,n})$  based on the generators  $\tau_{c_1}, \dots, \tau_{c_k}$  and check that the relations between these generators hold in  $\text{Inv}(V(g, S_1, \dots, S_n))$ . Note that the relations of  $\text{MCG}(\Sigma_{g,n})$  which already hold in  $\text{MCG}(\Sigma_{g,n}^o)$  are automatically satisfied; thus it is relevant to use a presentation of  $\text{MCG}(\Sigma_{g,n})$  which is a quotient of  $\text{MCG}(\Sigma_{g,n}^o)$  by some extra relations. For instance, recall that in the case  $n = 0$  we had to prove only the validity of one relation in  $\text{Inv}((H^*)^{\otimes g})$  (the hyperelliptic relation) because  $\text{MCG}(\Sigma_g)$  was the quotient of  $\text{MCG}(\Sigma_g^o)$  by this relation.

### 5.3.6 Explicit formulas for the representation of some Dehn twists

We will compute explicitly the representation on  $(H^*)^{\otimes g}$  of the Dehn twists  $\tau_\gamma$ , where the curves  $\gamma$  are represented in Figure 5.7. Thanks to Proposition 5.3.16, this amounts to compute the action of  $v_{\tilde{\gamma}}^{-1}$  on  $(H^*)^{\otimes g}$ .

We recall that the action  $\triangleright$  of  $\mathcal{L}_{g,0}(H)$  on  $(H^*)^{\otimes g}$  is defined using  $\Psi_{g,0}$  in (5.11) and that we denote the associated representation by  $\rho$ . Also recall the definition of the elements  $\tilde{h}$  in (2.31) and the notation  $RR' = X_i \otimes Y_i$ . Note that

$$X_i \otimes Y_i' \otimes Y_i'' = a_j X_i b_k \otimes Y_i \otimes b_j a_k. \quad (5.30)$$

Recall from Chapter 4 the representation  $\theta_1^0 : \text{MCG}(\Sigma_1^0) \rightarrow \text{GL}(H^*)$  given by the action of the elements  $v_A^{-1}, v_B^{-1} \in \mathcal{L}_{1,0}(H)$  on  $H^*$ :

$$\begin{aligned}\theta_1^0(\tau_a)(\varphi) &= v_A^{-1} \triangleright \varphi = \varphi^{v^{-1}}, \\ \theta_1^0(\tau_b)(\varphi) &= v_B^{-1} \triangleright \varphi = \mu^l(v)^{-1} (\mu^l(g^{-1}v?) \varphi^v)^{v^{-1}}\end{aligned}\tag{5.31}$$

where  $\beta^h = \beta(h?) \in H^*$  for any  $\beta \in H^*, h \in H$  and  $\mu^l$  is the left integral on  $H$ .

We will need the following generalization of Lemma 4.3.6 (in which we restricted to  $\varphi \in \text{SLF}(H)$ ).

**Lemma 5.3.21.** *For all  $\varphi \in H^*$ :*

$$\begin{aligned}(v_A^{-1}v_B^{-1}v_A^{-1})^2 \triangleright \varphi &= \frac{\mu^l(v^{-1})}{\mu^l(v)} \varphi(S^{-1}(a_i)g^{-1}v^{-1}S(?)b_i) \\ (v_A^{-1}v_B^{-1}v_A^{-1})^{-2} \triangleright \varphi &= \frac{\mu^l(v)}{\mu^l(v^{-1})} \varphi(b_jS^{-1}(?)a_jg^{-1}v)\end{aligned}$$

*Proof.* Write  $\varphi = \sum_{I,i,j} \Phi_{I,i}^j T_j^I = \sum_I \text{tr} \left( \Phi_I T^I \right)$  with  $\Phi_{I,i}^j \in \mathbb{C}$  and let  $z(\varphi) = \sum_I \text{tr} \left( b_i \Phi_I S^{-1}(a_i) M^I \right) \in \mathcal{L}_{0,1}(H)$ . Then  $z(\varphi)_B \triangleright \varepsilon = \varphi$  (where  $z(\varphi)_B = j_B(z(\varphi))$ , see notation at the end of section 5.1.1), and  $\varepsilon$  is the counit of  $H$ ). Indeed

$$z(\varphi)_B \triangleright \varepsilon = \sum_I \text{tr} \left( b_i \Phi_I S^{-1}(a_i) \overset{I}{L}^{(+)} \overset{I}{T} \overset{I}{L}^{(-)-1} \triangleright \varepsilon \right) = \sum_I \text{tr} \left( b_i \Phi_I S^{-1}(a_i) \overset{I}{a}_j \overset{I}{T} b_j \right) = \sum_I \text{tr} \left( \Phi_I T^I \right) = \varphi.$$

We simply used (5.11), (2.30), the cyclicity of the trace and the equality  $S^{-1}(a_i)a_j \otimes b_j b_i = 1 \otimes 1$ . Observe that

$$(\tilde{\tau}_a \tilde{\tau}_b \tilde{\tau}_a)^2 \overset{I}{(B)} = \overset{I}{v} \overset{I}{A}^{-1} \overset{I}{B}^{-1} \overset{I}{A} = \overset{I}{B}^{-1} \overset{I}{C}$$

where  $\overset{I}{C} = \overset{I}{C}_{1,0}$  is defined in (4.21). Hence:

$$\begin{aligned}(v_A^{-1}v_B^{-1}v_A^{-1})^2 \triangleright \varphi &= (v_A^{-1}v_B^{-1}v_A^{-1})^2 z(\varphi)_B \triangleright \varepsilon = z(\varphi)_{B^{-1}C} (v_A^{-1}v_B^{-1}v_A^{-1})^2 \triangleright \varepsilon \\ &= \frac{\mu^l(v^{-1})}{\mu^l(v)} z(\varphi)_{B^{-1}C} \triangleright \varepsilon = \frac{\mu^l(v^{-1})}{\mu^l(v)} z(\varphi)_{B^{-1}} \triangleright \varepsilon.\end{aligned}$$

We used Proposition 5.3.16, the formula of Lemma 4.3.6 applied to  $\varepsilon$ , and the fact that  $\overset{I}{C} \triangleright \varepsilon = \mathbb{I}_{\dim(I)} \varepsilon$  (which follows from 5.14). Now we compute

$$\begin{aligned}z(\varphi)_{B^{-1}} \triangleright \varepsilon &= \sum_I \text{tr} \left( b_i \Phi_I S^{-1}(a_i) \overset{I}{L}^{(-)} S(\overset{I}{T}) \overset{I}{L}^{(+)-1} \triangleright \varepsilon \right) = \sum_I \text{tr} \left( b_i \Phi_I S^{-1}(a_i) S^{-1}(b_j) a_j \triangleright S(\overset{I}{T}) \right) \\ &= \sum_I \text{tr} \left( b_i \Phi_I S^{-1}(a_i) S^{-1}(b_j) S(\overset{I}{a}_j) S(\overset{I}{T}) \right) = \sum_I \text{tr} \left( \Phi_I S^{-1}(a_i) \overset{I}{g}^{-1} \overset{I}{v}^{-1} S(\overset{I}{T}) b_i \right) \\ &= \varphi(S^{-1}(a_i)g^{-1}v^{-1}S(?)b_i).\end{aligned}$$

We used (2.27) and (2.10). The second formula is easily checked.  $\square$

**Theorem 5.3.22.** *Let  $\theta_g^0 : \text{MCG}(\Sigma_g^0) \rightarrow \text{PGL}((H^*)^{\otimes g})$  be the projective representation obtained in Theorem 5.3.19. The following formulas hold:*

$$\begin{aligned}\theta_g^0(\tau_{a_i})(\varphi_1 \otimes \dots \otimes \varphi_g) &= \varphi_1 \otimes \dots \otimes \varphi_{i-1} \otimes \theta_1^0(\tau_a)(\varphi_i) \otimes \varphi_{i+1} \otimes \dots \otimes \varphi_g, \\ \theta_g^0(\tau_{b_i})(\varphi_1 \otimes \dots \otimes \varphi_g) &= \varphi_1 \otimes \dots \otimes \varphi_{i-1} \otimes \theta_1^0(\tau_b)(\varphi_i) \otimes \varphi_{i+1} \otimes \dots \otimes \varphi_g, \\ \theta_g^0(\tau_{d_i})(\varphi_1 \otimes \dots \otimes \varphi_g) &= \varphi_1 \otimes \dots \otimes \varphi_{i-2} \otimes \varphi_{i-1} (S^{-1}(a_j) a_k ? b_k v''^{-1} b_j) \otimes \varphi_i (S^{-1}(a_l) S^{-1}(v'^{-1}) a_m ? b_m b_l) \\ &\quad \otimes \varphi_{i+1} \otimes \dots \otimes \varphi_g, \\ \theta_g^0(\tau_{e_i})(\varphi_1 \otimes \dots \otimes \varphi_g) &= \varphi_1 (S^{-1}(v^{(2i-2)-1}) ? v^{(2i-1)-1}) \otimes \dots \otimes \varphi_{i-1} (S^{-1}(v^{(2)-1}) ? v^{(3)-1}) \\ &\quad \otimes \varphi_i (S^{-1}(a_j) S^{-1}(v^{(1)-1}) a_k ? b_k b_j) \otimes \varphi_{i+1} \otimes \dots \otimes \varphi_g,\end{aligned}$$



with  $i \geq 2$  for the two last formulas,  $R = a_j \otimes b_j$  is the  $R$ -matrix<sup>8</sup> and the formulas for  $\theta_1^o(\tau_a), \theta_1^o(\tau_b)$  are recalled in (5.31) above.

*Proof.* First, it is useful to record that

$$\begin{aligned} \Psi_{1,0}^{\otimes g}(\Lambda_i) &= \Psi_{1,0}^{\otimes g} \left( \underline{C}^{(-)}(1) \dots \underline{C}^{(-)}(i-1) \right) = S^{-1}(b_j) \widetilde{a_j^{(2i-3)}} a_j^{(2i-2)} \otimes \dots \otimes \widetilde{a_j^{(1)}} a_j^{(2)} \otimes 1^{\otimes g-i+1} \\ \Psi_{1,0}^{\otimes g} \left( \underline{C}^{(+)}(1) \dots \underline{C}^{(+)}(i-1) \right) &= a_j \widetilde{b_j^{(2i-3)}} b_j^{(2i-2)} \otimes \dots \otimes \widetilde{b_j^{(1)}} b_j^{(2)} \otimes 1^{\otimes g-i+1} \end{aligned} \quad (5.32)$$

where the matrix  $\Lambda_k$  is defined in (5.9). The proof is a simple computation analogous to that of Lemma 5.2.3. Second, recall from the proof of Lemma 5.3.18 that

$$\mu^l(v)^{-1} \mu^l(vX_i) Y_i = v^{-1}. \quad (5.33)$$

We will write  $\mu^l(v)^{-1} \mu^l(v?) = \sum_I \text{tr} \left( c_I \overset{I}{T} \right)$ . Then  $v^{-1} = \sum_I \text{tr} \left( c_I \overset{I}{M} \right)$  under the identification  $\mathcal{L}_{0,1}(H) = H$ .

- *Proof of the formula for the action of  $v_{A(i)}^{-1}$ .* By definition and by (5.32), we have

$$\begin{aligned} \Psi_{g,0}(v_{A(i)}^{-1}) &= \sum_I \text{tr} \left( c_I \Psi_{1,0}^{\otimes g}(\Lambda_i \overset{I}{A}(i) \Lambda_i^{-1}) \right) \\ &= \sum_I \text{tr} \left( c_I S^{-1}(b_j) \overset{I}{X}_k \overset{I}{b}_l \right) \widetilde{a_j^{(2i-3)}} \widetilde{a_l^{(2i-3)}} a_j^{(2i-2)} a_l^{(2i-2)} \otimes \dots \otimes \widetilde{a_j^{(1)}} \widetilde{a_l^{(1)}} a_j^{(2)} a_l^{(2)} \otimes Y_k \otimes 1^{\otimes g-i} \\ &= \mu^l(v)^{-1} \mu^l(vS^{-1}(b_j) \overset{I}{X}_k \overset{I}{b}_l) \widetilde{a_j^{(2i-3)}} \widetilde{a_l^{(2i-3)}} a_j^{(2i-2)} a_l^{(2i-2)} \otimes \dots \otimes \widetilde{a_j^{(1)}} \widetilde{a_l^{(1)}} a_j^{(2)} a_l^{(2)} \otimes Y_k \otimes 1^{\otimes g-i} \\ &= \mu^l(v)^{-1} \mu^l(vS^{-1}(b_j S^{-1}(b_l)) \overset{I}{X}_k) \widetilde{a_j^{(2i-3)}} \widetilde{a_l^{(2i-3)}} a_j^{(2i-2)} a_l^{(2i-2)} \otimes \dots \otimes \widetilde{a_j^{(1)}} \widetilde{a_l^{(1)}} a_j^{(2)} a_l^{(2)} \otimes Y_k \otimes 1^{\otimes g-i} \\ &= \mu^l(v)^{-1} \mu^l(vX_k) 1^{\otimes i-1} \otimes Y_k \otimes 1^{\otimes g-i} = 1^{\otimes i-1} \otimes v^{-1} \otimes 1^{\otimes g-i} \end{aligned}$$

and the formula follows. We used (2.23), the formula  $R^{-1} = a_l \otimes S^{-1}(b_l)$  and (5.33).

- *Proof of the formula for the action of  $v_{B(i)}^{-1}$ .* This is the same proof as for  $v_{A(i)}^{-1}$  (the conjugation by  $\Lambda_i$  vanishes thanks to (2.23)).

- *Proof of the formula for the action of  $v_{\tilde{a}_i}^{-1}$ ,  $i \geq 2$ .* We first compute the action of  $\overset{I}{A}(i-1) \overset{I}{A}(i)$ . We have

$$\begin{aligned} \Psi_{g,0} \left( \overset{I}{A}(i-1) \overset{I}{A}(i) \right) &= \Psi_{1,0}^{\otimes g} \left( \overset{I}{\Lambda}_{i-1} \overset{I}{A}(i-1) \overset{I}{\Lambda}_{i-1}^{-1} \overset{I}{\Lambda}_i \overset{I}{A}(i) \overset{I}{\Lambda}_i^{-1} \right) \\ &= \Psi_{1,0}^{\otimes g} \left( \overset{I}{\Lambda}_{i-1} \overset{I}{A}(i-1) \underline{C}^{(-)}(i-1) \overset{I}{A}(i) \underline{C}^{(-)}(i-1)^{-1} \overset{I}{\Lambda}_{i-1}^{-1} \right). \end{aligned}$$

Hence:

$$\begin{aligned} \Psi_{g,0} \left( v_{A(i-1)A(i)}^{-1} \right) &= \sum_I \text{tr} \left( c_I \Psi_{1,0}^{\otimes g} \left( \overset{I}{\Lambda}_{i-1} \overset{I}{A}(i-1) \underline{C}^{(-)}(i-1) \overset{I}{A}(i) \underline{C}^{(-)}(i-1)^{-1} \overset{I}{\Lambda}_{i-1}^{-1} \right) \right) \\ &= \mu^l(v)^{-1} \mu^l(vS^{-1}(b_j) \overset{I}{X}_k S^{-1}(b_l) \overset{I}{X}_m b_n b_o) \widetilde{a_j^{(2i-5)}} \widetilde{a_o^{(2i-5)}} a_j^{(2i-4)} a_o^{(2i-4)} \otimes \dots \otimes \widetilde{a_j^{(1)}} \widetilde{a_o^{(1)}} a_j^{(2)} a_o^{(2)} \\ &\quad \otimes \widetilde{a'_n} \widetilde{a'_n} Y_k a''_l a''_n \otimes Y_m \otimes 1^{\otimes g-i} \\ &= \mu^l(v)^{-1} \mu^l(vX_k S^{-1}(b_l) \overset{I}{X}_m b_n) 1^{\otimes i-2} \otimes \widetilde{a'_n} \widetilde{a'_n} Y_k a''_l a''_n \otimes Y_m \otimes 1^{\otimes g-i} \\ &= \mu^l(v)^{-1} \mu^l(va_k S^{-1}(b_l) \overset{I}{X}_m b_n) 1^{\otimes i-2} \otimes \widetilde{a'_n} \widetilde{a'_n} b_k a''_n \otimes Y_m \otimes 1^{\otimes g-i} \end{aligned}$$

<sup>8</sup>Do not confuse the components  $a_j, b_j$  of the  $R$ -matrix and the loops  $a_i, b_i \in \pi_1(\Sigma_{g,0} \setminus D)$ .

We used (2.23) and the fact that  $X_k S^{-1}(b_l) \otimes a'_l \otimes Y_k a''_l = X_k S^{-1}(b_p) S^{-1}(b_l) \otimes a_l \otimes Y_k a_p = a_k S^{-1}(b_l) \otimes a_l \otimes b_k$ . We can assume without loss of generality that  $g = 2$  and  $i = 2$ , since the action is “local”. Moreover, this can be simplified. Let  $F : H^* \rightarrow H^*$  be the linear map defined by

$$F(\varphi) = \varphi(a_j ? b_j), \quad F^{-1}(\varphi) = \varphi(S^{-1}(a_j) ? b_j).$$

We compute:

$$\begin{aligned} & (F^{-1} \otimes \text{id}) \circ \rho \left( v_{A(1)A(2)}^{-1} \right) \circ (F \otimes \text{id})(\varphi \otimes \psi) \\ &= \mu^l(v)^{-1} \mu^l(v a_k b_l X_m b_n) \varphi(a_j S^{-1}(a'_n) a_l S^{-1}(a_o) ? b_o b_k a''_n b_j) \otimes \psi(? Y_m) \\ &= \mu^l(v)^{-1} \mu^l(v a_k b_l X_m b_n) \varphi(S^{-1}(a''_n) a_j a_l S^{-1}(a_o) ? b_o b_k b_j a'_n) \otimes \psi(? Y_m) = (\star). \end{aligned}$$

We used the formula  $R\Delta = \Delta^{\text{op}}R$ . Now, we have a Yang-Baxter identity

$$a_k b_l \otimes a_j a_l \otimes b_k b_j = R_{13} R_{23} R_{21} = R_{21} R_{23} R_{13} = b_l a_k \otimes a_l a_j \otimes b_j b_k$$

which allows us to continue the computation:

$$\begin{aligned} (\star) &= \mu^l(v)^{-1} \mu^l(v b_l a_k X_m b_n) \varphi(S^{-1}(a''_n) a_l a_j S^{-1}(a_o) ? b_o b_j b_k a'_n) \otimes \psi(? Y_m) \\ &= \mu^l(v)^{-1} \mu^l(v S^{-2}(b_p) b_l a_k X_m b_n) \varphi(S^{-1}(a_p) a_l ? b_k a_n) \otimes \psi(? Y_m) \\ &= \mu^l(v)^{-1} \mu^l(v a_k X_m b_n) \varphi(? b_k a_n) \otimes \psi(? Y_m) \\ &= \mu^l(v)^{-1} \mu^l(v X_m) \varphi(? Y''_m) \otimes \psi(? Y'_m) = \varphi(? v''^{-1}) \otimes \psi(? v'^{-1}). \end{aligned}$$

We used basic properties of the  $R$ -matrix and relations (5.30), (5.33). We have thus shown that

$$v_{A(1)A(2)}^{-1} \triangleright \varphi \otimes \psi = \varphi(S^{-1}(a_j) a_k ? b_k v''^{-1} b_j) \otimes \psi(? v'^{-1}).$$

Recall that  $\tilde{d}_2 = v^2 \overset{I}{A}(1) \overset{I}{B}(2) \overset{I}{A}(2)^{-1} \overset{I}{B}(2)^{-1}$ . Hence  $(\tilde{\tau}_{a_2} \tilde{\tau}_{b_2} \tilde{\tau}_{a_2})^{-2} (\overset{I}{A}(1) \overset{I}{A}(2)) = \tilde{d}_2$ . It follows that  $(\tilde{\tau}_{a_2} \tilde{\tau}_{b_2} \tilde{\tau}_{a_2})^{-2} (v_{A(1)A(2)}^{-1}) = v_{\tilde{d}_2}^{-1}$ , and thus by Proposition 5.3.16 and Lemma 5.3.21:

$$\begin{aligned} v_{\tilde{d}_2}^{-1} \triangleright \varphi \otimes \psi &= \left( v_{A(2)}^{-1} v_{B(2)}^{-1} v_{A(2)}^{-1} \right)^{-2} v_{A(1)A(2)}^{-1} \left( v_{A(2)}^{-1} v_{B(2)}^{-1} v_{A(2)}^{-1} \right)^2 \triangleright \varphi \otimes \psi \\ &= \left( v_{A(2)}^{-1} v_{B(2)}^{-1} v_{A(2)}^{-1} \right)^{-2} \triangleright \varphi(S^{-1}(a_j) a_k ? b_k v''^{-1} b_j) \otimes \psi(S^{-1}(a_l) g^{-1} v^{-1} S(v'^{-1}) S(? ) b_l) \\ &= \varphi(S^{-1}(a_j) a_k ? b_k v''^{-1} b_j) \otimes \psi(S^{-1}(a_l) g^{-1} v^{-1} S(v'^{-1}) S(b_m S^{-1}(?) a_m g^{-1} v) b_l) \\ &= \varphi(S^{-1}(a_j) a_k ? b_k v''^{-1} b_j) \otimes \psi(S^{-1}(a_l) S^{-1}(v'^{-1}) a_m ? b_m b_l) \end{aligned}$$

which is the announced formula.

• *Proof of the formula for the action of  $v_{\tilde{e}_i}^{-1}$ ,  $i \geq 2$ .* We first compute the action of  $\overset{I}{C}(1) \dots \overset{I}{C}(i-1) \overset{I}{A}(i)$ . We have

$$\begin{aligned} \Psi_{g,0} \left( \overset{I}{C}(1) \dots \overset{I}{C}(i-1) \overset{I}{A}(i) \right) &= \Psi_{1,0}^{\otimes g} \left( \underline{\overset{I}{C}}^{(+)}(1) \dots \underline{\overset{I}{C}}^{(+)}(i-1) \left( \underline{\overset{I}{C}}^{(-)}(1) \dots \underline{\overset{I}{C}}^{(-)}(i-1) \right)^{-1} \overset{I}{\Lambda}_i \overset{I}{A}(i) \overset{I}{\Lambda}_i^{-1} \right) \\ &= \Psi_{1,0}^{\otimes g} \left( \underline{\overset{I}{C}}^{(+)}(1) \dots \underline{\overset{I}{C}}^{(+)}(i-1) \overset{I}{A}(i) \left( \underline{\overset{I}{C}}^{(-)}(1) \dots \underline{\overset{I}{C}}^{(-)}(i-1) \right)^{-1} \right) \\ &= \overset{I}{a}_j \overset{I}{X}_k \overset{I}{b}_l \overset{I}{b}_j^{(2i-3)} \overset{I}{a}_l^{(2i-3)} \overset{I}{b}_j^{(2i-2)} \overset{I}{a}_l^{(2i-2)} \otimes \dots \otimes \overset{I}{b}_j^{(1)} \overset{I}{a}_l^{(1)} \overset{I}{b}_j^{(2)} \overset{I}{a}_l^{(2)} \otimes Y_k \otimes 1^{\otimes g-i} \\ &= \overset{I}{X}_k \overset{I}{Y}_k^{(2i-2)} \overset{I}{Y}_k^{(2i-1)} \otimes \dots \otimes \overset{I}{Y}_k^{(2)} \overset{I}{Y}_k^{(3)} \otimes Y_k^{(1)} \otimes 1^{\otimes g-i} \end{aligned}$$

thanks to (5.32) and (5.30). Hence, by (5.33):

$$\begin{aligned} \Psi_{g,0}\left(v_{C(1)\dots C(i-1)A(i)}^{-1}\right) &= \mu^l(v)^{-1}\mu^l(vX_k)\widetilde{Y}_k^{(2i-2)}Y_k^{(2i-1)}\otimes\dots\otimes\widetilde{Y}_k^{(2)}Y_k^{(3)}\otimes Y_k^{(1)}\otimes 1^{\otimes g-i} \\ &= v^{\widetilde{(2i-2)-1}}v^{(2i-1)-1}\otimes\dots\otimes v^{\widetilde{(2)-1}}v^{(3)-1}\otimes v^{(1)-1}\otimes 1^{\otimes g-i}, \end{aligned}$$

which means that

$$\begin{aligned} v_{C(1)\dots C(i-1)A(i)}^{-1}\triangleright(\varphi_1\otimes\dots\otimes\varphi_g) &= \varphi_1(S^{-1}(v^{(2i-2)-1})?v^{(2i-1)-1})\otimes\dots\otimes\varphi_{i-1}(S^{-1}(v^{(2)-1})?v^{(3)-1}) \\ &\quad\otimes\varphi_i(?v^{(1)-1})\otimes\varphi_{i+1}\dots\otimes\varphi_g. \end{aligned}$$

Recall that  $\tilde{e}_i = \overset{I}{v}{}^2\overset{I}{C}(1)\dots\overset{I}{C}(i-1)\overset{I}{B}(i)\overset{I}{A}(i)^{-1}\overset{I}{B}(i)^{-1}$ . Hence  $(\tilde{\tau}_{a_i}\tilde{\tau}_{b_i}\tilde{\tau}_{a_i})^{-2}(\overset{I}{C}(1)\dots\overset{I}{C}(i-1)\overset{I}{A}(i)) = \overset{I}{e}_i$ . As previously, it follows from Proposition 5.3.16 and Lemma 5.3.21 that

$$\begin{aligned} v_{\tilde{e}_i}^{-1}\triangleright(\varphi_1\otimes\dots\otimes\varphi_g) &= \left(v_{A(i)}^{-1}v_{B(i)}^{-1}v_{A(i)}^{-1}\right)^{-2}v_{C(1)\dots C(i-1)A(i)}^{-1}\left(v_{A(i)}^{-1}v_{B(i)}^{-1}v_{A(i)}^{-1}\right)^2\triangleright(\varphi_1\otimes\dots\otimes\varphi_g) \\ &= \varphi_1(S^{-1}(v^{(2i-2)-1})?v^{(2i-1)-1})\otimes\dots\otimes\varphi_{i-1}(S^{-1}(v^{(2)-1})?v^{(3)-1}) \\ &\quad\otimes\varphi_i(S^{-1}(a_j)S^{-1}(v^{(1)-1})a_k?b_kb_j)\otimes\varphi_{i+1}\dots\otimes\varphi_g, \end{aligned}$$

which is the announced formula.  $\square$

## 5.4 Equivalence with the Lyubashenko representation

In a series of papers [Lyu95a, Lyu95b, Lyu96], V. Lyubashenko has constructed projective representations of  $\text{MCG}(\Sigma_{g,n})$  by categorical techniques based on the coend of a ribbon category. Our assumptions on  $H$  allow to apply his construction to  $\text{mod}_l(H)$ , the ribbon category of finite dimensional left  $H$ -modules. Here we will show that these two representations are equivalent. For the case of the torus, we have already shown in Chapter 4 that the projective representation of  $\text{MCG}(\Sigma_{1,0})$  obtained thanks to  $\mathcal{L}_{1,0}(H)$  is equivalent to the Lyubashenko-Majid representation [LM94]. For works based on the Lyubashenko representation, see *e.g.* [FSS12, FSS14].

### 5.4.1 The Lyubashenko representation for $\text{mod}_l(H)$

Let us first quickly recall the Lyubashenko representation in the general framework of a ribbon category  $\mathcal{C}$  satisfying some assumptions (see [Lyu95b]).

Let  $K = \int^X X^* \otimes X$  be the coend of the functor  $F : \mathcal{C}^{\text{op}} \times \mathcal{C} \rightarrow \mathcal{C}$ ,  $F(X, Y) = X^* \otimes Y$  and let  $i_X : X^* \otimes X \rightarrow K$  be the associated dinatural transformation (see [ML98, IX.6]). Thanks to the universal property of the coend  $K$ , Lyubashenko defined several morphisms; we will need some of them which we recall now. The first is an algebra structure  $K \otimes K \rightarrow K$  (also see [Maj93]). Consider the following family of morphisms (for each  $X, Y \in \mathcal{C}$ )

$$\begin{aligned} d_{X,Y} : X^* \otimes X \otimes Y^* \otimes Y &\xrightarrow{\text{id}_{X^*} \otimes c_{X,Y^*} \otimes \text{id}_Y} X^* \otimes Y^* \otimes X \otimes Y \xrightarrow{\text{id}_{X^*} \otimes \text{id}_{Y^*} \otimes c_{X,Y}} X^* \otimes Y^* \otimes Y \otimes X \\ &\xrightarrow{\sim} (Y \otimes X)^* \otimes Y \otimes X \xrightarrow{i_{Y \otimes X}} K. \end{aligned} \tag{5.34}$$

Since the family  $d_{X,Y}$  is dinatural in  $X$  and  $Y$ , it exists a unique  $m_K : K \otimes K \rightarrow K$  such that  $d_{X,Y} = m_K \circ (i_X \otimes i_Y)$ , which is in fact an associative product on  $K$ . Actually,  $K$  is endowed with a Hopf algebra structure whose structure morphisms are similarly defined using the universal property, but we do not need this here.

Next, consider the following families of morphisms

$$\begin{aligned}
 \alpha_X &: X^* \otimes X \xrightarrow{\theta_{X^*} \otimes \text{id}_X} X^* \otimes X \xrightarrow{i_X} K, \\
 \beta_{X,Y} &: X^* \otimes X \otimes Y^* \otimes Y \xrightarrow{\text{id}_{X^*} \otimes (c_{Y^*, X} \circ c_{X, Y^*}) \otimes \text{id}_Y} X^* \otimes X \otimes Y^* \otimes Y \xrightarrow{i_X \otimes i_Y} K \otimes K, \\
 \gamma_X^Y &: X^* \otimes X \otimes Y \xrightarrow{\text{id}_{X^*} \otimes (c_{Y, X} \circ c_{X, Y})} X^* \otimes X \otimes Y \xrightarrow{i_X \otimes \text{id}_Y} K \otimes Y.
 \end{aligned} \tag{5.35}$$

The families  $\alpha_X$  and  $\gamma_X^Y$  (with  $Y$  fixed) are dinatural in  $X$ , and the family  $\beta_{X,Y}$  is dinatural in  $X, Y$ . Hence by universality of  $K$  (and also thanks to the Fubini theorem for multiple coends and to the universality of  $K \otimes K$  and of  $K \otimes Y$ ), there exist unique morphisms  $\mathcal{T} : K \rightarrow K, \mathcal{O} : K \otimes K \rightarrow K \otimes K, \mathcal{Q}_Y : K \otimes Y \rightarrow K \otimes Y$  such that

$$\alpha_X = \mathcal{T} \circ i_X, \quad \beta_{X,Y} = \mathcal{O} \circ (i_X \otimes i_Y), \quad \gamma_X^Y = \mathcal{Q}_Y \circ (i_X \otimes \text{id}_Y). \tag{5.36}$$

Finally, the morphism  $\mathcal{S} : K \rightarrow K$  is defined by  $\mathcal{S} = (\varepsilon_K \otimes \text{id}_K) \circ \mathcal{O} \circ (\text{id}_K \otimes \Lambda_K)$ , where  $\varepsilon_K$  is the counit on  $K$  and  $\Lambda_K$  is the two-sided cointegral.

Let  $X$  be any object of  $\mathcal{C}$  and  $V_X = \text{Hom}_{\mathcal{C}}(X, K^{\otimes g})$ . The Lyubashenko projective representation  $Z_X : \text{MCG}(\Sigma_g^0) \rightarrow \text{PGL}(V_X)$  [Lyu95b, Section 4.4] takes the following values on  $f \in V_X$ :

$$\begin{aligned}
 Z_X(\tau_{a_i})(f) &= (\text{id}_K^{\otimes g-i} \otimes \mathcal{T} \otimes \text{id}_K^{\otimes i-1}) \circ f, \\
 Z_X(\tau_{b_i})(f) &= (\text{id}_K^{\otimes g-i} \otimes (\mathcal{S}^{-1} \circ \mathcal{T} \circ \mathcal{S}) \otimes \text{id}_K^{\otimes i-1}) \circ f, \\
 Z_X(\tau_{d_i})(f) &= (\text{id}_K^{\otimes g-i} \otimes (\mathcal{O} \circ (\mathcal{T} \otimes \mathcal{T})) \otimes \text{id}_K^{\otimes i-2}) \circ f \quad \text{for } i \geq 2, \\
 Z_X(\tau_{e_i})(f) &= (\text{id}_K^{\otimes g-i} \otimes ((\mathcal{T} \otimes \theta_{K^{\otimes i-1}}) \circ \mathcal{Q}_{K^{\otimes i-1}})) \circ f \quad \text{for } i \geq 2.
 \end{aligned} \tag{5.37}$$

Recall that the curves  $a_i, b_i, d_i, e_i$  are represented in Figure 5.7. Since these Dehn twists are a generating set, we have an operator  $Z_X(f)$  for all  $f \in \text{MCG}(\Sigma_g^0)$ . If moreover we take  $X = \mathbf{1}$ , the unit object of  $\mathcal{C}$ , then this defines a projective representation  $Z_{\mathbf{1}} : \text{MCG}(\Sigma_g) \rightarrow \text{PGL}(V_{\mathbf{1}})$  of the mapping class group of  $\Sigma_g$ .

Now, let us explicit the above formulas in the case of  $\mathcal{C} = \text{mod}_l(H)$ . Recall from section 2.5 that the category  $\text{mod}_l(H)$  has braiding  $c_{X,Y} : X \otimes Y \rightarrow Y \otimes X$  and twist  $\theta_X : X \rightarrow X$  given by

$$c_{X,Y}(x \otimes y) = b_i \cdot y \otimes a_i \cdot x, \quad \theta_X(x) = v^{-1} \cdot x$$

and that the action on the dual module  $X^*$  is  $h \cdot \varphi = \varphi(S(h) \cdot ?)$  for all  $\varphi \in X^*, h \in H$ .

It is well-known (and not difficult to see) that  $K$  is  $H^*$  endowed with the coadjoint action:

$$\forall h \in H, \forall \varphi \in K, \quad h\varphi = \varphi(S(h')?h'')$$

and that the dinatural transformation of  $K$  is

$$i_X(\psi \otimes x) = \psi(? \cdot x) \in K.$$

Note that  $\psi(? \cdot x)$  is just a matrix coefficient of the module  $X$ . The dinatural family  $d_{X,Y}$  of (5.34) is

$$d_{X,Y}(\varphi \otimes x \otimes \psi \otimes y) = \psi(S(b_i)?b_j \cdot y)\varphi(?a_j a_i \cdot x)$$

where in the right of the equality it is the usual product in  $H^*$ :  $\langle fg, h \rangle = f(h')g(h'')$ . To compute the product  $m_K$  in  $K$  explicitly, observe that  $i_{H_{\text{reg}}}(\varphi \otimes 1) = \varphi$ , where  $H_{\text{reg}}$  is the regular representation of  $H$ . Thus

$$\begin{aligned}
 m_K(\varphi \otimes \psi) &= m_K \circ (i_{H_{\text{reg}}} \otimes i_{H_{\text{reg}}})(\varphi \otimes 1 \otimes \psi \otimes 1) = d_{H_{\text{reg}}, H_{\text{reg}}}(\varphi \otimes 1 \otimes \psi \otimes 1) \\
 &= \psi(S(b_i)?b_j)\varphi(?a_j a_i) = \varphi(a_j?a_i)\psi(S(b_i)b_j?)
 \end{aligned}$$

where we used  $R\Delta = \Delta^{\text{op}}R$  for the last equality. Moreover, the unit element of  $K$  is  $1_K = \varepsilon$ , the counit of  $H$ . We record the following lemma, already given in [Lyu95b].

**Lemma 5.4.1.** *Let  $\mu^r \in H^*$  be the right integral on  $H$  (unique up to scalar). Then  $\mu^r$  is the two-sided cointegral in  $K$  (unique up to scalar):*

$$\forall \varphi \in K, \quad m_K(\mu^r \otimes \varphi) = m_K(\varphi \otimes \mu^r) = \varepsilon_K(\varphi)\mu^r$$

where  $\varepsilon_K(\varphi) = \varphi(1)$ .

*Proof.* Using (2.23) and the basic properties of  $R$ , we get

$$m_K(\mu^r \otimes \varphi) = \mu^r(a_j?a_i)\varphi(S(b_i)b_j?) = \mu^r(S^2(a_i)a_j?)\varphi(S(b_i)b_j?) = \mu^r\varphi = \varphi(1)\mu^r.$$

Similarly:

$$m_K(\varphi \otimes \mu^r) = \mu^r(S(b_i)?b_j)\varphi(?a_ja_i) = \mu^r(S^2(b_jS^{-1}(b_i))?)\varphi(?a_ja_i) = \mu^r\varphi = \varphi(1)\mu^r.$$

□

The dinatural families of (5.35) are

$$\begin{aligned} \alpha_X(\varphi \otimes x) &= \varphi(v^{-1}? \cdot x), \\ \beta_{X,Y}(\varphi \otimes x \otimes \psi \otimes y) &= \varphi(?b_ja_i \cdot x) \otimes \psi(S(a_jb_i)? \cdot y) = \varphi(?v'^{-1}v \cdot x) \otimes \psi(S(v''^{-1})v? \cdot y), \\ \gamma_X^Y(\varphi \otimes x \otimes y) &= \varphi(?b_ja_i \cdot x) \otimes a_jb_i \cdot y = \varphi(?v'^{-1}v \cdot x) \otimes v''^{-1}v \cdot y \end{aligned}$$

where we used (2.11). It follows that the morphisms defined in (5.36) are

$$\begin{aligned} \mathcal{T}(\varphi) &= \mathcal{T} \circ i_{H_{\text{reg}}}(\varphi \otimes 1) = \alpha_{H_{\text{reg}}}(\varphi \otimes 1) = \varphi(v^{-1}?), \\ \mathcal{O}(\varphi \otimes \psi) &= \mathcal{O} \circ (i_{H_{\text{reg}}} \otimes i_{H_{\text{reg}}})(\varphi \otimes 1 \otimes \psi \otimes 1) = \beta_{H_{\text{reg}}, H_{\text{reg}}}(\varphi \otimes 1 \otimes \psi \otimes 1) = \varphi(?v'^{-1}v) \otimes \psi(S(v''^{-1})v?), \\ \mathcal{Q}_Y(\varphi \otimes y) &= \mathcal{Q}_Y \circ (i_{H_{\text{reg}}} \otimes \text{id}_Y)(\varphi \otimes 1 \otimes y) = \gamma_{H_{\text{reg}}}^Y(\varphi \otimes 1 \otimes y) = \varphi(?v'^{-1}v) \otimes v''^{-1}v \cdot y. \end{aligned}$$

In view of (5.37), note that  $(\mathcal{T} \otimes \theta_Y) \circ \mathcal{Q}_Y(\varphi \otimes y) = \varphi(?v'^{-1}) \otimes v''^{-1} \cdot y$ . Finally, thanks to Lemma 5.4.1, the morphism  $\mathcal{S}$  is

$$\mathcal{S}(\varphi) = \varphi(v'^{-1}v) \mu^r(S(v''^{-1})v?) = \varphi(S^{-1}(v''^{-1})v) \mu^r(v'^{-1}v?)$$

where the second equality is due to  $v'^{-1} \otimes S(v''^{-1}) = S^{-1}(v''^{-1}) \otimes v'^{-1}$  (which follows from  $S(v^{-1}) = v^{-1}$ ). Moreover, we will need the following lemma to prove the equivalence of the representations.

**Lemma 5.4.2.** *Let  $\rho$  be the representation of  $\mathcal{L}_{1,0}(H)$  on  $H^*$ , then the following formulas hold:*

$$\begin{aligned} \mathcal{T} &= \rho(v_A^{-1}) = (v^{-1})_*, \quad \mathcal{S} = \mu^l(v^{-1})g_*^{-1} \circ \rho(v_A^2v_B) \circ g_*, \\ \mathcal{S}^{-1} \circ \mathcal{T} \circ \mathcal{S} &= (g^{-1}v)_* \circ \rho(v_B^{-1}) \circ (gv^{-1})_*, \end{aligned}$$

where  $h_*(\varphi) = \varphi(?h)$  for all  $h \in H$  and  $\varphi \in H^*$ .

*Proof.* The formula for  $\mathcal{T}$  is obvious. Propositions 4.2.14 and 2.3.4 give  $\rho(v_B)$  and then we compute using (2.25) and (2.24):

$$\begin{aligned} \rho(v_B)(\varphi) &= v_B \triangleright \varphi = \mu^l(v^{-1})^{-1} (\mu^l(g^{-1}v^{-1}?)\varphi^v)^{v^{-1}} = \mu^l(v^{-1})^{-1} (\mu^r(gv^{-1}?)\varphi^v)^{v^{-1}} \\ &= \mu^l(v^{-1})^{-1} \mu^r(v'^{-1}?gv^{-1}) \varphi(S^{-1}(v''^{-1})g^{-1}v) \\ &= \mu^l(v^{-1})^{-1} (gv^{-2})_* (\mu^r(vv'^{-1}?) \langle g_*^{-1}(\varphi), S^{-1}(v''^{-1})v \rangle) \\ &= \mu^l(v^{-1})^{-1} (gv^{-2})_* \circ \mathcal{S} \circ g_*^{-1}(\varphi) = \mu^l(v^{-1})^{-1} \rho(v_A^{-2}) \circ g_* \circ \mathcal{S} \circ g_*^{-1}(\varphi) \end{aligned}$$

where  $\varphi^h = \varphi(h?)$  for  $h \in H$ . The last claimed formula follows from  $\mathcal{S} = \mu^l(v^{-1})(g^{-1}v)_* \circ \rho(v_A v_B v_A) \circ (gv^{-1})_*$  and the fact that  $v_A, v_B \in \mathcal{L}_{1,0}(H)$  satisfy the braid relation  $v_A v_B v_A = v_B v_A v_B$  (see Proposition 4.3.5). □

For the representation space, we take  $X = H_{\text{reg}}$ , so that  $V_X = \text{Hom}_H(H_{\text{reg}}, K^{\otimes g}) \cong K^{\otimes g}$ . Then by the previous formulas, we get the Lyubashenko projective representation of  $\text{MCG}(\Sigma_g^\circ)$  (5.37) applied to  $\text{mod}_l(H)$ :

$$\begin{aligned} Z_{H_{\text{reg}}}(\tau_{a_i})(\varphi_1 \otimes \dots \otimes \varphi_g) &= \varphi_1 \otimes \dots \otimes \varphi_{g-i+1}(v^{-1}?) \otimes \dots \otimes \varphi_g, \\ Z_{H_{\text{reg}}}(\tau_{b_i})(\varphi_1 \otimes \dots \otimes \varphi_g) &= \varphi_1 \otimes \dots \otimes (g^{-1}v)_* \circ \rho(v_B^{-1}) \circ (gv^{-1})_*(\varphi_{g-i+1}) \otimes \dots \otimes \varphi_g, \\ Z_{H_{\text{reg}}}(\tau_{d_i})(\varphi_1 \otimes \dots \otimes \varphi_g) &= \varphi_1 \otimes \dots \otimes \varphi_{g-i+1}(?v'^{-1}) \otimes \varphi_{g-i+2}(S(v''^{-1})?) \otimes \dots \otimes \varphi_g, \\ Z_{H_{\text{reg}}}(\tau_{e_i})(\varphi_1 \otimes \dots \otimes \varphi_g) &= \varphi_1 \otimes \dots \otimes \varphi_{g-i} \otimes \varphi_{g-i+1}(?v^{(1)-1}) \otimes \varphi_{g-i+2}(S(v^{(2)-1})?v^{(3)-1}) \otimes \dots \\ &\quad \otimes \varphi_g(S(v^{(2i-2)-1})?v^{(2i-1)-1}), \end{aligned} \tag{5.38}$$

with  $i \geq 2$  for the two last formulas. If we take  $X = \mathbb{C}$ , we get

$$V_{\mathbb{C}} = \text{Hom}_H(\mathbb{C}, K^{\otimes g}) = (K^{\otimes g})^{\text{inv}} = \{f \in K^{\otimes g} \mid \forall h \in H, h \cdot f = \varepsilon(h)f\}$$

where by definition of the action of  $H$  on  $K$ , the action of  $H$  on  $K^{\otimes g}$  is

$$h \cdot \varphi_1 \otimes \dots \otimes \varphi_g = \varphi_1(S(h^{(1)})?h^{(2)}) \otimes \dots \otimes \varphi_g(S(h^{(2g-1)})?h^{(2g)}). \tag{5.39}$$

Then  $Z_{\mathbb{C}}$  is a projective representation of  $\text{MCG}(\Sigma_g)$  (note that  $Z_{\mathbb{C}}$  is just  $Z_{H_{\text{reg}}}$  restricted to  $(K^{\otimes g})^{\text{inv}}$ ).

To conclude this section, we explain how to see  $\mathcal{L}_{0,1}(H)$  as a coend. Recall the algebra  $\mathcal{F}_{0,1}(H) \cong \mathcal{L}_{0,1}(H)$  from Remark 4.1.9. We put a left  $H$ -module structure on it by letting  $h \cdot \varphi = \varphi \cdot S^{-1}(h) = \varphi(S^{-1}(h'')?h')$ . Since  $h \cdot (\varphi * \psi) = (h'' \cdot \varphi) * (h' \cdot \psi)$ ,  $\mathcal{F}_{0,1}(H)$  is an algebra in  $\text{mod}_l(H^{\text{cop}})$ , where  $H^{\text{cop}}$  is  $H$  with opposite coproduct. Moreover, in  $H^{\text{cop}}$ , we replace  $\Delta$  by  $\Delta^{\text{op}}$ ,  $R$  by  $R'$  and  $S$  by  $S^{-1}$  so that the formulas for the product and the  $H$ -action in the coend of  $\text{mod}_l(H^{\text{cop}})$  are exactly those of  $\mathcal{F}_{0,1}(H)$ . We state this as a proposition.

**Proposition 5.4.3.** *It holds:*

$$\mathcal{L}_{0,1}(H) \cong \mathcal{F}_{0,1}(H) = \int^{X \in \text{mod}_l(H^{\text{cop}})} X^* \otimes X.$$

## 5.4.2 Equivalence of the representations

Recall the map  $F : H^* \rightarrow H^*$

$$F(\varphi) = \varphi(a_i?b_i), \quad F^{-1}(\varphi) = \varphi(S^{-1}(a_i)?b_i)$$

(already used in the proof of Theorem 5.3.22) and let  $\sigma : (H^*)^{\otimes g} \rightarrow (H^*)^{\otimes g}$  be the permutation

$$\sigma(\varphi_1 \otimes \varphi_2 \otimes \dots \otimes \varphi_{g-1} \otimes \varphi_g) = \varphi_g \otimes \varphi_{g-1} \otimes \dots \otimes \varphi_2 \otimes \varphi_1.$$

It satisfies  $\sigma^{-1} = \sigma$ .

**Theorem 5.4.4.** *The representation of Theorem 5.3.19 and the Lyubashenko representation of  $\text{MCG}(\Sigma_g^\circ)$  and  $\text{MCG}(\Sigma_g)$  are equivalent. More precisely:*

1) *The isomorphism of vector spaces*

$$\begin{aligned} (F \circ S)^{\otimes g} \circ \sigma : \quad & K^{\otimes g} \rightarrow (H^*)^{\otimes g} \\ \varphi_1 \otimes \dots \otimes \varphi_g & \mapsto \varphi_g(b_i S(?)a_i) \otimes \dots \otimes \varphi_1(b_i S(?)a_i) \end{aligned}$$

*is an intertwiner between the two representations:*

$$[(F \circ S)^{\otimes g} \circ \sigma] \circ Z_{H_{\text{reg}}}(f) = \theta_g^\circ(f) \circ [(F \circ S)^{\otimes g} \circ \sigma].$$

2) *The isomorphism of vector spaces*

$$(F \circ S)^{\otimes g} \circ \sigma : (K^{\otimes g})^{\text{inv}} \rightarrow \text{Inv}((H^*)^{\otimes g})$$

*is an intertwiner between the two representations:*

$$[(F \circ S)^{\otimes g} \circ \sigma] \circ Z_{\mathbb{C}}(f) = \theta_g(f) \circ [(F \circ S)^{\otimes g} \circ \sigma].$$

*Proof.* 1) We show that this isomorphism intertwines the formulas of Theorem 5.3.22 and of (5.38). Thanks to the properties of  $v$  (2.11), it is clear that  $(F \circ S)^{\otimes g} \circ \sigma \circ Z_{H_{\text{reg}}}(\tau_{a_i}) = \theta_g^{\circ}(\tau_{a_i}) \circ (F \circ S)^{\otimes g} \circ \sigma$ . Next, thanks to (5.31), (2.25) and (2.24), we have

$$\theta_1^{\circ}(\tau_b)(\varphi) = v_B^{-1} \triangleright \varphi = \mu^l(v)^{-1} \mu^r(gv^{-1}v'?) \varphi(vS^{-1}(gv'')).$$

Hence, for  $\varphi \in H^*$ ,

$$\begin{aligned} \theta_1^{\circ}(\tau_b) \circ (F \circ S)(\varphi) &= \mu^l(v)^{-1} \mu^r(gv^{-1}v'?) \varphi(vb_i gv'' a_i) = \mu^l(v)^{-1} \mu^r(g\bar{Y}_j?) \varphi(v^2 b_i g \bar{X}_j a_i) \\ &= \mu^l(v)^{-1} \mu^r(gS(a_j)S^{-1}(b_k)?) \varphi(v^2 gS^{-2}(b_i)b_j a_k a_i) = (\star) \end{aligned}$$

with  $\bar{X}_i \otimes \bar{Y}_i = (RR')^{-1}$ . We have a Yang-Baxter relation

$$\begin{aligned} S(a_j)S^{-1}(b_k) \otimes S^{-2}(b_i)b_j \otimes a_k a_i &= a_j S^{-1}(b_k) \otimes S^{-1}(b_j S^{-1}(b_i)) \otimes a_k a_i = (\text{id} \otimes S^{-1} \otimes \text{id})(R_{12} R_{31}^{-1} R_{32}^{-1}) \\ &= (\text{id} \otimes S^{-1} \otimes \text{id})(R_{32}^{-1} R_{31}^{-1} R_{12}) = S^{-1}(b_k)S(a_j) \otimes b_j S^{-2}(b_i) \otimes a_i a_k \end{aligned}$$

which allows us to continue the computation:

$$\begin{aligned} (\star) &= \mu^l(v)^{-1} \mu^r(gS^{-1}(b_k)S(a_j)?) \varphi(v^2 g b_j S^{-2}(b_i) a_i a_k) = \mu^l(v)^{-1} \mu^r(gS^{-1}(b_k)S(a_j)?) \varphi(vS^2(b_j) a_k) \\ &= \mu^l(v)^{-1} \mu^r(gS^{-1}(a_j b_k)?) \varphi(vb_j a_k) = \mu^l(v)^{-1} \mu^r(gvS^{-1}(v''^{-1})?) \varphi(v^2 v'^{-1}). \end{aligned}$$

We used (2.10) and (2.11). On the other hand, we compute

$$\begin{aligned} (F \circ S) \circ Z_{H_{\text{reg}}}(\tau_b)(\varphi) &= (F \circ S) \circ (\mathcal{S}^{-1} \circ \mathcal{T} \circ \mathcal{S})(\varphi) = (F \circ S) \circ (g^{-1}v)_* \circ \rho(v_B^{-1}) \circ (gv^{-1})_*(\varphi) \\ &= F \circ S(\mu^l(v)^{-1} \mu^r(v'?) \varphi(S^{-1}(v''))) = \mu^l(v)^{-1} \mu^r(v' b_i S(?) a_i) \varphi(S^{-1}(v'')) \\ &= \mu^l(v)^{-1} \mu^r(vS^2(a_i) \bar{Y}_j b_i S(?) \varphi(vS^{-1}(\bar{X}_i)) \\ &= \mu^l(v)^{-1} \mu^r(vS^2(a_i)S(a_j)S^{-1}(b_k)b_i S(?) \varphi(vS^{-1}(b_j a_k)) = (\star\star) \end{aligned}$$

where  $\rho$  is the representation of  $\mathcal{L}_{g,0}(H)$  on  $(H^*)^{\otimes g}$ . We used Lemma 5.4.2, (2.23) and (2.11). As previously, we have a Yang-Baxter relation

$$S^2(a_i)S(a_j) \otimes S^{-1}(b_k)b_i \otimes b_j a_k = S(a_j)S^2(a_i) \otimes b_i S^{-1}(b_k) \otimes a_k b_j$$

which allows us to continue the computation:

$$\begin{aligned} (\star\star) &= \mu^l(v)^{-1} \mu^r(vS(a_j)S^2(a_i)b_i S^{-1}(b_k)S(?) \varphi(vS^{-1}(a_k b_j)) \\ &= \mu^l(v)^{-1} \mu^r(S(a_j)gS^{-1}(b_k)S(?) \varphi(vS^{-1}(a_k b_j)) = \mu^l(v)^{-1} \mu^r(ga_j b_k S(?) \varphi(vb_j a_k) \\ &= \mu^l(v)^{-1} \mu^r(gvv''^{-1}S(?) \varphi(v^2 v'^{-1}) = \mu^l(v)^{-1} \mu^r \circ S(?S^{-1}(v''^{-1})vg^{-1}) \varphi(v^2 v'^{-1}) \\ &= \mu^l(v)^{-1} \mu^l(?S^{-1}(v''^{-1})vg^{-1}) \varphi(v^2 v'^{-1}) = \mu^l(v)^{-1} \mu^r(gvS^{-1}(v''^{-1})?) \varphi(v^2 v'^{-1}). \end{aligned}$$

We used (2.10) to simplify  $S^2(a_i)b_i = S(S^{-1}(b_i)S(a_i)) = gv^{-1}$  and the properties of  $\mu^l$  and  $\mu^r$  recorded in section 2.3. Hence, it holds  $\theta_1^{\circ}(\tau_b) \circ (F \circ S) = (F \circ S) \circ Z_{H_{\text{reg}}}(\tau_b)$ , which clearly implies that  $\theta_g^{\circ}(\tau_{b_i}) \circ (F \circ S)^{\otimes g} \circ \sigma = (F \circ S)^{\otimes g} \circ \sigma \circ Z_{H_{\text{reg}}}(\tau_{b_i})$ . Let us now proceed with  $\tau_{d_i}$  ( $i \geq 2$ ):

$$\begin{aligned} &(F \circ S)^{\otimes g} \circ \sigma \circ Z_{H_{\text{reg}}}(\tau_{d_i}) \circ \sigma \circ (S^{-1} \circ F^{-1})^{\otimes g}(\varphi_1 \otimes \dots \otimes \varphi_g) \\ &= (F \circ S)^{\otimes g} \circ \sigma \circ Z_{H_{\text{reg}}}(\tau_{d_i})(\varphi_g(S^{-1}(a_j)S^{-1}(?)b_j) \otimes \dots \otimes \varphi_1(S^{-1}(a_j)S^{-1}(?)b_j)) \\ &= (F \circ S)^{\otimes g} \circ \sigma(\varphi_g(S^{-1}(a_j)S^{-1}(?)b_j) \otimes \dots \otimes \varphi_i(S^{-1}(a_j)S^{-1}(v'^{-1})S^{-1}(?)b_j) \otimes \varphi_{i-1}(S^{-1}(a_j)S^{-1}(?)v''^{-1}b_j) \\ &\quad \otimes \dots \otimes \varphi_1(S^{-1}(a_j)S^{-1}(?)b_j)) \\ &= \varphi_1 \otimes \dots \otimes \varphi_{i-1}(S^{-1}(a_j)a_k?b_k v''^{-1}b_j) \otimes \varphi_i(S^{-1}(a_j)S^{-1}(v'^{-1})a_k?b_k b_j) \otimes \dots \otimes \varphi_g \\ &= \theta_g^{\circ}(\tau_{d_i})(\varphi_1 \otimes \dots \otimes \varphi_g). \end{aligned}$$

Finally, for  $\tau_{e_i}$  ( $i \geq 2$ ):

$$\begin{aligned}
 & (F \circ S)^{\otimes g} \circ \sigma \circ Z_{H_{\text{reg}}}(\tau_{e_i}) \circ \sigma \circ (S^{-1} \circ F^{-1})^{\otimes g}(\varphi_1 \otimes \dots \otimes \varphi_g) \\
 &= (F \circ S)^{\otimes g} \circ \sigma \circ Z_{H_{\text{reg}}}(\tau_{e_i})(\varphi_g(S^{-1}(a_j)S^{-1}(?)b_j) \otimes \dots \otimes \varphi_1(S^{-1}(a_j)S^{-1}(?)b_j)) \\
 &= (F \circ S)^{\otimes g} \circ \sigma(\varphi_g(S^{-1}(a_j)S^{-1}(?)b_j) \otimes \dots \otimes \varphi_{i+1}(S^{-1}(a_j)S^{-1}(?)b_j) \otimes \varphi_i(S^{-1}(a_j)S^{-1}(v^{(1)-1})S^{-1}(?)b_j) \\
 &\quad \otimes \varphi_{i-1}(S^{-1}(a_j)S^{-1}(v^{(3)-1})S^{-1}(?)v^{(2)-1}b_j) \otimes \dots \otimes \varphi_1(S^{-1}(a_j)S^{-1}(v^{(2i-1)-1})S^{-1}(?)v^{(2i-2)-1}b_j)) \\
 &= \varphi_1(S^{-1}(a_j)S^{-1}(v^{(2i-1)-1})a_k?b_kv^{(2i-2)-1}b_j) \otimes \dots \otimes \varphi_{i-1}(S^{-1}(a_j)S^{-1}(v^{(3)-1})a_k?b_kv^{(2)-1}b_j) \\
 &\quad \otimes \varphi_i(S^{-1}(a_j)S^{-1}(v^{(1)-1})a_k?b_kb_j) \otimes \varphi_{i+1} \otimes \dots \otimes \varphi_g \\
 &= \varphi_1(S^{-1}(v^{(2i-2)-1})?v^{(2i-1)-1}) \otimes \dots \otimes \varphi_{i-1}(S^{-1}(v^{(2)-1})?v^{(3)-1}) \otimes \varphi_i(S^{-1}(a_j)S^{-1}(v^{(1)-1})a_k?b_kb_j) \otimes \varphi_{i+1} \\
 &\quad \otimes \dots \otimes \varphi_g \\
 &= \theta_g^o(\tau_{e_i})(\varphi_1 \otimes \dots \otimes \varphi_g).
 \end{aligned}$$

We used  $\Delta^{\text{op}}R = R\Delta$  for the last equality.

2) It is not difficult to see that  $(F \circ S)^{\otimes g} \circ \sigma : K^{\otimes g} \rightarrow (H^*)^{\otimes g}$  is a morphism of  $H$ -modules, where  $K^{\otimes g}$  is endowed with the action (5.39) and  $(H^*)^{\otimes g}$  is endowed with the action (5.14) (with  $n = 0$ ). Hence, the restriction of  $(F \circ S)^{\otimes g} \circ \sigma$  to  $(K^{\otimes g})^{\text{inv}}$  indeed takes values in  $\text{Inv}((H^*)^{\otimes g})$ . Since

$$Z_{\mathbb{C}}(f) = (Z_{H_{\text{reg}}}(f))|_{(K^{\otimes g})^{\text{inv}}} \quad \text{and} \quad \theta_g(f) = \theta_g^o(f)|_{\text{Inv}((H^*)^{\otimes g})},$$

the result follows from the first part of the theorem. □





# Chapter 6

## Graphical calculus and relation to skein theory

The main topic of this last chapter is to explain how to compute in  $\mathcal{L}_{g,n}(H)$  in a graphical way and to define the Wilson loop map  $W$ . For that, we introduce a graphical element associated to a matrix with coefficients in  $\mathcal{L}_{g,n}(H)$  and combine it with the ones recalled in section 2.5. Hence, this can be seen as an extension of the Reshetikhin-Turaev functor (section 2.5), even though the map “evaluation of a diagram” is no longer a functor (the evaluation of a diagram is an element of  $\mathcal{L}_{g,n}(H) \otimes V$ , where  $V$  is a  $H$ -module). Note that such a graphical calculus can be used to compute in any algebra defined by means of matrix coefficients associated to a braided Hopf algebra (like  $H$ ,  $\mathcal{O}(H)$ ,  $\mathcal{H}(\mathcal{O}(H))$ ).

We first reformulate graphically the defining relations of  $\mathcal{L}_{g,n}(H)$ . Then we graphically define the Wilson loop map  $W$ , which to an oriented, colored and framed link in  $\Sigma_{g,n}^\circ$  associates an element of  $\mathcal{L}_{g,n}^{\text{inv}}(H)$ . This definition and the resulting properties are equivalent, but maybe simpler, to the Wilson loops of [BR96], whose definition was based on chord diagrams and did not use a graphical presentation of  $\mathcal{L}_{g,n}(H)$ , and to the Wilson loops of [BFK98a, BFK98b], whose formal definition in the setting of  $\mathcal{F}_{g,n}(H)$  (functions on connections, see section 5.1.3) was based on their notion of multitangles. Here we choose the canonical thickened graph of Figure 5.2; with this choice, the definition of the Wilson loop map becomes obvious and natural-looking, thanks to the use of the graphical calculus.

With the gauge algebra  $H = \bar{U}_q$ , we use the Wilson loop map and its particular properties in this setting to obtain representations of skein algebras. Note that, as in the case of the representations of mapping class groups, the restriction to  $\text{Inv}(V)$  allows us to glue back the disc  $D$  and to obtain a representation of  $\mathcal{S}_q(\Sigma_{g,0})$  (and not just of  $\mathcal{S}_q(\Sigma_{g,0}^\circ)$ ).

The main results of this chapter are

- The definition of the Wilson loop map  $W$  (Definition 6.2.1) and its natural and expected properties (Theorem 6.2.7, Propositions 6.2.3, 6.2.4, 6.2.9), which indicate that the definition of  $W$  is the good one.
- The representation of the skein algebra  $\mathcal{S}_q(\Sigma_{g,0})$  on  $\text{Inv}((\bar{U}_q)^{\otimes g})$  (Theorem 6.4.1).
- The explicit study of the representation of  $\mathcal{S}_q(\Sigma_1)$  on  $\text{SLF}(\bar{U}_q)$  (Propositions 6.5.2 and 6.5.5).

As previously, we assume that  $H$  is a finite dimensional factorizable ribbon Hopf algebra, even though these assumptions can be weakened for this chapter.

## 6.1 Diagrammatic description of $\mathcal{L}_{g,n}(H)$

Let  $I$  be a  $H$ -module. We have an isomorphism of vector spaces :

$$\begin{aligned} \mathcal{L}_{g,n}(H) \otimes I \otimes I^* &\xrightarrow{\sim} \mathcal{L}_{g,n}(H) \otimes \text{End}_{\mathbb{C}}(I) \\ x \otimes u \otimes \varphi &\mapsto x \otimes (y \mapsto \varphi(y)u). \end{aligned}$$

Let us choose a basis  $(v_i)$  of  $I$  and let  $(v^j)$  be its dual basis. Then  $\mathcal{L}_{g,n}(H) \otimes \text{End}_{\mathbb{C}}(I) \cong \mathcal{L}_{g,n}(H) \otimes \text{Mat}_{\dim(I)}(\mathbb{C}) = \text{Mat}_{\dim(I)}(\mathcal{L}_{g,n}(H))$  and the inverse of the above isomorphism is

$$\begin{aligned} \text{Mat}_{\dim(I)}(\mathcal{L}_{g,n}(H)) &\xrightarrow{\sim} \mathcal{L}_{g,n}(H) \otimes I \otimes I^* \\ M &\mapsto M_j^i \otimes v_i \otimes v^j. \end{aligned} \quad (6.1)$$

In this chapter, we systematically identify a matrix  $M \in \text{Mat}_{\dim(I)}(\mathcal{L}_{g,n}(H))$  with  $M_j^i \otimes v_i \otimes v^j$ , written more shortly  $M_j^i v_i \otimes v^j$ .

We denote by  $\overset{I}{X}$  an element of  $\mathcal{L}_{g,n}(H) \otimes \text{End}_{\mathbb{C}}(I) = \text{Mat}_{\dim(I)}(\mathcal{L}_{g,n}(H))$ . In general, we will restrict  $\overset{I}{X}$  to be a product of the matrices of generators  $\overset{I}{A}(i), \overset{I}{B}(j), \overset{I}{M}(k)$  up to some normalization  $\overset{I}{v}^r$ , namely:

$$\overset{I}{v}^r \overset{I}{A}(i_1)^{l_1} \overset{I}{B}(j_1)^{m_1} \overset{I}{M}(k_1)^{n_1} \dots \overset{I}{A}(i_s)^{l_s} \overset{I}{B}(j_s)^{m_s} \overset{I}{M}(k_s)^{n_s} \in \text{Mat}_{\dim(I)}(\mathcal{L}_{g,n}(H)) \quad (6.2)$$

with  $r, l_\alpha, m_\alpha, n_\alpha \in \mathbb{Z}$  and  $1 \leq i_\alpha, j_\alpha \leq g, g+1 \leq k_\alpha \leq g+n$ ; for instance  $\overset{I}{M}(3)^{-2} \overset{I}{B}(1)^{-1} \overset{I}{A}(2)$ . Using the identification (6.1), we represent graphically  $\overset{I}{X} = \overset{I}{X}_j^i v_i \otimes v^j$  by the following diagram:



$$\quad (6.3)$$

The module  $I$  colors the strand while the matrix  $\overset{I}{X}$  colors the handle. Mimicking (2.40), we define a graphical element corresponding to the negative orientation of the strand:

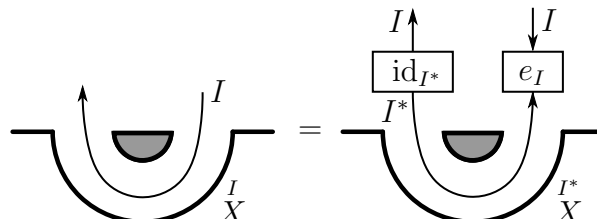

$$\quad (6.4)$$

where  $e_I : I^{**} \rightarrow I$  is the isomorphism (2.38). Let us explain (6.4). To define the graphical element on the left, we put a ribbon graph atop the one defined in (6.3). This ribbon graph represents a morphism  $I^* \otimes I^{**} \rightarrow I^* \otimes I$  in  $\text{mod}_l(H)$  (see section 2.5), which can be applied to  $\overset{I^*}{X}_j^i v^i \otimes \langle ?, v_j \rangle$  and thus gives a well-defined element in  $\mathcal{L}_{g,n}(H) \otimes I^* \otimes I$ . For further use we record that, due to (2.39) and (6.7) below, the converse of (6.4) is

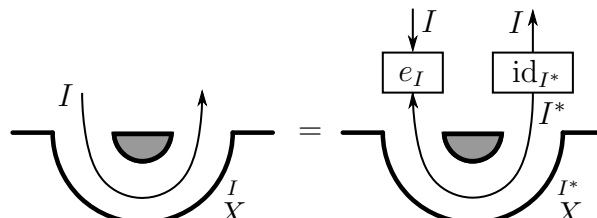

$$\quad (6.5)$$

The tensor product of two matrices  $\overset{I}{X}, \overset{J}{Y}$ , defined by

$$\overset{I}{X} \otimes \overset{J}{Y} = \overset{I}{X}_j^i \overset{J}{Y}_l^k v_i \otimes v^j \otimes w_k \otimes w^l$$

(where  $(v_i)$  is a basis of  $I$ ,  $(w_k)$  is a basis of  $J$  and  $(v^j), (w^l)$  are their respective dual bases), is represented by the gluing of the corresponding graphical elements:

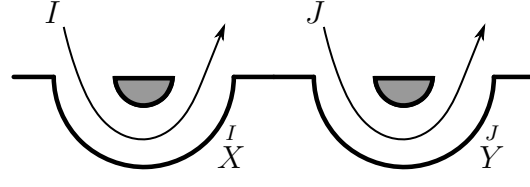
(6.6)

**Definition 6.1.1.** A diagram is obtained by gluing (as in (6.6)) several copies of the handle diagrams introduced in (6.3) and (6.4), and by putting atop an oriented and colored ribbon graph  $G$  (see section 2.5). The evaluation of a diagram, depicted in Figure 6.1, is a map  $\tilde{F}_{\text{RT}}$  which consists of applying  $F_{\text{RT}}(G)$  to the matrices associated to the handle diagrams introduced previously, where  $F_{\text{RT}}$  is the Reshetikhin-Turaev functor (see section 2.5). The evaluation of a diagram is an element of  $\mathcal{L}_{g,n}(H) \otimes J_1 \otimes \dots \otimes J_l$ , where  $J_1, \dots, J_l$  are  $H$ -modules.

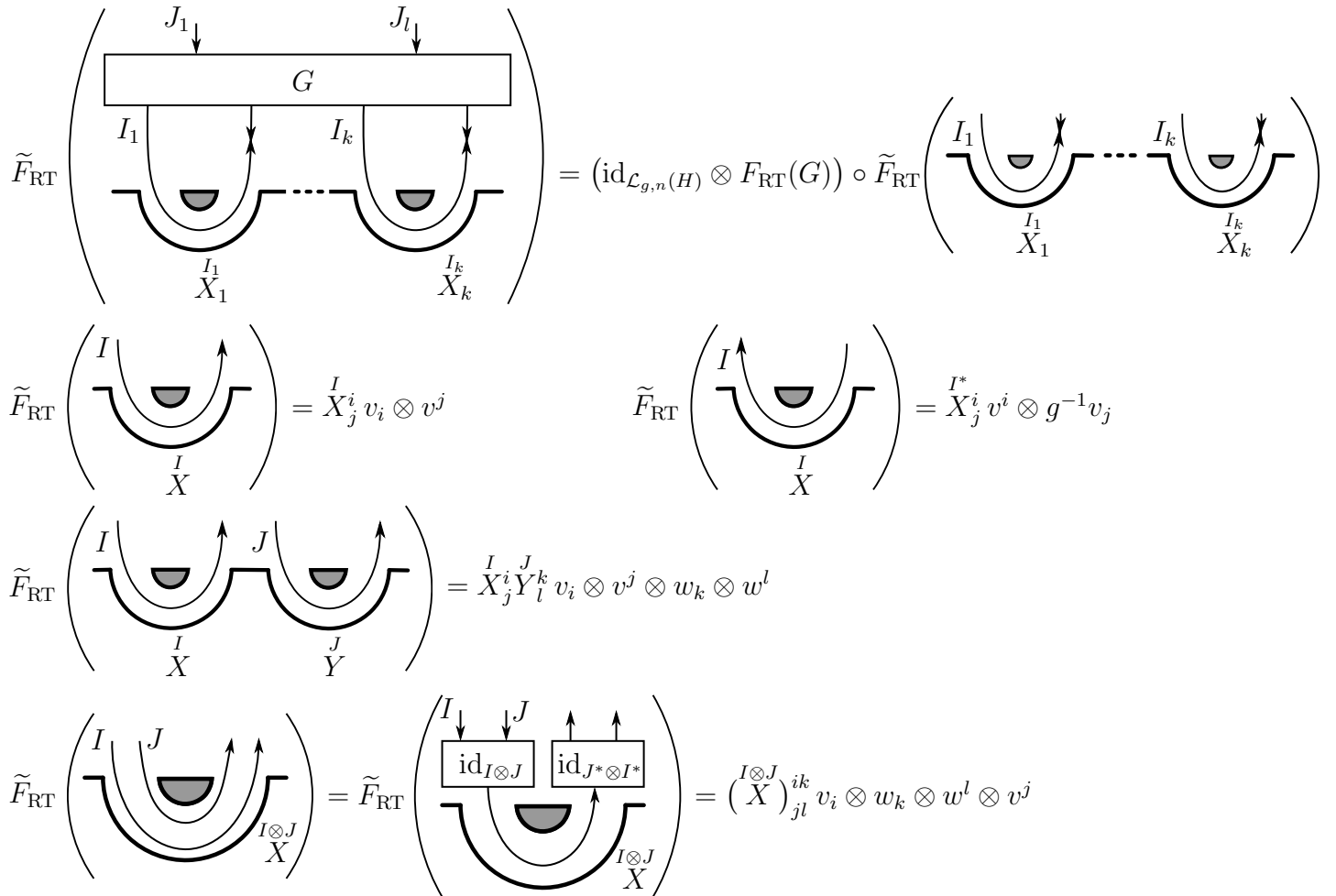

$$\tilde{F}_{\text{RT}} \left( \begin{array}{c} J_1 \downarrow \quad J_l \downarrow \\ \text{---} G \text{---} \\ I_1 \downarrow \quad I_k \downarrow \\ \text{---} \text{---} \text{---} \\ \text{---} \text{---} \text{---} \\ I_1 \downarrow \quad I_k \downarrow \\ \text{---} \text{---} \text{---} \\ \overset{I_1}{X_1} \quad \overset{I_k}{X_k} \end{array} \right) = (\text{id}_{\mathcal{L}_{g,n}(H)} \otimes F_{\text{RT}}(G)) \circ \tilde{F}_{\text{RT}} \left( \begin{array}{c} I_1 \downarrow \quad \dots \quad I_k \downarrow \\ \text{---} \text{---} \text{---} \\ \text{---} \text{---} \text{---} \\ \overset{I_1}{X_1} \quad \dots \quad \overset{I_k}{X_k} \end{array} \right)$$

$$\tilde{F}_{\text{RT}} \left( \begin{array}{c} I \\ \text{---} \text{---} \text{---} \\ \text{---} \text{---} \text{---} \\ \overset{I}{X} \end{array} \right) = \overset{I}{X}_j^i v_i \otimes v^j$$

$$\tilde{F}_{\text{RT}} \left( \begin{array}{c} I \\ \text{---} \text{---} \text{---} \\ \text{---} \text{---} \text{---} \\ \overset{I}{X} \end{array} \right) = \overset{I^*}{X}_j^i v^i \otimes g^{-1} v_j$$

$$\tilde{F}_{\text{RT}} \left( \begin{array}{c} I \quad J \\ \text{---} \text{---} \text{---} \quad \text{---} \text{---} \text{---} \\ \text{---} \text{---} \text{---} \quad \text{---} \text{---} \text{---} \\ \overset{I}{X} \quad \overset{J}{Y} \end{array} \right) = \overset{I}{X}_j^i \overset{J}{Y}_l^k v_i \otimes v^j \otimes w_k \otimes w^l$$

$$\tilde{F}_{\text{RT}} \left( \begin{array}{c} I \quad J \\ \text{---} \text{---} \text{---} \\ \text{---} \text{---} \text{---} \\ \overset{I \otimes J}{X} \end{array} \right) = \tilde{F}_{\text{RT}} \left( \begin{array}{c} I \downarrow \quad J \downarrow \\ \text{---} \text{---} \text{---} \\ \text{---} \text{---} \text{---} \\ \overset{I \otimes J}{X} \end{array} \right) = \left( \overset{I \otimes J}{X} \right)_{jl}^{ik} v_i \otimes w_k \otimes w^l \otimes v^j$$

Figure 6.1: The evaluation map  $\tilde{F}_{\text{RT}}$  (the double arrows in the first equality mean any orientation).

In the sequel, we always identify a diagram with its evaluation through  $\tilde{F}_{\text{RT}}$ .

For instance, consider the following diagram:

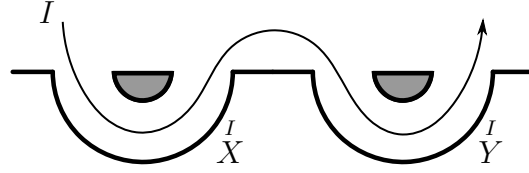

It is evaluated as

$$X_j^i Y_l^k \text{id}_I \otimes d_I \otimes \text{id}_{I^*}(v_i \otimes v^j \otimes v_k \otimes v^l) = X_j^i Y_l^j v_i \otimes v^l = (XY)_l^i v_i \otimes v^l.$$

Hence, we see that this diagram represents the matrix product  $XY$ . Similarly, the diagram

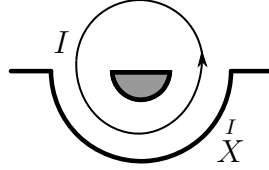

is evaluated as

$$X_j^i d_I^l(v_i \otimes v^j) = X_j^i v^j(gv_i) = X_j^i g_i^j = \text{tr}(gX) = \text{tr}_q(X),$$

and we see that it represents the quantum trace of  $X$ .

Recall that the matrices  $A(i), B(j), M(k)$  commute with the morphisms (naturality, see (5.4)). Hence, this is also true for matrices of the form (6.2). Namely we have  $fX = Xf$ , where  $f : I \rightarrow J$  is a morphism and we identify  $f$  with its matrix. Let us see the diagrammatic description of this fact. We have

$$\begin{aligned} X_j^i f \otimes \text{id}_{I^*}(v_i \otimes v^j) &= X_j^i f_i^k v_k \otimes v^j = (fX)_j^k v_k \otimes v^j = (Xf)_j^k w_k \otimes w^j \\ &= X_l^k w_k \otimes f_j^l w^j = X_l^k \text{id}_I \otimes f^*(w_k \otimes w^l) \end{aligned}$$

where  $f^* : J^* \rightarrow I^*$  is the transpose of  $f$ . Thus we get the first diagram below. The second diagram is a consequence of the first thanks to (6.4) and the equality  $f \circ e_I = e_J \circ f^{**}$ .

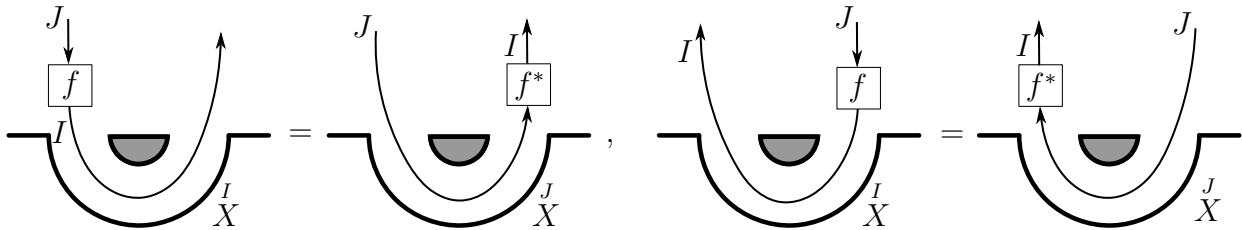

(6.7)

Let us now write the defining relations of  $\mathcal{L}_{g,n}(H)$  in a diagrammatic form. Note that for  $a, b \in H$ , it holds

$$(aXb)_j^i v_i \otimes v^j = X_j^i a v_i \otimes S^{-1}(b)v^j. \quad (6.8)$$

We will use this fact several times in the sequel.

- *Fusion relation of  $\mathcal{L}_{0,1}(H)$* : Recall that

$$M^{\otimes J} = M_1(I)_{12} M_2(I)_{12}^{-1} = \left( M \begin{matrix} I & I & I \\ b_i & b_i & b_j \end{matrix} \right)_1 \left( a_i M S(a_j) \right)_2.$$

Hence, we have:

$$\begin{aligned}
 M_{ln}^{I \otimes J, km} v_k \otimes w_m \otimes w^n \otimes v^l &= \left( M \begin{matrix} I & I & I \\ b_i & b_j \end{matrix} \right)_l^k \left( a_i \begin{matrix} J \\ M \end{matrix} S(a_j) \right)_n^m v_k \otimes w_m \otimes w^n \otimes v^l \\
 &= M_l^I M_n^J v_k \otimes a_i w_m \otimes a_j w^n \otimes S^{-1}(b_i b_j) v^l \\
 &= M_l^I M_n^J v_k \otimes S(a_i) w_m \otimes S(a_j) w^n \otimes b_j b_i v^l \\
 &= M_l^I M_n^J \text{id}_I \otimes \text{id}_J \otimes c_{J^*, I^*}^{-1} (v_k \otimes S(a_i) w_m \otimes b_i v^l \otimes w^n) \\
 &= M_l^I M_n^J (\text{id}_I \otimes \text{id}_J \otimes c_{J^*, I^*}^{-1}) \circ (\text{id}_I \otimes c_{J, I^*}^{-1} \otimes \text{id}_{J^*}) (v_k \otimes v^l \otimes w_m \otimes w^n).
 \end{aligned}$$

We thus obtain the diagrammatic identity below:

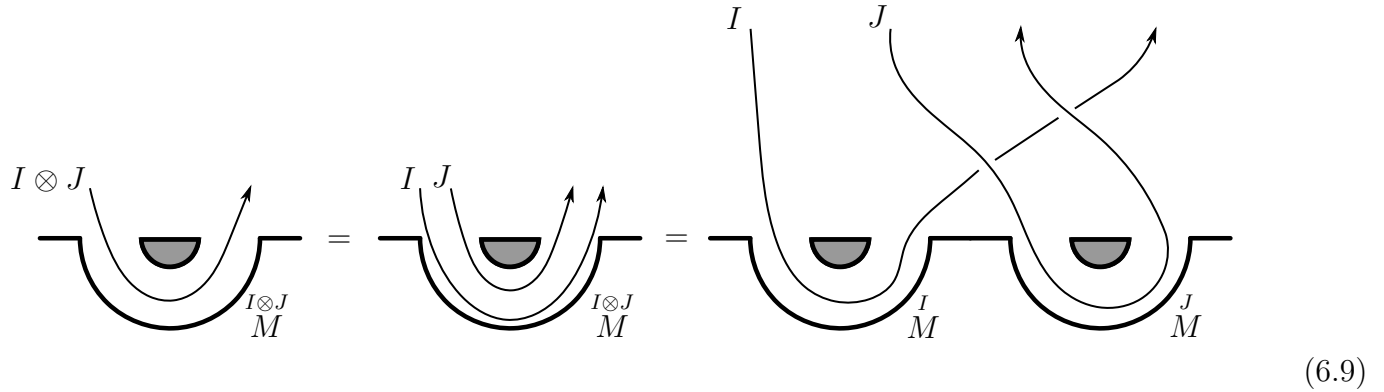

- *Reflection equation:* The reflection equation in  $\mathcal{L}_{0,1}(H)$  is the following exchange relation :

$$R_{12}^{IJ} M_1^I (R')_{12}^{IJ} M_2^J = M_2^J R_{12}^{IJ} M_1^I (R')_{12}^{IJ}.$$

The graphical representation of this equation is depicted as follows:

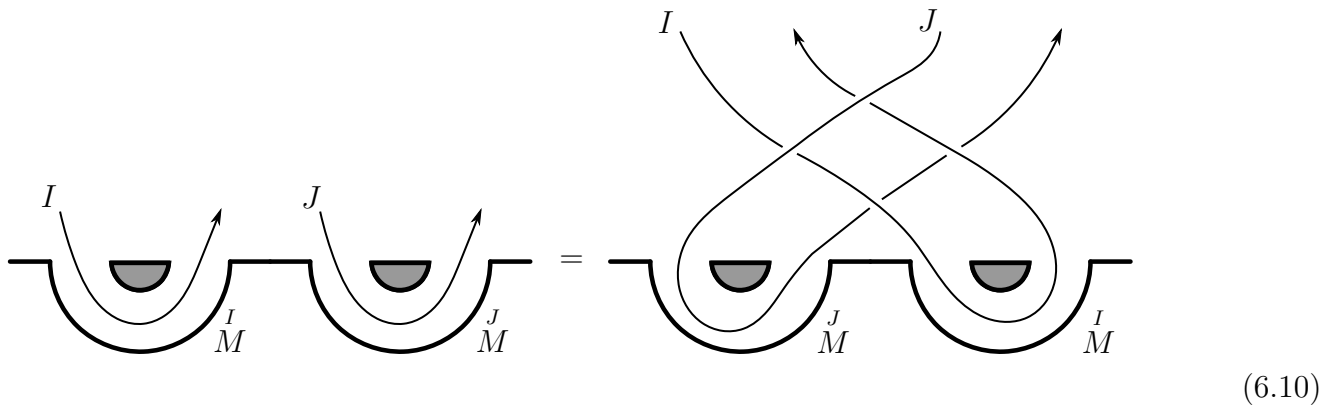

A diagrammatic proof of this relation is shown in Figure 6.2; this is simply a graphical reformulation of the proof of Proposition 4.1.3. For the second equality, we used naturality (6.7) and the fact that  $c_{J, I^*}^* = c_{J^*, I^*}$ .

If we plug the inverse of the tangle (which is a braid) and we exchange  $I$  and  $J$  in the reflection

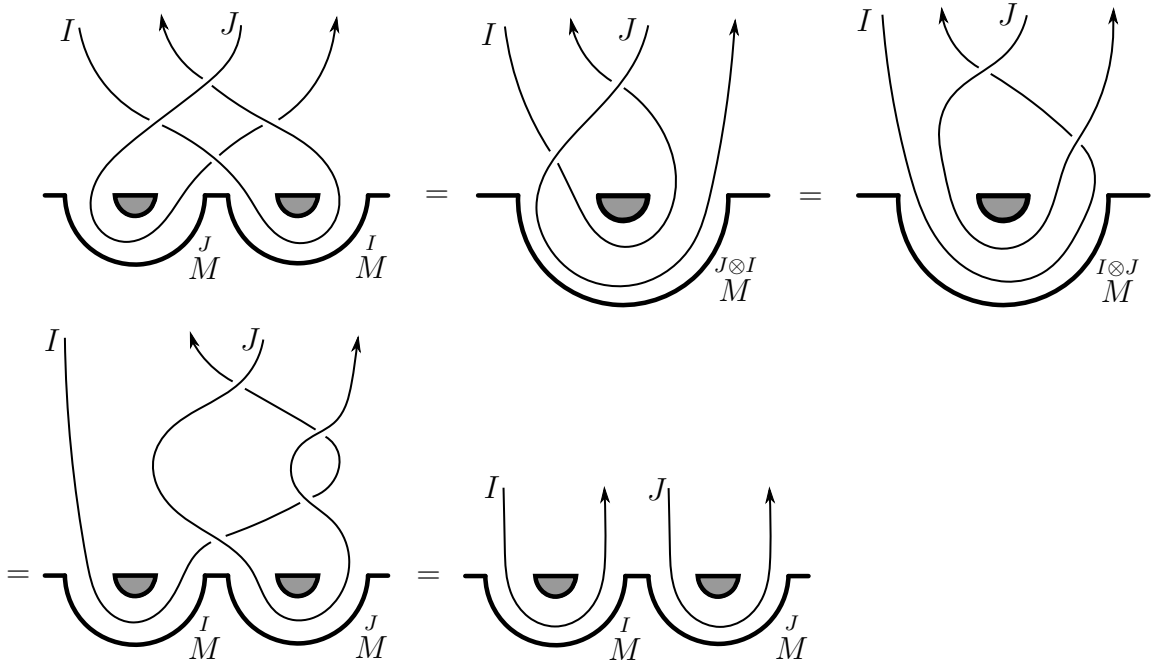

Figure 6.2: Proof of the reflection equation in  $\mathcal{L}_{0,1}(H)$ .

equation above, we get the following relation, which we also call reflection equation:

(6.11)

- *Negative orientation and inverse of  $\overset{I}{M}$* : Recall the algebra  $\mathcal{F}_{0,1}(H) \cong \mathcal{L}_{0,1}(H)$  of Remark 4.1.9, which is  $H^*$  endowed with the product  $\varphi * \psi = \varphi(?b_j S(b_i)) \psi(a_i ?a_j)$ . We identify  $\mathcal{L}_{0,1}(H)$  and  $\mathcal{F}_{0,1}(H)$  by  $\overset{I}{M} \mapsto \overset{I}{T}$ . In other words, we consider  $\overset{I}{M}$  as a matrix whose coefficients are linear forms on  $H$ ; the evaluation of  $\overset{I}{M}$  on  $x \in H$  is obviously defined by  $\overset{I}{M}(x)_j^i = \overset{I}{M}_j^i(x) = \overset{I}{x}_j^i$ .

**Lemma 6.1.2.** *Under the above identification, it holds*

$$\overset{I}{M}^{-1}(x) = (u^{-1} S(b_i) S(x) a_i)^I$$

where  $u = gv$  is the Drinfeld element (2.10).

*Proof.*

$$\begin{aligned}
 \left( \overset{I}{M}_j^i * (\overset{I}{M}^{-1})_k^j \right) (x) &= \left\langle \overset{I}{M}_j^i, x' b_m S(b_l) \right\rangle \left\langle (\overset{I}{M}^{-1})_k^j, a_l x'' a_m \right\rangle \\
 &= \left( \overset{I}{x' b_m b_l} \overset{I}{b_l} \overset{I}{b_l} \right)_j^i \left( \overset{I}{u^{-1} S(b_n)} \overset{I}{S(a_m)} \overset{I}{S(x'')} \overset{I}{a_l} \overset{I}{a_n} \right)_k^j \\
 &= \left( \overset{I}{x' b_m u^{-1} S^2(b_l)} \overset{I}{S^{-1}(b_n)} \overset{I}{S(a_m)} \overset{I}{S(x'')} \overset{I}{a_l} \overset{I}{a_n} \right)_k^i \\
 &= \left( \overset{I}{x' u^{-1} S^2(b_m)} \overset{I}{S(a_m)} \overset{I}{S(x'')} \right)_k^i = \left( \overset{I}{x' S(x'')} \right)_k^i = \varepsilon(x) \delta_k^i.
 \end{aligned}$$

We used that  $S^2(b_m)S(a_m) = S(b_m)a_m = u$ . □

Still under the identification  $\mathcal{L}_{0,1}(H) = \mathcal{F}_{0,1}(H)$  and by (2.16), we have  $\overset{I^*}{M}(x) = {}^t S \overset{I}{M}(x)$ . It follows that the formula of Lemma 6.1.2 can be rewritten as  $\overset{I}{M}^{-1}(x) = (u^{-1} S(b_i)) \overset{I^*}{M} \overset{I}{a}_i$ , and finally:

$$\overset{I^*}{M} = {}^t \left( \overset{I}{u b_i} \overset{I}{M}^{-1} \overset{I}{S^2(a_i)} \right).$$

Let us represent this formula graphically:

$$\begin{aligned}
 \overset{I^*}{M}_j^i \text{id}_{I^*} \otimes e_I(v^i \otimes \langle ?, v_j \rangle) &= \overset{I^*}{M}_j^i v^i \otimes g^{-1} v_j = \left( \overset{I}{u b_k} \overset{I}{M}^{-1} \overset{I}{S^2(a_k)} \right)_i^j v^i \otimes g^{-1} v_j \\
 &= (\overset{I}{M}^{-1})_i^j S(a_k) v^i \otimes v b_k v_j = (\overset{I}{M}^{-1})_i^j (\text{id}_{I^*} \otimes \theta_I^{-1}) \circ c_{I^*, I}^{-1}(v_j \otimes v^i).
 \end{aligned}$$

By definition of the value of a negatively oriented strand in a handle (6.4), we get:

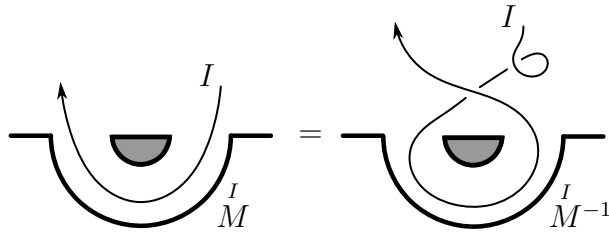

$$\text{Diagrammatic equation (6.12)}$$

Note that since this formula is true in  $\mathcal{L}_{0,1}(H)$ , it will be true for any matrix  $\overset{I}{X}$  with coefficients in  $\mathcal{L}_{g,n}(H)$  which satisfies the fusion relation. We also mention that (6.12) implies the following relation, which will be used later:

$$\text{tr}_q(\overset{I}{M}^{-1}) = \text{tr}_q(\overset{I^*}{M}). \tag{6.13}$$

Indeed, thanks to (6.4) and (2.40), we have:

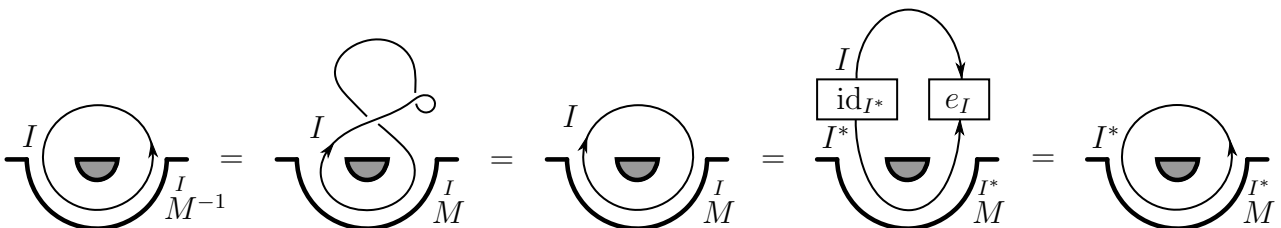



- *Exchange relation of  $\mathcal{L}_{1,0}(H)$* : Recall from (4.16) that this relation can be written

$$A_1^I B_2^J = (a_i)_2 (R')_{12}^{IJ} B_2^J R_{12}^{IJ} A_1^I (R')_{12}^{IJ} S^I(b_i)_1 = \left( \begin{matrix} J & J & J & J & J \\ a_i & a_j & B & b_k & a_l \end{matrix} \right)_2 \left( \begin{matrix} I & I & I & I \\ b_j & a_k & A & b_l & S(b_i) \end{matrix} \right)_1.$$

Hence we have:

$$\begin{aligned} & A_n^I B_p^J v_m \otimes v^n \otimes w_o \otimes w^p \\ &= \left( \begin{matrix} J & J & J & J & J \\ a_i & a_j & B & b_k & a_l \end{matrix} \right)_p^o \left( \begin{matrix} I & I & I & I & I \\ b_j & a_k & A & b_l & S(b_i) \end{matrix} \right)_n^m v_m \otimes v^n \otimes w_o \otimes w^p \\ &= B_p^J A_n^I b_j a_k v_m \otimes S^{-1}(b_l S(b_i)) v^n \otimes a_i a_j w_o \otimes S^{-1}(b_k a_l) w^p \\ &= B_p^J A_n^I b_j S(a_k) v_m \otimes b_l b_l v^n \otimes a_i a_j w_o \otimes a_l b_k w^p \\ &= B_p^J A_n^I \text{id}_I \otimes c_{J,I^*} \otimes \text{id}_{J^*} (b_j S(a_k) v_m \otimes a_j w_o \otimes b_l v^n \otimes a_l b_k w^p) \\ &= B_p^J A_n^I (\text{id}_I \otimes c_{J,I^*} \otimes \text{id}_{J^*}) \circ (c_{J,I} \otimes c_{J^*,I^*}) (w_o \otimes S(a_k) v_m \otimes b_k w^p \otimes v^n) \\ &= B_p^J A_n^I (\text{id}_I \otimes c_{J,I^*} \otimes \text{id}_{J^*}) \circ (c_{J,I} \otimes c_{J^*,I^*}) \circ (\text{id}_J \otimes c_{I,J^*}^{-1} \otimes \text{id}_{I^*}) (w_o \otimes w^p \otimes v_m \otimes v^n) \end{aligned}$$

and this yields the diagrammatic identity below.

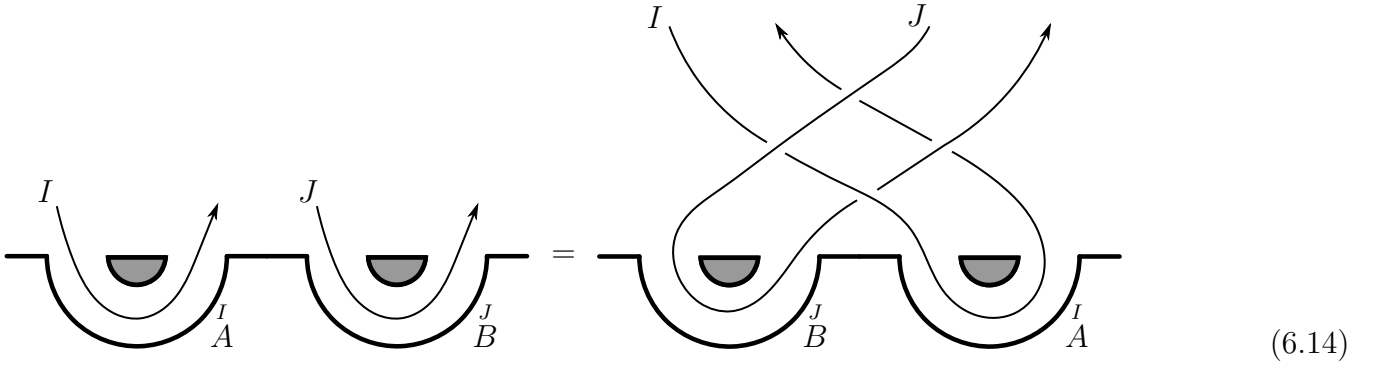

Remark that, as above, the tangle appearing in (6.14) is in fact a braid and it can be inverted in order to exchange  $\overset{J}{B}$  and  $\overset{I}{A}$ .

- *Exchange relation of  $\mathcal{L}_{g,n}(H)$* : Recall from (5.5) that for  $\alpha < \beta$

$$\overset{J}{V}(\beta)_2 \overset{I}{U}(\alpha)_1 = (a_i)_1 \overset{IJ}{R}_{12} \overset{I}{U}(\alpha)_1 \overset{IJ}{R}_{12}^{-1} \overset{J}{V}(\beta)_2 \overset{IJ}{R}_{12} \overset{J}{S}(b_i)_2 = \left( \begin{matrix} I & I & I \\ a_i & a_j & U(\alpha) & S(a_k) & a_l \end{matrix} \right)_1 \left( \begin{matrix} J & J & J \\ b_j & b_k & V(\beta) & b_l & S(b_i) \end{matrix} \right)_2.$$

where  $U, V$  are  $A$  or  $B$ . Hence we have:

$$\begin{aligned} & \overset{J}{V}(\beta)_n^m \overset{I}{U}(\alpha)_p^o v_m \otimes v^n \otimes w_o \otimes w^p \\ &= \left( \begin{matrix} I & I & I \\ a_i & a_j & U(\alpha) & S(a_k) & a_l \end{matrix} \right)_p^o \left( \begin{matrix} J & J & J \\ b_j & b_k & V(\beta) & b_l & S(b_i) \end{matrix} \right)_n^m v_m \otimes v^n \otimes w_o \otimes w^p \\ &= \overset{I}{U}(\alpha)_p^o \overset{J}{V}(\beta)_n^m b_j b_k v_m \otimes S^{-1}(b_l S(b_i)) v^n \otimes a_i a_j w_o \otimes S^{-1}(S(a_k) a_l) w^p \\ &= \overset{J}{V}(\beta)_p^o \overset{I}{U}(\alpha)_n^m b_j b_k v_m \otimes b_l b_l v^n \otimes a_i a_j w_o \otimes a_l a_k w^p \\ &= \overset{J}{V}(\beta)_p^o \overset{I}{U}(\alpha)_n^m \text{id}_I \otimes c_{J,I^*} \otimes \text{id}_{J^*} (b_j b_k v_m \otimes a_j w_o \otimes b_l v^n \otimes a_l a_k w^p) \\ &= \overset{J}{V}(\beta)_p^o \overset{I}{U}(\alpha)_n^m (\text{id}_I \otimes c_{J,I^*} \otimes \text{id}_{J^*}) \circ (c_{J,I} \otimes c_{J^*,I^*}) (w_o \otimes b_k v_m \otimes a_k w^p \otimes v^n) \\ &= \overset{J}{V}(\beta)_p^o \overset{I}{U}(\alpha)_n^m (\text{id}_I \otimes c_{J,I^*} \otimes \text{id}_{J^*}) \circ (c_{J,I} \otimes c_{J^*,I^*}) \circ (\text{id}_J \otimes c_{J^*,I} \otimes \text{id}_{I^*}) (w_o \otimes w^p \otimes v_m \otimes v^n) \end{aligned}$$

and this yields the diagrammatic identity below:

(6.15)

## 6.2 The Wilson loop map

In what follows, we will consider framed links which are oriented and colored, up to isotopy (equivalently, oriented and colored ribbons up to isotopy). By colored we mean that any connected component of the link is labelled by a  $H$ -module. We denote by  $\mathcal{R}_{g,n}^{\text{OC}}$  the set of isotopy classes of oriented, framed and colored links in  $\Sigma_{g,n}^{\circ} \times [0, 1]$ , and by  $\mathbb{C}\mathcal{R}_{g,n}^{\text{OC}}$  the  $\mathbb{C}$ -vector space whose basis is  $\mathcal{R}_{g,n}^{\text{OC}}$  (formal linear combinations of elements of  $\mathcal{R}_{g,n}^{\text{OC}}$ ).

Recall the view of  $\Sigma_{g,n}^{\circ}$  depicted in Figure 5.2 and assume that it represents  $\Sigma_{g,n}^{\circ} \times \{0\} \subset \Sigma_{g,n}^{\circ} \times [0, 1]$  (thickened surface). If we have a (framed oriented) link  $L \in \Sigma_{g,n}^{\circ} \times [0, 1]$ , we may assume up to isotopy that each of the thickened handles simply contains a bunch parallel arcs (*i.e.* it does not contain cups, caps or crossings) and that the thickened rectangle contains a  $(m, 0)$ -tangle (with  $m$  even) projecting onto  $\Sigma_{g,n}^{\circ} \times \{0\}$ , as follows:

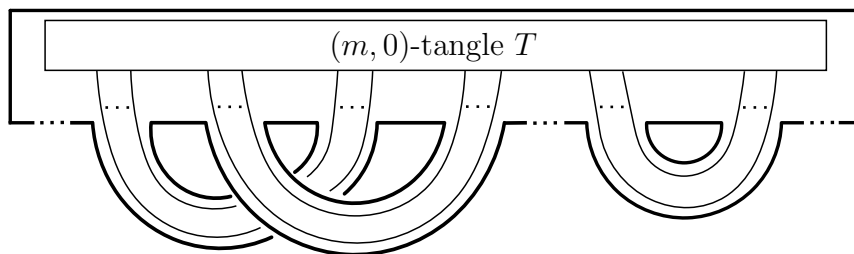

Hence we see that  $L$  can be represented by a (non-unique)  $(m, 0)$ -tangle  $T$ . The non-unicity comes from the fact that we can drag crossings, cups and caps of  $T$  along the handles and obtain another  $T'$  which also represents the link  $L$ .

**Definition 6.2.1.** *Let  $L$  be an oriented and colored framed link represented by a  $(m, 0)$ -tangle as explained above. The Wilson loop around  $L$  is an element  $W(L) \in \mathcal{L}_{g,n}(H)$  defined as the evaluation of the diagram at the bottom of Figure 6.3 (recall Definition 6.1.1). We extend  $W$  to  $\mathbb{C}\mathcal{R}_{g,n}^{\text{OC}}$  by linearity and this gives a map  $W : \mathbb{C}\mathcal{R}_{g,n}^{\text{OC}} \rightarrow \mathcal{L}_{g,n}(H)$ , which we call the Wilson loop map.*

Observe that since a tangle  $T$  representing the link  $L$  is of type  $(m, 0)$  (no outgoing strands),  $F_{\text{RT}}(T)$  is a morphism with values in  $\mathbb{C}$ . Hence, by Definition 6.1.1, the evaluation of the diagram in Figure 6.3 is indeed an element of  $\mathcal{L}_{g,n}(H) \otimes \mathbb{C} = \mathcal{L}_{g,n}(H)$ .

We note that  $W(L)$  does not depend on the choice of a tangle  $T$  representing  $L$ . First, since the Reshetikhin-Turaev functor is an isotopy invariant, the evaluation of the diagram in Figure 6.3 depends only on the isotopy class of  $T$ . Moreover, if we drag certain crossings, cups and caps along the handles in order to obtain another tangle  $T'$  representing  $L$ , then this does not change the value of  $W(L)$  thanks to naturality (6.7), see Figure 6.4.

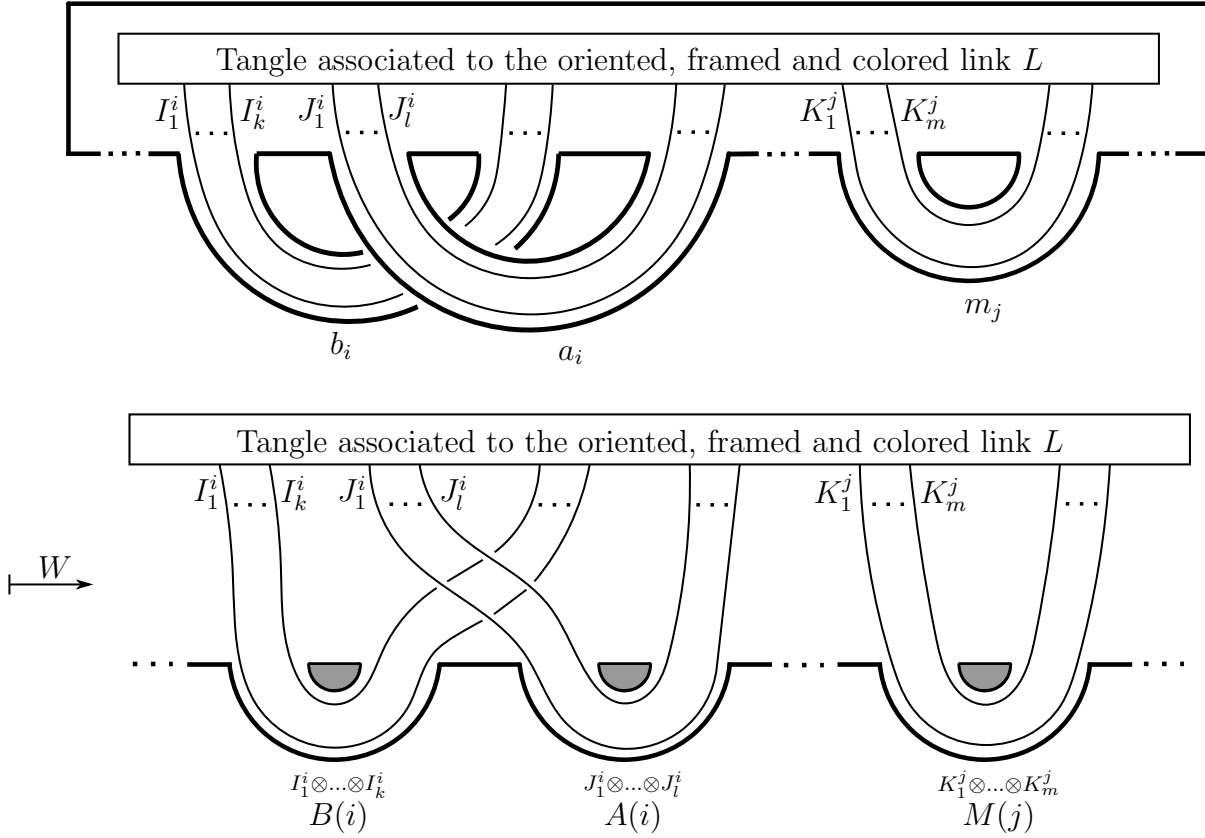

Figure 6.3: Definition of the Wilson loop map  $W$ .

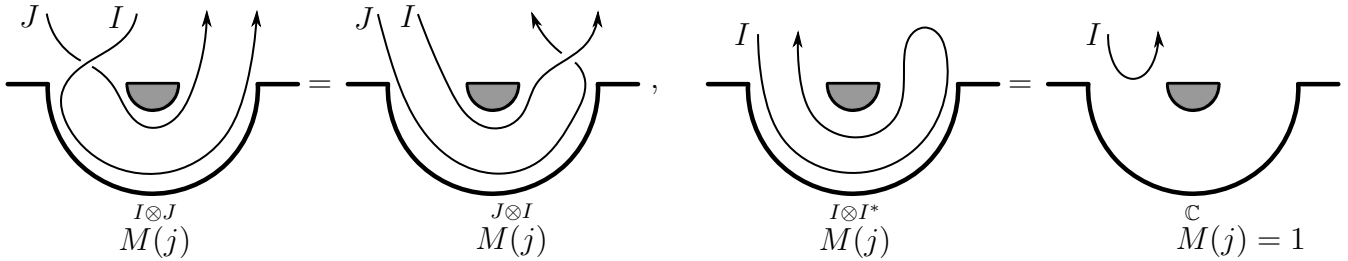

Figure 6.4: Examples of consequences of the naturality.

We stress that the diagrammatic rules introduced above allow us to compute the value of  $W$  in a purely graphical way. In order to clarify the definition of  $W$ , we will compute two examples below. Recall from (4.15) the notations  $\overset{I}{W}_A = \text{tr}_q(\overset{I}{A})$  and  $\overset{I}{W}_B = \text{tr}_q(\overset{I}{B})$ , which corresponds to Wilson loops around the loops  $a$  and  $b$ . More generally if  $\overset{I}{X}$  is a matrix of the form (6.2) we let  $\overset{I}{W}_X = \text{tr}_q(\overset{I}{X})$ , according to (4.6) and (5.8).

*Example 6.2.2.* In Figure 6.5, we compute the value of the Wilson loop around the simple closed curve  $b^{-1}a \subset \Sigma_{1,0}^o \times \{0\}$ . The result is not surprising: this is simply the quantum trace of the lift of the simple closed curve  $b^{-1}a$ , that is the quantum trace of the holonomy of the closed curve  $b^{-1}a$ . This property is always true, see Proposition 6.2.9.  $\triangle$

We now state the properties of  $W$ ; they are all natural-looking. The first property is that Wilson loops are invariant elements.

**Proposition 6.2.3.** *For any  $L \in \mathbb{C}\mathcal{R}_{g,n}^{\text{OC}}$ , it holds  $W(L) \in \mathcal{L}_{g,n}^{\text{inv}}(H)$ .*

*Proof.* We give a detailed proof although it is rather obvious. Keep Figure 6.3 in mind. The link  $L$  is represented by some  $(m, 0)$ -tangle  $T$ . We can assume that the orientations of the strands in the handles are all positively oriented. Indeed, if in the original link a strand enters an handle with the

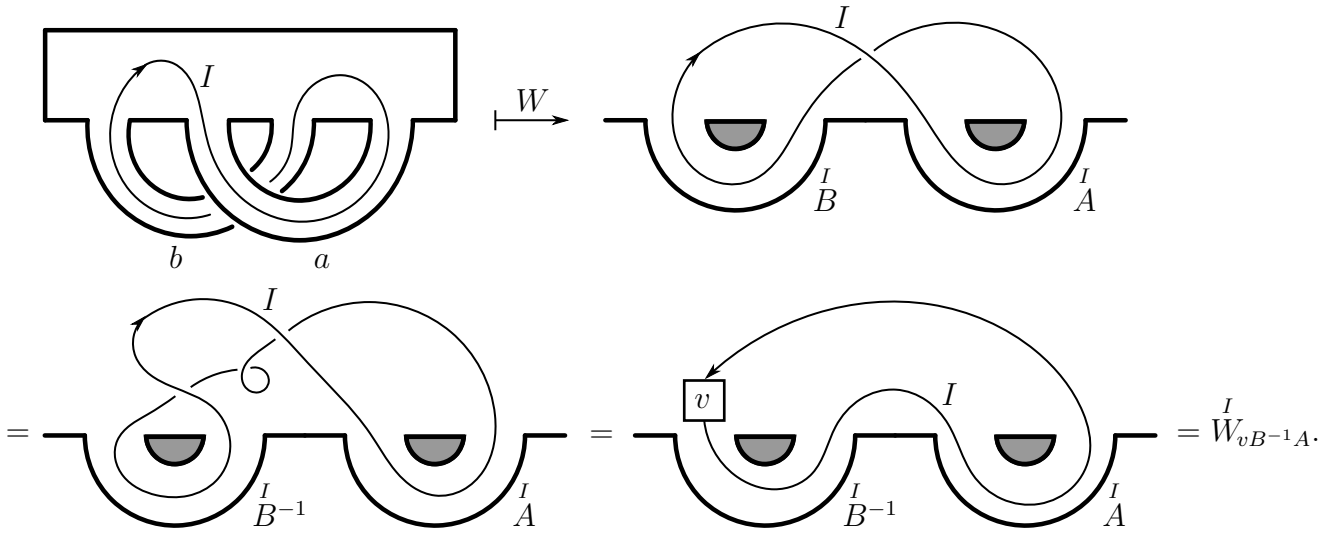
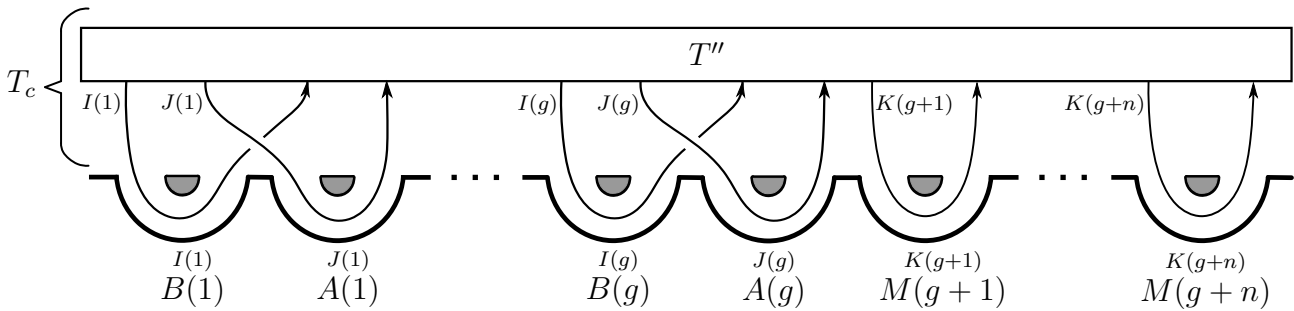

Figure 6.5: Example of computation of a Wilson loop.

negative orientation then we apply (6.4) and we push the coupons  $\text{id}_{I^*}$  and  $e_I$  near the tangle  $T$ , obtaining a ribbon graph denoted  $T'$ . Moreover, we can assume that there is only one strand passing in each handle. Indeed, if there are several strands, we use the coupons (6.16) below and we push them near  $T'$ , obtaining a new ribbon graph denoted  $T''$ .

$$\begin{array}{ccc}
 \begin{array}{c} V_1 \downarrow \dots \downarrow V_l \\ \boxed{\text{id}} \\ \downarrow V_1 \otimes \dots \otimes V_l \end{array} & & \begin{array}{c} V_1 \uparrow \dots \uparrow V_l \\ \boxed{\text{id}} \\ \uparrow V_1 \otimes \dots \otimes V_l \end{array}
 \end{array} \quad (6.16)$$

The diagram of  $W(L)$  now looks as follows:



where  $I(i), J(i), K(j)$  are tensor products as in (6.16). Let  $(u(\alpha)_i)$  (resp.  $(v(\alpha)_i), (w(\beta)_i)$ ) be a basis of  $I(\alpha)$  (resp.  $J(\alpha), K(\beta)$ ), then

$$\begin{aligned}
 & W(L) \cdot h \\
 &= \prod_{\alpha=1}^g (h^{(4\alpha-3)} B(\alpha) S(h^{(4\alpha-2)}))_{j_\alpha}^{i_\alpha} (h^{(4\alpha-1)} A(\alpha) S(h^{(4\alpha)}))_{l_\alpha}^{k_\alpha} \prod_{\beta=g+1}^{g+n} (h^{(4g+2\beta-1)} M(\beta) S(h^{(4g+2\beta)}))_{p_\beta}^{m_\beta} \\
 & F_{\text{RT}}(T_c) \left( \bigotimes_{\alpha=1}^g u(\alpha)_{i_\alpha} \otimes u(\alpha)^{j_\alpha} \otimes v(\alpha)_{k_\alpha} \otimes v(\alpha)^{l_\alpha} \otimes \bigotimes_{\beta=g+1}^{g+n} w(\beta)_{m_\beta} \otimes w(\beta)^{p_\beta} \right) \\
 &= \prod_{\alpha=1}^g B(\alpha)_{j_\alpha}^{i_\alpha} A(\alpha)_{l_\alpha}^{k_\alpha} \prod_{\beta=g+1}^{g+n} M(\beta)_{p_\beta}^{m_\beta} F_{\text{RT}}(T_c) \left( \bigotimes_{\alpha=1}^g h^{(4\alpha-3)} u(\alpha)_{i_\alpha} \otimes h^{(4\alpha-2)} u(\alpha)^{j_\alpha} \right. \\
 & \quad \left. \otimes h^{(4\alpha-1)} v(\alpha)_{k_\alpha} \otimes h^{(4\alpha)} v(\alpha)^{l_\alpha} \otimes \bigotimes_{\beta=g+1}^{g+n} h^{(4g+2\beta-1)} w(\beta)_{m_\beta} \otimes h^{(4g+2\beta)} w(\beta)^{p_\beta} \right) = \varepsilon(h) W(L).
 \end{aligned}$$

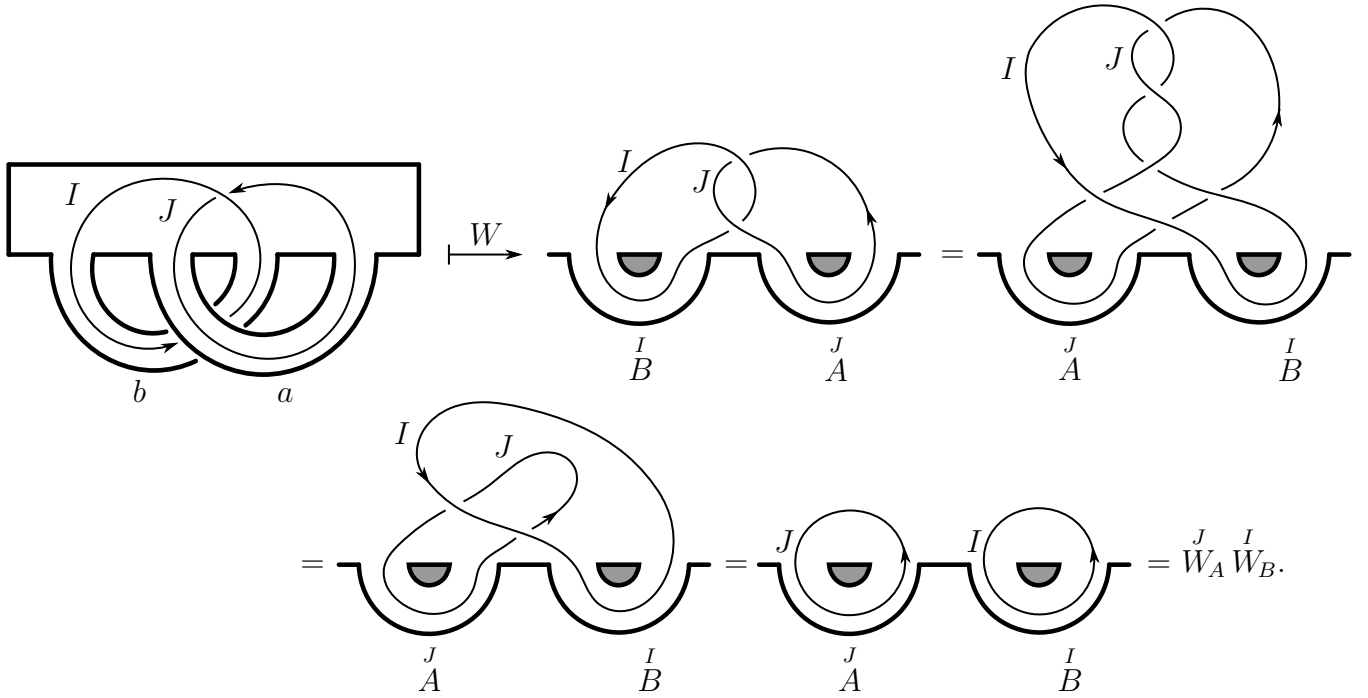

Figure 6.6: Example of computation of a Wilson loop.

We simply used (5.3), (6.8) and the fact that  $F_{\text{RT}}(T_c)$  is a morphism  $\bigotimes_{\alpha=1}^g I(\alpha) \otimes I(\alpha)^* \otimes J(\alpha) \otimes J(\alpha)^* \otimes \bigotimes_{\beta=g+1}^{g+n} K(\beta) \otimes K(\beta)^* \rightarrow \mathbb{C}$ .  $\square$

Let us see the behaviour of  $W$  under change of orientation. This is the generalization of the corresponding fact for the Reshetikhin-Turaev functor (see *e.g.* [KM91, Lemma 3.18]). Let  $L$  be an oriented framed link; we have  $L = (L_1, I_1) \sqcup \dots \sqcup (L_k, I_k)$  where the  $L_i$ 's are the connected components of  $L$  and the  $I_i$ 's are their colors. We denote by  $L_i^{-1}$  the oriented framed curve whose orientation is opposite to that of  $L_i$ .

**Proposition 6.2.4.** *With the notation above, it holds*

$$W((L_1^{-1}, I_1) \sqcup \dots \sqcup (L_k, I_k)) = W((L_1, I_1^*) \sqcup \dots \sqcup (L_k, I_k)).$$

*Proof.* We can assume that  $L = L_1$ . The result follows from the application of the local equalities (2.40), (6.4) and (6.5) on  $W(L_1)$  together with the fact that the diagram  $W(L_1)$  contains an equal number of cups and caps (a part of strand crossing a handle is considered as a cup).  $\square$

Now we show that  $W$  is compatible with the stack product.

**Definition 6.2.5.** *Let  $L_1, L_2 \in \mathcal{R}_{g,n}^{\text{OC}}$  and let  $L_1^- \in \Sigma_{g,n}^{\circ} \times [0, \frac{1}{2}[$  be isotopic to  $L_1$  and  $L_2^+ \in \Sigma_{g,n}^{\circ} \times ]\frac{1}{2}, 1]$  be isotopic to  $L_2$ . The stack product of  $L_1$  and  $L_2$  is  $L_1 * L_2 = L_1^- \cup L_2^+ \in \mathcal{R}_{g,n}^{\text{OC}}$ . We extend the stack product bilinearly to  $\mathcal{CR}_{g,n}^{\text{OC}}$ .*

*Example 6.2.6.* In Figure 6.6, we compute the value of  $W$  on the stack product  $a * b$ . We get that the Wilson loop around the stack product of the two links is the product of the Wilson loops around each of these links:  $W(a * b) = W(a)W(b)$ . This is a general fact, as we shall see now.  $\triangle$

**Theorem 6.2.7.** *The map  $W : \mathcal{CR}_{g,n}^{\text{OC}} \rightarrow \mathcal{L}_{g,n}(H)$  is a morphism of algebras:*

$$W(L_1 * L_2) = W(L_1)W(L_2).$$

*Proof.* The proof is purely diagrammatic. For instance, the proof for  $g = 1, n = 0$  is depicted in Figure 6.7. We used the definition of  $W$  (Figure 6.3), the fusion relation (6.9), the exchange relation (6.14) and obvious topological simplifications. The proof for the general case is similar: use the

definition of  $W$ , then use the fusion relation and simplify the diagram, and finally use the exchange relations and simplify the diagram. As explained in the proof of Proposition 6.2.3, we can assume that all the strands are positively oriented when they go through the handles and that there is only one strand in each handle.  $\square$

Finally, we show that the Wilson loop around a simple closed curve (simple loop or oriented circle<sup>1</sup>) is simply the quantum trace of its holonomy. We restrict to  $\Sigma_g^\circ$ , where  $\Sigma_g = \Sigma_{g,0}$ ; however, Proposition 6.2.9 and its corollaries are undoubtedly true for  $\Sigma_{g,n}^\circ$ .

An oriented circle  $\gamma \subset \Sigma_g^\circ$  can be seen as an oriented framed link lying in  $\Sigma_g^\circ \times \{0\}$  and thus  $W(\gamma)$  makes sense. Let  $x \in \pi_1(\Sigma_g^\circ)$  be a simple loop colored by some  $H$ -module  $I$  and let  $[x]$  be its free homotopy class. We define

$$W(x) = W([x])$$

Recall the lift  $\overset{I}{\widetilde{x}}$  of a simple loop  $x$  from Definition 5.3.7 (express  $x$  in terms of the generators  $b_i, a_i$  of  $\pi_1(\Sigma_g^\circ)$  and replace the loops  $b_i, a_i$  by the matrices  $\overset{I}{B}(i), \overset{I}{A}(i)$  up to the normalization  $\overset{I}{v}^{N(x)}$ , where  $N(x)$  is defined in section 5.3.2) and the lift  $\widetilde{f}$  of a homeomorphism  $f \in \text{MCG}(\Sigma_g^\circ)$  from Definition 5.3.9 (it satisfies  $\widetilde{f}(\overset{I}{\widetilde{x}}) = \overset{I}{\widetilde{f(x)}}$  for any simple loop  $x \in \pi_1(\Sigma_g^\circ)$ ).

**Lemma 6.2.8.** *Let  $f \in \text{MCG}(\Sigma_g^\circ)$  and let  $\gamma \subset \Sigma_g^\circ \times \{0\}$  be an oriented circle (colored by a  $H$ -module), then*

$$W(f(\gamma)) = \widetilde{f}(W(\gamma)).$$

*Proof.* We can assume that  $f$  is one of the Humphries generators. The proof is purely diagrammatic. Let  $I$  be the color of  $\gamma$ . We represent  $\gamma$  by a tangle  $T$  which does not contain crossings. As explained in the proof of Proposition 6.2.3, we can assume that all the strands are positively oriented when they go through the handles and that there is only one strand in each handle. Here since there is just one color, a strand going through a handle will be colored by  $I(\epsilon) = I^{\epsilon_1} \otimes \dots \otimes I^{\epsilon_k}$ , where  $\epsilon = (\epsilon_1, \dots, \epsilon_k)$  is a sequence of  $\pm$  signs and  $I^+ = I, I^- = I^*$ . Now, if  $f = \tau_{a_1}$ , we can restrict to  $\Sigma_1^\circ$  and we perform the graphical computation represented in Figure 6.8. We used the fusion relation and the reflection equation (6.11). The equalities for the others Humphries generators are shown similarly (but the diagrammatic computations are more cumbersome): for  $\tau_{b_i}$  we can also restrict to  $\Sigma_1^\circ$  and for  $\tau_{d_i}, \tau_{e_2}$  we can restrict to  $\Sigma_2^\circ$ .  $\square$

**Proposition 6.2.9.** *Let  $x \in \pi_1(\Sigma_g^\circ)$  be a simple loop colored by a  $H$ -module  $I$ , then*

$$W(x) = \text{tr}_q(\overset{I}{\widetilde{x}}).$$

*Proof.* Assume first that  $x$  is positively oriented (recall Definition 5.3.1). Then by Lemma 5.3.11 there exists a homeomorphism  $f$  such that  $x = f(y)$  where  $y$  is either  $a_1$  or  $s_1 \dots$  or  $s_g$  (recall (5.16)). One can check by direct computation that the result is true for these particular loops. Note that  $[f(y)] = f([y])$  and hence, due to Lemmas 6.2.8 and 5.3.10, we get:

$$W(x) = W(f(y)) = \widetilde{f}(W(y)) = \widetilde{f}\left(\text{tr}_q(\overset{I}{\widetilde{y}})\right) = \text{tr}_q\left(\widetilde{f}(\overset{I}{\widetilde{y}})\right) = \text{tr}_q(\overset{I}{\widetilde{f(y)}}) = \text{tr}_q(\overset{I}{\widetilde{x}}).$$

Assume now that  $x$  is negatively oriented. Thanks to Proposition 6.2.4, we have  $W(x) = W((x^{-1})^*)$  where  $(x^{-1})^*$  is  $x^{-1}$  colored by  $I^*$ . Moreover, since  $x^{-1}$  is positively oriented, we have a morphism

$j_{x^{-1}} : \mathcal{L}_{0,1}(H) \rightarrow \mathcal{L}_{g,0}(H)$  defined by  $\overset{J}{M} \mapsto \overset{J}{x^{-1}}$  (see (5.7)). Hence applying  $j_{x^{-1}}$  to (6.13) yields

<sup>1</sup>Recall that according to the terminology fixed in section 5.3.1, a circle is a simple closed curve up to free homotopy (not necessarily oriented, unless stated) while a loop (element of the fundamental group) is a based oriented curve up to fixed-basepoint homotopy (not necessarily simple, unless stated).

$$L_1 * L_2 =$$

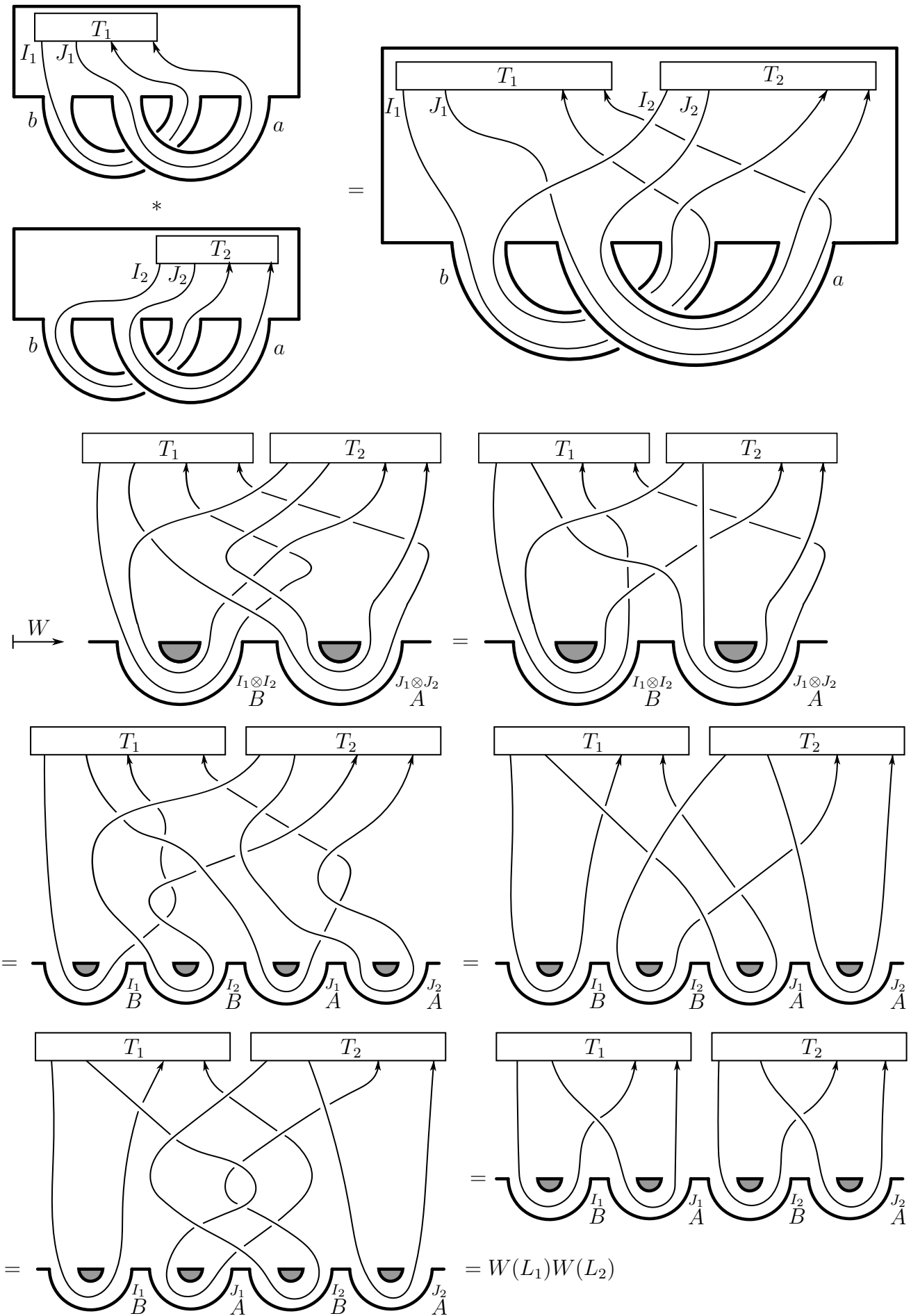
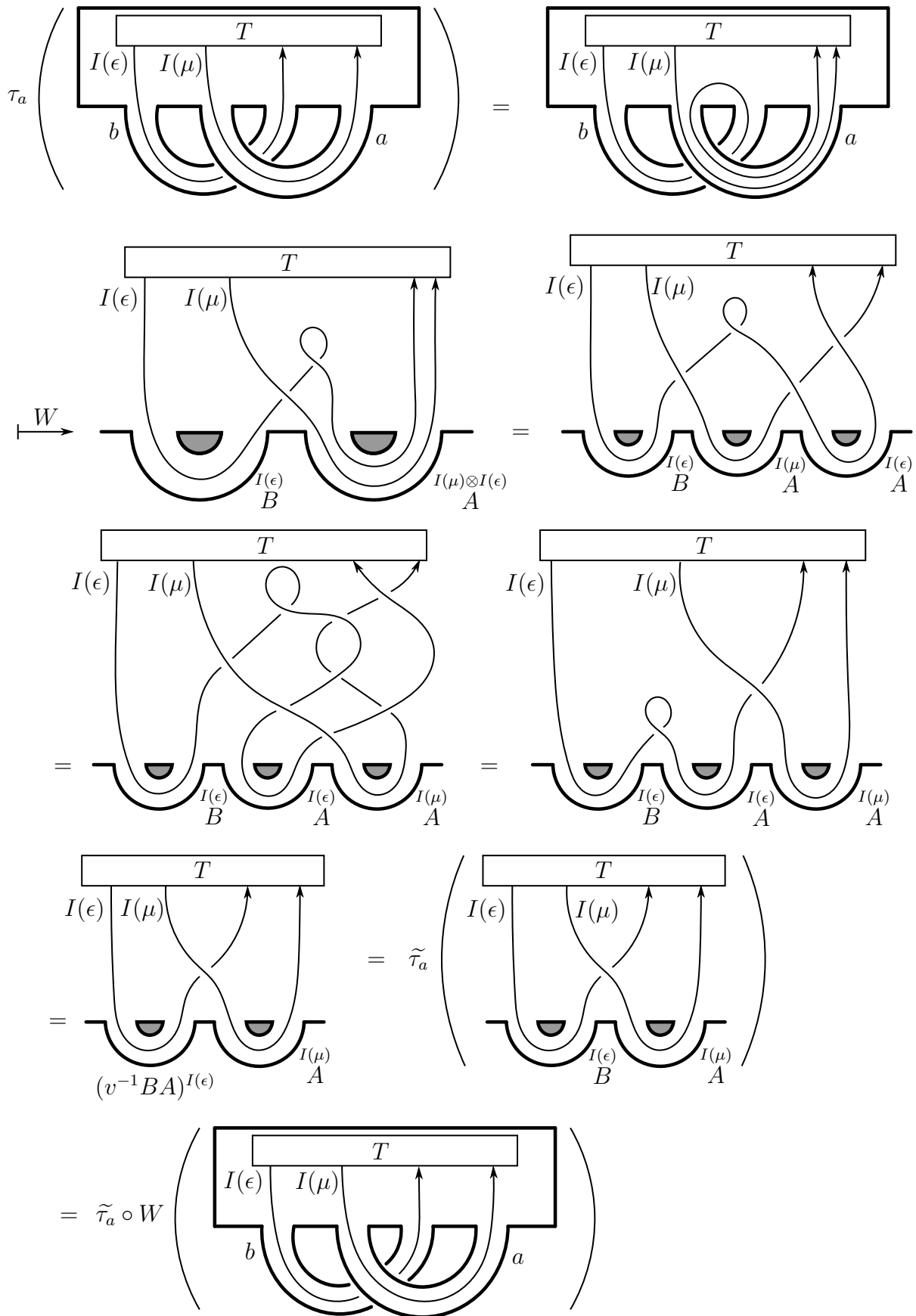

Figure 6.7: Compatibility of  $W$  with the stack product.

Figure 6.8: Proof of the equality  $W \circ \tau_a(\gamma) = \tilde{\tau}_a \circ W(\gamma)$ .



$\mathrm{tr}_q\left(\widetilde{x^{-1}}^{I^*}\right) = \mathrm{tr}_q\left(\widetilde{(x^{-1})^{-1}}^I\right)$ . Thus, using the formula just established for positively oriented circles and the definition of the lift of a negatively oriented loop, we get

$$W(x) = W((x^{-1})^*) = \mathrm{tr}_q\left(\widetilde{x^{-1}}^{I^*}\right) = \mathrm{tr}_q\left(\widetilde{(x^{-1})^{-1}}^I\right) = \mathrm{tr}_q(\widetilde{x}^I),$$

as desired.  $\square$

*Remark 6.2.10.* The second part of the above proof (and more precisely the formula (6.13)) reveals why we have been forced to distinguish the positively oriented case from the negatively oriented case when we have defined the lift of a simple loop (Definition 5.3.7). Indeed, if we use the same formula to define the lifts of the positively oriented simple loops and the negatively oriented simple loops, then we get that the lift of  $a_1^{-1}$  (for instance) is  $\overset{I}{v}A(1)^{-1}$ ; but  $W(a_1^{-1}) = \mathrm{tr}_q(\overset{I}{A}(1)^{-1})$  and thus with this definition  $W(a_1^{-1})$  would not have been the trace of the holonomy of  $a_1^{-1}$ .  $\triangle$

**Corollary 6.2.11.** *If  $x, y \in \pi_1(\Sigma_{g,0}^\circ)$  are simple loops colored by a  $H$ -module  $I$  and such that  $[x] = [y]$ , it holds:*

$$\mathrm{tr}_q(\widetilde{x}^I) = \mathrm{tr}_q(\widetilde{y}^I).$$

*Proof.*  $\mathrm{tr}_q(\widetilde{x}^I) = W(x) = W([x]) = W([y]) = W(y) = \mathrm{tr}_q(\widetilde{y}^I)$ .  $\square$

**Corollary 6.2.12.** *Let  $\gamma \subset \Sigma_{g,0}^\circ \times \{0\}$  be an oriented circle colored by a  $H$ -module  $I$ , then*

$$W(\gamma) = \mathrm{tr}_q(\widetilde{\gamma}^I).$$

Here  $\widetilde{\gamma}^I$  is a lift of  $\gamma$ , defined by  $\widetilde{\gamma}^I = \widetilde{y}^I$ , where  $y \in \pi_1(\Sigma_g^\circ)$  is a simple loop such that  $[y] = \gamma$ .

To conclude this section we mention that, thanks to Corollary 6.2.11, different choices of basepoints on an oriented circle imply equalities between traces. For instance in  $\mathcal{L}_{1,0}(H)$ , the equality

$$\mathrm{tr}_q(\overset{I}{v}B^{-1}\overset{I}{A}) = \mathrm{tr}_q(\overset{I}{v}^{-1}\overset{I}{A}B^{-1})$$

follows from choosing two basepoints on the circle  $[b^{-1}a] = [ab^{-1}]$ , which are depicted at the top of Figure 6.9. Reversing the orientation, we similarly obtain  $\mathrm{tr}_q(\overset{I}{v}B\overset{I}{A}^{-1}) = \mathrm{tr}_q(\overset{I}{v}^{-1}\overset{I}{A}^{-1}B)$ . In contrast,

$$\mathrm{tr}_q(\overset{I}{v}^m B\overset{I}{A}) \neq \mathrm{tr}_q(\overset{I}{v}^n A\overset{I}{B}).$$

for all  $m, n \in \mathbb{Z}$ . This is due to the fact that if we choose the basepoint numbered 2 on  $[ba]$  at the bottom Figure 6.9, we do not get a simple loop and the previous results do not apply. For instance, if  $H = \bar{U}_q(\mathfrak{sl}_2)$  and  $I = \mathcal{X}^+(2)$  (see Chapter 3),  $\overset{I}{v}$  is just a scalar and a computation reveals that

$$\mathrm{tr}_q(\overset{I}{A}\overset{I}{B}) = -qa_1a_2 - qb_1c_2 - q^{-1}c_1b_2 - q^{-1}d_1d_2$$

$$\mathrm{tr}_q(\overset{I}{B}\overset{I}{A}) = -a_1a_2 + (1 - q^{-2})a_1d_2 - q^2b_1c_2 - c_1b_2 + (1 - q^{-2})d_1a_2 + (-1 + q^{-2} - q^{-4})d_1d_2.$$

These two elements are not proportional since the monomials (4.34) are linearly independent. Hence such relations between traces in  $\mathcal{L}_{g,0}(H)$  follow from the geometry of simple closed curves on  $\Sigma_g^\circ$  and are not simply algebraic coincidences.

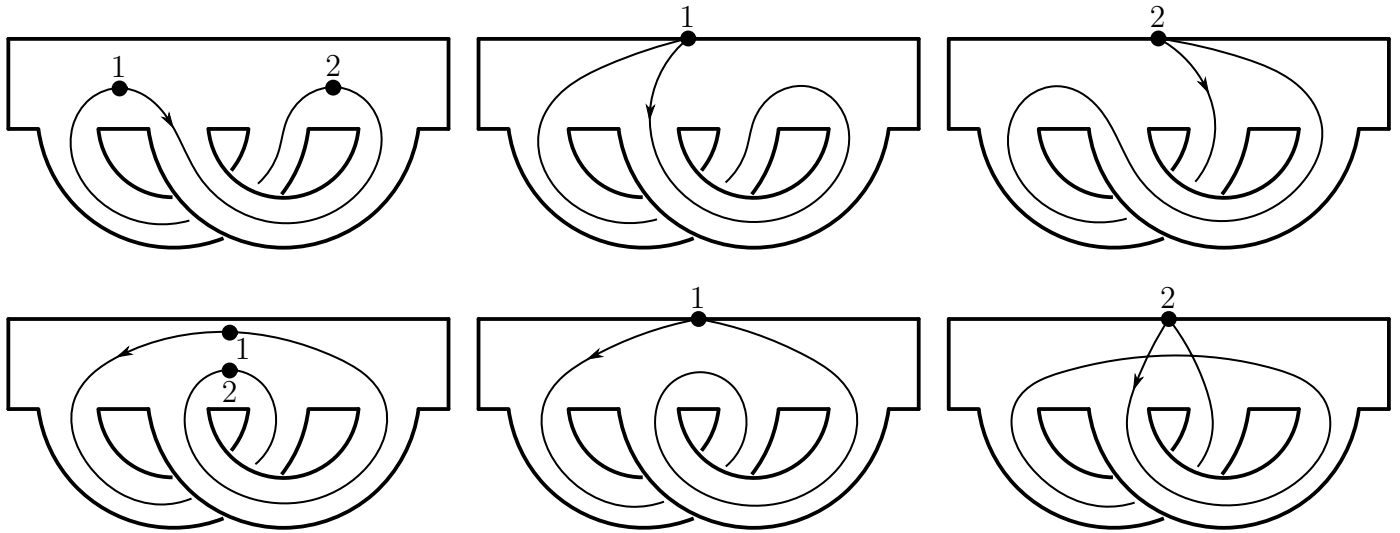
 Figure 6.9: Basepoints on the oriented circles  $[b^{-1}a]$  and  $[ba]$ .

### 6.3 Graphical calculus when $H = \bar{U}_q(\mathfrak{sl}_2)$

We take  $H = \bar{U}_q = \bar{U}_q(\mathfrak{sl}_2)$ . Moreover from now on, and otherwise indicated explicitly, *we assume that all the strands are colored by the fundamental representation  $\mathcal{X}^+(2)$ .*<sup>2</sup> In this case, the diagrammatic calculus (and *a fortiori* the Wilson loop map) explained in the previous sections satisfies the Jones skein relation:

$$q^{1/2} \begin{array}{c} \diagdown \\ \diagup \end{array} - q^{-1/2} \begin{array}{c} \diagup \\ \diagdown \end{array} = (q - q^{-1}) \begin{array}{c} \curvearrowright \\ \curvearrowleft \end{array} \quad (6.17)$$

This relation means that if  $d_+$ ,  $d_-$  and  $d_{||}$  are three diagrams which are equal except in a small disk  $D$ , such that  $d_+$  looks like a positive crossing in  $D$ ,  $d_-$  looks like a negative crossing in  $D$  and  $d_{||}$  looks like two vertical strands in  $D$ , then it holds  $q^{1/2}d_+ - q^{-1/2}d_- = \hat{q}d_{||}$ .

An important fact is that  $\mathcal{X}^+(2)$  is self-dual. Using this and the same kind of argument that in [KM91, Lem 3.18]<sup>3</sup>, we are going to show that the Wilson loop map  $W$  does not depend of the orientation of the link.

Let  $\{v_0, v_1\}$  be the canonical basis of  $\mathcal{X}^+(2)$  and  $\{v^0, v^1\}$  be its dual basis, then

$$\begin{aligned} D &: \mathcal{X}^+(2)^* \xrightarrow{\sim} \mathcal{X}^+(2) \\ &v^0 \mapsto -qv_1 \\ &v^1 \mapsto v_0 \end{aligned} \quad (6.18)$$

is an isomorphism of  $\bar{U}_q$ -modules. We denote  $e : \mathcal{X}^+(2)^{**} \xrightarrow{\sim} \mathcal{X}^+(2)$  the isomorphism with the bidual (see (2.38)).

**Lemma 6.3.1.** *It holds  $e \circ D^* = D$  and it follows that*

<sup>2</sup>Recall from section 3.1.3 that the  $R$ -matrix belongs to an extension of  $\bar{U}_q$  by a square root of  $K$ . In order to evaluate a crossing between two strands colored by  $\mathcal{X}^+(2)$ , we obviously define the action of  $K^{1/2}$  on  $\mathcal{X}^+(2) = \mathbb{C}v_0 \oplus \mathbb{C}v_1$  by  $K^{1/2}v_0 = q^{1/2}v_0$ ,  $K^{1/2}v_1 = q^{-1/2}v_1$ .

<sup>3</sup>Be aware that the algebra  $\mathbf{U}_q$  of [KM91] is not exactly  $\bar{U}_q$  since their  $K$  is a square root of our  $K$ , and that they choose  $g = K^2$  for the pivotal element ( $K$  in our notations). This choice of  $g$  changes some signs between their formulas and ours, see for instance [KM91, Th 4.3].

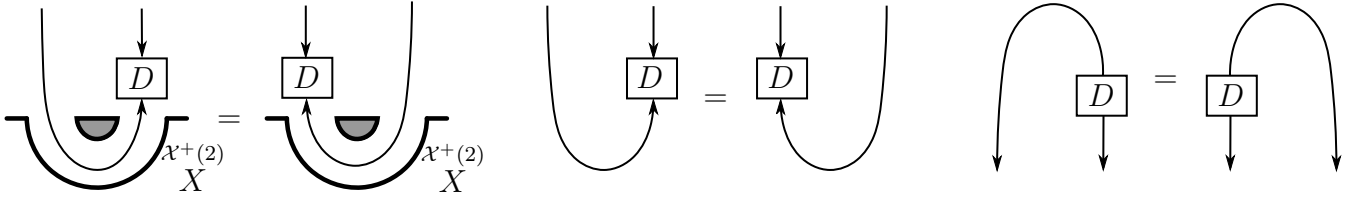

*Proof.* One checks easily that

$$D^*(v^0) = \langle ?, v_1 \rangle, \quad D^*(v^1) = -q \langle ?, v_0 \rangle.$$

Hence  $e \circ D^*(v^0) = e(\langle ?, v_1 \rangle) = K^{p-1}v_1 = -qv_1 = D(v^0)$  and similarly for  $v^1$ . Using this and (6.4), we get:

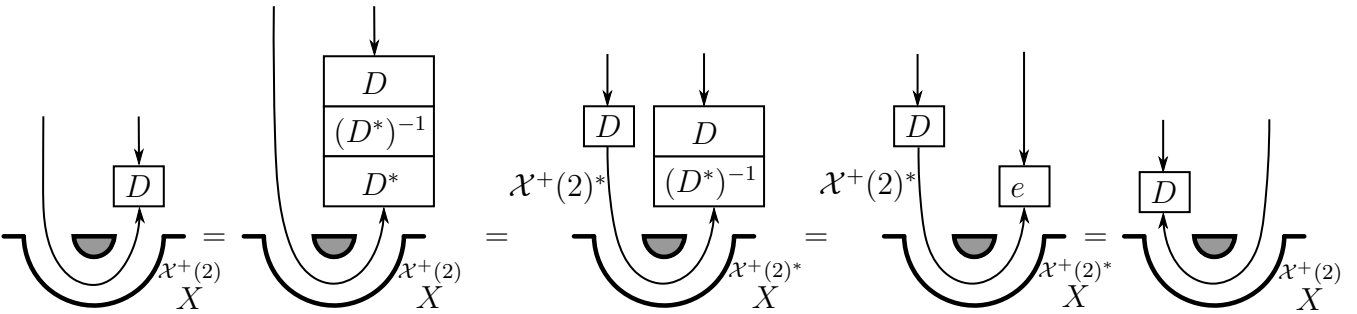

and the proofs of the others equalities are similar. □

*Remark 6.3.2.* If we choose  $K$  instead of  $K^{p+1}$  for the pivotal element  $g$  of  $\bar{U}_q$ , then a minus sign appears in the equalities of Lemma 6.3.1. In this case, the value of  $W(L)$  may depend of the orientation of  $L$  up to a sign. △

**Corollary 6.3.3.** *When  $H = \bar{U}_q$ ,  $g = K^{p+1}$  and all the strands of  $L$  are colored by  $\mathcal{X}^+(2)$ ,  $W(L)$  does not depend of the orientation of the strands of  $L$ .*

*Proof.* We can assume that  $L$  simply contains one connected component. Apply  $W$  to  $L$ . Then in the diagram representing  $W(L)$ , introduce two coupons  $D$  and  $D^{-1}$  in the strand, according to the orientation of  $L$ . Between these coupons, the orientation of the strand is reversed. Using the previous lemma, we move  $D$  along  $L$ : at each time it passes through a cup, a cap or a crossing, it changes the orientation. At the end, the coupon  $D$  arrives on the other side of  $D^{-1}$  and they both collapse, leaving  $W(L)$  with the opposite orientation. See the figure above, where we have introduced  $D$  and  $D^{-1}$  near a cap in  $W(L)$ .

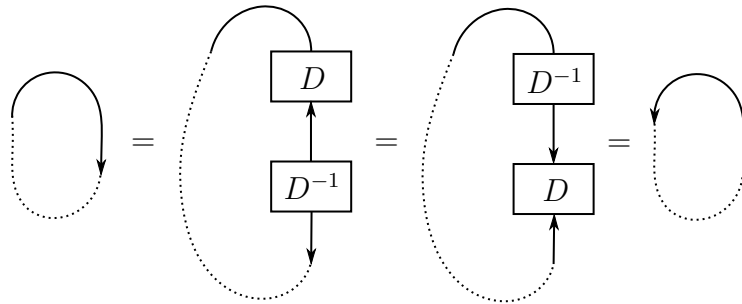

□

Hence, we can define the value of  $W$  on a non-oriented link: this is just the value of  $W$  on  $L$  with an arbitrary orientation (and colored by  $\mathcal{X}^+(2)$ ). Equivalently, we can define directly a non-oriented diagrammatic calculus for  $\mathcal{L}_{g,n}(\bar{U}_q)$ , with unoriented cups, caps, crossings and handles:

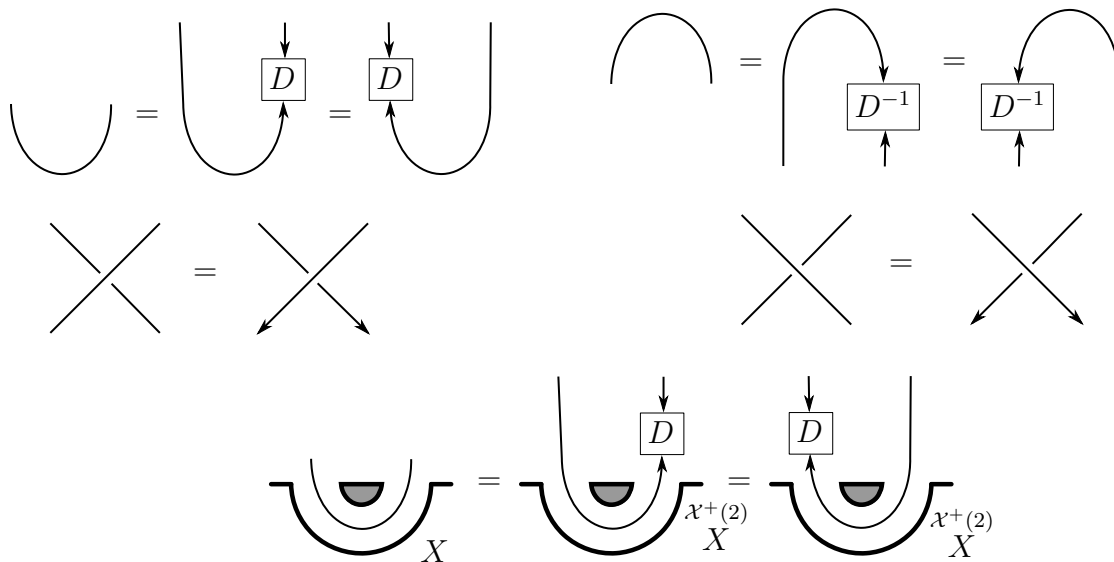

Note that until now we simply write  $X$  for the matrices  $X^{x^{+(2)}}$  labelling the handles. As in section 4.4.2, we denote by  $a, b, c, d$  the coefficients of the matrix  $M$ , which generate  $\mathcal{L}_{0,1}(\bar{U}_q)$ :

$$M = \begin{pmatrix} a & b \\ c & d \end{pmatrix} \in \text{Mat}_2(\mathcal{L}_{0,1}(\bar{U}_q)).$$

The explicit values of the unoriented graphical elements are:

$$\begin{aligned} \cup(1) &= v_1 \otimes v_0 - q v_0 \otimes v_1, & \cap(v_0 \otimes v_0) &= 0, & \cap(v_0 \otimes v_1) &= 1, \\ & & \cap(v_1 \otimes v_0) &= -q^{-1}, & \cap(v_1 \otimes v_1) &= 0, \\ \text{Crossing} &= q^{-1/2} \begin{pmatrix} q & 0 & 0 & 0 \\ 0 & 0 & 1 & 0 \\ 0 & 1 & \hat{q} & 0 \\ 0 & 0 & 0 & q \end{pmatrix}, & \text{Crossing} &= q^{1/2} \begin{pmatrix} q^{-1} & 0 & 0 & 0 \\ 0 & -\hat{q} & 1 & 0 \\ 0 & 1 & 0 & 0 \\ 0 & 0 & 0 & q^{-1} \end{pmatrix}, \\ \text{Handle } M &= -qa v_0 \otimes v_1 + b v_0 \otimes v_0 - qc v_1 \otimes v_1 + d v_1 \otimes v_0. \end{aligned}$$

A simple computation yields the Kauffman skein relation:

$$\text{Crossing} = q^{1/2} \left( \text{Crossing} \right) + q^{-1/2} \left( \text{Crossing} \right) \tag{6.19}$$

Alternatively, one can derive this relation from the Jones skein relation (6.17) and the independence of the orientation. Relation (6.19) means that if  $d_+, d_{||}$  and  $d_=-$  are three diagrams which are equal except in a small disk  $D$ , such that  $d_+$  looks like a positive crossing in  $D$ ,  $d_{||}$  looks like two vertical strands in  $D$  and  $d_=-$  looks like two horizontal strands in  $D$ , it holds  $d_+ = q^{1/2}d_{||} + q^{-1/2}d_=-$ . It is also useful to record the relation for negative crossings, for twists and for contractible circles:

$$\begin{aligned} \text{Crossing} &= q^{-1/2} \left( \text{Crossing} \right) + q^{1/2} \left( \text{Crossing} \right), \\ \text{Twist} &= -q^{3/2} \left( \text{Twist} \right), & \text{Twist} &= -q^{-3/2} \left( \text{Twist} \right), & \text{Circle} &= -[2] \emptyset \end{aligned}$$

where  $\emptyset$  is the empty diagram. The Kauffman skein relation allows us to resolve all the crossings in the diagrammatic calculus and is very useful to derive identities in  $\mathcal{L}_{g,n}(\bar{U}_q)$ , like the following proposition.

**Proposition 6.3.4.** *It holds:*

$$M^2 + q^{-1}W_M M + q^{-2}\mathbb{I}_2 = 0$$

where we recall that  $W_M = \text{tr}_q(M) = \text{tr}(K^{\mathcal{X}^+(2)} M)$  and  $\mathbb{I}_2$  is the  $2 \times 2$  identity matrix. We call this relation the quantum Cayley-Hamilton identity.

*Proof.* Using (6.12) and the Kauffman skein relation, we get:

which means that  $M^{-1} = -q^2 M - q W_M \mathbb{I}_2$ . The desired identity immediately follows.  $\square$

The proof of the previous proposition also shows that  $M^{-1} = \begin{pmatrix} d & -q^2 b \\ -q^2 c & q^2 a - q \hat{q} d \end{pmatrix}$ . Moreover, it is easy to show by induction that

$$M^n = (-1)^{n+1} q^{-n+1} R_n(W_M) M + (-1)^{n+1} q^{-n} R_{n-1}(W_M) \mathbb{I}_2 \quad (6.20)$$

where the polynomials  $R_n$  are defined by  $R_0(X) = 0$ ,  $R_1(X) = 1$  and  $R_{n+1}(X) = X R_n(X) - R_{n-1}(X)$  for  $n \geq 1$  (Chebychev polynomials of the second kind).

We now focus on  $\Sigma_{1,0}^\circ$ , and we want to prove the following proposition. In fact, it follows from the property that  $\mathcal{S}_q(\Sigma_1)$  is generated by the isotopy classes  $[b], [a]$ . However, we want to show it on the  $\mathcal{L}_{1,0}(\bar{U}_q)$  side, with the graphical calculus. Moreover, enhancing slightly the proof of Lemma 6.3.7, we can show a more general result: if  $X$  is any product of  $B^{\pm 1}, A^{\pm 1}$ , then  $W_X \in \langle W_A, W_B \rangle$ .

**Proposition 6.3.5.** *For any framed link  $L \subset \Sigma_{1,0}^\circ \times [0, 1]$  (whose all strands are colored by  $\mathcal{X}^+(2)$ ), we have  $W(L) \in \mathbb{C}\langle W_A, W_B \rangle$ . In other words, every  $W(L)$  can be written as a (non-commutative) polynomial in  $W_A$  and  $W_B$ .*

We need two lemmas.

**Lemma 6.3.6.** *We have:*

1.  $AW_A = W_A A$ ,  $BW_B = W_B B$ ,  $BAW_{BA} = W_{BA} BA$ ,
2.  $AW_B = q^{-1}W_B A - q \hat{q} BA$ ,
3.  $BW_A = qW_A B + q^2 \hat{q} BA$ ,
4.  $BAW_A = q^{-1}W_A BA - q^{-2} \hat{q} B$ ,
5.  $BAW_B = qW_B BA + q^{-1} \hat{q} A$ ,
6.  $W_{BA} = q^{-2} \hat{q}^{-1} W_B W_A - q^{-1} \hat{q}^{-1} W_A W_B$  (in particular,  $W_{BA} \in \mathbb{C}\langle W_A, W_B \rangle$ ).

It follows that, if  $P \in \mathbb{C}\langle x_1, x_2 \rangle$  is a (non-commutative) polynomial, then there exist  $Q, R, S \in \mathbb{C}\langle x_1, x_2 \rangle$  such that:

$$BP(W_A, W_B) = Q(W_A, W_B)A + R(W_A, W_B)B + S(W_A, W_B)BA.$$

This is also true if we replace  $B$  by  $A$  or  $BA$  but we will not need it.

*Proof.* Since  $W_M$  is central in  $\mathcal{L}_{0,1}(H)$ , we have  $MW_M = W_MM$ . But  $A, B$  and<sup>4</sup>  $v^{-1}BA = -q^{3/2}BA$  satisfy the fusion relation of  $\mathcal{L}_{0,1}(H)$ , thus we can apply the morphisms  $j_A, j_B, j_{v^{-1}BA}$  defined by  $j_A(M) = A, j_B(M) = B, j_{v^{-1}BA}(M) = v^{-1}BA$  and we get the three equalities of 1. Next, using the exchange relation between  $A$  and  $B$  (6.14), we prove relations 2 and 3 diagrammatically, see Figures 6.10 and 6.11. Relations 4 and 5 are immediate consequences. For instance:

$$BAW_A = BW_AA = qW_ABA + q^2\hat{q}BA^2 = qW_ABA - q\hat{q}BAW_A - \hat{q}B = qW_ABA - q^2BAW_A + BAW_A - \hat{q}B.$$

We used the quantum Cayley-Hamilton identity. It follows that  $0 = qW_ABA - q^2BAW_A - \hat{q}B$ ,

$$\begin{aligned} AW_B &= \text{diagram 1} = \text{diagram 2} = \text{diagram 3} \\ &= q^{1/2} \text{diagram 4} + q^{-1/2} \text{diagram 5} \\ &= -q^2 \text{diagram 6} + q^{-1} \text{diagram 7} + \text{diagram 8} \\ &= q^{-1}W_BA - q\hat{q}BA \end{aligned}$$

Figure 6.10: Proof of relation 2.

$$\begin{aligned} W_AB &= \text{diagram 1} = \text{diagram 2} = \text{diagram 3} \\ &= q^{1/2} \text{diagram 4} + q^{-1/2} \text{diagram 5} \\ &= -q^2 \text{diagram 6} + q^{-1} \text{diagram 7} + \text{diagram 8} \\ &= -q\hat{q}BA + q^{-1}BW_A \end{aligned}$$

Figure 6.11: Proof of relation 3.

as desired. To show relation 6, simply apply  $\text{tr}_q$  to relation 2. For the second part of the lemma,

<sup>4</sup>Recall that in this section, all is evaluated in  $\mathcal{X}^+(2)$  and thus  $v$  is identified with the scalar  $-q^{-3/2}$ , by (3.18).

we observe that it is a consequence of a more general fact, namely: if  $P \in \mathbb{C}\langle x_1, x_2 \rangle$  is a (non-commutative) polynomial, then there exist  $Q_i, R_i, S_i \in \mathbb{C}\langle x_1, x_2 \rangle$ ,  $i = 1, 2, 3$ , such that:

$$\begin{aligned} AP(W_A, W_B) &= Q_1(W_A, W_B)A + R_1(W_A, W_B)B + S_1(W_A, W_B)BA, \\ BP(W_A, W_B) &= Q_2(W_A, W_B)A + R_2(W_A, W_B)B + S_2(W_A, W_B)BA, \\ BAP(W_A, W_B) &= Q_3(W_A, W_B)A + R_3(W_A, W_B)B + S_3(W_A, W_B)BA. \end{aligned}$$

Indeed, we can assume that  $P$  is a monomial and show this set of three equalities by induction on the length of  $P$  (for instance,  $P = x_1x_2x_1^2$  has length 4) thanks to the previous commutation relations.  $\square$

**Lemma 6.3.7.** *For any a framed link  $L \subset \Sigma_{1,0}^\circ \times [0, 1]$  (whose all strands are colored by  $\mathcal{X}^+(2)$ ),  $W(L)$  is a linear combination of elements of the form*

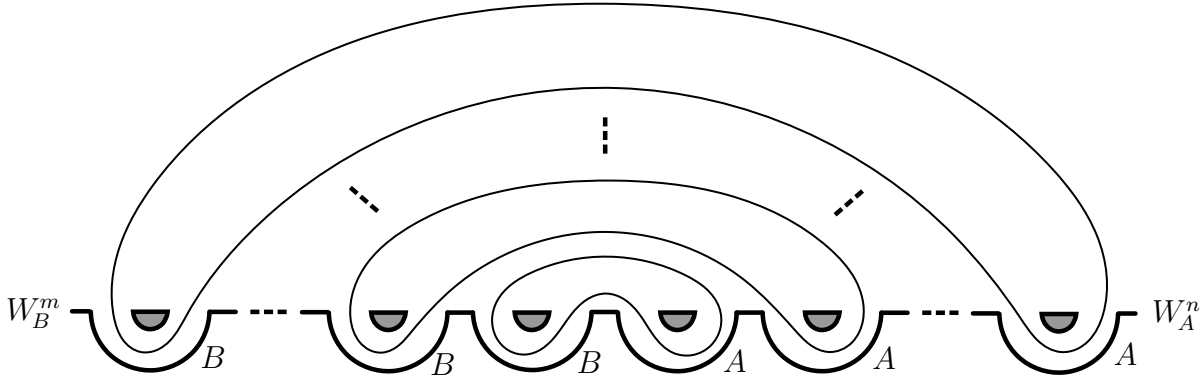

namely  $W_B^m \text{tr}_q(B \dots \text{tr}_q(B \text{tr}_q(BA)A) \dots A) W_A^n$ .

*Proof.* Apply the fusion relation to the two handles ( $B$  and  $A$ ) of  $W(L)$ . Then resolve all the crossings with the Kauffman relation. We get a diagram without crossings, with a lot of handles labelled  $B$  which contain only one strand at the left and a lot of handles labelled  $A$  which contain only one strand at the right. In general, after this transformation, the diagram will contain pieces which for instance look like

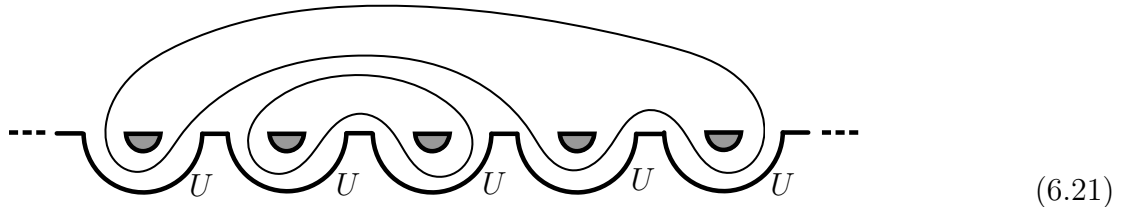

where  $U$  is  $B$  or  $A$ . But these elements can be transformed in a polynomial in  $W_U$  thanks to (6.20). For instance, with the piece of diagram below:

$$\begin{aligned} \text{tr}_q(U \text{tr}_q(U^2)U^2) &= \text{tr}_q(U \text{tr}_q(-q^{-1}W_U U - q^{-2}\mathbb{I}_2)U^2) = (-q^{-1}W_U^2 + q^{-2}\hat{q})\text{tr}_q(U^3) \\ &= (-q^{-1}W_U^2 + q^{-2}\hat{q})\text{tr}_q(q^{-2}(W_U^2 - 1)U + q^{-3}W_U \mathbb{I}_2) \\ &= (-q^{-1}W_U^2 + q^{-2}\hat{q})(q^{-2}(W_U^2 - 1)W_U - \hat{q}q^{-3}W_U). \end{aligned}$$

Then, since  $W_U U = U W_U$ , we can drag the powers of  $W_B$  on the left and the powers of  $W_A$  on the right:

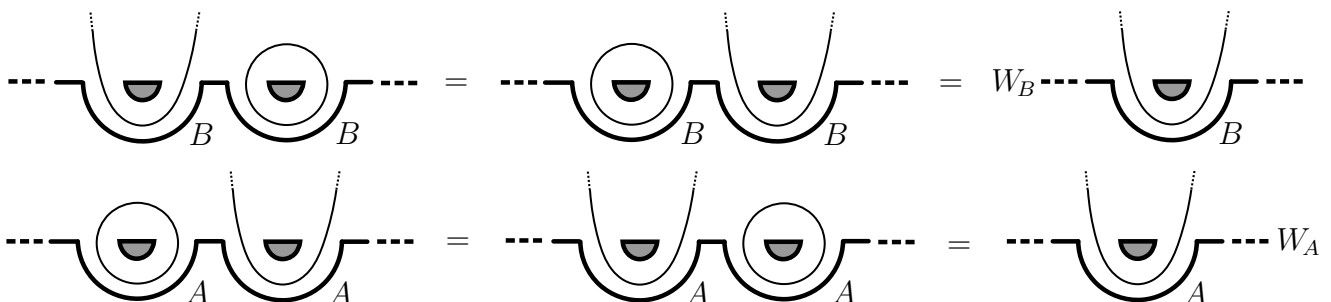





$g, n$ . Analogously to the representation of the mapping class group, we can glue back the disk  $D$  by passing to the invariants of the representation, and for  $n = 0$  we will see that this indeed provides a representation of  $\mathcal{S}_q(\Sigma_g)$  (the result is probably true for any  $\Sigma_{g,n}$ ).

Let  $j : \Sigma_g^\circ \rightarrow \Sigma_g$  be the canonical embedding and let  $j = j \times \text{id} : \Sigma_g^\circ \times [0, 1] \rightarrow \Sigma_g \times [0, 1]$  be the corresponding embedding. The corresponding map  $j : \mathcal{R}(\Sigma_g^\circ) \rightarrow \mathcal{R}(\Sigma_g)$  is surjective, as well as the corresponding morphism  $j : \mathcal{S}_q(\Sigma_g^\circ) \rightarrow \mathcal{S}_q(\Sigma_g)$ . If  $L \in \mathcal{S}_q(\Sigma_g)$ , we denote by  $L^\circ$  any element of  $\mathcal{S}_q(\Sigma_g^\circ)$  such that  $j(L^\circ) = L$ . Since  $j$  is a morphism, it holds  $(L_1 * L_2)^\circ = L_1^\circ * L_2^\circ$ .

**Theorem 6.4.1.** 1. Let  $\rho : \mathcal{L}_{g,n}(\bar{U}_q) \rightarrow \text{End}_{\mathbb{C}}(V)$  be a representation (with  $V = (\bar{U}_q^*)^{\otimes g} \otimes I_1 \otimes \dots \otimes I_n$ , where  $I_1, \dots, I_n$  are representations of  $\bar{U}_q$ ). The map

$$\begin{aligned} \mathcal{S}_q(\Sigma_{g,n}^\circ) &\rightarrow \text{End}_{\mathbb{C}}(V) \\ L &\mapsto \rho(W(L)) \end{aligned}$$

is a representation of  $\mathcal{S}_q(\Sigma_{g,n}^\circ)$ .

2. Assume  $n = 0$  and let  $\rho_{\text{inv}}$  be the representation of  $\mathcal{L}_{g,0}^{\text{inv}}(\bar{U}_q)$  on  $\text{Inv}((\bar{U}_q^*)^{\otimes g})$ . The map

$$\begin{aligned} \mathcal{S}_q(\Sigma_g) &\rightarrow \text{End}_{\mathbb{C}}(\text{Inv}((\bar{U}_q^*)^{\otimes g})) \\ L &\mapsto \rho_{\text{inv}}(W(L^\circ)) \end{aligned}$$

is well-defined and is a representation of  $\mathcal{S}_q(\Sigma_g)$ .

*Proof.* 1. is obvious.

2. Since  $j$  is a morphism, it holds  $(L_1 * L_2)^\circ = L_1^\circ * L_2^\circ$ . It remains to show that it is well-defined. Thanks to the Kauffman skein relation, we can assume that  $L$  is a simple closed curve in  $\Sigma_g \times \{0\}$ . Hence, since  $\pi_1(\Sigma_g) = \pi_1(\Sigma_g^\circ) / \langle c_{g,0} \rangle$  (where  $c_{g,0}$  is the boundary curve), it suffices to check that  $\rho_{\text{inv}}(W(\gamma)) = \rho_{\text{inv}}(W(\gamma_c))$ , where  $\gamma, \gamma_c \subset \Sigma_g^\circ \times \{0\}$  are the simple closed curves depicted below:



These pictures represent a neighborhood of the boundary (see Figure 5.4). Take a basepoint on each circle and endow it with the positive orientation as follows:



We get two positively oriented simple loops  $x, x_c = x^{-1}c_{g,0} \in \pi_1(\Sigma_g^\circ)$  such that  $[x] = \gamma, [x_c] = \gamma_c$ . It holds<sup>5</sup>  $\tilde{x}_c = \widetilde{x^{-1}C_{g,0}}$ , with  $C_{g,0} = \widetilde{c_{g,0}}$  (the lifts are implicitly considered in the fundamental representation  $\mathcal{X}^+(2)$ ). Indeed, to join the loops  $x^{-1}$  and  $c_{g,0}$  we must necessarily add a cap going from right to left and thus  $N(x_c) = N(x^{-1}) + N(c_{g,0}) - 1$  (see section 5.3.2). Moreover, due to (5.19) and (5.20),

$$N(x^{-1}) = N(\gamma^{-1}) = -N(\gamma) = -N(x) + 1.$$

This yields

$$\begin{aligned} \tilde{x}_c &= \text{ev}_{\mathcal{X}^+(2)}(v^{N(x^{-1}c_{g,0})}x^{-1}c_{g,0}) = \text{ev}_{\mathcal{X}^+(2)}(v^{N(x^{-1})+N(c_{g,0})-1}x^{-1}c_{g,0}) = \text{ev}_{\mathcal{X}^+(2)}(v^{-N(x)+N(c_{g,0})}x^{-1}c_{g,0}) \\ &= \text{ev}_{\mathcal{X}^+(2)}(v^{-N(x)}x^{-1})\text{ev}_{\mathcal{X}^+(2)}(v^{N(c_{g,0})}c_{g,0}) = \text{ev}_{\mathcal{X}^+(2)}(v^{N(x)}x)^{-1}\text{ev}_{\mathcal{X}^+(2)}(v^{N(c_{g,0})}c_{g,0}) = \widetilde{x^{-1}C_{g,0}} \end{aligned}$$

<sup>5</sup>In general it is of course not true that  $\widetilde{xy} = \widetilde{x}\widetilde{y}$ .

Hence, by Proposition 6.2.9 we have

$$\begin{aligned}\rho_{\text{inv}}(W(\gamma_c)) &= \rho_{\text{inv}}(W(x^{-1}c_{g,0})) = \rho_{\text{inv}}(\text{tr}_q(\widetilde{x^{-1}c_{g,0}})) = \rho_{\text{inv}}(\text{tr}_q(\widetilde{x^{-1}C_{g,0}})) = \rho_{\text{inv}}(\text{tr}_q(\widetilde{x^{-1}})) \\ &= \rho_{\text{inv}}(W(x^{-1})) = \rho_{\text{inv}}(W(x)) = \rho_{\text{inv}}(W(\gamma)).\end{aligned}$$

We used that  $\rho_{\text{inv}}(C_{g,0}) = \mathbb{I}_2$  (by definition) and that  $W$  does not depend of the basepoint (always true) nor of the orientation (when  $H = \bar{U}_q$ ).  $\square$

## 6.5 Explicit study of the representation of $\mathcal{S}_q(\Sigma_1)$

By Theorem 6.4.1, we have a representation of  $\mathcal{S}_q(\Sigma_1)$  on  $\text{Inv}(\bar{U}_q^*) = \text{SLF}(\bar{U}_q)$  and by Proposition 6.3.5,  $W(\mathcal{S}_q(\Sigma_1)) = \langle W_A, W_B \rangle$ . Hence, to study the representation of  $\mathcal{S}_q(\Sigma_1)$  on  $\text{SLF}(\bar{U}_q)$ , it suffices to study the action of the operators  $\rho_{\text{inv}}(W_A)$  and  $\rho_{\text{inv}}(W_B)$ . For this, we use again the GTA basis.

### 6.5.1 Structure of the representation

Recall that we denote by  $\triangleright$  the representation of  $\mathcal{L}_{1,0}(\bar{U}_q)$  on  $\bar{U}_q^*$ . Also recall the formulas (which are consequences of Proposition 4.2.14 and of (4.9)):

$$W_A \triangleright \varphi = -\hat{q}^2 \varphi^C, \quad W_B \triangleright \varphi = (\chi_2^+ \varphi^v)^{v^{-1}},$$

where  $\varphi^z = \varphi(z?)$  and

$$C = FE + \frac{qK + q^{-1}K^{-1}}{(q - q^{-1})^2} = \sum_{j=0}^p \frac{q^j + q^{-j}}{(q - q^{-1})^2} e_j + \sum_{k=1}^{p-1} (w_k^+ + w_k^-) \in \mathcal{Z}(\bar{U}_q)$$

is the Casimir element, with its decomposition in the canonical basis of the center (see Definition 3.1.3). We denote by

$$v_s = v_{\mathcal{X}^+(s)} = v_{\mathcal{X}^-(p-s)} = (-1)^{s-1} q^{\frac{-(s^2-1)}{2}} \quad (6.22)$$

the scalar corresponding to the action of  $v$  on the simple module  $\mathcal{X}^+(s)$  or  $\mathcal{X}^-(p-s)$ <sup>6</sup> ( $v_0$  being  $v_{\mathcal{X}^-(p)}$ ).

Let us compute the actions of  $W_A$  and  $W_B$  on the GTA basis. First, using the expression of  $C$  in the canonical basis of  $\mathcal{Z}(\bar{U}_q)$  above and the formulas (3.27) for the action of  $\mathcal{Z}(\bar{U}_q)$  on  $\text{SLF}(\bar{U}_q)$ , we get:

$$W_A \triangleright \chi_s^\epsilon = -\epsilon(q^s + q^{-s})\chi_s^\epsilon, \quad W_A \triangleright G_s = -(q^s + q^{-s})G_s - \hat{q}^2(\chi_s^+ + \chi_{p-s}^-). \quad (6.23)$$

To compute the action of  $W_B$ , we must use the multiplication rules in the GTA basis (Theorem 3.4.1), the expressions of  $v$  and  $v^{-1}$  in the canonical basis of  $\mathcal{Z}(\bar{U}_q)$  (3.17) and the the formulas (3.27) for the action of  $\mathcal{Z}(\bar{U}_q)$  on  $\text{SLF}(\bar{U}_q)$ . If  $1 < s < p$ :

$$W_B \triangleright \chi_s^\epsilon = v_{\mathcal{X}^\epsilon(s)} (\chi_2^+ \chi_s^+)^{v^{-1}} = v_{\mathcal{X}^\epsilon(s)} (\chi_{s-1}^\epsilon + \chi_{s+1}^\epsilon)^{v^{-1}} = \frac{v_{\mathcal{X}^\epsilon(s)}}{v_{\mathcal{X}^\epsilon(s-1)}} \chi_{s-1}^\epsilon + \frac{v_{\mathcal{X}^\epsilon(s)}}{v_{\mathcal{X}^\epsilon(s+1)}} \chi_{s+1}^\epsilon.$$

For  $s = 1$ :

$$W_B \triangleright \chi_1^\epsilon = v_{\mathcal{X}^\epsilon(1)} (\chi_2^+ \chi_1^\epsilon)^{v^{-1}} = v_{\mathcal{X}^\epsilon(1)} (\chi_2^\epsilon)^{v^{-1}} = \frac{v_{\mathcal{X}^\epsilon(1)}}{v_{\mathcal{X}^\epsilon(2)}} \chi_2^\epsilon.$$

And for  $s = p$ :

$$\begin{aligned}W_B \triangleright \chi_p^\epsilon &= v_{\mathcal{X}^\epsilon(p)} (\chi_2^+ \chi_p^\epsilon)^{v^{-1}} = v_{\mathcal{X}^\epsilon(p)} (2\chi_{p-1}^\epsilon + 2\chi_1^{-\epsilon})^{v^{-1}} = 2 \frac{v_{\mathcal{X}^\epsilon(p)}}{v_{\mathcal{X}^\epsilon(p-1)}} \chi_{p-1}^\epsilon + 2 \frac{v_{\mathcal{X}^\epsilon(p)}}{v_{\mathcal{X}^{-\epsilon}(1)}} \chi_1^{-\epsilon} \\ &= 2 \frac{v_{\mathcal{X}^\epsilon(p)}}{v_{\mathcal{X}^\epsilon(p-1)}} (\chi_{p-1}^\epsilon + \chi_1^{-\epsilon}),\end{aligned}$$

<sup>6</sup>The symmetry property expressed in the second equality of (6.22) is true for any central element of  $\bar{U}_q$ , see (3.11)

thanks to the (6.22).

Let

$$\mathcal{P} = \text{vect}(\chi_s^+ + \chi_{p-s}^-, \chi_p^\pm)_{1 \leq s \leq p-1} = \text{vect}(\chi^P)_{P \in \text{Proj}_{\bar{U}_q}}$$

be the subspace generated by the characters of the projective  $\bar{U}_q$ -modules. Introduce notation for the basis elements of  $\mathcal{P}$ :

$$X_0 = \chi_p^-, \quad X_s = \chi_s^+ + \chi_{p-s}^- \quad \text{for } 1 \leq s \leq p-1, \quad X_p = \chi_p^+.$$

The formulas above and (6.22) give

$$\begin{aligned} W_A \triangleright X_s &= -(q^s + q^{-s})X_s \quad \text{for } 0 \leq s \leq p, \\ W_B \triangleright X_0 &= 2 \frac{v_0}{v_1} X_1 = -2q^{\frac{1}{2}} X_1, \\ W_B \triangleright X_s &= \frac{v_s}{v_{s-1}} X_{s-1} + \frac{v_s}{v_{s+1}} X_{s+1} = -q^{-s+\frac{1}{2}} X_{s-1} - q^{s+\frac{1}{2}} X_{s+1} \quad \text{for } 1 \leq s \leq p-1. \\ W_B \triangleright X_p &= 2 \frac{v_p}{v_{p-1}} X_{p-1} = 2q^{\frac{1}{2}} X_{p-1}. \end{aligned}$$

In particular,  $\mathcal{P}$  is a submodule of  $\text{SLF}(\bar{U}_q)$  under the action of  $\mathcal{S}_q(\Sigma_1)$ .

Now we compute the action on  $G_s$ . First, note that

$$\begin{aligned} G_t^v &= v_t G_t + \hat{q} v_t \frac{p}{[t]} \chi_t^+ - \hat{q} v_t \frac{t}{[t]} X_t, \\ G_t^{v^{-1}} &= v_t^{-1} G_t - \hat{q} v_t^{-1} \frac{p}{[t]} \chi_t^+ + \hat{q} v_t^{-1} \frac{t}{[t]} X_t. \end{aligned}$$

Hence:

$$\begin{aligned} W_B \triangleright G_s &= (\chi_2^+ G_s^v)^{v^{-1}} = v_s (\chi_2^+ G_s)^{v^{-1}} + \hat{q} v_s \frac{p}{[s]} (\chi_2^+ \chi_s^+)^{v^{-1}} - \hat{q} v_s \frac{s}{[s]} (\chi_2^+ X_s)^{v^{-1}} \\ &= v_s \frac{[s-1]}{[s]} G_{s-1}^{v^{-1}} + v_s \frac{[s+1]}{[s]} G_{s+1}^{v^{-1}} + \hat{q} \frac{v_s}{v_{s-1}} \frac{p}{[s]} \chi_{s-1}^+ + \hat{q} \frac{v_s}{v_{s+1}} \frac{p}{[s]} \chi_{s+1}^+ - \hat{q} \frac{v_s}{v_{s-1}} \frac{s}{[s]} X_{s-1} - \hat{q} \frac{v_s}{v_{s+1}} \frac{s}{[s]} X_{s+1} \\ &= \frac{v_s}{v_{s-1}} \frac{[s-1]}{[s]} G_{s-1} + \frac{v_s}{v_{s+1}} \frac{[s+1]}{[s]} G_{s+1} - \hat{q} \frac{v_s}{v_{s-1}} \frac{p}{[s]} \chi_{s-1}^+ + \hat{q} \frac{v_s}{v_{s+1}} \frac{p}{[s]} \chi_{s+1}^+ - \hat{q} \frac{v_s}{v_{s-1}} \frac{s-1}{[s]} X_{s-1} - \hat{q} \frac{v_s}{v_{s+1}} \frac{s}{[s]} X_{s+1} \\ &\quad + \hat{q} \frac{v_s}{v_{s+1}} \frac{s+1}{[s]} X_{s+1} + \hat{q} \frac{v_s}{v_{s-1}} \frac{p}{[s]} \chi_{s-1}^+ + \hat{q} \frac{v_s}{v_{s+1}} \frac{p}{[s]} \chi_{s+1}^+ - \hat{q} \frac{v_s}{v_{s-1}} \frac{s}{[s]} X_{s-1} - \hat{q} \frac{v_s}{v_{s+1}} \frac{s}{[s]} X_{s+1} \\ &= \frac{v_s}{v_{s-1}} \frac{[s-1]}{[s]} G_{s-1} + \frac{v_s}{v_{s+1}} \frac{[s+1]}{[s]} G_{s+1} - \hat{q} \frac{v_s}{v_{s-1}} \frac{1}{[s]} X_{s-1} + \hat{q} \frac{v_s}{v_{s+1}} \frac{1}{[s]} X_{s+1} \\ &= -q^{-s+\frac{1}{2}} \frac{[s-1]}{[s]} G_{s-1} - q^{s+\frac{1}{2}} \frac{[s+1]}{[s]} G_{s+1} + \hat{q} q^{-s+\frac{1}{2}} \frac{1}{[s]} X_{s-1} - \hat{q} q^{s+\frac{1}{2}} \frac{1}{[s]} X_{s+1}. \end{aligned}$$

for all  $1 \leq s \leq p-1$  (with the convention that for  $s=1$  and  $s=p-1$  the undefined terms are 0).

Consider the following subspaces of  $\text{SLF}(\bar{U}_q)$ :

$$\mathcal{U} = \text{vect}(\chi_s^+)_{1 \leq s \leq p-1}, \quad \mathcal{V} = \text{vect}(G_s)_{1 \leq s \leq p-1}.$$

The formulas above reveal that the structure of  $\text{SLF}(\bar{U}_q)$  under the action of  $\mathcal{S}_q(\Sigma_1)$  has the following shape:

$$\begin{array}{ccc} \mathcal{U} & & \mathcal{V} \\ & \searrow^{W_B} & \swarrow_{W_A, W_B} \\ & \mathcal{P} & \end{array}$$

Let us check that this gives rise to a composition series:

$$J_1 = \mathcal{P} \subset J_2 = J_1 \oplus \mathcal{U} \subset J_3 = J_2 \oplus \mathcal{V} = \text{SLF}(\bar{U}_q).$$

**Lemma 6.5.1.** Recall Definition 3.1.3 and notation (4.14). Then  $(e_s)_A \in \mathbb{C}\langle W_A \rangle$  for all  $0 \leq s \leq p$  and  $(w_t^+ + w_t^-)_A \in \mathbb{C}\langle W_A \rangle$  for all  $1 \leq t \leq p-1$ ; in particular these elements belong to  $W(\mathcal{S}_q(\Sigma_1))$ .

*Proof.* Recall from (3.14) that the central elements  $e_s$  and  $w_t^+ + w_{p-t}^-$  belong to the subalgebra of  $\mathcal{Z}(\bar{U}_q)$  generated by the Casimir element  $C$ . Now, in (4.33), we computed that

$$W_M^{\chi^{+(2)}} = \text{tr}\left(K^{p+1} M\right) = -\hat{q}^2 C$$

with  $\hat{q} = q - q^{-1}$ , under the identification  $\Psi_{0,1}$  between  $\mathcal{L}_{0,1}(\bar{U}_q)$  and  $\bar{U}_q$ . It follows that the elements  $e_s, w_t^+ + w_t^-$  can be written as polynomials of  $W_M^{\chi^{+(2)}}$ . Hence, applying the morphism  $j_A : \mathcal{L}_{0,1}(\bar{U}_q) \rightarrow \mathcal{L}_{1,0}(\bar{U}_q)$  defined by  $\overset{I}{M} \mapsto \overset{I}{A}$ , we get that the elements  $(e_s)_A = j_A(e_s), (w_t^+ + w_t^-)_A = j_A(w_t^+ + w_t^-)$  can be written as polynomials in  $W_A = W_A^{\chi^{+(2)}} = j_A(W_M^{\chi^{+(2)}})$ .  $\square$

**Proposition 6.5.2.**  $J_1 \subset J_2 \subset J_3$  is a composition series of  $\text{SLF}(\bar{U}_q)$  under the action of  $\mathcal{S}_q(\Sigma_1)$ . More precisely, the structure of the representation is schematized by the following diagram:

$$\begin{array}{ccc} \mathcal{U} & & \mathcal{V} \\ & \searrow^{W_B} & \swarrow_{W_A, W_B} \\ & \mathcal{P} & \end{array}$$

Moreover, this representation is indecomposable.

*Proof.* We will use the element  $W(b^{-1}a) = W_{vB^{-1}A}$  which by Lemma 4.4.5 implements the multiplication by  $\chi_2^+$ :

$$W_{vB^{-1}A} \triangleright \varphi = \chi_2^+ \varphi.$$

•  $J_1$  is simple: Let  $0 \neq S \subset J_1$  be a submodule, and let  $0 \neq \psi = x_0 X_0 + \dots + x_p X_p \in S$ . Thanks to Lemma 6.5.1 we can use the elements  $(e_s)_A$ . Note that (3.27) gives  $(e_i)_A \triangleright X_j = \delta_{i,j} X_j$ , and thus

$$\forall 0 \leq j \leq p, \quad (e_j)_A \triangleright \psi = \psi(e_j) = x_j X_j \in S.$$

Since  $x \neq 0$  one of the  $x_j$ , say  $x_s$ , is not 0. Then  $X_s \in S$ , and using  $Y$  we get

$$\begin{aligned} (e_{s-1})_A W_{vB^{-1}A} \triangleright X_s &= (e_{s-1})_A \triangleright (X_{s-1} + X_{s+1}) = X_{s-1} \in S, \\ (e_{s+1})_A W_{vB^{-1}A} \triangleright X_s &= (e_{s+1})_A \triangleright (X_{s-1} + X_{s+1}) = X_{s+1} \in S. \end{aligned}$$

Continuing like this, we get step by step that all the  $X_j$ 's belong to  $S$ , and hence  $S = J_1$  as desired.

•  $J_2/J_1$  is simple: Let  $\bar{\chi}_s^+ = \chi_s^+ + J_1$  for  $1 \leq s \leq p-1$ ; these elements form a basis of  $J_2/J_1$ . We have

$$\begin{aligned} (e_i)_A \triangleright \bar{\chi}_j^+ &= \delta_{i,j} \bar{\chi}_j^+, \\ W_{vB^{-1}A} \triangleright \bar{\chi}_1^+ &= \bar{\chi}_2^+, \quad W_{vB^{-1}A} \triangleright \bar{\chi}_s^+ = \bar{\chi}_{s-1}^+ + \bar{\chi}_{s+1}^+ \text{ for } 2 \leq s \leq p-2, \quad W_{vB^{-1}A} \triangleright \bar{\chi}_{p-1}^+ = \bar{\chi}_{p-2}^+. \end{aligned}$$

The same reasoning as for  $J_1$  gives the result.

•  $J_3/J_2$  is simple: Let  $\bar{G}_s = G_s + J_2$  for  $1 \leq s \leq p-1$ ; these elements form a basis of  $J_3/J_2$ . We have

$$\begin{aligned} (e_i)_A \triangleright \bar{G}_j &= \delta_{i,j} \bar{G}_j, \\ W_{vB^{-1}A} \triangleright \bar{G}_1 &= [2] \bar{G}_2, \\ W_{vB^{-1}A} \triangleright \bar{G}_s &= \frac{[s-1]}{[s]} \bar{G}_{s-1} + \frac{[s+1]}{[s]} \bar{G}_{s+1} \text{ for } 2 \leq s \leq p-2, \\ W_{vB^{-1}A} \triangleright \bar{G}_{p-1} &= [2] \bar{G}_{p-2}. \end{aligned}$$

The same reasoning as for  $J_1$  gives the result.

For the last claim, write  $\text{SLF}(\bar{U}_q) = U_1 \oplus U_2$ . At least one of the two subspaces  $U_1$  or  $U_2$  contains an element of the form  $\varphi = G_1 + \sum_{i \neq 1} \lambda_i G_i + \sum_{j, \epsilon} \beta_j^\epsilon \chi_j^\epsilon$ . Assume for instance that it is  $U_1$ . Then, thanks to Lemma 6.5.1 we can use the elements  $(w_s^+ + w_s^-)_A$  and (3.27) yields

$$(w_1^+ + w_1^-)_A \triangleright \varphi = \varphi((w_1^+ + w_1^-)?) = G_1((w_1^+ + w_1^-)?) = \chi_1^+ + \chi_{p-1}^- \in \mathcal{P} \cap U_1.$$

It follows that  $\mathcal{P} \subset U_1$ . Now, let  $\psi = \sum_i \eta_i G_i + \sum_{j, \epsilon} \gamma_j^\epsilon \chi_j^\epsilon \in U_2$ ; then

$$\begin{aligned} \forall 1 \leq i \leq p-1, \quad (w_i^+ + w_i^-)_A \triangleright \psi &= \eta_i(\chi_i^+ + \chi_{p-i}^-) \in \mathcal{P} \cap U_2 = \{0\} \quad \text{and thus } \eta_i = 0, \\ \forall 0 \leq j \leq p, \quad (e_j)_A \triangleright \psi &= \eta_j G_j + \gamma_j^+ \chi_j^+ + \gamma_{p-j}^- \chi_{p-j}^- = \gamma_j^+ \chi_j^+ + \gamma_{p-j}^- \chi_{p-j}^- \in U_2 \end{aligned}$$

with the convention that  $\chi_0^+ = \chi_0^- = 0$ . Now for any  $j$ , we have

$$\begin{aligned} (e_{j-1})_A W_{vB^{-1}A} \triangleright (\gamma_j^+ \chi_j^+ + \gamma_{p-j}^- \chi_{p-j}^-) &= \gamma_j^+ \chi_{j-1}^+ + \gamma_{p-j}^- \chi_{p-j+1}^- \in U_2, \\ (e_{j+1})_A W_{vB^{-1}A} \triangleright (\gamma_j^+ \chi_j^+ + \gamma_{p-j}^- \chi_{p-j}^-) &= \gamma_j^+ \chi_{j+1}^+ + \gamma_{p-j}^- \chi_{p-j-1}^- \in U_2. \end{aligned}$$

Continuing as long as necessary to apply  $(e_{j \pm k})_A W_{vB^{-1}A}$ , we will get that  $\gamma_j^+ \chi_p^+, \gamma_j^- \chi_p^- \in U_2$ . But  $\chi_p^+, \chi_p^- \in \mathcal{P} \subset U_1$  and it follows that  $\gamma_j^+ = 0, \gamma_j^- = 0$ . Hence  $\psi = 0$  and  $U_2 = \{0\}$ , as desired.  $\square$

*Remark 6.5.3.* The first claim of Proposition 4.4.12 is a consequence of the previous proposition. Indeed,  $\text{SLF}(\bar{U}_q)$  is indecomposable under the action of  $W(\mathcal{S}_q(\Sigma_1)) = \mathbb{C}\langle W_A, W_B \rangle \subset \mathcal{L}_{1,0}^{\text{inv}}(\bar{U}_q)$ , and hence it is indecomposable under the action of the whole algebra  $\mathcal{L}_{1,0}^{\text{inv}}(\bar{U}_q)$ .

## 6.5.2 Relationship with the skein representation

Consider a handlebody  $H_g \subset \mathbb{R}^3$ , such that  $\partial H_g = \Sigma_g \subset \mathbb{R}^3$ , for instance  $H_g = \Sigma_{0,g+1} \times [0, 1]$ . Let  $d$  be the Euclidean distance on  $\mathbb{R}^3$ , let  $\varepsilon > 0$  and define

$$H_g^{\leq \varepsilon/2} = \left\{ x \in H_g \mid d(x, \partial H_g) \leq \frac{\varepsilon}{2} \right\}, \quad H_g^{\geq \varepsilon} = \left\{ x \in H_g \mid d(x, \partial H_g) \geq \varepsilon \right\}. \quad (6.24)$$

Take  $\varepsilon$  sufficiently small, so that  $H_g^{\leq \varepsilon/2}$  is diffeomorphic to  $\Sigma_g \times [0, 1]$  and  $H_g^{\geq \varepsilon}$  is diffeomorphic to  $H_g$ . This dichotomy gives a representation  $\rho$  of the skein algebra  $\mathcal{S}_q(\Sigma_g) = \mathcal{S}_q(H_g^{\leq \varepsilon/2})$  on the skein module  $\mathcal{S}_q(H_g) = \mathcal{S}_q(H_g^{\geq \varepsilon})$ , defined by:

$$\rho(L_1)(L_2) = \langle L_1 \cup L_2 \rangle, \quad (6.25)$$

where  $\langle L \rangle$  is the value of  $L$  in  $\mathcal{S}_q(H_g)$ . In practice, this just means that we put the link  $L_1 \subset \Sigma_g \times [0, 1]$  very close to  $\partial H_g$  and the link  $L_2 \subset H_g$  very close to the core of  $H_g$ .

Recall, for  $0 \leq n \leq p-1$  (where  $q^{2p} = 1$ ), the  $n$ -th Jones-Wenzl idempotent  $f_n$ . This is an element of the Temperley-Lieb algebra on  $n$  strands  $\text{TL}_{q,n} = \text{End}_{\bar{U}_q}(\mathcal{X}^+(2)^{\otimes n})$  (see *e.g.* [CFS95] and the references therein)<sup>7</sup>. The properties of these elements  $f_n$  are listed in Figure 6.12. Note that  $\mathcal{X}^+(2)^{\otimes n} \cong V \oplus \mathcal{X}^+(n+1)$ , where  $V$  does not contain  $\mathcal{X}^+(n+1)$  as a direct summand; then  $f_n \in \text{End}_{\bar{U}_q}(\mathcal{X}^+(2)^{\otimes n})$  is the unique (up to scalar) morphism which factorizes through  $\mathcal{X}^+(n+1)$ :  $\mathcal{X}^+(2)^{\otimes n} \rightarrow \mathcal{X}^+(n+1) \rightarrow \mathcal{X}^+(2)^{\otimes n}$ .

For each  $n$ , we have a closure map  $\text{cl} : \text{TL}_{q,n} \rightarrow \mathcal{S}_q(H_1)$  (note that  $H_1$  is a thickened annulus  $S^1 \times [0, 1] \times [0, 1]$ ):

$$\text{cl} \left( \begin{array}{c} \vdots \\ \vdots \\ \boxed{D} \\ \vdots \\ \vdots \end{array} \right) = \begin{array}{c} \bigcirc \\ \bigcirc \\ \bigcirc \end{array}$$

(n strands)

<sup>7</sup>Note that for  $n \geq p$  the identification between the Temperley-Lieb algebra on  $n$  strands and the centralizer of  $\bar{U}_q$  on  $\mathcal{X}^+(2)^{\otimes n}$  is not true: instead we have a *strict* embedding  $\text{TL}_{q,n} \hookrightarrow \text{End}_{\bar{U}_q}(\mathcal{X}^+(2)^{\otimes n})$ .

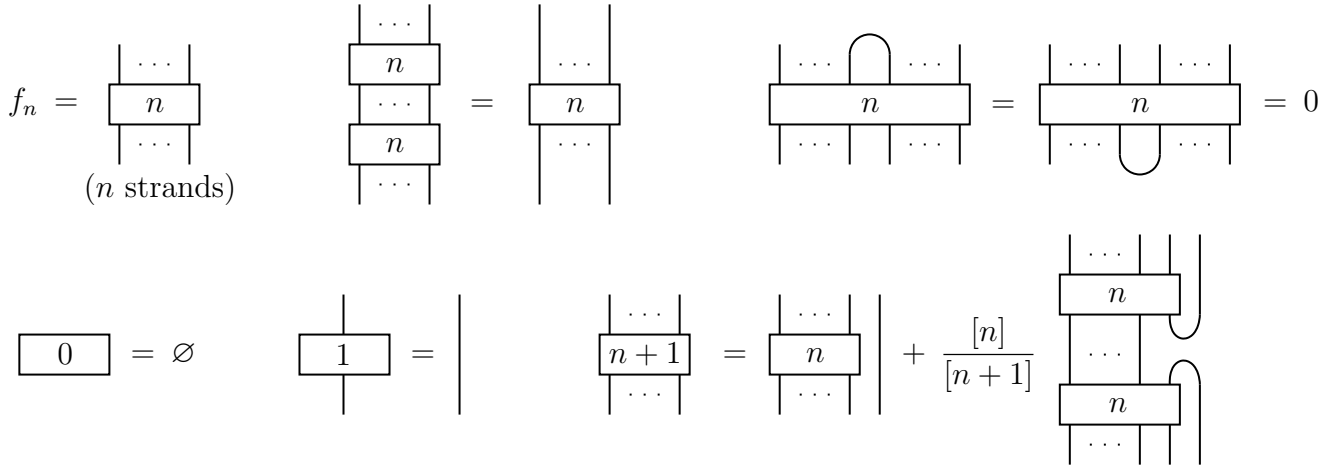
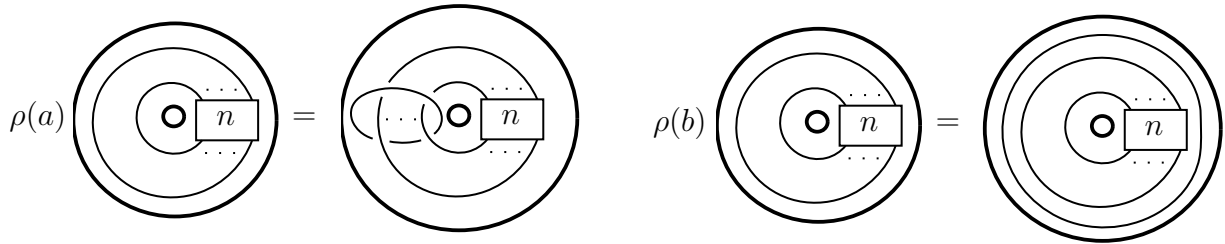

Figure 6.12: Jones-Wenzl idempotents.

Since  $q$  is a  $2p$ -th root of unity, we can consider the reduced skein module  $\mathcal{S}_q^{\text{red}}(H_g)$ , which is a quotient of  $\mathcal{S}_q(H_g)$  by relations involving the Jones-Wenzl idempotents, see *e.g.* [Cos15]. In particular, any diagram containing  $f_{p-1}$  is null in the reduced skein module. Here we consider the case  $g = 1$ , and a basis of  $\mathcal{S}_q^{\text{red}}(H_1)$  is given by the (classes of the) closures  $\text{cl}(f_n)$ , with  $0 \leq n \leq p-2$ .

Let us study the representation of  $\mathcal{S}_q(\Sigma_1)$  on  $\mathcal{S}_q^{\text{red}}(H_1)$ . It is known that  $\mathcal{S}_q(\Sigma_1)$  is generated by the circles  $[a]$  and  $[b]$ ; by definition of the representation, their actions are given by



where we denote  $\rho(a), \rho(b)$  instead of  $\rho([a]), \rho([b])$ .

**Lemma 6.5.4.** *In  $\mathcal{S}_q^{\text{red}}(H_1)$  it holds*

$$\begin{aligned} \rho(a)(\text{cl}(f_n)) &= -(q^{n+1} + q^{-(n+1)})\text{cl}(f_n), \\ \rho(b)(\text{cl}(f_0)) &= \text{cl}(f_1), \quad \rho(b)(\text{cl}(f_n)) = \text{cl}(f_{n-1}) + \text{cl}(f_{n+1}), \quad \rho(b)(\text{cl}(f_{p-2})) = \text{cl}(f_{p-3}). \end{aligned}$$

*Proof.* Observe that, for  $n \geq 2$ ,

$$\begin{aligned} \text{cl} \left( \begin{array}{c} \dots \\ \boxed{n} \\ \dots \\ \text{---} \end{array} \right) &= q^{-1/2} \text{cl} \left( \begin{array}{c} \dots \\ \boxed{n} \\ \dots \\ \text{---} \end{array} \right) = q^{-1} \text{cl} \left( \begin{array}{c} \dots \\ \boxed{n} \\ \dots \\ \text{---} \end{array} \right) \\ &= \dots = q^{-n+1} \text{cl}(f_n) \end{aligned}$$

We used the fact that the composition of a cup or a cap with the Jones-Wenzl idempotents is 0 and the cyclicity of  $\text{cl}$ . Now, assume by induction that  $\rho(a)(\text{cl}(f_n)) = \lambda_n \text{cl}(f_n)$  for a family of scalars  $\lambda_n$ . It is easily checked that  $\lambda_0 = -(q + q^{-1})$ ,  $\lambda_1 = -(q^2 + q^{-2})$ . Applying the Kauffman skein relation twice in  $\text{TL}_{q,n}$ , we obtain

$$\begin{aligned}
 \text{cl} \left( \begin{array}{c} \cdots \\ \boxed{n+1} \\ \cdots \\ \text{---} \\ \text{---} \\ \cdots \end{array} \right) &= q \text{cl} \left( \begin{array}{c} \cdots \\ \boxed{n+1} \\ \cdots \\ \text{---} \\ \text{---} \\ \cdots \end{array} \right) + (1 - q^{-2}) \text{cl} \left( \begin{array}{c} \cdots \\ \boxed{n+1} \\ \cdots \\ \text{---} \\ \text{---} \\ \cdots \end{array} \right) \\
 &= (q\lambda_n + (1 - q^{-2})q^{-n}) \text{cl}(f_{n+1})
 \end{aligned}$$

For the second equality we used the recurrence formula for the Jones-Wenzl idempotents together with the induction hypothesis. Hence  $\lambda_{n+1} = q\lambda_n + (1 - q^{-2})q^{-n}$ , and it follows that  $\lambda_n = -(q^{n+1} - q^{-(n+1)})$ , as desired. To compute the action of  $\rho(b)$ , note first that thanks to the recurrence formula, we have

$$\begin{array}{c} \cdots \\ \boxed{n} \\ \cdots \end{array} \text{---} \text{---} = -\frac{[n+1]}{[n]} f_{n-1}$$

Hence, using again the recurrence formula of the  $f_n$ 's and the cyclicity of  $\text{cl}$ , we get

$$\begin{aligned}
 \text{cl} \left( \begin{array}{c} \cdots \\ \boxed{n} \\ \cdots \end{array} \right) &= \text{cl} \left( \begin{array}{c} \cdots \\ \boxed{n+1} \\ \cdots \end{array} \right) - \frac{[n]}{[n+1]} \text{cl} \left( \begin{array}{c} \cdots \\ \boxed{n} \\ \cdots \\ \boxed{n} \\ \cdots \end{array} \right) \\
 &= \text{cl} \left( \begin{array}{c} \cdots \\ \boxed{n+1} \\ \cdots \end{array} \right) - \frac{[n]}{[n+1]} \text{cl} \left( \begin{array}{c} \cdots \\ \boxed{n} \\ \cdots \\ \boxed{n} \\ \cdots \end{array} \right) \\
 &= \text{cl} \left( \begin{array}{c} \cdots \\ \boxed{n+1} \\ \cdots \end{array} \right) - \frac{[n]}{[n+1]} \text{cl} \left( \begin{array}{c} \cdots \\ \boxed{n} \\ \cdots \end{array} \right) \\
 &= \text{cl}(f_{n-1}) + \text{cl}(f_{n+1})
 \end{aligned}$$

The case  $n = 0$  is obvious and the case  $n = p - 2$  follows from the previous equality and the fact that  $f_{p-1} = 0$  in  $\mathcal{S}_q^{\text{red}}(H_1)$ .  $\square$

Let  $\bar{\mathcal{U}} = J_2/J_1 = \text{vect}(\bar{\chi}_s^+)_{1 \leq s \leq p-1}$ , where  $\bar{\chi}_s^+$  is the class of  $\chi_s^+$  modulo  $\mathcal{P}$  (see Proposition 6.5.2).

**Proposition 6.5.5.** *The  $\mathcal{S}_q(\Sigma_1)$ -modules  $\mathcal{S}_q^{\text{red}}(H_1)$  and  $\bar{\mathcal{U}}$  are isomorphic. The isomorphism is given by*

$$\begin{aligned}
 F : \mathcal{S}_q^{\text{red}}(H_1) &\rightarrow \bar{\mathcal{U}} \\
 \text{cl}(f_n) &\mapsto v_A^{-1} \triangleright \bar{\chi}_{n+1}^+ = v_{n+1}^{-1} \bar{\chi}_{n+1}^+
 \end{aligned}$$

where  $v_s$  is defined in (6.22).

*Proof.* Recall that

$$\begin{aligned}
 W(a) \triangleright \bar{\chi}_s^+ &= -(q^s + q^{-s}) \bar{\chi}_s^+, \\
 W(b) \triangleright \bar{\chi}_1^+ &= \frac{v_1}{v_2} \bar{\chi}_2^+, \quad W(b) \triangleright \bar{\chi}_s^+ = \frac{v_s}{v_{s-1}} \bar{\chi}_{s-1}^+ + \frac{v_s}{v_{s+1}} \bar{\chi}_{s+1}^+, \quad W(b) \triangleright \bar{\chi}_{p-1}^+ = \frac{v_{p-1}}{v_{p-2}} \bar{\chi}_{p-2}^+.
 \end{aligned}$$

The result follows by comparison with the formulas of Lemma 6.5.4.  $\square$

The representation  $\mathcal{S}_q^{\text{red}}(H_1)$  can be described in terms of the Reshetikhin-Turaev topological quantum field theory (RT TQFT for short). Recall the cobordism category  $\mathcal{C}$  for this TQFT: the objects are closed oriented surfaces and the morphisms  $\text{Hom}_{\mathcal{C}}(S_1, S_2)$  are pairs  $(M, L)$ , where  $M$  is a compact oriented 3-manifold endowed with a  $p_1$ -structure such that  $\partial M = (-S_1) \sqcup S_2$  and  $L \subset M$  is a framed link up to isotopy. For more informations, see [RT91, BHMV95], the lecture notes [Cos15] and also [BW16], where the representation of  $\mathcal{S}_q(\Sigma_g)$  given by the RT TQFT is shown to be irreducible. The 3-manifolds  $H_1^{\leq \varepsilon/2} \cong \Sigma_1 \times [0, 1]$ ,  $H_1^{\geq \varepsilon} \cong H_1$  of (6.24) with framed links inside them are cobordisms:

$$(\Sigma_1 \times [0, 1], L_1) \in \text{Hom}_{\mathcal{C}}(\Sigma_1, \Sigma_1), \quad (H_1, L_2) \in \text{Hom}_{\mathcal{C}}(\emptyset, \Sigma_1).$$

The functor  $Z : \mathcal{C} \rightarrow \text{Vect}_{\mathbb{C}}$  of the RT TQFT (which depends on the primitive root of unity  $q$ ), gives linear maps

$$Z(\Sigma_1 \times [0, 1], L_1) : Z(\Sigma_1) \rightarrow Z(\Sigma_1), \quad Z(H_1, L_2) : Z(\emptyset) = \mathbb{C} \rightarrow Z(\Sigma_1).$$

Hence  $Z(H_1, L_2)$  is just a choice of an element of  $Z(\Sigma_1)$ . As recalled in [BW16, Lemma 5], every element of  $Z(\Sigma_1)$  can be written  $Z(H_1, L_2)$  for some link  $L_2 \subset H_1$ . Moreover, the maps  $Z(M, \cdot)$  satisfy the Kauffman skein relation:

$$Z(M, L_+) = q^{1/2} Z(M, L_{\parallel}) + q^{-1/2} Z(M, L_-)$$

where  $L_+, L_{\parallel}, L_- \subset M$  are identical except in a little ball in which they look like in (6.19). It follows that  $Z(\Sigma_1 \times [0, 1], \cdot) : \mathcal{S}_q(\Sigma_1) \rightarrow \text{End}_{\mathbb{C}}(Z(\Sigma_1))$  furnishes a representation of  $\mathcal{S}_q(\Sigma_1)$  on  $Z(\Sigma_1)$ :

$$L_1 \cdot Z(H_1, L_2) = Z((\Sigma_1 \times [0, 1], L_1) \circ (H_1, L_2)) \in \text{Hom}_{\mathcal{C}}(Z(\emptyset), Z(\Sigma_1)) = Z(\Sigma_1). \quad (6.26)$$

The map  $Z_{H_1} : \mathcal{S}_q(H_1) \rightarrow Z(\Sigma_1)$  defined by  $Z_{H_1}(L) = Z(H_1, L)$  is surjective, and more precisely it gives rise to an isomorphism  $Z_{H_1}^{\text{red}} : \mathcal{S}_q^{\text{red}}(H_1) \rightarrow Z(\Sigma_1)$ . Moreover,  $Z_{H_1}^{\text{red}}$  is an isomorphism of  $\mathcal{S}_q(\Sigma_1)$ -modules between  $\mathcal{S}_q^{\text{red}}(H_1)$  endowed with the action (6.25) and  $Z(\Sigma_1)$  endowed with the action (6.26).

We have seen that, for  $\Sigma_1$ , the representation of Theorem 6.4.1 “contains” the natural skein representation (6.25) on  $\mathcal{S}_q^{\text{red}}(H_1)$  (or equivalently (6.26)), in the sense that it is the composition factor  $J_2/J_1$ . By [BW16, Theorem 7], we know that the representation (6.26) is irreducible in any genus. Hence we conjecture the following.

**Conjecture 6.5.6.** *The representation (6.25) of  $\mathcal{S}_q(\Sigma_g)$  on  $\mathcal{S}_q^{\text{red}}(H_g)$  is a composition factor  $J_{i+1}/J_i$  of the representation of Theorem 6.4.1 (namely the representation induced by the Wilson loop map  $W : \mathcal{S}_q(\Sigma_g) \rightarrow \mathcal{L}_{g,0}(\bar{U}_q)$  and the representation of  $\mathcal{L}_{g,0}(\bar{U}_q)$  on  $(\bar{U}_q^*)^{\otimes g}$ ).*





# Bibliography

- [Ari10] Y. Arike: *A construction of symmetric linear functions on the restricted quantum group  $\bar{U}_q(\mathfrak{sl}(2))$* , Osaka J. Math. **47**(2), 535-557 (2010).
- [AGPS18] N. Aghaei, A.M. Gainutdinov, M. Pawelkiewicz, V. Schomerus, *Combinatorial Quantisation of  $GL(1|1)$  Chern-Simons Theory I: The Torus*, arXiv:1811.09123.
- [Ale94] A.Y. Alekseev, *Integrability in the Hamiltonian Chern-Simons theory*, Algebra i Analiz **6**(2), 53–66 (1994).
- [AGS95] A.Y. Alekseev, H. Grosse, V. Schomerus, *Combinatorial quantization of the Hamiltonian Chern-Simons theory, I*, Commun. Math. Phys. **172**(2), 317–358 (1995).
- [AGS96] A.Y. Alekseev, H. Grosse, V. Schomerus, *Combinatorial quantization of the Hamiltonian Chern-Simons theory, II*, Commun. Math. Phys. **174**(3), 561–604 (1996).
- [AS96a] A.Y. Alekseev, V. Schomerus, *Representation theory of Chern-Simons observables*, Duke Math. J. **85**(2), 447–510 (1996).
- [AS96b] A.Y. Alekseev, V. Schomerus, *Quantum Moduli Spaces of Flat Connections*, arXiv:q-alg/9612037.
- [AB83] M. F. Atiyah, R. Bott, *The Yang-Mills Equations over Riemann Surfaces*, Philos. Trans. R. Soc. A **308**, 523-615 (1983).
- [BaR] S. Baseilhac, P. Roche, *Unrestricted moduli algebras: the case of punctured spheres*, in preparation.
- [BBGa18] A. Beliakova, C. Blanchet, A.M. Gainutdinov: *Modified trace is a symmetrised integral*, arXiv:1801.00321.
- [BBGe17] A. Beliakova, C. Blanchet, N. Geer: *Logarithmic Hennings invariants for restricted quantum  $sl(2)$* , Algebr. Geom. Topol. **18**(7), 4329-4358 (2018).
- [BZBJ18] D. Ben-Zvi, A. Brochier, D. Jordan, *Integrating quantum groups over surfaces*, J. Topology **11**(4), 874–917 (2018).
- [BHMV95] C. Blanchet, N. Habegger, G. Masbaum, P. Vogel, *Topological Quantum Field Theories derived from the Kauffman bracket*, Topology **34**(4), 883-927 (1995).
- [BW16] F. Bonahon, H. Wong, *The Witten-Reshetikhin-Turaev representation of the Kauffman bracket skein algebra*, Proc. Am. Math. Soc. **144**(6), 2711-2724 (2016).
- [BR95] E. Buffenoir, P. Roche, *Two dimensional lattice gauge theory based on a quantum group*, Commun. Math. Phys. **170**(3), 669–698 (1995).
- [BR96] E. Buffenoir, P. Roche, *Link invariants and combinatorial quantization of Hamiltonian Chern Simons theory*, Commun. Math. Phys. **181**(2), 331–365 (1996).
- [BNR02] E. Buffenoir, K. Noui, P. Roche, *Hamiltonian quantization of Chern-Simons theory with  $SL(2, \mathbb{C})$  group*, Class. Quantum Grav. **19**(19), 4953–5015 (2002).
- [BFK98a] D. Bullock, C. Frohman, J. Kania-Bartoszyńska, *Skein Quantization and Lattice Gauge Field Theory*, Chaos, Solitons & Fractals **9**(4–5), 811–824 (1998).
- [BFK98b] D. Bullock, C. Frohman, J. Kania-Bartoszyńska, *Topological interpretations of lattice gauge field theory*, Commun. Math. Phys. **198**(1), 47–81 (1998).
- [CFS95] J.S. Carter, D.E. Flath, M. Saito, *The Classical and Quantum  $6j$ -symbols*, Mathematical Notes **43**, Princeton University Press (1995).

- [CW08] M. Cohen, S. Westreich, *Characters and a Verlinde-type formula for symmetric Hopf algebras*, J. Algebra **320**, 4300–4316 (2008).
- [Cos15] F. Costantino, *Notes on Topological Quantum Field Theories*, Winter Braids Lecture Notes **2**, 1–45 (2015).
- [CR62] C. Curtis, I. Reiner: Representation Theory of Finite Groups and Associative Algebras, Interscience Publishers (1962).
- [Dri89] Drinfeld V. G., *On almost cocommutative Hopf algebras*, Leningrad Math. J. **1** (1990), 321–342.
- [EGNO15] P. Etingof, S. Gelaki, D. Nikshych, V. Ostrik, *Tensor categories*, Mathematical Surveys and Monographs **205**, American Mathematical Society (2015).
- [Fai18a] M. Faitg, *A note on symmetric linear forms and traces on the restricted quantum group  $\bar{U}_q(\mathfrak{sl}(2))$* , arXiv:1801.07524. To appear in Osaka J. Math.
- [Fai18b] M. Faitg, *Modular group representations in combinatorial quantization with non-semisimple Hopf algebras*, arXiv:1805.00924.
- [Fai18c] M. Faitg, *Projective representations of mapping class groups in combinatorial quantization*, arXiv:1812.00446. To appear in Commun. Math. Phys (DOI 10.1007/s00220-019-03470-z).
- [FM12] B. Farb, D. Margalit, *A Primer on Mapping Class Groups*, Princeton University Press (2012).
- [FGST06a] B.L. Feigin, A.M. Gainutdinov, A.M. Semikhatov, I.Y. Tipunin, *Modular group representations and fusion in logarithmic conformal field theories and in the quantum group center*, Commun. Math. Phys. **265**(1), 47–93 (2006).
- [FGST06b] B.L. Feigin, A.M. Gainutdinov, A.M. Semikhatov, I.Yu. Tipunin: *Kazhdan-Lusztig correspondence for the representation category of the triplet  $W$ -algebra in logarithmic CFT*, Theor. Math. Phys. **148**(3), 1210-1235 (2006).
- [FR93] V. V. Fock, A. A. Rosly, *Flat connections and polyubles*, Theor. Math. Phys. **95**(2), 526–534 (1993).
- [FR98] V.V. Fock, A.A. Rosly, *Poisson structure on moduli of flat connections on Riemann surfaces and  $r$ -matrix*, arXiv:math/9802054.
- [FG00] C. Frohman, R. Gelca, *Skein modules and the noncommutative torus*, Trans. Amer. Math. Soc. **352**(10), 4877–4888 (2000).
- [FSS12] J. Fuchs, C. Schweigert, C. Stigner, *Modular invariant Frobenius algebras from ribbon Hopf algebra automorphisms*, J. Algebra **363**, 29–72 (2012).
- [FSS14] J. Fuchs, C. Schweigert, C. Stigner, *Higher genus mapping class group invariants from factorizable Hopf algebras*, Adv. Math. **250**, 285–319 (2014).
- [GR17a] A.M. Gainutdinov, I. Runkel, *Symplectic fermions and a quasi-Hopf algebra structure on  $\bar{U}_i\mathfrak{sl}(2)$* , J. Algebra **476**, 415–458 (2017).
- [GR17b] A. M. Gainutdinova, I. Runkel, *Projective objects and the modified trace in factorisable finite tensor categories*, arXiv:1703.00150 (2017).
- [GT09] A.M. Gainutdinov, I.Yu. Tipunin: *Radford, Drinfeld and Cardy boundary states in the  $(1, p)$  logarithmic conformal field models*, J. Phys. A: Math. Theor **42**(31), 315207 (2009).
- [GJS19] I. Ganey, D. Jordan, P. Safronov, *The quantum Frobenius for character varieties and multiplicative quiver varieties*, arXiv:1901.11450.
- [GKP11] N. Geer, J. Kujawa, B. Patureau-Mirand: *Generalized trace and modified dimension functions on ribbon categories*, Selecta Mathematica **17**(2), 453-504 (2011).
- [Gol86] W.M. Goldman, *Invariant functions on Lie groups and Hamiltonian flows of surface group representations*, Invent. math. **85**(2), 263–302 (1986).
- [Iba15] E. Ibanez: *Evaluable Jones-Wenzl idempotents at root of unity and modular representation on the center of  $\bar{U}_q\mathfrak{sl}(2)$* , PhD Thesis (in French), arXiv:1604.03681.
- [Kas95] C. Kassel, *Quantum Groups*, Graduate Texts in Mathematics **155**, Springer (1995).

- [KM91] R. Kirby, P. Melvin, *The 3-manifold invariants of Witten and Reshetikhin-Turaev for  $\mathfrak{sl}(2, \mathbb{C})$* , Invent. Math. **105**(1), 473–545 (1991).
- [KS11] H. Kondo, Y. Saito: *Indecomposable decomposition of tensor products of modules over the restricted quantum group associated to  $\mathfrak{sl}_2$* , J. Algebra **330**(1), 103-129 (2011).
- [Lab13] F. Labourie, *Lectures on Representations of Surface Groups*, EMS publishing house, Zurich Lectures in Advanced Mathematics (2013).
- [LM94] V. Lyubashenko, S. Majid, *Braided Groups and Quantum Fourier Transform*, Journal of Algebra **166**(3), 506–528 (1994).
- [Lyu95a] V. Lyubashenko, *Modular transformations for tensor categories*, J. Pure Appl. Alg. **98**(3), 279–327 (1995).
- [Lyu95b] V. Lyubashenko, *Invariants of 3-manifolds and projective representations of mapping class groups via quantum groups at roots of unity*, Commun. Math. Phys. **172**(3), 467–516 (1995).
- [Lyu96] V. Lyubashenko, *Ribbon abelian categories as modular categories*, J. Knot Theory and its Ramif. **5**(3), 311–403 (1996).
- [ML98] S. Mac Lane, *Categories for the working mathematician*, 2nd edition, Graduate texts in Mathematics **5**, Springer (1998).
- [Maj93] S. Majid, *Braided groups*, J. Pure Appl. Algebra **86**(2), 187–221 (1993).
- [Maj95] S. Majid, *Foundations of Quantum Group Theory*, Cambridge University Press (1995).
- [MW15] C. Meusburger, D.K. Wise, *Hopf algebra gauge theory on a ribbon graph*, arXiv:1512.03966.
- [Mon93] S. Montgomery, *Hopf algebras and their action on rings*, CBMS Regional Conference Series in Mathematics **82**, American Mathematical Society.
- [Mur17] J. Murakami: *Generalized Kashaev invariants for knots in three manifolds*, Quantum Topology **8**(1), 35-73 (2017).
- [Rad94] D.E. Radford: *The trace function and Hopf algebras*, J. Algebra **163**(3), 583-622 (1994).
- [Rad11] Radford D.E., *Hopf algebras*, Series on Knots and Everything **49**, World Scientific.
- [RS88] Reshetikhin N.Yu., Semenov-Tian-Shansky M.A., *Quantum R-matrices and factorization problems*, J. Geom. Phys. **5** (1988), 533–550.
- [RT90] N. Y. Reshetikhin, V. G. Turaev, *Ribbon graphs and their invariants derived from quantum groups*, Commun. Math. Phys. **127**(1), 1–26 (1990).
- [RT91] N. Y. Reshetikhin, V. G. Turaev, *Invariants of 3-manifolds via link polynomials and quantum groups*, Invent. math. **103**(1), 547-597 (1991).
- [Sch98] V. Schomerus, *Deformed Gauge Symmetry in Local Quantum Physics*, Habilitation thesis, Hamburg (1998).
- [Sut94] R. Suter: *Modules over  $\bar{U}_q(\mathfrak{sl}(2))$* , Commun. Math. Phys. **163**(2), 359-393 (1994).
- [Waj83] B. Wajnryb, *A simple presentation for the mapping class group of an orientable surface*, Israel J. Math. **45**(2–3), 157–174 (1983).
- [Wit91] , E. Witten, *On Quantum Gauge Theories in Two Dimensions*, Commun. Math. Phys. **141**(1), 153–209 (1991).