



**HAL**  
open science

# Dependability approaches for mobile environment : Application on connected autonomous vehicles.

Abdallah Dabboussi

► **To cite this version:**

Abdallah Dabboussi. Dependability approaches for mobile environment : Application on connected autonomous vehicles.. Other. Université Bourgogne Franche-Comté, 2019. English. NNT : 2019UBFCA029 . tel-02507101

**HAL Id: tel-02507101**

**<https://theses.hal.science/tel-02507101>**

Submitted on 12 Mar 2020

**HAL** is a multi-disciplinary open access archive for the deposit and dissemination of scientific research documents, whether they are published or not. The documents may come from teaching and research institutions in France or abroad, or from public or private research centers.

L'archive ouverte pluridisciplinaire **HAL**, est destinée au dépôt et à la diffusion de documents scientifiques de niveau recherche, publiés ou non, émanant des établissements d'enseignement et de recherche français ou étrangers, des laboratoires publics ou privés.

# SPIM

## Thèse de Doctorat



école doctorale sciences pour l'ingénieur et microtechniques

UNIVERSITÉ DE TECHNOLOGIE BELFORT-MONTBÉLIARD

# **DEPENDABILITY APPROACHES FOR MOBILE ENVIRONMENT - APPLICATION ON CONNECTED AUTONOMOUS VEHICLES**

■ **Abdallah DABBOUSSI**



# SPIM

## Thèse de Doctorat



école doctorale sciences pour l'ingénieur et microtechniques  
UNIVERSITÉ DE TECHNOLOGIE BELFORT-MONTBÉLIARD

Thèse présentée par

**Abdallah DABBOUSSI**

pour obtenir le

Grade de Docteur de

l'Université de Technologie de Belfort-Montbéliard

Spécialité : **Informatique**

**APPROCHE POUR LA SURETE DE  
FONCTIONNEMENT EN ENVIRONNEMENT MOBILE  
APPLICATION AUX VEHICULES AUTONOMES ET  
CONNECTES**

Soutenue le 20 décembre 2019 devant le Jury :

Mr. Pascal LORENZ	Président du jury	Professeur, Université de Haute Alsace UHA
Mr. Tarek El-GHAZAWI	Rapporteur	Professeur, George Washington University GWU
Mr. Ahmed NAIT-SIDIMOH	Rapporteur	Maître de Conférences, HDR, Université de Picardie Jules Verne (UPJV)
Mr. Rachid OUTBIB	Examineur	Professeur, Université d'Aix-Marseille
Mr. Maxime WACK	Directeur de thèse	Professeur Émérite, UTBM
Mr. Raed KOUTA	Co-directeur de thèse	Maître de Conférences, HDR, UTBM
Mr. Jaafar GABER	Co-directeur de thèse	Maître de Conférences, HDR, UTBM
Mr. Bachar EL-HASSAN	Co-directeur de thèse	Professeur, Université Libanaise



# Acknowledgments

*First and above all, I praise God the almighty for granting me this opportunity, and for health, protection, and capability to finish this thesis successfully.*

This thesis would have not been possible without the assistance and guidance of several people to whom I offer my sincere thanks and gratitude.

It is difficult to state my gratitude to my supervisors Dr. Maxim WACK, Dr. Raed KOUTA and Dr. Jaafar JABER due to ongoing support, inspiration, and great efforts in guiding me throughout the thesis. They have provided me with encouragement, sound advice, and good company. For your efforts, guidance and support, which brought this work to a successful completion, I would like to say THANK YOU!

I want to express my deep thanks to Dr. Bachar EL HASSAN and Dr Lina NACHABEH for their kind support, warm encouragement, caring guidance and critical comments. May the Almighty God richly bless you.

I would like to thank the jury members for accepting to review my thesis, Drs Tarek EL-GHAZAWI, Ahmed NAIT-SIDIMOH, Pascal LORENZ and Rachid OUTBIB; Thank You...

This work would not have been possible without the help, support and encouragement of my colleagues. Special thanks to the director of Cisco Academy at Lebanese University Mr. Mustafa BADWI. I also thank my colleagues in OMNI and in UTBM, for their support and for the good times spent together. Particular big thanks to Dr. Mohamad SLEIMANI cannot finish without thanking my family...

Nobody has been more important to me in the pursuit of this project than the members of my family. I would like to thank my mom, whose love and guidance are with me in whatever I pursue.

I want to thank my brother Fouad, Thank you for your encouragement and support...

Finally, I wish to thank my loving and supportive wife, Najwa, and my four wonderful children, Nadine, Ahmad, Hassan and Sara.

I thank all who in one way or another supported me and contributed towards the completion of this thesis.

# Table of Contents

<b>CHAPTER 1 - GENERAL INTRODUCTION.....</b>	<b>13</b>
1.1 THE RESEARCH DOMAIN .....	14
1.2 BACKGROUND.....	14
1.3 PROBLEM STATEMENT.....	16
1.4 THE CONTRIBUTIONS .....	17
1.5 ORGANIZATION OF THE DISSERTATION .....	18
1.5.1 <i>General presentation</i> .....	18
1.5.2 <i>Global view</i> .....	19
1.5.3 <i>Chapter Contents</i> .....	19
<b>CHAPTER 2 - CAV: INFLUENCES AND CHALLENGES .....</b>	<b>21</b>
2.1 INTRODUCTION .....	23
2.1.1 <i>What is an autonomous vehicle?</i> .....	23
2.1.2 <i>What is a connected vehicle?</i> .....	25
2.1.2.1 VANETs applications.....	26
2.1.2.2 <i>Safety applications</i> .....	27
2.1.2.3 <i>User applications</i> .....	27
2.2 CONNECTED AND AUTONOMOUS VEHICLES (CAV) .....	27
2.2.1 <i>The advantages of CAV</i> .....	28
2.2.1.1 Road safety.....	28
2.2.1.2 Protect the environment.....	28
2.2.1.3 Improve the way of life .....	29
2.2.1.4 Allow people with disabilities to move more easily .....	29
2.2.1.5 Save time and money.....	29
2.2.2 <i>CAV: How does it work?</i> .....	29



2.2.3	<i>Conditions for CAV Deployment.</i>	31
2.2.4	<i>Example of existence and revolution</i>	32
2.3	THE ECONOMIC, SOCIAL, ETHICAL AND LEGAL IMPACT OF A CAV DEPLOYMENT	33
2.3.1	<i>The Economic impact</i>	33
2.3.1.1	Platform for new services	34
2.3.1.2	New automobile industry	34
2.3.1.3	New business model	35
2.3.1.4	Improve preventive maintenance	35
2.3.1.5	No need to own a personal car	35
2.3.2	<i>Social impact</i>	36
2.3.2.1	Sharing CAV	36
2.3.2.2	Mobility and Quality of Life	36
2.3.3	<i>Ethical impact</i>	37
2.3.3.1	Ethics of driving	37
2.3.4	<i>The ethical dilemma</i>	37
2.3.5	<i>Legal impact</i>	38
2.4	THE TECHNOLOGICAL AND SCIENTIFIC CHALLENGES OF CAV	39
2.4.1	<i>Challenges related to autonomous navigation</i>	39
2.4.1.1	Sensors	40
2.4.1.2	Environment interpretation	41
2.4.1.3	Planning routes	42
2.4.1.4	Planning maneuver	43
2.4.1.5	Vehicle-user interactions	43
2.4.1.6	Trajectory planning	43
2.4.1.7	High level control-command	44
2.4.2	<i>Challenges related to integration and dependability</i>	45
2.4.2.1	The design of embedded architectures	45
2.4.2.2	The formal proofs of the algorithms	45
2.4.2.3	Hardware and software optimization	45
2.4.2.4	Resilience, fault tolerance, uncertainty management	45
2.4.2.5	Physical systems security and reliability	46
2.4.3	<i>Reliable communication between vehicles</i>	46

2.4.4	<i>Cybersecurity</i> .....	47
2.4.5	<i>The Big Data Processing</i> .....	48
2.4.6	<i>Validation of the CAV system</i> .....	49
2.4.7	<i>The modeling of large systems: road traffic and fleet management</i> .....	50
2.5	STATE OF ARTS.....	51
2.6	CONCLUSION .....	57
<b>CHAPTER 3 - GLOBAL QUALITATIVE STUDY OF DEPENDABILITY OF CAV.....</b>		<b>58</b>
3.1	INTRODUCTION .....	59
3.2	DEPENDABILITY OVERVIEW .....	61
3.3	THE PROPOSED APPROACH .....	63
3.4	PRELIMINARY RISK ANALYSIS (PRA).....	64
3.4.1	<i>Definition</i> .....	64
3.4.2	<i>Functional Architecture of CAV</i> .....	65
3.4.3	<i>Severity, Frequency and Controllability</i> .....	69
3.5	EXTERNAL FUNCTIONAL ANALYSIS.....	71
3.5.1	<i>Bull chart</i> .....	72
3.5.2	<i>Octopus diagram</i> .....	73
3.5.2.1	Manufacturing and transportation .....	74
3.5.2.2	Maintenance .....	75
3.5.2.3	Use .....	75
3.5.2.4	End of life .....	76
3.6	INTERNAL FUNCTIONAL ANALYSIS.....	76
3.6.1	<i>The functional block diagram</i> .....	77
3.6.2	<i>Global functional block diagram</i> .....	78
3.6.2.1	Functional block diagram of sensors.....	79
3.6.3	<i>Functional analysis table</i> .....	81
3.7	FAILURE MODE, EFFECTS AND CRITICALITY ANALYSIS (FMECA).....	82
3.7.1	<i>The "project" benefit FMECA</i> .....	82
3.7.2	<i>The "system" objectives of FMECA product</i> .....	83
3.7.3	<i>The FMECA "Product"</i> .....	84

3.8	CONCLUSION .....	86
<b>CHAPTER 4 - A FAULT TREE ANALYSIS FOR THE RELIABILITY OF CAV.....</b>		<b>87</b>
4.1	INTRODUCTION.....	88
4.2	COMPONENT OF V2X TECHNOLOGY .....	89
4.2.1	<i>Communication reliability of CV .....</i>	<i>89</i>
4.2.1.1	On Board Unit (OBU).....	90
4.2.1.2	Trusted Platform Module (TPM) .....	91
4.2.1.3	Road Side Unit (RSU).....	92
4.2.2	<i>RBD.....</i>	<i>92</i>
4.3	PROBABILISTIC MODELING OF THE FAULT TREE EVENTS .....	95
4.3.1	<i>Lifetime distributions.....</i>	<i>95</i>
4.3.2	<i>The exponential distribution.....</i>	<i>96</i>
4.3.3	<i>Reliability of OBU and RSU .....</i>	<i>96</i>
4.3.4	<i>V2V Reliability.....</i>	<i>99</i>
4.3.5	<i>V2I Reliability.....</i>	<i>100</i>
4.3.6	<i>V2X Reliability.....</i>	<i>101</i>
4.4	FAULT TREE FOR CAV .....	102
4.5	IMPROVEMENT PROPOSAL FOR THE FAULT TREE .....	110
4.6	CONCLUSION FOR THE FAULT TREE .....	115
<b>CHAPTER 5 - RELIABILITY AND CONNECTIVITY ANALYSIS FOR BSM IN CAV.....</b>		<b>118</b>
5.1	INTRODUCTION.....	118
5.2	RELIABILITY OF CONNECTED VEHICLES .....	119
5.2.1	<i>Experimental results.....</i>	<i>121</i>
5.2.1.1	Reliability CAV connectivity against transmission range .....	121
5.2.1.2	Reliability CAV connectivity against Density .....	123
5.2.1.3	Reliability for CAV connectivity against safety headway distance .....	125
5.3	COMMUNICATION RELIABILITY .....	126
5.3.1	<i>BSM Fundamentals.....</i>	<i>127</i>
5.3.2	<i>The Analytic Approach.....</i>	<i>127</i>
5.4	RELIABILITY OF BSM IN VANET .....	129

5.5	RELIABILITY OF SAFETY APPLICATIONS IN DSRC.....	133
5.6	ANALYTIC VALIDATION FOR THE NUMBER OF RETRANSMISSIONS .....	135
5.7	CONCLUSION .....	140
<b>CHAPTER 6 - CONCLUSIONS &amp; PERSPECTIVES.....</b>		<b>142</b>
6.1	SUMMARY.....	143
6.2	FUTURE WORK .....	144
<b>LIST OF PERSONAL PUBLICATIONS .....</b>		<b>146</b>
<b>LIST OF TABLES .....</b>		<b>147</b>
<b>LIST OF FIGURES .....</b>		<b>148</b>
<b>LITERATURES .....</b>		<b>150</b>
<b>ACRONYMS AND ABBREVIATIONS .....</b>		<b>159</b>

## **Abstract**

Connected and Autonomous vehicles (CAV) must have adequate reliability and safety requirements in uncertain environments with complex circumstances. Sensor technology, actuators and artificial intelligence (AI) are constantly and rapidly evolving, thus enabling further development of self-driving vehicles, and increasing the automation of driving. CAV shows many benefits in human life such as increasing road safety, reducing pollution, and providing independent mobility to non-drivers. However, these advanced components create a new set of challenges concerning safety and dependability. Hence, it is necessary to evaluate these technologies before implementation.

We study in this thesis the reliability of CAV as a whole, focusing on sensors and the communication system. For that purpose, a functional analysis was done for the CAV system.

Our scientific approach for analyzing the CAV reliability was structured with methods that combine quantitative and qualitative approaches such as internal and external functional analysis, Preliminary Risk Analysis (PRA), and failure modes and effects criticality analysis (FMECA), in addition to other analysis techniques.

In order to prove our results, a simulation was done using the Fault Tree analysis (FTA) probability in order to validate the proposed approach. The data (Failure ratio) used were from a professional database related to the type of components presented in the system. Using this data, a probabilistic model of degradation was proposed. A probability calculation was performed in relation to a reference time of use. Thereafter, a sensitivity analysis was suggested concerning the reliability parameters and redesign proposals developed for the components.

CAV provides several communication models: vehicles to vehicle (V2V), or with Road Side Infrastructure: vehicle to infrastructure (V2I). Dedicated Short Range Communication (DSRC) employs a multichannel approach to cater for a variety of safety and non-safety applications. Safety applications necessitate appropriate and reliable transmissions, while non-

safety applications require performance and high speed. Broadcasting of Basic Safety Messages (BSM) is one of the fundamental services in today's connected vehicles. For that, an analytical model to evaluate the reliability of IEEE 802.11 based V2V safety-related broadcast services in DSRC system on highway was proposed. Finally, an enhancement on the proposed model was made in order to increase the reliability of the V2V connection, taking into consideration many factors such as transmission range, vehicle density, and safety headway distance on highway, packet error rate, noise influence, and failures rates of communication equipment.

Evaluating these problems leads to a sensitivity analysis related to reliability parameters, which helps further innovation in CAV and automobile engineering.

**Keywords:** Connected Autonomous vehicles, Dependability, Reliability, BSM, DSRC, VANET, wireless network, FMECA, Fault Tree.

## Résumé

Les véhicules autonomes et connectés (VAC) doivent avoir une exigence de fiabilité et de sécurité adéquate dans un environnement incertain aux circonstances complexes. La technologie des capteurs, les actionneurs et l'intelligence artificielle (IA) améliorent constamment leurs performances, ce qui permet un développement continu des véhicules autonomes et une automatisation accrue de la tâche de conduite. Les VAC présentent de nombreux avantages dans la vie humaine, tels que l'augmentation de la sécurité routière, la réduction de la pollution et la fourniture d'une mobilité autonome aux non-conducteurs. Cependant, ces composants avancés créent un nouvel ensemble de défis en matière de sécurité et de fiabilité. Il est donc nécessaire d'évaluer ces technologies avant leur mise en œuvre.

Nous étudions dans cette thèse la fiabilité du VAC dans son ensemble, en nous concentrant sur les capteurs et le système de communication. Pour cela, une analyse fonctionnelle a été réalisée pour le système VAC. Notre approche scientifique pour l'analyse de la fiabilité du VAC a été structurée avec des méthodes combinant des approches quantitatives et qualitatives (telles que l'analyse fonctionnelle interne et externe, l'analyse préliminaire des risques (APR) et l'analyse des modes de défaillance, de leurs effets et de leur criticité (AMDEC), etc. Afin de prouver nos résultats, une simulation a été réalisée à l'aide de la probabilité d'analyse d'arbre de défaillance (ADD) et elle a été réalisée pour valider l'approche proposée. Les données (taux d'échec) utilisées proviennent d'une base de données professionnelle concernant le type de composants présentés dans le système. À partir de ces données, un modèle probabiliste de dégradation a été proposé. Le calcul de probabilité a été effectué par rapport à un moment d'utilisation de référence. Par la suite, une analyse de sensibilité a été suggérée concernant les paramètres de fiabilité et des propositions de restructuration ont été élaborées pour les composants.

CAV fournit des services de communication entre véhicules : véhicules à véhicules (V2V) ou avec infrastructures côté rue : véhicules à infrastructures (V2I). La technologie des

“Communications dédiées à courte portée” (DSRC = Dedicated Short Range Communications) utilise plusieurs canaux pour fournir une variété d'applications de sécurité. Les applications de sécurité nécessitent des transmissions appropriées et fiables, tandis que les applications non liées à la sécurité exigent des performances et une vitesse élevée. Aujourd'hui, la diffusion de messages de sécurité de base (Basic safety message, BSM) est l'un des services fondamentaux des véhicules connectés. Pour cela, un modèle analytique destiné à évaluer la fiabilité des services de diffusion V2V relatifs à la sécurité basée sur IEEE 802.11 dans le système DSRC sur autoroute a été proposé. Enfin, une amélioration du modèle proposé a été faite afin d'accroître la fiabilité de la connexion V2V, en tenant compte de nombreux facteurs tels que la portée de transmission, la densité du véhicule, la distance de sécurité sur l'autoroute, le taux d'erreur de paquets, l'influence de bruit et les taux de défaillants pour les équipements de communications.

L'évaluation de ces problèmes conduit à une analyse de sensibilité liée aux paramètres de fiabilité, ce qui contribue à davantage d'innovation dans les domaines de l'ingénierie automobile.

**Mots clés :** Véhicule autonome et connecté, Sûreté de fonctionnement, fiabilité, BSM, DSRC, VANET, Réseaux sans fil, AMDEC, arbre de défaillance.



# Chapter 1 - General Introduction

<b><u>CHAPTER 1 - GENERAL INTRODUCTION</u></b> .....	13
<u>1.1 THE RESEARCH DOMAIN</u> .....	14
<u>1.2 BACKGROUND</u> .....	14
<u>1.3 PROBLEM STATEMENT</u> .....	16
<u>1.4 THE CONTRIBUTIONS</u> .....	17
<u>1.5 ORGANIZATION OF THE DISSERTATION</u> .....	18
<u>1.5.1 General presentation</u> .....	18
<u>1.5.2 Global view</u> .....	19
<u>1.5.3 Chapter Contents</u> .....	19

## 1.1 The research domain

General context: Dependability in the context of mobile-based systems considering Connected Autonomous Vehicles (CAV) as an application.

Specific context: Reliability analysis approach for CAV. Applications on the basic safety message in Vehicular Ad hoc Networks (VANETs).

## 1.2 Background

The number of road traffic deaths continues to climb, from 1.25 million in 2013, reaching 1.35 million in 2016, according to the World Health Organization [1]. Connected and Autonomous Vehicles (CAV) are proposed as one solution to improve road safety, by eliminating driver-related accident-causing factors where human error is estimated to account for 94% of the total accidents [2]. Human errors that lead to crashes are many, such as inattentive driving, over speed, dozing off, and driving under the influence of drugs or alcohol (which amounts to 20% of the accidents) [3]. CAV systems will help the driver to avoid all these accidents or reduce their severity. The aim is to divide the percentage accident ratio by ten by employing full or partial automation penetration [4].

However, other than enhancing road safety, autonomous and connected vehicles have other important benefit such as human timesaving, reducing energy consumption and emissions, and giving social accessibility for disabled, elderly, handicapped and blind persons [5]. It may also facilitate mobility for youngsters. This marks a sign that we are at the dawn of a revolution in the world of transportation and mobility.

CAV imposes completely new modes of transport and promises many disruptions to transportation, but more importantly, will have political, legal, economic and ethical impacts—in which the dependability and the safety will play an essential part [6].

Transport is responsible for millions of tons of pollutant emissions, as well as a quarter of global energy consumption and CO<sub>2</sub> emissions in the atmosphere. The deployment of autonomous vehicles should significantly reduce the number of vehicles in circulation [7].

To develop these complex systems, which use emerging technologies and various scientific disciplines, it is necessary to understand the scientific and technological challenges obstructing the fast progress of CAV.

A strategic concern with automated driving at this phase of its growth is that it is not yet dependable and safe enough. This fast growing area provides great opportunities but also poses significant challenges from a dependability point of view. Currently, in VANET, most of the work carried out relates to the evaluation of the communication performance and for routing protocols, without taking into consideration dependability and operational safety of the system as whole. System reliability is greatly reliant on the availability of hardware and software components and their life time cycle. Given that this problem is relatively new for applications in the mobile environment using ad-hoc networks, the development of methods and models to assess the reliability of smart vehicles by the approaches of reliability and dependability analysis, that evaluate quantitative and qualitative measures characterizing the dependability of CAV, has become indispensable. However, a full understanding of how CAVs can fail and the causes of such failures is still needed.

This thesis evaluates this problem by enabling the designers of CAV to ensure that the selected system is well suited to fulfill the dependability requirements. We mainly take into account the impact of dependability on the self-driving services.

### 1.3 Problem Statement

An autonomous vehicle should also be a connected vehicle. To be autonomous; it must be able to communicate with other vehicles, as well as with the road infrastructure. In this thesis, we use the term CAV for a Connected and Autonomous Vehicle.

To gain a better understanding of the radical changes imposed by these intelligent vehicles, we first need to understand the specific features of a CAV. A collaboration between many different aspects of research, technologies, and sciences should take place. This includes safety and reliability engineering, automation techniques, artificial intelligence (AI), geo-location, mathematical modeling, robotic techniques, processing and multisensory fusion, telecommunications, networks, cybersecurity, and others...

Ad-hoc communications are present in wireless sensor networks (WSNs), for VANETs [8]. Communication in VANETs has many reliability challenges due to the high mobility, dynamic topology and different traffic patterns. Safety applications have strict latency constraints to the order of a few milliseconds, in addition to very high reliability and relevance requirements. Therefore, it is essential to establish a reliable communications platform.

One of the biggest challenges to introduce CAV is to achieve a sufficient level of reliability for the technology. For that, we analyze the reliability of CAV as a whole, and focus on the Basic Safety Message (BSM) and applications that necessitate appropriate and reliable transmissions for vehicle-to-vehicle (V2V) or with Road Side Infrastructure: vehicle to infrastructure (V2I) using Dedicated Short Range Communication (DSRC).

In vehicular networks, connected vehicles broadcast safety messages periodically that contain the vehicle identity, current location, velocity, acceleration and other useful information. For that, an analytical model for the reliability of BSM reception was proposed.

This thesis evaluates this problem by enabling the designers of CAV to ensure that the

selected system is well suited to fulfill the dependability requirements. We mainly take into account the impact of dependability on the self-driving services. Several dependability properties and quantitative measures were investigated and analyzed, with a particular focus on reliability and safety.

## **1.4 The contributions**

CAVs are targeted to improve safety in road. A CAV requires that a user must accept protective safety measures in the development process. The user should trust the vehicle and accept the possible risks; otherwise, it cannot be deployed in the market, before having a suitably sufficient level of reliability.

For any complex system such as CAV, it is essential to focus the analysis efforts on the most critical points.

To validate the potential risks related to the system, we should divide our CAV system into subcomponents. A comprehensive behavior study for each single component was achieved to establish the relationships between the components and overall system function. An analysis of the more critical components helps in developing a complete reliability analysis.

Safety applications in CAV extend driver knowledge about the surrounding environment and warn drivers of undesirable road conditions. For example, if the in-vehicle ABS is activated, it might indicate bad road conditions, and if this information is shared between vehicles, other vehicles are warned to take preventive actions before getting to a dangerous situation, for that BSMs are sent periodically. We aim in this study to increase the reliability of this safety message.

This dissertation mainly addresses the reliability in the context of mobile-based systems, considering CAV as an example. Particularly, within the scope of the thesis the following contributions have been made:

- A complete reliability analysis was developed by achieving a comprehensive behavior study between each component and overall system function, by using qualitative tools such as Preliminary Risk Analysis (PRA), External Functional Analysis (EFA), Internal Function Analysis (IFA), Failure mode, and Effects and Criticality Analysis (FMECA).
- A probabilistic fault-tree analysis tool was used to identify the reliability of the CAV and the potential risks. This qualitative analysis using the exponential probabilistic models of degradation can be used as feedback to redesigning the system.
- Analytical model to evaluate reliability and the connectivity of IEEE 802.11P based vehicle-to-vehicle (V2V) safety-related broadcast services in DSRC system on highway was proposed. Finally, an enhancement on the proposed model was suggested in order to increase the reliability of the V2V communication, the proposed model takes into consideration many parameters such as the hardware reliability, transmission range, vehicle density, safety headway distance, packet error rate, and noise influence.

## **1.5 Organization of the Dissertation**

### ***1.5.1 General presentation***

The Dissertation is structured in six chapters, including a general introduction, conclusions and perspectives. The first chapter provides a general introduction and information about the problem statement, the objectives and the contributions. The second chapter provides an overview of the main concepts of CAV and their challenges and influences. The third chapter proposes global and qualitative study of dependability of CAVs. The fourth and fifth chapters present the Fault Tree Analysis, and the probabilistic models of degradation for the CAV components. Simulation results for the proposed analytical model concern the V2V connectivity for the BSM are presented in the fifth chapter. Finally, we present conclusions and perspectives in the sixth chapter.

### **1.5.2 Global view**

- Chapter 1: General Introduction.
- Chapter 2: CAV: influences and challenges.
- Chapter 3: Global qualitative study of dependability of CAV.
- Chapter 4: A fault tree analysis for the reliability CAV.
- Chapter 5: Reliability and Connectivity Analysis for BSM in CAV.
- Chapter 6: Conclusions & Perspectives.

### **1.5.3 Chapter Contents**

#### ***A. Chapter 1: General Introduction***

This chapter provides information about background and motivation, problem statement, the objectives and contributions of the dissertation.

#### ***B. Chapter 2: CAV influences and challenges.***

This chapter presents the main concepts of CAV, The economic, social, ethical and legal impact of a CAV deployment, in addition to the technological and scientific challenges of CAV.

#### ***C. Chapter 3: Global qualitative study of dependability of CAV***

In this chapter, we present in details our reliability analysis approach in CAV. We explain the functional and dysfunctional analyzes of the system. The proposed analysis focuses on the safety and reliability components of CAV. Hence, the analytical tools dedicated to the forecast reliability must be implemented using the most suitable tools are such as PRA, EFA, IFA and FMECA.

#### ***D. Chapter 4: A Fault Tree analysis for the reliability of CAV***

In this chapter, we present the fault tree and the probabilistic models of degradation for the CAV. Using data concerning the failure rates from a professional database an exponential

model of reliability was proposed. After simulation, an improvement on the fault tree was suggested concerning the reliability parameters, and a redesign proposal is developed for the components.

***E. Chapter 5: Reliability and Connectivity Analysis for BSM in CAV***

CAV must be able to communicate with other vehicles, as with the infrastructure road. For that, in this chapter, we represent a connected vehicle environment in order to assess the reliability of V2V communication applications by proposing an analytical approach to evaluate reliability and the connectivity of IEEE 802.11p based vehicle-to-vehicle (V2V) for safety-related broadcast messages, in a DSRC system on highways. The proposed model takes into account many factors that affect the wireless communication in the vehicular environment, such as transmission range, vehicle density, safety headway distance on highway, packet error rate, noise influence and failure rates of DSRC hardware equipment.

***F. Chapter 6: Conclusions and Perspectives***

In this part of the dissertation, we present the summary of the work and future work, i.e., perspectives are listed at the end of the chapter.



# Chapter 2 - CAV: influences and challenges

---

<b>CHAPTER 2 - CAV: INFLUENCES AND CHALLENGES</b> .....	<b>21</b>
<b>2.1 INTRODUCTION</b> .....	<b>23</b>
2.1.1 <i>What is an autonomous vehicle?</i> .....	23
2.1.2 <i>What is a connected vehicle?</i> .....	25
2.1.2.1 <i>VANETs applications</i> .....	26
2.1.2.2 <i>Safety applications</i> .....	27
2.1.2.3 <i>User applications</i> .....	27
<b>2.2 CONNECTED AND AUTONOMOUS VEHICLES (CAV)</b> .....	<b>27</b>
2.2.1 <i>The advantages of CAV</i> .....	28
2.2.1.1 <i>Road safety</i> .....	28
2.2.1.2 <i>Protect the environment</i> .....	28
2.2.1.3 <i>Improve the way of life</i> .....	29
2.2.1.4 <i>Allow people with disabilities to move more easily</i> .....	29
2.2.1.5 <i>Save time and money</i> .....	29
2.2.2 <i>CAV: How does it work?</i> .....	29
2.2.3 <i>Conditions for CAV Deployment</i> .....	31
2.2.4 <i>Example of existence and revolution</i> .....	32
<b>2.3 THE ECONOMIC, SOCIAL, ETHICAL AND LEGAL IMPACT OF A CAV DEPLOYMENT</b> .....	<b>33</b>
2.3.1 <i>The Economic impact</i> .....	33
2.3.1.1 <i>Platform for new services</i> .....	34
2.3.1.2 <i>New automobile industry</i> .....	34
2.3.1.3 <i>New business model</i> .....	35
2.3.1.4 <i>Improve preventive maintenance</i> .....	35
2.3.1.5 <i>No need to own a personal car</i> .....	35
2.3.2 <i>Social impact</i> .....	36
2.3.2.1 <i>Sharing CAV</i> .....	36
2.3.2.2 <i>Mobility and Quality of Life</i> .....	36
2.3.3 <i>Ethical impact</i> .....	37

2.3.3.1	Ethics of driving	37
2.3.4	<i>The ethical dilemma</i>	37
2.3.5	<i>Legal impact</i>	38
2.4	THE TECHNOLOGICAL AND SCIENTIFIC CHALLENGES OF CAV	39
2.4.1	<i>Challenges related to autonomous navigation</i>	39
2.4.1.1	Sensors	40
2.4.1.2	Environment interpretation	41
2.4.1.3	Planning routes	42
2.4.1.4	Planning maneuver	43
2.4.1.5	Vehicle-user interactions	43
2.4.1.6	Trajectory planning	43
2.4.1.7	High level control-command	44
2.4.2	<i>Challenges related to integration and dependability</i>	45
2.4.2.1	The design of embedded architectures	45
2.4.2.2	The formal proofs of the algorithms	45
2.4.2.3	Hardware and software optimization	45
2.4.2.4	Resilience, fault tolerance, uncertainty management	45
2.4.2.5	Physical systems security and reliability	46
2.4.3	<i>Reliable communication between vehicles</i>	46
2.4.4	<i>Cybersecurity</i>	47
2.4.5	<i>The Big Data Processing</i>	48
2.4.6	<i>Validation of the CAV system</i>	49
2.4.7	<i>The modeling of large systems: road traffic and fleet management</i>	50
2.5	STATE OF ARTS	51
2.6	CONCLUSION	57

## 2.1 Introduction

Autonomous vehicles will increasingly rely on connectivity to have the ability to receive and transmit data from the external environment in order to achieve autonomy. The two technologies can be complementary and with the technology convergence, will result in intelligent vehicles that are both connected and autonomous [9].

This vehicle will radically change the way we move. Its deployment will have an impact on the evolution of society in terms of security, environment, urbanism ... The automotive industry itself, to produce vehicles in which telecommunications and AI will play a decisive role, is in the process of undergoing a profound transformation, and is already seeing the arrival of new players from the digital world.

### 2.1.1 What is an autonomous vehicle?

The autonomous vehicle is able to move safely due to its ability to sense its surroundings and to detect and identify objects and landscape around it. The fully autonomous vehicle is entirely driven by AI. It is able to go alone, interact with its environment and adapt its behavior according to events (accidents, road works ...) and other road users (cars, pedestrians, cyclists ...). This means that it can move to a certain place without human intervention. While some current prototypes approach these circumstances in certain particular situations, they do not yet cover all the real cases [10].

There are two main standards of automation classifications. The international Society of Automotive Engineers (SAE) and the US National Highway Traffic Safety Administration (NHTSA). The main variance is that SAE is using a six-level scale for defining the stage of automated driving, while NHTSA is using five. Later NHTSA accepted SAE standard and published it. For that reason, this thesis will use SAE standard that classified AV into six levels [11].

- Level 0: no automation. The driving is entirely under the responsibility of the driver that should control the braking, the steering, the throttle, and the motive power.

Driver's responsibilities: the human driver is responsible for the full-time performance of all aspects of driving task. He is responsible for the safe operation of the vehicle and has to monitor and be aware of the traffic around the vehicle.

- Level 1: also called driver assistance automation, the driver is always responsible for the maneuvers, but delegates some of the tasks to the system, typically for the longitudinal control of the vehicle, for example through: adaptive cruise control (ACC), lane-keeping assistance (LKA) and electronic stability control (ESC). It can be referred to as a traffic jam assistant that keeps the vehicle in a flow.

Driver's responsibilities: The driver is fully responsible for the overall control of a vehicle and its safe operation. He can turn on the driver assistance and hand over the control of the vehicle to a system in a specific occasion. He must be able to fully regain control over driving if the situation requires it.

- Level 2: also called partial automation, the maneuvering responsibility is delegated to the system, but everything is done under constant supervision of the driver, who can decide to take back the hand at any time, for example during an automatic lane change. Another illustration is Parking Assist, which is activated only when a parking space is detected or selected by the driver.

Driver's responsibilities: the driver must still pay attention to driving conditions at all times and take over immediately if the conditions exceed the system's limitations, of which there are many.

- Level 3: called conditional automation, the driver can delegate driving on both the guiding dimensions (longitudinal and lateral) and can lower his level of alertness to focus on other tasks. The intelligent piloting system then takes care of positioning and maintaining the vehicle on its

track while maintaining a pace adapted to the speed and traffic conditions. Level 3 can sense and identify the traffic signs, red lights thus being able to operate in urban areas, but it may have difficulties in sensing surroundings in different weather conditions.

Driver's responsibilities: The driver must remain able to regain control of the operation if the conditions require it, but only after a warning and a short transition time.

- Level 4: highly automated Level: an automated driving system performs all dynamic tasks of driving, e.g., monitoring of the environment and motion control... On the other hand, this level concerns only certain modes of driving, and under certain conditions. For example, AV may be limited to travel only on specific roads or under certain weather conditions. The Waymo (Google car) is an example of such vehicle.

Driver's responsibilities: the driver no longer intervenes and can completely divert his attention to do something else. The driver activates and deactivates the automated mode and he is capable of getting full control of the vehicle's safety-critical functions under certain scenarios.

- Level 5: it is the ultimate or full automation: all the driving functions of a vehicle are completely automated and performed safely without the need for human interaction. Everything is under the responsibility and control of the system in all scenarios, on any road and under any condition. The presence of a human being at the controls is no longer necessary.

Driver's responsibilities: The human driver does not intervene any more, neither in the control, nor in the supervision of the task of driving or navigation. In this case, the driver acts as a passenger, he can request the car on demand by his phone to his desired location.

### **2.1.2 What is a connected vehicle?**

A connected vehicle (CV) integrates wireless telecommunications systems that allows it to collect information that it can record, process, operate and relay to other vehicles, or send to

the road infrastructure. The data collected by the vehicle are numerous and varied. Some data is related to the security of the route, such as distance information with another vehicle measured by a radar, or geo-location data. Other data concerns the experience on board, for example, the transfer of music stored on a smartphone or a film ... [12].

Connecting vehicles is realized through a topology known as vehicular networks or vehicular ad-hoc networks (VANETs), which provides communication between Vehicle-to-Vehicle (V2V) and Vehicle to Roadside unit (V2R) communication in order to increase driver/vehicle safety, transport efficiency and comfort. These vehicles will be connected using dedicated short-range communication (DSRC) radios, operating in the FCC-granted 5.9 GHz band for DSRC with a bandwidth of 75 MHz and very low latency for the safety-critical applications [13].

However, due to some limitations on quality of service (QOS), and unbounded channel access delay for this technology, a focus on leveraging the high penetration rate of long-term evolution (LTE) and 5G cellular networks has initiated to support vehicle-to-everything (V2X) services [14]. It is easy to imagine that future CV will process up to several gigabytes of data per second.

Since 2017, by decision of the European Union, all new vehicles must be connected in order to automatically make emergency calls in case of an accident: this is the e-Call service. By 2020, it is estimated that 80% of the car fleet will be connected [15].

### 2.1.2.1 VANETs applications

Applications in VANETs can be categorized into two main classes, i.e., user or comfort applications and safety applications [16] [17]. However, safety and user applications are not completely separated from each other. For example, a message generated for accident can be seen as a safety and urgency message from the perspective of nearby vehicles. The same can

message can be seen by farther vehicles as an informative message to choose an alternative optimal route with lower traffic jams [18].

#### 2.1.2.2 *Safety applications*

Safety messages are time-critical; they play a significant role in reducing the number of accidents. The goal is to improve the safety level of passengers by exchanging safety relevant information between vehicles, which are required to disseminate warnings immediately to avoid probable accidents and traffic congestions [19].

Typically, safety applications can be classified to 4 types: accident warnings, intersections warnings, road congestion warnings, and passive safety applications.

Safety information should be disseminated to other surrounding vehicles in order to inform and eventually take preventive actions. It gives an early warning to the drivers by giving an alert message of any accident down the road, thus preventing further accidents by giving some extra time for the driver to react. Another example would be a vehicle having an embedded traffic detection sensor, which can disseminate current traffic state to other vehicles to avoid the congested area [18].

#### 2.1.2.3 *User applications*

In general, comfort related applications aim at improving passenger comfort and traffic efficiency, e.g. traffic-information, weather information, gas station or restaurant locations, advertisements and other Internet services [20]. User applications can provide road users some valuable information, traffic-information, weather information, entertainment services, advertisements, gas station or restaurant location etc. Parking availability services and Internet connectivity are examples of user applications.

## **2.2 Connected and autonomous vehicles (CAV)**

An autonomous vehicle is a vehicle that is, in the broadest sense, capable of driving itself

without human intervention. A connected vehicle is a vehicle with technology that enables it to communicate and exchange information wirelessly with other vehicles, infrastructure, other devices outside the vehicle and external networks.

Connected driving can be regarded as a cooperative intelligent transport system [21] that accelerates the introduction of automated driving significantly. Cooperative and CV can lead to improved traffic, because it enables approaches for collective learning to identify and resolve inappropriate behavior and driving strategies quickly.

CAVs have two essential features; namely, automation capability and cooperation (connectivity). By integrating connected vehicle (V2V and V2I communication) with autonomous vehicle technology, an effective cooperative driving network can be recognized [22]. Hence, in this thesis we use the terminology: connected and autonomous vehicles (CAV) that leverage autonomous and connected vehicle capabilities.

### ***2.2.1 The advantages of CAV***

CAVs bring plenty of potential benefits. Driverless vehicles are designed to make lives easier and safer by:

#### **2.2.1.1 Road safety**

Safety is a primary goal for driverless vehicles. The National Highway Traffic Safety Administration (NHTSA) declares based on data from the Fatality Analysis Reporting System (FARS) that in 2016 there were an estimated 7,277,000 police-reported traffic crashes the United States, in which 37,461 people were killed and an estimated 3,144,000 people were injured [23]. Many accidents happen because of human error. The expected result is to reduce fatal accidents using CAVs.

#### **2.2.1.2 Protect the environment**

CAVs can be very beneficial for the environment. They consume less energy and reduce



operational CO<sub>2</sub> emissions, unlike a vehicle driven by a human being. Generally, most gas burned when driving at high speed, braking or accelerating too fast. Autonomous vehicles eliminate these factors from their driving style, which reduces air pollution [7].

### 2.2.1.3 **Improve the way of life**

Driverless technology will assure travel comfort. It will have profound impact on every person in the community by reducing stress related to driving where they could rest, read a book, surf the web, watch a movie, or talk with other passengers or work while traveling.

### 2.2.1.4 **Allow people with disabilities to move more easily**

All people who cannot drive (People with disabilities, elderly, teenagers) can enjoy the benefits of autonomous driving with increased freedom and mobility. In USA 79 percent of seniors age 65 and older live in car-dependent communities [24].

### 2.2.1.5 **Save time and money**

Due to their integrated electronic system and locators, CAVs are able to predict the shortest and most economical paths. Many hours wasted in traffic every day, when an automated car takes over driving responsibilities, are saved by drivers who can take advantage of this time to do other things [25]. In addition, thanks to the communication system between the vehicles, the traffic could be fluidized and thus avoid traffic jams. Finally, CAV may save money also through the partial or total disappearance of insurance since they are safer and more reliable.

## 2.2.2 ***CAV: How does it work?***

Autonomous cars have become a reality. They work through a combination of miniature sensors and a powerful embedded computing AI systems.

A fully autonomous car is equipped with several hardware elements (sensors) and software that cooperate automatically thanks to an AI. CAV operates independently, but it is in relation with its environment due to the autonomous system (computer of the car). The autonomous

system responds to a long series of algorithms based on the information that it receives. Each algorithm has its level of importance based on the situation. Therefore, AI is the engine of the functioning of the autonomous car.

To be autonomous, CAV asks various information that are given to it by different sensors (Fig. 2-1). These new vehicles include many sensors: Cameras that detect obstacles, traffic lights and signs, radar that detects long-range obstacles, and an ultrasonic rangefinder that detects short-range obstacles, and Light Detection and Ranging (LIDAR) that measures the distances between obstacles.

CAV also needs a central inertia that detects if the car is moving without a satellite connection, an anti-crossing system that detects if the car is still online and a Global Positioning System (GPS) that geolocates the car for routing the path.

The software using the AI is the "brain" of each autonomous car as it processes data of each sensor. It is with deep learning and analyzing sensor data that the car can build a 3D map of everything around it to make the best decisions.

This AI requires enormous computing power because the data collected is massive: each sensor sends information continuously and this information must be interpreted by AI software. For example, cameras record at least 30 frames per second (30 fps), each of which consists of thousands of pixels and their colors. These pixels must be processed to determine if a panel is present, or if a car arrives etc. The amount of data to be processed is monumental. For all that, the AI is able to process all the data in order to make decisions then it orders the actuators that are responsible for the vehicle control such as breaking, accelerating, steering.

In particular, this quasi-instantaneous decision-making capability will eventually make autonomous vehicles more reliable than human drivers.

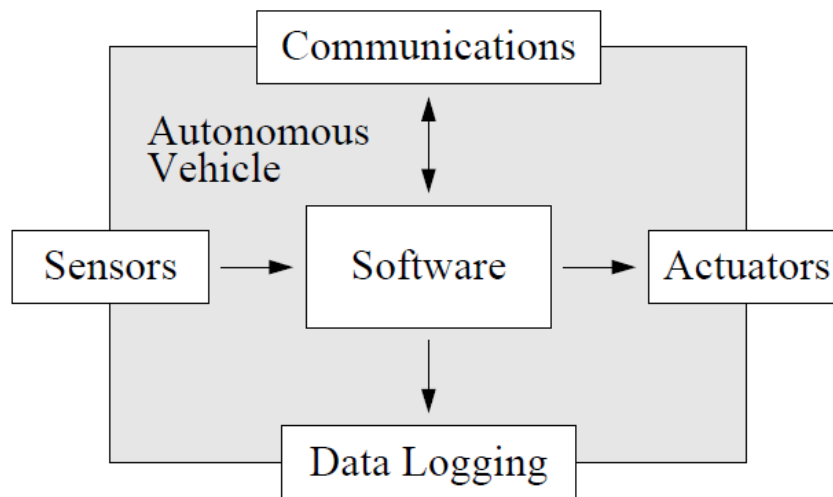

Figure 2-1 General view of CAV

### 2.2.3 Conditions for CAV Deployment.

The evolution towards autonomous vehicles is inevitable, and it will affect all manufacturers in transportations sectors such as: stockholder of vehicles, equipment manufacturers, transport operators, software publishers or manufacturers of electronic components. However, to be deployed on a large scale, CAV will have to:

1. Achieve a level of technological maturity that meets the reliability and the security requirements [26]. CAV is an assembled systems "system of systems" - the majority of components are sensors that interact with the software. A first challenge will be to ensure the dependability of the vehicle by studying the reliability and fault tolerance of the systems that make it up [27]. Two main locks must be lifted:

- The management of uncertainties, in embedded devices that interact with the environment, whether in terms of location, perception, or decision-making.
- Dependability: Whatever the disruption, the system must continue to operate with the required level of security. The solution involves design optimization and verification, testing, and validation.

2. Ensure the interoperability of different systems, through cooperative infrastructures, standards and norms, certification, etc. [28].

3. Offer new mobility services [29].
4. Guarantee their economic viability [30].
5. Enter into a defined legal and regulatory framework, nationally and internationally [31].

Other important considerations concern the deployment of the underlying infrastructures necessary for the large-scale operation of CAVs: first, a wireless vehicular network that satisfies - in terms of bandwidth and latency - the enormous data needed to be transferred, and also, depending on the operating models that will emerge, the installation of signposts or dedicated lanes [32]. It can be noted that the use of CAVs could develop at different speeds in urban and rural areas: better network coverage and more infrastructure can provide richer features in the city, at least initially.

#### ***2.2.4 Example of existence and revolution***

The California Department of Motor Vehicles (CA DMV) is the state agency that registers motor vehicles and issues driver's licenses in the U.S. state of California, and is responsible for permitting and monitoring the testing of autonomous vehicles [33].

At the time of writing (June 2019), 61 AV testing permit holders acquired permission from the DMV to begin testing on California public roads, listed by the date the permit was issued: Volkswagen Group of America, Mercedes Benz, Waymo LLC, Delphi Automotive, Tesla Motors, Bosch, Nissan, GM Cruise LLC, BMW, Honda, For, Zoox, Inc, Faraday & Future Inc, Baidu USA LLC, Valeo North America, Inc., NIO USA, Inc., Telenav, Inc., NVIDIA Corporation, AutoX Technologies Inc, Subaru, Udacity, Inc, Navya Inc., Renovo.auto, PlusAi Inc, Nuro, Inc, CarOne LLC, Apple Inc., Pony.AI, TuSimple, Jingchi Corp, SAIC Innovation Center, LLC, Almotive Inc, Aurora Innovation, Nullmax, Samsung Electronics, Continental Automotive Systems Inc, Voyage, CYNGN, Inc, Roadstar.Ai, Changan Automobil, Lyft, Inc., Phantom AI, Qualcomm Technologies, Inc. ,SF Motors Inc., Toyota Research Institute, Apex.AI, Intel Corp, Ambarella Corporation, Gatik AI. Inc., DiDi Research America LLC,

TORC Robotics Inc, Boxbot Inc, EasyMile, Mando America Corporation, Xmotors.ai, Inc., Imagry Inc., Ridecell Inc., AAA NCNU, ThorDrive Inc, Helm.AI Inc, Argo AI, LLC.

The original draft of the DMV regulation for deployment prohibited manufacturers from selling driverless fully autonomous vehicles, allowing deployment of only semi-autonomous vehicles with a back-up driver. Recently, DMV approved testing driverless autonomous vehicles on public roads starting April 2018. However, in 2018 all the listed holders were still doing their testing in the presence of a backup driver [33].

The arrival of autonomous cars is already shaking the world of the automotive industry. As noticed above, major manufacturers and traditional equipment manufacturers are still present (Volkswagen, Mercedes Benz, Nissan, GM, BMW, Honda...) but new players have joined them. The big digital groups, like (Google –Waymo, Tesla, AppleInc. NVIDIA...), have become the first partners of the automobile industry, and very soon they will become their main rivals. For the first time after 100 years of existence, the mechanics and the thermal are no longer the alpha and the omega of a car. The engine risk becoming simple and valueless, while all focus is currently on computerization. Due to the mass of data collected by connected vehicles from sensors, manufacturers will be able to improve the design of cars, and develop new activities by creating new services, for example, predictive and preventive maintenance of vehicles will definitely be improved by reading and analyzing collected data.

## **2.3 The Economic, social, ethical and legal impact of a CAV deployment**

CAV will not only be a system of great technological complexity, its large-scale deployment will induce profound changes in the functioning of society, which will affect the organization of cities, transportation means, civil liability, and industry.

### ***2.3.1 The Economic impact***

The revolution in the different uses of this type of vehicles will also renew the traditional

form of the automobile and its core functions.

### 2.3.1.1 Platform for new services

Traditional Vehicles were designed to be driven by human beings, for private and family use. However, in an autonomous car, there is no need, for instance, to have front seats and rear seats: all seats could instead face each other to allow passengers to exchange in more user-friendly ways. We can also imagine vehicles with work tables, large windows to contemplate the landscape, coffee machines ... Mercedes-Benz presented in January 2015 a concept car offering such an approach [34]. Start-up manufactures such as Zoox are also working on this. From the moment human beings are exempted from the need to drive, the cabin of the car can be thought of as a platform of services intended for users [35].

### 2.3.1.2 New automobile industry

The arrival of autonomous cars is already shaking the world of the automotive industry. Major manufacturers and traditional equipment manufacturers are still present, but they are joined and already jostled by new players. However, it is also the big digital groups, like Google (Waymo), Uber, Apple and Microsoft, who become the first partners of the automobile industry, and very soon their main rivals.

The major suppliers of chips and processors, NVidia, Qualcomm or Intel, are also key players in the development of autonomous vehicles. Intel, for example, bought Mobileye, a specialist in smart cameras for the car for \$ 14.7 billion [36]. Many start-ups are working on features and components specific to the autonomous car, such as cartography (Civil Maps, Here), smart cameras (Mobileye), LIDAR sensors (Velodyne, Quanergy, Innoviz, leddarTech, AI(Drive, AI, Nuro.AI, Nauto, Five AI, AIMotive, ...).

### 2.3.1.3 **New business model**

A car has traditionally been something private, whether in the form of taxis or shared cars, a convergence between public and private transport will occur. All the automotive players, manufacturers and equipment manufacturers, dealers, repairers, renters will have to rethink their business model [37]. The value chain should gradually migrate to software providers and mobility service providers.

### 2.3.1.4 **Improve preventive maintenance.**

For the first time after 100 years of existence, the mechanics and the thermal engine are no longer the most important modules for the car. The engine risk is becoming simple and valueless, while all focus in now is on computerization. Due to the mass of data collected via CAV from sensors, manufacturers will be able to improve the design of cars, and develop new activities by creating new services like the predictive and preventive maintenance of vehicles by reading and analyzing this data [38].

### 2.3.1.5 **No need to own a personal car**

The real revolution in progress is that of the uses of the smart automobile. The success of car sharing companies like Blablacar, Uber, or Lyft, gives an idea of the changes to come. With CAV, it will be very simple for a city-dweller to travel by ordering a vehicle via an application, this vehicle that will move on its own to the client, has a much lower cost than owning an individual car. With an upcoming advanced technology of autonomous vehicles, ride-hailing service providers will challenge the current model of personal vehicle ownership. In fact, with the progressive replacement of private cars by "on-demand" vehicles, the ownership link between the driver and his vehicle will change [39].

### **2.3.2 Social impact**

CAV will be an essential component of future smart cities.

#### **2.3.2.1 Sharing CAV**

Indeed, with the new transport services, being collective or private, intensively using shared autonomous vehicles will significantly reduce the number of cars circulating in the heart of crowded cities. This explains the interest of many cities in the world to pilot autonomous shuttles or taxis (or "robot-taxis").

A 2013 study by Columbia University shows the dramatic effects that can be expected from the introduction of shared AVs in a city. For the city of Ann Arbor, Michigan, whose population of 285,000 has 200,000 vehicles, the authors of the study calculated the size of the shared fleet that would be needed to meet the mobility needs of the entire community for the population, without imposing too long waiting times. With only 18,000 vehicles, the fleet of autonomous and shared vehicles would allow an average waiting time of less than one minute, for a vehicle utilization rate of 70% during the hours of the day. Another study made for New York City by MIT has showed that introducing shared vehicles can diminish the vehicle fleet by 80 percent [37]. Noting that decreasing the number of vehicles leads to increasing safety by reducing the potential accidents. Diminishing the number of vehicles in a city has many other benefits like less traffic jam, wasted time, and air and noise pollution.

#### **2.3.2.2 Mobility and Quality of Life**

Level 5 of the CAV could even lead to eliminating the need for driver's licenses. For the long term, one imagines that children could go alone to the school in autonomous shuttles and disabled people will benefit from increased mobility.



### **2.3.3 Ethical impact**

The arrival of "smart vehicles" also raises ethical questions. Due to its high technicality and the wide diffusion, autonomous and connected vehicles poses the traditional questions usually related to technology and digitization in the society: security, responsibility, decision-making by AIs, security of the communications, respect for privacy and personal data, etc...

#### **2.3.3.1 Ethics of driving**

If it were necessary to enact a first ethical principle of CAV, it could be expressed as follows: the development of autonomous and connected vehicles is justified only if it results in a substantial reduction in the number and severity of road accidents.

Even if the perception of the environment and risks by a CAV, given the technologies already available, would become better than that of humans, it will still be impossible to completely prevent accidents. The deployment of automated vehicles will create a new situation to which governments, enterprises and society as a whole must prepare.

### **2.3.4 The ethical dilemma**

The crucial ethical question for a CAV is already clear. When a vehicle is confronted with two driving options that both pose a risk to human life - for example, hitting another vehicle or changing direction at the risk of mowing pedestrians - what will the decision be and how should it be made? Can we entrust AI with the task of settling this dilemma?

A decision made by a CAV, without human intervention, is ultimately only the result of the execution of a computer program: who will define the ethical rules included in this program? Who will verify that the databases used for learning AIs are sufficient and do not induce bias? The problem is similar to the one that already arises for robots or for AI programs, but with consequences, in the case of CAV, which can be dramatic. No one today has answers to these questions. However, it is now necessary to ask them.

For this purpose, The Ethics Commission of the Federal Minister of Transport and Digital Infrastructure in Germany, proposed a set of twenty ethical rules to follow for the development of CAVs, under the name of “Ethical rules for automated and connected vehicular traffic” [40].

### **2.3.5 Legal impact**

When an autonomous vehicle automatically takes, without human intervention, decisions that engage the safety of passengers, pedestrians and other vehicles, who is responsible for the consequences? The transfer of responsibility for driving from the driver to manufacturers or manufacturers of "smart" components of the CAV is a new issue for not only lawyers, but also for insurers.

However, even with the many questions cited above which have no clear answers, we could expect many other economic and social benefits of CAVs such as:

- Creating new jobs, in automotive manufacturing, as example in UK by 2030, the global economic benefits of CAVs are expected to £51 billion per year, and the economic revenue of adjacent industries such as digital services, telecoms, technology, and freight will be £16 billion yearly [30].
- Saving lives and preventing serious crashes, the use of technology such as, low-speed autonomous emergency braking (AEB), has led to a 38% reduction in real world rear-end accident [41].
- Cleaner mobility and reduced emissions of at least 20% of CO<sub>2</sub> by using connected cars [42].
- Improved traffic flow and efficiency and reduced fuel consumption [43].

## 2.4 The technological and scientific challenges of CAV

The design and development of autonomous and connected vehicles with an increasingly high level of autonomy poses tremendous technological and scientific challenges. Mathematics, system engineering, software engineering, AI and dependability including reliability and cybersecurity are among the major areas of digital science involved. We can group the different areas related to the development of CAVs into three distinct categories:

- **Autonomous navigation:** algorithms and functions necessary for decision-making and navigation, from sensor to locomotion should be dependable and ensure road safety.
- **Reliability of the Integrated and embedded systems:** aspects related to the practical integration of software, functional architectures, and real-time connectivity taking into consideration the cybersecurity risks.
- **Modeling - wide scale integration:** modeling of traffic and interactions between CAV and users. Aspects of data collection and data mining, remote diagnosis, large-scale simulation, intelligent mobility, etc...

It should be noted beforehand that to meet most of these challenges, a reliable wireless network coverage and high QOS guarantee would be required. Without minimal bandwidth and especially limited latency, a CAV will not work properly. This problem will most certainly be limited in urban areas but crucial in areas which lack effective network coverage. Of course, the 5G new technologies deployment will be one of the main motives for the connected car, and it will increase the performance, but having a reliable communication is a much more complex. In the below sections, we tackle the main scientific and technological challenges related to the CAV.

### 2.4.1 Challenges related to autonomous navigation

In order to navigate autonomously, without a pilot, CAV must do the below:

- 1) Perception: perceive the environment using multiple sensors [44].
- 2) Planning: analyze and interpret the received data based on perception, and localization and mapping information [45].
- 3) Decision Making and Vehicle Control: make decisions related to driving the vehicle to do the appropriate action such as acceleration or steering [46].

Achieving these functions faces multiple scientific and technological challenges related mainly to the constraints of real time processing.

#### 2.4.1.1 Sensors

Currently available sensors should have sufficient reliability, even in rough environments such as bad weather conditions (snowy roads, rainy or dusty weather), to enable fully autonomous driving. Many challenges concerning the sensors face the CAV development.

##### *A. Multisensory perception*

CAV must be able to detect and identify all the fixed or moving objects in its environment: vertical (traffic lights, signs,) and horizontal signs (zone markings, stop lines, etc...), pedestrians, other vehicles, any objects on the road ... CAV should also follow and predict the changes of locations of objects and people over time. It must finally establish a map of the environment, and locate its own position on a local and global map [47].

These functions are achieved through multiple sensors, and algorithms to analyze the scene from the data collected.

##### *B. Data storing and processing in real time*

In order to assure a certain degree of autonomy, a vehicle should be equipped with multiple sensors: radars, ultrasonic sensors, several cameras, LIDAR, and GPS. A first challenge will be to be able to process and store, in real time, the large amount of data generated by the

multiple sensors of the vehicle.

### ***C. Reliability of the sensors:***

The reliability of the sensors remains a major challenge today. All sensors have limitations that make them unusable under certain conditions: masking, reduced range, bias, inaccuracies, bad weather ... In addition, the failure of a sensor can arise at any time.

We explain in the next chapter diversified redundancy and multisensory fusion, which combines data provided by different sensors to obtain relevant global information, multisensory fusion is an effective way of addressing this problem.

#### **2.4.1.2 Environment interpretation**

Environment interpretation through multiple sensors remains a difficult issue in the development of navigation systems. As the sensors are imperfect, it is necessary to develop reliable and efficient multi-sensor fusion schemes, in order to achieve a geometric modeling of the vehicle environment, and a semantic modeling (the identification of perceived objects: tapes and traffic lane, signs, pedestrians, other vehicles ...) allowing a complete understanding of the scene.

The advancement of AI algorithms will be one of the main driving forces for CAVs, particularly the deep learning methods (DL). It is common for the perception and the interpretation of the scene for CAVs to be built using machine language (ML) methods that are used for decision making at different levels. However, ML/DL techniques have been recently found vulnerable to carefully crafted adversarial perturbations and lack on the vision system of autonomous cars [48].

### ***A. Objects and obstacles detection***

To understand the environment, CAV must first recognize objects and obstacles. Whatever the objects to be detected (pedestrians, vehicles, panels); it is the Machine Learning techniques

that currently give the best results. Deep learning is considered very promising, provided it has a sufficiently important learning base. Many databases already exist for various types of objects including vehicles, pedestrians, and road signs. Among those devoted to pedestrians, we find that of Daimler (Daimler Pedestrian Detection Benchmark), Caltech, and Inria [24].

### ***B. Local and global localization***

The fusion of GNSS (satellite location), inertial unit, and odometers and / or magnetic compass data is currently quite widespread. Methods have been developed to refine the location by relying on onboard sensors [22]. Localization in urban environments is a problem now almost solved by means of Simultaneous Localization and Mapping (SLAM), which consists of building or improving a map of its environment and simultaneously locating it [49].

On the other hand, locating a vehicle in an open environment like a highway remains a challenge. Research is moving towards methods that combine proprioceptive (that perform local measurements) and exteroceptive (that measure the global environment) sensors [50]. The challenge is to provide a localization solution with a precision at the scale of meter, or even decimeter.

#### **2.4.1.3 Planning routes**

Today, route planning is based on well-mastered techniques. However, it is now necessary to take into account new optimization criteria:

- The traffic model, for better estimation and forecasting of travel times;
- The consumption of each vehicle according to the topology of each segment of the journey and the state of the traffic, in order to optimize energy consumption and the emission of pollutants.
- Passenger comfort, for example by minimizing traffic in "at-risk" locations, rough roads, or with many intersections and roundabouts.

#### 2.4.1.4 **Planning maneuver**

The autonomous vehicle must decide on the maneuvers to be undertaken according to the planned route, the current road situation and the condition of the driver or the vehicle. For example, it will decide whether to overtake and whether to trigger an emergency stop (driver in distress, breakdown, impending collision).

Several approaches exist to develop decisions. Fuzzy logic, for example, is often used to develop decision trees, usually based on established or learned rules. Decision schemes can also be developed using multi-criteria optimization techniques.

Work on maneuver planning is beginning to yield interesting results even if they are still limited. Thus, they are generally only for multi-route roads with a single direction. On two-way roads, the profiles of vehicles arriving in the opposite direction should be taken into account and, therefore, added to the risk assessment calculation. It is also necessary to work on even more restrictive road configurations, such as intersections and roundabouts, which require more elaborate decision patterns. This will likely involve the integration of behavioral patterns of motorists arriving at these intersections.

#### 2.4.1.5 **Vehicle-user interactions**

When an autonomous vehicle passes on an urban road with more or less dense traffic, it is necessary to take into account the interactions with its users. AI will allow developing better behavioral models and human-machine interfaces in the future, which can be integrated into vehicle decision systems.

#### 2.4.1.6 **Trajectory planning**

The planning of geometric trajectories of autonomous vehicles has greatly benefited from the methodologies developed for autonomous mobile robots. However, not all methods

developed for robots are immediately transferable to the autonomous vehicle, but should be subject to additional constraints. Thus, more and more planning methods are based on the modeling of behaviors and not on purely geometric prediction of trajectories.

The learning-based techniques (deep learning and others) are then implemented, with the idea of learning typical behaviors corresponding to different road configurations.

These learning techniques should also make it possible to develop typical driving profiles of the human driver in order to reproduce them during the development of the trajectories and the associated controls. Different profiles will be loaded into the central unit of the vehicle according to its intended use: school buses, private vehicles on the motorway, low speed urban shuttles, etc.

#### 2.4.1.7 High level control-command

The control-command methods, inspired by those developed for mobile robots, are put at the service of a vehicle control, which must optimally ensure:

- The stability of the vehicle;
- Passenger comfort, with constraints on longitudinal and lateral acceleration;
- Avoidance or catching of slips, control of skating.

The kinematic and dynamic models are different from those of a robot, but the theoretical frameworks are the same: control of non-linear systems, robust control, optimal control, fuzzy adaptive control, predictive control MPC (Model Predictive Control), etc. Specific control was also developed for convoy driving. Finally, the specific development of electric vehicles requires the development of corresponding models as well as adapted control laws in order to manage and handle charging needs for these vehicles [51].



### **2.4.2 Challenges related to integration and dependability**

In CAV, the software component will make up the bulk of production costs. The integration of software in a highly automated vehicle is therefore a major issue. Many points should be studied before a CAV is on the road:

#### **2.4.2.1 The design of embedded architectures**

CAV equipped with multiple sensors, must have real-time processing capabilities. Specific treatment units based on multicore processors are studied. However, designing and developing efficient on-board solutions remains a challenge.

#### **2.4.2.2 The formal proofs of the algorithms**

Algorithms are the basis of decision-making architecture. The validation of these algorithms, by means of formal proof methods, will be a legal and economic necessity (in particular, to reduce the costs during the prototyping and deployment phases).

#### **2.4.2.3 Hardware and software optimization**

Today, the few systems deployed in vehicles (for example at Tesla) incorporate only very few software components, compared to a global navigation or decision-making architecture. When millions of lines of code are embedded, it will be necessary to optimize the hardware and software architectures, and probably design dedicated hardware architectures.

#### **2.4.2.4 Resilience, fault tolerance, uncertainty management**

No system existing today, in a vehicle, knows how to handle failures and errors, whether they come from hardware, software or sensors. For an intelligent system to be reliable, the embedded architecture will have to be resilient. It will therefore be necessary, for example, to ensure a duplication of the functions performed by the embedded systems. This will require

not only the development of multiple solutions to perform the tasks, but also effective tools of supervision and scheduling.

#### **2.4.2.5 Physical systems security and reliability**

The security of computer and physical systems is an obligation. It is also necessary to secure the on-board telecommunications means in order to avoid any intrusion. Since the advent of the first advanced driver assistance systems (ADAS) on the market, many failures have led to "repatriations" of vehicles. These problems, due to a lack of quality, have led the automotive industry to seriously study ways to improve the quality of software development. This is the objective of ISO 26262, which establishes a formal framework for the implementation of this reform.

#### **2.4.3 Reliable communication between vehicles**

The deployment of CAV cannot be done without a deep adaptation of telecommunications networks, and without their security. The explosion of the number of communicating agents - the vehicles, or the computer servers of network management - will have a strong impact on the occupation of the communication channels, which are already largely saturated. In this perspective, the IEEE decided to allocate a frequency band around 5.9 GHz dedicated to vehicular applications (IEEE 802.11p).

Road safety requires a highly responsive and reliable exchange of information between neighboring vehicles, under any traffic conditions. The challenge, therefore, is to design reliable wireless communications in high-density scenarios.

Among the solutions currently studied, VLC (Visible Light Communication) technology provides wireless communication using visible light. Very well adapted to short distances, it was very quickly considered for autonomous vehicle applications traveling in convoy. However, for a more general use, it will be necessary to take into account the heterogeneity of

the networks of communication: cellular networks, mesh networks of weak power, WiFi (weak consumption) and Bluetooth (weak power) can answer various needs of communication of an autonomous and connected vehicle. Each, however, uses different tradeoffs between reliability, power consumption and throughput [52]. It is therefore necessary to study the limitations of each technology and to develop clear criteria for selecting the one that best suits each use.

The heterogeneity of communication networks also imposes the question of the transition from one technology to another ("handover"). This problem must be studied in the context of a dynamic and dense environment.

Finally, to avoid saturation of the networks, a possible solution is to better target the messages, thanks to geo-localized networking (or GeoNetworking: Geographic Addressing and Routing). It consists of restricting and disseminating the information communicated to a limited geographical area and optimized thanks to dedicated routing techniques.

#### ***2.4.4 Cybersecurity***

One of the major problems facing telecommunications today is that of vulnerability to attacks. For connected vehicles, the question of the integrity and confidentiality of information circulating on networks is a critical issue. The worst scenario that could be considered would be, for example, the remote control of a connected vehicle. Since CAV is planned to provide road safety, which is life-critical, thus ensuring the security of such vehicular systems is crucial.

This is why cybersecurity is becoming a priority for the transport industry. Means of protection already exist, but now they must be integrated into the vehicle development process.

Different types of attacks can affect CAV networks at different layers. In the application layer, attacks can threaten the integrity, confidentiality, authenticity, and availability of a specific vehicular application [53]. Moreover, CAV is vulnerable to denial of service (DoS)

or distributed denial of service (DDoS) attacks, by channel jamming that causes disconnection in the communications network over a geographic area [54].

Cyber security solutions must ensure:

- Firewall functions in interfaces with external networks, intrusion detection and protection;
- securing internal communications, communications between the vehicle and information systems, or communications between vehicles, by encryption [55]. To protect them against unauthorized use and to ensure messages' integrity, digital signatures can be used [56].

- The "hardening" of embedded computers (data and program protection);

- Preserving the privacy of vehicles and drivers is very important for this vehicular system.

Otherwise, a passive hacker can exploit the vehicle identities and other critical information by attempting eavesdropping. The pseudonymous can be used to hide the identity of the vehicle. More generally, securing the information systems involved in the circulation of autonomous and connected vehicles.

#### ***2.4.5 The Big Data Processing***

CAV systems will produce huge amounts of data of different types: data provided by onboard sensors on vehicles, location data, image flows, emails, SMS, and entertainment data. CAV could thus produce up to 1 GB of data per second. Based on an expected deployment of hundreds of thousands of connected vehicles, all this data will have to be stored, managed, and processed automatically by research centers, operators, and users for various purposes. The storage and processing of these masses of data are yet to be defined and represent a challenge, both economically and technically, without neglecting ethical aspects related to the confidentiality of personal data.

Big Data techniques (processing very large volumes of data) and data analytics will be used to extract exploitable information from embedded data sources. The exploitation of data by

data-mining methods should first lead to a better knowledge of the habits, preferences and needs of the user of the vehicle. It will then contribute to the development of many driver assistance applications, or serve as a support for services to consumers, or operators. Many applications are expected; in particular:

- High priority security data, even in real time (emergency situations, incidental events, collision avoidance, etc.);
- Consumer service information (insurance, self-diagnosis, detection / prevention of failures ...);
- Data useful to the comfort of the driver, the driver or the passengers (availability of parking spaces, geographic data, adapted advertising, etc.);
- Energy management and optimization (optimization of the speed profile)
- Traffic management (congestion, lane closures ...);
- Assistance to make driving more comfortable (choice of driver profile or automatic driver, setting of vehicle control ...).

In addition, this big data can be used for analytics purposes to evaluate the reliability of the CAV. Having an accurate and detailed data concerning the CAV performance diffidently could help in designing intelligent vehicles that are more reliable, safer and more efficient. Using this data will improve strategic decision making in the business, which should increase the penetration of this vehicles into market

#### **2.4.6 Validation of the CAV system**

An autonomous and connected vehicle, like any automated system, must go through a validation and certification phase. To evaluate the reliability of an autonomous vehicle, real data should be available representing the many scenarios that it may face. These data are missing, and it is impossible to perform travels for millions of kilometers that would be needed

to assess its failure rate under multiple conditions. The design of CAV will therefore necessarily involve virtual prototyping and simulation.

The simulation of CAV is a particularly difficult problem. Indeed, even if each subsystem could individually be validated by simulation, we would still need to validate the complexity of the integrated system in real use on the road. It would be necessary to simulate the operation of all the technological bricks simultaneously, while adding the complexity of road scenes, the behavior of other drivers and their reactions to foreseeable situations, and taking into account the simultaneous operation of a large number of autonomous vehicles.

The conclusion is that today there is no simulator adapted to all the features of the autonomous and connected vehicle. The future simulator dedicated to the CAV will have to include, among others, traffic models, behavioral models of various drivers, kinematic and dynamic models of the vehicles, models of the sensors (including the inaccuracies and uncertainties of measurement), models of realistic environment with urban scenes, peri-urban or highway, models of weather environment (rain, snow, fog, etc...), and models of communication.

The simulators available today only take into account some of these aspects. The development of tools capable of simultaneously simulating all technological bricks, including the behavior of humans and different weather conditions - for instance - remains a real challenge.

#### ***2.4.7 The modeling of large systems: road traffic and fleet management***

With a large number of connected vehicles crisscrossing roads, traffic modeling will be enriched with data collected by vehicles acting as moving sensors. The evolution of traffic on a road network can be described by microscopic models (where we follow the trajectory of each vehicle, the formation of traffic jams, etc...), mesoscopic or macroscopic (traffic prediction), where the traffic is treated as a fluid circulating on the network.

Traffic can be studied and modeled as a large "random" system, relying on various

mathematical approaches. For example, by the exploitation of probabilistic methods or from statistical physics.

Several recent works in applied mathematics and transportation engineering are studying the impact of the introduction of autonomous and connected vehicles into road traffic. For example, this research aims to exploit inter-vehicle communications to increase throughput, efficiency and traffic safety. In fact, optimal management of lane changes and intersections could lead to a better use of space on the roads, and thus reduce the capacity drop due to intersections. To go even further, one can imagine controlling autonomous and connected vehicles to stabilize traffic by preventing the appearance of "stop-and-go" waves, and thus improve the flow of traffic. Several studies have shown very promising results, even for low penetration rates of this type of vehicle: congestion can be completely eliminated with only 25% of vehicles running with ACC.

Modeling also has an important role to play in managing fleets, for example a set of shared vehicles, where one of the main problems is the reallocation of vehicles on an increasingly dense and dynamic urban network.

This is typically a problem of multi-criteria optimization, where the number of vehicles and their distribution by station depends on many aspects: the distances traveled, the energy autonomy of the vehicles, the topology of the segments of the road network, etc.

### **2.5 State of arts**

The California Department of Motor Vehicles (CA DMV) is the state agency that registers motor vehicles and issues driver's licenses in the U.S. state of California, and is responsible for permitting and monitoring the testing of autonomous vehicles. At the time of writing (June 2019), 61 AV testing permit holders acquired permission from the DMV to begin testing on California public roads (CA DMV, 2018). DMV published reports concerning AV

failures or disengagement, which is the failure event where the autonomous car failed to take the right decision. DMV defines Autonomous Miles Driven per Disengagement as an indicator to measure failure and reliability of CAV. Waymo is one of the stakeholders doing test in California. Waymo experienced a reduction, from 0.8 per thousand miles of autonomous driving in 2015 to 0.2 disengagements in the current 2016, which mean a 75 % reduction in disengagement rate [57]. However, Waymo did not mention the reliability of each individual car, or the probability of failures for each vehicle.

The fault tree is commonly used to evaluate the reliability of complex systems in many fields. It identifies the possible causes of an undesired event, which leads to a failure, and can lead to safety hazards. The FTA studies the impact of a particular component failure on the overall performance of a system [58].

Some researchers used fault trees to analyze the impact of sensor failure on overall system [59]. In 2013, Duran identified basic hazards using FTA, the causes and effects of these hazards as related to 2 main sensors in the Autonomous Ground Vehicles (AGV): the LIDAR and the computer vision systems. The author did not combine the impacts of failures for all the different vehicle components and telecommunication system on the whole system [60]. With the same approach, Swarup and Rao analyzed the reliability ACC, which is an automotive feature that allows a vehicle's cruise control system to adapt the vehicle's speed to the traffic environment. The authors used FMEA and FTA to explore basic potential cause of failures for the RADAR and for the speed sensor. In this study, a qualitative safety analysis of the ACC was considered. However, the failure probability value of the overall system was not calculated [61].

How many miles of driving would it take to demonstrate autonomous vehicle reliability? In order to answer this question, a study using a statistical approach demonstrated that a CAV would have to be driven hundreds of billions of miles to demonstrate their reliability in terms



of fatalities and injuries, which is not reasonable [62]. For all the CAV manufactures, scientists are using simulators that can replay the real-world miles and can build completely new realistic virtual scenarios. The simulations provide feedback to the designer in order to evaluate the car, do the necessary modifications in the design and maybe create a new generation of self-driving vehicles. This process is referred to as safety through Iterative design [63].

Some researchers suggest the simulation method to validate the CAV reliability and performance in various situations [64]. However, simulation and test procedures should include all road conditions and run a lot of regression testing in order to identify the critical reliability gap [65]. This advanced simulator should be able to run a lot of structure tests and virtual tests to give the confidence that the CAV is safe and reliable enough to be deployed on the road.

Safety and reliability features include a fault-tolerant computing system. For that, a set of redundant sensors with overlapping viewing areas is necessary to create a reliable representation from the autonomously driving vehicle's surroundings [66]. However, redundancy is not always an affordable solution.

Reliability also tackles advanced navigation, environment perception, object detection and fusion, and machine learning strategies, smooth and intuitive autonomous-manual switching and the ability to fully disengage and power down the drive-by-wire and computing system upon E-stop [67]. As mentioned by Waymo, the reaction times, which is the time needed for a driver to take control on the vehicle in case of a disengagement event (autonomous failure), was 0.91 seconds on average for all measurable events [68]. Further, with increased vehicle miles travelled, the reaction times were found to increase, which suggests an increased level of trust [69]. However, as proved later, for better safety in level 3 (conditional automation) and even in level 4 (highly automated Level) the reaction time of the back-up driver should be minimized.

Many things can affect the safety of CAVs and can be reasons for the unreliability of CAV. Significant sensor noise can exist whereby computer vision systems existing in CAV may not properly realize low error rates for autonomous navigation. Visual or perception systems can fail in poor visibility conditions or in low illumination environments [70]. Moreover, in complex circumstances, such as accident areas, construction zones and unexpected scenarios, reaching human-level precisions and reliability in the higher-level perception, planning, and decision-making is still a doubt.

For more reliable decision-making, Berger et al., provided the prospect of applying software engineering to achieve safe and reliable driving on urban environments with an anticipatory CAV. They present the combination of sensor-gathered and wirelessly received information to retrieve information from obstructed and non-visible scenarios [71].

CAV may cause many accidents and some of them lead to fatalities due to failures of the autonomous system. A study investigates the crash rate of CAV compared to the police-reported rate estimated from the Second Strategic Highway Research Program (SHRP 2) and Naturalistic Driving Study (NDS). The results show that self-driving cars estimated at a rate per million miles are reported to have a lower crash rate than regular cars, especially for severe crashes [72].

Adouane et al. proposed the design and development of appropriate Multi-controller Architectures (MCAs) and mechanisms to manage these controllers' interactions, and enhance the metrics/criteria concerning the overall control reliability in complex and dynamic environments [73].

Shi et al., utilizes generalized stochastic Petri nets to model the reliability of Redundant Vehicle Management Computer System and efficient fault monitoring device designs [74].

Several researches focused on reliability of perception of CAV [75]. Data fusion from multiple sensors can minimize shortcomings of individual sensors and increase the reliability

and robustness of the system [76]. Bresson et al., proposed a cooperative fusion architecture based on two main algorithms: a laser-based Simultaneous Localization and Mapping process and a lane detection and tracking approach [77].

Concerning the reliability of communication between the CAVs: vehicles to vehicle (V2V) or vehicle to infrastructure (V2I), most of research focused on reliability of communication protocols used in VANET such as Dedicated Short Range Communication (DSRC) and Wireless Access in Vehicular Environments (WAVE). Moreover, most of them emphasized on reliability in terms of successful packet delivery and the optimization of the number of packet drops.

For example, in 2011, Kazerooni examined the connectivity as a function of traffic load. In 2012, Ma et al. investigated additional metrics, such as reliability in terms of packet reception ratio, and effective range of coverage [78]. Lann presents the safety and reliability for Intelligent Vehicular Networks (IVN) for platoons and cohorts. To avoid failure, he introduces diversified functional redundancy, giving a replacement in case of telemetry failures as an example [79].

Many researches focus on finding reliable routing in connected vehicles, and on classifying routing protocols.

In 2008, He et al., present a new algorithm with two notations: virtual equivalent node (VEN) and differentiated reliable path (DRP) to solve the problem of link failures, Road Side Unit (RSU) will play the role of VEN if the route failed [80]. In 2007, Kihl introduced a routing protocol ROVER (Robust Vehicular Routing) based on positions of location-aware vehicles to define the zones [81]. The protocol broadcasts control packets and works as Ad hoc On-Demand Distance Vector (AODV) protocol to discover the best routing path. A classification is described in Gongjun in 2010 to classify the existing VANET routing protocols into five categories according to their used routing metrics [82]. In 2016, Dharmaraja calculated the

reliability of the On Board Unit (OBU) in function of hardware reliability and channel availability without taking hardware security into consideration and by using simulations instead of real data [83]. Ahmad et al, listed all papers working on the reliability of communication networks and classified them according to the modeling and analysis techniques. For each paper listed in their work, authors provided a survey of each application in communication networks mentioning the strong and weak points of different approaches [84]. As for VANET applications, only the research of Dharmaraja et al., (2016) mentioned above is listed.

Other studies focused only on the connected vehicles' security challenges and their possible related solutions. In 2013, Dhamgaye et al., presented the most recent challenges for VANET security and presents proper solutions [85]. In another paper, the authors presented a recent classification of VANET attacks and provided possible cryptographic solutions to the security challenges of VANETs [86].

Despite of this, the intersection between dependability and security attributes while studying the security of CAV is not enough since dependability is defined as an umbrella that covers other attributes including maintainability [87].

Many researchers used a Markov chain model to estimate the reliability and the performance of IEEE 802.11P. In [88], the author proposed a Markov chain model to analyze the back-off procedure of beacon and emergency messages, and then he evaluated the probability and throughput of packets. Yao et al. proposed two Markov chains to study the performance and the reliability of the IEEE 802.11P safety communication on the Control Channel (CCH). Safety-related messages were classified as four ACs with different priorities based on the degree of emergency. The Packet Reception Rate (PRR) and packet delay were analyzed in detail by using virtual collisions [89].

## 2.6 Conclusion

A strategic concern with automated driving at this phase of its growth is that it is not yet reliable and safe enough. This fast growing area provides great opportunities but also poses significant challenges from a dependability point of view

In all aforementioned articles, we notice that the quantitative and qualitative reliability analysis for the CAV system as whole was ignored in realizing their functions. Hence, we propose to analyze the reliability of CAV in terms of functions reliability, of the whole system based on real data gathered from a professional database called Quanterion Automated Databook (QAD) that uses Electronic Parts Reliability Data (EPRD).

Currently, in connected cars, most of the researches and works carried out relate to the evaluation of the communication performance and for routing protocols, without taking into consideration dependability and operational safety of the system as whole. Given that this problem is relatively new for applications in the mobile environment using ad-hoc networks, the development of methods and models to assess the reliability of smart vehicles by the approaches of reliability and dependability analysis, that evaluate quantitative and qualitative measures characterizing the dependability of AV, has become indispensable.

The valuation of these problems is the subject of quantitative and qualitative reliability analysis for the CAV that enables the designers of CAV to ensure that the selected system is well suited to fulfill the dependability requirements.

## Chapter 3 - Global Qualitative Study of Dependability of CAV

---

<b>CHAPTER 3 -</b>	<b>GLOBAL QUALITATIVE STUDY OF DEPENDABILITY OF CAV.....</b>	<b>58</b>
3.1	<u>INTRODUCTION</u> .....	59
3.2	<u>DEPENDABILITY OVERVIEW</u> .....	61
3.3	<u>THE PROPOSED APPROACH</u> .....	63
3.4	<u>PRELIMINARY RISK ANALYSIS (PRA)</u> .....	64
3.4.1	<u>Definition</u> .....	64
3.4.2	<u>Functional Architecture of CAV</u> .....	65
3.4.3	<u>Severity, Frequency and Controllability</u> .....	69
3.5	<u>EXTERNAL FUNCTIONAL ANALYSIS</u> .....	71
3.5.1	<u>Bull chart</u> .....	72
3.5.2	<u>Octopus diagram</u> .....	73
3.5.2.1	<u>Manufacturing and transportation</u> .....	74
3.5.2.2	<u>Maintenance</u> .....	75
3.5.2.3	<u>Use</u> .....	75
3.5.2.4	<u>End of life</u> .....	76
3.6	<u>INTERNAL FUNCTIONAL ANALYSIS</u> .....	76
3.6.1	<u>The functional block diagram</u> .....	77
3.6.2	<u>Global functional block diagram</u> .....	78
3.6.2.1	<u>Functional block diagram of sensors</u> .....	79
3.6.3	<u>Functional analysis table</u> .....	81
3.7	<u>FAILURE MODE, EFFECTS AND CRITICALITY ANALYSIS (FMECA)</u> .....	82
3.7.1	<u>The "project" benefit FMECA</u> .....	82
3.7.2	<u>The "system" objectives of FMECA product</u> .....	83
3.7.3	<u>The FMECA "Product"</u> .....	84
3.8	<u>CONCLUSION</u> .....	86

### 3.1 Introduction

Before the twenty-first century, researchers and industrial leaders have been competing to develop the first fully autonomous vehicle that is robust, reliable, and safe enough for real-world and high-speed driving environments. Major contributions to early CAV research were limited to CAV tests and competitions held around the world. Those however, identified major difficulties and shortcomings in CAV software and hardware, some of which remain unresolved especially in terms of safety and reliability.

The user should trust the vehicle and accept the remaining risk; it cannot be deployed in the market before having a suitably sufficient level of reliability [62].

To gain a better understanding of these radical changes, imposed by these intelligent vehicles, we first need to understand the specific features of a CAV. Collaboration between many different aspects of research, and sciences should occur, including safety and reliability engineering, automation techniques, AI, geo-location, mathematical modeling, robotic techniques, processing and multisensory fusion, telecommunications, networks, cybersecurity, and others...

Koopman et al., [90] mentions that the reliability of CAV is affected by multi-disciplinary interaction with all levels of functional hierarchy. These interactions include hardware fault tolerance, software architectures, resilient machine learning, communication between humans and vehicles, cooperation with humans driving conventional vehicles, perception in highly dynamic environments, regulatory approaches, testing and validation of systems operation in different environments, etc. The apparent risks associated with these new technologies begin to multiply thus making the dependability analysis process more important than ever.

Currently, a major concern is unsafe driving by drivers who are not aware of how the intelligent vehicle functions on the road. Furthermore, in order for autonomous vehicles to have significant improvements to safety and efficiency, the driver must be aware of the

capabilities of the technology. This includes critical factors such as the limitations of the technology, the application of the technology, and the suitable situations to use this technology [91].

In general, robust and reliable perception and localization (fed from the sensors) leads to a reliable AI decision for vehicle control. However, the driver needs to fully understand how and when a CAV can fail and the causes of such failure.

After several fatal accidents, such as Uber on March 18, 2018, and Tesla's on May 2016 [92] [93], it was concluded that more reliability is needed, and more constraints should be introduced on the certification of level 3 autonomous vehicles. In the Uber accident, the self-driving car killed a woman in Arizona because of a failure in the perception system to identify a pedestrian thus not decelerating swerving to avoid crashing into the pedestrian. Whereas in the Tesla accident, the autonomous system failed to apply the brakes. Many manufactures have adopted the idea of ignoring conditional automation (Level 3). These automakers intend to go directly for full automation (Level 5) which they think is a safer alternative [94] .

With this strategic decision, a new generation of vehicles will be on the road, thus increasing the challenge of safety and of dependability. However, the questions remain the same: what are the guarantees? What are the risks of this step? What are the failure modes and effects analysis of using full-unrestricted automation of vehicles on the roads for every driving scenario?

Complex electronic systems failures or even small failures such as vehicle operating system failures, faulty sensors, distorted signals, or software errors can have catastrophic results. Self-driving vehicles will certainly have failures that contribute to crashes; the question is their frequency compared to human drivers. For that, in this chapter we utilize the reliability analysis to identify the potential hazard sources and accident scenarios and to assess the potential impact these can have on human life, environment, and technology.

This chapter aims to provide a comprehensive reliability and functional analysis of CAVs



to address a lack of synthesized information about sensor, hardware, and algorithm requirements for effective CAV deployment. Furthermore, this chapter performs a failure analysis to evaluate how reliable the system would be. Therefore an internal and external functional analysis, Preliminary risk analysis (PRA) and failure modes and effects criticality analysis (FMECA) were done to analyze the reliability and possible failures.

The purpose of this research is also to identify the threats associated with CAV. Reliability analysis is a potential source of information for all stakeholders in transportation sector such as vehicle manufacturers, equipment manufacturers, transport operators, software publishers or manufacturers of electronic components to evaluate the regulations and the policies needed for CAV mass utilization.

### **3.2 Dependability Overview**

Dependability and safety are one of the key issues in CAV development. The shift from traditional vehicles to intelligent vehicles poses fundamental challenges concerning the security and the reliability of such systems.

The dependability of a system is a set of properties or attributes such as reliability, maintainability, safety, availability, and security. Dependability is the ability of a system to perform its desired functions or tasks correctly in a certain environment at a certain point in time. In other words, dependability is the ability to deliver a service that can justifiably be trusted. The service delivered by a system is its behavior as perceived by its user(s); where a user is the entity interacting with the system [95]. Some of these attributes, such as reliability and availability, are quantitative whereas others are qualitative, for instance, safety and security [96].

Reliability is defined as the ability of a functional unit to perform a required function under given conditions for a given time interval [97]. In CAVs, reliability is the probability that the CAV will work without failure during its running time under the specified operating

conditions. Reliability analysis of autonomous CAVs identifies undesirable events and sequences of events leading to autonomous navigation failure, which could lead to road crashes, vehicle damage, fatalities or injuries. It is important to differentiate between availability and reliability concepts; reliability refers to failure-free operation during an interval, while availability refers to an operation which is free of failure at a given instant of time and how quickly it can be repaired, restored, or recovered [98] .

Dependability is a global concept, which includes various notions that can be grouped into three classes: the threats, the attributes, and the means by which dependability is attained.

The threats to dependability are: faults, errors, and failures that might affect the service(s) delivered by the system. They are undesired, but not in principle unexpected circumstances causing or resulting from lack of dependability.

**Fault:** An incorrect step, process, hypothesize, or data definition, which causes the system to perform in unanticipated manner and cause an error. It is an inherent weakness of the design or implementation, which might result in a failure.

**Failure:** occurs when the delivered service no longer complies within the specified requirements.

**Error:** is the part of the system state that may lead to its subsequent service failure.

**Failure Cause:** Could be a defect or broken part, which is the underlying cause of a failure

**Failure Mode:** “A single event, which causes a functional failure.” (SAE JA 1011/SAE JA 1012)

**Failure Effect:** Effect due to a failure mode

Faults are the cause of errors that may lead to failures.

Failure Cause → Failure Mode → Failure Effect.

In order to evaluate failures and manage or predict reliability of a CAV, we used some

common methods such as Time to Failure (TTF), Failure Mode and Effect Analysis (FMEA) and Failure Mode Effects and Criticality Analysis (FMECA).

### 3.3 The proposed approach

For any complex system such as the connected autonomous vehicle (CAV), it is essential to focus the analysis on the most critical components.

To detect the potential risks related to a system, first we should divide our CAV system into subcomponents. A comprehensive behavior study for each single component was achieved to establish the relationships between the components and overall system function. An analysis of the more critical components helps in developing a complete reliability analysis.

This chapter presents the functional and dysfunctional analyzes of the system. The proposed analysis focuses on the reliability attribute of dependability. Hence, the analytical tools dedicated to the forecast reliability must be implemented. Those commonly used tools are: [99]:

- a- Preliminary Risk Analysis (PRA):** It identifies the risks associated with different system failure scenarios. This analysis is particularly necessary for the integration of security objectives into the design of a system. This is a qualitative analysis.
- b- External Functional Analysis (EFA):** It aims to identify the main functions and expected constraints related to the system environment. It is independent of the operation of the system. It is expressed by the functional specifications. It is a qualitative analysis.
- c- Internal Function Analysis (IFA):** It analyzes the way in which the system responds to the functions identified in external functional analysis. It is expressed on the basis of the architecture of the system, by the technical specifications.
- d- Failure Mode, Effects and Criticality Analysis (FMECA):** Its objective is to list the consequences of all modes of failure of the studied system and to prioritize them. This

measure evaluates the criticality of failure modes.

- e- **Fault Tree:** For a dreaded event identified in PRA or FMECA, a fault tree is used to analyze the sequence of causes that can cause this event. This qualitative analysis can be used quantitatively to estimate the predictive reliability. The fault tree starts from a complete system failure and moves backwards to identify all possible causes.

These different tools must be used according to a defined methodology such as that presented in Fig. 3-1 [100]. We propose to adopt the following method: first, it is necessary to define the system to study. This is a technical definition but also an environmental one. The second step is to analyze how the system works in order to study potential malfunctions. Then comes the modeling of the system, which is realized here by the development of fault trees.

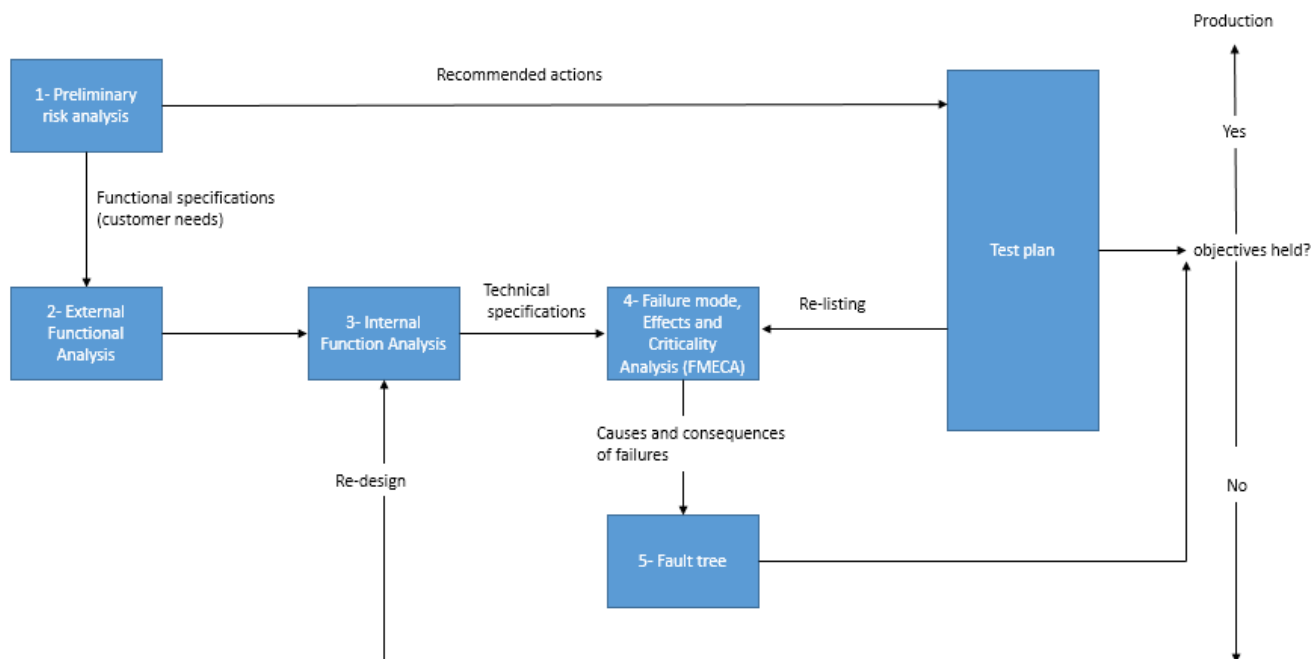

Figure 3-1 Qualitative analysis approach of dependability

## 3.4 Preliminary risk analysis (PRA)

### 3.4.1 Definition

This approach begins with the functional analysis of the system in which the functional safety of the autonomous vehicle is integrated. In order to ensure a safe response to the system,

the identification of potential hazards is carried out even before the beginning of the functional analysis.

Preliminary Hazard Analysis (or PRA) “is a hazard identification and analysis technique that can be used in the early stages of design to identify hazards and assess their criticality” according to the IEC-300-3 standard of 1995. Its purpose is to identify sources and scenarios that pose danger to the person, and to assess the severity of the consequences. Hazard identification is carried out with the experience and knowledge of the experts. By field of application, the analysis is based on lists of dangerous situations. A Preliminary Hazard Analysis usually includes an estimate of the probability of occurrence of hazardous situations and potential accidents as well as their effects and consequences. This analysis helps suggest measures to remove those hazards. These measures can then be translated into security objectives.

The main advantages of this tool are that it is economic in terms of the time spent and that it does not require a very detailed level of description of the system studied.

On the other hand, the preliminary analysis of the risks alone does not enable identifying the chain of events likely to lead to a major accident for complex systems such as autonomous vehicles. The integration of results in terms of safety objectives when setting the specifications ensures that they are taken into account in the early design phases. However, in simple systems where the working group has sufficient experience, the PRA method can be enough. This analysis can be updated at key points of the design progress. It can also be a support for the writing of user or operating guides.

In order to carry out our preliminary risk analysis, we have chosen the simplified schema below that represents how an autonomous vehicle works [101].

### ***3.4.2 Functional Architecture of CAV***

A functional architecture is an architectural model that identifies a system’s functions and

its interactions and how they work together to achieve their goal. Taking the approach of bio-inspiration and the brain-inspired computing, we can compare the functional architecture of CAVs to the anatomy of the human body. The functional architecture of CAVs explains how the components of the vehicle interact together to complete the operation of self-driving without violating the rules exactly like the anatomy map which shows the different organs and the numerous ways in which they interact in order to keep the body alive.

We can broadly categorize the main components of the CAV into hardware, software, communication, actuator and human-machine interface.

Continuing the analogy with the bio-inspiration from the human body, we can compare the hardware components of the CAV to the physical parts of the human body, which allow the body to interact with the environment. The hardware components enable the CAV to achieve such tasks as seeing (through sensors), communication media (through V2V technology), and moving (through actuators).

Fig. 3-2 depicts a functional view of the data flow in a fully equipped sensing and control system for an autonomous vehicle.

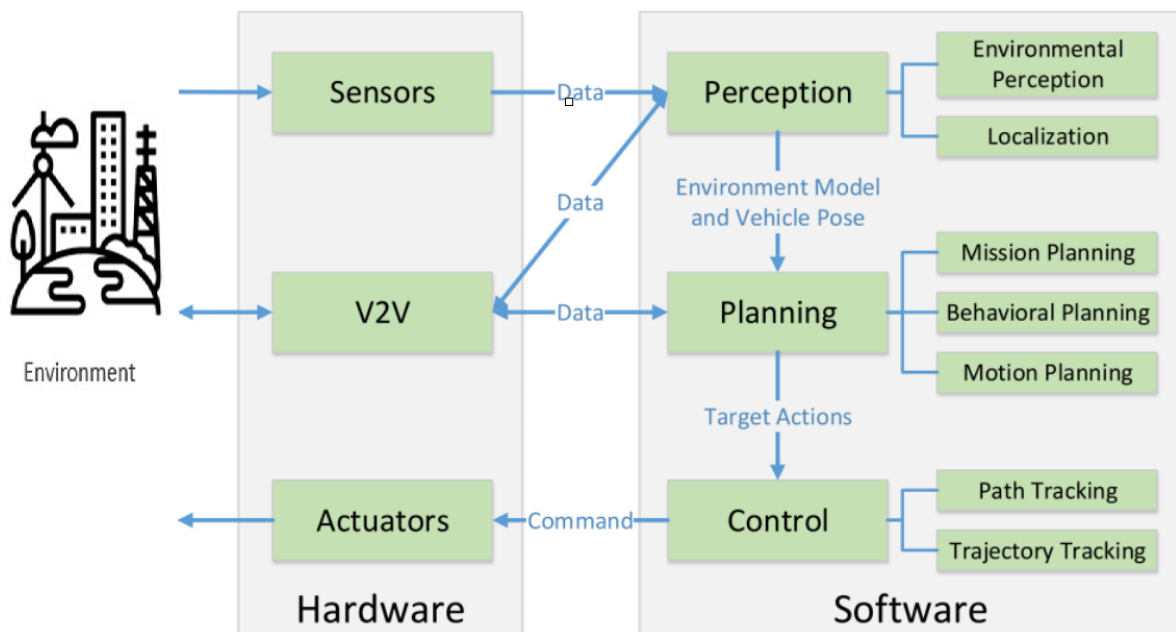

Figure 3-2 Functional Architecture for the CAV

**A. Hardware:**

The left section of figure 3-2 shows the hardware, which is divided into the input sensors, (such as cameras, LIDAR, radar and ultrasound), and the communication media with other vehicles or with the infrastructure v2x and the actuator.

- 1- **Sensors:** Sensors are analogous to the eyes of a human. They are the components that allow the CAV to take raw information about the environment. Using sensors, the CAV will understand the surroundings. Usually sensors emit energy in the form of electromagnetic waves and measure the return time to determine parameters such as distance. Examples include ultrasound sonar, wheel encoder, camera vision, radar, and LIDAR sensors.
- 2- **The communication media: V2X technology (V2V and V2I technology):** Using DSRC protocol gives the ability for vehicles to communicate with each other V2V and to infrastructure V2I. Using V2I communication makes a CAV aware about the external environment by providing a network for intersections, road signs and construction signs from infrastructure [102]. CAVs can send and receive information from other machine agents in the environment, such as transmitted information from a traffic light that it has turned green or warnings from an oncoming car. Other sensors in CAV as used for localization like GPS/Inertial Measurement Unit (IMUs) to determine the vehicle's global and local position. It is important to secure communications between vehicles, by encryption and signatures using Trusted Platform Module (TPM). The On-Board Unit (OBU) computer gives the vehicle the ability to communicate with other V2X. V2X technology can be compared to the mouth and the ears of a human.
- 3- **Actuators:** Actuators are the components responsible for vehicle control such as braking, accelerating, and steering. Actuators are like muscles of a human body, responding to electrochemical signals from the brain that order the arm or leg to move or to stop.

### **A- Autonomous Vehicle Software**

Self-driving software is the “brain” of a CAV, which processes all the information coming from the sensors and the communication media about the environment and uses that information to make the best driving decisions for each situation.

thanks to AI, self-driving software can detect the presence of other objects, understand what an object is, how it is likely to behave, and how that should affect CAV’s behavior on the road. Autonomous vehicle software can be categorized into three systems: perception, planning, and control [103].

- 1- Perception: Perception is the part of the software that detects and classifies objects on the road, while also estimating their speed, direction, and acceleration over time. The software takes the myriad of details coming from sensors and V2x, and turns those into a cohesive real-time view of the world. Perception helps a CAV differentiate vehicles, motorcyclists, cyclists, pedestrians, or other objects. It also distinguishes the color of traffic lights. Perception enables the vehicle to understand the situation around it, whether a light is green and clear for the vehicle to proceed, or whether a lane is blocked because of the cones ahead [50]. This process is analogous to how the brain processes the information obtained through sight into meaningful information. The photoreceptors of our eyes (the sensors) absorb light waves emanating from the environment and convert those light waves into electrochemical signals. Networks of neurons pass these electrochemical signals all the way back to the visual cortex of the brain, where the brain processes what these electrochemical signals mean. In this way, the brain can understand whether a certain light pattern hitting retina represents a person, a vehicle, or another object.
- 2- Planning system: considers all the information gathered from perception, and plots out a path for the CAV. Planning can also think several steps ahead. Planning identifies multiple paths per second, and constantly chooses the best one to meet changing road



conditions and events [104]. The planning system in CAV works in the same way of the frontal lobe of the human brain, which enables us to reason and make decisions.

- 3- Control: the control competency converts intentions into planned actions. It refers to the autonomous vehicle's ability to execute the planned actions that have been generated by the higher level processes. Its main purpose is to execute the planned intentions by providing necessary inputs to the hardware level (the actuators) that will generate the desired motions. As an example, slowing down when approaching a red light by applying the brakes [50]. Cerebellum in human brain process in the same way. The cerebellum in the human brain works in a similar manner. The cerebellum is responsible for the important function of motor control. For example, it enables us to chew when the desired intention is to eat.

### **3.4.3 Severity, Exposure and Controllability**

Now we can find in the table below the main elements of the preliminary risk analysis.

The three indices “Severity, Exposure and Controllability” referred in Table 3-1 as S, E, and C, are scored on a scale from 0 to 10, 0 for a very low level and 9 being the highest degree of the characteristic. Thus, a severity ranking of 0 means that the initiating event is not dangerous. Whereas, a or exposure ranking of 0 indicates that the event will never take place. Finally, a controllability or detectability ranking of 0 indicates that the event is easily controllable if it occurs.

Risk is the combination of probability, severity, and criticality – also known as risk priority number (RPN) - is calculated as the multiplicity of all three rankings “Severity, Exposure and Controllability”.

The numbers between 0 and 10 in the table are chosen according to a logical way based on Automotive Safety Integrity Level (ASIL) which is a risk classification scheme defined by the ISO 26262 - Functional Safety for Road Vehicles standard.

Each hazardous event is classified according to the severity (S) of injuries it can be expected to cause:

**Severity Classifications (S):**

- S0: No Injuries; refer to numbers: 0, 1 and 2.
- S1: Light to moderate injuries; refer to numbers: 3, 4 and 5.
- S2: Severe to life-threatening (survival probable) injuries; refer to numbers: 6, 7 and 8.
- S3: Life-threatening (survival uncertain) to fatal injuries; refer to numbers: 9 and 10.

Within the hazard analysis and risk assessment process of this standard, the likelihood of an injurious hazard is further classified according to a combination of: exposure (E) (the relative expected frequency of the operational conditions in which the injury can possibly happen) and control (C) (the relative likelihood that the driver can act to prevent the injury).

**Exposure Classifications (E):**

- E0 Incredibly unlikely; refer to numbers: 0, and 1.
- E1 Very low probability (injury could happen only in rare operating conditions); refer to numbers: 2, and 3.
- E2 Low probability refer to numbers: 4 and 5.
- E3 Medium probability refer to numbers: 6, 7 and 8
- E4 High probability (injury could happen under most operating conditions) refer to numbers: 9 and 10

**Controllability Classifications (C):**

- C0 Controllable in general; refer to numbers: 0, 1 and 2.
- C1 Simply controllable; refer to numbers: 3, 4 and 5
- C2 Normally controllable (most drivers could act to prevent injury); refer to numbers: 6, 7 and 8.

- C3 Difficult to control or uncontrollable; refer to numbers: 9 and 10.

**Table 3-1 preliminary risk analysis**

Initiating event	Effect on system	Scenario description	Dreaded event for the user	S	F	C	RPN	Safety goal
Sensor failure	Lack of information about environment	- Defect in the manufacture of the sensor -Low illumination environments - Poor visibility conditions - Heavy traffics - Attack (intentional noise, jamming and spoofing)	Vehicle and property damage	6	7	4	168	sensor fusion, diversified functional redundancy
V2V and V2I components failure	Lack of information about the other vehicles and about Road side unit	- Defect in the manufacture -congestion in channel - loss of packets	Vehicle and property damage	4	7	5	140	Add more components in standby, diversified functional redundancy
Control system failure	Software system failure	-Programming problem in AI and machine learning. -lack of reinforcement learning and semantic reasoning	shock and serious injury or victim	9	3	9	243	Simulation and test procedures in all road conditions.
Actuators failure	loss of controllability	Defect in the manufacture	shock and serious injury	7	4	8	224	Periodic and preventive maintenance

According to Table 3.1, we can notice that all failures are dangerous, especially those related to the control system.

### 3.5 External Functional Analysis

The external functional analysis considers the system in a global and unitary way; it studies the functions that the system must be able to perform with respect to its external environment, regardless of the technical solution envisaged for the system [105].

To do this, we will separate the external analysis into two different parts illustrated by two types of diagram:

- Bull chart (Fig. 3-3).
- Octopus diagrams (Fig. 3-4).

First, the bull chart is essential as it identifies the main functions in relation to customers. Then, the octopus diagram allows identifying the main functions and constraints in different phases of the life of the product.

### 3.5.1 Bull chart

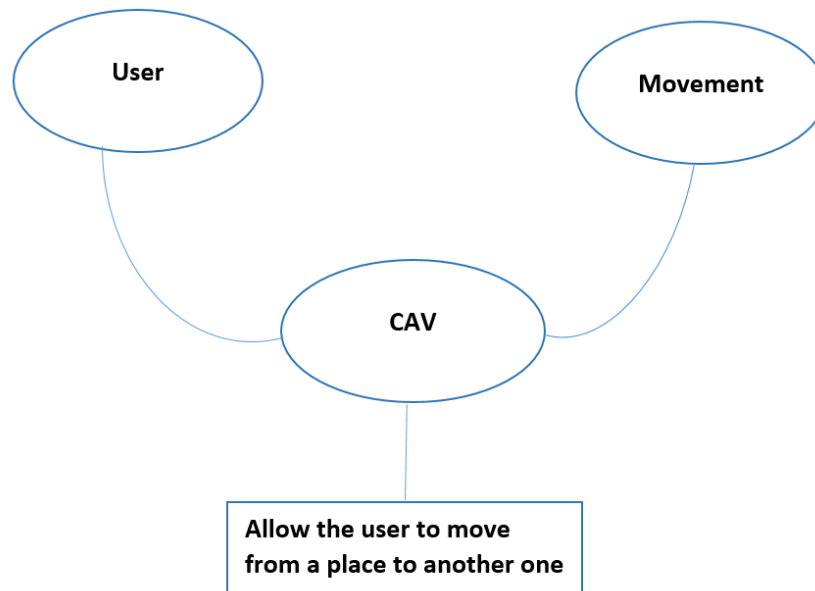

Figure 3-3 Blue chart for CAV

After having realized our Bull chart, we answered three questions about the existence of the product. They are detailed below:

#### **Why this product exists?**

CAVs exist to allow the user to move autonomously with minimal or no human assistance in a safe way.

#### **What could make it disappear?**

We believe that two main things make CAVs fail:

- 1- CAVs hold the promise of saving millions of lives. Nonetheless, CAVs will inevitably have some accidents. Thus, CAVs must be able to prevent many more accidents than those caused by conventional vehicles, otherwise they will disappear.
- 2- An external environment too aggressive due to product liability litigation, which is widely perceived as one of the largest obstacles to autonomous consumer vehicles. Challenges

facing the CAV production are many such as cyber security cost and impact. Crippling suits could force manufacturers to exit the market because of a belief that the sales cost are not worth the risk.

### **What could change it?**

New types of control and improvement in the pilot program allowing it to be more efficient.

We can conclude from the Bull chart that a main function can be highlighted for this product; we will tackle that in the octopus diagram.

### **3.5.2 Octopus diagram**

In order to express the different functions, we will start by highlighting the contexts of use and life cycle of the product.

The life cycle is the set of phases the product goes through and all the situations during the life of the product. The object is in contact with a number of elements of its environment. The "external environment of use" is composed of all these elements.

The different phases associated with our product life cycle are the following:

- Manufacturing
- Transportation
- Use
- Maintenance
- End of life

In addition, the functions are relations between the object to be designed and the external environment. They are the behavior necessary for the product to fulfill the goals previously expressed in the objective specifications and they are in the form of operations on the flows (energy, material, and signal). When using the product, functions are services that the object must render to the customer. They are characterized in terms of goals. It is important to note that functions are expressed without any hint to a solution.

### 3.5.2.1 Manufacturing and transportation

CAVs will quickly solve many transportation problems. Manufactures predict that such vehicles will be sufficiently convenient and affordable to displace most human-operated vehicles. Providing many savings and benefits to users and society overall. However, manufacturing of CAVs should respect a lot of standards and regulation.

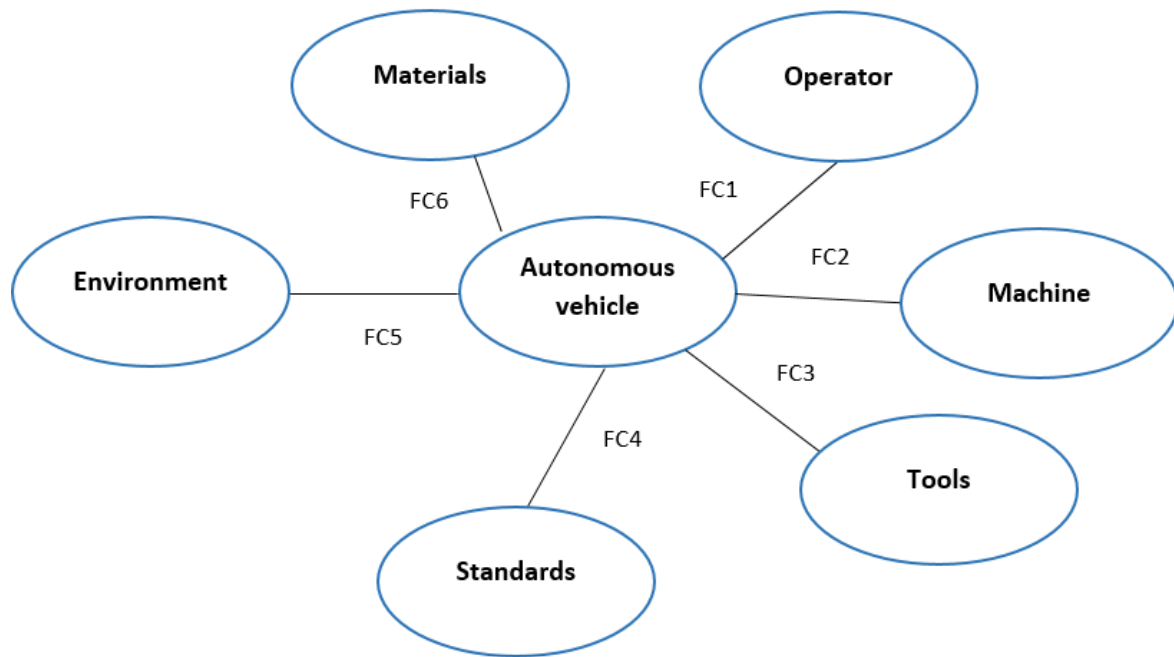

Figure 3-4 Octopus diagram for manufacturing and transportation of CAV

#### Details of the functions:

FC1: Keeping the operator safe

FC2: Ability to be controllable by machines

FC3: Ability to be manufactured using standard tools

FC4: Respecting standards: The National Highway Traffic Safety Administration (NHTSA) within the Department of Transportation (DOT) specifies minimum safety performance requirements for motor vehicles and equipment.

FC5: Adapting to the environment of the manufacturing workshop, knowing that CAVs reduce traffic/congestion, which decreases air pollution through efficient traffic flow.

FC6: Ability to be manufactured using "standard" material keeping in mind that the

manufacturing of CAVs needs many innovative materials.

### 3.5.2.2 Maintenance

The predictive and preventive maintenance of vehicles definitely will be improved by reading and analyzing the data collected from the sensors. However, CAV may require further maintenance standards, in roadway infrastructure, such as clearer line painting and special traffic signals [106].

Shared autonomous vehicles will reduce vehicle ownership. Thus the responsibility for maintenance, repairs, and updates should be defined. Second, the warranties and the indemnifications should have a well-clarified scope and responsibility. Moreover, liability between automaker, technology company and vehicle owner/operator should be distinct. Finally, responsibility for compliance with federal, state, and local laws and regulations should be described.

### 3.5.2.3 Use

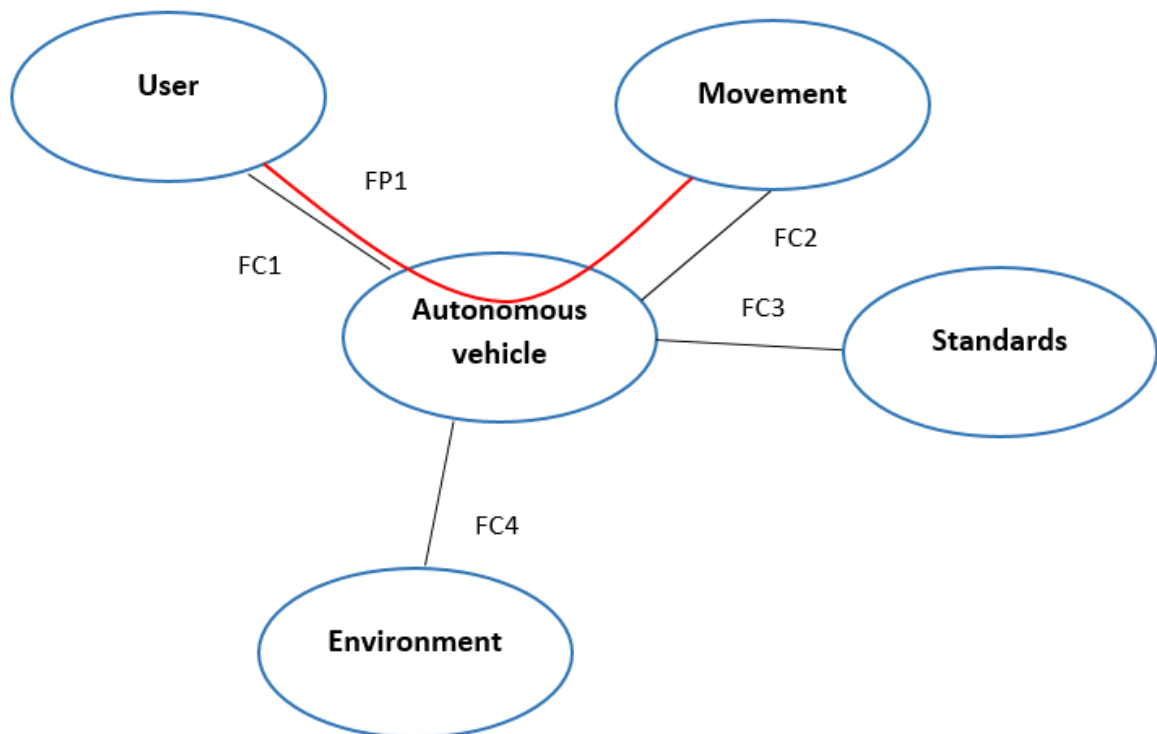

Figure 3-5 Octopus diagram for manufacturing and transportation of CAV.

The use of CAV should respect many functions. In the Fig. 3-5, the red line that connects the user with the movement represents the main function. However, the other lines represent the constraint functions.

**Details of the functions:**

FP1: Allow the user to move safely from one place to another without the need for human interaction (partially or fully) in a safe way.

FC1: Be controllable by the user: The user can safely take over the vehicle's control, when the system faces some difficulties.

FC2: Be able to move and operate safely using automated driving mode

FC3: Respect the standards: Automakers must certify compliance before selling vehicles.

FC4: Adapting to the environment

**3.5.2.4 End of life**

The CAV material should be recyclable when it reaches the end of its life.

The external functional analysis allows us to identify the different functions that the autonomous vehicle must perform in the different phases of its life. Indeed, it is necessary to start with external functional analysis to identify the various important points which will be used to do the internal functional analysis as discussed in the following section. These points will also be used to make Failure Modes, Effects and Criticality Analysis (FMECA).

**3.6 Internal functional Analysis**

The external functional analysis must be supplemented by the internal functional analysis (or analysis of the functioning). For this analysis, the knowledge of the operation of the system is necessary. The functioning of the autonomous vehicle corresponds substantially to the operations conventionally encountered as shown in Fig. 3-2. The internal functional analysis examines how the proposed solution responds to the functions identified in the external



functional analysis. In other words, how each of the functions identified above are provided by the different components of the system. In order to set up the system architecture, one must remain open to the fact that the functional architecture may be different from the physical layout of the components. Indeed, the analysis is generally carried out before the final design of the system.

Each of the subsystems does not necessarily intervene in the response to all the functions identified in external functional analysis. It is therefore useless to analyze the failure modes in a systematic way for all the functions of each of the subsystems. This internal functional analysis thus finds its full interest in targeting further study of the system. However, by its simplification, it must also be carried out meticulously because, once again, an oversight at this level may hide a potential failure whose effects and causes would not be taken into account in the calculation of the achievement of the objective.

The internal functional analysis is divided into two parts:

- The functional block diagram
- The functional analysis table

### ***3.6.1 The functional block diagram***

The functional block diagram allows us to analyze the components present in the system that will make it possible to respond to the main functions. In addition, it allows linking the "loop" functions of the system. The loop function, which is represented by the green line, can be seen on the general functional block diagram with a system looped between different components.

Indeed, we have made two functional block diagrams, the first is for the overall operation of the system named "Global Functional Block Diagram" (Fig. 3-6) and the second is the "Functional Block Diagram of Sensors (Fig. 3-7).

## 3.6.2 Global functional block diagram

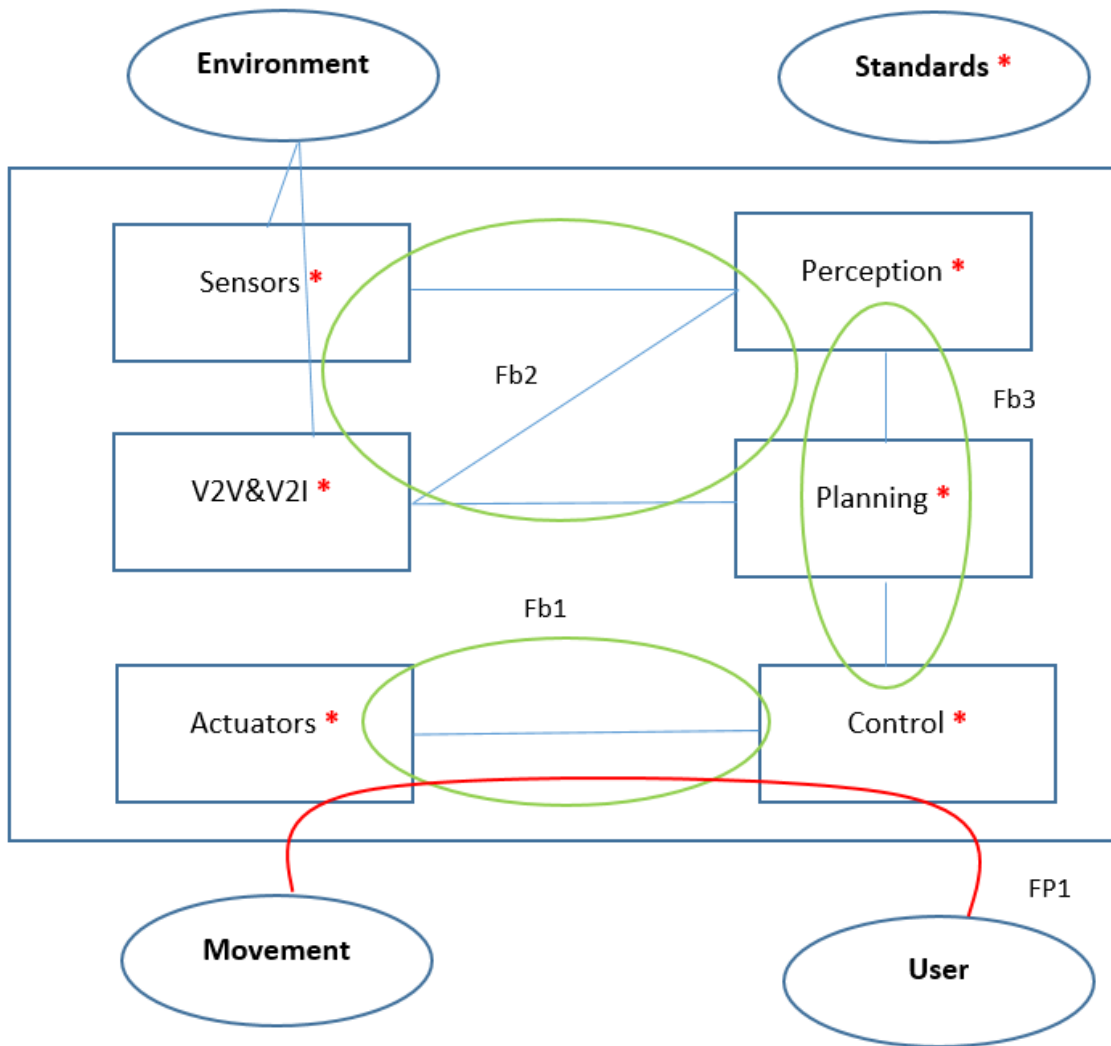

Figure 3-6 Global functional block diagram for CAV

**Loop functions:**

**Fb1:** The Automated control system should control actuators (steering, braking, signals, etc.)

**Fb2:** The perception system analyses the data from the sensors and from the V2X, to plan the vehicle actions. The proprioceptive sensors that are responsible for sensing the vehicle's state, and the exteroceptive sensors that are responsible for sensing the surroundings of vehicle, should give all data to the perception system. Machine Language (ML) will have a predominant role in building the perception algorithm and the plain system of CAV.

**Fb3:** the perception after collecting information and extract relevant knowledge from the

environment, the planning is responsible to making purposeful decisions in order to achieve the automation higher order goals. Finally the control Execute the planned actions

Noting that the red star mean that the standards is connected to all the components, which mean all the components should respect the standards

### 3.6.2.1 Functional block diagram of sensors

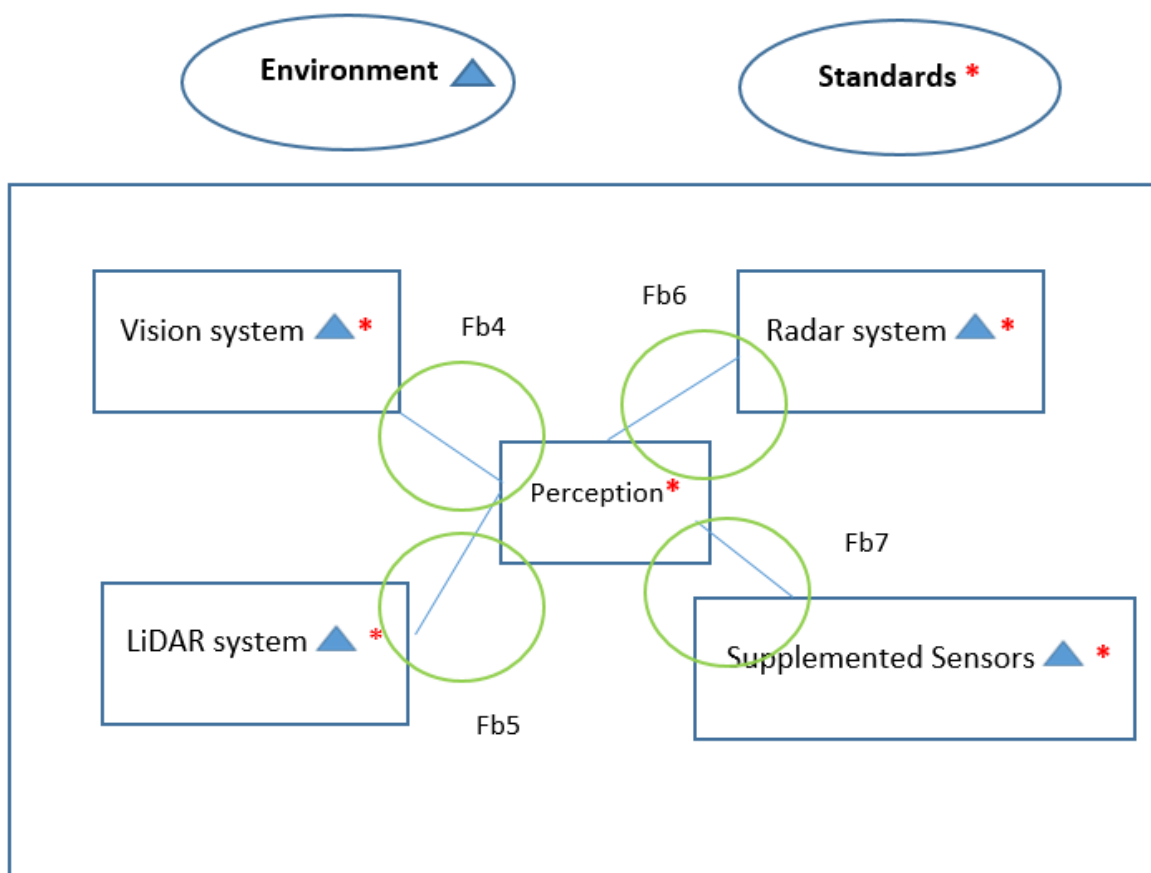

Figure 3-7 Functional block diagram of sensors

#### Loop functions:

- Fb4: Vision system should give data to the perception AI system; CAV have video cameras to see and interpret objects on a road just as human drivers do with their eyes. By equipping cars with cameras at all angles, the vehicles are able to maintain a 360° view of the external environment and provide a broader picture of traffic conditions

around. Today, 3D cameras are available to display highly detailed realistic images. Image sensors automatically detect objects, classify them, and determine the distance to them. For example, the cameras can identify other cars, pedestrians, cyclists, traffic signs and signals, road markings, bridges, and guardrails.

- Fb5: LIDAR system should give data to the perception; Lidar stands for Light Detection and Ranging (LiDAR), acts as an eye of the CAV providing them a 360-degree view. It work similar to radar systems. However, Lidar use light in the form of a pulsed laser to measure different distances from its airborne location to earth, instead of electromagnetic and radio waves. Apart from measuring the distances to various objects on the road, lidar allows creating 3D images of the detected objects and mapping the surroundings. Moreover, lidar can be configured to create a full 360-degree map around the vehicle rather than relying on a narrow field of view. These two advantages make it, as the most widely used sensor for CAV
- Fb6: Radar system should give data to the perception software; Radar (Radio Detection and Ranging) sensors make a crucial contribution to the overall function of autonomous driving: they send out radio waves that detect objects and gauge their distance and speed in real time. Short- and long-range radar sensors are usually deployed all around the car for different purposes like adaptive cruise control, Lane-Keeping Assist (LKA), blind spot warning collision warning, Automatic Emergency Braking (AEB), and collision avoidance.
- Fb7: Supplemented sensors such as ultrasound sensors are used for object detection at close range (less than 2 m from the vehicle) should give data to the perception algorithm. In addition, the wheel encoder is used to keep track of an autonomous car's direction, speed and the distance a wheel travels.

Same as the red star, the small blue triangle means that the environment is related to all the listed sensors showed in the functional block diagram.

### 3.6.3 Functional analysis table

It is from the functional block diagram and especially the highlighted functions that we can approach the table of functional analysis. This makes it possible to identify which functions are in relation to which parts and thus the realization of the failure modes, Effects and Criticality Analysis (FMECA) that we will tackle thereafter.

**Table 3-2 Functional analysis table**

	External functional analysis					Internal functional analysis						
	FP1	FC1	FC2	FC3	FC4	Fb1	Fb2	Fb3	Fb4	Fb5	Fb6	Fb7
V2V&V2I				X	X		X	X				
Actuators	X		X	X		X						
Perception				X			X					
Planning				X			X					
Control	X	X	X	X		X						
Vision system				X	X			X	X			
Radar system				X	X			X			X	
LIDAR system				X	X			X		X		
Supplemented sensors				X	X			X				X
Controller				X				X	X	X	X	X

The functional analysis table (Table 3-2) is constructed as follows:

- Identify all the functions present in the use phase
- List all the components of the system

Then we must mark the components in connection with the different main functions,

constraints, and loops. The objective of this step is to make the connection between the external and internal analysis in order to be able to realize the FMECA

### **3.7 Failure Mode, Effects and Criticality Analysis (FMECA)**

Thanks to the previous studies, and the Internal Functional Analysis, we are able to develop a FMECA: Analysis of failure modes, their effects, and criticality. FEMCA's purpose is to determine the failure modes of the CAV components for different main functions and constraints listed above, as well as the expected effects. For that, a system disintegration is needed, i.e. dividing the whole system into basic components.

The FMECA identifies and evaluates how the system may not respond to the functions identified in the functional analysis (failure mode). The FMECA analysis lists exhaustively all system failures [107]. The analysis of technological developments installed in CAV could be a way to figure out the sensitive components of these vehicles.

The key components of CAV are the sensors. For vehicle automation, sensors based on camera and radar and LIDAR technology are used. They allow the vehicle to see and sense everything on the road, as well as to collect information needed to drive safely. The purpose of sensing is to build a 360-degree environmental model around the vehicle for detection of different kinds of objects. The information collected with sensors, including the actual path, traffic jams, and obstacles on the road, are shared between the connected cars (V2V communication) in order to improve driving automation.

#### **3.7.1 *The "projected" benefit FMECA***

Beyond the main objective of identifying the weak points of a system, FMECA obliges and forces the different experts to have the same level of knowledge of the system and thus avoid the risk of "sectoring" the system. In other words, FMECA is an opportunity for the different experts working on the same system not to be confined to their own field of expertise, but to have common objectives which converge towards a solution that achieves these goals.

### 3.7.2 *The "system" objectives of FMECA*

Above all, it is necessary to specify different FMECA orientations with different objectives, among which we distinguish the following:

- 1- The FMECA "Project": it aims to analyze the risks of a project as a whole. This is a permanent job throughout a project.
- 2- The FMECA "Product" / "System": it aims to ensure the reliability of a product / system by improving its design. is carried out during the design of the product. This is the focus of the FMECA used in this study.
- 3- The FMECA "Process": helps ensure the quality of a product by improving the production operations of the product. This work is done during the development phase of the product.
- 4- The "Tool" FMECA: makes it possible to ensure the availability and the safety of a means of production by improving the conception, the exploitation or the maintenance.
- 5- The FMECA "Product" (or "System"): is produced for this study and makes it possible to identify the potential weaknesses of the system: likely modes of failure, possible causes for each mode, and the effects of each failure according to the phase of the mission or life cycle in which it occurs.

One of the risks of using the FMECA tool is that it is time-consuming if it is done without respecting the homogeneity of the level of the analysis set. In addition, the completion of the FMECA level-by-level study highlights the causal linkages of identified failures. The failure trees associated with this system, which are developed below, are based on these links. On the other hand, the determination of the criticism at each line of the analysis aims at establishing a hierarchy of the failures in order to consider only the most "critical" for the continuation of the study.

In our FMECA, we started by defining the possible failure modes of the CAV components. Then we studied the different causes of these failures, as well as their effects on the system. Then we evaluated them with a note according to the severity of the failure, the frequency of

the failure occurrence, as well as its detection (of 1 to 10, 1 the lowest, 10 the highest).

Finally, thanks to these three notes listed above, we were able to determine the criticality of each failure, by multiplying the notes between them.

### 3.7.3 The FMECA "Product"

In Table 3-3 columns labelled S, F, D and C refer respectively to the severity of the failure, the frequency of occurrence of the failure, the detectability of failure, and the criticality of the failure.

The numbers between 0 and 10 in the table are chosen according to a logical way based on ISO 26262 and a professional database called Electronic Parts Reliability Data (EPRD).

ISO 26262 defines functional safety for automotive equipment applicable throughout the lifecycle of all automotive electronic and electrical safety-related systems.

**Table 3-3 FMECA for CAV**

Component	Mode of failure	Effects	S	Causes of failure	F	Detection	D	C
Actuators	One or more failed actuators	Vehicle not compliant with use	6	Defect in the manufacture /accident	7	Regular maintenance	3	126
Control system	-Non-compliance with standards -Bad control -Not suitable decision-making	Vehicle not controllable/ Failure of vehicle	9	-Defect in the manufacture. -Fail to execute the planned actions. -Programming bugs in AI -lack of reinforcement learning. -Bad or fault semantic reasoning.	7	Error message	8	504
V2V&V2I	-Non compliance with standards -Failure of V2X components	Lack of information about the other vehicles and about road side unit	6	-Defect in the manufacture -Congestion in channel -Connection lost -Delayed or loss of packets -Wrong or defective packet received. -Bandwidth or range too small - High signal to noise ratio - Bad weather. -DOS attack, Jammed channel. -Receiving or sending wrong data.	8	Indicator light	5	240
Perception system	Non-compliance with standards -Bad data reception	-Vehicle not compliant with use - Navigational Failure	7	-incomplete information -imprecise perception of the environment. - Machine Learning problem in classification or recognition	5	-Error message -Return to manual mode	7	245



				- Misunderstanding of the raw information form sensors or V2X				
Planning system	Non-compliance with standards	Vehicle not compliant with use Navigational Failure	7	Programming bugs in AI. -Machine Learning problem in classification or recognition. -object is beyond the training data range	5	Error message return to manual mode	7	245
Vision system	Non-compliance with standards -VS failure	Lack of information from the environment	6	-Defect in the manufacture Lens Damage, -Misalignment, shockwave, overvoltage, short-circuit, vibration from rough terrain, -Improper Lighting -Bad weather (rain, fog and snow) -low illumination environments -poor visibility conditions -heavy traffics	8	Indicator light	5	240
Radar system	-Electrical components failure -noise ratios -Clutter Effect	-Lack of information from the environment -Random variations on the reflected received signal -Bad performance issues with radar systems	6	-Hardware failure -Noise affect the accuracy of the radar as distance increases -Detection curves drawn with respect to signal -due to long waveguide between the transceivers. Very near measurement. -Bad weather	8	Indicator light	5	240
LIDAR system	Non-compliance with standards Electrical components failure -Unable to send information to the system	-Lack of information from the environment -Object cannot be well identified	6	Electrical Failure, Laser malfunction, mirror motor malfunction, position encoder failure, over voltage, short-circuit, Optical receiver damages. ,bad weather	8	Indicator light	5	240
Supplemented sensors	Non-compliance with standards	Lack of information from the environment	6	-Detection beyond the range. -Defect in the manufacture -Bad weather	8	Indicator light	5	240
Controller	Non-compliance with standards Deterioration	Lack of information from the environment	7	Defect in the manufacture	7	Indicator light	7	343

Note that the most critical failure is the failure of the control system. Indeed, it is the most difficult failure to detect in the system and which is very crucial for the user because it leads to the failure of vehicle.

### 3.8 Conclusion

This chapter introduced the concepts of reliability as well as the required background information including some approaches and techniques for mobile-based environment dependability evaluation, with a particular focus on CAVs.

Our work relies on modeling in order to provide a quantitative approach for evaluating the dependability and forecasting the reliability.

An overview of a hierarchical and stepwise modeling approach aimed at the evaluation of CAVs was discussed. This approach is based on the evaluation of the CAV at different abstraction and decomposition levels using a combination of various evaluation techniques and an integrated way in order to provide end-to-end evaluations. Therefore, to develop an efficient and reliable approach to assessing the reliability of the CAV, the internal and external functional analysis functional analysis for CAV are adopted to address a lack of synthesized information about sensor, hardware, and algorithm requirements for effective CAV deployment. Therefore, PRA and FMECA were done to analyze the reliability and possible failures.

Finally, a detailed FMECA analysis of the CAV was performed in order to obtain a detailed understanding of the vehicle failure modes. The FMEA is an engineering method that we used to help identify weak points of CAVs (hardware and software). This qualitative analysis showed how reliable the designed system is by identifying potential failures of CAV components. Our goal is to prevent these failures as early as possible and before they happen. Potential failures could then be avoided by alternative designs or redundancies. Hence, in the next part, we will realize the Fault tree with “Failure of CAV” as the head event (the primary fault or failure being analyzed).

The understanding gained from the FMECA is then used in the next chapter to construct fault trees describing the failure of each subsystem.

## Chapter 4 - A Fault Tree analysis for the reliability of CAV

---

<b>CHAPTER 4 - A FAULT TREE ANALYSIS FOR THE RELIABILITY OF CAV.....</b>	<b>87</b>
4.1 INTRODUCTION.....	88
4.2 COMPONENT OF V2X TECHNOLOGY .....	89
4.2.1 <i>Communication reliability of CV</i> .....	89
4.2.1.1 On Board Unit (OBU).....	90
4.2.1.2 Trusted Platform Module (TPM) .....	91
4.2.1.3 Road Side Unit (RSU).....	92
4.2.2 RBD.....	92
4.3 PROBABILISTIC MODELING OF THE FAULT TREE EVENTS .....	95
4.3.1 <i>Lifetime distributions</i> .....	95
4.3.2 <i>The exponential distribution</i> .....	96
4.3.3 <i>Reliability of OBU and RSU</i> .....	96
4.3.4 <i>V2V Reliability</i> .....	99
4.3.5 <i>V2I Reliability</i> .....	100
4.3.6 <i>V2X Reliability</i> .....	101
4.4 FAULT TREE FOR CAV.....	102
4.5 IMPROVEMENT PROPOSAL FOR THE FAULT TREE .....	110
4.6 CONCLUSION FOR THE FAULT TREE .....	115

### 4.1 Introduction

The FMEA and the FTA are different procedures, but they are complementary. The FTA is a top down approach that analyzes the details of the events at the top. However, The FMEA goes bottom up and analyzes the effect chain of a failing part.

Constructing an FMECA is often one of the first steps in constructing a fault tree, as it help us in determining the possible component failures, and thus the basic events.

In this chapter, in order to identify availability and reliability of the CAV, a fault tree was developed and analyzed.

The methods and techniques designed to carry out reliability evaluations can be conducted in two ways:

**Ordinal evaluation:** such as FMEA, uses methods and techniques to identify, list, and rank failures.

**Probabilistic evaluation:** such as reliability block diagrams and fault tree analysis. It evaluates in terms of probability the degree of reliability attributes of communication components in CAV as an example [108].

The two types of evaluation techniques are complementary, since probabilistic evaluation requires, as a first step, the identification of failure modes to be taken into account in the assessment of the quantitative dependability measures.

Fault forecasting is performed using evaluation of the behavior of a system relative to the occurrence of faults and their consequences. It aims at estimating the present number, the future incidence, and the likely consequences of faults. By adopting a structural view of a system, evaluation consists of reviewing and analyzing the failures of its components and their consequences on the

system's reliability. The analysis can be performed iteratively by a fault tree, which considers different levels of decomposition and abstraction of the system.

A fault tree study allows to graphically represent the causes of an identified fault event which one wishes to control according to certain priorities. Hence, the main objective is to reveal the causes or combination of causes that can produce the defined head element, using two approaches:

***A. A deductive approach:***

In contrast to an inductive approach of FMECA, the analysis is done top down.

***B. A static approach:***

Represents a sequence of causes leading to the failure that we want to describe for a state of the system at a given moment.

This Fault Tree calculates the probability of occurrence of the head event, which in our case is "CAV failure".

## 4.2 Component of V2X technology

First, we study the subcomponents of the V2X technology, which consists of an OBU for CV and an RSU on the infrastructure using Reliability Block Diagrams (RBD), which is an effective technique for modeling reliability and availability of communication networks [84].

We present a design of RBD for: (1) the OBU based on Dedicated Short Range Communication (DSRC) Standard, (2) the RSU and (3) the devices that are especially interesting for security purposes such as Trusted Platform Module (TPM). TPM is often mounted on vehicles to offer reliable storage (e.g. user credentials and keys) and to compute cryptography. TPM hardware is assumed to be tamper resistant so that hackers can't gain access, even with physical presence [109].

### 4.2.1 Communication reliability of CV

A reliable communication in connected vehicle is dependent upon reliable hardware involved in communication.

### 4.2.1.1 On Board Unit (OBU)

An OBU is a mobile or portable wireless device that is located inside intelligent vehicles [52]. It works as a communication device and allows DSRC communications with other OBUs or RSUs. OBU includes other communication systems (e.g. GPS.), and other subcomponents like application unit hardware, Human Machine Interface (HMI) and power supply. Each vehicle equipped with an OBU collects data and information, (such as vehicle's speed, position, brake status, signal status, etc...) analyzes, processes and encrypts the data in order to send it as a safety message to other vehicles (V2V) or RSUs (V2R) through the wireless medium;

An automated vehicle is equipped with an OBU system designed to ensure a number of functions. In addition to processing, inputs/outputs, and storage functions, an OBU system provides other major functions such space-time localization and scene recognition, longitudinal telemetry and short-range omnidirectional communications.

The set of system components required for OBU are:

- Resource Command Processor (RCP): It directs the operation of the other units by providing timing and control signals. All other resources are managed by the RCP, which is the processing unit of the system. It must permit a local elaboration of the data gathered from the infrastructure and from the smart vehicle. The reliability of the RCP, shall be denoted by  $R_{RCP}$ .
- GPS system: 360° positioning and global time keeping in order to allow the vehicle to communicate its own position to perform geo-location. The reliability of the GPS communication module shall be denoted by  $R_{GPS}$ .
- Wireless communication: VANET uses DSRC to provide an omnidirectional 360° radio wireless communication between moving vehicles. DSRC refers to 802.11p, which is an improvement of IEEE 802.11a. The reliability of the DSRC, shall be denoted by  $R_{DSRC}$ .

- Antenna: used with a transmitter or a receiver in order to achieve the dedicated range of wireless networks. The reliability of the antenna shall be denoted by  $R_{Ant}$ .
- HMI: an electronic display screen that is used for driver assistance in collision avoidance applications. HMI shows awareness messages such as: indications, warnings, and advices using different ways of interaction like visual (flashing light, image) and auditory (sound, alarm). The reliability of the HMI, shall be denoted by  $R_{HMI}$ .
- Vehicle services: interacts directly with the body chassis systems of the car doing a tactile and kinesthetic functions such as the vibrations of the driver's chair or the steering wheel. The reliability of the vehicle services shall be denoted by  $R_{VS}$ .

### 4.2.1.2 Trusted Platform Module (TPM)

In CV, data is broadcasted over shared communication media: a malicious node may easily intercept, modify or inject data [110]. Data injection can provoke collisions in a vehicular system.

Weak security leads to many traffic problems putting human lives at risk. In Vehicle-Based Security System (VBSS), the OBU generates the BSM that collect vehicle and road conditions data. These BSM should be certificated and signed in order to preserve privacy and enhance essential security services, such as authentication, integrity, confidentiality and nonrepudiation.

A secured vehicle needs some hardware requirements, such as TPM that can be integrated into the OBU; TPM is the hardware module that forms the security issues such as encryption/decryption, hashing and digital signature. It is able to protect and store data and keys in shielded locations.

From hardware point of view, a TPM contains the below components:

- Assembled controller: A TPM contains a controller bus, for the connection and coordination among its memory and peripherals. The reliability of the controller shall be denoted by  $R_{Cont}$ .
- NVRAM: Non-volatile random-access memory is used for permanent storage of the

startup configuration that is writeable. It is also used for permanent storage of hardware revision, identification information and the cryptographic keys. The reliability of the memory shall be denoted by  $R_{Mem}$

- Crypto unit: as its name indicates, it is responsible for random number generation, public-key cryptographic algorithm, cryptographic hash functions, symmetric-key algorithms, digital signature generation and verification, and Elliptic Curve Cryptography (ECC). The reliability of the crypto unit shall be denoted by  $R_{Cryp}$

### 4.2.1.3 Road Side Unit (RSU)

RSU is installed at the roadside [111]. It includes communication hardware (e.g. Wi-Fi, UMTS, ITS G5, etc.), and serves as a gateway between OBUs and the communications infrastructure. It could provide location based services and Internet access for mobile devices to improve the communication connectivity. The main functions of RSUs are as follows:

- Network coverage extension of the Ad Hoc network and communication medium between OBUs and RSUs.
- Source of safety and awareness information like weather status.
- Prioritize management messages to and from the OBU.
- Gateways that allow vehicles to establish connection with the internet.

The RSU is connected to the V2I communications network. Prioritization of messages is also managed by the RSU to and from the vehicle. Similar to OBU, an RSU is composed of a communication transceiver (802.11 & 1609), GPS and a processor. RSU contains a router that acts as an interface to the V2I cloud network. RSU is also connected to a local safety processor that is related to traffic light signal controller.

### 4.2.2 RBD

The reliability of OBUs, RSUs and TPMs are explored using RBDs. RBD for the OBU (Fig. 4-



1) shows a graphical representation consisting of blocks representing system components and the connection between these components. The system is functional, if at least one path of properly functional components from input to output exists; otherwise, it fails [110].

An RBD construction can follow two main basic patterns of component connections:

1- Series connection: With a series design, the system will fail if any component fails.

Therefore, in the series connection all the components should be functional for the system to be remain functional. Assuming that the components are independent, the reliability of the series design can express as:

$$R_{Series} = R_1 R_2 \dots R_n$$

Simply by multiplying the probabilities. Since each reliability value is less than one, we may conclude that a series design is less reliable than its least reliable component.

2- Active redundancy or standby redundancy (parallel): The components in active redundancy, might be connected in a parallel design, the system will work as long as any component works. Therefore, the reliability of the parallel design can express as

$$R_{parallel} = 1 - (1 - R_1) (1 - R_2) \dots (1 - R_n)$$

All the subcomponents of OBU are designed in series way, excluding the HMI and the vehicular services that are designed in parallel, thus the reliability of an OBU, represented by  $R_{OBU}$ , is given below:

$$R_{OBU} = R_{Ant} R_{DSRC} R_{GPS} R_{PS} R_{RCP} [(R_{HMI} + R_{VC}) - R_{HMI} R_{VC}] R_{TPM} \quad (4.1)$$

Where the reliability of the TPM is set below:

$$R_{TPM} = R_{Cryp} R_{Mem} R_{Cont} \quad (4.2)$$

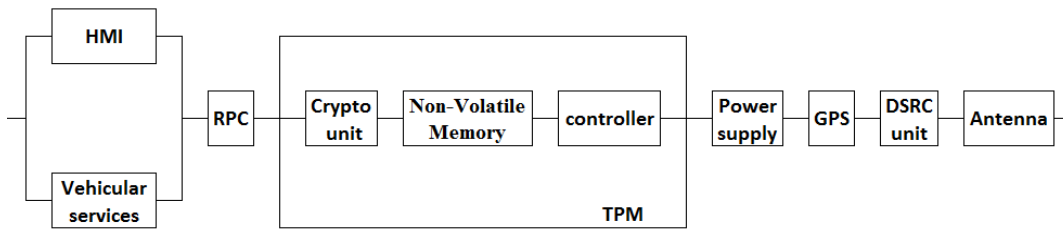

Figure 4-1 Reliability block diagram for OBU including the TPM

The RBD of RSU will be as show in Fig. 4-2



Figure 4-2 Reliability block diagram for RSU

Consequently, the reliability of an RSU, represented by  $R_{RSU}$ , is given by:

$$R_{RSU} = R_{Ant} R_{DSRC} R_{GPS} R_{PS} R_{Process} R_{STL} \quad (4.3)$$

Many quantitative data are needed in order to achieve this analysis; hence the necessity that the data should be accurately targeted. QAD contains data fields of failure rates on a variety of electrical, mechanical, electromechanical, and microwave parts and assemblies. It is used as a source of reliability failure rate data. Data contained in EPRD reflects industry average failure rates, especially the summary failure rates that were derived by combining several failure rates on similar parts/assemblies from various sources. At  $t = 0$ , the population of parts has not experienced operation. As operating time increases, parts in the original population are replaced and the failure rate increases.

Probability of events is modeled from component failure rates. These are defined by the average of failure rate (Failure rate Mean ( $\lambda_{Mean}$ )), (Failure rate Lower ( $\lambda_{Min}$ )), Failure Rate Upper ( $\lambda_{Max}$ )), and by standard deviation of failure rate (Failure rate SD ( $\lambda_{SD}$ )).

The component failures of the system follow an exponential distribution on a total duration of

1year (8760 hours) to take into account the history of degradation in the estimation of the fault. During this time, we consider that the OBU system and the RSU system are operating in real conditions

### 4.3 Probabilistic modeling of the component failure events

The objective of this section is to present the probabilistic approach applied on data from the event tree. The top event is the OBU Failure. Reliability data expressed in failure rate are random.

#### 4.3.1 Lifetime distributions

From an engineering point of view, the ability to predict the lifetime of a whole system or a system component is very important. Such lifetimes can be predicted using a statistical approach using appropriate distributions. Such systems can be CAVs with their system components and the components of electronic systems such as sensors and computers. If we can develop a lifetime model for the CAVs and their system components, the results can be used to plan preventive maintenance and part replacement schedules or whole system replacements and reliability testing schedules.

We start by looking at the duration of use of a system or component prior to failure (the age prior to failure) and from this develop a definition of reliability. Lifetime distributions are functions of time and may be expressed as probability density functions.

$$F(t) = \int_0^t f(t)dt$$

$F(t)$  represents the probability that the system or component fails anywhere between 0 and t. The probability that the system or component is still functioning at time t may be written as:  $R(t) = 1 - F(t)$ ; Where the function  $R(t)$  is usually called the reliability function.

The reliability information of these events are:  $\lambda_{\text{Min}}$  = minimum degradation rate, and  $\lambda_{\text{Max}}$  = maximum degradation rate, and  $\lambda_{\text{Mean}}$  = mean degradation rate, and  $\lambda_{\text{SD}}$  = standard deviation of degradation rate.

### 4.3.2 The exponential distribution

CAVs are classified as “safety critical” because they are directly related to human safety. For this reason, in this paper we used the exponential model, which is very conservative. Moreover the exponential model is the widely used for electronics components such as in the OBU and the sensors; even if it is a pessimistic scenario. The exponential distribution describing failure, met the form:

$$f(t) = \lambda e^{-\lambda t}, t \geq 0$$

$$f(t) = \frac{1}{\mu} e^{-t/\mu}, t \geq 0$$

Where  $\lambda$  the failure rate and  $\mu$  is is the mean time to failure.

Exponential distributions, with failure rate  $\lambda$  and time-to-failure random variable, are used in order to express the reliability or availability of these individual components of the OBU. The dependability of each component is then used in order to determine the reliability of the overall VANET system by utilizing mathematical expressions that are presented in eq.4.1. The failure  $\lambda$  rate is considered as a random variable, which is defined between two limits. Its mean and standard deviation are known.

### 4.3.3 Reliability of OBU and RSU

Table 4-1 depicts the failure events data for all the components of the OBU, obtained from a professional database called Quanterion Automated Databook (QAD) that uses Electronic Parts Reliability Data (EPRD). The power supply (E008) has the greater failure rate, and has a significant influence on the reliability of the OBU, since the power supply is implemented in series in the RBD, which means definitely, when the power supply of OBU fails the whole system will fail. As an improvement, we suggest to use a dual power supplies in the OBU.

Table 4-1 Failure events data

Basic event	Label	$\lambda_{Min}$	$\lambda_{Max}$	$\lambda_{Mean}$	$\lambda_{SD}$
HMI	E005	1.4E-06	1.8E-06	1.6E-06	1.8E-07
Vehicular services	E006	4.2E-07	2.3E-06	1.2E-06	8.08E-07
RCP	E007	2.8E-06	3.7E-06	3.3E-06	3.7E-07
Power Supply	E008	4.7E-06	9.1E-06	6.3E-06	2.01E-06
GPS	E009	1.4E-06	1.8E-06	1.6E-06	1.8E-07
DSRC	E010	1.05E-06	1.2E-06	1.1E-06	8.18E-08
Antenna	E011	4.8E-07	6.2E-07	5.5E-07	6.18E-08
Crypto Unit	E012	2.8E-06	3.7E-06	3.3E-06	3.7E-07
Memory	E013	4.6E-07	2.5E-06	1.1E-06	9.04E-07
Controller	E014	1.2E-06	3.3E-06	2.1E-06	9.6E-07

The redundant power supply, shown in Fig. 4-3, might be connected in parallel. After the redesigned RBD for the OBU, we noticed an improvement in reliability between the OBU having a single power supply and the redesigned OBU having dual power supplies.

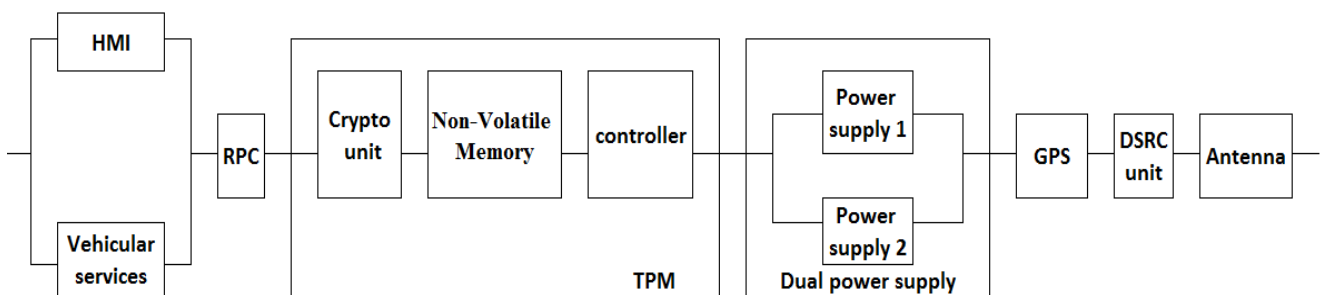

Figure 4-3 RBD for OBU2 using dual Power supply

Thus, the reliability of an OBU, after adding a redundant power supply  $R_{PS2}$ , represented by ROBU2, is given below:

$$R_{OBU2} = R_{Ant} R_{DSRC} R_{GPS} [(R_{PS1} + R_{PS2}) - R_{PS1}R_{PS2}]R_{RCP} [(R_{HMI} + R_{VC}) - R_{HMI}R_{VC}]R_{TPM} \quad (4.4)$$

As shown in Fig. 4-4, after 8760 hours (1 year) of running, the OBU1 powered by a single power supply reaches a reliability value equal to 81%, however the OBU2 powered by a dual power supply reaches 89% of reliability, that means an increase of at least 8%. This improvement becomes more evident and visible as time passes.

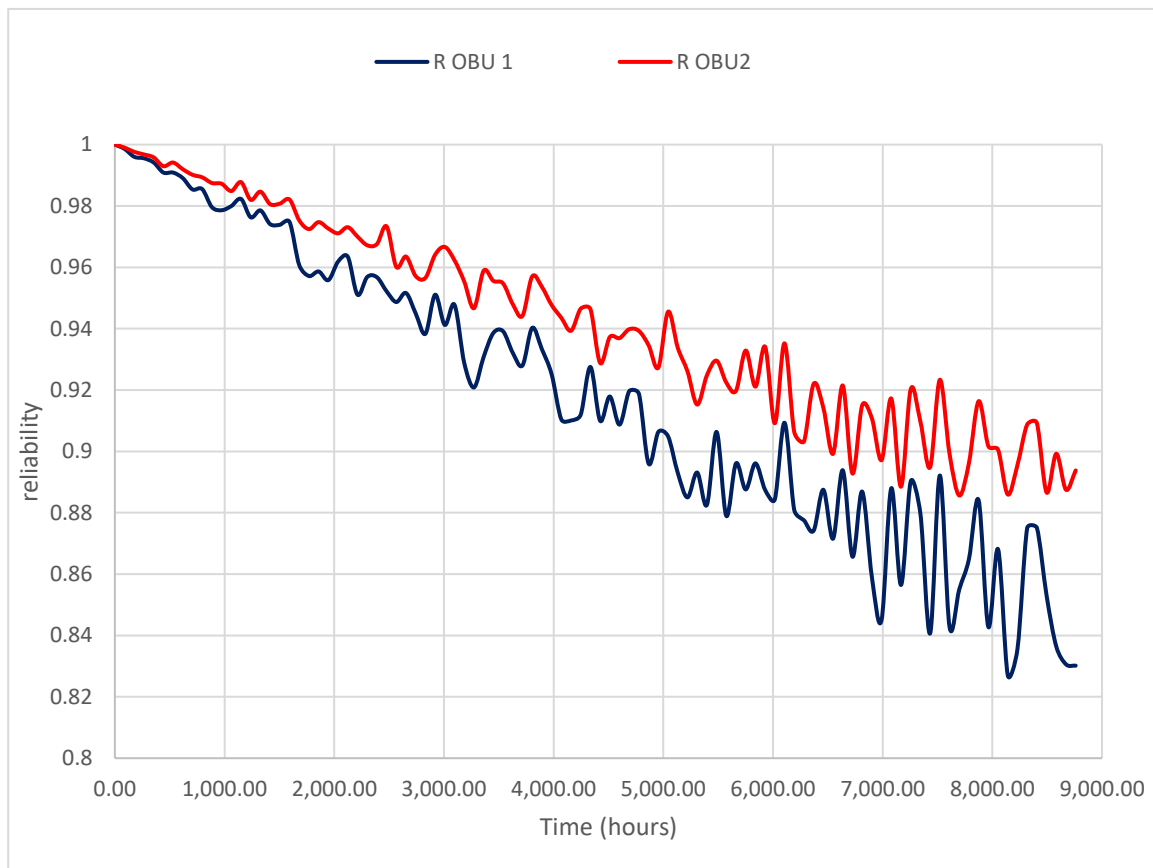

Figure 4-4 Reliability comparison between OBU1 and OBU2

Concerning the RSU, and since all the components are implemented in serial, the remodeling proposed to implement the RSU with dual power supplies increases the reliability for more than 17%. In (Fig. 4-5) it is clear that the degradation in reliability in RSU2 powered by dual power supplies is less severe than RSU1 that powered by a single power supply.

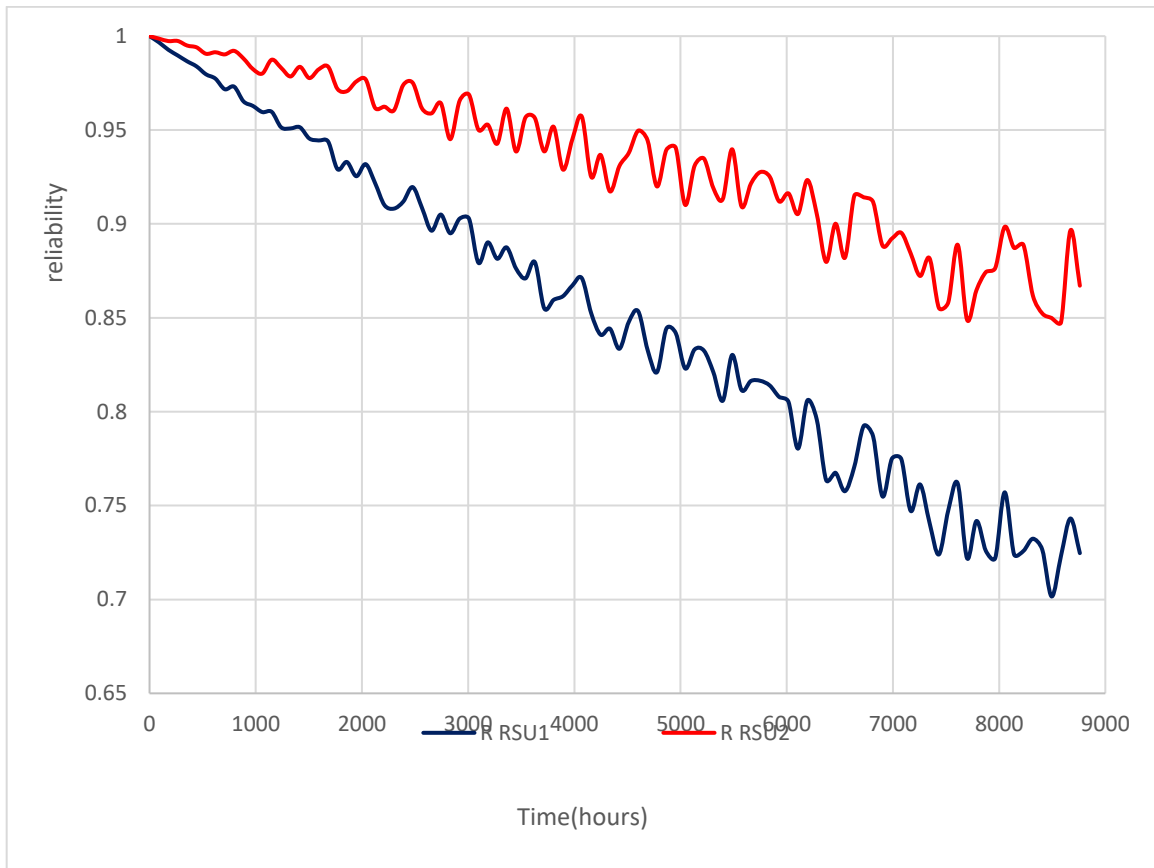

Figure 4-5 Reliability comparison between RSU1 and RSU2

#### 4.3.4 V2V Reliability

Communication in VANET is mainly between the CAVs. For a defined transmission range, the reliability in V2V communication is evident if at least one connected car can communicate with one or more cars. Therefore, within a transmission range V2V reliability is dependent upon the number of OBUs working in this range. Let  $n$  the number of CAVs having OBUs operational within a transmission range that can communication with our desired OBU. Supposing that all OBUs have the same reliability.

$$R_{v2v} = R_{OBU} \cdot [1 - (1 - R_{OBU})^n] \quad (4.5)$$

For the minimum scenario where  $n=1$ , only 1 CAV can communicate with our vehicle. However, having more CAVs in the network will increase the reliability of V2V communication; we will discuss the effect of density on the reliability in section 4.

$$R_{v2v} = R_{OBU} \cdot R_{OBU} \quad (4.6)$$

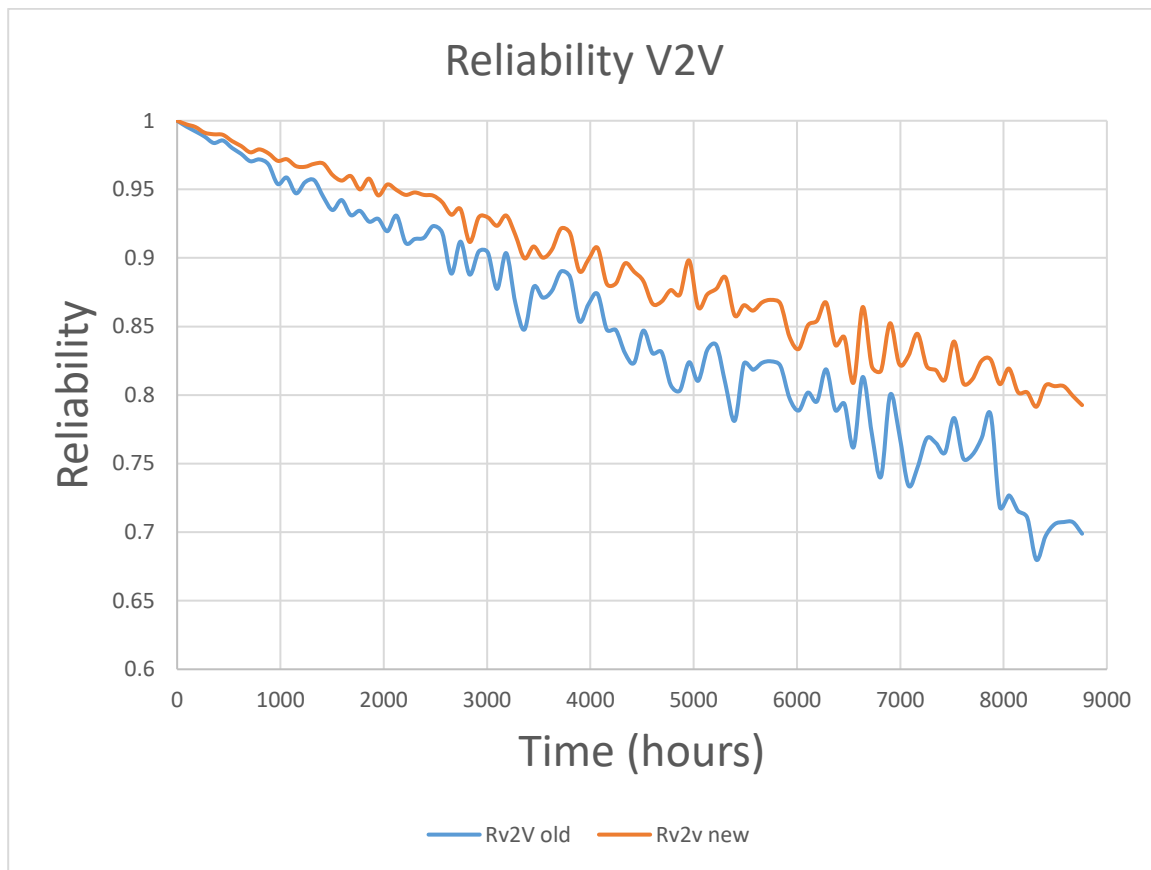

Figure 4-6 Reliability of V2V

The reliability V2V old represent the OBU1 powered by a single power, however the reliability V2V new represent the OBU2 powered by a dual power.

A clear enhancement of 10% on the V2V reliability when we used the redesigned OU as showed in Fig. 4-6

#### 4.3.5 V2I Reliability

V2I communication could provide useful information about the infrastructure such as traffic light information, road layout changes, and speed limits to CAVs [111]. For V2I communication, one or more OBUs communicate through an RSU. Hence, the reliability of the RSUs is also a matter of concern.

$$R_{v2I} = R_{RSU} \cdot R_{OBU} \quad (4.6)$$

The reliability V2I old design represent the OBU and the RSU powered by a single power, however the reliability V2I new design represent the OBU and RSU powered by a dual power.



Evaluating the enhancement in reliability for V2I communications, is shown in Fig. 4-7

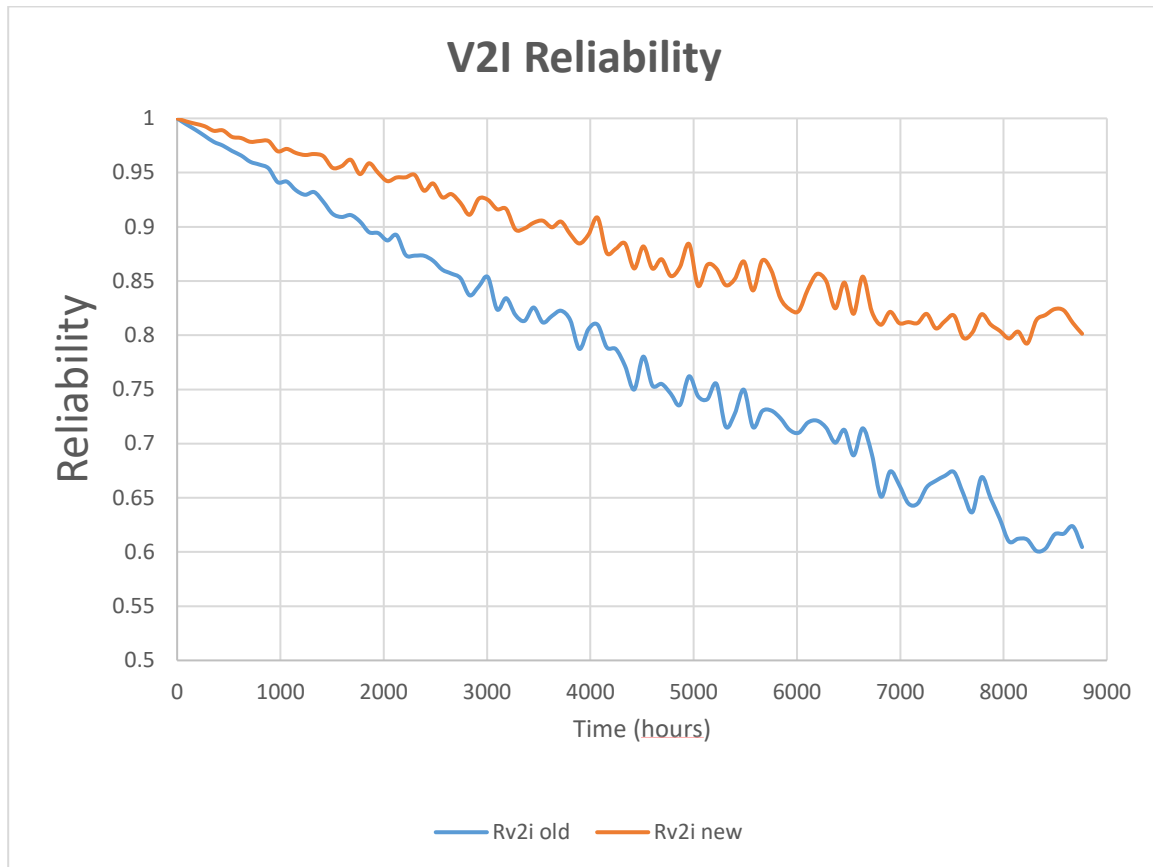

Figure 4-7 Reliability of V2I

#### 4.3.6 V2X Reliability

In order for the CAVs to communicate with each other, V2V network or V2I network should exist. For that, the V2X reliability can be written as the bellow:

$$R_{v2X} = (R_{v2v} + R_{v2i}) - (R_{v2v} \cdot R_{v2i}) \quad (4.7)$$

There is a clear enhancement in the V2X reliability from 88% for the old design that represent the OBU and the RSU powered by a single power, to 96% for the redesigned V2X that new design represent the OBU and RSU powered by a dual power (Fig. 4-8).

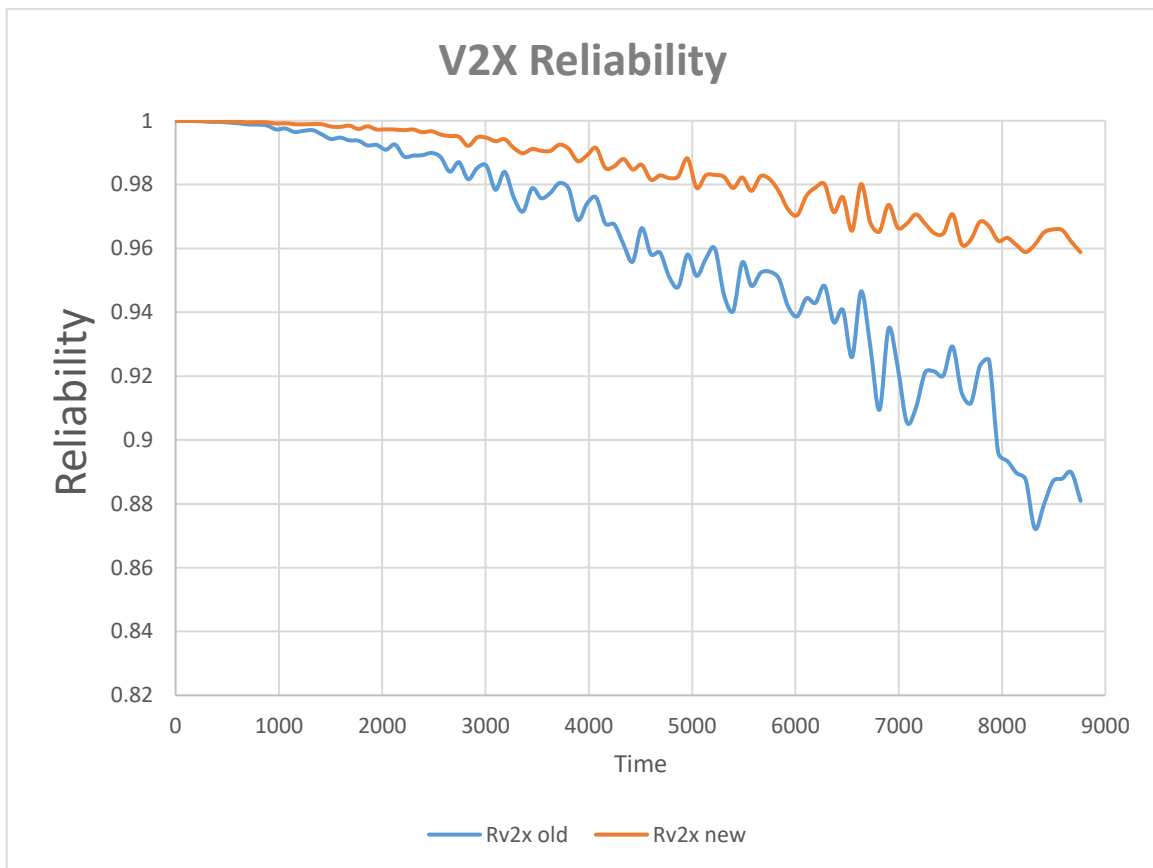

Figure 4-8 V2X Reliability

#### 4.4 Fault tree for CAV

Fault Tree analysis is a graphical technique performed to know the probability of occurrence of the top event; i.e., sensor failure can cause the whole system to fail. These causes of system failure are represented in the form of a tree rooted by the top event as depicted in Fig. 4-9. Logic Boolean gates are used to link two or more causes provoking one fault. The OR gate is presented when one fault from any node is enough to cause a fault, OR gate used in series design. While the AND gate is used when the fault (output) occurs when all inputs fail (inputs are independent), AND gate used in parallel design.

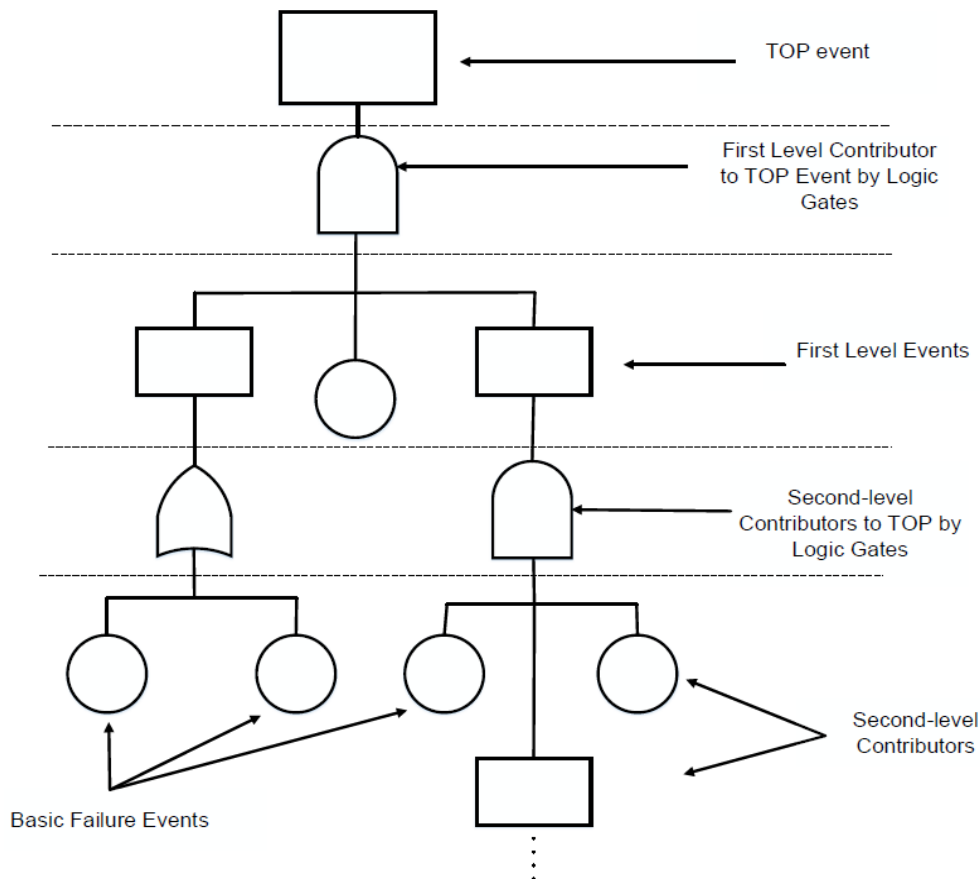

Figure 4-9 Standard Fault Tree Diagram

The failure of the CAV could be due to two main reasons: failures due to environment, or failures due to of vehicular components (Fig. 4-10).

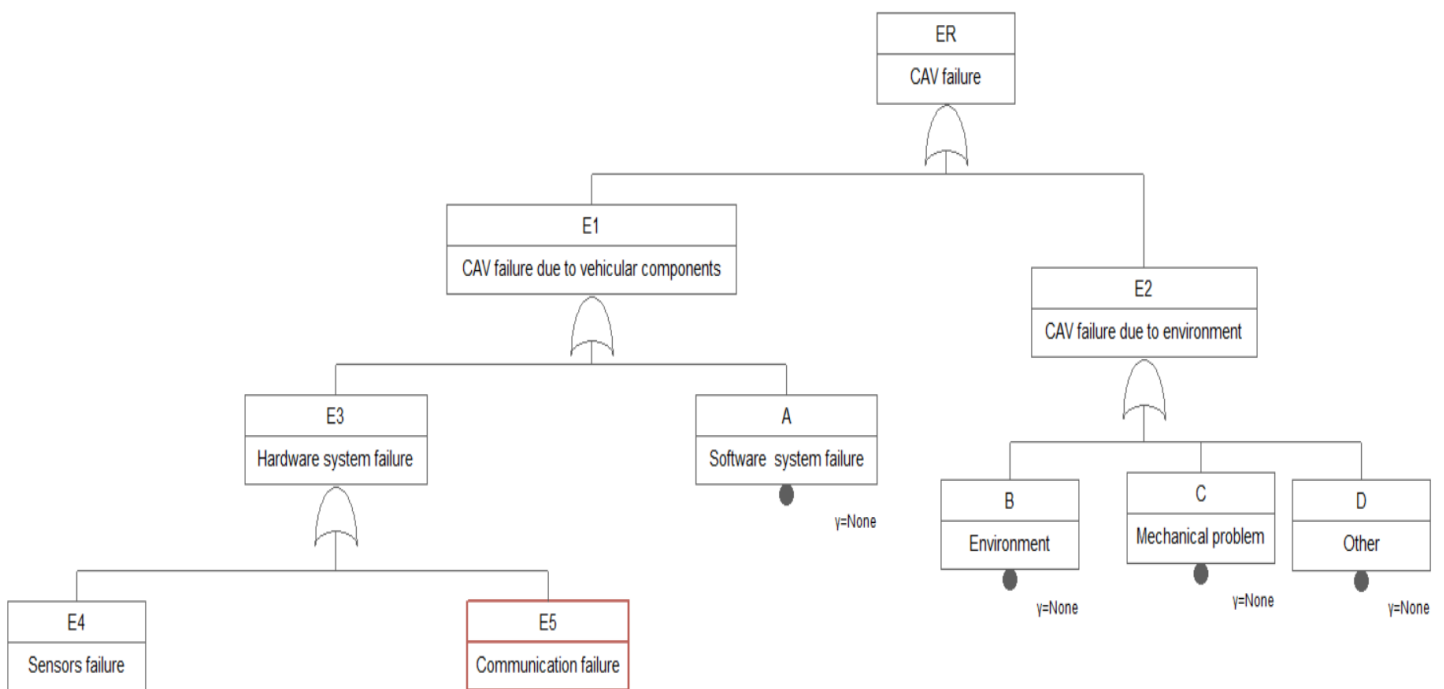

Figure 4-10 CAV Fault Tree

Concerning the crash due to environment and external factors such as mechanical vehicle component's failures, and weather; the National Motor Vehicle Crash Causation Survey (NMVCCS), conducted from 2005 to 2007 a research which aimed at collecting on-scene information about the events and associated factors leading up to crashes. Several facets of crash occurrence were investigated during data collection. A weighted sample of 5,470 crashes was investigated over a period of two and a half years, which represents an estimated 2,189,000 crashes nationwide. About 4,031,000 vehicles, 3,945,000 drivers, and 1,982,000 passengers were estimated to have been involved in these crashes. The critical reason, which is the last event in the crash causal chain, was assigned to the driver in 94 percent ( $\pm 2.2\%$ ) of the crashes. In about 2 percent ( $\pm 0.7\%$ ) of the crashes, the critical reason was assigned to a vehicle component's failure or degradation, and in 2 percent ( $\pm 1.3\%$ ) of crashes, it was attributed to the environment (slick roads, weather, etc.) [112]. Therefore, the external environment failures, which present less than 6% of crash, was ignored. With this assumption, after a total penetration of CAVs that replace driver, 94% of crashes can be avoided.

Autonomous vehicle components. In Chapter 3, the literature review presented automotive features, which could convert a conventional vehicle into an autonomous vehicle. These automotive features then led to the development of the necessary sensors and components of an autonomous vehicle. All these sensors and components were categorized into three major subsystems: hardware, software, and communication. The hardware system includes sensors and components, such as LIDAR, radar, camera, GPS, and wheel encoders. The sensors in hardware system are utilized to collect the surrounding information, whereas the software subsystem consists of the data processing software required for autonomous navigation. The fault-tree model was developed (Fig. 4-11) considering the failure of a CAV due to vehicular components. The failure of the whole system could be due to the failure of one sensor. To ensure a reliable self-driving, and a safe transportation system, the reliability analysis for each sensor is required.

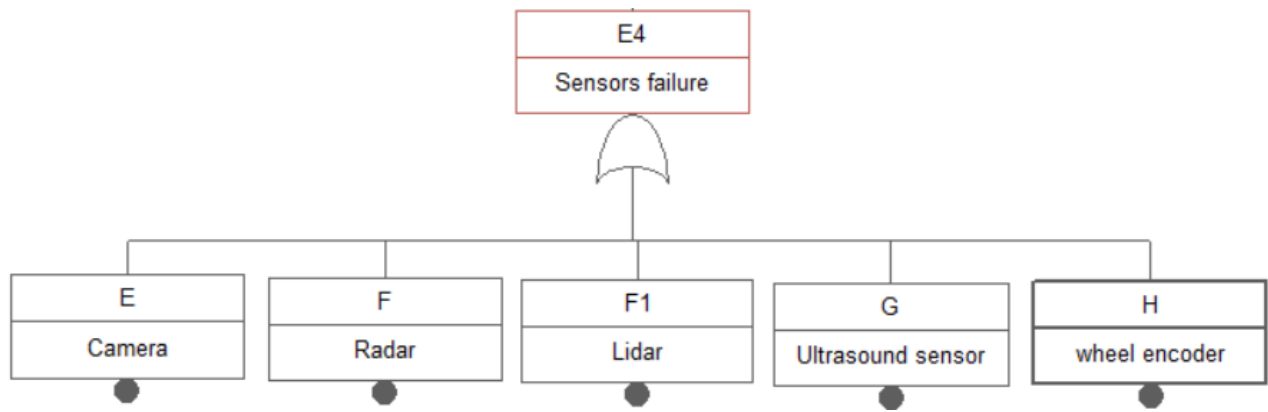

Figure 4-11 FTA for sensors failures of CAV

Table 4-2 depicts the failure events data for all the sensors and the software.

Table 4-2: Failure events data for sensors and software

Failure Ratio	Label	$\lambda$ min	$\lambda$ sup	mean $\lambda$	Standard Deviation
Radar	E015	1.6E-06	2.0E-06	1.8E-06	1.8E-07
LIDAR	E016	1.8E-06	2.0E-06	1.9E-06	7.2E-08
Camera	E017	2.9E-06	3.5E-06	3.2E-06	2.4E-07
wheel encoder	E018	4.4E-07	2.8E-06	1.3E-06	1.0E-06
Ultrasound sensors	E019	9.6E-07	1.2E-06	1.1E-06	1.2E-07
Software	E20	9.3E-07	1.4E-06	1.1E-06	1.9E-07

Vehicle-to-vehicle (V2V) and vehicle to infrastructure (V2X) communication platforms are included in the FT communication subsystem (Fig. 4-12).

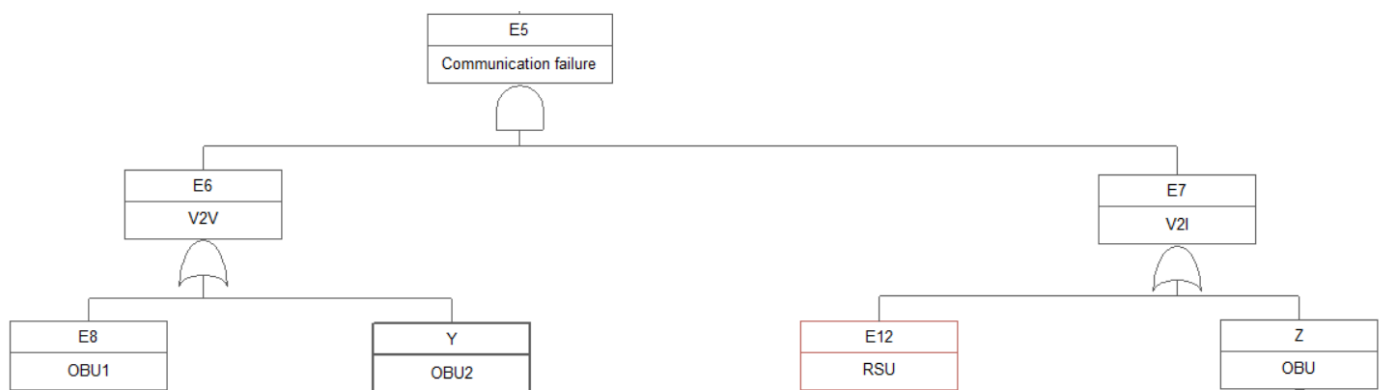
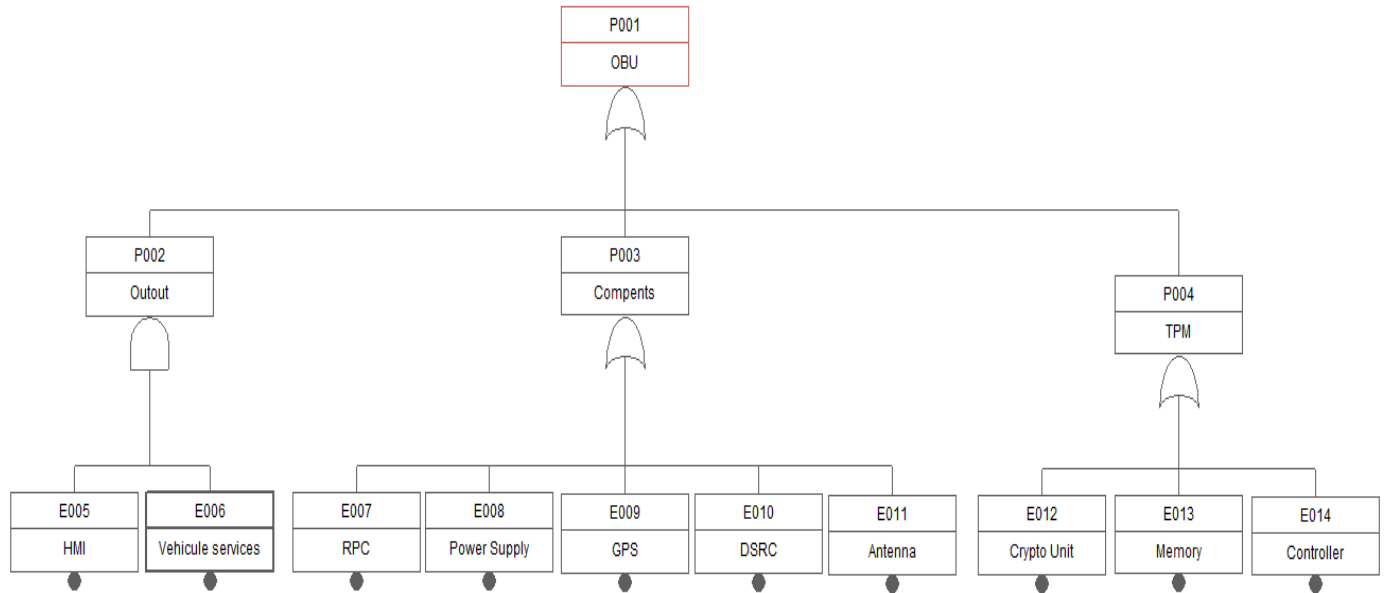

Figure 4-12 FTA for communication failure of CAV

Usually the On-Board Unit (OBU) computers give the connect vehicle the ability to communicate with other V2X. In Fig.4-13 we illustrate the subcomponent of the OBU using the FT.



**Figure 4-13 Fault Tree event of OBU in CAV**

**Fault tree mathematical formulation.**

In the above FT (Fig. 4-13), the logical relationships are restricted to “OR” and “AND” gates. An OR gate represents events that are mutually exclusive events, where one of the preceding events could lead to the failure of the overall system. In “Set Theoretic” terms, this is equivalent to the union of the basic and intermediate events. The probability of the OR gate output can be formulated as follow:

$$P(X \text{ OR } Y) = P(X \cup Y) = P(X) + P(Y) - P(X \cap Y)$$

In our case and Since the components and sensors are independents, no intersection between the component event failures, for that  $(X \cap Y) = 0$

On the other hand, an AND gate represents a combined failure of all events required to lead to a whole system failure. This gate is related to the intersection of two sets in the “Set Theory.” The mathematical formulation of AND gate is given below:

$$P(X \text{ AND } Y) = P(X \cap Y) = P(X) \times P(Y)$$

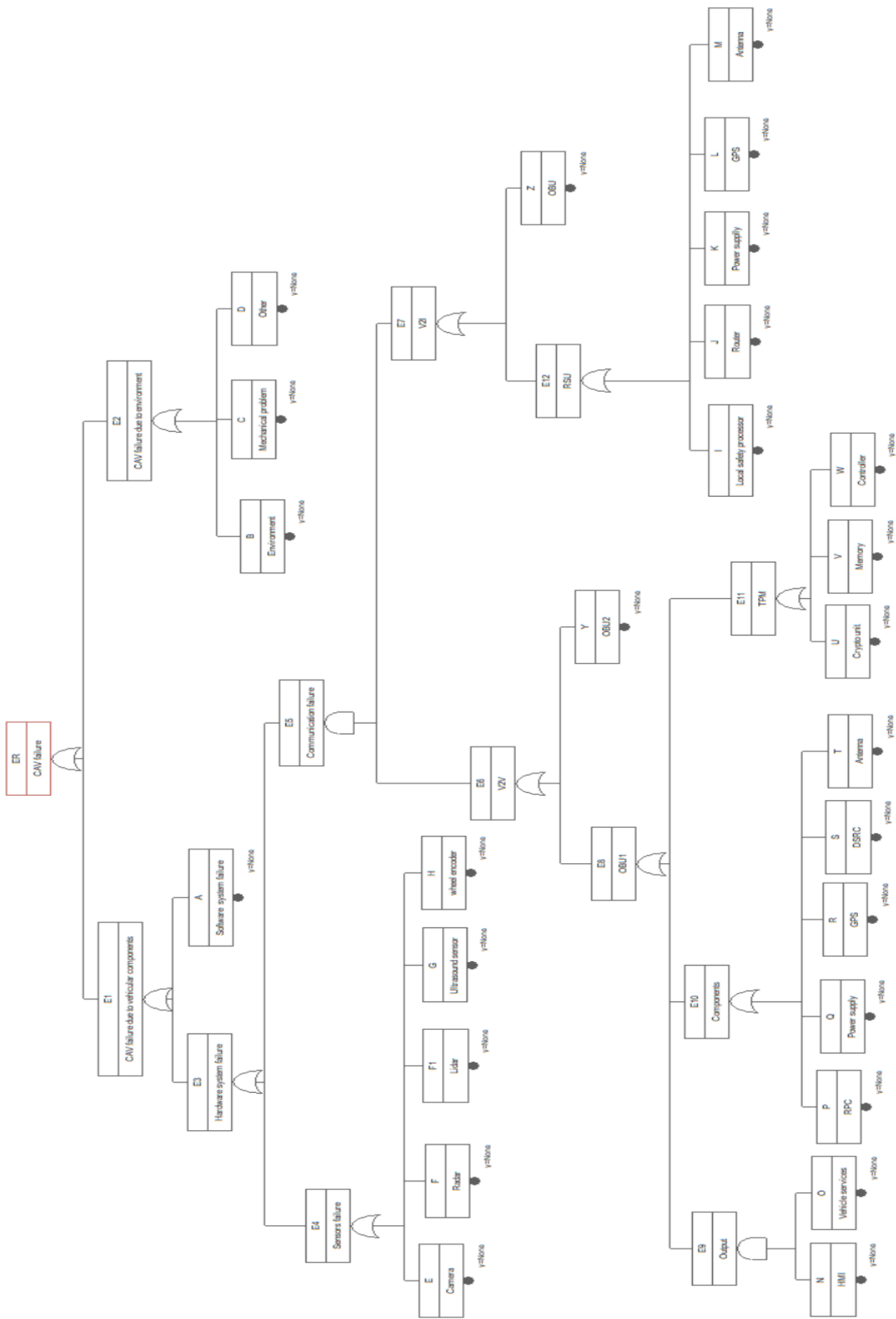

Figure 4-14 Fault tree analysis for CAV

### **Calculation of probabilities:**

$$P(ER) = P(E1) + P(E2) \quad (4.8)$$

$$P(E1) = P(E3) + P(A) \quad (4.9)$$

$$P(E2) = P(B) + P(C) + P(D) \quad (4.10)$$

$$P(E3) = P(E4) + P(E5) \quad (4.11)$$

$$P(E4) = P(E) + P(F) + P(F1) + P(G) + P(H) \quad (4.12)$$

$$P(E5) = P(E6) * P(E7) \quad (4.13)$$

$$P(E6) = P(E8) + P(Y) \quad (4.14)$$

$$P(E7) = P(E12) + P(Z) \quad (4.15)$$

$$P(E8) = P(E9) + P(E10) + P(E11) \quad (4.16)$$

$$P(E9) = P(N) + P(O) \quad (4.17)$$

$$P(E10) = P(P) + P(Q) + P(R) + P(S) + P(T) \quad (4.18)$$

$$P(E11) = P(U) + P(V) + P(W) \quad (4.19)$$

$$P(E12) = P(I) + P(J) + P(K) + P(L) + P(M) \quad (4.20)$$

### **Minimal cut sets**

After the creation of our FT, minimal cut sets (MCSs) are usually obtained by performing qualitative analysis. Each MCS could contain a single event or multiple events combined by logic gates. The order of a minimal cut set defines the number of basic events that contribute to that minimal cut set or to the system failure.

MCS provide important information about the vulnerabilities of a system. A cut set is a set of components that can together cause the system to fail. Thus, if an FTA contains cut sets with just a few elements, or elements whose failure is too likely, this could result in an unreliable system. Reducing the failure probabilities of these cut sets is usually a good way to improve overall reliability.



Thanks to the complete FTA of CAV shown in Fig. 4-14, that illustrate all subcomponent of the CAV, we can determine the most influential events and components of a planned failure, so we will set up a nominal cut analysis as follows in (Fig. 4-15). This analysis method has the ability to identify the shortest route (i.e., MCS) to failure of the top-level event. This mathematical method was used to identify all combinations that are essentially the hierarchical sequence of events that can result in the failure of the main event. The logical relationships between top level and basic event are transformed using Boolean algebra, where all basic event failures are considered binary in nature, i.e., either operational or failed.

Using the fault tree, we established the nominal cuts in order to determine which components had to be corrected first. MCS cuts help to prioritize which components need to be addressed first to improve the reliability and the safety performance of a CAV.

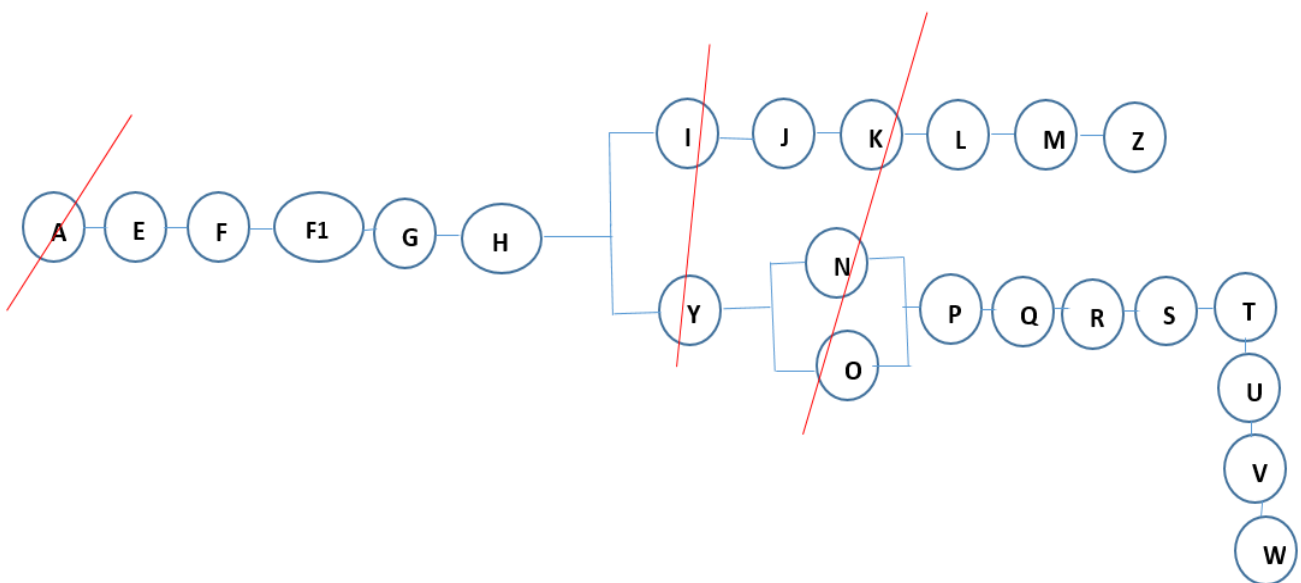

**Figure 4-15 nominal cut analysis**

In the diagram above, we did not show all the cuts to keep the scheme readable. We can carry out the below orders:

- Order 1: 6 cuts of first order MCS that consist of a single basic event, which mean any failures of one components in this 6 cuts lead directly to fail in the whole CAV. Therefore, this single

component becomes a candidate for upgrade or to replicate.

- Order 2: 54 cuts: which means two components of systems fails in this 54 cuts, lead to failure of the vehicle.
- Order 3: 6 cuts: that mean 3 components of the systems fails in this 6 cuts of order 3, make the CAV out of functions.

### 4.5 Improvement proposal for the fault tree

The autonomous function failures fall in two modes, recoverable failures and unrecoverable failures. Recoverable failures are tolerable whenever, in due time masking or recovery is feasible by other sensors. Unrecoverable failure is fatal whenever in due time, some function is lost, and no other function can replace the lost function.

As noticed from the failure events data shown in Table 4-3, the power supply of the OBU has a significant influence on the reliability of the communication system, since the power supply is implemented in series, it lead to single point of failure. As an improvement, the first suggestion to use a dual power supplies in the OBU.

In order to increase the reliability of CAVs, every autonomous function shall be implemented out of diversified redundant sensors, data, and software capabilities, to avoid common cause failures.

Any automation functions failure due to sensor failures may threaten the safety requirements thus leading to crashes. In every safety-critical domain (e.g. in aircraft), the control system and communication parts may be tripled or quadrupled [113]. The solution used in aircrafts could be cloned into vehicles in order to provide distinct redundancy of hardware. Referencing aeronautics, the design principles that have been used in that domain over the past years can be useful to CAVs.

We believe that the use of multi-sensor data fusion can limit the impact of sensors' drawbacks and exploit the advantages of each sensor through using the sensors complementarily and

redundantly. Combining these sensor technologies will reduce faults and improve the reliability and the accuracy, and certainty provide the necessary redundancy for autonomous driving.

In this improvement, we doubled the camera. Indeed, we grouped a camera with the radar on the one hand and a camera with the LIDAR on the other hand in order to have system vision 1 (combination between camera and radar) and a redundant system vision 2 (combination between camera and Lidar) as shown in the tree of Fig. 4-16. This multisensory fusion is in fact a necessity not only to increase the reliability of sensor and for the vision system, but also to carry out the different tasks of perception for better detection and monitoring of obstacles. Increasing the reliability of perception of CAVs will lead to making the right and safe decision by the vehicles.

Using more sensors and sources for sensor fusion provides the necessary diversity for autonomous driving and definitely improves the reliability and the certainty to ensure safety without increasing the cost.

Since we are planning for redundancy, we can replace the logical gate "or" by "and" in order to decrease the probability of the head event. Hence, we can modify the fault tree as follows (Fig. 4-17).

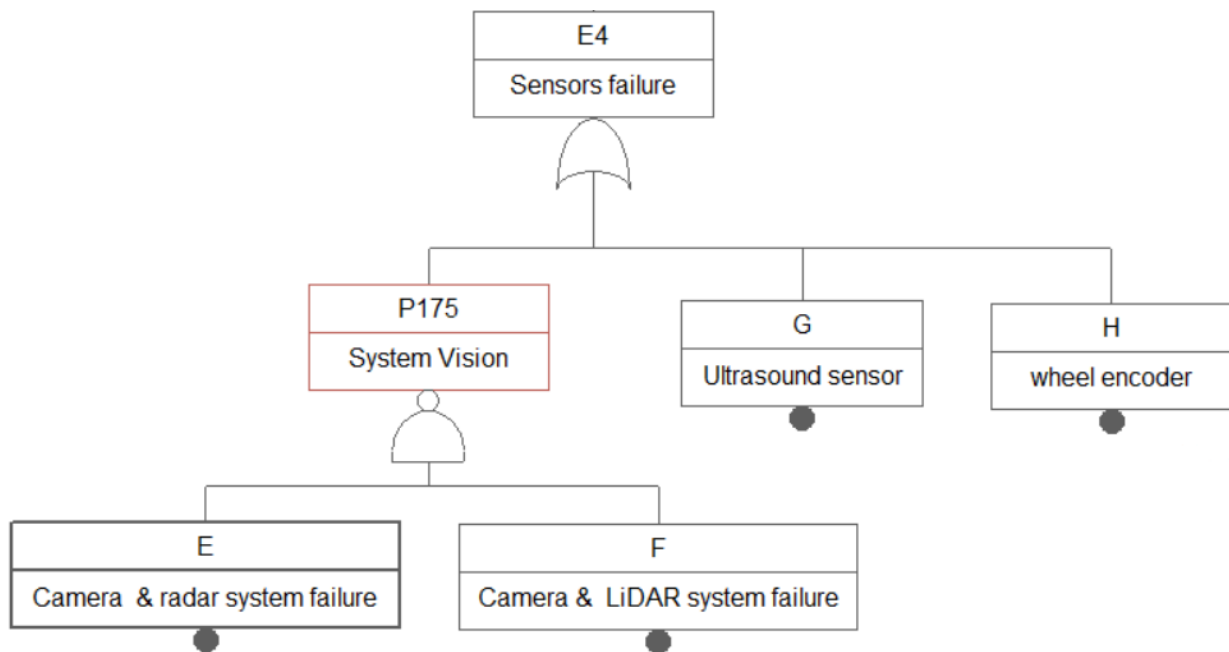

Figure 4-16 Redundant system vision by multisensory fusion

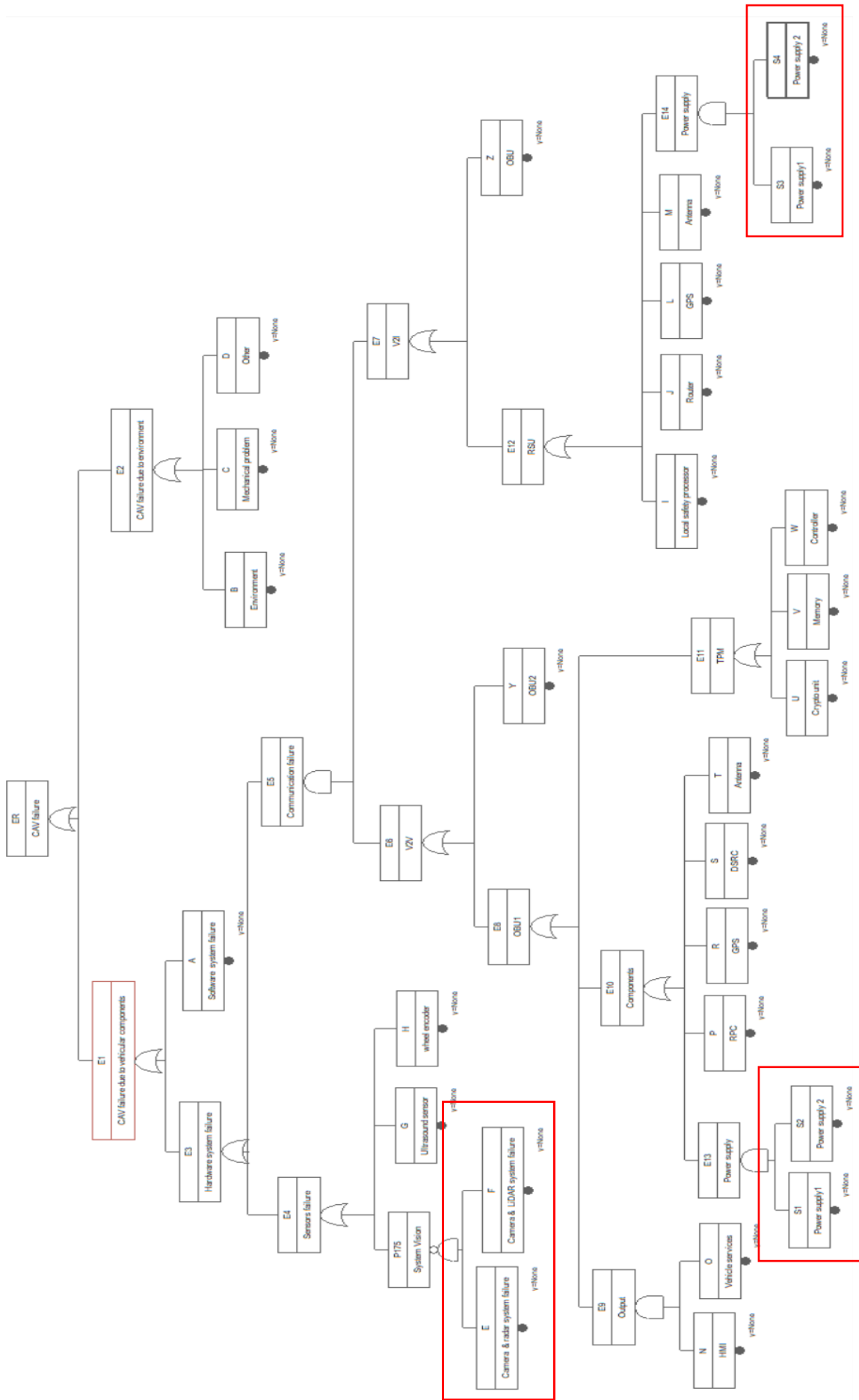

Figure 4-17 Improvement fault tree

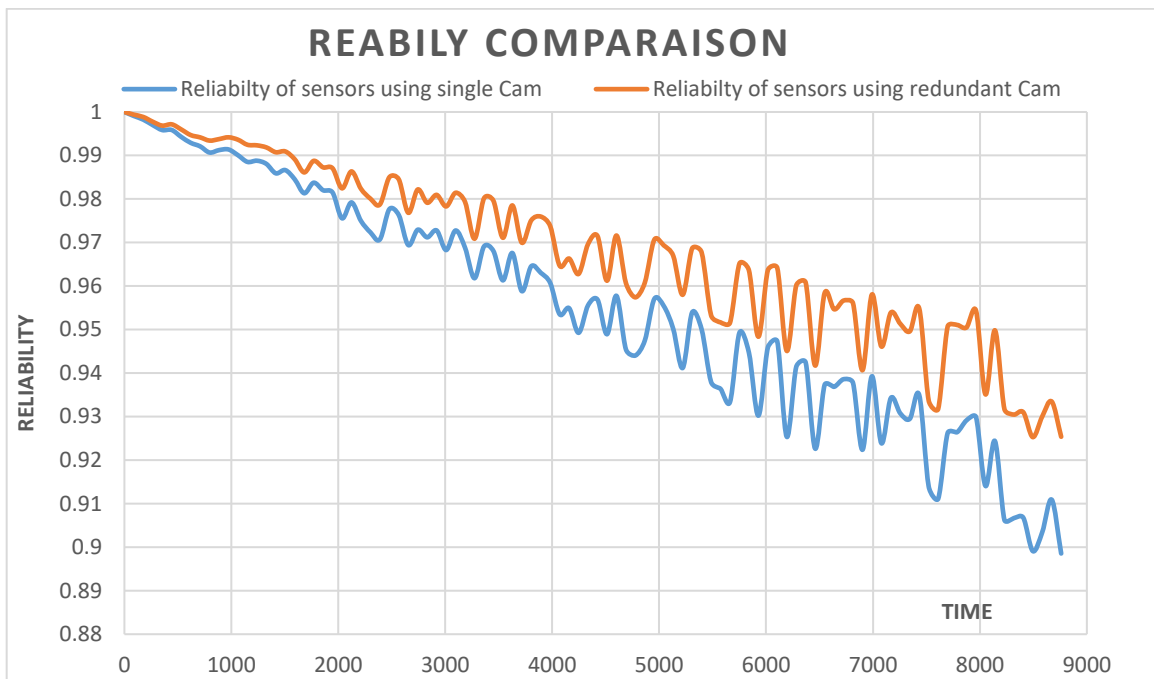

Figure 4-18 Reliability comparison for sensors hardware

Worth noting in Fig. 4-18, having redundancy on the camera increases the reliability for the sensors from 0.90 to 0.93. However, the real improvement was done by building a redundant vision system, which increases the reliability to a level of 0.97, while it was less than 0.90 for the traditional system (Fig. 4-19).

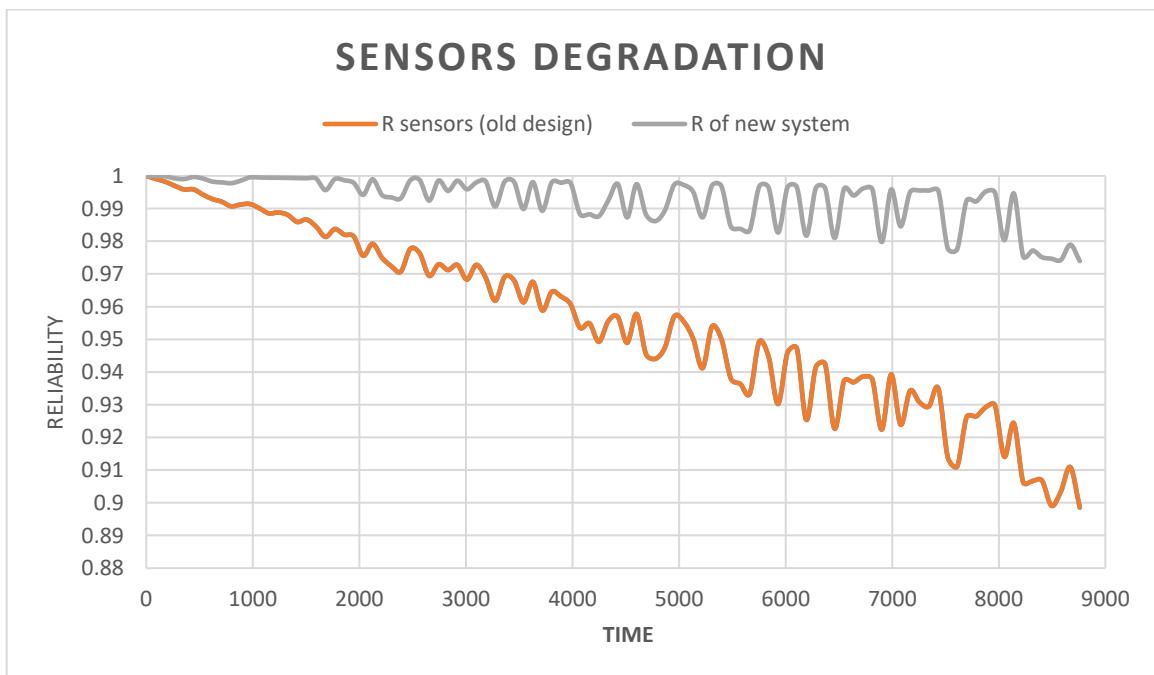
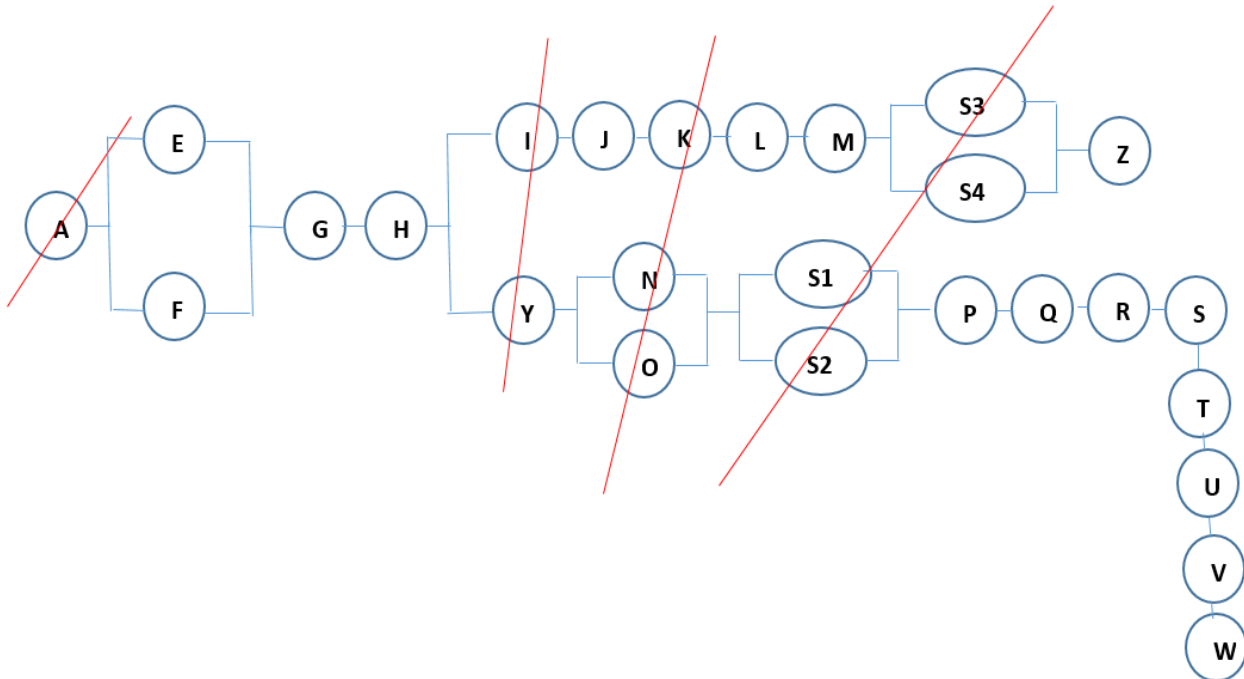

Figure 4-19 reliability comparison between sensors having a single vision system and sensors having a redundant vision system

**MCSs Improvement:**

Now, as a result, we present the following nominal cut analysis for the improved FTA shown in figures 4-17



**Fig. 4-20 Nominal cut analysis improvement**

In this diagram (Fig. 4-19), we can carry out 3 cuts with order 1, 55 cuts with order 2, 20 cuts in order 3 and 2 cuts with order 4.

It is clear that the number of cuts with order 1 has decreased to 3 cuts. First, order MCS that consist of a single basic event, i.e., a single failure event alone can cause failure CAV.

The number of cuts with order 2 and 3 has increased. In addition, the cuts with order 4 have emerged. A fourth order MCS contains four basic events that should failed together, before that the CAV fail. This result confirms the decrease of failure probability by increasing the number of components in a path that leads to system failure.

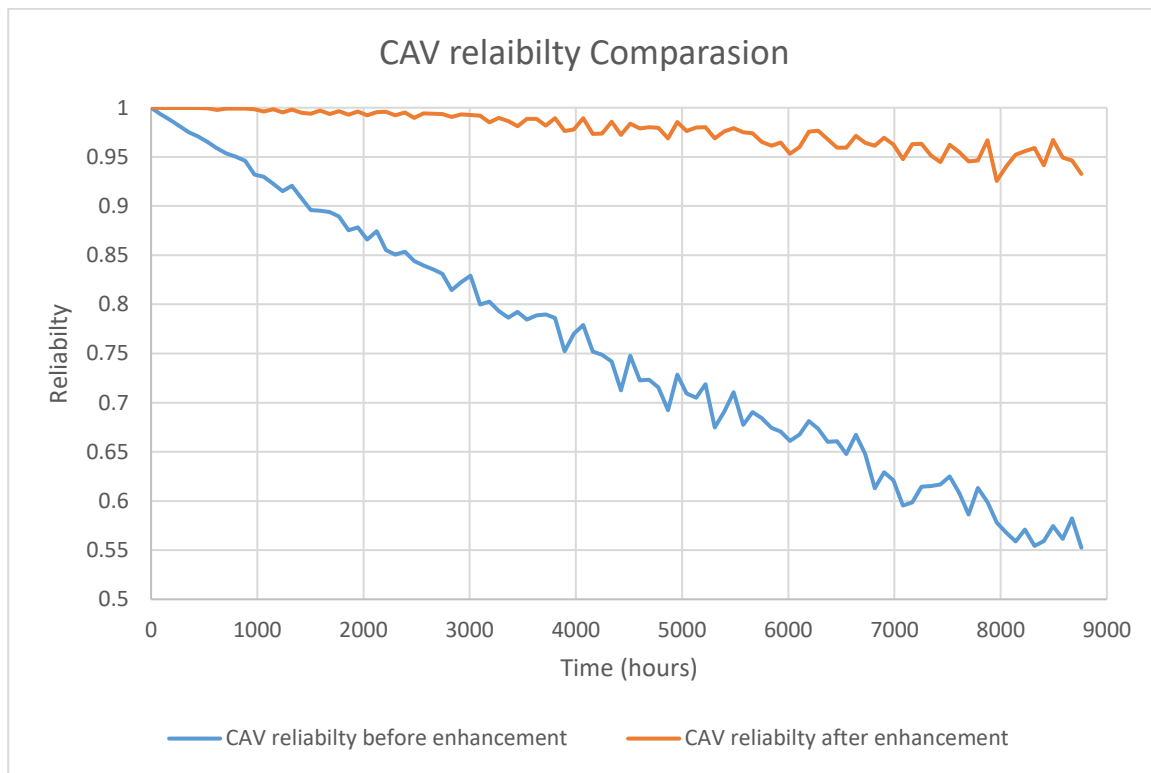

Figure 4-21 Reliability comparison between old design CAV and enhanced design.

It is clear in Fig. 4-21, that we reached a reliability enhancement of 38% by redesigning the system, therefore the reliability improvement is a cumulative process, enhancing the reliability for many components such as the V2X communication and the system vision will directly affect the reliability of the whole system.

#### 4.6 Conclusion for the fault tree

The failure of a sensor can occur at any time; in addition, as analyzed by the FMECA, all sensors have limitations that make them unusable under certain conditions: bad weather, masking, high noise ratio, reduced range, bias, inaccuracies, etc...

Following FMECA done in chapter 3, the reliability of the CAV system is analyzed via FTA and the vehicles reliability is evaluated using the exponential probabilistic method. By performing the analysis, the acceptability of failure can be analyzed, and hence the service capability and potential critical failure of the CAV system can be reviewed.

After constructing our fault tree model for the CAV, both qualitative and quantitative analysis are carried out. A qualitative analysis in this context allows the identification of all combinations of basic failure events, known as cut sets, which can cause the top event to occur. The MCSs are those cut sets that do not contain any subset of the basic cause events that are still a cut set and are obtained by applying boolean algebraic operations on these cut sets. The smaller the number of basic cause events in these cut set, the modeled system is considered more resilient to failures. The results show that the redesigned FTA lead to an effective cut analysis improvement.

The quantitative analysis is used to evaluate the probability of occurrence of top event by considering these minimal cut sets, which significantly contribute to the system failures.

In this chapter, we demonstrated the importance of reliability analysis using mixed approach between qualitative and quantitative methods. As a result, we detected that the reliability of a communication system having a single point of failure such as the OBU system with serial subcomponents - will immensely degrade with time. Using a very pessimistic exponential model resulted in the degradation of the OBU's reliability by 16% over a short period of one year – the failure rates of the OBU electronic components were in the range of E-07 to E-06.

However, a tradeoff between the disadvantages of redundancy (cost, weight, power saving and design complexity...) and increasing the reliability, should always be considered. Moreover, one of the most important advantages of vehicular networks is that there are no energy constraints, unlike wireless sensor networks and other types of mobile devices used in MANETs where limited battery life is a major concern. Taking into consideration this feature, we can implement the redundancy components for the CAV without worrying about energy consumption.

Concerning the vision system, LIDAR, for example, is great at capturing information in various types of ambient light (whether night or day), whereas cameras have difficulty in handling certain occlusions caused by shadows or other poor lighting conditions. The combination of these two sensors can be a complementary to each other, and give a system vision that can overcome the weak point of each sensor working alone.



In order to increase the reliability of CAVs, every autonomous function shall be implemented out of diversified redundant sensors, data, and software capabilities, to avoid common cause failures.

Despite the fact that combining data provided by different sensors to obtain relevant global information creates more complexity in system perception and increases the cost; the results show that using multi-sensors fusion, is an efficient way of addressing sensor problems and failures. This way can increase the reliability of the whole CAV system.

## Chapter 5 - Reliability and Connectivity Analysis for BSM in CAV

---

<b>CHAPTER 5 -</b>	<b>RELIABILITY AND CONNECTIVITY ANALYSIS FOR BSM IN CAV.....</b>	<b>118</b>
5.1	INTRODUCTION.....	118
5.2	RELIABILITY OF CONNECTED VEHICLES .....	119
5.2.1	<i>Experimental results</i> .....	121
5.2.1.1	Reliability CAV connectivity against transmission range .....	121
5.2.1.2	Reliability CAV connectivity against Density .....	123
5.2.1.3	Reliability for CAV connectivity against safety headway distance .....	125
5.3	COMMUNICATION RELIABILITY .....	126
5.3.1	<i>BSM Fundamentals</i> .....	127
5.3.2	<i>The Analytic Approach</i> .....	127
5.4	RELIABILITY OF BSM IN VANET .....	129
5.5	RELIABILITY OF SAFETY APPLICATIONS IN DSRC.....	133
5.6	ANALYTIC VALIDATION FOR THE NUMBER OF RETRANSMISSIONS .....	135
5.7	CONCLUSION .....	140

### 5.1 Introduction

Connected Vehicle research has emerged as one of the highest priorities in the transportation systems because connected vehicle technology has the potential to improve safety, mobility, and environment for the current transportation systems.

The 5.9 GHz DSRC is considered for wireless connectivity by the majority of the international automakers [114]. DSRC-enabled Vehicle-to-Vehicle (V2V) communication through broadcast of BSMs enables safety applications for crash warning and avoidance.

The wireless communication coverage is one of the major factors for event-driven applications due to its impact on the distance of information propagation. In this chapter, we present connected vehicle environment in order to assess the reliability of V2V communication applications by proposing an analytical approach to evaluate reliability of IEEE 802.11p-based vehicle-to-vehicle (V2V) safety-related broadcast services in DSRC system on the highway.

Some researches study the influence of 1 or 2 parameters on connectivity, such as the vehicle density [115], equipment reliability [52] or the transmission range [116]. Our proposed model takes into account many factors that have an influence in VANET communication environments such as transmission range, vehicle density, safety headway distance on the highway, packet estimation error, noise influence and failure rates of DSRC hardware equipment.

### 5.2 Reliability of connected vehicles

Connected vehicles use the network to travel from their departure points to their destinations. By definition, a street is a linear traffic area connecting two separate points with a fixed length. Moreover, a street can be separated into many lanes depending on the direction of vehicles.

For example, the street in Fig. 5-1 is split into two lanes corresponding to two opposite directions.

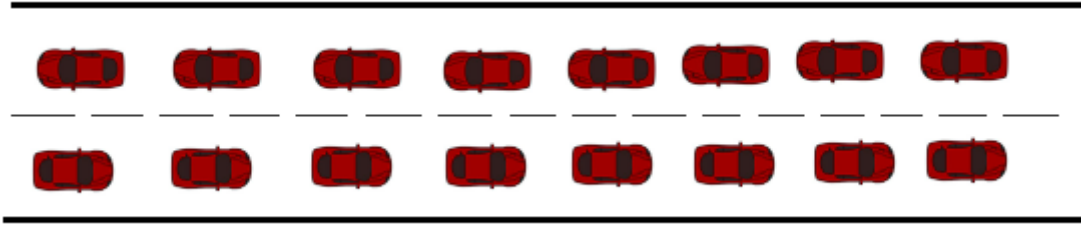

**Figure 5-1 Street with two lanes**

In these lanes, the average number of vehicles is given by the following equation:

$$N_L = Lv \quad (5.1)$$

Where  $L(m)$  is the length of the lane and  $v(veh/m)$  is the vehicle density.

It is well known that two vehicles can be considered connected if the transmission range is greater than the distance between them. Mathematically, it means that

$$x_i \leq R_{tran} \quad (5.2)$$

Where  $x_i$  is the distance between two vehicles and  $R_{tran}$  is the transmission range.

Now, according to literature in [117], [118], the reliability  $R_{v2v}$  of two connected vehicles can be presented as exponentially distributed:

$$R_{v2v} = 1 - e^{-vR_{tran}} \quad (5.3)$$

In order to guarantee the safety between vehicles, we consider a minimal headway distance ( $H_s$ ) amongst vehicle. Then, the reliability becomes:

$$R_{v2v} = 1 - e^{-v(R_{tran}-H_s)} \quad (5.4)$$

It follows that the reliability of a network is given by:

$$R_N = \prod_{i=1}^{N_L-1} R_{(v2v)_i} = (R_{v2v})^{(N_L-1)} \quad (5.5)$$

Consequently, the reliability of the street with two lanes can be represented by the following equation:

$$R_T = 1 - \prod_{i=1}^2 (1 - R_{(v2v)_i}) \quad (5.6)$$

### 5.2.1 Experimental results

In this section, we show the reliability performance illustrated so far. In this context, we consider the example of the street as shown in Fig. 5-1, having 2 lanes.

DSRC Radio Transmission Range: The OBU shall transmit DSRC messages throughout a range of 1m to 300m, in an open field every 10 MHz [119].

#### 5.2.1.1 Reliability CAV connectivity against transmission range

Firstly, in order to show the relation between reliability and the transmission range, we realized a simulation without safety headway distance by considering the density  $0.03 \text{ veh/m}$ , the length of lane  $1000\text{m}$ . Then, the number of an average vehicle  $N_L = 30 \text{ veh}$ .

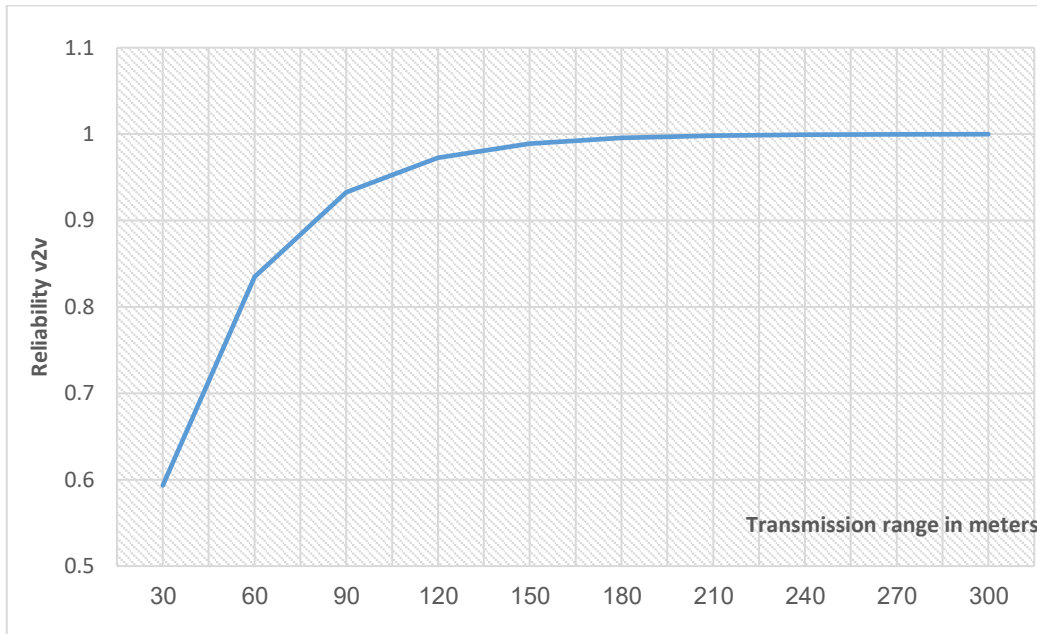

Figure 5-2 Reliability V2V against transmission range

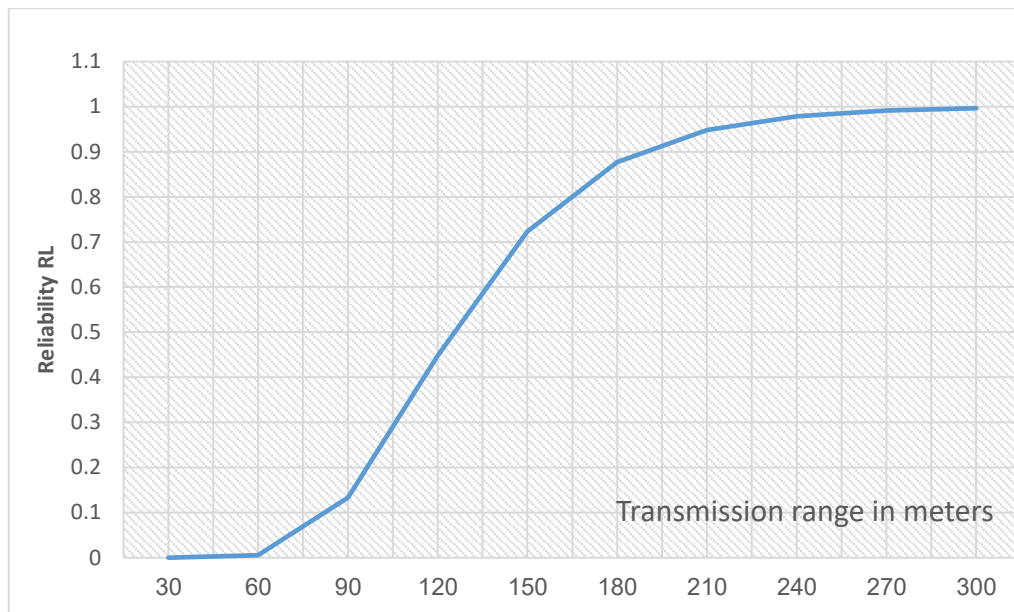

Figure 5-3 Reliability of Network against transmission range

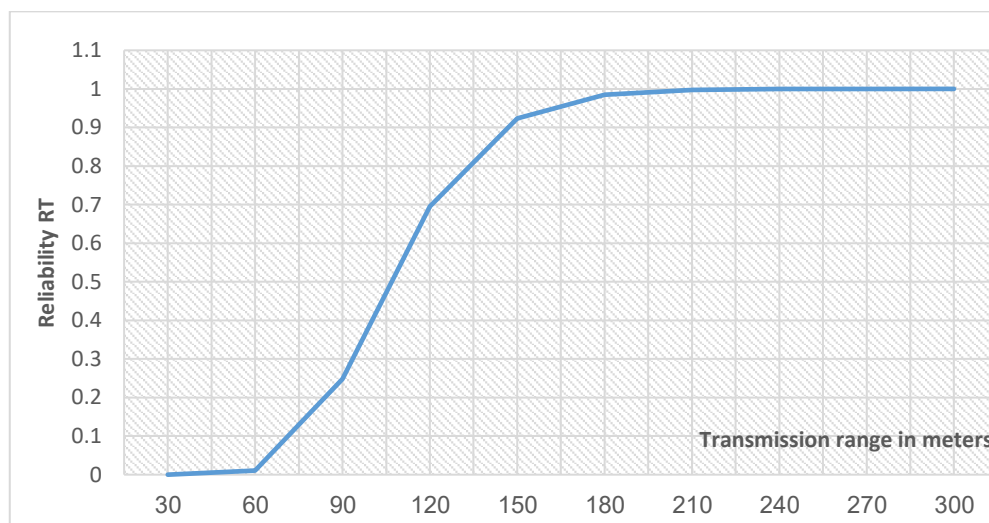

Figure 5-4 Reliability of route against transmission range

One can immediately observe that the reliability increases when the transmission range increases. However, for V2V, when a vehicle is at least connected with one other vehicle, the acceptable rate of reliability (0.99) cannot be reached until the transmission range is greater than 180 meters. (Fig. 5-2)

Concerning the network, and for a density of 30 vehicles per 1 km, the radio transceiver system of the connected vehicle should have a transmission range of less than 270m, to assure communication with all the vehicles on the network, with a reliability of 99%. (Fig. 5-3).

The same effect of the transmission range appears for the route. It is evident, as shown in Fig. 5-4, that the reliability of a route is better than the reliability of the network for the same transmission range, since the vehicle can receive information from other vehicles in other lanes.

For that, the transmission range should be analyzed very well in order to assure high connectivity and to avoid signal attenuation due to the distance between the sender and receiver. However, the topology of the roadmap is an important factor that affects the average distance between the sender and the receiver, as well as the different obstacles present on the road.

### 5.2.1.2 Reliability CAV connectivity against Density

Secondly, our goal is to observe the effect of density on reliability. Hence, in these simulations, we have fixed the transmission range on  $R_{tran} = 100\text{ m}$ .

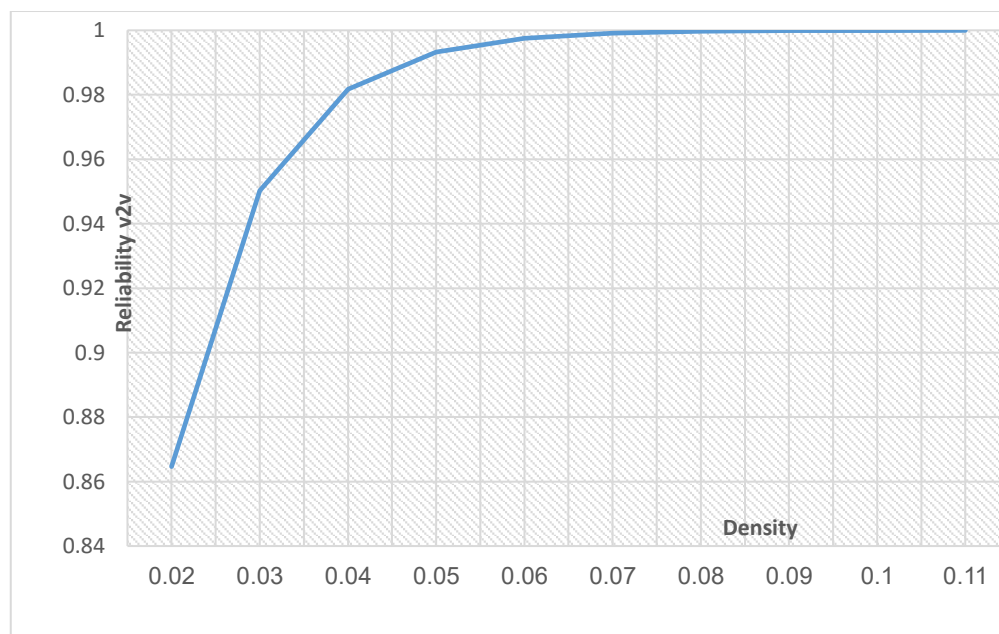

Figure 5-5: Reliability V2V against density

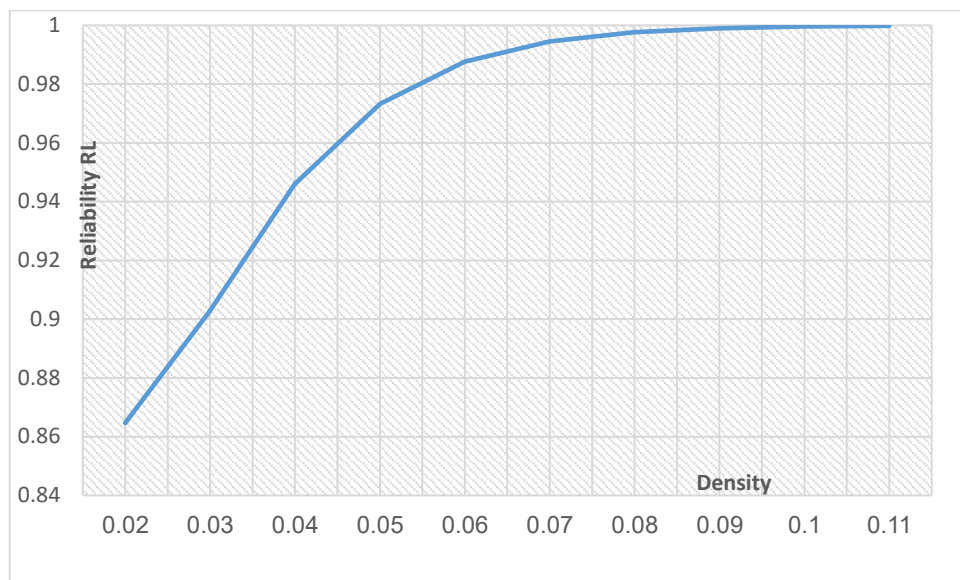

Figure 5-6: Reliability of Network against density

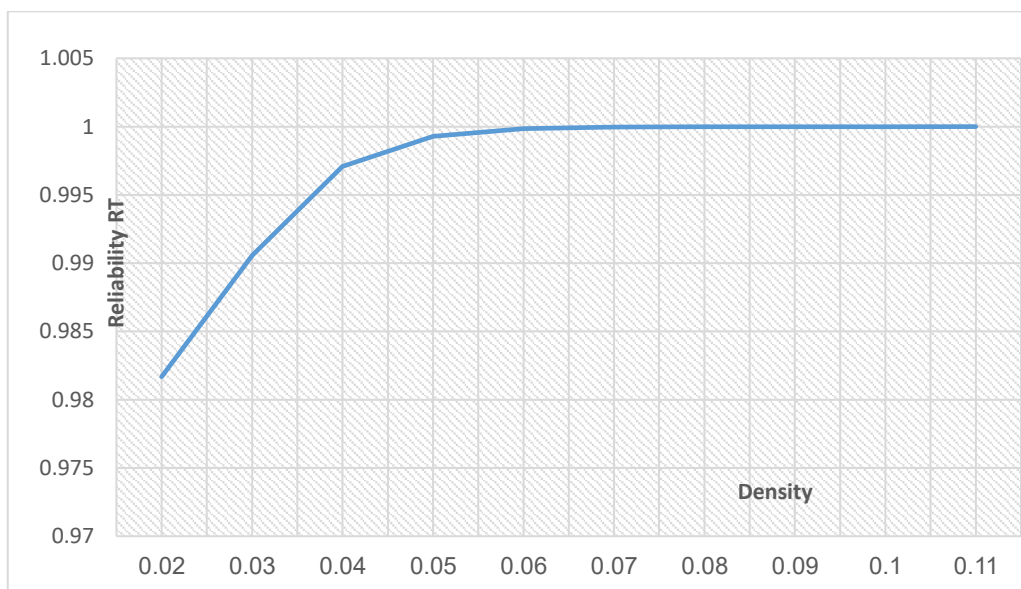

Figure 5-7 Reliability of route against density

Figs 5-5, 5-6, 5-7 display the changes in reliability against density. We see that reliability improves with the increase of density, since many CAVs can communicate.

For that in order to achieve a 99% reliable connectivity between two vehicles with a transmission range of 100m, a density of 0.05 v/m (50 vehicles in the lane of 1 km) should be presented on the highway. However, at night the density decreases and may reach a level less than 0.05 v/m. (Fig. 5-5)



Although driving at night requires high reliability of communication between vehicles, due to poor visibility and excessive speed. Thus, a question poses itself: how we can improve communication reliability when we have less density, especially when the safety requirements necessitates it? We believe that the adaption of the transmission range based on the predicted local vehicle density and velocity can improve the connectivity and reliability for CVs.

### 5.2.1.3 Reliability for CAV connectivity against safety headway distance

Headway is the average time or distance separating vehicles, and is related to capacity in that it is the reciprocal of traffic flow. Therefore, shorter headways allow for a higher throughput of traffic (flow) and hence greater capacity. However, it is useful to keep a safe headway distance to avoid a crash.

Researches claim that CAVs may have the potential to decrease vehicle headways thus improving traffic flow and capacity [120].

For that, we proposed a comparison between the reliability shown in the above simulation and the reliability if we consider a safety headway distance for two values:  $H_s$  equals 10 meters (Fig. 5-8) and  $H_s$  equals 30 meters (Fig. 5-9).

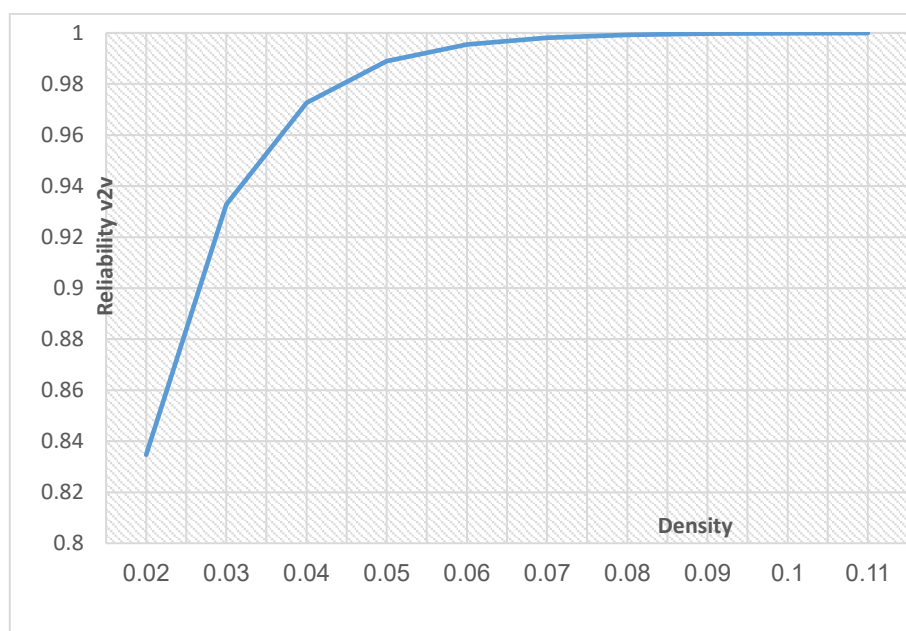
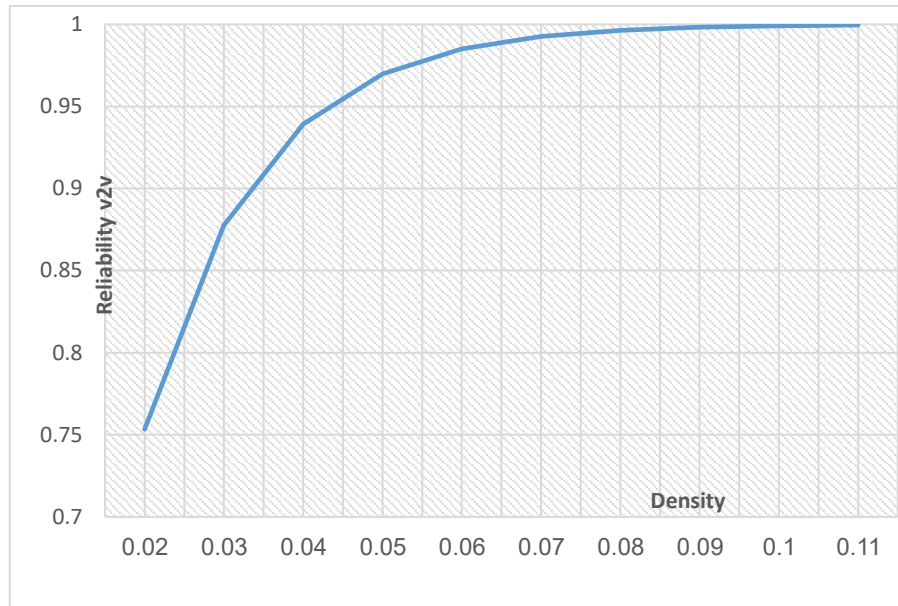

Figure 5-8 Evolution of reliability with  $H_s=10$  m



**Figure 5-9 Evolution of reliability with  $H_s=30$  m**

One can notice that reliability decreases when the safety headway between the vehicles increases. Despite of that , the safety headway distance leads to decreasing in communication reliability, it is critical to keep a minimum safe headway (in seconds depending on the speed of vehicle) which is greater than the reaction time, taking into consideration other parameters such as the speed of the vehicle and the braking deceleration time. The reaction time is the maximum time it takes a following vehicle to detect a malfunction in the leader, and the driver should take control to apply the emergency brakes for example

In conclusion, these simulations show that each parameter influences the reliability of the system. In addition, it is clear that we cannot ignore the safe headway when we design the network reliability model.

### **5.3 Communication reliability**

In this part, we study the reliability of DSRC wireless communication and specifically the BSM message using an analytical model while taking into account the length of a packet, packet corruption by noise and interference, and the bit error rate.

### 5.3.1 *BSM Fundamentals*

Vehicles can exchange information to support safety applications, such as emergency brake, cooperative collision avoidance, and automatic notification of crashes on the road. In addition to non-safety applications, such as infotainment, Internet access, video streaming, etc. [18].

The IEEE 802.11 working group proposed a family of standards for vehicular networks called WAVE (Wireless Access in the Vehicular Environment). WAVE is composed of two categories of standards: (i) 802.11p for the physical and medium access control layers and (ii) IEEE 1609 for security, network management as well as other aspects of VANETs [121]. 802.11p supports Intelligent Transportation Systems (ITS) applications such as cooperative safety, traffic and accident control, intersection collision avoidance, and emergency warning.

During the CCH interval, nodes transmit safety-related messages and control messages. The Enhanced Distributed Channel Access (EDCA) mechanism classifies the safety messages into four Access Categories (ACs) with different priorities based on the degree of emergency and according to their criticality for the vehicle's safety. Non-safety messages are transmitted during the SCH interval [122].

In DSRC protocol, OBU generates BSM messages that collect vehicle and road condition data and provides them to the other OBU. BSM has two parts [123]:

Part 1: Contains core data elements, (vehicle size such as width and length, position, speed, heading acceleration, brake system status, temporary ID, UTC time) and its default transmission rate equals 10 Hz.

Part 2: Contains vehicle safety extensions and is dependent on events (e.g., ABS activated, exterior lights, etc.).

### 5.3.2 *The Analytic Approach*

In this part, we study the reliability of DSRC wireless communication and specifically the

BSM message, and then we try to clarify the difference between BSM packet reliability and safety application reliability.

In DSRC, each safety message is usually very short and thus usually mapped to a single packet. DSRC systems should have high reliability and low delay so that all BSMs are well-received [124].

V2V communication allows vehicles to share data, such as vehicle state, positioning, or intention to change lanes, with other vehicles [125]. This type of communication suffers from channel fading in DSRC, caused by multiple reflecting objects that lead to degrade the strength and quality of the received signal. However, the Doppler Effect has a significant negative influence due to high mobility, and since Orthogonal Frequency Division Multiplex (OFDM) is used in DSCR, thus the Bit Error Rate (BER) becomes higher [27].

Connected vehicles operating in the DSRC band could cause significant interference to BSM packet reception, leading to unknown and perhaps high Inter-Packet Gap (IPG) and Packet Error Rate (PER). The channel fading is calculated by simply introducing packet error probability [126].

$$p_e = 1 - (1 - p_{ber})^m \quad (5.7)$$

Where  $m$  is the length of the packet, and  $p_{ber}$  is the fixed BER probability.  $p_{ber}$  can be numerically evaluated for a Rician fading channel [127].

Mobility of nodes is one of the most important factors that can cause packet errors. BSM packet size is usually between (85~365 bytes) [128]. Capture effect and propagation problems are not considered in this calculation.

For  $p_{ber} = 10^{-4}$  and  $m$  is the size of BSM message we calculate the probability for the packet that will be received  $p_r$  correctly.

$$P_r = (1 - p_{ber})^m \quad (5.8)$$

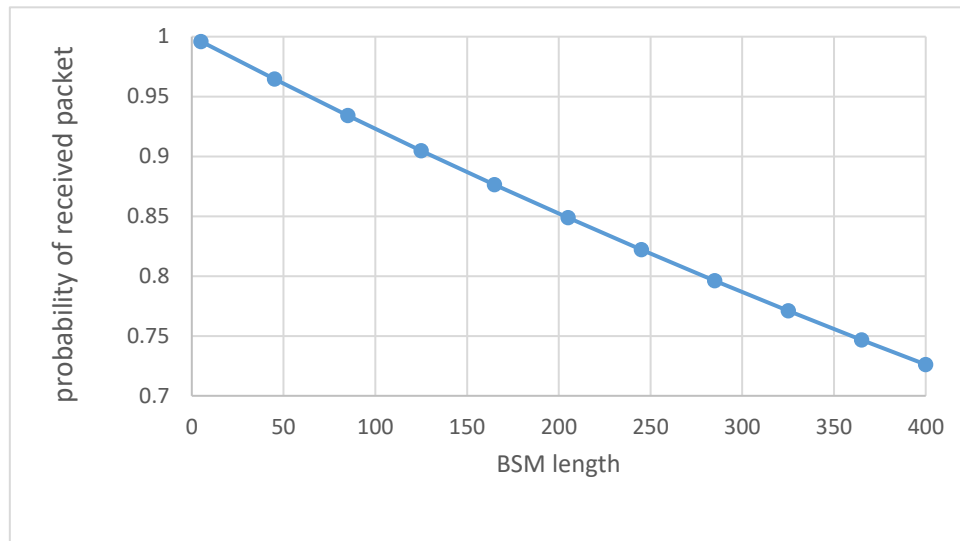

Figure 5-10 probability of received packet against BSM length

As shown in Fig. 5-10, for BSM packet of maximum length 365 Bytes, the probability of a correctly received packet is less than 0.75, which is considered low for critical applications. A solution is needed to increase this probability.

#### 5.4 Reliability of BSM in VANET

Reliability of VANET is a matter of contention since real time communication is involved in this type of adhoc environment, which is time sensitive. In VANET, in order to ensure the communication of V2V, the OBU should be available. Besides the hardware, reliability of connection is also dependent upon transmission range, density, and packet loss by noise. Hence, in this section, we explore the reliability of connection as a function of the transmission range reliability, packet loss and hardware availability of OBU and RSU.

As discussed in the previous chapter, the time to failure of the components of an OBU are assumed to follow an exponential distribution. The failure rate gathered from Quanterion Automated Databook (QAD) for each component is mentioned in Table 5.1.

Over a period of 8760 hours (1 year) of running and after the improvements discussed in the previous chapter, the OBU powered by a dual power supply reaches 89% of reliability.

The communication reliability depends on of the transmission range, length of packet, packet loss and the hardware availability of OBU.

The total reliability of connectivity for the BSM can be presented as:

$$R_{BSM} = R_{v2v} P_r (R_{OBU2})^2 \quad (5.9)$$

**Table 5-1 Parameters used in the Estimation of the BSM reliability**

Parameter	Value
Highway length	1000 m
Transmission range	100 m
Vehicle density	0.03/m
headway safety	20 m
BSM packet size	85 - 365 Bytes
Bit error Rate	$10^{-4}$
Reliability of OBU hardware component	0.88

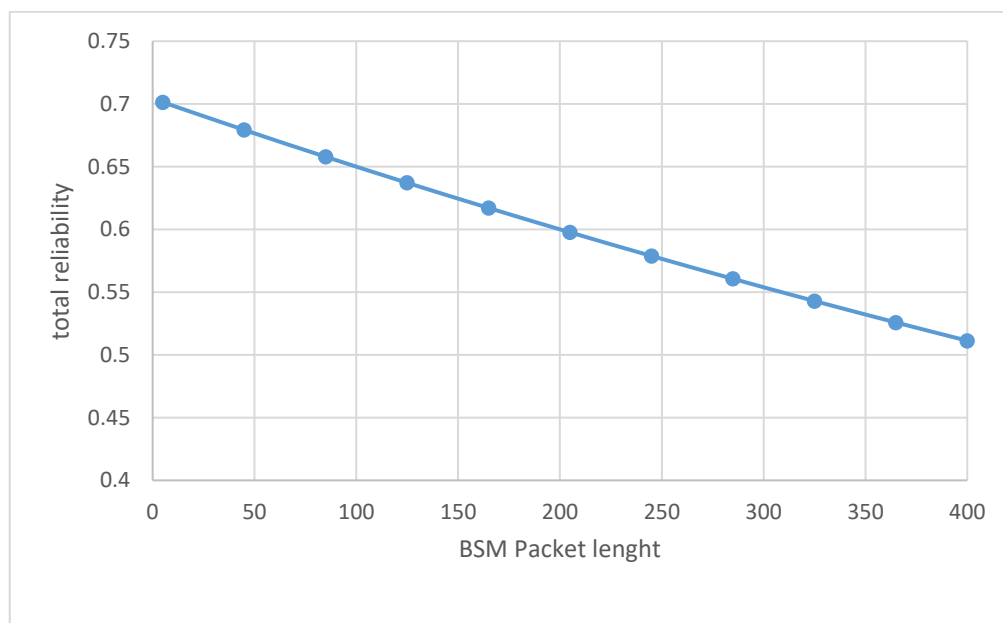

**Figure 5-11 total reliability versus BSM length**

As noticed in Fig. 5-11, due to BER, as the length of the packet increases, the probability of successful delivery decreases. For a BSM of 365 Bytes, the probability of successful delivery of a packet is less than 55%. Therefore, it is necessary to keep the BSM length as small as possible. However, for security reasons, encryption should be done on this message thus increasing in the size of BSM packets.

Now we want to study the influence of vehicle density on the total reliability for Different BSM packet length.

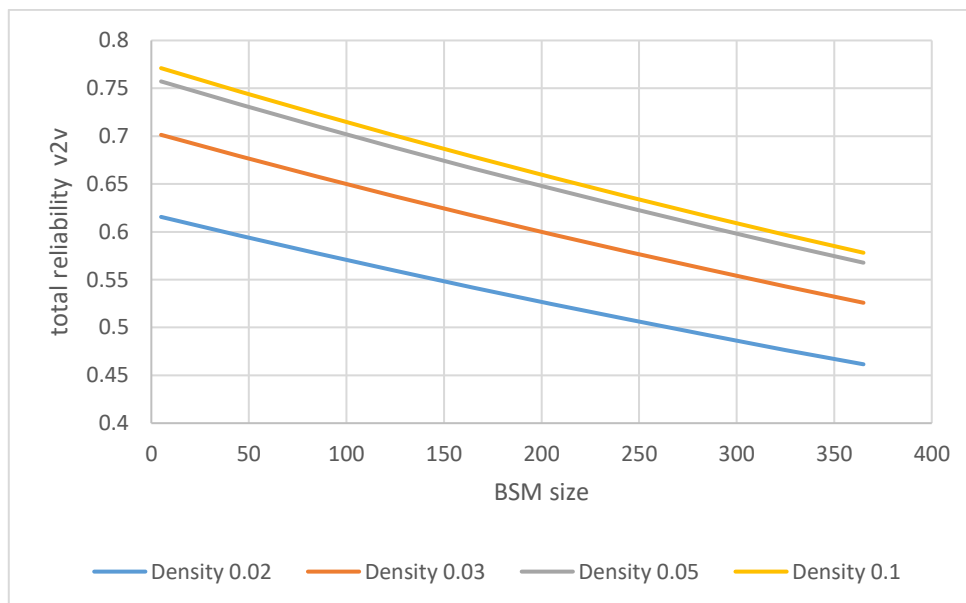

**Figure 5-12 Influence of density on the total reliability V2V for Different BSM packet length.**

The message propagation process highly depends on the number of vehicles, since lower densities can provoke message losses due to reduced communication capabilities. It is clear that low density leads to the decrease of probability of receiving the BSM message (Fig. 5-12).

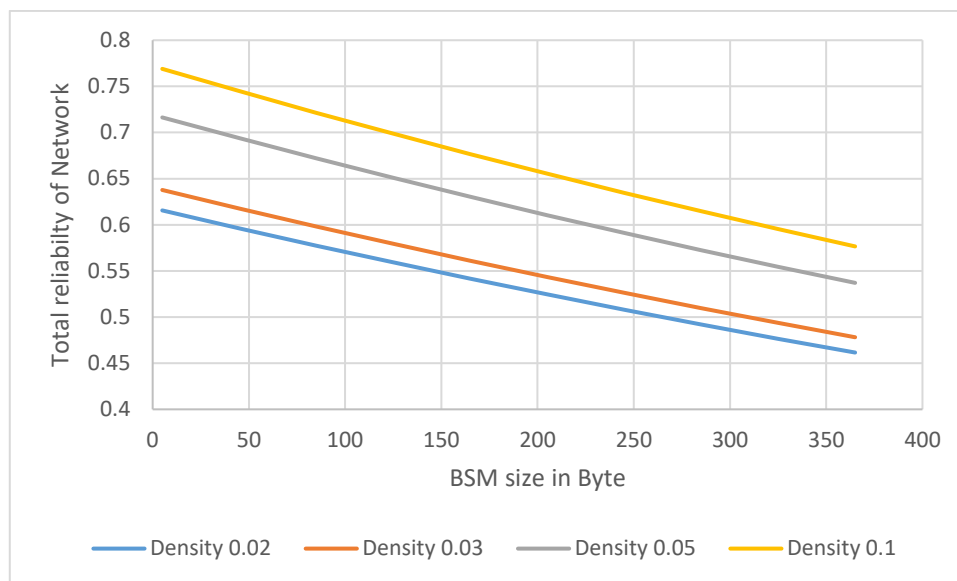

**Figure 5-13 influence of density on the total reliability for the Network using Different BSM packet length.**

The reliability of the network is affected by the reliability of the OBU as show in Fig. 5-13. Using high density, all OBUs must work properly in order to assure the reliability of the Network.

Whereas, on the application layer, higher densities can provoke reduced message delivery due to contention and massive packet collisions that cause broadcast storm problems [129] which severely affect the resources due to re-broadcast. Therefore, many algorithms were developed to reduce the number of redundantly received packets, by using certain parameters like broadcast probability and hop counters [130].

Now we will study the influence of the transmission range on the reliability. As noticed, even for a transmission range of 300 m and BSM packet length of 300 Bytes, reliability did not reach more than 60% probability of successful reception. However, as the transmission range decreases the reliability of BSM also decreases (Fig. 5-14).



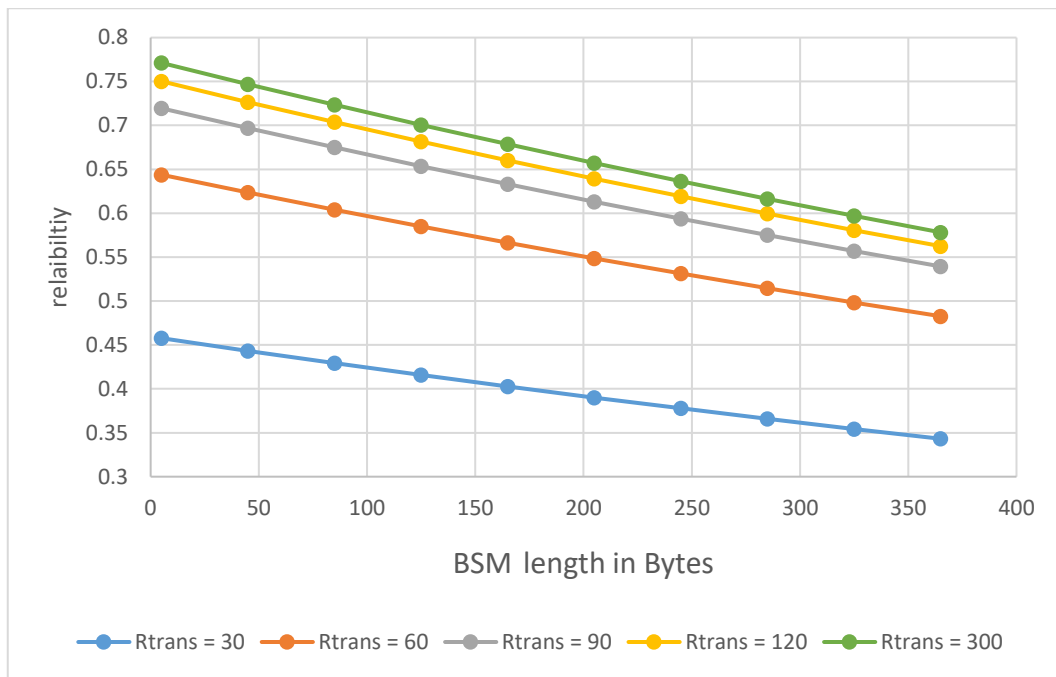

Figure 5-14 influence of Transmission Range on the total reliability for Different BSM packet length.

For this reason, and in order to increase reliability, we should calculate the number of attempts the protocol should be launched in order to guaranty that the BSM messages will be received.

### 5.5 Reliability of Safety applications in DSRC

The single-hop BSM is broadcast periodically or event-driven when an emergency takes place. A direct message broadcasting should be enough to reach all the possibly affected vehicles who should respond immediately due to the proximity of the vehicle location to the source vehicle of BSM.

Safety messages should be delivered to endangered drivers in a tight time slot, for example [3]:

- Forward Collision Warning (FCW) [0.3-1 sec]
- Electronic Emergency Brake Light (EEBL) [0.4-2 sec]
- Lane Change Assistance (LCA) [0.4-2 sec] [131]

- Stop Vehicle Ahead (SVA) [0.5-3 sec]

Due to the independency between packets in BSM communication, where each packet contains full updates about the status of the car regardless of the previous packet; mobility applications will not be affected even if several old packets are lost as long as a newer packet is received within a certain time slot called S (multiple of 100 milliseconds). During this time S, the vehicle safety application can take the right decision and do the needed reaction and intervention without affecting safety.

Having  $P_{BSM}$  the probability of losing a message and K the number of retransmissions of independent BSM packets, we calculate the failure rate of the DSRC protocol as a function of loss and  $k$  the number of times. The failure rate of communication as a function of the variable follows a binomial distribution,  $P_r$  (receiving no packet among K repeated BSM packets) Therefore,

$$P_r = (1 - P_{BSM})^K \quad (5.10)$$

Calculating the probability of receiving all the messages without any loss, for K consecutive BSM packet.

$$P_r = 1 - (1 - P_{BSM})^K \quad (5.11)$$

Introducing the time slot S, which is determined by the requirement of specific safety applications (such as: forward collision warning, emergency electronic brake light, blind spot warning, lane change warning, control loss warning, intersection movement assist) leads us to calculate the reliability of the system allowable transmission BSM loss.

$$R_{SA}(d, t) = 1 - (1 - R_{BSM}(d, t))^{\frac{S}{p}} \quad (5.12)$$

Where:

- $R_{SA}$ : The reliability of the safety application at time t, and at distance d (depending on

the transmission range).

- $R_{BSM}$ : The reliability of receiving one BSM message at time  $t$ , and at a distance  $d$  (depending on the transmission range).
- $S$ : Maximum time, during which at least one BSM message must be well received in order for the safety application to react correctly,  $S$  is different from one safety application to another, but it is predictable for the majority of safety applications to be between [0.4- 1sec]
- $p$ : Periodic transmissions rate equal to 100 ms.

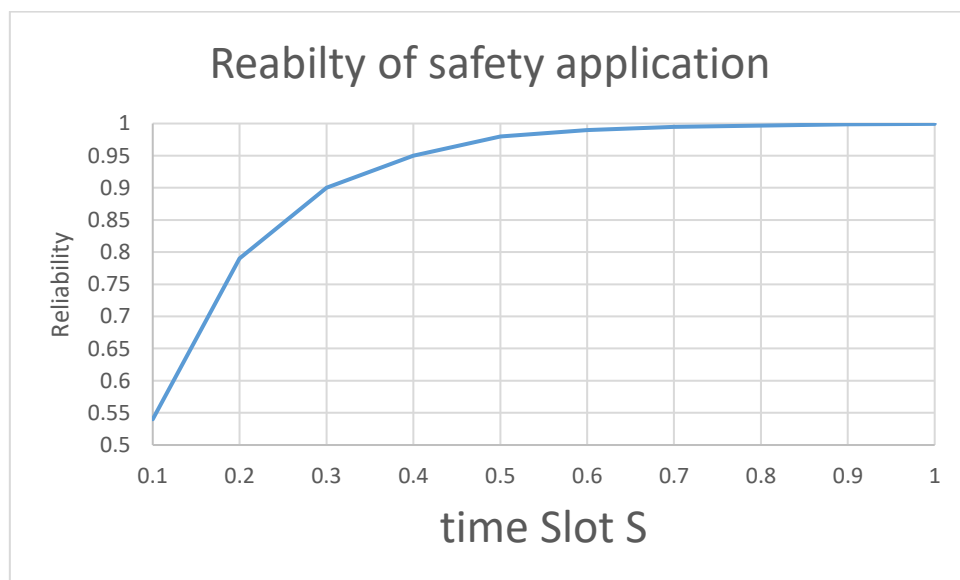

**Figure 5-15 Reliability of safety application for BSM message of length 365 Byte during time Slot S form [0.1 – 1 S].**

Fig. 5-15 shows that reliability increases as the BSM packet (length of 365Bytes) is resent each 0.1 second.

### 5.6 Analytic validation for the number of retransmissions

In this section, we try to verify that  $T$  (number of retransmissions) assures the minimum acceptable probability of success called  $x$

For the safety application of the connected vehicle, having probabilities of reception failure

of 1/1000 to 1/100 per message may be adequate [132].

For that having  $x$  as the accepted reception probability, and  $R_{BSM}$  the current probability; and in order to increase the reliability of the safety application, the failure probability after  $T$  retransmissions is  $(1 - R_{BSM})^T$

Hence,

$$(1 - R_{BSM})^T \leq (1 - x) \quad (5.13)$$

$$e^{T(1-R_{BSM})} \leq e^{(1-x)} \quad (5.14)$$

Calculating the number of attempts that we have to resend the message in order to ensure its delivery, we obtain:

$$T > \frac{\ln(1-x)}{\ln(1-R_{BSM})} \quad (5.15)$$

Where  $0 < x < 1$  and  $0 < R_{BSM} < 1$ .

For example, in the case of the Maximum length of BSM, we have  $R_{BSM} = 0,54$

And the reception failure of is 1/100 per message,

$$T > \frac{\ln(1 - 0.99)}{\ln(1 - 0.54)}$$

$$T > 5.9$$

We need six attempts in order to guaranty that the message is properly delivered with a probability greater than 99%.  $T=6$

When BSM is transmitted 10 times per second, hence, after six transmissions (after 0.6 second); the probability of receiving at least one BSM packet will be greater than 99%.

Which means that after 600 milliseconds (six independent BSM packets were sent); it is guaranteed that one of them should be well received with a probability greater than 99%. (Fig.

5-15).

For example, for FCW message, having  $P=0.1$ ,  $S$  is varying in the range of [0.3-1 sec]. The number of transmissions for the independent BSM packet “ $S/p$ ” will be between 3 to 10 during the time slot  $S$ .

Remembering that the reliability is the ability of a system or component to perform its required functions under stated conditions for a specified interval of time. Specifically, for each given time  $t_0$ , if at least one packet is received during the period, the BSM application is said to perform its functionality, thus it is considered reliable at time  $t_0$ .

Finally, to assure the mentioned level of reliability, the number of retransmission  $T$ , should be less than or equal to the Time slot for each safety application divided by Periodic transmission rates.

$$T \leq S/p \quad (5.16)$$

**Table 5-2 Parameters used in the Estimation of the safety application reliability**

<b>Parameters</b>	<b>Value</b>
Highway length	1000 m
Transmission range	100 m
Vehicle density	0.03/m
headway safety	20 m
BSM packet size	85-365 Bytes
Bit error Rate	$10^{-4}$
Reliability of OBU hardware component	0.88
BSM Periodic transmissions rate $P$	100 ms
time slot $S$	600 ms (6 packets retransmission BSM )

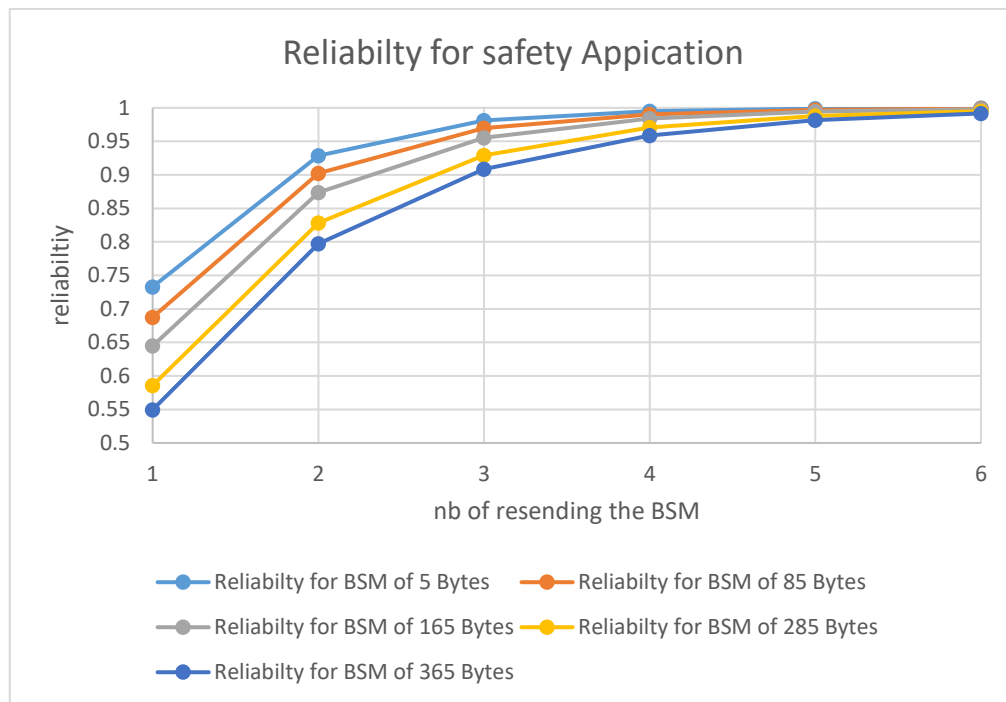

**Figure 5-16 Reliability of safety application after 6 retransmissions**

After this simulation shown in Fig. 5-16 for different BSM application length, we conclude the below in order to increase the reliability of BSM transmission without having side effects on the network.

1. BSM should always be packaged into a single packet.
2. BSM should have the smallest possible length, a smaller packet has higher reliability
3. BSM should be prioritized as per the criticality of the safety application.
4. The time slot S is dependent on the application and on the size of the message. For that, reducing the number of BSM messages reduces the load in a vehicular network. However, sending fewer BSM will affect the provision of safety information to CAVs in a given time window. Therefore, adaptation of periodic transmission rates P should be achieved with precaution.
5. We should have a compromise between keeping the message small, and securing the BSM (certificate and signature) which increases the size of packet.
6. The loss of one BSM packet, can be overcome smoothly without affecting the reliability

of the safety application. In other words, losing of one or more BSM packets, does not directly lead to loss of communication, if at least one BSM packet was well received during the time slot  $S$ . Others lost BSM packets can be considered as allowable BSM failures.

7. A direct relation exists between the time slot and the reaction time, which is the period between a disengagement event where the CAV driver was alerted of a technology failure, and the driver actually assuming manual control of the vehicle. However, time slot for safety application should be less than reaction time, otherwise the driver will not trust the autonomous system and he will take the control when it is not needed. Giving a short time slot for the safety application in CAV to automatically react, decreases the probability of the safe operation done by the driver.
8. A relationship should be considered among the reaction time of the driver, head distance, and the time slot of safety application. This safety margin can be calculated depending on the speed of the vehicle. Headway distance reduces the transmission range that leads to decreasing the communication reliability, however as shown previously, and since BSM messages are independent and periodic, the reliability of receiving one message will increase during the time slot of a safety message. On the other hand, it is important to keep the headway distance (as time) greater than twice the reaction time.
9. At the application layer, a compromise should be done between the number of redundantly received messages and reliability; while maintaining good latency and reachability. Due to rebroadcasting, a tradeoff between reliability and efficiency under different vehicle densities should be considered.
10. Having a fixed transmission range, in high vehicular density, the network would suffer from a broadcast-storm, however at night while in low vehicular density the connectivity could be lost frequently. A dynamic transmission range could be a solution for this problem.

### 5.7 Conclusion

The main feature for the successful propagation of safety applications message in the V2V communications is link connectivity. Generally, the transmission range, density of vehicles, noise influence, hardware reliability, and the arrival rate of vehicles will affect the network reliability performance. In this chapter, we design a reliability calculation scheme, which considers the influence of the minimal safe distance amongst nearby vehicles under the tunnel. The results obtained by simulations prove that the deviation of the safe distance will bring substantial changes in the network reliability when transmission range of vehicles is less than 150m. Hence, while designing the network reliability models, the safe headway cannot be ignored.

In this chapter, we evaluated the impact of different factors that affected the connectivity and the reliability for connected vehicles. We analyzes the reliability of DSRC wireless communication and reliability of DSRC-based safety applications, for freeway traffic environment. We design a reliability calculation scheme for the DSRC wireless communication based on metric packet receiving ratio probability, which considers the influence of transmission range, vehicle density, safety headway distance, packet estimation error, and the reliability of communication hardware equipment.

The results obtained by simulations prove that the reliability of communication is very affected by the factors listed above, Therefore this parameters are well studied in order to avoid reaching -in some case- an unacceptable level of reliability for the receiving of a single BSM packet.

Moreover, we have developed an analytical model that related the DSRC communication reliability and the safety application reliability. We proved using this analytical model the independence between packet reliability and the safety application reliability. The safety



application can assure a high level of the reliability if at least BSM message is well received during a time slot  $S$ , other failed packets can be considered as allowable transmission failures during time slot  $S$ , depending on the safety application requirements. This model clearly illustrates how communication reliability under different traffic environments will significantly affect the corresponding safety application reliability, and provides a design input on how to use DSRC wireless communication to improve the overall reliability of safety applications.

The communication reliability of BSM helps us prioritize the safety-application and define a suitable time slot for it, i.e. if the BSM is well received, during the defined time slot, then the safety application could be considered reliable.

Finally, we list all the factors that should take into consideration in order to have a greater probability the receiving of the BSM packet and we conclude our research with 10 key points that increase the reliability of BSM applications without having side effects on the network.

## Chapter 6 - Conclusions & Perspectives

---

<b><u>CHAPTER 6 - CONCLUSIONS &amp; PERSPECTIVES</u></b> .....	<b>142</b>
<u>6.1 SUMMARY</u> .....	143
<u>6.2 FUTURE WORK</u> .....	144

### 6.1 Summary

Reliability of mobile-based environment has become a hot topic in the automotive domain in the last recent years. As long as wireless networks, radio communication and other embedded technology will enable our vehicles to sense traffic and stop accidents before they happen, the use of such wireless and mobile technologies to improve traffic safety as well to share and produce data for entertainment will become widespread. Ultimately, users expect such services to achieve acceptable levels of dependability.

Ultimately, users expect such services to achieve acceptable levels of dependability.

This thesis focused on the development of modelling approaches aimed at the reliability evaluation of CAV using a combination of V@V and V2I wireless and mobile communications. To the best of our knowledge, this problem has been seldom addressed and there is a lack of practical examples illustrating how dependability evaluation in this context can be carried out.

CAVs will allow drivers to do non-driving related activities such as work, relax, access digital media or shop online. However, under the unreliable situations of system failure, it is important to ensure that the human driver reacts in an appropriate and timely manner to control the vehicle and to resume driving manually. It is important to recognize the reasons for disengagements and the resulting driver reaction times.

In this dissertation, we mainly focus on the combined modeling of connectivity dynamics under various mobility scenarios and the integration of such information in higher-level dependability models for the CAV.

In addition, in this dissertation, we demonstrated the importance of dependability analysis using a mixed approach between qualitative and quantitative methods. For this reason, it is very important to analyze each component functionality to identify its failure rate ratio in order to redesign for redundancy, which leads to further innovation in vehicle automation and

automobile engineering.

Connected vehicle technology, such as vehicle-to-infrastructure (V2I) and vehicle-to-vehicle (V2V) communication, may be able to fill the gap resulting from heavy reliance on a priori information and to resolve and increase the dependability of CAV.

In V2V communications, vehicles exchange safety-critical information (e.g., information beacons, road and traffic conditions) among each other. This BSM communication, which can be performed periodically or when triggered by some event, requires high reliability and is sensitive to delay.

In this dissertation, we analyzed also some connectivity characteristics in dynamic vehicular communication scenarios that are important for the design and the performance and dependability assessment of such safety applications. We investigated the influence of each parameters on different cases using the corresponding analysis technique (analytical, simulation) and the main conclusions derived.

Concerning the BSM, we proved using the analytical model the independence between packet reliability and the reliability of the safety application. The proposed model takes into account many factors such as transmission range, vehicle density, safety headway distance on highway, packet error rate, noise influence and failures rates of DSRC hardware equipment.

We tackled the dependability of the whole system in the operation mode for the full CAV, and evaluated the reliability of communication from sender to receiver to include the reliability of data transmission while using real network and traffic conditions on the proposed modeling technique.

## 6.2 Future work

The safety-critical nature of CAVs clearly demands that the technology it uses should be reliable against all kinds of potential failure, accidental, intentional, or adversarial. In this work, we presented a comprehensive analysis of the reliability for CAVs.

The application of wireless ad hoc networking is growing due to its easy connection features. CAVs are examples of widely used areas that require adaptive communication techniques to connect objects in dynamic environments. Our proposed approaches could be easily applicable for other applications with some modifications. In the near future, we plan to continue our research in the construction of hybrid networks where CAV networks could connect to Internet and other services through the use of other infrastructure techniques. Researchers from academia and industry are currently investigating vehicle to everything communication where the vehicle will not only send information to other vehicles or to infrastructure, but also to any entity such as V2P (vehicle-to-pedestrian), V2D (vehicle-to-device) and V2G (vehicle-to-grid). V2X will be integrated with the Internet of Things (IoT), and CAV will be a fundamental component of the internet of vehicles (IoV) [133]. Moreover, future work will include more simulations with different scenario's (highway and urban areas).

Some CAV OEM declare that 90% of development of CAV has already been done, however the remaining 10% needs 90% of the efforts work to ensure the dependability and the safety of the CAV.

CAVs require reliable, safe, secure, and highly responsive solutions to be able to make split-second decisions based on a detailed understanding of the driving environment. Understanding the driving environment requires an enormous amount of data to be captured by a myriad of different sensors across the car. AI, especially machine language, neural networks and deep learning have become an absolute necessity to make CAVs function properly and safely and thus leading the way for the launch of Level 5 autonomous vehicles. Using the same approach in analyzing dependability, we will continue our study to evaluate the reliability of AI in CAV and find the proper method to enhance the reliability for this application.

## List of personal publications

---

- [1] **A. Dabboussi**, R. Kouta, J. Gaber, M. Wack, B. El Hassan "Reliability Analysis for Basic Safety Messages in Connected Autonomous Vehicles (CAV)" IEEE transactions on Reliability, Submitted.
- [2] **A. Dabboussi**, R. Kouta, J. Gaber, M. Wack, B. El Hassan, L. Nachabe "A New Approach for The Reliability of Vehicular Ad hoc Networks" in *The 2nd international conference on smart applications and data analysis for smat cities*, Casablanca, Morocco, February 2018.
- [3] **A. Dabboussi**, R. Kouta, J. Gaber, M. Wack, B. El Hassan, L. Nachabe "Dependability Overview for Autonomous Vehicles and Reliability Analysis for Basic Safety Messages "in *The Sixth International Conference on Digital Information, Networking, and Wireless Communications (DINWC2018)* Beirut, Lebanon , 2018.
- [4] **A. Dabboussi**, R. Kouta, B. El Hassan, L. Nachabe, J. Gaber, M. Wack, "Reliability Block Diagram and Fault Tree for on Intelligent Vehicular Network (IVN)" in *IEEE Middle East & North Africa COMMunications Conference MENACOMM; University of Kaslik (USEK) Jounieh - Lebanon, April 2018*
- [5] **A. Dabboussi**, R. Kouta, J. Gaber, M. Wack, B. El Hassan, L. Nachabe" Reliability Analysis of Connected Automated Vehicle (CAV)" in *European Safety and Reliability Conference ESREL*, Trondheim, Norway, June 2018.

## List of Tables

Table 3-1 preliminary risk analysis .....	71
Table 3-2 Functional analysis table .....	81
Table 3-3 FMECA for CAV .....	84
Table 4-1 Failure events data .....	97
Table 4-2 Failure events data for sensors and software.....	105
Table 5-1 Parameters used in the Estimation of the BSM reliability .....	130
Table 5-2 Parameters used in the Estimation of the safety application reliability .....	137

## List of figures

Figure 2-1 General view of CAV .....	31
Figure 3-1 Qualitative analysis approach of dependability.....	64
Figure 3-2 Functional Architecture for the Autonomous Vehicle.....	66
Figure 3-3 Blue chart for CAV.....	72
Figure 3-4 Octopus diagram for manufacturing and transportation of CAV .....	74
Figure 3-5 Octopus diagram for manufacturing and transportation of CAV.....	75
Figure 3-6 Global functional block diagram for CAV .....	78
Figure 3-7 Functional block diagram of sensors .....	79
Figure 4-1 Reliability block diagram for OBU including the TPM .....	94
Figure 4-2 Reliability block diagram for RSU .....	94
Figure 4-3 RBD for OBU2 using dual Power supply .....	97
Figure 4-4 Reliability comparison between OBU1 and OBU2.....	98
Figure 4-5 Reliability comparison between RSU1 and RSU2 .....	99
Figure 4-6 Reliability of V2V .....	100
Figure 4-7 Reliability of V2I.....	101
Figure 4-8 V2X Reliability.....	102
Figure 4-9 Standard Fault Tree Diagram.....	103
Figure 4-10 CAV Fault Tree .....	103
Figure 4-11 FTA for sensors failures of CAV.....	105
Figure 4-12 FTA for communication failure of CAV .....	105
Figure 4-13 Fault Tree event of OBU in CAV.....	106
Figure 4-14 Fault tree analysis for CAV .....	107
Figure 4-15 nominal cut analysis .....	109
Figure 4-16 Redundant system vision by multisensory fusion .....	111



Figure 4-17 Improvement fault tree .....	112
Figure 4-18 Reliability comparison for sensors hardware .....	113
Figure 4-19 reliability comparison between sensors having a single vision system and sensors having a redundant vision system.....	113
Fig. 4-20 Nominal cut analysis improvement .....	114
Figure 4-21 Reliability comparison between old design CAV and enhanced design. ....	115
Figure 5-1 Street with two lanes.....	120
Figure 5-2 Reliability V2V against transmission range .....	121
Figure 5-3 Reliability of Network against transmission range.....	122
Figure 5-4 Reliability of route against transmission range .....	122
Figure 5-5: Reliability V2V against density.....	123
Figure 5-6: Reliability of Network against density .....	124
Figure 5-7 Reliability of route against density .....	124
Figure 5-8 Evolution of reliability with $H_s=10$ .....	125
Figure 5-9 Evolution of reliability with $H_s=30$ .....	126
Figure 5-10 probability of received packet against BSM length.....	129
Figure 5-11 total reliability versus BSM length.....	130
Figure 5-12 Influence of density on the total reliability V2V for Different BSM packet length.....	131
Figure 5-13 influence of density on the total reliability for the Network using Different BSM packet length. ....	132
Figure 5-14 influence of Transmission Range on the total reliability for Different BSM packet length. ....	133
Figure 5-15 Reliability of safety application for BSM message of length 365 Byte during time Slot S form $[0.1 - 1 S]$ . ....	135
Figure 5-16 Reliability of safety application after 6 retransmissions.....	138

## Literatures

---

- [1] N. Tran, "Global status report on road safety 2018," Organization, World Health, 2018.
- [2] B. W. Smith, "Human error as a cause of vehicle crashes," Center for Internet and Society at Stanford Law School, 2013.
- [3] R. Naja, *Wireless Vehicular Networks for Car Collision Avoidance.*, Eds Springer., 2013..
- [4] G. L. Lann., "Safe Fully Automated Driving on Roads and Highways," Séminaire System X, Palaiseau, France, 2015..
- [5] D. Fagnant and K. Kockelman, "Preparing a nation for autonomous vehicles: opportunities, barriers and policy recommendations," *Transp. Res. Part A: Policy Pract*, 2015.
- [6] A. M. Khan, A. Bacchus and S. Erwin, "Policy challenges of increasing automation in driving.," in *IATSS Research.*, 35, 79-89 (2011).
- [7] K. Bullis, "How Vehicle Automation will Cut Fuel Consumption," in *MIT's Technology Review.*, 2011.
- [8] Y. B. M. Olimjon, A. Nait Sidi Moh and J. Gaber, "Wireless sensor networks: Basics and fundamentals.," 2016.
- [9] SMMT, "Connected and Autonomous Vehicles: SMMT Position Paper," Society of Motor Manufacturers and Traders, 2017.
- [10] W. Wachenfeld, H. Winner, J. Gerdes, B. Lenz, M. Maurer, S. Beiker, E. Fraedrich and T. Winkle, "Use Cases for Autonomous Driving.," in *Autonomous Driving. Springer.*, Berlin, Heidelberg, 2016.
- [11] SAE, "Taxonomy and Definitions for Terms Related to Driving Automation Systems for On-Road Motor Vehicles," Warrendale: SAE International, J3016\_201806, 15 June 2018.
- [12] Dorothy J. Glancy, " Autonomous and Automated and Connected Cars—Oh My! First Generation Autonomous Cars in the Legal Ecosystem," vol. 16 *Minn. J.L. Sci. & Tech.* 619, 2015.
- [13] J. B. Kenney, "Dedicated Short-Range Communications (DSRC) Standards in the United States," *Proceedings of the IEEE*, vol. 99, no. 7, pp. 1162-1182, 2011.
- [14] S. E. Shladover., " Connected and automated vehicle systems: Introductionand overview.," *Journal of Intelligent Transportation Systems*, 22(3):190–200, 2018.

- [15] A. Bonyár, A. Géczy, O. Krammer, H. Santha, B. Illés, J. Kaman, Z. Szalay, P. Hanak and G. Harsanyi, "A review on current eCall systems for autonomous car accident detection," in *I-8. 10.1109/ISSE.2017.80009*, 2017.
- [16] K. Dar, M. Bakhouya, J. Gaber, M. Wack and P. Lorenz, "Wireless communication technologies for ITS applications," *IEEE Communications Magazine*, pp. 156-162, 2010.
- [17] T. Nadeem, P. Shankar and L. Iftode, "A comparative study of data dissemination models for VANET," in *the 2nd Annual International Conference on Mobile and Ubiquitous Systems: Networking and Services*, 2006.
- [18] H. Hartenstein and K. Laberteaux, *VANET: Vehicular Applications and Inter-Networking Technologies*, John Wiley & Sons Ltd., 2010.
- [19] Y. Zhuang, J. Pan, Y. Luo and L. Cai, "Time and location-critical emergency message dissemination for vehicular ad hoc networks," *IEEE Journal on Selected Areas in Communications*, vol. 29, no. 1, pp. 187-196, 2011.
- [20] M. Caliskan, D. Graupner and M. M., "Decentralized discovery of free parking places," in *VANET '06: Proceedings of the 3rd ACM International Workshop on Vehicular Ad Hoc Networks*, Los Angeles, California, 2006.
- [21] E. Uhlemann, "Introducing connected vehicles," *IEEE Vehicular Technology Magazine*, vol. 10(1), p. 23–31, 2015.
- [22] S. Kaviani, M. O'Brien, J. Van Brummelen, D. Michelson and H. Najjaran, "Ins/gps localization for reliable cooperative driving," in *IEEE Canadian Conference Electrical and Computer Engineering (CCECE)*, Vancouver, Canada, 2016.
- [23] NHTSA, "Summary of Motor Vehicle Crashes 2016," NHTSA's National Center for Statistics and Analysis, 2018.
- [24] S. Rosenbloom, "The Mobility Needs of Older Americans: Implications for Transportation Reauthorization," The Brookings Institution, 2003.
- [25] Waymo, "Waymo Safety Report: On the Road to Fully Self-Driving," 2018.
- [26] J. Peti and S. Shladover., "Potential Cyberattacks on Automated Vehicles.," *IEEE Trans. Intell. Transp. Syst.*, 16, 546–556., 2015.
- [27] A. Dabboussi, R. Kouta, J. Gaber, M. Wack, B. E. Hassan and L. Nachabe, "Dependability Overview for Autonomous Vehicles and Reliability Analysis for Basic Safety Messages," in *The Sixth International Conference on Digital Information, Networking, and Wireless*, Beirut, 2018.
- [28] M. Alonso Raposo, B. Ciuffo, M. Makridis and C. Thiel, "The r-evolution of driving: from Connected Vehicles to Coordinated Automated Road Transport (C-ART).," no. Part I: Framework for a safe & efficient Coordinated Automated Road Transport (CART), 2017.
- [29] M. K. J. Alonso Raposo, J. Després, A. Mourtzouchou, B. Ciuffo, B. Saveyn, C. Thiel, A. Krasenbrink, C. Galassi, L. Levati, M. Grosso and E. Fernández Macías, "An analysis of possible socio-economic effects of a Cooperative, Connected and Automated Mobility (CCAM) in Europe.," no. Effects of automated driving on the economy, employment and skills. 211 p. doi: 10.2760/007773., 2018.

- [30] KPMG, *Connected and Autonomous Vehicles: The UK Economic Opportunity.*, 2015.
- [31] ERTRAC, "Automated Driving Roadmap: Connectivity and Automated Driving," ERTRAC Working Group, 2017.
- [32] R. Naja and R. Stanica, "Quality of Service Provisioning in Wireless Vehicular Networks: Challenges and Mechanisms.," Vols. (eds) *Wireless Vehicular Networks for Car Collision Avoidance*. Springer, New York, NY, 2013.
- [33] CADMV, Article 3.7–Testing of Autonomous Vehicles, Title 13, Division 1, Chapter 1, [Online]. Available: <https://www.dmv.ca.gov/portal/dmv/detail/vr/autonomous/testing>. [Accessed 2019].
- [34] D. Sherman, "Semi-autonomous cars compared! tesla model s vs. bmw 750i, infiniti q50s, and mercedes-benz s65 amg," Feb 2016. [Online]. Available: <http://www.caranddriver.com/features/semi-autonomous-cars-compared-tesla-vs-bmw-mercedes-and-infiniti-feature>.
- [35] ZOOX, "SAFETY INNOVATION," 2018.
- [36] F. Lambert, "Tesla's "vision" and autopilot chip efforts validated by intel's \$15 billion acquisition of mobileye.," Mar 2017. [Online]. Available: <https://electrek.co/2017/03/13/teslavisision-autopilot-chip-intel-mobileye>.
- [37] L. BARREHAG, "The Future of Autonomous Cars: A Scenario Analysis of Emergence and Adoption," Chalmers University of Technology, Sweden, 2018.
- [38] N. Parker, A. Shandro and E. Cullen, "Autonomous and connected vehicles: navigating the legal issues," Allen & Overy LLP, 2017.
- [39] A. Andrew Keen, "'The Future of Travel: How Driverless Cars Could Change Everything,'" *CNN Business Traveler*, 2013.
- [40] BMVI, "Ethics Commission Automated and Connected Driving," the Federal Minister of Transport and Digital Infrastructure, 2017.
- [41] B. Fildes, "'Effectiveness of low speed autonomous emergency braking in real-world rear-end crashes,'" *Accident Analysis & Prevention*, vol. 81, pp. 24-9., 2015.
- [42] J.-C. Pandazis and A. Winder, "Study of Intelligent Transport Systems for reducing CO2 emissions for passenger cars," ERTICO – ITS Europe, Belgium, 2015.
- [43] Atkins, "Research on the Impacts of Connected and Autonomous Vehicles (CAVs) on Traffic Flow," Department for Transport, 2016.
- [44] H. Cheng, *Autonomous Intelligent Vehicles: Theory, Algorithms, and Implementation*, Springer Science & Business Media., 2011.
- [45] C. Katrakazas, M. Quddus, W.-H. Chen and L. Deka, "Real-time motion planning methods for autonomous on-road driving: State-of-the-art and future research directions," *Transp. Res. Part C: Emerg. Technol.* 60, p. 416–442, 2015.
- [46] D. Gruyer, S. Demmel, V. Magnier and R. Belaroussi, "Multi-hypotheses tracking using the dempstershafer theory, application to ambiguous road context," *Information Fusion*, vol. 29, p. 40–56, 2016.

- [47] H. Zhu, K.-V. Yuen, L. Mihaylova and H. Leung, "Overview of environment perception for intelligent vehicles," *IEEE Transportation*, vol. Intelligence Transportation system, p. 1–18, 2017.
- [48] N. Papernot, P. McDaniel, S. Jha, M. Fredrikson, Z. B. Celik and A. Swami., "The limitations of deep learning in adversarial settings," in *IEEE European Symposium on Security and Privacy (EuroS&P)*, pages 372–387., 2016.
- [49] T.-W. Huang, C.-C. Hsu, W.-Y. Wang and J. Baltes, "ROSLAMa faster algorithm for simultaneous localization and mapping (SLAM)," *Robot Intelligence Technology and Applications 4. Advances in Intelligent Systems and Computing*, no. Springer, p. 65–74, 2017.
- [50] B. Vanholme, "Highly automated driving on highways based on legal safety," PhD thesis, University of Evry-Val-d'Essonne, 2012.
- [51] A. Nait Sidi Moh, A. Ruzmetov, M. Bakhouya and Y. a. G. J. Nait Malek, "A Prediction Model of Electric Vehicle Charging Requests," *Procedia Computer Science*, vol. 141, no. 10.1016/j.procs.2018.10.158., pp. 127-134, 2018.
- [52] A. Dabboussi, R. Kouta, J. Gaber, M. Wack, B. E. Hassan and L. Nachabe, "Reliability Analysis of Connected Automated Vehicle (CAV)," in *European Safety and Reliability Conference ESREL*, Trondheim, Norway, 2018.
- [53] I. A. Sumra, H. B. Hasbullah and J.-l. B. Ab-Manan, "Attacks on security goals (confidentiality, integrity, availability) in vanet: a survey," *Vehicular Ad-Hoc Networks for Smart Cities*, no. Springer, p. 51–61, 2015.
- [54] M. T. Gari, M. E. Gursoy, P. Reiher and M. Gerla, "Congestion attacks to autonomous cars using vehicular botnets," in *NDSS Workshop on Security of Emerging Networking Technologies*, San Diego, CA, 2015.
- [55] M. Mejri, J. Ben-Othman and M. Hamdi., "Survey on VANET security challenges and possible cryptographic solutions," *Vehicular Communications*, vol. 1(2), p. 53–66, 2014.
- [56] M. Amoozadeh, A. Raghuramu, C.-N. Chuah, H. M. Z. J. R. Dipak Ghosal and K. Levitt, "Security vulnerabilities of connected vehicle streams and their impact on cooperative driving," *IEEE Communications Magazine*, vol. 53(6), p. 126–132, 2015.
- [57] Waymo, "Report on Autonomous Mode Disengagements For Waymo Self-Driving Vehicles in California," 2016.
- [58] J. Ansell and F. Wharton, *Risk: Analysis, Assessment and Management*, Chichester: John Wiley & Sons, 1992.
- [59] A. Dabboussi, R. Kouta, J. Gaber, M. Wack, B. E. Hassan and L. Nachabe, "A New Approach for The Reliability of Vehicular Ad hoc Networks," in *The 2nd international conference on smart applications and data analysis for smat cities*, Casablanca, Morocco, 2018.
- [60] D. R. Duran, E. Robinson, A. J. Kornecki and J. Zalewski, "Safety analysis of Autonomous Ground Vehicle optical systems: Bayesian belief," in *Computer Science and Information*, 2013.

- [61] M. B. Swarup and M. S. Rao, Safety Analysis of Adaptive Cruise Control System Using FMEA and FTA, *International Journal of Advanced Research in Computer*, 2014.
- [62] N. Kalra and S. Paddock, "Driving to safety: How many miles of driving would it take to demonstrate autonomous vehicle reliability?," *Transportation Research Part A: Policy and Practice*, p. 94:182–193, 2016.
- [63] J. Nielsen, "Iterative User Interface Design," *IEEE Computer*. 26 (11), p. 32–41, 1993.
- [64] R. Kianfar, P. Falcone and J. Fredriksson, "Safety verification of automated driving systems," *IEEE Intelligent Transportation Systems Magazine*, p. 5(4):73–86, 2013.
- [65] D. Fagnant and K. Kockelman, "Preparing a nation for autonomous vehicles:opportunities, barriers and policy recommendations," *Transportation Research Part A: Policy and Practice*, p. 77:167–181., 2015.
- [66] J. Wei, J. Snider and J. Kim, "Towards a viable autonomous driving research platform," *In Intelligent Vehicles Symposium (IV), IEEE*, p. 763–770, 2013.
- [67] M. Aeberhard, S. Rauch and M. Bahram, "Experience, results and lessons learned from automated driving on Germany’s highways," *IEEE Intelligent Transportation Systems Magazine*, p. 7(1):42–57., 2015.
- [68] Waymo, "Report on Autonomous Mode Disengagements For Waymo Self-Driving Vehicles in California," 2017.
- [69] V. Dixit, S. Chand and D. Nair, "Autonomous vehicles: disengagements, accidents and reaction times," *PLoS one*, p. 11(12), 2016.
- [70] W. Schwarting, J. Alonso-Mora and D. Rus, "Planning and decision-making for autonomous vehicles," *Annual Review of Control, Robotics, and Autonomous Systems*, p. 1:187–210, 2018.
- [71] C. Berger and B. Rumpe, "Autonomous driving-5 years after the urban challenge: The anticipatory vehicle as a cyber-physical system," 2014.
- [72] M. Blanco, J. Atwood, S. Russell, T. Trimble, J. McClafferty and M. Perez, "Automated vehicle crash rate comparison using naturalistic data," *Virginia Tech Transportation Institute*, 2016.
- [73] Adouane L., "Toward fully autonomous vehicle navigation: From behavioral to hybrid multi-controller architectures," in *11th International Workshop on Robot Motion and Control*, 2017.
- [74] J. Shi, Y. Meng and S. Wang, "Reliability and safety analysis of redundant vehicle management computer system," *Chinese Journal of Aeronautic*, p. 26(5):1290–302., 2013.
- [75] J. Marais, C. Meurie, D. Attia, Y. Ruichek and A. Flancquart, "Toward accurate localization in guided transport: combining gnss data and imaging information.," *Transp. Res. Part C: Emerg. Technol*, pp. 43, 188–197, 2014.
- [76] D. Gruyer, R. Belaroussi, X. Li, B. Lusetti, M. Revilloud and S. ., Glaser, "A central sensors fusion electronic control unit for the development of perception-based

- ADAS," in *14th IAPR International Conference on Machine Vision Applications*, 2015.
- [77] G. Bresson, M. Rahal, D. Gruyer, M. Reveilloud and Z. Alsayed, "A cooperative fusion architecture for robust localization: Application to autonomous driving," in *IEEE 19th International Conference on Intelligent Transportation Systems (ITSC)*, Rio de Jane, 2016.
- [78] X. Ma, X. Yin and K. S. Trivedi, "On the reliability of safety applications in VANETs," *Int J Perform Eng*, p. 8(2):115–30, 2012.
- [79] G. L. Lann., "Integrated Safety and Efficiency in Intelligent Vehicular Networks," *Transport Research Arena Europe*, pp. Elsevier, 48, pp.951-961, 2012.
- [80] R. He, H. Rutagemwa and X. Shen, "Differentiated reliable routing in hybrid vehicular ad-hoc networks.," p. pp. 2353–2358., 2008.
- [81] M. Kihl, M. Sichitiu, T. Ekeroth and M. Rozenberg, "Reliable Geographical Multicast Routing in Vehicular Ad-Hoc Networks.," *Springer Berlin Heidelberg*, 2007.
- [82] Y. Gongjun, N. Mitton and X. Li, "Reliable Routing in Vehicular Ad hoc Networks," in *The 7th International Workshop on Wireless Ad hoc and Sensor Networking*, Genoa, Italy, 2010.
- [83] S. Dharmaraja, R. Vinayak and K. S. Trivedi, "Reliability and survivability of vehicular ad hoc networks: An analytical approach.," *Reliability Engineering & System Safety*, Volume 153, pp. pp. 28-38.4, 2016.
- [84] W. Ahmad, O. Hasan, U. Pervez and J. Qadir, "Reliability modeling and analysis of communication networks," *Journal of Network and Computer Applications*, Volume 78, pp. 191-215, 2017.
- [85] A. Dhamgaye and N. Chavhan, "Survey on security challenges in VANET," *Int. J. Comput. Sci.* 2, p. 88–96, 2013.
- [86] M. Nidhal, J. Ben-Othman and M. Hamdi, "Survey on VANET security challenges and possible cryptographic solutions," *Vehicular Communications. 1*, 2014.
- [87] A. Avizienis, J. Laprie, B. Randell and C. Landwehr, "Basic Concepts and Taxonomy of Dependable and Secure Computing," *IEEE Transactions on Dependable and Secure Computing*, pp. 1(1), 11-33., 2004.
- [88] K. Hafeez, L. Zhao, Z. Liao and N. Ma, "Performance Analysis of Broadcast Messages in VANETs Safety Applications," in *In Proceedings of the 2010 IEEE Global Communications Conference*, Miami, FL, USA, 2010.
- [89] Y. Yao, L. Rao and X. Liu, "Performance and Reliability Analysis of IEEE 802.11p Safety Communication in aHighway Environment.," *IEEE Trans. Veh. Technol.*, p. 4198–4212, 2013.
- [90] P. Koopman and M. Wagner, "Autonomous vehicle safety: An interdisciplinary challenge.," *IEEE Intelligent Transportation Systems Magazine*, vol. 9(1), p. 90–96, 2017.

- [91] M. Kyriakidis, J. de Winter, N. Stanton, T. Bellet, B. van Arem, K. Brookhuis, M. Martens, K. Bengler, J. Andersson and N. Merat, "A hum. Factors perspective on automated driving," *Theoret. Issues Ergon*, p. 1–27., 2017.
- [92] T. Krisher and D.-A. Durbin, "Tesla update halts automatic steering if driver inattentive.," 2016.
- [93] NHTSA, "Office of Defective Investigation–Preliminary Report Summary 2015 Tesla Model S Crash," 2016.
- [94] A. Davies, "The Very Human Problem Blocking the Path to Self-Driving Cars," 2017.
- [95] A. Avizienis, J.-C. Laprie and B. Randell, "Fundamental concepts of dependability," *University of Newcastle upon Tyne, Computing Science Newcastle upon Tyn, UK*, 2001.
- [96] M. Al-Kuwaiti, N. Kyriakopoulos and S. ., Hussein, "A comparative analysis of network dependability, fault-tolerance, reliability, security, and survivability," *Communications Surveys & Tutorials*, pp. 106-124, 2009.
- [97] P. Hoang., *System Software Reliability*, Eds Springer Series in Reliability Engineering, 2006.
- [98] K. S. Trivedi., *Probability & statistics with reliability, queuing and computer science applications*, Eds John Wiley & Sons, 2008.
- [99] A. G. Mihalache, "Mod'elisation et 'evaluation de la fiabilit'e des," 2007.
- [100] Noyes and Pérès, "Analyse des systèmes sureté de fonctionnement," *Techniques de l'Ingénieur*, ag3520, 2007.
- [101] M. Maurer, J. Gerdes, B. Lenz and H. Winner, *Autonomous Driving*, Berlin, Heidelberg: (Eds.),Springer, 2016.
- [102] S. Ilgin Guler, M. Menendez and L. Meier, "Using connected vehicle technology to improve the efficiency of intersections," *Transportation Research Part C: Emerging Technologies*, vol. 46, no. ISSN: 0968-090X,, pp. 121-131, 2014.
- [103] ISO26262, "Road Vehicles - Functional Safety," International Organization for Standardization Information technology – Security techniques – Application security – Part 2: Organization normative framework, 2016.
- [104] D. Pendleton, "Perception, planning, control, and coordination for autonomous vehicles," *Machines*, vol. 5, no. 1, p. p. 6, 2017.
- [105] T. Douglas, "Structured analysis (sa) : Structured analysis for requirements definition," p. 3 :6–15, 1977.
- [106] S. Lawson, "Tackling the Transition to Automated Vehicles, Roads that Cars Can Read Report III," European Road Assessment Association, 2018.
- [107] W. Veseley and F. Goldberg, "Fault Tree handbook.," 1981.
- [108] A. Dabboussi, R. Kouta, B. E. Hassan, J. Gaber, M. Wack and L. Nachabe, "Reliability Block Diagram and Fault Tree for on Intelligent Vehicular Network (IVN)," in *EEE Middle East & North Africa COMMunications Conference MENACOMM*, Kaslik,Lebanon, 2018.



- [109] I. Sumra, H. Halabi, J. Manan and M. Rehman, "Trust and Trusted Computing in VANET," *Computer Science Journal Volume 1, Issue 1*, 2011.
- [110] W. Ahmed, O. Hasan and S. Tahar, "Formalization of reliability block diagrams in higher-order logic," *journal of Applied Logic 18*, pp. 19-41, 2016.
- [111] J. Barrachina, J. Sanguesa, M. Fogue, P. Garrido, F. Martinez, J.-C. Cano, C. Calafate and P. Manzoni, "V2X-d: A vehicular density estimation system that combines V2V and V2I communications," in *IFIP Wireless Days (WD)*, Valencia, 2013.
- [112] S. Singh, "Critical Reasons for Crashes Investigated in the National Motor Vehicle Crash Causation Survey," 2015.
- [113] J. R. Sklaroff, "Redundancy Management Technique for Space Shuttle Computers," *IBM Journal of Research and Development*, 1976.
- [114] S. A. Ahmad, A. Hajisami, H. Krishnan, F. Ahmed-Zaid and E. Moradi-Pari, "V2v system congestion control validation and performance," *IEEE Transactions on Vehicular Technology*, Vols. 68, no. 3, p. 2102–2110, 2019.
- [115] A. Sanguesa, F. Naranjo, V. Torres-Sanz, M. Fogue, P. Garrido and F. Martinez, "On the Study of Vehicle Density in Intelligent Transportation Systems," *Mobile Information Systems*, vol. 2016, 2016.
- [116] A. A. Almohammed, N. K. Noordin and S. Saeed, "Evaluating the Impact of Transmission Range on the Performance of VANET," *International Journal of Electrical and Computer Engineering (IJECE)*, Vols. Vol. 6, No. 2, pp. 800-809, 2016.
- [117] S. Yousefi, E. Altman and R. El-Azouzi, "Analytical model for connectivity in vehicular ad hoc networks," *IEEE Trans. Veh. Technol.*, pp. 3341-3356, 2008.
- [118] M. Artimy, W. Roberston and W. Philips, "Connectivity in inter-vehicle ad hoc networks," *Proc.IEEE.Conf.Elect.Comput.*, 2004.
- [119] F. Perry, K. Raboy, E. Leslie, Z. Huang and D. ., Van Duren, "Dedicated short range communications roadside unit specifications," U.S. Department of Transportation, 2017..
- [120] D. Bishop, S. Bevely and M. S. Boyd, "Evaluation and Testing of Driver Assistive Platooning: Phase one results," *ITS World Congress Bordeaux*, 2015.
- [121] F. A. Teixeira, V. F. e-Silva, J. L. Leoni, D. F. Macedo and J. M. Nogueira, "Vehicular networks using the IEEE 802.11p standard: An experimental analysis," *Vehicular Communications, Elsevier*, vol. 1, pp. 91-96, 2014.
- [122] J. R. Gallardo, D. Makrakis and H. T. Mouftah, "Performance analysis of the edca medium access mechanism over the control channel of an ieee 802.11 p wave vehicular network," in *ICC'09. IEEE International Conference*, 2009.
- [123] C. Michaels, D. Kelley, R. Sumner and S. Chriss, "DSRC Implementation Guide A guide to users of SAE J2735 message sets over DSRC," *Communication*, pp. 210, 2010., 2010.

- [124] X. Ma, X. Chen and H. H. Refai, "Performance and reliability of dsrc vehicular safety communication: A formal analysis," *EURASIP J. Wirel. Comm*, pp. pp. 1-13, 2009, 2009.
- [125] K. Dey, A. Rayamajhi, M. Chowdhury, P. Bhavsar and J. Martin, "Vehicle-to-vehicle (V2V) and vehicle-to-infrastructure (V2I) communication in a heterogeneous wireless network – Performance evaluation," *Transportation Research Part C: Emerging Technologies*, vol. 68, no. ISSN: 0968-090X, pp. 168-184, 2016.
- [126] G. Beaulieu and i. N. C. Farhad, "Connectivity and bit error rate analysis of mobile ad hoc wireless networks," in *in Proceedings of the 64th IEEE Vehicular Technology Conference*, Montreal, Canada, 2006.
- [127] X. Ma and X. Chen, "Saturation performance of IEEE 802.11 broadcast network," *IEEE Communications Letters*, Vols. 11,no. 8, p. 686–688, 2007.
- [128] B. Cronin., "Vehicle Based Data and Availability," Intelligent Transportation Systems Joint Program Office Research and Innovative Technology Administration, USDOT, 2015.
- [129] S. Ni, Y. Tseng, Y. Chen and J. Sheu, "The Broadcast storm problem in a Mobile Ad hoc Networks," in *Proceedings of the 5th annual ACM/IEEE international conference on Mobile computing and networking*, Washington, 1999.
- [130] S. Medetov, M. Bakhouya, J. Gaber, K. Zinedine, M. Wack and P. Lorenz, "A Decentralized Approach for Information Dissemination in Vehicular Ad hoc Networks," *Journal of Network and Computer Applications, Elsevier*, vol. 46, pp. 154-165, 2014.
- [131] R. Dang, J. Ding, B. Su, Q. Yao, Y. Tian and K. Li, "A lane change warning system based on v2v communication," in *17th Int. IEEE Conference Intelligent Transportation Systems (ITSC).*, 2014.
- [132] X. Qing, M. Tony, J. K. and S. Raja, "Vehicle-to-vehicle safety messaging in DSRC," in *Proceedings of the 1st ACM international workshop on Vehicular ad hoc networks*, Philadelphia, PA, USA, 2004.
- [133] N. Lu, N. Cheng, N. Zhang, X. Shen and J. W. Mark., "Connected vehicles: Solutions and challenges," *IEEE internet of things journal*, vol. 1(4), p. 289–299, 2014.

## Acronyms and Abbreviations

Abbreviation	Designation
<b>ABC</b>	Artificial Bee Colony
<b>ABS</b>	Automatic Braking System autonomous emergency braking
<b>ABE</b>	Autonomous Emergency Braking
<b>ACC</b>	Adaptive Cruise Control
<b>ADAS</b>	Advanced Driver Assistance Systems
<b>AI</b>	Artificial Intelligence
<b>AV</b>	Autonomous Vehicle
<b>BER</b>	Bit Error Rate
<b>BSM</b>	Basic Safety Message
<b>C2C</b>	Car to Car
<b>CV</b>	Connected Vehicle
<b>CA DMV</b>	California Department of Motor Vehicles
<b>CAV</b>	Connected Autonomous Vehicle
<b>DSRC</b>	Dedicated Short-Range Communications
<b>DL</b>	Deep Learning
<b>FMEA</b>	Failure Mode, Effects Analysis
<b>FMECA</b>	Failure Mode, Effects and Criticality Analysis
<b>FTA</b>	Fault Tree Analysis
<b>EFA</b>	External Functional Analysis
<b>ESC</b>	Electronic Stability Control
<b>GPS</b>	Global Positioning System
<b>IFA</b>	Internal Functional Analysis

<b>IMU</b>	Inertial Measurement Unit
<b>ITS</b>	Intelligent Transportation Systems
<b>LIDAR</b>	Light Detection and Ranging
<b>LKA</b>	Lane-Keeping Assistance
<b>ML</b>	Machine Language
<b>MCS</b>	Minimal Cut Set
<b>MOVE</b>	Mobility model generator for Vehicular networks
<b>NHTSA</b>	National Highway Traffic Safety Administration
<b>OSI</b>	Open Systems Interconnection
<b>PRA</b>	Preliminary Risk Analysis
<b>QOS</b>	Quality Of Services
<b>RDT</b>	Random Delay Time
<b>RSU</b>	Road Side Unit
<b>SAE</b>	Society of Automotive Engineers
<b>V2R</b>	Vehicle to Roadside
<b>V2V</b>	Vehicle to Vehicle
<b>V2X</b>	Vehicle to Everything
<b>VANETs</b>	Vehicular Ad hoc Networks
<b>VRC</b>	Vehicle-Roadside Communication
<b>WAVE</b>	Wireless Access in the Vehicular Environment

## **Abstract:**

Connected and Autonomous vehicles (CAV) must have adequate reliability and safety requirement in the uncertain environment with complex circumstances. Sensor technology, actuators and artificial intelligence (AI) are constantly improving in their performance, which enables continuous further development of self-driving vehicles, and increasing automation of the driving task. CAV shows many benefits in human life such as increasing road safety, reducing pollution, and providing independent mobility to non-drivers. However, these advanced components create a new set of challenges concerning safety and dependability. Hence, it is necessary to evaluate these technologies before implementation.

We study in this thesis the reliability of CAV as a whole, focusing on the sensors and on the communication system. For that, a functional analysis was done for the CAV system.

Our scientific approach for the analyzing the CAV reliability, was structured with methods that combine quantitative and qualitative approaches such as functional analysis for both internal and external, Preliminary risk analysis (PRA) and failure modes and effects criticality analysis (FMECA), etc.

In order to prove our result, a simulation was occurred using the Fault Tree analysis (FTA) probability and it has been conducted to validate the proposed approach. The data (Failure ratio) used were from professional database concerning the type of components presented in the system. From this data, a probabilistic model of degradation was proposed. The probability calculation was performed in relation to a reference time of use. Thereafter a sensitivity analysis was suggested concerning the reliability parameters and redesign proposals are developed for the components.

CAV provide communication services among one another: vehicles to vehicle (V2V) or with Road Side Infrastructure: vehicle to infrastructure (V2I). Dedicated Short Range Communication (DSRC) employ multichannel to provide a variety of safety and non-safety applications. Safety applications necessitate appropriate and reliable transmissions, while non-safety applications require performance and high speed. Broadcasting of Basic Safety Messages (BSM) is one of the fundamental services in today's connected vehicles. For that, an analytical model to evaluate reliability of IEEE 802.11 based V2V safety-related broadcast services in DSRC system on highway was proposed. Finally, an enhancement on the proposed model was made in order to increase the reliability of the V2V connection, taking into consideration many factors such as transmission range, vehicle density, and safety headway distance on highway, packet error rate, noise influence, and failures rates of communication equipment.

Evaluating these problems leads to a sensitivity analysis related to reliability parameters, which helps further innovation in CAV and automobile engineering.

**Keywords:** Connected Autonomous vehicles, Dependability, Reliability, BSM, DSRC, VANET, wireless network, FMECA, Fault Tree.

## **Résumé**

Les véhicules autonomes et connectés (VAC) doivent avoir une exigence de fiabilité et de sécurité adéquate dans un environnement incertain aux circonstances complexes. La technologie des capteurs, les actionneurs et l'intelligence artificielle (IA) améliorent constamment leurs performances, ce qui permet un développement continu des véhicules autonomes et une automatisation accrue de la tâche de conduite. Les VAC présentent de nombreux avantages dans la vie humaine, tels que l'augmentation de la sécurité routière, la réduction de la pollution et la fourniture d'une mobilité autonome aux non-conducteurs. Cependant, ces composants avancés créent un nouvel ensemble de défis en matière de sécurité et de fiabilité. Il est donc nécessaire d'évaluer ces technologies avant leur mise en œuvre.

Nous étudions dans cette thèse la fiabilité du VAC dans son ensemble, en nous concentrant sur les capteurs et le système de communication. Pour cela, une analyse fonctionnelle a été réalisée pour le système VAC. Notre approche scientifique pour l'analyse de la fiabilité du VAC a été structurée avec des méthodes combinant des approches quantitatives et qualitatives (telles que l'analyse fonctionnelle interne et externe, l'analyse préliminaire des risques (APR) et l'analyse des modes de défaillance, de leurs effets et de leur criticité (AMDEC), etc. Afin de prouver nos résultats, une simulation a été réalisée à l'aide de la probabilité d'analyse d'arbre de défaillance (ADD) et elle a été réalisée pour valider l'approche proposée. Les données (taux d'échec) utilisées proviennent d'une base de données professionnelle concernant le type de composants présentés dans le système. À partir de ces données, un modèle probabiliste de dégradation a été proposé. Le calcul de probabilité a été effectué par rapport à un moment d'utilisation de référence. Par la suite, une analyse de sensibilité a été suggérée concernant les paramètres de fiabilité et des propositions de restructuration ont été élaborées pour les composants.

CAV fournit des services de communication entre véhicules : véhicules à véhicules (V2V) ou avec infrastructures côté rue : véhicules à infrastructures (V2I). La technologie des « Communications dédiées à courte portée » (DSRC : Dedicated Short Range Communications) utilise plusieurs canaux pour fournir une variété d'applications de sécurité. Les applications de sécurité nécessitent des transmissions appropriées et fiables, tandis que les applications non liées à la sécurité exigent des performances et une vitesse élevée. Aujourd'hui, la diffusion de messages de sécurité de base (Basic safety message, BSM) est l'un des services fondamentaux des véhicules connectés. Pour cela, un modèle analytique destiné à évaluer la fiabilité des services de diffusion V2V relatifs à la sécurité basée sur IEEE 802.11 dans le système DSRC sur autoroute a été proposé. Enfin, une amélioration du modèle proposé a été faite afin d'accroître la fiabilité de la connexion V2V, en tenant compte de nombreux facteurs tels que la portée de transmission, la densité du véhicule, la distance de sécurité sur l'autoroute, le taux d'erreur de paquets, l'influence de bruit et les taux de défaillants pour les équipements de communications.

L'évaluation de ces problèmes conduit à une analyse de sensibilité liée aux paramètres de fiabilité, ce qui contribue à davantage d'innovation dans les domaines de l'ingénierie automobile.

**Mots clés :** Véhicule autonome et connecté, Sureté de fonctionnement, fiabilité, BSM, DSRC, VANET, Réseaux sans fil, AMDEC, arbre de défaillance.

