



HAL
open science

Sustainability Transitions: Multi-scale modelling of renewable energy technologies diffusion and urban resilience under a network approach in the Swiss Alps and in the South Region of France

Diego Fernando Rojas Angulo

► **To cite this version:**

Diego Fernando Rojas Angulo. Sustainability Transitions: Multi-scale modelling of renewable energy technologies diffusion and urban resilience under a network approach in the Swiss Alps and in the South Region of France. Geography. Université Côte d'Azur, 2021. English. NNT : 2021COAZ2013 . tel-03356465

HAL Id: tel-03356465

<https://theses.hal.science/tel-03356465>

Submitted on 28 Sep 2021

HAL is a multi-disciplinary open access archive for the deposit and dissemination of scientific research documents, whether they are published or not. The documents may come from teaching and research institutions in France or abroad, or from public or private research centers.

L'archive ouverte pluridisciplinaire **HAL**, est destinée au dépôt et à la diffusion de documents scientifiques de niveau recherche, publiés ou non, émanant des établissements d'enseignement et de recherche français ou étrangers, des laboratoires publics ou privés.



THÈSE DE DOCTORAT

TRANSITIONS DURABLES :

Modélisation multi-échelles de la diffusion des technologies d'énergie renouvelable et de la résilience urbaine dans le cadre d'une approche en réseau dans les Alpes suisses et sur la Région SUD-Provence-Alpes-Côte d'Azur.

Diego ROJAS

ESPACE - Étude des Structures, des Processus d'Adaptation et des Changements de l'Espace UMR 7300

Présentée en vue de l'obtention
du grade de docteur en Géographie
d'Université Côte d'Azur

Dirigée par: Christine Voiron-Canicio
Co-encadrée par: Jean-Christophe Loubier
Soutenue le : 14 juin 2021

Devant le jury, composé de :

Dominique Badariotti, Professeur,
Université de Strasbourg
Ola Hall, Professeur, Lund University
Didier Josselin, Directeur de Recherche CNRS,
Université d'Avignon
Serge Lhomme, Maître de conférences,
Université Paris-Est Créteil
Jean-Christophe Loubier, Professeur, University of
Applied Sciences and Arts Western Switzerland
Christine Voiron-Canicio, Professeure,
Université Côte d'Azur



TRANSITIONS DURABLES :

Modélisation multi-échelles de la diffusion des technologies d'énergie renouvelable et de la résilience urbaine dans le cadre d'une approche en réseau dans les Alpes suisses et sur la Région SUD-Provence-Alpes-Côte d'Azur.

SUSTAINABILITY TRANSITIONS:

Multi-scale modelling of renewable energy technologies diffusion and urban resilience under a network approach in the Swiss Alps and in the South Region of France.

Jury :

Président du jury

Didier Josselin, Directeur de Recherche CNRS, Université d'Avignon.

Rapporteurs

Dominique Badariotti, Professeur, Université de Strasbourg

Ola Hall, Professeur, Lund University

Examineurs

Didier Josselin, Directeur de Recherche CNRS, Université d'Avignon

Serge Lhomme, Maître de conférences, Université Paris-Est Créteil

Jean-Christophe Loubier, Professeur, University of Applied Sciences and Arts

Western Switzerland, Switzerland (co-directeur)

Christine Voiron-Canicio-Canicio, Professeure, Université Côte d'Azur (Directrice)

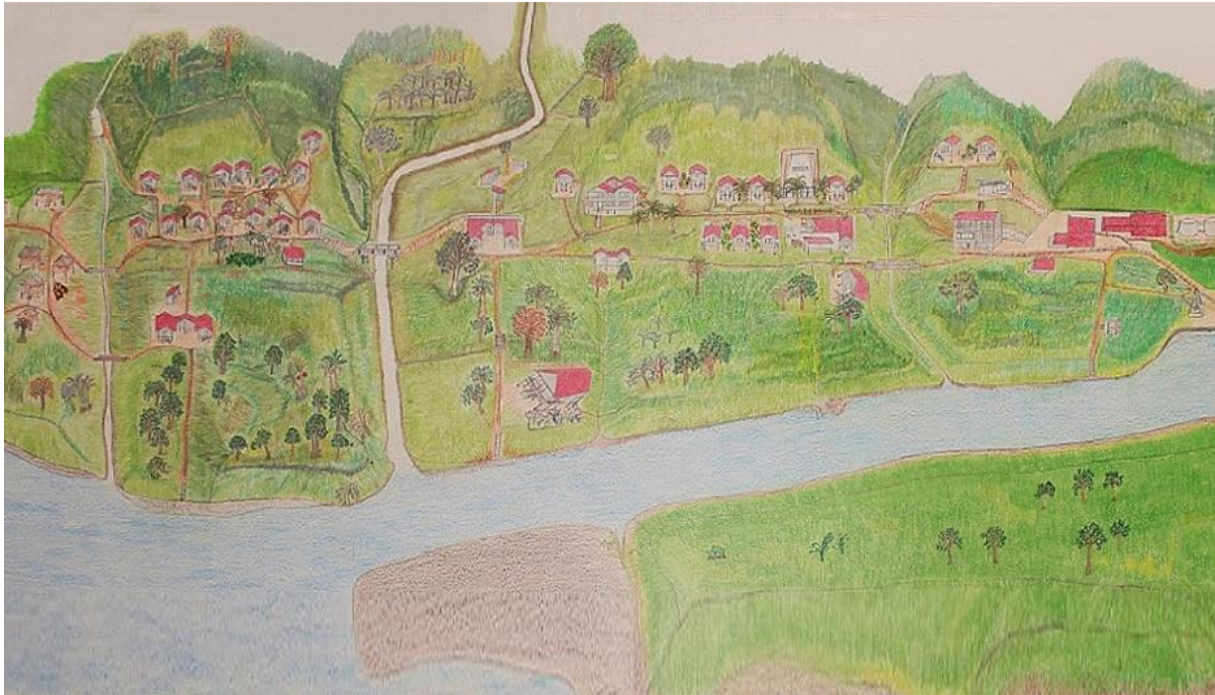

Barbacoas, Nariño-Colombia 1950, by Samuel Angulo

“If everything occurred at the same time, there would be no development. If everything existed in the same place there could be no particularity. Only space makes possible the particular, which then unfolds in time.” — Lösch

A mis abuelos Samuel y Ana Franquelina.

PhD Dissertation in Geography, 2021.
Diego ROJAS

Acknowledgements

I want to thank you all the people involved in this achievement that is certainly not only mine. I want to thank my supervisor Jean-Christophe Loubier, who has become my friend. I had the great opportunity to meet him, which implied a total change in my professional life. He introduced to that strange concept called in French: Espace. Coming from engineering was not easy to really understand what it really meant at first, but slowly through different projects led by Jean-Christophe at the GISlab I could learn and this thesis is a result of it. I am really grateful for his support not only at academic level, but at a personal level as well.

I also want to acknowledge my gratitude to Christine Voiron-Canicio for accepting this international adventure and her support throughout my Ph.D. With her guidance I was introduced to urban resilience that indeed, was one of the most challenging intellectual exercises I had to do during this dissertation. I really appreciate all the discussions we had during my stays in Nice, her 24/7 availability and for her helping attitude picking me up at the airport even on Sundays.

I would also like to thank Marc Schnyder for his support and for giving me the opportunity to do this Ph.D in a very unusual international configuration, which greatly enriched the work achieved in this research. A very special acknowledgment to Pascal Favre whose unique talents in computer science and his inputs helped me a lot to develop the formalisation of various scientific theories in this Ph.D.

This would not be possible without the everlasting support of my family, specially I want to thank my grandparents who actually are my parents. Esta tesis se la dedico a mi mama Ana Franquelina y a mi papa Samuel como una ofrenda de reconocimiento por su dedicación, paciencia y amor incondicional. A pesar de que este trabajo lo hice muy lejos de ustedes, yo no estaría aquí si no fuera por su apoyo inefable. I also want to thank my own family, Helena and Samuel that supported me and endured my long working hours and my continuous absence due to my travels. Helena this would not have been possible without your support and I will be forever really thankful.

I want also to say thanks to my mom Patricia and my brother Samuel and family in Switzerland who supported me from the moment I landed in Geneva in 2008. Mafer, Pierre-Antoine, Mateo, Helen, David and Joel I would not have been able to achieve this without you! I also want to thank my sister Angelica and brother-in-law Jure for their helpful attitude all the time. I also want to say thanks to Michael and Marianne for their warm welcoming in their family and all the nice moments in different places and hopefully soon in Colombia.

This intense period of three and a half years was definitely eased by the company of nice people, Maya Simon thanks for the cool after works at the Machine in Sierre, Julien Mabillard thanks for the nice talks and the help provided with the GISLab's computer all the time. Thanks Francesco Cimmino for the unfinishable conversations on science, life, beers and future and Ralph Lugon for fun times talking about what science is not. Thank you Stefano and Daniel for the fun jam sessions in Lausanne, thanks Anita Bueno and Ramses for the nice moments in Lausanne and Rasmus thanks for the nice conversations at the 'office' in Malmo. I crossed many important people in this journey, the first people that introduced me to science Miriam Scaglione and Emmanuel Fragnière thank you very much for your dedication to education, knowledge, science and friendship. A special thanks to Gonzalo F. Rueda who has been a great inspiration in my research journey since I was a teenager.

The list is even longer, and I cannot really stress how thankful I am with all of you folks, but I hope we will have more opportunities to share time together.

Gracias, totales.

Abstract

This doctoral dissertation is an interdisciplinary research work at the intersection of geography and innovation studies through the prism of two subjects: diffusion of sustainable innovations and urban resilience to energy transition. The research work was developed in the Swiss Alps and in the South Region of France in order to deploy comparative analyses. This Ph.D dissertation investigates the regions receptivity to sustainable innovations, specifically renewable energy technologies (RET) such as solar photovoltaics, solar thermal collectors in the Swiss Alps and electric and hybrid vehicles in Switzerland at the national level. As well as the research was developed in the South Region of France were six innovation indicators were analysed: solar photovoltaics, solar thermal collectors, wind power, small and big hydroelectric power plants, biogas and biomass. The research aimed at improving our understanding on regions' ability to integrate these innovations into their dynamics and the embedded urban resilience to energy transition, to adapt to change, accommodating disruptions in the diffusion process and develop new spatial diffusion paths.

The research questions aimed at underpinning our understanding on the network effects of the RET diffusion and on the potential insights that spatial information might provide regarding such diffusion processes. The underlying assumptions were that RET diffuses across scales in a non-random fashion and describe a preferential attachment mechanism. The implication of the latter assumption is that the urban renewable energy systems exhibit fractality, which is the signature of self-organized systems. By definition, resilient systems are self-organized, so in this context, the innovation systems are analyzed in the framework of urban resilience to the energy transition. Thus, a further assumption is made and proposes that more innovative places and locations are more resilient than less innovative locations.

The methodological approaches to address these research questions and verify the assumptions are described as follows. In the Swiss region a model called 'Spatial Preferential Attachment' (SPA) was created based on spatial interaction theory, relying on a gravity model that was built through agent-based modelling and systems dynamics approaches. The integration of the gravity model with the spatial information of the RET allowed to build a spatial network, which simulated the urban energy system of the region. The results allowed to accept the assumptions in which a preferential mechanism in the diffusion process take place, since the spatial diffusion distribution follow power laws. The model was also applied in Switzerland and in the South Region of France, obtaining similar results, following multi-level and hierarchical mechanisms. These results are in line with the path development theory proposed by economic geographers, where the specific-place legacy has at least a partial impact in the future intensity of diffusion processes

These results are important within the sustainability paradigm from a research perspective and challenging for the current innovation framework, the so-called Transformative Change, which aims at establishing a fairer view on socio-economic and environmental issues. The preferential attachment mechanisms in RET diffusion imply that there are hubs of innovation ruled by urban scaling laws that put in disadvantage other locations. The SPA was also used to simulate the urban resilience to energy transition in the Swiss canton of Valais. The energy urban network was 'attacked' by removing the hubs of the structure and the simulations showed that the system could reorganized itself at global level, showing strong sings of resilience however not at local level. Resilient systems are self-organized however it does not imply that resilient itself is fractal as differences were found from a multiscale spatial perspective.

Keywords: Sustainability transition, complex systems, renewable energy technologies diffusion, network modelling, self-organization.

Résumé

Cette thèse de doctorat est un travail de recherche interdisciplinaire à l'intersection de la géographie et des études sur l'innovation sur deux sujets : la diffusion des innovations durables et la résilience urbaine à la transition énergétique. Le travail de recherche a été développé dans les Alpes suisses et sur la Région SUD en France, afin de déployer des analyses comparatives. Ce travail de recherche étudie la réceptivité des régions aux innovations durables, notamment aux technologies des énergies renouvelables (TER) telles que les panneaux photovoltaïques (PF), les capteurs solaires thermiques dans les Alpes suisses et les véhicules électriques et hybrides en Suisse au niveau national. La recherche a également été développée sur la Région SUD où six indicateurs d'innovation ont été analysés : les PF, les capteurs solaires thermiques, l'énergie éolienne, les petites et grandes centrales hydroélectriques, le biogaz et la biomasse. La recherche visait à améliorer notre compréhension de la capacité des régions à intégrer ces innovations et la résilience urbaine à la transition énergétique, à s'adapter au changement, à s'accommoder des perturbations dans le processus de diffusion et à développer de nouvelles voies de diffusion spatiale. Les questions de recherche visaient à étayer notre compréhension des effets de réseau de la diffusion des TER et l'importance de l'espace dans ces processus.

Les hypothèses sous-jacentes étaient que les TER se diffusent à travers les échelles d'une manière non aléatoire et décrivent un mécanisme d'attachement préférentiel. Cette hypothèse implique que les systèmes urbains d'énergie renouvelable sont fractals, ce qui est la signature des systèmes auto-organisés. Par définition les systèmes résilients sont auto-organisés, dans ce contexte donc, les systèmes d'innovation sont analysés dans le cadre de la résilience urbaine à la transition énergétique. Ainsi, une autre hypothèse propose que les lieux les plus innovants sont plus résilients que les lieux moins innovants. Au niveau méthodologique, dans la région suisse un modèle appelé "Attachement Préférentiel Spatial" (SPA) a été créé sur la base de la théorie de l'interaction spatiale à l'aide d'un système multi-agents et des approches de dynamique des systèmes. L'intégration d'un modèle gravitaire avec des informations spatiales du TER a permis de construire un réseau spatial, qui a simulé le système énergétique urbain de la région. Les résultats ont permis d'accepter les hypothèses dans lesquelles un mécanisme préférentiel dans le processus de diffusion a lieu, car la distribution spatiale de la diffusion suit des lois de puissance. Le modèle a également été appliqué en Suisse et sur la Région SUD, obtenant des résultats similaires.

Ces résultats sont conformes à la théorie du *path development* proposée par les géographes économiques, selon laquelle l'héritage d'un lieu a au moins un impact partiel sur l'intensité future des processus de diffusion. Ces résultats sont importants dans le paradigme de la durabilité car ils constituent un défi pour le cadre d'innovation actuel, appelé "*Transformative Change*", qui vise à établir une vision plus juste sur des questions socio-économiques et environnementales. Les mécanismes d'attachement préférentiel dans la diffusion des TER impliquent qu'il existe des *hubs* d'innovation régis par des lois d'échelle urbaine et qui désavantagent d'autres lieux. Le modèle SPA a également été utilisé pour simuler la résilience urbaine à la transition énergétique dans le canton suisse du Valais. Le réseau énergétique urbain a été "attaqué" en supprimant les *hubs* de la structure. Les simulations ont alors montré que le système pouvait se réorganiser au niveau global, avec de forts signes de résilience, mais pas au niveau local. Les systèmes résilients sont auto-organisés, mais cela n'implique pas que la résilience elle-même soit fractale, car des différences ont été constatées dans une perspective spatiale multi-échelle.

Mots clefs : Transition vers la durabilité, systèmes complexes, diffusion des technologies d'énergie renouvelable, modélisation des réseaux, auto-organisation.

Contents

Acknowledgements

Abstract

Résumé

Introduction	1
Introduction (Français)	5
Part 1 An Overview on Innovation Studies and Urban Innovation Networks	10
Partie 1 (Français) Un aperçu sur les études sur l'innovation et les réseaux d'innovation urbaine.	10
1 An Overview on Innovation: A Path Towards Environmental and Societal Challenges.	11
1.1 First Period of Innovation Policy Framework – Post WW II to 1980's: Innovation for Growth.....	15
1.2 Second Period of Innovation Policy Framework – 1980's to 2000's: National Systems of Innovation.....	21
1.3 Third and Current Framing of Innovation Policy: <i>Transformative Change</i>	41
1.4 Diffusion of Innovations	56
1.5 Conclusion Chapter 1	65
2 Theoretical and Modelling Approaches for the Dynamics of Complex Urban Systems and Diffusion of Innovations	66
2.1 Urban Systems Modelling	66
2.1.1 Neoclassical and Behavioural Approaches in Urban Theory	67
2.1.2 Systems Dynamics Modelling	79
2.1.3 Urban Systems Dynamics and Simulation	82
2.1.4 Spatial Urban Dynamics.....	84
2.1.5 Land-Use Change Modelling.....	89
2.2 Innovation Diffusion as a Spatial Process	97
Time and Space	106
2.2 Resilience: A Review of Theoretical Conceptualizations in Urban Studies and Business Management	107
2.3.1 Conceptual Views on Resilience	109
2.3.2 Regional Resilience.....	117
2.3.3 Business Continuity Management: An Attempt to Integrate Resilience in Business Management.....	121

2.3.4	Urban Resilience and Sustainability Transition	126
2.3.5	Sustainability Transition: A Theoretical Review on Multiscale Modelling of Urban Resilience Under a Network Approach.	134
2.3.6	Overview of Research Questions	138
2.4	Conclusion Chapter 2	141
3	Study Area and Data.....	142
3.1	Urban and economic context in the Swiss region: the canton of Valais-Wallis.....	142
3.1.1	Demography	142
3.1.2	Economy	144
3.1.3	Nature, Climate Change and Spatial Planning in Valais.....	146
3.2	A rationale to Choose Renewable Energy Technologies as Innovation Indicators.	149
3.3	The Energy Transition Context in Valais – Wallis	154
3.4	Swiss Data.....	157
3.5	The Urban and Economic Context in the South Region of France.	157
3.5.1	Demography and Economy	157
3.5.2	Nature and Climate Change in the South Region of France	159
3.6	The Energy Context in the South Region.....	161
3.7	French Data	165
3.8	Conclusion Chapter 3	165
4	Integrating Network Science for Spatial Diffusion and Resilience Modelling to Renewable Energies: A Theoretical Background.	166
4.1	Preferential Attachment vs Randomness	167
4.1.1	Thresholds and Phase Transitions in Evolving Networks.....	169
4.1.2	Scale-free Networks: The Barabasi-Albert model.	171
4.2	Conclusion Chapter 4	180
4.3	Conclusion Part 1	181
4.4	Conclusion Part 1 (Français)	182
	Part 2 Modelling and Simulation of Spatial Diffusion of Innovations and Urban Resilience to Energy Transition.....	184
	Partie 2 (Français) : Modélisation et Simulation de la Diffusion Spatiale des Innovations et de la Résilience Urbaine à la Transition Énergétique.....	184
5	Modelling Framework for Innovation Diffusion: A Multiscale Geospatial Network Approach for Renewable Energy Technologies Diffusion in the Swiss Alps.	185
5.1	Objectives	185
5.2	Design of the General System of Simulation.	185

5.3 Phase 1A: A Spatial Diagnosis of the Major Land-Use Trends in Valais-Wallis Via the SLEUTH Approach.....	188
5.3.1 Data.....	189
5.3.2 Transition Matrix for Years 2006-2018 and Markov Chains.....	190
5.3.3 Trend Scenarios for Years 2006 – 2048.....	191
5.4 Geoprospective: Spatial Interaction Modelling for the Swiss Alps region.....	192
5.4.1 Potential Fields.....	194
5.4.2 Attractiveness.....	194
5.4.3 Data.....	196
5.4.4 Spatial Representation of the Potential Fields of Innovation.....	196
5.4.5 Population Dynamics Simulation Under a Multi-paradigm Approach: System Dynamics and Agent-based Modelling.....	198
5.4.5.1 System Dynamics Model.....	199
5.4.5.2 Population dynamics in the canton of Valais via the integration of a spatial interaction model and agent-based modelling.....	203
5.5 Multi-scale Spatial Network Diffusion Modelling for Renewable Energy Technologies in the Swiss Alps.....	206
5.5.1 Data.....	207
5.5.2 Exploratory Data Analysis of Renewable Energy Technologies.....	208
5.5.2.1 Solar Photovoltaics and Space: A Multiscale Statistical Analysis in the Swiss Alps.....	214
5.5.2.2 Solar Photovoltaics, Space and Time: A Multiscale Spatial Analysis of the Distributional Changes in the Diffusion of Renewable Energy Technologies in the Swiss Alps.....	218
5.5.2.3 Electric and Hybrid Vehicles, Space and Time: A Multiscale Spatial Analysis of the Distributional Changes in the Diffusion of Innovations in the Swiss Alps.....	223
5.5.3 Spatial Preferential Attachment: A Network Modelling Approach for Diffusion of Innovations and Geography of Sustainability Transitions in Switzerland.....	226
5.5.3.1 A Scale-free Network Spatially Explicit for Renewable Energy Technologies Diffusion: Solar PV in the Swiss Alps.....	227
5.5.3.2 A Scale-free Network Spatially Explicit Approach for Renewable Energy Technologies Diffusion: Electric and Hybrid Vehicles in Switzerland.....	240
5.6 Conclusion Chapter 5.....	244
6 A Multiscale Geospatial Network Approach for Renewable Energy Technologies Diffusion in the South Region of France.....	245
6.1 Objectives.....	245
6.2 Multi-scale Spatiotemporal Modelling Framework for Geography of Sustainability Transitions: Application of the Spatial Preferential Attachment Model in the South Region of France.....	245
6.2.1 Data.....	246

6.2.2 Exploratory Data Analysis of Renewable Energy Technologies in the South Region of France	247
6.2.2.1 Solar Photovoltaics and Space: A Multiscale Spatial Analysis of Energy Production in the South Region of France	247
6.2.2.2 Solar Thermal Collectors and Space: A Multiscale Spatial Analysis of Energy Production in the South Region of France	248
6.2.2.3 Solar Photovoltaics, Space and Time: A Multiscale Spatial Analysis of Energy Production in the South Region of France	249
6.2.2.4 Solar Thermal Collectors Space and Time: A Multiscale Spatial Analysis of Energy Production in the South Region of France	251
6.2.3 Spatial Preferential Attachment: A Network Modelling Approach for Diffusion of Innovations and Geography of Sustainability Transitions in France.....	253
6.2.3.1 A Scale-free Network Spatially Explicit for Renewable Energy Technologies Diffusion in the South Region of France: The Case of Solar Photovoltaics and Solar Thermal Collectors.	253
6.2.3.2 An application of the Spatial Preferential Attachment Model for Energy Production for Electricity Based on a Technology Mix of: Wind Power, Small and Big Hydroelectric Power Plants, Biogas and Solar Photovoltaic.	257
6.2.3.3 An application of the Spatial Preferential Attachment Model for Energy Production for Heating Based on a Technology Mix of: Biomass and Solar Thermal Collectors.....	259
6.2.3.4 An application of the Spatial Preferential Attachment to the Energy Produced for Electricity and Heating Based on a Technology Mix of: Wind Power, Small and Big Hydroelectric Power Plants, Solar Photovoltaic, Biomass and Solar Thermal Collectors.	261
6.2.3.5 Sensitivity Analysis	264
6.3 Conclusion Chapter 6	265
7 Network Science as a Conceptual Instrument for Urban Resilience to Innovation Diffusion: A Geospatial Simulation for Sustainability Transition.....	266
7.1 Objectives	266
7.2 Urban Resilience to Innovation Diffusion: A Simulation on Sustainability Transition. .	267
7.2.1 Model	268
7.2.1.1 Urban Resilience to Renewable Energy Technologies at 300 Square Meters: Size Matters.	269
7.2.1.2 Urban Resilience to Renewable Energy Technologies at 600 and 1200 Square Meters: Where Fractality Begins.....	271
7.3 Discussion: Resilient Systems are Fractal, but is Really Resilience Fractal?	274
7.3.1 Bridging Sustainability Transition Pathways and Resilience Modelling	275
7.4 Conclusion Chapter 7	280
7.5 Conclusion Part 2	282
7.6 Conclusion Part 2 (Français)	282

Conclusion and New Perspectives	283
Conclusions et Nouvelles Perspectives	289
References	296
List of Figures	333
List of Tables.....	341
List of Acronyms and Abbreviations.....	342
APPENDIX A.....	344
APPENDIX B	348

Introduction

In this Ph.D research we investigated the diffusion of innovations focusing on renewable energy technologies (RET) from a spatial perspective. Additionally, this research work also emphasized on the regions' receptivity to innovations and their resilience to adopt RET. The objective was to improve our understanding on the territories' ability to integrate changes into their dynamics and the related social organization processes involved from a spatial point of view. The study was done within the framework of sustainability transition, where the diffusion processes were analysed from two different viewpoints: *i) RET diffusion from a demand or end user point of view in the Swiss canton of Valais and ii) from a supply perspective or energy production in the South Region of France.*

This Ph.D dissertation addresses the connection between diffusion of innovations and resilience in a geography of sustainability transition context. Therefore, this research work is at the intersection of different fields, which is enriched by different methodological approaches. The complex nature embedded in innovation and resilience systems in urban contexts exhibits the unsuitability of the one-size-fits-all approach in terms of strategies and policies. In fact, the question of innovation diffusion in an urban and economic context, allow to observe a sequential adoption order in hierarchical regional systems or in specialized areas. This self-organized phenomenon is also referred to as growth corridors by Lundquist et al., (2017). The authors' thesis relies on the on the fact that not all regions are equipped to absorb, adopt, adapt or implement and commercialize a new technology in the same way and coined it as *"the regional receiver and development competence"*.

This means that the advantage taken from a new technology is reinforce or penalized by the region's ability and competence to integrate the complex dynamics linked to innovation. Such ability is influenced by structural socio-economic pre-conditions and territorial legacy that enable or prevent territories to translate innovation in economic growth (see Martin & Sunley, 2006; Dawley, 2014;). The latter line of thought is an important research direction taken by economic geographers however, an important share of regional growth models remains unexplained (Grillitsch et al., 2021). In this research work the focus is on sustainability transition, which is a paradigm where is required a transformation in different fronts and one of them is related to spatial diffusion of innovation. Therefore, the emphasis is given to the spatial diffusion of RET as one of the contributors of the sustainability transition framework.

Scholars have acknowledged that innovation diffusion processes are non-linear in fact, the subject is a complex phenomenon that follows trajectories reinforced or weakened by feedbacks-loops. An important aspect within this hierarchical organisation in innovation processes is the role of the spatial component, taken in this research work as an active agent within the system. If innovation diffusion processes follow a descending spatial hierarchy, we could wonder which are the lower boundaries of such processes when administrative limits do not interfere as an artificial barrier artefact?

This question from a mathematical point of view is analysed in this research work under the assumption that the way of hierarchical organisation travels through spatial scales at the national, regional and even smaller spatial scales. It will be shown that these spatial structures are triggered by a preferential attachment mechanism in which most innovative locations keep getting more innovative than less innovative locations, in a rich get richer process. The preferential attachment property was scientifically proven in the field of network science by Barabasi & Albert (1999) who created a robot, which had as a task to get information about the worldwide web (WWW) topology. The results indicated that the largest human-made network was not randomly connected, since there were hubs that is, hyperconnected documents via the Uniform Ressource Locators (URLs). This network exhibited two important characteristics *i) the networks' growth and ii) the preferential attachment*. The first feature implied that networks evolve in time, which was not a characteristic taken into account in the Erdős-Rényi

(1959, 1968) model. Second, the nodes with more links would keep attracting more links and grow accordingly to their size.

The conceptual idea of this theory was transferred to the mechanisms of RET diffusion as a spatial process in this dissertation. First of all, innovation diffusion is embedded in social systems, which are highly influenced by spatial organization therefore, socio-economic, cultural, technological, political and geographic aspects are at the core of the trajectories followed by urban structures. In this regard, if we visualize the space as an agent, which is not only a physical recipient of such aspects but also an influencer of the interaction between those characteristics, we could think that some locations become better at capturing the positive effects of such exchanges. Under this view, it is important to highlight that diffusion entails movement, dispersion and competition for space hence, we argue that the spatial dimension is very well suited as a '*major baseline variable*' for innovation studies.

This major baseline variable term means that space can be used as a point of reference, relying on any number, unit, product, services, viruses such as Corona, migration and across fields, which can be systematically compared from a spatiotemporal standpoint. The emphasis of the relevance of the spatial dimension is done since its integration in innovation studies has been rather low (Coenen et al., 2012; Hansen & Coenen, 2015). Nevertheless, its importance has broadly been acknowledged within the scientific community and its incorporation in science and policy is growing. The epistemological foundation of the spatiality paradigm explains very well how the relative positions and the geographical situations are probabilistically or partly influence the intensity and form of social interactions, including innovation diffusion processes (Pumain, 2004a). We propose that such levels of interactions which are influenced by the space, can be represented in a spatial network with the assumption that the topology has preferential attachment mechanisms.

The conceptual integration of preferential attachment property with the spatiality paradigm gives to innovation diffusion a research framework that is in line with the work of Swedish geographer Torsten Hägerstrand (1952, 2953). The author in a period of a very early stage of computational development, successfully conducted one of the first empirical mathematical models on innovation diffusion and concluded that the colonization process of innovations starts by local concentrations. The concentration term is a key aspect that intrinsically means spatial proximity within a milieu, which has been largely reported in the specialised literature as a central aspect in diffusion processes (Saint-Julien, 2004; Kiesling, 2011).

The studies of spatial proximity and the scientific convergence towards the major role of the spatial component in social organization is unambiguous. For example, the first law of geography states that "Everything is related to everything else, but near things are more related than distant things" (Tobler, 1970). This theory resonates with earlier theoretical approaches such as spatial interaction theory and gravity models (Reilly, 1927; Hotelling, 1929, Converse, 1949, Huff, 1963, 1964). Within the same line of thought, physicists have been interested in urban modelling for decades, where Newtonian-type models based on proximity attributes are at the core of their reasoning for example, in social physics (Stewart; 1941, 1942) and central place models (Allen & Sanglier, 1979, 1981). However, the prominent Central Place Theory (CPT) proposed by Christaller (1933) is probably the most notorious in the family of central models.

Later, the French school of proximity also worked on the subject, looking at spatial patterns of innovation systems and designed different types of proximity such as geographical, organizational and institutional proximities (Carrincazeaux et al., 2008). Parallel to this school, the Geography of Innovation (GOI) emerged in the 1990's and focused on similar questions. Freeman (1994) worked on the economics aspects of GOI coupled with a spatial perspective on innovation and Boschma & Martin (2010) worked on GOI on an evolutionary economic geography approach and clusters formations in geographical contexts (see Freeman, 1994). The evolutionary views on GOI have also been transferred to studies in regional resilience, which takes resilience under a new dimension known as adaptive resilience, that is rooted on complex science where the adaptability of systems plays a central role

(Giacometti & Teräs, 2019). A parallel between regional and urban resilience will be drawn in this research work in section 2.2 (see Rogov & Rozenblat, 2018; Voiron-Canicio & Fusco, 2020).

This Ph.D thesis is organized in two main parts, in which the first part focuses on the theoretical background linked to innovation diffusion, complex urban systems, urban resilience and network science. The dissertation on these topics is linked to the methodological approach developed in the second part 2. In the Part 2 we develop a practical model of spatial RET diffusion called Spatial Preferential Attachment (SPA), which is applied in the Swiss region and at the national level in Switzerland. The results suggest that a fractal behaviour of the spatial structure of RET diffusion is exhibited through the prism of a network approach. A second application of the SPA model is integrated in the French region where similar results were obtained and finally a simulation of urban resilience to RET diffusion is deployed in the Swiss territory. The different chapters of this Ph.D dissertation will be briefly described as follows. In Chapter 1 it will be discussed the innovation frameworks from a policy and scientific perspective, starting from the post-World War II (WW II) period onwards, describing the evolution and the gradual integration of the spatial dimension in studies and policies overtime. It will be shown that during this period of innovation studies it has gradually been acknowledged the need to integrate a more holistic view regarding the link of innovation with socio-economic issues and climate change.

In Chapter 2 it will be discussed theoretical and modelling approaches of dynamics of complex urban systems and diffusion of innovations. The chapter describes and analyses different conceptual theories and models such as central place theory, spatial interaction, innovation networks and land-used dynamics under a Markovian approach. These theories and models are discussed in the light of a research framework that integrates innovation, urban networks, change and sustainability transition. It is also discussed the need of more collaboration between scholars from different scientific fields and specially within the field of geography as it is the case of economic, physical and quantitative geographers, which could collaborate more in a complementary fashion. The role of geographers from different fields is not only important for climate change studies but for innovation studies as well, where the integration of the spatial dimension has historically been rather neglected. Theories such as path development in economic geography is in line with the concept of spatial preferential attachment presented in this dissertation (see Chapter 4). This also resonates with the studies done in urban and regional resilience, where the former is more oriented towards economic studies and the latter towards sustainability (see section 2.2).

In Chapter 2 the resilience concept is reviewed and its ramping success in different fields is discussed and also the lack of a scientific consensus about a unique definition. The discussion is developed regarding the different definitions and research angles of scholars from different fields such as geography, physics, ecology and economics. An interesting development within the field of economic geography is the adoption of the adaptivity resilience under an evolutionary economic geography perspective, a concept derived from complex science. In the same chapter, the panarchy concept is introduced as a conceptual approach within the framework of sustainability transition (see section 2.3.4). The main definitions and a discussion of the concept in the context of urban resilience is developed in order to establish the theoretical background for the model built in Chapter 7.

Chapter 3 introduces the regions of study, which was developed in the Swiss canton of Valais and in the South Region of France and presents an overview of the general contexts of the territories. The description of the geographic, economic, socio-demographic and natural characteristics is developed, showing the dynamic aspects of both regions in terms of sustainability transition. The introduction of the rationale of choosing RET technologies as innovation indicator for this research work is developed in the same chapter. Here, a more global view on climate change and the anthropogenic greenhouse gas (GHG) emissions are discussed to make a point regarding the importance of developing further studies and models for sustainability transition purposes.

Chapter 4 discusses the fundamental basis of scale-free networks, which exhibit preferential attachment, fractality and thus self-organization and explains the difference concerning random networks. The main goal in this chapter is to present the implications of the discovery of scale-free networks within the framework of complexity. The

change from the random network paradigm that reigned from the late 1950's towards the preferential attachment concept that arrived in the late 1990's (Barabasi & Albert, 1999). The impact of this relative new theory has contributed to narrowed down the gap between innovation diffusion and network science, which allowed graph theory to gain momentum in innovation studies. Furthermore, an explanation of the mathematical basis for modelling scale-free networks and a theoretical view on phase transition processes are developed, integrating views from different fields.

Chapter 5 contains the general system of simulation and the development of the model RET diffusion in the canton of Valais. Within this section the methodological aspects of the model are discussed through, alongside the rationale of each choice that results in an interdisciplinary approach. Fundamentally, the spatial and time effects on the RET diffusion are at the base of the research work, in which other elements are systematically added according to the pertinence at social and physical levels. The chapter begins with the development of a Markovian approach to model the land-use change processes in the region and it is followed by the construction of a gravity model (see section 5.3) which was supposed to be the substrate to calculate the Potential Innovation Fields (PIF) in the region developed in sections 5.4.1 and 5.4.4. However, the results showed that the land use dynamics did not enrich the final model. Thus, different methodological approaches such as agent-based modelling (ABM) and Systems Dynamics (SD) are used to build a gravity model and in a later stage the integration of spatial network model is developed. The innovation indicators studied in the Swiss canton of Valais are solar photovoltaics (solar PV) for heating and hot water usage and electric and hybrid vehicles at the national level in Switzerland. The analysis is developed under a multiscale spatial approach, which accounts for the observation of complex phenomena emergence at different scales. The results suggest a preferential attachment in the RET spatial diffusion, which is major aspect from a strategic and policy perspective within the framework of climate change and the sustainability goals.

Chapter 6 presents the development of the SPA model in the South Region of France, where the innovation indicators is the production of renewable energy via solar photovoltaic, solar thermal collectors, big and small hydroelectric plants, wind power, biomass and biogas. Therefore, including the RET studied in the Swiss region, nine innovation indicators are studied in total in this dissertation. The main difference between the research work in both regions, are *i) The research work in the South Region of France is done from the supply perspective therefore, the analysis focused on renewable energy production; ii) Therefore, a gravity model is not used in the development of the research work and iii) The study is only at regional level, not at the national level as it was done with the electric and hybrid vehicles in Switzerland.*

Chapter 7 discussed the integration of network sciences as a conceptual instrument for urban resilience to innovation diffusion, in this case focusing on RET. After the introduction of the resilience concept in Chapter 2, a practical model is proposed and developed in the Swiss region of Valais. The way to simulate the urban resilience to innovation diffusion, in this context sustainability transition relies on the ability of the territory to cope with change and its capacity to reorganized itself after a shock. The data and the model are exactly the same that were used in Chapter 5, the difference is that the networks are '*attacked*', since a series of major hubs from the network are removed. The removal of the hubs intends to simulate the arrival of a shock, which puts at risk the RET diffusion process causing subit changes. The results show an interesting dual behaviour at local versus global, due to the emergence of a scale-dependent fractal dimension effect.

Introduction (Français)

Dans cette recherche de doctorat, nous avons étudié la diffusion des innovations axées sur les technologies des énergies renouvelables (TER) d'un point de vue spatial. En outre, ce travail de recherche a également mis l'accent sur la réceptivité des régions aux innovations et leur résilience à adopter les TER. L'objectif était d'améliorer notre compréhension de la capacité des territoires à intégrer les changements dans leur dynamique et des processus d'organisation sociale impliqués d'un point de vue spatial. L'étude a été réalisée dans le cadre de la transition vers la durabilité, où les processus de diffusion ont été analysés de deux points de vue différents : *i) la diffusion des TER du point de vue de la demande ou de l'utilisateur final dans le canton suisse du Valais et ii) du point de vue de l'offre ou de la production énergétique sur la Région SUD-Provence-Alpes-Côte d'Azur.*

Cette thèse de doctorat traite du lien entre la diffusion des innovations et la résilience dans un contexte de géographie de la transition vers la durabilité. Par conséquent, ce travail de recherche se situe à l'intersection de différents domaines, ce qui est enrichi par différentes approches méthodologiques. La nature complexe des systèmes d'innovation et de résilience dans les contextes urbains montre l'inadéquation d'une approche unique en termes de stratégies et de politiques. En effet, la question de la diffusion des innovations dans un contexte urbain et économique, permet d'observer un ordre séquentiel d'adoption dans des systèmes régionaux hiérarchisés ou dans des régions spécialisées. Ce phénomène auto-organisé est également qualifié de corridors de croissance par Lundquist et al, (2017). La thèse des auteurs s'appuie sur le fait que toutes les régions ne sont pas équipées de manière égale pour absorber, adopter, adapter ou mettre en œuvre et commercialiser une nouvelle technologie, ce qu'ils ont baptisé "*la compétence régionale de réception et de développement*".

Cela signifie que l'avantage tiré d'une nouvelle technologie est renforcé ou pénalisé par la capacité et la compétence de la région à intégrer les dynamiques complexes liées à l'innovation. Cette capacité est influencée par les conditions socio-économiques structurelles préalables et l'héritage territorial qui permettent ou empêchent les territoires de traduire l'innovation en croissance économique (Martin & Sunley, 2006 ; Dawley, 2014). Ce dernier axe de réflexion est une direction de recherche importante prise par les géographes économiques, cependant une part importante des modèles de croissance régionale reste inexplicée (Grillitsch et al., 2021). Dans ce travail de recherche, l'accent est mis sur la transition vers la durabilité, qui est un paradigme où une transformation est requise sur différents fronts, dont l'un est lié à la diffusion spatiale de l'innovation. Par conséquent, l'accent est mis sur la diffusion spatiale des TER comme l'un des contributeurs du cadre de la transition vers la durabilité.

Les chercheurs ont reconnu que les processus de diffusion de l'innovation ne sont pas linéaires ; en fait, le sujet est un phénomène complexe qui suit des trajectoires renforcées ou affaiblies par des boucles de rétroaction. Un aspect important de cette organisation hiérarchique des processus d'innovation est le rôle de la composante spatiale, considérée dans ce travail de recherche comme un agent actif au sein du système. Si les processus de diffusion de l'innovation suivent une hiérarchie spatiale descendante, nous pouvons nous demander quelles sont les limites inférieures de ces processus lorsque les limites administratives n'interfèrent pas comme un artefact de barrière artificielle ?

Cette question est analysée d'un point de vue mathématique dans ce travail de recherche en partant de l'hypothèse que le mode d'organisation hiérarchique se déplace à travers les échelles spatiales nationales, régionales et même dans des plus petites échelles. Il sera démontré que ces structures spatiales sont déclenchées par un mécanisme d'attachement préférentiel dans lequel les lieux les plus innovants deviennent plus innovants que les lieux moins innovants, dans un processus d'enrichissement itératif. La propriété d'attachement préférentiel a été scientifiquement prouvée dans le domaine de la science des réseaux par Barabasi & Albert (1999) qui ont créé un robot dont la tâche était d'obtenir des informations sur la topologie de la toile mondiale

(WWW). Les résultats ont indiqué que le plus grand réseau créé par l'homme n'était pas connecté de manière aléatoire, puisqu'il y avait des hubs, c'est-à-dire des documents hyperconnectés via les *URL* (Uniform Resource Locator). Ce réseau présentait deux caractéristiques importantes : *i) la croissance des réseaux et ii) l'attachement préférentiel*. La première caractéristique impliquait que les réseaux évoluent dans le temps, ce qui n'était pas une caractéristique prise en compte dans le modèle d'Erdős-Rényi (1959, 1968). Deuxièmement, les nœuds ayant le plus de liens continueraient à attirer plus de liens et grandiraient en conséquence de leur taille.

L'idée conceptuelle de cette théorie a été transférée aux mécanismes de diffusion de la TER en tant que processus spatial dans cette thèse de doctorat. Tout d'abord, la diffusion de l'innovation est intégrée dans les systèmes sociaux, qui sont fortement influencés par l'organisation spatiale ; par conséquent, les aspects socio-économiques, culturels, technologiques, politiques et géographiques sont au cœur des trajectoires suivies par les structures urbaines. À cet égard, si nous visualisons l'espace comme un agent, qui n'est pas seulement un récepteur physique de ces aspects mais aussi un influenceur de l'interaction entre ces caractéristiques, nous pourrions penser que certains lieux deviennent plus aptes à capter les effets positifs de ces échanges. Dans cette optique, il est important de souligner que la diffusion implique le mouvement, la dispersion et la concurrence pour l'espace. Nous soutenons donc, que la dimension spatiale est très bien adaptée en tant que "*variable de base majeure*" pour les études sur l'innovation.

Ce terme de variable de base majeure signifie que l'espace peut être utilisé comme point de référence, en s'appuyant sur n'importe quel nombre, unité, produit, service, virus comme Corona, migration et à travers les domaines, qui peuvent être systématiquement comparés d'un point de vue spatio-temporel. L'accent est mis sur la pertinence de la dimension spatiale car son intégration dans les études sur l'innovation a été plutôt faible (Coenen et al., 2012 ; Hansen & Coenen, 2015). Néanmoins, son importance a été largement reconnue au sein de la communauté scientifique et son incorporation dans les sciences et les politiques est en augmentation. Le fondement épistémologique du paradigme de la spatialité explique très bien comment les positions relatives et les situations géographiques influencent de manière probabiliste ou partiellement l'intensité et la forme des interactions sociales, y compris les processus de diffusion de l'innovation (Pumain, 2004a). Nous proposons donc, que de tels niveaux d'interactions qui sont influencés par l'espace, peuvent être représentés dans un réseau spatial avec l'hypothèse que la topologie a des mécanismes d'attachement préférentiel spatial.

L'intégration conceptuelle de la propriété de l'attachement préférentiel avec le paradigme de la spatialité donne à la diffusion des innovations un cadre de recherche qui s'inscrit dans la lignée des travaux du géographe suédois Torsten Hägerstrand (1952, 2953). L'auteur dans une période d'un stade très précoce du développement informatique dans les années 1950's, a réalisé avec succès l'un des premiers modèles mathématiques empiriques sur la diffusion de l'innovation et a conclu que le processus de colonisation des innovations commence par des concentrations locales. Le terme de concentration est un aspect clé qui signifie intrinsèquement la proximité spatiale dans un milieu, qui a été largement rapporté dans la littérature spécialisée comme un aspect central dans les processus de diffusion (Saint-Julien, 2004 ; Kiesling, 2011).

Les études sur la proximité spatiale et la convergence scientifique vers le rôle majeur de l'espace et sa pertinence dans l'organisation sociale ne sont pas ambigus. Par exemple, la première loi de la géographie stipule que "*Tout est lié à tout le reste, mais les choses proches sont plus liées que les choses éloignées*" (Tobler, 1970). Cette théorie entre en résonance avec des approches théoriques plus anciennes telles que la théorie de l'interaction spatiale et les modèles de gravité (Reilly, 1927 ; Hotelling, 1929, Converse, 1949, Huff, 1963, 1964). Dans le même ordre d'idées, les physiciens s'intéressent à la modélisation urbaine depuis des décennies, où les modèles de type newtonien basés sur les attributs de proximité sont au cœur de leur raisonnement ; par exemple, dans la physique sociale (Stewart, 1941, 1942) et les modèles de place centrale (Allen & Sanglier, 1979, 1981). Cependant, l'éminente théorie des lieux centraux (CPT) proposée par Christaller (1933) est probablement la plus célèbre de la famille des modèles centraux.

Plus tard, l'école française de la proximité a également travaillé sur le sujet, en examinant les modèles spatiaux des systèmes d'innovation et en concevant différents types de proximité tels que les proximités géographiques, organisationnelles et institutionnelles (Carrincazeaux et al., 2008). Parallèlement à cette école, la géographie de l'innovation (GI) a émergé dans les années 1990 et s'est concentrée sur des questions similaires. Freeman (1994) a travaillé sur les aspects économiques de la GI couplés à une perspective spatiale de l'innovation et Boschma & Martin (2010) ont travaillé sur la GI selon une approche de géographie économique évolutive et sur la formation de clusters dans des contextes géographiques (voir Freeman, 1994). Les vues évolutionnistes sur le GI ont également été transférées aux études sur la résilience régionale. Elles confèrent à la résilience une nouvelle dimension connue sous le nom de résilience adaptative, qui est ancrée sur les sciences de la complexité où l'adaptabilité des systèmes joue un rôle central (Giacometti & Teräs, 2019). Un parallèle entre la résilience régionale et urbaine sera établi dans ce travail de recherche dans la section 2.2 (voir Rogov & Rozenblat, 2018 ; Voiron-Canicio & Fusco, 2020).

Cette thèse de doctorat est organisée en deux parties principales. La première partie se concentre sur le contexte théorique lié à la diffusion de l'innovation, aux systèmes urbains complexes, à la résilience urbaine et à la science des réseaux. La thèse sur ces sujets est liée à l'approche méthodologique développée dans la deuxième partie 2. Dans la deuxième partie, nous développons un modèle pratique de diffusion spatiale des TER appelé Attachement Préférentiel Spatial ou en anglais *Spatial Preferential Attachment (SPA)*, qui est appliqué dans la région suisse et au niveau national en Suisse. Les résultats suggèrent l'existence d'un comportement fractal des structures spatiales de la diffusion des TER et est présenté par le biais d'une approche réseau. Une deuxième application du modèle SPA est intégrée dans la région française où nous avons obtenu des résultats comparables à ceux atteints en Suisse. Enfin une simulation de la résilience urbaine à la diffusion des TER est déployée sur le territoire suisse. Les lignes qui suivent présentent brièvement les chapitres qui composent cette thèse de doctorat.

Le Chapitre 1 aborde le cadre des études d'innovation d'un point de vue politique et scientifique, à partir de la période qui a suivi la Seconde Guerre mondiale, en décrivant l'évolution et l'intégration progressive de la dimension spatiale dans la recherche scientifique et la politique. Nous montrerons qu'au cours de cette période la nécessité d'intégrer une vision plus holistique du lien entre l'innovation, des questions socio-économiques et du changement climatique a été progressivement reconnue. Le Chapitre 2 aborde les approches théoriques et de modélisation de la dynamique des systèmes urbains complexes et de la diffusion des innovations. Le chapitre décrit et analyse différentes théories et modèles conceptuels tels que la théorie des lieux centraux, l'interaction spatiale, les réseaux d'innovation et la dynamique de changement d'occupation des sols selon une approche markovienne. Ces théories et modèles sont discutés à la lumière d'un cadre de recherche qui intègre l'innovation, les réseaux urbains, le changement et la transition vers la durabilité.

La nécessité d'une plus grande collaboration entre les chercheurs de différents domaines scientifiques est également discutée, en particulier dans le domaine de la géographie, où des géographes économiques, physiques et quantitatifs, pourraient collaborer davantage de manière complémentaire. Le rôle des géographes de différents domaines n'est pas seulement important pour les études sur le changement climatique mais aussi pour les études sur l'innovation, où l'intégration de la dimension spatiale a historiquement été plutôt négligée. Des théories telles que le *path development* en géographie économique ont un lien fort avec le concept d'attachement préférentiel spatial présenté dans cette thèse (voir chapitre 4). Cela résonne également avec les études réalisées sur la résilience urbaine et régionale, où la première est plutôt orientée vers les études économiques et la seconde vers la durabilité (voir section 2.2).

Dans le Chapitre 2 le concept de résilience est examiné et son succès croissant dans différents domaines est discuté, ainsi que l'absence de consensus scientifique sur une définition unique. La discussion porte sur les différentes définitions et les angles de recherche des chercheurs dans différents domaines tels que la géographie, la physique, l'écologie et l'économie. Un développement intéressant dans le domaine de la géographie est l'adoption de la résilience de l'adaptabilité dans une perspective de géographie économique évolutionnaire, un

concept dérivé des sciences de la complexité. Dans le même chapitre, le concept de panarchie est présenté comme une approche conceptuelle dans le cadre de la transition vers la durabilité (voir section 2.3.4). Les principales définitions et une discussion du concept dans le contexte de la résilience régionale sont développées afin d'établir le contexte théorique du modèle construit dans le Chapitre 7.

Le Chapitre 3 introduit les régions d'étude, c'est-à-dire le canton suisse du Valais et la région SUD en France. Un aperçu des contextes des territoires y est présenté. Par exemple, la description des caractéristiques géographiques, économiques, socio-démographiques et naturelles est développée, montrant les aspects dynamiques des deux régions en termes de transition vers la durabilité. L'introduction de la justification du choix des technologies TER comme indicateur d'innovation pour ce travail de recherche est aussi développée dans le même chapitre. Ceci est fait en élargissant le champ de vision au changement climatique aux émissions anthropiques de gaz à effet de serre afin de souligner l'importance de développer des études et des modèles ayant pour finalité la transition vers la durabilité.

Le Chapitre 4 aborde les bases fondamentales des réseaux invariants d'échelle ou *scale-free* en anglais, qui présentent un attachement préférentiel, en conséquence, fractals, ce qui est la signature de l'auto-organisation. La différence avec les réseaux aléatoires est expliquée. L'objectif principal de ce chapitre est de présenter les implications de la découverte des réseaux sans échelle dans le cadre de la complexité. Le changement du paradigme des réseaux aléatoires qui régnait depuis la fin des années 1950 vers le concept d'attachement préférentiel qui est survenu à la fin des années 1990 (Barabasi & Albert, 1999). L'impact de cette théorie relativement nouvelle, a contribué à réduire l'écart entre les études de la diffusion de l'innovation et la science des réseaux, et ainsi permis à la théorie des graphes de prendre de plus en plus d'importance dans les études sur l'innovation. Ce chapitre donne, en outre, une explication de la base mathématique de la modélisation des réseaux sans échelle, et un point de vue théorique sur les processus de transition de phase est développé, en intégrant les points de vue émanant de différents domaines.

Le Chapitre 5 porte sur le système général de simulation et le développement du modèle de diffusion des TER dans le canton du Valais. Dans cette section, les aspects méthodologiques du modèle sont introduits, ainsi que la justification de chaque choix qui procède d'une démarche interdisciplinaire. Fondamentalement, les effets spatiaux et temporels sur la diffusion des TER sont à la base du travail de recherche, dans lequel d'autres éléments sont systématiquement ajoutés en fonction de leur pertinence aux niveaux social et physique. Le chapitre présente tout d'abord le développement d'une approche markovienne pour modéliser les processus de changement d'utilisation des sols dans le canton du Valais puis, est suivi par la construction d'un modèle gravitaire (voir section 5.3). Celui-ci était censé être le substrat sur lequel calculer les champs d'innovation potentiels (PIF) dans la région, comme développés dans les sections 5.4.1 and 5.4.4 . Cependant les résultats ont montré que les dynamiques d'occupation des sols n'enrichissent pas le modèle final. Ainsi, différentes approches méthodologiques telles que la modélisation basée sur un système multi-agents (SMA) et sur la dynamique des systèmes (SD) sont utilisées pour construire un modèle gravitaire. Et pour l'étape, qui suit, l'intégration du modèle de réseau spatial est développée.

Les indicateurs d'innovation étudiés dans le canton suisse du Valais sont les panneaux photovoltaïques destinés au chauffage et la production d'eau chaude, ainsi que les véhicules électriques et hybrides au niveau national en Suisse. L'analyse est développée selon une approche spatiale multi-échelle, qui rend compte de l'observation de l'émergence de phénomènes complexes à différentes échelles. Les résultats suggèrent un attachement préférentiel dans la diffusion spatiale des TER, ce qui, d'un point stratégique et politique, est un aspect majeur dans le cadre du changement climatique et des objectifs de durabilité.

Le Chapitre 6 présente le développement du modèle SPA sur la Région SUD-Provence-Alpes-Côte d'Azur, où les indicateurs d'innovation sont : la production d'énergie renouvelable via des capteurs solaires photovoltaïques, des capteurs solaires thermiques, de grandes et petites centrales hydroélectriques, l'énergie éolienne, la biomasse et

le biogaz. Ainsi, en incluant les TER étudiées dans la région suisse, neuf indicateurs d'innovation sont étudiés au total dans cette thèse de doctorat. Les principales différences entre le travail de recherche dans les deux régions sont les suivantes : i) *Le travail de recherche sur la Région SUD-Provence-Alpes-Côte d'Azur est effectué du point de vue de l'offre, l'analyse se concentre donc sur la production des énergies renouvelables ; ii) Par conséquent, un modèle gravitaire n'est pas utilisé dans le développement du travail de recherche ; et iii) L'étude se fait uniquement au niveau régional, et non au niveau national comme cela a été fait avec les véhicules électriques et hybrides en Suisse.*

Le chapitre 7 traite de l'intégration des sciences des réseaux comme un instrument conceptuel de la résilience urbaine à la diffusion de l'innovation, en se concentrant dans ce cas sur les TER. Après l'introduction du concept de résilience dans le Chapitre 2, un modèle pratique est proposé et développé dans la région suisse du Valais. La manière de simuler la résilience urbaine à la diffusion de l'innovation, dans ce contexte de transition vers la durabilité, repose sur la capacité du territoire à faire face au changement et à se réorganiser après un choc. Les données et le modèle sont exactement les mêmes que ceux utilisés dans le Chapitre 5, la différence étant que les réseaux sont "attaqués", puisqu'une série de nœuds majeurs ou hubs du réseau sont supprimés. La suppression des hubs vise à simuler l'arrivée d'un choc, qui met en péril le processus de diffusion de la RET, provoquant des changements subits. Les résultats montrent un double comportement intéressant au niveau local versus niveau global, dû à l'émergence d'un effet de dimension fractale dépendant de l'échelle.

Part 1 An Overview on Innovation Studies and Urban Innovation Networks

The first part of this Ph.D dissertation introduces the evolution of innovation studies from the post WW II. The gradual changes on the direction and focus of innovation studies and policies are described and analysed with the aim at establishing a framework for innovation diffusion within the sustainability context in a later stage. The first lines have a content that is mainly based on innovation studies from an economic point of view and an incremental inclusion of the spatial component is integrated as it becomes more relevant in the discussions' timeline. In fact, although major developments within the field of innovation diffusion were proposed by geographers, such as the contributions of Torsten Hägerstrand (1952), the incorporation of the spatial dimension has historically remained alienated in innovation policies. The reading is developed thus, considering historical developments in fields such as innovation, where three framings of innovation policy are discussed, relying on the work of Schot & Steinmuller (2018). Furthermore, a Schumpeterian evolutionary perspective is approached, which is at odds with the equilibrium theory (Schumpeter, 1943; Kiesling et al., 2012). An important emphasis is also given to urban modelling and the complexity embedded in such spatial structures (Pumain et al., 2006). These theoretical concepts are later approached with the resilience concept that has lately been adopted by economic geographers in regional resilience studies and quantitative geographers in urban studies. Finally, a technical discussion of scale-free networks and the preferential attachment property is introduced with the aim to establish a theoretical background for the models developed in the Part 2.

Partie 1 (Français) Un aperçu sur les études sur l'innovation et les réseaux d'innovation urbaine.

La première partie de cette thèse de doctorat présente l'évolution des études sur l'innovation depuis l'après-guerre. Les changements progressifs de la direction et de l'orientation des études et des politiques d'innovation sont tout d'abord décrits et analysés dans le but d'établir un cadre pour la diffusion de l'innovation, puis, dans un deuxième temps, dans le contexte de la durabilité. Les premières lignes portent principalement sur des études d'innovation traitées d'un point de vue économique, l'espace est intégré au fur et à mesure que son inclusion devient plus pertinente dans la chronologie des discussions. En effet, bien que des développements majeurs dans le domaine de la diffusion de l'innovation aient été proposés par des géographes, comme les contributions majeures de Torsten Hägerstrand (1952), l'incorporation de l'espace est historiquement restée étrangère aux politiques d'innovation. La lecture est ainsi conduite, en considérant les développements historiques dans des domaines tels que l'innovation, où trois cadrages de la politique d'innovation sont discutés, en s'appuyant sur les travaux de Schot & Steinmuller (2018). Par ailleurs, une perspective évolutionniste schumpétérienne est abordée, qui s'oppose à la théorie de l'équilibre (Schumpeter, 1943 ; Kiesling et al., 2012). L'accent est également mis sur la modélisation urbaine et la complexité inhérente à ces structures spatiales (Pumain et al., 2006). Ces concepts théoriques sont ensuite abordés avec le concept de résilience qui a été récemment adopté par les géographes économiques dans les études de résilience régionale et par les géographes quantitatifs dans les études urbaines. Enfin, une discussion technique sur les réseaux sans échelle et la propriété d'attachement préférentiel est introduite dans le but d'établir un contexte théorique pour les modèles développés dans la partie 2.

1 An Overview on Innovation: A Path Towards Environmental and Societal Challenges.

« [...] Pour moi la copie c'est le succès,
il n'y a pas de succès sans copie[...] »

“[...] Being copied is the ransom of success,
there is no success without copy [...]”
Coco Chanel.

In this chapter, we will discuss about the origins and evolution of innovation studies and innovation policy frameworks, which have shaped the essence of the innovation concept *per se*, from a scientific point of view and also in practice. Innovation might arguably be as old as humankind itself and even though different disciplines have focused on innovation studies, according to some scholars, innovation has not received the attention it deserves (Fagerberg & Mowery, 2009). Fagerberg and Mowery argue that long-run economic change studies used to be focused mainly on aspects such as capital accumulation or working of markets but not really on innovation. Nevertheless, they concede that this has been changing the recent years and a special focus on socio-economic issues and environmental change is taking place.

In the specialized literature the *innovation studies* term we know today has had different labels depending on the field and it has also changed over the time. For instance, in the 1960's *innovation studies* was commonly known as *science policy* or *research policy* and subsequently, in the 1970's and 1980's different compositions emerged with the words science, technology and innovation, or engineering and R&D (Martin, 2012a). During the 1990's researchers started to converge to the term 'innovation studies' as the term 'policy' for example was limiting and biasing the real meaning of the concept (Martin, 2012a). Scholars have acknowledged the difficulty in defining *innovation studies*, prompting an important detailed study on the core of literature and contributions that was developed by Fagerberg et al., (2012). They evidently found a high diversity of central contributions, some of them were theoretical, in which Schumpeter occupies a prominent position due to the relevance of his early work on innovation (Schumpeter, 1934) that is still conceptually at the centre of innovation studies today (Fagerberg, 2003; Fagerberg et al., 2004).

Innovation has historically been from its origins a topic for economists. However, different fields of sciences have embraced innovation and the concept has evolved as a result of interdisciplinary research work and applications. Innovation has also been an important discipline in the field of geography, in the recent scientific literature we find emergent fields as a result of integrative conceptual approaches proposed by geographers. It is important to acknowledge that the spatial dimension has systematically been neglected in innovation studies and policies, therefore the first chapter of this study will discuss about innovation with a rather economic standpoint. However, the inclusion of geographic aspects will be also discussed accordingly with the evolution of the innovation-geography over time. Furthermore, in this dissertation we argue that the current framework of innovation policy can greatly benefit from the implementation of explicit geographical approaches in order to meet current societal challenges such as climate change and social-economic inequalities.

During the different innovation policy frameworks, the space dimension has played a very basic role at most, while economic growth has had a central position since the post-World-War II. From a geographical perspective, economic growth has been uneven and the consequences of a pervasive spatial biased growth under these conditions, has become a real issue for societies and for innovation policy makers. We argue that the space dimension cannot continue to be ignored in innovation framings, since the field of geography, which is the *science of where*, is endowed with the ability to tell us where dynamic behaviours of innovation, economic growth and sustainability transition are taking place.

The evolutionary theory of Schumpeter (1939, 1951) has had a revival in economic geography (Boschma, 2004; Boschma and Frenken, 2006; Boschma & Martin, 2010; Lundquist et al., 2017). This approach has been an important cornerstone of innovation studies through the so-called neo-Schumpeterian focus where a lot of research on structural change and growth has been developed the last decades (see Saviotti, 2001; Fagerberg, 2003; Nelson & Winter, 2004). The role of the spatial component seems to become indisputable, the current spatial organization of firms and production of good and services has gotten a real toll with the Coronavirus outbreak in 2020. Supply chain and transportation has become an even more critical factor for companies and states in the first semester of 2020. The vertical integration of supply chain with several intermediaries in the production, assemblage, distribution and commercialization processes of goods have shown low resilient levels across the globe. Indeed, space seems to become an increasing factor of importance in innovation: sustainability transition, inequality and health issues are constraining scientist and decision-makers to think of space as an explicit component of innovation and not only as a distance metric. The importance of this assumption will be developed in this Ph.D dissertation on innovation and resilience with a strong spatial component.

It has historically been observed that creativity and innovation processes are not lineal, meaning that there are periods where some disruptive innovations emerge and diffuse conquering regional and national systems. Some of the most radical innovations which are also referred as the introduction of new general-purpose technology (Lundquist et al. 2017) are cyclical and are accompanied by economic growth and job market changes which generate dynamic trajectories in urban systems. These economic activity changes are known in economics as a creative destruction phenomenon, term coined by Schumpeter (1943). From an economic point of view, the theory of innovation diffusion has its foundations on the Schumpeterian evolutionary perspective (Kiesling et al., 2012) which is fundamentally at odds with the equilibrium theory, given the discontinuous character of its process (Schumpeter, 1928).

Like innovation cycles, we also observe changes in economic activities depicting pikes and valleys over the course of time, as a consequence of some periods of intense creativity. These long cycles of economic growth have origins from major technological shifts, which are also called revolutions in the economics and historical literature (Schumpeter, 1939; Freeman, 1982; & Perez 1983; Berry, 1991). We can highlight in the last three centuries five major creativity periods where general purpose technology breakthroughs are closely linked to long waves of economic growth, urbanization and diversification of urban activities. The first ones are maritime trading worldwide and the banking sector in the 17th and 18th century respectively, introduction of steam machines and railways in the 19th century, the electricity and automobile in the 20th century.

In the 1970's it was witnessed the impact of microprocessors in the computing industry which propelled the Nanotechnology, Biotechnology, Information technology and Cognitive science (NBIC) technology convergence (Pumain et., al, 2006). The recent technological developments and the emergence of Industry 4.0 (Lasi et al., 2014) that was coined in Germany in 2011 due to a high-tech strategy of the government represents the current paradigm that promotes the usage of IoT and artificial intelligence together (Tjahjono et al., 2017).

These *long waves* of economic growth were first empirically noticed by Kondratiev (1925) in the Soviet Union in the 1920's and they are also referred to as *Kondratiev waves* after Russian scholar Nikolai Kondratiev. Since then,

this topic brought the attention of scientists and important research has been done focusing on different aspects of the *long waves* phenomenon. Researchers investigated the underlying patterns primarily to identify long waves (Haustein and Neuwirth 1982; Metz 1992) and other scholars worked on the economic factors triggering them (Mandel 1975; Marchetti; 1980 Gordon, 1980; Forrester, 1981; Sterman, 1985). Triggering factors have exposed to be as a structural mixture of economic layers with cyclical upswings and downswings, where capital appears to be at the centre in different flavours such as institutional capital, knowledge capital, fixed capital, among others.

Nonetheless, all these advances did not reveal the key factor at the centre of these economic revolutions, which would be later proposed by Schumpeter (1939, 1942). The roots at the origin of the *Kondratiev waves* were the introduction of radical technological breakthroughs. Schumpeter (1939) recognized that historians of '*crisis*' would emphasize on the superficial layers of the phenomenon such as employment, stock market events, price levels, production among other aspects. Instead, Schumpeter focused on the underlying mechanisms of those observed superficial layers which hide the real source and were the real propellers of *long waves*.

Schumpeter argued that radical technological innovations would incentivize investment, bringing economic growth and such economic context would consequently engender a blossoming market with an interesting potential for new competitors acting as imitators. The arrival of new competitors or imitators will in the first place generate a price correction mechanism and will also boost the continuous improvement of technologies in an incremental fashion. This incremental improvement of general purpose of technologies will leave behind obsolete technologies, which will be replaced by new ones, in a process mentioned above called creative destruction. During this period, such a competition creates a *long wave* of economic growth (Verspagen, 2004) possibly in an exponential way until the system's absorption is limited by an increasing function of a loss coefficient represented by the exhaustion of technological development, which will eventually flatten the curve. All these events have also repercussions on urban systems and are able to change deeply the trajectory of territories in different perspectives.

The pikes of these *long waves* propelled by innovation breakthroughs do not come alone and generate fundamental changes in regional and national systems. Regional studies show that in countries and regions, which are in a constant competition *per se*, some places are better prepared to incorporate these new technology waves accompanied by underlying social, economic and technological effects. During this process, some regions are able to absorb these innovations and adapt their urban structures to new technologies and other are unfortunately left behind in less advantageous positions (Lundquist & Olander 2001). Furthermore, structural shift's spill-overs might intensely change social, economic and urban paradigms at different levels. A similar behaviour was observed at firms' level by Cohen & Levinthal (1989) who claimed about the importance of absorptive capabilities.

According to the hierarchical behaviour of innovation diffusion in urban systems, the first-tier region of a national system perceives the growth first and is later followed by the regions in the lower hierarchical national system. At socio-economic level for example, if we look at the effects that the introduction and acceptance of radical innovations generate, we can recognize that high-tech companies are able to offer better paid jobs than other industries. These better-paid jobs are frequently suited for a highly educated population (Lee & Clarke, 2019) which are often located in metropolitan areas. Hence, populations in peripheral areas where job market structures are different, sparser, rather smaller and less sophisticated, is fed by a less qualified population, which are likelier to earn lower salaries (OECD 2016; EC 2017; Iammarino et al., 2017).

On another note, economic geographers have recently highlighted that it appears that there is a link between innovation and inequality, suggesting that innovation might create disparities in regions in Europe and in the United States (Lee, 2011; Lee & Rodriguez-Pose, 2012; Rodriguez, 2017). Therefore, this prompts policy makers for the necessity of looking at innovation in a more holistic way, which is the innovation policy focus today where societal and environmental challenges have a special emphasis (Grillitschet al., 2019). Innovation do not occur everywhere, therefore the spatial component should be taken more into account, as it is already the case with

systematic usage of time metrics. Swedish geographer Torsten Hägerstrand's views on time-space integration was very clear "*The division between a distinct time perspective and a distinct spatial perspective is something given by tradition, and something which I perceive as a weakness*" (Hägerstrand, 1991, p. 134; present author's translation). We would argue that this view on space and time perspective should also apply to innovation policy frameworks in a much more integrative way than it is practiced today.

It has been widely acknowledged in the scientific literature and by governments that innovation plays a key role in regions development and in their competitiveness. For instance, in Europe, there is an important emphasis on R&D investments by governments in order to boost technological firms, research institutions and infrastructure. This strong interest in the application of policies that support businesses with a high R&D intensity, ranks innovation as a priority for policy purposes (Tödtling and Trippl, 2005). One can argue that the word innovation is a concept with many faces or at least is a term used for a wide variety of purposes from a governmental standpoint. Governmental institutions through their policies have an important role of the focus of innovation and the meaning behind the concept via policies and subsequently its usage.

In the following section, we will discuss about innovation policy and how it has contributed to shape not only the conceptual and broad meaning of what innovation is and what is not, but also the implications in terms of national and intra-national financial funding allocation and innovation support and subsequently the instruments of survival for some industries and businesses. This section has been done with descriptive and analytical purposes about the different innovation policies framings from the post-World War II (WWII) until today. The historical evolution of policies in the field of innovation has had a major impact on societies, for example in the case of advanced economies, there has been continuing re-structuring and alignment processes of different political agendas under the umbrella of innovation. The relevance of this, it is that these decisions affect markets and how people live, how they commute and for how long, where they work or if they can find a job at all.

Innovation policies have the power to create growth but also disparities in different perspectives, since not all regions are *innovative* or their economies are not able to adjust the complex dynamics generated by innovations in their territory, establishing spatial distributions with heterogeneous innovation capacities and levels. The regional receiver and development capacity enable regions to develop industries and growth, establishing inert cycles of the rich get richer enhancing thus the likelihood of getting public funds for innovation and R&D purposes in the most promising areas. Maskell (2001) would put it in similar words as follows: "*The economic future of the Regions is conditioned by their capacity to create knowledge, to access knowledge, to use knowledge.*"

Economic geographers have been working with the concept of path dependency, also referred to as structural pre-conditions, which means that the historical inertia enable regions to have a higher performance when its past is suited to do so (David, 1975; Grabher, 1993; Martin & Sunley, 2006; Boschma & Frenken, 2006; Grillitsch & Trippl, 2016; Grillitsch et al., 2018). This characteristic is one amongst different evolutionary economics and economic geography theoretical approaches that are currently mainstream and of high importance for policy makers, although not uncontested. There is evidence that some proportions of regional growth cannot be explain only by the place-specific legacy or the structural path dependency theories (see Rodriguez-Pose, 2013). Researchers are currently working on this issue. Grillitsch & Sotarauta (2018) proposed a holistic view on the problem by integrating path dependency and structural forces combined with the role of agency and the future opportunities embedded in it. A recent literature review of the research body of this concept has been done by MacKinnon et al., (2019)

This process of rich get richer from a regional perspective implies that disparities emerge, so some places are likelier to attract more work activities and firms than others, creating thus socio-economic imbalances. For a very long time, governments have had growth as the cornerstone of innovation policies which is finally responsible at least in part, on the cumulative ability to provide better quality of life to citizens. However, growth cannot be perennial

and at all costs, that said by Forrester already in 1971 after his world simulation model, in which he clearly stated that we needed to voluntarily limit the industrialization and population growth rates otherwise the social and environmental internal processes of complex systems will choose for us and option this might be painful.

The relation between innovation and growth is also directly related to job creation. The capacity of creating jobs is one of the most important items in political campaigns and an important part of the assessment of elected politicians' performance in a mandate. From a political perspective, it would be fair to say that some of the key performance indicators (KPI) for elected servants at the regional and national level are their capacity to create jobs and growth. A possible failure on these issues have direct consequences in the ballot-box por elected servants. In this regard, innovation policy plays an important role, as massive investments for technological and R&D developments seem to systematically benefit metropolitan areas, creating geographical disparities that have largely contributed to the emergence of a social and economic polarization wave in the recent years. These societal challenges will be discussed in the innovation policy framework section, where the environment is also currently at the core of the academic and political debate. The following discussion is declined in periods where three major frameworks of innovation policy shifts occurred. This subdivision is based on Schot and Steinmuller's (2018) work who recognized these different innovation policy changes and group them following a timeline. This approach has been chosen with the aim of integrating the main focus of innovation policy frameworks in a chronological manner, easing the readiness of the evolution of the field contrasted with the underlying implications for R&D, governments, citizens, the environment and the economy over time.

The first framing emphasized on growth after the WWII until the 1980's where an institutionalization process of government support for sciences and R&D was boosted in order to accelerate the economic recovery process, within a period known in France as the *Trente Glorieuses* (The Glorious Thirty). The second innovation policy frame starts in the 1980's, which was the national systems of innovations where competitiveness was at the centre and globalisation was born. The third and current innovation policy framing is transformative change where transformative refers to the implementation of innovation to meet societal challenges and sustainability transition that were previously neglected.

1.1 First Period of Innovation Policy Framework – Post WW II to 1980's: Innovation for Growth

During the first innovation policy framing starting in the post-WWII period (Schot & Steinmuller, 2018), the particular emphasis on growth was fuelled with a mass consumption strategy. Economics Nobel Prize laureate Simon Kuznets recognized six characteristics related to the modern economic growth in that period in developed and non-communist economies (Kuznets, 1973) giving a special role to the first two characteristics which will be briefly declined:

- **Science-based industry development.**
- **Increase on factor productivity levels.**
- Structural change typified on the transition from agriculture to industry and ultimately to services.
- Increase on urbanization and secularization processes.
- Technological improvements in transportation and communications (civil and war).
- Pervasive delay of three quarters of the population in terms of economic growth.

Sciences-based industry developments and an incremental productivity in economic growth rates in the 1950's and 1960's showed the highest improvements in recent history (at the time of Kuznets' publication) and if we

extend this affirmation until nowadays this claim would still be true. By a way of comparison, the productivity for Western Europe over the period of the beginning of the middle age until the mid-nineteenth century, estimations suggest that the growth rate was increased ten times for product per capita (see also Kuznets 1971). Kuznets (1973) argued that the economic growth in the last century (at that time of his publication) the rates of growth per year were 2 % for product per capita, 1 % for population and 3 % for total product. This growth emphasis had a response from economic historians, which advocated for industrialization basing their claims on the prominent position in research and sciences of the main actors in the WWII: United States, Germany, France, United Kingdom, Japan and Russia (Kuznets, 1966).

The steady introduction and diffusion of technologies in the post-WWII opened up the market stage to higher competition and for more market players as well as to economy of scales in different industries. These facts have contributed to technologies cost decline in different technologies over time. Technological development is an important indicator for economic growth and since technological development relies on innovation, we will briefly refer to a time-series and the costs and prices over time.

The Figure 1A shows a comparison of prices of photovoltaic (PV) modules, nuclear electricity and coal prices based on a long-term historical data base in the US. The authors showed that in the last 150 years the inflation-adjusted price of coal fluctuated by at least of a factor of three but it is not possible to observe a long term. The prices for PV modules are in US dollars per watt-peak, this means the associated cost for the capacity to produce a watt of electricity in full sunlight. The prices for nuclear power and coal are calculated in US dollars per kilowatt hour. An important finding in this study is that it seems that coal prices follow a random walk.

Electricity generated with nuclear power has witnessed an increased by a factor of two or three, while a watt of solar PV capacity cost has decreased by a factor of 2330. A steady decremental trend in the PV modules costs is occurring since 1980, an average decrease in cost of around 10%. In the Figure 1B we can observe the evolution of solar PV modules cost and prices of the physical components of modules such as crystalline silicon, monocrystalline silicon and multicrystalline silicon. A clear reduction in these components is observed in both, costs, and prices, for more details on the methodology see Kavlak et al., (2018).

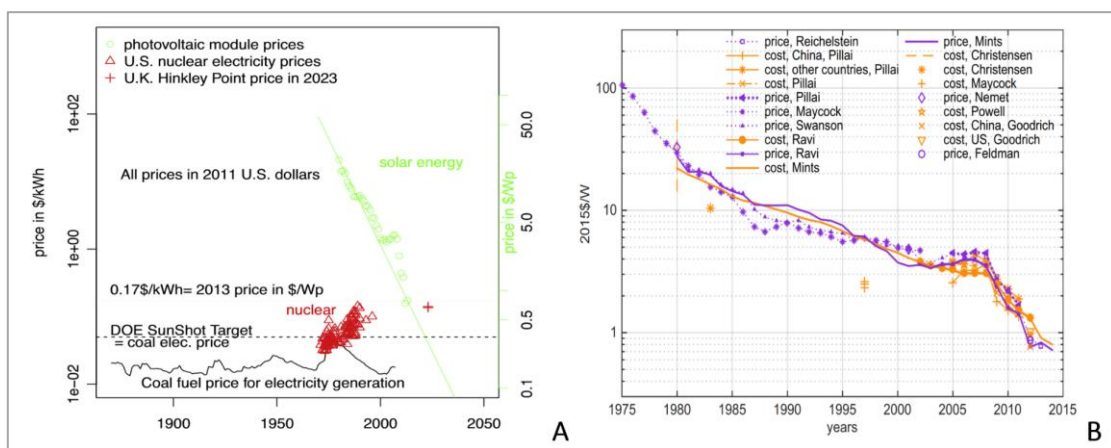

Figure 1A comparison of long-term price trends for coal, nuclear power and solar photovoltaic modules in the US, source: Farmer & Lafond, 2016. Figure 1B. Module costs and prices since 1975. Costs are shown in orange, and prices are shown in purple, source Kavlak et al., (2018).

Photovoltaics cost has dropped approximately of 97 % between 1980 and 2012, the factors explaining the solar plummeting costs have been studied by Kavlak et al., (2018). The second aspect that Kuznets highlighted was the **increase on factor productivity levels**. The productivity levels were dramatically increased in a continuous pace in advance economies independently of the heterogenous organizational characteristics of the institutions and

culture across the developed world. Productivity is a major feature of innovation, Schumpeter (1939) proposed a rigorous definition of innovation. His definition partly relied on a variation of the production function, which is an economic concept that links different kinds of factors such as labour, services of natural agents and so-called intermediate products like equipment and raw material to the production levels by each of the infinite number of ways of configurations that these factors can be set up to do a productive task within a technological environment (Schumpeter, 1939). Schumpeter view on productivity has been taken into account in economic geographical approaches, for example Aydalot (1985) dealt with the question of choosing the right location for businesses relating production functions and the innovative milieu.

The limitations with this definition are that this function gives information about the relationship between the variation of factors against products' variation. In order to have an innovation it is necessary not only to vary the factors' quantities but the form of the function that is, a new production function (Schumpeter, 1939). Otherwise, a mere variation of the factors' quantity would not cover the production of a new commodity or new organizational changes (Schumpeter, 1939).

This view is in line with the classical definitions of growth from the time of David Ricardo (1891) to Robert Solow (1956). Since the first innovation framing was based in economic growth, we find relevant to show the evolution of productivity which is intrinsically related to the capacity to produce more with less and allowed advanced economies' growth levels to increase. Figure 2 illustrates the evolution of labour productivity per hour in selected economies.

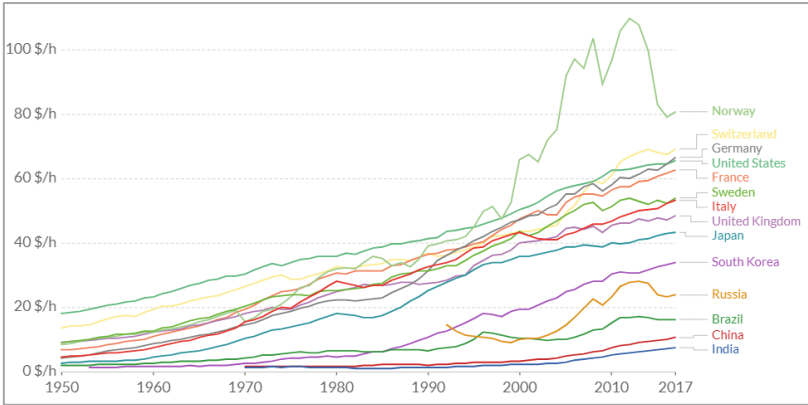

Figure 2. Productivity^a per hour worked, 1950 to 2017, source: Feenstra et al., (2015)

^a Labour productivity per hour is measured as gross domestic product (GDP) per hour of work. GDP is adjusted for price differences between countries (Purchasing Parity Power adjustment) and for price changes over time (inflation)

A geographical visualization of a yearly improvement of productivity in the world was proposed by Feenstra et al., (2015). Here we will depict the data every 15 years since 1950 until 2017. The figures below show labour productivity per hour worked in the world and in Europe respectively. Labour productivity per hour is measured as gross domestic product (GDP) per hour of work. GDP is adjusted for price differences between countries purchasing parity power (PPP) adjustment and for price changes over time (inflation).

In 1950, the United States had the highest productivity per hour, 18.14 US\$ dollar in average (Figure 3 and Figure 4). In Europe it was Switzerland leading with 13.76 US\$ dollars in average followed by Sweden with 9,31 US\$ dollars in average. The productivity in France was 6.8 US\$ dollars, in the United Kingdom 9,24 US\$ dollars, Italy had a 4.50 US\$ labour productivity per hour and Germany 4.27 US\$ dollars. In Asia, another country involved in the war, Japan had a 2.64 US\$ dollars labour productivity.

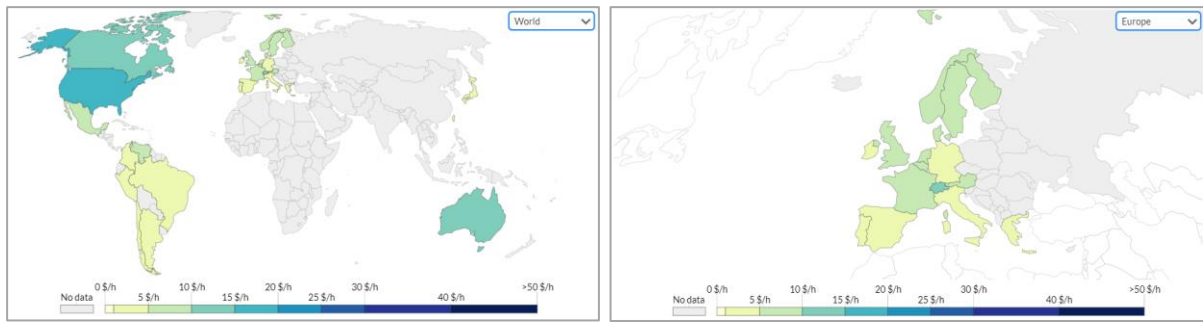

Figure 3 Productivity per hour worked in the world in 1950. Figure 4 Productivity per hour worked in Europe in 1950

In the 1980's (Figure 5 and Figure 6) during the early period of diffusion process of microprocessors we witnessed an impressive amelioration of productivity rates. In the case of the United States which was at the top worldwide, had a 36.03 US\$ dollars labour productivity per hour, that is roughly a 30 % increase. In Europe, France with 30.63 US\$ dollars and the United Kingdom 24.95 US\$ dollars had largely improved. Switzerland was still the leader with 32.67 US\$ dollars closely followed by Norway with 32.19 US\$ dollars.

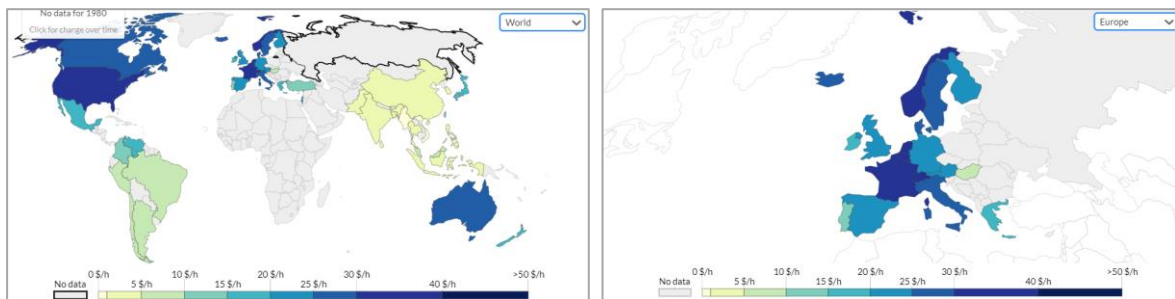

Figure 5 Productivity per hour worked in the world in 1980. Figure 6 Productivity per hour worked in Europe in 1980

The focus of the first framing of innovation policy on economic growth that ended in the 1980's was very successful as the productivity levels and economic growth show it. The third characteristic that Kuznets mentioned was a structural change typified on the transition from agriculture to industry and ultimately to services. Then he highlighted the fourth aspect which was the increase of urbanization and secularization processes, accompanied by the fifth characteristic related to the important technological improvements in military and non-military transportation and communications which facilitated rich economies to embrace the beginnings of globalization. The last characteristic emphasized by the author was the pervasive delay of three quarters of the population in terms of economic growth given the technological possibilities.

During this first framing, innovation policy practices had an important focus on research however, policy makers still needed to negotiate funds allocation for R&D purposes. Investment on science and policy intervention became evident since general purpose of technology impacts have shown a serious boost for economies in the past, which led economists to inquire on theoretical approaches about the role and the suitability of incentives of market actors to generate the wished advanced scientific knowledge level. Economists Arrow (1962a) and Nelson (1959) addressed this question and coincided that firms who invest on R&D would appropriate the knowledge preventing the competition to benefit from it. The latter theoretical reasoning combined with previous empirical insights derived from technology structural shifts were instrumental for the rationale for public funding. This approach was basically designed for fundamental research adopting thus, a position where innovation was seen only from a discovery or invention point of view.

In this regard, discovery and invention were perceived as public goods, therefore the malfunctioning of it was rather acceptable since public goods might suffer from "market failure". Worded otherwise, a public good as roads or schools could be in bad conditions because of *market failure* reasons, so R&D which would belong to the same

category, could also fall into the same failure process. The argument that science is a public good and also Nelson and Arrow's assumptions about R&D investment by firms were questioned later (see Collins, 1974; Callon, 1994; Rosenberg 1990).

Since this first framing was intended for R&D, the *market failure* concept was not used to the subsequent phases of the introduction of a general-purpose technology such as applied research and commercialization and the chain link model of innovation that would arrive years later (Kline and Rosenberg, 1986). The reason for this, was basically that at later stages of the process, firms were able to protect their inventions through industrial property, industrial secrecy or simply by the first-mover advantage. This period of innovation policy could greatly benefit from the previous work of innovation of brilliant minds in the field such as Schumpeter, which was one of the most influential theorists in social sciences in the last century. His early work focused mainly on individual entrepreneurs the so-called approach "Schumpeter Mark I" and later his research also focused on large firms, sometimes referred to as "Schumpeter Mark II". His most prominent works related to innovation are the *Theory of Economic Development* published in 1911 in German while he was still in Vienna and was translated to English in 1934. *Business Cycles* (1939), *Capitalism, Socialism and Democracy* (1943) and *History of Economic Analysis* (1954) a posthumously publication, are also some of the most well-known works he developed (Fagerberg & Mowery, 2009). Schumpeter popularized the term creative destruction, which implies that the incremental advances of technology, supply, resources, and the changing configuration between them will create cycles where new activities will replace the old ones. As it was mentioned above, this phenomenon creates cycles of change in urban and economic activities as well as economic growth.

Schumpeter's impact on innovation continued influencing schools of thought for example, Christopher Freeman who was a British economist and a major contributor in the field of innovation, was also a key figure in the revival of Schumpeter's approaches. He established the journal *Research Policy* in 1972, which is a major academic journal in the field of innovation studies. Two years later he published a seminal book *The Economics of Industrial Innovation*, (1974) and soon he became one of the major figures in the field of innovation, as it is shown in a recent bibliometric review on the most influential scholars in the field (Cancino et al., 2017). The study puts Freeman into this selected group covering a period from 1979 until 2006. Amongst the most relevant work, Cancino et al., (2017) cited Freeman (1974) along with Schumpeter (1934, 1942) and Arrow (1962b) which are scientific publications that have largely contributed to extend the barriers of knowledge in the field. Other important research works during this period were done by Schmookler (1966), Rosenberg (1976), Nelson and Winter (1977) and during an overlapping period between the first and second framing period of innovation policy Freeman et al., (1982).

Scholars noticed remarkable persuasive imbalances between developed and developing economies. The nature of large technology-based firms (NTBFs) in Europe and in the USA allowed them to create jobs and outputs at big and fast levels. In the meantime, developing economies did not have the economic possibilities to follow this pace, suffering as a consequence of disadvantages at technological, social, economic and sovereignty levels (Sagasti, 1980; Stewart, 2008). This context led developing countries to adopt other strategies, creating more liberal economies, for example giving imports a special place in Latin America and in Asia reinforcing in this way the persuasive disadvantages between the two worlds, the great exception it was the tigers of East-Asia.

These imbalanced contexts pushed towards the second framing in the 1980's which intended to address these disparities. The concept of innovation as a public good, was in principle designed to allow a transfer of technology to every country, where less developed countries could have access at a later stage. Nevertheless, this technology transfer did not happen at the speed that was thought, generating bigger gaps between developed and developing countries. This problem highlighted the difficulties of innovation diffusion as a spatial process, in the sense that geographically speaking it was difficult to diffuse technology since education, cultural and path-development issues would prevent it. Years later, the capacity of regions and firms' absorption of innovation that was mentioned before, took a central place in the second framing of innovation.

The oil crisis in the end of the 1970's and the economic crisis of 1981 in the United States would intensify the competition amongst countries and would lead to a focus of innovation on national systems. In parallel, during the first innovation framing there was introduced a new branch in the field of innovation studies, scholars started to pay attention to *innovation diffusion processes*. The integration of the space as an active agent in the field of innovation was implemented by geographers in a rather slow pace when compared to other fields. In geography studies, economic geographers have dealt with the spatial aspects of innovation and diffusion of innovations however, the integration of space might differ in intensity and in meaning itself, depending on the geography school of thought.

In spite of a relative limited amount of works on innovation diffusion by geographers, during the post-WWII we find the seminal work of Swedish geographer and Vautrin Lud Prize recipient Torsten Hägerstrand (1952, 1953) who based his work basically on Swedish geography research works done in the first half of the XX century. Hägerstrand stands up as a major early contributor, specifically in the field of spatial diffusion of innovations (SDI) and time geography, here we will focus in the former. Two major publications, '*The propagation of innovation waves*' in 1952, and his doctoral dissertation *Innovations 'Förloppet ur korologisk synpunkt'* which literally means '*The course of innovation from a chorological point of view*' and translated to English by American geographer Allan Pred as *Innovation Diffusion as a Spatial Process* (1953).

Hägerstrand identified recurrent characteristics in the process of SDI and one of the major characteristics in his model is that the SDI starts from major agglomerations and decays with distance increase. The notion of geographic proximity is an aspect that geographers have dealt since a long time ago. This concept had already been studied, not only for innovation diffusion purposes but from a solely spatial diffusion and economic perspective. One of the earliest models that might have not been directly related to innovation studies but served as a basis for later contributions in economic geography and spatial planning was the model of von Thünen (1826). Thünen proposed a model that minimizes the economic function by the production and transportation of food supplies to the market.

The name of Thünen's planning theory is the Bid Rent Theory (BRT) which was reformulated by Haig (1927) and was central for Christaller's neoclassical approach (1933, 1966) named the Central Place Theory (CPT) which has been attributed to the integrated work of Christaller and Lösch (1943, 1954). These patterns link different topics in the field of geography such as spatial interaction, gravity models, spatial diffusion, CPT and central place systems proposed by Allen & Sanglier (1981). Nevertheless, the role of the space dimension is not really considered in the first innovation framing. A detailed discussion on these theoretical approaches is carried out in Chapter 2. Few years later, Bass (1969) developed his well know diffusion model and Rogers (1962) set solid theoretical bases for innovation diffusion processes which have a large variety of applications of contemporary usage (Rogers, 2003). Work on diffusion of innovations was already undertaken in the beginning of the XX century (Tarde, 1903; Wissler, 1915; Svensson, 1935, 1942).

In summary, this first innovation policy framing during the post-WWII was not explicit and structured in such a way that the role of the state was clear (Schot and Steinmuller, 2018). Uniformity growth rates were observed during this period in countries that underwent economic development even with different inner cultural and institutional characteristics such as Japan, United States, United Kingdom and Russia (Kuznets, 1966). The lack of the first framing in terms of technology transfer from developed towards developing economies did not occur as expected, reinforcing the economic, technological and sovereignty divergence between the two worlds. In parallel, seminal work from geographers and economists propelled the advancements in the fields of DOI and SDI in the 1950's and 1960's however, the spatial dimension was not taken as key aspect for innovation policies. A more detailed discussion on the contributions specifically in the field of DOI will be carried out in the section 1.4 and with an emphasis on the spatial dimension in the section 2.2.

1.2 Second Period of Innovation Policy Framework – 1980's to 2000's: National Systems of Innovation

In the second framing proposed by Schot & Steinmuller (2018) policy makers tried to readdress the issues related to innovation and the imbalances between developed and developing economies and the capacity of territories to absorb technology transfer in order to catch up with most advanced economies. Scientist would pay attention to four main aspects in this second wave of innovation policy. A first characteristic that scholars raised, was the importance of innovation adoption in different kind of territories, even though economists do not literally speak of innovation diffusion as a spatial process, we could argue that this second framing was indeed an attempt to address and enhance such a process.

Established evidence show that the learning capacities of territories are heterogeneous. For that reason, to affirm that innovation travels freely in the space is not accurate because different underlying processes take place to prevent innovation to move uniformly (Asheim & Gertler, 2006) an issue that will be largely discuss in this Ph.D dissertation. This capability was referred to as *sticky information* (von Hippel, 1994), this term implies that the information required to solve a problem is costly and it is not possible to transfer or relocate it easily. Von Hippel (1994) claimed that *sticky information* would remain at one site, referring to the source place and the problem solving would take place at that locus.

The second aspect in this framing was directly related with the absorptive capabilities of research and network of researchers (Cohen and Levinthal, 1989). The argument raised here was that the development of R&D and subsequently of new technologies not only provides the creation of new information to firms but also helps firms to improve how to absorb and use or reuse existing knowledge. This would work as a feedback-loop effect where new knowledge would enhance the comprehension of existing information, subsequently reinforcing the capability to create new knowledge. The intrinsic implication within this process is that incremental technological development requires existing knowledge in a related field. Different words are used in the literature to refer to these learning capabilities. Therefore, we will refer to them with different terms such as absorption, adoption or learning capacities.

The third aspect aimed at highlighting that education was not enough to facilitate the absorptive capabilities, but social capabilities of entrepreneurship were needed to strengthen the process (Schot & Steinmuller, 2018). The fourth and last aspect was the path-dependency nature of structural change (David, 1975; Arthur, 1983; Grabher, 1993; Martin & Sunley, 2006; Boschma & Frenken, 2006). It turns out that this absorption capacity is cumulative which allows firms to reinforce their pre-conditions and expand their capacity of adoption and assimilation of new technologies, building new entry-barriers preventing new competitors to enter.

This shift of innovation policy implied a new configuration between stakeholders, prompting governments, R&D institutions, firms and society to function with another setup. These networks configurations and the interactions of its elements would be different with distinct outputs and a subject of interest for scholars. These configurations receive the name of national systems of innovations (Freeman, 1987; Freeman et al., 1988; Lundvall et al., 1988; Lundvall, 1992; Lundvall et al., 2009). One of the strengths of this approach it was that the study of national systems of innovation would allow perform comparative analysis. The spatial distribution of learning processes and not only R&D investments were identified as a key aspect during this period (see Kim, 1999).

The term national systems of innovations were introduced by Freeman (1988) and Lundvall (1992). British economist Freeman focused on the configuration of national institutions and policies highlighting similarities and differences (Freeman, 1987, 1988). While Swedish economist Lundvall emphasized on the role of centralization

policies for learning processes, advocating for the geographic and political boundary mechanisms embedded in national systems of innovation. This premise would rely on the first hand on the national character of institutions and innovation policies and on the characteristics of knowledge diffusion, which are bounded by spatial and cultural barriers on the other hand.

Regional systems of innovation became a way to differentiate the performance of innovation processes, where two main streams took place. One was the *sticky knowledge* concept (von Hippel, 1994) in which the spatial dimension plays a central role and the second was the clustering processes of cognitive association of players in an industry regardless their nationalities (see Edquist, 1997). The intensification concerning the collaboration between universities, industry and government was an important aspect of this framing, this was known as the Triple Helix (Etzkowitz & Leydesdorff, 1997). Nowadays, this theory has been taken forward through multiple Helix approaches and it is known as quadruple and quintuple Helix, which are composed by university, industry, government, public and environment in a knowledge economy framework (Carayannis & Campbell, 2009; Peris et al., 2016).

It is important to add that growth was still at the core of innovation policies and as all systemic fluctuations, the desired changes regarding the improvement of inequalities with less developed countries did not occur quickly and it is still a work on process today. These facts did not prevent advanced economies to continue with the high rates of economic growth, there is data that backs up this claim, if we look at the numbers during the 1980's we could see that growth has not slow down but contrarily it has been continuously reinforced. Productivity continued increasing which made possible economic growth to happen. Figure 7 and Figure 8 are part of the sequence shown in the previous section, this time the data depicts data from 1995, when the United States had a 44.88 US\$ dollars per hour productivity, an increase of approximately 25 % from 1980. Important incremental behaviours on productivity were seen elsewhere like in France for example, there was an increase of 30 %, putting the productivity per hour at 39.84 US\$ dollars. Switzerland had an increase of 38.97 US\$ dollars, that is an incremental change of 19 %.

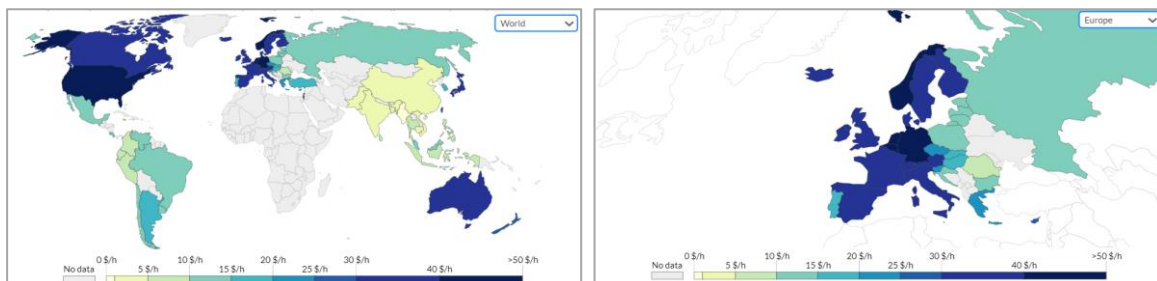

Figure 7 Productivity^a per hour worked in the world in 1995. Figure 8 Productivity per hour worked in the Europe in 1995.

^a Labour productivity per hour is measured as gross domestic product (GDP) per hour of work. GDP is adjusted for price differences between countries (Purchasing Parity Power adjustment) and for price changes over time (inflation).

Germany had an astonishing growth in productivity of 81%, passing from 22.51 US\$ dollars in 1980 to 40.89 US\$ dollars in 1995. Nordic countries, Sweden, Norway, Denmark, and Finland had productivities of 36.37, 45.06, 35.1 and 38.27 US\$ dollars respectively. The second innovation frame intended to strength innovation systems at a national level, which in a neo-liberal context pushed competition at a higher level, increasing the economic gap between rich and poor economies intensifying the process of rich get richer (Keeley, 2015). At a capital level, a parallel economic issue was brewing during the 1970's and 1980's regarding capital distribution (Piketty, 2014). Likewise, from a firm perspective, it was observed a decrease of correlation between companies' performance and CEO's and top executive salaries. Actually, salaries for top managers skyrocketed in unprecedented levels (Gabaix & Landier, 2008) and at the same time, the working class have systematically been paid less.

During the post-WWII framing period of innovation economist already noticed these imbalances, Kuznets would argue that inequality would stabilize as a correction process derived from balancing forces such as growth, competition and technological advances (Piketty, 2014). Kuznets' (1955) theory, was hand in hand with the exponential growth from 1945 to 1975, referred in France as the *Trente Glorieuses*, which stands for English as the thirty glorious years (Piketty, 2014). Robert Soete (2013) raised similar arguments about the stabilization process of inequality.

The importance of the linkage between growth and inequality regarding innovation is of capital interest nowadays. In the field of geography, it has been shown that highly innovative, knowledge-intensive economic activities are spatially clustered, and it is not uniform and randomly distributed (Asheim & Gertler, 2006) and this trend is continuously increasing (Leyshon & Thrift, 1997; Feldman, 2001; Cortright & Mayer, 2002; Juhász, 2019). In its origins, the role of spatial dimension has not been at the core of the economic theory, it has merely been reduced as a generator of costs of transportation (Zimmermann, 2008). The concept of territory arises with the work of Marshall (1920) who stated that production costs are reduced if a determined number of companies are located nearby. The usage of the spatial dimension was initially reduced to the accessibility between two points, but later it was acknowledged that the location of economy activities and people, actually transform the environment, how people make decisions, and all these aspects end up being intertwined (Zimmermann, 2008).

Since around four decades, scholars have reckoned the need of theoretical and empirical development of the spatial dimension in economic activities (Zimmermann, 2008). In the 1980's there were two major movements that intended to implement the space as an active component to explain urban economic activities (Zimmermann, 2008). The first one was the innovative milieu (Aydalot, 1986; GREMI, 1989; Camagni, 1991; Crevoisier, 2001; Zimmermann, 2008) where economic space is defined as a "*relational space*". In this approach, social, interpersonal interactions and synergies take place in associative processes creating knowledge spillovers, which subsequently influence the innovative ability of local areas (Camagni & Cappello, 2002).

The second movement was focused on externalities also found in industrial districts theory under the economic approach of the *third Italy* model¹ (Zimmermann, 2008, see also Bellandi, 1982; Beccatini, 1987) coupled with the new economic geography line of thought proposed by the Nobel laureate in economics Krugman (1991). Both in the innovative milieu and the externalities effects approaches, the role of local interactions is assumed as an existing and a factual situation. This implies that it is difficult to analyse the concentration of local versus global interactions from a geographical perspective (Zimmermann, 2008).

Another contemporary stream that was present during the 1990's was the regional innovation model called learning regions. It was a policy approach designed among other targets, to prevent regions to have political lock-ins in old industrial regions stemmed from path dependency (Asheim, 1996; Morgan, 1997; Hassink, 2005). During the 1990's the French school of proximity was proposed by researchers in regional systems of innovation. Scientists noticed the importance of differentiation of regions in order to perform regional comparisons in terms of innovation. Several regional studies were done in order to explain the innovation processes of clusters and how the different types of proximities were intertwined (Kirat & Lung, 1999; Torre & Gilly, 2000; Torre & Rallet, 2005; Boschma, 2005). For that matter, there are two main schools, the institutionalist framework that deals with three kinds of proximities and the interactionist approach that works with two categories of proximities (Kirat & Lung, 1999; Talbot & Kirat, 2005). The institutionalist approach works with the three following proximities:

Geographical proximity is "*defined by the distance from one point to another, functionally calculated in terms of money and/or time. It depends on infrastructures and transport services*" (Rallet, 2003). Organizational proximity: "*it relates to complementary resources held by players that could potentially participate in a common productive*

¹ Regarding the third Italy model see Bianchini (1991)

process, within the same organization (firm, group), or within a set of interacting organizations (cooperation network, industry, local productive system)”. (Carrincazeaux et al., 2008). Institutional proximity: “it rests on the players’ sticking to shared rules of actions—explicit or implicit rules (*habitus*)—and, in some cases, to a shared system of representations, and even values. This institutional proximity is not univocal in that such common rules are not definitive as a result of ever provisional compromises between players with divergent and conflicting interests (firm-employee wage relationships), between firms (competition and cooperation), between private and public players (private versus public goods), etc ». (Carrincazeaux et al., 2008).

The second school of proximity is the interactionist, which states that there are “only two” variations for the concept of proximity, citing first *geographical proximity* and second *organized proximity* which is defined by common resemblance in terms of similarity (Rallet, 2003; Carrincazeaux et al., 2008). The table below shows different proximity dimensions proposed in the literature by economists of proximity.

	Geographical proximity	Organizational proximity	Organized proximity	Institutional proximity	Other proximity
Bellet, Colletis, and Lung, 1993	X	X			Territorial
Kirat and Lung, 1999	X	X		X	Technological
Gilly and Torre, 2000	X	X			
Rallet, 2003	X		X		
Dupuy and Burmeister, 2003	X		X		
Pecqueur and Zimmermann, 2004	X	(X)	X		Relational

Table 1 The various forms of proximity in the proximity group’s publications source: Carrincazeaux et al., (2008).

The French group *Proximity Dynamics* provided a solid collective contribution with theoretical and empirical approaches mainly developed in France. This group gave an essential role to the spatial dimension and not a merely supporting or neutral functionality for social and economic interactions between stakeholders in innovation processes. The group focus did not rely on territorial aspects or on geography itself to develop their theories as a starting point, but they rather worked in what they called the *endogenization of the space*.

That is, that different kinds of proximity were systematically analysed in such a way that the spatial component was just another but an important proximity dimension (geographical proximity) in which innovation processes, economic activities and production were embedded in the system (Bellet et al., 1993; Gilly & Torre, 2000; Carrincazeaux et al., 2008). Within the study of tacit knowledge in the field of economic geography and industrial economics, Gertler (2003) discussed about the attributes provided by geography proximity: accessibility, transferability, trust and reciprocity (see also Hansen, 2015). Geographical proximity shares conceptual bases of the theoretical approach called spatial interaction, which conceptually allocates a higher interaction level to objects that are closer, a more complete discussion on this theory is developed in the section of neoclassical approaches.

In parallel to the school of proximity, a related field called *geography of innovation* (GOI) emerged, focusing on similar questions. The latter focused on geographical proximity attributes where a close look to spatial patterns of innovation and production and also clusters and networks formation among urban stakeholders such as university and industry R&D and their respective spill-overs were at the core of the studies (Feldman, 1993; Audretsch & Feldman, 1996). The central subjects in GOI are based on the stakeholders’ configurations in geographical contexts and how they interact at different spatial scales. Freeman (1994) worked on the economics aspects of GOI coupled with a spatial perspective on innovation and Boschma & Martin (2010) worked on GOI on an evolutionary economic geography approach. Subsequently, during the 1990’s the role of networks in the field of innovation started to take importance for scholars (Freeman 1991; Powell et al. 1996; Hagedoorn 2002; Boschma & Frenken, 2009). The literature on networks is fed by different disciplines in line with the interdisciplinary nature of

innovation studies, therefore the interdisciplinary research work on innovation networks has led to an incremental scientific development with a rich variety of applications (Ozman, 2009).

Nonetheless, the application of networks on innovation studies by geographers has been rather modest when one compares it with the amount of innovation studies in the field of economics, a notorious work in the field of geography was proposed by Rozenblat & Melancon (2013). From an economic point of view, the role of spatial economics has mainly focused on the analysis of enterprises within the theoretical framework of neoclassical economics (Zimmermann, 2008). The main question for economists was how to minimize costs and optimize profits by choosing the right location for a new business whose production function has fixed coefficients in terms of inputs in a homogeneous space (Aydalot, 1985; Zimmermann, 2008).

This view was first proposed by Weber (1909) who contributed with the theory of industrial location, in the beginning was a simple model, in the Figure 9A the inputs **A** and **B** and the output **C**. The optimal location is within the **ABC** triangle whose exact position depends on the coefficients' weight between the inputs **A** and **B** and the output **C**. That model was later improved by adding the isodapane lines (see Figure 9B) which indicates in a radial way the intersection of the isocosts per production factor where the optimal location is at the core of the system, notated **P**.

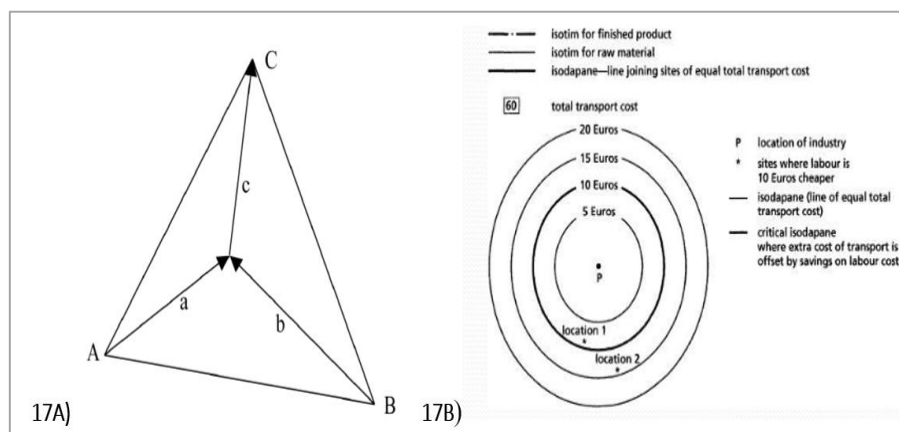

Figure 9A) Location based on transportation costs. B) Isodapane lines, Weber (1909).

The industrial location theory eventually needed to be reviewed since a globalized world would change different parameters for costs minimization and profit optimization.

Some contributions in the mid 2000's marked the beginning of some attempts towards an integration of networks of innovation and space (see Gluckler, 2007; Giuliani, 2007). Nonetheless, the paper of Boschma & Frenken (2009) clearly stated the need of more studies in that direction. More work has been developed since then, with a vast diversity of applications and domains within innovation studies. An important developmental aspect with the introduction of network-based approaches was the implementation of a non-territorially bounded dimension to studies of innovation (Bunnell & Coe, 2001).

The studies on clusters have also been a step towards the inclusion of local dimensions, territoriality, industrial organization and innovation, where the analysis of the performance of productivity is not the only focus but the about their interactions (Zimmermann, 2002). The role of innovation in this context became clearer with time, not only because of the ease to manage economic activities derived from geographic proximity but because of the inherent aspects of it such as the shared values and rules of agents and also the organizational links (Rallet et Torre 2001; Zimmermann, 2002). Economics and geography have continually been getting closer over time as a result

of needed approaches to provide answers to development and territorial equity; and GOI is an attempt to fulfil this gap (Fieldman, 1994) jointly with the economics of knowledge (Stephan, 1996).

In the early 2000's economists got interested in the application of network theory, one example was the usage of *small-world* networks as a proxy for application in *clusters* (Zimmermann, 2002). According to Porter (1998) *clusters* are geographic agglomerations of enterprises and institutions of the same or related fields. These entities are mutually important for competition and providing supporting businesses such as suppliers of specialized components, services and also infrastructure (Porter, 1998).

The latter author also added that *clusters* spread vertically towards customers and horizontally towards companies that produce complementary items and related skills and technologies. A third important aspect of *clusters* is that they might be composed by different actors such as universities, governmental institutions, companies and research institutions amongst others, a similar configuration with the multiple helix ecosystems mentioned above (Etzkowitz and Leydesdorff, 1997; Porter, 2008; Carayannis & Campbell, 2009; Peris et al., 2016). As an additional note, *clusters* did offer a framework in the 1990's to conceptualize and empirically study industrial systems (Porter, 1998; De Bresson & Hu, 1999).

The concept of *clusters* in economics in spite of missing a clear and a general scholar consensus in its definition, it embodies an important focus for policy analysis and allows reducing the usage of rigid instruments and static sectorial approaches, broadening the perspective of the *industrial district* concept (Zimmermann, 2002). Alfred Marshall, the founder of the Cambridge School of Economics is at the origin of the concept '*industrial district*'. The concept means that a geographical concentration of companies settles down, but the concept is not limited to a simply localised industry (Marshall, 1920; Belussi & Caldari, 2008).

"A localised industry is an industry concentrated in certain localities (...) The reasons for a geographical concentration of firms may be various: first, the needs of the manufacturers to be close to the resources on which they depend. Localisation is particularly related to physical conditions (such as climate, soil, mines, quarries, access to land or water) and characterises the origin of many English districts like Staffordshire, Bedfordshire and Buckinghamshire. Second, 'the patronage of a court' that produces a 'demand for goods of especially high quality' Third, the presence of a town: 'almost every industrial district has been focussed in one or more large cities (Marshall, 1920). At the time Marshall would add that the advantages of these industrial settlements are hereditary skills, the growth of subsidiary trades, the used of highly specialized machinery and local market for skills (Marshall, 1920).

These concepts were rather forgotten for several years and had a revival in the 1980's thanks to the research work regarding the resistance capacity and economic success of Italian towns however, the concept got obsolete and needed complementary approaches (Zimmermann, 2002). According to Zimmermann (2002) some of the complementary economic theories that was considered along with the concept of *industrial districts*, was an integration with "*pôles de croissance*" or growth poles². Some theoretical studies on growth poles were developed in the United States in the 1950s (Isard, 1958, 1972) and in France (Perroux, 1961; Boudeville, 1968) focusing on the territorial anchoring process of large firms (see also Bailly, 1988).

A second aspect proposed by Zimmermann (2002) is the capacity of systems to not depend only on local resources but also to develop the ability to absorb external resources, which had been neglected by *industrial location* theory. Other authors such as Carayannis & Campbell (2009) would discuss about the concept of *glocal* or *glocalising* which are contractions for global and local within a concept of glocal knowledge economy and society (see Martin & Moodysson, 2013). As Zimmermann (2002) would highlight, one of the characteristics of the

² In regional development, a growth pole is a group of companies or industries that have higher performance and growth supported by governmental policies in specific locations that highly depend on the input-output linkage (see Higgins, 1971).

proximity concept developed in France is in part its simultaneous spatial and non-spatial nature and the organizational coordination of activities and processes between agents. Correspondently, the notion of the traditional theory of location would focus on the local presence of agents and their activities and processes in the location of reference and not somewhere else. The evolution of these different theoretical constructions might have opened a window opportunity to *clusters* theory. This movement allowed clusters to have a more relevant position in the economics literature since it could provide a conceptual framework to the dual local and global aspects in industrial processes (Porter, 1998; Zimmerman, 2002). In this sense, the geographic concentration should not be seen as the only or the major attribute to enhance productivity but as an important element in a bigger constellation of global aspects. For example, how the local agents are connected with agents that are outside the local *cluster*. This notion is in resonance with the innovation diffusion processes and fundamentally the role of innovators as gatekeepers in the theory proposed by Rogers (1963).

As discussed before, the role of innovators within a network diffusion process is to create a disruption within the social system, allowing new ideas, products, services and knowledge to get inside the system. As a parallel process, the local agents of a system in this case called *cluster*, might be composed by stakeholders with different levels and characteristics in terms of innovation. Those agents who have more access to external resources will help to keep renewing innovation processes by disrupting the internal boundaries of the social system. In the 1990's was carried out contemporary research by economists and economic geographers where network-modelling approaches started to take a prominent position. The *small-world* problem was an important advancement in network science, it was initially proposed by American psychology Stanley Milgram (1967) who studied path length in networks in an experiment. Even though Milgram is infamously better known by his controversial experiments on obedience; his *small-world* experiment was a ground-breaking study on human interconnectivity.

The experiment was about sending letters through persons that were not directly known to them. The objective with this study was to find the 'distance' between two people in the United States. In the experiment 64 out of the 296 letters succeeded to arrive to its recipient. This experiment confirmed the original idea of *six degrees of separation* proposed by Frigyes Karinthy in a short story called '*Chains*' in 1929 (Karinthy, 1929; Jackson, 2008; Barabasi, 2016). Karinthy wrote: "*it's always easier to find someone who knows a famous or popular figure than some run-the-mill, insignificant person*" meaning that we are closer to hubs than to less connected nodes. The experiment showed that in average a person could reach anyone through six degrees of separation³ exposing the concept of *small-world* (see also Kochen, 1989). This idea was confirmed by an experiment carried out by Facebook in May 2011, using their social graph with 721 million active users at the time and 68 billion symmetric links between friends and found an average distance $d \approx 4.74$, identifying thus only '*four degrees of separation*' (Backstrom et al., 2012).

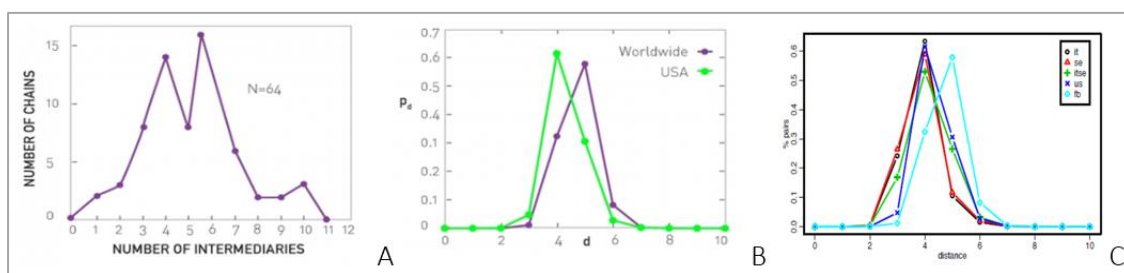

Figure 10A) Degrees of Separation by Milgram (1967). B and C Results from Backstrom et al., (2012).

^a In figure C) It=Italy graph; se = Sweden graph; itse=combination of Italian and Swedish graphs; us= United States graph; fb = Facebook graph.

³ This experiment has been reproduced several times, for example Watts emailed messages in a big experiment where around 50000 individuals from 157 countries were involved (Jackson, 2008). For other applications of small-world problems see also Travers & Milgram, 1969; Korte & Milgram, 1970.

Similar experiments have been developed to determine the distance between two web documents. The first estimates were carried out in 1999, with 800 million of documents and an average distance $d \approx 19$. Subsequent experiments showed $d \approx 16$ with a 200 million sample. In 2016, the WWW was estimated to have a size of over a trillion nodes ($N \sim 10^{12}$) with an average distance $d \approx 25$ (Barabasi, 2016). Those changes are explained by the fact that the WWW is continuously growing, which implies that the distance between documents also increases. Watts & Strogatz (1998) also studied Milgram's idea, the authors performed simulations with other kind of networks such as the neural network of the worm *Caenorhabditis elegans*, the power grid of the Western United States and the collaboration Hollywood network of film actors. These networks appeared to be *small-worlds* (Watts & Strogatz 1998)⁴.

The experiment consisted in interpolating between regular and random graphs by putting a number of n vertices and k edges per vertex in a ring lattice. The procedure was to rewire the nodes with a random probability p therefore, the connectivity rate of the network is between **regularity** ($p = 0$) and **disorder** ($p = 1$). Regularity or a regular network connectivity is one of the extreme possible results, the intermediate region is the *small-world* and in the other extreme random as it is shown in the Figure 11.

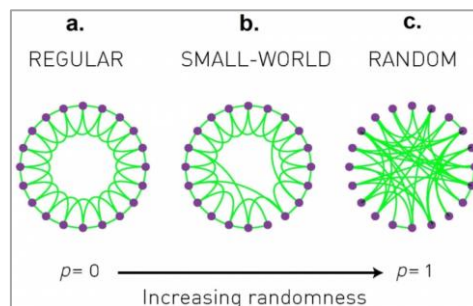

Figure 11 Network rewiring interpolation between regularity and randomness in a ring lattice (Watts & Strogatz, 1998).

In a regular network the connectivity of a vertex n was only possible with its two neighbours $2k$, which is a local relation, highly clustered where $C(p)$ measures the cliquishness of a local cluster, the path length denoted by $L(p)$, which measures the separation between two vertices, L growth behaves linearly with n and it is a large world. If the average connectivity is $2k$, it means that the dispersion grows with p (Barrat & Weigt, 2000). The cliquishness is a property to measure local clustering coefficient of a vertex and it was introduced by Watts & Strogatz (1998). For the random regime at $p = 1$ is a small world with a low level of clustering and L grows logarithmically with n . About the intermediate region where $0 < p < 1$ at the time was little known, so one of the main findings was that for intermediate values of p the graph is highly clustered, similarly to a regular graph but with a small L like in a random graph and is a *small-world*.

After this short review on the *small-world* problem, we will discuss about an application in industrial location, more specifically with the concept of *clusters*. Zimmermann (2002) related the *small-world* network theory to *clusters*. Although Watts & Strogatz (1998) did not talk specifically about spatial proximity, Zimmermann by analogy proposed that the regular graphs were local from a spatial perspective since a vertex is connected only to its $2k$ edge closest neighbours, so a high spatial proximity is present. For random graphs, a global characteristic is present, and then a low spatial proximity is observed since their location are random (Zimmermann, 2002).

In this regard, Zimmermann (2002) considered the *small-world* and clustering phenomena as a proximity issue applicable to the theory of industrial location. Under this optic, Zimmermann (2002) would propose to see regular networks as local and random as global. Then, the intermediate values of an alternance rewiring process would

⁴ About one year after Watts & Strogatz (1998) publication, Barabasi & Albert (1999) showed that the power grid of Western United States actually was approximated by a power law with an exponent $\gamma_{power} \approx 4$. Also, for the actor film social network, it was shown that it had a power-tail for large k , $P(k) \sim k^{-\gamma_{actor}}$ and it was approximated by $\gamma_{power} = 2.3 \pm 0.1$. For more information see section 4.1.2

affect the clustering of the network which depends on a probability p where there is a proportion p if the edge is replaced randomly, so with a global nature or a proportion $(1-p)$ then, with a local nature.

The interesting analysis proposed by Watts & Strogatz (1998) and highlighted in the fields of economics by Zimmermann (2002) lies on the fact that a regular network when gets global links or shortcuts, has two immediate effects, which is to enhance accessibility at the detriment of network cohesion or *clustering coefficient*. Accessibility is the average path length in a network, which is an important indicator about how close vertices are and how long it takes to reach an average vertex (Jackson, 2008). The clustering coefficient gives information about the probability of two vertices A and B to get connected with a third vertex C whose probability of connection is the same between A and B ⁵ (transitive triples) that is how loosely knit a circle of nodes is (Barabasi, 2002).

The behaviour of regular and random networks constitutes a trade-off, where regular networks have a high clustering level but low accessibility level while random networks have a low cohesion level but high accessibility. This information poses an optimization problem, where the feasibility zone must be found, Figure 12 illustrates a good compromise between accessibility and clustering. This simulation shows a zone with a p value between 0.01 and 0.1, which shows a considerable good accessibility level and slight detriment level of *clustering*. In this simulation $N=20$ and $K= 4$, in a similar procedure Cowan & Jonard (1999) found the same properties with the values $N=500$ and $k=10$.

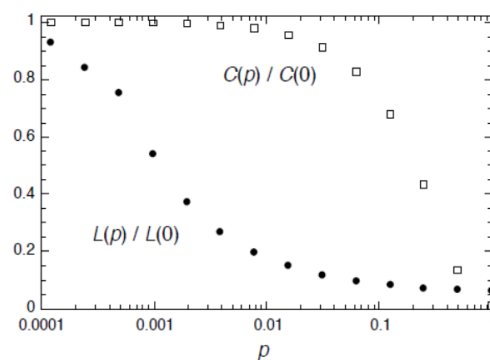

Figure 12 Characteristic path length $L(p)$ and clustering coefficient $C(p)$ for the family of randomly rewired graphs described in the previous figure.

According to Zimmerman (2002), this optimization process in network theory suggests a good compromise between regular networks of local nature and random networks of global characteristics. Where the local interactions are spatial and can be measured while global connections of random nature are a-spatial but the links can take place relating other aspects in *clusters*. This theoretical approach in network science present in small-world networks is similar to the local-global characteristics empirically exhibit by *clusters*.

Cowan & Jonard (1999) did an application of networks in *clusters* taking as innovation indicator knowledge diffusion and found structures also present in *small-world* type networks. At local level they observed that a good level of clustering makes sure the diffusion within network and a global level the interaction with external agents allows to have an “irrigation system” inter-*clusters* helping the network to get new knowledge. A major contribution of the Watts-Strogatz model was to bring the Granovetter (1973) and the Erdős-Rényi models together however, Erdős-Rényi and Watts-Strogatz models did not predict the presence of hubs (Barabasi, 2002). In both models, the nodes were not likely to have a very high number of links, which was the work undertaken by Barabasi and his team when their robot found hubs in the World Wide Web (Barabasi & Albert, 1999; Barabasi,

⁵ A detailed explanation of network theory concepts is deployed Chapter 4. The emergence of scale-free networks questioned some of the assumptions proposed by Watts & Strogatz related the small-world problem.

2002). A further development of the Barabasi-Albert scale-free model and network sciences in general will be developed in Chapter 4.

Network science captured the attention of sociologists some decades ago, for example, the paper published by Granovetter (1973) entitled “The strength of weak ties”. This is one of the most cited paper on social networks and recognized as one of the most influential papers in the field of sociology, featured in *Citation Classic by Current Contents 1986*. Granovetter while studying at Harvard in the 1970’s which was one the hubs for networks studies jointly with MIT, published his first-ever paper about how people get jobs (Barabasi, 2002).

In Granovetter’s model, a person in a network who he called “Ego” would have a close-knit network of friends which tend to know each other. In parallel, Ego has some acquaintances or a loose-knit network, that do not know each other but that have their own closely-knit clump different from Ego’s in an entangled way (Granovetter, 1973). At the time it was believed that society was rather homogeneous however, Granovetter showed that there are clusters formed by groups of people. He showed that weak ties were more effective than strong ties in terms of contacts to get a job. Weak ties were 28% effective to find a job while strong contacts were only 17%. The interesting fact with Granovetter’s model is that that type of networks are not the Erdős and Rényi’s (1959, 1968) random network model that was the absolute predominant approach (Barabasi, 2002). In this kind of network, the implications were very important since the network would have very close-knit clusters through strong ties and few nodes would have weak ties through links toward an outsider node which was part of another cluster.

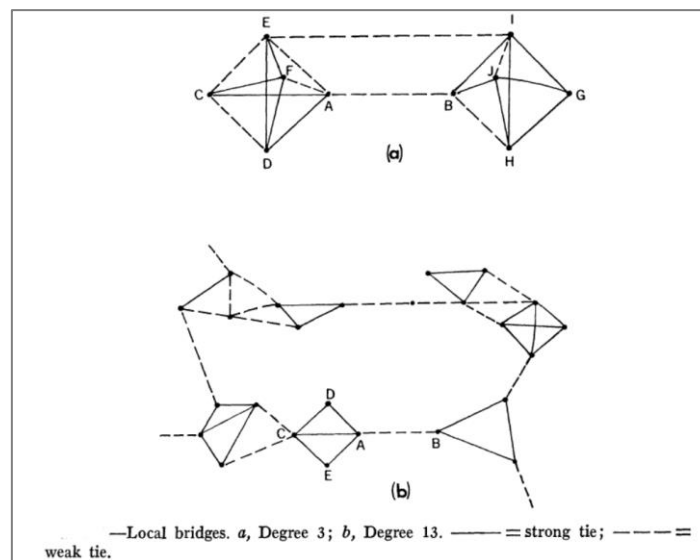

Figure 13 Local Bridges of Granovetter (1973).

Therefore, there was a hidden pattern that was later formalised by Watts & Strogatz (1998) with the *small-world* theory. In the figure above we observe how weak ties allows nodes to connect to other clusters and access the outside world. *Small-world* theory made possible to adapt randomness nature of networks with clustering, a model that got the acceptance of both, mathematicians, and physicists (Barabasi, 2002). Cowan et al., (2003) developed a study with the concept of matching (match between searchers and firms)⁶. The matching principle was analysed by looking at the agents’ interactions in terms of knowledge complementarity and similarity. They found that a model where similarity is dominant, the agents are organized in cliques in a rather disconnected manner, whereas in a model with a complementarity dominance the network structure is of global nature with a path length and a clustering coefficient observed in random networks. In the case of an intermediate behaviour between similarity

⁶ This topic is beyond the scope of this research work, readers interested in matching modelling are referred to Goudet et al., (2012) and for different models of urban labour economic theory see Zenou (2009).

and complementarity, it was observed that the clustering coefficient level was high and the path length very low almost at its minimum value.

The authors concluded that even though they did not have the assumption of a spatial location of the agents, this structure is identifiable as a *small-world*. One of the main conclusions of this model is that the transition between a compartmentalized world to a homogenized and global world is constrained by a balance between specialization and complementarity, a phenomenon also observed in clusters. Studies on strategic firm alliances with the lenses of network theory was proposed by Cowan et al., (2006), their thesis to build the model was that innovation boosts partnership. In the process there is a trade-off where knowing your partners will reduce risks given the existing trust, while unknown potential partners might imply greater benefits but a higher risk. The authors argued that this “*organized proximity*” is derived from former successful collaborations, which generates structured networks of innovation with a limited clique of partners. Cowan et al., (2006) model focused on the “*the production of shared knowledge, and how firms’ behaviour in this regard leads to the emergence of networks*”.

The mechanisms followed by the model’s agents (firms) are based on the alliances in each period and they rely on the potential benefits perceived from a partnership. Then, the agents share their knowledge to create a common stock of information. Once the benefits have been acquired, every agent adds to their own stock of knowledge the lessons learned from the collaboration and the alliance is ended, repeating the process on a new network formation. The mathematical formalisation of the model is described below:

$$v^m(i, j) = (1 - \theta) \min\{v^m(i), v^m(j)\} + \theta \max\{v^m(i), v^m(j)\}, m = 1, \dots, l \quad (1.1)$$

The agents are located in an l -dimensional knowledge space, where i and j are two agents that collaborate to innovate together. The total agents population is finite and denoted $S = \{1, \dots, n\}$ where each agent $i \in S$ and has properties of several kinds of knowledge endowment represented by the vector $v(i) = v^1(i), v^l(i)$ where; every factor of v^m typifies the quantity of knowledge of the category $m = 1, \dots, l$ owned by agent $i \in S$.

Once the collaboration between agents i and j has ended and the innovation has taken place, three assumptions are required to happen *i)* the knowledge stock of both profiles i and j has increased. *ii)* the knowledge profiles of both profiles have changed. *iii)* the common knowledge stock variation entails that both profiles reduced the relative distance in terms of knowledge space between them that is, they become closer or similar knowledge wise. The agents combine their knowledge in order to build a common knowledge profile through the equation 2 where θ can be interpreted as an indicator of the taste for dissimilar partners which are specialized in different tasks in order to maximize the value of θ .

Therefore, when the collaboration of specialized agents is highly performant $\theta \approx 1$. So, when $\theta \approx 0$ then any factor m where $v^m(i) < v^m(j)$ entails that the lack of knowledge in that category to perform a given task, agent i reduces the effectiveness of j and the opposite is also true. When partners achieve $\theta \approx 1$ is stemmed from their own interest of finding either similar partners or partners whose strengths would be complementary and benefit each other. The combined or pooled knowledge vector is used as input for the innovation production function, which is formalised as a standard constant elasticity of substitution production:

⁷ Notes from the authors: We have assumed here that agents are pursuing knowledge for its own sake. This is unrealistic in general for firms, who pursue knowledge more generally for the sake of profits. To incorporate that explicitly in the model adds significant complication, demanding a fully blown goods market with production and consumption. We avoid that by this simplifying assumption, which, in an industry involved in rapid technical change, will be behaviourally quite adequate (Cowan et al., 2006).

Function $\phi: R^L \rightarrow R^+$, with:

$$\phi(v(i, j)) = \left[\sum_m (v^m(i, j))^\beta \right]^{1/\beta} \quad (1.2)$$

Where the parameter β is an indication of the inversed measure of the elasticity found in the substitution across knowledge categories and is represented by $1/(1-\beta)$. The mechanisms embedded in this mathematical formalisation mean that $1/(1-\beta)$ has an effect on the kind of collaborations desired by the agents with asymmetric profiles and ϕ indicates symmetric profiles in terms of strengths and weaknesses. Therefore, the desirability of partnership is different, depending on finding a profile that allows them to have an even distribution with the aim of achieving a higher isoquant. So, when β is close to 1, it is observed less networking as both agents are evenly skilled in a category of knowledge m hence, substitution is less important as it gets easier to replace between knowledge categories. In the contrary, when β tends to 0 the agent has a high degree of substitutability in different categories of knowledge, so the agent is more open to a partnership and more networking can take place.

Subsequentially, Cowan et al., (2006) added another factor, which was to measure the success and experience in partnership. This was done by considering historical collaborations between agents, so the probability of success in the jointly development of an innovation is an a priori probability based on the beliefs about success denoted $\pi t(i, j)$ where $t+1$ denote the attempts of successful collaborations. The former expression was used to measure the number of total attempts in terms of collaboration and the results obtained in such partnership. This approach also allows capturing a measure about failure risks, which is an inherent aspect in the development of innovations. The authors stressed that risks failures are not only related to trust issues but in the inherent capacity of innovate together. For that matter, the parameter $\gamma t(i, j)$ was designed to measure the historical success between partners where $\pi t(i, j)$ is an increasing function of $\gamma t(i, j)$. The role of the latter expression is to capture the gradual impact of successful collaborations. Therefore, its form is lineal and weighted, with higher weight for the most recent partnership.

$$\gamma t(i, j) = \sum_{1 \leq s \leq t} p^{t-s} X_s(i, j) \quad (1.3)$$

The parameter $0 < p < 1$ has a discounting task whereas $X_s(i, j) = 1$ indicates a successful partnership attempt and is equal to 0 in case of failure. The model incorporates the amount of knowledge produced in case of a successful partnership and is multiplied by the probability of a successful cooperation.

$$F(i, j) = \pi t(i, j) \cdot \phi(v(i, j)) \quad (1.4)$$

Where;

$$\pi t(i, j) = \pi L + \gamma t(i, j) (\pi H - \pi L) (1 - \rho), \forall t \geq 1 \quad (1.5)$$

The parameters πL and πH represent the lower and upper probability bound of a successful partnership respectively. For a first joint collaboration between agents i and j the parameter $\pi_0(i, j) = \pi L$ for all $i \neq j$ so it is the lower probability bound of a successful collaboration.

The authors performed a numerical experiment based on the model explained above and other supplementary information that is thoroughly developed in their paper. With $n=100$ firms, the firms would collaborate with other firms or would remain alone in order to innovate. The matching process between agents becomes stable when all the parts are satisfied and the created value in the cooperation is equal to the expected quantity of knowledge produced in the collaboration. Once the innovation has taken place, the stock knowledge is increased and their profiles' knowledge change of category while experience is accumulated. At the end, the matches are dissolved, and the process starts all over again, in this case study, the authors performed a simulation of 1000 periods, registering the complete data of the industry's history.

The lower and upper bounds of success probability were initially $\pi_L = 0.9$ and $\pi_H = 0.99$ respectively, where the increase was reported as a consequence of a learning process. The accumulated presence and absence of learning process was evaluated along with the parameters θ and β via a random generation of 100 values following a uniform distribution (0, 1). This process was followed by a non-parametric estimation method called kernel regression⁸ (see Silverman, 1986; Yatchew, 1998). The method focused on calculating the allocation of knowledge, where:

$$\phi = \sum_i \phi(v(i)) \quad (1.6)$$

And ϕ is included in the following equation that measures the variation of high and low levels of agents' knowledge, where a high v value shows evenly distributed knowledge amongst agents and a low value indicates a high variance.

$$v = \frac{\sqrt{\sum_i \phi(v(i))^2 / n - (\phi/n)^2}}{\phi/n} \quad (1.7)$$

Then, Cowan et al., (2006) created a network relying on the small-world model, emphasising on the distribution of agents' collaboration. To do this, the average path length and the cliquishness were analysed. The partnership were simulated via a network (S, V_t) which was composed of isolated agents q and $(n - q)/2$ non-connected pairs of nodes. The criteria to link a pair was based on a matching process that associates the v value in function of time where $vt(i, j) = 1 \in \mu t$, and μ represents a stable matching between agents i and j . In the contrarily, if $vt(i, j) = 0 \notin \mu t$ no links are generated between the agents. The iterations of the periods t allow generating a dynamic network which is weighted based on the frequency of interactions between agents i and j and it is denoted (S, W_t) . The procedure to calculate $W_t(i, j)$ is indicated as follows:

$$W_t(i, j) = \sum_{1 \leq s \leq t} V_s(i, j) / t \quad (1.8)$$

In order to calculate the average path length, it is necessary to determine the distance between the agents $d(i, j)$. The distance between two nodes is the length or number of links in the shortest path, which is also known as geodesic. In the case of non-existing path between two nodes, then the distance is infinite (Jackson, 2008). The process to determine the distance between agents, was to define the highest frequency path linking agents i and

⁸ The kernel regression will be further discussed in Chapter 5.5.3. This approach is a fundamental methodology in the construction of the general model developed in this dissertation.

j . Also, note that any path i_0, i_1, \dots, i_z where $i_0 = i$ and subsequently $i_z = j$ then they have a path associated frequency denoted by:

$$\prod_{l=1, \dots, z} (Wt(i_{l-1}, i_l), \text{length } z \geq 1) \quad (1.9)$$

And a path with a maximum frequency exists. Thus, the final mathematical expression to determine $d(i, j)$ is the following one:

$$d = \frac{1}{n(n-1)} \sum_i \sum_{j \neq i} d(i, j) \quad (1.10)$$

The cliquishness of the neighbourhood of a vertex i was determined as follows.

$$\Delta = \frac{1}{n} \sum_i n_i \quad (1.11)$$

Where the neighbourhood of vertex i is denoted by:

$$\Gamma(i) = \{j \neq i : d(i, j) = 1\} \quad (1.12)$$

And the size of the neighbourhood of vertex i is formalised as:

$$n_i = \#\Gamma(i) \quad (2.13)$$

Then, we have the complete expression to calculate the cliquishness:

$$c = \frac{1}{n} \sum_i \sum_{j, l \in \Gamma(i)} \frac{X(j, l)}{n_i(n_i - 1)} \quad (1.14)$$

Where $X(j, l) = 1$ if $d(j, l) = 1$ and 0 otherwise.

The results obtained from the previous mathematical expressions will be discussed as follows. As a reminder, the objective was to analyse the capacity of increasing knowledge through a pooling process between firms. In the figure below the results, with two charts each time where the left one displays the results of the probability to do a partnership with an average agent and past experience is not considered. So, the probability of success is $\pi_H = 0.99$. In the right panel, past experience is considered so the priori probability $\pi_L = 0.90$ so it can increase over the time if successful past experiences take place. The axes show θ and β , which are the pooling knowledge and the capacity of knowledge substitution in categories to perform a task.

In the Figure 14A we can observe a clear-cut difference of a magnitude of a factor 5 between the left and right panel, that is without and with experience considered respectively. The authors argued that the sharp differences between the two scenarios rely on the size of the innovation and the experience, which are substitutes in the score value of the equation (1.4). This worded otherwise, entails that firms learn how to collaborate and become

more attractive to partnership with over the course of time and that implies that networking decreases when experience matters as the potential result of a collaboration becomes more predictable.

In the case of the high-tech sector, there were big technological changes in the 1980's and 1990's, which pushed companies to collaborate given the incremental interdisciplinary R&D trend, major risks, and increased costs (Contractor & Lorange, 1988; OECD, 1992; Dussauge & Garrette, 1999; Roijakkers, 2003). In this risky context, firms are inclined to collaborate with known partners in order to optimize their chances of success (Roijakkers, 2003).

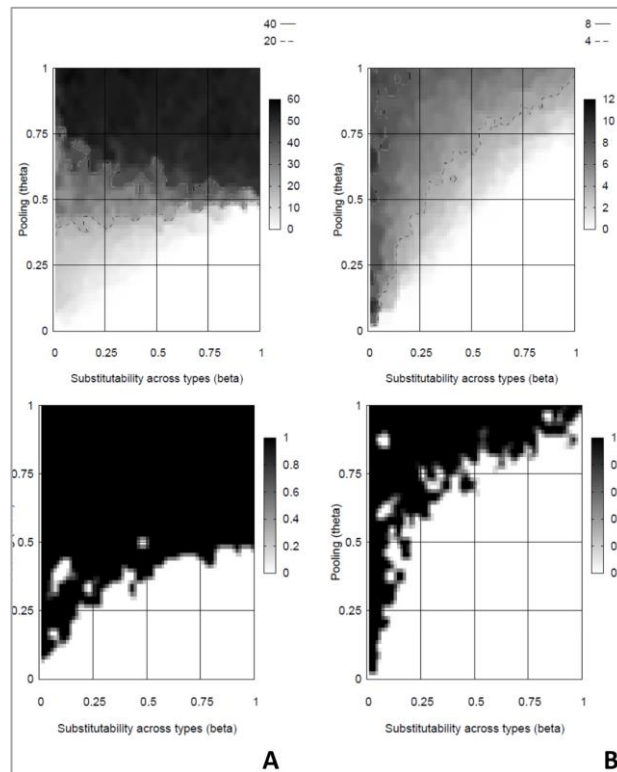

Figure 14.A) Average degree of the network in the (β, θ) -space (left: no learning; right: learning) .B) The emergence of connectedness in the (β, θ) -space (left: no learning; right: learning), Cowan et al., (2006).

The Figure 14B shows the results of the emergence of connectedness in the (β, θ) space, where the white area represents disconnected: 0 and the black area connected: 1 . The grey pixels are a device formed by the kernel smoothing process. The results below show a trade-off between connectedness and β , which is the capacity of a firm to substitute knowledge. When β is large, there is an autarchy innovation process and the “white islands” inside the black area appear, since the need to substitute knowledge profiles decreases so the connectedness also drops. In the contrary, if β is small, that means that firms are struggling to substitute a knowledge profile so they would be more eager to do networking. In the case of a large value for θ , this means that firms are willing to do partnership and remain connected for a long time with already known partners, entailing that less networking will be developed. Otherwise, when θ is small, firms are switching partnership more often and tend to have more collaborations, which creates a higher level of connectedness in the network via a trial-error-trial process in terms of collaborations.

Figure 15A shows the average path distance between partners, the results look similar to those obtained in Figure 14B, which was the connectedness of the network. The authors did a pertinent comparison regarding the nature of the randomness of the network. They argued that given that a random graph has a homogenous degree Δ , its average path length can be approximated by $\ln n / \ln \Delta$, which is the case of partnership formed without a learning process, meaning that agents are linked randomly as experience no matters. It is worth noting that in random

networks (Erdős & Rényi, 1959) the presence of hubs is not possible, that is that few vertices have a high number of edges (Barabasi, 2002, 2016).

When experience matters, the network's degree can differ by a factor of 4, suggesting that the process is not random. What the authors did not mention, was the possibility of finding hubs in such a network as it is observed in real life. However, it is important to clarify that the small-world model does not predict the presence of hubs in networks (Barabasi, 2002, 2016). Hence, it was not possible to observe hubs with the small-world model, so that suggest that this model could be improved by an integration of the scale-free model proposed by Barabasi & Albert (1999) where the emergence of scaling in random networks is observed. Another important aspect in Figure 15A is that when firms find new partners, they do not seek for shortcuts, but they rather try to reinforce local coherence.

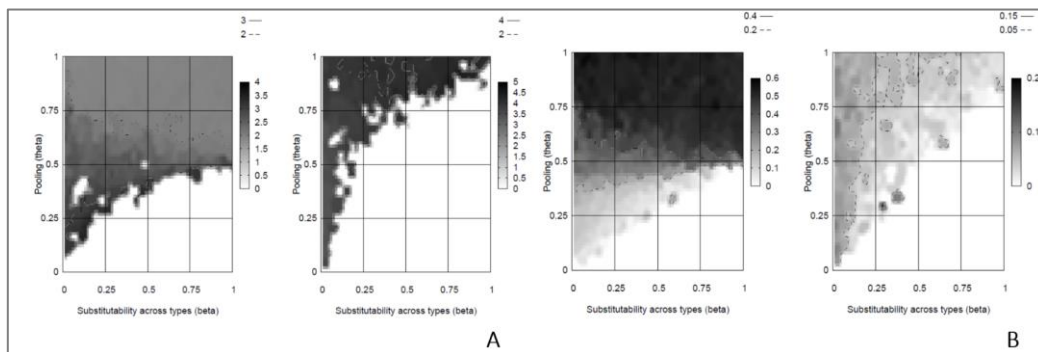

Figure 15 A) Average distance in the (β, θ) -space (left: no learning; right: learning). B) Cliquishness in the (β, θ) -space (left: no learning; right: learning).

The Figure 15B depicts the cliquishness of the network, this measure shows how close-knit a network is, for example the extent to which an agent's partners are partners with each other. A close concept in network science is a clique that is a fully connected subnetwork inside a network. As it is stressed by Jackson (2008), it is important to distinguish a clique from a component, since a clique must be completely connected, and it does not have the restriction to be a subset of a subnetwork that is also completely connected. Whereas a component needs to be path-connected and not strictly be a subset of any subnetwork that is path-connected. In this simulation, results showed again an important difference between the model when experience matters and when it is not considered. The magnitude differs by a factor almost up to 3 and there was no evidence that the path length considerably changes when the network grows. The reinforcement of local coherence in firms that find new partners is in line with the white area at the bottom of the Figure 15B, where firms rather decide to follow an autarchy innovation process and the clustering is define to zero level.

In summary, this model suggests that the evolution of the network shows a structure that is not fully predicted by a random network. It appears that the network has a more structured behaviour than a random network when there is a transition between individual innovation processes towards collaboration. It was not possible to determine that the behaviour is the same to the small-world model since the cliquishness and the distance were excessively large. Another important aspect is that the knowledge accumulation process is that the increase of knowledge pooling would influence on the decrease of individual specialization.

Related work was developed by Zimmermann et al., (2003) who stated that diffusion in social networks self-organization processes of an influence network is not a monotonic process. This applies from a structural perspective of the network and also regarding its capacity to diffuse. They proposed to use the weak ties concept developed by Granovetter (1973) analysing this property in networks. We also find more work from Cowan & Jonard (2004) who created a model of knowledge diffusion in which agents exchanged different kinds of knowledges in a small-world network model. Plouraboué et al., (1998) carried out earlier work in France, they built

a model under a neural network approach in order to simulate the foundations of a social influence-based approach for the diffusion of innovations. We will briefly describe their model, as it will introduce us to one of the methodological approaches used in this dissertation, which is closely related to network theory and power laws. An interesting aspect about this work is the inclusion of the self-organized criticality (SOC) concept developed by physicists Bak et al., (1987), which is one of the main contributions in statistical physics in the last decades playing an important role in the evolution of complexity science (Watkins et al., 2016).

Plouraboué et al., (1998) did an application in learning diffusion in social systems, in this model, agents would make decisions about adopting or not a standard and the social network is defined as critical if an agent adopts the standard and it is likely to spread it to the rest of agents, theoretically reaching all the agents in a network. The authors argued that localized disturbance at elemental level would cause a critical state where a phenomenon could spread progressively at global level. They compared physical systems by analogy where a microscopic disturbance could generate the macroscopic shifting of the structure to a new phase. In a social system, a small number of individuals would be able to change the whole system.

Neural network models provide the possibility to analyse critical states in self-organized systems including social systems, which was the rationale of its application for this model. The model was built in two steps, first they constructed the sphere of influence and defined the rules on how the neurones are interconnected and the rules of evolution. The set of neurones that would shift to a critical state in the network are represented by $i \in I$. The second step dealt with the criticality aspect, defining how the network could reach that state and proposed the definition and measure of the exponent of criticality.

In critical networks, there are agents that are able to influence a large proportion of the network, the critical state of such a phase is called in physics scale-invariance, where the sphere of influence could attain any value. This theoretical approach is important for this research given that the methodological approach used to build the spatial model relies on the scale-free networks, whose name implies that the degree of the neighbour can take any scale. This concept has been applied in economics regarding income distribution, the so-called Pareto law, which is not called like that by physicists and mathematicians, they talk about power laws. The following mathematical formalisation represents the not theoretical limit of the size of the influence of sphere.

$$Var(w_i) \int_{\alpha=1}^{+\infty} s^2 p(s) ds = +\infty \quad (1.15)$$

Where w_i represents the number of neurones in the influence of sphere and $p(w_i=s) = p(s)$ is a probability function to generate a link between the neurones. The size of the sphere follows a Pareto law, $P(s) = (\alpha-1) \times s^{-\alpha}$ where $\alpha > 1$ or $P(s) = \lambda \times s^{-\alpha}$ in order to make sure that s has a large value enough. In order to attain criticality in a network, it is necessary that the so-called critical exponent α has a value in the range $1 < \alpha < 3$ which generates an infinite variance, if $\alpha > 3$ the network is not critical (Plouraboué et al., 1998). The first endogenous simulation was run 10.000 times for a random neuron and $n = 1000$. The authors used the Hebbian learning rule⁹ to determine the weight of the links between the neurons (see Hebb, 1949). The second step was to reach the criticality phase and measure the exponent. Figure 16 depicts the demonstration of '*learning induced criticality*' through the log-log plot of the function $P(s)$, where above a threshold value it seems that the sphere of influence follows a power law. It has a slope $-\alpha+1 \approx -1.1$ and a critical exponent $\alpha = 2.1$ which validated the infinite invariance denoted by $Var(w_i) = \infty$.

⁹ It is a learning rule that determines the weight of the connection between the neurones, depending on the proportion of the product of their activation. For further reading, see Bechtel & Abrahamsen (1993).

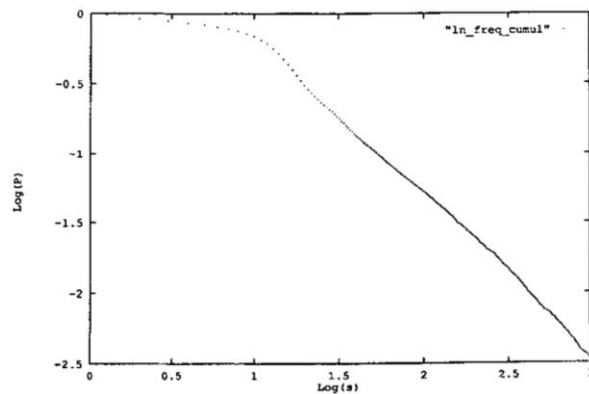

Figure 16 Decimal log - log plot of the inverse cumulated distribution of influence sphere sizes, Plouraboué et al., (1998).

A central aspect that needs to be highlighted is that the transition derived from a microscopic perturbation generated by few agents and subsequently attained the whole network, means that random networks became important and other did not. In this model, it is not possible to determine beforehand which agents are going to become important and which ones not. Therefore, this approach differs of the one proposed by Rogers (1963) which elaborated the *method of adopter categorization* for innovators. Rogers' contributions are thoroughly discussed in the section 1.4. Plouraboué et al., (1998) thus, stated that their model does not distinguish innovators from imitators, as it is the case in other approaches like the compartmental model proposed by Bass (1969). Instead, agents become innovators through the learning process and their importance resides in their position within the structure of the network and the network's structure itself.

Regarding the latter argument, where a distinction between innovators and imitators is not made, this view might present some issues. That implies a randomness nature in the network where every agent is likely to be either an innovator or an imitator with the same probability. Plouraboué and his colleagues' paper was written in 1996, at this time the random network theory of Paul Erdős and Alfréd Rényi still dominated the scientific discourse on graph theory since late 1950's until the arrival of the already reviewed small-world model and subsequently the scale-free model of physicists Barabasi & Albert (1999). Barabasi & Albert demonstrated that the World Wide Web (WWW) is not a random network because the distribution of degrees or the number of edges per vertex follows a power law and does not follow a bell-curve as is the case with random networks.

One of the most important implications with these results is that in the random network theory proposed by Erdős & Rényi (1959, 1968) as the network's degree distribution follows a bell curve, then they have no hubs, so all vertices have the same probability of being connected. On the contrary, the fact that a network follows a power distribution indicates the presence of hubs, so not all vertices have the same probability of being connected. There are some vertices that have more connections, this a process called by the Barabasi & Albert (1999) preferential attachment. The name of preferential attachment comes from the fact that new nodes in a network are more likely to 'prefer' to be linked to existing nodes that have a high degree (Barabasi & Albert, 1999). This non-random distribution of connections or power distribution is the main identifier of networks called "scale-free". This implied that from 1959 until 1999 complex and non-complex systems were equivalent when they were modelled via graph theory.

We would argue that the importance of the agents would determine their position in the structure of the network and that is not a random process. As mentioned by Barabasi (2002) the connectivity procedure in several networks found in nature and social systems follow power laws. Plouraboué et al., (1998) talked about the distribution followed by the influence sphere was a power law but not the degree distribution of the network. The authors assumed a random distribution of agents in the simulation in time t_0 that would imply that all agents have the same probability of becoming innovators. We argue that the structure of the network partly depends on the distribution degree, which is triggered by the importance or the value of the vertices. The peak of the degree

distributions in random networks shows that most nodes have the same degree and those differing are rare. In scale-free networks, the biggest hub is followed by few smaller hubs and subsequently by some smaller and smaller (Barabasi, 2002). Figure 17 shows a scale-free network simulated on NetLogo, where the right image is the same as the left one but with the vertices resized according to their degree distribution.

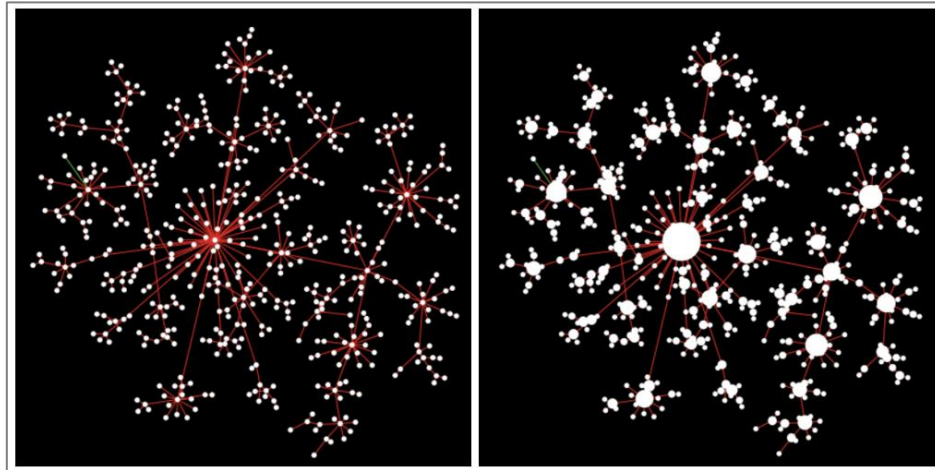

Figure 17 Scale-free network (Barabasi & Albert, 1999). Simulated on NetLogo.

Further literature on knowledge and innovation diffusion modelling in the French literature has been proposed by Steyer & Zimmermann (1996; 2004) who worked about the externalities of networks in diffusion processes and on social influence networks, respectively. Longhi & Quéré (1993) discussed on technopoles and innovative networks under an applied perspective on the case of Sophia-Antipolis. Cowan et al., (2003; 2004) proposed other models related knowledge and innovation diffusion based on network theory (see also Cowan & Jonard, 2004). Further work on innovation diffusion has been discussed in the specialized literature, for instance, Thomas Valente has extensively contributed with network models for social systems applications (see Valente, 1995; Valente et al., 2015; Valente & Vega, 2020). Kiesling (2011) proposed an important literature review related to innovation diffusion under ABM and networks sciences.

Lately some studies focused on GOI have been considering inclusive growth linked to the competitiveness of regions and countries under an innovation for inclusive growth approach (see McGahan & Stein, 2018). More literature review on this subject will be discussed in the next section as well as the geography of sustainability transition, which is a focus in the third framing of innovation so-called *transformative change*. On the other hand, during the second framing scholars started rising questions on the suitability of one innovation policy at a national level when the clear internal heterogeneity in national systems was not addressed consequently, creating disparities at social and economic levels.

A Seminal work done by Tödtling & Tripl (2005) is in line with the internal national diversity of regions, which entails that innovation policies should be tailored to the type of region. The title of their work *One size fits all?* is an important research question, which has gained the interest of researchers nowadays. The emphasis here, is regarding the differences between metropolitan and peripheral areas, where the former has been a privileged recipient of institutional funding for intense R&D and economic activity while the latter have been left behind as indicated by Rodriguez-Pose (2017) in his recent work *"The revenge of the places that don't matter (and what to do about it)"*.

Larger and more dense areas are better equipped to attract and retain firms, since the size, capacity, relations and performance of suppliers, distributors, services, infrastructure, institutional strength, diversified skilled manpower and learning processes are stronger than in other areas (Duranton & Puga, 2004). There have been studies that

show the clear advantages for firms of being based in metropolitan areas Combes et al., (2012) suggest that firms are on average 9.7 % more productive than in less dense areas. These facts have considerably contributed to regional disparities at economic level, which consequently generate social upheavals. At innovation diffusion level, larger areas are more likely to adopt innovations through hierarchical and self-organised processes, this has already been proven since some time ago (Hägerstrand, 1952, 1953; Pumain et al., 2006). This implies that path development occurs in different ways in different types of regional innovation systems (Grillitsch and Hansen, 2019; Tödtling & Trippl, 2005; Grillitsch & Asheim, 2018; Trippl & Isaksen, 2016).

In particular, the high-tech sector has a prominent role in this situation, the current innovation wave which has aimed at the convergence of different NBIC technologies has among others, the goal of improving human life (Roco & Bainbridge, 2003; NBIC Convergence 2003; Canton, 2004). Nevertheless, innovation can also lead societies towards destructive creation as discussed by Soete (2013) where those who cannot participate of the new flourishing industries remain marginalised. Benefiting thus, few people at the expense of the many, broadening the poverty gap, which might allegedly imply that the cure could be worse than the disease.

The difficult question to answer is how to make sure that technology can benefit all layers of society, not only in terms of consumption by end users but from the genesis of the innovation processes. This reasoning takes us once again to the spatial diffusion of innovation process which is uneven, and it is reinforced by the path-dependency theory in which the inertia of the past will influence the future transition phases towards growth or systematic decline. The reiterative forms of a sort of discrimination on innovation funding from a geographical perspective have shown a correlation with inequality, which poses a crucial question on the innovation agenda of institutions such as the European Commission which stated *"...given the weight of high-tech sectors in the overall level of business R&D intensity, a change should include the sectoral composition of the business sector, a move towards a higher share of high-tech companies"* and policy should *"change the balance of the industrial structure in favour of these research-intensive sectors..."* European Commission (2008; p. 11&16).

The former paragraph poses a major problem: What about the industries and people that cannot access the research-intensive sectors? From an economic geographic perspective, the spatial agglomeration of the high-tech companies and R&D intensity suggest the general Darwinism approach in evolutionary economics where at the macro level, only the fittest regions prevail. These mechanisms are also observed at meso-level regarding networks for production and innovation purposes and at micro level within firms. A concrete example is depicted in a paper done by Krueger (1993) which showed that workers using computers at that time, when the Internet was not commercially diffused yet, earned around 10 to 15 % more than others. In the US from 1900 to 1980 the inequalities in terms on income related to education was shortened (Goldin and Katz, 2009) but since 1980 this gap has been increasingly growing (Krueger, 1993; Autor et al., 1998; Murphy, et al., 1998; ; Bresnahan, et al., 2002; Atkinson, 2008; Goldin and Katz, 2009). Computers and technology were not the only factors contributing to this gap, but it has widely accepted in the literature that computers had a big impact on this issue (Autor, et al., 1998).

Inequality seems to be one of the most difficult questions to answer for innovation policy makers nowadays and we argue that geographers could have a major role since the importance of the spatial dimension in inequalities, innovation and innovation policy is incontestable. We go further in this point and argue that it is unconceivable to deal with issues related either with inequality or innovation or both, without actively considering the spatial component. To try to solve these problems without using the spatial dimension, it would be something like trying to solve a problem ignoring 'where' the problem is. The *one-size-fits-all* approach in national innovation systems to address socio-economic imbalances and the exponential deterioration of the environment and a ramping climate change prompted policy makers to review their agendas. Thus, some have proposed radical changes which that will be discussed in the third framing of innovation as follows.

In summary, we discussed the policy framework change in the 1980's which intended to address the inequalities engendered by an incremental economic growth in advanced economies leaving behind developing countries in a persuasive cycle of poor innovation, stagnation and poverty. National systems of innovations were established, and the competitiveness of countries become more acute and the concepts of absorptive capacities of learning processes and *sticky knowledge* gave an important role to space in innovation systems. This framing though, failed at addressing socio-economic and environmental challenges, which required the introduction of new policy frameworks that enable to meet these issues.

1.3 Third and Current Framing of Innovation Policy: *Transformative Change*

The third and current innovation policy framing is *transformative change* where transformative refers to the implementation of innovation to meet societal challenges and sustainability transition plays a key role (Grillitsch et al., 2019). Transformative change is also referred to as challenge-driven innovation policy (Coenen et al., 2015, Grillitsch et al., 2020) or also next generation innovation policy (Kuhlmann & Rip, 2018; Grillitsch et al., 2020). Natural resource depletion jeopardizes our very civilization, as we know it therefore during the last years a special attention has been paid in the literature to those technological advancements that are required to overcome this threat. Nonetheless, those technological advances are not enough to help us to cope to the escalating exhaustion of natural resources, as we need radical shifts in production and consumption behaviours in socio-technical systems such as transportation, electricity, buildings, heat and agro-food, these shifts are known as *sustainability transition* (ST) (Elzen et al., 2004; Grin et al., 2010; Köhler et al., 2019).

This focus exists since about a decade however, it has been acknowledged by the OECD (2015) that this framing is not well developed yet (Steward, 2012) but at the same time recently Grillitsch et al., (2020) argued that transformative change is not really a novel approach. Research on innovation has shifted the last decades where the emphases was mainly on science and technology with economic growth as a drive. Nowadays, this focus is holistic and intends to address major societal issues. The last years governments have agreed that socio-economic and environmental challenges should be addressed in alignment with innovation goals. The Lund declarations in 2009 and 2015¹⁰ state that European research must emphasize its efforts on the grand challenges of our time and turn them into sustainable solutions. The United Nations (2015) sustainability agreement signed in Paris is a part of the global agenda to implement those changes through the 17 Sustainable Development Goals (SDGs).

Societal and environmental challenges need to be aligned with other ways of economic growth and doing R&D, which are required to create greener and sustainable societies. A practical example can be observed in Europe through the Horizon 2020 program where Responsible Research and Innovation (RRI) is the EU's framework for research projects addressing the challenges mentioned above. This is a clear illustration on how innovation, technology and science have lately been implemented in different disciplines in order to face climate change, inequalities, and poverty among other societal and environmental issues.

During the third framing, high levels of productivity and economic growth continued to increase. At a national level, advanced economies have been successful at keeping the evolution of economic boost, but when we take a closer look, that is at the regional level, the reality is different and when we take even a closer look to social and environmental advances the results are not so satisfactory.

¹⁰ Available online at: <https://www.vr.se/english/mandates/international-work/responsibility-within-horizon-2020/eus-next-framework-programme/the-lund-declaration-2015.html> Available

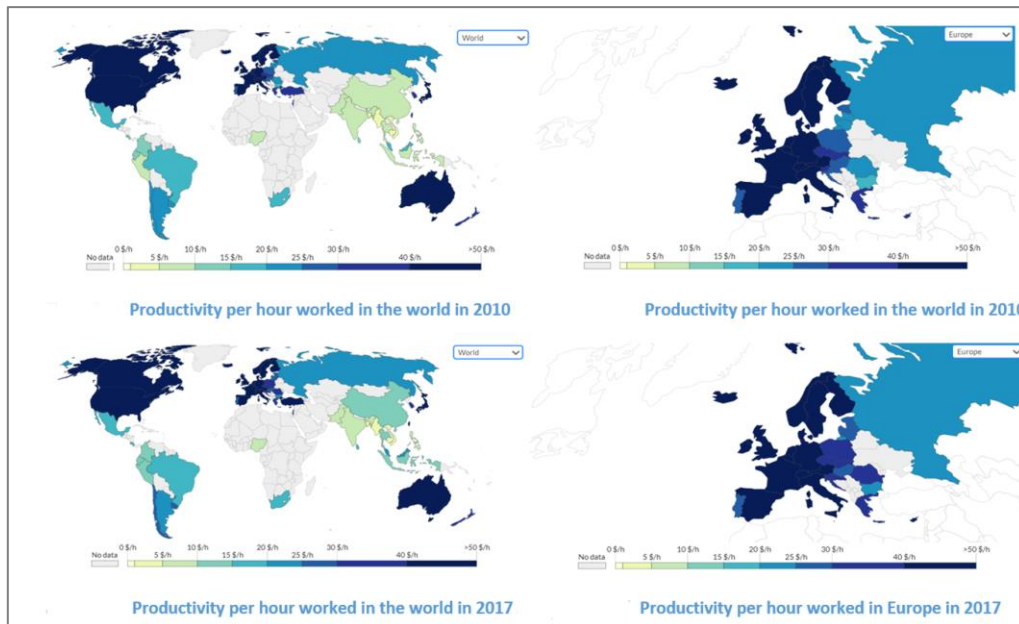

Figure 18 Productivity per hour in the world and in Europe in 2010 and 2017.

The figure above clearly depicts a gap between North and South Hemispheres, the exceptions are Australia and New Zealand, which are located at the South-eastern hemisphere in 2017. The third innovation framework shift was triggered by the result of the application of different strategies for innovation policy that failed at addressing aspects outside of sciences and economic growth: societal and environmental challenges. A key aspect of the innovation policy focus today is the environment, there is sufficient scientific evidence that supports the premise of humans' impact on emission levels and temperature increase around the globe. This issue requires new ways of doing sciences with a particular enrichment of interdisciplinary efforts, fostering collaboration between experts from different backgrounds and horizons (see Manfredi et al., 2014) a task that in practice has proven to be an arduous one.

The transitional phase from national systems of innovation to transformative change is designed as a global strategy that still keeps growth, productivity, and competition as key aspects to make a better world with the assumption that governments will be able to invest in green technology missions (Schot & Steinmueller, 2018). Another assumption is that growth will provide resources to address inequalities issues (Schot & Steinmueller, 2018). As a reminder of an aforementioned similar assumption, Kuznets (1955) proposed a hypothesis arguing that inequality would automatically stabilize in advanced phases of capitalism, which has not happened in reality (Piketty, 2014).

These assumptions are founded on the basis of national systems of innovations where the application of policies relies on governments and in their capacity to deliver which again, is not a heterogeneous competence across the globe and corruption in some countries could undermine these goals. Schot & Steinmueller (2018) stated that national systems of innovation are not fit to face the societal challenges that we are confronted with today. Some of their arguments, which it would be worth noting again, it is the link between innovation and poverty in some territories. The first and second innovation framings had the assumption that innovation systematically provides better quality of life for all.

When the reality is that few people are benefited from radical innovations and innovation itself in a global perspective, even though its development boosts the creation of jobs, a lot of people end up with low paid jobs and rather little attention has been paid to that problem (see Broz et al., 2019). The general governmental and institutional consensus has been inclined to think that even though innovation triggers these imbalances, in the

end it is worth it and the general benefits compensates for the bad side effects bringing more good than bad (Schot & Steinmuller, 2018).

The NBIC technology convergence, which is the current economic revolution, has been incrementally contributing to both, job creation but also job destruction, depending on the socio-economic layer we observe, it is likely to encounter either way. A research from Oxford by Frey & Osborne (2013) was a pioneer study on the impact of automation and jobs replacements. An estimation of 47 % of jobs in the US risked being automated since then, numerous studies have been carried out with quite different results, such as the study done by researchers from Mannheim University (Arntz et al., 2017) in which they arrived to a 9 % of job replacements. An OECD study (OECD, 2018) developed for 32 countries states that 14 % of jobs are at stake and 32 % of additional jobs have 50 to 70 % risk to be transformed as a direct consequence of automation. The two latter studies took their starting point from the same methodology used by Frey & Oxford (2013) so comparative instances could be taken at some extent. The figure below shows a chart of probability of computerisation of jobs in some selected industries, falling into three categories.

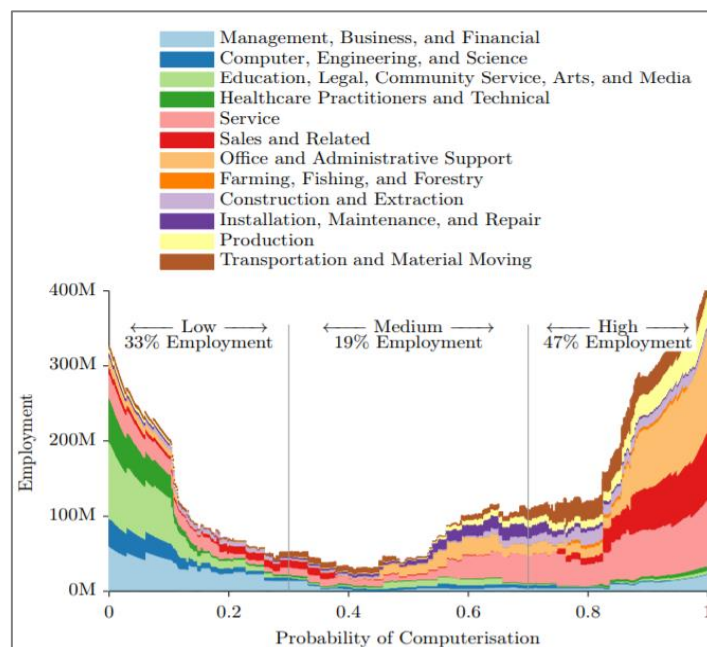

Figure 19 The distribution of Bureau of Labour Statistics 2010 occupational employment over the probability of computerisation, along with the share in low, medium, and high probability categories. Note that the total area under all curves is equal to total us employment. Source: Frey & Osborne, 2013.

Frey & Osborne (2013) gave a very good example on how quick technological development is happening in these last years. Levy & Murnane (2004) claimed that driving in traffic was not a likely task to be automated in the near future however, only seven years later Brynjolfsson & McAfee (2011) showed that technological developments is going faster that it was expected. Self-driven cars developed by Google at the time was a clear example. A pioneer study of jobs replacement in the 1980's was developed by Autor et al., (2003), where they showed the replacement trend of jobs with repetitive tasks, which were at some extent predictable (Frey & Osborne, 2013). The weakness of Frey & Osborne study is that they do not account for the impact of the introduction of general purpose of technology, a possible reason to explain this is that in the case of the US there was not available data at the moment of the publication.

These different socio-economic scenarios generated by radical innovations, job replacements, creative destruction and destructive creation is certain that is happening, but we observe that studies have different results, depending sometimes on the methodology or due of lack of data availability. In any case, it is clear that addressing inequality

is a difficult task for innovation policy makers. Today, transformative change framing's ultimate goals are one of the most ambitious strategies undertaken by governments, scientists, and society as a whole. Within this innovation framework, we observe during the last years the emergence of new integrative approaches, which are intended to contribute within the framework of transformative change.

The development of research on socio-technical systems is a fundamental approach in this framing and it is gaining ground. The bridge between modelling and socio-economic sciences has been increasingly discussed in the literature as an important approach to tackle the most urgent societal and environmental challenges that regions face today (Hof et al., 2019; van Sluisveld et al., 2018; Turnheim et al., 2015; Farla et al., 2012; Manfredi et al., 2014; Van Vuuren & Hof, 2018). In this context, the evaluation of the sustainability of transition pathways through Integrated Assessment Modelling (IAM) is an attempt to combine different approaches in an interdisciplinary way prompting collaborations between natural scientists, social scientists, and engineers. Furthermore, IAM's promote the integration of different stakeholders such as citizens, businesses, governmental institutions to create scenarios based on socio-technical transition studies (van Bruggen et al., 2019).

The specialized literature shows a variety of integrated models with different purposes, fields, sizes and complexity levels. Many models are based on medium-to-long term perspectives and try to incorporate behavioural and technological factors, which is a challenge (Avineri, 2012; Turnheim et al., 2015; McCollum et al., 2016). We find integrated models that deal with energy and transportation (McCollum et al., 2016), low-carbon societies and sustainable transitions (Turnheim et al., 2015) among others. This approach is characterized also by the usage of qualitative methodologies, for example van Sluisveld et al., (2018) discussed about the Initiative-Based Learning (IBL) in which actors' behaviour is modelled regarding technology diffusion processes and learning with the aim of enhancing the representation of the model.

The inner complexity of sustainable technological transitions, which involves different systems and non-linear interactions between the systems' elements set a high bar for sciences. It appears that some of these integrated models are not realistic and have many assumptions and fail at capturing social, cultural and political aspects of real systems (Anderson & Peters, 2016; van Sluisveld et al., 2018). Models are a simpler representation of reality, an intrinsic goal of models is to simplify the complexity of the real world, so that we are able to catch the main mechanisms of a phenomenon. However, models should be simple enough to facilitate users the reading and the interpretation of the model without missing the relevant processes undergoing in the system.

This balance between simplicity and complexity in modelling for policy purposes represents a milestone in the building process of IAM's. A review of criticisms on IAM's and some solutions to address these issues were proposed by Gambhir et al., (2019). The authors conceded that many models lack transparency about their structure, assumptions on behaviour change and an over-reliance on some technologies. They addressed the criticisms under the lens of bioenergy with carbon capture and storage (BECCS) and proposed solutions to these criticisms that fall in three main groups:

“ i) scrap the models and use other techniques to set out low-carbon futures; ii) transform them by improving their representation of real-world processes and their transparency; iii) and supplement them with other models and approaches”.

An additional characteristic that hinders the suitability of IAM's is that they use analytical approaches, however scholars have discussed about the possibilities of combining agent-based modelling (ABM) and IAM's. ABM is a computer-assisted approach used to model dynamics of complex systems, which are composed of elements that are called agents. These agents are autonomous and behave and interact in an independent way based on a set of rules implemented by the modeller. As a result of these interactions, a phenomenon called emergence might appear, which follow non-linear trajectories and it are not predictable by simply adding the elementary properties

of a set of elements. ABM earned momentum in the last two decades and has applications in different fields such as ecology, geography, engineering, political sciences, and economics, among others. ABM's need four parameters: the environment, the definition of autonomous agents in terms of decision-making, the set of rules for the interactions between agents and the environment and the rules between agents (Araldi, 2019).

The development of ABM has had applications in different fields including diffusion of innovation and simulation of systems of cities evolution, which are the topics of interest in this dissertation. The origins of the development of multi-agents systems date back to the 1980's and was at the intersection of Artificial Life (Langton, 1989; Ferber, 1995) and Distributed Artificial Intelligence (Amblard et al., 2015). The application of ABM in economics modelling or Agent-based Computational Economics (ACE) has also its origins in the 1980's. However, scholars have highlighted that early work in the 1980's and 1990's were published after long periods of delay or just remained as working papers (Tsfatsion, 2002), which might have slowed down the diffusion of the paradigm.

The possibilities provided by ABM allows to perform individualistic and heterogenic simulations, following intuitive behaviours observed in the real world. The ABM paradigm allows to do representations of real problems in an artificial way approaching reality at several levels. The observations derived from phenomena's emergence at aggregated levels and the subsequent representations can be counterintuitive, which is a feature of complex systems (Forrester, 1995; Pumain, 2008). Social innovation prediction falls into the categories of subjects treated on ABM literature, where pioneer studies on modelling complex systems and social science were based on adaptive agents and interactive cognitive agents (Bura et al., 1996; Allen, 1995; Pumain 2008).

ABM are seen as the next phase of the object concept, enhancing adaptability, learning processes and autonomy (Amblard et al., 2015). Another strength of ABM is that as a methodology but also as a paradigm is fundamentally structured on dividing big and complex problems in smaller articulations that are easier to handle. Scholars agree that ABM is a powerful tool to model spatial interaction, in which innovation diffusion and urban networks evolution are directly affected. The advancements achieved in the scientific development of ABM, from the start in the 1970s with the famous cellular automaton *life game* developed by Conway (Gardner, 1970) and parallel work from Burks (1970) or the element of evolution theory proposed by Wolfram (1994) until today is enormous. The current state of the art can be illustrated by the work of Banos et al., (2015) entitled *Agent-based spatial simulation with NetLogo, Volume 1* and the subsequent volume 2 (Banos et al., 2017). The authors show broad applications of ABM in urban systems via the open-source software NetLogo, with an explicit usage of the spatial component. In both books the authors explain throughout how to build an agent-based spatial model with different emphases and applications covering statistical analysis with other open-source software such as R.

Within the same ABM family, we find some models that incorporate social-psychologic approaches (Jager et al., 2000; Schwoon, 2006; Zhang & Nuttall, 2011). Some models integrate network approaches such as scale-free (Rahmandad & Sterman, 2008; Bohlmann et al., 2010; van Eck et al., 2011) also small-world networks (Alkemade & Castaldi, 2005; Bohlmann et al., 2010; Delre et al., 2007; Thiriot and Kant, 2008). Other type of interaction topology for agent modelling is lattice (Hohnisch et al., 2008; Goldenberg et al, 2010). A spatial diffusion model via network modelling was proposed by (Lengyel et al., 2019).

An integration between ABM and IAM's is feasible if it is done in a complementary way nevertheless theoretical issues about IAM could arise. Sluisveld et al., (2018) proposed two mechanisms to do this task; the first possibility is to initially develop an ABM model with different kinds of agents instead of a representative agent or a *centralized social welfare maximizer*. The problem with this approach is that the introduction of different kinds of agents would change the underlying theoretical aspects of IAM. The second option proposed by the authors, is to develop the ABM model and integrate the results in the IAM or the other way around. Academics have recently discussed about the need of an even larger interdisciplinary collaboration to improve IAM scenarios (Victor, 2015; Peters, 2016; Stern, 2016; De Cian et al., 2020). **In terms of approaches to deal with the energy transition faced by regions, we can be distinguished two main streams that intend to deal with the subject. The first one is the strategic or**

normative approach and the second deals with the exploration of the future with predictive models, which is the research angle of this dissertation.

Related work in France regarding regional studies and energy transitions, a relevant work called Rethinking cities in the post-carbon society was carried out by Theys & Vidalenc (2013). In this study the authors explored six scenarios concerning the future of cities vis-à-vis the energy transition process until 2050. The authors acknowledge the lack of the integration of spatiotemporal in political debates that address the sustainability transition, in spite of the fact that this process has an important territorial impact. Hence, the authors intended to incorporate the spatial and temporal dimensions in France. The post carbon-city is based on the idea to develop the capacity to systematically reduce the dependency on fossil resources such as oil, gas and coal. To reach that goal, the EU is committed to work on three main objectives: *i) to reduce by a factor of 3 or 4 the GHG emissions; ii) to become autonomous regarding oil and other fossil resources consumption; iii) to readdress the global warming trajectory¹¹ around 1.5 °C (IPCC, 2018a).*

The “post-carbon cities” concept requires a sociological and behavioural disruption of the way how cities function in the last two centuries and specially since the second half of the last century. The massive levels of energy needed to make work cities how we know them today have shown that it is not sustainable. The Swedish city of Gothenburg is a pioneer region that decided to analyse the changes required to reach the sustainability goals by 2050. The analysis showed that the changes need to be made in both, demand and supply not only focusing on the supply as it has been the emphasis in France (Theys & Vidalenc, 2013). This implies a real rupture in many perspectives, such as reducing by half the per capita energy consumption, but also changing almost the whole energy-mix as it exists today.

These changes deeply affect various social-technical systems and the way we live today, the urban forms, mobility, food and housing among others. These major changes are aligned with what is scientists refer to as urban metabolism, where the global functioning of the city is interrelated with its environment. In the scenario Gothenburg, the energy consumption per capita in 2050 should be 25 000 kWh, which is half of the current consumption and the energy would be provided mainly by solar, hydroelectricity, biomass and wind or tidal energy.

The comprehensive study was developed by Eek & Swahn (2003) and complementary work on the subject was developed by Phdungsilp (2011), see also Franzen (2003). Theys & Vidalenc (2013) proposed an integrated forecasting-backcasting approach in order to create scenarios of post-carbon cities. The backcasting methodology in this context was proposed by Eek & Swahn (2003), which is composed of four steps *i) the first step is to describe and analyse the current state of the situation and the associated trends; ii) determine the framework conditions regarding objectives and criteria that need to be met for a sustainable society; iii) images of the future are used to generate change processes and are the base for the development of strategies. iv) identification of change opportunities and an analysis on how to reach the images of the future.*

¹¹ At the moment of the Theys & Vidalenc publication in 2013, the global warming levels were suggested around 2° C and 4 °C. The publication of the International Panel on Climate (IPCC) in 2018 suggested 1.5°C.

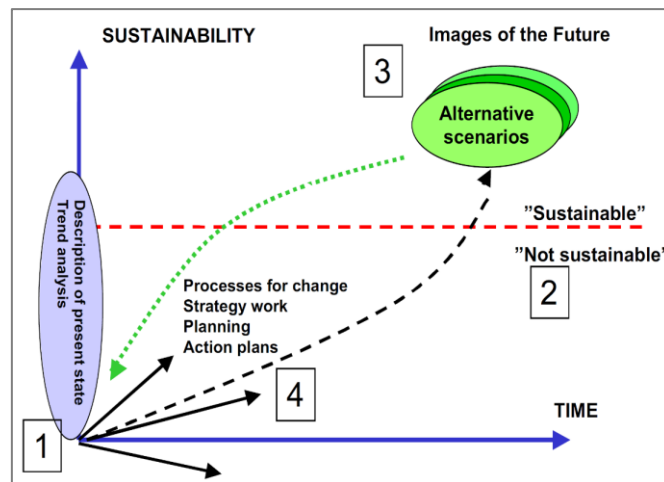

Figure 20 The Backcasting methodology. Source: Eek & Swahn (2003).

In the development of scenarios for post-carbon cities carried out by Theys & Vidalenc (2013) have a starting point in the environmental policies already pursued in the regions of reference. The rationale is to extend the perspective timewise and look at the possible conditions in the 2050 horizon. The authors warned about uncertainty issues in models that have such a long-term perspective, therefore a cautious interpretation is recommended. The nature of the six scenarios presented by the authors were based on the perception of the stakeholders of each region concerning opportunities and risks involved in the sustainability transition processes.

An aspect that was relevant for the construction of the scenarios was the participatory approach. Different stakeholders such as decision makers, scientists, and representatives of the municipalities could contribute with the aim of building a more inclusive scenario for each city. The general process was based in the backcasting steps described above however, the authors highlighted that in France the most significant difference was the valuable research work and findings on the levers and blocking factors in specific cities. For the French scenarios thus, three main phases were used: *i) exploratory phase of possible future contexts taking around 100 variables which were parameterized according the assumptions made for each scenario based on the history of the territory; ii) construction of backcasting scenarios oriented towards six directions targeting the same goals but with different configurations of actors' perception; iii) evaluation of all scenarios under a qualitative approach, but a quantitative approach would be also possible to develop (see Allio et al., 2012).*

In this context, scholars propose three political configurations in which different intensities of scepticism or adoption perceptions regarding radical ruptures at urban, energy and infrastructure renewal. We will briefly discuss the scenarios proposed in this study, but for an exhaustive review on the subject, readers are referred to Theys & Vidalenc (2013). The six scenarios were subdivided in two different groups, the first one was based on the actual trends and the second one on a favourable rupture towards innovations, which implies radical changes. Therefore, there are three scenarios for each group and each scenario is developed in different contexts.

The first context is related to the national and international conjunctures where the margin of manoeuvre is rather the capacity to react and seize opportunities. Under this context, two scenarios are proposed regarding the reaction to cope with change *i) intelligent attentiveness or a wait-and-see political attitude; ii) 'carbon creativity'*. In the first scenario, the actual trends are extended, so a cautious approach is favoured, a moderated rise of the oil prices is expected and the concerns for the GHG emissions are reduced. Investments are not massive and used to develop further green mobility such as carpooling, biking lanes, walking, better public transportation services and incentives for teleworking. These measures are accompanied of new standards for housing and renewable energy renovations.

In the second scenario, a technological and economic incentives are higher, including favourable fiscal policies, especially carbon taxation. These actions can be used to foresee possible future constraints and enable behavioural and technological changes at an early stage to increase RET usage, improve production systems, new materials, among others. The second context is related to the possibilities of investments and infrastructure and again, two scenarios regarding that question were developed i) new climate and energy infrastructures; ii) 'Biopolis'. In the first scenario, a massive housing renovation relating renewable energies is achieved, which would reduce by a factor of 3 the fossil fuels consumption. Also, important changes of scale in the energy supply systems are expected, giving more space to RET, this is accompanied of important investments on infrastructure and protection systems against climate change. Moreover, a change of scale in infrastructure of public transportation targeting the goal by the standards reached by Freiburg im Breisgau, one third of automobiles, one third of public transportation and one third of soft mobility.

The second scenario called by the authors 'Biopolis', decentralized solutions are favoured. Local stakeholders are responsible of decision-making processes regarding energy production. Additionally, natural environments and biomass are used in various ways such as vegetation, wood energy, biofuels, biomaterials are used to produce renewable energy. At urban level, city centres are vegetated and equipped with heating networks that work with renewable energy and peripheral urban areas are big "garden cities" with an integration of continuous fabric and agricultural areas. All the free services granted by the nature are properly taxed.

The third and last context is about the possibilities of actions on urban forms and lifestyles. Here, the authors also proposed two scenarios i) 'the city continues'; ii) thoughtful urbanism. In the first scenario, local stakeholders and urbanists play a central role in the sustainability transition. They are equipped of different tools such as spatial planning, land use control measure, housing policies, among others.

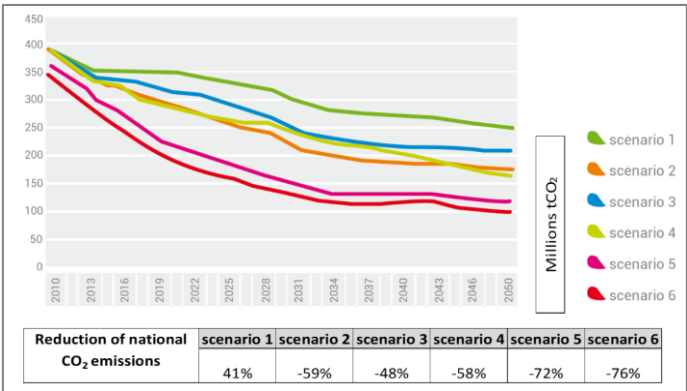

Figure 21 Emission reduction trajectories of CO₂ by scenario for 2050 in France. Source: Theys & Vidalenc (2013).

In the same study the authors discussed the complex interactions between demographic, economic, natural, technological, and behavioural variables in a heterogenous ways from a spatial standpoint. The acknowledgement of the variability of the behaviour of variables studied under a spatial perspective enriches the accuracy of prediction models, not only from GHG emissions perspective but helps for a planning perspective. The figure below A shows a clear example of the geographic differences in the temperature during the heat wave in 2003 in Paris. Models for the future maximal temperatures in 2050 and 2100 in France also show importance geographical variations of maximal temperatures.

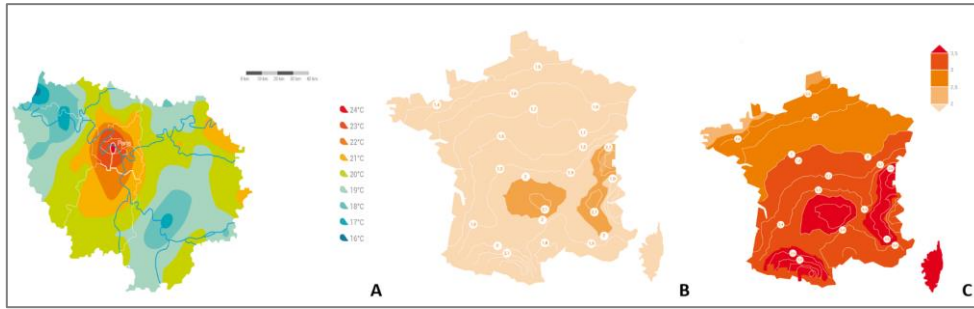

Figure 22 A) A specific vulnerability in city centres: amplification due to "heat islands" in Paris. Source Theys & Vidalenc (2013). B) Maximal temperature projected for 2050 in France. C) Maximal temperature projected for 2100 in France. Source ORNEC (2013).

We stress thus, that the spatial dimension is a fundamental aspect for the possible solutions of global warming and the development and diffusion of green technologies, respectively. Even though there is a strong and increasing interest in ST studies (Markard et al., 2012) it has been acknowledged that the role of space has not been explicitly considered (Smith et al., 2010; Coenen et al., 2012; Hansen & Coenen, 2015). At urban level, some projects based on ABM technologies with an integrative aspect of the spatial dimension under the umbrella of sustainability have increasingly been implemented. For example, The Cityscope¹² project developed by MIT researchers at the Media Lab, is an interesting approach in which a different set of variables such as mobility, water and energy management and also design and architecture features (Noyman et al., 2019). In general, it has been clear the growing interest on ST by the scientific community in the last 20 years as it is shown in the Figure 23 as follows.

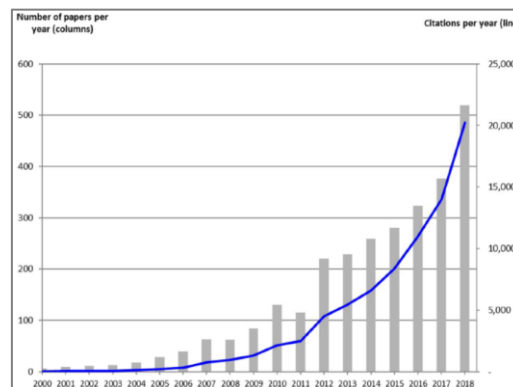

Figure 23 Number of papers on sustainability transitions in peer reviewed journals and citations. Source: Scopus, January 12, 2019; Köhler et al., (2019).

Regional studies that account for sustainable transition paths is exponentially gaining importance and the amount of academic work is not negligible. Since about a decade, it was created an important interdisciplinary network of scientists who are focused on sustainability transitions, called the Sustainability Transitions Research Network (STRN). Major contributors in the discipline are part of this network and have recently developed a state of the arts in the field and propose future directions of the agenda for sustainability transitions research (Köhler et al., 2019).

The creation of the STRN in 2009 (STRN, 2010) have contributed with different kind of methodologies, technical, social oriented, socio-technical and with approaches with an incremental consideration of the spatial dimension and har an early focus on Northern European countries. This network has contributed to a significant expansion

¹² Available online at: <https://www.media.mit.edu/publications/cityscope-a-data-driven-interactive-simulation-tool-for-urban-design-use-case-volpe/>

of transition studies in which *geography of sustainability transition* (GST) is part of the 2019 agenda¹³ (STRN, 2019), called: ‘*Geography of transitions: space, scales, places.*’ Since 2010, the STRN’s manifesto pointed at the need of considering the space in transition studies and identified two main issues. The first one was that analyses and comparative case studies failed at explaining how the spatial dimension matters. Consequently, considerations with an explicit geographical perspective were required in order to unfold the specificities of a variety of transition pathways contexts to theoretically better understand the transition processes.

The second challenge was to address the criticism rooted on the evident lack of scalar territoriality in the contemporary transition studies, which has the underlying and tacit assumption that transitions happen in an isotropic way, something that has been proven untrue and we have already extensively discussed in this study. The inclusion of space in innovation and ST is slow though, during the last decade we observe research work on the importance of space in ST studies that highlight the importance of more inclusion of space (Aoyama et al., 2011; Coenen et al., 2012; Lawhon & Murphy, 2012; Murphy, 2015; Hansen & Coenen, 2015). The broadening process of different fields doing advancements in ST is an integrated process with an interdisciplinary essence. The Figure 24 shows the evolution of research strands in ST studies converging in fourth main streams.

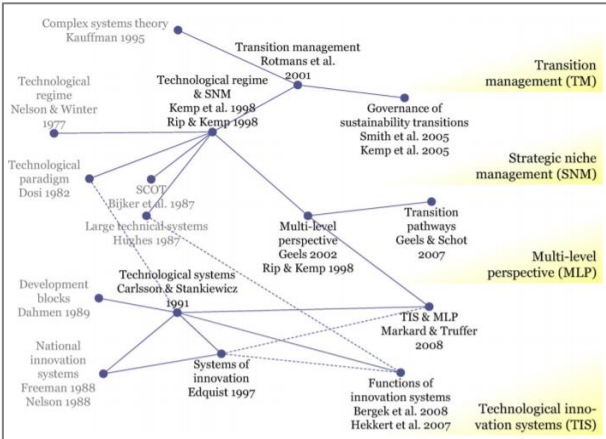

Figure 24 Evolution of research on sustainability transition, source: Markard et al., (2012).

In the literature of ST we find prominent conceptual frameworks such as Multi-Level Perspective (MLP). The MLP is an important middle-rang theory (MRT) that puts into a framework dynamic patterns observed in socio-technical transitions (Geels, 2011). The MRT was proposed by Merton (1968); the theory has been vastly used in sociology and it is based on the verification of theories through data analysis and observation. For other sciences than sociology for instance, this could be just the simple definition of a theory by itself, which is based on an assumption and then is tested and verified. Apart of that, there is an important aspect on Merton’s (1968) contribution: *“theories that lie between the minor but necessary working hypotheses that evolve in abundance during day-to-day research and the all-inclusive systematic efforts to develop a unified theory that will explain all the observed uniformities of social behaviour, social organization and social change”*.

The application of MLP conceptual framework based on MRT for sustainable transition purposes has been an important angle of research in the field. Epistemologically speaking, MLP is based on an evolutive premise that allows to incorporate different paradigms, theories, methodologies, and frameworks. For example, we find theories such as evolutionary economics, path dependence, social networks, niches, regimes, routines, trajectories (Geels, 2011). The MLP as a result of taking into account these different paradigms where complexity is present, also considers the non-linearity of transitions which are generated by the intertwined dynamics, which Rip and Kemp (1998) and Geels in his string of papers (2002, 2005, 2011) declined in three levels:

¹³ Available online at: https://transitionsnetwork.org/about-strn/research_agenda/

“... i) niches (the locus for radical innovations); ii) socio-technical regimes (the locus of established practices and associated rules that stabilize existing systems); iii) and an exogenous socio- technical landscape...”. The Figure 25 shows Geel’s (2002) MLP model:

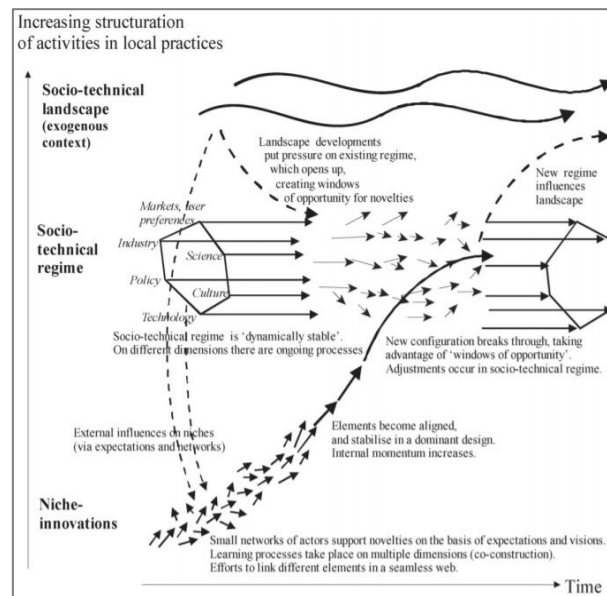

Figure 25 Model of Multi-Level Perspective. Source: Geels (2002).

Level 1. The lower level which is a micro-space for innovation called *niche-innovations* refers to protected ‘spaces’ for sciences and R&D which should be subsidized and supported to develop innovations (Geels & Schot, 2007; Smith & Raven 2012). For instance, some of these ‘spaces’ are the EPFL innovation park in Lausanne, also the pioneer European Technology Park Sophia Antipolis in Nice, Inovallée in Grenoble and the Ideon Science Park in Lund . These niches are characterized by a high interaction between sciences and the market, fostering a double transition from sciences to innovation and subsequently to products or services ready to market via spin-offs and start-ups.

Level 2. The *sociotechnical regime*, groups meso-dominant practices that account for the shaping process of the fundamental structure and stability of a sociotechnical systems which are defined by the Geels (2002, 2011) as the group of codes and rules of social groups that give directions to the decision-making process and coordinated activities that are reproduced in the system. Some of these regime rules are cognitive routines, shared beliefs, lifestyles, and institutional culture (Geels, 2011).

Level 3. The upper level of MLP is *the sociotechnical landscape*, which is a macro-setting that refers to the global context of the system that has been categorized as a “residual category”. This category has been criticized as it is a kind of a ‘garbage can’ because everything that is not explained in the lower levels falls into this category. van Driel & Schot (2005) proposed a framework with three elements: i) *Aspects that* do not change or evolve very slowly i.e., climate; ii) *rapid shocks* i.e., wars; iii) *long term changes* i.e., demographic changes (Geels, 2011). The term *landscape* should not be interpreted with geographic lenses, as this kind of terms has led to some confusion in the transition literature because they might have another meaning in geography (Lagendijk, 2006; Geels & Raven, 2006; Hansen & Coenen, 2015). This approach has not been uncontested but some answers to the lacks observed in the MLP have been addressed and the three levels are further explained and enhanced by Geels ¹⁴(2011; pp 26). According to the author, the higher levels of MLP are more stable than the lower ones regarding the number of stakeholders and degrees of alignment among the elements of the system. The spatial dimension

¹⁴ The original publication was proposed earlier by Geels (2002; pp 1261).

is not really considered in this approach, but we would argue that the direction of innovation and ST is inevitably opening opportunities to explicit geographical approaches with a high component in spatial modelling and simulation. For a deeper literature review on MLP (see Genus & Coles; 2008; Geels, 2019; El Bilali, 2019).

Other prominent approaches to study regional STs are Strategic Niche Management (SNM) and Technological Innovation System (TIS). The SNM gives a noticeable importance to the technological development in niches, which should be developed in a so-called *protected space* (Geels & Schot, 2007). Smith & Raven (2012) specifically developed an important work on the definition and implications around the *protective space* concept in the field of sustainable transitions. The TIS, refers to the second framing of innovation discussed in the previous section¹⁵ which has gradually been declined into Regional TIS or *Regional Innovation Systems* (RIS) where the spatial dimension increasingly begins to take a more relevant status (see Zukauskaitė, 2013). Moreover, Martin (2012) did a bibliographic study in which he compiled innovation studies that more precisely he called ‘*science policy and innovation studies*’ (SPIS).

In Figure 26 we can observe the broadening process of different approaches and fields in innovation studies (Markard, 2017). We observe at the centre of both, innovation studies (red dashed circle) and STs (blue dashed circle) that MLP stands as a prominent approach, also SNM studied in natural sciences, Transition Management¹⁶ (TM) in political sciences, Large Technical Systems¹⁷ (LTS) in engineering is slightly getting into the STs group . Inside the innovation studies group but outside of STs group we find RIS, which is rather a recent focus in economic geography, and we arguably state that advancements of RIS could gain more importance in the ST, a step further in that direction is the field of geography of sustainability transition.

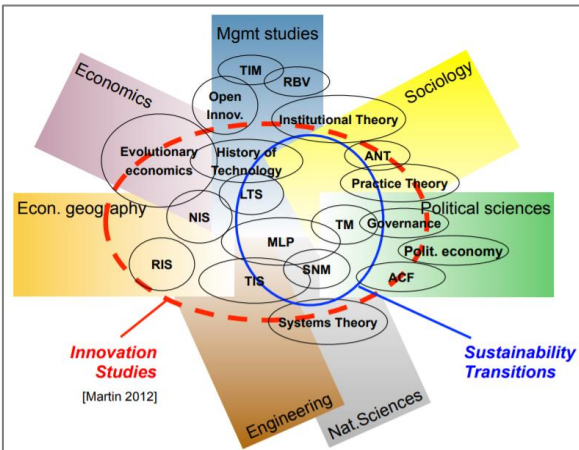

Figure 26 . Scientific emphases on sustainability transition studies. Source: Markard (2017).

Innovation and Geography of Sustainability Transitions

Geographical aspects are currently gaining the interest of researchers and policy makers thanks to the evolution of innovation frameworks and the gradual integration of sustainability transition approaches. It has been observed that the emergence of evolutionary economic geography (EEG) has been generating a new branch of research, addressing regional adaptation and urban development since the mid 2000’s (Martin & Sunley 2006; Isaksen, 2015; MacKinnon et al., 2019; Giacometti & Teräs, 2019). This new wave has a strong basis on path dependency theory, a place-specific legacy of a region to innovate and create new economic activities, influencing urban and

¹⁵ Bergek et al., 2008 discussed about the functions of innovation systems in the framework of TIS.
¹⁶ Readers interested in this approach are referred to Loorbach (2010).
¹⁷ see also Bolton & Hannon (2016)

regional changes (Neffke et al., 2011; Dawley, 2014; Binz et al., 2016). The development of this new wave of research has lately been accompanied by questions regarding sustainability transition. The emergence of EEG focusing on path creation appears to be contemporary to studies raising questions on the lack of geographical approaches in STs (Gibbs, 2002, 2006; Soyez & Schulz, 2008). The acknowledgement of geographical aspects within ST processes has boosted the birth of the already briefly discussed field geography of sustainability transitions (GST). There was a neglect of space integration within innovation policy during the first and second framings where economic growth and national systems were central. Recently, the incorporation of the spatial dimension in innovation frameworks has shown its benefits by providing relevant information related to new economic and urban activities, regional growth and regional imbalances and also environmental consequences at sub-national and intra-regional levels.

Scholars have recognized the great potential derived from interdisciplinary collaborations between economic geography and sustainability transition studies. For example, there is work related to water management (Binz et al., 2016), also Boschman et al., (2017) worked on integrative approaches of EEG and transition studies. Contemporary scientific literature has been addressing the spatial heterogeneity of regions and propose policy frameworks to boost green industries, covering innovation advantages and disadvantages regarding the geographical and path development of regions (Grillitsch & Hansen, 2019). The specialized literature also shows a convergence of innovation, growth, ST and GST which is meant to address the systemic conditions needed for innovation frameworks. An important question that GST addresses is why sustainability transitions occur in some places and not in others? (Hansen & Coenen, 2015). Innovation diffusion as a spatial process also addresses that very question on a more global perspective regardless of sustainability aspects for instance, spatial diffusion of any technology such as information, energy, people, knowledge, goods amongst others.

Supporting evidence suggests that the sustainability transition entails environmental and societal changes, so geographers need to deal with spatial issues at a socio-economic level and spatial heterogeneity in the process of diffusion of green technologies. However, the integration of the spatial component is not an easy task (Dainton, 2001) and besides this, the spatial dimension is understood and interpreted in different ways even within the field of geography. The arrival of new research directions such as the development of GST is an interesting focus that could open opportunities of collaboration between geographers from different schools of thought. The domain of GST is a topic of great interest for economic geographers since recent years, which means that innovation diffusion and GST are fields within geography predominantly studied by economic geographers. According to an important bibliographic review on GST (Hansen & Coenen, 2015) which focused on place specificity and importance and also on the geography of inter-organisational relations, the specialized studies mainly emphasise on niche development than on regimen dynamics. The authors mentioned that a lot of attention has been paid to understand the importance of place-specificity at local level and there is a general consensus about the relevance of the topic. However, there are very few theoretical approaches that provide a characterization of sustainability transitions.

Geographers have greatly contributed on innovation studies, starting by the spatial diffusion mechanisms of innovation diffusion, which will be discussed in the next section. The interest of innovation in geography is now partly focusing on sustainability transitions with early contributions in urban sustainability studies related to infrastructure and low-carbon transitions (Hoorweg, 2011; Hodson & Marvin, 2009; Hansen & Coenen, 2015). Similarly, as it was discussed earlier regarding the non-randomness of spatial diffusion of innovations, geographers have also been working on the spatial heterogeneity of sustainability transitions in urban systems (Asheim and Gertler, 2006). Current research projects developed through the prism of geography of GST such as GONST¹⁸ project that stands for The Geography of Nordic Sustainability Transitions is a Nordic initiative between six universities and research institutes from Sweden, Denmark, Norway, and Finland. In this project they dealt with

¹⁸ <https://www.gonst.lu.se/>

the question of the unsuitability of one-size-fits-all approach to foster ecological transitions in economies but rather a place-based policy-making practice, based on the specific attributes of the socio-economic, technical, and geographical context in regions. The most recent scientific outputs of this project dealt with a longitudinal study on the role of agency in structural change and path-developments of regions engaging in green industries (Jolly et al., 2020).

In terms of bibliographic reviews, Hansen & Coenen (2015) did rigorous syntheses insights on ST studies and detected different aspects that are place-specific (see also Capasso et al., 2019). The authors argued that regional policies help to shape the interactions of stakeholders giving them directionality that contributes to locally develop the diffusion of niche innovations and regional systems of innovation. It has been acknowledged that these developments do not appear because of a consensus between actors but rather as a consequence of the struggle at different scales (Hodson & Marvin, 2010; Coenen & Truffer, 2012). They also notice that the scarcity of natural resources is a propeller for green technologies (Carvalho et al., 2012; Bridge et al., 2013) and warned that local knowledge and specialization is a boundary for the implementation of new technologies and practices (Maassen, 2012; Bridge et al., 2013).

This technology lock-in effect, which might be positive or negative as discussed by Grabher, (1993) and Hassink (2010) depends on the cumulative process of specialization and knowledge for the former or the impossibility to move to new economic activities for a region in the latter. Regarding the diffusion of innovations e.g., renewable energy technologies are influenced by different issues that have underlying systemic conditions such as market structure, institutional relations, knowledge infrastructure and capabilities (Negro et al., 2012). Hansen & Coenen (2015) also underpinned the importance found in the literature concerning the relevance of cultural and social bound values at territorial level alongside strategies and policies in order to understand the GST (see also Maassen, 2012; Bridge et al., 2013).

The regional consensus about environmental issues and the acceptance of regulatory decisions and trust between networks that are meant to enhance the implementation and the adoption of green technologies are instrumental for the success of ST. The bounding values and culture at the regional level help to strength the local ties but can also function as a close system where new ideas from outside of the system are hardly accepted and diffused. The acceptance and diffusion processes of new ideas such as the introduction of sustainable technologies and policies in a region moves unevenly space-wise, so the role of specific actors in specific places within regional systems is essential. Hence, if we look at a regional system as a network where the nodes are the actors and the links represent the interactions between them, a too strong institutional, technological, market and culture might be deprived of new connections with other networks outside the system (Negro et al., 2012). The strength of intra-regional ties is a major factor for the GST but the complement of strong and weak ties outside the system's network will allow the system to evolve and reinforce its capacity to adapt and keep being innovative.

These factors will feed the inertia of the system creating along the way a spatial legacy of creativity and acceptance of new ideas that the territory will incorporate in its functioning as an integrative part of the system. On the contrary, if a regional system is not able to receive new brand ideas and knowledge the system risks to be self-dependent in terms of inner creativity which might imply a lock-in. From this perspective, it has been underpinned by scholars that the early adoption of environmentally friendly services and products in some parts of regions, generate strong environmental values on the one hand and eases to prepare and establish the ground for early end-user engagement to new technologies on the other hand (Binz et al., 2012; Hansen & Coenen, 2015). In terms of research directions, the STRN agenda on GST (Köhler et al., 2019) proposes a more spatially oriented research on regimes conceptualization. We would like to add that the *“Geography of transitions: Spaces, scales and places”*, which is intended to be a conceptual platform for transition studies with a high spatial nuance is an excellent research platform to incorporate an active integration of the spatial dimension coupled with approaches such as the MLP proposed by Geels (2002). This Ph.D dissertation follows that direction and intend to contribute

to the MLP's meso-level of the so-called socio-technical regime, which is aligned to the current and future research in the field.

The different conceptualization of space depending on the schools of geography might be a barrier for future collaborations, but we argue that they can be complementary by their own right. Here we will refer to the spatial dimension in two main ways, the first and most recurrent is the usage of space as a spatial agent with a supporting role, for example in the last decades when scholars refer to the spatial dimension in regional systems. Under this view in regional studies, space is often related to administrative borders at sub national entities such as counties, departments, cantons, states or cities; the names vary per country. This consideration of space is especially useful for policy purposes i.e., in economic geography studies usually refer to space in this way, since the boundaries are ruled by political authorities who can enable decisions at the spatial dimension studied. A clear example within the EU is the Nomenclature of Territorial Units for Statistics¹⁹ (NUTS) which is a system that contains statistical information categorized by different spatial levels such as municipalities, counties or regions.

Now, borders are man-made, while many societal and environmental phenomena are not delimited or ruled by administrative boundaries that are designed by human agreements or laws. As a response to this limitation, quantitative geographers have developed another view to complement the lack of this approach, which can consider administrative borders but can also overcome man-made limits through spatial analysis processes. For instance, in the case of RET adoption of technologies such as solar and thermal panels, regional studies aggregate instrumental data, hiding the underlying urban conditions of the diffusion process in smaller spatial scales than a city. As a response to these difficulties, a stream of quantitative and theoretical geographers started to take the spatial component as an active agent in the system. This means that the space dimension is not only referred to in order to design the name of a place or to merely give information regarding the distance of the elements inside the system. From this perspective, space is taken at the same level of relevance as other variables and interacts as another agent such as people, businesses, innovation or economic growth. Here, space behaviour is non-linear and is able to trigger further interactions among other elements of the system via positive or negative feedback loops.

This approach enables quantitative geographers to analyse the complex relations emerged due to the space influence in a system. Consequently, a determined process can be reinforced or debilitated by the influence of space. Some phenomena can be captured in a scale-dependent fractal dimension way, which is known in complex systems as emergence. This space perspective is very often used for modelling purposes and analysis under computer-aided techniques such as spatial analysis via GIS. This view of the space allows quantitative geographers to model non-linear behaviours of different phenomena space-related which has a proven influence in human activity such as social relations, population dynamics, employment, mobility, diffusion processes, settlements, businesses, innovation amongst others. Thanks to the massive production of digitalized spatial data today we can access geo-referenced information at one-meter resolution in some countries like Switzerland. The incremental investments of governments in geo-referenced data facilitates today the development of models and simulations with high accuracy, allowing experts to use a variety of resolutions which range from very few meters to a national or continental level. The granularity of the resolution depends on the purpose and logically on data availability.

We argue that the integration of both views on the spatial dimension is promising and would strengthen the contribution of geographers in the third framing of innovation so-called transformative change. The alignment of socio-technical studies should not be oblivious to geographers; interdisciplinarity is imposing its way in manners never seen in history. As mentioned before, a clear example is the current economic revolution due to the emergence of NBIC that is precisely a result of fruitful interdisciplinary work. We claim that GST is an emergent field that gives the opportunity to conduct interdisciplinary research in the field of innovation and transitions studies to geographers from different horizons. Unequivocally, climate change mitigation and societal challenges

¹⁹ See <https://ec.europa.eu/eurostat/web/nuts/background>

contain many flavours, and it is only possible to deal with them with the collaboration of social and natural sciences and engineering. The arrival of socio-technical systems is a window opportunity for more comprehensive approaches in geography that have historically been separated in some schools of geography slowing the advances and contributions of geographical approaches in innovation and transition studies. The complementarity between not only quantitative geography and economic geography, but more globally between human geography and physical geography could be an important step to improve and increase the scientific contribution of geography in innovation and transition studies.

In terms of the scientific field, we have now arrived at a critical point, which we have resorted in this dissertation. The research perspective of the hereby study has precisely been enriched by the integration of different streams from geography that to our knowledge is an efficient and rigorous way of tackling the research questions of interdisciplinary nature. Furthermore, the position of this Ph.D project is within the third framing of innovation that is *transformative change* with an intended directionality towards spatial diffusion of sustainable innovation, which is subsequently within the framework of GST. The usage of epistemological and application of methodological approaches range from engineering to spatial modelling and principles of evolutionary economics. In summary, the third framing of innovation has brought fundamental changes for innovation policy and sciences, and their instrumentalization to fulfil the socio-economic and environmental voids left by the previous frameworks of innovation. The interest for a transition towards a bioeconomy has deployed interdisciplinary work in different fronts. These advancements include the work of geographers in ST research contributions and urges geographers to seize the opportunity to take a more prominent role in the field of innovation studies and potentially participate more actively in policy-making processes that until now has been a role mainly for economists.

1.4 Diffusion of Innovations

Diffusion of innovations (DOI) is a subject that has been studied in different disciplines and has attracted the attention of scholars from the beginning of the 20th century. It is fair to concede that DOI might be as important as the concept of innovation itself. At the end of the day what really matters is the diffusion of an innovation and not the only introduction to market. Innovation diffusion is one of the topics most studied in social sciences (Rogers, 2003; Kiesling, 2011) and a major mechanism for social and technological change (Katz et al., 1963). Diffusion processes have interested the scientific community since a long time ago, in the geography field is a common topic when it comes to territory dynamics modelling. In other fields, there is a lot of literature on the spread of disease (Anderson & May, 1991; Dumolard, 1999; Jinjark et al., 2020), rumours Daley and Kendal (1965), innovation (Rogers, 1962; Fourt & Woodlock, 1960; Mansfield, 1961; Bass, 1969). A little more recently, Sterman (2000) publish his classic book on product diffusion with system dynamic approaches.

Diffusion of innovation was first studied by one of the most outstanding and one of the fathers of sociology and social psychology in the XIX century in France, Gabriel Tarde (1903), even though he was not very well known by English readers. Tarde was a thinker and had a very advanced view on innovation diffusion in his time, he noticed some regularities on the diffusion process that he called "*law of imitations*" which is what we nowadays call *adoption of innovations* and he also coined the term *early adopters* (Rogers, 1983). Tarde was also a judge and noticed that criminals knew each other and appeared that they learned their techniques in a reciprocal imitation process, diffusing their behaviour through a knowledge network. He successfully could observe the S-shape curve or logistic distribution followed by the diffusion of innovations as a function of time. This observation is a major finding that has been studied afterwards by several scientists including in the field of geography. It is important to note that geographical diffusion not only follows an S-shape curve (see Patrice, 2007).

Tarde observed that in the beginning of a diffusion process only few people in a social system would adopt an innovation. In a second phase, more adopters would join making the spread process faster. He also noticed that this acceleration of diffusion, when the diffusion takes off and starts to follow an exponential curve in the beginning is highly triggered by opinion leaders. This concept is widely used nowadays in digital marketing through social-media networks such as Instagram where opinion leaders are commonly known as *influencers* or *influentials* in the specialized literature. Tarde stressed the social influence on the diffusion process arguing that *"Before being a production and an exchange of services, society is first and foremost a production and an exchange of services exchange of needs as well as production and exchange of beliefs; this is indispensable"* (Tarde in natural Darwinism and social Darwinism, *Revue Philosophique*, t. XVII, 1884, p.619, cited by Lazzarato, 2002).

The role of opinion leaders in DOI theory is still a contemporary research subject (Mahajan et al., 2000; van Eck et al., 2011), in the current digital world the *word of mouth* is still a growing field in marketing, but it is not new, it is older than hundred years thanks to Tarde. In the 1960's, during the first innovation policy framing, there were important scientific contributions in the DOI field, major figures as Everett Roger (1962) who put solid theoretical bases in the field and Frank Bass (1969) who developed his famous DOI model. The model of Bass was a breakthrough contribution in the field of DOI, specifically in marketing. His special interest in the *word-of-mouth* process made a milestone in the topic.

Another key contribution from Tarde, was his observations and conclusions regarding the similarity proximity of new ideas adoption to former accepted innovations, the closer a new idea is to an existing one, the more likely this new idea will be adopted, thus accelerating its diffusion (Tarde, 1903; Rogers 1983). A pioneer work was also done in the fields of ethnology and cultural anthropology by Svensson (1935, 1942) whose work was an inspiration for Swedish geographer and Vautrin Lud prize recipient Torsten Hägerstrand who did a breakthrough on the field of innovation diffusion as a spatial process (Hägerstrand, 1952, 1953).

Hägerstrand successfully observed spatiotemporal patterns in the diffusion of several innovations in Sweden and could approximate their spatial diffusion through a Monte Carlo simulation. This simulation was highly computer-dependent, he used one of the first computers in Sweden, thanks to his friend, computer scientist and physicist Carl-Erik Fröberg who also introduced him to the Monte Carlo simulation. It is difficult to establish when computers were used for the first time for geographical research (Brunn et al., 2004). Nonetheless, historical evidence seems to back up what Morrill (1984) stated, who argued that Hägerstrand and his colleagues at Lund University and also Bill Garrison at the University of Washington are among the first scientists to do computer-aided geographical studies. An important fact is that Hägerstrand was part of a generation of Swedish geographers with a strong background in both, physical and human geography. The innovative and comprehensive approaches used by Hägerstrand on diffusion and later on time geography, boosted the reputation of Lund University as a major centre in cultural geography in the world.

In the 1960's the DOI theory was broadly spread in the scientific community thanks to the work of Rogers Everett (1962). According to the author, at the moment of the first edition of his work in 1962 entitled "Diffusion of Innovations" there were 405 publications on DOI, in 1971 there were around 1,500 publications, in 1983 the total of publications in the topic was about 3,085. Nowadays we find over 79.000 publications published by Elsevier. Rogers highlighted four elements in the diffusion process: the innovation, communication channels, time and social systems.

During several years researchers would assign different names to the categories of innovation adopters for instance the most innovative groups were called *"progressists," "high-triers," "experimentals," "lighthouses," "advance scouts," and "ultraadopters."* And the least innovative got names such as *"drones," "parochials," and "diehards."* (Rogers, 1983). The names as we know them today were proposed by Rogers (1962), which finally became a predominant terminology derived from analyses of the S-shape curve and a bell-curve behaviour of innovation diffusion processes.

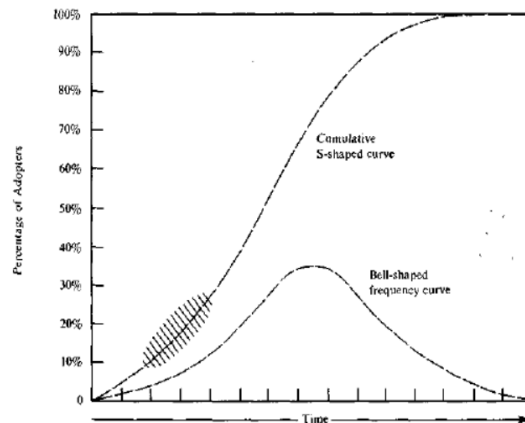

Figure 27 The bell-shaped frequency curve and the s-shaped cumulative curve for an adopter distribution. Source: Rogers (1983).

Both curves displayed above used the same data of a diffusion process, the bell-shape illustrates the frequency of adopters each year while the S-shape curve represents the cumulative behaviour of diffusion over time. The marks in the S-shape curve represent the moment when the diffusion “takes off”. The categories of innovation adopters proposed by Rogers (1983) was called by the author as the *Method of Adopter Categorization*. This method is in line with the Kolmogorov’s axioms in probability theory, which implies:

- i) Non-negativity. The probability of an event is a real number x is ≥ 0
for an event $A \subseteq \Omega$ $P(A) \in \mathbb{R} \wedge P(A) \geq 0$
- ii) Normalization. The probability that at least one of a set of experiments outcome is = 1:
 $P(\Omega) = 1$
- iii) Countable set. When events A and B are mutually exclusive, then the probability of either A or B is: $P(A \cup B) = P(A) + P(B)$

$$P(A_1 \cup B_2 \cup \dots \cup B_i) = \sum_{i=1}^{+\infty} P(A_i)$$

Rogers raised three main concerns that scientists were confronted with: i) *how many categories of adopters characterize the adoption phenomenon*; ii) *What was the ratio of each category* and iii) *which methodological approach was the most appropriate to define the adopter categories*. What it was clear for scholars by then, it was the criteria analysed: innovativeness. The gradual changes related to the moment in which a group of individuals accept a new idea either at a very early or a gradually later stage was a parameter used to distinguish the categories.

The methodology to determine the adopter categories followed by Rogers was based on a transformation of innovativeness continuous variable as a discrete variable, an operation he would refer to as a *device*. Even though some data is lost in the process, this operation is broadly accepted, and it is known as discretization. Discretization is an easier knowledge-level representation than continuous values (see Liu et al., 2002). In the case of innovation adopters this process was used to divide the bell-curve into categories using two statistical parameters present in normal distributions which are the mean x and the standard deviation sd , where x represented by a vertical axis divides the bell-curve in two equal areas and the sd represents the average amount of variance at the two sides of the bell-curve which are split with vertical axis

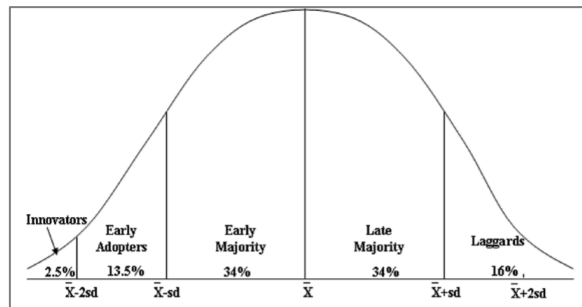

Figure 28 Adopter categorization based on innovativeness. Source: Rogers (1983).

Rogers defined five zones to categorize the level of adopters regarding their innovativeness as follows:

- Innovators: Venturesome 2.5%
- Early Adopters: Respectable 13.5%
- Early Majority: Deliberate 34%
- Late Majority: Sceptical 34%
- Laggards: Traditional 16%

Statistically speaking, **innovators** correspond to the 2.5% of the population of study, equivalent to the average minus two standard deviations. He called this sophisticated group *innovators*, which are typically people who are very eager to try new things and ideas and are often part of cosmopolitan elites. Recurrent and common characteristics are found in these individuals such as friendships and communication patterns. This pioneer group is willing to cope with lower levels of risk aversion and high uncertainty contexts where imperfect information and dealing with complex and technical information is accepted. This requires the access to substantial financial resources to cushion possible loss. These pre-conditions limit the possibilities to be part of this selected group, Rogers (1983) called the salient value of innovators as venturesomeness. Innovators play a key role in the diffusion process as they are the ones who dare to create a disruption in the boundaries of a social system by adopting new ideas, Rogers called them gatekeepers of ideas. From a network perspective, innovators and influencers are the hubs of the system that is, the nodes with the highest number of links or the highest degrees. A possible representation on a network for innovators as a main source of diffusion is shown in the Figure 29.

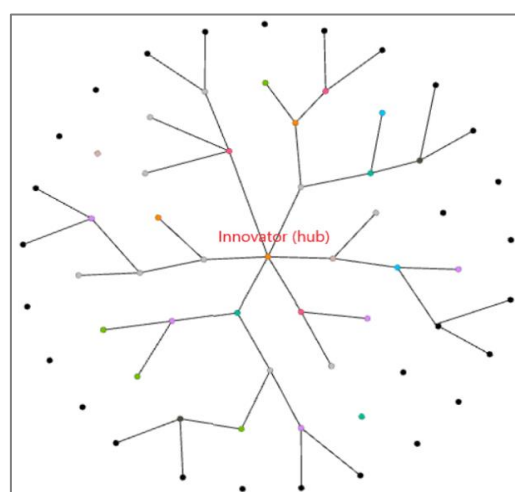

Figure 29 Network representation for Innovators.

Early adopters are the second group and is typically represented by 13.5 % of the population according to Rogers's work (1983). They are also considered as *innovators* and it has been observed that early adopters have the highest

impact in terms of opinion leadership than any other social group (Rogers, 1983), that is the reason why Rogers called them as *respectable*. The position of this category allows its individuals to be ahead of the rest of the population but still at reach therefore, they usually play a role model for potential adopters, which often refer to them for information and new ideas.

A central aspect of the early adopter role is to decrease the uncertainty embedded in new ideas and transmit it to their pairs in a “safer way” by means of interpersonal networks. Regarding the latter characteristic, it is important to add that this category at the contrary of innovators, their influence is operated in a discrete manner and the diffusion process is developed one to another. Figure 30 shows a possible representation of early adopters, which have a connection with an innovator and subsequently with other early adopters and potential adopters that might become the *early majority*, as it is explained as follows.

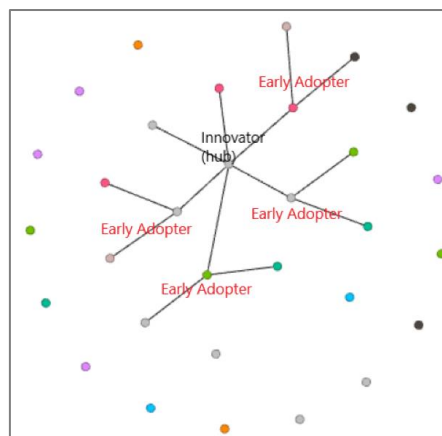

Figure 30 Network representation for early adopters.

The early majority is the category right before the average adopter that entails that this group of people wait until a new idea or innovation has proven to be worthy. The early majority is described by Rogers (1983) using the motto of Pope Alexander: *"Be not the first by which the new is tried, nor the last to lay the old aside"*. This group needs more time than innovators and early adopters before adopting an innovation, their mid position in the diffusion process between early adopters and late majority prompt them to be an important connecting part of the diffusion process.

From a network perspective, if we observe the formation of a network as a function of time, this group even though is not the most innovative is located at a critical position as they are in the middle between innovators and laggards. In network theory, the property that allows to calculate this centrality measure is called betweenness centrality which is discussed throughout in Chapter 4. Betweenness centrality is a property proposed by Freeman (1977), which gives information on how important a node is at connecting other nodes that is, as an intermediary connector. The early majority in a network might not have a big influence as innovator, but it has been discussed in the network science literature that a node can have a critical position in terms of an intermediary role even if its degree of influence is low (Jackson, 2008). In the Figure 31 the node 4, which represents *early majority*, illustrates the key role of a central node in a network that in spite of having a low degree centrality²⁰ it is the node that allows the diffusion to happen between innovators and laggards, otherwise we would have two components composed by nodes 1, 2 and 3 in the left side and 5, 6 and 7 in the right side.

²⁰ Degree centrality provides information on how well connected a node is. As an example, the node that represents innovators shown in the Figure 30 is highly connected, meaning that has a high degree centrality. For more information about networks science see Chapter 4.

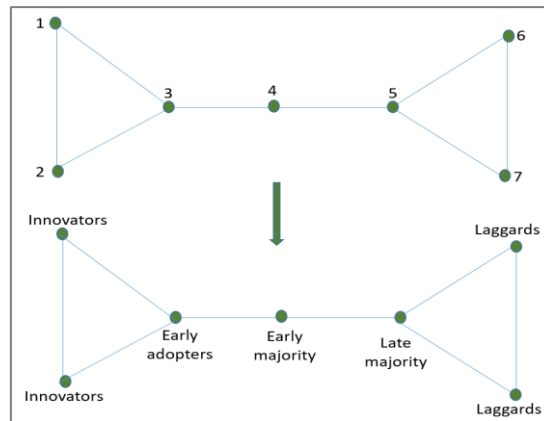

Figure 31 A Central Node with Low Degree Centrality. Source: adapted from Jackson (2008).

In the graph above if the node 4 is deleted, the component structure of the network will be transformed creating two different components, interrupting thus the diffusion process. Hence, the position of central nodes in a diffusion process, in this case of the early majority fulfils a critical task in the social system.

The late majority category comes right after the average adopter and it is described as a group that adopts an innovation driven by two main motivations, adopts for economic necessity and to respond to social pressure. This group is sceptical and even after seeing that the large majority have adopted a novel idea and that they are convinced that the innovation works they need social pressure to become adopters. Economic factors are a major issue for this group hence, the risk aversion and scepticism to invest are high, so they need to be reassured before they adopt an innovation. This group represents an important proportion of the social system, that is around one third of the total adopters in the process.

Laggards or the “*traditional*” category is the last group of adopters whose vision on future decisions are based in the past, which put them in the group with least opinion leadership. The social circle of this group is very horizontal in terms of innovative vision, which suggests that they do not interact so much with other categories generating thus a non-innovative pervasive effect continually reinforced. Economics aspects are also important in this group, which is traditional and sceptical towards innovation and change. These individual often adopt an innovation when they are sure that it will not fail and is often obsolete already, as innovators have already adopted the newest ideas or technology.

According to the literature there are a lot of variables to explain the innovativeness in individuals, Rogers (1983) declined them in three main aspects: *i)* socio-economic status; *ii)* personality; *iii)* communication behaviour. Furthermore, a general aspect that appears to be recurrent in innovation studies ranging from DOI to economic geography and economics is a link between innovation and wealth that systematically leads to inequalities. For example, in DOI an interesting question related to wealth and innovation was posed by Rogers (1983): *Do innovators innovate because they are rich, or are they rich because they innovate?*

If we look at this question keeping in mind the recent literature on innovation and inequality discussed in the first section of this study, we could be able to draw an interesting analysis on the topic. Innovators and early adopters as described before, are individuals who have the financial capacity to adopt new ideas and innovations and tend to have a lower risk aversion than the other categories. This implies that innovators are able to cope with the economic barriers that for example technological innovations pose when they entry the market. The underlying condition in general terms, is that financial capacity is necessary to adopt innovations, this gives advantage to the first adopters who can afford it and in the case of a successful investment they will have larger profits and will subsequently increase the gap between them and the rest of innovation categories. The underlying condition in general terms, is that financial capacity is necessary to adopt innovations, this gives the first-mover advantage

who can afford it. In the case of a successful investment, they will have larger profits and will subsequently increase the gap between them and the rest of innovation categories, letting laggards become relatively poorer.

Another aspect that we would argue that plays a key role is the readiness to innovate not only in terms of ability and technical knowledge to understand and manage complex information but also in terms of gauging the value of a technological innovation. As it was argued by British geographer Eric Sheppard (2018), there is more to value than price when it comes to commodities. The adequacy of price of commodities has been a research subject and there are questions about whether value can be really quantified at all (Barnes, 1996). *“Use value, the idiosyncratic question of what an object means to a particular person in a particular place and time, is qualitative and subjective”* (Sheppard, 2018). The combined nature of all these aspects that are part of an innovation process, has led scholars to draw some conclusions that suggest a recurrent and systematic link between wealth and innovation that triggers inequalities:

- i) at individual level as it is explained in DOI literature (Rogers, 1983, 2003);
- ii) ii) at the regional level in economic geography literature (Lee, 2011; Lee & Rodriguez-Pose, 2012, Rodriguez, 2017);
- iii) iii) at a national level in the literature of national systems of innovation (Schot and Steinmuller’s (2018) and
- iv) iv) at global level in the economics literature since the times of Adam Smith (1776) who wondered why England was wealthier than continental Europe and later the disparities among developing and developed economies (Kuznets, 1973, Piketty, 2014).

Innovation has intrinsically a notion of outstanding performance or productivity against the status quo in a system composed by agents who are in a competition. This entails that the existing conditions in the system must be disrupted so a winner can succeed through an innovation. Therefore, equality attributes are not kept forever, so it is not possible to be outstanding and equal at the same time. This attribute of innovation poses a major question: Is it inequality an inherent mechanism of innovation by itself?

Until here, we have been referring to inequality as a bias where wealthier individuals, regions or countries as a whole are in an advantage position to be innovators. The term inequality can be used in different contexts, synonyms such as disparities, differentiation, irregularity, or disproportion could be used in an innovation context and for the purposes of this research in geography we will refer from now on as a spatial preferential attachment. To further develop this concept, we intend to give theoretical aspects that back up this proposition of disparities in DOI and SDI respectively, relying on network theory. Particularly the model proposed by physicists Barabasi and Albert (1999) called preferential attachment, this subject will be further discussed in Chapter 4.

Findings suggest that the couple of innovation with wealthier individuals, groups or territories is reproduced at different scales and in different places. This might indicate several assumptions that need a broader research than the one provided in this doctoral thesis, but this opens new directions of research in innovation studies. Nonetheless, we can already address some issues that are fundamental for this research work and that have implications about heterogenous adoption of innovations from a spatial perspective that clearly show a non-random behaviour in the diffusion process.

This premise of rich get richer or Jackson effect in economics (Dauphiné, 2011) or Matthew effect in sociology (Merton, 1968), can be linked to two concepts both in economic geography and network sciences. For the former, the concept of path dependency in social sciences, where structural pre-conditions and historical inertia could at least at some extent predict the future performance of a region. For the latter, the concept of preferential attachment introduced by physicists Barabasi & Albert (1999), which is fundamentally based on the 80/20 rule proposed by Pareto. Similar processes of fat-tailed distributions (Price, 1965) have been discussed since a long time ago, other examples is the Yule process (Yule, 1925), the first-digit law of Benford (1938), Gilbrat’s Law (see

also Zipf 1949; Simon, 1955). We will develop further in section 4.1 the aspects of preferential attachment and fat-tailed distributions under a graph perspective.

In the DOI modelling field, early models developed in order to simulate the DOI process, starting in the very beginning with compartmental models or aggregate-level models. Bass (1969) proposed a model to simulate DOI, the model was based on differential equations as it is also explained in the classical book of business dynamics of Sterman (2000). Bass propose a complete model first in a publication in 1963 (Bass, 1963) but it did not have empirical evidence and was finally accordingly adapted in 1969. In the classic Bass model potential adopters become actual adopters at a rate that depends on two sources. One is an external influence such as advertising and the other is an internal influence such as word-of-mouth promotion. Thus, some of the potential adopters will be adopters at a probability rate p in a given time period t . Bass model is based on the following differential equation:

$$\frac{f(t)}{1 - F(t)} = p + \frac{q}{M} [A(t)] \quad (1.16)$$

The model has three parameters, which are M , p and q .

Where;

M = The potential market or the potential total number of adopters

p = coefficient of innovation

q = coefficient of imitation

Furthermore:

$f(t)$ = the portion of M that adopts at time t

$F(t)$ = the portion of M that have adopted by time t

$a(t)$ = adopter (or adoptions) at t

$A(t)$ = cumulative adopters (or adoptions) at t

The differential equation would read as the proportion of the potential market M that adopts at time t given that they are still potential adopters (or adoptions) is equal to a linear function of the adopters (or adoptions). The parameter p is called coefficient of innovation given that is not multiplied by $A(t)$, which is the cumulative function of adopters (or adoptions) at t ; whereas the parameter q is called coefficient of imitation as it is multiplied by the cumulative of adopters²¹ (or adoptions) $A(t)$.

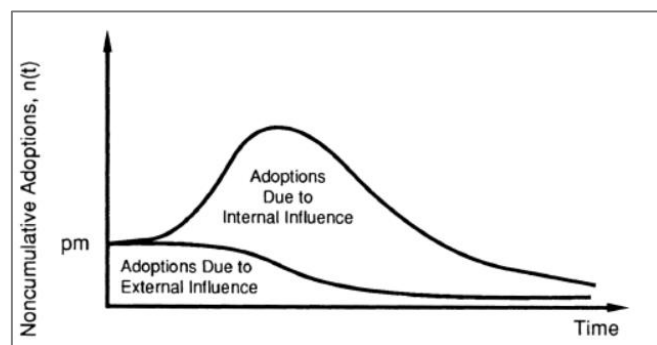

Figure 32 Adoptions due to external and internal influence in the Bass model, Source: Mahajan et al., (1990).

²¹ The multiplication of the parameter q with the cumulative function $A(t)$ represents an imitation process, as q value depends on the cumulative function, which typifies earlier adopters (or adoptions).

Figure 32 shows an example of adoption curves with different coefficient values for p and q and M is usually assumed constant although some modifications of Bass model have been developed where M might vary (Mahajan et al., 1979). Bass model has been broadly adopted in companies since several years ago (Bass, 1980) and it continues to be used (Thiriot & Kant, 2008). Innovation diffusion models such as Bass model that functions at aggregate-level, are typically based on differential equations (Chatterjee & Eliashberg 1990). The 'Bass-type' models have not been uncontested since they use aggregate-level approaches and have the assumption that all adopters behave homogeneously (Tanny and Derkzo 1988; Van den Bulte & Stremersch 2004). This means that adopters cannot be treated individually, and the granularity of data is compromised given that the method cannot catch differences amongst potential adopters. Therefore, the intricacies of complex dynamic systems in social processes, as happens in the real world, cannot be captured (Mahajan et al. 1990).

The process of diffusion of innovations is shaped by different factors such as a system of values, assumptions, perceptions, customs, and beliefs that are individually or collectively developed in a cultural perspective. Moreover, different variables such as the level of education, the socio-economic situation of the individual, her cultural background, and preferences play an important role in the decision-making process. Decision-making processes have been studied in the field of psychology, neurosciences, and behavioural economics, where empirical research on human cognition has shown the duality condition in decision-making processes which are composed by cognitive and affective states (Baddeley, 2010). The underlying cognitive characteristics involved in mental processes related to decision-making are beliefs, expectations, and knowledge among others whereas the affective level is shaped by feelings and emotions (Lempert and Phelps, 2014).

In the field of geography, an example of a decision-making process related to the adoption of a land-use law under a participatory approach where both states, cognitive and affective were present was done by Rojas & Loubier (2017). As it is shown by the authors, decision-making processes in spatial projects which commonly involve several criteria are complex procedures where inconsistency of what individuals desire frequently arises. Besides, when the decision process is made by more than one individual, land managers and experts need to deal not only with individual inconsistency but with consensus, a task that proves to be complex.

Other limitations of the Bass model reside on its predictive power that depends on the coefficient values, which have been studied by scholars given the difficulty of their estimation (Van den Bulte and Lilien, 1997). The reliability of the estimates of the coefficients has been questioned as a lot of historical data is needed to build a reliable model. The problem is that the historical data gathering process takes time and it is often too late to use it for forecast purposes (see Bernhardt & Mackenzie, 1972; Heeler & Hustad, 1980; Kohli et al., 1999; Mahajan et al. 1990; Kiesling, 2011). An additional limitation regarding the explanatory power of Bass model has been discussed in the literature given unrealistic assumptions (Maier, 1998) derived from a non-behavioural based approach (Goldenberg et al., 2000). Katz & Shapiro (1985, 1986) started a new generation of diffusion models after Bass, in which they stressed the relevance of analysing network externalities to better understand the adoption mechanisms through market competition.

The limitations present in aggregate-level or compartmental models have been addressed via the usage of ABM. The great advantage of ABM is that this approach enables automata or entities to make rule-based decisions, which allows the system to evolve based on the dynamics of change that might be increasingly complex at each stage. The increase of complexity is the result of incremental non-linear interactions between the agents. These interactions can be modelled through rule-based decisions in which cognitive states trigger the actual behaviour of agents (Thiriot & Kant, 2008). The development of ABM has gained momentum in the last years given its applications in a variety of disciplines such as economics, geography, ecology, political sciences, among others. Kiesling (2011) did a doctoral dissertation on innovation diffusion under ABM approach where social influence is modelled and compiled a relevant bibliographic literature review on the subject as it is shown in the table below. For an exhaustive bibliographic review on ABM simulation of innovation diffusion see Kiesling et al., (2012).

Authors	Decision-making process of agents	Interaction approach
Abrahamson & Rosenkopf (1997)	threshold relying on individual assessment.	densely-linked + weakly-linked
Plouraboué et al., (1998)	social influence and learning induced criticality	neural network
Gondelberg et al., (2000)	heterogeneous individual utility	multidimensional lattice (2-5)
Gondelberg et al., (2001)	probability to get awareness via wom in strong and weak ties	lattice
Deroian (2002)	evolving network based on homophily	peopenessy to adopt based on expected utility
Alkemaded & Castaldi (2005)	neighbourhood threshold	k-regular, random & small-world
Deffuant et al., (2005)	fixesd state transition scheme based on interest and information states	small-world
Cowan et al., (2006)	evolving utility of shared knowledge based on organized proximity	random, small-world
Delre et al., (2007a)	threshold function based on individual preference and social influence	small-world
Delre et al., (2007b)	threshold function based on individual preference and social influence	small-world
Thiriote & Kant (2008)	awareness and information search	small-world
Rahmandad & Sterman (2008)	passive agents, state changes at stochastic rates	random, small-world, scale-free, lattice, fully connected
Cantono & Silverberg (2009)	price below individual reservation price	lattice with periodic boundary conditions
Bohman et al., (2010)	probabilistic threshold	lattice, random, scale-free and random
Goldenberg et al., (2010)	adoption if the global network externality threshold is exceeded	lattice
Choi et al., (2010)	utility involving individual and network effects	small-world
Kuandykov & Skolov (2010)	fraction of adopters in the neighbourhood	random, 3 clusters with random internal and external links, scale-free
van Eck et al., (2011)	threshold function based on individual preference and social influence	
Aral et al., (2013)	modelling networks with seed strategies via wom process in innovation and information diffusion	adoption probability via wom (different mathematical approaches)
Badham et al., (2018)	diffusion based on seed parameters individual preference and social influence	random, scale-free
Valente & Vega (2020)	contagion process based on the characteristics of initial adopters, seven seeds (3 opinion leadership indicators, 2 bridging measures, marginally positioned seeds and random seeds. Four threshold functions.	random, small-world, scale-free

Table 2 Modelling of agent decision-making and interaction approaches. Source: updated from Kiesling (2011).

In the field of geography, we find studies with a behavioural approach done under the ABM approach using two main ABM open-source software NetLogo and Gamma. The former, was released by Uri Wilensky (Tisue & Wilensky, 1999; Wilensky, 1999). The latter was developed by French and Vietnamese universities, some examples of simulations with strong geographical focus was developed by Patrick et al., (2014) see also Lammoglia et al., (2019) and Emery et al., (2020). There is other software that support ABM simulations, belonging to private companies such as *Anylogic*, which was used in this dissertation to build a gravity model in a Swiss region (see chapter 4). Kiesling (2011) in his doctoral thesis developed a spatially explicit model for innovation diffusion and integrated time among other parameters that are discussed in section 4.1.2.

1.5 Conclusion Chapter 1

In summary, this section discussed about the roots of DOI²² which has been a field of interest in social-psychology since the beginnings of the XX century and later in other disciplines such as ethnology, anthropology and geography in the 1930's-1950's and for economists and marketers in the 1960's. The development of deeper and still applicable theoretical approaches and also of DOI models started in the 1960's with aggregate-level approaches which are found in the specialized literature of geography as neoclassical approaches, were later it was witnessed a technological shift towards ABM's like was the case of the shift from neoclassical to behavioural approaches in urban systems in the field of geography as we will discuss it as follows. In the next section we will emphasise on theoretical approaches in the field of geography, which intended to explain the development of urban systems. This review has been done in order to contextualize the linkage between DOI and SDI.

²² Readers interest in a recent bibliographic review on innovation diffusion are referred to van Oorschot et al., (2018).

2 Theoretical and Modelling Approaches for the Dynamics of Complex Urban Systems and Diffusion of Innovations

“Seven years of great abundance are coming throughout the land of Egypt, but seven years of famine will follow them. Then all the abundance in Egypt will be forgotten, and the famine will ravage the land”.

— Genesis 41: 29-30

In this chapter we will focus on the evolution of urban systems modelling, which has been shaped by different flavors with economic, social and spatial emphases. Time, space and change are major actors in different models and the way how these variables are used have similar patterns in field such as innovation diffusion, SDI and urban system modelling. Those similarities are basically embedded in the nature of the origin of aggregate-type models, which were important to describe the behaviour of urban systems and their link with innovation. With time scholars and practitioners acknowledged the limitations that characterize such models and the new mathematical models coupled with the technological progress of computers and the data availability allowed to develop agent-based models. In the first part of the chapter, we will review the most prominent models and approaches in urban modelling, and we gradually will integrate innovation as an important aspect of urban networks development.

2.1 Urban Systems Modelling

The development of urban system models is an attempt to underpin our understanding of cities and systems of cities and the complex character of their elements’ interaction. As the number of theories and developments in the field is not negligible, the Figure 33 is shown to help to grasp the major approaches ranging from location theory, passing by social physics and spatial morphology and we will focus on the modelling aspect.

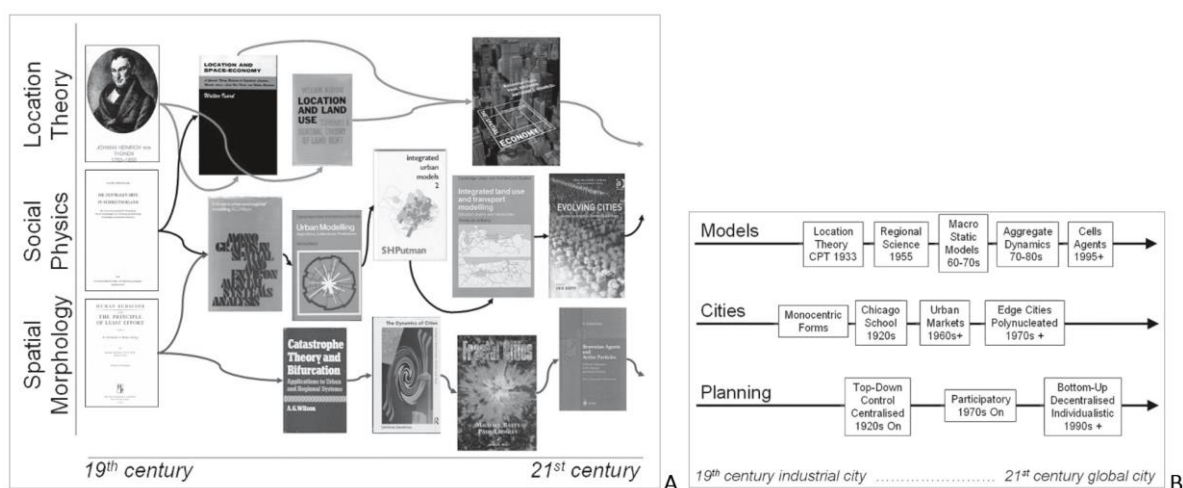

Figure 33 Snapshots along the urban modeling timeline. Source: Batty (2008).

Once the urban networks modelling will be achieved, we will embark on a deeper view on innovation diffusion as a spatial process and discuss about the role of the spatial dimension as an active factor of social organization.

2.1.1 Neoclassical and Behavioural Approaches in Urban Theory

The development of models to explain human activities at urban and economic perspective has mainly European and American origins. For example, Hotelling (1929) was interested in industrial location and competitiveness, developing the principle of minimum differentiation. Reilly (1927) worked about retail gravitation, which is the cornerstone of spatial interaction theory (SIT) and Converse (1949) proposed a new model based on Reilly's work, doing notorious empirical tests and modifications to Reilly's original model (Converse, 1943, 1949). Converse work, although less known that the prominent CPT from Christaller (1933) has been used for retail planning policies at international level (Dawson, 1980; Araldi, 2019).

Within the SIT, the concept of potential has been a recurrent approach used in human geography. Gravity or potential models are designed to capture and measure the potential interaction between different entities such as cities, enterprises or social-economic groups which are spatially located in different points. The nature of these interactions is diverse, by way of illustration we could name social media messages, goods, services, ideas, merchandise flows or circular migration. In order to understand the concept of demographic gravity models it is necessary to refer to its origins. In the early 1940's, when the astronomer John Q. Stewart noticed a peculiarity in the composition of his class at Princeton University, students mainly came from the region and the proportion of students coming from somewhere else reduced when the distance increased as a distance decay effect. His seminal works were published (Stewart; 1941, 1942) and built the bases for demographic gravitation. His observation prompted him to apply physics concepts to demographic studies, he would then at some extent compare census data to catalogues of stars or tables of spectroscopic wave lengths (Stewart, 1948). The figure below is probably the first potential map done by Stewart in 1947 in New York.

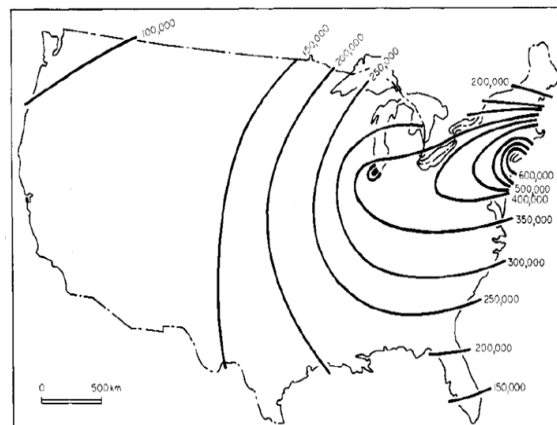

Figure 34 Map of population potentials in the United States, Stewart (1947).

Other scientific contributions helped to improve these models such as Zipf (1941) who proposed the law that has his name which was based on earlier studies done by Auerbach (1913). The Zipf's law was originally used in quantitative linguistics to describe the frequency of the usage of a word which is inversely proportional to its rank. This concept was later applied to describe population ranks of cities in a country. French scientist and recipient of Vautrin Lud Prize Denise Pumain has extensively worked on the rank-size concept (see Pumain et al., 2006). These developments allowed to formalise by analogy the concept of potential model derived from gravitational models, which gave to the field the name of social physics. The social statistician Adolphe Quetelet coined the term 'social physics' back in 1836 and the first attempt to look at human interaction from a gravity perspective was probably made by Carey in 1858 (Rich, 1980). See also Stewart (1952) where he proposes some basis for social physics.

Other authors developed related models, where the distance decay effect also plays an important role. For instance, Hägerstrand (1952, 1953, 1957) worked on innovation diffusion and also on migration taking explicitly

the spatial dimension. In the field of economic geography, we find some early spatial interaction models, for example Von Thünen (1826) dealt with space optimisation issues. In a continuous improvement process Huff (1963, 1964) proposed a model in order to tackle the limitations of the Reilly-Converse model. Reilly (1929) had proposed an empirical model for consumer shopping movements between cities in a so-called field “retail gravitationalists”.

Reilly’s model focused on the shopping centres and was deterministic, while Huff’s model emphasises on the consumers and was primarily probabilistic. Huff’s model aimed at estimating trade areas, which were subject of market analysts’ speculations relying on conclusions derived from empirical studies except for gravitational models. Huff’s model was drawn from analysis of the existing models at the time, proposing thus a stronger theoretical approach with a higher prediction power. A main contribution with this model is given by the probabilistic formalisation of the Reilly’s law, which in its origins the focus was on firms, so one of the novelties is that Huff introduced a focus on the customers. By comparison, Huff’s approach facilitates to get granular information on the competition between several places and the distance effect among them and not only between two places.

In the original Reilly’s model, a developmental approach on customers’ movements between two cities was built based on empirical observations. Hence, the model aims at establishing the boundaries of areas of attractiveness, formalised with the following mathematical expression:

$$\frac{Ba}{Bb} = \frac{Pa}{Pb} \left(\frac{Da}{Db} \right)^2 \quad (2.1)$$

Where **B** indicates the proportion of retail businesses from an intermediate town, which is attracted by a city **a** or **b**. The variable **P** represents the population and **D** the distances from an intermediary town. The significant modification implemented by Converse (1949) was the breaking point formula based on Reilly’s parameters:

$$Db = \frac{1}{1 + \sqrt{Pa/Pb}} \quad (2.2)$$

Where **D_b** is the breaking point amongst cities **A** and **B** measured from city **B**. The variable **D_{ab}** is the distance between cities **A** and **B** and **P** represents the population of **A** and **B**. The breaking point has been given this name as the formula allows to determine the approximate point where cities **A** and **B** have equal weights, letting to estimate the area of influence. Converse did not demonstrate how he derived his formula from Reilly’s however, this was demonstrated by Huff (1964). A part of this demonstration, Huff also provide insights regarding the exponent of the formula which might vary depending on factors such as the type of shopping movements that according to him, distribution centres are likely to have different trading areas based on the diversity of the sold products. Now we will discuss about the gravity model proposed by Huff (1964) since it will be implemented in the model in the section 5.4. Huff proposed the following equation:

$$P_{ij} = \frac{A_j^\alpha D_{ij}^{-\beta}}{n \sum_{j=1} A_j^\alpha D_{ij}^{-\beta}} \quad (2.3)$$

Where;

P_{ij} is the probability of a consumer located at the point **i** to travel to a shopping centre located at the point **j**.

A_j is the attractiveness measure of a place **j**

α is a parameter for the sensitivity of the probability P_{ij} associated with the characteristic attraction in a data point in the field.

D_{ij} is the distance from i to j .

β is a distance decay parameter, estimated based on empirical observations.

n is the total number of locations that contain the place j in their area of attraction in the field.

Complementary, the expected number of consumers at a point of origin i shopping at shop j is equal to the number of consumers at i times the probability that a consumer located at the point of origin i will choose the shop j and is formalised by the expression:

$$E_{ij} = P_{ij} C_i \quad (2.4)$$

Where E_{ij} represents the expected number of consumers at point i that potentially will travel to a shopping centre j . And C_i is the number of consumers at the point of origine i .

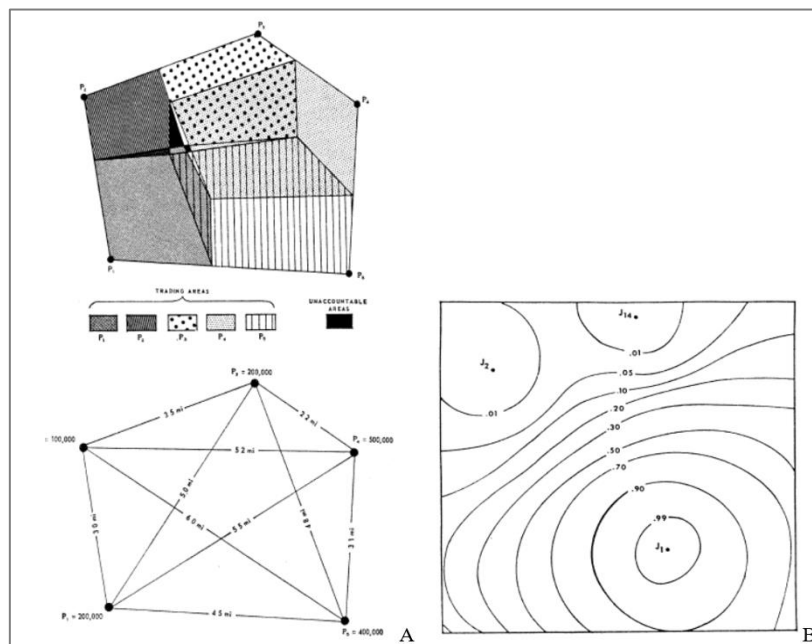

Figure 35 A) Illustration of the estimates of multiple trading areas with the breaking point formula (Reilly, 1927). B) A retail trading area portrayed in terms of probability contours (Huff, 1964).

One of the problems that Huff highlighted about the “Reilly-Converse type” model was that the breaking point formula was not flexible enough to be able to provide estimates in a gradual way either below or over the inflexion point between two centres (Figure 35A). Huff’s model has a theoretical and empirical duality in which spatial behaviour of consumers are theorized and gives the possibility to deduce mathematical interpretations on consumers’ spatial behaviour enabling the user to apply them in the real world. Besides, Huff’s model does not assume that the exponent β is not expected to be to the second power, but it fluctuates, which occurs in real world problem as the author demonstrated it in pilot projects (see Huff, 1964). When β increases the time expenditure decreases, and the scope of the trading area become more restrictive. Huff’s equations allow to calculate in a gradual fashion the estimated area for trading, expressed as $P < 1$ to $P > 0$, Figure 35B shows the contours of an estimated trading area of a shopping centre J_n . For deeper theoretical aspects on Huff’s model see Huff (1963).

More recently related research in spatial interaction theory have been used with different applications as for example to model the flows of commuters in Germany (Reggiani et al., 2011; Reggiani 2012). In that work five different approaches were highlighted and tested focusing on the types of decay functions as follows:

i) Exponential-decay function:

$$f_{(d_{ij})} = e^{-\beta d_{ij}} \quad (2.5)$$

ii) Power-decay function:

$$f_{(d_{ij})} = d_{ij}^{-\beta} \quad (2.6)$$

iii) Exponential-normal decay function:

$$f_{(d_{ij})} = e^{-\beta d_{ij}^2} \quad (2.7)$$

iv) Exponential-square-root decay function:

$$f_{(d_{ij})} = e^{-\beta \sqrt{d_{ij}}} \quad (2.8)$$

v) Log-normal-decay function:

$$vi) \quad f_{(d_{ij})} = e^{-\beta \ln(d_{ij})^2} \quad (2.9)$$

For the model developed in this PhD dissertation, the power-decay function was used as it is thoroughly explained in Chapter 5. Readers interested in spatial interaction are referred to Sen & Smith (1995), Roy (1990, 2004) and Östh et al., (2016).

Central Place Theory

As mentioned early the BRT model (Thünen, 1826; Haig, 1927) and the CTP (Christaller, 1933; Christaller & Lösch, 1954) also have conceptual proximity on theoretical views about urban an economic activity such as innovation diffusion. Urban networks have been an important topic for economists and geographers, the first proposed global theory on cities were the central place theories (Claval, 1968). Christaller's model was developed with the aim to explain the economic network emergence in homogeneous spatial structures. For some scholars, Christaller's CTP has been the most successful attempt to theorize spatial structures (Stevens, 1985).

The CPT got the attention of scholars given its explanatory power about the commercial configuration from a spatial perspective of micro-economic compositions of free-trade markets (Beavon 1977, Brown 1992, Araldi, 2019). The specific development of Christaller's CPT was created relying on paving the space with hexagons, which are organized through the hierarchical arrangement of services (Dauphiné, 2003). However, the CPT can hardly explain the complexity involved in the process and the underlying conditions on how these urban networks are constructed (Claval, 1966, 1981; Derycke et al., 1970; Bailly & Beguin, 1996; Dauphiné 2003).

CPT as it is the case with the Bass' innovation diffusion model (1969) and other innovation diffusion models based on differential equations, had similar assumptions in which agents have homogeneous behaviour. In this case, the agents are consumers and providers. Under this school of thought, on the one hand, consumers have good information related to the goods, they are rational, small, and their purchasing power is rather similar and want to optimize their utility function (Araldi, 2019). On the other hand, providers are also small and rational agents

with the goal to optimize their profits. CPT as gravity models considers the distance decay effect, which is correlated to the cost of goods. The distance decay effect in the CPT was implemented in a two-ways fashion that allowed to define two variables for both consumers and providers consecutively. For the former the variable is the range, which typifies the maximal travel distance, which might be considered by a customer to purchase a good. The latter is the threshold, which gives information on the minimum demand needed for a shop to be able to operate its business.

The construction of the hexagons illustrated in Figure 36, are built based on these two parameters whose values depend on the purchasing frequency. Thus, higher frequency values are determined by smaller values of both; range and threshold, so shorter distances mean smaller hexagons. Contrarily, lower frequency values are determined by lower interactions between consumers and shops and less shopping activities when the distance increases. Distance decay is combined with the type of goods that are purchased where necessity goods for example have higher frequencies represented by smaller hexagons and products that are seldomly bought such as jewellery are represented by larger hexagons. The hierarchical structures of the hexagons are defined by the overlap between market areas with dissimilar sizes.

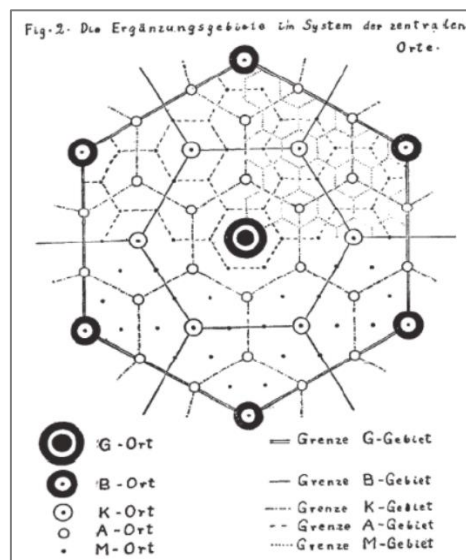

Figure 36 Nested hexagons in the Central Place Theory proposed by Christaller (1933).

The first empirical studies of the Christaller's CPT were done by Estonian geographer Kant who fled Estonia to Sweden during the Soviet Union occupation. Kant applied this theory during the reform of Estonian rural municipalities after the First World War (Tammiksaar et al., 2018). Christaller's CPT was widely diffused thanks to the interactions of Kant and Hägerstrand at Lund University in Sweden and years later with Edward Ullman and Brian Berry in the United States (Tammiksaar et al., 2018). CPT has been modified and improved and different new models based on the initial contribution of Christaller have been proposed (Berry 1967; Potter 1980).

The assumptions in Christaller's model related to behavioural homogeneity of agents are also found in different early models in innovation diffusion (see Bass, 1969) and potential models (see Reilly, 1929). Parallely, the critics to these aggregated-type models have similar flavours: they fail at capturing the granularity aspects of agents' behaviours where decision-making processes are at the core of the criticism. As it was aforementioned, there are different categories of innovators, therefore if we look at purchasing processes in an urban system through the lens of DOI we could argue that consumers do not behave in the same way regarding any kind of goods or services.

A similar criticism was developed by Kivell et al., (1980) which argued that under this view all consumers have a similar and systematic behaviour (see also Golledge et al., 1966) ruled by economic optimizing principles known

as the “optimizing men”. This simplifying view on human behaviour has been contested since spatial structures are derived from complex processes and not only from economic principles (Scott 1970; Kivell et al., 1980; Brown 1993, 1994; Wayens 2006). The definitions of city and urban networks have also benefited from the work of sociologists with stronger qualitative views, where for example the differences between the countryside and urban areas were undoubtedly exaggerated (Claval, 1968). Nevertheless, sociological findings helped to identify that social structures in urban areas allow higher levels of interaction (Claval, 1968).

The roots of the formalisation of urban system modelling have had an important development through history, which can be related to innovation diffusion modelling. Hence, we find relevant to recall some of the most important contributions in the last decades. The conceptual proximity between the growth of urban networks and diffusion of innovations could be observed through the convergence of scientific approaches used to model both phenomena. Some of the pioneer models for urban networks growth and for diffusion of innovations, are based on differential equations and compartmental models (Bass, 1969; White, 1978; Allen & Sanglier, 1979).

Another similarity in terms of modelling approaches within the field of systems of cities evolution modelling and innovation diffusion is the Monte Carlo Simulation. For systems of cities evolution, we could name the Morrill Method (Pumain, 2008), which was designed to model urban growth and transitions from rural areas towards interurban migration flows. Regarding diffusion of innovation, Hägerstrand (1952, 1953) also used Monte Carlo Simulation in his seminal work in that field. Other theories were also used as the base to attempt to model the evolution of systems of cities, an example is the catastrophe theory²³ (see Casti & Swain 1975; Wilson 1980).

Moreover, Allen (1981) and Weidlich (1987a, 1987b) have studied and developed models that simulate urban growth and self-organization processes through the prism of dissipative structures (Nicolis & Prigogine, 1977; Prigogine et al., 1977) and synergetics (Haken, 1977) respectively. Nevertheless, it is important to add that the theory of dissipative structures pays little attention to spatial organization (Dauphine, 2003). The positive aspects of such approaches are their power to capture the urban dynamics from both top-down and bottom-up perspective however, the disadvantage is the complexity nature of the mathematics involved (Portugali, 2008). About the last note, some of the most important modelling contributions in the field of geography have been done by people with backgrounds such as physics. This is an example of the richness of interdisciplinary research work.

Another interesting similarity between evolution of systems of cities and innovation diffusion is the limitation of the approaches used to model them. Scholars encounter the optimizing men principle as a limitation coupled with unrealistic scenarios displayed by models assuming the same behavioural characteristics for all agents. This limitation applies for both, urban networks evolution and innovation diffusion, which have been tackled with tailored solutions provided by ABM. Otherwise, some scholars focused on micro-simulation models which rather overlooked the resulting patterns from a macro level perspective (Clarke, 1996; Holm & Sanders, 2001).

Now, focusing more on urban networks evolution, in the Dynamic Model of a Central Place System proposed by Allen & Sanglier (1979) and later improved (Allen & Sanglier, 1981) the authors presented a model that explained the spatial interaction between two variables: population and employment. The authors argue that urban systems are complex where positive feedbacks between these two variables triggers a process of self-organization of the

²³ Thom (1972) exposed the catastrophe theory in his book *Structural Stability and Morphogenesis*. The author called catastrophe theory the application of particular mathematical outcomes in the field of differential topology and the theory of singularities. This theory is in particular valuable when forces after long periods of equilibrium, gradually produce changes and consequently sudden effects. The application of the concept is often used in subjects influenced by a ‘minimization principle’, where a non-linear system shows a stable equilibrium but slight dynamics in some parameters could cause major regime changes attracting or repelling new states. This could even generate the appearance or disappearance of the whole system. In the case of self-organized systems, since small changes can produce large changes, that implies that a non-linear system could have multiple stable states.

spatial structure of the system (Allen & Sanglier, 1981). This process is composed by chance events and general economics laws, that the author calls *historical chance* and we previously referred to, as economic dependency path, which is marked by a historical inertia for growth or decline. These oscillations are known as “*order by fluctuation*” (Allen & Sanglier, 1981).

In Allen’s model the system is composed by the population X_i located in a point in the system (space) i . The population fluctuates in function of a number of jobs S_k offered by the market in each sector k . The spatial distribution of the agents is ruled by the uneven potential of employment in the points i which varies according to the market’s laws such as the demand and supply.

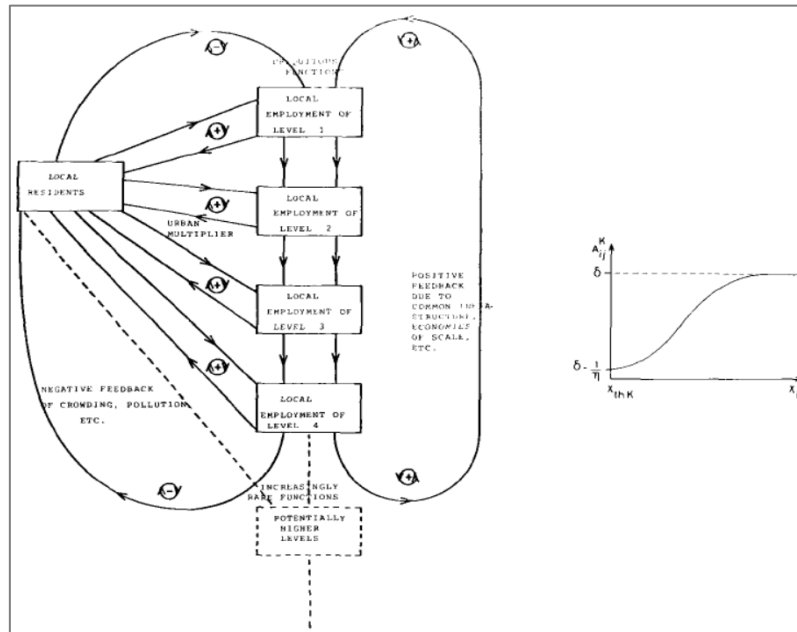

Figure 37 The behaviour of the Attractiveness for activity k at i as felt by the population X_i as the size of the center i grows. Source: Allen & Sanglier (1981).

The mathematical representation of the model is given by the following equation:

$$\frac{dx_i}{dt} = bx_i(n_i + \sum_{k=1}^{n_i} S_i^k - x_i) - mx_i \sum_i e^{-\phi dij} (x_i^2 - x_j^2) \quad (2.10)$$

Where:

- x_i represents the population change at point i .
- b here is related to the birth and immigration rate.
- m is related to mortality and emigration rates.
- N is the carrying capacity of the territory.
- S_i^k is the job offered for each economic activity of type k in point i .

The equation above allows to simulate the evolution of the population at a given location i as a function of the jobs offered in the system. The simulation aspect is related to the fact that the criteria k can be decided for each point. This approach also makes it possible to manage delay effects, for example if the population grows in response to a potential job offer. A systematic and condensed population growth in a point i was called a “crowding

effect" by Allen. The second part of the equation is an expression that corresponds to a negative feedback loop effect also shown in Figure 37.

$$e^{-\emptyset d_{ij}} (x_i^2 - x_j^2) \quad (2.11)$$

This negative feedback loop depicts the "unpleasantness" of the population at point i increases in proportion to the square of the local density and the population working at point i decides to live at point j , at a distance d_{ij} . This distance d_{ij} depends partly on \emptyset , which is a factor that represents the ease of travelling between i and j . Therefore, the observation of the evolution of the quality of the transport system should be followed up so the parameter \emptyset is systematically updated. The variables S_i^k , which represent the jobs offered in the different economic sectors in each point i , allows us to see how its relative importance. Regarding the question of demand (jobs) Allen & Sanglier (1981) proposed to follow a similar process to the one we developed for the potential job at point i using a demand modelling equation, which was already developed by Allen and Sanglier (1979).

$$\frac{dS_i^k}{dt} = \alpha S_i^k (E_i^k - S_i^k) \quad (2.12)$$

This equation assumes that the number of jobs adjusts to the demand of point i for activity k . The parameter α measures the rate speed of the adjustment of entrepreneurs concerning the changes of goods needed. The parameter E_i^k represents the potential number of jobs resulting from the production of goods k in the point i which are needed per unit of production in a potential market D_i^k affected by the center i . With this approach, it is possible to identify a probability law that will describe the demand and this law can be one of the parameters of variation of different scenarios. The model needs to be further explain given the composition of the equations as follows. The potential number of jobs derived from the production of k at i is given by the equation as follows:

$$E_i^k = p^k D_i^k \quad (2.13)$$

Where ϵ^k is the amount of goods or services of category k desired by a consumer at unit price. The variable p^k is the number of jobs per unit of production. P_i^k is the price of the good or service of category k at the point i , while \emptyset^k is the cost per unit distance of transporting k where d_{ij} is the distance between i and j . The parameter β fluctuates accordingly to the elasticity of demand of k and A_{ij}^k is the general attractiveness of the centre i for function according to the potential consumers x_i at j .

$$D_i^k = \sum_i \frac{\epsilon^k x_i}{(P_i^k + \emptyset^k d_{ij})^B} \cdot \frac{A_{ij}^k}{\sum A_{ij}^k} \quad (2.14)$$

Where the attractiveness of the centre i for function k is:

$$A_{ij}^k = \frac{(\delta - \frac{1}{(\eta + e^k(x_i - x_{ithk}))})^Y}{(\frac{A_{ij}^k}{P_i^k + \emptyset^k d_{ij}})^Y} \quad (2.15)$$

A graphical representation developed by Allen & Sanglier (1981) is the result of the simulation of population dynamics in two regions **A** and **B**. **A** and **B** correspond to two young urban hierarchies in the beginning of the

simulation (See Allen & Sanglier, 1981) where the population and the spatial economic structure of the region do not have much economic interaction between local centres.

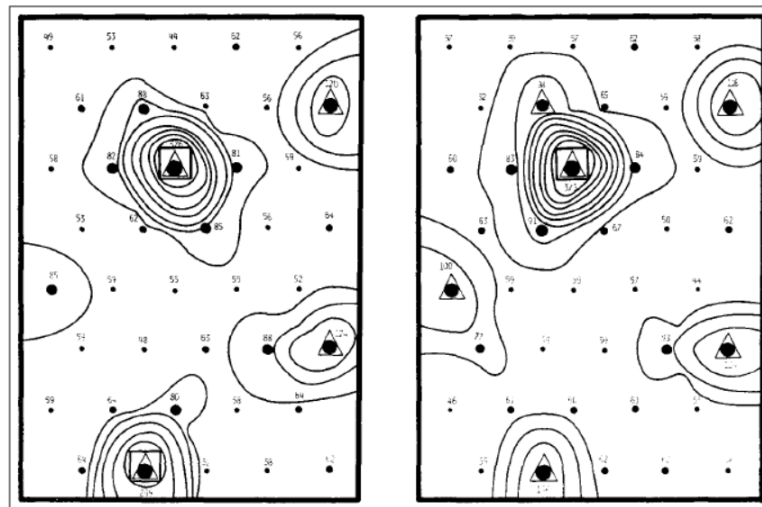

Figure 38 Central Place Systems Model from Allen & Sanglier (1981). (Left). Structure (A'B') The urban structure at $t = 42$, when the frontier between A'_1 and B'_1 was removed at $t = 21$. We have constant total population and "good" transportation. (Right). Structure (AB). The stable state attained at $t = 21$, when the two regions A_1 and B_1 are United at $t = 0$. The population is constant, and we have "good" transportation.

The conditions change successively with the addition of economic activity over time simulated in a triangular lattice platform. The Figure 38 represents two states at time $t = 21$ and $t = 42$. The centres emerge according to the values of each variable and are displayed with the contours. In general, this model allows to observe the evolution of spatial structures based on economic activities and on the quality of transportation. By changing the parameters in the simulation, it is possible to observe the complex evolution of the variables and capture long term effects. Urban structures are intricately linked to economic activities and consequently influencing population dynamics. The development of theories and methodologies to better understand the mechanisms entangled in the process have different sources from a discipline perspective. Some of these methodologies as we know them today and that are applied in geography come from engineering, like is the case of system dynamics (SD), which built a bridge between engineering and social sciences (Sanders & Sanders, 2004).

Urban Scaling Laws

In the French specialized literature, we find research work that links urban systems, innovation and social change with a perspective of complex science. Pumain (2008) proposed a multi-level model for socio-spatial dynamics of urban and innovation processes. The author discusses issues related to the comprehension of the interconnectivity of cities and how these interactions and networks evolve accompanied of continuous social and economic innovation development whilst keeping a hierarchical, functional and spatial differentiation, which evolves at slower rates. An important reminder is made regarding the fundamental concept for geographers that is that they consider cities as a configuration of 'systems within systems of cities' (see Berry, 1964). The connectedness of urban areas and their interactions trigger the emergence of complex behaviours, in urban dynamics modelling some authors addressed the issue of not considering these interactions and it is referred as the boundary problem (Graham, 1974; Alfeld, 1995).

Regarding the French speaking literature dealing with conceptual approaches on central place, diffusion and gravity models see Bailly (1988). Beguin & Thill (1985) did a practical implementation of the theoretical limits of

urban areas and hierarchies in Belgium, Andrews (1980) also worked with similar scientific lines of thought Montréal. More recent work was carried out in France by Pumain (2008), the author worked on an ABM approach to simulate the growth and evolution of cities and towns in order to observe the interaction processes between urban systems and the exchanges of material and immaterial elements. This is a relevant phenomenon since those exchanges and interactions occur while macro-geographical scales, urban hierarchies and spatial differentiation develop at a lower speed. The author worked on a model that aimed at verifying different hypothesis regarding urbanisation processes in which certain configurations could be tested. For example, the changes in spatial interaction features embedded in systems such as transportation, economic activities, proximity and long-distance networks connectivity. The model addressed these questions including three forms of urban systems *i)* developed countries with old settlement systems, *ii)* developed countries with more recent urbanisation, *iii)* developing countries.

Pumain discussed about urban transition and demographic transition, which she linked with the concept of phase transition in physics (see also Zelinski, 1971). The urban process refers to a drastically change from small, disaggregated rural areas to urban settlements with large agglomerations. A phase transition in physics refers to the change or transition of a substance from one state or phase to another, for example from solid to liquid, which is generated by changes in the temperature and pression, for a complete review on phase transitions see section 4.2. In our context, the urban transition is an emergence process where the connectivity of urban systems drastically increases. According to Pumain (2008) the highly densification of some cities is the result of interaction between cities and systems of cities, which generates the emergence of larger concentration of population and economic activities. This growth is also observed from a qualitative perspective for example, the increase of knowledge, social and technological innovation in cities. The figure below shows the size-rank relation of large cities in the world, where in such places the concentration of knowledge is supposed to be located and thus boost innovation.

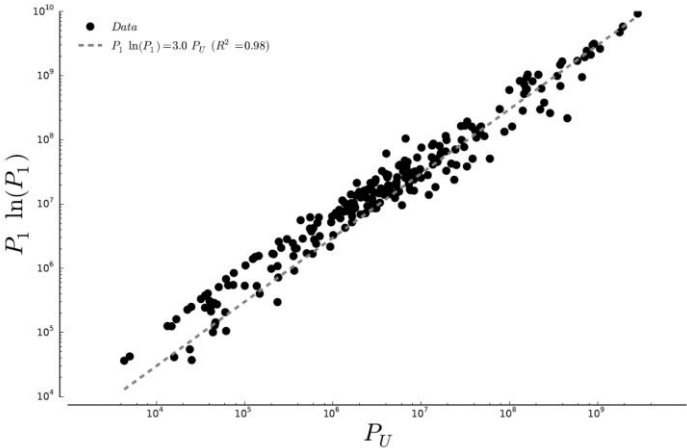

Figure 39 The law of metropolises revisited. Population of the largest city of systems of cities P_1 versus the total urban population P_U in that system. Source: Louf (2015).

However, the size-rank has not been explicitly accepted by all scholars as it will be discussed in section 5.4 (see also Péguy, 2001; Pumain, 2004b; Dauphine, 2013). Within the interaction processes in urban systems, it has been acknowledged a multilevel fashion of exchanges between cities and systems of cities as it is depicted in Figure 40 where structural properties emerge. According to Pumain (2008) a possible way to describe systems of cities in consequential manner can be done by observing the object at two levels. Both levels present emergence processes for example one city is represented as an organization that is the product of exchanges among several urban agents, while at the upper level we observe systems of cities that are formed by the interactions of goods, people, information and capital between cities and towns.

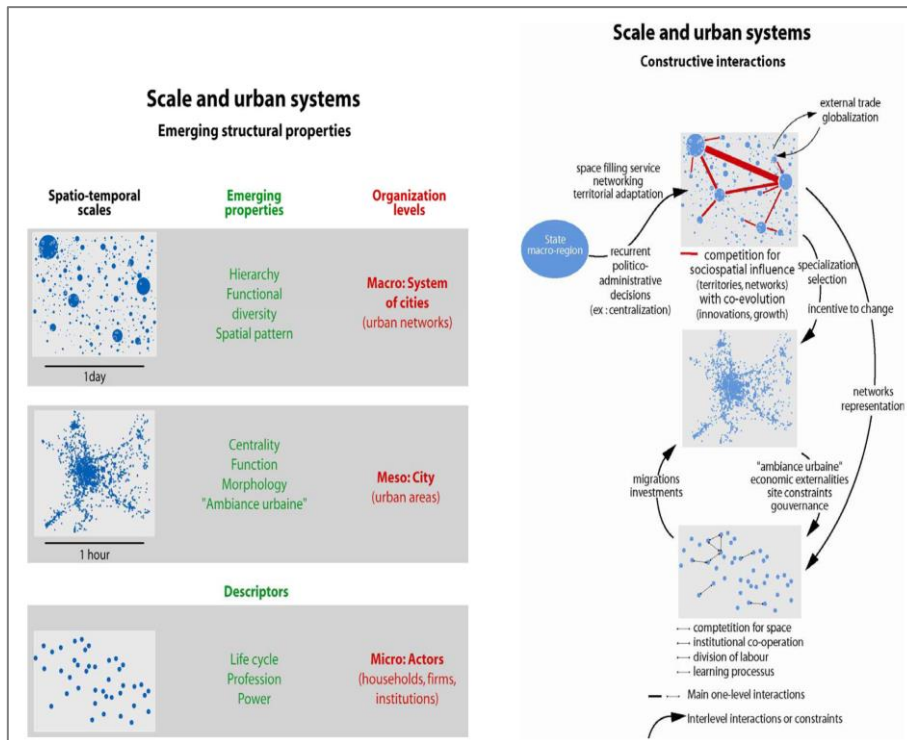

Figure 40 To the left, Urban scales, emerging properties and organization level. To the right, Interactions between different urban scales. Source: Pumain (2008).

A relative stability in these systems is observed space and timewise. In this regard, the properties observed in such systems have already been discussed in this research work *i)* regular spatial organisation, which has been formalised by the central place theory (see Allen & Sanglier, 1979, 1981), *ii)* The recurrent hierarchical organisation of their sizes, which can be predicted by the Zipf's law (see Zipf, 1941), *iii)* the third property is related to the functional specialisation, which can eventually be threatened by lock-ins (see Grabher, 1993; Hassink, 2010; Maassen, 2012; Klitkou et al., 2015). The author argues that even though these systems remain stable, they also present evolutionary changes but without changing the roots of their structure. The Figure 41 shows two examples in France and in the US respectively about the impact of businesses expansion.

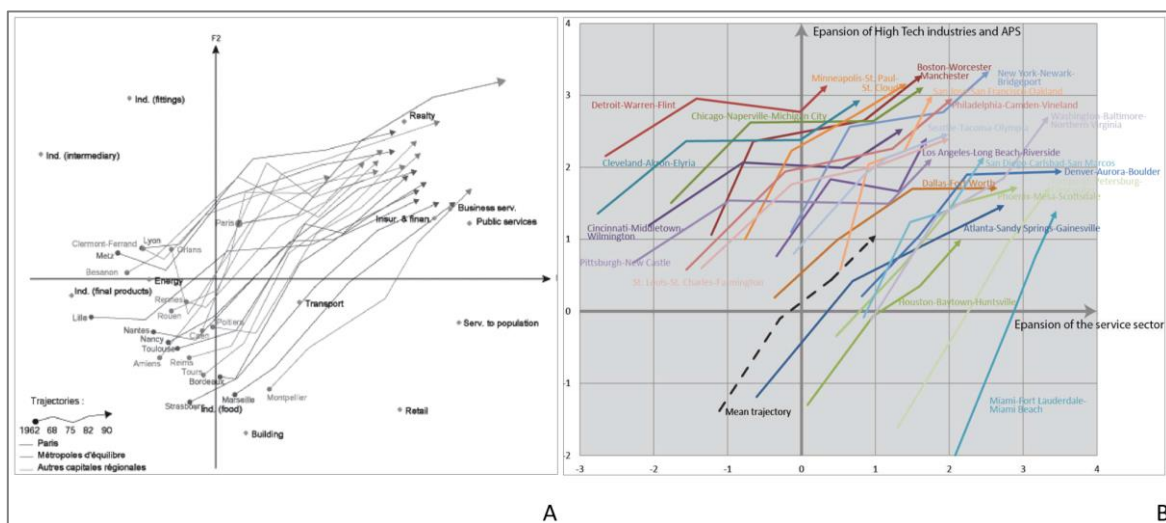

Figure 41A Trajectories of cities in an economic space in France from 1950 to 2000). B) Co-evolution of US with more than 2 million inhabitants. Source: Paulus (2005).

The propeller of these changes is the diffusion of innovations, which involves urban networks exchanges, the increase of businesses in agglomerations located in metropolitan areas. These mechanisms are accompanied of cycles of evolution and self-correction as previously discussed and referred to as long waves or Kondratiev waves. The Figure 42A and B show two examples about the long waves regarding the GDP growth cycles in Sweden and the long-term employment growth in the UK, US and Australia respectively.

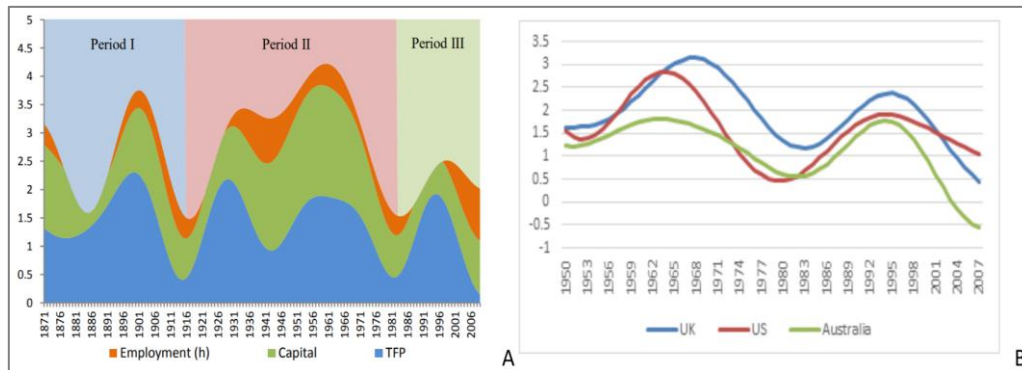

Figure 42A GDP growth trends (%) with underlying factors in Sweden^a, source: Nilsson et al., (2013). B) Long-term employment growth (hours worked), 1950–2009 in the UK, US and Australia. Source: Pålsson et al., (2013).

^aEmployment = hours worked, Capital= real capital in the form of buildings and machines, TFP = productivity for a weighted index of production factors.

The mechanisms embedded in these growth cycles were already discussed in the first part of this dissertation. Therefore, now we will rather focus on the considerations to model the evolution of systems of cities and how the arrival of ABM has facilitated the task. The ABM paradigm seems to be a suitable approach for geographic studies since it considers the environment of the system and allows to operate with great number of agents in different levels with a large range of interactions rules between them and with the environment or the spatial dimension (Pumain, 2008; Banos et al., 2015). An early application of ABM in geography was done by Bura et al., (1996) with the model called *SIMPOP* (see also Sanders et al., 1997). The authors simulated the growth of urban settlements for a period of 200 years, in this model agents do not move as they characterize the spatial dimension and the size of the population.

The model's interactions occur at a high level where aggregated data of geographical objects' interactions is capture, but the model does not reduce the scale towards individual agents' behaviours. In this model the cells represent a diversity of resources from economic activities and agricultural production starting in 1800. The emergence of towns occurs accordingly to the central place theory and the cells develop under a competition environment. A second model called *SIMPOP2* (see Pumain, 2008) dealt with a multi-level geographic representation and was able to capture the emergence of an urban hierarchy derived from the interactions between cities. In this model the interactions are enhanced, including two new agents which embodies governance and innovation within the complex system. This model operated three types of spatial interaction, where the degree of influence of regions are characterized by the most common ways of exchanges within and between interurban areas *i) proximity constrained interactions; ii) constrained interactions influenced by administrative boundaries at different scales and iii) constrained interactions by specialized networks where the distance is not necessarily a restrictive factor*. The authors acknowledged that some of the assumptions remain uncertain as the question of innovation appearance has still several unanswered questions.

Hägerstrand (1952, 1953) proposed the conditions for the diffusion of innovation but not the origin itself, this will be thoroughly discussed in the section 2.2. This is an important question since Schumpeter views on innovation proposed that urban growth is triggered by economic growth, which is propelled by the development of innovations. The question of how an innovation takes place in a determined place is not new (see Svensson, 1942) and some aspects remain unsolved (see McKinnon et al. 2003). For related work on systems of cities linking

international and transnational perspectives see Rozenblat et al., (2018). An observation that has been shared by different scientists regarding the evolution of urban systems is the presence of scaling properties. For example, it has been shown that there are statistical regularities from a geographic standpoint in different urban and natural phenomena, where power laws, fractality and hierarchical structures are present (White & Engelen, 1993; Frankhauser, 1994, 2008; Batty & Longley, 1994; Soo, 2002; Ioannides & Overman, 2002; Kaizoji, 2003; Dauphiné, 2003, 2011; Pumain, 2004b; Andersson et al., 2006; Pumain et al., 2006; Pumain et al., 2009; Cebrat & Sobczyński, 2016; Pumain & Reuillon, 2017).

By the late 1980s fractal geometry and chaos theory got momentum in science and some scholars tried to apply such theories to better understand the underlying dynamics in the evolution of urban systems (Batty, 2008). The classical studies on rank-size are an example of scaling properties and a fractal signature in urban systems, a topic that has extensively studied by Pumain (2004, 2008; Pumain et al., 2009). Some of the first studies of fractals in the field of geography in France, was first developed by theoretical physicist and geographer Pierre Frankhauser (Dauphine, 2011). The first Ph. D research relating fractals in earth sciences in France was probably done in 1985 by Lassaad Nouaili, the title was the *'fractal study of the seismicity of subduction zones'* (Queiros-Condé et al., 2015). **The behaviour of innovation diffusion as a spatial process also seems to follow power laws in the Swiss region, see sections 5.5.2 and 5.5.3 and also in the French region, see sections 6.2.2 and 6.2.3. The scaling properties found in the spatial diffusion of RET from demand and supply perspectives suggest self-organization processes and opens new research directions in the fields of innovation and change. A further discussion about scaling properties in urban phenomena are developed in Chapter 7 under the umbrella of resilience.**

In this section we have discussed about different urban dynamics models in order to review some of the most well-known approaches. In the next section we will specifically discuss about the **System Dynamics (SD) paradigm and methodology, since is one of the approaches used to simulate the demographic, jobs and RET distributions in this dissertation.** Therefore, this part will cover the most important aspects of the approach and will prepare readers to better understand the rationale of methodological choices. Since this approach has its advantages and disadvantages, we will finally discuss more about ABM as a methodology for urban dynamics modelling.

2.1.2 Systems Dynamics Modelling

The roots of the systemic approach are linked with the concept of complexity that has its origins in the XX century. The classical analytical approach became insufficient to support the transition from simple to complex causality research. Atlan (1979) proposed a definition "complexity is an order whose code is unknown". Complexity as the word indicates, it is something that is not simple. The notion "simple" allows us to conceive an object as an entity separable from the system. Consequently, the "simple causality" between objects should be of deterministic nature. Therefore, we should be able to separate cause and effect and unambiguously be able to predict the effect based on the cause with no contradiction whatsoever or without observing any counterintuitive behaviour of the variables studied (Morin, 1974). Nevertheless, our world it is much complex than that (see also Haken, 1977; Prigogine & Stengers, 1979; Morin, 1990, 1994).

Scholars in the 1930's acknowledged the limitations of analytical stances on complex systems and the need of a more comprehensive approach. The limitations of analytical approaches and their inadequacy to solve non-linear problems were exposed by scientists of different horizons such as biology, mathematics, neurobiology or engineering. Dynamic complexity emerges because systems are dynamic, counterintuitive (Forrester, 1995) tightly coupled, governed by feedbacks loops, non-linear, history-dependent, self-organizing, adaptive, policy resistant and characterized by trade-offs (Sterman, 2000). The answer to this issue, would arrive in the 1960's with the development of SD which is a paradigm but also a methodology *per se* (Cambien, 2007). The concept was proposed by Jay W. Forrester (1961) with his work *Industrial Dynamics*. Previously, an interdisciplinary work between

different scientists of different disciplines from the 1930's to the 1970's would result in the development of the cybernetics discipline. The sharing process amongst these different fields had the ability to connect machines, organisms and society in an interdisciplinary way.

The father of cybernetics, Norbert Wiener who was a child prodigy, received his Ph.D from Harvard at 18 years old and later became a professor at MIT, where he later collaborated with neurophysiologist Arturo Rosenblueth from Harvard University. They respectively noticed during an experiment that the damage of pointing devices for anti-aircraft guns under certain conditions had a similar behaviour to the damage of the cerebellum in humans. The specific similarities they found, were that an oscillatory phenomenon created a disturbance in the stability of the systems. Thus generating, an intelligent behaviour and emergence of complex interactions of feedback loops and consequently a new dynamic stability in the system (Cambien, 2007; 'Return of Cybernetics', 2019). The first applications of this theory were intended for assembling lines and rockets in the 1940's.

The feedback loops discovery had implications in a vast set of fields such as systems control in engineering, computer science, neurosciences, biology, and it was later applied in social science such as business, economics and geography. Wiener coined himself the name *cybernetics* and feedback loops, the findings is credited to be one of the first important basis for artificial intelligence (AI). However, Wiener very early showed his apprehensions about the implications of technology and cybernetics in society, people and animals. After WWII, Wiener proposed a science of "*cybernetics, the theory of feedback and control in animal and machine*" (McCarthy, 1996).

Already in 1950 Wiener in his book '*The human use of human beings: cybernetics and society*' clearly illustrated his concerns about human control and the replacements of human jobs by robots which proved him right not only soon after his publication but for the years to come. Wiener refused to work in military cybernetic developments during the cold war but proposed to collaborate with non-military models of cybernetics (Wiener, 1989). All these developments were substantial for Forrester work, who was an American professor at the Massachusetts Institute of Technology (MIT). Jay Wright Forrester during his career as a scientist emphasized on the importance of theorization with practical purpose. Forrester, at the international Banquet Talk in the meeting of the System Dynamics Society in Stuttgart (Forrester, 1989) explained the origins of SD that will be briefly described here.

He grew up in a cattle-ranch in the Sand Hills region of North-Western Nebraska in an agricultural region where dynamic factors such as costs, prices, supply and demand of crops were serious and constant issues for survival. He was then, confronted with the need of solving real problems with the application of theoretical approaches. For example, he built a wind-driven electric plant that provided electricity to his home when he was in high school. Years later Forrester almost joined the Agricultural College but actually attended electrical engineering school at the University of Nebraska which was the only program offering a strong training in theoretical dynamics. He went to MIT to work with Gordon S. Brown who was a specialist on feedback control systems and wrote the principles of servomechanisms in 1948, which still the reference in the field. Forrester joined the team and during the WWII started working on the development of an experimental control for a radar on aircraft carriers in order to direct airplanes against enemy targets.

After the war, he worked on aircraft simulations and slightly left the field of engineering to work more on management-related problems since he thought that the pioneer days of digital computer science were over. However, the creation of a management faculty in a technical university like MIT, meant a different approach than the one taken by the management faculties of universities as Columbia or Harvard. Therefore, Forrester stay within the field of engineering in a way. In the 1950's there were a series of situations that would turn Forrester research focus, in that regard there were two central circumstances. The first one, was related to a problem taking place at General Electric (GE). The Sloan School of Management was created with a grant donated by Alfred Sloan who was the president and CEO of GE, this explains the relative closeness between both institutions. The problem was related to inventories, demand and supply instabilities in a household appliance plant in Kentucky, which

prompted Forrester to do a simulation. This was an optimization problem: GE would hire a number of employees based on the demand but years after they would have to fire half of those employees. Forrester did a paper-based simulation which allowed him to observe:

“.. It became evident that here was potential for an oscillatory or unstable system that was entirely internally determined. Even with constant incoming orders, one could get employment instability as a consequence of commonly used decision-making policies. That first inventory control system with pencil and paper simulation was the beginning of system dynamics”. In 1961 Forrester published *Industrial Dynamics – A Major Breakthrough for Decision Makers* and during that decade he pursued his work in the field and several observations from industrial and business modelling and simulations were noticed. For example, he stated: *“...Over 90% of the variables in that model lay in the top-management influence structure, leadership qualities, character of the founders, how goals of the organization are created, and how the past traditions of an organization determine its decision making and its future. The model also dealt with the interactions between capacity, price, quality, and delivery delay...”*

The second situation which was a turning point for Forrester’s research was when he started a collaboration with former Boston Mayor John Collins who was then a visiting professor of Urban Affairs at MIT and was interested in urban issues related to aging cities. This is the departing point where SD becomes important in the field of geography. Forrester built a model which analysed and would ultimately help to solve problems in urban systems. Forrester decided with the help of Collins to meet up half a day per week during months with people involved in the urban processes of the city of Boston. As it was said before, Forrester had a very practical and applied approach which in this case prevented him to base his model on the scientific literature but on the urban systems experts’ opinions. This decision will be later reproached by the scientific community. John Sterman who is the Jay W. Forrester Professor of Management at Sloan School Management at MIT, is a former student of Forrester and published one of the most important contributions in the field (see also Richardson, 1991), called *Systems thinking and modelling for a complex world* (2000). Forrester’s simulation is a modelling technique using differential equation systems. These equations are located in the background of a graphical language that allows the construction of a global interaction model. The SD mechanisms can be explained with a bathtub as it is shown in the Figure 43. The basic components of this language are stocks, flows, connectors and converters. The underlying mathematical system is represented by a hydraulic metaphor of inflow and outflow of water into reservoirs (stocks), it was proposed by Forrester (1961).

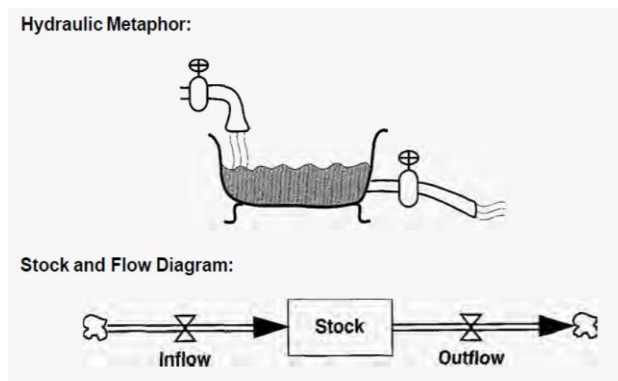

Figure 43. Hydraulic Metaphor, source: Forrester (1961).

The idea behind Stocks is that they represent the amount of something in the system in a specific time t in the system, that is the integrated quantity of water in a moment t in the hydraulic metaphor of Forrester. The integral equation of Stock is given by:

$$Stock = \int_{t_0}^t [Inflow(s) - outflow(s)]ds + Stock(t_0) \quad (2.16)$$

Flow gives information about the change rate of water with respect to time, the differential equation is given by:

$$\frac{d(Stock)}{dt} = Inflow(t) - Outflow(t) \quad (2.17)$$

From a mathematical point of view the flow is the derivate of the stock which reciprocally means that the stock is the integral of the flow as it is shown above. In Sterman's book (2000) the author illustrates the mechanisms of SD in the Figure 44, which are composed by stocks, flows and causal loops diagrams. In the example depicted in the next figure, the bathtub diagram is used as a metaphor to illustrate the impact of car leasing. This model was developed for General Motors in a real case in the 1990's when leasing came into the American market. The stock in the bathtub represents the number of cars in the company (warehouse). This stock is fed by car production and new car substitutes that in this case are represented by faucets.

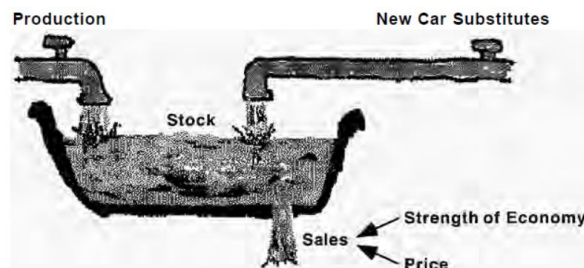

Figure 44. Forrester's Systems Dynamics representation for car leasing impact, source: Sterman (2000).

The question here was: "Why do short-term leases make us more vulnerable during an economic downturn?" In a hypothetical economic crisis, the amount of sales would decrease, obligating the company to reduce the price and subsidize leases, decrease, or stop production but the flow of expiring leases of new car substitutes into the market cannot be stopped. During an economic downturn, clients would not use their option to buy but switch their off-lease cars back to the lessor. Forrester developed a simulation for this problem and the model was successfully presented to the managing board of GM. All these interactions that are nonlinear generate feedback loops (see Sterman, 2000). The ability of the company to do business combined with the market context would have an impact on how the flow of the stock would work. The simulation helped GM managing board to figure the following answers out: i) when industry demand falls, the flow of returning lease cars cannot be stopped; ii) prices of used cars will decrease; iii) new car prices will decrease; iv) Some clients will opt for cheap used cars; v) price does not affect the supply of new car substitutes. Some of these results were counterintuitive and contrary to what had been done in the industry at that time. This model helped the managing board to rethink their business models.

2.1.3 Urban Systems Dynamics and Simulation

Forrester published his book *Urban Dynamics* in 1969, which is an integration of his previous work on industrial dynamics and his collaboration with former Boston Mayor John Collins who was then a professor at MIT and was interested in urban issues related to aging cities (Cambien et al. 2007). The urban system proposed by Forrester was built with three main dimensions: population, jobs, and housing but the space was not explicitly considered in this model.

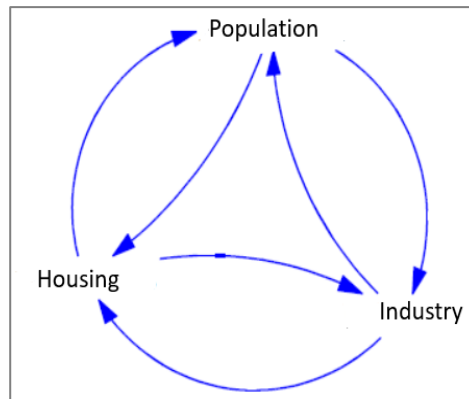

Figure 45. General Simulation Urban System, source: Forrester (1969).

These three variables interact with each other generating the emergence of intelligent behaviour: feedback loops. For example, when the population increases, the availability of housing and jobs decrease. While this is happening, an increase of housing price and less jobs will in return discourage more people to move in the area, diminishing its **attractiveness**. This is what is known as feedback loops in this model whose right construction, representation and interpretation embodies one of the most important features in SD. Figure 46 shows how mental models of the real world are the fundamental basis for strategies, structure and decision rules. This structure leads to decision-making processes, which influence the real world and consequently generate a feedback on decision-making processes in return.

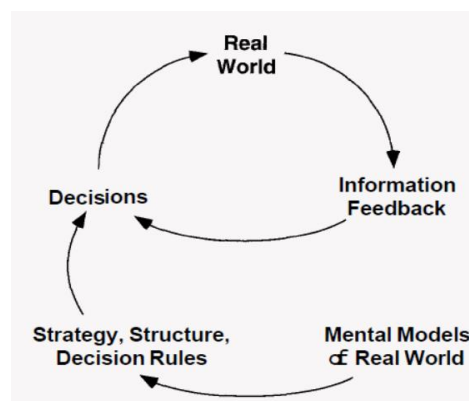

Figure 46. Feedback loop, source: Sterman (2000).

The three subsystems proposed by Forrester in Figure 45 were declined in nine levels in Figure 47, where each level is composed by three different classes.

Population was divided in three classes:

- MP stands for *Managerial-Professional* which are at the top of the pyramid.
- L stands for *Labour* which are in the middle.
- U stands for *under-employed* which is the category for non-qualified workers and those who undertake marginal work activities with low salaries.

Housing was categorized in three groups corresponding to the three classes of population as follows:

- PH stands for Premium Housing, which MP were the most likely to have access to.
- WH stands for Worker Housing, which L were the most likely to be in this category.
- UH stands for Underemployed Housing, which was mainly used by the under-employed category.

Enterprises were classified according with their age.

- NE stands for New Enterprises.
- MB stands for Mature Business.
- DI stands for Declining Industry.

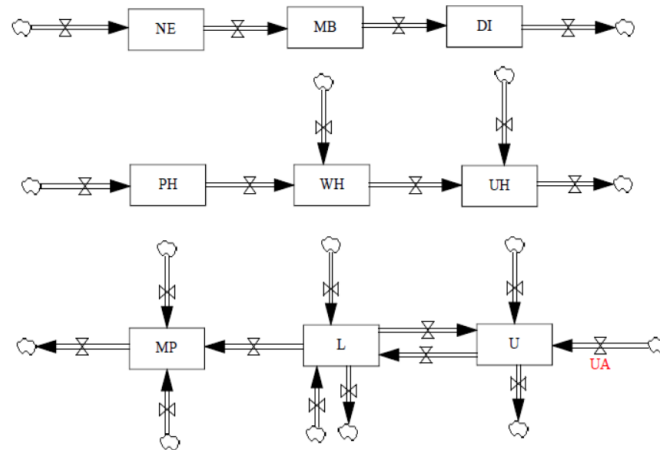

Figure 47 The nine levels of Forrester's model. Source: Forrester (1979).

The cloud, which might have different representations depending on the software, represents an illimited provision of something, like in this case the cloud is feeding **NE**, meaning that an illimited or a very high upper-bound of *New Enterprises* might be provided and it is not limited by the system's capacity. Respectively **DI** has an illimited outflux since **NE** has an illimited provisions and then becomes **MB** and ultimately **DI** which is the last stage of that level of the systems, creating an exit of the size of the entry. Afterwards, in the 1970's SD started to have an important scientific relevance and the research in this field was multiplied and other researchers joined the SD wave. Forrester's model was scrutinized by scholars and was the object of critics (see Rochberg, 1972; Babcock, 1972; Pessel et al., 1972; Mass, 1974; Graham, 1974).

Criticism to Forrester's model were established within the scientific community and generated controversial debates. The argumentative reproaches went in different directions, some scientists would state that the behavioural assumptions in the model were overly simplistic to capture the real essence of urban systems, while others would argue that the model was too complex (Cambien, 2007).

2.1.4 Spatial Urban Dynamics

Sanders & Sanders (2004) did a review of the main aspects that were object to the criticism and also discussed about the implications of the lack of the spatial dimension, which generated some limitations to perform a validation of the model from an urban perspective. They did apply the spatial dimension to the Dutch city of Rotterdam that was struggling in the beginning of the 2000's with urban decay issues, where housing decline and underemployment were present in an important proportion of the urban area. Hence, the Forrester's urban dynamics model of would have a transition to '*spatial urban dynamics*'.

Forrester's model involved two markets, housing and labour associated to population dynamics. The feedback mechanisms are represented as follows. Figure 48 illustrates the systemic relation between the variables in an urban system.

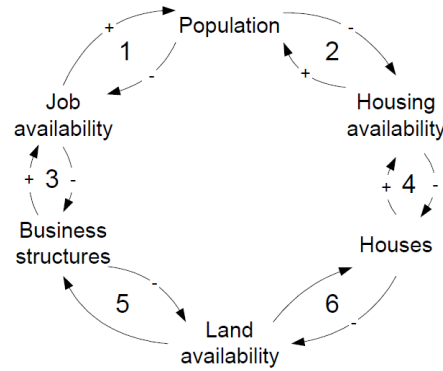

Figure 48 Urban system area is a system of interacting sector (Alfeld & Graham, 1976).

The figure above shows that as the population increases, jobs and housing availability decreases. When there is a low job availability, the area becomes less attractive due to the high rents and low salaries. If there is a low job availability, more unemployed people will be willing to work for low salaries. Underemployment generates less attractiveness leading to out migration and if there is a high house availability prices will fall, so less houses will be built. The interconnectedness and interplay of the system systematically triggers the variables accordingly with the interactions between them. Forrester (1971) showed that when industrial buildings age employment opportunities decrease. When residential building age, lower-income population use them in high densities, which means that there is not a housing shortage but an excess of low-income housing. Forrester suggests that aging buildings are the cause of decreasing job availability and a population increase. Consequently, he argued that an excess on low-cost housing attracts low-income groups and unemployed people at the extent that a limit is attain when all available jobs are taken so the life quality is affected and the inflow ceases.

Before introducing the spatial urban dynamic aspects, it is important to establish the basics of the original model of Forrester. For Forrester, a system (a city) is endogenously driven, this means that the dynamics of the city take place inside of the city with little intervention of the environment. However, the population can vary depending on the attractiveness of the city in comparison with other cities, which are outside of the system. To distinguish which variables are part of the system it is important to identify the three following elements: specific area, relative attractiveness, limitless environment. The specific area relates to the boundaries of the system (see Figure 49), where its limits determine the contours including the variables that represent the theoretical aspects of interest. The specific area of interest let us know the interactions within the system, in the Forrester model that is the intertwined relations of labour, housing and population. It is assumed that the urban model provides information about what happens inside that restricted world without considering the surroundings and it is small enough to not affect the outside environment (Forrester, 1969).

Forrester's model assumes that the environment does not substantially influence the system and the system does not influence the environment, an issue called the boundary problem (see Alfeld, 1995). The basis of the argumentative criticism is related to the lack of interactions between the cities and the suburbs, which are not accounted for in the model, so a consequence of this assumption is that the dynamics of the system are endogenously driven (Gray et al., 1972; Rochberg 1972; Graham, 1974). A related paper on the interconnectivity of cities was also proposed by Berry (1964). The 'environment' creates a second set of structural conditions in the urban model that are relative to the system. The model shows thus, how attractive is the city regarding its environment, allowing the inflow of population for example when the attractiveness is high or the outflow when it is low. Forrester's model was criticized concerning the characteristic limitless environment given that it has not size or boundaries, suggesting that the environment could be the universe (Sanders & Sanders, 2004). The spatial component was not considered and the recognition of the amount of people living in cities in the US prompted scholars to argue that the environment should be seen as a collection of cities that are in competition one to

another (Babcock, 1972; Gray et al, 1972). So, this approach is focused on local optimization (for example a city) but do not support national optimization processes for instance, a group of cities.

Moreover, as mentioned before some of the model’s assumptions are not based on the scientific literature, this means that the model simulates a hypothetical city. Then some authors argue that the model’s results cannot be validated if hypothetical data is used to setup the parameters of the simulation (Gray et al., 1972) and there are not evidences to support some of the assumptions of the model (Garn & Wilson 1972). Regarding the data problem, Forrester’s answer was that when a variable’s data is not available is better to use an estimation than not using the variable at all (Forrester 1969; Forrester: 1980). The criticism to Forrester model was addresses by different scholars over the time, to some authors the most critical issue was the boundary problem, so Schroeder (1975) introduced a model that accounted for the interactions between the city and the suburbs. The inclusion of the suburb areas introduces the spatial dimension in the model but its complexity as well.

Schroeder (1975) developed two urban dynamic models, one was for the city and the other for the suburbs where the migration is a function of the attractiveness of the city and its suburbs as a whole in comparison with its environment. The migration is distributed around the city and its suburbs based on the attractiveness of the zones under the assumption that people who live in a location also work in that area. This model was the target of the same critics as the Forrester’s model since the city and the suburbs are not influenced by the environment, it means that Schroeder added a layer (the suburbs) but the environment still does not have a considerable impact on the dynamics of the system. Other similar improvements to tackle the problems of the Forrester model were achieved by Kadanoff & Weinblatt (1972) Laudet & Fournier (1979) and Fournier (1986). The model proposed by Kadannof considers some interaction between the city and the suburbs, but they are judged to be somehow ‘*primitives*’. This paradoxical situation which is characterized by the simplistic and at the same time complexity in systems modelling is a recurrent inconvenient in SD. The Figure 49 shows the evolution of the spatial dimension in SD. Furthermore, Burdekin (1979) divided the area in 16 zones, which enhanced the analysis in a spatial perspective where construction rates and types of housing were considered. The migration flows in the system are analysed in a city perspective however the population is not studied in each area.

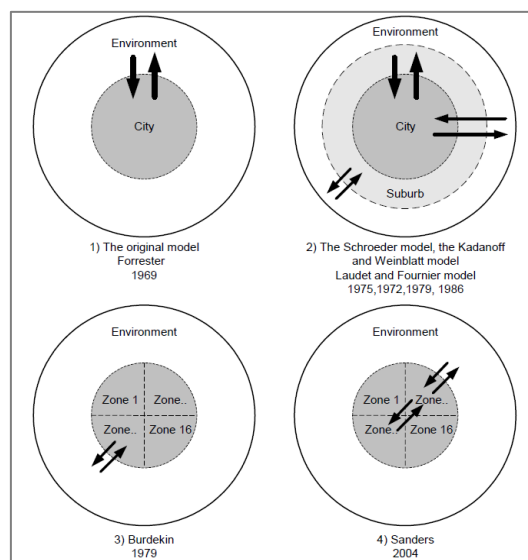

Figure 49 The development of the spatial dimension in Urban Dynamics. Source: Sanders & Sanders (2004).

Sanders & Sanders (2004) improved the Burdekin (1979) model, in which the area is divided into 16 zones. With Sanders & Sanders’ approach, it is possible to observe competition between areas and to distinguish the different

kind of population, housing and economy activities, relocation of people within and across the zones but in the same area of analysis. The active integration of the spatial dimension as an agent has important repercussion in many perspectives. A fundamental change that has implications in spatial modelling is the active interaction of the automata in mobility processes. For example, in the well-known example of predator-prey theory that has its origins in the Malthus-Verhulst logistic equation through the incorporation of the Lotka-Volterra equations (Vial, 2011; Amblard et al., 2015) and the Michaelis-Menten-Holling functional response to the predator and prey equations (Berryman, 1992) space works in a different way than in urban systems.

Figure 50 (left side) shows how the possibilities of migration for predators which are characterized only in an adjacent way. That is, a predator could move from the cell number 1 to the cell number 2 or to number 4 but not to number 5. In biological studies, this application can work in some cases like in the spread of toxics in the landscape, but it would not be realistic for population migration (Sanders & Sanders, 2004) or for innovation diffusion processes as it is developed in section 5.5.3.

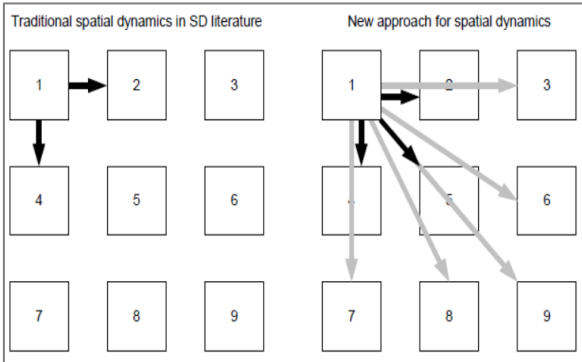

Figure 50 The difference between the traditional approach of SD and spatial dynamics, source: Sanders & Sanders (2004).

With the integration of the spatial dimension now, it is possible to migrate from the cell number 1 to the other 8 cells or urban areas. If we look at the incremental possibilities of mobility are of exponential order, passing from 9 possible flows to 36 flows (Figure 50 right side). Figure 51 shows a comparison between the results of the simulations performed by Sanders & Sanders model and Forrester. The S-shape is a curve observed in different kind of phenomena where growth is present, such as population dynamics, epidemics, and innovation diffusion. These processes are generally characterized by three phases, growth, overshoot and finally, stagnation. The stagnation stage appears because there is not any real quantity that can grow forever. For example, the growth process in innovation diffusion is limited either because the potential adopters have become actual adopters or because they are aware of the innovation but will not become adopters. So, the initial process of growth is fed by the action of positive feedbacks until the exhaustion of the carry capacity of the system is reached. Once the system is close to reach its limits, there is a nonlinear transition between the predominant positive feedbacks towards negative feedbacks, which under certain conditions results in an S-shape (Sterman, 2000).

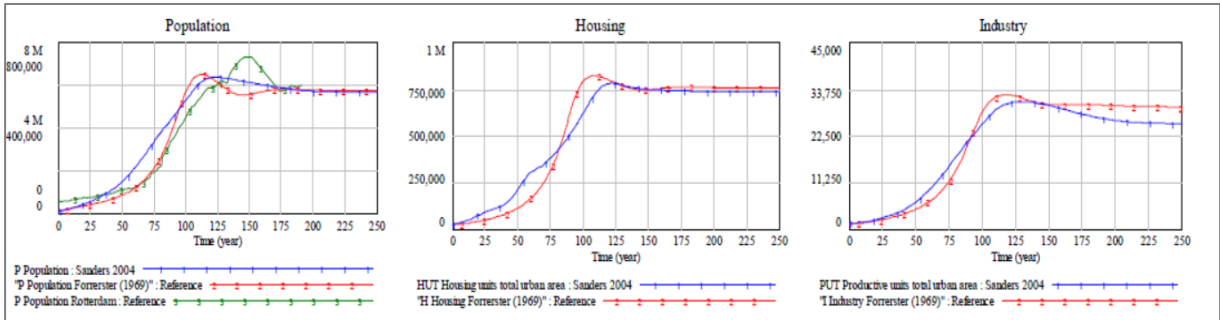

Figure 51 The base behaviour comparison with Forrester’s model, Sanders & Sanders (2004).

The consideration of the spatial component in the mode of Forrester’s showed that SD is a powerful tool for urban studies even though, Alfeld (1995) in his compilation work of fifty years of Urban Dynamics argued that SD “has never become an established method in the field of urban planning”. Voiron-Canicio & Chéry (2005) used the SD approach and worked on the interactions between population and housing in Nice in France with an active consideration of the spatial dimension and also modelled the Jurassic cross-border system between France and Switzerland (Voiron-Canicio & Chéry, 2005). After the *Urban Dynamics* model Forrester was contacted by the Club of Rome to address different worldwide challenges and SD seemed to be an appropriate tool to approach these issues. The output of this collaboration was *World Dynamics* (Forrester, 1971b). The capacity of the model to capture the counterintuitive nature of complex systems and also showed the necessity to reduce the growth rates:

“Our greatest challenge is to guide the transition from growth to equilibrium. There are many possible mechanisms for limiting growth. That current growth rates of population and industrialization will stop is inevitable. Unless we choose favourable processes to limit growth, the social and environmental systems by their internal processes will choose for us. The natural mechanisms for terminating exponential growth appear the least desirable. Unless the world understands and begins to act soon, civilization will be overwhelmed by forces we have created but can no longer control.” (Forrester, 1971b).

This is an early stance on the very topic that is central in the third innovation policy framing as it was discussed in Chapter 1 of this research work. This model suggested high environmental costs derived from the growth economy approach taken in the last decades. In a parallel research from the 1950’s, French glaciologist Claude Lorius with other scientists did several expeditions in the Antarctica that would later show that climate change was happening in unprecedented records (Lorius et al., 1990) a phenomenon captured by Forrester’s model. The *World Model* was improved later on by Donella Meadows et al., (1972), Meadows & Meadows (1973) and Dennis Meadows et al., (1974). Figure 52 shows the complex structure of the interactions of the *World Model*.

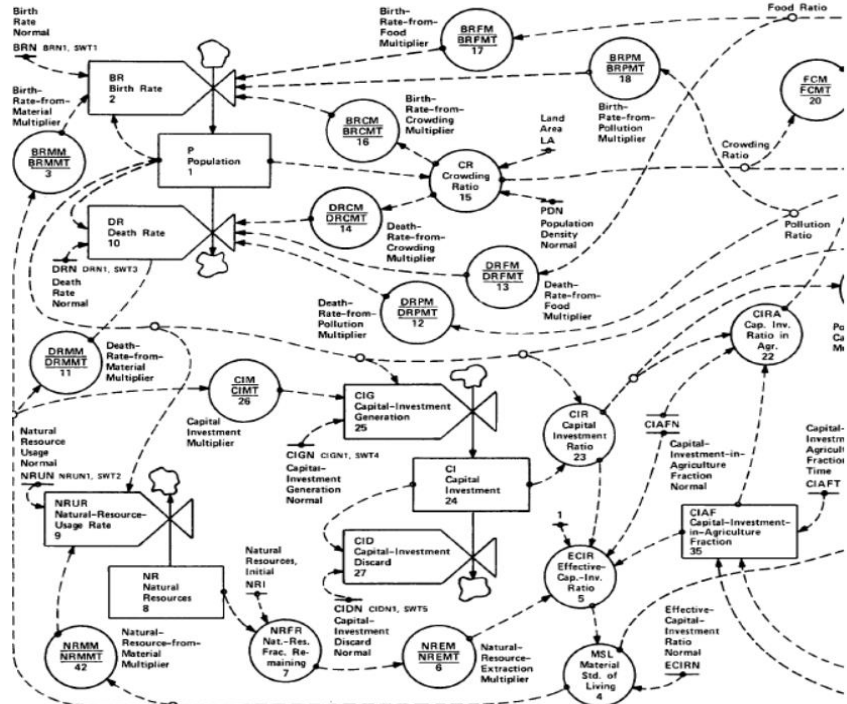

Figure 52. World Model, source: Forrester (1971).

Other relevant scientific publications followed (see Goodman, 1974; Forrester, 1971a, 1975, 1980, 1981, 1985, 1987, 1988, 1990, 1995; Forrester et al., 1976; 1980). In the 1980's scholars turned to develop software to simulate dynamic systems such as Dynamo (see Richardson & Pugh, 1981; Pugh 1986) and STELLA (see Richmond et al., 1987). Readers interested in related work are referred to Schroeder et al., 1975; Alfeld & Graham; 1976, Roberts, 1978; Randers, 1980; Forrester & Senge 1980; Roberts et al. 1983; Forrester, 1985; Meadows et al., 1992; Sterman, 1989, 1994, 2002; Meadows et al., 2004). John Sterman produced a classic book where he broadly discusses innovation diffusion and SD and is one of most cited publications (Sterman, 2000). For more information about applications of SD in innovation diffusion see Maier (1998) and Kiesling (2011).

The SD methodology and paradigm has been criticized regarding its application on diffusion of innovation since its standpoint is rather focused on feedback structures and non-intuitive secondary effects (Kiesling, 2011). Maier (1998) claimed that traditional aggregated models of innovation diffusion perform well for description and under restrictive assumptions for optimization purposes. However, they fail at improving our understanding of complex and dynamic behaviours embedded in innovation diffusion processes. Like it is the case of the Bass model, SD works with aggregates and differential equations which has implications in terms of scale in spatial modelling. Nowadays technology allows to perform multi-paradigm simulations, that are multi-scale and multi-approach models considering the same variables such as population, jobs and housing. The software Anylogic is typically a powerful tool that allows build models under three different paradigms: ABM, discrete events and SD simulation.

The possibilities with such technology are great since the same phenomenon can be simulated in different scales for different purposes but within the same model. The simultaneous implementation of these different approaches is also referred to as multiparadigm simulation, which is inspired on the vocabulary applied to describe computer languages. This concept entails that a multiparadigm language enables the usage of various programming paradigms simultaneously. This is the case of the general model of simulation built in this dissertation, which is composed of SD and ABM. In section 5.4.5 all the details of the multiparadigm model developed in this research work are explained.

2.1.5 Land-Use Change Modelling

Land change is the consequence of multiple human-environment interactions, which are developed across scales (Manfredo et al., 2014). Some scholars have focused on land-use change models (LCM), which have multiple usage such as the assessment the impact of land-use on biophysical processes, ecosystems stability, climate change, land degradation (Veldkamp & Lambin, 2001) and also for urban purposes (Loubier et al., 2017). Since a land-use change model was implemented in the framework of this dissertation in order to verify if it was possible to determine any impact of the RET diffusion on the landscape, we will introduce this approach.

Predicting land-use allows to observe the dynamical behaviour of the parameters of interest and test the sensitivity of territories' trajectories in order to anticipate the changes and the interactions between ecological and social systems (Veldkamp & Lambin, 2001; Veldkamp & Verburg, 2004). While it is not possible to predict spatial change, it is feasible to detect the trends in a territory and its propensity to change based on the historical developments (Voiron-Canicio & Fusco, 2020). Spatial change discontinuity can be modelled through the usage of cellular automata (CA), which were developed by John von Neumann and Stanislaw Ulam at the national lab in Los Alamos. This approached can be coupled with Markov chains and it is used to perform simulation of systems that can be characterised by a succession of states.

Now we will briefly identify the main properties and definitions of Markov analysis. Since the approach is applied in different fields such as financial markets to perform credit ranking for enterprises, which is done by agencies like Standard & Poor's or Moody Fitch's among others, we will review the method from a land-change modelling

perspective. We will focus on the mathematical aspects of the approach and its application in geography, which will help to better underpin our understanding of the model developed in section 5.5.3. Markov analysis is particularly suitable for simulating the dynamics of a global system such as a landscape mosaics or ecosystems. This methodology is often used by geographers to try to predict the evolution of land-use in a given territory. Markov's analysis is based on the observation of a system that may be in a certain state among a finite list. It is therefore necessary to know the classes of land-used in order to build a model capable of describing:

- i) How these possible states interconnect with each other.
- ii) How to switch from one state to another via a link and a probability rule

An effective way to carry out a Markov analysis is to first make a graph and then transform it into a transition matrix. The figure below shows an example of Markov Chain construction to deal with the possible states that can describe the evolution of the territory. A real simulation was performed in the region of Valais in Switzerland for 2048, the land-used was classified in 9 classes. The spatial units' resolution was of 250 sqm. The complete procedure is discussed on section 5.3.

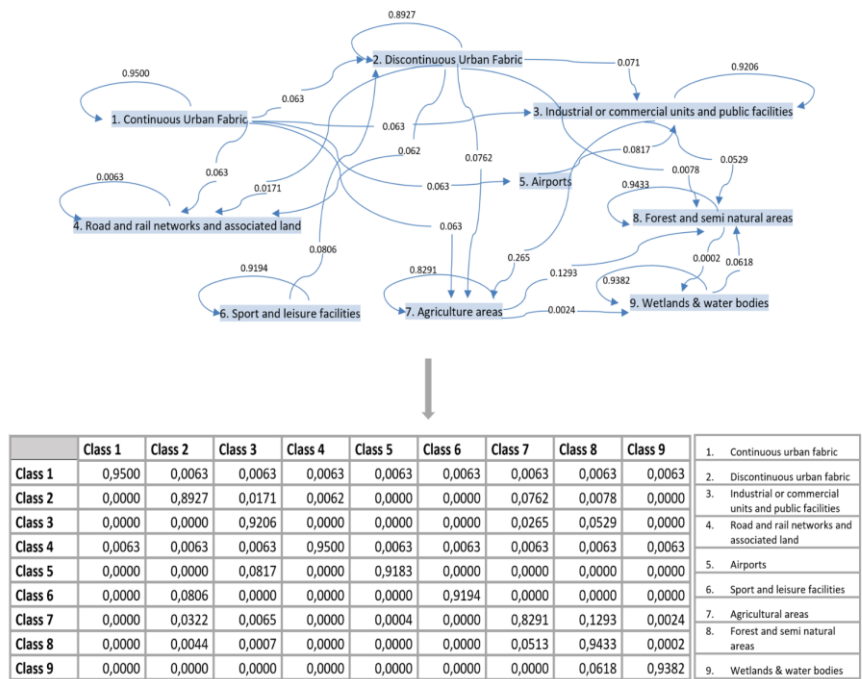

Figure 53 Markov Chains and Transition Matrix of land used in the canton of Valais-Wallis for 2030.

The transition matrix in the figure above describes the whole rule of the dynamics of this model. It has logical properties such as for example the fact that the sum of probabilities per row is equal to 1 because the territory is necessarily in any state whatever the time step. We can also know the transition mechanism in detail by studying the probabilities of each row. To calculate the probabilities, we divide the value of each cell by the sum of the row.

Property i) In a transition matrix all the elements are positive, and the sum of each row is 1.

Another fundamental property of Markov chains is that the transition matrix raised to the power n contains the transition probabilities from each of the states to all the other states in exactly n iterations. This is controlled by the Chapman-Kolmogorov equation which is the underlying process at work in a Markov chain.

Property ii) Let $P^{(n)}$ be the transition matrix in n steps of a Markov chain. So, for any non-negative integer l and n :

$$P^{(l+n)} = P^{(l)} P^{(n)}, \text{ which is } P^{(l)} = P^{(n)} \quad (2.18)$$

The Markov chains have different properties, such as the stationary processes, so we will present some definitions needed for the mathematical formalisation:

Definition i) A stochastic process is a sequence of experiments whose outcome depends on chance, i.e., an indexed set of random $\{X_t\}$ variables, on a set of periods $t \in T$. A random variable X_t represents the system's state at a period t .

Definition ii) The set of all possible configurations of the variables is called the state space. If this set is countable, the process is called a chain.

Definition iii) A stochastic process $\{X_t\}$, $t=0,1,2,\dots,n$ defines a Markov chain if:

$$P(X_{t+1} = j \mid X_{t+0} = k_0, X_1 = k_1, \dots, X_{t-1} = k_{t-1}, X_t = i \mid X_{t+1} = j \mid X_t = i), \text{ for all } t=0,1,2,\dots,n \text{ and} \\ \text{for all sequence } k_0, k_1, k_2, \dots, k_{t-1}, \quad (2.19)$$

This definition has deep consequences on land-use change modelling, since it entails that a future experiment's outcome will depend only on the present state and not on the previous states. Let's take an example of land-use change prediction. The land-use evolution is calculated by taking the data from the past (date 1) and compared to the data of the present (date 2) in order to calculate the future (date 3). For example, we have data sets of periods of every 6 years, which it is the case in Europe with the Corine Land Cover project (see section 5.3.1). If we would like to model the land-use change for 2024 we would use data of the present state, which is 2018 in this context. Then, the outcomes for 2024 will be solely based on the data input from 2018 and would not take into account the features of former periods such as 2012 or 2006. If we continue with the same exercise for 2030, then we would need to use the data set of 2024, meaning that the data of 2018 would not have impact on the predictions of 2030 and so forth. Therefore, we could say that the Markov chains do not have memory, since the past periods are not relevant to the future variables' state.

Since the probabilities of transition to period t depend only on the state at period t depend only on the state at period $t-1$, therefore we have:

$$P^{(n)} = P^{(n-1)}P \\ \text{Then, } P^{(n)} = P^{(n-1)}P = P = P^{(n-2)}PP = \dots \quad (2.20)$$

Thus, the transition probabilities in n steps can be calculated by taking the n -th power of P . We notice that for large values of n , $P^n \approx P^{n+1}$, these probabilities are then called stationary. From a geographical perspective, this indicates that the territory reaches a point where adjustment processes take place heading towards a temporal optimal state (see Loubier et al.,2017)

Definition iv) The matrix $P = (p_{ij})$, where the element p_{ij} is the transition probability in one step, from state i to state j , is called the transition matrix. In mathematics it is also referred to as stochastic matrix, Markov matrix or probability matrix. For the sake of terminology consistency, we will refer to it simply as a transition matrix.

Definition vi) A Markov chain is homogeneous if the transition probability between one state to another is independent of the period during which the transition takes place, and it is mathematically formalised with the following expression:

$$P(X_{t+1} = j | X_t = i) = P(X_1 = j | X_0 = i) \quad \forall t \in \mathbb{N} \quad (2.21)$$

That has a simplified form:

$$P_{ij}^{(n)} = P(X_{t+n} = j | X_t = i) \quad (2.22)$$

Where the $P_{ij}^{(n)}$ expression represents the conditional probability that the system be in the state j after n steps starting in the step i .

Definition vii) A Markov chain is said to be irreducible if it is still possible to go from state i to state j in one or more steps; then we can say that states i and j communicate. A state j is said to be periodic with period $t > 1$ if a return to the state j is only possible only after steps t ; $2t$; $3t$, ..., nt .. Otherwise, the state is said to be aperiodic.

Definition viii) A probability distribution on the states of a Markov chain is said to be stationary if it is possible to verify:

$$\pi = \pi P \quad (2.23)$$

The following property has been demonstrated, making it possible to characterise a Markov chain whose transition probabilities stabilise over the long term. Let P be the transition matrix of an irreducible and aperiodic Markov chain. For all initial distribution π_0

$$\lim_{n \rightarrow \infty} \pi_0 P^n = \pi \quad (2.24)$$

π is the unique solution of the system:

$$\begin{cases} \pi P = \pi \\ \pi \mathbf{1} = 1 \end{cases} \quad (2.25)$$

π is equal to any row of the matrix

$$\lim_{n \rightarrow \infty} P^n \quad (2.26)$$

Among the most used approaches, the SLEUTH stands out and it has been reported to have the greatest impact (Batty, 1997; Chaudhuri & Clarke, 2013). This approach relies on cellular automata (CA), which is a methodology that divides the landscape into cells (Figure 54) as it was also briefly reviewed in the Spatial Urban Dynamics discussion (see section 2.1.4). According to a systematic review done by Chaudhuri & Clarke (2013) the Sleuth method has been applied to more than 60 cities and regions. Under this methodology, the cells interact according to transition rules that are able to capture the behaviour and uncertainties of real urban processes. In the beginning this CA method was used to simulate wildfire spread (Clarke et al., 1993) and its code has continuously been updated and is open source. The Sleuth model is the result of the integration of the codes of two previous model, the Land Cover Deltaron Model and the Urban Growth Model. The model runs under Linux, Unix, Windows-based Unix simulator and Cygwin (Chaudhuri & Clarke, 2013). The name is derived from an acronym for the six gridded raster maps utilised as input data layers: *Slope, Land-use* (Caloz & Collet, 2011; Chaudhuri & Clarke, 2013).

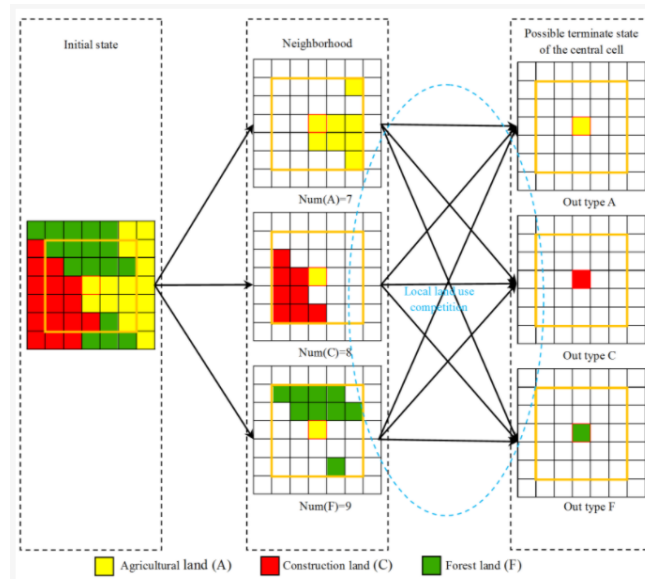

Figure 54 Sketch of mutual competition between different land use type cells in the neighborhood. Source: Yang et al., (2016).

In the figure above, we observe a diagram of a model proposed by Yang et al., (2016), this example was inspired on the spatial interaction theory. The diagram represents the mutual competition between the central cell and the neighbouring land-use cells. In the left column, the initial state of land-use is depicted, which is in competition with the neighbour's land-use type cells located in the central column. Finally, in the right column it is shown the possible final state of the central cell.

$$C_k^t(i, j) = \frac{\sum_{x=-2}^2 \sum_{y=-2}^2 [j(S^t(i+x, j+y))/d(i+x, j+y)]}{N} \quad (2.27)$$

The parameter N represents the total number of cells in the vicinity of the central cell, which is inside of the yellow square and its equal to 25. The expression $j(S^t(i+x, j+y))$ is used to evaluate the state of cell $(i+x, j+y)$, if it is $k=1$ for true and $k=0$ for false. The expression $d(i+x, j+y)$ is the convolution kernel and is the distance from the central cell (i, j) to the neighbouring cell $(i+x, j+y)$, if $(i+x, j+y)$ happens to be the central cell hence, $d(i+x, j+y) = 1$ if not, but it is a neighbouring cell then, $d(i+x, j+y) = 2$. In the case that $(i+x, j+y)$ and (i, j) are not a neighbouring cell and separated by only one cell, then $d(i+x, j+y) = 2$.

This mathematical formalisation simply indicates a distance decay effect, which is present in spatial interaction models. In order to predict land-use change, it is necessary to create a map of the potential transitions that can mathematically be expressed through transition matrices and Markov chains. These operational procedures are applied on a real territory and are thoroughly described by Loubier et al., (2017). The authors applied this methodology in the coastal zones of the Alps-Maritimes in France which has been facing serious threats by a high rate of diffuse urbanization. In order to apply this methodology, it is necessary to choose the classes of land-use and then the transition matrices are processed via the Markov Chains approach.

However, the nature of Markov chains is not 'spatial', so it is required to transpose the Markov chains to the spatial dimension, which is possible to do via CA (see also Coquillard & Hill, 1997; Caloz & Collet, 2011). The state of a cell or a delimited geographic area primarily depends on its initial state and subsequently of the state of the neighbouring cells. It is possible to do this kind of simulation with different GIS, the most well-known is the software IDRISI (see Eastman et al., 2005; Eastman et al, 2008; Eastman 2009).

A recent application with a massive data set was applied to model California land-use to 2100 (Clarke & Johnson, 2020). In the paper the authors focused on calibration issues and yield the research question whether a reliable land-use forecast could be performed with this approach for the year 2100. The null hypothesis was that all the 6 State Plane Zones and the 174 tiles in which the territory was partitioned would follow similar calibration outcomes, hence an equal rate of growth would be applied in the simulation.

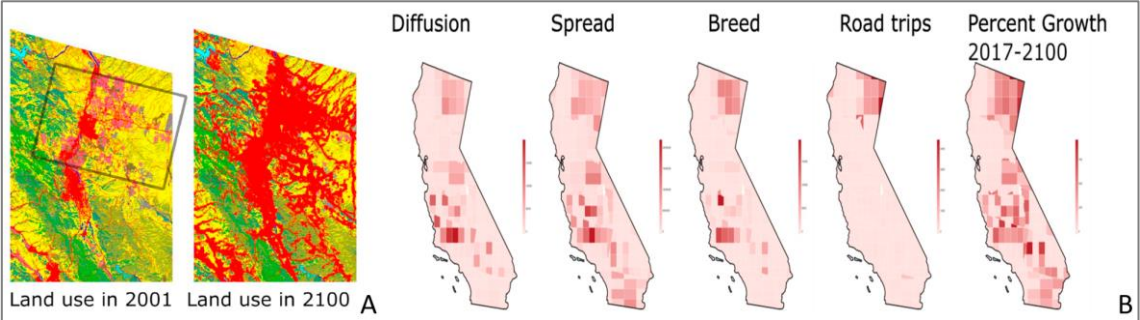

Figure 55 Land use maps in 2001 and 2100, class colors Red = Urban; Pink = Agriculture; Green = Forest and Rangeland. Counts of the number of pixels converted to urban during the 2017–2100 simulation by each of the four CA behaviour rules. Far right map is for the total urban growth rate by cells in percentage. Note that the scales vary by behaviour rule. Source: Clarke & Johnson (2020).

Results showed that the null hypothesis had to be rejected based on Moran’s I correlation value and a mapping process, the figure below shows some of the spatial representations. The computation time was reduced about a year of CPU time thanks to a genetic algorithm using two computers. Readers interested in more LCM applications, Fuller et al.,(2011) and Sangermano et al., (2012) did work on the subject to study biophysical systems. More recent approaches to perform urban dynamics and simulation have been developed for example, Pumain & Reuillon (2017) created a new model belonging to the *SIMPOP* agent-based models family presented in the previous section.

The authors developed *SimpopLocal*, which included new features such as making the innovation creation processes endogenous linked with the size of the settlements via an ABM approach. The model was built with NetLogo and Scala programming languages. The population growth mechanisms were based on the assumption that the settlements’ sizes depend on the available resources in a determined location and the trajectory follows a logistic distribution or the Verhulst model (Verhulst, 1845).

$$P_{t+1}^i = P_t^i [1 + r (1 - \frac{P_t^i}{R_m^i})] \tag{2.28}$$

Where, *r* is the annual growth parameter, the upper growth boundary is given by R_m^i which is the amount of available resources that depends on the number of M innovations in a determined settlement *i* at a time *t*. Finally, P_t^i represents the population of a settlement *i* at a time *t*.

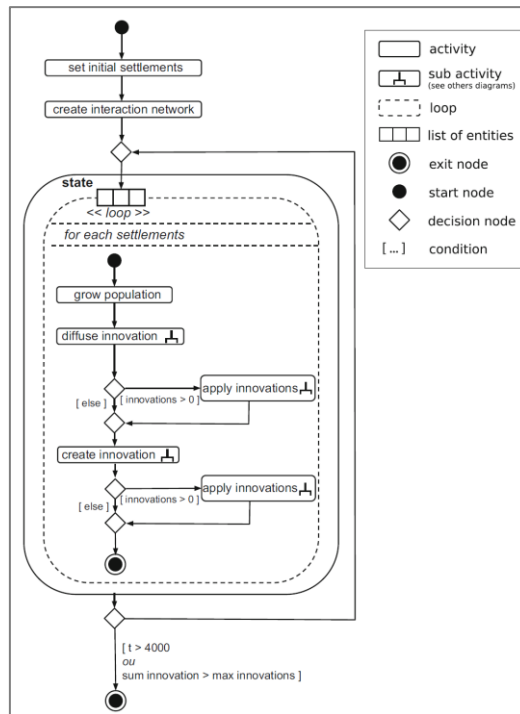

Figure 56 SimpopLocal Activity Diagram. Source: Pumain & Reuillon (2017).

These population processes were used to establish the innovation mechanisms as it is shown in the diagram above. The equation below was implemented to model the innovation diffusion process. The *Innovation Impact* is a factor that represents the impact of the adoption of an innovation and has a reducing influence on the amount of available resources R_{M+1}^i and R_{max} is the maximal carrying capacity.

$$R_{M+1}^i = R_M^i [1 + Innovation\ Impact (1 - \frac{R_M^i}{R_{max}^i})] \quad (2.29)$$

These equations were integrated with a series of equations that would give information about different distributional changes on variables such as the mechanisms embedded in diffusion of innovations. Furthermore, a gravity model was implemented in order to calculate the distance decay effects between settlements. The authors run 500 million of simulations with the aim of calibrating the parameters of the model and produce a series of results which displays a range of different possible scenarios, depending on the parameters' values. The lessons learned with this model are diverse for example, the conceptual notion of systems is at the center of the *SIMPOP* family of models, considering the interaction between villages, cities and regions.

This consideration is important from a simulation standpoint since the mechanisms that depict spatial interaction through the gravity model and the control of its impact via the distance decay parameter. The model was able to show the diffusion of innovations between cities keeping the descending hierarchical path as it is observed in real systems. An important fact to add, it is the importance of the distance decay role in the model, which controls the intensity of interaction between settlements according to the distance between them. Without this parameter the model would not be able to show the real development of actual urban systems. This proves once again, the influence of the spatial dimension in the organization of human settlements and their economic activities.

These claims derived from these results are in line with theoretical concepts like the 'geographic space': "Geographic space is the land area used and developed by societies for reproduction, not only for the purpose of food and shelter, but in all the complexity of social acts" (Brunet et al., 1992); and territory: "Territory is the portion

of land area appropriated by a social group to ensure its production and the satisfaction of its needs, vital needs" (Le Berre, 1992).

Pumain & Reuillon (2017) presented other kinds of modelling approaches, such as multi-modelling method and different algorithms that can be used to explore possible futures for systems of cities. In the same category of ABM models, we find an important and detailed contribution by Banos et al., (2015, 2017). In this work, the ABM are systematically reviewed and positioned within the scientific literature context highlighting the gaps covered by the approach and included an explicit implementation of the spatial dimension. The scholars treated various simulations topics for example, the spread of infections (Amblard et al., 2015) also panic via dynamical systems on NetLogo (Corson & Olivier, 2015). A relevant topic that is discussed in chapter 6 (see Becu et al., 2015) is the importance of interdisciplinary research work to model complex systems.

The authors acknowledge that the idea of a solitary researcher doing all the work alone is becoming something from the past and a collaboration is needed between mathematicians, computer scientists and field experts. This type of collaborations is in line with the increasing inclusion of different stakeholders including citizens and decision-makers through participatory processes. It appears that the mechanisms and processes related to the development of political action are progressively based of political relations through participatory approaches. In such processes, stakeholders are able to interact with information technology and decision-making processes for co-creation purposes (see Rojas & Loubier, 2017; Emsellem et al., 2018).

Participatory approaches take further the nature of interdisciplinary nature of research work, with the participation of non-experts in decision-making processes. Often in urban development projects the question of the competence of the stakeholders is often settled by delegating the voice to a person identified as competent which rises a real difficulty. The argument of incompetence might be used against minorities with the aim of impeding to be part of a collective decision in spite of the legal obligation to implicate them in the decision-making process. To deal with the notion of competence, quantitative and theoretical geographers propose a different approach: geo-governance.

Geo-governance is defined as *"an approach based on the use of methods and tools of spatial analysis, designed to make relevant territorial information available to all stakeholders throughout the chain of construction of a territorial project. Its objective is to help to make territorial complexity intelligible, to bring out the territory's social and spatial aspects at stake, as well as its evolutions in different time horizons"*(Masson-Vincent et al., 2012). According to the authors, geo-governance has a first meaning as 'the way of governing' (see Dubus et al., 2010). Since the Rio Conference in 1992, the notion of governance has entered the democratic debate. However, the relationships between stakeholders are linked to the degree of access to information on the one hand, and in the understanding of the complexity that the information flow generates on the other hand (Loubier, 2013).

It is therefore necessary to consider that co-constructed decisions can only be achieved when the information regarding the subject is shared and made intelligible for everybody. Some scholars claim that the geo-governance concept intends to be integrated in the field of spatial planning (see Masson-Vincent et al., 2012). As early as of 2001, Joliveau (2001) showed that the territorial dimension of participation is circumscribed by three constraints: the limit of the study area, the hierarchical level considered, without forgetting that this level is related to the other interlocking levels²⁴ Also, the organization of the territory, which will be influenced by the project.

Geo-governance is therefore a global concept where the process of co-construction of the territory is allowed by the use of the theory of spatial analysis combined with the help of cartography. Spatial analysis shows that the spatial dimension is not only a support for human action but also an element of social organization. Although space

²⁴ For example, the level of the district in relation to the urban area, the communal level in relation to the department or county level, and so forth.

is a social construction, it still has a position, a physical reality that cannot be evacuated if we want to understand it in its entirety. This observation is entirely presented in the first law of geography proposed by Tobler (1970) *"Everything is related to everything else, but near things are more related than distant things"*. This is a fundamental nomothetic approach which makes it particularly transposable to computer tools such as GIS.

Thanks to the tools proposed by GIS, it is possible to build a didactic system in quasi real time, where non-experts can contribute. Experiments proposed by Loubier (2013) have shown that 3D models promote the participation and co-building processes of spatial projects (see also Dubus et al., 2015). Scholars through interdisciplinary work have looked at methodological approaches using collected qualitative data under participatory approaches to perform spatial modelling techniques in urban environments (see Bideau et al., 2014). The development of all these techniques have been gaining ground in other fields, where dynamics and change from spatial and temporal perspective have a central role. For example, geospective is an approach used by quantitative and theoretical geographers to deal with complex phenomena where uncertainty is pervasive. The approach is composed of different methods and tools to analyse ecosystems and socio-technical systems, the capacity of such systems to cope with change and their resilience to forecast spatial change (Voiron-Canicio et al., 2020). We will discuss more about geospective in the section 2.2 where we will cover the concepts of urban resilience and change.

2.2 Innovation Diffusion as a Spatial Process

The development of methodological approaches in spatial diffusion of innovations (SDI) is the result of contributions from different disciplines over time. Although they might have been constructed with divergent goals in the beginning, some of these theories share the same lines of thought. As a result, we can name research work that converge at some extent in epistemological views on SDI and economic and urban activity. Innovation studies naturally gained the interest of geographers decades ago, with a singular emphasis on the spatial dimension, which is clearly a main component of the research body. Swedish geographer Hägerstrand did a major contribution in the field of SDI with his notable work in 1952 and his doctoral thesis in 1953. Hägerstrand motivations to work in the field of diffusion was primarily driven and based on Swedish geography.

We will briefly mention the scientific work that was previously done in the field in Sweden, which was a cornerstone for Hägerstrand scientific research contributions afterwards. Hägerstrand did find *"worthy of mention"* as he wrote in his doctoral thesis in 1953 entitled *"Innovation diffusion as spatial process"* some specific work developed by his peers. We note that we also find important to mention it here in order to show the variety of tangible and intangible innovation indicators studied in the past and the importance of the work done in the field of SDI back in the 1940's and early 1950's which set the basis of current research streams.

A first relevant work done in SDI by Hjulström (1940) called *"Sweden's electrification"*, then Dahl (1941) *"The implementation of the big shift and the single shift in Skåne"*. Another important research work was done by Jonasson (1949) which used data dating back from the 19th century and it was entitled *"The population and business sector in Central Sweden within the GDC's traffic area 1865-1940"* where a special emphasis on innovation diffusion is on the chapter called *"The rise of mining railways"*. In the same year Lägnert (1940) wrote *"wheat cultivation in Southern and Central Sweden"*.

Another geographical work based on information dating back from the 19th century was carried out by Wik (1949) called *"Northern Sweden's sawmill industry from the mid-19th century until 1937"* the chapter *"from water saw to steam saw"* and figures 1 to 6 are specially recommended. Godlund (1951) worked on the adoption of buses in the county of Skåne in Sweden from 1924 to 1948, his work's title was *"Traffic, surrounding areas and pies"*. In 1952, the same year that Hägerstrand published his seminal work *"The propagation of innovation waves"*, Lägnert

published his work entitled *"The poppy in Skåne's countryside from 1911 to 1948"* in which social democracy and farmers' union represented the innovation. Finally, the work of Godlung (1952) written originally in German *"A course of innovation in Europe, presented in a preliminary study on the spread of railway innovation"*. These pioneer works were used as a scientific basis for Hägerstrand's work, however Svensson's contributions (1942) had a major impact on his research.

All the research works mentioned above were developed in Sweden and in Swedish including Hägerstrand's work in 1952 and 1953, which arguably might have had an impact on the diffusion of his work outside of Sweden at least for some years. All these studies contributed in different aspects to the field of innovation diffusion nonetheless, according to Hägerstrand (1953) all of them failed at characterizing spatial innovation diffusion in a systematic way. According to American geographer Allan Pred, one of the possible explanations of why Hägerstrand could successfully build a theory about the systematic process of innovation diffusion at that time is related to his background (Hägerstrand, 1967).

Pred translated Hägerstrand's doctoral thesis from Swedish to English in 1967, therefore he had a first-hand knowledge of his work. The first generation of Swedish geographers was marked by scientists with different disciplinary backgrounds however, rather in natural than in social sciences. Hägerstrand was exposed to the work of geographers such as the theorizer Sten De Geer who was a geologist, David Hanneberg who had a background in physics and mathematics and later switched to historical geography and Estonian prominent economic geographer Edgar Kant.

Hägerstrand and Kant were among the first geographers to join the quantitative wave in geography in Sweden in the 1950's. In Sweden, geography split up in the 1950's in physical and human geography chairs, which alleviated the burden of specialized students in both, physical and human geography and since then, both departments keep functioning as two different streams of geography (Helmfrid, 2004). This brief bibliography to Hägerstrand's contribution intends to address once again, the importance and the potential of interdisciplinary approaches within the field of geography. After this short introduction on SDI studies, we will proceed to discuss the theoretical fundamentals of Hägerstrand's work and how they are applied in this research work. The diffusion property is the process of transmitting and spreading something through a system in an evenly fashion by successively altering its balance to another state of equilibrium until the system is saturated as it stops growing (Hägerstrand, 1952; Saint-Julien, 2004).

Spatial diffusion processes signature has two characteristics that are relevant to mention *i)* the first one is related to its own definition which states that the notion of diffusion describes processes where there is an involvement of motion of something, it can be people (migration), products/food (*i.e.*, exports), virus (diseases), languages (knowledge-culture); *ii)* for a successful diffusion process, an innovation must impose itself in a form of colonisation of something new, and the diffusion process must have a complexity level high enough to make the process predictable at different geographic scales (Saint-Julien, 2004). Hägerstrand (1952, 1953) noticed that spatial diffusion of innovation processes is characterized by three main phases, the *primary step* starts by local concentrations or agglomerations of initial acceptances of an innovation. This phase is characterized by a strong heterogeneous density in terms of spatial intensity of innovation adoptions in determined locations.

The second phase is the expansion step which depicts a radial dissemination emitted from the initial agglomeration and it is followed by the emergence of secondary agglomerations while the original main agglomerations keep a steady condensing process. The third and last phase is the *saturation step* where the growth ceases. Diffusion processes are present where movement and re-location are observed. Some of them can be for example the movement of goods, even people through migration processes and it could also be intangible things such ideas, information, energy and other kind of elements that are subject to movement.

A key aspect of an innovation diffusion process is observed in the local concentration of initial acceptance of an innovation. This phase entails that a local agglomeration is only possible when the quantity of the initial acceptance of an innovation in an area is dense enough to be able to generate momentum. This density represented by the initial acceptances of an innovation per spatial unit of observation, should be characterized by a settlement or a conquering process of the space. This colonization process and the possibility to capture the complexity of it in different scales are the first signs to detect a possible diffusion process in progress however, more conditions are needed to complete a spatial diffusion process. Hägerstrand (1952, 1953) did analyse the usage of some objects but only from the 20th century which he called “indicators”. The innovations he analysed were categorized into two main groups, the first one was directly related to agriculture, meaning that the diffusion process would happen only into that social group (mainly farmers).

The agricultural indicators were state subsidize pastures, control of bovine tuberculosis and soil maps. The second category of innovation indicators he called them general indicators since they could be adopted by any kind of social group: postal checking services, automobiles and telephones. Other kind of innovations were also analysed but data availability hindered his work at some extent. The choice of these specific indicators was not essential to do the research *per se*, given that the same spatiotemporal regularities of the spatial diffusion process are observable with other indicators. The only condition needed to be fulfilled was that the innovation indicators should be adopted by a large number of people in the area of study. Hägerstrand (1952, 1953) proposed a series of conditions that are needed to be fulfilled in order to witness an innovation diffusion as a spatial process:

1. *“birth in some place of an innovation able to travel and to impose itself as such*
2. *ability of place of birth of innovation to become an emitting source*
3. *existence of a receiving environment which fosters a quick propagation*
4. *propagation force important enough and propagation time long enough to make interruption of the diffusion process hardly probable.”*

Table 3 Hägerstrand’s’ four conditions for spatial diffusion of innovations. Source: Hägerstrand, 1952.

These recurrent characteristics were found in the diffusion process of different types of innovations in Sweden in early 1950’s, these four conditions’ interplay have an intertwined mechanism. The first condition proposed by Hägerstrand, has the assumption that the innovation is already born and also that it has already come into a settlement. Here, the author focused on addressing the question of *“where the innovation appears and its ability to spread”*, but not the question of *“how and by what means the innovation colonized the place”* (Hägerstrand, 1953). Consequently, in this research work we have also focused on the *‘where question’* of diffusion and not on the *‘how question’* regarding the initial appearance of the innovation.

The author’s research was fundamentally inspired by Sigfrid Svensson’s work (1942) called in Swedish *“Bygd och yttervärld: Studier över förhållandet mellan nyheter och tradition”* which means *“the countryside and the outer world: studies on the relationships between today and tradition”*. Svensson was interested in *“how does an innovation initially appear in a settlement? Nevertheless, Hägerstrand’s work was more focused on “how does the adoption of an innovation become widespread once it has come into a settlement”* (Hägerstrand, 1953). Svensson’s work emphasised more on the previous processes to the diffusion, he analysed a vast variety of objects dating back from the 18th century till the 20th century in Sweden. He investigated building style changes, fashion trends of dresses, holiday customs and rhymes. Svensson’s studies were carried out in the field of ethnology and cultural anthropology, therefore spatial and quantitative analyses were done only when it was clearly relevant.

His work was an important basis for innovation studies and an incentive for Hägerstrand's work. Hägerstrand's work focused on observing places that were hubs of innovations space-wise, this implied that not all places are equal in terms of ability to generate the colonization of an innovation. This subsequently suggests that the place of birth of an innovation is not random and that the probability of the appearance of an initial innovation differs amongst locations. The initial appearance of an innovation in a given place and the continuous incremental adoption of that innovation in particular places and not everywhere might indicate that the innovation diffuses following a preferential spatial attachment.

Preferential attachment is a relative new name for a concept already known under different names such as Matthew Effect (Merton, 1968) or Jackson effect in economics (Dauphiné, 2011). This property entails that the rich elements in a system will get richer in a cycle boosted by the probability of getting richer based on the existing wealth. This property is further discussed in **sections 4.1** and Chapter 5.5.3 with a special focus on networks and on RET spatial diffusion respectively.

The second condition is the *"ability of place of birth of innovation to become an emitting source"* which is interdependent with the first condition. Therefore, once the innovation has appeared in a place suitable for displacement and has subsequently succeeded at coming into a settlement, it should then have the capacity to become a transmitting source. If we do the exercise of doing an analogy of a diffusion process in a network, we could agree that the vertexes with larger values of something would emit larger quantities than the smaller ones. For example, airport hubs have higher amounts of flights than small airports and these hubs will continue to get more flight connections under a rich get richer process. Hence in a similar process, in a spatial diffusion of innovation process the first local agglomerations of adoptions in a determine location will have a higher likelihood of becoming emitting sources than innovation laggard places.

This might suggest that in the incremental process of adoption, while the innovator places have an advantage the laggards will follow in speed rates that are smaller. From an urban perspective, innovation diffuses spatially under an urban descending hierarchical path, starting by the urban settlements with larger populations. This pattern is interrelated to the evolution of systems as discussed above. A fundamental reason of this phenomenon appears to be in part, that larger and more dense areas are better equipped to attract and retain firms on the first hand. Then, the performance between suppliers, distributors, services, infrastructure, transportation, institutional, diversified skilled work force, commercialization, and learning processes are higher in larger areas on the other hand (Duranton and Puga, 2004). There have been studies that show the clear advantages for firms of being based in metropolitan areas, for example Combes, et al., (2012) suggest that firms are on average 9.7 % more productive than in less dense areas.

Respectively, the third condition *"existence of a receiving environment which fosters a quick propagation"* which requires the fulfilment of the two previous conditions given the entangled process. If the innovation in question has succeeded in establishing itself in a place suitable for displacement (condition 1) and this place has the capacity to become an emitting source (condition 2), the third condition is linked to the "fertility of the environment which should encourage the rapid spread of innovation. This means that the appearance and diffusion of an innovation in a place can be positively or negatively influenced by the environment.

The territory's *"fertility of the environment"* with regard to an innovation and its ability to integrate disturbances and changes are crucial for the system to retain its qualitative properties and be able to successfully adapt these new dynamics. A fertile location for innovation diffusion is influenced by positive feedbacks that will allow the diffusion process to "take-off", a process first observed by Tarde (1903) but without the spatial component and further developed by Rogers (1963).

In diffusion processes this phase is highly triggered by opinion leaders, here from a spatial perspective we need to take into account distributional aspects regarding the position of individuals that have a role as innovators. The

relative geographic position of those leaders, innovators and early adopters must provide a milieu that fosters the adoption and settlement process of an innovation. In order to identify the position of innovators it is necessary to take a look at social and demographic data for example population. In Hägerstrand's work (1953), we find population as one of the factors analysed in a spatial perspective. As it is discussed in Chapter 2 urban networks development is accompanied by economic activities, so the spatial component of innovation is also coupled with similar conditions where economic activity location is linked with the adoption process. Fertile environments are located where people and economic activities occur. It is clear that it happens more in some places than in others, but it does not happen in inhabited locations absent of human activity and social organization. Therefore, the attractiveness of a location as a composite indicator might be an important parameter that gives a first picture of possible scenarios for innovation diffusion. A relevant task, it is to establish the distributional changes among highly populated locations with similar attractiveness and economic activities levels.

The so-called '*hypothesis of distributed receptiveness*' states that cultural innovation is not entirely adopted by a population. Rogers (1963) extensively demonstrated it, diffusion is a gradual process in a time perspective and Hägerstrand's insights resonates with the same line of thought from time and space standpoints. Hägerstrand proposed an assumption related to the adoption of innovation process, where innovators have certain material and immaterial pre-conditions that allow them to assimilate information and adopt cultural innovations faster than others. Theoretically speaking as it was argued by Hägerstrand (1953) that it is likely that an uneven distribution of willingness and opportunities embedded in economic and psychological aspects, let adopt an innovation faster in certain areas than in others.

Later Rogers (1963) would add other layers to the characteristics of innovators, where education, the capacity of managing complex information and risk aversion is intertwined in the process. Hägerstrand's work was developed in the 1950's, since then, research from different disciplines have advanced and help to better understand the underlying properties of a fertile environment from a spatial perspective. Research in social sciences like economics and sociology has shown different phenomena that contributed to explain the uneven distribution of certain processes that can be applied with a consideration of the spatial dimension.

Economist Schelling (1978) worked on collective organization, noticing a homophily behaviour in neighbourhoods in the United States, where it was difficult to find an ethnical mix among neighbours. The author developed a theory showing how micromotives would trigger macrobehaviours. Sociologists coined the term homophily in the 1950's (see Lazarsfeld & Merton, 1954) which means '*the love of the same*' in order to refer to the inexorable tendency in humans to be connected in ways that reinforce their core beliefs rather than put them under a test (see also McPherson et al., 2001).

Schelling's model shows that a segregation phenomenon is triggered by an ethnocentric process where each agent in a neighbourhood would be happy only if a certain threshold of agents of the same ethnic are their neighbours. Figure 57 is an image of a simulation of Schelling's segregation model performed on the software NetLogo (Wilensky, 1999) under an ABM approach.

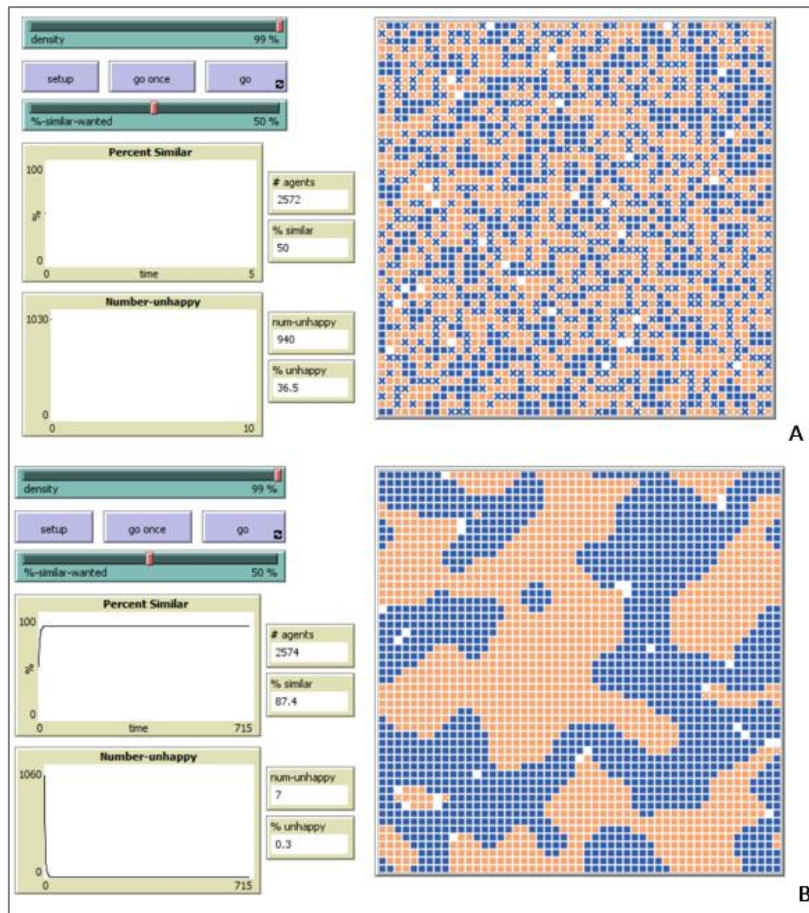

Figure 57 Schelling's segregation model. A) Initial random conditions. B) Results of simulation. Performed on Netlogo, Source: Wilensky (1999).

In this model, there are the same amount of two types of agents blue and orange living in a neighbourhood and although they can live next to each other, they need to be sure that a certain threshold of similarity is respected. In this model the threshold can be gradually adapted with a percentage value, in this example was set to 50%, that means that each agent will be happy only if it is surrounded by 50 % of agents with the same colour. In the initial conditions, there are 36.5 % of unhappy agents out of 2752. Once the simulation has been performed this unhappy value is dramatically reduced to 0.3 % giving the increase of homogeneity of the neighbourhood where the similarity percentage is around 87.4 %. Schelling (1969) also discussed about the different reasons and lines that separate people such as ethnics, gender, age, education, income, language, comparative advantage. Some of these segregation processes are organized or determined by economic laws.

It has widely been acknowledged the robustness of Schelling's model including the embedded spatial structure, which would slightly be affected by underlying spatial processes regardless their complexity. Banos (2010) however, showed that the effects of the spatial dimension should be actively consider as the impact is not negligible. The author demonstrated through graph-based spatial structures the influences of the spatial component, where the presence of cliques plays a central role on urban networks, thus reinforcing segregation effects in Schelling's model. Indeed, the author goes beyond that consideration and resonates with the arguments proposed by Moessinger (1996), which criticized the extremely simplistic way of Schelling's model to explain the agent's choices. The similarity-dissimilarity criterion certainly gives valuable information on the agents' choices from a probabilistic standpoint. However, it is useful as long as it works accordingly to Schelling's model, but it does not account for the real underlying reasons that the agents' have to make a choice. Once again, an aggregate-type model is criticized since it fails at capturing individual and granular information. In that sense, Banos (2010) argues that Schelling's model is rather a generic model of segregation, since it fails at catching the local effects in

the spatial structures that take place via the appearance of cliques. So, it is important to consider similarity-dissimilarity criteria but with caution.

More recent research has been dealing with the association of the fragmentation of urban network structures with income inequality in cities and towns (Tóth et al., 2019). The authors argue that *“Inequality is rising where social network segregation interacts with urban topology. Social networks amplify inequalities due to fundamental mechanisms of social tie formation such as homophily and triadic closure”*. The authors claim that little is known on the structural mechanisms behind the fragmentation, but it appears that space plays a key role in the segregation process.

The implications derived from homophily in a network perspective are important for innovation diffusion purposes. Hägerstrand’s research in the 1950’s was contemporary to the concept of homophily even though was unrelated research. Nevertheless, further research has shown that *‘the love of the same’* concept is present more often than one would expect due to the makeup of the population (Jackson, 2008). Scholars have worked on empirical research that backs up the homophily concept, for example Baerveldt et al., (2004) worked on the frequency of friendships in a school in the Netherlands. Table 4 shows that 79 % of Dutch students had friendships with other Dutch students, while only two percent of Dutch students had friendships with Moroccans and other two percent with Turkish.

Percent of Friends by Ethnicity:	Ethnicity of Students				
	Dutch n=850	Moroccan n=62	Turkish n= 75	Surinamese n=100	Others n=230
Dutch	79	24	11	21	47
Moroccan	2	27	8	4	5
Turkish	2	19	59	8	6
Surinamese	3	8	8	44	12
Others	13	22	14	23	30

Table 4 Friendship Frequencies (in percent) by Ethnicities in a Dutch High School; from Baerveldt et al., 2004.

Another example proposed by Jackson (2008) represented on a network is illustrated in the Figure 58 which is another school where 52 % of students are white, yet 83 % of friendships are with other whites. Whereas 38 % of students are black, yet 85 % of friendships are with other blacks. Hispanics represent 5 % of the population and exceptionally they are more integrated as they only have 2 % friendships with other Hispanics however, as stated by the author this was an exception among a sample of 84 schools.

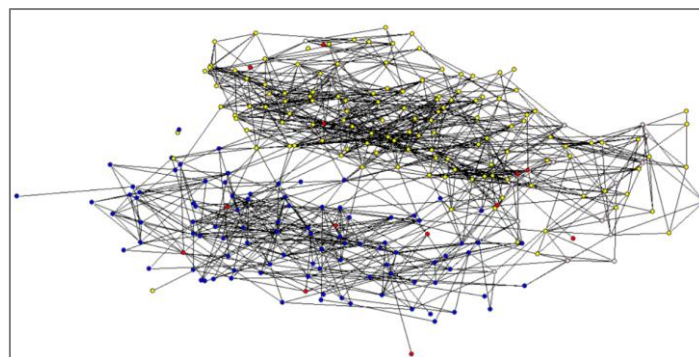

Figure 58 Friendships among high school students. Source: Jackson (2008).

^a Coded by Race: Blue=Black, Yellow=White, Red=Hispanic, Green=Asian, White=Other.

If the homophily phenomenon was not present, arguably it would be possible to state that 52 % of whites would roughly have 52 % of friendships with other whites instead of 83 %, this phenomenon is called “inbreeding homophily” and has a serious influence in diffusion processes (Jackson, 2008). Scientists have differentiated two types of homophily, where baseline homophily is an expected value of an uneven distribution and inbreeding homophily is a higher expected value that might have been triggered by personal preferences. An example of the latter in geography was developed by Holzhauer et al., (2013). Aral et al., (2013) demonstrated the importance of taking into account homophily in contagion processes and argued that simulations that do not estimate homophily might cast some doubts.

The features of spatial innovation diffusion in which the assumption that there is an unevenly distributed receptiveness (Hägerstrand, 1953), states that different factors generate initially an agglomeration of adoptions and then radial disseminations. This first agglomeration must be a fertile environment where different conditions at psychological, economic, homophily and access to information in a certain location fosters the diffusion process. Hägerstrand (1953) referred to these concentric zones as centres surrounded by favourable circumstances for acceptance where it decreases with increasing distance.

Finally, the fourth condition is that the strength and time of propagation must be large enough for the innovation to gain momentum. The radial disseminations sourced by a fertile environment needs to be strong enough to take off and keep a growth pace in the diffusion network. A diffusion network, needs a certain level of interconnectivity, size and diffusion rate and equivalent level of resilience in order to be able to coexist with the adoption of innovations, adapt and evolve. Condition 4 calls for a sufficiently large force and propagation time to avoid the interruption of the spatial diffusion process and this need to be accompanied by a level of a network’s resilience consistent with such a system.

The process of innovation diffusion proposed by Hägerstrand gave to the spatial dimension a relevant role and not to the innovation indicators studied *per se*. Here we propose to inverse the point of view when we analyse innovation indicators for sustainability transition purposes, that is not looking only how green technologies are diffused but from a spatial perspective how the space is impacted by these innovations, meaning that we look at what is happening in spatial structures regarding a specific indicator. The spatial perspective we propose here is that the innovation process is embedded in the space and in this study, we focused on the diffusion process RET as innovation indicators i.e., solar panels. Contrary to the low or no importance of the innovation indicators studied by Hägerstrand (1953), in this study the RET chosen as indicator are relevant.

It has broadly acknowledged that RET diffusion in spite of having a critical importance for sciences and society it does diffuse slowly (Negro et al., 2012; Karakaya & Sriwannawit, 2015). So, getting more insights and understanding the underlying mechanisms that could trigger a catalysis of the trajectory of the RET diffusion process it is important for the ecological transition. Based on this premise, the spatial dimension is a key aspect that can greatly contribute and catalyse the improvements. The advancements of GIS coupled with other techniques such as ABM, network theory and statistical modelling are tools that can definitely be implemented to better understand how RET diffuse in the space and timewise.

As an example, the representation of a diffusion process in the space can be model over a surface simplified in a matrix, that is a raster representation. The increasing geographic data availability allows us to deploy different methodological approaches in order to virtually apply a grid on a region in which numerical variables represent spatial trends. The deployment of a grid in spatial structures can be developed and function in different ways, here we could look at every spatial unit depicted as a pixel in Figure 59 as a recipient of different parameters. In spatial units X_n simultaneous phenomena such as a, b, c, d and e occur. The interaction of a, b, c, d and e will trigger feedback loops that would reinforce or cancel the effect of some of the phenomena in spatial units $X_1, X_2, X_3...X_n$ with a distance decay effect that may follow different kinds of probability distributions such as exponential-decay,

exponential-normal decay, exponential-square-root decay function log-normal or power decay function as it is the case of RET spatial diffusion as it will be developed and demonstrated in section 4.

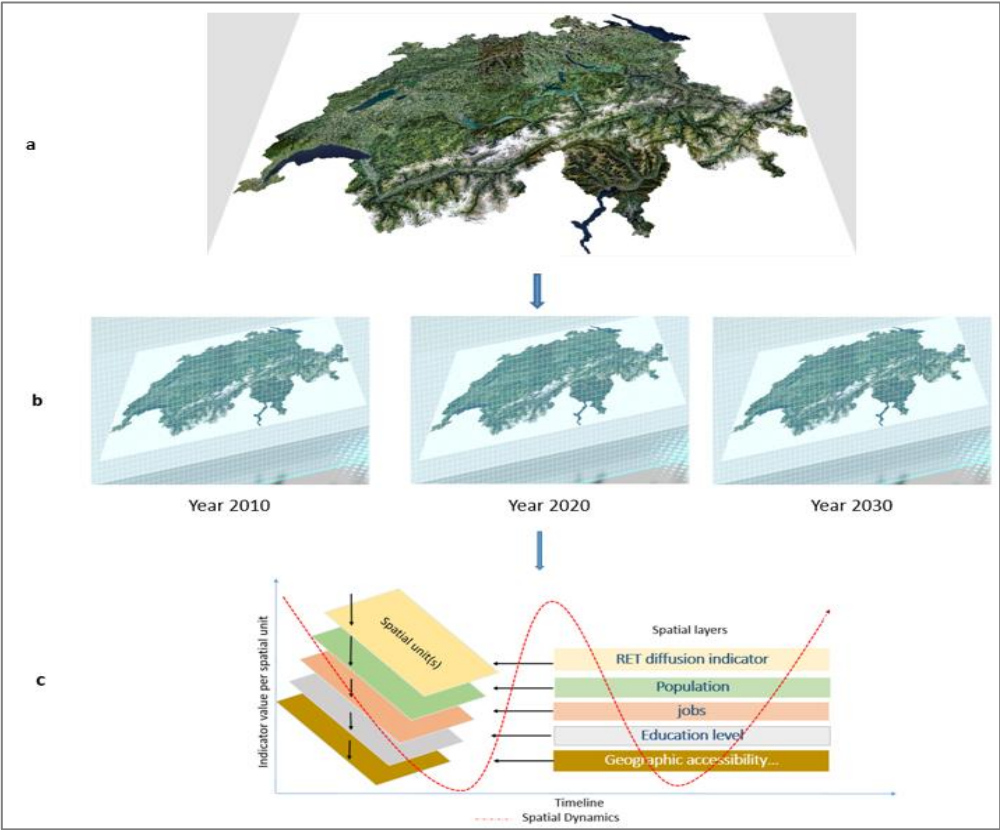

Figure 59 Spatial Dynamics for Innovation Diffusion

In the figure above, we observe an example of data allocation to spatial units, the selection of the variables is determined by their explanatory power. The spatiotemporal relation for example between jobs and population can be explained as people live where they can find a job, which implies that they have certain levels of geographic accessibility for mobility purposes. Then, if we think about RET, in the case of solar panels we could assume that solar panels are located where there are houses spatially distributed along with the population and that a relative ease of accessibility is present between the places where people live and where they work.

All these interconnections between these variables can be modelled through spatial structures in different scales. The non-linear interactions between these variables have the capacity to trigger the *emergence* of new phenomena that might be observables in determined scales (scale-dependency) or can be observed in any scale (scaling laws). This is also true from a time perspective as it is the case of the *long waves* in structural change, that are only observable in long periods of time. This behaviour is also observed in physical geography where the landscape patterns not only depend on physiographic and physiologic interactions but the spatiotemporal scales at which the processes are observed is important (Hall & Hay, 2003). The duality of time-space and scale-dependency in processes observed in human and physical geography are factors that allow geographers to use similar or compatible approaches. An example of the observation of the same variable in the same region in different periods of time and with different spatial scales is illustrated in Figure 60.

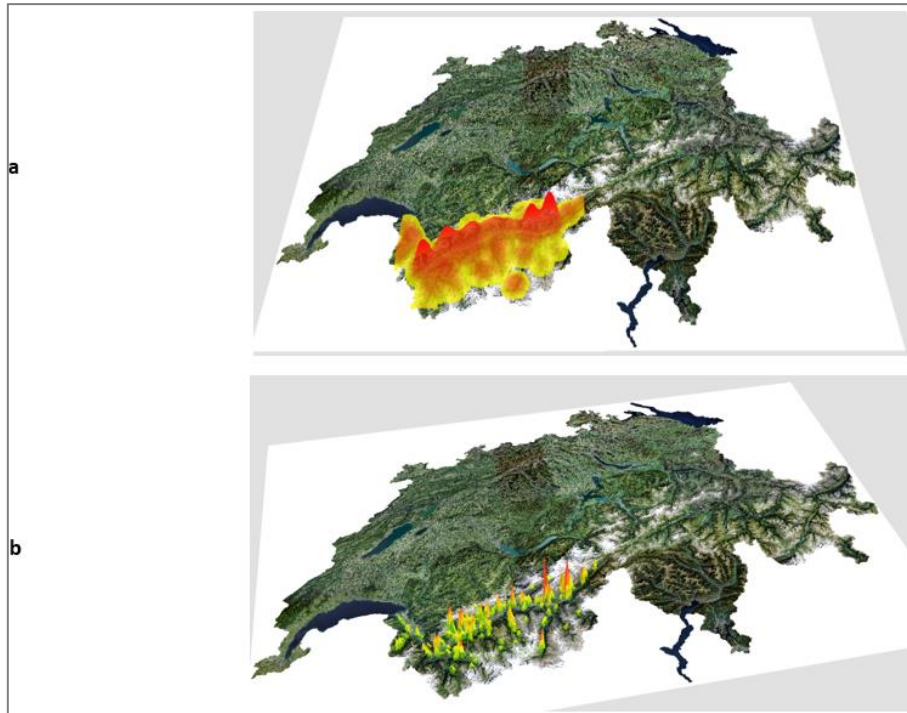

Figure 60 Kernel density of solar panels adoption in the canton of Valais, Switzerland.

- a. Kernel of solar panels adoption for heating, raster resolution 600 sq m, Valais, Switzerland, 2012.
- b. Kernel of solar panels adoption for heating, raster resolution 300 sq m, Valais, Switzerland, 2016.

Sustainability transition's complexity is a result of the combined and inherent complexity of the systems and elements involved in the process. Human and physical non-linear interactions are susceptible to be observed in a closer way when we divide the whole difficulties of sustainability transition in small pieces, this analogy refers to smaller spatial scales. This is typically an engineering approach where instead of finding a big solution for a big problem, the problem is subdivided in small problems that can be addressed with small solutions, so an active implementation of the space dimension in sustainability transition can be instrumental in this approach. The benefits of doing this are multiple, first of all it would give a common ground and facilitates as a criterion to measure the adoption of RET, e.g., per spatial unit. Subsequently, it can inform about patterns and trends in spatiotemporal perspectives and determine the rate speed against goals set by decision-makers.

Time and Space

The spatiality paradigm gives a deep sense of the fundamental basis of this work: *"Spatiality combines all conditions and practices of individual and social life that are linked to relative position of individuals and groups with regard to one another. One fundamental postulate of geography is that those relative positions (or geographical situations) determine, probably or partly, form and intensity of social interactions"* (Pumain, 2004a). If we admit that spatiality affects the intensity, the probability and the ways how individuals and groups related to one another we can put forward the following assumption. The information and communications technology (ICT) and the new usages they generate, impact individual and social life practices and then, in a cascading fashion they impact the spatial structures derived from these practices and ultimately regional dynamics. For example, the general organisation of the current regional economic structures is generally defined in terms of the places where we work and where we live, and these places are often mutually exclusive.

The development of the ICT in society combined with the technological extensions such as smartphone and internet, is about to abolish the borders between these places. In line with this perspective, land use planning and

urban forms and the ways of using these technologies should change, all of which is influenced in an underlying way by the issue of connectedness. It therefore seems relevant to try to address the issue of the diffusion of innovations but also the resilience of territories to these innovations. The field of application of resilience in the processes of diffusion of innovation in this research concerns the arrival of renewable energies in the study areas and how they disrupt the structure and the dynamics. RET's are interesting to study because it influences both individual and social life practices, economic development, spatial structures and the dynamics of the territory.

In geography the important role of space is reinforced by the integration of time: *"If everything occurred at the same time, there would be no development. If everything existed in the same place there could be no particularity. Only space makes possible the particular, which then unfolds in time."* (Lösch1954). Hence, in this work the author intends to integrate systematically time and space as a fundamental approach, and this consequently justifies the methodologies chosen in this research work. Furthermore, the integration of time-space in geography allows to use different methodologies that are capable to capture distributional changes in both dimensions in a dynamical way. The underlying richness of it, is clearly the possibility to model real world phenomena that are caused by nature or are human made in a more realistic way even though we are still talking about models which in all cases are by default a simplified and reduced version of reality.

The proximity and distance decay concepts in terms of the intensity of how things, groups and individuals are related was also discussed by Tobler (1970) in his first law of geography. The intensity and the importance of the role of space on how everything is related poses a major epistemological question in geography and in the field of diffusion of innovations. From a practical perspective, one of the main reasons why there are several studies with a rather little consideration of space as an active agent has been justified by the lack of data availability. Nonetheless, this is rapidly changing given the important budgets that governments have being investing on geographical data digitalization the last years.

Nowadays there is more available data regarding RET production and adoption, this facilitates longitudinal spatial analyses to establish possible relations with other socio-demographic and also physical variables such as the spatial dimension. In summary, in this section we have covered some relevant aspects of the mechanisms of innovation diffusion as a spatial process after a review on urban dynamics, which are two intertwined subjects. In the next section we will integrate another subject that is also interrelated, which is resilience. The dynamic nature of urban systems and innovation diffusion prompted us to incorporate the analysis of how urban systems' capacity to cope with change regarding innovation diffusion processes. To do so, we will establish the fundamental notions of the resilience concept with the aim of finding a theoretical position at the intersection of innovation diffusion as a spatial process.

2.2 Resilience: A Review of Theoretical Conceptualizations in Urban Studies and Business Management

The resilience concept has witnessed such a ramping success in management and in research, that has been widely adopted in different fields however, there is not a global consensus about a unique definition. Because of this reason is common to observe in research works preliminary sections with an overview of the concept definition focusing primarily on clarifications on the term. In this section we will start by a brief rationale of the study of urban resilience and then a review of the original theoretical views of the concept and its evolution in order to establish a clear framework. Subsequently, we will proceed to do a link of the resilience property with innovation within an urban context, in an attempt to give the spatial dimension a role as an active agent for social organization.

In this research work the link between RET diffusion and resilience is in the framework of sustainability transition, consequently in a climate change conjuncture. Through the lens of network science, it is possible to observe, spatialize and understand how RET diffuse and also to investigate resilience aspects of the process. Here, we concretely propose to analyse the resilience of a network that simulates the RET diffusion process for example, we will observe dynamical aspects in the topology of urban networks. The observation of how a RET diffusion network copes with change and how spatial reorganization processes take place, provide valuable information that might be scale dependent.

The construction of an urban network in the Swiss region with a spatial layer of RET and spatial diffusion simulations are deployed in Chapter 7. The changes on the overlay analysis is also compared with the dynamical behaviour of the network in the French region, which only contains renewable energy production data. Thus, the construction of a network is useful as a methodological approach that serves as a proxy to analyse both phenomena, innovation diffusion and resilience from a spatial perspective. Such analysis will account for the potential of sustainable technology diffusion with a georeferenced data coupled with the possible dynamics of such potentials. Understanding the phenomenon of RET diffusion and network resilience will provide insights to ameliorate conceptual views on the process. Also, will contribute to the development of practical tools to predict the diffusion process and eventually will serve to design policies to reinforce and accelerate RET adoption processes. It is important to add that the relevance of the resilience concept in this study also resides on its central role as a topic in the sustainability research context (Perrings et al. 1995, Kates et al. 2001).

Some scholars have argued that the incremental usage of the resilience term is related to the 9/11 terrorist attacks perpetrated in New York and to the hurricane Katrina (Comfort et al., 2010). Other authors make the linkage with climate change issues (Klein et al., 2003), see also Lhomme (2012) and Reghezza-Zitt et al., (2012). The resilience concept has been adapted in social systems especially in development and climate change conjunctures for example, the OECD has created guidelines for resilience systems analysis (OECD, 2014). Resilience became a key subject for the OECD after the financial crisis given its holistic approach vis-à-vis the risks and shocks at environmental, political, social and economic level. There are other initiatives to promote resilience, such as 100 Resilient Cities initially founded by the Rockefeller Foundation²⁵ which focuses on urban resilience and contributes to the SDG 11 (see Galderisi et al., 2020).

International organizations such as the UN, have also been deploying important financial resources to promote resilience. Although, they implicitly acknowledge that they are not sure that they are actually measuring resilience and not another proxy such as vulnerability (Rufat, 2018). The question that the latter author raised is about the paradoxical issue derived from the promotion of resources, applications, community and political engagement to build projects based on a notion that cannot be measured. Somehow, this implies that some investments and projects are carried out on a basis where decision makers give the benefit of the doubt to the definition of resilience.

The author delves into the subject and observes that different theoretical views on the concept have propelled the development of methods and models to estimate and measure resilience. The difficulty stems from the fact that these theories point in various directions and some of them are not even linked with each other at all. Furthermore, it is very difficult to know if some of these methods are actually measuring resilience or not. Another struggle is the possibility to validate some research works, whose data accessibility is difficult and prevents to cross-validate the approaches and results deployed. A strong proposal by Rufat (2018) states that if one cannot measure resilience nor validate its measurements, maybe the remaining usage of the concept should be confined to discourse analysis. The evident lack of consensus on the scientific stage raises serious concerns. Its fashionable

²⁵ Available online at: <https://www.rockefellerfoundation.org/100-resilient-cities/>. Today they operate as an independent network. The SDG 11 established by the UN General Assembly in 2015, which is about “*Making cities and human settlements inclusive, safe, resilient and sustainable*”, available online at: <https://sdgs.un.org/goals/goal11>.

usage appears to resonate with the use of concepts such as 'eco', sustainability or governance, which are often linked to resilience (Aschan, 2000; Gallopin, 2006; Reghezza-Zitt et al., 2012).

The resilience concept has been subjected to different theoretical and operational functionalities as described by Lhomme (2012). For example, to be resilient it is necessary to be resistant, flexible and adaptive or being able to bounce back (Smith et al., 2008) or bounce forward (Bonß, 2016; Muštra et al., 2016, Giacometti & Teräs, 2019). More recent views on the concept in regional studies propose an evolutionary approach where multi-dimensional and multifaceted aspects characterize resilience, giving it a non-linear, high complexity and adaptative features (Martin & Sunley, 2015; Sensier et al., 2016; Martin et al., 2016; Giacometti & Teräs, 2019).

All these theoretical directions make it difficult to evaluate the adequacy of a subsequent given methodology to deal with the subject. This brief introduction illustrates the difficulty characterized by the definition and usage of the concept however, we will intend to establish a conceptual framework with definitions and then, we will narrow the angle of application of the resilience notion related to this research work. This means that we acknowledge the scientific cacophony concerning the resilience property. Nevertheless, with some considerations and a real-world application, a concrete model is proposed relying on spatial analysis and network sciences. Moreover, the methodology and the data will be available for cross-validation and replication purposes, which is often not possible in resilience studies.

2.3.1 Conceptual Views on Resilience

The initial descriptive ecological function of the resilience concept has been redefined in different disciplines (e.g., Holling, 2001; Ott & Döring, 2004, Pickett et al. 2004; Hughes et al. 2005; Brand & Jax, 2007; Lhomme, 2012) and used as a proxy to analyse social-ecological systems (Anderies et al., 2006, Folke 2006; Brand & Jax, 2007). Before entering into definitions, we will first distinguish two meanings of resilience in ecology.

The first one, refers to the dynamics around an equilibrium point after a disturbance has taken place. This meaning aims at establishing the time that a system requires to return to an equilibrium point after experiencing a disturbance. This property has been termed as engineering resilience and it has been acknowledged to be very close to the stability property, for example elasticity (Grimm & Wissel 1997; Brand & Jax, 2007). The engineering-based notion proposes a bouncing back process, a returning mechanism anchoring the system to the previous 'equilibrium' position (Pimm, 1991).

The second meaning of resilience that ecologists offer, refers to the magnitude of disturbance that a system can integrate in its functioning before changing to another stable regime that is controlled by a new set of variables characterized by a different structure (Brand & Jax, 2007). This meaning has been coined as *ecosystem resilience* (Gunderson & Holling 2002) and is also almost systematically referred to as *ecological resilience* (see Holling 1996; Gunderson, 2000; Gunderson and Pritchard 2002, Anderies et al. 2006; Brand & Jax, 2007) or simply *resilience* in ecology (Holling 1973, 1986; Carpenter & Cottingham, 1997; Carpenter et al. 2001, Carpenter & Folke, 2006), in economics (Arrow et al. 1995; Colon, 2016) and in bioeconomy (Perrings et al. 1995).

In this second meaning an important development is included which is the proximity with complex adaptive systems, this represents a milestone in the resilience research field and its interdisciplinary application. Levin (1998) claimed that resilience *"is a property of any complex, non-linear systems, whether ecological or socioeconomic, do not lend themselves to management protocols based on assumptions of linear, globally stable, single equilibrium systems"* (see also Levin, 1998; Walker, 1998). Since the inclusion of the complex adaptive systems notion in social systems, geographers embraced this approach within the regional resilience context, for instance see Martin et al., (2016).

After having mentioned the two meanings of the resilience notion in ecology, now we will discuss the definitions and applications in social science. There has been a lot of attempts to compile definitions and schools of thoughts regarding resilience, here we will review some of the most relevant definitions and systems of categorization. The table below summarizes some definitions of the resilience concept by category and class. For example, a category is 'ecological science' and the classes are the two meanings of resilience *i)* original-ecological definition (Holling, 1973) and *ii)* extended-ecological resilience (Gunderson & Holling, 2002; Walker et al., 2002; Folke et al, 2004; Walker et al., 2006).

Categories and classes	Definitions	References
(I) DESCRIPTIVE CONCEPT		
<i>(1a) ECOLOGICAL SCIENCE</i>		
1) Original-ecological	Measure of the persistence of systems and of their ability to absorb change and disturbance and still maintain the same relationships between populations or state variables.	Holling 1973:14
2) Extended-ecological	The magnitude of disturbance that can be absorbed before the system changes its structure by changing the variables and processes that control behavior and The capacity of a system to experience shocks while retaining essentially the same function, structure, feedbacks, and therefore identity.	Gunderson and Holling 2002:4 Walker et al. 2006:2
2a) Three characteristics	capacities i) to absorb disturbances, ii) for self-organization, and iii) for learning and adaptation.	Walker et al. 2002
2b) Four aspects	1) latitude (width of the domain), 2) resistance (height of the domain), 3) precariousness, 4) cross-scale relations	Folke et al. 2004:573
3) Systemic-heuristic	Quantitative property that changes throughout ecosystem dynamics and occurs on each level of an ecosystem's hierarchy	Holling 2001
4) Operational	Resilience of what to what? and The ability of the system to maintain its identity in the face of internal change and external shocks and disturbances.	Carpenter et al. 2001 Cumming et al. 2005
<i>(1b) SOCIAL SCIENCES</i>		
5) Sociological	The ability of groups or communities to cope with external stresses and disturbances as a result of social, political, and environmental change.	Adger 2000:347
6) Ecological-economic	Transition probability between states as a function of the consumption and production activities of decision makers and The ability of the system to withstand either market or environmental shocks without losing the capacity to allocate resources efficiently.	Brock et al. 2002:273 Perrins 2006:418
(II) HYBRID CONCEPT		
7) Ecosystem-services-related	The underlying capacity of an ecosystem to maintain desired ecosystem services in the face of a fluctuating environment and human use.	Folke et al. 2002:14
8) Social-ecological system		
8a) Social-ecological	The capacity of a social-ecological systems to absorb recurrent disturbances (...) so as to retain essential structures, processes and feedbacks.	Adger et al. 2005:1036
8b) Resilience-approach	A perspective or approach to analyze social-ecological systems.	Folke 2006
(III) NORMATIVE CONCEPT		
9) Metaphoric	Flexibility over the long term.	Pickett et al. 2004:381
10) Sustainability-related	Maintenance of natural capital in the long run.	Ott and Döring 2004:213f
(IV) EVOLUTIONARY AND DYNAMIC CONCEPT		
11) socio-economic, environmental and ecological	Complex, adaptive, territorial and multi-dimensional.	Sensier et al., 2016; Martin & Sunley, 2015; Martin et al., 2016; Giacometti & Terras, 2019; Voiron-Canicio & Fusco, 2020

Table 5 Eleven definitions of resilience with respect to the degree of normativity. Updated from Brand & Jax, 2007.

As stated by Pendall et al., (2008) the research work on the application or the usage of the metaphor of resilience in regional studies has often three assumptions in which scholars emphasize. First that the system studied has at least one underlying equilibrium. The second point is on the characteristic complexity of non-linear systems and the nested subsystems. The third is the assumption of path-dependency in which systems are embedded. Before we arrive to the application of the resilience concept for regional analysis purposes, we will develop a review of the origin of resilience.

Ecological Resilience Definition

Holling (1973) defined resilience as a “measure of the persistence of systems and of their ability to absorb change and disturbance and still maintain the same relationships between populations or state variables”. The focus here was to determine the populations’ persistence at ecosystem level, where the height of the smallest value of

population's domain of attraction. This would give information of the probability of extinction of different species. The context in which this definition was coined, was in the study of populations and how they could persist in the occurrence of random events. At the time of the Holling's seminal paper, ecology was one of the only fields that had intensive and extensive data that enabled researchers to analyse how random events could change the trajectory of population growth (Holling, 1973).

Extended-Ecological Resilience Definition

In the ecological definition some key aspects are developed, such as the self-organization capacity of resilient systems. According to this scientific view, the hierarchical structure of ecosystems is dominated by a small set of plants, animals and abiotic processes functioning at multiple levels (Holling, 1992). Walker et al., (2006) argued that relevant dynamical processes in ecosystems can be observed by taking key variables, which are commonly not more than five. This implies that the emphasis is done into essential aspects of the ecosystem.

Following the last argument, it seems that one possible way of analysing resilience in ecosystems is finding the key parameters that are able to maintain the function, feedbacks, structure and consequently the system's identity (Walker, 2006; Brand & Jax, 2007). Within this definition, three characteristics are highlighted, which represent the major capacities of a resilient system:

- i) Absorption of disturbances: it refers to the capacity of a system to undergo changes and stay in the same attraction basin. The absorption of disturbances has been interpreted in social science in different ways and has been related to the resistance of the system. This notion has been criticized as resistance implies rigidity and not elasticity. Another contemporary note on resistance in social science, is related to the depth of reaction to shock (Martin et al., 2016). We will get back to this definition later in this section when we will discuss the definitions and applications of resilience in regional studies.
- ii) *ii) Self-organization*: it refers to the system's capacity level of self-organization. A signature of self-organization is that the state variables follow a power law for example, the $1/f$ law proposed by Mandelbrot. A power law has the form:

$$Y = X^n \quad 2.30$$

Where the exponent n is an integer when we refer to the geometry of traditional objects, but for fractal objects n is not an integer number. This means that fractal objects have a non-integer dimension, and its shape is scale invariant.

- iii) *adaptation*: it denotes the learning capacity degree of a system (see Folke 2006).

Complementary to these characteristics, ecologists have proposed other factors aligned with resilience that primarily focus on the concept of alternative regimes, which exist in alternative basins of attraction. Scheffer & Carpenter (2003) proposed four factors related to the basins of attraction *i) recovery: the highest amount of change that a system can undergo before losing its capacity to recover; ii) resistance: in the sense of the system's difficulty to cope with change for example, the basin's topology; iii) precariousness: it refers to the proximity state to collapse, which is bounded by a threshold; iv) cross-scale relations: it denotes the intertwinement of the three factors described above and the dynamical interactions across scales (Folke et al., 2004; Walker et al, 2004, see also Brand & Jax, 2007).*

Resilience Beyond Ecology

Some of the previous definitions, aspects and characteristics of the resilience notion have been transposed to social systems. For example, the two first factors mentioned in the last paragraph, recovery and resistance have been adopted by evolutionary economic geographers in the context of regional economic resilience. The former is defined as the depth of reaction to shock and the latter as the post-shock regional developmental pathway. Among the various definitions and descriptions of the resilience property, which is illustrated by some authors as a system that is in a stable state X and if that system undergoes a disturbance, it should be able to integrate it bounce back to its initial state (in physics) or the capacity to return to a planned trajectory (in econometrics).

Some authors have resorted to the Latin origins of the resilience word root *resilire* “*to leap back or to rebound, refers to the ability of an entity or system to recover form and position elastically, following a disturbance or disruption*” (Martin, 2012b). The idea of bouncing back has lately been rejected in the field of geography (see Giacometti & Teräs, 2019) as it implies a return to the initial state, which is not in line with the evolutionary approach of adaptability. In this regard the engineering resilience concept, which proposes a bouncing back process, a returning mechanism anchoring the system to the previous ‘equilibrium’ position is close to the so-called ‘*plucking-model*’ of economic fluctuations (see Friedman, 1993; Sinclair, 2010).

In both approaches, engineering resilience and the equivalent plucking-model in economics, the systems would get back to their previous growth paths (see also Simmie & Martin, 2010; Martin, 2012). This resilience view though, does not provide a reorientation for the trajectory of a given system as it has recently proposed by evolutionary economic geographers (Martin et al., 2016; Giacometti & Teräs, 2019). This latter line of research takes resilience under a new dimension known adaptive resilience, that is rooted on complex science. According to the specialized literature, the application of the resilience concept in the field of geography entails that the process of adaptation to disturbances makes the system stronger.

For example, cities are complex systems composed of socio-technical systems that operate with non-linear interactions (see Sensier et al., 2016). This additional notion means that a stronger order appears after the disturbance, which would be a vector of disorder. Therefore, it is not only a question of maintaining the system, but also of strengthening the general system while integrating the new changes (Aschan, 2000). On another note, we could see this property as a vector that contributes to the inertia of a place in terms of urban trajectories, which is referred to as path development as it was already discussed. That would mean that when a system that is already strong enough to cope with a given disturbance, it will end up even stronger once it has assimilated it into its functioning. In the contrary, if the system cannot resist, reorientate and recover from the disruption is possibly because it was not strong and flexible enough to integrate and adapt the changes in its structure (Martin et al., 2016). This would mean that the system will end up in a more debilitated state.

These effects are partly a result of the place legacy, this line of thought is very close to the one developed in the first chapter regarding innovation in regional systems. The similarity with innovation is rooted in the territorial inertia of developmental pathways. As proposed by Hägerstrand (1952, 1953), the conditions needed for spatial diffusion processes, the place of the appearance of an innovation needs to have special characteristics: it needs to facilitate the innovation to travel and impose itself as such, become an emitting source and foster a quick, strong diffusion in a time long enough to prevent interruptions.

Such characteristics are not random and need to be developed in the long term, so the system can integrate the interaction of different socio-technical systems. One could say that under a *resilience discourse*, a successful integration of innovations implies that the system is resilient as the social system is able to cope with change and technological disruptions, making the system better and stronger. However, before going deeper into this

argument, we will complete the review on the concept in order to identify in our proxy, the RET diffusion process which definitions are applicable to both innovation diffusion and resilience.

As mentioned above, the resilience property must however be reviewed since it has been object of malleable definitions and referred to as an approach or boundary object (Brand & Jax, 2007). The reason is that its usage has even been proven contradictory in different kind of fields and contexts (Lhomme, 2012). The increasing practice of resilience across fields although is a positive fact in terms of interdisciplinary contributions has also created a vague and a rather flexible application accordingly to the authors' fields and views. The figure below depicts the multidisciplinary nature of the resilient concept.

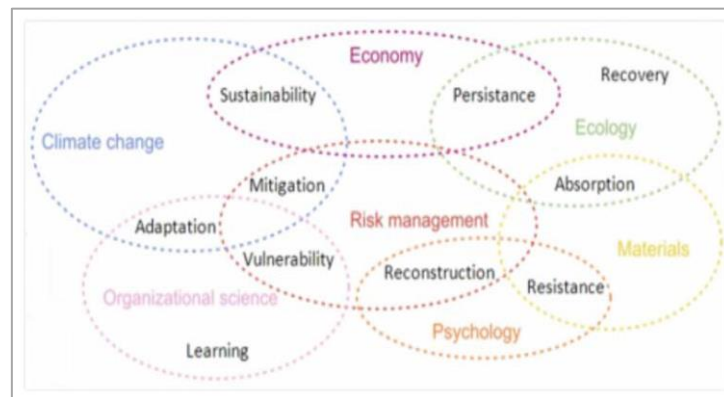

Figure 61 The multidisciplinary aspect of resilience. Source: Lhomme, 2012.

The different use that has been given to the resilience term, has triggered a reaction within the scientific community prompting scholars to attempt to address the issue. A clear example of the confusion rooted in the resilience debate is that some authors have even written about what resilience is not (see Reghezza-Zitt et al., 2012). The latter authors did a comparison of different definitions, which will be later discussed. As stated by Walter (1998) the discussion of resilience in a determined context must start with the following question: "The resilience of what to what?" and the system requires to be defined by *i) the state variables; ii) the nature and measurements of external shocks* (see also Pendall et al., 2008).

A relevant note that is worth of mentioning is that the ambiguity of the resilience concept is not only a consequence of interdisciplinary work, but also because of the evolution of research and understanding of systems (Lhomme, 2012). We would like to highlight that we agree with the latter argument. We acknowledge that doing this very investigation, the fact of grasping the real meaning of resilience in social systems proves very difficult as many factors of the RET diffusion process are still unknown. This lack of knowledge prevents us to fully understand for example how and why the RET makes appearance in the first place, which are the underlying processes. Therefore, the improvement of our understanding of social systems goes hand in hand with enhancing our understanding of resilience. For example, the definition ecosystem resilience, was highly influenced by the advent of the theory on complex adaptive systems (Brand & Jax, 2007), see Levin (1998). Another example that typifies our limitation in understanding systems is our capacity to prevent the disasters. Engineers have designed dikes along rivers and upstream dams to prevent floods, also buildings capable to resist earthquakes however, it is not possible to precisely predict the magnitude of such events.

Keeping parallel examples, but from an economic perspective, Rosling et al., (2018) argued that even the best economists in the planet failed every year at predicting the recovery from the subprime financial crisis. The last 50 years of research on resilience have not been enough to have a consensual definition in the scholarship, this might be a sign of the intrinsic difficulty in understanding systems. Following the scientific quest for the definition of resilience in social systems, Bahadur et al., (2010) and Béné et al., (2012) attempted to characterize the notion

in the framework of climate change adaptation and risk disaster reduction (see also Norris et al., 2008). A summary of different schools of thoughts is depicted below.

Characteristics	School of thought
1. A high level of <i>diversity</i> in groups performing different functions in an ecosystem; in the availability of economic opportunities; in the voices included in a resilience-building policy process; in partnerships within a community; in the natural resources on which communities may rely; and in planning, response and recovery activities.	Theoretical ecology + Economic (on risk management and diversification)
2. Effective governance and institutions which may enhance community cohesion. These should be decentralised, <i>flexible</i> and in touch with local realities; should facilitate system-wide learning; and perform other specialised functions such as translating scientific data on climate change into actionable guidance for policymakers.	Decentralised governance
3. The inevitable existence of <i>uncertainty</i> and <i>change</i> is accepted. The non-linearity or randomness of events in a system is acknowledged, which shifts policy from an attempt to control change and create stability to managing the capacity of systems to cope with, adapt to, and shape change.	Resilience characteristic
4. There is <i>community involvement</i> and the appropriation of local knowledge in any resilience-building projects; communities enjoy ownership of natural resources; communities have a voice in relevant policy processes.	Decentralised governance
5. <i>Preparedness</i> activities aim not at resisting change but preparing to live with it; this could be by building in redundancy within systems (when partial failure does not lead to the system collapsing) or by incorporating failure scenarios in Disaster Management (DM) plans.	Ecology applied to DDR
6. A high degree of social and economic <i>equity</i> exists in systems; resilience programmes consider issues of justice and equity when distributing risks within communities.	Participatory / governance
7. The importance of <i>social values</i> and <i>structures</i> is acknowledged because association between individuals can have a positive impact on cooperation in a community which may lead to more equal access to natural resources and greater resilience; it may also bring down transaction costs as agreements between community members would be honoured.	Participatory / social justice
8. The <i>non-equilibrium dynamics</i> of a system are acknowledged. Any approach to building resilience should not work with an idea of restoring equilibrium because systems do not have a stable state to which they should return after a disturbance.	Resilience
9. Continual and effective <i>learning</i> is important. This may take the form of iterative policy/institutional processes, organisational learning, reflective practice, adaptive management and may merge with the concept of adaptive capacity.	Adaptive – management learning
10. Resilient systems take a <i>cross-scalar perspective</i> of events and occurrences. Resilience is built through social, political, economic and cultural networks that reach from the local to the global scale.	Resilience thinking

Table 6 Characteristics of a resilient system in the contexts of climate change adaptation and disaster risk reduction (DRR). Source: Bahadur et al., 2010.

The resilience approach has also been studied by geographers in the framework of natural disasters, an example is the work developed by Dauphiné & Provitolo (2007). The authors discussed about the resilience concept linked to natural disasters under a risk management perspective and highlighted the difficulty entrenched in the measurement of this property. The operationalisation of the concept is a critical issue and a challenge but underpinning our understanding on the property is important to adapt new ways of dealing with natural and social risks.

Technological approaches to face risks in socio-technical systems are not sufficient, so a more holistic methodological strategies and tactics are needed to cope with change and potential hazards. Hence, if we do not fully understand the non-linear behaviour of the interactions of social systems, to comprehend how such systems recover, or cope with change, or how resistant they are, needs to be dealt with.

A distinction must be done between risk and disaster from a spatial perspective: the terms risk and disaster refer to a potential and a reality that do not overlap. Risk, which is persistent and spatially widespread is distinct from disaster, which is often rather brief and has an irregular in form (Dauphiné & Provitolo, 2013). Continuing with the examples of the conceptual amalgamation of the resilience notion, a compilation of multiple scientific positions was done by Lhomme (2012), where the author exposed that some of them might even appear contradictory.

Theoretical/Practical	Stability (equilibrium)/Persistence	Property/Process	Antonym vulnerability/Continuity or complementarity
Holling, 1973; Provitolo, 2009	Pimm, 1985; Dovers & Handmer, 1996; Sheffy, 2006; O'Rourke, 2007; Sensier et al., 2016; Giacometti & Teräs, 2019	Klein et al., 2003; Pelling, 2003	Folke et al., 2002, Dovers & Handmer, 1996; UNISDR, 2005
Folke et al., 2002; Godschalk, 2003; UNISDR, 2005	Holling, 1973, 1996; Berkes et al., 2002; Walker & Salt, 2006, Martin and Sunley, 2015	Manyena, 2006; Mc Entire et al., 2002	Cutter et al., 2008; Provitolo, 2009; Gallopin, 2006
Resistance/Adaptation	Social/Physical	Systemic/Analytic	Positive/Neutral
Mileti, 1999; Alwang et al., 2001; Muštra et al., 2016; Bonš, 2016	Mc Manus et al., 2008; Dovers & Handmer, 1996; Vale & Campanella, 2005	Berkes et al., 2002; Carpenter et al., 2001; Gallopin, 2006; Giacometti & Teräs, 2019	Godschalk, 2003; Folke et al., 2002
Comfort, 1999; Dovers & Handmer, 1996; Fiksel, 2003; Sensier et al., 2016; Giacometti & Teräs, 2019	Cimellaro et al., 2010; sheffy, 2006; O'Rourke, 2007; Bruneau et al., 2003	Cardona, 2003; Boin et al., 2010	Klein et al., 2003; Boin et al., 2010

Table 7 The contradictions attached to the concept of resilience. Source: Updated from Lhomme, 2012.

As discussed by Reghezza-Zitt et al., (2012) resilience and its features such as the ability and capacity according to different authors can be defined in various ways, which are not always compatible. For instance, the definition from physics states that:

1. *“the resilience of a material is the quality of being able to store strain energy and deflect elastically under a load without breaking or being deformed”* (Gordon, 1978). This definition applied to social systems refers to the adaptation and flexibility capacity of a community or an individual.
2. According to Mileti (1999), *“resiliency to disasters means a locale can withstand an extreme natural event with a tolerable level of losses. It takes mitigation actions consistent with achieving that level of protection”*. This view is also related to the approach in management with risk mitigation and level of loss acceptance (Fraginière & Sullivan, 2007) and with the impact approach in physical vulnerability and engineering.
3. *“Resilience is the ability to recover or rebuild”*. This view was used by Klein et al., (2003) in a metaphorical way.
4. *“Resilience provides the capacity to absorb shocks while maintaining function”*. Resilience provides the components for renewal and reorganisation” (Holling, 1973, 2002). This definition comes from ecology and entails a return to the original state of equilibrium or normality²⁶.
5. More recently, in economic geography, scientists proposed the *evolutionary approach: adaptive resilience*. This view considers resilience as the capacity of a system to withstand environmental or economic shocks while keeping the ability to allocate resources efficiently (Muštra et al., 2016). Additionally, authors describe it as multi-dimensional and highly complex (Sensier et al., 2016; Martin & Sunley, 2015), a multifaceted process (Martin et al., 2016) with four key conditions: risk, resistance, reorientation and recoverability. Regarding this definition, there seems to be a rapprochement in regional studies between innovation and resilience (Boschma, 2015) via an evolutionary theory.

In their analysis of the first four definitions above, Reghezza-Zitt et al., (2012) observed the polemic debates derived from the inconsistency between them, where the first two definitions are yet unresolved. These two definitions oppose the concepts of resistance and persistence, where resistance is linked to solid strength and

²⁶ Since Hollings contributions in resilience have had a major impact in different fields, we will extend the discussion in this section about the context of its origins and its evolution in social science.

stiffness, which was the point that Holling's wanted to object (Holling, 1973). As a reminder, the term used in Holling's definition is 'persistence', which is carefully chosen word to use in the definition of the concept. For other authors, resistance is related to damages while resilience refers to impact (Smit et al., 2000; Adger, 2000). As mentioned by Reghezza-Zitt et al., (2012) it has been more broadly accepted in the scholarship that resilience is related to flexibility, adaptability rather than resistance which implies stiffness.

Additionally, to the richness of the interdisciplinary and multi-disciplinary characteristic use of resilience, it appears that the etymological proximity of words in the definitions such as persistence and resistance do not help to clarify the differences. Both words come from Latin and were adopted from French to English. According to the *Oxford dictionary*, the etymology of the word persistence originated in the XVI century, from Latin *persistentem* (nominative *persistens*) and French 'persistence', which has the present participle of *persister* in French and *persist* in English. The word persistence is defined as '*continuing steadfastly*' in English. *Steadfastly has two main meanings today i) firmly fixed in place, immovable and a second definition ii) not subject to change. Steadfast has old English origins, derived from 'stedefæst', which was a composed word where 'stede' meant 'place' or 'stead' and 'fæst' meant firmly fixed.*

If we look at the French definition of the word persistence, according to *LeRobert* dictionary, it means "*le fait de ne pas changer*", which means the '*fact of not changing*'. The definitions of the verb 'persister' in French is '*Demeurer inébranlable*' or '*remaining steadfast*' in English. The definition of '*inébranlable*' comes from the opposite meaning which is '*ébranlable*' and means "*To give an oscillating movement to a moving object*". Therefore, if an object is '*inébranlable*', means that it cannot oscillate or vibrate, and the solidity cannot be compromised. Parallely, the word resistance also comes from the old French *resistance* and from late Latin '*resistentia*' and means "*to make a stand against, oppose, to stand back, withstand*", from "*re- against*". In French means "*the act of resisting, of opposing one force (to another)*". As proposed by Reghezza-Zitt et al., (2012) some authors amalgamate both terms, and are sometimes used interchangeable, which generates confusion.

To summarize this brief etymological review, it appears that the roots and the current definitions of persistence are related to "*firmly fixed in place, immovable, not subject to change, fact of not changing, remaining steadfast*". In the case of resistance, the word is related to oppose one force to another and standing against. Both definitions often do not fit the purposes intended by the authors on resilience studies for example, the system's capacity of elasticity is often related to one of those two terms. However, it seems that the etymological origins and the evolution of these works do not really serve these purposes.

The relevance of reviewing those definitions relies on the distinctive usage and broader applications by authors. For instance, the recent literature in economic geography takes resistance capacity instead of persistence as an important aspect of regional economic resilience. Moreover, the authors define resistance as the '*degree of sensitivity or depth of reaction of regional economy to a recessionary shock: scale of decline in output, jobs, etc. reaction to the shock*' (see Martin, 2012b; Martin et al., 2016; Giacometti & Teräs, 2019). The definition of resistance here is a proposition however, out of this context readers could understand it as '*to make a stand against*'. Thus, it appears that the usage of the resilience notion from ecology in social systems has trade-offs, since some of its properties are redefined in order to be applied in social-ecological systems.

It seems that the resilience word is not the only boundary object in this context, but some of its allegedly characteristics are also interpreted in different ways. Therefore, we are confronted to two levels of malleable definitions coupled with the complex multidisciplinary aspects and use of resilience. It is possible that at improving our understanding on systems new concepts and probably the emergence of new words will enhance the approximation of the definitions of such dynamics on systems. The linkage of sustainability, regional resilience and urban resilience has gained the interest of scholars from diverse academic horizons. In objective in the next sections is to develop a review of the state-of-the-art regarding the relationship between those concepts and identify gaps in the literature in order to propose a contribution.

2.3.2 Regional Resilience

Taking into account all the apprehensions cited and explained in the previous sections, we will introduce regional resilience, where economic geographers have enormously contributed in the context of regional economies. The study of the resilience property in the field of geography is varied, as it is the field itself. The different schools of geography with the dual interpretation of the spatial dimension, either just as a support or as an active and prominent agent influence the subjects of research and cascade down impacting the conceptual approaches in subjects such as resilience.

For the sake of building a literature review around the urban and regional resilience, we will take into account both views regarding the interpretation of the spatial component. The rationale of doing this, is to try to curb the cleavage between geographical views and attempt to generate a contribution able to conciliate different approaches. The resilience concept is already surrounded by numerous inconsistencies and loopholes by its own right. Hence, we will review some of the research lines mainly developed by economists and economic geographers and then we will integrate the spatial dimension as an influential factor. For instance, resilience is defined in the framework of regional economies as *“the capacity of a regional economy to maintain an above average long-term economic growth rate by adopting to the shocks arising from the endogenous or exogenous invention, innovation or diffusion of technological innovations”* (Simmie, 2017, Rogov & Rozenblat, 2018).

Parallely, contributions in regional studies are aligned with resilience definition under the evolutionary theory of economic change approach, which is associated with a neo-Schumpeterian view. This research stream is taking the current scientific spotlight, and additionally this line of work is logically in accordance with the evolutionary perspective on innovation studies. One of the strengths of this scientific position is that innovation, economic geography and regional resilience are looked at through the same lens: evolutionary theory. We will go deeper on this point, since it typifies the state-of-the art for both resilience and innovation, which are at the core of this research work. In that regard, evolutionary economics and EEG take different shapes but they share the following aspects:

- *Technological development and structural change* as search and selection process (Darwin theory) see Nelson (2006) and Lundquist et al., (2017).
- *Path Dependency*, place-specific legacy and historical inertia, which influence future developments, helping to flourish or to fade economic transformation (Neffke et al., 2011; Dawley, 2014; Binz et al., 2016).
- *Non-linear growth*, crises and growth are linked as change and stability through creative destruction (Schumpeter, 1928, 1934, 1939).
- *Innovations*: diffusion of innovation for technological development, what matters is innovation diffusion not innovation introduction.
- *Entrepreneurship as game changer*, Schumpeter Mark I and II approach (Schumpeter, 1934).

The apparent convergence effect of evolutionary theory on resilience and innovation is also in line with the views of EEG and urban studies (Boschma & Frenken, 2006; Pumain et al., 2006; Boschma & Martin, 2007; Boschma & Frenken, 2009; Boschma & Martin, 2010; Martin & Sunley, 2015; Hu & Hassink, 2015; Boschma, 2015; Muštra et al., 2016; Sensier et al., 2016 ; Martin et al., 2016; Boschma et al., 2017; Giacometti & Teräs, 2019). Recently, economic geographers have argued that regional economic resilience is complex and multi-dimensional (Martin & Sunley, 2015; Martin et al., 2016; Sensier et al., 2016; Giacometti & Teräs, 2019). This approach resonates with evolutionary economic geography that is essentially at odds with equilibrium theory to this end, Boschma (2015) proposed an evolutionary standpoint on regional resilience. Boschma claimed that regional resilience is not only the capacity of a region to integrate a shock, but also to improve its ability to accommodate such disturbance and develop new growth paths. Martin et al., (2016) worked on the deconstruction of regional economic resilience,

acknowledging the different approaches and views on the concept. They observed that after economic shocks in regions, a trending approach to analyse the recovery processes is to isolate cycles by the first de-trending the data (see Partridge & Rickman, 2005). However, the authors warned that most of such approaches do not make distinctions between growth and the Keynesian business cycles theory²⁷. Furthermore, they often smooth the time series which might have an impact on the inflexion points of the trajectories (see Zarnowitz & Ozyldirim, 2005).

Fingleton (2012) suggested that economic cycles could be assumed to follow cyclical movement within a long run 'equilibrium time path'. Then time series error-correction models could be applied to estimate the so-called long-run equilibrium path and the time needed to adjust to the cyclical disturbances. A supplementary method proposed by the same authors is to approach the analysis via explanatory structural models (Fingleton et al., 2015). Initially, the authors cited the theoretical approach proposed by Friedman (1988) in which the peaks and the valleys of the trajectories are the peaks and the bottom maximum levels of growth and recessionary shocks. To back up this theory it is necessary to determine the maximum and minimum hypothetical levels in a given economy.

Economic geographer Ron Martin (2012) proposed a multidimensional model which has been slightly modified in the recent years (see Martin et al., 2016). Martin (2012) initially in an exploratory empirical study of UK regions, proposed to link the concept of resilience to hysteresis. Hysteresis is a property that can be found in some systems, probably the most-well known is in ferromagnetic. It is a distinctive physical phenomenon where the value of a property is lagging behind the effects it caused, an example is when a magnetic induction is lagging behind the magnetizing force. In other words, is when a ferromagnet is magnetised and it keeps the magnetic signal even after the magnetic field that induced it is removed. In practice, a magnetometer is used to measure the magnetic field and the hysteresis cycle, some of these devices are used to change the direction of the typical sinusoidal curves. So, the hysteresis is in a way the tendency of a material to keep some of its properties in the absence of the stimulus that generated it. The hysteresis phenomenon is also described as 'the tendency to remember their magnetic history', which is by analogy the path dependency theory in economics and in EEG. Hysteresis in ecology, is a pattern observed when the recovery pathway of an ecosystem is different to the degradation pathway (Suding & Hobbs, 2009), which ecologists refer to as path-dependence. In this process various thresholds must be traversed for recovery purposes, often accompanied of time lags even if the change stressors have already halted (Selkoe et al., 2015).

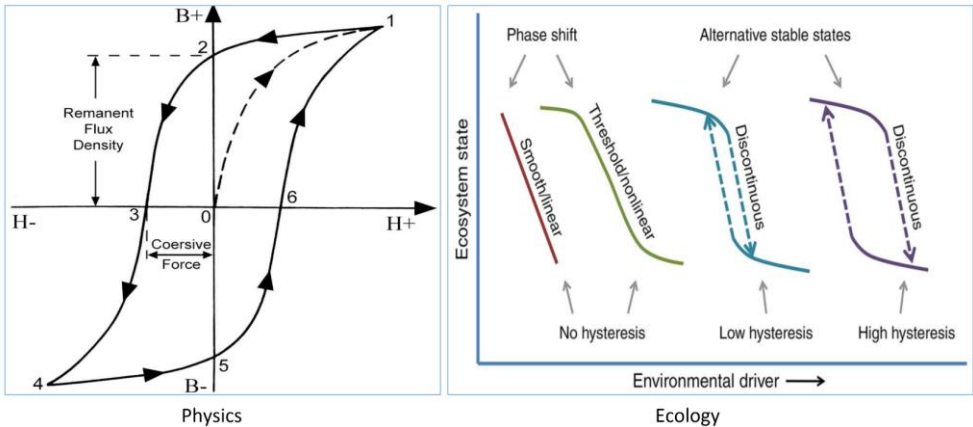

Figure 62 (Left) Hysteresis loop for a solenoid's ferromagnetic core. (Right) Types of regime shifts. Phase shifts can be smooth or nonlinear, whereas alternative stable states show discontinuous change with some level of hysteresis. Source: Selkoe et al., (2015).

²⁷ Although some scientists claim that the dependence of GDP levels related to the history of recessionary shocks, which economist refer to as hysteresis should definitely unify growth and business cycles (Cerra et al., 2020).

Particularly in ecology we find a rich similarity of concepts that have been in one way or another transferred to social-science and more specifically to fields such as geography and the economic geography branch. The systemic approach of both, ecology and geography has somehow driven this practice. So, hysteresis has also been applied to economics since some decades ago, one of the earlier explicit reference to the term in the literature might be the study done by Clark (1989). The author worked in the context of labour markets, specifically in the persistence of unemployment in Europe. The hysteresis definition was related to path dependency as follows:

“Formally, a dynamic system is said to exhibit hysteresis if it has at least one eigenvalue equal to zero (unity, if specified in discrete time). In such a case, the steady state of the system will depend on the history of the shocks affecting the system. Thus, we should say that unemployment exhibits hysteresis when current unemployment depends on past values with coefficients summing to 1”. Unemployment has historically been an indicator for business cycles, where the fluctuations were conceived as a change in the level of economic slack and unemployment was a notorious indicator of such slack (Cerra et al., 2020). The observations on the pervasive European unemployment levels were studied and deemed very high, which triggered the believe that normal labour market frictions could not explain such levels, these effects were coined as hysteresis. Thus, the concepts of hysteresis and resilience have been borrowed from natural science by Martin (2012) in order to explain the capacity of regional systems to adapt to recessionary shocks. This theoretical view proposes the possibility of multiple economic equilibria in regions, whose regime changes are triggered by shocks. In such cases, urban networks are able to adapt to multiple regimes from an economic perspective. The term regime is preferred to that of ‘state’ since urban systems are not really ‘static’ but dynamically stable. Martin et al., (2016) proposed four dimensions that characterize resilience:

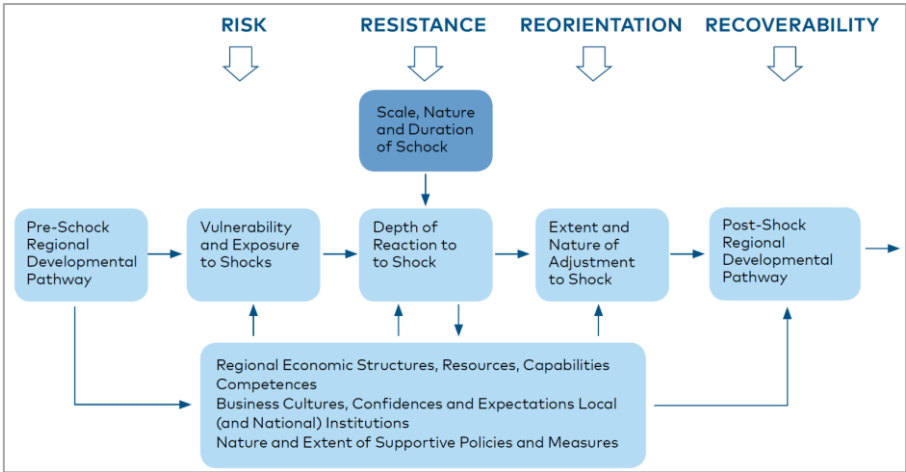

Figure 63 Regional resilience from recessions. Source: Martin et al. (2016).

For the authors, the four components are linked and dependent on scale, nature and duration of the economic shock. The first component are the risks embedded in regions’ systems, which are composed by different stakeholders such as industries, institutions, firms and workers. The second factor is the resistance to such risks, where resistance to economic recessionary shocks is defined as the ‘depth of reaction to shock’. The third aspect is the re-orientation ability of the regions’ actors in order to get back to the main activities. The four and last factor is the recoverability degree that a region has. In a study of regional economic resilience in the Nordics Giacometti & Teräs (2019), attempted to identify new indicators to measure economic resilience at several levels.

The goal was to contribute with new views on resilience and map regions’ adaptive capacity to address recessionary shocks. The authors reminded the warning recommended by Sensier et al., (2016) about the common confusion between the regions’ capacity to cope with change and the real output of such efforts. A fundamental criticism of this approach is that the analysis is only done at meso level, leaving other scales out of the analysis.

Therefore, the connection of adaptive cycles between scales remains unsolved, opening opportunities for new research directions (Rogov & Rozenblat, 2018). Regarding the last note, we argue that the development of adaptive resilience in economic geography which has a regional focus, requires to connect and analyse interactions at micro and macro levels to expose the nature of cross-scale interactions.

According to Sensier et al., (2016) and Giacometti & Teräs (2019), it is possible to measure the outcomes of a region subjected to a shock by its own reference indicators or by a comparative analysis. However, in the case of measuring adaptive capacity, it appears that some indicators used in the past do not disclose information about resilience directly. Instead, they improve our understanding on those capacities and adaptive mechanisms that empower regions to be resilient. Resilience and regional resilience seem to be context dependent therefore, the indicators should be developed also at local level, which would give information about local paths, preconditions and knowledge. The evolutionary approach of adaptive resilience emphasises on the existing paths of a region to cope with change therefore, the local aspects of resilience is indispensable. Thus, the previous dynamic states of a region from an economic, social, infrastructure, knowledge, environmental, political and all the different kinds of associated capital will partially define the resilience level of a region.

For this reason, the OECD (2014) focused on the context-specific and place-based perspective regarding resilience analysis. This view is in line with the need of place-specific approaches for sustainability transition processes (Hansen & Coenen, 2015). The OECD (2014) provided some insights to build resilience systems, where the assessment of pre-existing regional assets should be evaluated in the light of identified stressors in order to design policy responses. An example of methods based on case-studies for a general overview and assessment of regional assets to face recessionary shocks was provided by Martin & Sunley (2015). The authors presented different indicators that can contribute to measure regional economic resilience.

Method	Focus	Examples
1. Case-study based	Mainly narrative based, may involve simple descriptive data and interviews with key actors, interrogation of policies.	Munich (Evans and Karecha, 2014); Cambridge and Swansea (Simmie and Martin, 2010); Buffalo and Cleveland (Cowell, 2013)
2. Resilience indices	Singular or composite, comparative, measures of (relative) resistance and recovery, using key system variables of interest.	UK regions (Martin, 2012); US cities and counties (Augustine et al., 2013; Han and Goetz, 2013)
3. Resilience indices Statistical time series models	Impulse response models; error correction models. These estimate how long it takes for impact of shock to dissipate (how much of the impact is subsequently eliminated per unit time period).	US regions (Blanchard and Katz, 1992); UK regions (Fingleton et al., 2012)
4. Causal structural models	Embedding resilience in regional economic models to generate counterfactual positions of where system would have been in the absence of shock.	US regions (Blanchard and Katz, 1992); UK regions (Fingleton et al., 2012) US metropolitan areas (Doran and Fingleton, 2013); EU regions (Fingleton et al., 2014)

Table 8 Alternative approaches to measure regional resilience. Source: Martin & Sunley (2015).

The authors suggest complementing the analyses of economic indicators with qualitative analyses (see Bristow & Healy, 2014; 2018). Place-based specificity is a recurrent term in innovation studies and on sustainability and resilience research work. This PhD thesis is at the intersection of these research fields, where multi-scale geospatial analysis via graph theory seems to be an enabling methodology to study the local and global aspects of the urban resilience to RET diffusion. From a regional perspective, the critics towards the engineering-rooted approach are based on the fact that even if a region could preserve its structure, domain and identity, in order to absorb and integrate a shock, a certain level of reorganization and change processes need to take place (Muštra et al., 2016).

This new research direction embeds relevant changes, questioning opposing views such as *bouncing back* or *bouncing forward*? which describe two different notions. Bouncing back implies going back to the previous or

normal position recovering the former structure, whereas bouncing forward entails replacing parameters and finding a new normal structure (Bonß, 2016). To illustrate the two notions from a regional perspective, the former could occur when a region succeeds at absorbing a shock without needing to change its core industrial roots and go back to business as usual. In the latter, a region would not be able to return to business as usual since the underlying conditions changed (Muštra et al., 2016; Bonß, 2016; Giacometti & Teräs, 2019).

In summary, regional resilience studies focus on economic recessionary shocks where meso and macro levels are the main emphasis of analysis. After the next section on Business Continuity Management, we will investigate the state-of-the-art of urban resilience and also the similarities and differences with regional resilience research through the sustainability prism.

2.3.3 Business Continuity Management: An Attempt to Integrate Resilience in Business Management.

In business management the word resilience is often used in traditional contexts where norms, standards and programs are developed to face eventual dysfunctional issues. However, this is not in line with the concept of resilience used in ecology (see Holling, 1973; Hollnagel, 2006). The same incongruency apply for regional studies with economic focus (Martin et al., 2016); urban technical networks emphases (Lhomme, 2012; Dutozia, 2013; Dutozia & Voiron-Canicio, 2017) or socio-ecological systems (Voiron-Canicio & Fusco, 2020). Nevertheless, organizations are part of the micro level from a multi-level perspective (Rogov & Rozenblat, 2018). As it will be discussed in this chapter, the multi-level approach seems to be a research direction to integrate urban and regional resilience studies. Therefore, the following review on resilience programs will be developed, acknowledging their limitation and as Levin (1998) argued, complex systems are not linear and management protocols cannot cope with them. The idea is to do a brief review as for sustainability monitoring some of the tools developed in management are still valuable.

One of the main reasons about the dissonance of the resilience notion between risk management in business and in economics in regard to urban and regional resilience approaches is the linearity embedded in risk management programs. As proposed by Morin (1990) and taken over by Lhomme (2012) '*it appears necessary to think in terms of strategies and no longer in term of programs*'. This becomes more evident when we deal with complex systems, which obliges a system to move away from pre-conceived compliances and regulations as it needs to interact and cope with a moving environment (Hollnagel, 2006). Nevertheless, economists and management experts have done contributions regarding tools and methodologies to deal with risk that are valuable. In the context of this research, we will limit a short review of some of these approaches as some of them have the potential of being transferred to urban resilience studies. The focus here is not in the integration of programs from risk management but discuss some *data observation tools* that could be adapted to measure urban phenomena.

In business management different methods and tools have been conceived in order to deal with risks and hazards. A special attention is given to Business Continuity Management (BCM), which is a method designed to ensure that, in the event of events (internal/external), critical functions remain operational or become operational again as quickly as possible. Within the BCM's objectives there is:

- The minimization of consequences of unwanted events at operational, financial, legal and reputation level.
- The continuation or rapid resumption of operations in unexpected or crisis situations. It therefore concerns all areas of activity and all organisational units of a company.

This approach is a standard provided by the International Organization for Standardization (ISO), which has produced different norms to address risks and vulnerability issues. The ISO has linked the concept of BCM with resilience through guidelines such as the ISO 31000 for risk management and the ISO 22301:2019 for security and resilience. The BCM systems requirements, was first issued in 2012 and certified companies have 3 years to do the transition. The 22301:2019 standard specifies the requirements “for planning, establishing, implementing and monitoring, controlling, reviewing, maintaining and continually improving a documented management system to protect against, reduce the likelihood of, prepare for, respond to and recover from disruptive incidents”. BCM is addressed to all types and sizes of companies and mainly for those that operate in high risks environments such as transportation, oil and gas, financial services, food production and telecom. BCM is a paradigm that unifies different subjects and areas for the continuing functioning of the organizations that traditionally were managed in a silo approach.

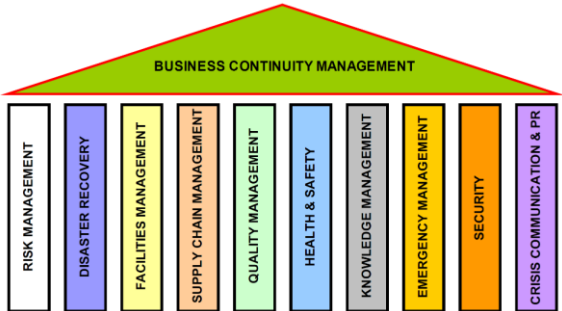

Figure 64 Unification process of Business Continuity Management.

The BCM approach is an attempt to combine different methodologies under the same umbrella and involve strategic and operational tasks. The underlying idea of BCM is to integrate different conceptual methods and operational instruments to protect complex systems through mechanisms that can be deployed when is required. The BCM concept could be illustrated as the set of different protocols and processes that involve personnel, infrastructure, financial resources as follows:

$$BCM= DRP + BCS + BIA + BCP + CS +WS + HS + CMT + PC...$$

Where;

- DRP stands for Disaster Recovery Plan and it is the set of procedures and provisions planned to guarantee the company's (e.g., financial, IT system, reputation, infrastructure, legal) recovery in the event of a disaster. Sub-assembly of the BCP which covers e.g., financial, legal, infrastructure, IT and telecom resources. It guarantees: the recovery of systems designated as critical within the minimum time set; the recovery with the minimum loss set, for instance data in the case of IT systems failure.
- Business Continuity Strategy (BCS) must be consistent with the company’s overall strategy and consists of making a choice of activities to be prioritised in order to preserve business continuity in the event of a failure of critical resources. For instance, to determine the acceptable level of risk and the analysis of possible actions and policy decisions on the provision of replacement resources. The BCS relies on the Business Impact Analysis (BIA), which relies on the Business Continuity Plan (BCP).
- The BIA is the mechanisms through which businesses’ impacts are identified and measured from a quantitative and qualitative perspective in the event of failure, disruptions or losses. The final goal is to identify recovery priorities, the associated resources to the recovery, the critical personnel needed and finally to help to structure a BCP.

- The BCP is the set of actions, procedures, processes, and deployment of resources that enable the company to respond to crisis scenarios, including extreme shocks, in order to ensure the continuity of critical activities.
- Cold sites (CS), warm sites (WS) and hot sites (HS) are backup sites with different intensity of preparedness and usage in terms of IT infrastructures and equipment.
 - For instance, in a CS there is equipment that is stored but not installed nor connected. In the event of a disaster, the amount of work to be done in order to get the site up and running would be high. This implies that it would also take a lot of time so leading to long recovery times in case of a disruption. Nevertheless, the operating costs are low as there are long periods where the systems are idle outside the activation period.
 - A WS are intermediate backup sites, which in general one finds some equipment installed, but updates staggered in relation to the production site. Some data might be recorded at local level but not distributed into computer systems.
 - A HS is a backup site where all the servers and other systems are in operation, updated, interconnected, parameterised and supplied with the saved data. The site must also have all the infrastructure to accommodate the necessary IT staff at all times and allows to resume business continuity in the shortest possible time (a few hours). Such a site almost doubles the company's IT capacity (redundancy) and therefore has a significant budgetary cost.
- The crisis management team (CMT) is composed of the heads of each user Directorate concerned by the PCP. It also includes members of the Executive Committee, the General Services, the Human Resources Department, the Communication Department, the IT Department and the BCP managers. Its role is to meet in the event of a serious incident to decide whether or not to trigger the BCP. Its members must be on call (on-call service) or at least be available at any time and in any place.
- CP stands for critical personnel, which is the minimum number of (key) people required to function properly.

These protocols are just a brief description of the whole BCM approach, since the complete list and definitions are beyond the scope of this research work. Thus, the underlying idea of BCM is to have a large grip of methods, approaches, tools and protocols to improve the capacity of companies to integrate changes in their functioning. Continuing with the normative framework of business continuity we will briefly mention a non-exhaustive list of BCM guidelines. An example is the norm ISO 27031, which is the business continuity standard. Another is the standards ISO 22399 are the guideline for incident preparedness and operational continuity management. ISO 19011-2002 - Guidelines are for Environmental Management Systems Auditing. Another guide is the Afnor BP Z74-700 – which is the Service Continuity and Business Resumption Best Practices Repository. The ISO/IEC 17799 standard involves Information technology, security techniques and the code of practice for information security management. The ISO/IEC 24762 project – is the guidelines for information and communications technology disaster recovery services.

Within the normative agenda of BCM, there is also the BSI PAS 56, Complementary BCM guides published by the British Standards Institution in a joint collaboration with the BCI and Insight Consulting Group. In the United States there is a Standard on Disaster/Emergency Management and Business Continuity Programs called NFPA 1600 – 2004. From a homeland security perspective there are also guidelines addressing the aspects of BCM, such as the

Business Continuity of Defence in the UK. There are other frames of reference for good practices like best BCM guides BS25999-1 and the guide to implement a Business Continuity Management System (BCMS): BS25999-2. The banking industry appears to be one of the most advanced in the field of risk management even though the sector acknowledges that there are still several unknowns regarding risks. Nevertheless, some of the approaches developed within the bank sector are useful to operationalise regional economic resilience. Hence, we will introduce some of the practical methodologies used within the bank sector that have a potential to be transferred and adapted in regional contexts.

From an economic perspective, risk managers have designed methodologies to mitigate the impact of hazards for companies and financial markets. Particularly, the banking sector has been very keen into developing laws, agreements, methods and tools such as the Basel Standards, in order to deal with market liquidity risks, capital adequacy and stress testing. Some attempts have been aiming at the identification and topology of risks for instance, the endogen nature of risks are human factors, processes and systems. Under the same idea, exogen risks are strategic and reputation risks. Some of the risks that companies are confronted with, are controllable if they are well defined understood and insurable. Contrarily, non-controllable risks are those ones that we cannot predict or those that have human or markets origins, and it is compulsory to accept them. A lesson learned from the banking industry is that risk assets management proves difficult when one needs to quantify an event and its potential impact. The impact of a potential risks is measured by the magnitude times the probability, which is often '*calculated*' based on managers' experience, therefore a subjective input. According to the nature of risks, these can be managed by transferring them to another party (insurance), mitigate them (shared with partners or partially insured) or simply accept them. Companies and banks are often confronted with risks with human roots, which prove to be uncontrollable²⁸.

Within the banking industry a field that is at the cutting edge is risk technology and cybersecurity, an example is the development of BCM. This approach is used by prominent banks and has as an objective to assure the functioning of their services, based not only in technological methods but protocols that involve employees, processes, resources and infrastructure. The figure below shows the 'sphinx curve' which is a representation of the evolution of a crisis within the bank sector. In the left, two trajectories depict the evolution from weak signals towards the paroxysm point, where the green line represents a resilient system that anticipates hazards, and the red line represents a not resilient system. The trajectory is discretised as shown in the right where seven different levels of impact intensity are compartmentalized in function of time, which allows managers to take measures accordingly.

Following this line of thought, nor for resilience purposes but for sustainability monitoring, the RET diffusion network could also be followed-up from a multiscale perspective, in order to detect weak signals of diffusion issues at early stages. Weak signals can be illustrated in a Cartesian coordinate system, where the y-axis measures the hazard impact and the x-axis the time. In the Figure 65 we can observe two different outcomes in the trajectory of a system. The red line symbolizes the trajectory of a system that would not be ready to anticipate a hazard, therefore the impact of the risk would be more important reaching an inflexion point before following an extended path towards normality. Contrarily, the green line shows a less sharp inflexion point as a result of weak signals detection and anticipation to change. A similar schematization of the conceptual idea of resilience has been proposed in the field of geography by Lhomme et al., (2012) and Voiron-Canicio & Fusco (2020) see Figure 71.

²⁸ Readers interested in a deeper review on the subject with an emphasis on economics and management are referred to Fragniere & Sullivan, (2007).

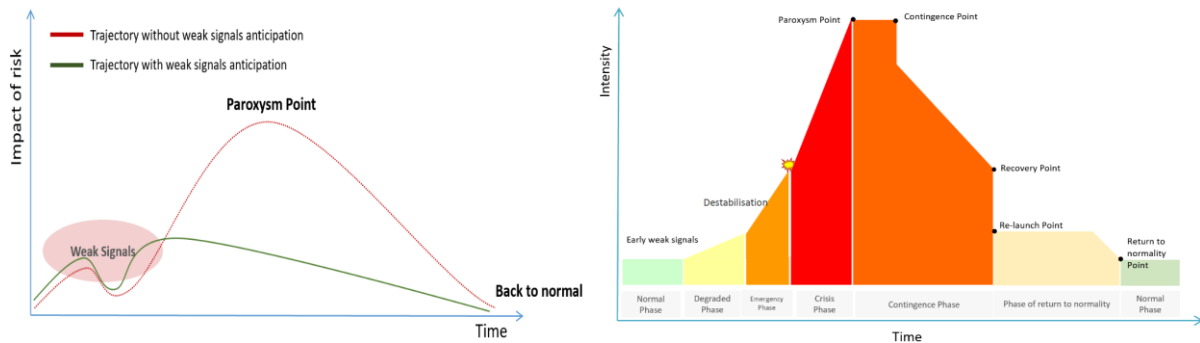

Figure 65. (Left) Precursory signs of a crisis. (Right). Evolution of a crisis situation. Source Pictet & Cie, J-P. Therre (2014).

Within the BCM approach that intends to deal with risks and hazards under a more resilient systems approach, managers are required to prioritize the activities that need to keep working even during a period under a disturbance phase. In the IT area of banking for example, there are two fundamental concepts within BCM: Recovery Point Objective (RPO) and Recovery Time Objective (RTO). The RPO defines the degree of data freshness, corresponding to the loss of data considered acceptable between the cessation of the activity and its resumption. For instance, at disaster recovery start-up, data may date from the night before, the morning or the minute of the disaster. RPO indicates then how much information is acceptable to lose from the last backup to the incident.

The RTO defines the target time needed to resume a specific business operation and it has two components: the duration of the disruption until the activation of a business continuity plan, and the duration from the activation of the business continuity plan to the resumption of the specific business operation. This is the total time required between the interruption of the activity and the release of technological resources and logistics functions to users. In the figure below it is shown the arrival of a disturbance after a normal functioning period. A shock takes place and the system is affected, some data is lost and a recovery time period is needed before the system is established again. But before a total recovery phase and return to business as usual, the service is provided with a lower quality during a limited period. Hence, to be able to deploy a rapid response preparation is needed.

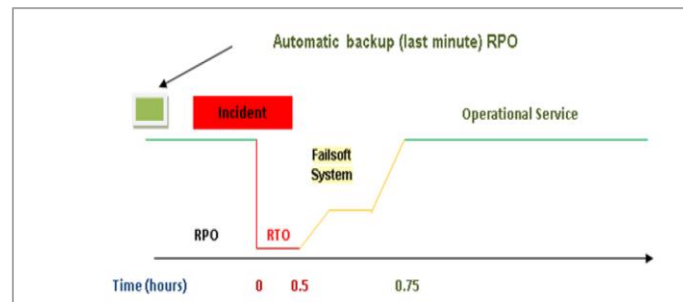

Figure 66. Recovery Point Objective & Recovery Time Objective. Source Pictet & Cie, J-P. Therre (2014).

Some of the underlying ideas of the methods used in BCM are valuable and could be adapted to observe the development of urban trajectories. For example, the evolution of a RET diffusion network could be monitored in order to detect weak signals of stagnation or network topology changes. In this line of thought, decision-makers could determine the acceptance level of stagnations in a period before a threshold is overtaken. Following this reasoning, strategies and policies could be developed in order to influence and change unwanted trajectories.

In summary the approaches of risk management and BCM regarding the resilience notion are still in the early stages and keep traditional views on how to deal with risks. However, some underlying conceptual views are potentially transferable and valuable for sustainability transition monitoring.

2.3.4 Urban Resilience and Sustainability Transition

In this section we will focus on the main topic of this research work, which is the urban resilience to innovation diffusion, where RET are the innovation indicators and are used as a proxy for sustainability transition purposes. Given the complexity embedded in the interaction of socio-ecological systems, a systemic complexity approach is privileged to deal with the question of urban resilience to green innovation. Scholars suggest taking the systemic resilience approach rather than disciplinary resilience as a reference (Dauphine & Provitolo, 2007). The close relation between resilience and sustainability transition studies has generated different views, Marchese et al., (2018) categorized three major frameworks where both concepts are often studied *i) sustainability as a component of resilience; ii) resilience as a component of sustainability and iii) resilience and sustainability as separate objectives*. The authors claimed that the proximity and theoretical differences depended on the research framework.

Rogov & Rozenblat (2018) highlighted some distinctions between sustainability and resilience that are worth of noting. Regarding the notion of resilience, they noted that are processes such as adaptive evolution, complexity, change and the ability to learn and cope with external shocks. For example, in resilience processes the multifaceted, multidimensional, and multiscale mechanisms regarding climate change are often framed under adaptive measures in which the social system's ability to integrate shocks is put to test. In this regard, resilience is a paradigm to describe systems. The authors view on the systemic complexity of resilience is congruent with the discussion developed in this research work. While sustainability relies on normative characterization, which targets preferable systems' states based on assumptions, information, preferences or goals such as the S&D Goals proposed by the UN in 2015 (Xu et al., 2015). Sustainability is often referred to as a '*transformation process*' rather than adoption *per se*. According to a systematic review Rogov & Rozenblat (2018) several studies link sustainability with terms such as "*institutions*", "*policies*" and "*decision-making*" and "*climate change*". These terms are used under a context of systems transformation, which implies a deeper and profound socio-technical and socio-ecological restructuring.

The underlying changes for sustainability transition are deep-rooted and require structural shifts from the current situation, which might have become untenable (Walker et al., 2004; Walker et al., 2006 Nelson et al., 2007). Within this stream of thinking one could say that such studies in sustainability transition suggest a major change in the structural composition of a social-ecological system where its qualitative structure might be compromised and even changed. This idea runs counter to the seminal definition of resilience proposed by Holling (1973). According to these views on resilience and sustainability respectively, change is within both equations, however the level of depth and its effects on the system's qualitative structure are not the same. In the context of this Ph. D research work, we highlight the conceptual linkage between urban resilience and sustainability as follows: *strengthening the resilience levels of a city, implies that a city potentially becomes more sustainable however, strengthening the sustainability of a city does not require that it becomes more resilient*.

The practical angle of sustainability transition here is approached by the study of the capacity of RET spatial diffusion and the urban ability to recover from eventual shocks and slowdowns in the spatial adoption process in the Swiss Alps and the South Region of France. The relevance of this lies on the socio-technical systems' capacities to continue with the RET diffusion process in spite of negative events. To deal with this question it is proposed to look at the urban systems' capacity to cope with change from a multiscale perspective: *Are urban systems equally capable to cope with change in RET diffusion process from a multiscale point of view?* This question pinpoints a relevant issue regarding strategies and policies that are deployed and affect hierarchical urban systems, in which implicitly often policies have a 'fractal' flavour: one-size-fits-all.

Voiron-Canicio & Garbolino (2020) emphasized on the importance of multiscale spatial differentiation in ecosystems and territorial resilience contexts. The authors discussed the subject while presenting the

geoprospective approach, which was born in France as a result of interdisciplinary research work in environmental and territorial dynamics, whose interests converged on spatial change. The shared interest was focused on the future evolution and the anticipation of such spatial changes. According to the authors, the term *geoprospective* was coined by the Bureau of Geological and Mining Resources (BGMR) in France in the beginning of the 1980's however, the definition of the concept was not very precise. The context of the usage of the word was in the scientific research framework of evolution of the geophysical properties of radioactive waste at storage sites and their correspondent control. The risk assessments related to radioactive waste management were relevant from a geographic perspective as any event leading to the loss of the material could have devastating consequences.

Later in the 1990's the term was defined as follows "*The geoprospective approach aims to work out plausible and coherent scenarios of this natural evolution and to assess its consequences in order to draw profitable lessons in terms of the capacity of a site to accommodate a project, and even of devising the project itself. It thus contributes to scientific objectives (demonstrating the project's feasibility), also technological and operational (project optimization) and to decision-making (selection of sites, project acceptability)*" (see Godefroy et al., 1994). The *geoprospective* approach has mostly been developed by French scientists, forming a scientific community in the beginning of the 2000's. Within this stream in the field of geography, the spatial dimension is interpreted as an active agent. Voiron-Canicio & Fusco (2020) discussed the challenges of territorial resilience under a *geoprospective* approach through a systemic prism. For the authors, the importance of territorial resilience should be looked at from all perspectives, at local and global levels.

A fundamental question that the authors reiterate is that the *geoprospective* approach aims at addressing the trajectory that regions would take when a shock take place in a not very distant future. Questions of the like *how a shock will impact the territory? And which will be the likely responses to such changes?* In general, these are the major underlying theoretical questions addressed on regional resilience studies however, they can be breakdown in a considerable list of scientific questions. One of the main differences with the *geoprospective* approach, is that it emphasizes on the spatial point of view as a factor of social organization to answer those questions. Those questions are related to different aligned approaches that have been reviewed in this research work such as complex systems, evolutionary adaptation, system dynamics and the sustainable development paradigm (Voiron-Canicio & Fusco, 2020).

The authors suggest applying such theoretical approaches to analyse territories' resilience, under three possible perspectives: *'as a state, as a process and as a property'*. The most common approach of studying regional resilience is a *posteriori* research analysis in which a region is observed after having been subjected to a shock and then a diagnostic is developed. According to Voiron-Canicio & Fusco (2020), this stream tries to give insights on the process that generate resilience based on the past reactions of a regional systems subjected under a shock to draw a possible future response.

A less common view on regional resilience research is the *ex-ante* research position proposed by the *geoprospective* approach (Voiron-Canicio & Fusco, 2020). This research stream deals with the question of regional resilience by assessing the future trajectories of a territory with regard to its potential of adaptability. This implies a radical methodological deflection in relation to the methods to investigate regional resilience as a whole. As a conceptual baseline regarding the definition of resilience, Voiron-Canicio & Fusco's (2020) view resonate with Holling's (1973) definition anchored in ecological systems. Thus, the reorganization feature of living systems is taken as major vector of directionality in research terms undertaken by the authors. To better understand the implications of reorganization the authors call upon complex system theory (see Morin, 1974, 1990, 1994; Haken, 1977; Prigogine & Stengers, 1979), in which four characteristics are prioritized to analyse territorial systems: "complexity, adaptiveness, self-organization and creativity".

Voiron-Canicio & Fusco (2020) take systemic complexity as a framework and claim that the more complex behaviours are observed in a system, the more flexibility and adaptability is shown to cope with the environment.

These mechanisms will trigger in return changes in the environment through feedback loops in order to generate a more suitable adaptation. As a consequence of these interactions the complexity levels are increased and the deterministic nature of some interrelations are systematically reduced (see also Levin, 2002). The role of self-organization, which is a signature of complex systems, entails the development of stochastic trajectories resulting in vast forms of organization.

A congruent view on the systemic resilience property is proposed where multiple dynamic states are possible *i)* in ecological systems (Holling, 1973); *ii)* also by the geopropective approach, which considers alternative stable states (Voiron-Canicio & Fusco, 2020) and *iii)* economic geographers acknowledge dynamic states in regional economic resilience (Martin, 2012; Martin et al., 2016). These similar points of view can open new research directions for geographers of different branches within a systemic complexity approach. As for the creativity, Voiron-Canicio & Fusco (2020) argued that it is an intrinsic notion within the self-organization character of complex systems. The underlying idea is that self-organization involves creativity since adaptive systems are able to build new forms at macro level, which are not predictable but are derived from micro elements and micro interactions. This notion is what we have previously referred to as emergence. These mechanisms are reinforced by the multi-level functionality of complex systems at different scales of time, space and social organization, under the framework of panarchy²⁹.

Following the systemic resilience property research line, Voiron-Canicio & Fusco (2020) developed a discussion on the linkage between territorial resilience and the paradigm of sustainable development. From early 2000's research on resilience has reinforced the field of sustainability science, which intends to underpin our understanding on the intertwined relations between nature and society targeting a more sustainable path (Independent group of scientists, 2019). Sustainable development is seen rather as a dynamic process and a path than as an end *per se*, which is strengthened via the adaptative capacity in social resilience and ecological systems to cope with change (Berkes et al., 2003; Voiron-Canicio & Fusco, 2020). Furthermore, it seems that the reinforcement of resilience contributes with the objectives of sustainable development (Da Cunha & Thomas, 2017; Scherrer, 2017).

As suggested by Voiron-Canicio & Fusco (2020) this requires further research involving social resilience and sustainable development. The authors raised the questions "*As far as public action is concerned, does resilience help to operationalize the utopian vision of sustainable development? Is it the path to follow to move toward sustainable territorial development, and how?*". Such questions seem to put scholars in a position where collaboration between sciences tend to be unavoidable. Since some decades ago, scientists have wondered about the future of science. Some authors have proposed a desirable scenario where in the future a '*reintegration of the study of humans and the rest of nature*' (Constanza, 2003) will take place. In this view, science will bring together humanities and all sciences through a 'consilience' process. The word consilience literarily means '*a jumping together*' or '*to leap together*' a word formed from the Latin '*com*' that means *with or together* and '*salire*' as in *resilience (resilire)* that means 'to leap' .

This term indicates the willingness of bringing together knowledge and information from different disciplines and unrelated sources in order to create a common knowledge framework of reference. For instance, the observation in complex systems of alternative stable states, emergence, adaptability and other phenomena are present in ecological and in social sciences. This consilient transdisciplinary could be possible by taking a pragmatic approach based on complex systems theory and modelling where for example a consistent notion of biological and social co-evolution is modelled under multiscale approaches (Constanza, 2003). In *future studies*, scholars use *envisioning* tool as a cornerstone for disparate (and even adversarial) communities to collaborate on envisioning a desired future in a suitable forum (Garret, 1993; Kouzes & Posner, 1996; Adesida & Oteh, 1998). In this regard,

²⁹ This concept will be developed further in this section, for reference see Figure 69.

geo-governance and geopropective approaches are very well suited from scientific and operational perspectives since both paradigms try to address interdisciplinary and prospective issues. The challenge is to make operational such scientific views as every research and pragmatical question needs to be dealt with in a specific way.

To overview the question of resilience within the field of geography we are again confronted to the geography schools of thought. Is it the spatial dimension considered as an active agent or is it only a substrate for further analysis? Since resilience is a concept borrowed from natural science, we suggest to explicitly take the spatial dimension, which would help to determine self-organization processes from a spatial perspective. The spatial component is essential in resilient systems as it allows to observe dynamic spatiotemporal scales. Such changes are critical to determine which parameters are important in a given process. Under a common framework such as complex systems theory is possible to analyse different kinds of problems that involve distinct elements and types of interactions, ranging from industrial development, sustainability to socio-demographic evolution in a region. As argued by Voiron-Canicio & Fusco (2020) it is not just a question of doing analogies between systems, but the spatial component is different if we compare an ecosystem with a wine-growing region or a transnational industrial system.

Within the field of innovation in Chapter 1 we discussed different approaches linking diffusion processes, knowledge and the spatial dimension. In the state-of-the-art in innovation studies there is no question about the role of spatiality in organization and innovation processes. We discussed different approaches such as industrial location, the French school of proximity, innovative milieu, geography of innovation and integration of networks of innovation and space among others. These approaches tend to take the spatial component in an explicit way, as it is the intention within this research work. Sustainability transition is directly linked with the adoption of innovation and ideas, the former related to technologies such as RET and the latter to sociological changes. The capacity of regions to adopt RET is embedded in a systemic complexity, where innovative and resilient characteristics are present and can reinforce the sustainability of an urban system. Through a network model RET clearly show self-organized characteristics from a diffusion perspective and also when the network experiences shocks, having major consequences at local level. This kind of information is important in order to understand the alternative stable states of the process.

The observation of complex systems such as energy transition must be accompanied of a follow-up of questions such as where and when RET adoptions are taken place? Hence, spatiotemporal analyses will enhance the interpretation of the complex behaviour in complex systems such as the one observed in RET diffusion. Therefore, from an operational standpoint geospatial analysis coupled with graph theory seems to be a suitable approach to determine self-organization characteristics of a system. Furthermore, it contributes to do analyses of other kinds, such as absorption and adaptation capacities of systems, which are fundamental characteristics of resilient systems in ecology and in social systems. Absorption and adaptation capabilities are possible to be observed under multiscale analysis performed in an urban network.

In this regard, the resilience analysis of RET diffusion contributes from a modelling point of view to enrich our understanding of the geography of transition under a systemic view. The self-organized nature of this phenomenon and the spatial consequences derived from changes across scales are relevant from a place-specificity point view. The relevance of the observation of local changes is based on the scientific acknowledgement of the lack of generalisable knowledge on how place-specificity matters for sustainability transition (Hansen & Coenen, 2015). The latter authors in a systematic review on the geography of transition found that most of research is focusing on the niche geography than in regime dynamics. In this context, the scholars emphasized on the importance given by scientists to better understand the relevance of place-specificity.

Recent studies within the field of urban and regional sustainability transition are aligned with the fractal nature embedded in resilience systems, however a differentiate multilevel approaches should be taken at micro, meso and macro level. Rogov & Rozenblat (2018) did a systematic review on urban resilience and sustainability and

urban sustainability, the meta-analysis of approximately 800 papers published between 1973 to 2018. Based on the database provided by Scopus the authors found 242 papers on resilience and sustainability, 596 on urban resilience and 174 on regional resilience. The complete procedure is detailedly explained in their paper, the figure below shows a network representation of the linkage between related concepts.

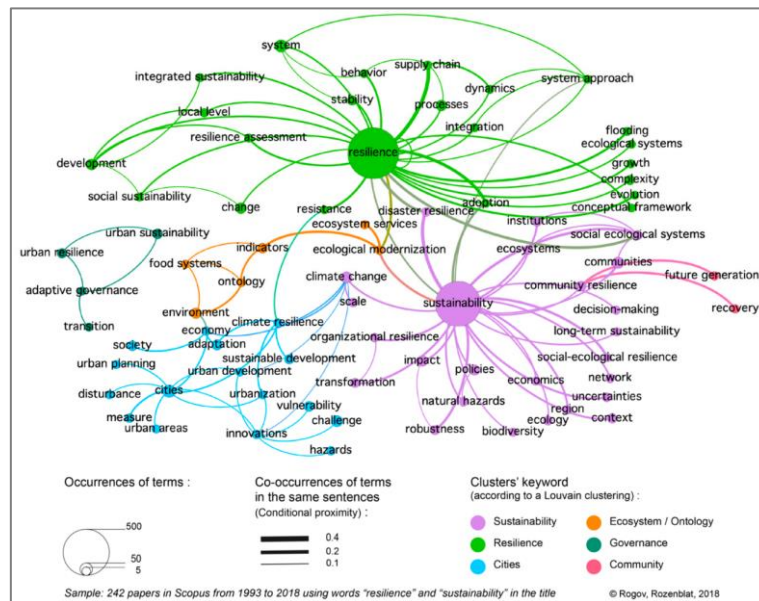

Figure 67 Co-occurrences of terms appearing in the abstracts of papers with “Sustainability & Resilience” in their title. Source: Rogov & Rozenblat (2018).

The network above represents the linkage of the scientific discourse on resilience and sustainability. According to the authors the underlying topics that allowed this connectivity are ‘*adoption and social ecological systems, ecological modernization and disaster resilience*’. The qualitative analyses of these publications suggest that the studies that considered adoption, which is in line with this research work, focused on the adoption of sustainable practices and policies in agriculture, standards and resilience policies. The study also suggests that the acknowledged diversity of definitions of resilience and sustainability were influenced by the research objectives and were depicted as a “*constructive tension*” in resilience research works (Wilson, 2018). The proximity of both concepts has been influenced by shared characteristics such as both are related to nature and society (Voiron-Cancio & Fusco, 2020) and can be applied at micro (e.g., organizations), meso (cities) and macro levels (regional) (Rogov & Rozenblat, 2018). A network was also developed by the latter authors to visualize the connection in urban resilience and regional resilience studies respectively.

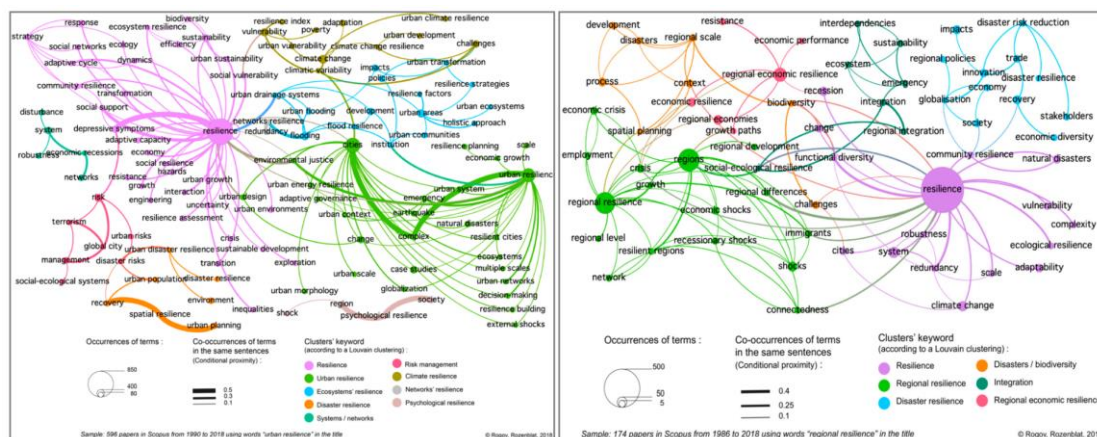

Figure 68 To the left: Co-occurrences of terms in the abstracts of papers with “Urban resilience” in their title. To the right: Co-occurrences of terms in the abstracts of papers with “Regional resilience” in the title. Source: Rogov & Rozenblat (2018).

According to Rogov & Rozenblat (2018) the definitions of sustainability and resilience appear to depend on the emphasis of research. The findings suggest that there are two distinctive trends in terms of scientific approaches regarding the multilevel analyses' perspective in regional and urban resilience studies. According to the authors it appears that: *i) studies on urban resilience rather focus on micro and meso levels, while considering the origin of shocks bottom-up, such as natural disasters; ii) studies on regional resilience focus on meso and macro level, considering the origin of shocks top-down, such as global economic shocks.* The authors suggested a research direction in which a combination of both approaches would benefit and improve our understanding of resilience from a multilevel perspective³⁰.

According to the results from the graph above, urban resilience research often links concepts like ecology and social resilience. The emphasis seems to be on socio-ecological resilience systems, which involves terms such as “*natural disasters resilience*”, flood and climate resilience and ecosystem resilience, among others alike. Research work including economic aspects are also present in urban resilience, but according to the authors words like economic recessions are directly associated to natural disasters, which is linked to disaster risk reduction. The need of local-context research in ecology might be interlinked with the common intra-urban oriented research work developed in urban resilience. Rogov & Rozenblat (2018) referred to as a ‘*lock in*’ in urban resilience studies, which generates new research questions about expanding research towards other levels (see also Meerow, 2017; Lee, 2018).

By a way of comparison, the foremost term used in regional resilience is *economy*, while other nodes representing climate change or ecological resilience although are present, they do not generate new clusters. As it was introduced in the previous section, employment is a critical indicator in regional resilience studies. Taking into account the latter indicator, is common to observe that regions provided data on jobs, aggregating the information in administrative boundaries. This facilitates the research work, and some scholars argued that this is one of the reasons to do research with this spatial approach (Martin, 2012b). However, we would argue that the explanations might have deeper roots as discussed throughout this dissertation. The data availability is indeed an important factor nevertheless, the interpretation of the spatial dimension by researchers working in regional resilience and urban resilience is often different. For example, the functional criterion of an urban system seems a more appropriate methodology to analysed employment for some scientists. These kinds of questions are related to the boundary problem it was discussed in section 2.1.1.

In an attempt to address some of the weaknesses of urban and regional resilience, Rogov & Rozenblat (2018) proposed a multi-level approach based on adaptive cycles and used the panarchy framework. The panarchy term was coined by Gunderson & Holling (2002) and is a notion in social-ecological sciences that refers to the multiple spatiotemporal scales and interactions across scales, which determine the functionality embedded in complex systems. According to the authors, the structural interaction across scales allows to connect adaptive cycles in a nested hierarchy. Within this theory, resilience is a fundamental variable that regulates the adaptive cycles of nested hierarchies in systems (Angeler et al., 2016).

The Figure 69A depicts the four adaptive cycles in complex systems, which are *growth (r) (also known as adaptation or exploitation)*, *conservation (K)*, *release (Ω)* and *reorganization (α)*. The diagram only shows three levels for pattern-process with spatiotemporal scale interactions for visual convenience. The connectivity depicted between the hierarchical scales is a contributor to resilient systems since shocks and negative effects in a determined scale can be absorbed by other scales in the system through feedbacks (Nash et al., 2014, Angeler et al., 2016). According to Gunderson & Holling (2002), panarchy the operating mechanisms of adaptive cycles are

³⁰ The ‘*multi-level perspective*’ proposed by Rogov & Rozenblat (2018) is not the same theoretical approach that has the same name proposed by Geels (2002,2005,2011, 2019), which was discussed in section 1.3, for reference see Figure 25.

categorized in three dimensions. Figure 69B displays these dimensions: i) *The inner capacity or potential of a system for change*; ii) *The connectedness level and the measure of flexibility or rigidity* and iii) *and resilience*, whose definition was proposed by one of the authors of panarchy theory (see Hollings, 1973).

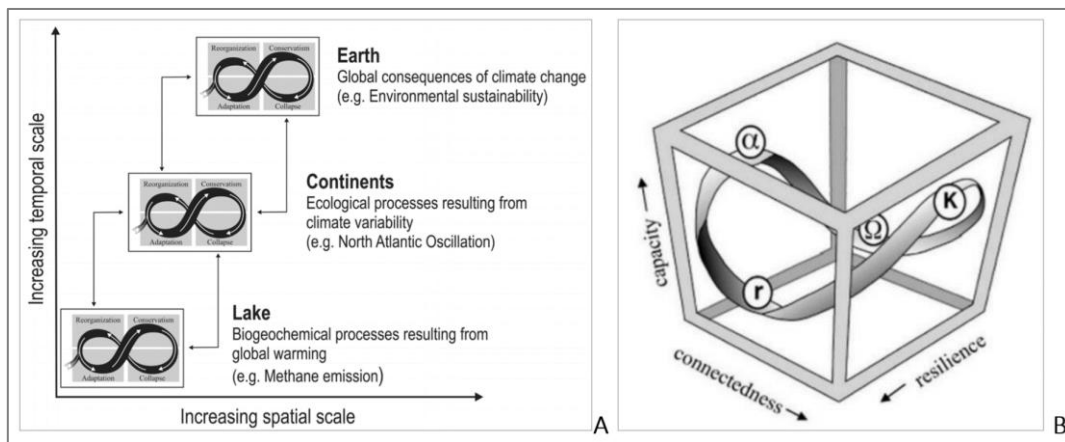

Figure 69A Diagram of Panarchy: Complex Systems Dynamics exhibiting adaptive cycles. Source: Angeler et al., (2016), inspired from Gunderson & Holling (2002). B) Representation in three dimensions of the adaptive cycle metaphor with respect to the three properties of systems. Source: Westerveld (2014).

The ecological conceptual idea on panarchy theory, resonates with the cohesive entity view of interactions between cities and systems of cities (Berry, 1964; Pumain, 2006, 2008) as discussed in section 2.1.1. Regarding cities' levels, Rogov & Rozenblat (2018) argued that under a network approach even though the same networks are observed at different levels, the processes that occur at micro, meso and macro levels are different (see also Rozenblat, 2010). These interactions trigger the emergence of new properties that characterize the city as a collective unit (Pumain, 2006). Rogov & Rozenblat (2018) claimed that one of the urban properties that emerge in such processes could be the resilience property, as a result of inter and intra exchanges and urban processes. The figure below shows a multilevel perspective of urban and regional resilience research in the Figure 70 (left), which is consistent with the emerging properties and organizational levels or urban networks proposed by Pumain (2008).

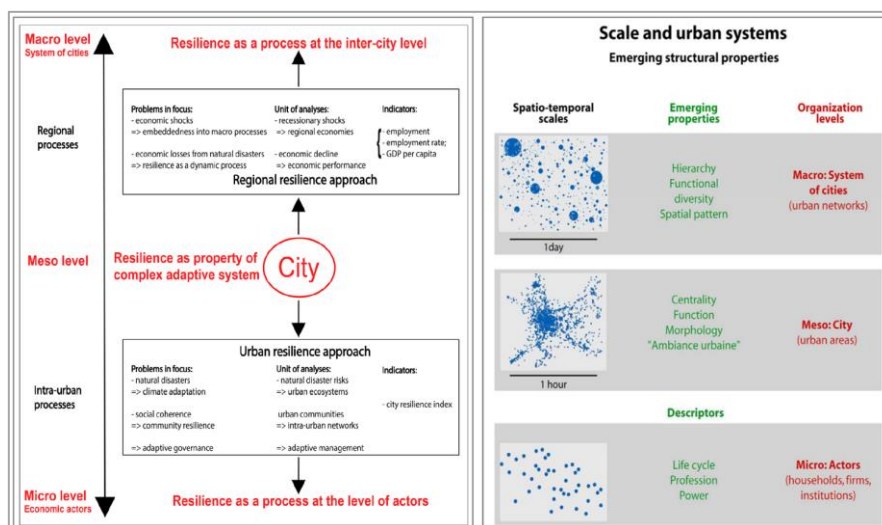

Figure 70 (Left). Urban and regional resilience research in a multi-level perspective. Source : Rogov & Rozenblat (2018). (Right). Urban scales, emerging properties and organization level. Source: Pumain (2008).

Parallely, as discussed in the section 2.1.1, this multi-level perspective is consistent with the constructive interactions between scales and urban systems also proposed by Pumain (2008), for reference see Figure 40. The author argued that the main difference of the research position regarding regional and urban resilience, is that the former considers a region as an open system which interacts with other systems at global scales. They carry out top-down analysis that are a major factor for economic analysis, which in return developed into the main instrument for regional resilience research. From a sustainability perspective, down-scaling methodologies in the same way is not accepted in the literature, and perhaps that is one of the reasons why sustainability is a secondary topic in such research studies.

Linking the concepts of resilience and sustainability from urban and regional perspective requires an important reflection. Both concepts take into account systems evolution, but resilience intrinsically takes into account shocks within the system and how the system improves from the disturbance. While sustainability does not focus on how disturbances could take socio-ecological systems to a more desirable state. Therefore, the operationalisation of theoretical frameworks for resilient and sustainability might be a combination of strategies and programs respectively. In other words, while resilient cannot be measured or looked at through traditional management tools, sustainability transition is more adapted to be measure and analysed with such methods. Sustainability has long terms goals, which involve different actors in social-ecological systems, decision processes and the advancements towards goals, while measuring the systems' performance. For instance, at micro level (organizations), the ISO have established the 14001 standards, which is a series of guidelines for environmental management systems.

There are other initiatives regarding social-ecological sustainability such as the sustainability reporting standard called Global Reporting Initiative (GRI), which intends to create transparency and accountability on organizations' environmental impacts. Currently there are several programs within the same line of thought but with different approaches few examples are The Principles for Responsible Investment (PRI) from the UN, Corporate Environmental Responsibility (CER) or the Green House Gas Protocol. This short list is not meant to be exhaustive but attempts to mention some of the protocols that deal with sustainability indicators, but none has a goal to deal with shocks as resilience does.

Hence, research on resilience and sustainability has a fine line, which is necessary to be kept as sustainable systems become more sustainable when they are more resilient. The inoperability of programs in resilience proves to be necessary in sustainability but a distinction needs to be emphasized when discussing both topics. Keeping in mind the similarities and differences between resilience and sustainability, research on a multilevel perspective involving urban and regional resilience is a promising research path. It is aligned with diverse and prior research development formulated in this research work. Rogov & Rozenblat (2020) presented the multi-perspective approach where the micro, meso and macro levels are analysed from both perspectives, urban and regional resilience. The argued that the intra-urban and cross-scale processes are tailored through the adaptive cycles. Whose development would equip urban systems to oppose to vulnerability, cope with change and reinforced the system.

The state-of-the-art regarding this approach is at theoretical level, which needs to be reinforced with further research including empirical approaches. The combination of both, urban and regional resilience and sustainability is a research direction that could improve our understanding but certainly will increase the complexity. Added to this, the spatial dimension could also improve our understanding but will also increase the degree of difficulty to both, model and interpretate empirical research. It is important to add, that the combination of approaches has a big potential, but it is required to not ignore the dangers when multiple approaches are superposed. The trade-offs of simplicity and complexity in modelling approaches are an important as both extremes would slowdown scientific progress.

In summary the research development of resilience and sustainability transition have a mainstream research relying on urban resilience studies, where socio-ecological systems are more studied than in regional resilience studies. A second major paradigm in ecology is coupled with resilience, where the same author Holling proposed the panarchy theory years later to develop an explanation of natural systems and humans, where the key aspect are adaptive cycles. As mentioned above, the improvement of our understanding in complex system is a cornerstone of urban resilience and sustainability research and more research is still needed. Within the scope of this research work, we focused on the urban resilience approach however, economic data is used in an empirical model under a network approach, which will be discussed in the next section.

2.3.5 Sustainability Transition: A Theoretical Review on Multiscale Modelling of Urban Resilience Under a Network Approach.

Innovation and resilience have extensively been discussed in the literature however, the relation between them has been less studied from a modelling perspective in urban environments. Innovation systems and resilience are two complex notions by their own right, therefore we tried to somehow simplify the study of the interaction of these two concepts under the same umbrella: network theory. With this research direction, we attempt to narrow the scientific gap from a modelling perspective.

The methodological approaches chosen in this research are meant to be used not only for sustainability purposes but to unveil the inner properties of innovation, which opens the possibility to apply this model on other innovation indicators as well. The inclusion of the spatial dimension is aligned with the increase usage of geo-referenced data in research and technology, which gives the field of geography an important role in the innovation scene. In spite of the fact that the spatial component has proven to be neglected, its relevance has gradually been acknowledged within innovation ecosystems research. These premises are then used to model a system where resilience is studied under graph theory. The underlying conceptual and practical purposes in this study are to develop a tool capable to identify and measure changes in the system represented in a network. The richness and capabilities of network science open possibilities to better understand spatial change and the impacts embedded on a RET diffusion process. Unquestionably, we cannot predict spatial change and social reorganization without uncertainties nevertheless, network models can contribute to better understand those changes.

The incorporation of socio-economic and environmental aspects on innovation are meant to make cities more resilient, capable to cope with change and adapt to new states and a dynamic equilibrium fashion. To do so, preparedness plays an important role, since not all places and locations are equally equipped to integrate disturbances either from innovation or hazards. Therefore, we argue that the capacity of a place or a location to cope with positive or negative changes are not isotropic. The underlying idea of the '*regional receiver and development competence*' notion proposed by Lundquist & Olander (2001) making a reference to innovations could be at some extent linked to resilience. The idea is that that competence refers to the capacity to deal with change, which in the case of innovations is perceived as positive shocks. But in the case of resilience, regions are also confronted to changes of other nature such as hazards or interruption of innovation diffusion, which would be negative disturbances.

For example, the interruption or the slowdown of RET diffusion as it was discussed earlier (see also Negro et al., 2012) seems to be strongly rooted on the systemic character of innovation systems. The different factors embedded in the interruption process even though are not completely understood and how they operate, or it is difficult to quantify them, it is possible to see their effects on the space. As a reminder see Table 9 and section 3.2

in general, where we discuss the different factors interrupting the RET diffusion process, which are listed however, the interaction between them is not fully understood. A spatial perspective on the subject could improve our understanding about how the dynamics of RET diffusion and diffusion interruption could interplay. The intertwines between innovation and resilience analysed from a spatial standpoint and under a network theory enable us to simulate possible 'scenarios' with RET diffusion. Network modelling let us observe and analysed the changes in macro and specific parameters. Just to name some of the summary statistics regarding a network are its degree, average degree and degree distribution, diameter average path length, cliquishness, cohesiveness, and clustering. The observation in such parameters coupled with spatial statistics analyses seem to be an appropriate methodology to study the topology of the spatial and social-economic RET network. For this research as it will be developed in Chapter 5.5.3, the spatial diffusion of RET is modelled via a network with scale-free topology. In this research, the focus is given to the spatial consequences derived from shocks to the spatial diffusion process of RET.

From an empirical point of view, a way to apply a quantitative approach and operationalise the resilience concept to the spatial diffusion of RET is through the self-organized nature of scale-free networks. As it is thoroughly demonstrated in Chapter 5.5.3, RET spatial diffusion follows a hierarchical and multi-level structure, displaying a fractal phenomenon. The characteristic scale-invariance of the adoption of these technologies implies from a network standpoint that some specific locations are hubs of the diffusion process. These hubs, that can be characterized as spatial units with multiple connections and a high distribution degree, are fundamental agents to keep going the diffusion process at the observed levels. Those spatial units have a value that is a composite indicator containing socio-economic, RET and spatial information. Consequently, information on the behavioural characteristics of these hubs can be used as KPI's that account for the network's resilience and capacity to adaptation to change from a sustainability transition point of view.

Indeed, we suggest that such approach can offer valuable information since it would be possible to simulate and change different parameters of RET diffusion processes. For example, a spatial unit of 600 sqm labelled as the major hub of RET diffusion can be affected by a systematic (simulated) reduction of RET density. This would affect the composition of the network however, since we are observing a self-organized system, the new composition of the network would generate a new hub. The interesting information behind this operation is to observe where the new hub will be located and how it will affect the new neighbouring spatial units, as a different preferential attachment processes would occur.

In this context if we observe the phenomenon through the lenses of Hägerstrand's views, the potential fields of innovation need to keep the necessary strength for a period of time long enough in order to keep the diffusion process. If the network is capable to adapt within the new configuration that might include new spatial conditions, we could say that such network is resilient. The simulation performed in the canton of Valais-Wallis in Switzerland, showed a spatial diffusion process of solar PV for heating and hot water. The detailed explanation of the simulation is explained through sections 5.5.3, Chapter 6 and an application of resilience modelling is done in Chapter 7.

The resilience model is based on interacting spatial units, which contain raster values that are the result of a composite indicator built with socio-economic data under an ABM approach and solar PV kernel densities. Those values were affected by '*attacking the network*' through the removal of spatial units with the largest values, therefore the network loses its hubs. This represents a slowdown in the diffusion process and the subsequent reorganization of the network plays a central role in the analysis.

The findings in this study suggest that the RET diffusion process might be resilient at global level however, a bifurcation could occur at local level, taking local elements towards another equilibrium point. In the context of this research work, the goal was to observe the possible spatial reorganization of the diffusion process within the network and to analyse if a '*normal functioning level*' would take place. Under this view it is possible to verify that

the new configurations keep showing a fractal phenomenon therefore, new hubs would appear, keeping higher degree distributions within the network structure. This means that the scale-free topology is kept.

Self-organization seems to be at the intersection of RET spatial diffusion processes and urban resilient systems. Resilient systems are self-organized however, the findings suggest that resilience *itself* is not self-organized. As it will be developed in Chapter 7 there is scale variance when the diffusion network suffers shocks. An important distinction is required to be done regarding the main implications of such behaviour. It appears that while resilient systems are self-organized, therefore fractal, it does not imply that resilience itself is fractal. Findings in this study show that urban resilience to RET diffusion is not fractal since self-organization, absorption and adaptation processes are seen at global scale, it is still possible catastrophic consequences at local level. Although we will not directly apply catastrophe theory³¹ in this research as it is not within the scope of this research work, we observe a dual behaviour concerning RET diffusion at global and local levels.

The idea that resilience is not fractal was already proposed by French economist Olivier Godard (1996), we will revisit this conceptual approach in Chapter 7 through prism of resilience modelling. The main question is thus, the resilience and vulnerabilities from a spatial scale perspective, where local levels remain the most vulnerable to hazards. Within the context of climate change Voiron-Canicio & Fusco (2020) argued for example, that the global atmospheric studies carried out by the IPCC (2007) used downscaling methods on lower levels. Even though such models are rapidly improving, the climate data derived from such forecasts is not very accurate at local levels. This happened in spite of the fact that geographers have demonstrated that the spatial variability of climate is present on geosystems since as a while ago (see Yoshimo, 1975; Bonnardot, et al., 2012; Quenol, 2013). The reasons are that a local-scales, geosystems are affected by factors such as land-use and topography issues. As for the flora, the microclimatic variability in geosystems can also allow species to persist locally even if analyses at larger scales would suggest otherwise (see Engler et al., 2011).

The interruption of RET diffusion seems to be a relevant risk in the sustainability transition context. The analysis of RET spatial diffusion robustness via network science has been the chosen methodology since it allows to analyse the interaction embedded in discrete data. The choice of RET as innovation indicators has been motivated by the urgent challenge posed by global warming and the need to develop new approaches to contribute to meet environmental needs. Thus, a resilience analysis on a network could be performed for example once or twice a year³² and spatial changes on the RET diffusion phenomenon can be identified and analysed. As it will be further discussed in Chapter 7, a complementary advantage of this approach is the removal of social and physical barriers including artificial boundaries such as administrative borders, which has been a critic to regional resilience studies. In this regard, a network approach is a powerful able to account for and elucidate potential risks embedded in the robustness of RET's networks and administrative boundaries or functional criteria could be applied.

Regarding the note on data availability relying on administrative boundaries, it will be presented in Chapter 5.5.3 a gravity model based on ABM and SD, which was used to determine the population at a 100 sqm resolution. In the case of European countries, an increase of georeferenced data has been witnessed the last year however, the data often has privacy constraints, which makes difficult to do some kinds of analysis. Nevertheless, today it is

³¹ There have been theories and mathematical approaches to describe and explain the behaviour of dynamic systems that might have multiple equilibrium states. French mathematician René Thom for example proposed the catastrophe theory (Thom, 1972), which originally described the dynamics and evolution of forms in nature. Thom initially worked in semiotics and linguistics in the 1970's, where he found an application of graph theory to grammar. Basically, his idea was that the centre of a sentence is composed by a kernel, which is represented by the verb and it is surrounded by lighter agents such as nominal phrases and nouns (see Wildgen, 1995). The theory has been broadly accepted by scholars and was popularized by Zeeman's work in the 1970's. As a consequence, the concept has been applied in different disciplines, ranging from classical physics, mathematics, biology to engineering, sociology, archaeology, geography and music among other fields. As a scientific exercise, this theory has been controverted and defended (see Zeeman, 1993; Wildgen, 1995). Urban modelling applications were proposed by Casti & Swain, 1975; Wilson, 1980). It is worth to note that catastrophe theory resonates with the theory of self-organized criticality (Bak et al., 1987).

³² The data is released once a year in Switzerland and every two years in France.

possible to deal with these obstacles thanks to *i) state-of-the art regarding methodological approaches for modelling; ii) the steady increase of data availability and iii) current computational capacity.*

An important aspect that is relevant to highlight is that spatial network resilience is a conceptual instrument that can be used to face risks therefore the capacity to anticipate crisis has consequences for planning and policy. For instance, the self-organized nature of RET diffusion could have an eventual structural change, where new the network's topology or degree distribution could provide insights at risk or stress levels. Therefore, a following-up of structural spatial changes would help to arrange and adapt policies to keep RET diffusion levels with positive and incremental growth rates. In terms of practical tools, the Geoprospective approach has developed different methodologies. For example, Voiron-Canicio & Fusco (2020) discussed a theoretical approach in this direction where the adaptive capacity of a territory is detected.

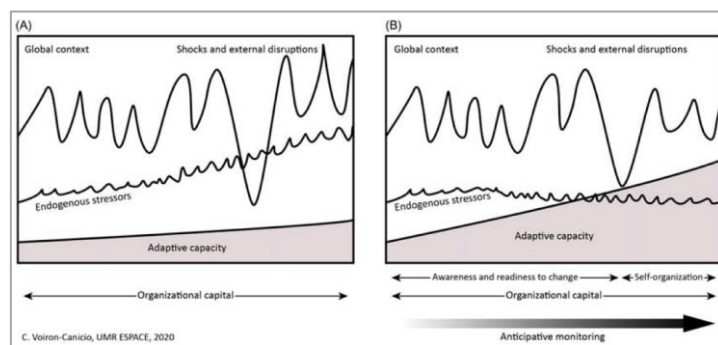

Figure 71 Relationship between adaptive capacity to shocks/stressors and organizational capital: (A) weak organizational capital and (B) strengthened organizational capital. Source: Voiron-Canicio & Fusco (2020).

Resilience thinking is in line with preparation for uncertainty and unexpected future events, which is an opposite view to the way of thinking in the 1960's and 1970's where scientific advancements were expected to systematically solve future problems in an 'optimistic planning' way (Bonß, 2016). Paradoxically, in spite of the broad usage of GIS in the field of risks studies, it has often been relegated to secondary tasks such as the spatialisation of vulnerabilities (November et al., 2008; Lhomme, 2012).

As for contributions to resilience studies with explicit applications of the spatial dimension, Dutozia & Voiron-Canicio (2018) discussed urban resilience to risks in the context of climate change. Lhomme (2012) worked on resilience via networks topology. Serre et al., (2012) introduced the territorial dimension in resilience towards risks. Fusco & Venerandi (2020) have developed contributions within the field of morphological resilience. In the next section the subjects of RET diffusion and resilience will be narrow down and a network approach is proposed for methodological purposes since it allows to simulate both diffusion and resilience with an explicit integration of the spatial component. Loubier (2020) worked through the geoprospective prism using a multiparadigm simulation approach in the canton of Valais-Wallis linking tourism with climate change. An extensive production of literature in resilience has been produced by the Resilience Alliance organization³³

In summary, scientific researchers in resilience and sustainability are heading towards integrative approaches under the umbrella of complex systems. These new research directions involve various methodological paths, in which the spatial dimension is gaining ground as a fundamental component of resilience analyses. The research on regional and urban resilience have historically focus on different domains, the former in the link between economic growth and recessionary shocks and the latter on more socio-ecological systems. Additionally, the spatial dimension is not used in the same way in regional and urban resilience research however, there are recent

³³ Available online at <https://www.resalliance.org/about>

proposals of approaching both topics with more integrative spatial methods. By doing so, the combination of both research directions would be more consistent.

2.3.6 Overview of Research Questions

This doctoral dissertation is at the intersection of innovation diffusion, sustainability and urban resilience. The interdisciplinary composition of this research has obliged us to do an extensive introduction of different fields with the aim of positioning the research subject within the literature. Innovation diffusion has been studied with the lenses of network theory (Jackson, 2008) as well as urban resilience (Lhomme, 2012; Voiron-Canicio & Fusco, 2020). This theoretical and methodological proximity has allowed us to study innovation diffusion and resilience under the umbrella of network science. This approach coupled with GIS techniques has been extensively used in a broad set of applications in geography, for example in the study of urban morphology (Araldi, 2019), knowledge, transportation and distribution of goods amongst others.

A special attention is given to the spatial component and as it was stressed in the two previous chapters, the interdisciplinarity nature of innovation, sustainability and resilience studies opens new research directions for geographers. The approaches on both, regional resilience and urban resilience or the views of the spatial dimension by economic geographers and quantitative geographers do not mutually exclude each other. Contrary, those approaches are complementary and the open new opportunities of scientific collaboration among geographers from various backgrounds. This research project emphasizes on the regions' receptivity to sustainable innovations and their resilience to adopt these innovations. The research aims at understanding regional ability to integrate changes into their dynamics such as RET adoption. To do this, the theory of DOI is coupled with the concept of urban resilience.

The spatial anisotropic nature of innovation diffusion, sustainability transition and urban resilience coupled with the multi-level mechanisms from spatiotemporal standpoint of such phenomena, generate different scientific questions. Here, three research questions are outlined:

1. **Can demographic, economic (jobs distributions) and spatial information provide some insights to better understand the network effect of adoption and diffusion of renewable energy technologies?**

The hypothesis underlying this question is that the combination of spatiotemporal distributions of demographic and economic (jobs) provides information of hidden patterns of spatial interaction mechanisms embedded in renewable energy technologies diffusion.

2. **The network effect of diffusion of renewable energy technologies does follow a preferential attachment from a spatial and temporal perspective?**

The hypothesis underlying this second question is that innovation diffusion does not follow a random distribution from a network perspective. The degree distribution of a spatial network might follow a power law, showing signs of fractality and self-organization.

3. **Are places and locations with higher levels of innovation more resilient to energy transition than less innovative locations?**

The hypothesis for this question is connected with the previous research question and its subsequent hypothesis. By definition resilient systems are self-organized therefore, if the hypothesis above of self-organization is verified, the hypothesis for this question is yes, more innovative places are more resilient to renewable energy diffusion.

With the aim of answering these questions, different approaches have been used to address different scientific challenges that came up while building the model developed in this PhD dissertation. This research work is fundamentally based on quantitative geography with a special focus on spatial analysis techniques. Nevertheless, the epistemological approaches developed before the practical usage of GIS and geospatial tools, are based on theories derived from different disciplines sharing similar lines of thought. Therefore, from an epistemological point of view this research is intended to be aligned with the views on innovation from the following perspectives: *i) Quantitative and Theoretical Geography ii) Economic Geography and iii) Economics*. Furthermore, the research on resilience has a focus on urban resilience however, some insights are proposed to develop its applicability to regional resilience studies from an empirical standpoint in order to create bridges across disciplines.

Figure 72 illustrates the interdisciplinary nature presented in this research, which will be thoroughly developed and explained in the methodological section. The methodology is the result of an approach based on the review of the current state-of-the-art. In this research we focused on RET as innovation indicators since the contemporary shift of innovation regarding environmental challenges is a central topic today.

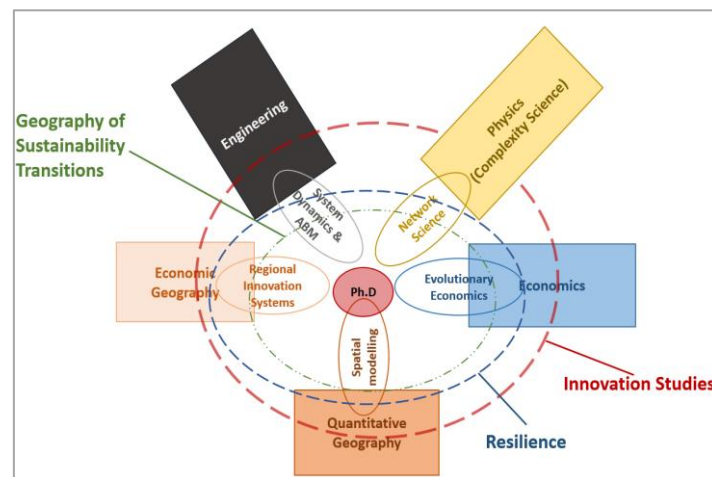

Figure 72 Interdisciplinary scientific position of the doctoral dissertation.

The methodological approach responds to recent suggestions from scholars to emphasize on multi-level studies on geography of sustainability transition (Hansen & Coenen, 2015; Garbolino & Voiron-Canicio, 2020) and urban on resilience (Rogov & Rozenblat, 2018; Voiron-Canicio & Fusco, 2020) from an empirical viewpoint. The current shift of innovation policy regarding environmental challenges is a central topic today and this is an opportunity for geographers to contribute to the scientific discourse of innovation and sustainability transitions. The presence of complex systems with spatial effects in phenomena such as innovation diffusion, sustainability and resilience are fields that scientifically fit the core of geographers' knowledge. Additionally, the problem of the connectedness of DOI with urban resilience seems to have received little attention in empirical studies within the field of geography and there is still a big knowledge gap, especially with sustainable innovations.

The diffusion of RE has been rather slow (Negro et al., 2012) and given the relevance embedded in the catalysis of RE adoption we intend to better understand the underlying properties in the diffusion process from an urban perspective. The RE diffusion is a critical topic not only in science or from a policy perspective but for the society as a whole therefore, advancements in the subject are utterly needed as energy is present in all urban and economic activities, in socio-technical systems such as transportation, housing, food, electricity and heat. The adoption of RET constitutes a major innovation diffusion process within the sustainability transition. This process involves a lot of variables at social, economic, cultural, technological and urban levels. The alignment of all these variables in socio-technical systems implies at high complexity level of favourable conditions so the four conditions of spatial diffusion proposed by Hägerstrand (1952, 1953) could take place. The additional issue regarding RET is

the time constraint. As it was extensively discussed in the first chapter, innovation today it is not only about growth anymore, actually the diffusion of RE are one of the very innovations targeting the environmental challenges.

Analysing the endogenous ability of regions to generate a larger and faster absorption of sustainable innovations within their urban dynamics, will provide useful insights within the framework of the sustainability paradigm. As discussed before, innovation is a dynamic phenomenon that generates cyclical upswings and downswings over the course of time. These waves do not occur in an isotropic manner from a geographic perspective, and this differential distribution of ability across space puts regions in different contexts at urban and socio-economic level. The different distributional adoption of RET across space is a topic although important, relatively little studied from an empirical standpoint. This is explained in part by the unavailability of relevant and suitable data providing potential meaningful insights on the subject nonetheless, this limitation is rapidly decreasing in advanced economies. In the framework of this research, we have implemented a socio-demographic and spatial analysis of RET adoption in two different regions, in the canton of Valais in Switzerland and the South Region in France.

The objectives of this research are oriented in both, basic and applied research. The methodological approach must therefore be reproducible in other regions and other themes, which justifies developing the research across borders in two different regions. Relevant geographic, social and economic differences exist between the two regions so, the goal of this research work is the construction of a general model able to explain the underlying dynamics in RET urban adoption process that will provide theoretical insights on spatial diffusion processes of sustainable innovations in relation with the territory's resilience. The development of urban networks and the diffusion of technologies within these networks are not solely based on economic principles. Indeed, we have the assumption that the spatial adoption of RE is a complex process where elements from different socio-technical complex systems feed the phenomenon in a nonlinear way. Some of these systems are related to population, place attractiveness, spatial structures, jobs, geographic accessibility among others.

The disentangling process of the nonlinear interplay mechanisms between all these variables coupled with the preconditions and regional legacy of territorial capacity to will partially determine the ability to adopt innovations. This process is accompanied with the absorption, development, implementation and integration of innovations into the regional socio-technical systems might help to better understand the dynamics of RE urban adoption. This process is characterized by horizontal spatial relations that are not well documented in the specialized literature from an empirical viewpoint. It has been found that scientific contributions focus on the geography of niche development rather than in regime dynamics, and that there is a consensus on understanding the importance of place-specificity at the local level. While there is a wide consensus that place-specificity matters there is still little generalisable knowledge about how place-specificity matters for transitions (Hansen & Coenen, 2015).

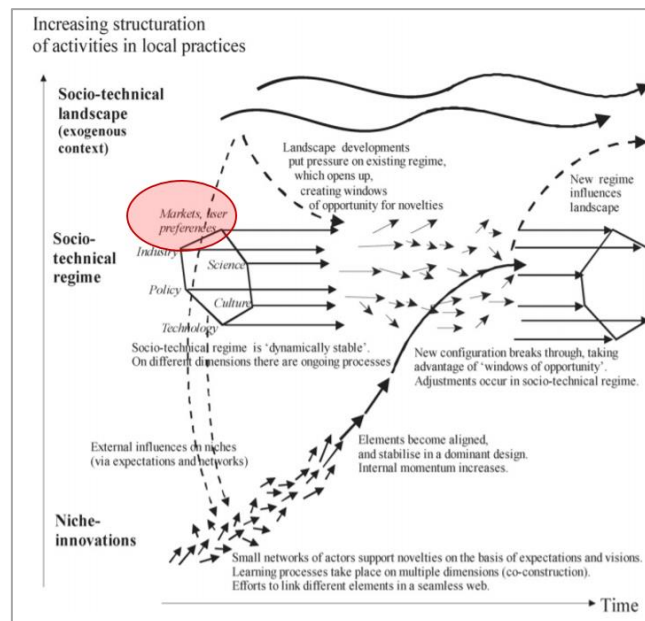

Figure 73. Research position on Geel's model of Multi-Level Perspective.

Most contributions add spatial sensitivity to frameworks from the transition literature, but few studies suggest alternative frameworks to study sustainability transitions. To address this, the review suggests promising avenues for future research on the GST, so we intend to contribute to fulfil this gap by proposing an empirical approach that could be applied to different kinds of regions.

2.4 Conclusion Chapter 2

In this section we have discussed different urban dynamics models ranging from neoclassical approaches such as the Bid Rent Theory, industrial location, the central place theory, gravity models. In the 1980's and 1990's new approaches emerged such as the geography of innovation, the French school of proximity, innovative milieu, clusters and the multiple helix approaches. The evolution of such methodological streams has been accompanied by other fields which also happen to be paradigms for example system dynamics in the 1960's and later agent-based modelling. The arrival of behavioural approaches has boosted the amount of research work in urban modelling where network science and specifically scale-free networks is a topology that has gained momentum. The underlying theoretical approaches in urban modelling were also discussed through the prism of sustainability transition. In this context, a discussion on the resilience concept is developed, analysing the etymological origin of the word and the different usages in physics, ecology, economics and geography. As well as a parallel between regional and urban resilience is developed, in which an adaptive resilience seems to be adopted in the two streams. The concept of panarchy is integrated in the framework of urban resilience studies through the prism of sustainability. Finally, the research position of this Ph.D is discussed and the research questions with the respective assumptions are addressed. The next chapter will introduce the two territories of study in both, Switzerland and France and the rationale of the choice of energy transition as a research subject.

3 Study Area and Data

An important aspect in modelling is the replicability of the constructed model in order to draw comparisons and possibly produce generalisable knowledge. In an attempt to contribute with scientific evidence on the RET spatial diffusion mechanisms and the urban resilience to these innovations, two regions were chosen in order to apply the same model. In Switzerland, the alpine canton of Valais (in French) and Wallis (in German) is one the territories analysed, depicted in the North-east of the figure below. The second territory is the South Region of France formerly called in French *the Région Provence-Alpes-Côte d'Azur (PACA)* and currently *Région SUD*, which is displayed in the South.

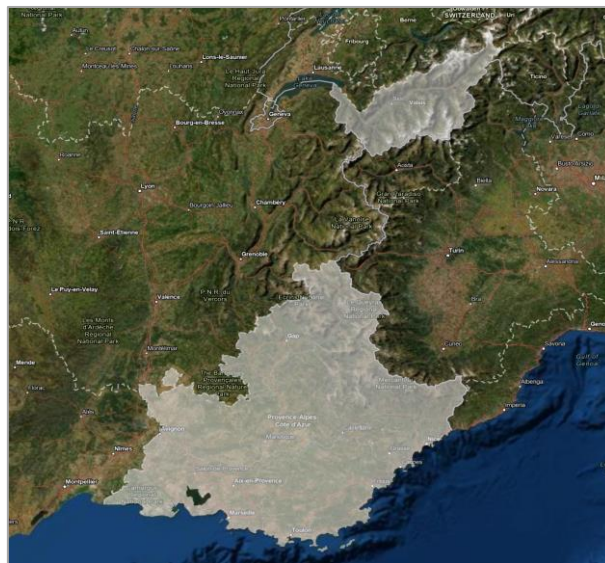

Figure 74 Studied regions: South Region of France and the canton of Valais in Switzerland. Generated with Arcgis Pro, 2021.

The objective is to apply the same model in two territories that have different social, economic, geographic, political and historical conditions. Implicitly, the legacy and pre-conditions for innovation diffusion and sustainability transition are not the same. Furthermore, in the French territory the analysis will be done from a supply perspective (energy production) and in the Swiss territory the diffusion of RET technologies will be analysed from the demand perspective (RET adoption). Therefore, the model will be applied on the two sides of the market.

3.1 Urban and economic context in the Swiss region: the canton of Valais-Wallis

In this section we will develop an overview of demographic, economic, environmental and geographic aspects of the area of study in Switzerland. This information will allow the reader to get a big picture of the area before entering the topic related to renewable energy issues.

3.1.1 Demography

The canton of Valais-Wallis is located in the South-West part of Switzerland. Economic and geographic studies of the region often divide the canton of Valais in either two or three main regions. Some authors divide it into lower and upper Valais, and others include central Valais. According to the Cantonal Statistics Office of Valais (CSO, 2017)

the canton's population was 341.463 on the 31st of December 2017. The gender balance is almost fully symmetric, with women making up to 50.46% of the population and men 49.54%. The population of Valais mainly lives in agglomerations, and more than half of the population lives in the fifteen most densely populated municipalities in the canton. Of these fifteen municipalities, three are located in the Upper Valais, five in the Lower Valais and seven in central Valais. Central Valais is the most densely populated region with 40% of the population of Valais, followed by Lower Valais, with 36%, and Upper Valais with 24%. Figure 75 shows the kernel density (A) and a hot spot analysis (B) of the canton of Valais, which shows a high concentration of inhabitants in the municipalities in the Rhone valley. More precisely, almost 70% of the total population lives in the plain (Canton of Valais, 2018).

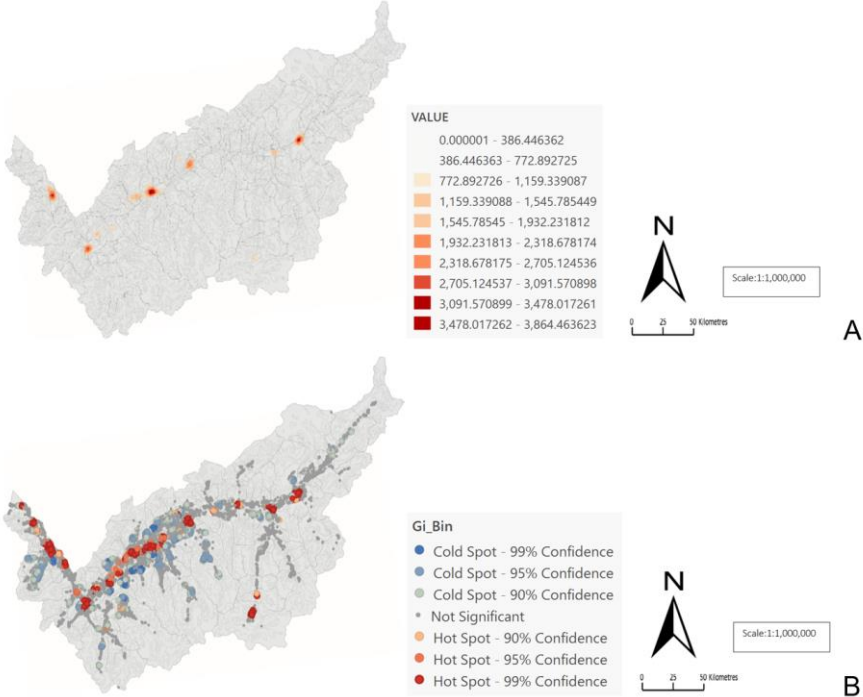

Figure 75. A) Kernel Density of the Population in Valais in 2017, analysis at 100 sq m resolution. B) Optimized Hot Spot Analysis of Population in Valais 2017, at 100 sq m resolution. Data source: FSO (2018), generated with ArcGIS Pro.

According to the Valais Health Observatory (VHO) in the coming years, according to the CSO's average scenario, the number of permanent residents in Valais should increase by 12% between 2017 and 2040, to reach 373,647 (VHO, 2018). This value is however below the forecasts done by the Swiss statistical office and the model performed in this dissertation which are 421.137 and 401.547 inhabitants respectively (see section 5.2.3). The increase in the population will come from natural growth coupled with a positive migratory balance. The average natural increase in the population over the last 10 years is lower than the average for the period 1991-2017 of more than 200 residents. Conversely, the 10-year average of the international and inter-cantonal net migration is higher than the average for the period 1991-2017. The 10-year average includes almost 4,000 new arrivals, compared with just over 2600 since 1991. Until 2000, Valais even experienced years with negative net migration (CSO, 2018). Residents from other cantons and other countries therefore show a definite interest in the canton of Valais. However, it is important to note that, since 2013, population growth has been less steady. This is mainly due to a sharp decline in net international migration (CSO, 2018). In Chapter 5 a gravitation model is developed in order to calculate the population's dynamics.

3.1.2 Economy

The figures available for calculating productivity in the primary sector in the Valais-Wallis do not allow an in-depth analysis of the branches of activity that make up the primary sector.

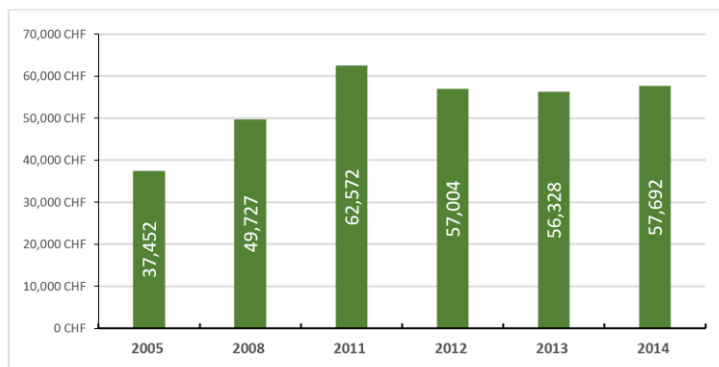

Figure 76 Evolution of the productivity of the primary sector in Valais from 2005 to 2014. Nominal Gross Value Added divided by the number of full-time equivalent jobs (FTEs). Source: CREA, 2017; FSO, 2018.

Thus, agriculture, forestry and fishing are grouped together in the available statistics. However,) It is worth noting however, that according to the FSO (2018) this is the sector with the greatest volatility, both in terms of productivity and Gross Value Added (GVA). The figure below shows the evolution of different industries from the secondary sector. From the outset, it appears that the production and distribution of electricity and water were the most productive branches in Valais-Wallis until 2013. The economic branch comprising the chemical, pharmaceutical, coking and refining industries became the most productive branch of the Valais secondary sector in 2014. This is followed by four branches which are at least half as productive. These four branches thus weigh on the sector's productivity for around 60% of FTEs and between 52% and 58% of the sector's GVA. Conversely, the production and distribution of electricity and water accounts for between 13% and 16% of the sector's GVA, whereas it employs only 7% of the sector's FTEs (CREA, 2017; FSO, 2018). It is interesting to note that the two most productive industries in the secondary sector are also the most productive industries across all sectors.

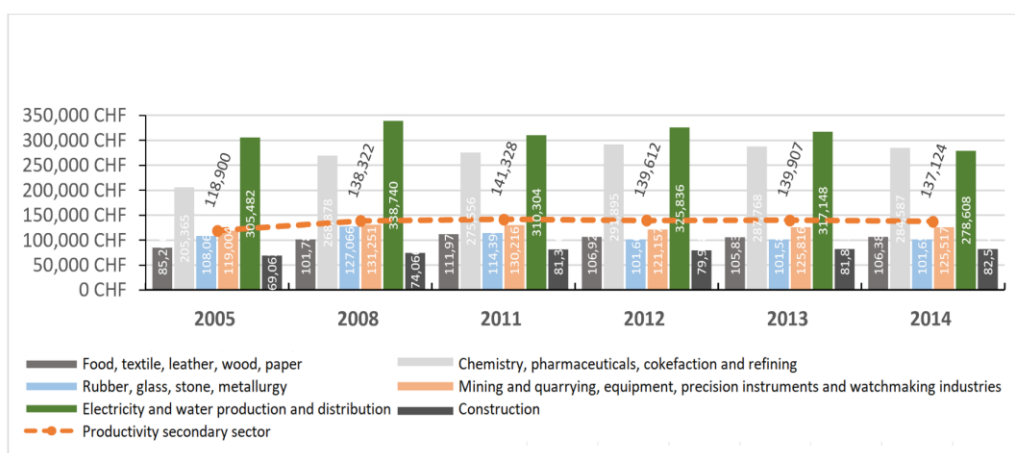

Figure 77 Productivity trends in the Valais secondary sector and its branches of activity from 2005 to 2014. Nominal GVA divided by the number of FTEs. Source: (FSO, 2018)

The tertiary sector has the highest GVA. Nevertheless, its productivity suffers from the large number of FTEs it uses. The secondary sector uses 2.47 times less EFA than the tertiary sector for a GVA 2.26 times lower. This explains the lower productivity of the tertiary sector.

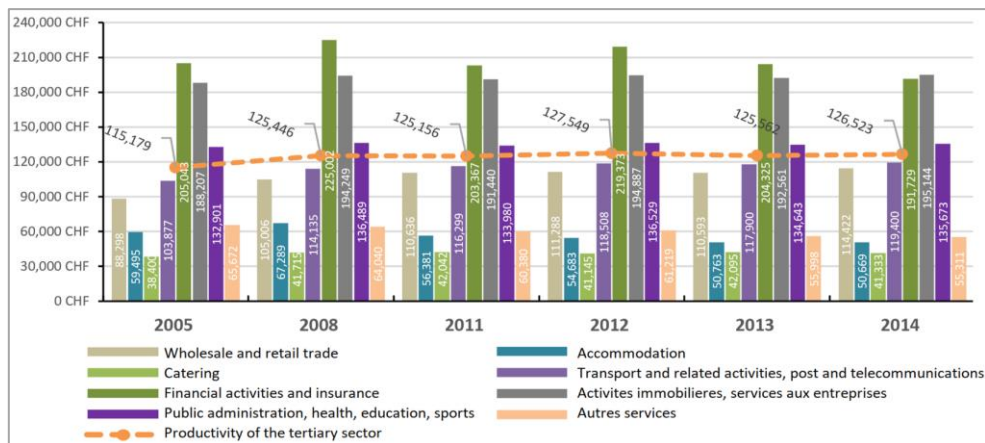

Figure 78 Productivity trends in the tertiary sector and its industries from 2005 to 2014 (CREA, 2018; FSO, 2018).

In the tertiary sector, three branches are the most productive: financial and insurance activities; the branch combining real estate assets, business services, specialised activities and rental value; and all activities deriving from public services such as administration, health, education, among others. These three branches exceed CHF 130,000 per capita in productivity. Tourism is a major contributor to the GDP, Perruchoud et al., (2016) developed an economic geographic study focusing on the added value of tourism in Valais. The analysis showed that it represented 14.5% of the added value in the region, that is CHF 2.39 billion out of 16.5 CHF billion of the canton's added value in 2014. The tourism sector represents around 18.6% of FTEs jobs in the canton, which makes tourism a major player in the regional economy. The region's well-known ski resorts such as Zermatt, Verbier, Crans-Montana, Saas-Fee among others are major drivers for the tourism economy.

The map below corresponds to a Silverman's smoothing (Silverman, 1986) of a GDP distribution simulated in order to visualise the areas of wealth production in the canton of Valais, Switzerland. The peaks in blue represent the areas with the highest GDP levels. This map is interesting because it gives a better picture of the reality of wealth production by eliminating a bias of over-representation.

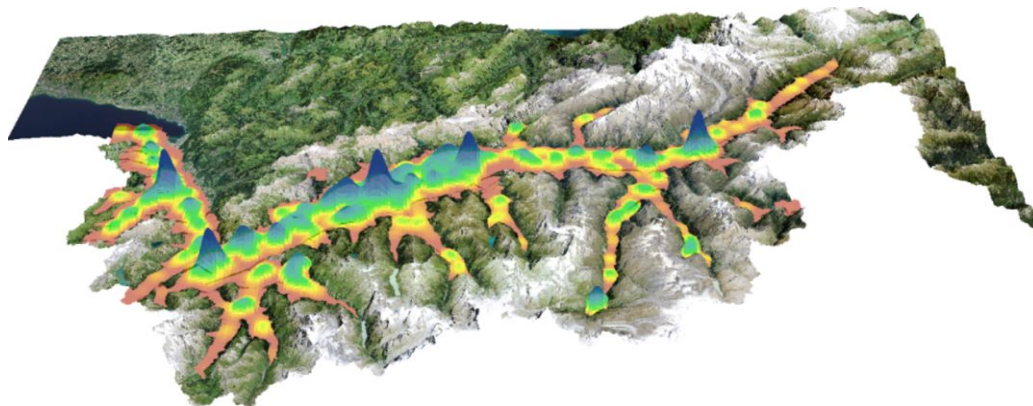

Figure 79 3D Mapping of the GDP for the canton of Valais in 2016, 3D isometric view of 45° at a 100 sq m resolution. The blue peaks should be understood as high intensities of GDP production.

The process followed to build the map below was the following: a longitudinal analysis of the GDP growth in Valais from 2012 to 2015 was developed, following the GDP per capita revision proposed by the FSO³⁴. All the procedures regarding the population are thoroughly described in section 5.4.5, which is based on the work

³⁴ Available in French and German at: <https://www.bfs.admin.ch/bfs/fr/home/statistiques/themes-transversaux/mesure-bien-etre/indicateurs/pib-reel-par-habitant.assetdetail.350183.html>

of Kunte & Damani (2015) where the spatial distribution of the population was calculated by age groups. Then, the results were integrated in the GDP per capita model proposed by the FSO:

$$\underbrace{\left[\frac{GDP}{Pop_{tot}} \right]}_{\text{Growth of GDP percapita}} = \underbrace{\left[\frac{GDP}{EWH} \right]}_{\text{Hourly productivity growth}} + \underbrace{\left[\frac{Population_{employed}}{Population_{active}} \right] + \left[\frac{Population_{active}}{Pop_{age(15-64)}} \right] + \left[\frac{Pop_{age(15-64)}}{Population_{total}} \right]}_{\text{Growth in labour input per capita (Effect of the use of labour)}} \quad (3.1)$$

According to the FSO, these ratios are defined as follows:

$$\left[\frac{GDP}{Pop_{tot}} \right] \text{ represents the GDP percapita} \quad (3.2)$$

$$\left[\frac{GDP}{EWH} \right] \text{ EWH stands for Effective Working Hours and the ratio of GDP to EWH is the hourly labour productivity in the territory of reference} \quad (3.3)$$

$$\left[\frac{Population_{employed}}{Population_{active}} \right] \text{ This is the unemployment effect, which is the ratio of employed population to the total employable population} \quad (3.4)$$

$$\left[\frac{Population_{active}}{Pop(15-64)} \right] \text{ The participation rate in the labour market is the ratio of the working population}^{35}. (Population_{active}) \text{ to the permanent resident population of working age (between 15 and 64 years old)} \quad (3.5)$$

$$\left[\frac{Pop(15-64)}{Population_{total}} \right] \text{ The share of the working age population in the total population} \quad (3.6)$$

The limitations of this model are related to data availability regarding the EWH which is only calculated at the national level in Switzerland, accounting for 32.1 hours per week in average. When doing a global comparison of the GDP at cantonal level with the actual data, this simulation showed an error of 0.59% for 2015 and the highest error was for 2014, reaching 3.9%, see also Loubier (2020).

3.1.3 Nature, Climate Change and Spatial Planning in Valais

Valais covers an area of 522,442 km², making it the third largest canton in Switzerland. Its geographical configuration makes a large part of its territory unsuitable for agriculture or the development of housing and infrastructure. Indeed, according to the CSO (2017) the majority of the surface area, corresponding to 54% of the canton is unproductive. This share is significantly higher than the Swiss average, which is 22%. Around one third of the land is covered by forests, 19% is used for agriculture, and the balance (4%) represents the built-up area (CSO, 2017). In terms of climate, the Valais benefits from a high duration of sunshine, generally exceeding 60%

³⁵ The working population or *Population_{active}* is defined as employed population + unemployed population as defined by the International Labour Office.

over the year, which puts the region's average annual sunshine duration among the highest in the country as shown in Figure 80.

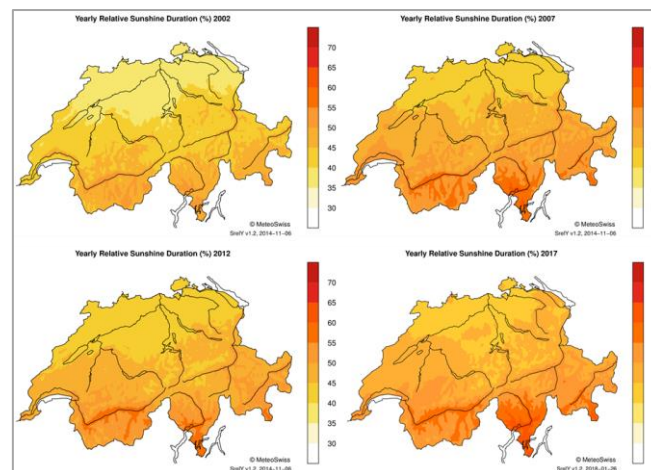

Figure 80 Average annual sunshine duration. Source: Federal Office of Meteorology and Climatology MeteoSwiss (OFMC, 2018).

The rainfall is low, and the climate is favourable to the practice of outdoor activities in summer and winter, attracting not only tourists but also for new inhabitants. The richness of the ecosystem in Valais-Wallis is of great importance for Switzerland. About 25% of the surface area is part of the national landscape issued by the inventory of landscapes, sites and natural monuments office and 9% of the surface area is inhabited by biotopes of national significance. Another examples of the importance of the biodiversity in Valais-Wallis is that it accounts for 150 of 200 breeding birds inhabiting in Switzerland (Loubier, 2020).

As discussed by Rojas et al., (2018) global warming is jeopardizing ecological systems and also socio-economic for instance, the winter sport's business model. As discussed earlier, tourism plays an important role in the local economy and the snow provision in winters is a key issue for all ski stations but mainly for those located in low and mid-altitude ski areas. According to the Federal Office of the Environment (FOEN), in Switzerland by the end of the century the ski season could be reduced on average by 5 to 9 weeks especially if binding measures are not developed (FOEN, 2014). The Swiss case seems to be one of the most critical if one takes a look at the decrease of skier days in comparison to the neighbouring countries such as France, Austria and Italy. However, it is worth to note that the loss of attractiveness of winter sports is also a problem reinforced by a mix of sociological phenomena.

The competition with extra-alpine destinations due especially to the low-cost flights is also an issue. Mountain's tourist population is ageing (Bourdeau et al., 2009) which might suggest that younger people are not replacing this market segment. Scientist have set a 100-days rule of snow reliability as follows: if there is at least 100 days with at least 30 cm of snow on the ground from the 1st of December to the 15th of April in 7 out of 10 winters, then it can be considered reliable to operate a ski lift company in a given location (Scaglione & Doctor, 2011). Currently alpine ski areas have 100% reliable snow coverage according to the 100-day rule. Nevertheless, with a warming of 4 ° C for example in 2100 and with little change in human habits, these ski areas will become only 50% reliable in Switzerland and only 5% in the Bavarian Alps at relatively low altitudes (Agrawala, 2007). The Swiss federal office of meteorology and climatology agency (OFMC) have recorded data regarding natural fluctuations and climate change. The temperature data series shows the fluctuations since 1755 in the Figure 81, where a clear trend is observable from the beginning of the XX century. While the climate fluctuations in the beginning had natural origins, from 1900 the steady incremental temperature trends are only explained by human intervention: anthropogenic greenhouse gas (GHG) emissions.

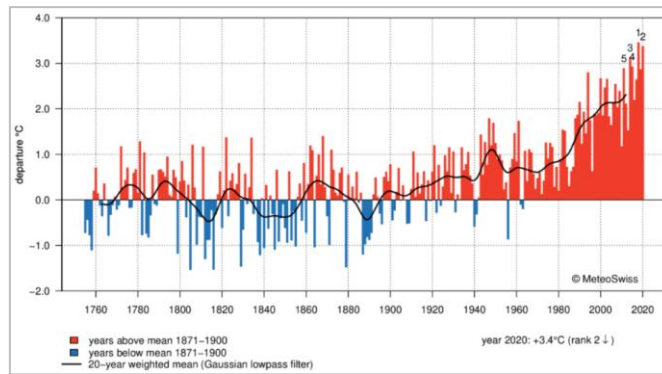

Figure 81 Annual Temperature in Switzerland from 1755 to 2020. Source: OFMC (2020).

Since 1864 Switzerland's average temperature has augmented around 2 °C as of 2020, with steep trajectories during the last years. Among the natural fluctuations it has been seen a drastic reduction of snow since the 1980's and the precipitations have been altered. As for the summers, they have become drier and an increase of extreme weather events have been witnessed. Climate fluctuations are detectable by measuring various indicators however a robust parameter is temperature. According to OFMC (2019) in the last 30 years the temperature of the atmosphere nearby the ground has not been below the average temperature seen between 1961 and 1990. The figure below shows the temperature deviation from 1961 to 1961 mean in Switzerland for every year between 1864 - 2020. The years with temperature below the average are depicted in blue and the years with higher temperatures than the average are in red.

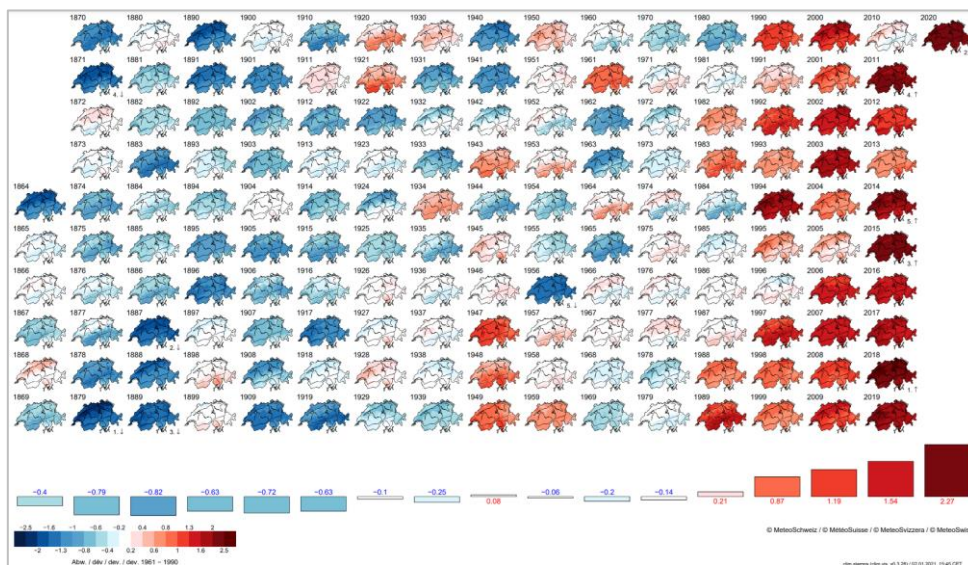

Figure 82 Temperature evolution from 1864 to 2020. Source: OFMC (2020).

To summarize, according to the state-of-the-art on climate change research in Switzerland, there are four major changes: i) drier summers; ii) heavier precipitation; iii) more hot days and iv) winters with little snow (CH,2018). Readers interested in the climate change scenarios for Switzerland are referred to the most recent technical report called Climate Change Scenarios (CH, 2018) carried out by a Swiss research consortium.

Spatial Planning: A special issue on second homes law voted in 2012 and a law on land-use voted in 2013

The spatial planning context in the canton of Valais-Wallis has been rapidly changing in the last few years, giving a new directionality to tourism, real estate, urban sprawl and economic models. The direct democratic system in Switzerland allows citizens to participate actively in the decision-making processes in different fields of interest. In 2012 Swiss people voted in favour of limiting the construction of second homes, this initiative had as slogan *“To put a stop to the invasive spread of second homes”*. The purpose of the initiative by Franz Weber was designed to protect citizens, heritage and the nature as well as the creation and maintenance of cities, habitats and liveable landscapes. Swiss citizens in 2012 voted for a restriction on the construction of second homes, according to the initiative, second homes cannot exceed 20 percent of the total community housing of a municipality. Currently this initiative is a federal law adopted by the national council and must be applied by all municipalities.

Additionally, to the situation mentioned above, in 2013 Swiss citizens voted for the implementation of another law on land-use, despite the rejection of more than 80 percent of Valais-Wallis' voters. This law proposes that the size of the zones to be built should be based on the foreseeable needs for the next fifteen years. By accepting this new spatial planning law, Swiss citizens showed their interest in the heritage and economic value of the landscape by their desire to reduce the oversized building zones. The reduction of building zones recommended by the law on land-use reinforces the transfer of constructions of second homes to neighbouring communes and even to more distant perimeters. Moreover, the new law on land-use also includes the introduction of a 20 percent tax of the land value when the creation of new surfaces proves necessary, which means a third major modification on the policy of the development of the territory.

In this region, the economic model is based on real estate speculation where large urban sprawl areas need to satisfy the market. Hence, the new law on land-use is seriously threatening this economic model. This situation also had underlying social issues related to cultural heritage and the justification of politicians' choices to allocated construction permits. All these factors are part of a complex spatial decision process which are commonly studied in the literature as a paradox of economic and conservation-oriented goals (Greene et al. 2011). At a national level large areas have been built, the explanation for this according to the Swiss Federal Office for Spatial Development (ARE), is the population growth, which has triggered the need of further housing and infrastructure (ARE, 2017). According to the federal office, the living space per inhabitant has doubled since in the last 40 years.

Under this new legal frame land planners needed decision-making tools which would provide an objective assessment on the current situation and also be able to simulate future developments on the basis of changing framework conditions. Rojas & Loubier (2017) developed a methodology under a participatory approach for the practical adaptation of the new laws on land-use. The main goal of the research was to develop a decision support methodology to help DM to make decisions objectively while minimizing the negative impacts of these choices and several municipalities have successfully adopted the methodology.

3.2 A rationale to Choose Renewable Energy Technologies as Innovation Indicators.

The relevance of sustainability transition within the global warming context, provided a significant scientific and practical interest to study RET as innovation indicators for this dissertation. As it was previously stated, GST arises the question on why sustainability transitions occur in some places and not in others (Hansen & Coenen, 2015). Energy is part of our everyday life, the World Bank has estimated that a citizen of an OECD country consumes in

average 11.3 kg of oil (World Bank, 2017³⁶) which corresponds to fifty-six times the quantity of energy needed by the human body³⁷.

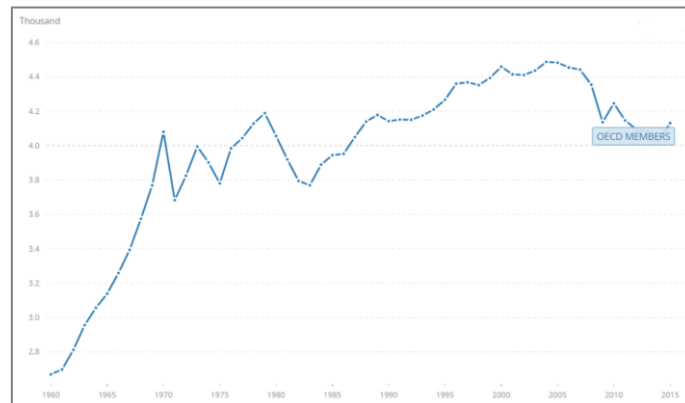

Figure 83 Energy use (kg of oil equivalent per capita) - OECD members, World Bank (2020).

The figure above shows a steep incremental trend since the 1950's and as for 2014 according to the International Energy Agency (IEA) this energy was provided by around 81.1 % of the world primary energy supply (IEA, 2016). The anthropogenic GHG emissions are triggered by the combustion of such fuels, which consequently are a major climate change propeller. According to the IEA (2016) the world total primary energy supply (TPES) by biofuels and waste accounted for 10.5 % in 1973 and 9.7 % in 2015.

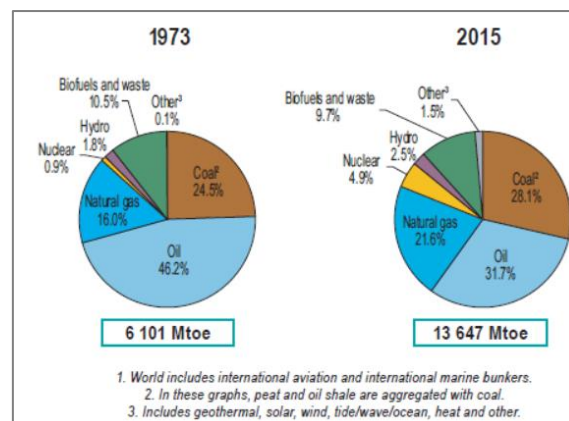

Figure 84 Fuel shares of TPES from 1973 to 2015, source: IEA (2016).

^a Mtoe: million tonnes of oil equivalent

The IEA (2014) estimated a scenario for 2050 about energy consumption trends and the results show a 70% increase in the energy demand, which consequently implies a 60% GHG emission increase in comparison to 2011 levels, which is explained by the systematic growth of developing economies. Under these climate change circumstances; the Paris agreement has the goal “holding the increase in the global average temperature to well below 2 °C above pre-industrial levels and pursuing efforts to limit the temperature increase to 1.5 °C above pre-industrial levels”. To accomplish this goal, major transformations are needed for the global energy systems as we know them today (IEA, 2019).

Both the EU and the Swiss confederation have agreed to the energy transition in 2050 and some EU countries have even established shorter deadlines. In order to achieve this transformation, the IEA’s Sustainable

³⁶ Average primary energy consumption in OECD countries in 2015. 41868 kJ/kilogram of oil equivalent

³⁷ Assuming a diet of 2000 kcal/day.

Development Scenario (SDS), which has established an 80% probability of bounding the increase of the global temperature below 2 °C in comparison to pre-industrial levels, necessitates a GHG emissions reduction as of 50% of the levels we have today (IEA, 2016). These goals must be reached without putting at stake the access to energy a global level, which is part of the SDG 7, keeping in mind the reduction of health effects of air pollution, which is part of the SDG number 3 and tackle climate change that is developed in SDG number 13 (IAE, 2019).

The report published by the IPCC (2018a), evaluated several scenarios that had a 50% chance to limit the temperature rise to 1.5 °C and 88 out of 90 scenarios assumed at least some level of net negative emissions (IEA, 2019). The SDS estimates a temperature rise below 1.8 with a 66% probability without considering global net negative CO² emissions, which is equivalent to limit the temperature rise to 1.65 °C with a 50% probability (IEA, 2019). An important instrument to tackle GHG emissions are energy demand scenarios, which have historically been difficult to establish. Moret (2017) in his doctoral thesis extensively discussed on uncertainty issues related to energy strategic planning. For example, Figure 85 shows an analysis of errors in energy demand forecasts in different sectors in the US.

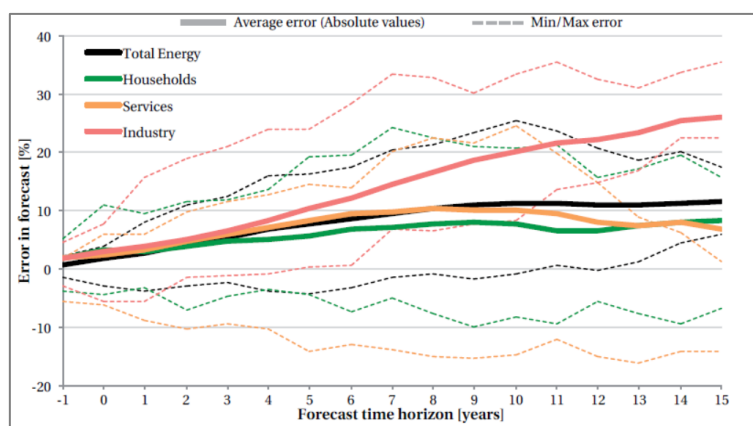

Figure 85 Analysis of errors in the yearly US Energy Information Administration (EIA) Annual Energy Outlook (AEO) energy demand forecasts for the years 1994-2014. Full lines indicate the average of errors in absolute values. The dotted lines indicate errors. Source: Moret, 2017.

Another example also shown by Moret (2017) is related to the forecast of price of natural gas for electricity production in the US as follows.

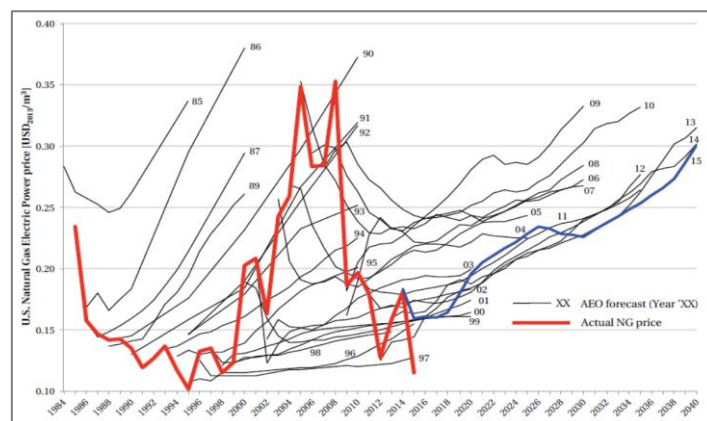

Figure 86 Natural gas for electricity production price in the US. Comparison between the yearly EIA Annual Energy Outlook (AEO) price forecasts and the actual values for the years 1985-2015. The black lines are the forecasts made in different years. The red line represents the actual NG price. The blue line is the last available forecast. Source: Moret (2017).

It is assumed that today decision-makers proceed to develop policies and decisions based on parameters such as energy demand, fuel prices and the technological development of the last year of the planning horizon of

reference (Moret, 2017). This implies that for example a forecast for 2040 is based in today's technology and do not take the development of such parameters into account during the planning horizon until 2040. All these elements show only some of the challenges regarding modelling aspects, which aim to contribute to reduce GHG emissions. The SDS is not based on net negative emissions, but it acknowledges that further green technological advancements and technology at scales would help further to fight against warming (IEA, 2019). In alignment with the last argument, green technologies diffusion is a major factor that would contribute to improve such scenarios as stated in the IPCC's Summary for Policy Makers (IPCC, 2018b):

“The systems’ transitions consistent with adapting to and limiting global warming to 1.5°C include the widespread adoption of new and possibly disruptive technologies and practices and enhanced climate-driven innovation. These imply enhanced technological innovation capabilities, including in industry and finance. Both national innovation policies and international cooperation can contribute to the development, commercialization and widespread adoption of mitigation and adaptation technologies. Innovation policies may be more effective when they combine public support for research and development with policy mixes that provide incentives for technology diffusion.”

Innovation policy making, plays an important role to implement the most effective strategies to deal with global warming, at the same time policy should rely on science and modelling and simulation. For example, RET diffusion modelling has a great potential to reduce the gap of our understanding of the problem. This view is not new, as it was stated by Forrester (1995), humans would never send a spaceship to the moon without testing prototypes before the actual mission and the same applies for companies when they want to launch a new product; they first perform tests. These tests and simulations do not guarantee 100% of missions' success but they allow detecting weaknesses that can be addressed before the actual launching process. In the context of warming, the systems' transition heavily rely on human behaviour, that is on social systems, which is much more complex to understand than technological systems (Forrester, 1995). The costs involved in wrong policies regarding GHG emission reduction are unaffordable for our societies, hence a step forward in the integration of sciences as intended in this study via spatial modelling, and simulation are needed to unveil socio-technical systems behaviours.

The underlying properties embedded on the diffusion processes of RET from a spatial perspective are not clear yet. What has been observed is indeed the slow adoption rates across different territories. Another important aspect in this subject, is that there have been developmental approaches with different models of RET diffusion. Nevertheless, the integration of the spatial component has been rather modest. The slow diffusion of RET might be explained by two different paradigms. The first one is the neo-classical economic paradigm that gives a central place to market failures (Arrow, 1962a) as the predominant impediment (Negro et al., 2012). Subsidies and taxes for innovation and R&D are proposed as a good mechanism to compensate private investments and get a correction in the prices. However, the market failure approach was not clear enough regarding where those subsidies and at what level they should have been applied (Smith, 2000; Negro et al., 2012).

The second paradigm that helps to explain the slow diffusion of RET according to scholars is outlined in the systemic character of innovations. From this perspective, innovations are processes rooted within an environment (Negro et al., 2012). Therefore, scholars argued that *“In their view, the speed, direction and success of innovation processes are strongly influenced by the environment in which innovations are developed. This environment is called innovation system, technological system or innovation ecosystem. Innovation systems are socio-technical configurations of actors, rules, physical infrastructures and their relations”* (Negro et al., 2012).

This line of thought is congruent with Hägerstrand's view on innovation diffusion where the environment is central for innovation diffusion as a spatial process. Three out of four conditions proposed by Hägerstrand for the diffusion process (see Table 3) include either the milieu or the environment in which the phenomenon is observed. As previously reviewed, innovation systems are composed by complex interactions of socio-technical agents, which influence each other. Thus, research from different fields seem to agree on the central role of the environment or

milieu as either a catalyser or a barrier for innovation diffusion. The analysis of RET diffusion processes has given it fruits at theoretical level. Here we will discuss the most important assumptions and theories that have been drawn by scholars in social sciences in order to better outline the diffusion process within innovation ecosystems.

An important review was developed by Negro et al., (2012) on the diversity of factors that may hinder the rapid trajectory of RET diffusion from an innovation perspective. The table below is an overview on the most common systemic problems found in the literature regarding innovation diffusion within an innovation ecosystem perspective. According to Table 9 depicted below, in the literature the systemic problems listed in a ranked fashion, show that the first problem is hard institutions, followed by market structures and soft institutions, etc. The numbers work just as an indication of the reiterative interest on the problem and consequently the cases discussed in the literature, for the full description of these systemic problems, see Negro et al., (2012). The authors took 50 case studies into account, all related to RET diffusion using a socio-technical framework. The papers were chosen from Scopus by using the following keywords: innovation systems, technological change, socio-technical, transition management, biomass, biofuels, biopower, CHP, hydrogen, green power, renewable energy, photovoltaic, PV and wind.

Systemic problems	Empirical sub categories	No. of cases
Hard institutions	1. 'Stop and go policy': lack of continuity and long-term regulations; inconsistent policy and existing laws and regulations 2. 'Attention shift': policy makers only support technologies if they contribute to the solving of a current problem 3. 'Misalignment' between policies on sector level such as agriculture, waste, and energy, and on governmental levels, i.e. EU, national, regional level, etc. 4. 'Valley of Death': lack of subsidies, feed-in tariffs, tax exemption, laws, emission regulations, venture capital to move technology from experimental phase towards commercialisation phase	51
Market structures	1. Large-scale criteria Incremental/near-to-market innovation Incumbents' dominance	30
Soft institutions	1. Lack of legitimacy Different actors opposing change	28
Capabilities/capacities	1. Lack of technological knowledge of policy makers and engineers Lack of ability of entrepreneurs to pack together, to formulate clear message, to lobby to the government Lack of users to formulate demand Lack of skilled staff	19
Knowledge infrastructure	– Wrong focus or no specific courses at universities and knowledge institutes – Gap/Misalignment between knowledge produced at universities and what needed in practice	16
Too weak interactions	– Individualistic entrepreneurs – No networks, no platforms – Lack of knowledge diffusion between actors – Lack of attention for learning by doing	13
Too strong interactions	– Strong dependence on government action or dominant partners (incumbents) – Network allows no access to new entrants	8
Physical infrastructure	– No access to existing electricity or gas grid for RETs – No decentralised, small-scale grid – No refill infrastructure for biofuels, ANG, H ₂ , biogas	2

Table 9 Allocation scheme of systemic problem from Negro et al., (2012).

Hard institutions in innovation systems stand for the institutional context where the structure of the system might hamper innovation. Hard institutionality is explicit and not tacit, written rules, laws, policies and decisions are intended made under this scheme. While soft institutionality is rather tacit, informal, culture and values oriented, and is shaped in a more spontaneous way without the need of formalisation of procedures or structures (Negro et al., 2012). The set and interaction of all these factors create the environment in which knowledge institutes and policy makers are embedded (Klein et al., 2005). The innovation systems framework has been very useful to identify and analyse these sorts of problems related to innovation diffusion in order to deploy policy intervention (see Edquist & Hommen, 1999; Klein et al., 2005). The view of RET diffusion from a spatial perspective, is an interesting approach to investigate regions' behaviours which have different systemic environments, configured with dissimilar political, geographic and cultural setups across the space.

For this dissertation, we have chosen two different study areas with two different perspectives in terms of innovation indicators. In Switzerland, we have developed a spatial analysis in the Valais region, which is a canton

located at the southwestern part of the country. There, we deployed an investigation from the demand perspective for solar PV for heating and hot water usage. Moreover, we performed a multi-scale simulation also on the demand side for electric cars at a national level, going down in the hierarchical urban scale to municipality level. Respectively in France, in the South Region of France we deployed a spatial analysis from the supply viewpoint of renewable energies such as: wind power, Solar PV for heating and hot water usage, biomass for heating usage, small and big hydroelectric power, biogas for electricity usage.

Besides, in the case of the Swiss area of study for RET diffusion, the simulations were performed coupled with other demographic indicators. The indicators listed above are amongst the main RET currently used, therefore the relevance to develop this study. The choice of the indicators was based on both, the interest on geography of transition sustainability and on data availability. The explanation and rationale on the study areas is fully discussed in Chapter 3 and the specifics related to the indicators will be declined by region in the same section. The methodological approach chosen in this study relies on network theory, which allows to model the diffusion process of RET and transpose it to the spatial dimension via GIS.

As it was aforementioned, the integration of the resilience concept within the innovation diffusion process is the second part of this research project. Resilience will also be analysed with the lenses of network theory, which will help to integrate innovation diffusion and resilience under the same theoretical approach and consequently modelled via GIS. The inclusion of the resilience concept in this research is an attempt to contribute to the knowledge on sustainability transition and how innovation diffusion modelling can help to fight natural depletion processes in the epoch of Anthropocene. The ways we live, produce and consume must change and in a very short period of time where we are confronted with, which is known as the paradox of economic and conservation-oriented goals (Greene et al., 2011).

3.3 The Energy Transition Context in Valais – Wallis

The canton of Valais has a policy regarding the energy transition with objectives for 2035 and a vision for 2060. The region is aiming at generating a 100% renewable energy supply locally produced. The vision implies the following aspects:

- The energy consumption must be drastically reduced by changing behaviours and improving the energy efficiency of buildings, technical installations and vehicles.
- The residual energy needs are met by renewable energy locally produced (electricity and heat).
- The infrastructures for the production of renewable energy, transportation and distribution networks, as well as energy storage units should be locally owned.

According to the Swiss Energy Foundation (SEF, 2021), Switzerland as of the 6th of April 2021, will depend on foreign energy imports at least until the end of the year as they have exhausted the amount of energy locally produced. Hence, the 5th of April marks the 'Switzerland's Energy Independence Day' in 2021. The challenges in the energy transition processes are important, therefore at a national level, complementary actions are proposed, such as harvesting solar energy outside of settlements, which implies spatial planning intervention. The sustainability paradigm's multilevel nature is thus observable here, where the EU, Swiss and cantonal policies alignment represent a difficult task to achieve. The figure below depicts some of the measures from a spatial planning perspective taken in Switzerland and in the canton of Valais. According to SEF (2021) in order to achieve the Switzerland's climate and energy policy goals by 2050, it is necessary to install around 40 gigawatts of photovoltaic power, so an expansion outside settlements is needed.

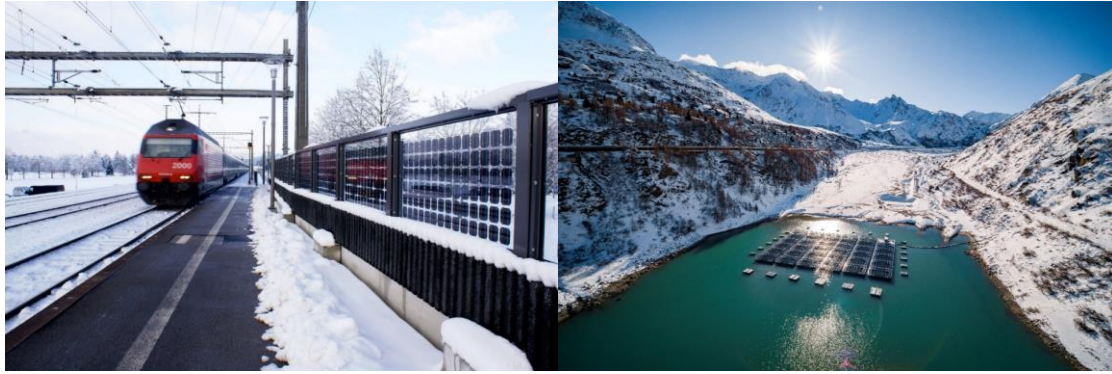

Figure 87 To the left: Noise protection wall at the train station Münsingen (Bern) with bifacial solar modules (electricity production on both sides). Power 12.8 kW. Photo: TNC Consulting AG. To the right: Floating solar system on the lake Lac des Toules, Bourg-St-Pierre, Valais. Performance approx. 500 kW, Picture: Novelty Energy. Source: SEF (2021).

The current yearly expansion needs to be at least quadrupled if the target is set to be achieved by 2035. The process that starts by adapting buildings and facades in continuous urban fabric areas is not easy as the cycles of buildings renovations coupled with the willingness of owners to do changes limit the pace of the diffusion of photovoltaics. The pictures above show how the spatial expansion of photovoltaic infrastructure can be managed in a convincing aesthetically way. The canton of Valais' energy strategy regarding the populations' habits change in energy consumption and industry demand is represented by the Figure 88.

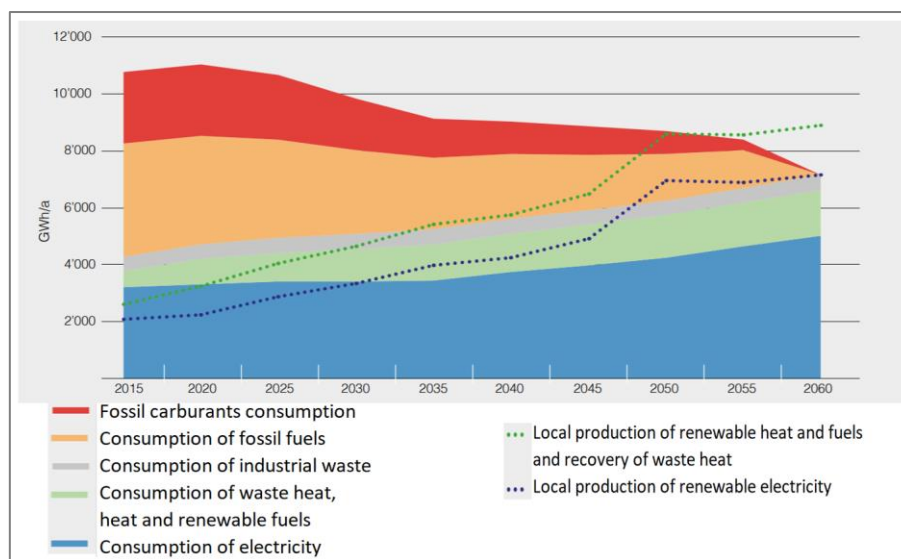

Figure 88 Energy demand (including consumption of large industrial sites) and cumulative renewable production in Valais in GWh/a. Available online at <projections 2015-2060https://www.vs.ch/web/sefh/strategie-energetique>

The energy in Switzerland largely depends on imports, about 75% of the supply is provided by foreign countries, an example of the commodities imported are natural gas and uranium (SEF, 2021). The calculations of the energy demand are very difficult as it was discussed in section 3.2, where the demand for cooling and heat is a relevant element for planning thermal networks. The heat density of 700 MWh/a per hectare is considered the lower suitable boundary, where the temperatures might vary depending on the areas as some industries require very high levels that sometimes is not possible to be produced by thermal networks. Therefore, the data of industrial and residential/commercial zones is managed in a separated way. Below is displayed the energy demand for residential and commercial buildings in Switzerland.

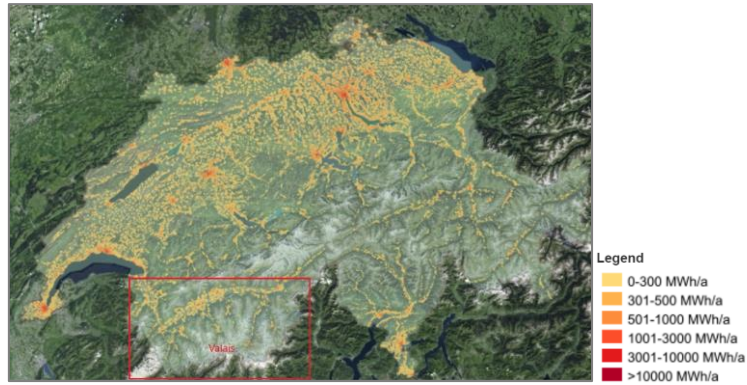

Figure 89 Thermal networks: demand from residential and commercial buildings in 2013. Source: Swiss Federal Office of Energy³⁸

The canton of Valais counts with three wind energy plants in Valais are located in Collonges, Martigny and Charrat respectively and all of them are large single systems. Switzerland has an important potential to increase wind energy and the objective is to reach the electricity production to 4000 GWh by 2050.

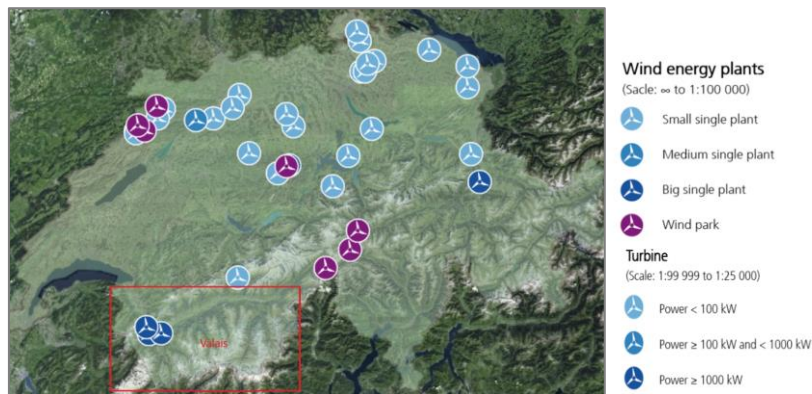

Figure 90 Wind energy plants. Source: Swiss Federal Office of Energy (2021).

Here below in Figure 91A we can observe the spatial distribution of the headquarters of Swiss hydropower plants with an output of at least 300 kW, where we can observe a highly clustered system in the canton of Valais. Switzerland has a long history with dams, especially in Valais where 46 dams produce more than a quarter of the hydroelectric power consumed in Switzerland and Valais also hosts the Grande-Dixence dam, which was the tallest in the world until 2018, with 285 m. In Figure 91B we can observe the high number of dams in the Valais region.

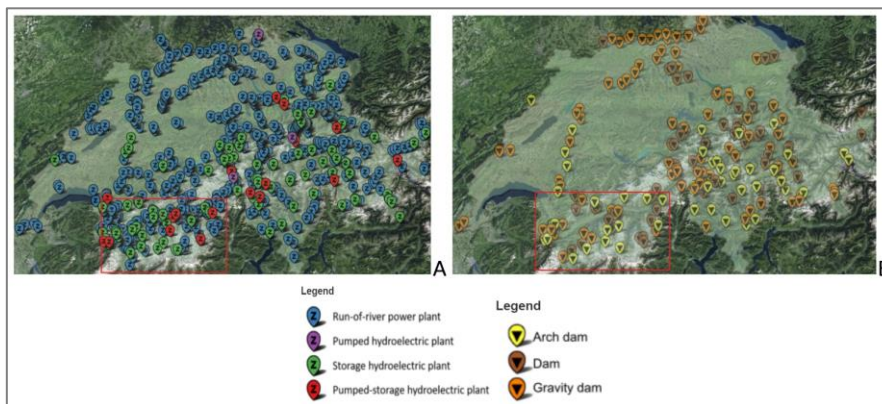

Figure 91 A) Statistics on hydropower plants, source: SFOE, 2019. B) Dams under federal supervision, source: SFOE (2020).

³⁸ Available online at <https://map.geo.admin.ch/>

The pace at which Switzerland is doing the energy transition has been criticized, since it seems that the European neighbors are achieving better results. For example, according to the SEF (2020) Switzerland's electricity³⁹ generated via solar and wind power is about 4.2%, while Germany accounts for more than 50% and Denmark 33%. The fact is that this pace puts at stake the climate goals, so SEF (2020) claims that it is required that Switzerland increases the annual production to 80 TWh by 2035, where currently 36 TWh are generated from hydropower.

The canton of Valais has been making important steps to accelerate the transition process from the scientific and technological front. The creation of a scientific Energypolis platform that integrates the Swiss Institute of Technology EPFL, the University of Applied Science and Arts Western Switzerland and the Ark Foundation is the best example. One of the most recent outputs of the research developed in this area is the work led by Professor Mohammad Khaja Nazeerudd on perovskite, which is a material composed of calcium and titanium oxides. This material is used for the conversion of solar energy into electricity and for diodes used in light displays. The current market accounts for 95% of silicon cells but the production process is expensive.

By using perovskite, the costs of solar PV productions dramatically drop. The efficiency of solar PV depends on factor such as weather conditions, orientation, placement and similar aspects. The technology developed by Nazeerudd has been certified by an American lab with an efficiency of 24.8%. The work at the EFPL Valais is currently focusing on the instability and low resistance level of the perovskite against water and the temperature of UV rays. The relevance of the work of Nazeerudd puts him on the top of the most cited scientists in the world in the recent years. In summary, Switzerland and the region of Valais have a great potential of increasing the pace of the energy transition since they count with the infrastructure, physical and financial resources as well as the innovative ecosystem. However, the challenges are many and a serious change of trajectories is needed at different levels in order to be in line with the climate goals.

3.4 Swiss Data

The data used in this dissertation for the model in Switzerland has been provided by different Swiss federal offices and most of the data is open source. There was a conscious effort in using data that can be reused by other scholars in order to replicate studies and verify the outcomes of this research work. The data sources are indicated at every step of the construction of the model. In Chapter 5 different data sets were used to build the general system of simulation, ranging from population, jobs and solar PV to land-use.

3.5 The Urban and Economic Context in the South Region of France.

The South Region is the second territory in which this research work has been carried out therefore, we will present a descriptive synthesis of socio-economic, environmental and geographic aspects of the region. This information will be followed by the discussion on the renewable energy context in the area.

3.5.1 Demography and Economy

In this study the focus is across all the region since the georeferenced data used is at municipality level. The exceptional nature and landscapes of the region have attracted tourists from all over the world and specially the

³⁹ Available online (in German) at <https://www.energiestiftung.ch/medienmitteilung/die-schweiz-hinkt-bei-solar-und-windstrom-europa-hinterher.html>

European elite. This phenomenon helped to boost the urban development outside of the historical centres, but along spaces with excellent morphological conditions along the railways mainly in the French Riviera. The urban growth was reinforced by rural migration to the cities, the immigration waves from Italy and Russia (Ellis 1988) and the repatriation of the Pied-Noirs in the 1950's and 1960's. Another event that played an important role in the urban development process, was the demographic growth fueled by the *Glorious Thirty* between 1943 and 1975 (Araldi, 2019).

The current population of the region is approximately 5,052,832 as of 2020, which is in more than fourteen times the population of the Swiss region of Valais, this difference is interesting for comparative purposes. The South region has had an increase of over 75% in terms of population since 1962, while the national average was of approximately 35%. The exceptional landscapes in the region are also a constraint for urban development since approximately half of the territory is covered by mountains nevertheless its 700 km of coastline keeps attracting people from all over the world. Around 9 out of 13 people live in the large urban areas and the urbanization in peripheral areas is important. The increase in the population has generated this peripheral phenomenon, which has as a consequence land-use changes, where around 20 % of agricultural areas were urbanized from 1970 to 2000 (INSEE, 2012).

The real state situation in the South Region is the second highest after the Île-de-France regarding the land square-meter prices (INSEE, 2012). The South Region is second in the inequalities ranking at national level, according to the criterion: hosting the 10% of richest and 10% of poorest in the population. Nevertheless, according to INSEE (2012), the South Region was one the strongest departments during the subprimes crisis in 2008, where the employment rates were amongst the best in the country. At the same time the structural unemployment has been slightly higher in the South Region as of April 2021, where 72.3% of the employable population was active⁴⁰, while at the national level was 74.0 %. The GDP per capita of the South Region was approximately 32,997 euros while in France was 35,252 euros in 2018.

Among the main touristic events in the South Region, it is important to mention that it hosts global events such as the Monaco Grand Prix since 1929 and the Cannes Festival since 1946 in the French Riviera. In this specific region, around 25% of the housing were second homes in 2005, which is another good indicator of the attractiveness of the region. Senior citizens are at the origin of an important share of the second homes, where the population older than 60 years old is about 30% at the department level and in locations such as the centre of Antibes and Cannes the share is higher than 35%. The South Region of France relies at some extent on tourism, with a contribution in the French Riviera of 15% to its economy in 2018 and represents approximately 118.000 jobs, being the second most visited place in France after Paris. Those figures resemble to the 14.8% of the added value of tourism in the Valais region in Switzerland (Perruchoud et al., 2016), although each region has its own tourism specificities. Thus, we can note that both regions have high levels of attractiveness for tourists in general.

The airport in Nice is a major hub of transportation for the South Region, being the third airport in terms of tourists in France and it is expecting to see an important growth in the incoming years after the expansion of the airport. The health situation with the Corona virus has delayed the growth though. The coast is also an important resource for the economic development of the region where 4.3 km² host 29 maritime centres and additionally two ports in Monaco and two fluvial centres. According to Araldi (2019), the economic activities associated with the usage of maritime trade generates 2.3 billion euros of revenue represented in more than 2.2 economic activities.

⁴⁰ Population between 15 and 64 years old.

3.5.2 Nature and Climate Change in the South Region of France

The geographic position of the South Region gives the region an exceptional biodiversity, the South-Eastern of France has been designated as one of the 35 hotspots in the world. A biodiversity hotspot is a biogeographical zone that hosts extraordinary biodiversity that is particularly threatened by the activity of humans (Myers et al., 2000). According to Médail and Quézel (1997) biodiversity hotspots on a global scale have at least 1500 endemic species, high threats of biodiversity loss that would account for more than 75% of the disappearance of the original vegetation.

The South Region of France has a Mediterranean climate, which is characterized by hot and dry summers and relative mild temperatures in winter (Blondel et al., 2010). The specific location of the region is on the Southern boundary of the temperature's fluctuation, that is between the cold polar zone and the warm intertropical zone (Blondel et al., 2010; GREC-SUD, 2016; Vignal, 2020). During the summer, the South of France often has anticyclonic atmospheric circulation, which lifts the air masses and consequently the period is characterized for its dryness. In Winter times, the region is influenced by cyclonic atmospheric circulation, which has the consequence of cold low-pressure at low latitudes. However, the proximity to the Mediterranean Sea and the intermediate position of the South-Eastern France region help to keep mild winter temperatures (Vignal, 2020).

The high urban sprawl in the region has increased the vulnerability to climate change effects, more specifically in Marseille, Nice and Toulon, which concentrate more than 50% of the population in the region. For example, the city of Marseille has the third rank in terms of inhabitants in France and also hosts a remarkable natural stock, which is protected at different scales, for instance the National Park of Calanque is the first peri-urban national park in Europe. The South Region is also influenced by storm systems which trigger precipitations mostly in Autumn. As discussed by Vignal (2020), the climate conditions are affected depending on the relief, in which the altitudinal gradient ranges from 0 to more than 4101 m above the sea level at the Barre des Écrins in the French Alps.

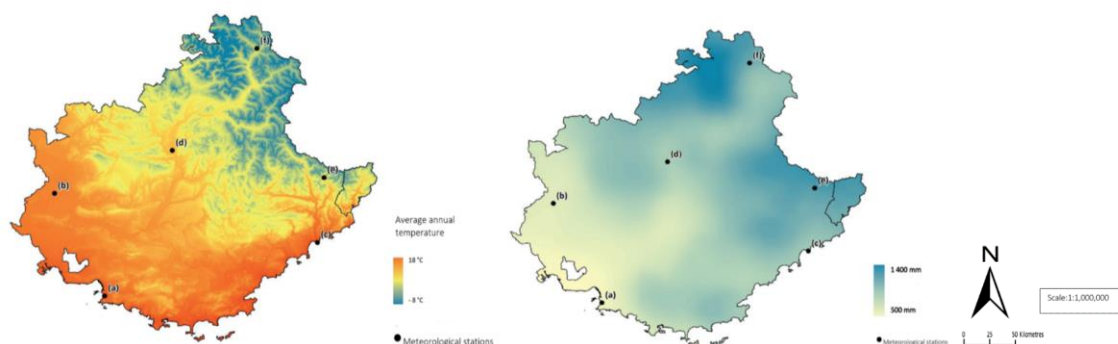

Figure 92 Climate maps of the study area. Left) Average Annual Temperature (AAT). Right) Cumulative Annual Rainfall (CAR). Source : Vignal (2020). (a) Marseille ; AAT : 15.7 °C ; CAR : 555 mm. (b) Avignon ; AAT : 14.8 °C ; CAR : 677 mm. (c) Nice ; AAT : 16.0 °C ; CAR : 733 mm. (d) Sisteron ; AAT : 11.8 °C ; CAR : 822 mm. (e) Saint-Martin-Vésubie ; AAT : 11.8 °C ; CAR : 1 135 mm. (f) Briançon ; AAT: 8.3 °C; CAR: 759 mm. Source: TOPO data base from IGN , climate data from ALADIN-CLIMAT model (2016).

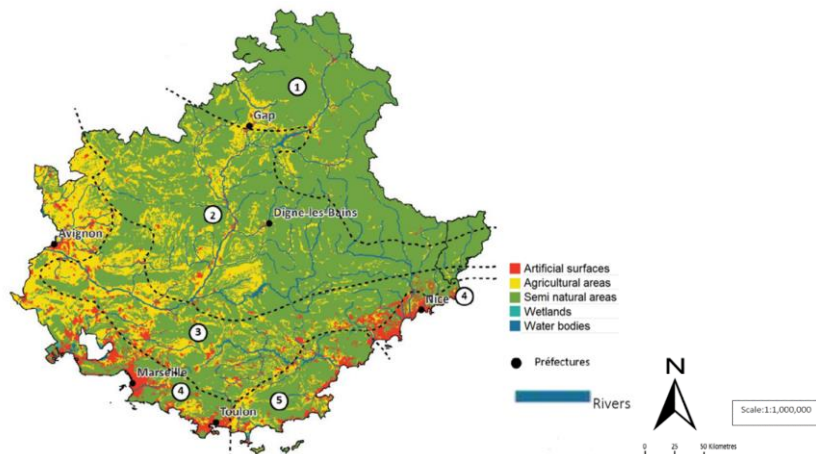

Figure 93 Land-use in the South Region of France: 1. Southern alps and alpine peaks; 2. Haute Provence or middle country; 3. Lower Provence or Provençal hills; 4. Provençal plains and coastline; 5. Crystalline Provence. Source: Corine Land Cover (2018).

The figure above shows the land-used in the South Region. According to the regional platform called Information System for the Inventory of Natural Heritage (SINP), there are over 4,600 plant species, where the French National Botanical Conservatory states that 31 species are endemic to the region. Furthermore, the region hosts approximately 70% of the flora present in the Alps and the endemic part accounts for more than 40% (Noble et al., 2015; Vignal, 2020). In terms of scenarios regarding the climate, we can observe in the figure below an increase in the temperature and in the precipitation levels.

The black and grey curves represent the precipitation derived from pollen data (pollinique in the figure) in 100-years intervals, from 10,000 year before present (BP). The blue-purple lines are the PDSI that stands for Palmer Drought Severity Index⁴¹, which is an indicator of summer drought and was built from three ring data also known as dendrochronology. To the furthest right in the figure below, the curves in magenta are the annual precipitation observed by the Climate Research Unit⁴² (CRU). The CRU observations are the interpolations on a 5° longitude and 2.5° latitude grid of the CRU in East Anglia, from which the sub-grid encompassing the South Region has been extracted (GREC-SUD, 2016). The green and red curves represent the RCP 2.6 and RCP 8.5 scenarios respectively where RCP stands for Representative Concentration Pathway. The RCP's are four scenarios of the evolution of the Radiative forcing (RF) of earth's climate.

The RF measures the average radiative imbalance at the top of the atmosphere or at the tropopause induced by a factor for instance, the increase of a greenhouse gas, before the climate system has time to adjust to it. Readers interested in the subject are referred to Ramaswamy et al., (2019). Thus, the RCP 2.6 implies a drastic reduction of GHG emissions, and it is considered as the optimistic scenario and the RCP 8.5 is the pessimistic scenario, the two intermediary scenarios are RCP 4.5 and 6.0. the uncertainty increases from 2040 as the RCP scenarios start diverging and from 2050 this trend is reinforced.

⁴¹ The annual drought index calculates the monthly precipitation and temperature and is normalised between -10 and +10. This represents the extreme dry or wet conditions for the region of reference: 0 representing average conditions (0 in Algiers therefore represents a drier climate than 0 in Marseille).

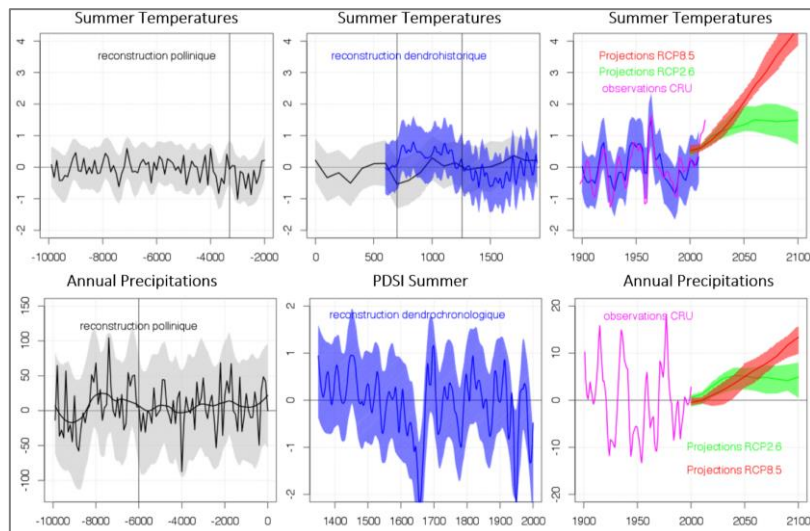

Figure 94 Climate change in the South Region over the past 10,000 years. Source: GREC-SUD, 2016.

Climate simulation have revealed an increase in the temperatures since the end of the last century, where the delta between the average annual temperature and the average annual reference temperature. The simulations indicate a difference of the order of +1.9°C to +5.5°C by the end of this century, with heterogeneous values depending on the locations and the RCP scenarios. Regarding scenarios of the impact of global warming in the flora in the region, readers are referred to Vignal (2020). In summary, in this section it was discussed the major aspects of the nature and climate in the South Region, including the scenarios for the future, which in terms of global warming are similar to those in the Swiss region. These brief picture of the actual situation introduces us to the energy transition context in the South Region, which gives information about the political, socio-economic and socio-technical responses to the challenges discussed above.

3.6 The Energy Context in the South Region

The political context in terms of the energetic transition in France was accepted by the national council in 2015, which established the objectives of renewable energies production and for the reduction of GHG emission 2030. These goals are the results of the previous objectives instituted at European level in 2014: *i) Increase by 32% the renewable energy share in the final energy consumption; ii) decrease by 40% the GHG emissions levels, which means a reduction by a factor of 4 regarding the levels in 1990; iii) reduce the yearly energetic intensity 2.5% accompanied of a reduction of energy consumption by 50% in 2050 in regard to 2012.* In the South Region, the Regional Climate Air Energy (SRCAE) is a scheme established in 2013, which had as a goal to increase the photovoltaic power installations by 1380 Megawatt-peak (MW_p) in 2020. The objectives are continually revised under the Regional Scheme of Planning, Sustainable Development and Territorial Equality after its abbreviation in French (SRADDET). This project has a timeline of objectives regarding photovoltaic installations in the region as follows *i) 2684 MW_p for 2023 ii) 2755 MW_p for 2026; iii) 2850 MW_p for 2030 and iv) 12778 MW_p for 2050.*

As of 2018 the PACA region was the 3rd in photovoltaic power installed at a national level after l'Aquitaine and l'Occitanie, which had 1223 and 1822 respectively (SRADDET, 2018). The geographic location of the South Region puts it in a privileged hotspot in terms of solar energy potential. A recent study focused on the evaluation of the photovoltaic potential in the PACA region, the analysis was done by the Centre for Studies and Expertise on Risks, the Environment, Mobility and Development or CEREMA (2019). The authors identified 97 criteria considered to be relevant, regarding the territorial capacity of ground-mounted photovoltaic plants, involving environmental,

technical, economic and legal aspects such as: *i) Urban planning, living environment and housing; ii) The relief of areas where the photovoltaics would be ground-mounted; iii) Geological and hydrological risks; iv) Preservation of natural environments and v) Heritage and landscape.* The spatial analyses relied on the database 'OCSOL 2014', which covers the entire territory and divides the land-use zones according to 5 themes: artificial surfaces, agricultural surfaces, forests and wetlands and water bodies. This nomenclature corresponds to the level 1 of the Corine Land Cover project. The identification of the land-use zones aimed at evaluating the potential of ground-mounted installations of solar PV, in a similar way as it has been done in the Swiss region (section 3.3), doing a spatial expansion outside settlements.

In this strategic line, the photovoltaic power plants are recognized as an extension of the urbanisation, as a continuity of towns and villages. Alternatively, the extension is possible in the case of the urbanization processes near the shorelines if it is justified by the local urbanism plan, authorised by the Territorial Coherence Scheme (ScoT) or by the Scheme for the Development of the Sea (SMVM). After the evaluation of the zones, a categorization of four levels was done, regarding the issues at stake. The four levels indicate the intensity of the challenges found in a given zone regarding the installation of photovoltaic power plants: *i) Redhibitory issues; ii) Strong issues; iii) Moderate issues and iv) Not issues identified.* The 97 criteria were cross validated according these four levels of issues in the potential zones for installations.

County	Redhibitory Issues	Strong Issues	Moderate Issues	No Issues
Alpes-de Haute -Provence	574 993	112 659	9 970	1 795
Alpes-Maritimes	405 629	22 970	769	136
Bouches-du-Rhône	461 331	39 259	5 560	3 360
Hautes-Alpes	490 283	74 380	3 393	503
Var	546 478	49 698	5 121	2 480
Vaucluse	305 113	44 660	6 733	1 306
TOTAL PACA (ha)	2 783 827	343 625	31 546	9 580

Table 10 Land area of stake levels by department measured in hectares. Source: CEREMA (2019)

The results obtained showed that only approximately 0.3% (9,580 Ha) of the surfaces analysed had no issues at stake and an overwhelming 87.86% presented redhibitory issues, accounting for 2,783,827 ha. The surface with moderated and no issues account all together for the 1.3% of the territory, which is around 41,000 ha. At the county level, the distributional proportions of the spatial situation regarding strong, moderate and no issues is shown below.

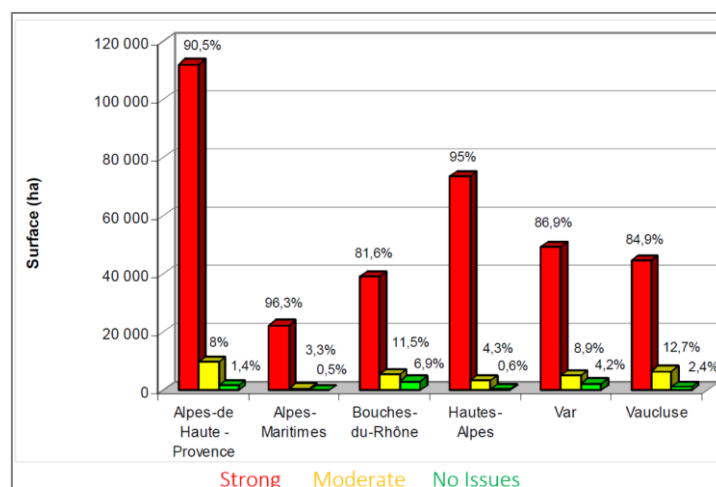

Figure 95 Ground area of the "non-redhibitory" levels of stakes by department, taking into account the critical size of the parcels (1 ha). Source: CEREMA (2019).

The region is developing other efforts in the energy transition front, a scientific research for example, was developed taking an explicit integration of the spatial dimension. Voiron-Canicio & Voiron (2020) performed an assessment of the spatial potential for the adoption of electric mobility (EM) in the region, relying on an expert system which evaluates the potential for the horizon 2019-2040. The study aimed at addressing the spatial differences within the region in terms of potential adoption of EM and the capacity of municipalities to react to change and adapt under a resilience view. The figure below shows three different scenarios, which evaluate: *i) the ease of charging towards and 'all-electric' decarbonized mobility in 2040 vs a diversified decarbonized mobility in 2040; ii) the interest in purchasing an e-vehicle – toward an 'all electric' decarbonized mobility in 2040 vs a diversified decarbonized mobility in 2040 and iii) the overall acceptance capacity for electromobility in an 'all electric' decarbonized mobility scenario for 2040 vs the overall acceptance for electromobility in a diversified mobility in 2040.*

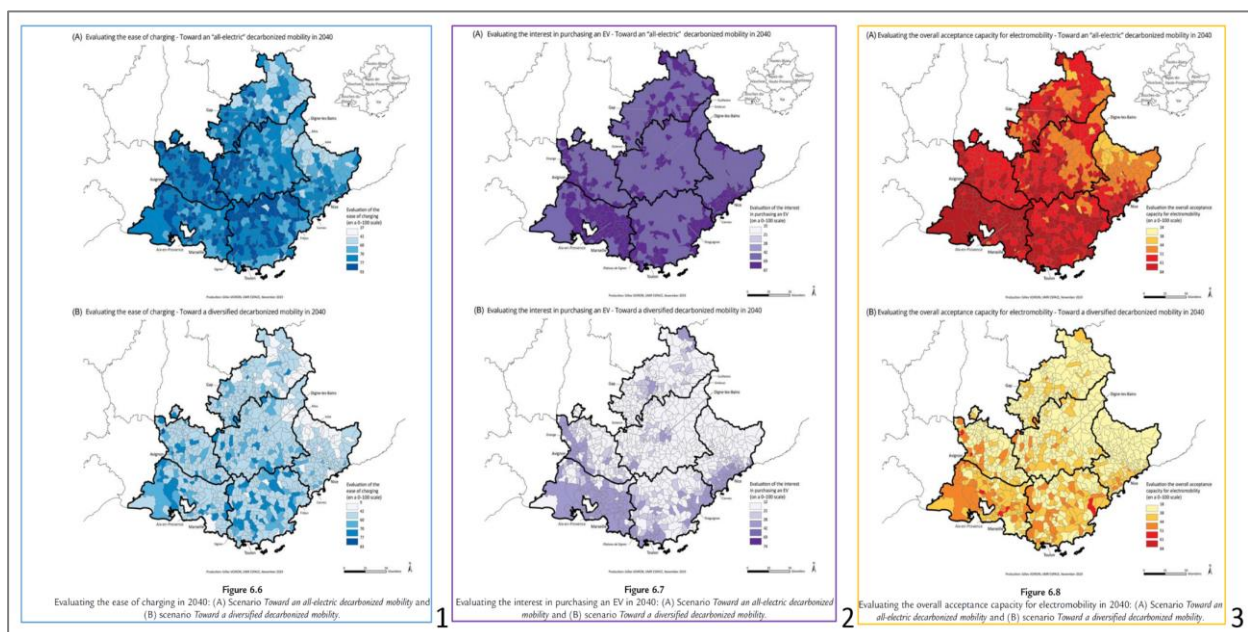

Figure 96 Assessment of territorial adoption potential of electric mobility. Source: Voiron-Canicio & Voiron (2020).

The conclusions of the study showed that the volume of electric vehicles (e-vehicles) is still very modest, which implies that is not possible to develop a spatial diffusion model at the moment, only theoretical ideas can be drawn. However, the authors stated that the EM is a territorialized system in which its structural composition and the interaction between its elements have been determined. Hence, this allows to identify the requirements and the necessary conditions that a municipality needs to meet in order to increase its ability to adopt and cope with change in terms of EM. The findings show that the territory has rather a high adaptability to change, especially the areas with high population densities, which is in line with the theoretical aspects of innovation diffusion, spatial interaction and central models. The results also shown that the territory has a capacity to adopt other kind of decarbonized technologies, which the authors considered as a sign of a potential adaptivity embedded in the territorial system.

In the region there are numerous efforts in different fronts within the sustainability transition process, here we will name some of them. For instance, the Chamber of Agriculture has launched a regional study focusing on biomass of agricultural origin (animal and vegetable). The study was an inventory of the different sources of biomass of agricultural origin that had a potential to produce energy (see Charbonnier, 2009). As well as the authors developed an analysis of the potential of valorisation of this biomass within the framework of combustion and methanization. The evaluation of the recoverable biomass took into account the preservation and assurance that organic matter returns to the soil, ADEME et al., (2017) have developed a more recent analysis. The Regional

Directorate for the Environment, Planning and Housing (DREAL) proposed the regional framework for development of photovoltaic projects in the South Region (DREAL, 2019). In the study the authors discussed the energy situation in France with regards to Europe and then analysis is declined towards the South Region. The region counts with an average solar load factor of 15.6% and 1,223 MW installed as of December 31 in 2018, that is around 14% of the installed capacity in urban areas in France, which puts the South Region region as one of the most dynamics regions in terms of photovoltaic transition. The region has as a goal to multiply the installed capacity by a factor of five in 2028.

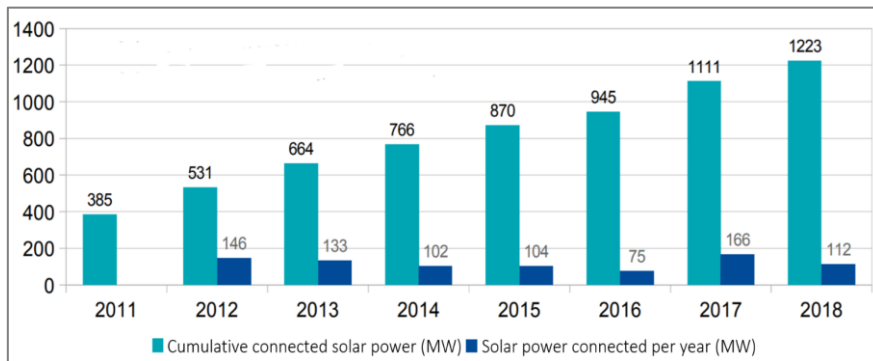

Figure 97 Photovoltaic Power Generated in the South Region in 2018.

Regarding wind power, the region through the DREAL (2012) launched a scheme for the development of installations and electricity production with wind power. The plan was adjusted with previous strategies such as the integration of Wind Power Development Zones, which were created in 2005. These zones are specific areas where the installation of wind power infrastructure is allowed, and they benefit from an obligation to purchase the electricity produced at a subsidies prices with regulated rates. Furthermore, the purchase obligation is guaranteed for 15 years. The development of the installations takes places in both, onshore and offshore where three categories of wind turbines can be identified: i) Large wind: power > 350 kW, turbines' heights are from 80 to 150m; ii) Medium wind: power between 36 kW and 350 kW, turbines' heights are blow 80m in general and iii) Small wind turbine: power between 1 kW and 36 kW, turbines' heights are approximately from 10m to 20m. The goals of the DREAL (2012) for the horizon 2020 were to contribute with approximately 3% to the national projections, which were set at 19,000 MW 2020. According to the Regional Observatory of Energy, Air and Climate of the South Region (ORECA), at the national level it was produced 17,600 MW in2020 and in the South Region 96 MW, which represents 0.55%. Regarding the regional goals set by the SRADDET per year, we can also observe a gap with the actual results as it is shown in the figure below.

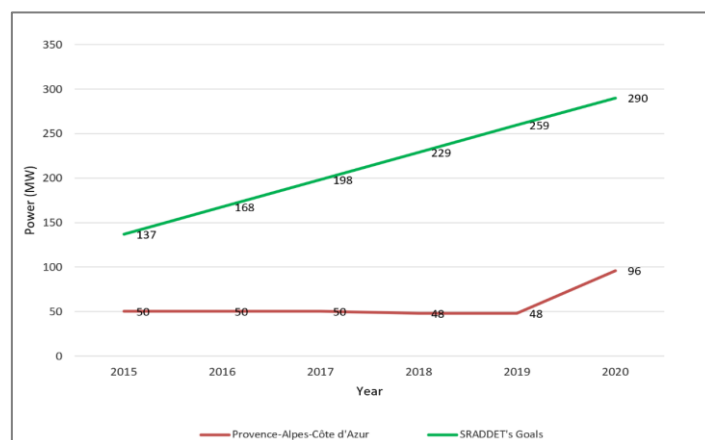

Figure 98 Evolution of the wind power in the South Region in MW. Source: ORECA⁴³

⁴³ Available online at: <https://trouver.datasud.fr/dataset/installations-eoliennes-raccordees-au-reseau-par-departement>

In summary, the region of study in the France is a territory which is very dynamic in the energy transition process and benefits from its exceptional geographic location. It appears that the region has a high level of adaptivity in terms of RET adoption, but a lot of work is still needed to speed up the pace of the transition according to the goals. It appears that the two regions of study both, in Switzerland in France would benefit of practical and operational strategies regarding the development of the sustainability transition. In that sense, we think that the integration of socio-technical approaches with the incorporation of the spatial dimension can contribute to accelerate the transition processes that seems to be posing considerable challenges to the regions.

3.7 French Data

The data used in the French region is completely open-source, in order to *i) Facilitate the verification of the results obtained in this PhD dissertation by other scholars and ii) Assure that the application of the model can be adopted and replicated by other scholars and decision-makers*. The latter aspects are intended to contribute to the field of research discussed in this research work by sharing the data and also the source codes developed here in an academic spirit of collaboration. In the case of the South Region, the model was built using data provided by the Air Quality Monitoring Association (ATMOSUD, 2019) in a data based called CIGALE⁴⁴, which is available only in French. The georeferenced data was provided by the National Institute of Geographic and Forestry Information⁴⁵.

3.8 Conclusion Chapter 3

The Chapter 3 discussed the contextual issues regarding the two territories of study which are the Swiss canton of Valais and the South Region of France. The socio-demographic situation of each region is described as well as the natural landscapes and their energy context. In both territories is found a high level of innovation studies regarding the energy transition as well as a political willingness to reduce the GHG emissions and meet the sustainable goals. It is also highlighted that more efforts are needed in both regions to fulfil with the requirements of the 2050 sustainability objectives. The innovation indicators that are analysed in this dissertation are presented and as well as the rationale of the subject topic of the research work, which is sustainability transition. The next chapter discusses the major characteristics of scale-free networks from a theoretical and practical perspective. A series of comparisons with random networks is carried out and the scientific implications of the difference between them is drawn. As well as an explanation of phase transition is developed as it's a phenomenon observed in the models' results in Chapters 5, 6 and 7.

⁴⁴ Available online at <https://cigale.atmosud.org/extraction.php>

⁴⁵ Available online at <https://geoservices.ign.fr/>

4 Integrating Network Science for Spatial Diffusion and Resilience Modelling to Renewable Energies: A Theoretical Background.

*“For whoever has will be given more,
and they will have an abundance.*

*Whoever does not have,
even what they have
will be taken from them”.*

—Matthew 25:29

The integration of network modelling in innovation diffusion is not new (see Valente, 1995; Kiesling et al., 2012). With the arrival of ABM, modelling interactions and decision-making processes have become more accessible within different fields, where scale-free networks topology has increasingly gained the scholarship’s attention. The idea is not to apply ABM everywhere but use it when is relevant for example, when the hidden and vast microscopic interactions result in a pattern only observable at macro level. A common approach to model interaction is graph theory and its application on spatial modelling is a powerful tool to unveil hidden microscopic interaction patterns. Under this multiscale vision, this section will focus on scale-free networks in order to define the fundamental characteristics of such networks. In the state-of-the-art we already introduced some modelling approaches of knowledge and innovation diffusion with some theoretical conceptualizations. A deeper review on graph theory is still needed though, in order to understand the methodological choices and the procedures that were followed in the construction of the diffusion model of RET.

The rationale of the methodological choice of network sciences relies on different reasons nonetheless, the most relevant is that in this study we look at urban systems as urban networks. Under this view, the urban networks are composed of agents such as people, jobs, housing, energy, information, goods, services, space among other variables. They interact with each other, generate exchanges and are in competition. Hence, in this dissertation we considered the network approach as a conceptual instrument to develop compatible models for RET diffusion and urban resilience to such diffusion process. The view of urban systems as urban networks is an approach that helps to characterize the structure of social phenomena such as the diffusion of RET. The questions we try to understand is how RET diffuse within a social system that is composed by different types of agents living in spatial structures which are agents themselves. Taking a network view on such social-spatial systems, the question of RET can be analysed by taking a blueprint and a list of ‘parts’ of the system as a first step to understand the social organization patterns of the phenomenon. Since the size and the volume of data and the derived interactions are too big it is necessary to determine fewer ‘parts’ of the system that are able to provide significant information about the whole system.

By analogy, a car is composed by thousands of parts however, a driver only needs to know how to use four of them to go from point A to point B: the steering wheel, gas (accelerator), brakes and clutch. However, a car is composed of thousands of parts, which a driver is not entitled to know. The application of network science in complex systems could be understood as a facilitator, which allows scientist to look at very few parameters to draw conclusions of complex systems’ datasets.

In a practical sense, observing at the geo-referenced data of solar PV at first might seem to be random however, it is possible to find a certain order in the irrigation process of adoption. The big amount of data and the vast possible number of explanatory variables of RET diffusion might look complex and messy, but certain order might be found after all, even though a randomness might be suggested by the nature of phenomenon itself. The increasing data production in different fields have allowed to discover several networks that used to be invisible, such as the one presented here. A sense of simplicity also underlies the choice of the network approach for modelling both phenomena, RET diffusion and urban resilience. The idea is to model and simplify the complexity of the real mechanisms, since adding the spatial dimension can contributed to the difficulty (see Sanders & Sanders, 2004). A conscious development and avoidance of piling models over models is taken in this study, therefore keeping network theory as methodology for RET diffusion and urban resilience is aligned with that conceptual posture.

In the next section we will focus on the some of the fundamentals in networks science and a continuous comparison between random and scale-free networks will be carried out. Such comparisons are made with the aim of consistency with the non-randomness found in innovation and spatial diffusion processes as well as the self-organize nature of such processes. In this section also will be developed some of the mathematical and statistical fundamentals for network analysis in order to describe the back-end processes carried out by algorithms. The correspondent analyses will be developed largely relying on Hungarian American physicist Albert-László Barabási's work, since he is the main author of the preferential attachment concept, which is a cornerstone of this research.

4.1 Preferential Attachment vs Randomness

Before we start developing the conceptual definitions, we will briefly note a distinction between network science and graph theory, which is rarely made. For the sake of clarity in the usage of the terminology in the next sections, we depict in the **Error! Reference source not found.** the interchangeability of terms in the field and their equivalence in network science and graph theory. The usage of 'network theory' often is done in the context of real systems such as the social network of colleagues or family. While the utilization of 'graph theory' is often to refer to mathematical representations for example, the web graph. The terms used in both streams are synonyms.

Network Theory	Graph Theory
Network	Graph
Nodes	Vertex
Links	Edge

Table 11 Networks Science or Graph Theory.

Now we will proceed with a brief review on network science and will start by reviewing random networks, which was the predominant theory since its introduction in late 1950's by Erdős & Rényi (1959). Random networks had a big impact in science for four decades and among some of the inherent implications of the acceptance of this theory was that it somehow equalized complexity with randomness (Barabasi, 2002). There are two definitions of a random network accepted by the scientific community *i)* the $G(N,L)$ Model where N nodes are connected with L randomly distributed links. This definition was proposed in two papers by Erdős & Rényi (1959, 1968) and *ii)* the $G(N, p)$ Model where each pair of N nodes is connected based on a probability p . This definition was introduced by Gilbert (1959). According to the $G(N,L)$ model, the network formation is modelled by calculating the number of links L . In this model the average degree of a node has the form $\langle k \rangle = 2L/N$. This approach is mainly used to study static random networks. Whilst the $G(N, p)$ model focuses on the probability p of two nodes to be connected. The

latter seems to be a preferred approach given its facility to calculate other characteristics of networks and also because real networks often keep growing so the number of links too. Regardless of the approach used to determine the random nature of a network, it is important to add that random networks are really random. In random network theory all vertices have the same probability to be connected with another link. In Figure 99, we observe a random network generated with $N=10$ and a wiring probability $P=0.6$.

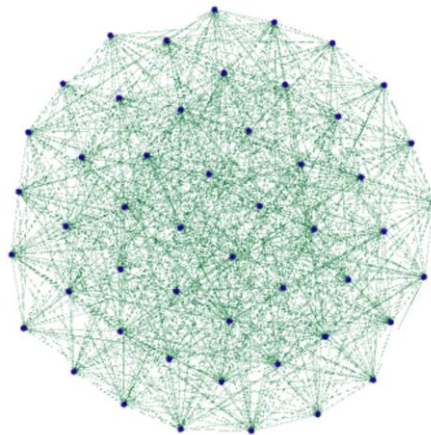

Figure 99 Random network, generated with Gephi.

The exact form of a random network's degree distribution is the Binomial distribution for $N \gg \langle k \rangle$ and the Binomial is very well approximated by a Poisson distribution (Barabasi, 2016). Where N is the number of vertices and $\langle k \rangle$ is the average degree of the network. Both formulas fit well the distributions however, the Poisson distribution is more commonly used as it needs only the parameter $\langle k \rangle$ while the Binomial distribution depends on p and N , which ease calculations processes it is shown below.

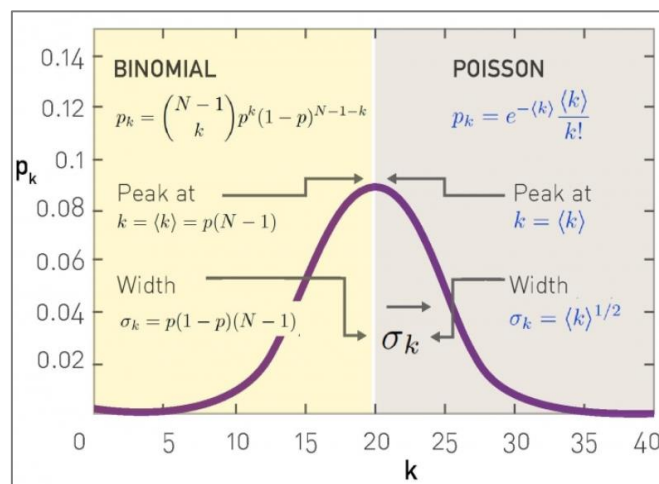

Figure 100 Binomial vs. Poisson Degree Distribution (Barabasi, 2016).

A milestone in network science is that the Erdős-Rényi and the Watts-Strogatz models assumed a static and fixed number of nodes (Barabasi, 2002), while scale-free networks assume a continuous growth. Growth is an important feature in real networks such as diffusion processes with a spatial focus, where spatiotemporal changes are a fundamental aspect of systems dynamics. Before entering to the discussion on scale-free networks, a general overview on theoretical aspects of graph theory will be addressed. Evolving networks have properties such as phase transitions and thresholds which will be discussed as follows.

4.1.1 Thresholds and Phase Transitions in Evolving Networks

Barabasi (2002) showed some examples of phase transitions found in the nature. Water, which is the most common substance on the planet and the most studied, follows an interesting process between order and disorder depending on the temperature. Gases and crystals are rather simple since the former are flying in empty space and the latter are a rigidly organized lattices. Water is different and complex, a balanced movement between gases and crystals, as it has its molecules contained in a movement between chaos and order. In high temperatures, H₂O molecules follow diffusive movements but at a threshold of 0 °C all the molecules form a stable and solid structure (see Figure 101A). Also, in ferromagnetic materials we observe that the atoms' spins, point at random directions when they are above certain temperatures. However, under a threshold in a cooler critical temperature T_c all atoms' spins, point to the same direction and the material creates a magnetic field (see Figure 101B). Thus, the freezing process of water and the emergence process of a magnet, undergo a phase transition from chaos to order (Barabasi, 2002).

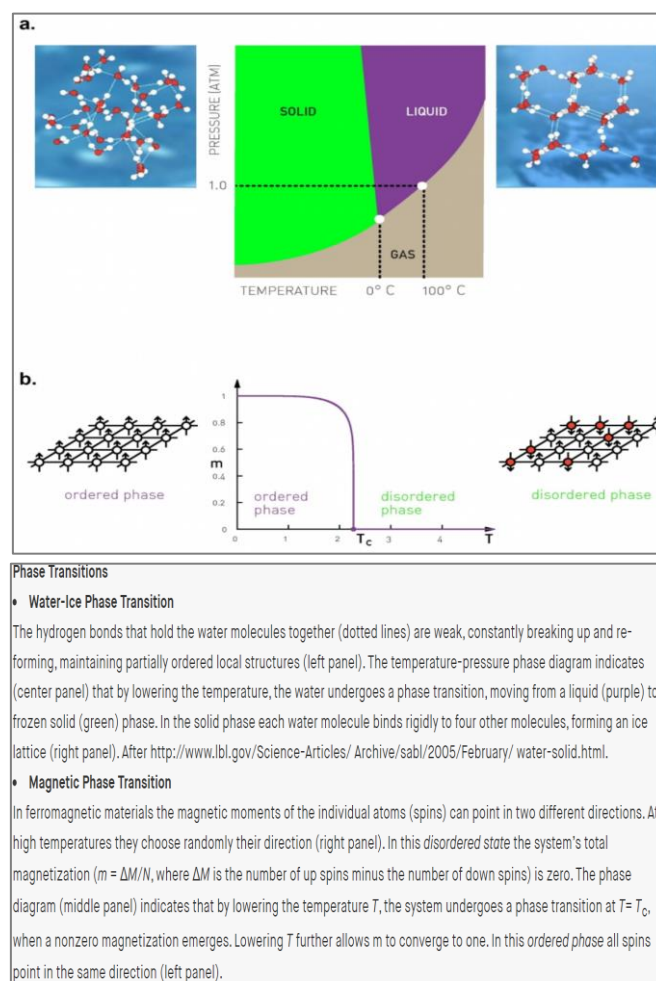

Figure 101 Phase Transitions, Barabasi (2016).

Similarly, the same concept is applied in network theory, so this an interesting concept for applications in urban networks and spatial diffusion of innovations. In random networks, isolated nodes and isolated clusters can become a large cluster or a giant component through a similar process, once a threshold is reached. The networks shown in the Figure 102 were simulated with the software Gephi (Bastian et al., 2009) and depicts four different wiring probabilities Poisson $p(n)$ in random networks. Note that the threshold for the emergence of cycles and a

giant component is $p = 0.02$ which can be observed in Figure 102B and the threshold for connection is $p = 0.08$, see Figure 102D.

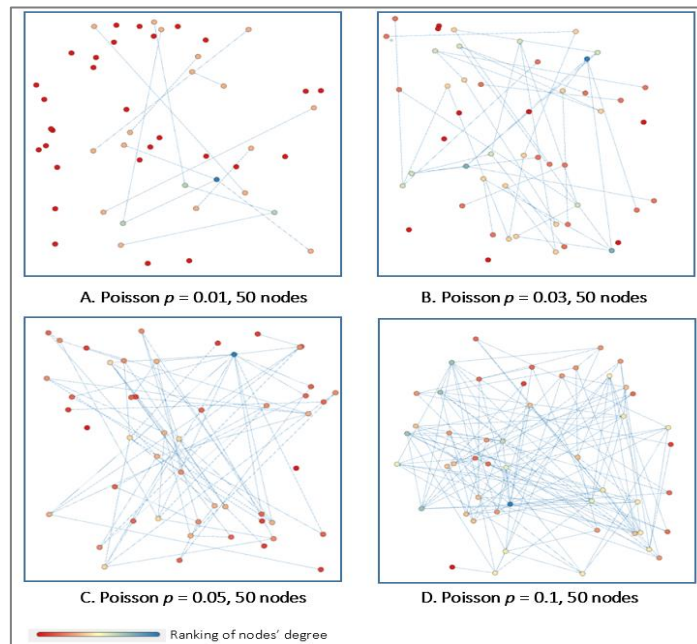

Figure 102 Thresholds for Poisson Random Networks, generated with Gephi.

The mathematical formalisation of thresholds and phase transitions in Poisson random networks will be developed as follows. The most common properties used to analyse growing networks are called monotone or increasing properties. A monotone property has a kind of an inheritance designation for growing networks, that means that a given network g satisfies a property $A(N)$ and if we add more links to g so we have a subset g' then, g' also satisfies $A(N)$. So mathematically speaking that is $A(N)$ is monotone if $g \in A(N)$ and $g \subset g'$ implies that $g' \in A(N)$ (Jackson, 2008).

The transition from disconnected nodes to a giant component is not a gradual process in a network $G(N)$ on the set of nodes N , where $N_G = 1$ to $N_G = N$ if $p(n)$ increases from 0 to $N-1$. The actual process as shown in Figure 102 and as discussed by Barabasi (2016) and also depicted in Figure 103, N_G/N has a value equal to zero for small $p(n)$ which designates a small value that indicates that there is not a cluster. The emergence of a giant component begins when $p(n)$ reaches a threshold and only one more link would be enough to generate the emergence of a large cluster. The general formalisation to calculate the threshold function in a random network model⁴⁶ is discussed as follows. A Poisson random network, where $p(n)$ designates the set of nodes N , a threshold function of a given property is a function $t(n)$ where that given property has a probability that approaches 1 , for instance:

$$(Pr[A(N)|p(n) \rightarrow 1] \text{ if } p(n)/t(n) \rightarrow \infty) \quad (4.1)$$

Otherwise, the given property holds with a probability approaching 0:

$$(Pr[A(N)|p(n) \rightarrow 0] \text{ if } p(n)/t(n) \rightarrow 0) \quad (4.2)$$

In the case that the threshold function exists, then a phase transition emerges at that critical point. As pointed by Jackson (2008) eventually; if there is not a precise threshold function it is still possible to determine lower and

⁴⁶ For a complete review on random graph theory see: Erdős & Rényi, 1959, 1968; Gilbert, 1959; Bollobas, 1985; Jackson, 2008; Barabasi 2002, 2016.

upper bounds for a given property that holds for $p(n)$'s within the range of those bounds. Barabasi (2016) presented the phase transition process focusing on the nodes' degree $\langle k \rangle$, where the largest component is denoted by $N_G \sim N^{2/3}$. Thus, the network's size grows faster than N_G and its relative size decreases as $N_G/N \sim N^{-1/3}$ in the $N \rightarrow \infty$ limit.

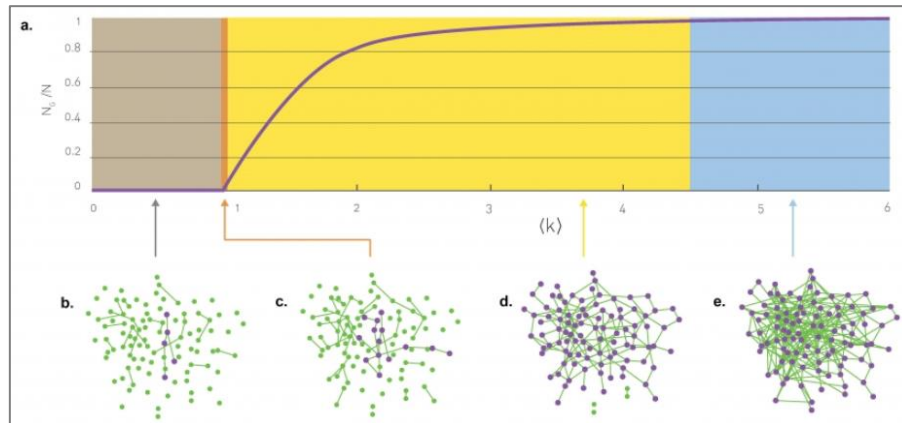

Figure 103 Evolution of a Random Network, Barabasi (2016).

These changes of regime have interested physicists since the 1960's, which generated an incremental number of experiments on phase transitions. As described by Barabasi (2016) these experiments in the field of statistical physics allowed scientists to identify that near the critical point different key quantities followed power laws. The distance in between atoms communicate with each other is used as a rough measure of the cluster size (Barabasi, 2016). A phenomenon occurs when the distance between atoms that communicate with each other or correlation length is reduced. It appears that once they are approaching the critical point, the correlation length increases and follows a power law, and it has a unique critical exponent (Barabasi, 2016). The correlation length indicates the measure of the constraint amongst high movements of points that are near each other. So, this constraint should be significant when the points are within the correlation length and otherwise outside that distance (see Franceschetti & Riccio, 2007).

The critical exponent is a parameter that describes the behaviour of physical quantities when they approach the threshold of phase transitions. Researchers showed that, when metals approach the phase transition temperature, then distance over which the spins know about each other increases (Barabasi, 2016). Moreover, the strength of the magnet when is near the temperature threshold is determined by the proportion of spins that point the same direction and it was found that it follows a power law but with a different exponent (Barabasi, 2016).

Kenneth Wilson took Kadanoff's idea of looking at atoms as a unified group when they are at the vicinity of the critical point, so putting boxes of atoms that would behave similarly (Kadanoff, 1993). Wilson's work (1971a, 1971b) had as a starting point the scale invariance, he had the assumption that a system near the critical point the laws of physics would apply in the same way at all scales, single atoms and boxes with millions of atoms. His theory is called renormalization and could demonstrate that every time the system was in the vicinity of the critical point, there were power laws and a phase transition from chaos to order. Wilson's discovery was awarded with a Nobel prize in physics in 1982.

4.1.2 Scale-free Networks: The Barabasi-Albert model.

The self-organized nature of various networks in the real world seems to be observed also in social organization processes, one of the most well-known examples is the WWW network topology. This is the largest man-made

network, and it is composed by hubs that are described by power laws. In the Barabasi-Albert (1999) model in which the authors analysed the WWW network, they found power laws when they fit the histogram of the nodes' connectivity on a so called log-log plot. In this model the vertices are the documents and the edges are the URLs that help 'surf' the web with one click.

The authors showed that genetic networks such as the WWW have a common characteristic feature with other large networks where the growth process presents a process of rich get richer. That is that vertices with more edges will systematically get more vertices connected to them. Barabasi & Albert (1999) called this property preferential attachment. This term in network science designates the non-random vertex connectivity behaviour observed in large networks. Preferential attachment is a property of connectivity in which, new nodes attach preferentially to link that are already well connected. The World Wide Web (WWW) is the largest network built by human beings and has an estimated size over 1 trillion documents or $N \approx 10^{12}$. This is even larger than the human brain ($N \approx 10^{11}$ neurons) or the planet's social network $N \approx 7 \times 10^9$ Barabasi (2016). Modelling and computing the WWW network has also helped to continue in this direction of research on non-random networks and thus discover that there are nature and social networks that follow power distributions such as the actors' network in Hollywood.

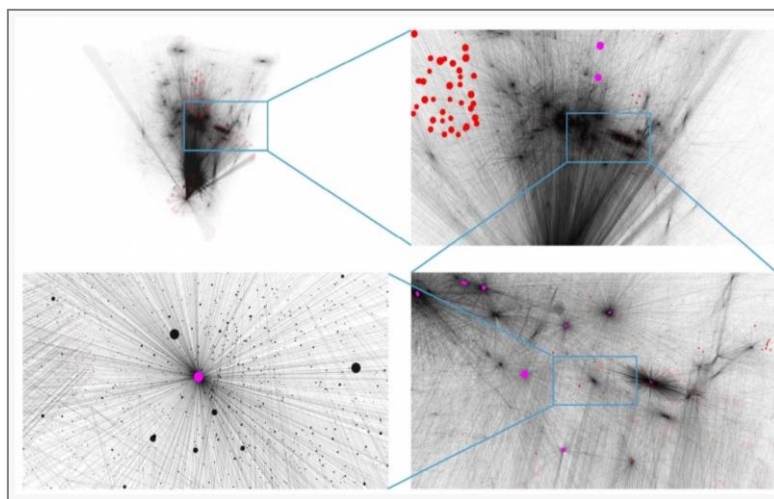

Figure 104 The Topology of the World Wide Web, Source: Jeong et al., (1999)

The figure below showed some of the results of the seminal paper written by Barabasi & Albert (1999).

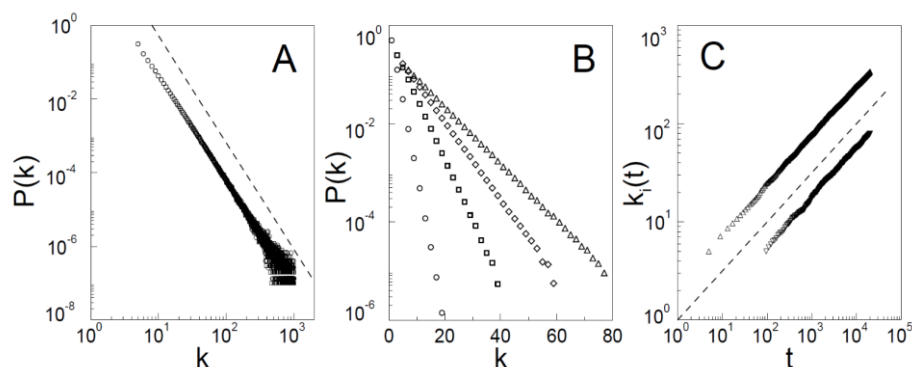

Figure 105 The distribution function of connectivity for various large networks. (A) Actor collaboration, n graph with $N = 212$, 250 vertices and average connectivity $\langle k \rangle = 28.78$; (B) World wide web, $N = 325, 729$, $\langle k \rangle = 5.46$ (6); (C) Power grid data, $N = 4, 941$, $\langle k \rangle = 2.67$. The dashed lines have slopes (A) $\gamma_{actor} = 2.3$, (B) $\gamma_{www} = 2.1$ and (C) $\gamma_{power} = 4$.

The network topology observed in the electrical powergrid of Western US is a spatially explicit example of urban and industrial development embedded in a self-organized system. In this system the nodes represent the

electricity generators, substations and transformers, while the links correspond to the high voltage transmission lines between them (Barabasi & Albert, 1999) see also Watts & Strogatz (1998).

This distributional phenomenon was already observed outside of network science, prominent economist Vilfredo Pareto who was also an enthusiastic gardener, observed that 80 % of his peas were produced by only 20 % of the peapods. He transferred this observation to economic laws: in Italy 20 % of the population owned 80 % of lands. In spite of the fact that Pareto never used the expression 80/20, his principle has been coined in management, which might be referred to as the Murphy's law where 80 % of profits come from 20 % of clients or 20 % of employees produce 80 % of profits and so forth.

This principle has migrated to other fields as well, for example 80 % of crimes are committed by 20 % of criminals and it has also been used in sociology. Sociologist Robert Merton (1968) coined the term *Matthew effect* also known as the *Matthew effect of accumulated advantage* (see Price, 1976). The name is derived from the parable of the talents written in the biblical Gospel of Matthew, where the adage "the rich get richer and the poor get poorer" comes from. A last curious comment on the last note, is that the following biblical verse says: "And throw that worthless servant outside, into the darkness, where there will be weeping and gnashing of teeth." This is a similar process to what happens in scale-free networks in the small- k fat-tailed region where most of k_{min} nodes are located: isolated with a larger pathlength to the well-connected nodes (see Figure 17).

Physicists refer to the Pareto rule as power laws (Barabasi, 2016). It is important to observe that this principle does not apply to any kind of networks, but to a special family of phenomena where a property that plays a key role in understanding complex networks (Barabasi, 2016). There are other networks that follow the same distribution such as the e-mail network or the protein-protein interaction network (Barabasi, 2016).

The observation of fat tails distributions in large social systems, although pioneers like Zipf (1949) modeled the usage of words and Auerbach (1913) city sizes, the first one to report fat tails in a network setting was Price (1965). British physicist Derek de Solla Price developed a study on the citations among scientists taking into account both incoming and outgoing links. A fat-tailed network with a degree distribution that follows a power law in the high- k region. Later, other studies regarding scientific citations under a graph approach have been conducted in economics (Goyal et al., 2006) mathematics (Grossman, 2000) and biology, computer science and physics (Redner, 1998; Newman, 2001). For a deeper reading on network approaches on learning, collaboration, research and innovation see Jackson (2008). A parallel research to the Barabasi's team was developed by the Google founders Sergey Brin and Larry Page (Brin & Page, 1998). Both research works are related in the sense that they analysed the WWW connectivity, a major difference is that Google's algorithm had an indexation of pages. Barabasi and his team used the term 'scale-free' which is used in a branch of statistical physics, the so-called theory of phase transitions that was briefly described above. This term was used as the WWW behaviour shows that the power law persists for about four orders of magnitude. The underlying idea of this term is that scale-free lack a scale, where the behaviour of the average degree $\langle k^n \rangle$ is affected by the asymptotic limit of the largest hub $k_{max} \rightarrow \infty$.

Random networks do have a scale, if we look at the Poisson degree distribution $\sigma_k = \langle k \rangle^{1/2}$ is smaller than $\langle k \rangle$. Therefore, the nodes of the network have degrees in the interval $k = \langle k \rangle \pm \langle k \rangle^{1/2}$ (Barabasi, 2016). This means that the average degree of a node in a random network is $\langle k \rangle$. Evolving networks have different *moments* in which the average degree is changing and in the case of scale-free networks the average degree $\langle k \rangle$ provide the following information at each moment:

The n^{th} moment of the degree distribution is defined as follows:

$$\langle k^n \rangle = \int_{K_{min}}^{\infty} K^n p_k \int_{K_{min}}^{\infty} K^n p(k) dk \quad (4.3)$$

- i) Moment 1: The average degree $\langle k \rangle$
- ii) Moment 2: $\langle k^2 \rangle$, where the variance $\sigma^2 = \langle k^2 \rangle - \langle k \rangle^2$ and allows to measure the degrees
- iii) Moment 3: $\langle k^3 \rangle$, gives information on how symmetric is p_k around the average $\langle k \rangle$

Where scale-free networks, the n^{th} moment is:

$$\langle k^n \rangle = \int_{k_{min}}^{k_{max}} K^n p(k) dk = C \frac{k_{max}^{n-\gamma+1} - k_{min}^{n-\gamma+1}}{n - \gamma + 1} \quad (4.4)$$

The k_{min} value is often fixed however, in evolving scale-free networks the largest hub k_{max} is constantly increasing alongside with the network. The limit $k_{max} \rightarrow \infty$ predicts that $\langle k^n \rangle$ term is depending on the intertwined relation between n and γ as follows:

If:

- i) $n - \gamma + 1 > 0$; then $\langle k^n \rangle$ would go to infinity as the hub $k_{max} \rightarrow \infty$. Hence all moments larger than $\gamma - 1$ diverge.
- ii) $n - \gamma + 1 \leq 0$; then $k_{max}^{n-\gamma+1}$, goes to zero as the hub k_{max} increases, which means that all moments that satisfies the term $n \leq \gamma - 1$ are finite.

According to the Barabasi-Albert model, there are two factors required in the emergence of scale-free networks. The first one is *growth*: most real-life networks trend to grow therefore is not static and increases with time. In scale-free networks, the network has a few numbers of nodes (m_0) in the beginning and then one vertex with m ($\leq m_0$) edges is added at each time step t and it will get connected to older vertices already existing in the network.

Expected degree (ED) for node i born at $m < i < t$ is $m + m/(i+1) + m/(i+2) + \dots + m/t$

The approximation for this expression can be the following one, which is also known as harmonic numbers:

$$ED = m \left(1 + \log \log \left(\frac{t}{i} \right) \right) \quad (4.5)$$

The second characteristic is *preferential attachment*: When a new node chooses the nodes to connect with, the model assumes that the probability π that that new node connects to a node i present already in the system will depend on the current connectivity k_i of that existing node. This can be formalised like this:

$$\pi(k_i) = \frac{k_i}{\sum_j k_j} \quad (4.6)$$

After the appearance of new nodes, the Barabasi-Albert model leads to a random network $t + 1$ with m_0 and mt links. The interesting result of the combination of growth and preferential attachment is that the network evolves in a scale-invariant distribution, with the probability that a node has L links, following a power law. Barabasi (2016) later discussed why are hubs missing in random networks. According to the Poisson distribution formula:

$$Pk = e^{-\langle k \rangle} \frac{\langle k \rangle^k}{k!} \quad (4.7)$$

The factorial term in $1/k!$ rapidly reduces the probability of nodes having large degrees. The Stirling⁴⁷ approximation for factorials:

$$n! \sim \sqrt{2\pi n} \left(\frac{n}{e}\right)^n, \text{ when replacing } n \text{ by the degree } \langle k \rangle \text{ we have then:} \quad (4.8)$$

$$k! \sim \sqrt{2\pi k} \left(\frac{k}{e}\right)^k, \text{ which can be rewritten as follows:} \quad (4.9)$$

$$Pk = \frac{e^{-\langle k \rangle}}{\sqrt{2\pi k}} \sim \left(\frac{e\langle k \rangle}{k}\right)^k \quad (4.10)$$

The term in the parenthesis is smaller than 1 for degrees $k > e\langle k \rangle$, therefore for large k both k -dependent terms in the Stirling approximation. For instance, $1/\sqrt{k}$ and $(e\langle k \rangle/k)^k$ rapidly decreases when k increases. In other words, the Stirling formula predicts that in random networks, the probability of witnessing a hub decreases faster than exponentially (Barabasi, 2016). An example of a spatially explicit application where hubs are observed, is the transportation system. In the chart below, Figures A and B show the highway connection between cities in the US, which follow a bell-curve shape. Figures C and D show the connection between airports and, which follow a power law or a fat-tail distribution where there are several airports with very few connections and few highly connected airports which are referred to as hubs. A relevant aspect regarding the qualitative characteristics that differentiate a power law from a bell-curve is related to the tail of the distribution.

The curves of Poisson distributions have exponentially decaying tails quicker than those exhibit by power laws, which is the ultimate reason of the non-existence of hubs (Barabasi, 2002, 2016). Note that there is an important qualitative difference between a power law and a bell curve when it comes to the tail of the distribution. Curves have an exponentially decaying tail, which is a much faster decrease than that displayed by a power law. This exponential tail is responsible for the absence of the hubs. In comparison, power laws decay far more slowly, allowing for “rare events” such as the hubs. For related research, readers can look at Barrat et al., 2005; Pumain et al., 2006; Barthelemy, 2011.

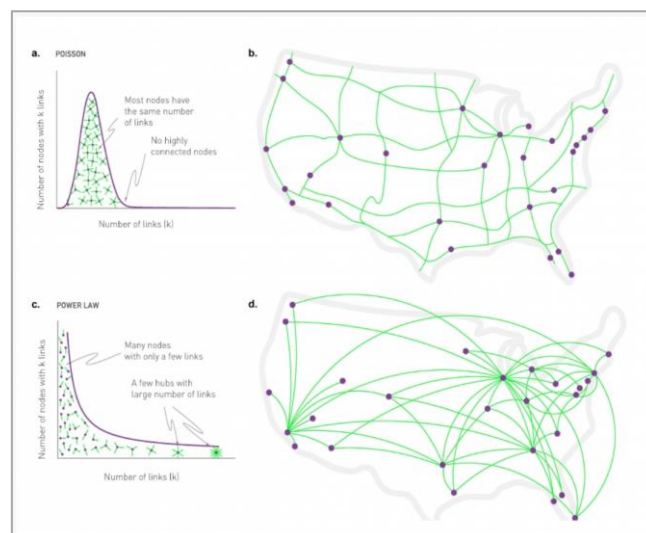

Figure 106, A and B are the degree distribution of the highway system network in the US. C and D are the degree distribution of the airline system network in the US. Source: Barabasi (2002).

It is possible to observe the in the scale-free distribution a fatter tail in the lower tail, that is for lower degrees, whereas for the higher degrees it is a bit harder to see the differences. A way to improve the aesthetics in the

⁴⁷ It is possible to define the exponential function in different ways in order to develop useful formulas that can be used in graph theory for example. The application in this case is for functions with large n , but the usage could be done to fixing X at any complex, negative or positive value: $\lim_{n \rightarrow \infty} \left(1 + \frac{x}{n}\right)^n = e^x$ or another definition of e is giving by: $e^x = \sum_{i=0}^{\infty} \frac{x^i}{i!}$ (see Jackson, 2008)

upper tail of such charts is by converting the linear plot to a log-log plot of the frequency versus the degree. The Figure 107 section A shows the lineal plot of both Poisson and Power law and the Figure 107 section B shows the log-log plot of the same distributions. In random networks all vertices have the same probability of being connected and hubs are forbidden. This means that the connectivity of the graph is similar for all vertices, which is observably in the highway system in the the US.

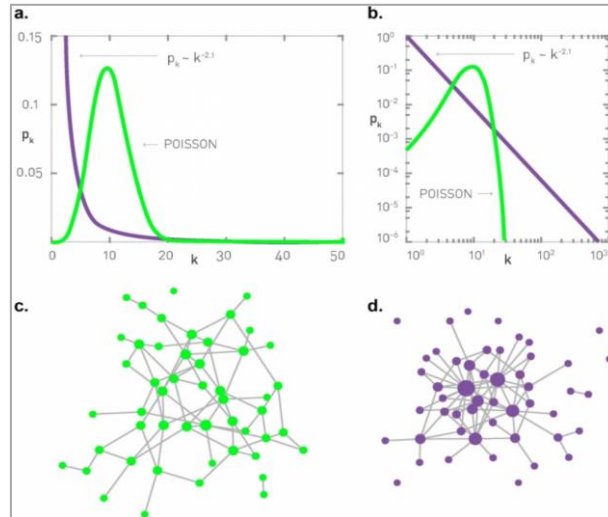

Figure 107 Poisson vs. Power-law Distributions. Source: Barabasi (2016)

More details on the procedure related the construction of scale-free networks will be developed in the next Chapter, where the data of RET in Switzerland will be done and in the subsequent Chapter in France. In the network building process important information is provided by the Barabasi-Albert model and is how to detect the largest hub of the system. The meaning of the largest hub has only a significance within the context of the research subject. Taking into account that the goal in this research work is to develop a simulation of the RET diffusion in a spatial network, for the case of the Swiss region socio-economic data was used. Within context as it will be thoroughly developed, a virtual grid was deployed in the territory at multiple scales. The spatial units or pixels resulting from this operation are the nodes of the network, whose physical sizes are identical within a given scale but with the different values stemmed from a composite indicator.

The value of the composite indicator is considered as a potential field of innovation, where a concentration of high raster values is present in very few locations and the values decrease following a power law. The conceptual idea of this view is that the phenomenon observed in innovation diffusion at a national level as discussed in Chapter 1, it continues to occur at much smaller scales. From a spatial viewpoint, the largest hub would have different physical sizes and values depending on the scale of observation. According to Barabasi (2016) a relevant question to be asked is *'how does the network size affect the size of its hubs?'* The sizes of the hubs are naturally affected by the network size since the bigger the network there are more possibilities for nodes to get connected with other new nodes. But to specifically answer this question, it is necessary to determine the size of the largest hub k_{max} , which is the cutoff of the degree distribution p_k (Barabasi, 2016). Before dealing with the calculation of the largest hub, a brief review on the calculation of the degree distribution is required, to do so the procedure used by the author of the model will be followed. The Barabasi-Albert model approximated the degree distribution of the WWW with a power law distribution, where for an undirected network we have the following expression:

$$P_k \sim k^{-\gamma} \tag{4.11}$$

And for a directed network we have:

$$\tag{4.12}$$

$$P_{kin} \sim k^{-\gamma_{in}} \quad \text{and} \quad P_{kout} \sim k^{-\gamma_{out}}$$

This is a power law distribution and γ is its degree exponent. A lin-lin scale will not allow us to see the distribution because of two major reasons. First, scale-free networks are composed by few hubs or nodes with thousands of links, which it is the case on the networks in this research project. A linear k -axis would significantly reduce the high number of nodes with small degrees within a small k region, which implies that it would not be possible to see them. The second reason relies on a disproportional issue, which is characterized by the difference of the magnitudes between Pk and k , where k values are large, Pk values can be thousands of times smaller. This issue is solved by applying a log-log plot taking into account that values equal to zero are not shown since $\log 0 = -\infty$. Then, we have the equation in the form:

$$\log p_k \sim -\gamma \log k \quad (4.13)$$

Subsequently for a directed network we have:

$$\log p_{kin} \sim -\gamma_{in} \log k \quad (4.14)$$

And:

$$\log p_{kout} \sim -\gamma_{out} \log k \quad (4.15)$$

The subsequent step is to determine the γ value, which is required to be calculated for K_{in} and K_{out} when the developed network is directed like in this study. This phase is a major milestone in the process given that networks behaviour is highly influenced by this parameter, prompting systems to work in different ways depending on the γ value. While doing analytical calculations, often is assumed that the degrees have positive values. In the case of scale-free networks, the power law degree distribution can be written as follows:

$$p(k) = Ck^{-\gamma} \quad (4.16)$$

Whose normalization condition has the form:

$$\int_{k_{min}}^{\infty} p(k) dk = 1 \quad (4.17)$$

Where;

$$C = \frac{1}{\int_{k_{min}}^{\infty} k^{-\gamma} dk} = (\gamma - 1)k_{min}^{\gamma-1} \quad (4.18)$$

The former expression is then used in the continuum formalism of the degree distribution, where k_{min} is the smallest degree that holds for the power avoiding a divergence⁴⁸

$$P(k) = (\gamma - 1)k_{min}^{\gamma-1}k^{-\gamma} \quad (4.19)$$

As for the largest hub k_{max} it is assumed that at most one node in a network of N nodes will be in the (k_{max}, ∞) regime. That means that the probability to have a node with a degree exceeding k_{max} is $\frac{1}{N}$. For networks of scale-free nature, the natural cutoff is given by:

$$k_{max} = k_{min} N^{\frac{1}{\gamma-1}} \quad (4.20)$$

⁴⁸ The discrete gives the likelihood p_k that a node has k links, where $\zeta(\gamma)$ is the Riemann-zeta function: $Pk = \frac{k^{-\gamma}}{\zeta(\gamma)}$; which the discrete power-law distribution has this form when $k > 0$ and diverges when $k=0$.

Agreeing with the term above it is possible to prove that the larger the network, the larger is the biggest hub's degree. k_{max} as a dependent term and additionally having a polynomial dependence, entails that it is possible to obtain different orders of magnitude between the smallest node (k_{min}) and the biggest hub (k_{max}) of the network. The figure below is an example of two scale-free network, where the green straight line has $N-1$ nodes than the purple and the sizes of the network and the biggest hub are observable.

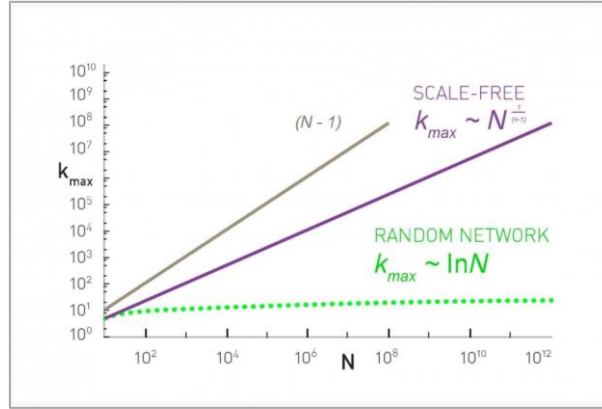

Figure 108 Hubs in scale-free networks. Source: Barabasi (2016)

In order to correctly plot scale-free networks and thus show their properties it is necessary to calculate p_k , which is calculated through the following term: N_k/N . The important issue then, is to plot p_k , which should be done in a log-log plot with a logarithmic binning, thus avoiding a linear binning. The cumulative distribution should be used with the aim of getting more information about the tail of p_k as follows:

$$p_k = \sum_{q=k+1}^{\infty} Pq \quad (4.21)$$

If the network's p_k is described by a power law, then the emergence of scaling in the cumulative distribution has the form:

$$P_k \sim k^{-\gamma+1} \quad (4.22)$$

For more details in the procedure, readers are referred to Barabasi (2016) in the section *Advanced Topic 3.B*. The next step is to determine the degree exponent γ , whose value determines the scale-free properties of a network. This is the most difficult task in the process of plotting scale-free networks, a global explanation will be developed as follows, relying on Barabasi's (2016) procedures. Additionally, a fitting power-law algorithm proposed by Clauset, et al., (2009) is available online⁴⁹.

- i) First it is required to estimate the degree exponent by choosing a value of k_{min} located between k_{min} and k_{max} using the following equation:

$$\gamma = 1 + N \left[\sum_{i=1}^N \ln \frac{k_i}{K_{min} - \frac{1}{2}} \right]^{-1} \quad (4.23)$$

- ii) With the values found above (γ, k_{min}) and under the assumption that p_k has the following form:

⁴⁹ A fitting power-law code is available online at <https://aaronclauset.github.io/powerlaws/>

$$Pk = \frac{1}{\zeta(\gamma, k_{min})} k^{-\gamma}; \text{ where} \quad (4.24)$$

The cumulative distribution function (CDF) for the degree distribution is given by:

$$Pk = 1 - \frac{\zeta(\gamma, k)}{\zeta(\gamma, k_{min})}; \text{ where} \quad (4.25)$$

- iii) The maximum distance D among the CDF of the data $S(k)$ and the fitted model found with the CDF is calculated with the Kolmogorov-Smirnov test.

$$D = \max_{k \geq k_{min}} |S(k) - P_k| \quad (4.26)$$

- iv) The same procedure of the previous steps is done for the whole range between k_{min} and k_{max} in order to find the minimal distance D . And finally, as for the standard error of the degree exponent $\sigma\gamma$ is calculated as follows and the best fit is $\gamma \pm \sigma\gamma$:

$$\sigma\gamma = \frac{1}{\sqrt{\left[\frac{\zeta''(\gamma, k_{min})}{\zeta(\gamma, k_{min})} - \left(\frac{\zeta'(\gamma, k_{min})}{\zeta(\gamma, k_{min})} \right)^2 \right]}} \quad (4.27)$$

For example, the WWW the exponent degree calculated by Barabasi & Albert (1999) was $\gamma_{power} = 2.3 \pm 0.1$. The application of networks with the scale-free topology have been used under the ABM approach in order to model innovation diffusion processes. A close application to the model in this dissertation was developed by Kiesling (2011). The author implemented an ABM model to simulate the market introduction of biofuels in Austria. This model was spatially explicit and took into account different parameters such as consumer behaviour, choices of gas stations, mobility behaviours, population density, time among others. The data was parametrized based on surveys and on the specialized literature and different scenarios were deployed. The figure below is a series of maps displaying the spatial distribution of a) gas stations; b) population and c) 10,000 consumer agents based on the population's density.

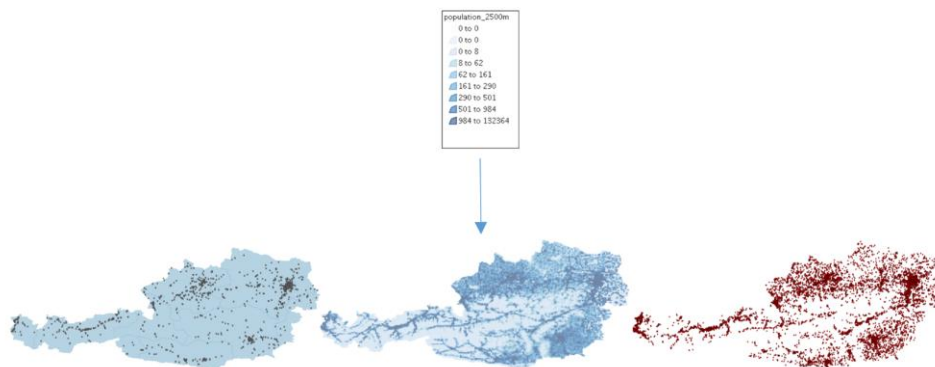

Figure 109 Geographic model for a biofuel application in Austria. To the left: Distribution of 1,571 gas stations. In the center: Population density. To the right: Distribution of 10,000 consumer agents according to population density. Source: Kiesling (2011).

The following figure displays a summary of the results of the simulation. We can observe the degree distribution in a lin-lin plot, and some statistical measures of the network are depicted to the right. At the bottom-left of the figure the social network of Austria is shown, and a more detailed image of the network is at the bottom-right. The social network clearly displays a scaling behaviour as it is the case of several social networks as it has been discussed in Chapter 1. As well as the low average shortest path length and high clustering is in line to previous empirical studies.

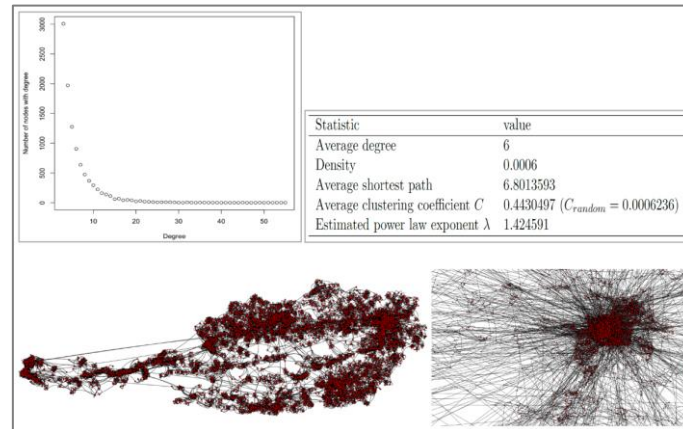

Figure 110 Social network detail, $\alpha=-5$, $\beta=1$ $n_{link}^{spatial}=3$, seed=1299961164. Source: Kiesling (2011).

Where α and β are two spatial exponent that influence the clustering process and the geographic distance between agents. This approach is similar to spatial interaction theory, where a Newtonian-type model uses the distance decay. In the case of this model, which was inspired on the model proposed by Manna & Sen (2002) and later implemented by Yook et al., (2002). Kiesling's model modification was that the incoming nodes are not linked to a single existing node but more generally to $n_{link}^{spatial}$ existing node (Kiesling, 2011). The difference of the model proposed in this dissertation is that we focused on other innovation indicators than biofuels. An important operational implication of this is that in our model there is not any distance between the consumers and the technology. For instance, a solar panel is at the location where the consumer is at, not like the case with biofuels where the spatial distribution of the population is processed with the spatial distribution of gas stations.

Another relevant aspect is that the general architecture of the models is different, for example in our model the agents are population, jobs and RET raster cells as a composite indicator. Whilst in Kiesling's model the agents are consumers with heterogenous and mobility behaviours parametrized according to surveys. In our model a special focus is given to the spatial dimension, where the agents are a composite indicator of RET density, jobs and population embedded in a spatial unit. Furthermore, a major objective is to understand the spatial effects in the RET diffusion from a demand and supply viewpoint in two different countries' regions. So, we chose to develop a multiscale model that accounts for the interaction of the composite indicator of RET in the Swiss region from a demand perspective and a RET supply indicator in the French region. In general, although both models share similar conceptual approaches yet, they differ in the form and in the specificity regarding territorial aspects such as geography, policies and socio-economic factors. Regarding other applications of innovation diffusion under a network approach, readers are referred to section 1.2.

4.2 Conclusion Chapter 4

In summary, scale-free networks show the evolution from chaos to order, from random to preferential attachment, where power laws seem to be the signature of systems in such transition. Within the context of this research work, the application of the preferential attachment property is a relevant aspect in RET diffusion as it appears that the spatial dimension provides meaningful information. While there is a clear self-organized process of diffusion and adoption of RET in the Swiss and the French regions, the scale-free approach through the prism of a spatial perspective shows a transition signature. In the next chapter the model of RET diffusion under a spatial network approach will be discussed. The model is based on different theoretical concepts that were described and analysed when it was required in the previous sections. Therefore, for the sake of clarity readers can refer to the state-of-the art if needed.

4.3 Conclusion Part 1

The review of the state-of-the-art in the different fields that are at the intersection of this Ph.D dissertation showed that there are great opportunities for further modelling developments in the field of sustainability transition. It is argued that the diffusion of innovation across spatial scales is not random as innovation and sustainability do not occur everywhere in a homogeneous fashion. Such disparities generate imbalances in regions and societies that tend to concentrate wealth and technological development in the most populated areas, while leaving behind peripheral regions. This pervasive behaviour seems to have contributed to generate social upheavals across USA and Europe, where an important proportion of the population feel left behind (Rodriguez-Pose, 2017). Thus, a discussion is developed about the apparent preferential attachment mechanisms on innovation diffusion processes with the rich get richer effect and we argued that these effects are possible to be modelled spatially explicit via a network approach.

It was also discussed that the spatial component although has been neglected in innovation studies however, there is an increasing discussion among scholar of different fields about its relevance. Indeed, the effects induced by socio-economic issues, technology, nature and global warming are better understood when the time and space couple is systematically integrated. From a scientific perspective there is no reason to continue avoiding the active incorporation of the spatial dimension in innovation studies. In the case of the sustainability paradigm, scholars have integrated the spatial component in a more proactive way than in innovation studies however, it seems that there is a misunderstanding of the spatial effects in topics such as global atmospheric studies. In such studies, some of the methodologies have been downscaled, which entails that the phenomena observed are understood as linear. Indeed, the reality of the behaviour of global warming or social systems are embedded in complex spatial structures where one-size-fit-all approaches cannot account for real-world solutions.

The same argument is true for innovation policies that have historically been designed with a 'one-size-fits all' view, where the same strategies should work in the same way in the descending urban hierarchies. In this context the resilience concept is reviewed under both perspectives: regional resilience and urban resilience, where the former is mainly focused on an economic standpoint and the latter on sustainability (see Rogov & Rozenblat, 2018). The discussion focused on the linkage of urban resilience through the prism of sustainability where we agreed with the theoretical views proposed by Godard (1984, 1996) in which he claims that resilience is not fractal. In fact, we develop the same idea based on findings that are carried out in Chapter 7 where it is shown through a simulation, important differences at local and at global level. We argue that resilient systems are self-organized since is one of the main properties of such systems however, it does not imply that resilience itself is resilient. Additionally, the resilience concept is integrated with the ecological conceptual idea of panarchy theory, which resonates with the cohesive entity view of interactions between cities and systems of cities.

The interactions within and between these urban networks trigger the emergence of new properties that characterize the city as a collective entity and as discussed by Rogov & Rozenblat (2018) one of these properties might be resilience. We agree with the latter authors views on urban networks approach where the same networks are observed at different levels, but the underlying processes in each level are different. In this context in the Part 2 we will develop a model to verify the assumptions and answer the questions research proposed in section 2.3.6. The Chapters 5 and 6 will develop a RET diffusion model to better understand the network effects of RET diffusion and if RET diffusion is characterized by a spatial preferential attachment. In Chapter 7 will present a practical model on urban resilience to sustainability transition and we will observe the multi-scale differences from a spatial point of view.

4.4 Conclusion Part 1 (Français)

La revue de la littérature dans les différents domaines qui sont à l'intersection de cette thèse de doctorat a montré qu'il existe de grandes possibilités pour de nouveaux développements le domaine de la modélisation de la transition vers la durabilité. La diffusion de l'innovation à travers les échelles spatiales n'est pas aléatoire car l'innovation et la durabilité ne se produisent pas partout de manière homogène. Ces disparités génèrent des déséquilibres dans les régions, et les sociétés tendent à concentrer la richesse et le développement technologique dans les zones les plus peuplées, tout en délaissant les régions périphériques. Ce comportement répandu semble avoir contribué à générer des bouleversements sociaux aux États-Unis et en Europe, où une proportion importante de la population se sent laissée pour compte (Rodriguez-Pose, 2017). Ainsi, une discussion est développée sur les mécanismes apparents d'attachement préférentiel dans les processus de diffusion de l'innovation avec l'effet "*rich get richer*" et nous avons argumenté que ces effets peuvent être modélisés de manière spatialement explicite via une approche en réseau.

Il a également été discuté que la composante spatiale, bien qu'elle ait été négligée dans les études sur l'innovation, fait l'objet d'une discussion croissante entre les chercheurs de différents domaines quant à sa pertinence. En effet, les effets induits par les questions socio-économiques, la technologie, la nature et le réchauffement climatique sont mieux compris lorsque le couple temps-espace est systématiquement intégré. D'un point de vue scientifique, il n'y a aucune raison de continuer à éviter l'incorporation active de l'espace dans les études sur l'innovation. Dans le cas du paradigme de la durabilité, les chercheurs ont intégré l'espace de manière plus proactive que dans les études sur l'innovation ; cependant, il semble qu'il n'y ait pas une bonne compréhension des effets spatiaux dans des sujets tels que les études sur l'atmosphère globale. Dans ces études, certaines méthodologies ont été appliquées en réduisant les échelles, ce qui implique que les phénomènes observés sont considérés comme linéaires (Voiron-Canicio & Fusco, 2020). En fait, la réalité du comportement du réchauffement climatique ou des systèmes sociaux s'inscrit dans des structures spatiales complexes où les approches uniques ne peuvent pas rendre compte des solutions dans le monde réel.

Le même argument vaut pour les politiques d'innovation qui ont historiquement été conçues dans une approche "cartésienne" où les mêmes stratégies devraient fonctionner de la même manière dans les hiérarchies urbaines plus petites. Dans ce contexte, le concept de résilience est examiné sous deux angles : la résilience régionale et la résilience urbaine, la première étant principalement axée sur un point de vue économique, et la seconde sur la durabilité (voir Rogov & Rozenblat, 2018). La discussion s'est concentrée sur la résilience urbaine sous l'angle de la durabilité où nous avons rejoint les considérations théoriques proposées par Godard (1984, 1996) dans lesquelles il affirme que la résilience n'est pas fractale. En fait, nous développerons la même idée sur la base des résultats obtenus dans le Chapitre 7, où nos simulations montrent des différences importantes au niveau local et au niveau global. Nous soutenons que les systèmes résilients sont auto-organisés car c'est l'une des principales propriétés de ces systèmes ; cependant, cela n'implique pas que la résilience elle-même soit résiliente. En outre, le concept de résilience est intégré à l'idée conceptuelle écologique de la théorie de la panarchie, et entre en résonance avec la vision d'entité cohésive des interactions entre les villes et les systèmes de villes.

Les interactions entre ces réseaux urbains déclenchent l'émergence de nouvelles propriétés qui caractérisent la ville en tant qu'entité collective et comme discuté par Rogov & Rozenblat (2018). L'une de ces propriétés pourrait être la résilience. Nous sommes d'accord avec les opinions de ces derniers auteurs sur l'approche des réseaux urbains où les mêmes réseaux sont observés à différents niveaux, mais les processus sous-jacents à chaque niveau sont différents. Aussi, dans la Partie 2, nous développerons un modèle pour vérifier les hypothèses et répondre aux questions de recherche proposées dans la section 2.3.6. Dans les Chapitres 5 et 6 nous développons un modèle de diffusion des TER pour mieux comprendre les effets de réseau de la diffusion des TER. Le Chapitre 7 présentera un modèle pratique sur la résilience urbaine à la transition vers la durabilité, et on observera les différences multi-échelles d'un point de vue spatial.

This page intentionally left blank

Part 2 Modelling and Simulation of Spatial Diffusion of Innovations and Urban Resilience to Energy Transition.

The Part 2 of this dissertation discusses the development of a multiscale spatial model relying on a network approach. In Chapter 5 the model is built with information containing the spatial situation of the population and jobs in the Swiss canton of Valais. This input data is processed via agent-based modelling and System Dynamics approaches in order to create a spatial layer that represents the innovation fields. The underlying theoretical approach is based on spatial interaction thus, a gravity model is constructed and is in a later stage coupled with the spatial information of buildings and solar photovoltaic installations. The model's results exhibit preferential attachment behaviours, which has allowed to verify the assumptions made in the first part of this research work. The model is also applied to the electric and hybrid vehicle diffusion at the national level in Switzerland, finding similar fractal behaviours in the diffusion processes. In Chapter 6 the SPA model is applied to the renewable energy production system in the South Region of France, where the results reconfirm the findings of the previous simulations in Chapter 5. The Chapter 7 discusses the application of an urban resilience model to sustainability transition in the Swiss region, where the urban network displays resilience at global level but not a local level. Finally, the general conclusions and new research directions are discussed regarding the implications of the spatial preferential attachment in the energy transition process and urban resilience to energy transition.

Partie 2 (Français) : Modélisation et Simulation de la Diffusion Spatiale des Innovations et de la Résilience Urbaine à la Transition Énergétique.

La partie 2 de cette thèse de doctorat traite du développement d'un modèle spatial multi-échelles reposant sur une approche réseau. Dans le Chapitre 5, le modèle est construit avec des informations contenant la situation spatiale de la population et des emplois dans le canton suisse du Valais. Ces données d'entrée sont traitées par des approches comme les systèmes multi-agents et la dynamique des systèmes afin de créer une couche spatiale qui représente les champs potentiels d'innovation. L'approche théorique sous-jacente est basée sur l'interaction spatiale, ainsi, un modèle de gravité est construit et est, dans une étape ultérieure, couplé avec les informations spatiales des bâtiments et des panneaux photovoltaïques. Les résultats du modèle montrent des comportements d'attachement préférentiel, ce qui a permis de vérifier les hypothèses faites dans la première partie de ce travail de recherche. Le modèle est également appliqué à la diffusion des véhicules électriques et hybrides au niveau national en Suisse, ce qui permet de trouver des comportements fractals similaires dans les processus de diffusion. Dans le Chapitre 6, le modèle est appliqué au système de production d'énergie renouvelable sur la Région SUDen France, où les résultats confirment les conclusions des simulations précédentes discutés dans le Chapitre 5. Le Chapitre 7 porte sur l'application d'un modèle de résilience urbaine à la transition vers la durabilité dans la région suisse, où le réseau urbain fait preuve de résilience au niveau global mais pas au niveau local. Enfin, les conclusions générales et les nouvelles directions de recherche sont discutées concernant les implications de l'attachement préférentiel spatial dans le processus de transition énergétique et la résilience urbaine à la transition énergétique.

5 Modelling Framework for Innovation Diffusion: A Multiscale Geospatial Network Approach for Renewable Energy Technologies Diffusion in the Swiss Alps.

“The greatest value of a picture is when it forces us to notice what we never expected to see”.

—John Tukey

The literature review on innovation diffusion previously developed in this study revealed different research gaps. According to our knowledge there are not empirical studies that analyse the RET spatial diffusion and the spatial interactions in the context of this research, which was developed in two different territories. In the following two chapters a spatially explicit model of RET diffusion will be developed in the Swiss and French regions respectively.

5.1 Objectives

A major objective in the construction of this model is to bridge the gap between theoretical models from innovation studies, urban modelling and network theory. The development of this model aims at contributing to the field of GST, where a research gap in modelling approaches has been evoked by scholars. Moreover, the objectives of this model are twofold as it is intended to contribute to basic and applied research. The results of this model will be used to simulate urban resilience to RET diffusion in Chapter 7. The model developed in the canton of Valais can be used as a substrate to simulate different kinds of socio-economic phenomena under an urban network approach.

5.2 Design of the General System of Simulation.

The reflexion, conception and design processes were structured following different stages, which are graphically represented below. The construction process of the structure of the conceptual model is composed of three levels as suggested by Guermond (1984). The verbal model was based on the state of the art and the development of the theoretical background led us to generate the first assumptions that would be tested afterwards. These assumptions were contrasted with the state of the art in different fields, given the interdisciplinary nature of this study. Some of these assumptions were for example that RET spatially diffuses and is adopted in a non-randomness way and following a preferential attachment process. Such assumption would have some implications, like self-organization and non-linear behaviours present in the urban organization context of innovation diffusion. Consequently, the effects of the spatial component would take an important role in the underlying mechanisms involved in such social and industrial interactions.

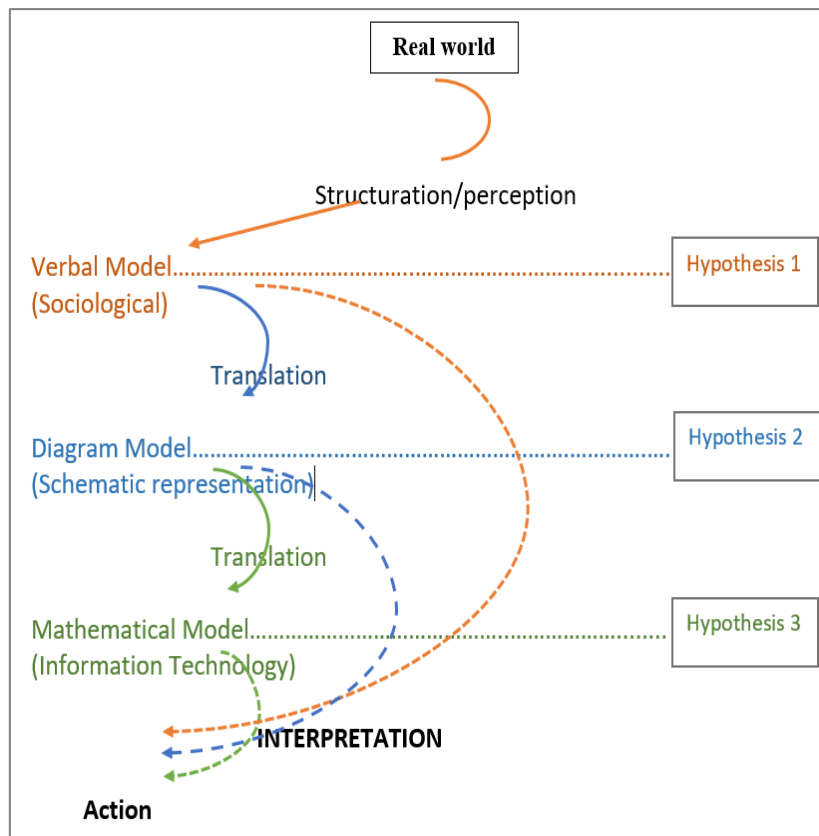

Figure 111 The various levels of modelling reality, Guermond (1984).

In this regard, the spatial interaction theory provides a scientific framework to further develop these assumptions. Furthermore, Hågerstrand's views on innovation diffusion as a spatial process would reinforce the scientific substrate to continue the development of the verbal model. As well as other theoretical approaches some more abstracts than others, would contribute to complete a general epistemological foundation. For example, concepts as homophily, segregation, micromotives and macrobehaviours were used to generate a dissertation quite theoretical in the first place in Chapters 1 and 2. This verbal model was later translated to a schematic representation which is the diagram model which allows to visualize the general system of simulation. The model is composed of three phases that are subsequently built based on different scientific methodologies. The depicts the general system, whose phases and sub-phases will be introduced and progressively developed in the following sections. At this stage, a methodological consideration was thoroughly developed in order to establish accompanied with a systematic review of the state of the art.

The goal with these activities was to evaluate the potential of a model from an operational perspective, based in the literature review, data availability within the scope of the research work. This allowed to do an alignment of the methodological choices with the reality of the studied regions and in this way to proceed to design and build the simulation model. The rationale for the methodological choices is fundamentally at the cross-roads of innovation diffusion and resilience with an angle of geography of sustainability transitions, which implies an 'overlay' of methods. The following figure depicts the fundamental phases of the general system of simulation of Renewable Energy Technologies Diffusion and Spatial Resilience to Renewable Energies Diffusion. There are three main phases subdivided in multiple tasks, which will be described in this chapter.

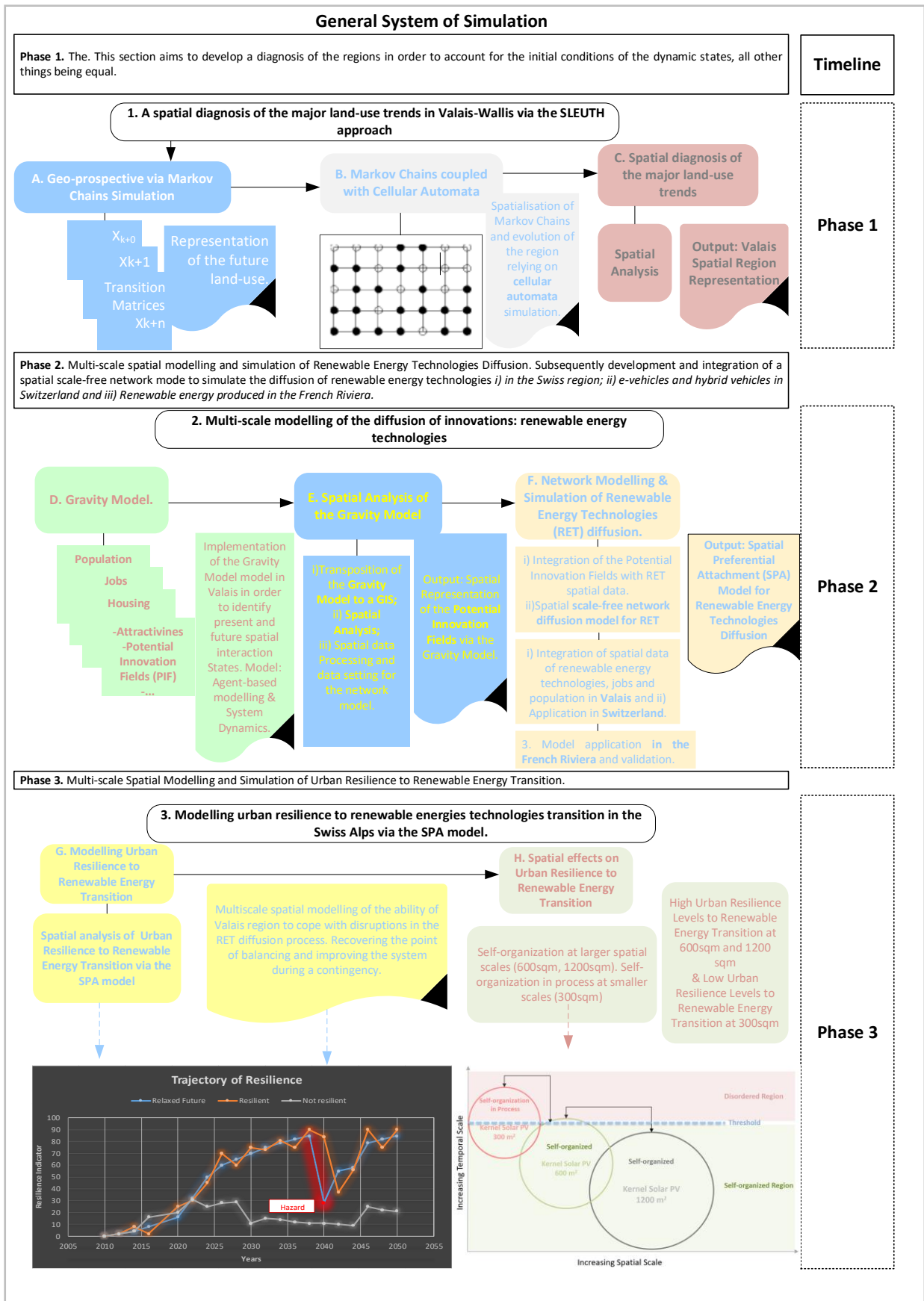

Figure 112 General System of Simulation of Renewable Energy Technologies Diffusion and Spatial Resilience to Renewable Energies Diffusion.

A summary of the relevant theoretical approaches used in this work to build the operational model; we find a list as follows:

- i) We extensively discussed on the socioeconomic disparities across the space, which suggested that innovation do not diffuse randomly from a spatial standpoint. The implications are vast, but one of the most relevant for this work is that the diffusion does not follow a normal distribution from a spatial perspective.
- ii) One of the research questions pointed at the possible preferential attachment nature of innovation diffusion processes, in this case of RET. A way of cross-verification is naturally a network construction and its respectively analysis. From a methodological perspective, scale-free networks modelling seemed to be a good conceptual and operational instrument to deal with these questions.
- iii) According to the assumptions proposed in the verbal model, the spatial interaction theory appeared to have a great suitability to deal with social, spatial and innovation diffusion issues. Therefore, it was used to develop a gravity model and thus, calculate the attractiveness in the Swiss region. This allowed to make a linkage with the social economic disparities and the no-randomness of spatial distribution of urban phenomena.

A more detailed information of each methodology will be developed throughout the next sections. The third phase level of modelling reality according to Guermond (1983). The mathematical operationalisation and information technology was implemented as previously shown in. The mathematical model relied in a set of software and programming languages to implement different tasks ranging from statistical analysis with the R software to network modelling with R, Python and Gephi and spatial analysis with ArcGIS Map and ArcGIS Pro and IDRISI. In fact, these kinds of approaches are common nowadays in the analysis of complex systems for example, Netlogo has an interesting interface capacity, see Banos et al., (2015,2017). The usage of programming languages and virtual environments are duly mentioned and referenced at each stage of the model. Following the steps of the general system of simulation shown in Figure 112, we will develop each phase in the same order. The general system of simulation is composed by three main phases, which are subsequently structured in specific tasks. For example, the phase 1 is composed of three tasks:

A)Geoprospective via Markov Chains Simulation; B)Markov Chains Coupled with Cellular Automata and C)Spatial Diagnosis of the Major Land-Use Trends. The same structure applies for the subsequent phases and tasks, now we will proceed with the development of phase 1 as follows.

5.3 Phase 1A: A Spatial Diagnosis of the Major Land-Use Trends in Valais-Wallis Via the SLEUTH Approach.

The Phase 1 of the general system of simulation intended to develop a substrate of the initial conditions of the dynamics of the territory in Switzerland. Concretely we implemented the SLEUTH approach, which is initially based on the probabilities derived from the transition matrix of the land-used via Markov chains (see section 2.1.5). The changes in land-use were calculated using Markov chains analysis in the stage 1.A (see Figure 113). Nonetheless, Markov's approach is not a spatial methodology, so it was necessary to develop the *spatialisation* process using a cellular automata model in a second stage (1.B). At the end of this phase, in the stage 1.C a spatial analysis allowed to carry out the representation of the territory and the transition probabilities of land-use.

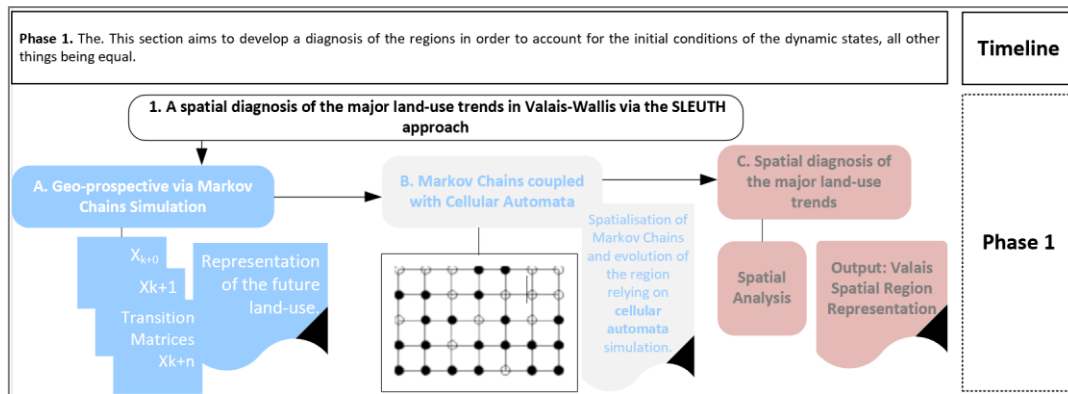

Figure 113 Phase 1 of the General System of Simulation

The Phase 1 aims to develop a diagnosis of the regions in order to account for the initial conditions of the dynamic states, all other things being equal. The goal with this phase is to observe if important changes occurred during the period of the longitudinal study regarding the diffusion of renewable energy technologies (RET) and evaluate the region’s capacity to return to the trajectory of the major land-use trends after a disturbance. This phase represents the major trends or ‘relaxed future’ of the chart of section 3.

5.3.1 Data

The model to determine land-use changes was deployed in the canton of Valais-Wallis in Switzerland, the data was provided by the Corine Land Cover (CLC) project. The CLC project was designed in the 1980’s with the aim of inventory the land cover in Europe under a standardized data collection framework⁵⁰. The first survey was done in 1990 and after that, new surveys were carried out in 2000, 2006, 2012 and the most recent version was done in 2018. As Switzerland is not part of the EU, the last survey in 2018 was done by the Swiss Federal Institute for Forest, Snow and Landscape Research (WSL) under an agreement with The European Environment Agency (EEA). The spatial data provided by CLC project has the following technical specifications:

- Minimum mapping unit (MMU): 25ha (status layer)
- Minimum width of linear elements:100m
- Nomenclature: standard European level - 3
- Positional accuracy: better than 100 m
- Thematic accuracy: 85 %
- Equivalent scale: 1:250.000 (status layer)

The data is organized in a nomenclature called European level-3, where level-1 is the general category and level-3 contains the most granular data level. The land-use datasets were reclassified since it some classes were not required for this study. For example, the specification of ‘inland waters’ was not needed as the phenomenon observed in this research work was unrelated with water issues. Furthermore, changes in the nomenclature overtime occurred, therefore it was required to do a data pre-processing in order to harmonize the datasets from 2006, 2012 and 2018, the reclassification details are in APPENDIX . Once this process was achieved the transition matrices were calculated.

⁵⁰ For Switzerland’s data visit: <https://www.wsl.ch/en/index.html>. For France, visit the European Union’s data: <https://land.copernicus.eu/pan-european/corine-land-cover>

5.3.2 Transition Matrix for Years 2006-2018 and Markov Chains

Here the SLEUTH approach was used in the region of Valais in order to establish the initial conditions of the dynamic trajectories of the territory, all other things being equal. The land-use dynamics were thus calculated, and it was represented in 9 classes as follows:

1.	Continuous urban fabric (class 1)
2.	Discontinuous urban fabric (class 2)
3.	Industrial or commercial units and public facilities (class 3)
4.	Road and rail networks and associated land (class 4)
5.	Airports (class 5)
6.	Sport and leisure facilities (class 6)
7.	Agricultural areas (class 7)
8.	Forest and semi natural areas (class 8)
9.	Wetlands & water bodies (class 9)

Table 12 Land-use classified in 9 classes.

Table 13 displays the results of the Markovian simulation of the land use trajectories in the territory of the Valais-Wallis region in Switzerland. These calculations were carried out using the IDRISI software. The size of the pixels used to make these calculations was 250 square metres, given probability of change to:

	Class 1	Class 2	Class 3	Class 4	Class 5	Class 6	Class 7	Class 8	Class 9
Class 1	0,9500	0,0063	0,0063	0,0063	0,0063	0,0063	0,0063	0,0063	0,0063
Class 2	0,0000	0,8927	0,0171	0,0062	0,0000	0,0000	0,0762	0,0078	0,0000
Class 3	0,0000	0,0000	0,9206	0,0000	0,0000	0,0000	0,0265	0,0529	0,0000
Class 4	0,0063	0,0063	0,0063	0,9500	0,0063	0,0063	0,0063	0,0063	0,0063
Class 5	0,0000	0,0000	0,0817	0,0000	0,9183	0,0000	0,0000	0,0000	0,0000
Class 6	0,0000	0,0806	0,0000	0,0000	0,0000	0,9194	0,0000	0,0000	0,0000
Class 7	0,0000	0,0322	0,0065	0,0000	0,0004	0,0000	0,8291	0,1293	0,0024
Class 8	0,0000	0,0044	0,0007	0,0000	0,0000	0,0000	0,0513	0,9433	0,0002
Class 9	0,0000	0,0000	0,0000	0,0000	0,0000	0,0000	0,0000	0,0618	0,9382

Table 13 Transition Matrix of land used in the canton of Valais-Wallis.

This transition matrix is a homogenous Markov chain with a finite state space of order 1 since it describes a finite state random process, in this case of land-use types. The land-use changes calculated in spatial units of 250 sq m is depicted below:

	Class 1	Class 2	Class 3	Class 4	Class 5	Class 6	Class 7	Class 8	Class 9
Class 1	6	0	0	0	0	0	0	0	0
Class 2	0	1048	20	7	0	0	89	9	0
Class 3	0	0	115	0	0	0	3	7	0
Class 4	0	0	0	7	0	0	0	0	0
Class 5	0	0	2	0	28	0	0	0	0
Class 6	0	2	0	0	0	28	0	0	0
Class 7	0	102	21	0	1	0	2617	408	8
Class 8	0	162	24	0	0	0	1878	34509	8
Class 9	0	0	0	0	0	0	0	15	231

Table 14 Transition Areas: expected transition (cell size: 250 sq m).

The nature of this matrix is ergodic given that it is irreducible (see definition *vi* in section 2.1.5) and the length of the circuit is equal to 1, which inevitably leads to a global stationary state. As discussed by Loubier et al., (2016) the relevance of this information lies on the trends towards an optimal adjustment of the territory. This implies that beyond such global stationary states that typifies an equilibrium, it would not be possible to introduce changes without facing risks to truly disturb the territory's balance. Once the Markov chains were calculated for subsequent periods of 6 years in the future, that is 2024, 2030 until 2048, the next step was to implement the cellular automata as the Markov Chains do not have spatial properties. The present state of a given spatial unit is thus influenced by *i) the initial state and ii) the state of the neighbouring spatial units* (see Figure 54 and section 2.1.5).

5.3.3 Trend Scenarios for Years 2006 – 2048

The development of the trend scenarios coupling the Markov chains and the cellular automata yielded the following results. The changes are mainly occurring in agricultural areas and forest and semi natural areas. In fact, in the canton of Valais there are two classes of forest given in the Swiss nomenclature: *i) Protected forest*, which are protected areas from avalanches and *ii) Forest for exploitation*, that is semi-agricole, which is rather scarce in the Valais region. The nomenclature is not exactly equivalent with the CLC project therefore, according to the Nomenclature used, according to the model here it seems that the agricultural areas gain space and with the data from the canton of Valais the forest gain space under the same approach (see Loubier, 2020).

Class	Code name	2006	2012	2018	2018 forecast	Comparison Backcast 2018	Comparison Backcast 2018 (%)	2024	2030	2036	2042	2048
		Cell counts	Cell counts	Cell counts	Cell counts	Difference		Cell counts	Cell counts	Cell counts	Cell counts	Cell counts
0	Background	50894	50894	50894	50894			50894	50894	50894	50894	50894
1	Continuous urban fabric	6	6	6	6	0	0	6	6	6	6	6
2	Discontinuous urban fabric	1143	1174	1176	1157	-19	-2%	1161	1151	1176	1152	1146
3	Industrial or commercial units and public facilities	97	125	125	145	20	16%	145	153	147	154	160
4	Road and rail networks and associated land	3	7	7	13	6	86%	13	19	7	7	7
5	Airports	30	30	30	30	0	0%	30	30	30	30	30
6	Sport and leisure facilities	31	30	30	30	0	0%	30	30	30	30	30
7	Agricultural areas	3293	3156	3154	4611	1457	46%	4609	4601	4590	4613	4619
8	Forest and semi natural areas	36511	36582	36582	35125	-1457	-4%	35123	35121	35142	35142	35112
9	Wetlands & water bodies	242	246	246	239	-7	-3%	239	245	228	222	246

Table 15 Transition Areas in Valais, Switzerland: expected transition from 2006 to 2048 of (cell size 250 sq m).

The observation of the territory's dynamics under this approach did not contribute with the development of the research work of this dissertation as the periods of the data availability of RET unfortunately did not match the periods of the CLC project. The data of RET in Switzerland was published from 2009 until 2016. Other quantitative procedures such as the net change were carried out in order to observe land-use changes. Furthermore, the time scales in which the land-use dynamics take place are much longer than the development of RET diffusion hence, the period of RET diffusion observation is too short in terms of land-use change. This was deployed using the Idrisi's Land Change Modeller module. The calculations for all spatial layers are depicted as follows.

NET CHANGE TABLE																
Class	Code name	2006	Net change	2012	Net change	2018	Net change	2024	Net change	2030	Net change	2036	Net change	2042	Net change	2048
		Cells		Cells		Cells		Cells		Cells		Cells		Cells		Cells
1	Continuous urban fabric	6	0	6	0	6	0	9	0	9	0	6	0	6	0	6
2	Discontinuous urban fabric	1143	31	1174	2	1176	-15	1319	-10	1303	25	1357	-24	1363	-6	1345
3	Industrial or commercial units and public facilities	97	28	125	0	125	20	129	8	129	-6	125	7	125	6	125
4	Road and rail networks and associated land	3	4	7	0	7	6	13	6	19	-12	7	0	7	0	7
5	Airports	30	0	30	0	30	0	34	0	34	0	31	0	31	0	31
6	Sport and leisure facilities	31	-1	30	0	30	0	37	0	39	0	31	0	31	0	31
7	Agricultural areas	3293	-137	3156	-2	3154	1455	3114	-8	3127	-11	3109	23	3103	6	3121
8	Forest and semi natural areas	36511	71	36582	0	36582	-1459	36455	-2	36450	21	36444	0	36444	-30	36444
9	Wetlands & water bodies	242	4	246	0	246	-7	246	6	246	-17	246	-6	246	24	246

Table 16 Net Change in Land-use in Valais from 2006 to 2048.

The outputs provided by IDRISI is a raster series shown below:

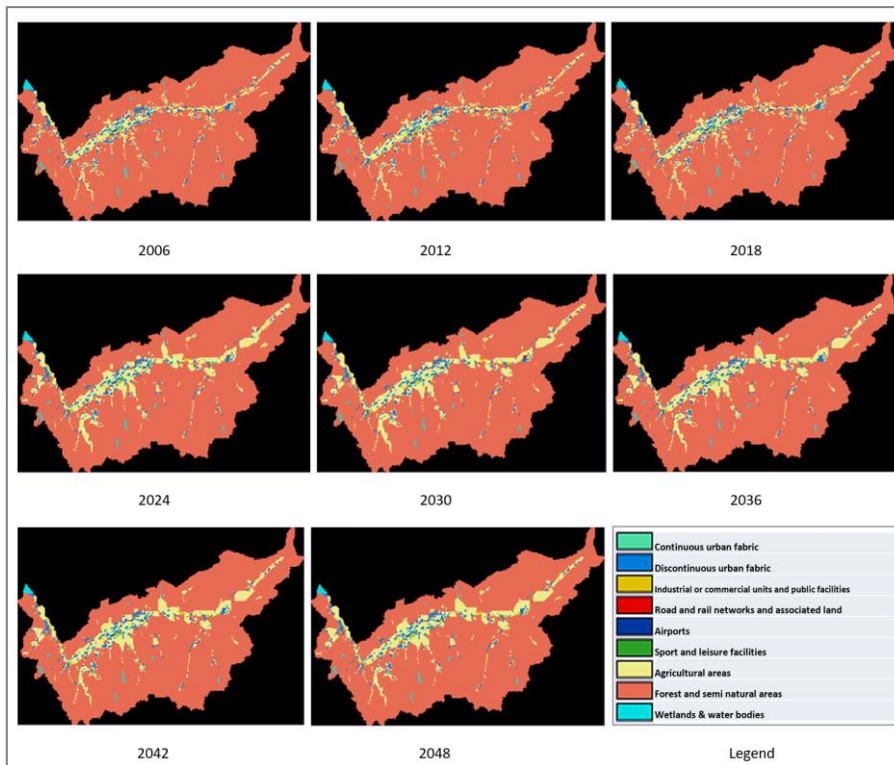

Figure 114 Transition Areas in Valais, Switzerland: expected transition from 2006 to 2048, 250 sq m resolution.

Additional results are provided in APPENDIX A.

5.4 Geoprospective: Spatial Interaction Modelling for the Swiss Alps region.

This section systematically describes the construction process of the gravity model, which is based on spatial interaction theory. This subphase characterizes the first step of the final model proposed in this doctoral dissertation, since the land-use change model described in the previous section was not finally integrated in the model, see Figure 115 for orientation purposes within the general system of simulation.

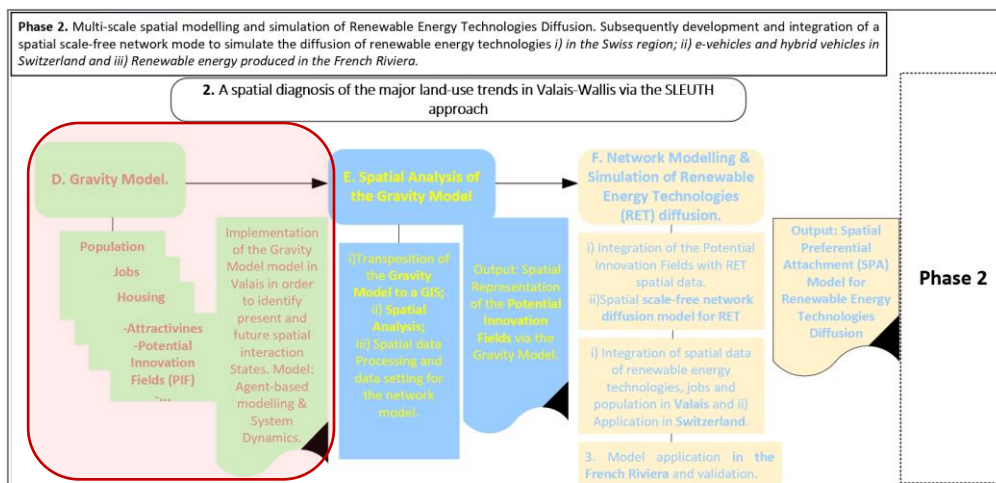

Figure 115 Phase 2: Gravity Model for the Valais Region, Switzerland.

The goal of this section is to simulate the socio-spatial interactions on the territory of Valais modelled in the previous section, integrating a model for the spatial diffusion renewable energies. The gravity model was

developed in the canton of Valais-Wallis with two main subphases, the first task was to develop a potential field which is derived from spatial interaction theory (Rich, 1980). The model simulates a reduction in the intensity of interaction of the agents when the spatial distance increases, this decay is a Newtonian-type inverse power law (see section 2.1.1). The potential field was calculated in order to spatially characterize the attractiveness levels in the region, based on the distribution of population and jobs. The spatial distribution of population and jobs is informative in terms of the regional spatial interaction. An additional process was needed to be done in order to determine the potential innovation fields, which was a parameter so-called attractiveness. The latter is an operationalization step of the spatial interaction theory where jobs and population are affected by the attractiveness parameter due to the spatial situation in a location i .

The second subphase was to develop a system dynamics model that was carried out to model the population evolution in India, which was applied from a global perspective. A subsequent simulation was performed with the ABM approach that allowed to calculate the population at local level. The spatial representation of the attractiveness of the regions allows us to map human activities and observe the territory as an urban network where heterogeneity and non-linear processes take place across the region.

This line of thought is in line with the first chapter of this study, where it was argued that innovation occurs with different intensity levels not only at a national or regional level, but also at intra-regional level. The underlying idea with this model, was to look at urban activities and social distributions as a base to integrate aspects that are in general distributed in dissimilar ways. Some of these aspects are the innovation diffusion processes such as energy renewable technologies, which will be integrated in the subsequent step. Thus, this model becomes the substrate that was initially intended with the land-use change model.

The Figure 116 shows the conceptualisation of the gravity model for the Valais-Wallis region. This representation shows the multi-paradigm approach used to build this model, in which the interplay of system dynamics and ABM was developed in different ways according to their scientific nature but with the same objective. The rationale to use this multi-paradigm approach was the nature of complex systems behaviour at different scales. So, the global aspects such as population in the canton of Valais-Wallis were simulated under the systems dynamics approach and both, the local and global aspects and interactions were simulated with an ABM framework.

In the so-called 'low spatial interactions level' we refer to the canton of Valais-Wallis where a high abstraction level of details in the spatial dimension are captured and data is aggregated. Contrary, in the 'high spatial interaction level' there is a low abstraction of details hence, changes in the system can be captured in shorter periods of time with higher accuracy and granular data (see Figure 116). This entails that both paradigms are used, system dynamics and ABM.

As it was reviewed in the state of the art, system dynamics is only suitable for aggregated data, so applications of this approach in spatial modelling implies that its usage is possible at global level. Once we decrease the spatial scale of analysis, ABM becomes an essential scientific approach and operational instrument to perform the simulations since it has no scale restrictions. The figure below shows the conceptual approach for the gravity model. In the next section we will describe the model of the evolution of population in Valais-Wallis, which was the first parameter simulated.

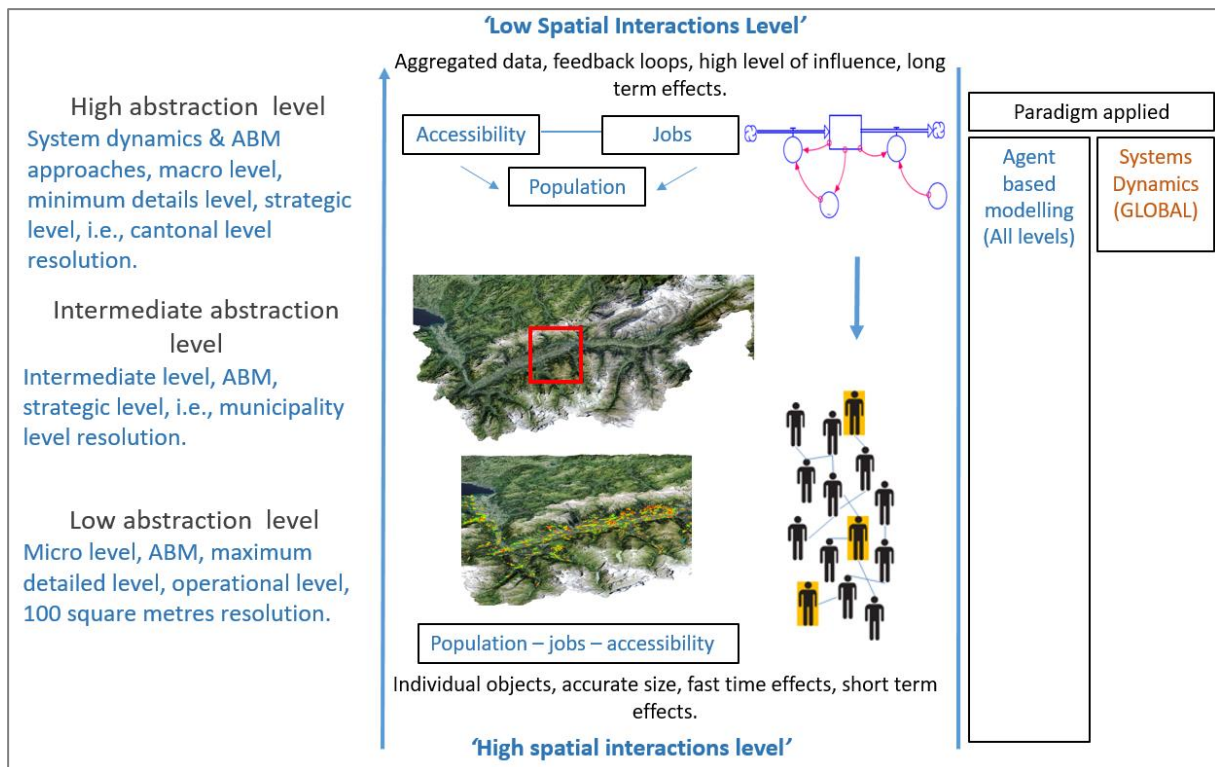

Figure 116 Conceptual structure of the gravity model for the Valais-Wallis region. Sources: The figures displaying human beings in black was provided by Anylogic⁵¹.

5.4.1 Potential Fields

The potential field is from an operational point of view is a spatial layer that measures the 'influence' of a location on another. Under this view, locations are in a competition to attract more people and more jobs then, the potential field gives a picture of the development of this competition. The underlying mechanisms that take place in areas with high intensities of the potential field are linked to the high level of interactions and exchanges. The assumption here is that such processes boost creativity, connectiveness, knowledge and a fertile milieu for the diffusion of innovations. This task was developed by taking data points on a grid containing the values that are actually the density of jobs and people in an area. So, the larger the value the larger its attractiveness level, which was subsequently compute with a distance parameter that follows a power-decay function as it will be discussed in the next section.

5.4.2 Attractiveness

Attractiveness is an indicator that gives information on the connectedness of the urban network where social and economic activities take place and where people are attracted to be at. To determine the attractiveness of the Valais region two main aspects were the underlying factors to build the model. The first issue was to keep the model simple as the reality is complex already, therefore limited variables were tested under this premise. The second aspect is directly linked with the first one, which is the limited amount of data availability. Hence, by choice or not the model was developed with very few variables but with a robust explanatory power. The unevenly spatial

⁵¹ <https://www.anylogic.com/>

distribution of the supply of labour, population, and housing parameters were computed using Huff's (1964) model as a theoretical and operational approach. The Huff's model was already introduced in section 2.1.1 and now we will describe the procedure to implement the equation to model the attractiveness of the Swiss region.

$$P_{ij} = \frac{A_j^\alpha D_{ij}^{-\beta}}{n \sum_{j=1} A_j^\alpha D_{ij}^{-\beta}} \quad (2.3)$$

Where;

A. Huff's model application to estimate a trading area.	B. Application of Huff's model to a demographic and employment gravity model in this research work.
P_{ij} is the probability of a consumer located at the point i to travel to a shopping centre located at the point j .	P_{ij} is the probability of a spatial unit located at the point i to attract a person or a job located at point j in the field.
A_j is the attractiveness measure of a place j , by spatial unit.	A_j is the attractiveness measure of a place j , by spatial unit in the field.
α is a parameter for the sensitivity of the probability P_{ij} associated with the characteristic attraction in a data point in the field.	α is a parameter for the sensitivity of the probability P_{ij} associated with the characteristic attraction for jobs and population in a data point in the field.
D_{ij} is the distance from i to j .	D_{ij} is the distance from i to j (1 ha).
β is a distance decay parameter, estimated based on empirical observations.	β is a distance decay parameter, estimated based on empirical observations (in this study it follows a power decay function) ⁴⁹
n is the total number of locations that contain the place j in their area of attraction in the field.	n is the total number of locations in the field.

Table 17 Application of Huff's model to a demographic and employment gravity model.

The right side of the table above shows the interpretation and implementation of each parameter of Huff's model in this research using demographic and employment georeferenced data. With the attractiveness calculation, we could determine the values of each parameter at a 100 m² resolution. The attractiveness value calculated based on Huff's model is a probability, therefore its value is contained between the range 0 and 1. As it has continuously been highlighted through this dissertation, the spatial dimension plays a major role in this model and its application is not only explicit but is an active component that is modelled as another agent, such as people movement or jobs distributions. Therefore, the spatial units are agents containing a value of parameters such as number of jobs and people, which means that spatial units are agents like 'spatial boxes' that contain other agents such as inhabitants and jobs.

These spatial units are in competition to attract more jobs or people and its performance is measured by the level of attractiveness or influence to succeed at concentrating more jobs and people. So, these so-called 'spatial boxes' act in such a way that their spatial influence could be compared to a catchment area. The underlying assumption is that those locations that attract more human activity are locations within an urban network that have concentrations, which might absorb higher levels of adoption of innovations, in this case of RET. By analogy, if a place is represented by a network, the locations containing higher levels of concentration of human activity including adoption of innovations, then they could be represented by the hubs of a network.

The advantage to use this methodology on the one hand relies on the ease to up-to-date population and jobs data without needing to change the system structure. On the other hand, if the structure of the system changes, it would be possible to use the local values of the attractiveness in order to analyse and quantitative and spatially represent the consequences of policies at social-economic and environmental levels. So, it would be possible to perform simulation on these issues by implementing variations of the attractiveness value in the potential field

without putting at risk eventual risks at updating the model. This model will be used in section 5.4.5.2 where the integration of the spatial interaction model will be deployed under an ABM approach to model population and jobs dynamics.

5.4.3 Data

The data used for the development of this model was provided by the FSO, which is available in German and French⁵². The data files that were used are called STATPOP for population and STATENT for jobs. The data set contains information on the population including information by age group and gender by age groups of 5 years. This information allowed building the population system for Valais-Wallis in 19 stages.

5.4.4 Spatial Representation of the Potential Fields of Innovation

Since the data has geographic coordinates, the next step was to spatially represent the data on the GIS IDRISI. The Figure 117 shows a summary of the process to calculate the potential field of attractiveness in the canton of Valais-Wallis, also referred to as the Potential Innovation Field (PIF). The georeferenced population and jobs data (A) was computed according to the Huff's model (B), following a reverse Pareto function (C) and the output is the spatial representation (D).

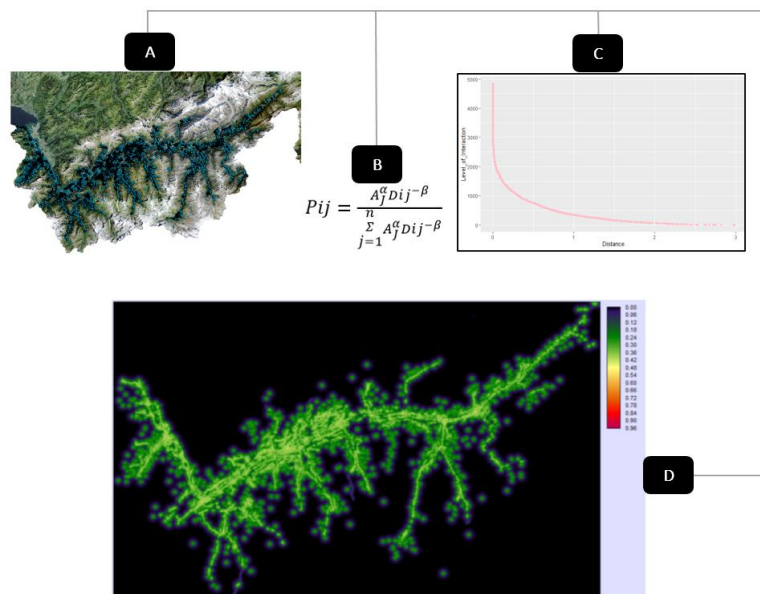

Figure 117 Map of the Potential Field of Innovation at 100 sq m resolution in the Valais region^a.

^a The inversed power law distribution is hypothetical based on the mathematical formulation of the Huff's model which describes a distance decay. The real results are displayed in Figure 119.

According to the Figure 117 a suggestion of spatial clustering was considered, which had important implications on the choices of spatial statistics methodologies used in the next phases. For example, was not possible to use a geographically weighted regression given this clustering behaviour. Below it is depicted the distribution of the attractiveness indicator per spatial unit, where n= 27084 at a 100 sq m resolution. The figure below shows the

⁵² available online: <https://www.bfs.admin.ch/bfs/fr/home/statistiques/catalogues-banques-donnees/publications.assetdetail.6027955.html> and <https://www.bfs.admin.ch/bfs/fr/home/actualites/quoi-de-neuf.assetdetail.9526894.html>

kernel density for jobs in the Valais region in 2015, this is an example of the complementary developments carried out in section 5.5.3 with the construction of a network.

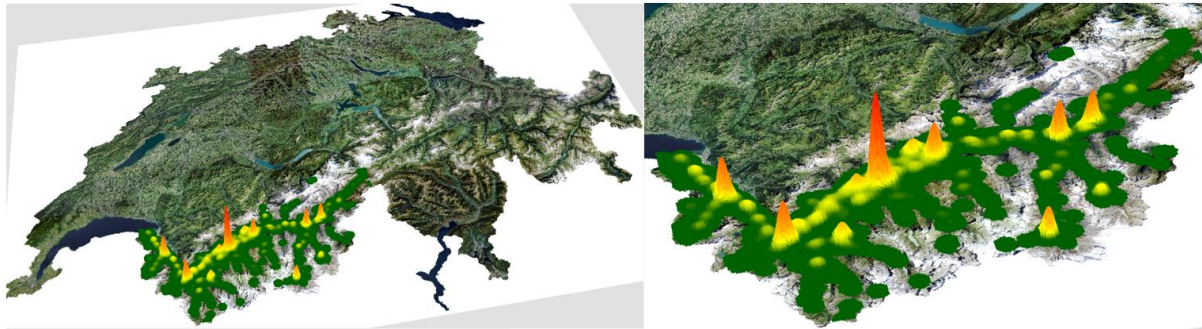

Figure 118 Kernel density for full time equivalent jobs in the canton of Valais-Wallis in 2015 at 100 sq m resolution. The red peaks should be understood as the higher levels of attractiveness.

The application of the power law decay function from Huff’s model on the territory of reference generated the outputs displayed in Figure 119, where in the chart of the left side it is possible to observe some hubs. After that there is a descending line until it reaches a negative inclined straight line which contains most of values from 0.40 to 0.25, the spatial units within that range in that plateau approximately represent 93% of all spatial units. Whilst the hubs that are more easily observed in the log-log plot (in the centre) only represent % 0.0406. The hubs in this context are the values larger than 0.8, that turned out to be only 11 with N= 27084. The final tail that falls very rapidly comprises 4.9% of the spatial values comprised in the interval $0.249 \geq x \geq 0.00166$.

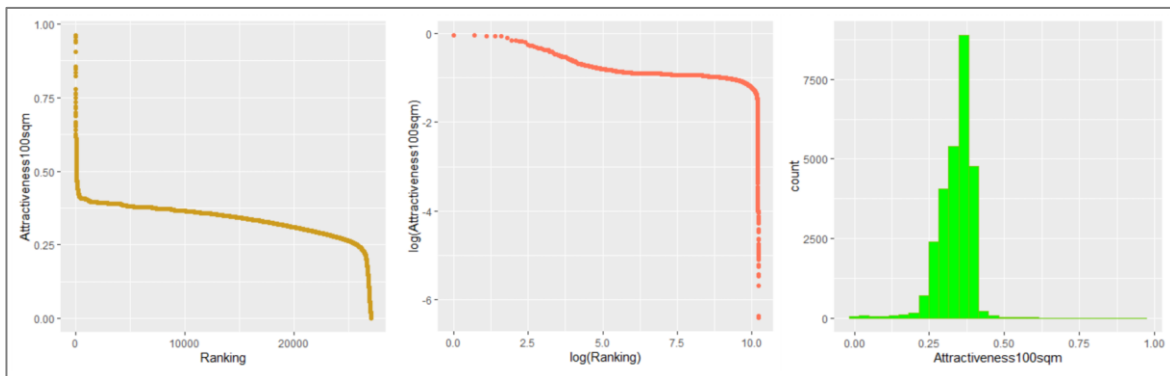

Figure 119 Distribution of Attractiveness at 100 sq m Resolution in the Valais Region in Switzerland in 2016.

In the figure below it is shown in the left side the attractiveness with another symbology performed on ArcGIS where the data is classified following a geometrical interval of 32 classes and the zero values are excluded. This spatial representation allows to observe the intensity of the spatial units’ attractiveness. In the right side it was performed an average nearest neighbour analysis to statically determine the existing of a clustering process. With this procedure we calculated the nearest neighbour index relying on the average distance from each spatial unit to their neighbours. The attractiveness of the Valais region is clustered given that the spatial distribution of the population also follows this pattern. The geographic situation of the most populated areas, which are between two valleys have a natural influence on the clustering mechanisms illustrated by the Nearest Neighbour Ratio = 0.42280.

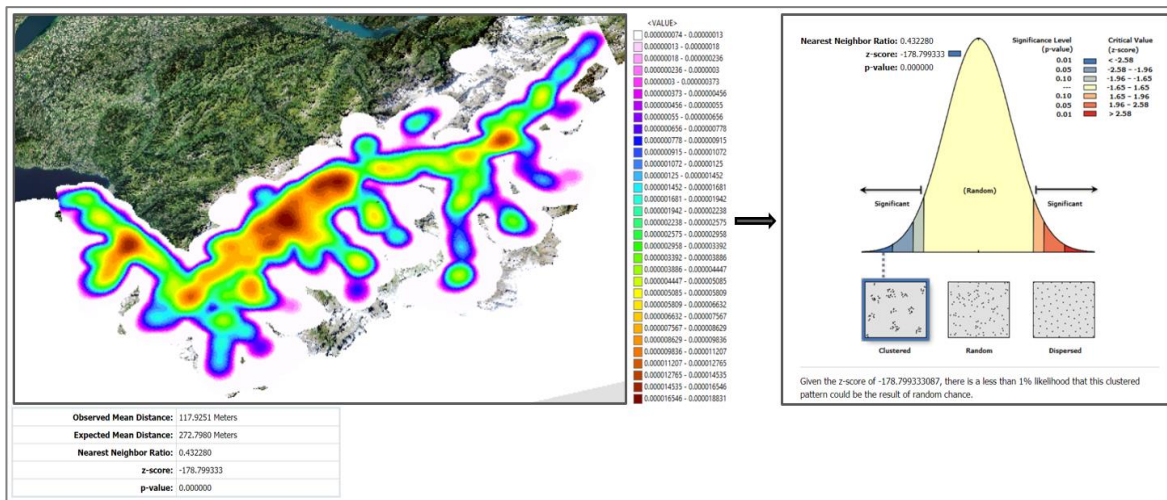

Figure 120 Average Nearest Neighbour Analysis at 100 sq m resolution in Valais, Switzerland. Generated with ArcGIS.

The z-score being -178.799333087 means that there is a less than 1% likelihood that the clustered pattern found in the attractiveness could be just the result of random chance. The probabilistic nature of the Huff model resonates with the approaches used to build the general system of simulation in a later stage, such as the preferential attachment model. The PIF's outputs will be afterwards used to build a forecast model of the population in the territory of reference at a 100 sq m resolution. The population will be calculated first at global level, that is at the cantonal level in the Valais region. The PIF will only be implemented for the simulation at local level in order to calculate the spatial distribution of population and jobs at intra-cantonal level.

In summary, the PIF is a valuable instrument to characterize the dynamics and the spatial interactions of a territory from a quantitative perspective. A practical feature of this model is that it can be modified by decision-makers according to the evolution of the variables that are only two: population and jobs. Thus, variables are controlled by two parameters, the attractiveness and the distance between data points, which serves as the substrate for different scenarios regarding human geography, economics or environmental issues.

5.4.5 Population Dynamics Simulation Under a Multiparadigm Approach: System Dynamics and Agent-based Modelling.

The population dynamics model was built under the so-called multiparadigm approach, which allows to simultaneously approach programming languages in various ways. The reason to use this term is because i) the model is built relying open several simulations tools and ii) we used two out of the tree major paradigms in simulation: SD and ABM. In terms of environment modelling the Anylogic platform was used as it allows to perform multiparadigm simulations. The state charts for modelling purposes provided by this platform have been improved overtime and included as a part the Unified Modelling Language (UML). The figure below depicts the conceptual ideas of SD and its transfer to ABM. A fundamental difference between both paradigms is the rules of change, where SD is synchronous and depends on rate, ABM is asynchronous and depends also on rate but this can change overtime.

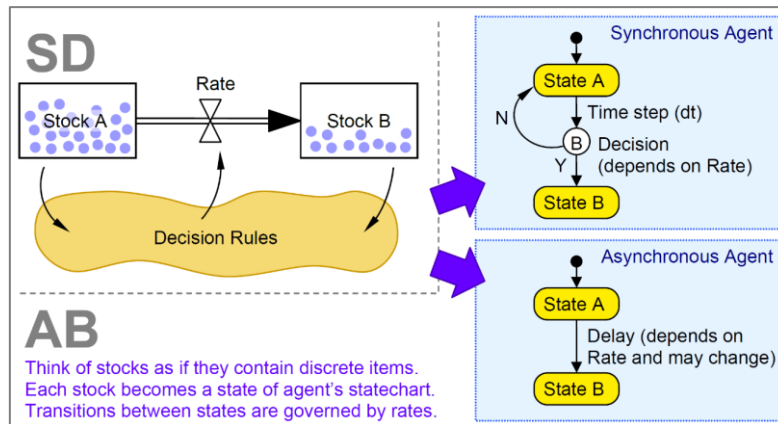

Figure 121 Re-Conceptualizing a System Dynamics Model into Agent Based Model. General Scheme. Source: Borshchev & Filippov (2004).

The following simulations concerning the populations' dynamics with under a multi-paradigm approach were developed at the GISLab at the School of Management of the University of Applied Science Western Switzerland. The project was jointly done with the collaboration of Pascal Favre⁵³ and Jean-Christophe Loubier. The model is the structure for different types of simulations under the spatial interaction umbrella for example, see Loubier (2020) where the model is used to perform stress tests in ski resorts in Valais. A pre-print publication at the moment of the preparation of this dissertation also presents the development of the model and the acknowledgement of its authors (see Rojas et al., 2021).

5.4.5.1 System Dynamics Model

The simulation of the population dynamics at a cantonal or global level was based on the model proposed by Kunte & Damani (2015). The authors attempted to improve the predictions of population change by modelling the population evolution in two different stages. The first model was done with data categorized in four age groups. In the second model they created age groups of five years. The variables that were take into account for each age group were birth rate, death rate, immigration rate, emigration rate and the global population. The authors chose a transition of 20 % of the population to the next age group each year to simulate the ageing process of the population. We did use this rule of 20 % transition and also other values, nevertheless the former value was the best fit. The figure below shows the simplest representation for a population model via SD.

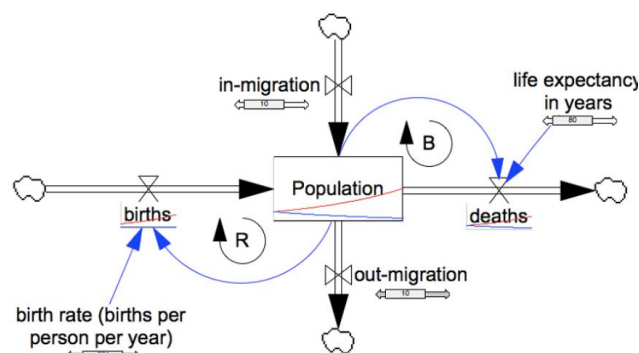

Figure 122 Population System. Source: Metcalf & Peterson (2018).

⁵³ Pascal.favre@hevs.ch

Actually, real population systems are more complex and accurate simulations demand further granularity taking into account parameters such as fertility and mortality rates per groups of age and also in-migration and out-migration rates linked to their respective fertility and mortality rates. Moreover, it has been shown that populations projections are very sensitive to variations in fertility overtime. As discussed by Kante & Damani (2015) a 10% variation of the current fertility in India, could lead to major changes, such as an exponential increase of the population to a decline.

The authors first analysed births and deaths rates related to four distinct age categories: children, adults, seniors and the elderly. They then extended this model with a separation by age group increasing by 5 years per age groups 0-4 years, 5-9 years and so forth. Thus, the authors' final model is composed of 12 stages as is shown in the Figure 68, the stages are the age groups that are represented by stocks. For each of these classes, the variables indicating the birth rate, the death rate and the overall population were used to calculate the evolution. An arbitrary shift of 20 % of the population to the next age group was made each year to simulate the population ageing process. We did use this rule of 20 % transition and also other values, nevertheless the former value was the best fit. The same model was subsequently adapted for the territory of Valais-Wallis as follows.

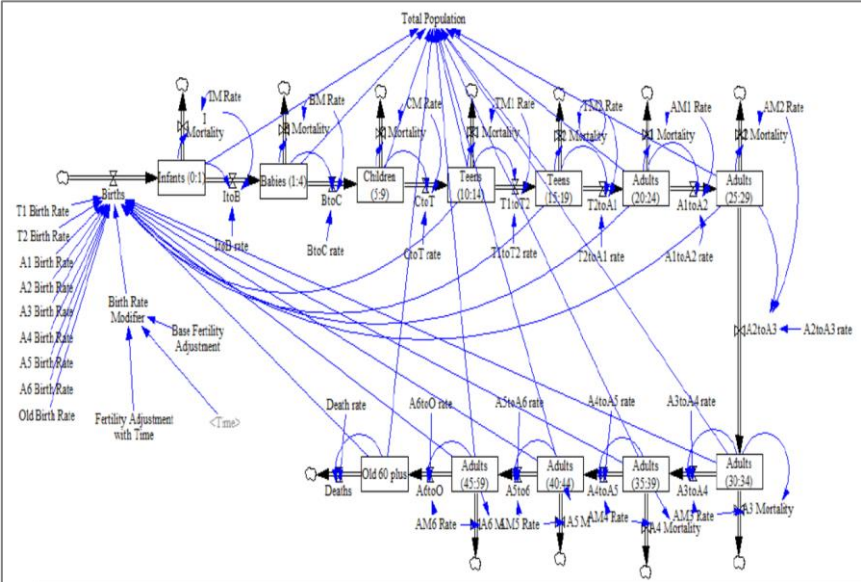

Figure 123 Stage Model from Kunte & Damani (2015).

Birth & Death Rates

In order to calculate the birth and deaths rate by age group, we used data containing births and stillbirths' information⁵⁴ from 2000 to 2016 and deaths⁵⁵ from 1991 to 2016 applying the Swiss national averages to the Valais-Wallis region. With this data, the first simulations were performed, and it was completed with in-migration and out-migration data in a second step.

In-migration and Out-migration Data

Apropos of the in-migration and out-migration data, it was also provided by the FSO. The table used is called "Migration of the permanent resident population by canton, 1999-2016"⁵⁶. Once the simulation was developed with birth and death rates we integrated the coefficients linked to the population arriving to the canton of Valais-

⁵⁴Data available on the Swiss FSO website <https://www.bfs.admin.ch/bfs/en/home.assetdetail.2901858.html>
⁵⁵ Data available on the Swiss FSO website <https://www.bfs.admin.ch/bfs/fr/home/statistiques/sante/etat-sante/mortalite-causes-deces/infantile-mortinaissances.assetdetail.137526.html>
⁵⁶ Data available on the Swiss FSO website <https://www.bfs.admin.ch/bfs/fr/home/statistiques/population/migration-integration.assetdetail.3202964.html>

Wallis (in-migration) and consequently the inhabitants leaving the canton (out-migration). Then, it was accordingly added and respectively removed, in-migration and out-migration rates to each of the age groups. The model calculates the pass-through rates of each variable by age groups, that is from a stock to another stock, therefore the interplay of all the variables allows to determine the final population per each age group.

Age group	Births	Deaths	In-migration	Out-migration	Population	Evolution
1	birth_rate_0_4	death_rate_0_4	in-migration_0_4	out-migration_0_4	population_0_4	evo_to_4
2	birth_rate_5_9	death_rate_5_9	in-migration_5_9	out-migration_5_9	population_5_9	evo_to_9
3	birth_rate_10_14	death_rate_10_14	in-migration_10_14	out-migration_10_14	population_10_14	evo_to_14
4	birth_rate_15_19	death_rate_15_19	in-migration_15_19	out-migration_15_19	population_15_19	evo_to_19
5	birth_rate_20_24	death_rate_20_24	in-migration_20_24	out-migration_20_24	population_20_24	evo_to_24
6	birth_rate_25_29	death_rate_25_29	in-migration_25_29	out-migration_25_29	population_25_29	evo_to_29
7	birth_rate_30_34	death_rate_30_34	in-migration_30_34	out-migration_30_34	population_30_34	evo_to_34
8	birth_rate_35_39	death_rate_35_39	in-migration_35_39	out-migration_35_39	population_35_39	evo_to_39
9	birth_rate_40_44	death_rate_40_44	in-migration_40_44	out-migration_40_44	population_40_44	evo_to_44
10	birth_rate_45_49	death_rate_45_49	in-migration_45_49	out-migration_45_49	population_45_49	evo_to_49
11	birth_rate_50_54	death_rate_50_54	in-migration_50_54	out-migration_50_54	population_50_54	evo_to_54
12	birth_rate_55_59	death_rate_55_59	in-migration_55_59	out-migration_55_59	population_55_59	evo_to_59
13	birth_rate_60_64	death_rate_60_64	in-migration_60_64	out-migration_60_64	population_60_64	evo_to_64
14	birth_rate_65_69	death_rate_65_69	in-migration_65_69	out-migration_65_69	population_65_69	evo_to_69
15	birth_rate_70_74	death_rate_70_74	in-migration_70_74	out-migration_70_74	population_70_74	evo_to_74
16	birth_rate_75_79	death_rate_75_79	in-migration_75_79	out-migration_75_79	population_75_79	evo_to_79
17	birth_rate_80_84	death_rate_80_84	in-migration_80_84	out-migration_80_84	population_80_84	evo_to_84
18	birth_rate_85_89	death_rate_85_89	in-migration_85_89	out-migration_85_89	population_85_89	evo_to_89
19	birth_rate_90	death_rate_90	in-migration_90	out-migration_90	population_90	evo_to_90

Table 18 Variables of the population system categorized by age groups.

The validation of this first step was carried out by a way of comparing the simulated evolution between 2010 and 2015 with the real data containing the evolution for the same period. Furthermore, in order to converge towards an effective simulation, it was followed two different procedures with an ABM approach. In a first stage, the whole system was placed at the level of the population agents. Before developing the ABM approach, we will proceed to present the results obtained under the SD methodology.

Results of Simulations and Spatial Representations

In this section the results of the simulations of the population evolution will be shown and the respective development of the spatial strategy for the maps representations. By way of comparison, the scenarios produced by the FSO on the evolution of the population by canton for the coming years were used as an indicator to do a long-term simulation. The simulations were performed in two phases, in the first one we used fixed rates for births, deaths, in-migration and out-migration and in the second phase it was implemented the dynamic rates per age group. The following table contains the results of an initial simulation with a relatively simple basic model with fix rates of evolution. Historical data was used to set up the starting conditions of the model, therefore the simulation begins on the 1st of January 2010 that is the date of reference for the population data provided by the FSO.

Year	Swiss Federal Statistical Office's Population Simulation	Systems Dynamics coupled with Agent-based modelling of population	Δ
2015	331784	332063	0.1%
2020	353637	347483	-1.7%
2025	373936	362192	-3.1%
2030	393366	376098	-4.4%
2035	410277	389202	-5.1%
2040	421137	401547	-4.7%
2045	428598	413179	-3.6%
Average difference			-3.2%

Table 19 Population Dynamics Simulation with fix births and deaths rate in the canton of Valais-Wallis.

The average difference per every 5 years forecast between the model presented in this dissertation is -3.2% with regard to the simulations performed by the FSO, in a time horizon until 2045.

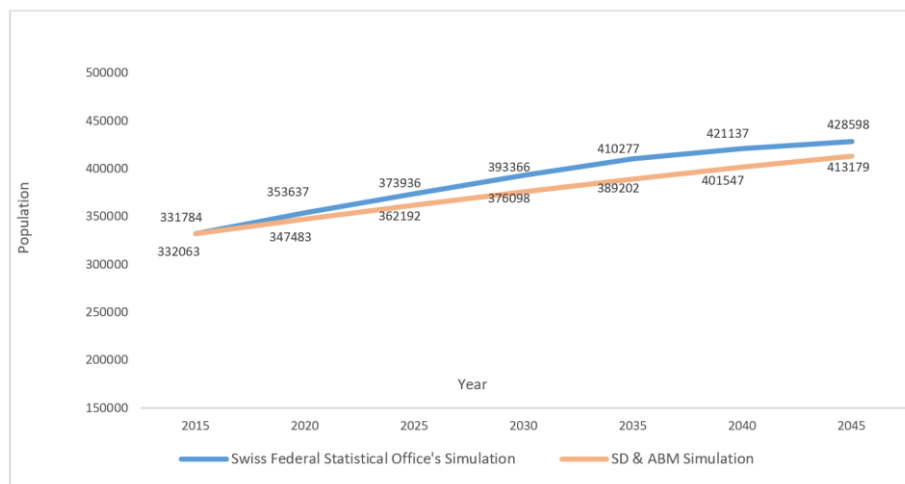

Figure 124 Forecast of population dynamics in Valais-Wallis horizon 2045

The next step taken to simulate the population dynamics was to change the rates over time. In the document "*Scenarios of population change in Switzerland 2015 - 2045*⁵⁷", the FSO reviews a whole series of indicators such as fertility, mortality and migration. According to the FSO's forecasts, the fertility rate at a national level is expected to change slightly between now and 2045, from an average of 1.51 children per woman in 2015 to 1.58 children in 2045, which represents a rate increase of 4.7%. According to the FSO's simulations, this value should stabilise at this level. To relate this rate increase to the model presented here, a so-called "target" variable for the different age groups was created, the birth rate is then gradually increased to reach the target in 2040.

Year	Swiss Federal Statistical Office's Population Simulation	Systems Dynamics coupled with Agent-based modelling of population	Δ
2015	331784	335266	1.0%
2020	353637	347694	-1.7%
2025	373936	362680	-3.0%
2030	393366	376967	-4.2%
2035	410277	390559	-4.8%
2040	421137	403501	-4.2%
2045	428598	415811	-3.0%
Average difference			-2.8%

Table 20 Population Dynamics Simulation with dynamic fertility, mortality and migration rates in Valais, horizon 2045.

With these adjustments we can observe that the average delta between the simulations was slightly reduced to -2.8 %. These simulations are at a cantonal level, so now we will present the integration of the gravity model with the population evolution at smaller spatial scales. To spatially explicit perform the simulation of the population distribution we used data provided by the FSO, whose data sets follow rules for data protection: It must not be possible to identify an individual, so the minimum value is set to 3 for all data points with 3 or fewer individuals (people or jobs). This led to some issues of overestimation of the population of the canton present in the original data set. The potential field layers of the attractiveness were used to overcome these problems (see section 5.4.2) in order to distribute the population from a spatial perspective at a 100 sq m resolution.

⁵⁷ Available online <https://www.bfs.admin.ch/bfs/en/home/statistics/catalogues-databases/graphs.assetdetail.5906436.html>

5.4.5.2 Population dynamics in the canton of Valais via the integration of a spatial interaction model and agent-based modelling.

The data protection measure taken by the FSO mentioned afore prompted us to deploy an integrated model. The development of the point attraction system ranging from 0 to 1, with 0 for zero attraction and 1 for maximum attraction. Indeed, SD simulations are not spatial, therefore the spatial scale reductions become more complex to achieve under the SD paradigm. Hence, it was needed another methodology to operate the scale change simulation allowing to establish a rule for allocating the attractiveness at each data point. To accomplish this, it was used an ABM model. Two ABM approaches were used in order to change the scale of analysis, under this approach, first it was followed a bottom-up method from local to global level and the second procedure was from global to local level. In this way a precise calculation of the evolution of the population could be made, considering the local specificities in the region. The first model will be referred to as the **Local to Global ABM model**. Once the first version of the population evolution system was tested, a second model was created, this time with the dynamics of the system at the level of the main activity in the canton. The aim here is to calculate the overall population change at the level of the canton, and then to redistribute it to local agents (see Figure 125) according to the general structure of the simulation model. This model will be referred to as the **Global to Local ABM model**.

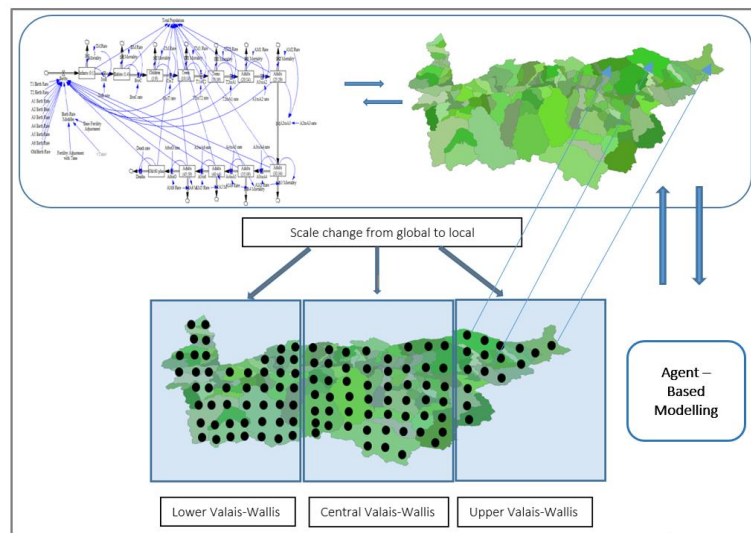

Figure 125 General Structure of the Population Dynamics Model.

The multiparadigm nature of the model allowed to approach the programming aspects of the model in another manner since we needed to address other components of the system typified in the scale change. The description of the procedures to build the ABM models will be discussed in the next section.

Version 1 Local to Global ABM Model

The georeferenced data provided by the FSO was used to build the first version of the model, where the smallest spatial unit has a 100 sq m resolution, and the territory analysed was the canton of Valais. Nevertheless, we were confronted with a difficulty related to data protection measures taken by the FSO. The data provided by the FSO has a restriction for spatial units of 100 sq m with less than three data points. Consequently, if there are less than three data points in a 100 sq m spatial unit, the data point value will be three by default. This restriction generated an overestimation of the population so logically we needed to address this problem from the beginning before doing a forecast of the population integrating that scale.

The simulations were developed on the software *Anylogic* by implementing a series of rules to distribute the population of spatial units when **population ≤ 3** in a 100 sq m spatial units. This procedure was necessary as it was needed to have a high approximation of granular data of the population. The goal was to create agents with several attributes such as age, gender, with birth and mortality as well as in-migration and out-migration rates in order to do a forecast of the population evolution in the subsequent phase. Here we will describe the main rules of the code to calculate the population per 100 sq m as follows:

Algorithm 1 Population Dynamics at 100m² Spatial Resolution With Data Protection

- i. We took the population data of the canton of Valais from 2012 and created two different variables, the **total population** and *the population > 3* per spatial unit of 100 m². These were the two known variables of the equation and they were used to isolate the variable **population ≤ 3**, which was unknown.

- ii. $(Total\ population) - (population > 3) = population \leq 3$, which is the population to distribute in the spatial units where the data protection is enabled. (5.1)

- iii. The next phase was to create agents that represent the variable **population ≤ 3**, those are spatial units of 100 m² where **population ≤ 3**:

$$intAgentPopulation \leq 3 = count(populations, p \rightarrow p.populationTotal \leq 3) \text{ this function counts the integer number of agents where data protection is enabled.} \quad (5.2)$$

- iv. Once the agents were identified and counted, they were computed with the average Huff's likelihood⁵⁸: $AveragePopHuff_likelihood = averageWhere(populations, p \rightarrow p.huff_likelihood, p \rightarrow p.populationTotal \leq 3)$ (5.3)

- v. Then, we proceeded to compute the known population, the Huff's likelihood and the agents in order to find the real population values with the following equation:

$$maxPop = (1 / AveragePopulationhuff) * (populationToDistribute / AgentsPopulations \leq 3) \quad (5.4)$$

Where **maxPop** denotes the maximal number of people in the spatial unit of reference. The same algorithm was used to calculate the number of jobs per spatial unit when the protection data restriction was enabled. This was possible because the data about population and jobs was set up in the exact same way. The only procedure that was needed to do, it was to replace the variable: **maxPop** by **maxJobs**

Consequently, we would arrive to the same final formula but replacing the population variable by jobs:

$$maxJobs = (1 / AverageJobshuff) * (jobsToDistribute / AgentsJobs \leq 3) \quad (5.5)$$

The age groups categorized by gender were subsequently integrated to follow the rules that were previously described in a loop as follows:

```
//Population variables to loop through
String[] variables = new String[] { "b10Bm01" b10Bw01..." }
```

Where;

⁵⁸ Huff model is discussed in the section Neoclassical approaches 2.1.1

The letter **b** stands for the German word *Bevölker*, which means population; 10 = year 2010; the letters **m** and **w** mean men and women respectively; and 01 is the age group number 1. The next step was to update the database values and check if the spatial units of 100m² resolution had three data points or less. If so, the agent's value is equal to maxPop * p.huff, if not the variable takes the value as it comes. The following stage was to categorize the previous results per age group and gender. The code is available in APPENDIX A.

Version 2 Global to Local ABM Model.

For this version of the model, the starting point is at a global level to do a redistribution of the population, so it was required data by age group at the canton level. Once the simulation changed of spatial scale, from local (100 sq m) to global (cantonal level), the model carried out the calculations. The next step was to update the population data provided by the FSO, and it was adapted to the fertility, mortality, in-migration and out-migration rates that were previously used in the SD model. Once these calculations were performed, a very good approximation of the real population and jobs per spatial unit was reached in spite of the data protection feature. This procedure can be used for economic geography studies such as regional economic resilience and urban resilience as discussed in sections 2.3.4 and 2.3.5, which is often limited by data with administrative boundaries. The calculations were done with data from 2012 to 2015 for both, population and jobs and the results were compared with the real data, the Figure 126 shows the residual distribution of the population's simulation where the green colour represents a residual value equal to zero.

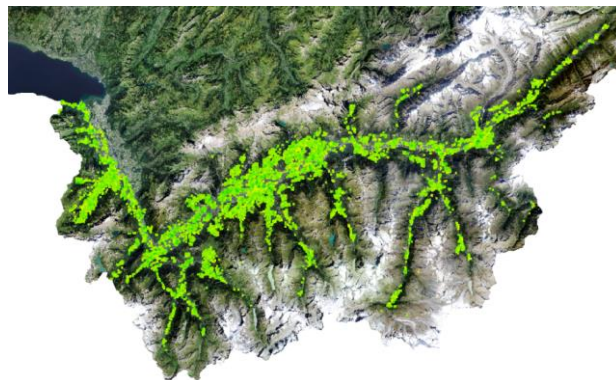

Figure 126 Residuals distribution of the simulation of the population 2015 at 100 sq m in the canton of Valais.

This map shows that the model fits well, and we estimate that this model with the actual data might allow us to simulate the population dynamics for a horizon of 10 years while controlling all the procedures. Beyond that period, it is very likely that uncertainty issues linked to the complexity of interactions of the population dynamics, this model would not fit the data anymore. The following map shows the results obtained from the simulation of the population's dynamics for the canton of Valais. The Figure 127 is a map with a 3D isometric view of 45° of the canton of Valais. The red colour represents the spatial units where the population is decreasing, and the green represents the areas where the population increases. It can be observed that city centres are losing population, this is also the case in the Conche valley. This model is thus the initial situation of the general simulation, in which the innovation indicators will be integrated in the next step. As innovation diffusion is a social process, and in the case of RET the diffusion consists of interactions and exchanges between agents that are at determined locations. Therefore, the dynamics of population and jobs will be considered as a starting point. An interesting issue observed is that the city centre is losing population, regarding this fact usually, peripheral areas host more workers than jobs. The trend towards dissociation between place of residence and place of work explains the behaviour of many second home residents in the countryside in Switzerland who, as soon as the working week is over, leave to get some rest 'in the countryside' (see section 3.1.3).



Figure 127 Representation of Population Dynamics at 100 sq m resolution in the canton of Valais.

The concentration of jobs and the explosion of the price per square metre in the centre of urban areas, as well as the improvement of transport networks, have contributed to making this withdrawal plan a good strategy. Thus, in practice, a second home in the countryside can become a principal residence. For readers interested in this model, a detailed description of the procedures followed on the simulation software *Anylogic* to build the model, a guideline is available online⁵⁹

5.5 Multi-scale Spatial Network Diffusion Modelling for Renewable Energy Technologies in the Swiss Alps.

This part of the dissertation deals with the spatial analysis of RET, more specifically heating and hot water usage in the Swiss Alps and electric cars in Switzerland. This is the subphase F of the second phase of the general system of simulation. This stage is a central part of the general model and the dissertation. The different steps followed to build a network will be thoroughly discussed. The Figure 128 illustrates the task within the generally system of simulation.

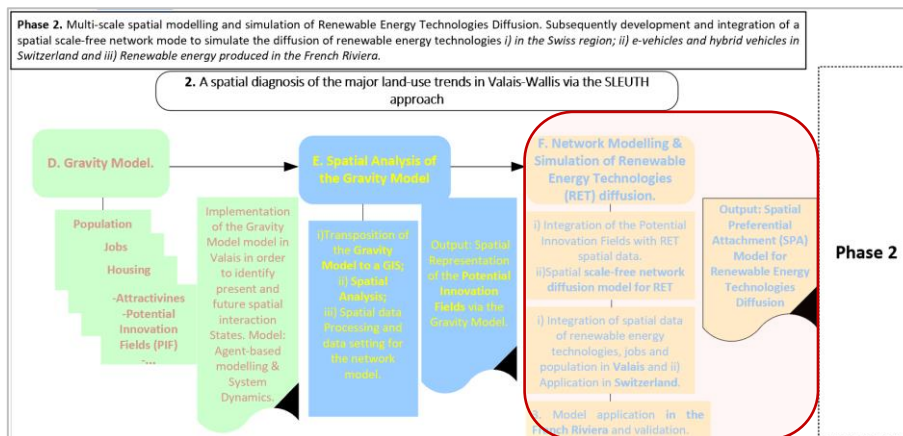

Figure 128 Multi-scale Network Modelling & Simulation of Renewable Energy Technologies Diffusion in the Swiss canton of Valais, in Switzerland and in the South Region of France.

⁵⁹ The guideline is available in French here: <https://github.com/DiegoFernandoRojas>

5.5.1 Data

The data was provided by the FSO⁶⁰, it is included in the data set containing the population's information. This dataset is subjected to data protection laws and is not available for free. Here we will present the variables relevant to perform exploratory data analysis (EDA), which will be developed in the next section. The original metadata is presented with acronyms from German (left column in Table 21). In Switzerland all inhabitants listed in the register of residents must have a at Building Identifier (EGID) as well as a Household Identifier (EWID).

Swiss Federal Statistical Office Codes	Variables' names in English	Qualitative Data	Quantitative Data	Building	Flat	Data Availability
EGID	Building ID	X		X		From 2009 to date
EWID	Household ID					From 2009 to date
GKATS	Building category	X		X		From 2009 to date
GBAUPS	Building construction time	X		X		From 2009 to date
GHEIZS	Heating system	X		X		From 2009 to 2015
GENHZS	Heating energy agent	X		X		From 2009 to 2015
GENWWS	hot water energy agent	X		X		From 2009 to 2015
GAZWOT	Number of flats in the building		X	X		From 2009 to 2015
GAPSW	Number of people in the building (permanent residence)		X	X		From 2011 to 2015
householdbyage25tot	Household inhabitants age	X			X	From 2013 to date
compbasicofphtot	Household composition	X			X	From 2013 to date
householdbynatiotot	Nationality	X			X	From 2013 to date
WAZIMS	Number of rooms		X		X	From 2009 to date
WAREAS	Dwelling surface		X		X	From 2009 to date
Wapto	Number of people in a dwelling		X		X	From 2012 to date
GKODESH	Coordinates X (metre/hectometre)	NA	X	NA	NA	From 2009 to date
GKODNSH	Coordinates Y (metre/hectometre)	NA	X	NA	NA	From 2009 to date
GDENAME	Name of the municipality	X	NA	NA	NA	From 2009 to date
GDENR	OFS municipality number	X	NA	NA	NA	From 2009 to date
DGRUNDPLZ4	ZIP code	X	NA	NA	NA	From 2009 to date
DGRUNDPLZZ	ZIP code complement (positions 5 and 6)	X	NA	NA	NA	From 2009 to date

Table 21 Housing Geometadata in Switzerland. Source: FSO, 2017.

Through this mechanism, it is possible to link the population to a building and to a house respectively across the country in order to have clearly identified residents. The Table 21 shows the metadata of georeferenced information regarding population, buildings, dwellings and energy systems in unified system. The data containing information on the energy systems for heating and hot water is linked to the building ID, indicating the origin of the energy used in a determined building, which is also linked to the population register. The data containing information on energy systems is based on categorical variables, in which is only indicated if an energy agent is present or not (see Figure 129).

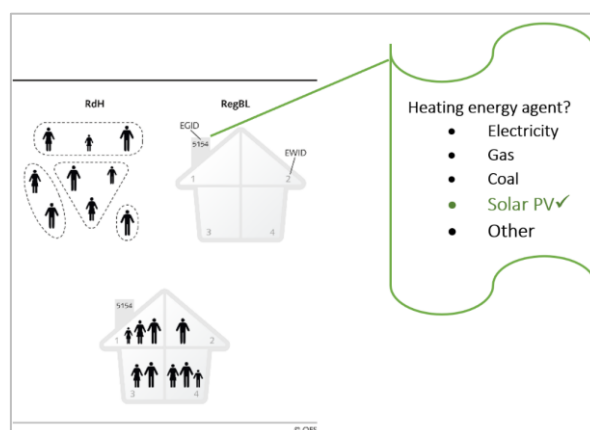

Figure 129 Overview of the Georeferenced Data of the Swiss Register System of Population, Buildings, Dwellings and Energy.

^a RdH stands for registers of inhabitants after the abbreviations in French and REgBL stands for register of buildings and dwellings.

Now we will proceed to the EDA section, where the RET indicators will be analysed.

⁶⁰ <https://www.bfs.admin.ch/bfs/fr/home/statistiques/catalogues-banques-donnees/publications.assetdetail.6027955.html>

5.5.2 Exploratory Data Analysis of Renewable Energy Technologies

An EDA was developed in order to better understand the studied real-world system. The EDA is an approach or a philosophy that aims at unveiling patterns through different techniques, therefore it is not a technique *per se* (see Tukey, 1977). Some of the techniques are statistical graphs and basic statistical measures tools such as histograms, box plots. An EDA was applied to the variables shown below, which is a breakdown of the previous table:

Swiss Federal Statistical Office Codes	Variable name	Breakdown			Data type			
		Variables' names in English	Code number and values in Swiss Register	New code number for calculations (if applies)	Type of variable	Information at Building (B) or Dwelling (D) level	Type of data Physical (P) or Social (S), which includes administrative data.	Data availability
EGID	building	Building ID			Nominal	B		From 2009
EWID	dwellinger	Dwelling ID			Nominal			From 2009
GKATS	buildclass	Individual dwellings	1021	1	Categorical	B	P	From 2009
		Houses with several dwellings	1025	2	Categorical	B	P	From 2009
		Building dwellings with alternative usage	1030	3	Categorical	B	P	From 2009
		Buildings partially dwellings	1040	4	Categorical	B	P	From 2009
G8AUPS	buildyear	Before 1919	8011	1	Categorical	B	P	From 2009
		From 1919 to 1945	8012	1	Categorical	B	P	From 2009
		From 1946 to 1960	8013	2	Categorical	B	P	From 2009
		From 1961 to 1970	8014	3	Categorical	B	P	From 2009
		From 1971 to 1980	8015	3	Categorical	B	P	From 2009
		From 1981 to 1985	8016	3	Categorical	B	P	From 2009
		From 1986 to 1990	8017	3	Categorical	B	P	From 2009
		From 1991 to 1995	8018	3	Categorical	B	P	From 2009
		From 1996 to 2000	8019	3	Categorical	B	P	From 2009
		From 2001 to 2005	8020	4	Categorical	B	P	From 2009
		From 2006 to 2010	8021	4	Categorical	B	P	From 2009
		From 2011 to 2015	8022	4	Categorical	B	P	From 2009
		From 2016	8023	4	Categorical	B	P	From 2009
GHEZS	heating_system	Heating system	As follows:	As follows:		B	P	From 2009 to 2015
		No heating system	7100	1	Categorical	B	P	From 2009 to 2015
		Potle	7101	2	Categorical	B	P	From 2009 to 2015
		Central heating system for one dwelling	7102	3	Categorical	B	P	From 2009 to 2015
		Central heating system for one building	7103	4	Categorical	B	P	From 2009 to 2015
		Central heating system for several buildings	7104	5	Categorical	B	P	From 2009 to 2015
		District heating (teleheating)	7105	6	Categorical	B	P	From 2009 to 2015
		Other	7109	7	Categorical	B	P	From 2009 to 2015
GENHS	heating_agent	Heating energy agent	As follows:	As follows:		B	P	From 2009 to 2015
		No energy agent	7200	1	Categorical	B	P	From 2009 to 2015
		Black oil mazout	7201	2	Categorical	B	P	From 2009 to 2015
		Coal	7202	3	Categorical	B	P	From 2009 to 2015
		Gas	7203	4	Categorical	B	P	From 2009 to 2015
		Electricity	7204	5	Categorical	B	P	From 2009 to 2015
		Wood	7205	6	Categorical	B	P	From 2009 to 2015
		Heat pump	7206	7	Categorical	B	P	From 2009 to 2015
		Solar PV	7207	8	Categorical	B	P	From 2009 to 2015
		District heating (teleheating)	7208	9	Categorical	B	P	From 2009 to 2015
Other	7209	10	Categorical	B	P	From 2009 to 2015		
GENHWS	hwater_agent	Hot water energy agent	As follows:	As follows:		B	P	From 2009 to 2015
		No energy agent	7200	1	Categorical	B	P	From 2009 to 2015
		Mazout	7201	2	Categorical	B	P	From 2009 to 2015
		Coal	7202	3	Categorical	B	P	From 2009 to 2015
		Gas	7203	4	Categorical	B	P	From 2009 to 2015
		Electricity	7204	5	Categorical	B	P	From 2009 to 2015
		Wood	7205	6	Categorical	B	P	From 2009 to 2015
		Heat pump	7206	7	Categorical	B	P	From 2009 to 2015
		Solar PV	7207	8	Categorical	B	P	From 2009 to 2015
		District heating (teleheating)	7208	9	Categorical	B	P	From 2009 to 2015
Other	7209	10	Categorical	B	P	From 2009 to 2015		
BAZWOT	airflat_build	Number of flats in the building	As follows:	As follows:	Continuous	B	P	From 2009
BAPSW	nrpp1_build	Number of people in the building (permanent residence)	N/A			B	S	From 2011
householdbyagec2stot	house_age_25	Household composition by age	As follows:	As follows:		D	S	From 2013
		1- Under de 25 years old	1	1	Categorical	D	S	From 2013
		2- From 25 to 64 years old	2	2	Categorical	D	S	From 2013
		3- From 65 years old and more	3	3	Categorical	D	S	From 2013
		4- From 0 to 64 years old	4	4	Categorical	D	S	From 2013
		5- Under 25 years old and from 65 years old and more	5	5	Categorical	D	S	From 2013
		6- From 25 years old to 65 years old and more	6	6	Categorical	D	S	From 2013
		7- All ages	7	7	Categorical	D	S	From 2013
		8- Not applicable	8	8	Categorical	D	S	From 2013
compbasicofphhtot	house_comp	Household composition				D	S	From 2013
		Man adult	101	1	Categorical	D	S	From 2013
		Woman adult	102	2	Categorical	D	S	From 2013
		Two adults of different sexes	110	3	Categorical	D	S	From 2013
		Two adults of the same sex	111	4	Categorical	D	S	From 2013
		Three or more adults	120	5	Categorical	D	S	From 2013
		An underage person	201	6	Categorical	D	S	From 2013
		Two underage people or more	202	7	Categorical	D	S	From 2013
		Single man with one or more underage people	210	8	Categorical	D	S	From 2013
		Single woman with one or more underage people	211	9	Categorical	D	S	From 2013
		Two adults of different sexes with one or more underage people	220	10	Categorical	D	S	From 2013
		Two adults of the same sex with one or more underage people	221	11	Categorical	D	S	From 2013
		Three adults or more with one or more underage people	230	12	Categorical	D	S	From 2013
Not applicable	8	13	Categorical	D	S	From 2013		
householdbynatiotot	house_nat	Swiss Household: all Swiss members	1	1	Categorical	D	S	From 2013
		Swiss-foreign household: at least one Swiss and one foreigner	2	2	Categorical	D	S	From 2013
		Foreign household: all foreign members	3	3	Categorical	D	S	From 2013
		Not applicable	4	4	Categorical	D	S	From 2013
WAZAMS	room_nr	Number of rooms	Numeric		Continuous	B	P	From 2009
WAREAS	house_area	Dwelling surface	Numeric		Continuous	B	P	From 2009
WAPTO	nrpp1_house	Number of people in a dwelling	Numeric		Continuous	D	S	From 2012
GKODES	coordx	Coordinates E (metre)	28480000	N/A	Continuous	B and D	P	From 2009
			28480000					
GKODNS	coordy	Coordinates N (metre)	10700000	N/A	Continuous	B and D	P	From 2009
			13000000					
GKODESH	coordhx	Coordinates E (hectometre)	28480000	N/A	Continuous	B and D	P	From 2009
			28480000					
GKODNSH	coordyh	Coordinates N (hectometre)	10700000	N/A	Continuous	B and D	P	From 2009
			13000000					
EDENAME	municipality	Name of the municipality	Swiss Official Communa Register (click here)		Nominal	N/A	P	From 2009
GDENR	municip_nr	DPS municipality number	Swiss Official Communa Register (click here)		Ordinal	N/A	S	From 2009
IGRUNDPLZA	zp_code	ZP code	N/A		Ordinal	N/A	S	From 2009
IGRUNDPLZLZ	zp_code_compl	ZP code complement (positions 5 and 6)	N/A		Ordinal	N/A	S	From 2009
GASTWS	nr_floors	Number of floors	1 - 35 (From 1 to 35 floors in a building)	N/A	Categorical	B	P	From 2009
BAPTO	nr1_build	Number of people in the building (total) ^a	Numeric	N/A	Continuous	B	S	From 2011
BAPHW	main_res	Number of persons in the building (main residence) ^b	Numeric	N/A	Continuous	B	S	From 2011
BAPSW	tot_resid	Number of people in the building (permanent resident) ^c	Numeric	N/A	Continuous	B	S	From 2011

Table 22 Breakdown of Housing Geometadata in Switzerland. Adapted from FSO (2017).

^a Number of persons with assigned EGID (the total number of persons does not correspond to the Swiss resident population, persons may be counted more than once). ^b Number of persons in primary residence with the assigned EGID (roughly corresponds to the definition of civil domicile in the census called RFP2000). ^c Number of people in the permanent resident population with the assigned EGID.

The conceptual idea of EDA has been embraced by geographers since some decades ago, since it offers powerful insights derived from visualisation to spatial ‘wandering’ as described by Banos (2001). This approach allowed us to design more sophisticated approaches in the next steps. The EDA was performed relying on population and RET in the region of Valais and in the South Region of France in Chapter 6. The FSO’s data privacy regulations do not allow to cross-analyse this dataset with other datasets therefore, the study is bounded by the variables presented here.

Based on the data previously presented, an EDA was done without developing any spatial analyses yet however, all the data sets are organized from a spatial perspective, using a 100 sq m resolution. The outputs derived from the ABM and SD approaches to calculate the population at a resolution of 100 sq m, were used to match the location of the population with the Buildings ID’s georeferenced data. Having the quantities and spatial data of both variables allowed to do an analysis of their spatial relation. The figures below show the scaling emergence in the population according to the three definitions mentioned in the last three lines in Table 22. The charts of this section were done with the library ggplot2 from R (Wickham, 2009).

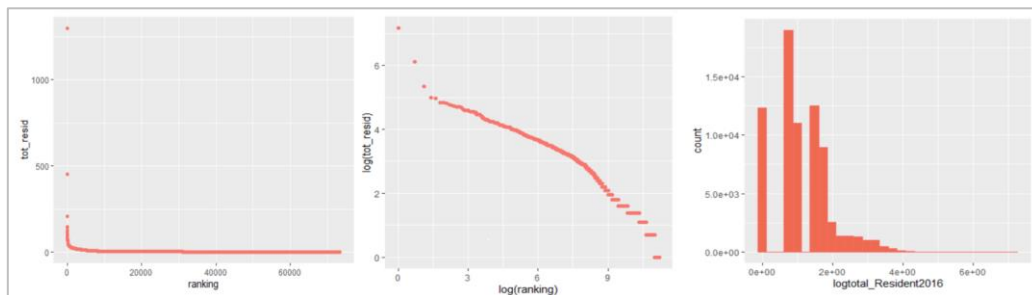

Figure 130 (Left) Rank-Size: number of people per building vs ranking: scaling emergence at building level in Valais, 2016. (Centre) The same chart on a log-log plot. (Right) Logarithmic histogram of permanent residents per building. N= 73,419; Ytotal_residents= -0.759; Adjusted-R²= 0,905.

The summary of the regression of the total residents per building with the rank is depicted as follows:

Call: `lm(formula = logtotResid2016 ~ logRank2016)`

Residuals:

Min	1Q	Median	3Q	Max
-2.82738	-0.05548	0.05995	0.15897	0.36813

Coefficients :

	Estimate	Std. Error	t value	Pr(> t)
(Intercept)	8.8700138	0.0093037	953.4	<2e-16 ***
logRank2016	-0.7590000	0.0009074	-836.4	<2e-16 ***

Signif. codes: 0 ‘***’ 0.001 ‘**’ 0.01 ‘*’ 0.05 ‘.’ 0.1 ‘ ’ 1

Residual standard error: 0.2458 on 73417 degrees of freedom

(37261 observations deleted due to missingness)

Multiple R-squared: 0.905, Adjusted R-squared: 0.905

F-statistic: 6.996e+05 on 1 and 73417 DF, p-value: < 2.2e-16

According to the distributional behaviour of the population shown here, suggest the emergence of power laws at building level. The consequences of these behavioural patterns on innovation diffusion also suggest that interactions, exchanges and diffusion processes might be influenced by the location of emitters and receptors within a social system perspective. In this case, such information flow and the RET diffusion would possibly also have a fat tailed distribution, this is an assumption, which will be tested later in this section.

Another statistical analysis was performed on RET indicators; the following inferential statics will introduce us to the subject. The dataset was composed of numeric and categorical variables, this prompted us to do a discriminant analysis (DA), which is used for statistical classification purposes in machine learning. For instance, in supervised

learning, known samples are used to build a model to predict a value for a future response, where regressions and classification are some of the main approaches used in supervised learning. In the former as shown in Figure 130, the labelled data are real numbers and it is used to estimate values of the new samples, whereas the latter, the known samples of categorical values such as 'heating_agent', which is represented by 8 classes⁶¹ is used to build the model.

The variable 'heating_agent' (see Table 22) has 8 levels or categories, therefore the objective here is to determine the category of 'heating_agent' using the following 8 explanatory variables⁶²:

nr_rooms (numeric); dwell_surf (numeric); nrppl_dwell (numeric); nr_floorsbuild (numeric); nrdwell_build (numeric); ppl_build (numeric); main_res (numeric); tot_resid (numeric)

With a sample with $n = 244434$ observations the model was built as follows. The development of a Quadratic Discriminant Analysis (QDA) was performed in R. All the 8 predictor variables were numeric, and the only categorical variable is the response variable 'heating_agent'. Afterwards, the Linear Discriminant Analysis (LDA) assumption analysis was done in order to determine if the covariance variance matrices for each class were equal to each other. LDA has the homoscedasticity assumption, which is one of three major assumptions in parametric statistical analysis. In multivariate analysis, this assumption entails that all pairwise combinations of variables follow a bell-curve. There are different ways to check this assumption, in this model we used two tests:

i) *Barlett's test of variance*

$$B = (N - k) \ln \frac{\left(\frac{\sum_{i=1}^k (n_i - 1) S_i^2}{N - k} \right) - \sum_{i=1}^k (n_i - 1) \ln(S_i^2)}{1 + \frac{1}{3(k-1)} \left[\left(\sum_{i=1}^k \frac{1}{n_i - 1} \right) - \frac{1}{N - k} \right]} \quad (5.6)$$

Where;

N is the sum of all sample sizes and has an asymptotic distribution χ^2 with $(k-1)$ degrees of freedom, where;

$$\begin{aligned} H_0 : \sigma_1^2 &= \sigma_2^2 = \dots = \sigma_k^2 \\ H_1 : \sigma_1^2 &\neq \sigma_2^2 \neq \dots \neq \sigma_k^2 \end{aligned}$$

Bartlett's K-squared = 6433800, df = 6, p-value < 2.2e-16

Therefore, the null hypothesis that the covariance variance matrices is equal to each other is rejected. A second test was performed as it has been acknowledged that the Barlett's test is very sensitive to data points departing from normality (Box, 1953), which it was expected since some population's variables follow a power distribution. This test can be used if the samples size is relatively large (Arsham & Lovric, 2011). Anyways, to double check a non-parametric test called the Fligner-Killeen test was performed, which is robust against departures from normality.

ii) *Fligner-Killeen test of homogeneity of variances:*

$$FK = \frac{\sum_{i=1}^k n_i (\alpha_i - \alpha)^2}{s^2} \quad (5.7)$$

⁶¹ The observations in the classes 'no energy agent' and 'other' were not include in the QDA, see Table 22.

⁶² See Table 22 for the definitions of the variables.

Where k represents the number of groups; n_i denotes the size of the i^{th} group and α_j represents the mean of the normalization values only for the j^{th} group; α is the mean of all normalization values and S^2 is the variance of the normalization values.

Fligner-Killeen K-squared = 1018900, df= 6, p-value < 2.2e-16

Hence, the null hypothesis of homogeneity of variance is rejected. These results are not surprising since it was shown above that some of the variables' distributions did not follow a bell-curve, but atypical data points or *hubs* were observed. The violation of the homoscedasticity assumption leads to heteroscedasticity, which implies that values of the explained variable appear to increase or decrease as a function of the explanatory variables. There are other approaches to check the homoscedasticity assumption such as the Levene and Box tests (see Salkin, 2010). Since the homoscedasticity assumption was rejected, a QDA was performed and the algorithm used to do that, it is explained as follows:

- i) # The data was randomly partitioned, the model was trained with 75% of the sample, that is 183,326 observations: `sample_size = floor(0.75 * nrow(`data`))`.
- ii) # A seed was set to replicate the partition of the data:
`set.seed(1000000)`
`training_ind = sample(seq_len(nrow(`data`)), size = sample_size)`
- iii) # A partition of 75% of the data is allocated in the variable called '*training*' and the remaining 25% in a variable called '*test*':
`Training = `data`[training_ind,]`
`testing = `data`[-training_ind,]`
- iv) # Once the dataset was randomly partitioned the QDA was performed:
`model = qda("heating_agent" ~., data = train)`
`predictclass = predict(model, newvalues= test)`
`table(test$heating_agent, predicted$class, dnn = c("Actual Group", "Predicted Group"))`
the model accuracy was calculated trough a confusion matrix:
`mean(predicted$class == test$heating_agent)`

		Actual Values	
		Positive (1)	Negative (0)
Predicted Values	Positive (1)	TP	FP
	Negative (0)	FN	TN

Figure 131 Confusion Matrix. TP= True Positive; FP= False Positive; FN: False Negative; TN: True Negative.

The explanatory power of the model was very low= 0.3173253.

Since these results did not explain the adoption of RET, it was implemented a spatial analysis, whose promising results show again the relevance of the spatial dimension in urban energy transition modelling. The multiscale spatial analysis process of socio-economic data and RET started by the calculation of the kernel density at three different spatial scales. The kernel estimation is a non-parametric statistical method used to calculate the probability density of a random variable. This calculation requires discrete variables such as the number of solar

PV in a determined area or the number of people or jobs in a given region of study. The calculation of the spatial density of phenomena by means of kernel density estimation (KDE) is an approach that aims at mapping variables at specific locations under a continuity fashion. To operationalize this method, it was used again the data from the FSO. This information is presented on a grid of points, as an example the grid in the Figure 132 contains the initial conditions composed by the local situations of the points position.

The geo-referenced data of population and the number of jobs at a 100 sq m resolution was coupled with the data of RET such as solar PV and solar thermal collectors in the canton of Valais-Wallis and electric cars at a national level in Switzerland. This data is presented on a grid of points that are set at the chosen spatial scale, for example in the case of solar PV and solar thermal collectors the scales were 300, 600 and 1200 sq m respectively.

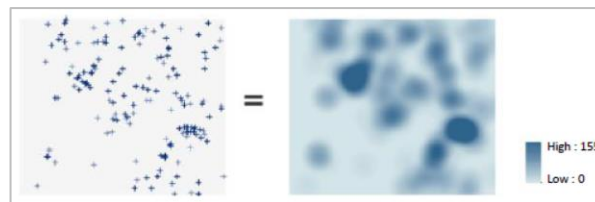

Figure 132 Kernel Density. Source: ESRI (2018).

To do this calculation, a sliding window or bandwidth, searches within a certain radius for the number of points i.e., number of solar PV that are in each mesh and in its vicinity. Thus, the algorithm, through a quadratic formula proposed by Silverman (1986) characterizes the surfaces around each pixel. The highest value is located in the centre of this area for instance, where the majority of the solar PV are located, and it then decreases when the pixel value becomes lower and the distance to the centre of the pixel increases. The latter is the distance decay we have referred to earlier. The concept relies on the density estimation of a function, if we take any random variable X that has a probability density function (PDF) f , the distribution of X and the probabilities associated with X can be calculated by specifying the function f :

$$P(a < X < b) = \int_a^b f(d) dx \text{ for all } a < b \quad (5.8)$$

The density estimation can be calculated with a parametric approach, for example when a data set has a normal distribution with known parameters mean μ and variance σ^2 . In this case, the density f could be estimated by replacing these parameters in the formula of normal density. In the case of kernel density estimation, we work with a non-parametric method, which reduces the constraints regarding the assumptions of the data distribution. The kernel method takes into account the neighbouring values of the variable observed, which is in line to the concept of proximity that we have advocated along this dissertation. This feature means that the value of a spatial unit, is influenced by the values of the surrounding spatial units. So, the kernel method is somehow related to the nearest neighbour approach. Now we will discuss about the application of the model propose by Silverman (1986), which is displayed below.

$$f(t) \frac{1}{n} + \sum_{j=1}^n K \left(\frac{1}{hdj_k} + \frac{t - X_j}{hdj_k} \right) \quad (5.9)$$

Where K is the kernel variable and is a positive integer, d_{jk} is the distance from X_j to the k^{th} nearest data point in the set containing the remaining $n-1$ points. The smoothing parameter h can be defined via the bandwidth, which in this model it represents the chosen output cell sizes of the spatial analysis for example, 300 sq m. The bandwidth of the kernel affecting X_j must be proportionally related to d_{jk} so the data points of RET located in areas that are sparse will get weaker kernel values related to them. This means that for any K fix value, the general smoothing will be depending on the value of the bandwidth. This smoothing model has been implemented in different

software, including GIS and they have had slightly adapted the Silverman’s formula. For this research we used the algorithm proposed by the spatial analyst of the virtual environment of ArcGIS. The model was built using the kernel density of RET, population and jobs will be explained as follows.

$$f(x) = \frac{\sum_{j=1}^{n_{mesh}} population(mesh_i) \left(\frac{d_{ij}}{\lambda} \right)}{\lambda^2} \quad (5.10)$$

The parameter λ is the size of the sliding window or bandwidth, d_{ij} is the distance between observation i and the mesh j , n is the value allocated to the pixel, for example number of solar PV or number of people living in a location, and K is the kernel function, that to our knowledge has not been communicated by ARCGIS (Certu, 2005). Therefore, we acknowledge that this unknown is a weakness from a scientific perspective. The kernel method was used to calculate the probability of finding a job, people and RET in a spatial unit that will become in a later stage a network’s node. In this perspective, we used the normal function as it is shown in the Figure 133A. The kernel function works as grid of points (Figure 133B) whose distance is accordingly adjusted with the bandwidth. Once the kernel density was calculated for every spatial layer, we used the Map algebra to perform different operations in order to create an overlay to build a suitable network in the next phase. An example of the operations performed in this phase was simply a sum of the layers affected by different weights and later processing the results with an algorithm that was developed to generate links between the spatial units.

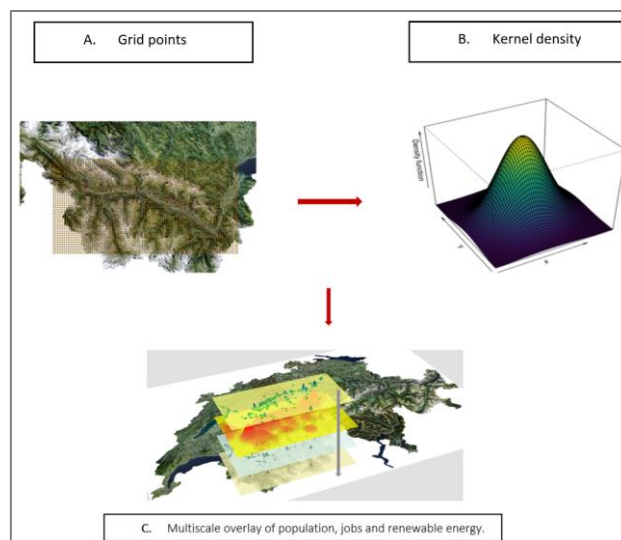

Figure 133 Kernel density and overlay of socio-demographic data and renewable energy technologies, 100 sq m resolution.

At this stage it was necessary to develop several simulations regarding the overlay of different configurations of kernel densities of the variables analysed and processing the information with the algorithm that will be described in the following section. Here we will show some selected results of the kernel density, starting by the population and jobs and then we will focus on RET. In the kernel function, the density of x depends on the number of observations $x_1, x_2, x_3, \dots, x_n$ that are in the vicinity of x . The figure below shows the centres of the areas with the highest values of innovation potential, which are displayed in red, less important in the areas in yellow, while the lowest values are depicted in green. The raster image below shows that there is effectively a concentration of jobs in Sion, which does not come as a surprise since is the capital of the canton of Valais and has the highest population density. Other important urban areas are Martigny, Sierre and Visp where there is a high level of industry and services activities.

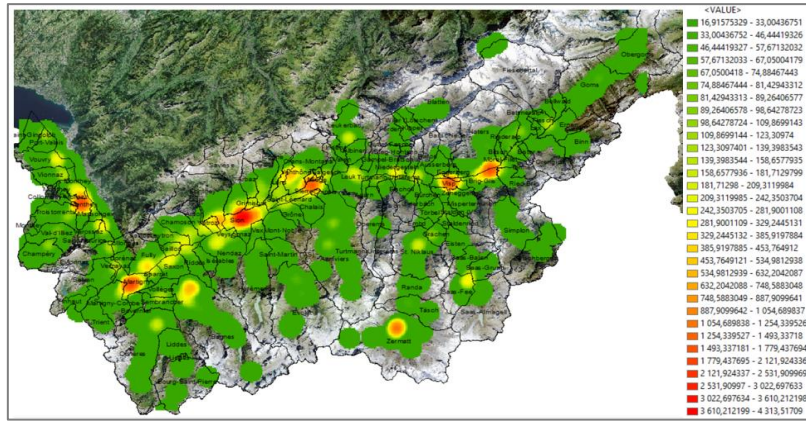

Figure 134 Kernel density of Total jobs in Valais in 2015, resolution 100 sq m.

5.5.2.1 Solar Photovoltaics and Space: A Multiscale Statistical Analysis in the Swiss Alps

The data provided by the FSO allowed us to perform different spatial statistical tests, which helped us to understand the mechanism of spatial diffusion. Here a series of results will be discussed in order to provide the final required elements to simulate the diffusion network of RET. Among the different test performed it was found out that a kernel density applied in a multi-scalar fashion would provide very important information. The kernel distribution of RET follows a power law, which implies scale invariance, which it is a signature of fractality (Dauphiné, 2003). Relying on the methodology explained in the previous section, a 3D visualisation of the kernel density estimation of solar PV for heating (solar PV_{heating}) and hot water (solar PV_{hotwater}) was developed and it is displayed in Figure 135. The spatial analyses were systematically implemented at three scales 300, 600 and 1200 sq m in the Valais region.

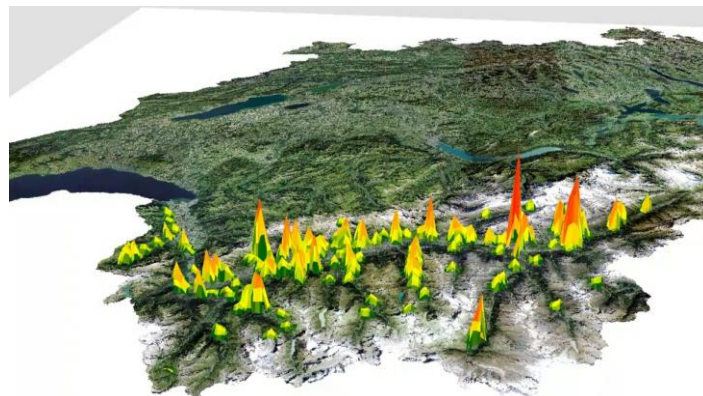

Figure 135 Kernel density of solar photovoltaics adoptions for heating and hot water usage in Valais in 2015 at 300 sq m resolution. The red pics represent a high intensity of adoption.

The subsequent question we addressed was to evaluate the assumption of randomness of the spatial distribution of solar PV. A multiscale spatial analysis was developed, starting with a kernel density implementation for solar PV_{heating}, solar PV_{hotwater} adoptions and for both usages simultaneously heating and hot water (solar PV_{h,w}) for years 2009-2015. The kernel density was calculated through the ArcGIS software, the algorithm performed in this operation is based on Silverman's work (1986) for a comprehensive explanation on kernel look at Yatchew (1998).

Solar Photovoltaics for Heating and Hot Water

The following histogram shows a fat tailed distribution calculated via a kernel density of solar PV_{heating} in 2015. The implications to this are vast, from self-organisation, complexity theory to size-rang urban applications and of course preferential attachment network modelling, which is at the heart of this research.

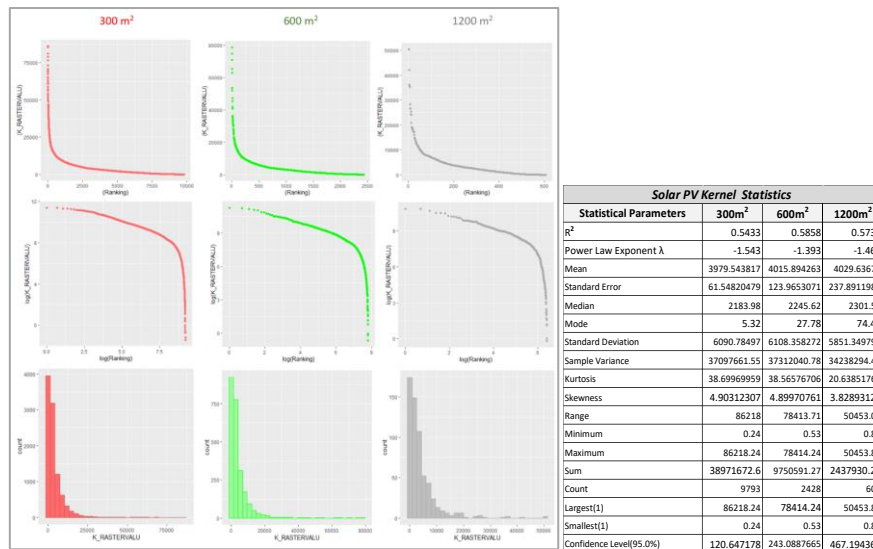

Figure 136 Multiscale kernel density of solar photovoltaics for heating in Valais, Switzerland 2015. Y-axis: Kernel Density Estimation, X-axis: Spatial Units' Ranking.

The first three charts horizontally displayed are a lin-lin plot of the kernel density values obtained in the three scales evoked on the figure. The x-axis 'K_RASTERVALU' is the raster value containing the information of each spatial unit's kernel density of solar panels multiply by a factor of 1'000.000. The reason to do so was only to avoid loss of information in the subsequent panels as often such values are extremely low with several decimal values. The y-axis 'count' represents the grid's spatial units of 300,600 and 1200 sq m respectively. An important phenomenon is observed in the frequency distribution of kernel density of solar PV_{heating}, also for solar PV_{hotwater} or both usages combined usage (see Figure 138 and Figure 146). These charts schematize a visual test of the spatial intensity in terms of solar PV, where some *hubs* or spatial units with a much larger amount of solar PV are observable. This means that very few spatial units have a very high solar PV_{heating} density and it decreases when the size of spatial units increases.

However, before affirming that these distributions follow a power law, a warning must be done, since there is a resemblance of Pareto with lognormal (see Petruszewycz, 1972; Dauphiné, 2013; Queiros-Condé et al., 2015). In the study of rank-size of agglomerations, according to Pumain (2004b) when there are small settlements included, the lognormal often is a better fit. In the latter case, there are not embedded scale-invariance properties, therefore no fractality. In the figure above we can observe in the log-log plots that after the straight line there is a descending curve. This curve is the fraction of the chart that poses doubts regarding the followed law by the distribution. Vilfredo Pareto used to adopt a strategy to deal with this kind of curves, he would not consider the lowest revenues, those that had the highest frequency and were responsible of the sudden fall of the curve (Dauphiné, 2013). Therefore, only the straight part of the line was kept, in our case this would mean to take out the spatial units with the lowest values as follows:

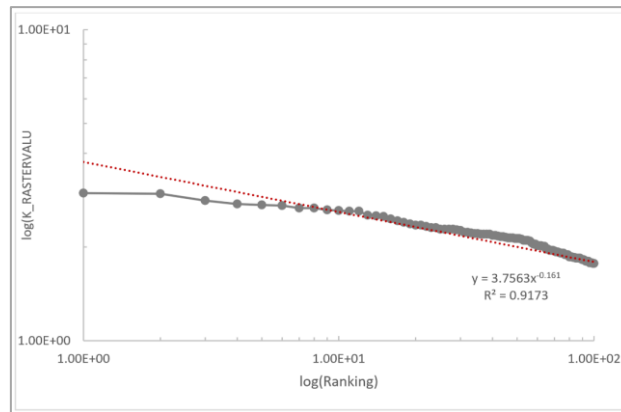

Figure 137 Adjusting and fitting the straight part of the curve. Y-axis: Kernel Density Estimation of solar photovoltaics for heating in Valais, Switzerland 2015. X-axis: Spatial Units' Ranking.

With this approach the fit dramatically improves to $R^2=0.91$ however, we would lose approximately 95% of the observations. To solve the dilemma between fractality and lognormal laws, it is possible to compare several power law models changing the cutoff area relying in a Kolmogorov-Smirnov test (Forriez, 2010) see also Clauset et al., (2009). With this approach, the latter author within a study framework of world cities, proposed a break-up at 144 300 inhabitants, since under this threshold, the geographical aspects of the phenomenon remained unclear. However, it is very difficult to determine the threshold between urban and rural structures in a general formulation as well as in the context of this research regarding RET. The charts below illustrate the kernel density of solar PV_{hotwater}, which follows a similar behaviour as solar PV_{heating}. This clarification seems very pertinent given that some scholars have criticized the work of geographers about rank-size, arguing that most of these studies were tarnished with mistakes of the like (Barbut, 1988; Dauphiné, 2013). There are different ways of dealing with this issue but it is beyond the objective of this section however, with the inclusion of the distributional changes in function of time in section 5.5.2.2 for solar PV and 5.5.2.3 for electric vehicles (e-vehicles) a clear trend towards scaling properties will be observed. Here below is illustrated the spatial density of solar PV_{heating} and solar PV_{hotwater}.

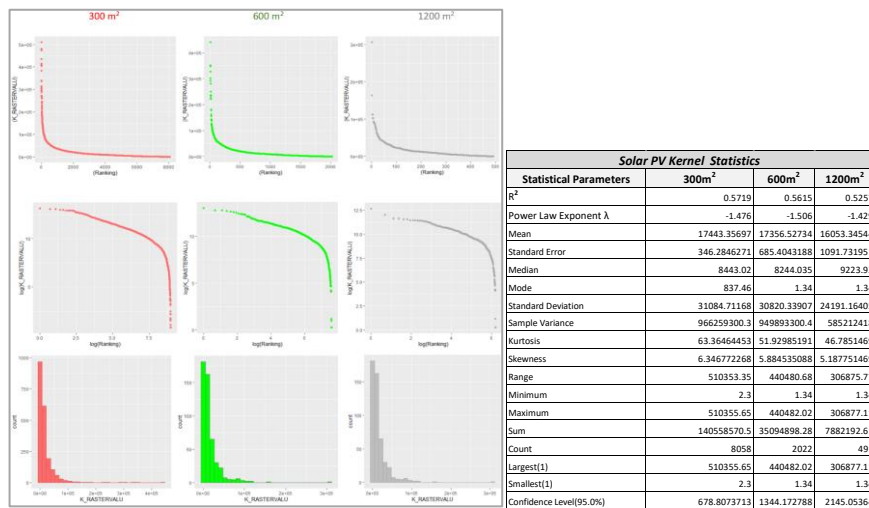

Figure 138 Kernel density of solar photovoltaics for hot water in Valais in 2015. Y-axis: KDE, X-axis: Spatial Units' Ranking.

From a mathematical standpoint, the diffusion of RET in Valais seems to follow a non-uniform scale law but rather asymptotic. Since there is only a fraction of observations that fit with the scaling parameter. Actually, this kind of laws are much more common than uniform scaling laws, where. The transformation of raw data in logarithms is a necessary step to do but not enough to capture the emergence of scaling properties. Some authors propose numerous techniques, one of the simplest ways to work around this problem is commonly used in biology and ecology: perform a subtraction of a constant $K=0.5$ to each value (Dauphiné, 2013). Nevertheless, as indicated by

the latter author, it is better to do an adjustment via the evaluation of the resemblance of models and choose one of the two approaches (Pareto or Log-normal) using tests such as the Akaike information criterion and Bayes.

Physicist have extensively work on phenomena presenting both scale invariance and scale relativity and also on the transition from lineal to non-lineal distributions. The transition from linear to non-linear distributions is a passage that corresponds to the first order to the second order of a derivate and in the field of statistical mechanics it relates to the transition from inertial scale to dynamic scale.

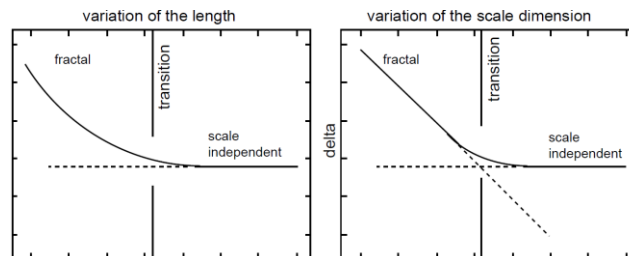

Figure 139 Scale dependence of the length and of the effective fractal dimension (minus the topological dimension) in the case of a constant 'scale-force', including a transition to scale independence at large scale. Source: Nottale (2007).

The figure above illustrates how some physical situations show that the distributions do not have a constant slope and the parabolic curve appears, physicists described this process as 'scale-dynamical' mechanism (Nottale, 2007). The author thus, suggest looking at the underlying scale-force responsible for such scale distortions. In the case of RET in the Valais region, it is possible that a transition process is taking place, see the discussion below in section 5.5.2.2, which suggests that the variable 'time' is one of the possible parameters responsible of these effects.

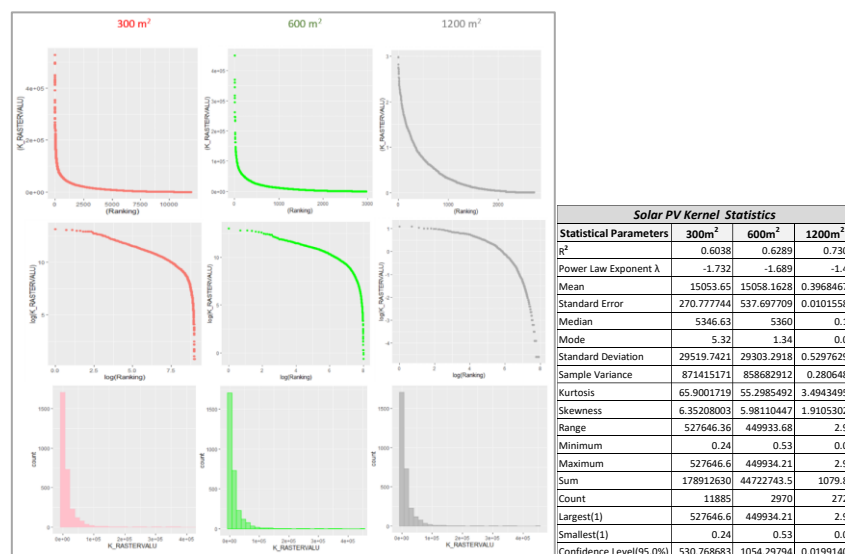

Figure 140 Multiscale kernel density of solar photovoltaics for Heating and hot water in Valais, Switzerland 2015. Y-axis: Kernel Density Estimation, X-axis: Spatial Units' Ranking.

The increasing evidence of scale-free behaviour in real-world systems have triggered a scientific debate, where some authors highlight that not all systems follow such patterns, as there seems be a trend pursuit by some research works. For example, earlier in this study in Chapter 4 we mentioned that research citations seemed to be scale-free. Some of these studies are from early 2000, but recently some authors argued that the scientific citations although follow power-laws, they are not free-scale since the distributions are nonstationary and the power law exponent γ fit decreases with time before coming to saturation (Golosovsky, 2017).

An additional analysis was performed to further investigate if the physical distribution of solar PV was clustered, random or disperse. The Average Nearest Neighbour (ANN) index was calculated via ArcGIS and it was possible to test the hypothesis of randomness in Solar PVs spatial distribution. This indicator provides information on the Nearest Neighbour Ratio (NNR) of the Observed Mean Distance (OMD) to the Expected Mean Distance (EMD) between solar PVs. If the ANN index is smaller than 1 it would mean that the spatial distribution of solar PVs follows a clustering pattern, if else the pattern exhibits a trend towards dispersion. We did evaluate the z-score and the p-value obtaining the following results:

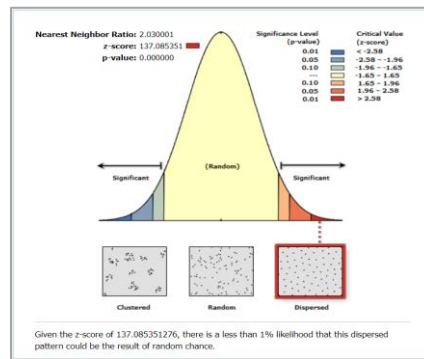

Figure 141 Average Nearest Neighbour for Solar photovoltaics for heating and hot water in the Valais Region in 2015.

The NNR is then calculated by replacing the OMD and EMD's values:

$$NNR = \frac{1200}{591.1328} = 2.030001 > 1$$

Since NNR is larger than 1, the spatial distribution of Solar PVs trends towards dispersion or competition, where dispersion processes imply movement and change, which take us through a further stage in the RET diffusion process.

5.5.2.2 *Solar Photovoltaics, Space and Time: A Multiscale Spatial Analysis of the Distributional Changes in the Diffusion of Renewable Energy Technologies in the Swiss Alps.*

The analyses previously deployed were somewhat a picture of the situation of RET in the region of Valais. In this section we will address the distributional changes in the RET adoption process. The integration of time is an important aspect of diffusion processes, Hägerstrand (1953) put it in this way: “...*Innovation diffusion in question aimed at gaining an understanding of distributional changes between close points in time... The period of time that the observations must be carried out depends on the rate of change, this varies a lot from indicator to indicator. The extent of which can compress them also depends on the sources availability*”. In this research work we are limited by the time span of data availability therefore, the analysis is quite bounded by a single period of seven years, from 2009 to 2015.

Here we are going to analyse the dynamics of RET timewise. This analysis is of a high importance since the patterns followed by the spatial changes in the RET diffusion will unveil if the distributional changes are for example taking place in a self-organized mannered or if the dynamics are following a normal distribution. The rates of change depend on the innovation indicator, here we have a case where the indicator are solar PVs but for different purposes heating and/or hot water hence, we will investigate if there are relevant differences.

Distributional Spatial Changes of the Diffusion of Solar Photovoltaics for Heating

The Figure 142 shows a statistical analysis performed on the rate change of RET adoption at the same three scales 300, 600 and 1200 sq m in Valais. The change rate suggests that spatial kernel density of solar PV_{heating} is increasing following a power law distribution. The figure shows the three different scales which have a similar adjusted R² values for 300m² R² = 0.9355, for 600m² R²=0.9663 and for 1200m² R² =0.9660.

It appears that the kernel density at 600 sq m is increasing slightly faster than at 1200 sq m as it became super linear before the two largest hubs get sublinear again. The superlinear behaviour is associated to the notion that the solar PV density in some locations increases faster than expected. The mean values at 600 sq m are the highest between the three scales observed, thus it is possible to observe the trajectory crossing, where the values at 600 sq m takes over those at 300 sq m.

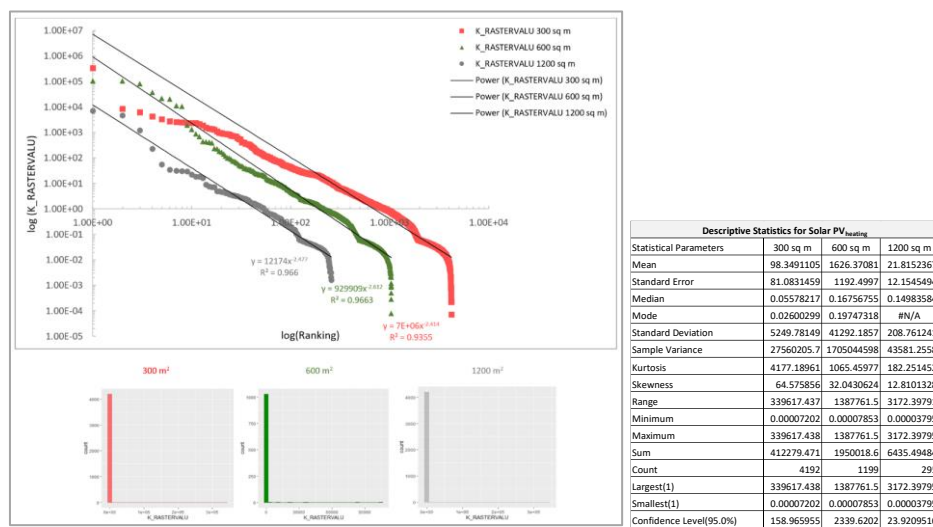

Figure 142 Multiscale spatial adoption rate change of solar photovoltaics for heating in Valais between 2014 and 2015. Y-axis: Log of Kernel Density Estimation, Log of X-axis: Spatial Units' Ranking.

The histograms also show a fat tailed distribution in each of the analysed scales. Similar results were found in the data sets of previous years. If this trend continues overtime, the ambiguity found in the RET kernel distributions about if followed a power law or a log-normal distribution, will be soon resolved by itself. Given that this longitudinal study has only seven periods, it is possible that in the future when more data will be available a Pareto distribution will be discernible in an easier manner.

Distributional Spatial Changes of the Diffusion of Solar Photovoltaics for Hot Water

The rate changes observed in solar PV_{hotwater} diffusion do not present the trajectory crossing of kernel density between spatial scales it was observed in PV_{heating}. A similar path between scales is unfolded, keeping median values really close across scales. The mean values of the kernel density at 300 sq m are approximately 68 times higher than at 600 sq m and 57 times higher than at 1200 sq m. However the standard deviation at 300 sq m is large enough that compensates such differences and allows the trajectory of each scale to avoid any crossing between scales.

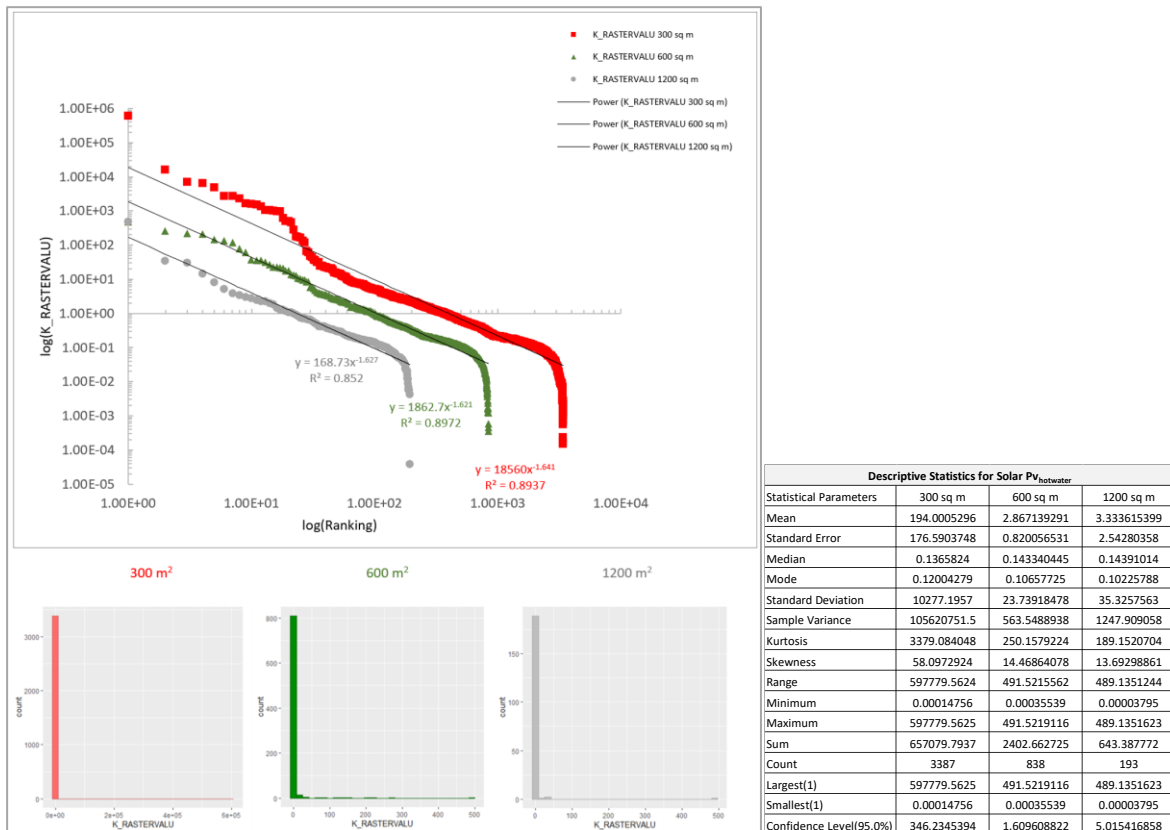

Figure 143 Multiscale spatial adoption rate change of solar photovoltaics for hot water in Valais between 2014 and 2015. Y-axis: Log of Kernel Density Estimation, Log of X-axis: Spatial Units' Ranking.

Distributional Spatial Changes of the Diffusion of Solar Photovoltaics for Heating and Hot Water

According to Figure 144, the spatial distributional changes for solar PV_{heating} and solar PV_{hotwater} previously reviewed, described a better power law fit for 600 and 1200 sq m respectively. The curve for the distribution of 300 sq m for solar PV_{hhw} appears to be in a transition phase, from chaos to order in the smallest scale studied here. The solar PV_{hhw} is or actually are two innovation indicators as it is for two different usages therefore, a hypothesis to interpretate this phenomenon is that there is a time lag on the transition process in smaller scales. It appears that it takes longer for a social system to self-organize itself vis-à-vis two different innovations in a location i than only one innovation like solar PV_{heating} or solar PV_{hotwater}.

The etymology *fractus*, is at the origin of words such as fraction or fracture, thus related with fractality, which is a property usually generated developed from large scales towards smaller ones. This element leads us to the scale-dependent fractal dimension, which was initially considered as a paradox. However, physicists since the 1980's gradually started to accept a less strict definition than the one proposed by Mandelbrot in the beginning, since several experiments described this behaviour (Queiros-Condé et al., 2015).

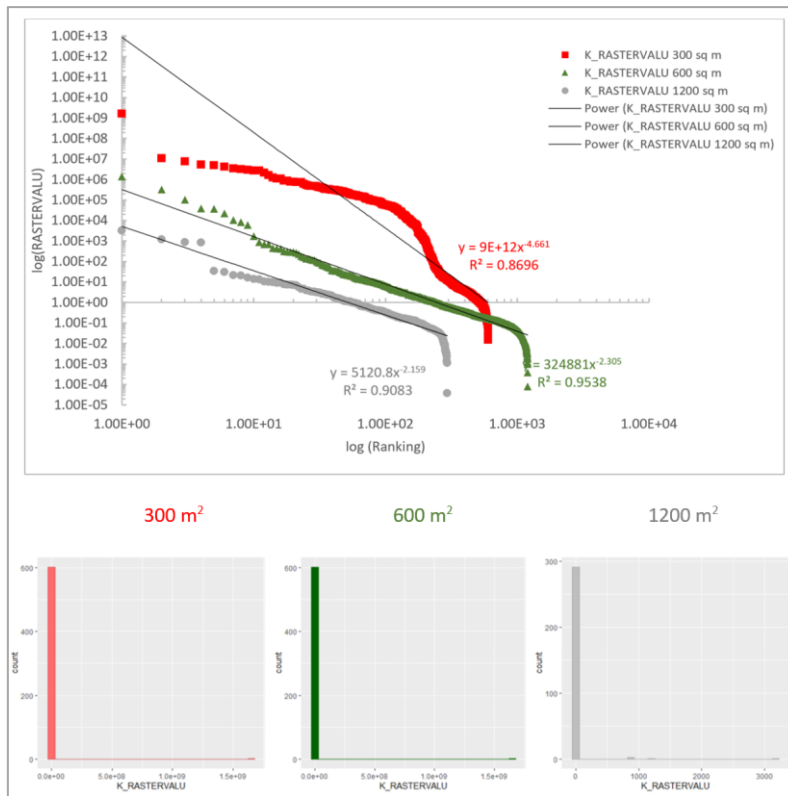

Figure 144 Multiscale spatial adoption rate change of solar photovoltaics for heating and hot water in Valais between 2014 and 2015. Y-axis: Log of Kernel Density Estimation, X-axis: Log of Spatial Units' Ranking.

In physical objects with a dimension d , meaning with a constant fractal dimension, the folded segments of a square or a disk in 2 dimensions or a cube or a sphere in 3 dimensions in a given scale of length r , vary accordingly to a power law. The power parameter actually represents the fractal dimension $N(r) \sim r^{-Df}$. According to this definition, at any scale the ratio of the space occupied by the fractal object in relation to what it would occupy if it had the dimension of the folding space in which it is developed remains constant. Aligned with this theoretical approach, it means that if the spatial distribution of solar PV_{hwh} complied with a constant ratio at any scale, the spatial extension of the diffusion process would occupy the space at any scale with the same proportion. Nonetheless, here it rather appears that the spatial diffusion of this technology is smoothed at 300 sq m resolution and possibly at smaller scales. This could be referred to as the shape degradation of a physical object in terms of fractality, which leads to the concept of entropy. Readers interested in entropy are referred to Queiros-Condé et al., (2015).

The RET diffusion seems to present instabilities and chaos as many dynamic systems, the interesting issue here is that it also appears that this social system is internally organized and tends to find a balance. The scale-dependent fractal dimension in the solar PV_{hwh} diffusion process provides information on the change variation while shifting scales, but it is as if the geometry of probabilities as fractal are described by Sapoval (1997) gets slightly deformed at determined scale, here at 300 sq m. These results are arguable since in Chapter 6 it will be discussed an opposite case where the fractality is visible at smaller scales in the South Region of France⁶³ however, it is not possible to draw direct comparisons. There are two reason for this, the first one is that here the system is studied from the end user perspective and we just did a KDE. The second reason is that in France, the system is analysed from a supply point of view and the results we make reference to are derived from the application of the model developed in section 5.5.3. The empirical observation of the evolution of the fractality property from larger scales towards smaller ones in solar PV_{hwh} is represented in the figure below in function of time. These results are aligned with

⁶³ For reference see Figure 187 and discussion.

panarchy theory that accounts for complex dynamics such as adaptation and conservatism, collapse and reorganization. The linkage of panarchy theory to this research work lies on the multiscale hierarchical processes observed in this study and it accounts for the complex dynamics embedded in socio-ecological systems, particularly here where there are underlying cross-scale feedbacks.

Additionally, the concept of panarchy is closely related to the resilience property as it was discussed in section 2.3.4, in this regard we can draw a conceptual approach on how resilient the process of solar PV_{hhw} diffusion is. These aspects on how innovation and resilience are linked will be further discussed in Chapter 7. These scale variability processes are important from a resilience to innovation perspective if we look at it through the modelling prism in the GST. Thus, the assumption of self-organization in resilient systems in the case of RET diffusion, appears to have at least two major components: *i) The social innovation process embedded in RET diffusion appears to follow a fractality path from large to smaller scales as it has been observed in some natural systems and that implies that ii) The phase transition from chaos to order in the RET diffusion process seems to take more time when the number of innovations studied at once increase and this is revealed when the phenomenon is observed at multiscale level.*

The baseline of these observations is grounded in the intertwined processes within a spacetime framework, as it was put it by Lössch (1954: 504) *“If everything occurred at the same time, there would be no development. If everything existed in the same place there could be no particularity. Only space makes possible the particular, which then unfolds in time.”* These findings are in line with the relevance of place-specificity at local level in the field of GST pointed by economic geographers (see Hansen & Coenen, 2015). The linkage of RET diffusion and resilience will be further simulated and discussed in Chapter 7. Looking more detailly to the data of Solar PV_{hhw} (Figure 144) we observe that the largest hub accounts for 94.5% of the total spatial density of solar PV_{hhw} in the region. The chart below clearly illustrates this imbalance nonetheless, it is very difficult to see the distributional relations of the rest of spatial units’ densities (Figure 145 left in blue). When we take out the largest hub, we can observe with more details the distribution of the remaining 15 hubs that account for 70% of the density of solar PV_{hhw} with N= 603, excluding the largest hub (Figure 145 right in red).

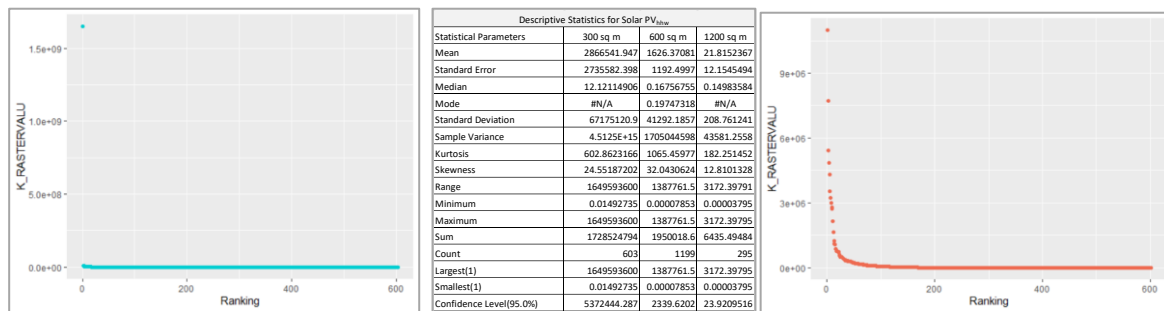

Figure 145 (Left) Lin-lin plot of spatial adoption rate change of solar photovoltaics for heating and hot water in Valais between 2014 and 2015. (Centre) Descriptive statistics of the chart in the left. (Right) Lin-lin plot without the largest hub. Y-axis: Kernel Density Estimation, X-axis: Spatial Units’ Ranking.

From a theoretical perspective, economists have shown that the self-organize process of the long waves in structural shifts happen in the long term (see discussion in Chapter 1, also section 2.1.1 and Figure 42). We acknowledge that that phenomenon only occurs with general purpose technologies nonetheless, the emergence of scaling and self-organization properties need time to develop in a transition process from chaos to order (see section 4.1.1). The presence of a dose of randomness should be considered, as systems could become probabilistic for some scales but may manifest a certain determinism on other scales (Queiros-Condé et al., 2015). Based on the data availability it is a little early to draw a definitive conclusion, but the results suggest that a transition process is occurring.

5.5.2.3 *Electric and Hybrid Vehicles, Space and Time: A Multiscale Spatial Analysis of the Distributional Changes in the Diffusion of Innovations in the Swiss Alps.*

Another innovation indicator that is part of the RET group are e-vehicles and hybrid vehicles (h-vehicles), which were analysed at a national level in Switzerland. The data was provided by the FSO⁶⁴, the resolution was at municipality level and the spatial analyses were conducted at 900, 1800 and 2700 sq m respectively. The data is available from 2010 until 2018 and is published every second year, which means that there were five datasets available at the moment on this study. According to the FSO, the amount of e-vehicles doubled in 2019 but the data was not available at the moment of this study.⁶⁵

The data contains information of the car stock by type and by municipality, where the former was slightly modified over the time. The main change was that 'hybrid' vehicles were not distinguished between diesel-electric and gasoline-electric in the datasets of 2010, 2012 and 2014. Hence, petrol-electric (PE) and diesel-electric (DE) were tagged simply as 'hybrid', for this reason we will keep the same nomenclature in order to be able to use all the datasets.⁶⁶ Hence, the information is analysed for all datasets using 'hybrid' and for the distinction for petrol and diesel h-vehicles we studied only the data available from years 20016 and 2018. Given the visible difference of adoption between PE versus DE, where PE cars represented 93% and 94.2% of the hybrid fleet vehicle in 2016 and 2018 respectively, the data analysis of h-vehicles was then broke down for PE vehicles. The Table 23 shows an increase of 40.5% of PE vehicles from 2016 to 2018 while DE vehicles 16.6%, this couple with the difference of the absolute quantities between both type of vehicles prompted us to unify both types in the analyses.

Year	2016	Difference %	2018
Petrol-Electric (units)	53445	40.5%	75081
Diesel-Electric (units)	3994	16.6%	4656

Table 23 Petrol-electric vs Diesel-Electric Vehicles

The vehicle fleet share in Switzerland is predominantly lead by petrol-powered vehicles accounting for an average of 73.71 % of the total fleet. However, this market share has fluctuated from 81.18 % in 2010 to 67.67% in 2018, that is a market share loss of -13.5% in those 8 years. Unfortunately, this share difference has been taken over by diesel-powered vehicles by approximately 86.7% and 3% by EV and 9.6% by h-vehicles.

Year	2010	2012	2014	2016	2018	Average %	Change % 2010-2018
Electric	0.02%	0.04%	0.10%	0.24%	0.42%	0.16%	0.4%
Hybrid	0.42%	0.66%	0.94%	1.27%	1.73%	1.00%	1.3%
Petrol	81.18%	77.06%	73.02%	69.63%	67.67%	73.71%	-13.5%
Diesel	18.13%	21.95%	25.63%	28.55%	29.86%	24.82%	11.7%
Other	0.25%	0.28%	0.31%	0.32%	0.32%	0.30%	0.1%
Total	100%	100%	100%	100%	100%	100%	

Table 24 Market Share of Vehicles Fleet in Switzerland. Table made by the author on the basis of the data provided by the FSO. Available from: <<https://www.bfs.admin.ch/bfs/en/home/statistics/mobility-transport.assetdetail.11407549.html>> (Available in French and German).

The general evolution of the vehicle fleet in Switzerland is dominated by petrol-based cars and shows a slight downward trend in terms of average delta in a two-years periods analysis between 2010 and 2018. According to

⁶⁴ Data available online at <https://www.bfs.admin.ch/bfs/en/home/statistics/mobility-transport.assetdetail.11407549.html>

⁶⁵ Data available online at <https://www.bfs.admin.ch/bfs/en/home/statistics/mobility-transport.assetdetail.11407549.html>

⁶⁶ The datasets from 2016 distinguish the type of hybrid cars.

the data below, petrol powered vehicles is approximately -1.5%, while electric cars is 134% in spite of the small absolute numbers.

Year	2010	%	2012	%	2014	%	2016	%	2018	Average %
Electric	665	164.4%	1758	152.5%	4439	141.6%	10724	78.9%	19181	134.3%
Hybrid	17156	63.7%	28090	46.5%	41158	39.6%	57439	38.8%	79737	47.2%
Petrol	3308634	-0.9%	3278675	-2.3%	3201710	-1.6%	3149902	-1.1%	3114726	-1.5%
Diesel	739112	26.4%	934084	20.3%	1123676	14.9%	1291500	6.4%	1374246	17.0%
Other	10258	18.1%	12118	11.5%	13507	7.1%	14464	2.3%	14798	9.7%
Total	4075825	4.4%	4254725	3.0%	4384490	3.2%	4524029	1.7%	4602688	3.1%

Table 25 Evolution of the Market Share of Vehicles Fleet in Switzerland. Table made by the author on the basis of the data provided by the FSO. Available from: <<https://www.bfs.admin.ch/bfs/en/home/statistics/mobility-transport.assetdetail.11407549.html>> (Available in French and German).

According to the latest data that was not used in this study but is available in the link depicted in the table above, 12200 new registered vehicles out of 312900 were e-vehicles in 2019, which corresponds to an increase of 143.9 %. While vehicles powered by petrol only increased by 1.9% and diesel decreased by -11.9%. In 2020 were registered 43400 electric vehicles representing an increase of 126.3% but in hindsight it is lower than the average since 2010 as shown in Table 25, that accounted for 134.3%. The increase in 2020 lowers that biennial average to 107.5% percent, indicating that more is needed to reach the sustainability goals. The share of e-vehicles in 2020 represents 0.9% of all passenger cars and the highest rate has been reported in Zug, accounting for a rate of 2% of e-vehicles. The map below corresponds to the kernel density of e-vehicles and h-vehicles in Switzerland, the analysis in this image was done at 2700 sq m resolution. The data is based on the data at municipality level, where the calculation of the distributions done with the data points in the centre of the municipalities' polygons.

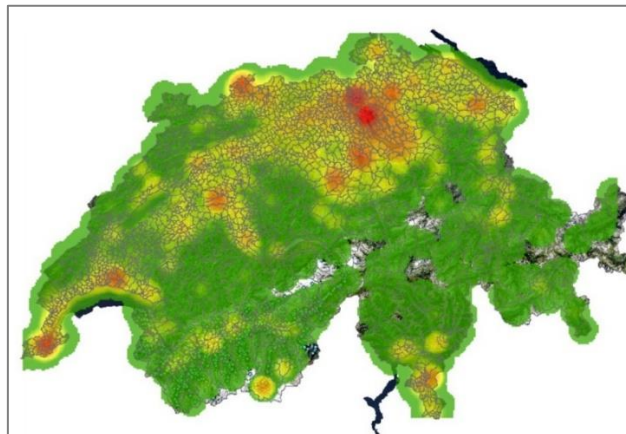

Figure 146 Kernel Density for Electric and Hybrid Vehicles Adoption in Switzerland in 2018 at 2700 sq m resolution.

The Spatial Adoption Situation of Electric Vehicles in Switzerland

The kernel density of the EV and HV in Switzerland revealed a self-organized processed. The figure below is an overview of the multiscale spatial analysis at 900, 1800 and 2700 sq m respectively. The adjusted R-squared of a power law fit was respectively 0.7839, 07843 and 0.7801 as shown in the table below.

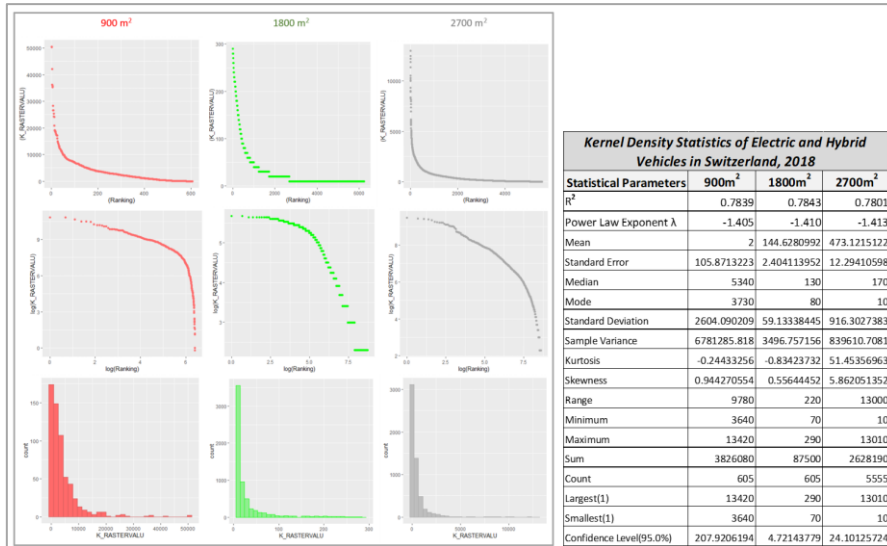

Figure 147 Kernel Density Distributions of Electric Vehicles in Switzerland in 2018.

The adoption of Solar PV and e-vehicles and h-vehicles at the regional and national level appear to follow similar mechanisms as Solar PV, which have already been reported in the specialized literature.

Distributional Spatial Changes of the Diffusion of Electric Vehicles

The chart below shows a clear fast diffusion of e-vehicles in Switzerland.

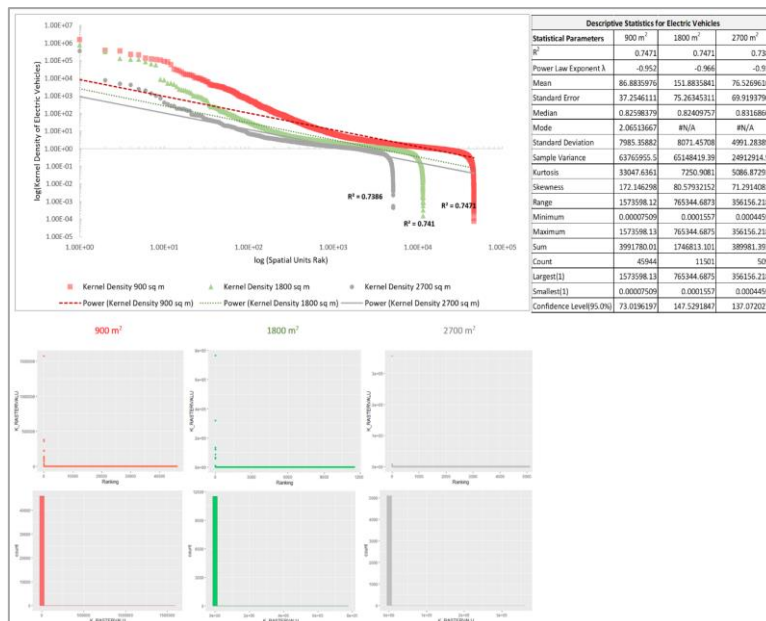

Figure 148 Multiscale spatial adoption rate change of electric vehicles in Switzerland between 2016 and 2018.

The adoption at 900 sq m overtakes the levels expected at 2700 sq m. Another interesting information provided by this chart is that three spatial scales converge towards the same regime for the delta of the years of reference. The hubs seem to take off in a pretty similar fashion and it is also observable that the lower values steadily decline like in the case of solar PVs. Additionally, similar values are seen in the descriptive statistics table for instance, the median of the kernel density value is very close for all the scales. The same pattern between these two scales is observed with the mean, the standard error values and range values. The three distributions display the largest hub as is typically reported in scale-free networks.

The Spatial Adoption Situation of Hybrid Vehicles in Switzerland

According to Table 24 and Table 25 the market share of h-vehicles was 1.73% in 2018 and it has been growing only 1% in average since 2010, reaching a total rate fluctuation of 1.3 between 2010 and 2018. Parallely, the amount of h-vehicles showed a downward trend in the increase levels although they are still positive, reaching a 47.2% increase average. The figure below shows the results of the deltas between 2016 and 2018 at 900 sq m, 1800 sq m and 2700 sq m respectively.

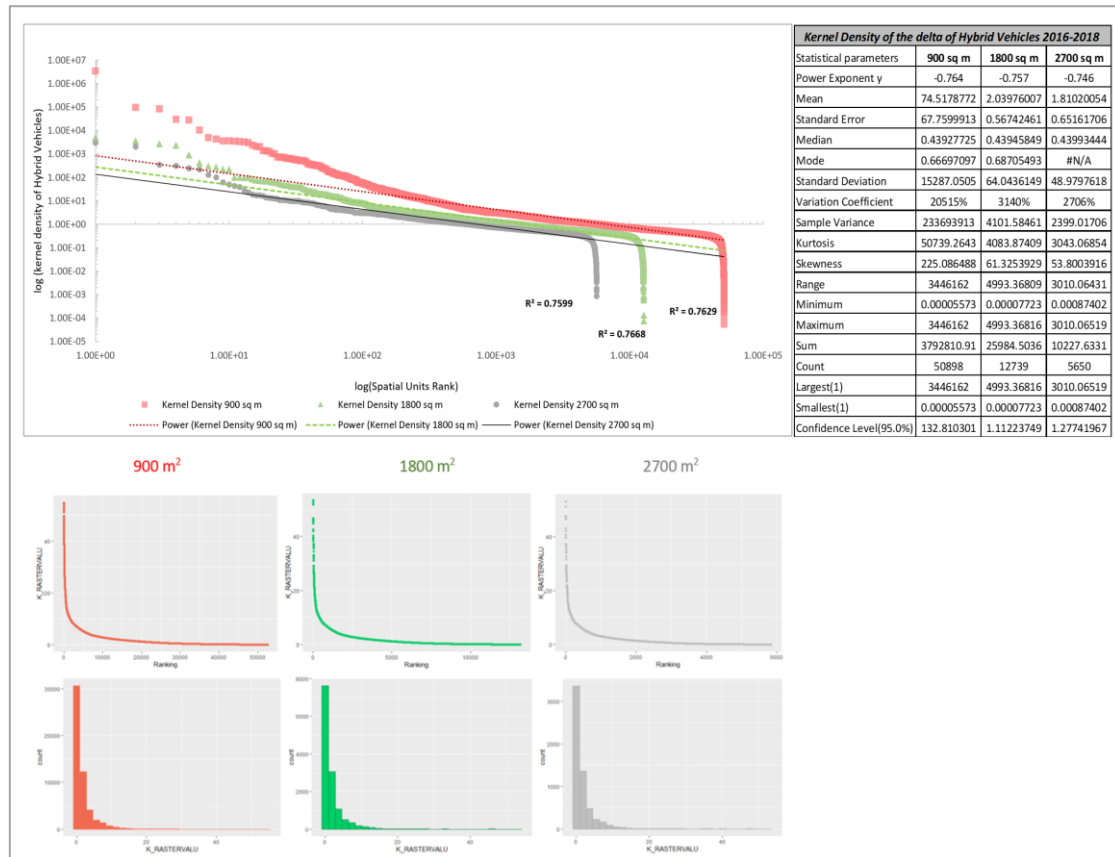

Figure 149 Multiscale spatial adoption rate change of Hybrid Vehicles in Switzerland between 2016 and 2018.

In summary the utilisation of the spatial component appears to be a fruitful approach in order to model the social organisation mechanisms in the adoption of such innovations. The spatial organisation of housing, jobs and RET appear to follow either scale-invariance or the scale-dependent fractal dimension patterns, which are a valuable information to underpin our understanding on urban energy systems and also for modelling purposes. In the next section we will present the model.

5.5.3 Spatial Preferential Attachment: A Network Modelling Approach for Diffusion of Innovations and Geography of Sustainability Transitions in Switzerland.

In this section we will present the model of innovation diffusion in which the integration of population, jobs and Solar PV will be developed for the region of Valais. The conceptual idea is that the potential field developed through the prism of spatial interaction theory in section 5.4.1, are the underlying mechanisms in the diffusion process in the region of Valais. Under this premise, grounded on the theory of preferential attachment in network

science proposed by Barabasi & Albert (1999) a network will be built, and this model will be referred to as Spatial Preferential Attachment (SPA). A second application of the model will be deployed at a national level in Switzerland using EV and HV as innovation indicators, in this application there is not the integration of gravity model, only the innovation proxies and the scale-free network created for solar PV's. The objective is to observe the similarities and differences at *i*) regional and national scales and *ii*) *compare the robustness of the model with and without population and jobs information*. In this model the goal was to identify the spatial structure of the adoption of the innovation indicators observed and determine a ranking system of attachment probabilities between nodes that in this case are spatial units or simply pixels.

5.5.3.1 A Scale-free Network Spatially Explicit for Renewable Energy Technologies Diffusion: Solar PV in the Swiss Alps.

The model is composed of three main stages that are aligned theoretical and operationally. The figure below depicts the model, where the part **A** of the equation represents the spatial interaction model followed by the part **B** of the equation, in which a similar approach was applied for RET. In both cases of the equation in parts **A** and **B**, the distributions followed by the diffusion are approximated by a power-decay function. The Part **C** is simply applied to determine the weight of each spatial unit and consequently identify the hubs of the network.

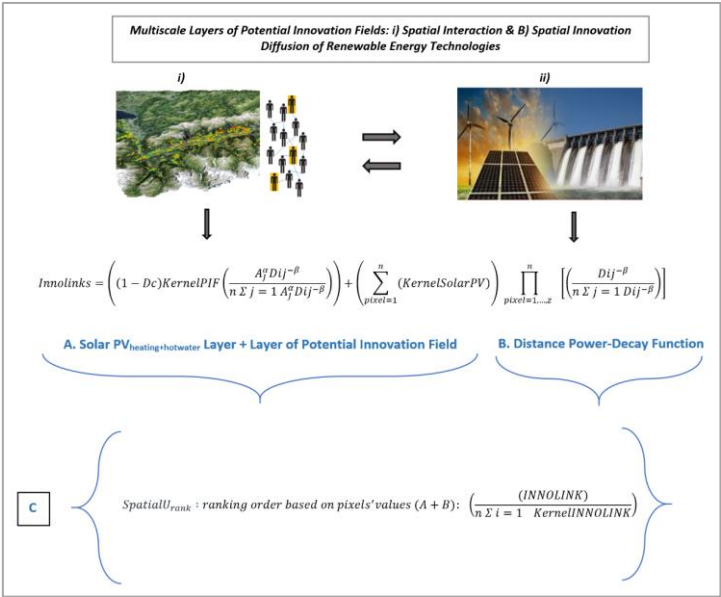

Figure 150 Spatial Preferential Attachment Model (SPA).

Where;

- A.** The part **A** of the equation of the SPA model, represents the spatial interaction model, which is a raster layer with the kernel density value of the attractiveness that here we call Potential Innovation Field (PIF) located at a data point *i*. This layer is weighted with a damping coefficient (DC) which is systematically set at 0.85. This parameter has the form **1- Dc**, which means that the GIS raster layer of PIF only weights 0.15. This value was set up based on empirical observations in the Swiss Alps as a result of different simulations and sensitivity analyses. The outputs are subsequently added to the spatial layer containing the kernel value of the solar PV.
- B.** The section **B** is a **power-decay function** of the distance between the spatial units that affects both, the PIF and the spatial layer of the solar PV. The link formation between nodes is done

through a combinatory process where the weight of each spatial unit (node) is multiplied with the distance decay parameter.

- C. The section **C** function is to categorize the values of the spatial units based on their weight derived from the previous equations. This categorization functions as an operationalization of the preferential attachment process, which implies that the objects grow and connect proportionally to their size. This procedure is similar to the Google's algorithm developed by Brin & Page (1998).

The meaning of the parameters used in the model are defined as follows:

KernelPIF = Kernel density value of the Potential Field of Innovation located at a data point *i*.

KernelSolarPV = Kernel density value of the spatial layer containing data on the solar PV_{heating}, PV_{hotwater} and PV_{hhw} located at a data point *i*.

INNOLINK = This is the 'innovation link' which represents the innovation diffusion between spatial units. It is generated based on the weight ranking of the spatial units that will become nodes to form the network.

Figure 150 shows the development of PIF based on spatial interaction theory and the potential field layers for RET diffusion. The underlying idea here is that such potential fields interact in a dialogue from a spatial perspective. In order to simulate the interaction between the two systems: the social and the innovation systems, it was deployed a weighted overlay of the two GIS raster layers containing the potential fields of systems **A** and **B** as it is shown in the Figure 151.

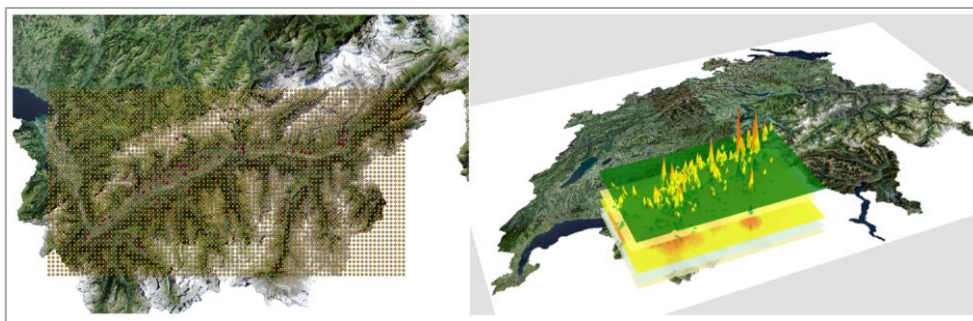

Figure 151 Weighted overlay of population, jobs solar photovoltaics in the canton of Valais, Switzerland 2015, at 300 sq m resolution.

The GIS layers overlay described above were converted to point and the values of the layers were subsequently extracted via ArcMap.

Network formation for Renewable Energy Technologies Spatially Diffused: Spatial Preferential Attachment Model

The network formation methodology used in this study was developed relying on the scientific literature in the field of quantitative and theoretical geography. The concepts of proximity and distance decay as discussed by Hägerstrand (1952, 1953) and Tobler (1970) we assume that things that are near are more related than distant things. According to the spatiality paradigm, the intensity and regularity of the interactions between the elements of an urban system are probably or partly defined by their position in relation to each other. Besides the proximity aspects in spatial interaction theory, a second element that was considered to develop the model was the homophily concept previously discussed in the state of the art. In this regard, when we look at the territory of study as a 'space for exchanges' between agents, we have the assumption that a higher intensity of exchanges and interactions take place between spatial units with a 'higher resemblance'. Thus, these two factors, proximity

and homophily are conceptualized and operationalized as rules for the simulation, where the homophily is characterised by the intensity of spatial interaction and the presence of RET in a location in a data point.

In order to create a network, the spatial units or nodes are connected following a basic rule which contains mainly two principles: *i) The size of the node partly determine the probability of connectivity and ii) The distance decay between nodes complement the partly probability of connectivity.* This means that the links between nodes appear depending on the nodes' weight and how close they are to each other; meaning that nodes with large values at near distance are very likely to get connected and diffuse more powerfully. Nonetheless, this does not exclude the probability that nodes with large values but located far away can get a link. In the latter case, the algorithm created here will link these kinds of nodes, but the links' diffusion values will depend on the actual influence of the distance decay on the nodes in mathematical terms. The Figure 152 illustrates the process of integrating the potential fields of innovation in a network fashion:

- i)* Estimation of PIF under the spatial interaction approach
- ii)* Calculation of the spatial distribution of RET via the kernel density
- iii)* Integration of PIF and RET's kernel density and application of the SPA algorithm to generate the links
- iv)* Output: Scale-Free network

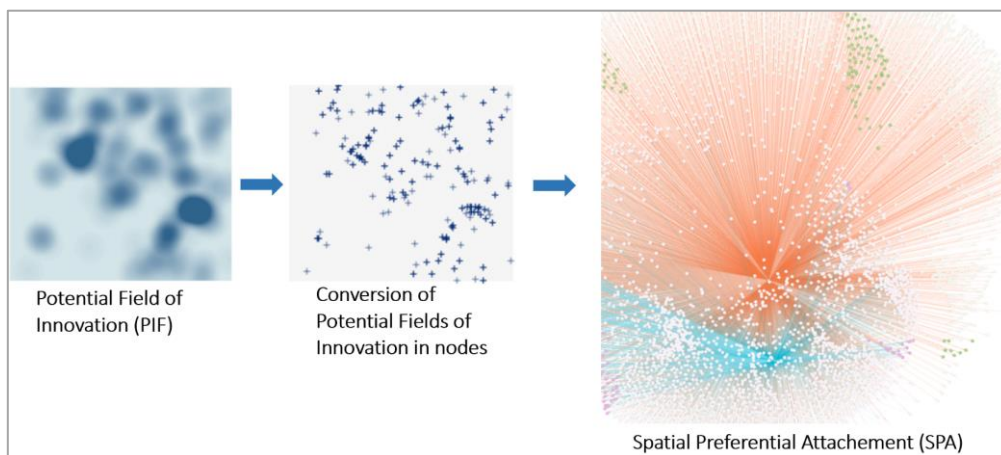

Figure 152 Spatial Preferential Attachment Process.

The network structure of the model presented here was determined by the sequence of rules that were implemented in a code done in **R** that will be thoroughly discussed as follows:

Algorithm 2 Spatial Preferential Attachment for Diffusion of Renewable Energy Technologies

- i)* **# The first step is to create a function to compute the distance between 2 points (pixels or nodes):**
`dist <- function(x1, y1, x2, y2) sqrt(sum((x2-x1)^2 + (y2-y1)^2))`
- ii)* **# Then, the total distance between all points is measured:**
`total_distance <- 0`
`for(i in 1:nrow(data))`
`{`
`for(j in i:nrow(data))`
`{`
`total_distance = total_distance + dist(data[i,'POINT_X'],data[i,'POINT_Y'],`
`data[j,'POINT_X'],data[j,'POINT_Y'])`
`}`
`}`

```

iii) # The third step is to define a new dataframe to store the results of the computations done above:
computation_results <- data.frame(id1=character(),
                                id2=character(),
                                innolink=double(),
                                direction=integer(),
                                stringsAsFactors = FALSE)

iv) # After we compute a new variable:
for(i in 1:nrow(data))
{
  id1 = as.character(paste(data[i,'POINT_X'],"_",data[i,'POINT_Y']))
  print(id1)
  for(j in i+1:nrow(data))
  {
    id2 = as.character(paste(data[j,'POINT_X'],"_",data[j,'POINT_Y']))
    innolink = 0
    if(data[i,'K_RASTERVALUE'] > 0)
    {

v) # Then we compute the distance between 2 points:
    distance_points = dist(data[i,'POINT_X'],data[i,'POINT_Y'],
                          data[j,'POINT_X'],data[j,'POINT_Y'])

vi) # The distance (with the decay parameter  $\beta= 1.9$ ) is divided by total_distance and multiplied by the kernel
value of innovation potential in a pixel located at a data point:
    (distance_points^-1.9/total_distance)*data[i,'K_RASTERVALUE']
    }

vii) # This network is directed, so to define the direction of relationship it was proceeded as follows:
    direction = 0
    if(!is.null(data[i,' K_RASTERVALUE ']) > !is.null(data[j,' K_RASTERVALUE']))
    direction = 1
    else
    direction = 0
    if(!is.null(data[i,' K_RASTERVALUE ']) == !is.null(data[j,' K_RASTERVALUE '])) {
    if(i > j)
    direction = 0
    else
    direction = 1
    }

viii) # The last step was to add rows to the results:
    computation_results[nrow(computation_results)+1,] = c(id1,id2,innolink,direction)
    }
}

```

This algorithm was not intended to be created with an optimized computation efficiency since it is a first trial and it would be beyond the scope of this doctoral dissertation. Instead, the goal was to simulate the urban interactions at social and innovation levels from a spatial perspective in order to verify the assumptions previously stated and reply to the research questions proposed in section 2.3.6. The algorithm needs a lot of time the computation due to the routine that follows, which is a comparison of values row by row in the tabular data representation of the pixels. As an example, see the discussion on the integration of the spatial component in the predator model in section 2.1.4, see Figure 50.

A second version with a faster running time is also proposed in R but it needs much more computation power. Both versions of the code are available in APPENDIX B and there is also an available version of the first code in Python as well. These codes can be optimized and open new research directions in the field with the amelioration of georeferenced data. The output of the algorithm is a file with two nodes linked per row, with the

link's weight computed, direction and an identification code which is formed from the XY coordinates of the two connected nodes as shown in the figure below.

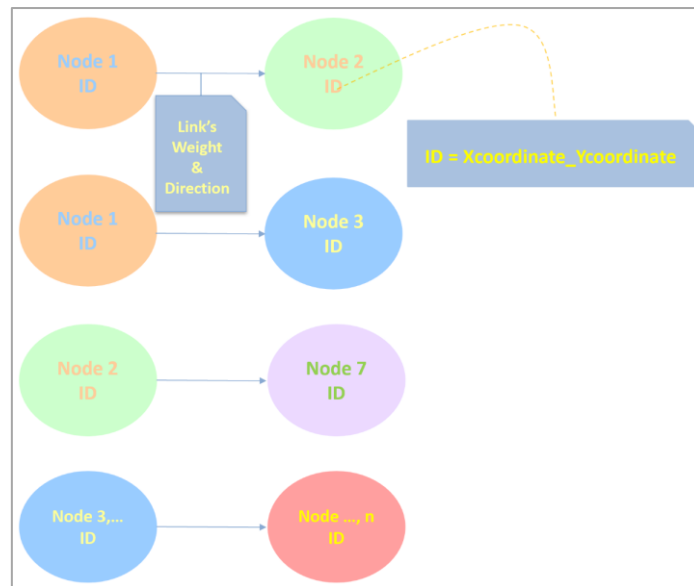

Figure 153 Data structure of the output of algorithm 2 for SPA model.

The direction of the connection is given by a binary value, which is next to the two identified nodes. The example below shows how the connection from ID1 towards ID2:

ID1, ID2, *Direction*
 Xcoordinate_Ycoordinate, Xcoordinate_Ycoordinate, **1**

The Algorithm 2 basically tells the spatial units that are agents in this model, to interact accordingly to their size and proximity, and not in a random fashion. The results obtained in the simulations were approximated by a power function confirming thus, the assumption that solar PV_{hotwater} spatially diffuse following a power law distribution. The log-log plot in Figure 154 shows the distribution of the link's weight fitted by a power law, where the hubs are visible at the top-left.

The variable in the y-axis called 'logInnolinkW' is the weight of the links of innovation transformed to a logarithmic scale, and spatial resolution is given in meters. The same applied nomenclature applies for the following plots, if the pre-fix 'log' is not present, it just means that the plot is a lineal chart.

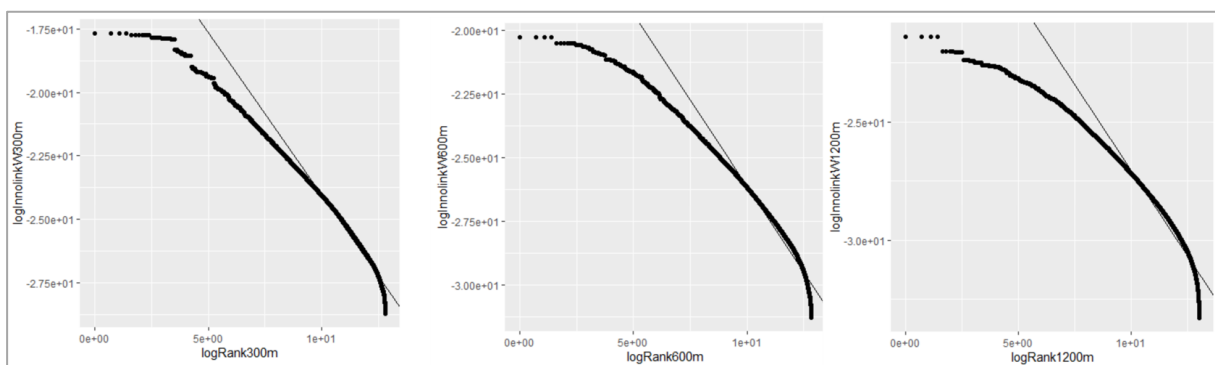

Figure 154 Distribution of the links' weight derived from the SPA model applied for solar photovoltaics for hot water at a 300, 600 and 1200 sq m resolution in Valais, 2015.

The log-log plot of the links INNOLINKS' weight had the following outputs after a regression was performed:

Solar PV hot water 300 sq m 2015					Solar PV hot water 600 sq m 2015					Solar PV hot water 1200 sq m 2015				
lm(formula = logInnolinkW ~ logRank)														
Residuals:					Residuals:					Residuals:				
Min	1Q	Median	3Q	Max	Min	1Q	Median	3Q	Max	Min	1Q	Median	3Q	Max
-6.4618	-0.1112	0.1306	0.1752	0.1862	-7.7329	-0.1344	0.1397	0.256	0.284	-8.8729	-0.1499	0.156	0.2836	0.3344
Coefficients:					Coefficients:					Coefficients:				
Estimate Std. Error t value Pr(> t)					Estimate Std. Error t value Pr(> t)					Estimate Std. Error t value Pr(> t)				
(Intercept) -1.122e+01 5.002e-03 -2242 <2e-16 ***					(Intercept) -1.253e+01 6.717e-03 -1865 <2e-16 ***					(Intercept) -1.252e+01 7.255e-03 -1725 <2e-16 ***				
logRank300m -1.284e+00 4.224e-04 -3040 <2e-16 ***					logRank600m -1.357e+00 5.656e-04 -2399 <2e-16 ***					logRank1200m -1.454e+00 6.027e-04 -2413 <2e-16 ***				
Signif. codes: 0 '***' 0.001 '**' 0.01 '*' 0.05 '.' 0.1 ' ' 1					Signif. codes: 0 '***' 0.001 '**' 0.01 '*' 0.05 '.' 0.1 ' ' 1					Signif. codes: 0 '***' 0.001 '**' 0.01 '*' 0.05 '.' 0.1 ' ' 1				
Residual standard error: 0.2543 on 362465 degrees of freedom					Residual standard error: 0.346 on 374393 degrees of freedom					Residual standard error: 0.4001 on 440804 degrees of freedom				
Multiple R-squared: 0.9623, Adjusted R-squared: 0.9623					Multiple R-squared: 0.9389, Adjusted R-squared: 0.9389					Multiple R-squared: 0.9296, Adjusted R-squared: 0.9296				
F-statistic: 9.243e+06 on 1 and 362465 DF, p-value: < 2.2e-16					F-statistic: 5.754e+06 on 1 and 374393 DF, p-value: < 2.2e-16					F-statistic: 5.823e+06 on 1 and 440804 DF, p-value: < 2.2e-16				

Table 26 Statistics Summary of the SPA model applied to solar photovoltaics for hot water in Valais at 300 sq m, 600sq m and 1200 sq m resolution in 2015.

Notice that after the application of the SPA model, an important attention is addressed to the links, as the KDE provided the nodes and the topology of the network is finally shaped by the connections. The INNOLINKS are denoted with L as follows.

Where N=8858 and L= 362.468 at 300 sq m, N= 2022, L= 374.395 at 600 sq m; N= 491 L= 444.807 at 1200 sq m. The size of the observation in each scale is derived from a combinatory process with the form: Estimation, X-axis: Spatial Units' Ranking.

$$\binom{n}{k} \frac{n!}{k!(n-k)!} \quad (5.11)$$

The structure of the equations used in the SPA model though, makes difficult to predict the number of the observations as the intertwined operations between spatial units must be larger than 0 according to the algorithm. When this value is equal to zero the link is not counted and consequently the observation neither. In the boxplots above is shown that the size of the hubs takes over the rest of the observations in a way that the 'box' practically become a straight horizontal line, therefore a logarithmic transformation was needed. It appears that the assumptions made in the construction process of the model are in line with the heavy tailed behaviour discussed in this dissertation.

Here we will present a series of plots derived from regressions, in order to show how the same behaviour is observed in different scales. Since the number of simulations was very vast, we will show a selected series of charts.

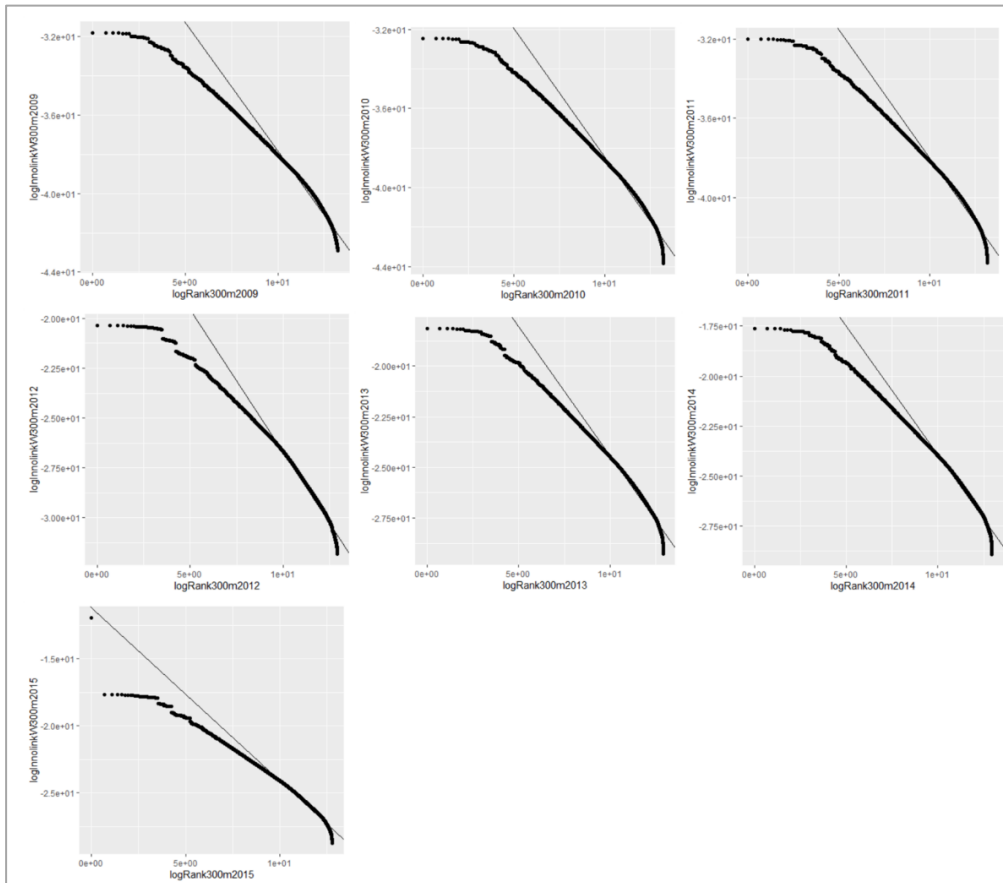

Figure 155 Distribution of the links' weight derived from the SPA model applied for solar photovoltaics for hot water at 300 sq m resolution in Valais, from 2009 to 2015. Year 2009)N= 7394; L= 561,123 and $Y_{\text{solarPV}_{\text{hotwater}}} \approx -1.3$; Year 2010) N=8523; L= 548,326 and $Y_{\text{solarPV}_{\text{hotwater}}} \approx -1.3$; Year 2011)N=9131; L= 519,499 and $Y_{\text{solarPV}_{\text{hotwater}}} \approx -1.3$; Year 2012)N=8523; L= 408,213 and $Y_{\text{solarPV}_{\text{hotwater}}} \approx -1.4$; Year 2013)N=10035; L= 410,115 and $Y_{\text{solarPV}_{\text{hotwater}}} \approx -1.3$; Year 2014)N=8431; L= 415,080 and $Y_{\text{solarPV}_{\text{hotwater}}} \approx 1.3$; Year 2015) N=8059, L= 362,466 and $Y_{\text{solarPV}_{\text{hotwater}}} \approx -1.3$. Adjusted R-square is larger than 0.96 for all the distributions.

The adjusted R-squared values for solarPV_{hotwater} were all larger than 96% with a significant fit, showing p-values of $< 2.2e-16$ for each power law regression. The same procedure was performed for solar PV_{heating} and PV_{hww} in different years and scales for instance, the Figure 156 depicts the links' spatial distributions obtained in the simulation for solarPV_{hww}, for years 2009-2015. The adjusted R² of a power law fit for each year is larger than 94% and showed a significant fit, with p-values: $< 2.2e-16$ for each regression. The plots below show the change of Solar PV_{hww} in a yearly fashion.

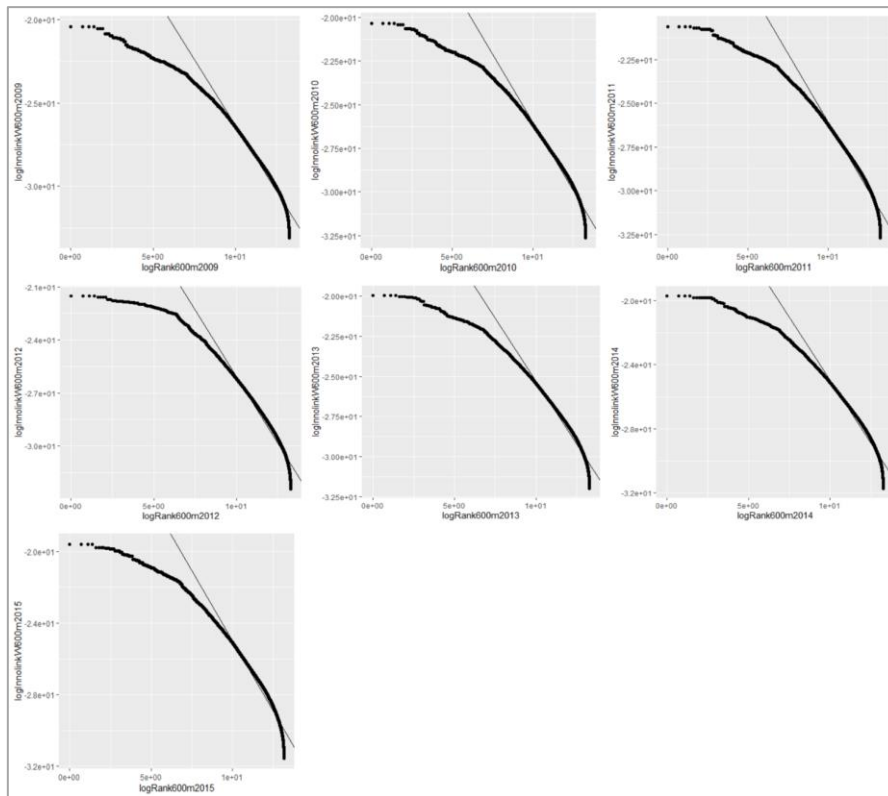

Figure 156 Distribution of the links' weight derived from the SPA model applied for solar photovoltaics for heating and hot water at 600 sq m resolution in Valais, from 2009 to 2015. 2009) N= 2572, L=586193 and $Y_{solarPV_{hhw}} \approx -1.58$; 2010) N= 2572; L= 575,850 and $Y_{solarPV_{hhw}} \approx -1.56$; 2011) N= 2695; L= 588,033 and $Y_{solarPV_{hhw}} \approx -1.56$; 2012) N= 3479; L= 586,384 and $Y_{solarPV_{hhw}} \approx -1.51$; 2013) N= 3067; L= 587,681 and $Y_{solarPV_{hhw}} \approx -1.57$; 2014) N= 2908; L= 575,139 and $Y_{solarPV_{hhw}} \approx -1.58$; 2015) N= 971; L= 523,614 and $Y_{solarPV_{hhw}} \approx -1.57$. Adjusted R-square is larger than 0.94 for all the distributions.

The Algorithm 2, which is the SPA model was applied to the datasets containing the yearly deltas of kernel density distributions of solar PV. This simulation allowed us to observe the behaviours of the connectivity, integrating changes occurred overtime, which were subsequently explored. The figure below shows the results of the simulation.

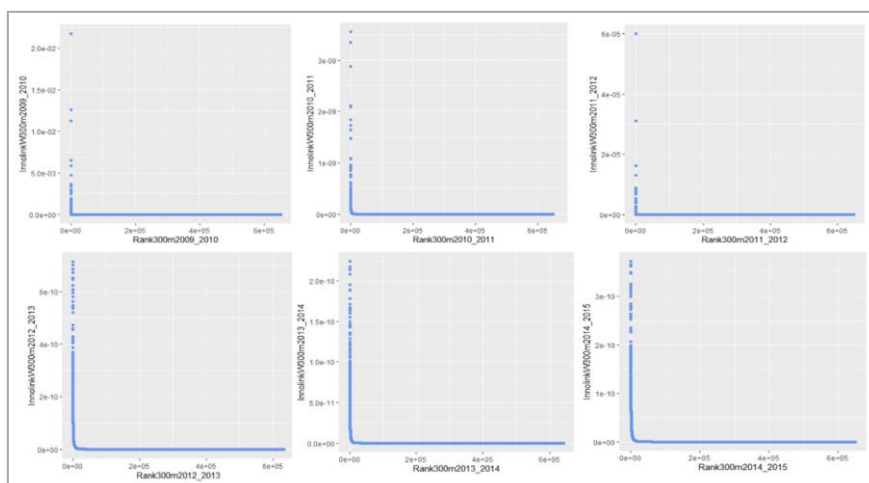

Figure 157 Lin-lin plot of the yearly delta simulation of the INNOLINKS weight in the diffusion process of solar photovoltaics for heating at 300 sq m resolution from 2009 to 2015.

The relevance of this information lies on the fact that time plays a major role as the spatial component in the diffusion process of solar PV. Hence, the exploration of the trends followed by such changes in function of time

for example, it appears that from the period 2012-2013 the links within the diffusion process started to be reinforced. That trend seems to be reinforced in the subsequent periods according to the data availability. The same analysis was developed for Solar PV_{hww} at a 1200 sq resolution and the results show a similar distributional behaviour in the evolution of the solar PV_{hww} diffusion overtime. Comparable effects were also observed in the distributions of solar PV_{heating}.

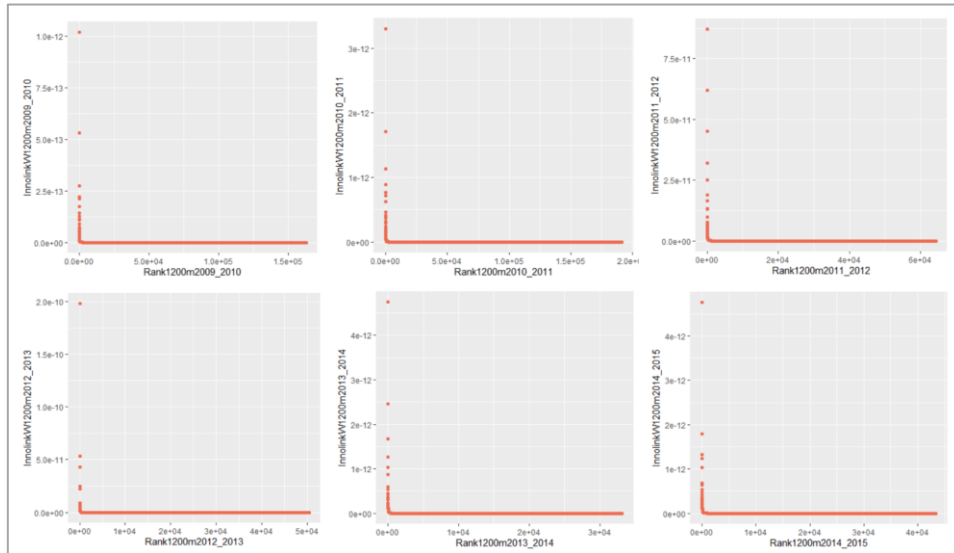

Figure 158 Simulation of the yearly evolution of the links between spatial units in the diffusion process of solar photovoltaics for heating and hot water at 1200 sq m resolution from 2009 to 2015.

The plot below has been made in order to better understand the trajectory of the yearly changes of solar PV_{hww}, Figure 159 shows the evolution in absolute numbers. According to the simulation, which has as a baseline the data provided by the FSO, the information linkages in terms of innovation diffusion between spatial units had a peak in the delta period of 2011-2012 (Figure 159A). A comparison of the deltas is done in Figure 159B, where the most prominent peak was between the deltas 2010-2011 versus 2011-2012. It is important to relativise these results, since the amount of solarPV in the Valais region is still very low.

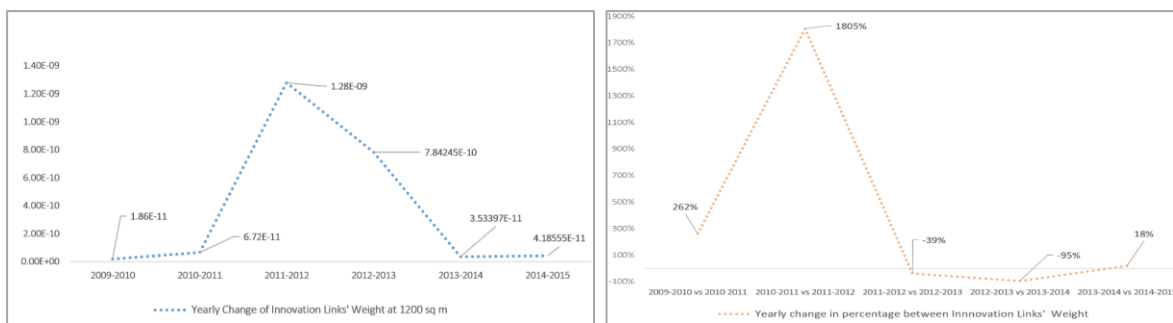

Figure 159 A) Evolution of changes of solar photovoltaics for heating and hot water at 1200 sq m. B) Evolution of changes in percentage.

A similar plot is displayed below, containing data on solarPV_{heating} at a 300 sq m resolution, which shows a peak in the delta in the years 2009-2010.

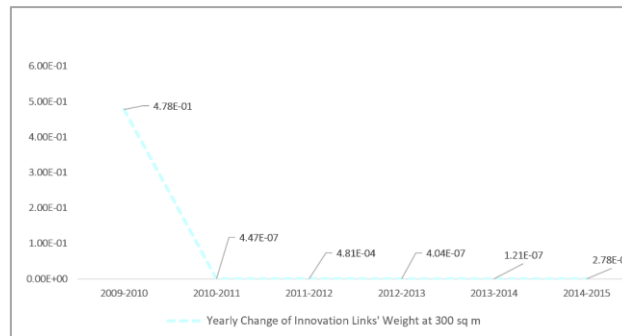
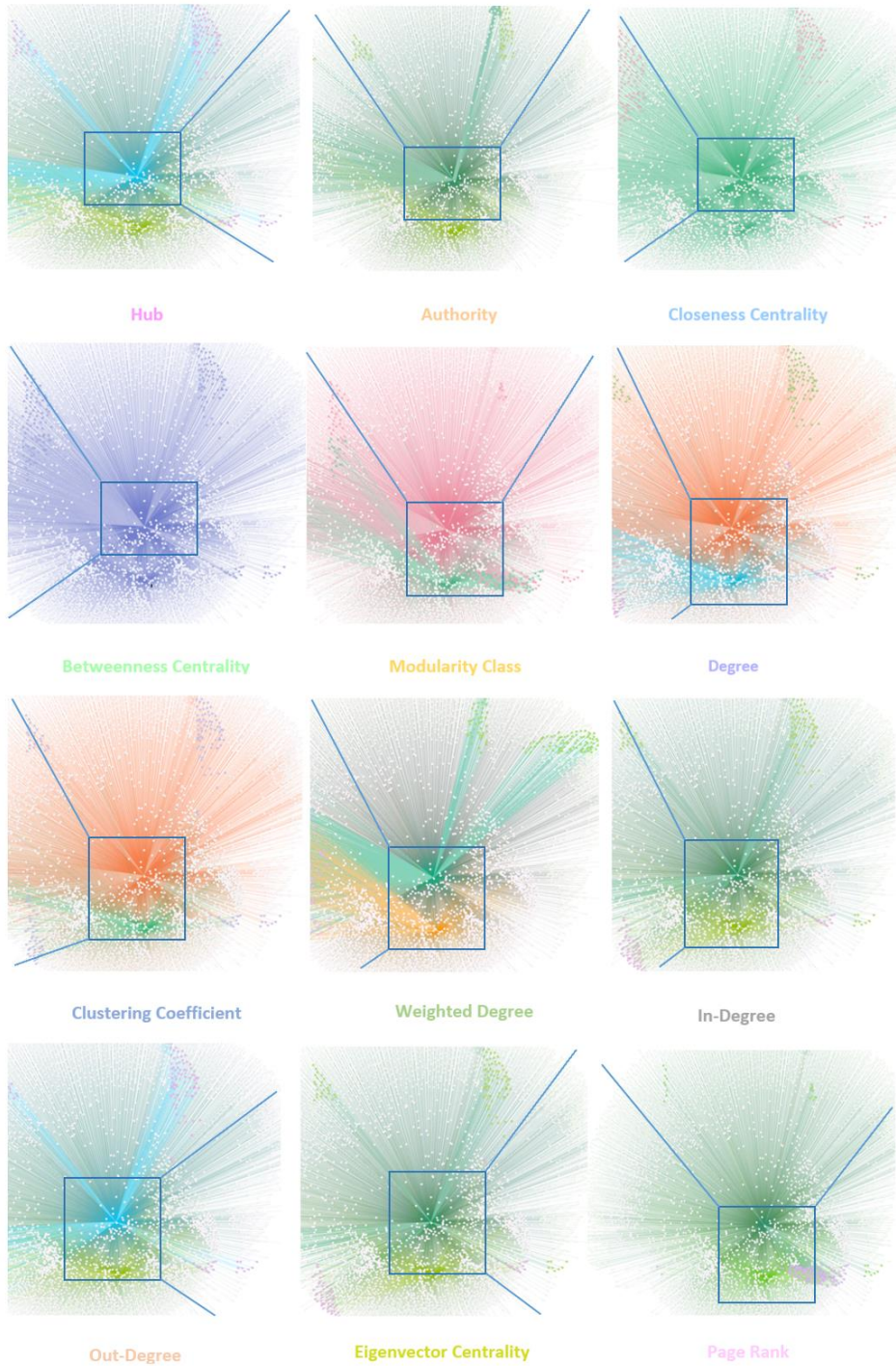

Figure 160 Evolution of changes of solar photovoltaics for heating at 300 sq m.

The outputs were used to build the network with the software Gephi (Bastian et al., 2009), which is an open-source software for network analysis. This software was chosen because is open source, also because of its high-quality visualization power and capacity of network analysis that even though was limited for scale-free analysis could be later performed in R . Among the various advantages of networks science there is the visualisation power embedded in this approach, as the old adage says, “*a picture is worth thousand words*”. Some of the results are shown in Figure 161, where the hubs of innovation are easily detectable and some important characteristics of the network’s measures are shown. The snapshots of the networks in the figure below represent the diffusion of solar PV_{hwh} in 2015 at a 1200 sq m resolution in the Valais region.

Different algorithms were used with the networks through the Gephi, where several indicators were calculated. One of these measures is the average degree of a network and the degree distributions. In contrast, the so-called ‘micro parameters’ are in a way more specific as its name implies it. We will discuss both type of parameters accordingly to their relevance to this study, here we will focus on the nodes’ characteristics and how they are related to each other, how they are positioned in a network and the implications derived from these features. Centrality measures are certainly important for networks as they help us to understand the role of a certain node in a diffusion process of innovations or diseases, as well as the importance it has from a geographical standpoint, which can be reinforced or penalised depending on its location in a spatially explicit network. There are four major centrality measures that have been developed to analyse networks. The degree of a node tells us how well connected a node is and it is denoted by K . In the case of undirected networks, the degree K_i is enough in terms of degree measurements, but in the case of directed networks as it is the case of this research work we have to determine two subsequent parameters which are K_{in}^i and K_{out}^i which represent the links going in and out from a node i respectively.

In this research, since we have been dealing with directed networks, we will focus then on the mathematical and statistical formalisation for directed networks. The degree centrality gives information based on an indicator from 0 to 1. Even though degree centrality gives limited information, centrals nodes might be located in a critical position of the network independently if its degree is low. Therefore, this information might be important in determined cases, for example a node with low degree could connect two components of a network, meaning that if it does not longer exist the diffusion process between two major network’s components would be interrupted generating a change in the structural behaviour of the network e.g., its modularity. The degree distribution is a property P_k whose task is to give the probability that a node randomly selected in a network has a degree k . The closeness centrality is a property that provides insights about the position of a node i in a graph G in terms of ease to reach other nodes. The Figure 161 shows snapshots of a solar PV network mapped via Gephi, where the images series show very few highly connected nodes depicted inside the blue rectangles as done by Jeong et al., (1999), which was discussed in section 4.1.2, see Figure 104.



Legend:

Hub <ul style="list-style-type: none"> 0.0 (99.92%) 0.32405692 (0.02%) 0.54613847 (0.02%) 0.54620636 (0.02%) 0.5462403 (0.02%) 	Authority <ul style="list-style-type: none"> 0.015471613 (54.89%) 0.012917029 (45.05%) 0.0 (0.02%) 0.0043060333 (0.02%) 0.008611798 (0.02%) 	Closeness Centrality <ul style="list-style-type: none"> 0.0 (99.92%) 1.0 (0.08%) 	Betweenness Centrality <ul style="list-style-type: none"> 0.0 (100%)
Modularity Class <ul style="list-style-type: none"> 0 (77.81%) 1 (22.19%) 	Degree <ul style="list-style-type: none"> 4 (54.89%) 3 (45.03%) 4840 (0.06%) 2660 (0.02%) 	Clustering Coefficient <ul style="list-style-type: none"> 0.5 (99.92%) 5.266268271952868E-4 (0.06%) 0.001127395429648459 (0.02%) 	Weighted Degree <ul style="list-style-type: none"> 4.0 (54.89%) 3.0 (45.01%) 6.0 (0.02%) 2660.0 (0.02%) 4840.0 (0.02%) 4841.0 (0.02%) 4842.0 (0.02%)
In-Degree <ul style="list-style-type: none"> 4 (54.89%) 3 (45.05%) 0 (0.02%) 1 (0.02%) 2 (0.02%) 	Out-Degree <ul style="list-style-type: none"> 0 (99.92%) 2657 (0.02%) 4838 (0.02%) 4839 (0.02%) 4840 (0.02%) 	Eigenvector Centrality <ul style="list-style-type: none"> 1.0 (54.89%) 0.33754748104982935 (45.05%) 0.0 (0.02%) 0.015793782775349475 (0.02%) 0.09134102867146045 (0.02%) 	PageRank <ul style="list-style-type: none"> 2.0659872649207866E-4 (54.89%) 2.065326431058851E-4 (45.01%) 2.0642381032254855E-4 (0.02%) 2.0646003791699408E-4 (0.02%) 2.0649636551143958E-4 (0.02%) 2.0664147588922164E-4 (0.02%)

Figure 161 Spatial Preferential Attachment in solar photovoltaic for heating and hot water at 1200 sq m resolution in the Swiss Alps in 2015. Generated with Gephi.

The power laws of the degree distributions were also verified via the procedures proposed by Clauset et al., (2009) as it was discussed in Chapter 4. Given the high amount of datasets, here we will refer to a limited number of distributions. Here below we can observe the measures performed on the dataset of solar PV_{hwo} at 300 sq m in 2009, which also shows very few nodes with high connectivity.

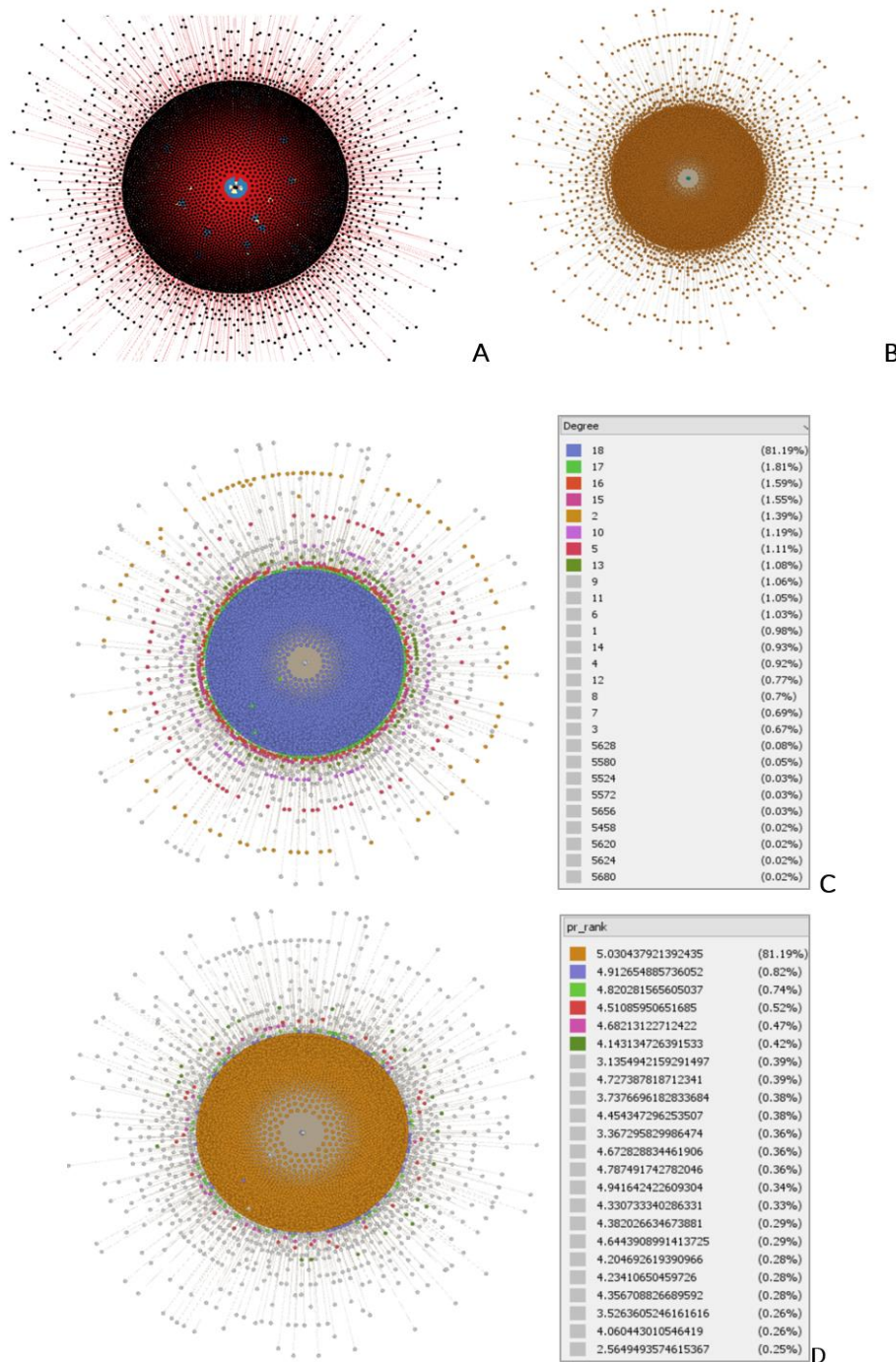

Figure 162 Scale-free spatial networks of solar photovoltaic diffusion at 300 sq m resolution in 2009, in the Swiss Alps. A) and B) Networks of Solar Photovoltaic for heating and hot water in 2009. C) Network partitioning according to the nodes' degree. D) Application of the Rank Page algorithm from Google (Brin & Page, 1998) to the Solar Photovoltaic Diffusion Network in Valais at 300 sq m resolution in 2009. Generated with Gephi.

The figure below displays screenshots of the solar photovoltaic network simulation applying the graph drawing by force-directed algorithm of Fruchterman Reingold (see Hansen et al., 2007). There we can observe two major hubs

of innovation diffusion in green and purple which are located in the capital of Valais, Sion and the industrial municipality of Visp (Viège in French) respectively, where the pharmaceutical company Lonza is located, which is in charge of developing the Moderna’s Covid 19 vaccine in Europe. The model mathematically predicts the areas with high RET activity, which is in a way an implicit validation of the model because it detects real phenomena on the ground.

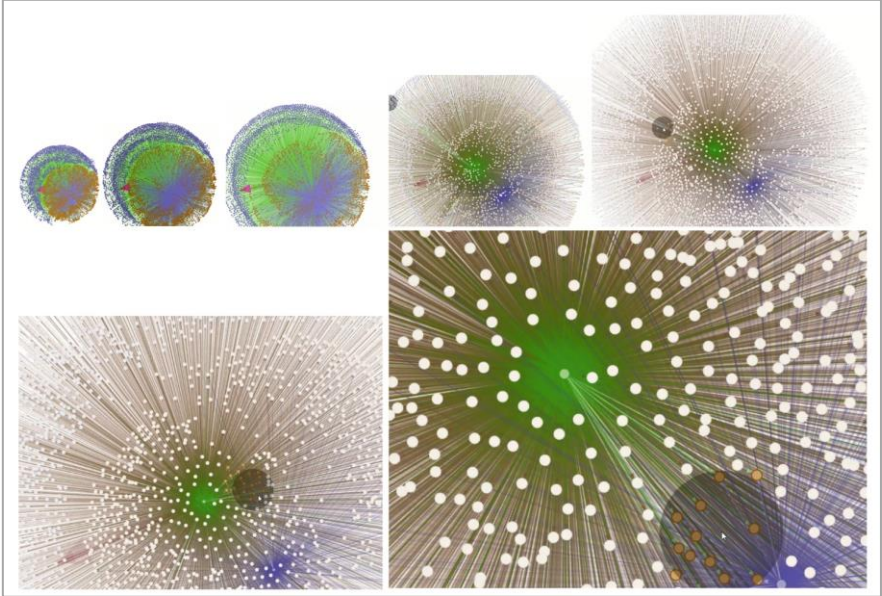

Figure 163 Wandering in Sustainable Cities: Screenshots of a Statistical Physics Simulation of the Spatial Diffusion of Solar photovoltaics for heating and hot water at 1200 sq m resolution in 2015 in the Swiss Alps. Generated with Gephi.

As an analogy, we could think of a big network as a car which is composed with thousands of elements. A driver only needs to know how to handle four elements out of those thousands, that is: the wheel, the accelerator, the break and the clutch. In a similar way we could refer to the networks will discuss here. The big number of nodes and links coupled with the information are similar to a big machine with millions of elements and millions of interactions. Nonetheless, thanks to the advances in network sciences we can deal with all this information by capturing few parameters of importance. Those parameters could be categorized in two families that we will call macro and micro parameters. The usage of these parameters is fundamental to represent and measure networks under a mathematical perspective. Since the size of the networks in the different scales were not negligible, their visualisation on maps series was not done as the high number of links would not allow to see the maps. Therefore, for a pedagogical sake the image below shows the virtual network in the Valais region.

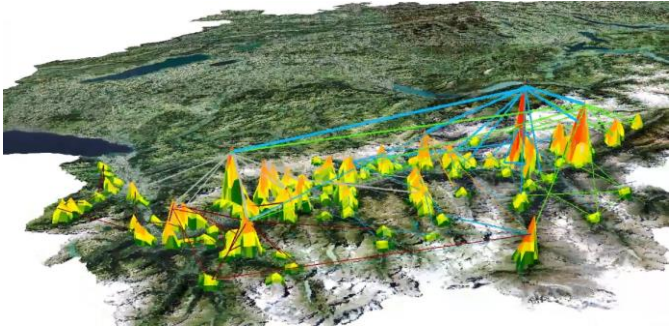

Figure 164 Virtual Network of Renewable Energy Technologies in 2015 in the Valais Region, 100 sq m resolution.

The table below shows a selected sample of the results obtained with the simulations performed in Valais for the adoption of solar PV_{hwh} in 2015. The values depicted below are done for illustrative purposes regarding the quick fall in the values since the distribution is heavy tailed, hence the thresholds of the groups do not have a special

meaning. The first column shows the number of the observation which are ranked in a descending order. There are depicted three groups A, B and C with some observations out of 1'025.140 observations in total. It is possible to observe how quickly the INNOLINK weight decreases already in the group A, the first 10 observations reach a normalized value of 0.94. By a way of comparison, the observation ranked in the position 387 has a value under 0.5, which means that 0.03765 % of the observations are over the normalized value of the INNOLINK at 0.5, $386/1'025.140 = 0.0003765$. The group C starts already at the ranking position 2661, which means that the links before have a combined weight of $2660/1'025.140 * 100 = 0.2595\%$. This shows the existence of hubs and how their large values contain most of the innovation processes.

Observation	ID1 (Coordinates Point X1,Y1)	ID2 (Coordinates Point X2,Y2)	INNOLINK_Weight	Normalized_weight	Direction	Groups
1	2593966.335 1119413.335	2593966.335 1120613.335	9.84E-16	1.000000	1	Group A (sample over 0.94)
2	2593966.335 1119413.335	2595166.335 1119413.335	9.84E-16	1.000000	1	
3	2593966.335 1119413.335	2592766.335 1119413.335	9.84E-16	1.000000	1	
4	2593966.335 1119413.335	2593966.335 1118213.335	9.84E-16	1.000000	1	
5	2593966.335 1120613.335	2595166.335 1120613.335	9.81E-16	0.996951	1	
6	2593966.335 1120613.335	2592766.335 1120613.335	9.81E-16	0.996951	1	
7	2593966.335 1120613.335	2593966.335 1121813.335	9.81E-16	0.996951	1	
8	2595166.335 1119413.335	2595166.335 1120613.335	9.32E-16	0.947152	1	
9	2595166.335 1119413.335	2595166.335 1118213.335	9.32E-16	0.947152	1	
10	2595166.335 1119413.335	2596366.335 1119413.335	9.32E-16	0.947152	1	
380	2634766.335 1127813.335	2634766.335 1129013.335	4.95E-16	0.503022	1	Group B (sample under the 0.50 threshold)
381	2634766.335 1126613.335	2633566.335 1126613.335	4.95E-16	0.503022	1	
382	2634766.335 1126613.335	2635966.335 1126613.335	4.95E-16	0.503022	1	
383	2634766.335 1126613.335	2634766.335 1125413.335	4.95E-16	0.503022	1	
384	2584366.335 1103813.335	2584366.335 1105013.335	4.95E-16	0.503022	1	
385	2584366.335 1103813.335	2584366.335 1102613.335	4.95E-16	0.503022	1	
386	2584366.335 1103813.335	2585566.335 1103813.335	4.95E-16	0.503022	1	
387	2593966.335 1119413.335	2595166.335 1120613.335	4.92E-16	0.499973	1	
388	2593966.335 1119413.335	2592766.335 1120613.335	4.92E-16	0.499973	1	
389	2593966.335 1119413.335	2595166.335 1118213.335	4.92E-16	0.499973	1	
390	2593966.335 1119413.335	2592766.335 1118213.335	4.92E-16	0.499973	1	
2661	2593966.335 1119413.335	2595166.335 1123013.335	9.84E-17	0.099951	1	Group C (sample under 0.1)
2662	2593966.335 1119413.335	2595166.335 1123013.335	9.84E-17	0.099951	1	
2663	2593966.335 1119413.335	2590366.335 1118213.335	9.84E-17	0.099951	1	
2664	2593966.335 1119413.335	2590366.335 1120613.335	9.84E-17	0.099951	1	
2665	2593966.335 1119413.335	2597566.335 1120613.335	9.84E-17	0.099951	1	
2666	2593966.335 1119413.335	2595166.335 1115813.335	9.84E-17	0.099951	1	
2667	2593966.335 1119413.335	2597566.335 1118213.335	9.84E-17	0.099951	1	
2668	2593966.335 1119413.335	2592766.335 1115813.335	9.84E-17	0.099951	1	
2669	2593966.335 1119413.335	2592766.335 1123013.335	9.84E-17	0.099951	1	
2670	2633566.335 1127813.335	2635966.335 1126613.335	9.84E-17	0.099951	1	
2671	2633566.335 1127813.335	2634766.335 1125413.335	9.84E-17	0.099951	1	

Table 27 Selected results sample of the SPA model.

5.5.3.2 A Scale-free Network Spatially Explicit Approach for Renewable Energy Technologies Diffusion: Electric and Hybrid Vehicles in Switzerland.

In this section we will deal with the application of the SPA model that was applied for solar PV in the previous section, but for e-vehicles. There are two fundamental differences in the application of the model to e-vehicles and h-vehicles *i) The model is applied at a national level in Switzerland and ii) There is not a gravity model, so spatial layers containing socio-demographic information are not involved in this model, only indicators of e-vehicles and h-vehicles.* The objective in this section is twofold *i) To understand the underlying mechanisms of e-vehicles and h-vehicles diffusion at a national level in Switzerland and ii) To test the SPA model in other kinds of innovations and excluding the gravity model, this also applies for h-vehicles.* Therefore, the data input to the SPA model is expressed in the form:

$$\left(\sum_{pixel=1}^n (\text{Kernel } e - \text{vehicles}) \right) \prod_{SpatialUnit=1, \dots, z}^n \left[\left(\frac{D_{ij}^{-\beta}}{n \sum_{j=1}^n D_{ij}^{-\beta}} \right) \right] \quad (5.12)$$

The data used for this model was provided by the Mobility and Transport section of the FSO⁶⁷ and the application of the SPA model in the dataset of e-vehicles had the following results, and the innovation systems systematically appears to follow power laws.

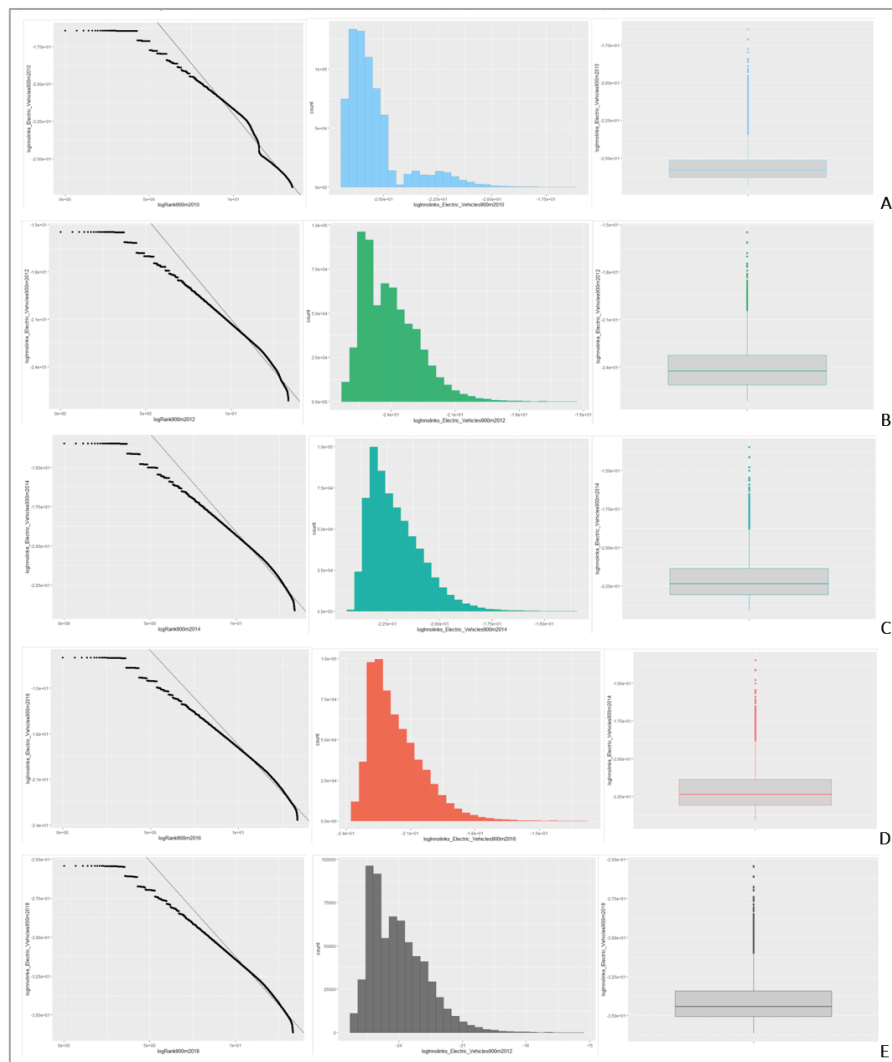

Figure 165 Results of the application of the SPA model to simulate the diffusion of electric vehicles at a 900 sq m resolution in Switzerland from 2010 to 2018. X-axis: Log of kernel density of INNOLINKS; Y-axis= Log of spatial units' rank. A) Year: 2010; Ye-vehicle ≈ -1.36 ; $R^2= 0.9715$; $N= 24,911$; $L= 617,104$. B) Year: 2012; Ye-vehicle ≈ -1.29 ; $R^2= 0.9544$; $N= 40,736$; $L= 708,857$. C) Year:2014; Ye-vehicle ≈ -1.254 ; $R^2= 0.9675$; $N= 45,825$; $L= 646,917$. D) Year:2016; Ye-vehicle ≈ -1.24 ; $R^2= 0.9724$; $N= 48,621$; $L= 646,917$; R. E) Year:2018; Ye-vehicle ≈ -1.23 ; $R^2= 0.9733$; $N= 49,978$; $L= 636,838$.

The results show that the SPA model is robust without the gravity model however, it is important to consider some factors that differentiate solar PV of e-vehicles regarding the development of this model. In the case of the solar PV, data about population, jobs and housing is relevant as the location of this technology is mainly either where people live or work. The available data for the solar PV simulation was at 100 sq m resolution although with privacy protection but it was possible to simulate via ABM the distribution of people and jobs in a very accurate way. The data available of e-vehicles is at municipality level hence, the spatial data point used for the model is the centre of the municipalities' polygons. The data from e-vehicles was also analysed at 1800 sq m and 2700 sq m respectively, here below we can observe some of the results derived from the application of the SPA model.

⁶⁷ Granular data is available in German and is open source under request at: <https://www.bfs.admin.ch/bfs/en/home/statistics/mobility-transport/transport-infrastructure-vehicles/vehicles/road-vehicles-stock-level-motorisation.html#1652458516>

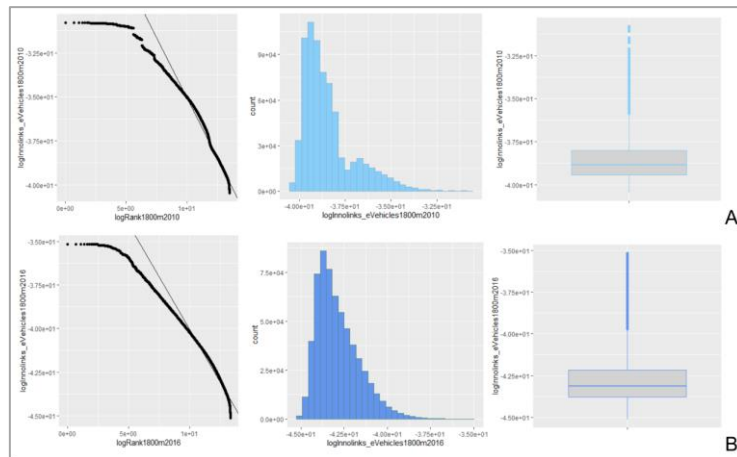

Figure 166 Results of the application of the SPA model to simulate the diffusion of electric vehicles at 1800 sq m resolution in Switzerland in 2010 and 2016. X-axis = log of kernel density of INNOLINKS; Y-axis= log of spatial rank. A) Year: 2010; Ye-vehicle ≈ -1.37 ; $R^2= 0.9801$; $L= 712093$. B) Year: 2016; Ye-vehicle ≈ -1.217 ; $R^2=0.9637$; $L= 605,404$.

The distributional changes timewise were calculated, obtaining thus the delta every two years, starting in 2010 until 2018. The SPA model through Algorithm 2 was applied to the outputs in order to introduce the changes and effects of time in the model, Figure 167 shows the results. It appears that the behavioural mechanisms of the distributional changes of the diffusion of e-vehicles also follows power laws, in which a scale-invariance is observed. All the power law exponents⁶⁸ are larger than 1, the exponents at 1800 sq m and 2700 sq m are over 2.

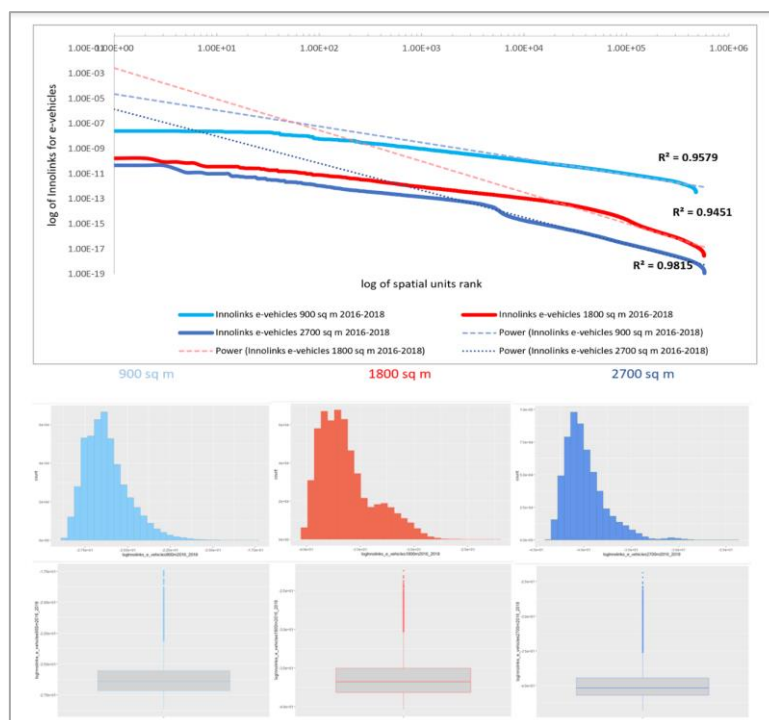

Figure 167 INNOLINKS: Multiscale spatial model SPA model applied to the delta distributions of electric vehicles between 2016 and 2018 at 900 sq m, 1800 sq m and 2700 sq m in Switzerland. Ye-vehicle900 ≈ -1.287 ; $R^2= 0.9579$; $N= 45,944$; $L=477,206$. Ye-vehicle1800m ≈ -2.48 ; $R^2= 0.9451$; $N=11,501$; $L= 573,221$. Ye-vehicle2700m) ≈ -2.154 ; $R^2= 0.9815$; $N= 5096$ $L= 578,380$.

The delta distributions of these technologies seem to be composed at least by two types of ‘diffusion pace’ where the plateau in the left side slightly shows a more matured process in terms of self-organization, for example see curve at 1800 sq m. The right side of that distribution is a similar behaviour observed in solar PV, where the heavy-tailed area of spatial units in the low regime struggles with the diffusion pace and needs more time to cope with

⁶⁸ Since the model is based on an inverse Pareto model in order to simulate the distance decay effects, the exponents are negative.

the adoption speed of hubs in the high regime. These interesting results put in evidence the nature of the adoption of this technology, in which the spatial dimension as an explanatory variable seems to be very robust. Similar outputs were observed in the distributions of h-vehicles, here below we will show some of the results of the delta distributions between the years 2016 and 2018.

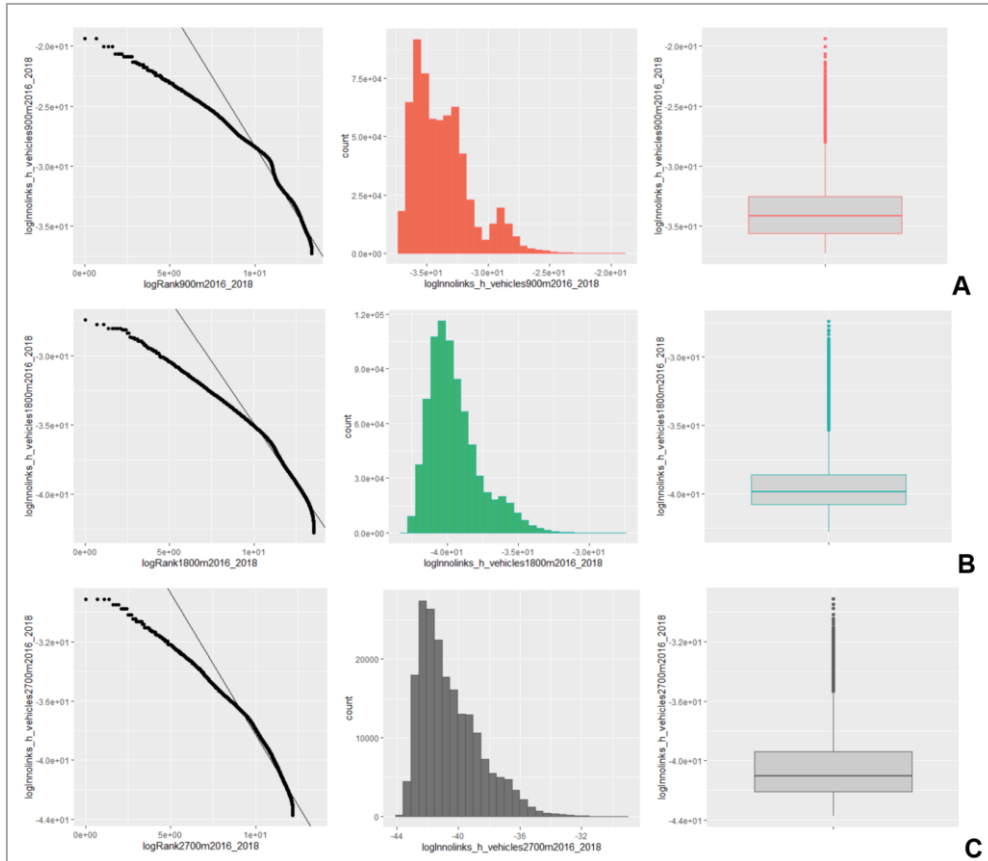

Figure 168 Results of the application of the SPA model on the delta distributions of hybrid vehicles between 2016 and 2018 at 900 sq m, 1800 sq m and 2700 sq m resolution in Switzerland. **A)** $Y_h\text{-vehicle} \approx -2.294$; $R^2= 0.9559$; $N= 50,898$; $L= 630,679$. **B)** $Y_h\text{-vehicle} \approx -1.79$; $R^2= 0.9626$; $N= 12,740$; $L= 784,151$. **C)** $Y_h\text{-vehicle} \approx -1.91$; $R^2= 0.9574$; $N=5650$; $L= 200,110$.

The systematic similarity of the results with solar PV, e-vehicles and h-vehicles gives relevant information on the embedded patterns in these socio-technical systems at urban level. The simulation at 900 sq m seems to have a slightly variation on the lower regime, in which some changes seem to be taking places. It is a similar behaviour also observed in smaller spatial scales of solar PV_{hwh} in section 5.5.2.2, where the distributional changes of the kernel density seemed to develop fractality patterns from large towards smaller scales. However, the distribution of h-vehicles at 900 sq m seems to fit better a power law, which might imply that the self-organization process is slightly more advanced at smaller scales than for solar PV_{hwh}. The latter argument must be taken cautiously since the model was not applied for the same periods of time, the latest available observation for solar PV is 2015 and for h-vehicles is 2018.

Hence, the spatial units with a prominent position in terms of density of solar PV and in terms of space are visible, but it is not possible to determine the boundary values of the hubs. The space distribution between the spatial units helped us to solve this question, by following a spatial interaction approach. The latter is determined based in different parameters such as population densities, spatial distribution of jobs, services, accessibility just to mention some of the factors playing a role in spatial organisation. The specialized literature on spatial interaction models (SIM) is vast as it was mentioned before and more specifically in the case of distance decay calculation

approaches, we find different propositions made by scholars. The choice of SIM and the distance decay parameter β are fundamental for the development of the analysis (see Östh et al., 2016). For this research we chose to use the power-decay function, the rationale of this choice relies on the preferential attachment assumption of RET diffusion. As a reminder, the preferential attachment property appears at the phase transition from randomness to fractality, where power laws are the mathematical signature of such transitions.

5.6 Conclusion Chapter 5

The systematic results obtained in the simulations of each RET in the previous section, suggest that interaction processes within the urban networks generate a sort of innovation diffusion corridors, which are represented by the links. In fact, the assumptions addressed in section 2.3.6 regarding the network effects of RET diffusion appear to be confirmed as these innovation diffusion corridors are not distributed in a random spatial way. The innovation diffusion links of the urban network seem to follow power laws and exhibit a spatial preferential attachment that can be determined with the SPA model.

The methodological framework used in this dissertation rely on different scientific approaches that are aligned from an epistemological perspective supporting their operational implementation. These results open new research perspective within the field of innovation diffusion and energy transition since questions such as: if power laws are the signature of phase transitions from chaos to order, what does it mean from a spatial perspective within the context of the sustainability paradigm? What kind of transition is happening from a spatial perspective?

The spatial preferential attachment mechanisms observed in the RET diffusion is a relevant phenomenon that have a concrete societal, environmental and political impact. The spatial effects in the urban energy structures are of major importance for innovation and sustainability studies, which has been a topic discussed in this dissertation. The results proves once again that the role of geography on the sustainability process is very important. The next chapter will discuss the application of the SPA model in the South Region of France in order to drawn comparisons with the results obtained in the Swiss region.

6 A Multiscale Geospatial Network Approach for Renewable Energy Technologies Diffusion in the South Region of France.

“The division of time and space is given by tradition, and something which I perceive as a weakness”.

—Torsten Hägerstrand

6.1 Objectives

In this Chapter we will deal with the question of innovation diffusion from the supply perspective through the modelling and simulation prism. Unlike the model developed in the Swiss region where the model focused on the end user, here we intend to analyse the RET supply segment. One of the main consequences of this choice, is that we will not develop a gravity model integrating parameters such as population and jobs. Instead, it will be emphasized the spatial effects embedded in the renewable energy production, analysing the processes by using a ‘degraded’ version of the SPA model. A multiscale spatial analysis will be developed, and the construction of a spatial network will simulate the diffusion process in the South Region of France. Furthermore, this application will be the basis to model the resilience to RET diffusion in Chapter 7.

6.2 Multi-scale Spatiotemporal Modelling Framework for Geography of Sustainability Transitions: Application of the Spatial Preferential Attachment Model in the South Region of France.

An important aspect of diffusion of innovations is that diffusion processes have two different kind of agents: emitters and receptors. The implications of this aspect from a modelling perspective are that for example the spatial interaction theory needs to be applied in a different way when possible. The simulation of the adoption of solar PV as shown in the previous chapter, would involve variables such as population and end user behaviour. In the case of the energy supply process at municipality level, like is the case of the data available in the PACA region, it was necessary to choose the indicators based on their suitability with the SPA model.

Another important aspect to consider, is the nature of the innovation indicator studied. By way of comparison let’s look at the spatial organization of solar panels and wind power mills. The studies of photovoltaic potential in the South Region of France (CEREMA, 2019) involved various territorial capacity indicators, some of those were urban planning, living environment and housing aspects. The spatial organization of solar PV allows to do

smoothing analyses with discrete data for example using Huff's model (Huff, 1964). However, in the case of wind power, or energy production via biomass, hydroelectric power and biogas such approach is not suitable. Therefore, we focused on the study to electricity and heat production via solar PV and solar thermic collectors and subsequently to other indicators such as biomass, biogas and hydroelectric power plants.

6.2.1 Data

The analyses in the South Region of France were developed with the data provided by the Air Quality Monitoring Association (ATMOSUD, 2019) and the database is called CIGALE⁶⁹, the data is available only in French. The resolution of the information is at municipality level and the following definitions and considerations are needed to interpret the data. The production of energy registered in the CIGALE database are electricity and heat at the output of the installations. The origin of extraction of these energies might be of primary production nature, as it is the case of solar PV or secondary production, when the energy has been transformed such as electricity or heat.

Variable Name	Variable Name in English	Detailed Information	Type of variable	Type of data Physical (P) or Administrative (A)	Data availability
INSEE_ID	Municipality ID	Codes created by the French National Institute of Statistics and Economic Studies (INSEE)	Categorical	A	2007-2018
Municipality	Name of municipality		Nominal	A	2007-2018
Production_type	Energy Production Type		Energy Production Type Detail		
	Electricity	Solar Photovoltaics	Continuous	P	2007,2010,2012,2013,2014,2015, 2016 and 2017
		Wind Power	Continuous	P	
		Biogas	Continuous	P	
		Small Hydroelectric Power Plants	Continuous	P	
		Big Hydroelectric Power Plants	Continuous	P	
	Thermal	Solar Thermal Collector	Continuous	P	
Biomass		Continuous	P		
Production_category	Renewable Energy		Categorical	P	
Production_category_detail	Energy_Agent	Energy Production Unit			
Unit_Value_MWh_LHV	Lower Heating Value in Megawatts/hour	These energy units applies for all technologies	Nominal	P	
Year	Year		Ordinal	A	

Table 28 Data of Energy Production in the South Region of France. Source: ATMOSUD (2019).

The INSEE is the abbreviation for the National Institute of Statistics and Economic Studies in France, making it the equivalent to the FSO in Switzerland. Regarding the unit value of the energy production registered in the data base, the calculation of the calorific value of a fuel provides information on its efficiency. The data is recorded in terms of MWh and measured which stands for LHV, which stands for Lower Heating Value. The heating value refers to the quantity of heat produced by a fuel combustion, which is measured as the unit of energy per unit mass or also volume of a substance e.g. KJ/Kg. The heating value is measured by considering a lower and an upper value called LHV and the Higher Heating Value (HHV) respectively.

Measuring HHV of natural gas for example, is equivalent to calculating the energy consumed by the combustion of 1m³ of gas by also adding the heat produced by the water steam at the time of combustion. The lower LHV for natural gas, on the other hand, only measures the energy created by combustion, which is also known as the Net Calorific Value. The HHV of natural gas therefore, always corresponds to the highest value that is why is also known as Gross Calorific Value. The LHV is often used as a conversion coefficient in the bills to convert the volume of gas used into kWh. In the case of biomass that is used in the South Region of France for heating purposes, the calculation of the LHV is derived from the HHV, and it is calculated by subtracting the energy of the water produced during the combustion reaction. The reason is that the water is not condensed when it leaves the system and the LHV accounts for that, and additionally the latent heat of condensation is not recovered from the combustion

⁶⁹ Available online at <https://cigale.atmosud.org/extraction.php>

process as useful energy. Readers interested in heating value, thermodynamics and robust optimization of renewable energies are referred to Moret (2017). Concerning the georeferenced data, the data base provided by GEOFLAT⁷⁰ was used to spatialise the information, which is available in French. Since the resolution of the energy production data was at municipality level, the centres of the municipalities' polygons were used as a data point for the location of the energy production.

6.2.2 Exploratory Data Analysis of Renewable Energy Technologies in the South Region of France

In this section we will develop an EDA in the South Region, which will allow to draw comparisons and conclusions regarding the research worked performed in the Swiss region.

6.2.2.1 *Solar Photovoltaics and Space: A Multiscale Spatial Analysis of Energy Production in the South Region of France*

The multiscale spatial analysis was performed at 900 sq m, 3600 sq m and 8400 sq m respectively. The procedure was initially the same as it was done for the Swiss region, a kernel density estimation was calculated in the spatial scales of reference.

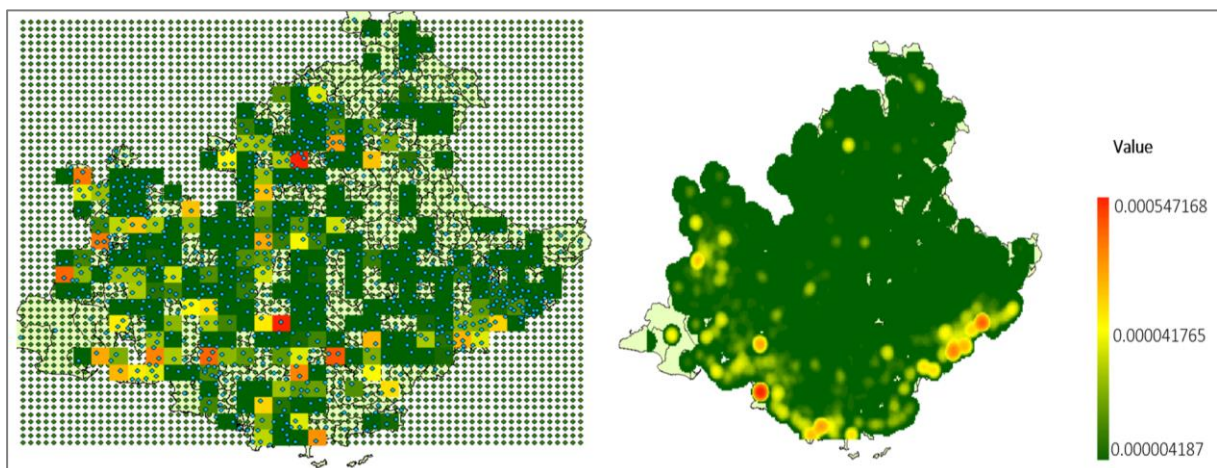

Figure 169 Spatial Kernel Density of Energy Production for Electricity in the South Region of France at 3600 sq m resolution in 2017.

An EDA approach was developed in the region of study via the kernel density of the energy produced for electricity via solar PV in the South Region of France. The lineal plots show already some signs of outlying, in which certain spatial units in the three spatial scales of reference in the figure below outstand most of their counterparts. The distributions at each scale were used to do a regression and the adjusted- R^2 , which are displayed in the table next to the figure below. These initial basic calculations give information on how much the model needs to improve the explanation model. In the case of solar PV, we can observe in Figure 179 that the adjusted R^2 values are significantly improved after the application of the SPA model.

⁷⁰ Available online at <https://geoservices.ign.fr/documentation/diffusion/index.html>

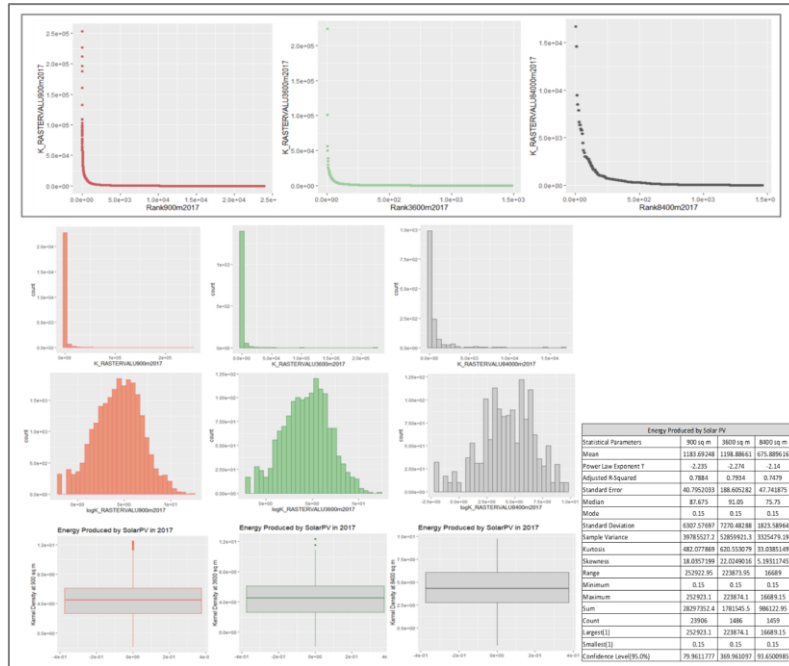

Figure 170 Multiscale Spatial Statistics of Kernel Density of Energy Production via Solar Photovoltaics in the South Region of France in 2017.

6.2.2.2 Solar Thermal Collectors and Space: A Multiscale Spatial Analysis of Energy Production in the South Region of France

The plot below shows the kernel density of the energy produced in the South Region of France via solar thermal collectors (Solar TC).

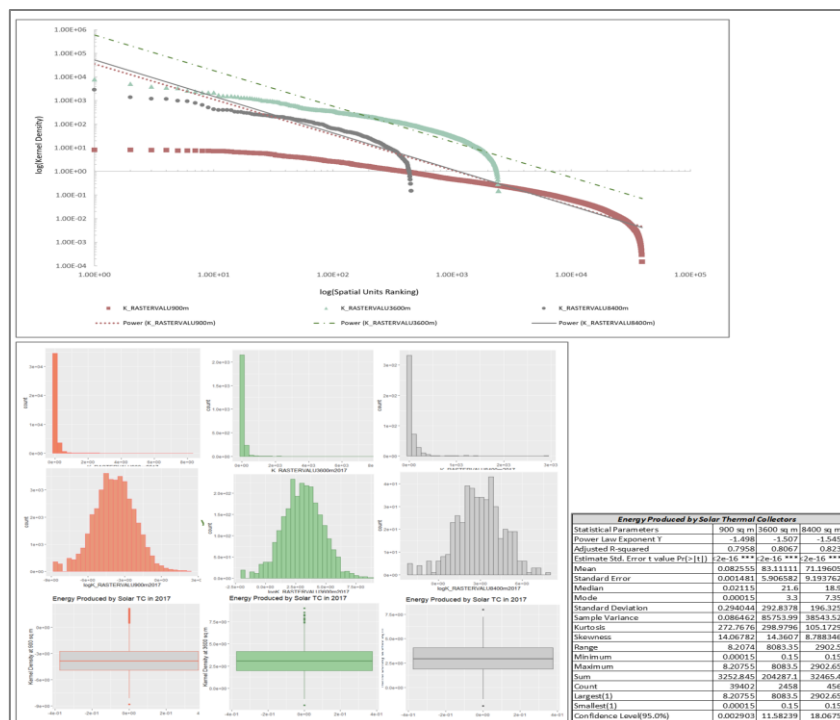

Figure 171 Multiscale Kernel Density of Energy Produced by Solar Thermal Collectors in the South Region of France 2017.

The spatial distributions of the energy produced via Solar TC at the three scales of reference, show similar patterns to those observed with solar PV, the INNOLINKS' weight which represent the diffusion process between nodes or

spatial units, show Adjusted-R² values higher than 0.98 in the regression of a power law function with the SPA model (see Figure 183). An interesting aspect of the similar results between solar PV and Solar TC is that the production of energy is for different ends, electricity and heating usage. Therefore, it appears that the mechanisms of diffusion are comparable to those observed in the Swiss region, just that here we are analysing the diffusion process from the supply perspective.

6.2.2.3 Solar Photovoltaics, Space and Time: A Multiscale Spatial Analysis of Energy Production in the South Region of France

Distributional Spatial Changes of the diffusion Energy produced by Solar Photovoltaics.

The chart below shows a multiscale spatial analysis of the energy produced via solar PV, in which the distribution at 8400 sq m is the best fitted with a power law function.

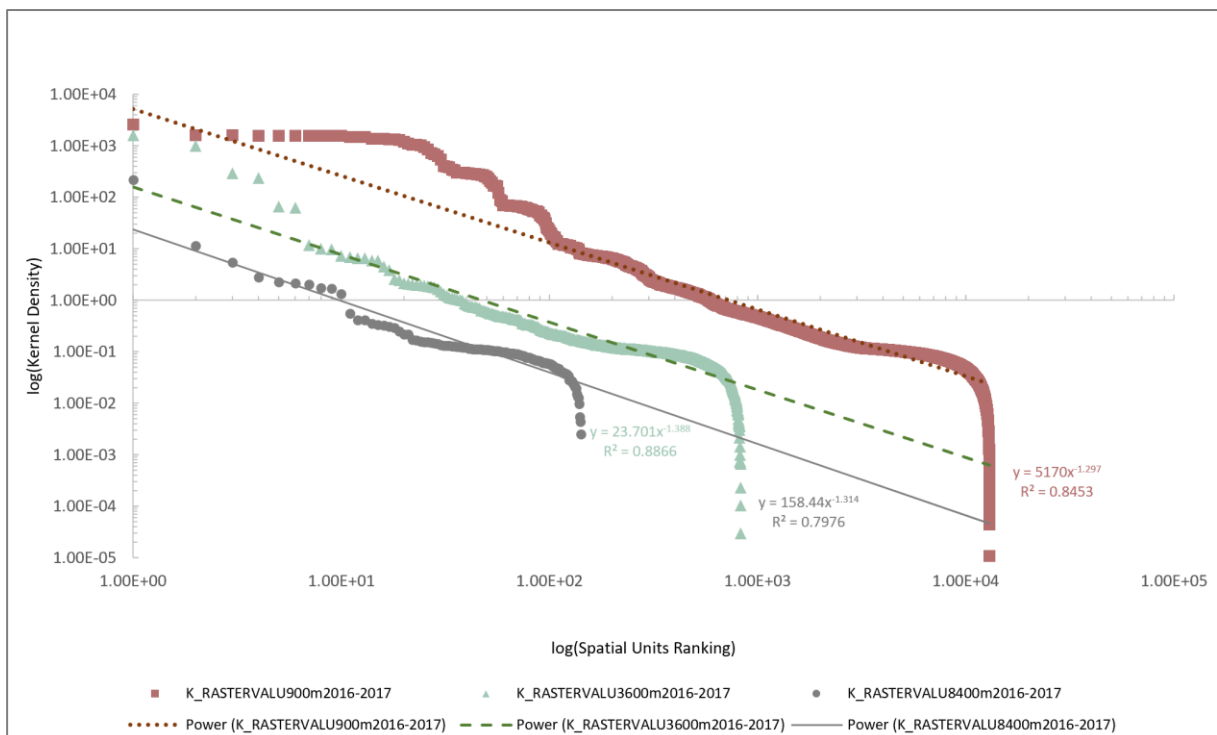

Figure 172 Delta of the Kernel Density Estimation of the Energy Produced in the South Region of France via Solar Photovoltaics at 900 sq m, 3600 sq m and 8400 sq m between 2016 and 2017.

In the lin-lin plot of the distribution at 8400 shows signs of solitary hub taking over, which is reflected in logarithmic histogram that shows signs of being slightly right-skewed when it is compared with the distributions at 900 sq m and 3600 sq m respectively.

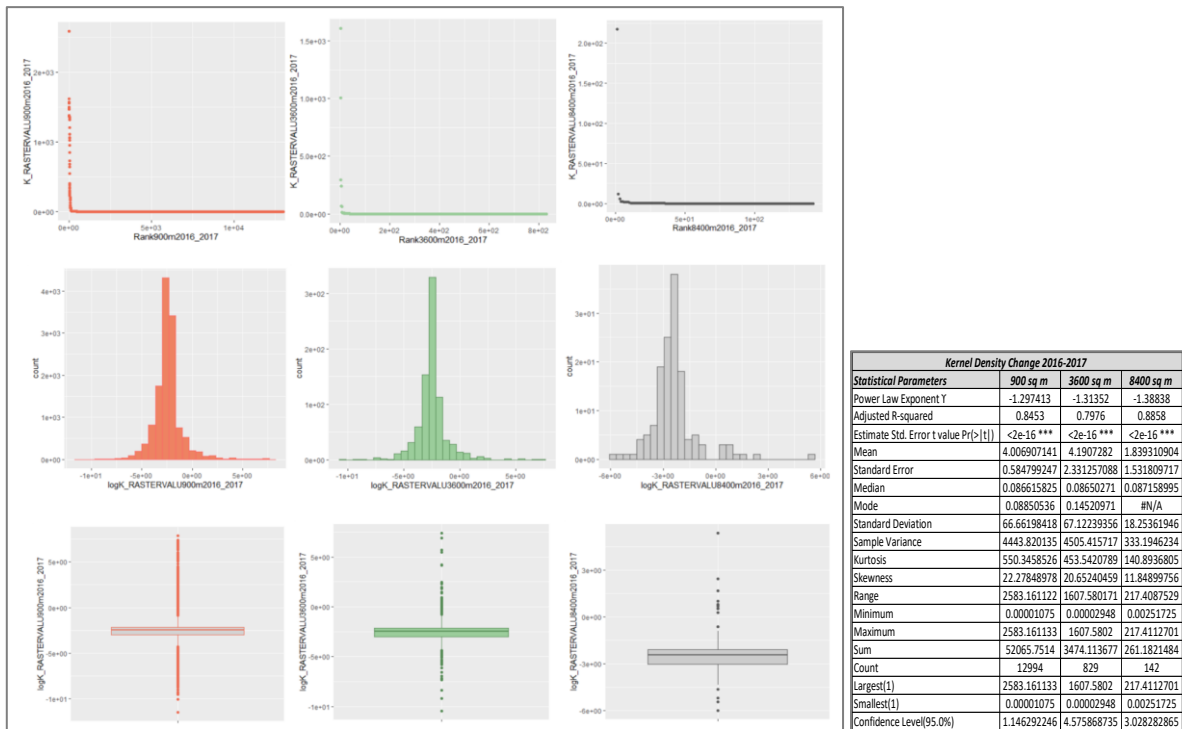

Figure 173 Multiscale spatial rate change of energy produced by solar photovoltaic between 2016 and 2017 in the South Region of France at 900 sq m, 3600 sq m and 8400 sq m respectively.

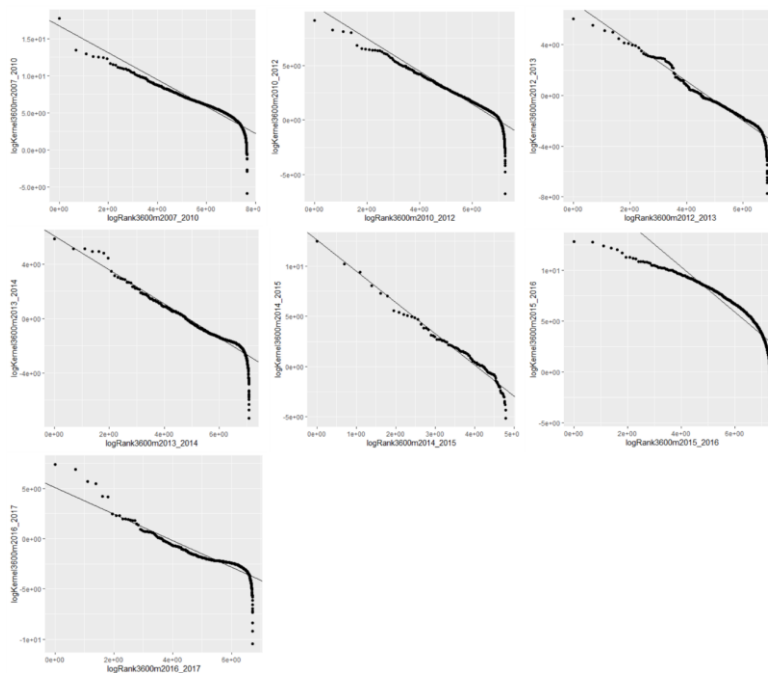

Figure 174 Multiscale spatial rate change of energy produced by solar photovoltaic at 3600 sq m resolution between 2007 and 2017 in the South Region of France.

The summary of the statistics from Figure 174 are shown in the table below. According to the plots above, it appears that the last years there had been sudden falls on the diffusion process from a spatial perspective in the low regimes.

Statistics of Kernel Density of Energy Produced by Solar PV at 3600 sq m							
Statistical Parameters	2007-2010	2010-2012	2012-2013	2013-2014	2014-2015	2015-2016	2016-2017
Powe Law Exponent Y	-1.82101	-1.50248	-1.558	-1.25053	-3.10504	-2.23109	-1.31352
Adjusted R-squared	0.8633	0.8718	0.9135	0.8814	0.9638	0.8085	0.7973
Pr(> t) Intercept	<2e-16 ***	<2e-16 ***	<2e-16 ***	<2e-16 ***	<2e-16 ***	<2e-16 ***	<2e-16 ***
Pr(> t) of X (logRank)	<2e-16 ***	<2e-16 ***	<2e-16 ***	<2e-16 ***	<2e-16 ***	<2e-16 ***	<2e-16 ***
Mean	26022.64318	27.27936064	2.180192273	1.566700083	2566.22104	2847.916243	4.1907282
Standard Error	24052.69203	7.709706985	0.593167276	0.413353214	2190.54489	444.3772802	2.331257088
Median	100.9009933	2.621593475	0.13509311	0.188627395	1.21738446	188.370575	0.08650271
Standard Deviation	1098289.218	290.1145426	18.29226324	14.25918814	24095.9938	17336.41014	67.12239356
Sample Variance	1.20624E+12	84166.44782	334.6068943	203.3244465	580616915	300551116.5	4505.415717
Kurtosis	2083.338889	697.1545113	334.3787114	350.4907887	117.902128	278.3482308	453.5420789
Skewness	45.6346993	24.48331731	16.86160012	17.19398164	10.8017529	15.33819838	20.65240459
Range	50141860	9048.728304	419.3880135	350.2736344	263770.057	371807.9892	1607.580171
Minimum	0.00287658	0.00118809	0.00044472	0.00065756	0.00584604	0.01080444	0.00002948
Maximum	50141860	9048.729492	419.3884582	350.274292	263770.063	371808	1607.5802
Sum	54257211.03	38627.57467	2073.362851	1864.373099	310512.746	4334528.522	3474.113677
Count	2085	1416	951	1190	121	1522	829
Largest(1)	50141860	9048.729492	419.3884582	350.274292	263770.063	371808	1607.5802
Smallest(1)	0.00287658	0.00118809	0.00044472	0.00065756	0.00584604	0.01080444	0.00002948
Confidence Level(95.0%)	47169.80555	15.12368435	1.16406957	0.810982953	4337.12642	871.657093	4.575868735

Table 29 Statistics summary of the spatial kernel density evolution of energy produced by solar photovoltaics from 2007 to 2017 in the South Region of France.

6.2.2.4 Solar Thermal Collectors Space and Time: A Multiscale Spatial Analysis of Energy Production in the South Region of France

From the observation before doing any statistical analysis we find an interesting case, which is similar to the solar PV_{hwh} in Switzerland where the forms of the curves at larger scales are closer to a straight line of a power law. Here we can observe that the distribution of the solar TC at 8400 sq m has a plateau where a straight line would have a good fit. However, when the spatial resolution is reduced to 3600 sq m and 900 sq m, the plateaus of the lines are deformed and a power law does not fit. Indeed, an exponential function explains much better the distributional changes of this technologies from a spatiotemporal perspective. An interesting aspect with the charts of these distributions is that they vary depending on the maturity level of the self-organization process.

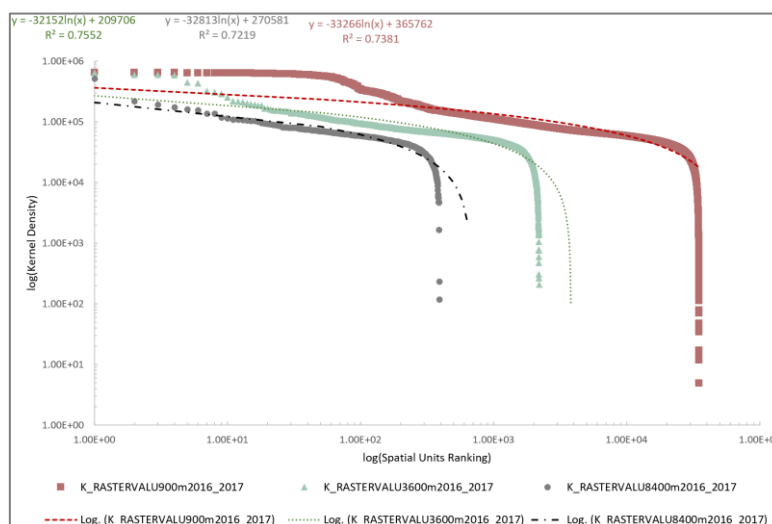

Figure 175 Multiscale spatial adoption rate change of energy produced by solar thermal collectors between 2016 and 2017 in the South Region of France.

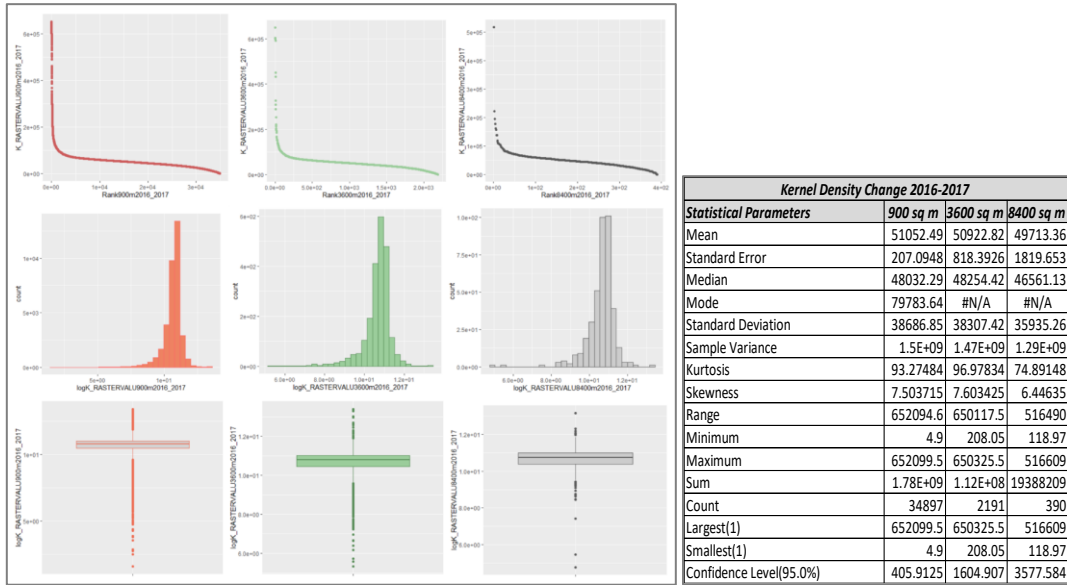

Figure 176 Distributions of rate change of energy produced by solar thermal collectors between 2016 and 2017 in the South Region of France.

Let's focus on the straight portion of the line followed by the data points before it suddenly falls shown in the plot above. By cutting off the data points of the lowest values, it is possible to observe a power law distribution. Figure 177 shows the results of this procedure, this has been done just in order to unveil the heavy tailed distribution in this data set for example by taking 30002 observations out of 34898, that is 86% at 900 sqm, the results are those shown in the Figure 177. A similar procedure was made with the observations at 3600 sq m and 8400 sq m, using 66% and 67 % of the observations respectively.

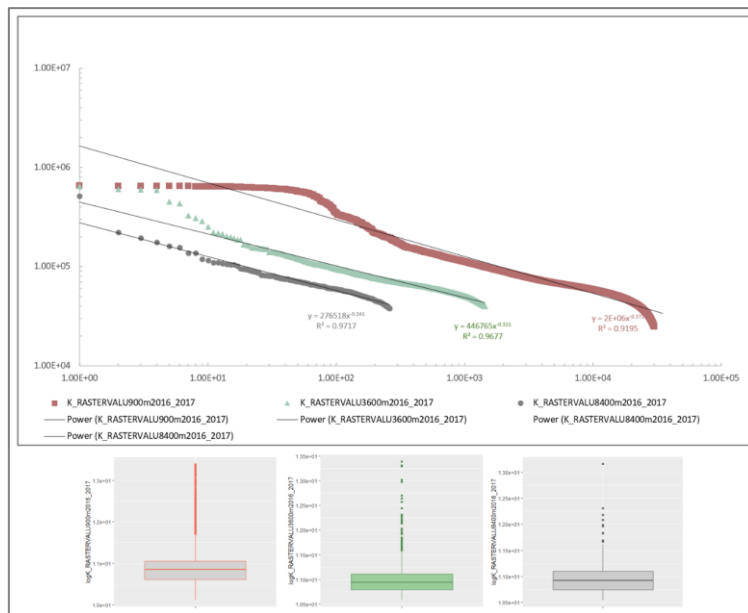

Figure 177 Adjustment of the multiscale spatial adoption rate change of energy produced by solar thermal collectors between 2016 and 2017 in the South Region of France.

The data on the straight line keeps the higher values also because the spatial effect embedded in the diffusion system, as the kernel density procedure allows to integrate the proximity between data points. The rate changes in the energy produced by solar PV appears to have less values in the lower tail than those observed in the energy

rate changes produced by solar TC. The interesting aspect of this behaviour in solar TC will be seen in with the application of the SPA model.

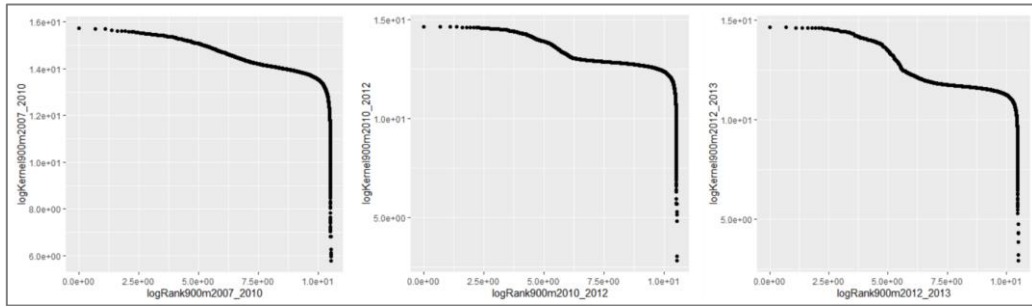

Figure 178 Change of energy produced by solar thermal collectors in three different time scales in the South Region of France. Left: three years between 2017 and 2010, centre: 2 years between 2010 and 2012 and to the right: 1 year between 2012 and 2013.

The trajectories of rate changes seem to compensate the diffusion in the right places and at the right time in such a way that the INNOLINKS follow a power law. The figure above shows the evolution of energy produced by solar TC and follows the same pattern observed in Figure 175, the same applies for all the deltas between 2007 and 2017. The analyses performed in this section introduces the application of the SPA model as follows.

6.2.3 Spatial Preferential Attachment: A Network Modelling Approach for Diffusion of Innovations and Geography of Sustainability Transitions in France.

The application of the SPA model in the French region was based only on the energy production per municipality affected by a power law function decay. With this equation the links of the network were formed:

$$Innolinks = \left(\sum_{SpatialUnit=1}^n (KernelRET) \right) \prod_{SpatialUnit=1, \dots, z}^n \left[\left(\frac{Dij^{-\beta}}{n \sum_{j=1}^n Dij^{-\beta}} \right) \right] \quad (6.1)$$

As it can be observed in the equation above, the difference with the original model is that the first part of the equation that integrated the spatial layer of the PIF with a dumping coefficient was removed (see Figure 150). Relying on the conceptual idea that proximity is important for diffusion and also adoption the model should work to model both, energy demand and supply.

6.2.3.1 A Scale-free Network Spatially Explicit for Renewable Energy Technologies Diffusion in the South Region of France: The Case of Solar Photovoltaics and Solar Thermal Collectors.

Now we are going to show the some of the results obtained with the SPA model in the French region. The idea is to observe different times and scales and the capacity of the model to simulate the connectivity of the potential of innovation from a spatial perspective.

Solar Photovoltaic

The transformation on a log-log plot allowed to deploy the charts below, which are fitted by a power law.

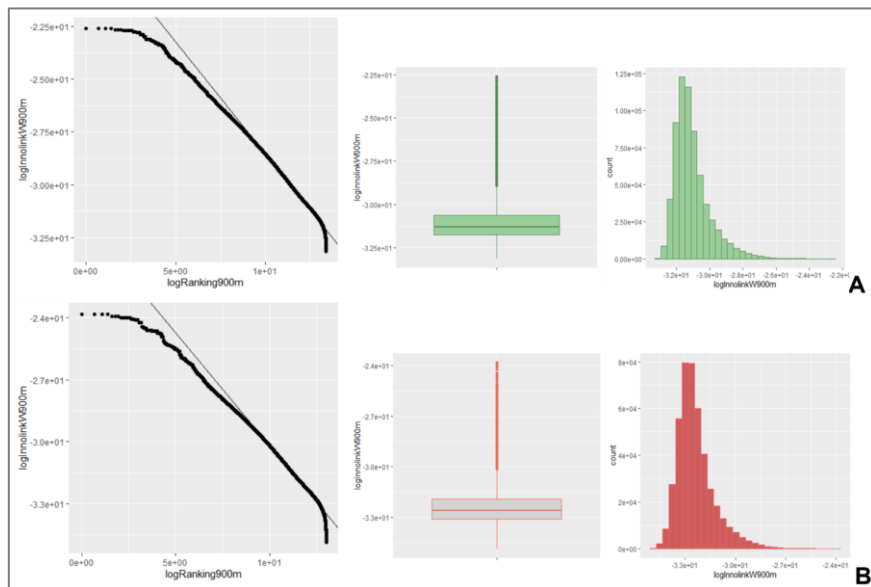

Figure 179 Distribution of the INNOLINKS' weight derived from the SPA model applied for energy production with solar photovoltaics at 900 sq m resolution in the South Region of France. A) Data from 2012: $\gamma_{\text{solarPV}} \approx -1.06$; R-squared= 0.986; N= 27,788; L= 441,023. B) Data from 2016: $\gamma_{\text{solarPV}} \approx -1.097$; R-squared= 0.9758; N=24,869; L= 650,724.

The plots below were also performed with solar PV data but at 3600 sq m, the resemblance to the results in the Swiss region are striking (see Figure 154, Figure 155 and Figure 156).

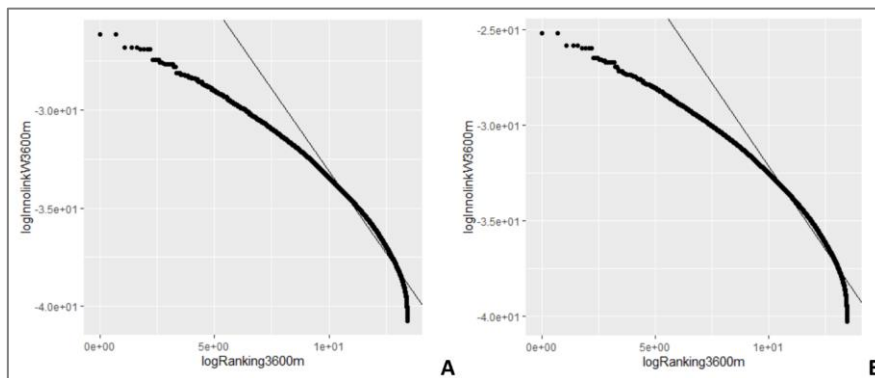

Figure 180 Distribution of the INNOLINKS' weight derived from the SPA model applied for energy production with solar photovoltaics at 3600 sq m resolution in the South Region of France. A) Data from 2016: $\gamma_{\text{solarPV}} \approx -1.68$ R-squared= 0.939; N=1551; L= 665,240. B) Data from 2017: $\gamma_{\text{solarPV}} \approx -1.74$; R-squared= 0.9364; N= 1487; L=704,917.

The application of the SPA model at 8400 sq m resolution had the following outputs:

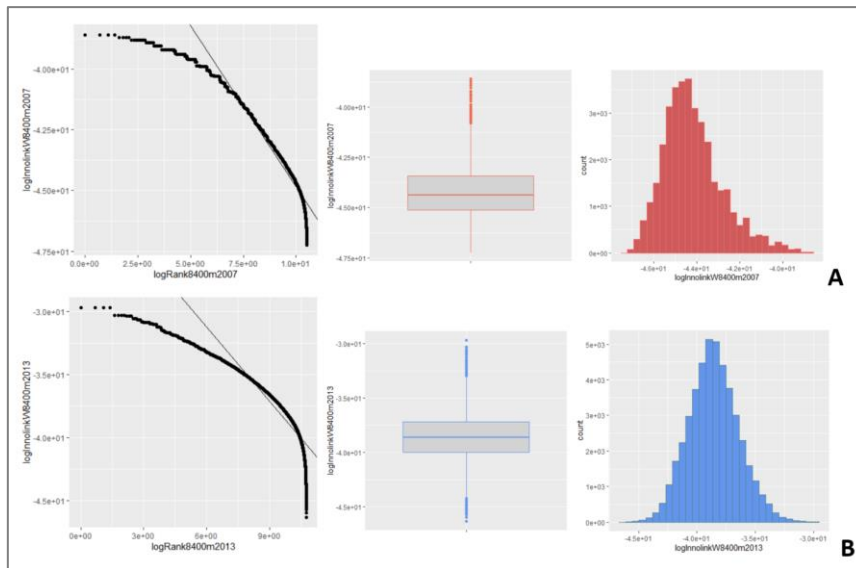

Figure 181 Distribution of the INNOLINKS' weight derived from the SPA model applied to the delta of the energy produced with solar photovoltaics at 8400 sq m resolution es in the South Region of France. **A)** Data from 2007: $Y_{solarPV} \approx -1.327639$ R-squared = 0.9333 L= 36,586. **B)** Data from 2013: $Y_{solarPV} \approx -1.972108$; R-squared= 0.8461 ; L= 45,452.

The integration of the time, as it was done in the Swiss territory was also implemented in the South Region of France at different spatial and time scales, the following figure shows the distribution of the INNOLINKS at three, two and one year deltas respectively. The delta distribution between 2007 and 2010 unsurprisingly has the highest amount of nodes and links followed by the two years delta between 2010 and 2012. Finally, the 1 year delta between 2016 and 2017 presents a sudden drop however, has a similar power exponent among the three distributions but it is not significant.

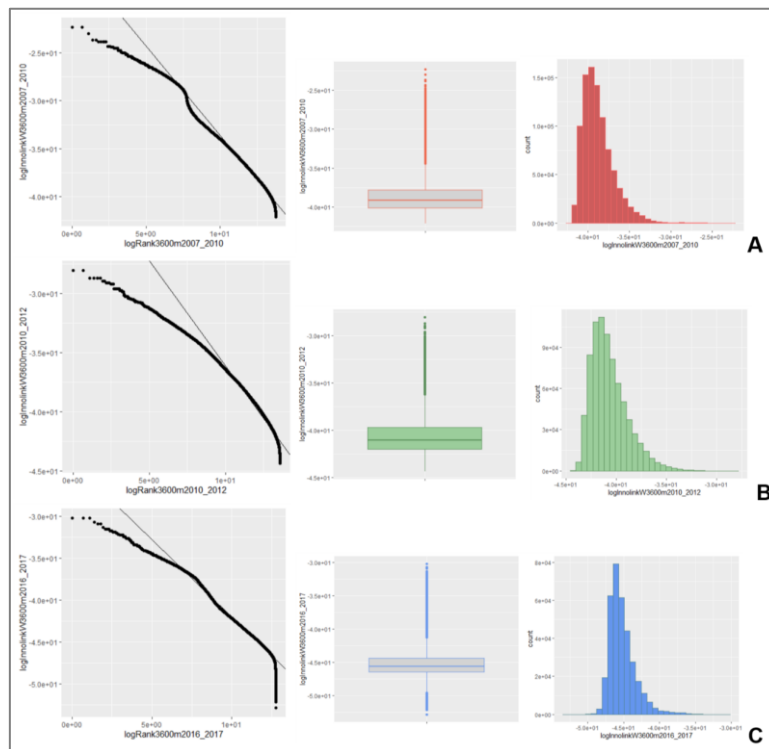

Figure 182 Distribution of the INNOLINKS' weight derived from the SPA model applied to the delta of the energy produced with solar photovoltaics at 3600 sq m in three different time scales in the South Region of France: **A)** Three years delta between 2007 and 2010: $Y_{solarPV} \approx -1.87$; R-squared= 0.9785; N=2085; L= 922,000. **B)** Two years delta between 2010 and 2012: $Y_{solarPV} \approx -1.783571$; R-squared= 0.9629; N= 1417; L= 774,346. **C)** One year delta between 2016 and 2017: $Y_{solarPV} \approx -1.850$; R-squared= 0.981; N= 829; L= 343,206.

The sudden fall in the distribution between 2016 and 2017 is confirmed by its skewness in the histogram, which is the lowest among the three distributions. This might be explained by the fact that the self-organization process in the delta values could need more than a single year.

Solar Thermal Collectors

The SPA model was also used to simulate the spatial connectivity for the diffusion process of heating production via solar TC and the distributions appear to follow similar patterns:

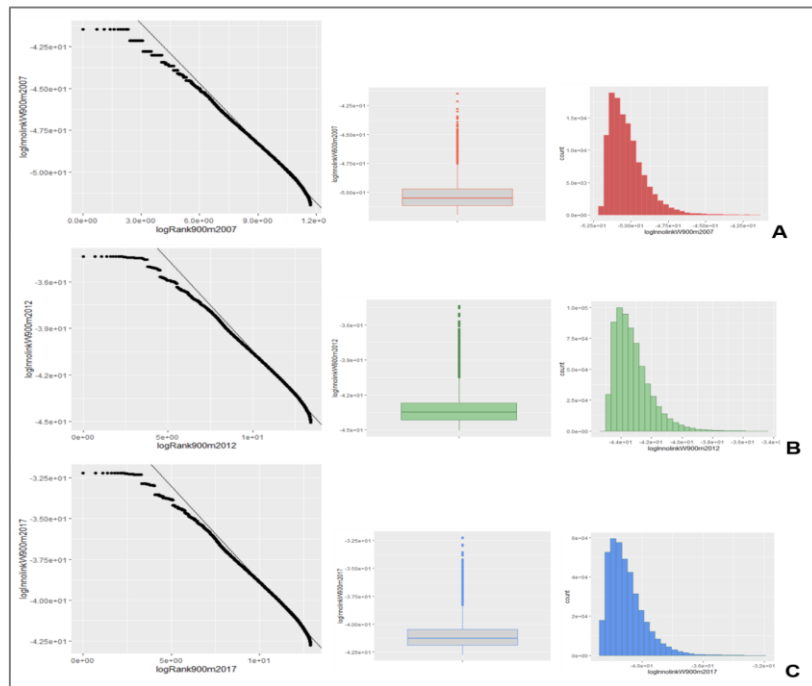

Figure 183 Distribution of the INNOLINKS' weight derived from the SPA model applied to heating production by solar thermal collectors at 900 sq m resolution in the South Region of France. **A) Data from 2007:** $Y_{solarTC} \approx -1.18$; R-squared= 0.9855; N=41,470; L= 127085. **B) Data from 2012:** $Y_{solarTC} \approx -1.173e+00$; R-squared= 0.984; N=39,876; L= 653111. **C) Data from 2017:** $Y_{solarTC} \approx -1.17$; R-squared= 0.9845; N= 39,402; L= 390983.

Here it is shown the plots of the INNOLINKS at three different spatial scales for the year 2017. The distributions at 900 sq m and 3600 sq m have quite high R-adjusted values, as for the distribution at 8400 sq m, there is a sudden fall that diverges from the power law fit however, the straight part of the line is well approximated.

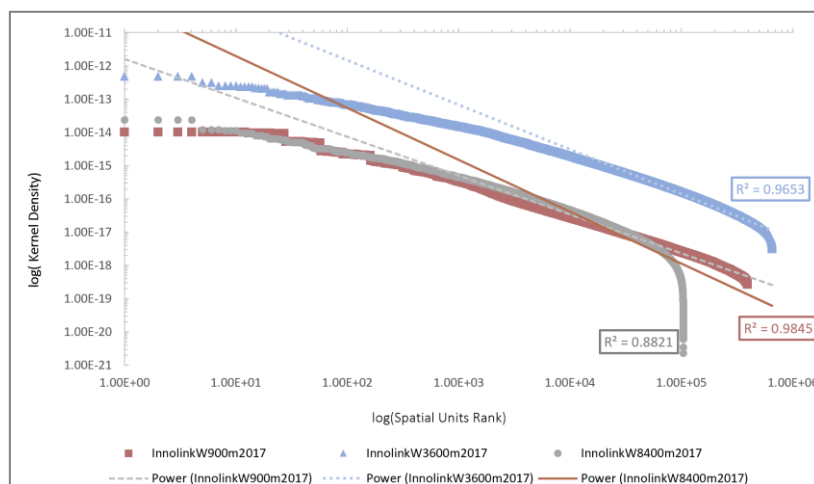

Figure 184 Distribution of the INNOLINKS' weight derived from the SPA model applied to heating production by solar thermal collectors at 900 sq m, 3600 sq m and 8400 sq m respectively in 2017 in the South Region of France.

The fractality level is not scale-invariant for all the indicators as it is depicted in the figure above, but a clear trend towards self-organization is in general observed in the innovation indicators studied in this dissertation. These figures are snapshots in a precise moment in time, but the processes are evolving and here it appears that the diffusion of solar TC needs more time at 8400 sq m to have a better fit with power laws. In the general conclusion these aspects are discussed.

6.2.3.2 An application of the Spatial Preferential Attachment Model for Energy Production for Electricity Based on a Technology Mix of: Wind Power, Small and Big Hydroelectric Power Plants, Biogas and Solar Photovoltaic.

The data provided on the CIGALE database contains information of the technology mix to produce electricity. These technologies are solar PV, small and big hydroelectric power plants (SHP) and (BHP), wind power and biogas. A systematic study of the distributions followed by the electricity produced by the technological mix based on wind power, small and hydroelectric power plants, biogas and solar photovoltaic (Techmix) exhibited power laws. The results displayed in Figure 185 are quite interesting, since the values of each year per spatial unit are so close that the trajectories of the spatial densities overlap. The zoom in at the top-right of the figure allows to see the trajectories followed by the larger hubs.

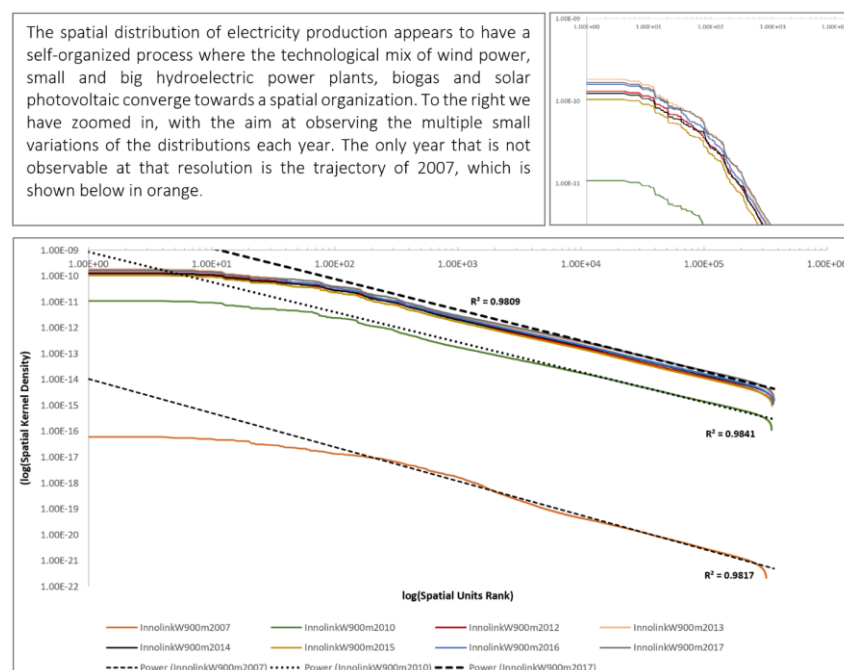

Figure 185 Distribution of the INNOLINKS' weight derived from the SPA model applied to energy production for electricity through wind power, small and big hydroelectric power plants, biogas and solar photovoltaics at 900 sq m resolution from 2007 to 2017 in the South Region of France.

An important note on the application of the SPA model is required at this point. The spatial discretization embedded in the location of energy production via SHP and BHP, wind power and biogas are not suitable to directly apply Huff's-type models or spatial kernel density equations. In such cases, when the distance between the energy production location is too big, the inversed power law function of the distance decay also become too big, as a consequence, the model loses its prediction power. Therefore, is advised to rather study these technologies by aggregating the data with technologies that are in a sense spatially diffusing on a much faster pace, such as solar PV or solar TC in the case of heating.

The high presence of solar PV across the territory, serves as an innovation proxy for other technologies. For example, the dataset of 2017 contains only 32 georeferenced data points with BHP and 87 with SHP in the South Region of France, while solar PV had 869 data points at municipality scale. The distance between the hydroelectric plants is too long to apply the SPA model for BHP and SHP, as they are scarce. A similar case is observed with biogas, that has only 15 georeferenced data points and wind power has 5 data points for the year 2017.

However, if the BHP and SHP's Megawatts produced are aggregated with solar PV, which are spatially broadly diffused in the territory, the values of the spatial units with solar PV data will be reinforced by the presence of BHP and SHP's values. Contrarily, where there is not energy produced via BHP nor SHP, only the solar PV data is accounted for. The plots below rely on the same data as Figure 185, but are displayed one-by-one with the statistics summary. All the regressions return adjusted-R² values larger than 0.98, presenting high significative p-values, smaller than 2e-16.

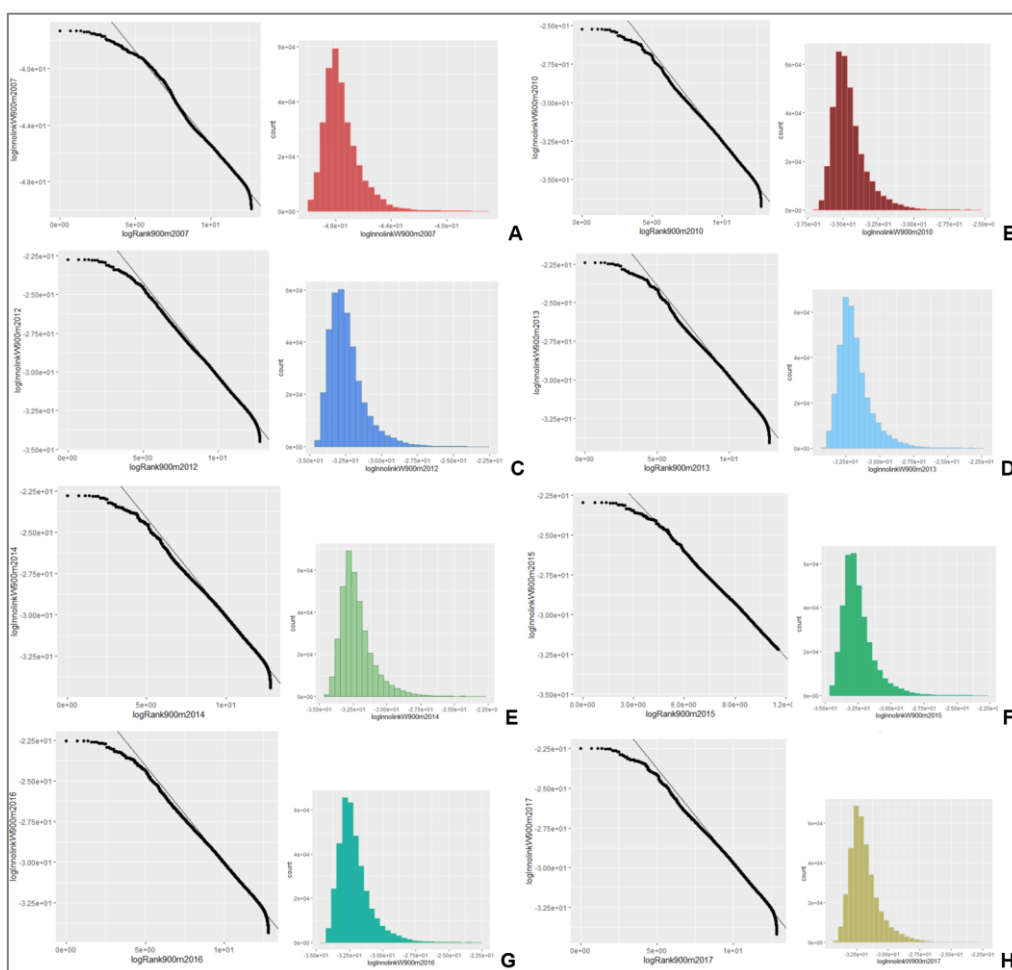

Figure 186 Distribution of the INNOLINKS' weight derived from the SPA model applied to electricity production by wind power, small and big hydroelectric plants, biogas and solar photovoltaics at 900 sq m resolution in the South Region of France: **A)** Year: 2007; $\Upsilon_{Techmix} \approx -1.31$; $R\text{-squared} = 0.9817$; $N = 5300$; $L = 320430$. **B)** Year: 2010; $\Upsilon_{Techmix} \approx -1.16$; $R\text{-squared} = 0.9841$; $N = 20,738$; $L = 354575$; **C)** Year: 2012; $\Upsilon_{Techmix} \approx -1.21$; $R\text{-squared} = 0.9842$; $N = 19,418$; $L = 361974$. **D)** Year: 2013; $\Upsilon_{Techmix} \approx -1.17$; $R\text{-squared} = 0.9805$; $N = 19,625$; $L = 361974$. **E)** Year: 2014; $\Upsilon_{Techmix} \approx -1.18$; $R\text{-squared} = 0.9831$; $N = 18,524$; $L = 364120$. **F)** Year: 2015; $\Upsilon_{Techmix} \approx -1.107$; $R\text{-squared} = 0.9991$; $N = 19,403$; $L = 357234$. **G)** Year: 2016; $\Upsilon_{Techmix} \approx -1.19$; $R\text{-squared} = 0.9824$; $N = 19,225$; $L = 361124$. **H)** Year: 2017; $\Upsilon_{Techmix} \approx -1.19$; $R\text{-squared} = 0.9809$; $N = 18,874$; $L = 371052$.

The simulation was also performed at other scales, below it is depicted the results at 3600 sq m and 8400 sq m respectively. The results from the year 2012 appears to have a sudden fall, which means that the power law function does not fit very well, this is also observable on the logarithmic boxplots and histograms which show fat

tails in both sides. Nevertheless, the distribution of the year 2014 at 8400 sq m shows more outliers in the higher regime of the distribution, which is reinforced overtime as in 2017 we observe that the histogram starts to change becoming positive-skewed. This is a sign of self-organization in process, where log-normal distributions of energy production begin to spatially redistribute in such a way, that the values of the lower kernel density values clustered and the hubs start to grow proportionally to their size. An interesting aspect that is worth of noting here, is that the system at larger scales is in phase transition process while at 900 sq m the urban energy system shows signs of fractality. These results give valuable information on the great adaptivity levels of the system to reorganize and cope with change in a relative short period of time. If the trend continues, more recent data would show stronger characteristics of scale-invariance.

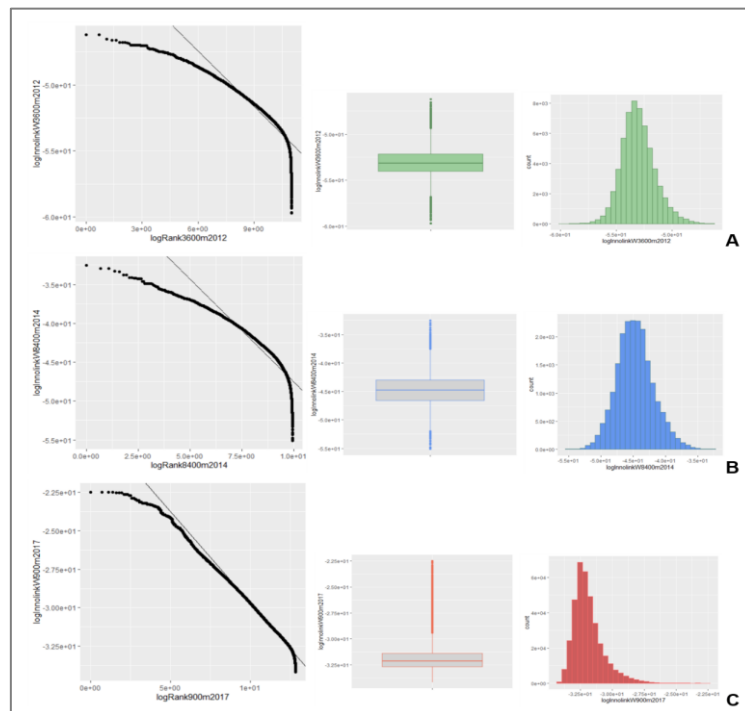

Figure 187 Distribution of the INNOLINKS' weight derived from the SPA model applied to electricity production by wind power, small and big hydroelectric power plants, biogas and solar photovoltaics in the South Region of France. **A)** Data from 2012; Spatial scale: 3600 sq m; $\Upsilon_{Techmix} \approx -1.40$; Adjusted R-squared= 0.8816; N= 1214; L= 58997. **B)** Data from 2014; Spatial scale: 8400 sq m; $\Upsilon_{Techmix} \approx -2.639856$; Adjusted R-squared= 0.8631; N= 1166; L=20707. **C)** Data from 2017; Spatial scale: 900 sq m; $\Upsilon_{Techmix} \approx -1.19$; R-squared= 0.9809; N=18,874; L= 371052.

Another interesting aspect is that here we are analysing several technologies and the self-organization process is observable at smaller spatial scales. In fact, it was the opposite in the Swiss region from an energy demand perspective where the self-organization was observable at larger scales. Therefore, further research is needed from a demand and a supply perspective with one technology indicator and with more than one to draw definitive conclusions.

6.2.3.3 *An application of the Spatial Preferential Attachment Model for Energy Production for Heating Based on a Technology Mix of: Biomass and Solar Thermal Collectors.*

Following the protocol used in the previous section, the diffusion of the energy produced via biomass was aggregated in the same spatial layers with solar TC. The SPA model produces links or spatial corridors of innovation diffusion for this category of RET, whose weights also follow power laws. Figure 188 shows the results of the simulation for the period 2007 to 2017, which show the presence of hubs and positive-skewed logarithmic histograms. The model's capability to capture the spatial dynamics of the energy produced in this category is

explained over 97% each year. For this category, the self-organization nature of the phenomenon seems stable at global level according to the available data.

In this kind of cases the diffusion process might have micro behaviours, which would affect the urban system at a local level in the sense that the emission of the RET diffusion might change locally but at global level the system is resilient. We would argue that in the situations of well-established self-organized processes of RET spatial diffusion, the phenomenon is better understood than those cases where the transition from chaos to order is still shaping. However, with the relatively small amount of data available and the simulations done in both, in the Swiss and French territories the self-organization processes does not seem to need many years.

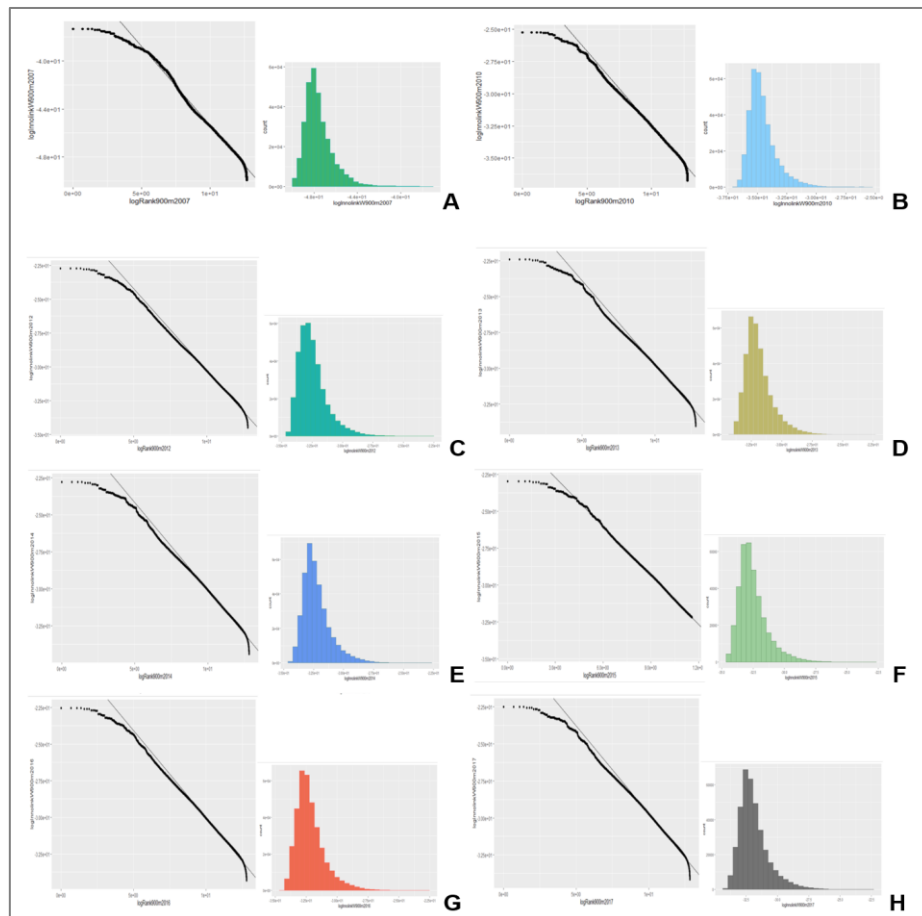

Figure 188 Distribution of the INNOLINKS' weight derived from the SPA model applied to energy production for heating through biomass and solar TC at 900 sq m resolution from 2007 to 2017 in the South Region of France. **A)** Year: 2007, $Y_{SolarTC} \approx -1.183$; R-squared= 0.9746; N=31,109; L= 121084 . **B)** Year: 2010, $Y_{SolarTC} \approx -1.174$; R-squared= 0.9841; N=29,815; L= 628061; **C)**Year: 2012, $Y_{SolarTC} \approx -1.173$; R-squared= 0.9816; N=21,458; L= 65311; **D)** Year: 2013, $Y_{SolarTC} \approx -1.172$; R-squared= 0.9838; N=29,698; L= 499022; **E)** Year: 2014, $Y_{SolarTC} \approx -1.171$; R-squared= 0.9754; N=29,947; L= 463225; **F)** Year: 2015, $Y_{SolarTC} \approx -1.173$; R-squared: 0.9779; N=29,798;N=29,469; L= 346153. **G)** Year: 2016, $Y_{SolarTC} \approx -1.168$; R-squared= 0.9711; L= 392217; **H)** Year: 2017, $Y_{SolarTC} \approx -1.168$; R-squared= 0.9845; N=29,466; L= 390982.

The relative short period of time needed to gestate and trigger the spatial transition towards a fractal structure is also relevant when it is looked in the light of climate change and the environmental goals. The challenge remains on the quantities involved in the transition process, which would satisfy and meet the levels needed for the transition towards a decarbonized society, while considering the demand.

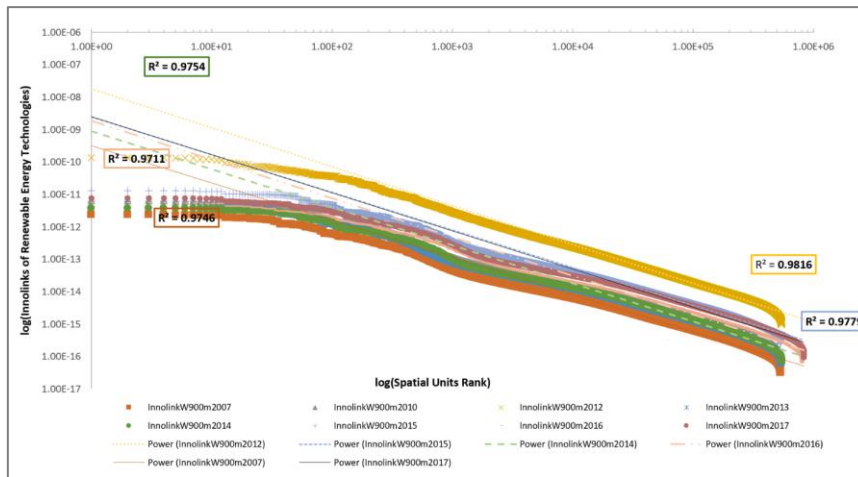

Figure 189 Distribution of the INNOLINKS' weight derived from the SPA model applied to energy production for heating through biomass and solar TC at 900 sq m resolution from 2007 to 2017 in the South Region of France.

The figure above shows the results of the energy produced via biomass and solar TC in the South Region of France from 2007 to 2017, but this time all together. Thus, this figure contains the same data of the previous figure however, it is interesting to observe the similar spatial effects year after year, which implies that the systems should continue growing in the same fashion overtime all other things been equal.

6.2.3.4 An application of the Spatial Preferential Attachment to the Energy Produced for Electricity and Heating Based on a Technology Mix of: Wind Power, Small and Big Hydroelectric Power Plants, Solar Photovoltaic, Biomass and Solar Thermal Collectors.

In this section all the technologies mix: solar PV, solar TC, small and big hydroelectric power plants, wind power and biogas were simulated through the SPA model in function of all energy combined for electricity and heat. In other words, these simulations take into account the whole renewable energy system from a production standpoint. Indeed, the results are remarkably interesting as it appears that the whole system arrives to a dynamic equilibrium, in which the spatial organization plays a central role.

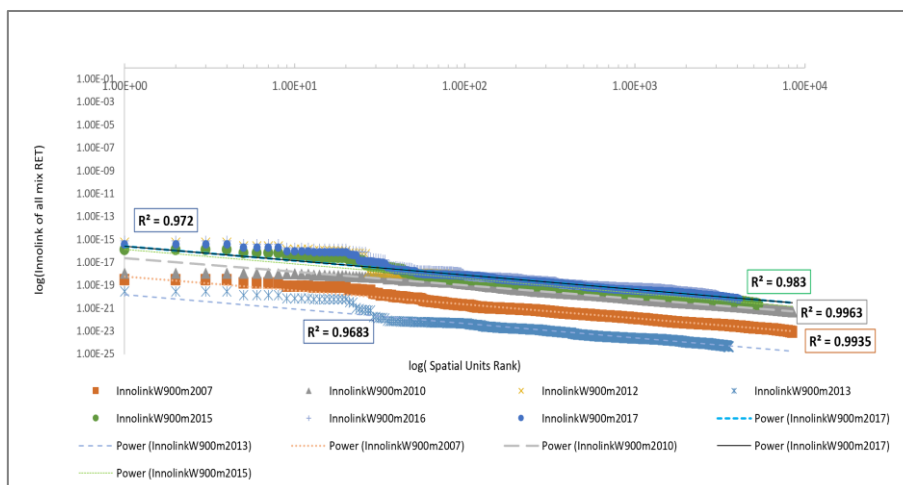

Figure 190 Distribution of the INNOLINKS' weight derived from the SPA model applied to energy production via the mix technologies of: Wind Power, Small and Big Hydroelectric Power Plants, Solar Photovoltaic, Biomass and Solar Thermal Collectors for electricity and heating in the South Region of France from 2007 to 2017 at 900 sq m resolution.

The dynamics of the RET in the South Region of France show a combination of stability and instability in terms of the trajectory, as it is observable a slight leap in the distributions, for example observe the trajectory in green for the year 2012 at 900 sq m in the figure below. The behaviour of the RET diffusion at 900 sq m describes a sudden rupture highlighted with the red square, while the trajectories at 3600 sq m and 8400 sq m the trajectories were stable.

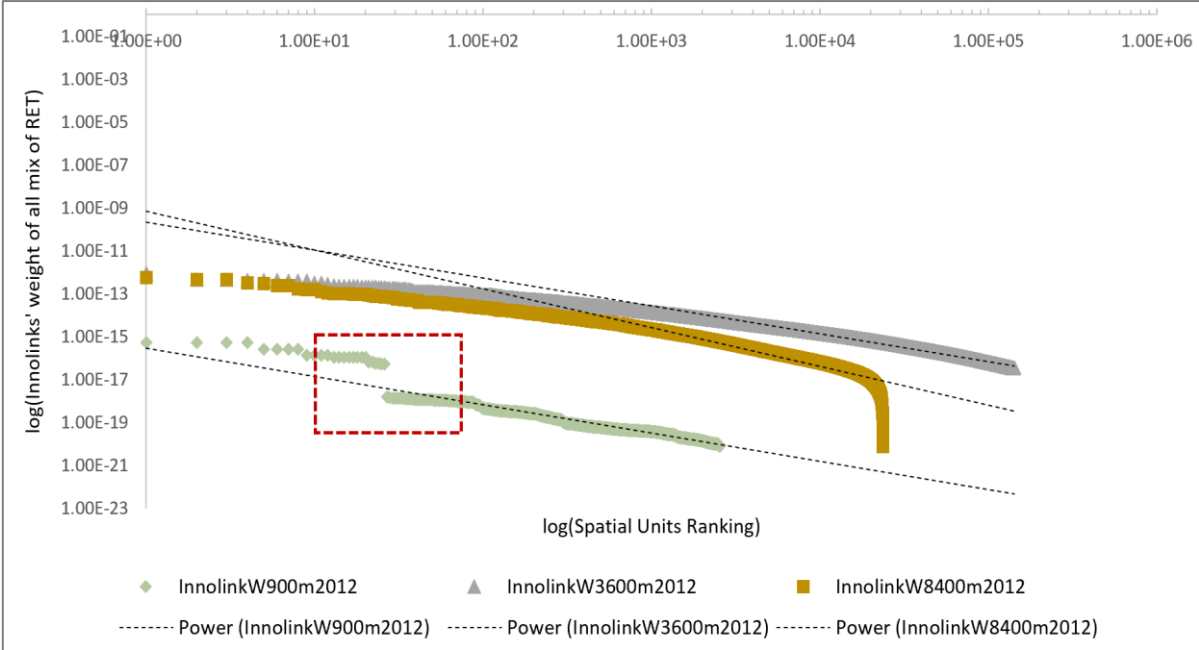

Figure 191 Distribution of the INNOLINKS' weight derived from the SPA model applied to energy production via the mix technologies of: Wind Power, Small and Big Hydroelectric Power Plants, Solar Photovoltaic, Biomass and Solar Thermal Collectors for electricity and heating in the South Region of France in 2012 at 900 sq m, 3600 sq m and 8400 sq m resolution.

These kinds of changes might be unpredictable and in some cases irreversible, which could trigger the disappearance of the systems in a given scale. All these events are also influenced by the inertia or legacy of the system, in which historical movements and trajectories might push the system to a variety of bifurcations. This theoretical concept is in line with the path development theory used by economic geographers, in which a region's trajectory is affected by its past.

Here for example, we can observe that the system continued stable at 3600 sq m and 8400 sq m, while some instabilities occurred at 900 sq m. The figure below shows the right-skewed histograms of the distributions discussed in the figure above as well as the boxplots that exhibit the presence of outliers, which in this context are innovation corridors of RET diffusion with the largest values. Most of the results derived from the simulations in the energy urban system in the South Region of France show signs of self-organization that differ in terms of phase transition maturity. In some cases, scale-dependent fractal dimension patterns are observed and only time will allow to unfold the future trajectories.

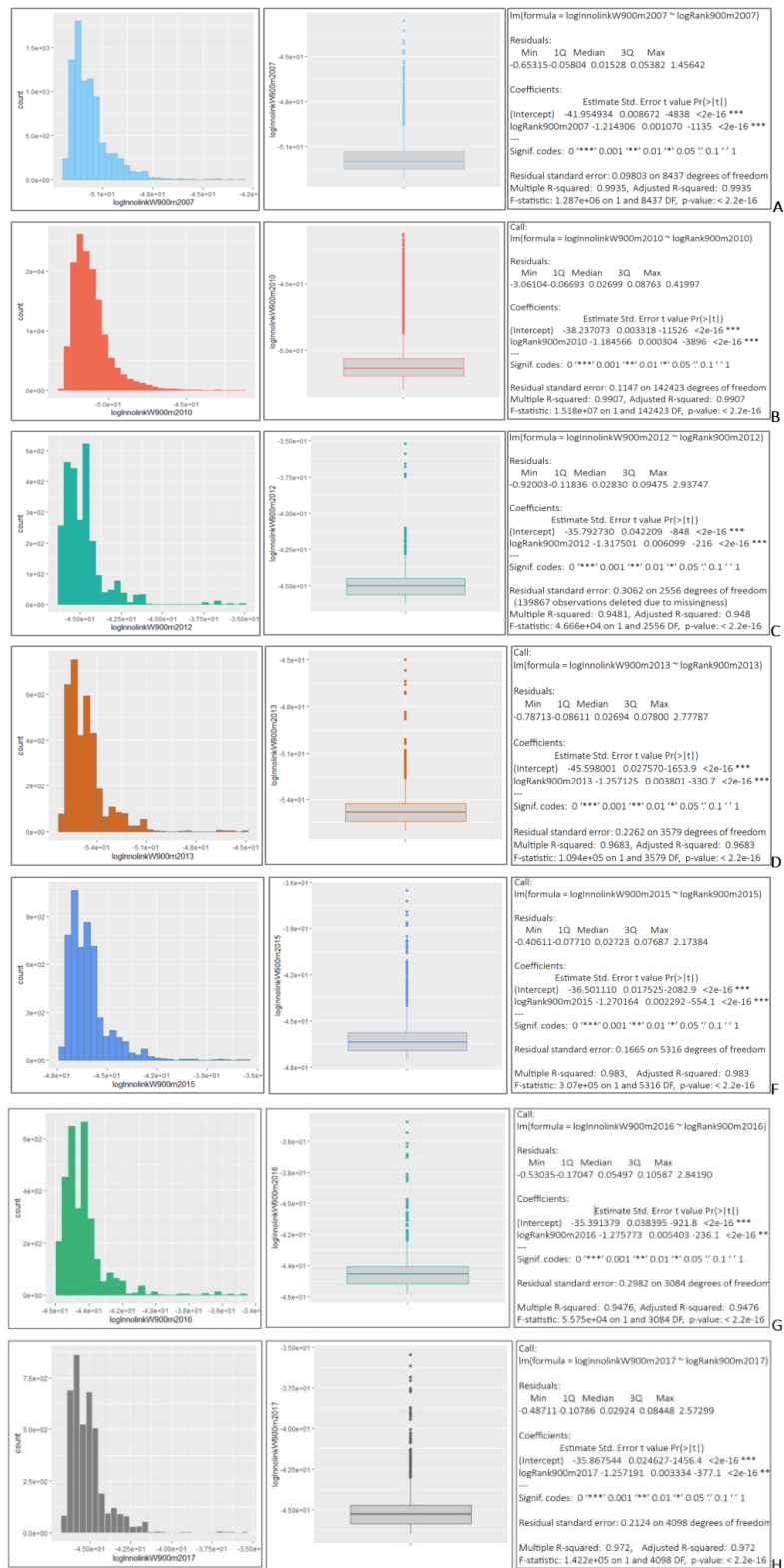

Figure 192 Histograms and boxplots of the INNOLINKS' weight derived from the SPA model applied to energy production via the mix technologies of: Wind Power, Small and Big Hydroelectric Power Plants, Solar Photovoltaic, Biomass and Solar Thermal Collectors for electricity and heating in the South Region of France from 2007 to 2017 at 900 sq m resolution.

The next section will introduce a sensitivity analysis that was performed in order to calibrate the model.

6.2.3.5 Sensitivity Analysis

In order to build the model, it was required to calculate the parameter β from the SPA model (see Figure 150), which is the distance decay parameter that was calculated relying on empirical observations:

$$Innolinks = \left((1 - Dc) KernelPIF \left(\frac{A_j^\alpha D_{ij}^{-\beta}}{n \sum_{j=1}^n A_j^\alpha D_{ij}^{-\beta}} \right) \right) \left(\sum_{pixel=1}^n (KernelSolarPV) \right) \prod_{pixel=1, \dots, z}^n \left[\left(\frac{D_{ij}^{-\beta}}{n \sum_{j=1}^n D_{ij}^{-\beta}} \right) \right] \quad (6.2)$$

The inversed power law exponent plays a major role in the robustness of the model therefore, a series of sensitivity analyses were performed via simulations to determine the best value for the parameter β . In general, the values around -2 performed well nevertheless $\beta = -1.9$ was systematically the best fit for all the innovation indicators in both regions, in Swiss Alps and in the South Region of France, which is suggested to use

Kernel Density of energy production Nodes R ²	Spatial Preferential Attachment Model (Links)	
	β	R ²
0.7819	-2.1	0.98
	-2	0.9808
	-1.9	0.9857
	-1.8	0.9728
	-1.6	0.9639

Table 30 Sensitivity analysis for distance decay parameter in the Spatial Preferential Attachment Model at the spatial scale of 8400 sq m. Mix of renewable energy technologies production for electricity and thermal energy usage in the South Region of France 2007^a

The table above shows the first sensitivity analysis that was developed with the kernel density of the total energy produced in the South Region of France via the mix of all RET to produce electricity and heating. The distribution had an adjusted-R²= 0.7819 with the application of a regression with a power law function. Once the SPA model was applied with different values of β , we observe that the results of the regression with a power law function are very high and $\beta = -1.9$ was slightly better. Although the latter value works really well, it was not always the best for example the results of a sensitivity analysis of the same dataset from year 2010, showed a better performance with $\beta = -2.1$ as it is displayed below.

The simulation generated an adjusted-R²= 0.9832 while with $\beta = -1.9$ adjusted-R²= 0.9650. At these kind of levels of fitness, the improvements are very little however, this information has a special relevance for future research since the development of such simulations are time consuming. Similar simulations were developed with other datasets for other years in other spatial scales as well as in the Swiss region and the results are pretty similar since most of the spatial effects on the diffusion processes are self-organized.

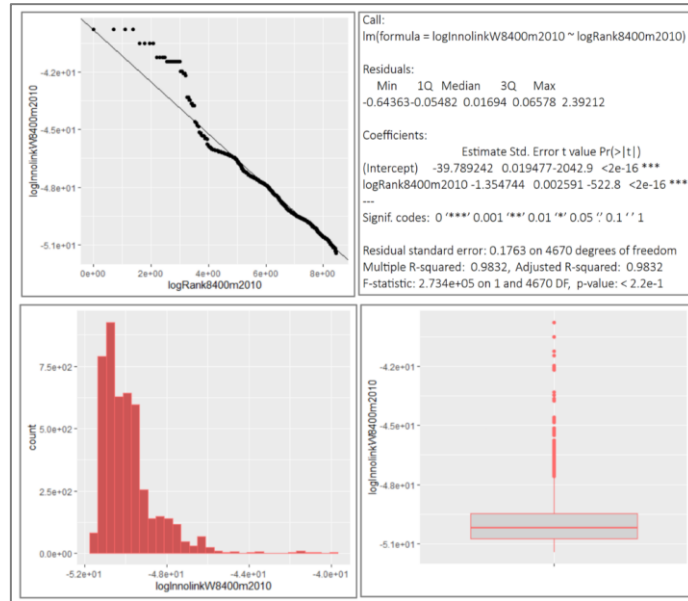

Figure 193 Sensitivity analysis of the Spatial Preferential Attachment model with distance decay parameter $\beta = -2.1$. Applied to the production of electricity and thermic energy with a mix of renewable energy technologies.

6.3 Conclusion Chapter 6

In summary, most of the RET reviewed in this research work exhibit at some degree signs of self-organization, which in some cases i) The renewable energy technologies diffusion is still in a transition process from chaos to order; ii) the renewable energy technologies diffusion exhibit scale-dependence, in which sometimes power laws are observable at smaller spatial scales and larger scales are either in a phase transition or will continue to follow log-normal distributions. Only time will allow to determine the real nature of some distributions at certain scales as the longitudinal study is not done with long periods of time therefore, it is important to be cautious before drawing definitive conclusions regarding the phase transitions. The following chapter will discuss the development of a series of urban resilience to sustainability transition simulations based on the SPA model, where the multiscale spatial analysis will continue.

7 Network Science as a Conceptual Instrument for Urban Resilience to Innovation Diffusion: A Geospatial Simulation for Sustainability Transition

“In the absence of interactions between species, evolution would come to an abrupt halt, or never get started in the first place... How can there be evolution if all things are in equilibrium? Systems in equilibrium by definition go nowhere”.
—Per Bak, 1996

In this part of the study, we will focus on the resilience property of the urban system in the region of Valais. The methodological approach to do this is based on network science, which is aligned to the previous analysis done in Chapters 5 and 6. The conceptual idea is based on the territory of study being an urban network where exchanges of information, people, economic and urban activities take place. The urban network is operationalized via the SPA model (see Figure 150) in which the potential of innovation fields coupled with the actual spatial diffusion of RET typifies the zones of intensive potential creativity. The theoretical developments in which this section is grounded, relies on the literature review on innovation in Chapter 1, on urban systems in Chapter 2, also on urban and regional resilience in section 2.2 and finally on the SPA model introduced in the Valais region in Chapter 5.

7.1 Objectives

The main objective of this section is to develop a model of urban resilience to RET diffusions relying on the previous work regarding RET diffusion. In innovation diffusion processes, there is a descending hierarchical mechanism from an urban structure perspective as it was demonstrated in Chapters 5 and 6, this self-organized process enables central places and more populated areas to profit of higher levels of innovation adoption. Relying on the networks generated with the SPA model, we will simulate changes of the hierarchical levels of the PIF in order to analyse the possible variations in the networks' topology.

The objective in this chapter is threefold: *i)* Observe the variations of the INNOLINKS in terms of diffusion intensity; *ii)* Analyse the spatial consequences of the variations observed in the INNOLINKS and *iii)* Observe if the network keeps the same topology as a scale-free network. With this approach, we will integrate the concept of innovation diffusion specifically applied to RET, having solarPV_{hhw} as innovation proxies. This focus intends to address the issues related to how resilient are the diffusion processes of RET diffusion in urban systems. The link between the concepts of innovation and resilience has not been thoroughly developed and in the sustainability transition context we argue that the analysis of the resilience of diffusion processes of green technology is a relevant topic to investigate. Although there is an important amount of literature about resilience and panarchy in complex systems, in which scale and the relationships across-scales are acknowledge, most studies would not extend beyond description (Allen et al., 2011). Therefore, we intend to narrow this research gap with the model presented here.

7.2 Urban Resilience to Innovation Diffusion: A Simulation on Sustainability Transition.

The diffusion of innovation processes is not static or in a permanent equilibrium as has previously been discussed in the first part of this study, therefore change is an inherent characteristic in such systems. Here we propose to analyse the RET diffusion mechanisms behaviours during continuous changes and eventual strong perturbances by the integration of diffusion and resilience concepts. It appears that change is an inherent feature of spatial diffusion, which implies in itself movement and resilience denotes how systems cope with change or movement. The movement word here applies for the spatial dynamics of the trajectories of information, people, innovations and the interactions between them.

The model focuses on the network's capacity of adaptability to change, to do this we have initially used the data of the yearly distributional changes of RET adoption. This is important as the understanding of distributional changes between close points in time and space all other things being equal. In our view, this typifies historical changes and based on path-dependency theory we could argue that the future changes are partially explained on the historical inertia of the region. These possible changes are the ones expected if a normal trajectory development occurs.

The simulations allow observing the adaptability capacity of the network to the changes that are triggered by the internal mechanisms of the system, creating oscillations with the assumption that they will be absorbed and integrated in the functioning of the system making it stronger. Another kind of change is the one that is unexpected therefore it is not possible to consider the dynamic system taking all other things being equal. In this scenario, an external shock disrupts the path and a reorganization in the system is undertaken. The nature of this reorganization process is the central part of this model. The way how urban resilience to innovation diffusion will be operationalised in this section is based on the simulation of shocks against the urban networks built with the SPA model. The empirical integration of this, is by means of 'attacking the robustness of the network' through the removal of hubs. As an analogy, let's take a system of antennas for telecommunications.

The quality of the systems' signal partially relies on the physical location of the antennas, if one out of three antennas is damaged, the signal quality can be compromised. In the case of RET diffusion process let's take four spatial units, which have been relatively spatially close and also in terms of potential field of innovation. If for some reason the adoption of RET is interrupted in one of the spatial units for example the major hub, this would have consequences not only within its location but will also affect its neighbours. In the Figure 194 we can observe on the top left marked with the letter A, the initial situation of four spatial units that are communicating with each other. Let's take the ordinal number of the spatial units as a hierarchical importance, where 1 is the most important, for instance a hub of innovation and 4 the least relevant. When 1 is removed (top right), the consequences of the diffusion process affect certain components shown in red in C, which subsequently propagates putting at risk of dysfunction the neighbouring components which are connected. The same principle has been used here, where the hubs of innovation are removed followed by the application of the Algorithm 2 to determine the new zones of innovation influence via the INNOLINKS.

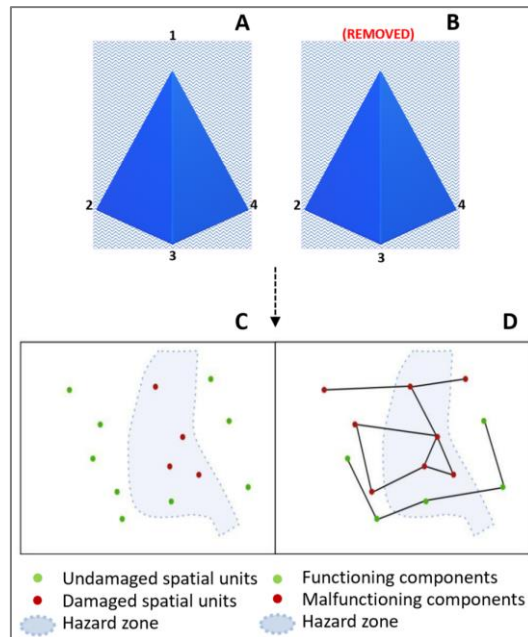

Figure 194 From a discrete innovation interruption towards a continuous innovation blackout. Source: Adapted from Lhomme (2012).

In the figure above in the section D, we can observe a functioning component which contains some nodes in green, meaning that the connectivity for diffusion purposes is still in process after the shock. In graph theory, an important aspect is how nodes can reach other nodes through paths in a given network. This characteristic is fundamental in the interplay of diffusion processes, learning and contagion. By removing a hub of the network, the structure changes as the PIF and the relative kernel density of RET coupled with the distance varies, new relationships are formed. A network (N, g) is path-connected if every two nodes in the network are also connected by some path in the given network. Mathematically this is expressed as (N, g) is connected if for each node $i \in N$ and node $j \in N$, exist a path in (N, g) between nodes i and j .

After the shock simulation a new structure is formed, which leads to the analysis of the resulting network, the focus will be on the changes of the qualitative structure of the social-innovation system from a spatial perspective. Here the qualitative structure refers to the topology of the network for example, would the network become a random or a small-world network? The qualitative structure is an important indicator within the resilience literature, which in the case of graph theory topology is also grounded on quantitative relations between the vertices.

7.2.1 Model

The simulation is based on the SPA application, which is *algorithm 2*, the datasets are the yearly distributional changes of RET adoption. Here we will only present the results from a multiscale spatial analysis of the datasets of the years 2014 and 2015 in the Valais region.

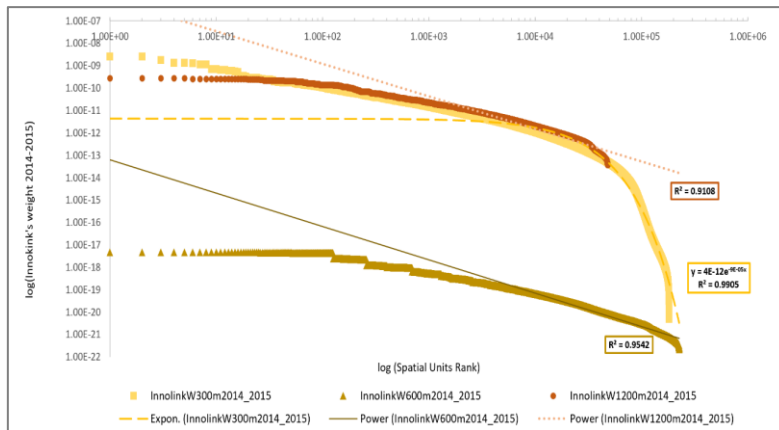

Figure 195 Multiscale Spatial Analysis of the INNOLINKS' weight after a shock. These are the results of the application of the SPA model applied to the distributional change of the solar photovoltaics for heating and hot water between 2014 and 2015 at 300 sq m, 600 sq m and 1200 sq in the Valais region.

The table below shows a summary of statistics, which will be discussed as follows.

Statistics of Innolinks' Weight for years 2014-2015			
Statistical parameters	300 sq m	600 sq m	1200 sq m
Power Law Exponent	N/A Power law	0.9542	0.9108
Adjusted R-squared	N/A Power law	-1.489	-1.452
Pr(> t)	N/A Power law	<2e-16 ***	<2e-16 ***
Mean	5.79887E-13	1.8457E-20	2.9361E-12
Standard Error	3.1068E-14	2.7786E-22	5.6414E-14
Median	1.81525E-15	2.45E-21	5.89E-13
Mode	6.52795E-13	1.04E-21	1.04E-12
Standard Deviation	1.3214E-11	1.32031E-19	1.234E-11
Sample Variance	1.7461E-22	1.74323E-38	1.5227E-22
Kurtosis	20232.91224	726.2899175	198.188907
Skewness	125.0773827	24.28327657	12.5340481
Range	2.57158E-09	4.62978E-18	2.7196E-10
Minimum	4.8733E-21	2.22E-22	3.67E-14
Maximum	2.57158E-09	4.63E-18	2.72E-10
Sum	1.04902E-07	4.16738E-15	1.4048E-07
Count	180901	225789	47846
Largest(1)	2.57158E-09	4.63E-18	2.72E-10
Smallest(1)	4.8733E-21	2.22E-22	3.67E-14
Confidence Level(95.0%)	6.08926E-14	5.44599E-22	1.1057E-13

Table 31 Statistics of Multiscale Simulation for Resilience to Renewable Energies Diffusion for the year 2014 and 2015 in the Valais region.

In order to facilitate the readability of the following analysis, the spatial analysis at 300 sq m will be developed first, as for the analyses at 600 sq m and 1200 sq m the analysis will be done together afterwards. The reason to do this, is because at 300 sq m the diffusion changes of solarPV_{hww} do not follow a power law, while it does at 600 sq m and 1200 sq m respectively.

7.2.1.1 Urban Resilience to Renewable Energy Technologies at 300 Square Meters: Size Matters.

Figure 196 shows the results of the resilience simulation for SolarPV_{hww} at 300 sq m, these results resonate with the behaviour of the solarPV_{hww} analysed in section 5.5.2.2, it is therefore suggested to take a look to Figure 144, which showed that the spatial density of SolarPV_{hww} exhibit a scale-dependent fractal dimension. The histogram of solarPV_{hww} exhibits a double-peaked or a bimodal histogram, which might be explained by the dual nature of the indicator solarPV_{hww} = solarPV_{heating} + solarPV_{hotwater}. Each peak of adoption is related to one of the latter technologies, as some end users adopt first or in bigger quantities one of the two technologies in different points in time and space. It is observable that the power law does not fit well, as a matter of fact, the distribution at 300

sq m is fitted by an exponential function (see Figure 196). Furthermore, the boxplot with logarithmic transformed data does not exhibit outliers, as the distribution is only a slightly over the centre of the box. The hypothesis in this case is in line with the argument discussed in section 5.5.2.2, where the integration of more than one innovation indicator has delay effects on the self-organization process at smaller scales. However, we do not know yet, which are the drivers that cause these responses. The simulation showed a spatial reorganization of the hubs in the systems, which has major implications in the structure and topology of the network. The results showed that at a 300 sq m, the spatial location of hubs would change and taking with them their effects after the shock. This means that a location an innovation hub of 300 sq m of surface might be displaced and adopt an innovation level similar to the levels observed in the low regime of the network.

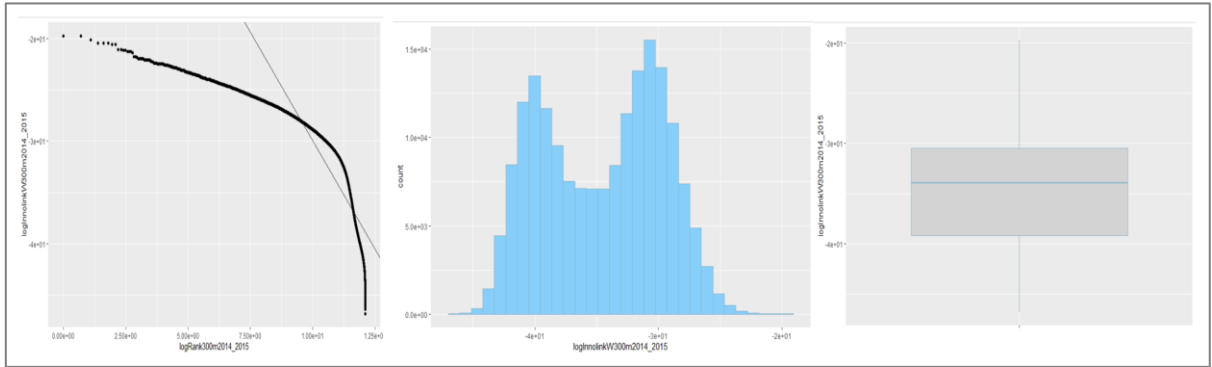

Figure 196 Distribution of the INNOLINKS' weight after a shock at 300 sq m resolution for the years 2014 and 2015 in the Valais region, Switzerland.

It is interesting to observe the results of the resilience simulation in the light of historic data. Below it is displayed the kernel density of solarPV_{hhw} from years 2009 and 2015 respectively. The distributions of kernel density in 2009 and 2015 at 300 sq m show an important evolution, it appears that the distribution is changing and tends to become heavy-tailed, all other things being equal. Nonetheless, the distribution in 2015 seems to be still in a transformation process as it is left-skewed, unless its counterparts at 600 sq m and 1200 sq m (see Figure 198) that are ahead in the process with more pronounced right-skewed distributions. The cause of this seems to be that the kernel density of solarPV_{hhw} is bounded by lower values, this is visible in the logarithmic transformed boxplot. These lower values are partly responsible of the delay in the self-organization process.

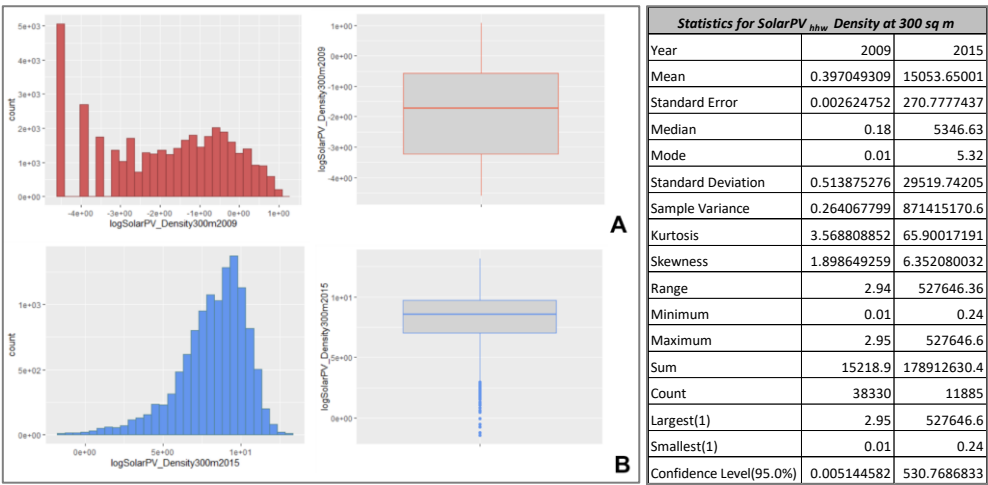

Figure 197 Kernel density of solar photovoltaics in 2009 and 2015 at 300 sq m resolution in the Valais region, Switzerland.

The values for 2009 apart of being lower in terms of density, the standard error was very small in comparison to 2015, which can be visually detected in the histogram. The kurtosis in 2009 is close to the value of a normal distribution, while in 2015 the value corresponds to a distribution that tends to have outliers or is heavy tailed.

The data available at the moment when this dissertation was prepared, suggests that the spatial effect at this scale is not fractal. Therefore, after the simulated shock the microscopic behaviour entailed changes in the position of the hubs, which implies that their influence for diffusion purposes would disappear and change the qualitative structure of the network. The spatial effect, which is the importance of the spatial component in the development of activities in a system (Coquillard et al., 1997) allows to observe a bifurcation that takes place at local level. This implies a change in the location of solarPV_{hwh}. This might not have important impacts at global level as it will be discussed as follows however, at small scales the effects are not negligible. A further discussion will be developed after the analysis of the simulation at 600 sq m and 1200 sq m respectively in the next section.

7.2.1.2 Urban Resilience to Renewable Energy Technologies at 600 and 1200 Square Meters: Where Fractality Begins.

Now let's take a look at the results of the simulation at 600 sq m and 1200 sq m respectively, which were approximated by a power law function. Here we can observe an interesting effect on the bimodal histogram, it seems that the double-peaked distribution has been clustered to the left, meaning that they are right-skewed. The changes induced by the shock at these spatial scales seem to be better absorbed by the system as the distributions' frequencies continue to behave in a self-organized fashion. The spatial distribution of the PIF is maintained and the topology of the network remains unchanged, which are signs of resilience. These results are aligned to the discussion in section 5.5.2.2, where the distributional changes at 600 sq m and 1200 sq also exhibited power laws. Therefore, the simulation shows that at larger partial scales, the system is able to reorganize itself. We do not know why these discontinuities are present in the system nor which are the drivers generating such effects. The hypothesis that we propose here relies on the arguments stated in section 5.5.2.2

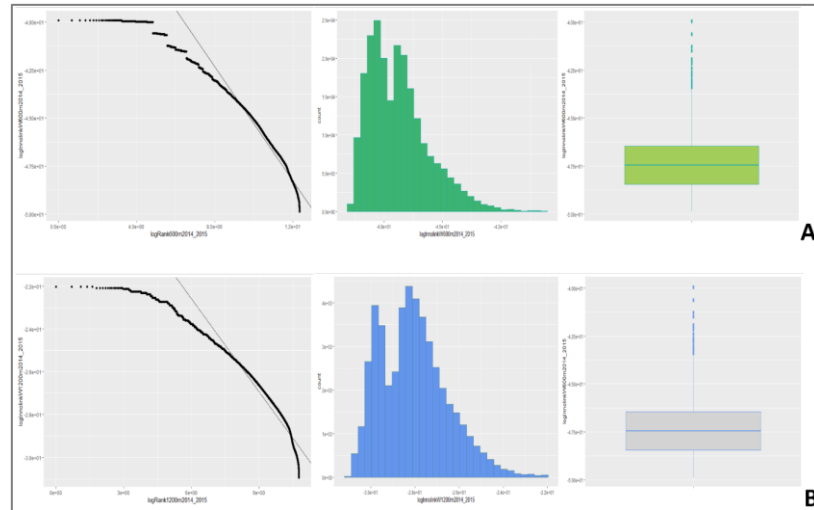

Figure 198 Distribution of the INNOLINKS' weight after a shock. for the years 2014 and 2015 in the Valais region. A) spatial scale: at 600 sq m. B) Spatial scale: 1200 sq m.

The historic data shows that the spatial kernel density of solarPV_{hwh} in 2015, had slightly started to be right-skewed and additionally the SPA model shows unambiguously the presence of hubs (see section 5.5.3.1).

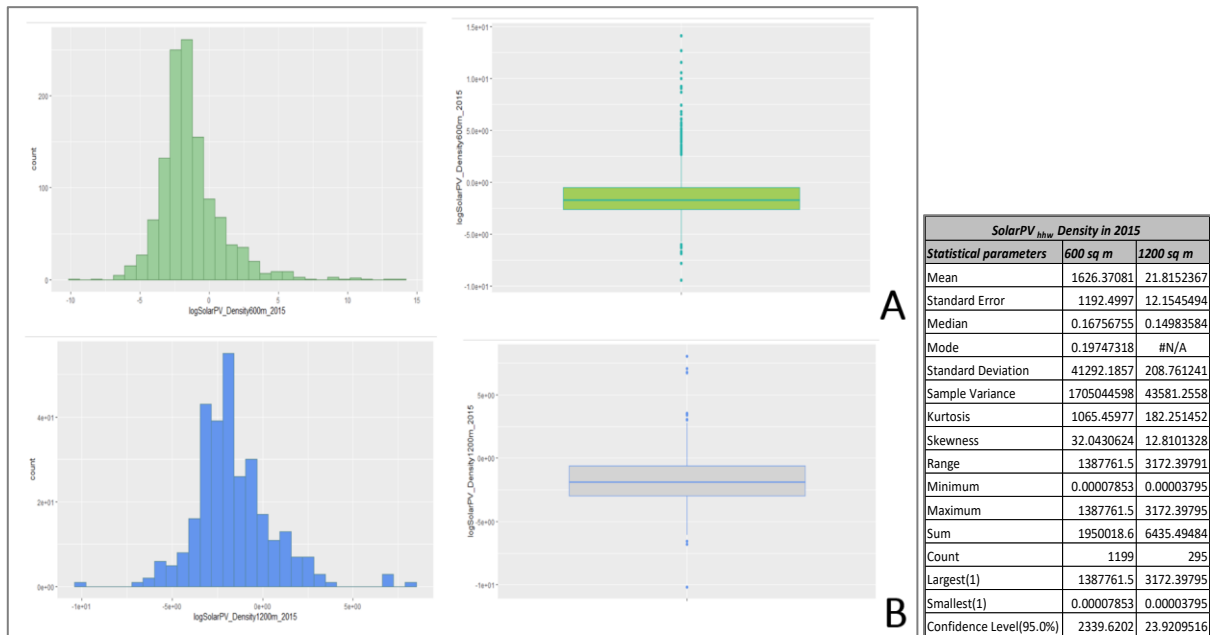

Figure 199 Kernel density of solar photovoltaics in 2015 at 300 sq m and 600 sq m resolution in the Valais region, Switzerland.

In order to validate the results obtained with larger spatial scales, we developed a second simulation. This time, a shock was simulated by removing the larger hubs according to the values in the power law applied to the delta of kernel density of solarPV_{hhw} between 2014 and 2015. Here, the underlying idea is the same, it is to observe the urban network's ability to cope with change by altering the structure through simulating modifications of certain hubs values which are sensitive points of the network.

We have the assumption that such modifications would not generate a different topology in the network at 600 sq m and 1200 sq m given the fractal nature of the system in those scales. These simulations were not done at 300 sq m since the first trial of removing only the major hub showed severe changes hence, it was not necessary to increment the intensity of the shocks. The simulations will be performed in three different ways as follows:

- i) Model A: Removal of nodes $x \geq 0.23$; they represent 0.6% of spatial units containing 18.7 %.
- ii) Model B: Removal of hubs in the interval $0.23 > x \geq 0.20$
- iii) Model C: Removal of hubs in the interval $0.20 > x \geq 0.18$. Thus, in total 29 nodes were removed in this dataset in three different steps as it is shown in the table below.

Readers are referred to the Table 32 in order to see the three groups of hubs chosen to be removed to perform the simulations.

Observation	Delta of Kernel Density of SolarPV _{hub} 2014-2015	POINT_X	POINT_Y	LONG	LAT
1	0.23	2583166.335	1117013.335	7.221454285	46.20559863
2	0.22	2583166.335	1118213.335	7.221411012	46.21639459
3	0.22	2581966.335	1117013.335	7.205904886	46.20556752
4	0.22	2584366.335	1117013.335	7.2370037	46.2056276
5	0.22	2583166.335	1115813.335	7.221497541	46.19480268
6	0.22	2584366.335	1115813.335	7.237043873	46.19483165
7	0.21	2581966.335	1118213.335	7.205858529	46.21636347
8	0.21	2584366.335	1118213.335	7.236963512	46.21642356
9	0.21	2581966.335	1115813.335	7.205951226	46.19477158
10	0.2	2585566.335	1117013.335	7.252553131	46.20565443
11	0.2	2585566.335	1115813.335	7.25259022	46.19485847
12	0.2	2583166.335	1114613.335	7.22154078	46.18400674
13	0.19	2583166.335	1119413.335	7.221367721	46.22719055
14	0.19	2584366.335	1119413.335	7.236923307	46.22721953
15	0.19	2585566.335	1118213.335	7.252516028	46.21645039
16	0.19	2580766.335	1117013.335	7.190355506	46.20553427
17	0.19	2581966.335	1114613.335	7.205997547	46.18397565
18	0.19	2584366.335	1114613.335	7.237084029	46.1840357
19	0.18	2581966.335	1119413.335	7.205812152	46.22715943
20	0.18	2580766.335	1118213.335	7.190306064	46.21633022
21	0.18	2580766.335	1115813.335	7.190404929	46.19473834
22	0.17	2585566.335	1114613.335	7.252627295	46.18406252
23	0.16	2580766.335	1119413.335	7.190256602	46.22712616
24	0.16	2585566.335	1119413.335	7.252478909	46.22724637
25	0.16	2580766.335	1117013.335	7.268102577	46.20567911
26	0.16	2580766.335	1115813.335	7.268136583	46.19488315
27	0.16	2580766.335	1114613.335	7.190454333	46.18394241
28	0.16	2583166.335	1113413.335	7.221584002	46.17321081
29	0.16	2584366.335	1113413.335	7.23712417	46.17323976
30	0.15	2583166.335	1120613.335	7.221324414	46.23798652
31	0.15	2584366.335	1120613.335	7.236883087	46.2380155
32	0.15	2580766.335	1118213.335	7.268068558	46.21647508
33	0.15	2579566.335	1117013.335	7.174806146	46.20549888
34	0.15	2581966.335	1113413.335	7.20604385	46.17317972

I'st tier distributional change (of hubs)

II'nd tier distributional change (of hubs)

III'rd tier distributional change (of hubs)

The rest of nodes (not hubs)

Table 32 List of hubs for the delta distribution of solar photovoltaics 2014-2015.

The criterion to choose the nodes to be removed was based on their value, which is also visually detectable, as it is shown in the red rectangle in the figure below.

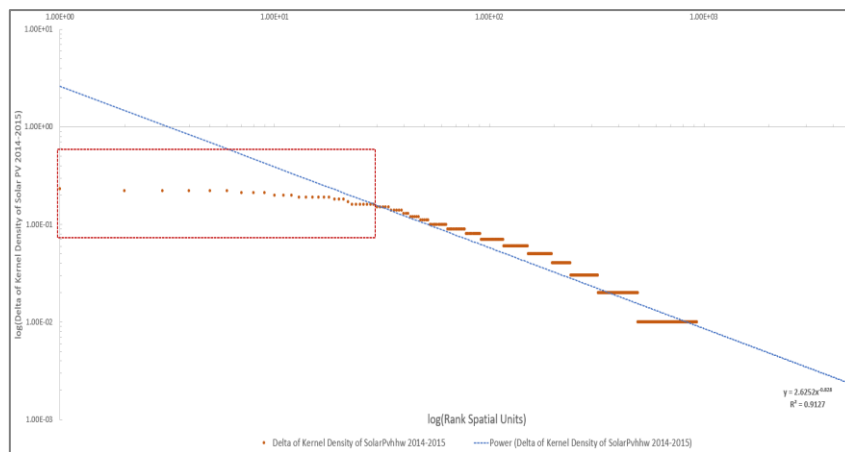

Figure 200 Hubs selected for removal to simulate the resilience of the innovation system.

The distribution change is approximated by a power law with $\alpha = -0.828$ and $R^2 = 0.9127$, the sublinear values of α are assumed to have a critical position in the network and consequently in the spatial diffusion process. The 'inflexion' point between sublinear and superlinear values in the figure is 0.15, therefore the values above this threshold will be affected and the algorithm used for the innovation diffusion will be applied to generate new links between the nodes. This is thus, a new set of rules for link generation in order to investigate how the distributional changes of innovation adoptions is affected and if is the case that the properties of scale-free networks would

change of regime. The results of the three models are quite robust and clearly depict power laws. These simulations' results that the system holds a self-organization process at 1200 sq m even under extreme shocks.

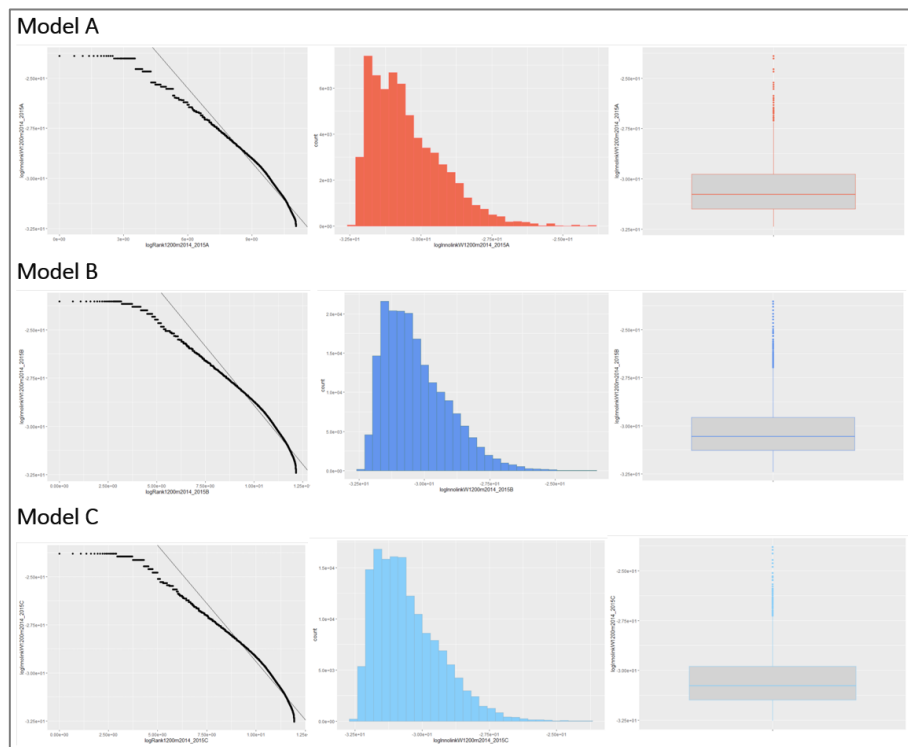

Figure 201 Simulation of shocks to slow down the diffusion of solar photovoltaics in the Valais region. Model A) Adjusted R-square= 0.9663 Model B) Adjusted R-squared = 0.9583. Model C) Adjusted R-squared = 0.9583.

Within the field of ecological science, scholars have developed statistical methodologies in order to spot early warning-signals for critical transitions. Unfortunately, the dataset provided by FSO only had seven data points timewise, that is 2009–2015 so the amount of data was not enough to apply methods such as the one proposed by Scheffer et al., (2009) or Nijp et al., (2019). By following this procedure, we found a recurrent fractal mechanism that repeats itself and tends to infinity (see Dauphiné, 2013). Nevertheless, it was necessary to do this analysis since the continuous fractality from a probability perspective does not implies that the new hubs would be located in the same areas given the new redistribution of the weights. The results are systematically aligned with the findings on section 7.2.1.2, which leads us to the final discussion.

7.3 Discussion: Resilient Systems are Fractal, but is Really Resilience Fractal?

The objective with the resilience model carried out above is not to measure resilience levels, since there is not yet a scientific consensus on how to do it, the goal is rather to investigate how the changes affect the global and the local levels of the system. From a spatial perspective, self-organized systems follow general behaviours such as the emergence of global order derived from local interactions. According to the resilience definition in ecology, resilient systems are able to absorb, adapt and are self-organized. In the same line of thought, fractality is a typical signature of self-organization, where hierarchical and multi-level organization can be observed at several spatial levels. These concepts are shared by urban structures (Pumain et al., 2006) and the findings of this research suggest that RET diffusion belongs to this category, therefore the concept of resilience here is analysed through

the lenses of self-organization. The application of network science through the SPA model to determine the resilience to RET diffusion in the region of Valais is a proposal to quantitatively analyse if a territory shows signs of resilience and if so at what spatial scales. The results at 300 sq m are interesting in the sense that they show a disruptive behaviour within the self-organization process at larger spatial scales. At the same time, it was observed that for an urban system to adopt two innovations allegedly requires more time first, to adopt and second to absorb possible shocks without changing its qualitative structure. The differences on the resilience levels to sustainability transition from a spatial perspective implies that policies need to be tailored and accordingly adapted.

While these mechanisms occur at 300 sq m, the system is still very resilient at 600 sq m and 1200 sq m, keeping stable the RET spatial diffusion at global level. These findings suggest that sustainable development strategies should not be applied across regional scales under a 'one-size-fits-all' reasoning. A fundamental issue here is that while self-organization is a property present in resilient systems, it does not mean that resilience itself is fractal according to this study, since the capacity of self-organization of the system varies with the spatial scale. Further research in this direction is needed to confirm the results obtained in this analysis. The idea of resilience not being fractal though is not new, it has actually been approached through discourse analysis, but to our knowledge it has not been proven through empirical approaches. French economist Olivier Godard (1996) criticized the following line of thought:

"Sustainable development implies adopting the same approach at the different territorial scales (global, continental, national and local): respecting the ecological carrying capacity of the environment at the territorial level under consideration". Godard argued that ecological constraints make sense at global level, while at other level the interactions, exchanges, substitutions and imbalances are relative to their own scale. This entails that the transposition of the same reasoning across scales has not meaning, since in that sense sustainable development is not 'fractal' and nonadditive (see also Godard, 1984). Within the same reasoning perspective in a more recent contribution, Voiron-Canicio & Garbolino (2020) agreed with Godard and added that the systemic complexity embedded in sustainable development is a major notion of multi-level interactions that requires to be taken into account.

The empirical studied achieved in this dissertation showed a variability of RET diffusion from a spatial scale perspective, which implies that there are different regimes, in which phase transition occurs near a critical point. In ecology these critical points are called thresholds, which is a point where disruptive shifts occur regarding the quality, property or phenomenon of an ecosystem, or also where small changes generate large responses. The discussion on the resilience model's results will continue under the framework of panarchy theory in the following section.

7.3.1 Bridging Sustainability Transition Pathways and Resilience Modelling

The simulations developed above give an important framework for real-world applications of resilience to sustainable innovation diffusion. Within the urban theory field, scholars have proposed to look at cities' levels through the prism of panarchy⁷¹, since the cohesive property between levels are shared by the two approaches. Based on the results of the simulation in the previous section, one of the properties that might have emerged is resilience, via the interactions from a multilevel perspective, which lets to connect adaptive cycles in a nested hierarchy fashion (Angeler et al., 2016). Based on this theoretical approach and the results obtained here,

⁷¹ Panarchy theory was introduced in section 2.3.4

resilience could be the fundamental driver that regulates such adaptive cycles of nested hierarchies in the diffusion of Solar PV as a result of inter and intra exchanges and urban processes.

If we accept this conceptual idea, under a network approach it was observed at scaling behaviour at 600 sq m and 1200 sq m with a spatial discontinuity at 300 sq m, where the Solar PV diffusion seems to be delayed in terms of self-organization. According to Rozenblat (2010; Rozenblat & Rogov, 2018) the intra and inter urban processes at micro, meso and macro levels describe the same networks, while exhibiting different processes at each level. The evolution of the innovation system embedded in RET diffusion seems to be unfolding timewise, therefore the description of same networks at all levels might be under way. Within this perspective and with the results available will try to bridge the gap between sustainability transition and resilience modelling, taking panarchy as a conceptual framework. With the state of this research is not possible to develop the full integration of panarchy however, we think that it is relevant to argue that the current state of the art allows to describe the proximity between the results and the panarchy theory.

Panarchy theory has been gaining relevance as a framework to improve our understanding on ecosystems connected with social-ecological systems and governance (Allen et al., 2011). According to the three dimensions of the panarchy theory, the network approach is suited to provide information about *i) the inner system's potential for change, ii) the connectedness of the system and its flexibility or rigidity from a spatiotemporal perspective and finally iii) resilience* (Gunderson & Holling, 2002; Nash et al., 2014). The results of the previous section showed the potential for change of the spatial network at 600 sq m and 1200 sq m respectively. Furthermore, the connectivity of the network remained, keeping the same topology at the spatial scales mentioned above. The flexibility of the systems is represented by the appearance of new hubs in new locations, which entails that the system is able to reorganize itself, which is an inner property of resilient systems.

The linkage of change and adaptation to novelty with resilience as it happens in innovation diffusion processes may be seen through the prism of panarchy theory, which is used in ecological studies. The non-linear behaviour of ecological, social systems and both combined, the cross-scale feedbacks within such structures and the nested adaptive cycles gives a framework to panarchy. According to the authors of the theory (Gunderson & Holling, 2002), panarchy can describe how complex systems for instance, composed of people and natural resources are dynamically structured and organized across spatiotemporal scales.

As it was discussed in this dissertation in Chapters 5 and 6, it appears that the adaptive processes of social systems to sustainability transition under the umbrella of RET diffusion, follow these behaviours. The emphasis done by the panarchy conceptual model is to understand ecosystem dynamics through hierarchical structuring (Allen et al., 2014). The latter authors proposed an application of the panarchy theory where time and space scales are two major drivers of the dynamics of complex ecological systems. The interesting aspect of this theory for this dissertation is that it relies on the resilience property. In the figure below, an example is derived from an ecosystem where the smallest spatial scales are described at the size of a tree's leaf or a needle, that is in centimetres. They would grow from centimetres to meters in a question of months to years, while a tree scale range would be measured between years and decades and a forest would be measured at decades and centuries scale range (see Figure 202A). In Figure 202B we observe a similar example of the application of the panarchy, it shows the changes of body mass distributions of resident animals in an ecosystem, where an aggregation of body mass distributions is observed and are scale-dependent and separated by discontinuities.

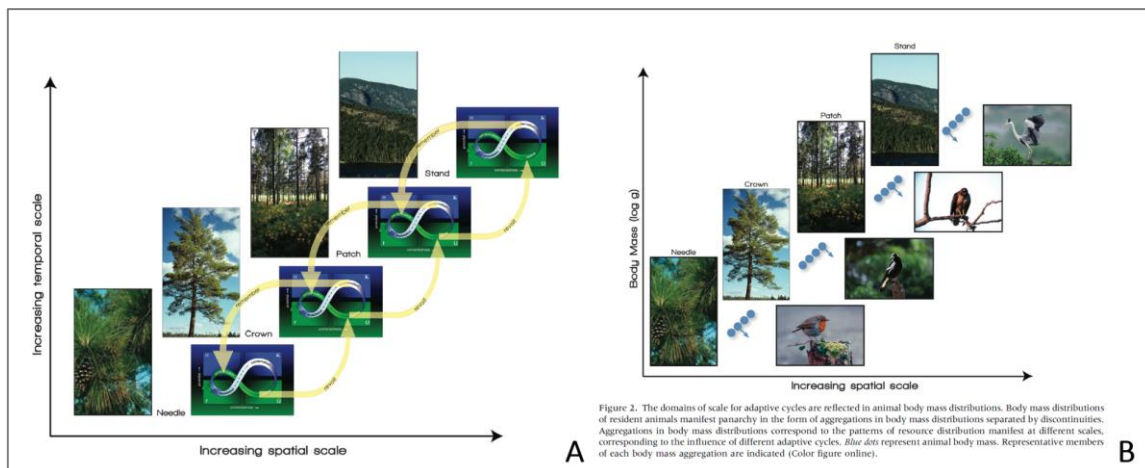

Figure 202 A) Relationship between scales of ecological structure and the nested adaptive cycles comprising a panarchy for a pine dominated ecosystem. Where r = growth; k = conservation; Ω = release; α = reorganization. Source: Adapted by Allen et al., (2014) from Holling (1986). B) Domains of scale for adaptive cycles in ecosystems. B) Domains of scale for adaptive cycles in energy transition. Source: Allen et al., (2011).

In the context of this research dissertation, by analogy the domains of scale for adaptive cycles in ecosystems might resemble those of sociotechnical systems. While dealing with kernel density of solar PV, the data available was only the number of Solar PV and not the quantities of consumed energy therefore further analyses were not possible. Nevertheless, with this information that is rather limited, it was possible to determine the discontinuities in terms of self-organization processes.

In the case of solar PV, the panarchy approach should be understood under the top-down view, where the self-organization process unfolds with the increase of spatiotemporal parameters therefore, the fractality property starts at global level and descends toward local levels. These patterns of 'fractality diffusion' have been reported in various systems (Queiros-Condé et al., 2015). The panarchy theory resonates with the diffusion process, in this case of solar PV in the sense that it is intrinsically related to change and connects the social diffusion of innovation across spatial scales in adaptive cycles hierarchical nested (Allen et al., 2014). In the figure below we observe that when time increases the self-organization process of solar PV diffusion develops from larger towards smaller scales. Within the panarchy paradigm, levels are affected by spatiotemporal drivers, which subsequently are represented the adaptive cycles.

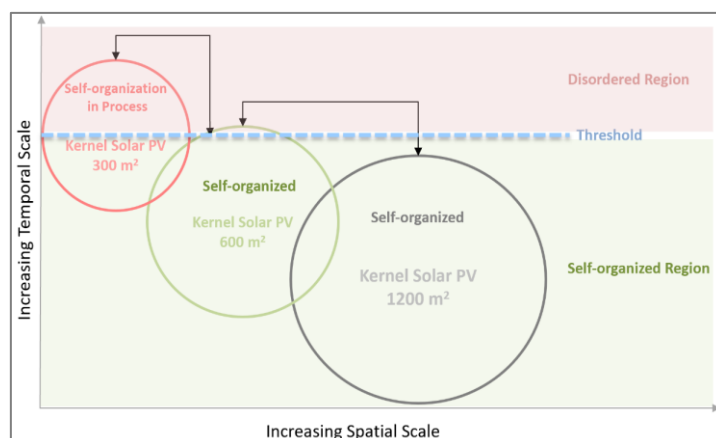

Figure 203 Towards an Evolutionary Perspective of Sustainability Transition. Top-down representation of the evolution of the self-organization levels of the spatial diffusion of solar photovoltaics in the Valais Region in 2015.

The interaction across scales between living elements (people) and not-living elements (solar PV) of the system, which drive different processes and patterns would be reinforced by positive feedbacks that allow the system to grow. Therefore, panarchy theory seems to be an appropriate approach to contribute to the resilience thinking and transformative approaches in environmental risk management and sustainability studies (see Angeler et al., 2016). Panarchy has been applied to determine threshold and opportunities regarding the interactions from a scale perspective (Van Apeldoorn, et al., 2011). This is relevant for this research as the observations in the behaviour of solar PV_{hhw} diffusion exhibited a threshold and a phase transition from disorder to order. Although the concept of threshold has been acknowledged as an insightful and efficient approach to deal with the depletion of natural resources and the environment, its non-linear behaviour and its characteristic complexity makes difficult its application.

Another aspect that makes difficult its usage is the challenging task of determining for example the critical pollutant quantities and the ubiquity of other threshold-based environmental troubles (Groffman et al, 2006). The limited usage of thresholds to approach environmental challenges has raised the question if that is a theoretical framework that helps to understand the functioning of ecosystems at all. The emergence of the so-called adaptive management adopted the threshold theory to solve practical problems however, it was found that the solutions must be tailored and re-evaluated on the basis of the ecosystem's response to adaptive management measures (Walters, 1986).

Apart of these challenges, it is important to highlight the formidable contribution of threshold analyses, as it was stated by Allen et al., (2011) “ *...Identifying thresholds (Groffman and others 2006), either between regimes in a system or between ranges of scale, allows for the identification of management intervention points, those points in the adaptive cycle where a transformation may most easily be implemented. The identification of the scales of structure present in a system therefore is non-trivial and has important implications for understanding the resilience of systems*”.

Groffman et al., (2006) discussed about the three applications of thresholds in ecology and identified methodologies to investigate them, where they defined the scope of ecological threshold based on three approaches: i) *Analysis of “dramatic and surprising” shifts in ecosystems states, where a small change at local level in a driver generates important changes in the ecosystem, ; ii) Determination of the critical pollutant loads that an ecosystem can absorb without changing of state or in determined function of the ecosystem and iii) The investigation of “extrinsic factor thresholds”, where a change in a parameter at a global level alters the relation between the drivers and responses at local level.*

In spite of the difficulty on the application of thresholds, it appears to be an important approach that can be applied in sociotechnical systems as the one studied in this dissertation. The underlying idea with this theoretical framework, is to determine the scale at which changes of the RET diffusion patterns occur. In sociotechnical systems in this case RET diffusion, thresholds and phase transitions can be identified as a phenomenon that is also observed in other fields such as physics (Kadanoff, 1993; Wilson, 1971a, 1971b), ecology (Holling, 1973; Groffman et al., 2006) and complex networks (Barabasi, 2002, 2016).

Hence, this behaviour is not new in science however, a research question emerges, in the late 1960's and early 1970's while physicists were trying to understand why water freezes and how magnets work, the renormalization group theory and scaling properties were discovered. Physicists observed that near the critical point, order emerges from chaos and the quantities of reference follow power laws, exhibiting a self-organized behaviour. However, is not clear the meaning of these phase transitions in complex networks (Barabasi, 2002) and now we propose the same research question in our context: what kind of spatial transition is taking place in renewable energies diffusion? This presents a new research direction. Relying on the results of the simulation in the previous section is not possible yet to evaluate the phases of the four panarchy theory however, the processes of exploitation, conservation, decline and reorganization, theoretically can be taken from an innovation perspective.

Assuming that an innovation ecosystem is structured in a dynamic and adaptive manner, is possible to draw a parallel with natural ecosystems as it was recently proposed by Boyer (2020).

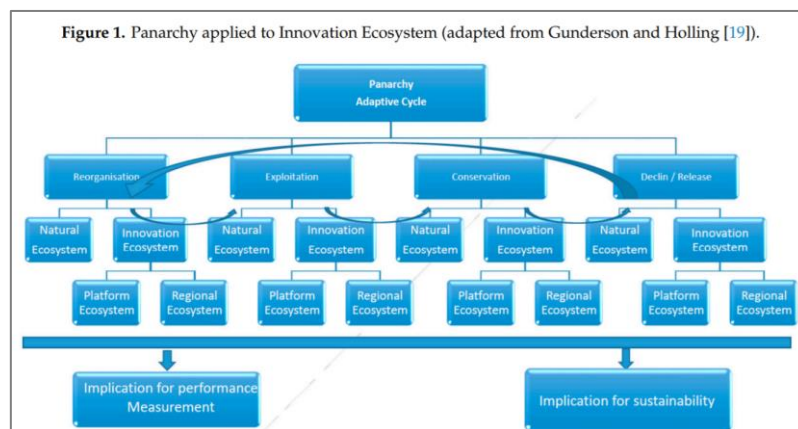

Figure 204 Method of the panarchy model application to main cases of innovation ecosystems. Source: Boyer (2020), adapted from Gunderson & Holling (2002).

To operationalise such a model for example in the particular case of solar PV, it would be suitable to have the consumption levels of RET and not only the location of the technologies. The kernel density of the consumption from a spatial perspective can be used as it used with ecosystems. Within the field of aquatic ecology, it has been used the KDE to observe the discontinuities of the pelagic specie and estimate size distributions in lakes on the basis of their body mass (see Havlicek & Carpenter, 2001). In the case of energy systems, we would be interested in the spatial patterns and size distributions of the energy consumption to deploy a similar approach.

The resilience of the system depends on the spatiotemporal phase in which the multilevel adaptive cycles are at ($growth = r$, $conservation = K$, $release = \Omega$ and $reorganization = \alpha$) and the connections between them. Relying on the simulation performed here and based on the self-organization mechanisms the higher levels of resilience are at 600 sq m and 1200 sq m. The simulation though, does not account for the stages of the connections between phases of the multilevel nested adaptive cycles. Therefore, it is not clear yet for example in which stage is the system at 600 sq m and 1200 sq m, where the resilience levels appear to be higher than a 300 sq m. To determine the stages in which the connection of the phases of the adaptive cycles are, needs further research that could be deployed as follows.

- i) Kernel density calculation of the renewable energy consumption spatially explicit represented.
- ii) Calculation of the distributional changes in time from a multiscale perspective.
- iii) Application of the SPA model at the distributional changes from a spatiotemporal point of view to create the links of innovation.
- iv) Removal of hubs of the network and apply the SPA model
- v) Spatial Analysis of the results: verification of the degree distribution of the network and its topology.
- vi) The regions where the distributions follow power laws are fractals, which is the signature of self-organization. If it applies, the regions where there is not fractality a statistical analysis is proposed to determine the structure of the distributions.
- vii) Estimation of the size of the RET diffusion's distributions and statistically determine the relationships between the size of the intensity of the diffusion and the spatial scales.

In this dissertation we did not cross data between innovation indicators for example, e-vehicles with solar PV in Switzerland or the links between wind power and big hydroelectric power plants in France. The reason is simply

because we know very little about how these variables interact with each other within an innovation system. Furthermore, one of the major challenges to apply the panarchy theory in a socio-technical system such as the diffusion of RET, is the restrictions at time level. The energy transition goals for the EU and for Switzerland are targeted for 2050, the question that arises here is, there will be sufficient data to deploy a practical model on time? An advantage in ecological science is the huge amount of data available even since the 1970's which allowed them to analyse consequences of the arrival of random events in ecosystems (Hollings, 1973). If we look at the data of RET available at the moment of this dissertation, a parallel with the nested cycles proposed by Holling et al., (2002) gives a perspective.

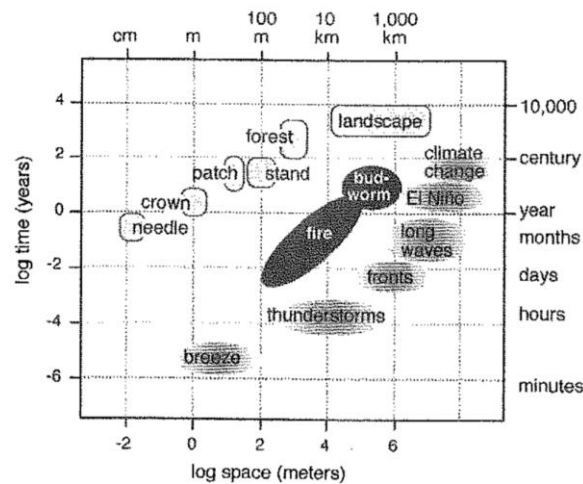

Figure 205 Nested Cycles. Source: Holling et al., (2002)

Within the view of evolutionary resilience in ecological science, adaptive resilience takes stochastic changes as an inherent aspect of complex systems where they tend to change without extrinsic disturbances (Scheffer et al., 2009). This conceptual idea embraces the view that change is a natural allied of complex systems and resisting or avoiding change could have unwanted consequences (Davoudi et al., 2012). The opposite undesirable situation that could occur is that the system gets stuck in an equilibrium state, meaning that movement and change is necessary for the system to subsist. In this regard, physicist Per Bak (1996) stated: *“How can there be evolution if all things are in equilibrium? Systems in equilibrium by definition go nowhere”*.

7.4 Conclusion Chapter 7

In summary, this Chapter discussed a practical model for urban resilience to innovation within a sustainability transition context. The non-linearity behaviour of the trajectory followed by the diffusion of RET shows signs of resilience, which in the case of solar PV_{hwh} exhibits a different social organization process from a spatial perspective. Such differences though, seem to be on their way of becoming less significant with the evolution of time. A major finding is the dual behaviour observed at local and global levels, where the system shows high levels of resilience in the latter and low levels in the former. The implications of such behaviour are relevant from a policy perspective and open new research direction within the field of urban energy systems and GST.

Thus, the lessons learned from this research work prompt us to recommend certain measures that should be considered to develop sustainability transition strategies. Foremost, from an urban perspective the neglect of the spatial dimension limits our understanding of the issues behind the pace of and the forms of sustainability transition processes. Second, the fact that we do not understand very well such issues, reinforce that often the policies seem to be developed on an all-size-fit-all fashion. This is clearly a limitation factor for the reinforcement

of the energy transition processes, since spatial discontinuities exist. This entails that the system is at different phases of spatial reorganization and the resilience levels are not equal across spatial scales.

The main contribution with this research work is the practical application of a model in a real territory. The concept of resilience has been theorized by many scholars, but there are very few real-world applications of models that can be cross validated by the scientific community. In this regard, with this model we intend to establish the basis of a concrete way to characterize the urban resilience to innovation diffusion and more specifically to RET. Thus, urban resilience within the context of sustainability transition can be further explored. The model developed in this Ph.D dissertation is a first proposal to analyse resilience, but it has the potential to be improved not only from the theoretical perspective but also from the informatic point of view.

7.5 Conclusion Part 2

In the Part 2, the SPA model was first introduced for the Swiss region and an unsuccessful attempt to integrate the SLEUTH model to better understand the social process of innovation diffusion was also carried out. In fact, the land-use trajectories identified with the SLEUTH model require long periods of time to unfold, while the RET diffusion processes are faster and it was not possible to make a link on how they influence the spatial organization of the urban system analysed. Thus, the SPA model was built in the region of Valais relying on spatial interaction theory through a gravity model that relied on spatial information of population, jobs and RET. The spatial organization of the innovation indicators were finally the most important element to investigate the underlying mechanisms in the diffusion processes, since their position in the space seem to be the result of a complex interplay within the urban system. The overlay analysis allowed to build a spatial network of RET where the diffusion exhibited signs of self-organization in the canton of Valais, in the South Region of France and in Switzerland at national level. The fractal nature of RET diffusion could pose the bases of a new paradigm in the GST, from modelling, research and policy perspectives. It was demonstrated that the spatial diffusion of RET across spatial scales is not random and a pattern of rich get richer in terms of preferential attachment and path dependency is evidentially observed. The self-organization nature embedded in these diffusion mechanisms were important in order to analyse the resilience to innovation diffusion, as self-organization is intrinsically present in resilient systems. The urban energy system of the Valais region showed levels of high resilience to energy transition at global level however, at local level the system was not resilient. The results suggest that resilience itself is not fractal, although resilient systems need to be self-organized according to ecologists.

7.6 Conclusion Part 2 (Français)

Dans la Partie 2, le modèle SPA a été introduit pour la région suisse, et une tentative infructueuse d'intégrer le modèle SLEUTH pour mieux comprendre le processus social de diffusion de l'innovation a également été réalisée. En effet, les trajectoires d'utilisation du sol identifiées avec le modèle SLEUTH nécessitent de longues périodes de temps pour se déployer, alors que les processus de diffusion des RET sont plus rapides, et il n'a pas été possible d'établir un lien sur la façon dont ils influencent l'organisation spatiale du système urbain analysé. Ainsi, le modèle SPA a été construit dans la région du Valais en s'appuyant sur la théorie de l'interaction spatiale par le biais d'un modèle gravitaire qui s'appuie sur les informations spatiales de la population, des emplois et des TER. L'organisation spatiale des indicateurs d'innovation a finalement été l'élément le plus important pour étudier les mécanismes sous-jacents des processus de diffusion, puisque leur position dans l'espace semble être le résultat d'une interaction complexe au sein du système urbain. L'analyse de superposition spatiale a permis de construire un réseau spatial de TER où la diffusion a montré des signes d'auto-organisation dans le canton du Valais, sur la Région SUD en France et en Suisse au niveau national. La nature fractale de la diffusion des TER pourrait poser les bases d'un nouveau paradigme majeur sur la géographie de la transition vers la durabilité (GTS), du point de vue de la modélisation, de la recherche scientifique et des politiques. Il a été démontré que la diffusion spatiale des technologies de l'information à travers des échelles spatiales n'est pas aléatoire et qu'un effet où les riches deviennent plus riches en termes d'attachement préférentiel et de *path dependency* est manifestement observé. La nature de l'auto-organisation intégrée dans ces mécanismes de diffusion était importante pour analyser la résilience de la diffusion de l'innovation, car l'auto-organisation est intrinsèquement présente dans les systèmes résilients. Le système énergétique urbain de la région du Valais a montré des niveaux élevés de résilience à la transition énergétique au niveau global, mais au niveau local, le système n'était pas résilient. Les résultats suggèrent que la résilience elle-même n'est pas fractale, bien que les systèmes résilients doivent être auto-organisés selon les écologistes.

Conclusion and New Perspectives

In this Ph.D thesis we investigated the temporal and spatial regularities of renewable energy technologies in the Swiss canton of Valais, in Switzerland and in the South Region of France, where important differences at geographical, socio-economic and political level exist. The dissertation is composed of epistemological contributions within the field of quantitative and theoretical geography and also applied research, with the development of a model relying on network science. The transnational nature of the study helped to better understand the spatial dynamics in locations that have been governed in different ways, with different type of natural and social resources and from two different perspectives: Renewable energy technologies' end user in the Swiss region and renewable energy supply in the French territory. The results obtained in the two regions are interesting since they are counterintuitive, as it is often the case of complex systems (Forrester, 1995).

The model developed in this dissertation was applied for the diffusion of solar photovoltaics in the canton of Valais and later in Switzerland at the national level to simulate the diffusion of electric and hybrid vehicles. The main difference with the application of the model at the national level is that there is not a gravity model at that spatial scale however, the model shows that is robust enough. Thus, in Chapter 5 major developments and discussions on the nature of the RET diffusion in urban networks are carried out, in a framework of complex systems. In a later stage in Chapter 6 the model was applied in the South Region of France, where similar results were obtained, confirming a self-organization nature in energy urban systems. In Chapter 7 the same model is applied to simulate urban resilience to energy transition by altering the values of the hubs of the urban network. The results provided information about the different levels of resilience depending on the scale of reference, where at global scale the system exhibits resilience but not a local level. These results proposed a discussion about the fractality nature of resilience, since resilient systems are self-organized, but it does not imply that resilience itself is self-organized, which the simulations of the urban energy system in Valais suggest.

The specialize literature in geography and innovation studies have clearly stated that diffusion of innovations across scales and territories is non-random. At the same time, to our knowledge there was not a concrete model applicable in the real world to determine the trajectories and the spatial effects of the diffusion of renewable energies from both standpoints that is, end users and energy supply. The trajectories of the nine innovation indicators are influenced by spatial effects at different scales and even though such networks are the same, the internal mechanisms are different, particularly timewise. The underlying interactions between scales, in a complex fashion have been reinforcing the diffusion process of renewable energy technologies in both territories, where a preferential attachment is observable. The latter property has been called spatial preferential attachment within the context of this Ph.D dissertation in order to give to the spatial dimension a major role in the sustainability transition paradigm.

The spatial preferential attachment is characteristically described by power laws, which are indicators of phase transitions from chaos to order. In this context, when a renewable energy technology is adopted in a location, it will initially follow the mechanisms of spread proposed by Hägerstrand (1952, 1953). Now we now that after a period of disorder and then of a gradual increase in the spread process, emitted from spatial concentrations that become more important in size and density, there is a moment where a threshold is overtaken at some spatial scale resolution. These complex interactions and positive feedback loops will then push the system towards a new dynamic state to reach order. This process is observable through the emergence of power laws, as they indicate when a system is approaching the threshold that takes the systems towards self-organization. The implications of this fractal behaviours are vast as end users and the supply urban energy systems seem to have had such phases transitions and although both systems are completely different both urban systems tend to converge towards self-organization.

The development of the Spatial Preferential (SPA) model in the Swiss and in the French region in Chapters 5 and 6 respectively, provided information to address the first two research questions proposed in section 2.3.6 as follows.

1. *“Can demographic, economic (jobs distributions) and spatial information provide some insights to better understand the network effect of adoption and diffusion of renewable energy technologies?”*

The answer to that question is that spatial information is definitely a powerful explanatory variable for the network effect of adoption and diffusion of renewable energy technologies. This is the case of the spatial information of the technologies and in a lower degree of importance the demographic and jobs spatial information. There is scientific evidence to draw a conclusion that the combination of spatiotemporal distributions of population and jobs contributes with information to unveil hidden patterns of spatial interaction mechanisms embedded in urban energy systems from a demand perspective. However, the effects derived from these variables is radically less important than the spatial distribution of the renewable energy technologies themselves as such. As it was shown in Chapter 5, the kernel density estimation (KDE) of the spatial layers of the population and jobs via the gravity model needed to be weighted with a coefficient= 0.85 in order to improve the explanatory power of the SPA model. Furthermore, the application of the SPA model at the national level in Switzerland did not considered population and jobs and the results were very good.

As well as, a non-parametric approach, the so-called Quadratic Discriminant Analysis, was used without considering the spatial organization of several variables such as: eight different types of energy technologies, dwellings' number of rooms, number of people in dwells, number of dwells in buildings, number of floors in buildings and total residents in buildings. The model had a poor performance, which shows the relevance of the spatial dimension in urban energy modelling. Once the spatial component was integrated via the SPA model, the associated patterns of the network effect of RET adoption were unveiled. Therefore, the answer to the research question is that the spatial information of RET definitely provides insights to better understand the network effect of RET diffusion however, population and jobs spatial distributions have a more mitigated role.

The analysis of the adoption of solar PV for heating and hot water is interesting from a spatial point of view, since the spatial organization of such systems is linked to the nature of the underlying socio-economic situation of the location. The concentration of this technology is situated in places with higher PIF values, which is derived from the spatial attractiveness of the location that was calculated based on the spatial situation of population and jobs. Therefore, the spatial distribution of this technology indirectly already contains information on the socio-economic aspects of the area studied. Most of solar PV are located where people live or work, which is narrowly related with the attractiveness of the place. The investments related to these technologies are considerably high for an individual e.g., solar panels or electric vehicles, therefore the high-density levels of solar PV and PIF are spatially distributed with similar intensities in urban areas. In other words, considering solar PV as a high-end product, it would be fair to say that its adoption is linked with the socio-economic situation in a data point i . A caution is required to be taken here as the spatial expansion of solar PV installation is a process that started few years ago in Valais and in the South Region of France as discussed in sections 3.3 and 3.6 respectively.

As it was explained in the latter sections, the expansion of these installations is taking place in several uninhabited locations, which implies that in the future gravity models might account only for urban areas highly densified. The SPA model presented in this Ph.D dissertation could be used in different contexts, urban and peripheral and uninhabited areas, which is a supplementary advantage of the model. The simulation of electric and hybrid vehicles diffusion at the national level in Switzerland was developed without considering the population, jobs and the attractiveness of the location. Furthermore, the granularity of the data was less accurate than the solar PV georeferenced information. The results of these simulations however, showed that the diffusion process still follow power laws, and that mere spatial information of the technologies was enough to understand the self-organized diffusion mechanisms. The latter note takes us to the discuss the second research question.

2. The network effect of diffusion of renewable energy technologies does follow a preferential attachment from a spatial and temporal perspective?

The answer to this question is positive. The underlying assumption of this second question was that innovation diffusion does not follow a random distribution from a network perspective. This hypothesis was based on the literature review in geography and innovation studies, which prompted us to think that the degree distribution of a spatial network might follow a power law and the weight of the links of the network too, showing signs of fractality and self-organization. Indeed, the spatial component appears to be a baseline for social innovation with physical consequences in the sustainability transition process in which the presence of hubs of innovation was detected in the energy urban networks in both territories of study. Furthermore, the hubs seem to be connected with other hubs in a self-organized fashion, creating corridors of high intensity of innovation for both processes: innovation adoption in the Swiss region and innovation diffusion in the South Region of France. In the other extreme of the regime, we find locations with low levels of interactions, exchanges, innovation diffusion and thus slow levels of sustainability transitions. According to the literature and the results it appears that such locations will continue trajectories of low transitivity towards sustainable paths all other things being equal.

This argument is in line with i) the path development theory in economic geography (Grillitsch & Hansen, 2019); ii) the preferential attachment theory where the rich get richer in network science (Barabasi, 2016) and iii) the Matthew effect of accumulated advantage in sociology (see Merton, 1968; Price, 1976) the Jackson effect in economics (Dauphiné, 2011). All these theories resonate with the early contributions of Hägerstrand (1953) in which he identified hubs of innovation space-wise, whose location were not random and their size was reinforced by their past situation. The spatial situation of the hubs plays a major role in the diffusion process within the urban network, coupled with a distance decay effect, which is responsible for allowing different degrees of interactions. In this regard, the SPA model developed in this dissertation has the underlying assumption that similar nodes that have high levels of innovation adoption are more likely to spread the innovations with a distance decay effect. This assumption was verified in both territories, as the behaviour of the nine innovation indicators follow power laws.

The fractality levels are not strictly the same with every innovation indicator at each spatial scale, as some processes are mature enough and the fractals have a scale-invariance nature. In other cases, like the solar PV for heating and hot water, exhibit power laws in larger scales while in the smaller, that is 300 sq m the self-organization mechanisms seem to be in process when we look at the KDE. However, when the model was applied to the KDE of solar PV for heating and hot water, the distributions of the links follow power laws, thus self-organization. The important findings are related to the preferential attachment behaviour of RET diffusion, as this poses major challenges for strategy and policy purposes. As the results suggest that in order to speed up the sustainability transition pace, the locations with RET hubs would be the most suitable to meet the sustainability targets. However, this implies that places with low levels of innovation diffusion will be left behind and this kind of unequal treatments is what the third framing of innovation, the so-called Transformative Change is trying to avoid.

Therefore, one of the main contributions of this Ph.D dissertation is a modelling framework for a typology of multicriteria decision analysis, where the space is the playground of suitable, unsuitable and conflict regions regarding the allowance of resources for sustainability transition. This question relies on the fact that there is an unequal adoption of RET, because not all places and locations are equal and are equipped to adopt, adapt or implement and commercialize new technologies in the same way (Lundquist & Olander, 2001). The discussions of these aspects are developed in Chapter 1 and are based on the argument that regions have different abilities and competences to integrate the complex nature embedded in innovation processes. At the same time, under the view of quantitative and theoretical geography, it is shown in Chapters 5 and 6 that these aspects are not limited to administrative boundaries such as a regional scale, but can continue further down in physical spatial scales.

This implies that the similar mechanisms continue to reproduce in the space and differentiate locations with high and low levels of innovation, beyond administrative borders. From an innovation viewpoint, Rogers (1983) discussed on the different kind of innovators, which describes a different levels of innovation in individuals, which could be related to the latter arguments as it seems that innovation diffusion often needs hubs.

A second major aspect in the RET diffusion is related to grow, as the preferential attachment is characteristically defined by two main mechanisms: *i) networks continue to grow, where one node is added at a time and ii) The new nodes in the network will probably connect to the more connected nodes, which is a property called preferential attachment.* The continuous iteration of these two steps, growth and preferential attachment generates the existence of hubs (see also Barabasi, 2002, 2016). The combination of these two elements implies that not all networks are random and that the degree distributions of the network would follow power laws. The name for such networks is scale-free, which are observed in the nature, in the human body (Barabasi, 2016) and in some social innovation processes (Kiesling, 2011). The SPA model is based on spatial interaction theory and homophily and from a network perspective, in which the nodes of the RET network are linked according to their size and distance which typifies the intensity of interactions and the reach capacity in spatial terms.

In Chapter 7 we developed a series of simulations of the urban resilience to energy transition relying still on the SPA model however, the urban energy networks of the Valais region were modified. The conceptual idea was to simulate shocks that would alter the mechanisms of innovation diffusion within the system. The procedure was to 'attack' the network by removing the largest nodes in which the highest levels of diffusion take place. By doing this, important changes occurred from a spatial perspective given the self-organized context of the RET diffusion. The results suggest that the urban system is resilient at global level, which implies that a reorganization process take place in such a way that new hubs and new links appear and the networks keep the scale-free structure. However, the system is not resilient at local level, as some locations with high intensity of innovation diffusion might disappear, which typifies a major aspect for transition sustainability planning.

The findings developed in Chapter 7 suggest that sustainable development strategies should not be applied across regional scales under a 'one-size-fits-all' reasoning. This poses a major challenge for municipalities and therefore the cantonal policy in the canton of Valais should be adapted to a smaller spatial scales such as municipalities and even neighbourhoods. A hypothesis that might explain this behaviours is based on the fact that the spatial diffusion of RET is not fractal with invariance-scale, but semi-fractal, where the process is further developed in larger scales such as 600 sq m and 1200 sq m. Therefore, the urban system is not able yet to cope with such shocks and reorganized itself at 300 sq m and smaller scales. The simulations performed at 300 sq m, which was the smallest scale studied, showed that the spatial location of hubs changed, which implies that new hubs emerge in other locations taking with them their influence and effects. This means that an innovation hub of on a 300 sq m surface might be displaced or disappear and the location would reduce its innovation levels, reaching a similar level to those in the low regime of the network.

An important observation concerning the results of the resilience simulation is that the network keeps its topology and its distribution continue to follow power laws. However, since the self-organization maturity in some cases is scale-dependent, differences were also found. From a spatial perspective, self-organized systems follow general behaviours such as the emergence of global order derived from local interactions. According to the resilience definition in ecology, resilient systems are able to absorb, adapt and are self-organized. In the same line of thought, fractality is a typical signature of self-organization, where hierarchical and multi-level organization can be observed at several spatial levels. A fundamental aspect is that the model informs that while self-organization is a property present in resilient systems, it does not mean that resilience itself is fractal according to this study, since the capacity of self-organization of the system varies with the spatial scale. Further research in this direction and in other contexts is required to confirm the results obtained in this analysis. The idea of resilience not being fractal though is not new, it has actually been approached through discourse analysis, but to our knowledge it has not

been proven through empirical approaches. French economist Olivier Godard (1996). Now we will address the third research question proposed in section 2.3.6.

3. Are places and locations with higher levels of innovation more resilient to energy transition than less innovative locations?

The hypothesis for this question is connected with the previous research question and its subsequent hypothesis⁷². By definition resilient systems are self-organized therefore, as it was possible to verify that the network effect of renewable energy technologies diffusion follows power laws, the answer to this research question is positive and depends on the spatial scale. Places and locations with high levels of innovation are more likely to be in the self-organized zone of spatial structures holding a prominent position as hubs. Changes in the spatial scales will vary the levels of innovation 'density', which will in a cascade affect the diffusion process however, it is possible to accept the assumption proposed in section 2.3.6. *By definition resilient systems are self-organized therefore, since the assumption of self-organization has been verified, the answer for this question is yes, more innovative places and locations are more resilient to energy transition.*

The data available at the moment when this dissertation was prepared, suggests that the urban resilience to energy transition at local scales is not fractal. Therefore, after the simulated shock the microscopic behaviour entailed changes in the position of the hubs, which implies that their influence for diffusion purposes would disappear and change the qualitative structure of the network at that scale. The spatial effect, which is the importance of the spatial component in the development of activities in a system (Coquillard et al., 1997) allows to observe a bifurcation that takes place at local level. This implies a change in the location of the solar photovoltaics. This might not have important impacts at global level as the systems shows resilience keeping the qualitative structure of the network at 600 sq m and 1200 sq m.

According to the literature in physics, fractality processes are often develop from large towards smaller (Queiros-Condé et al., 2015) as it was discussed in section 5.5.2.1. Here we are discussing similar behaviours but embedded in social systems of innovation with an explicit consideration of the spatial dimension, therefore further research is encouraged in order to draw more comparisons. Nevertheless, the findings in this research work are very valuable for scientific, practical and policies purposes. Geographical definitions of cities, regions, territories, locations and places might induce to mistakes in terms of the latter research question and its subsequent answer. That is the reason why the answer provided here explicitly address the issue of spatial scales, as local and global levels do not have a determined and fix scale.

Finally in Chapter 7, an introduction of the new research directions is proposed, integrating the concept of panarchy developed by Gunderson & Holling (2002) in ecology. Panarchy theory has been gaining relevance as a framework to improve our understanding on ecosystems connected with social-ecological systems and governance (Allen et al., 2011). According to the three dimensions of the panarchy theory, the network approach is suited to provide information about *i) the inner system's potential for change, ii) the connectedness of the system and its flexibility or rigidity from a spatiotemporal perspective and finally iii) resilience.*

The idea of linking the panarchy concept in the framework of urban resilience to innovation is derived from their proximity regarding change and complexity. As well as the non-linear behaviour of ecological, social systems and both combined, the cross-scale feedbacks within such structures and the nested adaptive cycles gives a framework to panarchy in the context of this Ph.D. According to the authors of the theory (Gunderson & Holling, 2002),

⁷² Previous research question: The network effect of diffusion of renewable energy technologies does follow a preferential attachment from a spatial and temporal perspective? *The hypothesis underlying this second research question is that innovation diffusion does not follow a random distribution from a network perspective. The degree distribution of a spatial network might follow a power law, showing signs of fractality and self-organization.*

panarchy can describe how complex systems for instance, composed of people and natural resources are dynamically structured and organized across spatiotemporal scales. Panarchy has been applied to determine threshold and opportunities regarding the interactions from a scale perspective (Van Apeldoorn, et al., 2011). This is relevant for this research as the observations in the behaviour of solar PV diffusion exhibited a threshold and a phase transition from disorder to order. Although the concept of threshold has been acknowledged as an insightful and efficient approach to deal with the depletion of natural resources and the environment, its non-linear behaviour and its characteristic complexity makes difficult its application. Thus, the discussion on panarchy in this Ph.D dissertation should be looked at as a scientific discourse analysis, which intends to open new research perspectives.

Regarding the limits of this research work, in the Swiss region of Valais was done with spatial data of solar photovoltaics and not with the power produced but such technologies. Therefore, further research is needed to cross-validate the KDE of the technologies with the actual power produced via such innovations. Hence, the information that is provided through the SPA model is still missing this relevant aspect. Another limitation in the study in the Swiss region was regarding the data privacy issued by the Federal Statistical Office, in which it was not possible to use the information with other datasets, for example to integrate an external survey. From a research perspective, the limitations are as often provided by time constrains.

An example is actually to developed studies from the demand and supply perspective in two or more territories in order to draw definitive conclusions from the same point of view. Regarding new research directions the spatial preferential attachment present in the energy transition process opens new research directions in which some difficult questions might be posed. One of them, is within the third framing of innovation, the so-called Transformative Change, which is discussed in section 1.3, where inequality and climate change are major drivers of the current innovation policy. In that context, we could wonder how innovation policy can drive social justice and equality through the prism of sustainability transition?

According to the results obtained in this research work, the innovation hubs, where the diffusion processes of RET have high intensity, are dramatically higher than in the locations with low diffusion levels, situated in the lower regime of the distributions. The issue here is that each node will keep growing proportionally to their size. This entails, that locations with low levels of adoption of RET in the Swiss region and RET generation in the South Region of France, statistically speaking have very low probabilities to catch up with the RET hubs. This means that policies should consider these aspects in order to optimize efforts and investments, with the aim at keeping in line the sustainability goals while considering equity and equality issues. The different ramifications within the field of geography, have divided the focus of research and thus the efforts to deal with related research. The emerging field of Geography of Sustainability Transition (GST) proposes an exceptional scientific platform for research collaboration between geographers in the sustainability transitions research stage. The new research directions contain a stronger presence of the spatial dimension in sustainability studies (see Köhler et al., 2019).

Conclusions et Nouvelles Perspectives

Dans cette thèse de doctorat, nous avons étudié les régularités temporelles et spatiales des technologies des énergies renouvelables (TER) dans le canton suisse du Valais, en Suisse, et sur la Région SUD-Provence-Alpes-Côte d'Azur, en France, où il existe des différences importantes au niveau géographique, socio-économique et politique. La thèse est composée d'apports épistémologiques dans le domaine de la géographie quantitative et théorique et aussi de recherche appliquée, avec le développement d'un modèle s'appuyant sur la science des réseaux. La nature transnationale de l'étude a permis de mieux comprendre les dynamiques spatiales dans des lieux qui ont été gouvernés de différentes manières, avec différents types de ressources naturelles et sociales et selon deux perspectives différentes. Les résultats obtenus dans les deux régions sont intéressants car ils sont contre-intuitifs, comme c'est souvent le cas pour les systèmes complexes (Forrester, 1995).

Le modèle développé dans cette thèse a été appliqué, pour la diffusion du solaire photovoltaïque, dans le canton du Valais, et ensuite en Suisse au niveau national pour simuler la diffusion des véhicules électriques et hybrides. La principale différence avec l'application du modèle au niveau national est que nous n'avons pas appliqué un modèle gravitaire à cette échelle spatiale ; cependant, le modèle montre qu'il est suffisamment robuste. Ainsi, dans le chapitre 5, des développements et des discussions majeurs sur la nature de la diffusion des TER dans les réseaux urbains sont menés, dans un cadre de systèmes complexes. Dans une étape ultérieure, au chapitre 6, le modèle a été appliqué à la Région SUD en France, où des résultats similaires ont été obtenus, confirmant la nature d'auto-organisation des systèmes énergétiques urbains. Dans le chapitre 7, le même modèle est appliqué pour simuler la résilience urbaine à la transition énergétique en modifiant les valeurs des nœuds du réseau urbain. Les résultats ont fourni des informations sur les différents niveaux de résilience en fonction de l'échelle de référence. A l'échelle globale le système présente de la résilience mais pas au niveau local. Ces résultats ont entraîné une discussion sur la nature fractale de la résilience, puisque les systèmes résilients sont auto-organisés, mais cela n'implique pas que la résilience elle-même soit auto-organisée, ce que les simulations du système énergétique urbain en Valais suggèrent.

La littérature spécialisée en géographie et les études sur l'innovation ont clairement indiqué que la diffusion des innovations à travers les échelles et les territoires n'est pas aléatoire. En même temps, à notre connaissance, il n'existait pas de modèle concret applicable dans le monde réel pour déterminer les trajectoires et les effets spatiaux de la diffusion des énergies renouvelables du point de vue des utilisateurs finaux et de l'offre. Les trajectoires des neuf indicateurs d'innovation sont influencées par des effets spatiaux à différentes échelles et même si ces réseaux sont les mêmes, les mécanismes internes sont différents, notamment dans le temps. Les interactions sous-jacentes entre les échelles, de manière complexe, ont renforcé le processus de diffusion des technologies d'énergie renouvelable dans les deux territoires, où un mécanisme d'attachement préférentiel est observable. Cette propriété a été appelée attachement préférentiel spatial dans le contexte de cette thèse de doctorat, afin de donner à la dimension spatiale un rôle majeur dans le paradigme de la transition vers la durabilité.

L'attachement préférentiel spatial est décrit de manière caractéristique par des lois de puissance, qui sont des indicateurs de transitions de phase du chaos à l'ordre. Dans ce contexte, lorsqu'une technologie d'énergie renouvelable est adoptée dans un lieu, elle suivra initialement les mécanismes de propagation proposés par Hägerstrand (1952, 1953). Nous savons maintenant qu'après une période de désordre puis d'augmentation progressive du processus de propagation, émis par des concentrations spatiales qui deviennent plus importantes en taille et en densité, il y a un moment où un seuil est dépassé à une certaine résolution d'échelle spatiale. Ces interactions complexes et des boucles de rétroaction positive vont alors pousser le système vers un nouvel état dynamique pour atteindre l'ordre. Ce processus est observable à travers l'émergence des lois de puissance, car elles indiquent quand un système s'approche du seuil qui l'amène vers l'auto-organisation. Les implications de ce comportement fractal sont vastes car les utilisateurs finaux et les systèmes énergétiques urbains

d'approvisionnement semblent avoir connu de telles transitions de phases et, bien que les deux systèmes soient complètement différents, les deux systèmes urbains tendent à converger vers l'auto-organisation. Le développement du modèle d'attachement préférentiel spatial (SPA) dans la région suisse et dans la région française, dans les chapitres 5 et 6 respectivement, a fourni des informations pour répondre aux deux premières questions de recherche proposées dans la section 2.3.6 comme suit.

1. "Les informations démographiques, économiques (distributions des emplois) et spatiales peuvent-elles fournir des éléments permettant de mieux comprendre l'effet de réseau de l'adoption et de la diffusion des technologies d'énergie renouvelable ?"

La réponse à cette question est que l'information spatiale est définitivement une variable explicative puissante de l'effet de réseau de l'adoption et de la diffusion des technologies d'énergie renouvelable. C'est le cas de l'information spatiale des technologies et, à un degré d'importance moindre, de l'information spatiale démographique et des emplois. Il existe des preuves scientifiques permettant de conclure que la combinaison des distributions spatio-temporelles de la population et des emplois contribue avec l'information à dévoiler les modèles cachés des mécanismes d'interaction spatiale intégrés dans les systèmes énergétiques urbains, du point de vue de la demande. Cependant, les effets dérivés de ces variables sont radicalement moins importants que la distribution spatiale des technologies d'énergie renouvelable en tant que telle. Comme il a été montré au chapitre 5, l'estimation de la densité du noyau (KDE) des couches spatiales de la population et des emplois via le modèle gravitationnel a dû être pondérée avec un coefficient = 0,85 afin d'améliorer le pouvoir explicatif du modèle SPA. En outre, l'application du modèle SPA au niveau national en Suisse n'a pas pris en compte la population et les emplois et les résultats ont été aussi très bons.

De même, une approche non paramétrique, appelée Analyse Discriminante Quadratique, a été utilisée sans tenir compte de l'organisation spatiale de plusieurs variables telles que : huit types différents de technologies énergétiques, le nombre de pièces des logements, le nombre de personnes dans les logements, le nombre de logements dans les bâtiments, le nombre d'étages dans les bâtiments et le nombre total de résidents dans les bâtiments. Les performances du modèle étaient faibles, ce qui montre la pertinence de la dimension spatiale dans la modélisation énergétique urbaine. Une fois que la composante spatiale a été intégrée via le modèle SPA, les structures associées de l'effet de réseau sur l'adoption des TER ont été dévoilées. Par conséquent, la réponse à cette question de recherche est que l'information spatiale des TER fournit certainement des indications pour mieux comprendre l'effet de réseau de la diffusion des TER ; cependant, les distributions spatiales de la population et des emplois ont un rôle plus mitigé.

L'analyse de l'adoption de l'énergie solaire photovoltaïque pour le chauffage et l'eau chaude est intéressante d'un point de vue spatial, car l'organisation spatiale de ces systèmes est liée à la nature de la situation socio-économique sous-jacente du lieu. La concentration de cette technologie est située dans des endroits où les valeurs des champs potentiels d'innovation (PIF) sont plus élevées, ce qui est dérivé de l'attractivité spatiale de l'endroit qui a été calculée sur la base de la situation spatiale de la population et des emplois. Par conséquent, la distribution spatiale de cette technologie contient déjà indirectement des informations sur les aspects socio-économiques de la zone étudiée. La plupart des systèmes photovoltaïques sont situés là où les gens vivent ou travaillent, ce qui est étroitement lié à l'attractivité spatiale du lieu. Les investissements liés à ces technologies sont considérablement élevés pour un individu par exemple, c'est le cas des panneaux solaires, où les niveaux de haute densité spatiale de ces technologies et de PIF sont spatialement distribués avec des intensités similaires dans les zones urbaines. En d'autres termes, si l'on considère les panneaux photovoltaïques comme un produit haut de gamme, il serait juste de dire que son adoption est liée à la situation socio-économique d'un point de données i . Il convient d'être prudent ici car l'expansion spatiale de l'installation des panneaux photovoltaïques par exemple, est un processus qui a commencé il y a quelques années en Valais et sur la Région SUD en France, comme nous l'avons décrit dans les sections 3.3 et 3.6 respectivement.

Comme il a été expliqué, l'expansion de ces installations a lieu dans plusieurs endroits inhabités, ce qui implique qu'à l'avenir les modèles gravitaires pourraient ne tenir compte que des zones urbaines fortement densifiées. Le modèle SPA présenté dans cette thèse de doctorat pourrait par contre, être utilisé dans différents contextes urbains, périphériques et dans des zones inhabitées, ce qui est un avantage supplémentaire du modèle. La simulation de la diffusion des véhicules électriques et hybrides au niveau national, en Suisse, a été développée sans tenir compte de la population, des emplois et de l'attractivité spatiale. De plus, la granularité des données était moins précise que les informations géoréférencées sur le photovoltaïque. Les résultats de ces simulations ont toutefois montré que le processus de diffusion suivait toujours des lois de puissance et que l'information spatiale des technologies était suffisante pour comprendre les mécanismes de diffusion auto-organisés. Cette dernière remarque nous amène à discuter de la deuxième question de recherche.

2. L'effet réseau de la diffusion des technologies d'énergie renouvelable suit-il un attachement préférentiel d'un point de vue spatial et temporel ?

La réponse à cette question est positive. L'hypothèse sous-jacente de cette deuxième question était que la diffusion de l'innovation ne suit pas une distribution aléatoire du point de vue du réseau. Cette hypothèse était basée sur la revue de la littérature en géographie et en études de l'innovation, qui nous ont incités à penser que les distributions des degrés des réseaux spatiaux pourraient suivre des lois de puissance et les poids des arêtes des réseaux également, montrant des signes de fractalité et d'auto-organisation. En effet, l'espace semble être une base de référence pour l'innovation sociale avec des conséquences physiques dans le processus de transition vers la durabilité dans lequel la présence de hubs d'innovation a été détectée dans les réseaux urbains énergétiques dans les deux territoires d'étude. D'ailleurs, les *hubs* semblent être connectés à d'autres *hubs* de manière auto-organisée, créant des 'corridors de haute intensité d'innovation' pour les deux processus : adoption de l'innovation dans la région suisse et diffusion de l'innovation sur la Région SUD en France. A l'autre extrême du régime, nous trouvons des lieux avec de faibles niveaux d'interactions, d'échanges, de diffusion de l'innovation et donc des niveaux lents de transitions vers la durabilité. D'après la littérature et des résultats, il semble que ces lieux poursuivront des trajectoires de faible transitivity vers des voies durables, toutes choses égales par ailleurs.

Cet argument est en accord avec i) la théorie de *path développement* en géographie économique (Grillitsch & Hansen, 2019) ; ii) la théorie de l'attachement préférentiel où il y a la prémisse que les riches deviennent plus riches en science des réseaux (Barabasi, 2016) et iii) l'effet Matthew de l'avantage accumulé en sociologie (voir Merton, 1968 ; Price, 1976) l'effet Jackson en économie (Dauphiné, 2011). Toutes ces théories entrent en résonance avec les premières contributions de Hägerstrand (1953) dans lesquelles il identifie des hubs d'innovation dans l'espace, dont la localisation n'est pas aléatoire et dont la taille est renforcée par leur situation passée. La situation spatiale des *hubs* joue un rôle majeur dans le processus de diffusion au sein du réseau urbain, couplé à un effet de décroissance de la distance, qui est responsable de la possibilité de différents degrés d'interactions. À cet égard, le modèle SPA développé dans cette thèse a l'hypothèse sous-jacente que les nœuds similaires qui ont des niveaux élevés d'adoption d'innovations sont plus susceptibles de diffuser les innovations avec un effet de décroissance influencé par la distance. Cette hypothèse a été vérifiée dans les deux territoires et au niveau national en Suisse, donc le comportement des neuf indicateurs d'innovation suit des lois de puissance.

Les niveaux de fractalité ne sont pas strictement les mêmes pour chaque indicateur d'innovation à chaque échelle spatiale, car certains processus sont suffisamment matures et les fractales ont une nature invariante d'échelle. Dans d'autres cas, comme le solaire photovoltaïque pour le chauffage et l'eau chaude, on observe des lois de puissance à des échelles plus grandes, alors qu'à des échelles plus petites, c'est-à-dire 300 m², les mécanismes d'auto-organisation semblent être en cours lorsque l'on regarde leur densité spatiale par noyau (KDE). Cependant, lorsque le modèle SPA a été appliqué au KDE des panneaux photovoltaïques pour le chauffage et l'eau chaude, les distributions des liens suivent des lois de puissance, c'est ce qui est la signature d'une auto-organisation. L'importance des résultats est liée au comportement d'attachement préférentiel de la diffusion des TER, car cela

pose des défis majeurs en matière de stratégies au niveau politique. Les résultats suggèrent qu'afin d'accélérer le rythme de la transition vers la durabilité, les lieux dotés de *hubs* de TER seraient les plus appropriés pour atteindre les objectifs de durabilité. Cependant, cela implique que les lieux ayant de faibles niveaux de diffusion d'innovation seront laissés pour compte et ce genre d'inégalités est ce que le troisième cadre de l'innovation, appelé '*Transformative Change*', tente d'éviter. Par conséquent, l'une des principales contributions de cette thèse de doctorat est un cadre de modélisation pour une typologie d'analyse décisionnelle multicritères, où l'espace est le terrain d'étude en ce qui concerne l'allocation des ressources pour la transition vers la durabilité où il y a des zones appropriées, inadaptées et conflictuelles. Cette question s'appuie sur le fait qu'il y a une adoption inégale des TER, car tous les lieux et emplacements ne sont pas égaux et ne sont pas équipés pour adopter, adapter ou mettre en œuvre et commercialiser de nouvelles technologies de la même manière (Lundquist & Olander, 2001).

Les discussions sur ces aspects sont développées au Chapitre 1, et sont basées sur l'argument selon lequel les régions ont des capacités et des compétences différentes pour intégrer la nature complexe des processus d'innovation. En même temps, du point de vue de la géographie quantitative et théorique, il est montré dans les chapitres 5 et 6 que ces aspects ne sont pas limités aux frontières administratives, aux échelles régionales, mais peuvent se poursuivre plus bas dans des échelles spatiales physiques. Cela implique que des mécanismes similaires continuent à se reproduire dans l'espace et à différencier les lieux à fort et faible niveau d'innovation, au-delà des frontières administratives. Du point de vue de l'innovation, Rogers (1983) s'est penché sur les différents types d'innovateurs, qui décrivent différents niveaux d'innovation chez les individus, ce qui pourrait être lié aux arguments précédents, car il semble que la diffusion de l'innovation nécessite souvent des hubs.

Un deuxième aspect majeur de la diffusion des TER est lié à la croissance, car l'attachement préférentiel est défini par deux mécanismes principaux : i) les réseaux continuent de croître, un sommet étant ajouté à chaque fois et ii) les nouveaux sommets du réseau se connecteront probablement aux sommets les plus connectés, ce qui est une propriété appelée attachement préférentiel. L'itération continue de ces deux étapes, croissance et attachement préférentiel, génère l'existence de *hubs* (voir également Barabasi, 2002, 2016). La combinaison de ces deux éléments implique que tous les réseaux ne sont pas aléatoires et que les distributions de degrés du réseau suivraient des lois de puissance. Le nom pour de tels réseaux est *scale-free*. Ceux-ci sont observés dans la nature, dans le corps humain (Barabasi, 2016) et dans certains processus d'innovation sociale (Kiesling, 2011). Le modèle SPA est basé sur la théorie de l'interaction spatiale et de l'homophilie et sur une perspective de réseau, dans laquelle les sommets des réseaux TER sont liés en fonction de leur taille et de leur distance, ce qui caractérise l'intensité des interactions et la capacité de portée en termes spatiaux.

Dans le chapitre 7, nous avons développé une série de simulations de la résilience urbaine à la transition énergétique reposant toujours sur le modèle SPA ; toutefois, les réseaux énergétiques urbains de la région du Valais ont été modifiés. L'idée conceptuelle était de simuler des chocs qui modifieraient les mécanismes de diffusion de l'innovation au sein du système. La procédure consistait à "*attaquer*" le réseau en supprimant les sommets les plus importants (*hubs*) dans lesquels les niveaux de diffusion les plus élevés ont lieu. Ce faisant, des changements importants se sont produits d'un point de vue spatial, étant donné le contexte auto-organisé de la diffusion des RET. Les résultats suggèrent que le système urbain est résilient au niveau global, ce qui implique qu'un processus de réorganisation a lieu de telle sorte que de nouveaux *hubs* et de nouveaux liens apparaissent et que les réseaux conservent leur structure sans échelle. Cependant, le système n'est pas résilient au niveau local, car certains lieux à forte intensité de diffusion de l'innovation pourraient se déplacer ailleurs ou disparaître, ce qui représente un aspect majeur dans le contexte de la planification de la durabilité de la transition.

Les résultats développés au chapitre 7 suggèrent que les stratégies de développement durable ne doivent pas être appliquées à l'échelle régionale selon un raisonnement de type "fractal". Cela représente un défi majeur pour les communes et, par conséquent, la politique cantonale du canton du Valais devrait être adaptée à des échelles spatiales plus petites telles que les municipalités et même des quartiers. Une hypothèse qui pourrait expliquer ces comportements est basée sur le fait que la diffusion spatiale des TER n'est pas fractale avec une échelle

d'invariance, mais semi-fractale, où le processus est plus développé à des échelles plus grandes telles que 600 m² et 1200 m². Par conséquent, le système urbain n'est pas encore capable de faire face à de tels chocs et de se réorganiser à des échelles plus petites telles que de 300 m². Les simulations effectuées à 300 m², qui est la plus petite échelle étudiée, montrent que la localisation spatiale des *hubs* a changé, ce qui implique que de nouveaux *hubs* émergent à d'autres endroits, emportant avec eux leur influence et leurs effets. Cela signifie qu'un *hub* d'innovation situé sur une surface de 300 m² pourrait être déplacé ou disparaître et que la surface réduirait ses niveaux d'innovation, pour atteindre un niveau similaire à celui du régime inférieur du réseau de référence.

Une observation importante concernant les résultats de la simulation de la résilience urbaine à la transition énergétique est que le réseau conserve sa topologie et que sa distribution continue de suivre des lois de puissance. Cependant, étant donné que la maturité de l'auto-organisation dans certains cas est dépendante de l'échelle, des différences ont également été trouvées. D'un point de vue spatial, les systèmes auto-organisés suivent des comportements généraux tels que l'émergence d'un ordre global dérivé d'interactions locales. Selon la définition de la résilience en écologie, les systèmes résilients sont capables d'absorber, de s'adapter et sont auto-organisés. Dans le même ordre d'idées, la fractalité est une signature typique de l'auto-organisation, où une organisation hiérarchique et multi-niveaux peut être observée à plusieurs niveaux spatiaux.

Un aspect fondamental est que le modèle indique que bien que l'auto-organisation est une propriété présente dans les systèmes résilients, cela ne signifie pas que la résilience elle-même est fractale selon cette étude, puisque la capacité d'auto-organisation du système varie avec l'échelle spatiale. D'autres recherches dans cette direction et dans d'autres contextes sont nécessaires pour confirmer les résultats obtenus dans cette analyse. L'idée que la résilience n'est pas fractale n'est pas nouvelle, elle a été abordée par l'analyse du discours (Olivier Godard, 1984, 1996) mais à notre connaissance elle n'a pas été prouvée par des approches empiriques. Nous allons maintenant aborder la troisième question de recherche proposée dans la section 2.3.6.

3. Les lieux présentant des niveaux d'innovation plus élevés sont-ils plus résilients à la transition énergétique que les lieux moins innovants ?

L'hypothèse relative à cette question est liée à la question de recherche précédente et à l'hypothèse qui en découle⁷³. Par définition, les systèmes résilients sont auto-organisés. Par conséquent, comme il a été possible de vérifier que l'effet de réseau de la diffusion des technologies d'énergie renouvelable suit des lois de puissance, la réponse à cette question est positive et cela dépend de l'échelle spatiale. Les endroits et les lieux présentant des niveaux élevés d'innovation sont plus susceptibles de se trouver dans la zone auto-organisée des structures spatiales occupant une position proéminente en tant que *hubs*. Des changements dans les échelles spatiales feront varier les niveaux de "densité" d'innovation, ce qui affectera en cascade le processus de diffusion ; cependant, il est possible d'accepter l'hypothèse proposée dans la section 2.3.6. Par définition, les systèmes résilients sont auto-organisés ; par conséquent, puisque l'hypothèse d'auto-organisation est vérifiée, la réponse à cette question est oui, les lieux plus innovants sont plus résilients à la transition énergétique.

Les données disponibles au moment où cette thèse a été préparée, suggèrent que la résilience urbaine à la transition énergétique à l'échelle locale n'est pas fractale. Par conséquent, après les simulations des chocs, les comportements microscopiques ont entraîné des changements dans la position des *hubs*, ce qui implique que leur influence à des fins de diffusion disparaîtrait et changerait la structure qualitative du réseau à cette échelle. L'effet spatial, soit l'importance de l'espace dans le développement des activités dans un système (Coquillard et al., 1997),

⁷³ Question de recherche précédente : *L'effet réseau de la diffusion des technologies d'énergie renouvelable suit-il un attachement préférentiel d'un point de vue spatial et temporel ?* L'hypothèse qui sous-tend cette deuxième question de recherche est que la diffusion de l'innovation ne suit pas une distribution aléatoire du point de vue du réseau. La distribution des degrés d'un réseau spatial pourrait suivre une loi de puissance, montrant des signes de fractalité et d'auto-organisation.

permet d'observer une bifurcation qui a lieu au niveau local. Cela implique un changement dans la densité de l'emplacement des panneaux photovoltaïques. Cela ne devrait pas avoir d'impact important au niveau global car les systèmes montrent de forts niveaux de résilience en conservant la structure qualitative du réseau à 600 m² et 1200 m².

Selon la littérature, les physiciens proposent que les processus de fractalité se développent souvent des grandes vers les petites échelles (Queiros-Condé et al., 2015), comme cela a été discuté dans la section 5.5.2.1. Ici, nous discutons de comportements similaires, mais intégrés dans des systèmes sociaux d'innovation avec une considération explicite de la dimension spatiale. En conséquence, des recherches supplémentaires sont encouragées afin d'établir plus de comparaisons. Néanmoins, les résultats de ce travail de recherche sont très précieux à des fins scientifiques, pratiques et politiques. Les définitions géographiques des villes, des régions, des territoires, des emplacements et des lieux peuvent induire des erreurs en ce qui concerne la dernière question de recherche et sa réponse. C'est la raison pour laquelle la réponse fournie ici aborde explicitement la question des échelles spatiales, car les niveaux 'local et global' n'ont pas d'échelle déterminée et fixe.

Enfin, dans le chapitre 7, une introduction des nouvelles directions de recherche est proposée, intégrant le concept de panarchie développé par Gunderson & Holling (2002) en écologie. La théorie de la panarchie a gagné en pertinence en tant que cadre pour améliorer notre compréhension des écosystèmes liés aux systèmes socio-écologiques et à la gouvernance (Allen et al., 2011).

Selon les trois dimensions de la théorie de la panarchie, l'approche réseau est adaptée pour fournir des informations sur i) le potentiel de changement du système interne, ii) la connectivité du système et sa flexibilité ou rigidité d'un point de vue spatio-temporel et enfin iii) la résilience. L'idée de relier le concept de panarchie à l'innovation dans le cadre de la résilience urbaine découle de leur proximité en matière de changement et de complexité. Le comportement non linéaire des systèmes écologiques, sociaux et les deux combinés, les rétroactions à plusieurs échelles au sein de ces structures et les cycles adaptatifs imbriqués donnent un cadre à la panarchie dans le contexte de cette thèse de doctorat. Selon les auteurs de la théorie (Gunderson & Holling, 2002), la panarchie peut décrire comment des systèmes complexes, composés par exemple de personnes et de ressources naturelles, sont dynamiquement structurés et organisés à travers des échelles spatio-temporelles.

La panarchie a été appliquée pour déterminer les seuils et les opportunités concernant les interactions dans une perspective d'échelle (Van Apeldoorn, et al., 2011). Ceci est pertinent pour cette recherche car les observations du comportement de la diffusion des panneaux photovoltaïques ont montré un seuil et une transition de phase du désordre à l'ordre. Bien que le concept de seuil ait été reconnu comme une approche efficace pour faire face à l'épuisement des ressources naturelles et de l'environnement, son comportement non linéaire et sa complexité caractéristique rendent son application difficile. Ainsi, la discussion sur la panarchie dans le chapitre 7 de cette thèse de doctorat doit être considérée comme une analyse du discours scientifique, qui vise à ouvrir de nouvelles perspectives de recherche.

En ce qui concerne les limites de ce travail de recherche, l'étude dans la région suisse du Valais a été faite avec des données spatiales des panneaux photovoltaïques et non avec l'énergie produite par ces technologies. Par conséquent, d'autres recherches sont nécessaires pour valider, par recoupement, les KDE des technologies avec l'énergie réellement produite par ces innovations. Par conséquent, les informations fournies par le modèle SPA ne renseignent pas sur cet aspect important. Une autre limite de l'étude dans la région suisse concernait la confidentialité des données émises par l'Office Fédéral de la Statistique, empêchant d'utiliser les informations avec d'autres ensembles de données, par exemple pour intégrer une enquête externe. Du point de vue de la recherche, les limitations sont aussi souvent dues à des contraintes de temps.

Un exemple de prolongement serait de développer des études du point de vue de la demande et de l'offre dans deux ou plusieurs territoires afin de tirer des conclusions définitives du même point de vue. En ce qui concerne

les nouvelles directions de recherche, l'attachement préférentiel spatial présent dans le processus de transition énergétique ouvre de nouvelles perspectives dans lesquelles certaines questions difficiles pourraient être posées. L'une d'entre elles s'inscrit dans le troisième cadre de l'innovation, le '*Transformative Change*', abordé dans la section 1.3, où l'inégalité et le changement climatique sont les principaux moteurs de la politique d'innovation actuelle. Dans ce contexte, nous pouvons nous demander comment la politique d'innovation peut favoriser la justice sociale et l'égalité dans le contexte de la transition vers la durabilité ?

D'après les résultats obtenus dans ce travail de recherche, les *hubs* d'innovation, où les processus de diffusion des TER ont une forte intensité, sont nettement plus élevés que dans les lieux à faible niveau de diffusion, situés dans le régime inférieur des distributions. Le problème ici est que chaque sommet va continuer de croître proportionnellement à sa taille. Cela signifie que les localités ayant de faibles niveaux d'adoption de TER dans la région suisse, et de production de TER sur la Région SUD en France, ont de très faibles probabilités de rattraper les hubs de TER. Cela signifie que les politiques devraient prendre en compte ces aspects afin d'optimiser les efforts et les investissements, dans le but de rester en ligne avec les objectifs de durabilité tout en considérant les questions d'équité et d'égalité. Les différentes ramifications dans le domaine de la géographie ont divisé l'objectif de la recherche et donc des efforts pour traiter des recherches connexes. Le domaine émergent de la géographie de la transition vers la durabilité (GST)⁷⁴ propose une plateforme scientifique exceptionnelle pour la collaboration entre géographes au stade de la recherche sur les transitions vers la durabilité. Les nouvelles orientations de recherche accordent une place plus grande à la dimension spatiale dans les études de durabilité (voir Köhler et al., 2019).

⁷⁴ Geography of Sustainability Transition

References

- Abrahamson, E. & Rosenkopf, L. (1997). Social network effects on the extent of innovation diffusion: A computer simulation. *Organization Science*, 8(3):289-309.
- ADEME, Deloitte Développement Durable, Association d'Initiatives Locales pour l'Energie et l'Environnement (AILE), Alterra Wageningen. (2017). Biomasse agricole : état de l'art et analyse prospective, 186 p.
- Adesida, O., & Oteh, A. (1998). Envisioning the future of Nigeria. *Futures*, 30, 569-572.
- Adger W. N., (2000). Social and ecological resilience: are they related?. *Progress in Human Geography*, 24(3), p. 347-364.
<https://doi.org/10.1191/030913200701540465>
- Agrawala, S. (2007). *Climate Change in the European Alps : adapting winter tourism and natural hazards management*. Paris: Organisation for Economic Co-operation and Development.
- Al-Ahmadi, K., Alahmadi, S., & Al-Zahrani, A. (2019). Spatiotemporal Clustering of Middle East Respiratory Syndrome Coronavirus (MERS-CoV) Incidence in Saudi Arabia, 2012–2019. *International Journal of Environmental Research and Public Health*, 16(14), 2520. <https://doi.org/10.3390/ijerph16142520>.
- Albert, R., Jeong, H., Barabási, A. (1999). Diameter of the world wide web. *Nature* 401, 130-131.
- Alfeld, L. E. & Graham, A. (1976). Introduction to urban dynamics review 11 (3) 199-217.
- Alfeld, L. E. (1995). Urban dynamics—The first fifty years. *System Dynamics Review*, 11(3), 199–217.
<https://doi.org/10.1002/sdr.4260110303>.
- Allen, C. R., Angeler, D. G., Garmestani, A. S., Gunderson, L. H., & Holling, C. S. (2014). Panarchy: Theory and Application. *Ecosystems*, 17(4), 578–589. <https://doi.org/10.1007/s10021-013-9744-2>
- Allen, P. M., & Sanglier, M. (1979). A Dynamic Model of Growth in a Central Place System. *Geographical Analysis*, 11(3), 256–272.
<https://doi.org/10.1111/j.1538-4632.1979.tb00693.x>
- Allen, P. M., & Sanglier, M. (1981). A Dynamic Model of a Central Place System-II. *Geographical Analysis*, 13(2), 149–164.
<https://doi.org/10.1111/j.1538-4632.1981.tb00722.x>
- Allen, P. M. (1997). Cities And Regions as Evolutionary, Complex Systems. In *Geographical Systems Vol 4*. pp103 – 130.
- Allio, C., Waisman, H., & Jean Charles Hourcade. (2012). Impacts macroéconomiques de scénarios villes postcarbone, CIREN, 2012.
- Alkemade, F., & Castaldi, C. (2005). Strategies for the Diffusion of Innovations on Social Networks. *Computational Economics*, 25(1–2), 3–23. <https://doi.org/10.1007/s10614-005-6245-1>
- Amblard, F., Daudé, E., Gaudou, B., Grignard, A., Hutzler, G., Lang, C., Marilleau, N., Nicod, J.-M., Sheeren, D., & Taillandier, P. (2015). 3—Introduction to NetLogo. In A. Banos, C. Lang, & N. Marilleau (Eds.), *Agent-based Spatial Simulation with NetLogo* (pp. 75–123). Elsevier. <https://doi.org/10.1016/B978-1-78548-055-3.50003-4>
- Anderies, J. M., Walker, B. H., & Kinzig, A. P. (2006). Fifteen Weddings and a Funeral: Case Studies and Resilience-based Management. *Ecology and Society*, 11(1), art21. <https://doi.org/10.5751/ES-01690-110121>
- Andersson, C. K., Frenken., & A. Hellervik. (2006). A Complex Network Approach to Urban Growth', *Environ Plan A*, vol. 38, no. 10, pp. 1941–1964, Oct. 2006, DOI: 10.1068/a37418
- Anderson, M., & R, May. (1991). *Infectious Diseases of Humans Dynamics and Control*. Oxford University Press, Oxford, UK.
- Anderson, K., & Peters, G. (2016). The trouble with negative emissions. *Science*, 354(6309), 182–183.
<https://doi.org/10.1126/science.aah4567>
- Andrews, W. (1980). *Environnement urbain*. Etudes Vivantes Limitée.

- Angeler, D. G., Allen, C. R., Garmestani, A. S., Gunderson, L. H., & Linkov, I. (2016). Panarchy use in environmental science for risk and resilience planning. *Environment Systems and Decisions*, 36(3), 225–228. <https://doi.org/10.1007/s10669-016-9605-6>
- Aoyama, Y., & the participants in the economic geography 2010 workshop. (2011). The Emerging Themes in Economic Geography: Outcomes of the Economic Geography 2010 Workshop: *Economic Geography*, 87(2), 111–126. <https://doi.org/10.1111/j.1944-8287.2011.01114.x>
- Aral, S., Muchnik, L., & Sundararajan, A. (2013). Engineering social contagions: Optimal network seeding in the presence of homophily. *Network Science*, 1(2), 125–153. <https://doi.org/10.1017/nws.2013.6>
- Araldi, A. (2019). Retail distribution and urban form : Street-based models for the French Riviera. Geography. Université Côte d'Azur, Doctoral Dissertation.
- ARE (2017). Statistique suisse des zones à bâtir en 2017. Statistique et analyses Office fédéral du développement territorial ARE, Bern.
- Arntz, M., Gregory, T., & Zierahn, U. (2017). Revisiting the risk of automation. *Economics Letters*, 159, 157–160. <https://doi.org/10.1016/j.econlet.2017.07.001>
- Arrow, K.J., (1962a). Economic welfare and the allocation of resources for invention. In: Nelson, R. (Ed.), *The Rate and Direction of Inventive Activity*. National Bureau of Economic Research and Princeton University Press, Princeton NJ, pp. 609–625.
- Arrow, K. J. (1962b). The economic implications of learning by doing. *Rev. Econ. Stud.*, 1962, 29, 155–173.
- Arrow, K., Bolin, B., Costanza, R., Dasgupta, P., Folke, C., Holling, C.S., Jansson, B.-O., Levin, S., Mäler, K.-G., Perrings, C., and Pimental, D. (1995). Economic growth, carrying capacity, and the environment. *Science* 268:520-521.
- Arsham, H., & Lovric, M. (2011). Bartlett's Test. In M. Lovric (Ed.), *International Encyclopedia of Statistical Science* (pp. 87–88). Springer Berlin Heidelberg. https://doi.org/10.1007/978-3-642-04898-2_132
- Arthur, W.B., 1983. On Competing Technologies and Historical Small Events: the Dynamics of Choice Under Increasing Returns. IIASA Working Paper WP-83-090. IIASA, Laxenburg, Austria.
- Aschan-Leygonie C. (1998). La Résilience d'un système spatial : l'exemple du Comtat. Une étude comparative de deux périodes de crises au XIXe et au XXe siècle. Paris Université Paris 1, thèse de doctorat.
- Aschan-Leygonie, C. (2000). Vers une analyse de la resiliance des systèmes spatiaux. *Espace géographique*, 29(1), 64–77. <https://doi.org/10.3406/spgeo.2000.1968>
- Asheim, B. T., & Gertler, M. S. (2006). *The Geography of Innovation: Regional Innovation Systems*. Oxford University Press. <https://doi.org/10.1093/oxfordhb/9780199286805.003.0011>
- Asheim, B. T. (1996). Industrial districts as 'learning regions': A condition for prosperity. *European Planning Studies*, 4(4), 379–400. <https://doi.org/10.1080/09654319608720354>
- Atlan, H. (1979). *Entre le cristal et la fumée*. Seuil, Paris
- Atkinson, A.B. (2008). *The changing distribution of earnings in OECD countries*. Oxford University Press.
- ATMOSUD (2019). *Inventaire énergétique et d'émissions de polluants et gaz à effet de serre*.
- Audretsch, D. B., & Feldman, M. P. (1996). R&D Spillovers and the Geography of Innovation and Production. *The American Economic Review*, published by American Economic Association, volume 86(3).
- Auerbach F. (1913). Das gesetz der bevölkerungskonzentration, *Petermanns Geographische Mitteilungen*, 59, 74–76.
- Autor, D., Katz, L.F. & Krueger, A.B. (1998). Computing inequality: have computers changed the labor market? *The Quarterly Journal of Economics*, vol. 113, no. 4, pp. 1169–1213.
- Autor, D., Levy, F., & Murnane, R.J. (2003). The skill content of recent technological change: an empirical exploration. *The Quarterly Journal of Economics*.

- Avineri, E. (2012). On the use and potential of behavioural economics from the perspective of transport and climate change. *Journal of Transport Geography*, 24, 512–521. <https://doi.org/10.1016/j.jtrangeo.2012.03.003>
- Aydalot, P. (1985). *Économie Régionale et Urbaine*, Economica 1985. <https://doi.org/10.7202/021825ar>
- Aydalot, P. (1986). *Milieux Innovateurs en Europe*, GREMI, Paris, 1986.
- Babcock, D. L. (1972). Assumptions in Forrester's Urban Dynamics Model and Their Implications. *IEEE Transactions on Systems, Man, and Cybernetics*, SMC-2(2), 144–149. <https://doi.org/10.1109/TSMC.1972.4309084>
- Backstrom, L., Boldi, P., Rosa, M., Ugander, J., & Vigna, S. (2012). Four degrees of separation. In *ACM Web Science 2012: Conference Proceedings*, pages 45–54. ACM Press.
- Baddeley, M. (2010). Herding, social influence and economic decision-making: Socio-psychological and neuroscientific analyses. *Philosophical Transactions of the Royal Society B: Biological Sciences*, 365(1538), 281–290. <https://doi.org/10.1098/rstb.2009.0169>
- Badham, J., Kee, F., & Hunter, R. F. (2018). Simulating network intervention strategies: Implications for adoption of behaviour. *Network Science*, 6(2), 265–280. <https://doi.org/10.1017/nws.2018.4>
- Baerveldt, C., Van Duijn, MAJ., Vermeij, L., Van Hemert, DA., & Hemert, D. A. V. (2004). Ethnic boundaries and personal choice. Assessing the influence of individual inclinations to choose intra-ethnic relationships on pupils' networks: Assessing the influence of individual inclinations to choose intra-ethnic relationships on pupils' networks. *Social Networks*, 26(1), 55–74. <https://doi.org/10.1016/j.socnet.2004.01.003>
- Bahadur, A. V., Ibrahim, M., & Tanner, T. (2010). The resilience renaissance? Unpacking of resilience for tackling climate change and disasters. *Strengthening Climate Resilience Discussion paper*. Institute of Development Studies (UK).
- Bailly, A. (1988). *Comprendre et maîtriser l'espace ou la science régionale et l'aménagement du territoire*. Montpellier (Hérault, France: G.I.P. Reclus.
- Bailly, A., & Beguin, H. (1996). *Introduction à la géographie humaine*. Paris, Armand Colin, 203p.
- Banos, A. (2001). A propos de l'analyse spatiale exploratoire des données. *Cybergeo : European Journal of Geography, Systems, Modelling, Geostatistics*. <https://doi.org/10.4000/cybergeo.4056>
- Banos, A. (2010). À la recherche d'effets réseaux dans la dynamique du modèle de ségrégation de Schelling », *Cybergeo : European Journal of Geography* [En ligne], Systèmes, Modélisation, Géostatistiques, document 492, mis en ligne le 09 mars 2010, consulté le 04 mai 2020. URL : <http://journals.openedition.org/cybergeo/22976> ; DOI : <https://doi.org/10.4000/cybergeo.22976>
- Banos, A., Caillou, P., Gaudou, B., & Marilleau, N. (2015). 4—Agent-Based Model Exploration. In A. Banos, C. Lang, & N. Marilleau (Eds.), *Agent-based Spatial Simulation with NetLogo* (pp. 125–181). Elsevier. <https://doi.org/10.1016/B978-1-78548-055-3.50004-6>
- Banos, A., Lang, C., & Marilleau, N. (2015). *Agent-based spatial simulation with NetLogo, Volume 1*, ISBN-13: 978-1785480553, Elsevier, London, 261p.
- Banos, A., Lang, C., & Marilleau, N. (2017). *Agent-based spatial simulation with NetLogo: Advanced concepts. Volume 2*, ISBN- 978-1-78548-157-4, Elsevier, London/Oxford, 232p.
- Bak, P., Tang, C., & Wiesenfeld, K. (1987). Self-organized criticality: An explanation of the 1/f noise. *Phys. Rev. Lett.*, 59(4), 381–384. <https://doi.org/10.1103/PhysRevLett.59.381>
- Bak, P., Chen, K., & Creutz, M. (1989). Self-organized criticality in the "Game of Life." *Nature*.
- Bak, P., & Paczuski, M. (1995). Complexity, contingency, and criticality. *Proceedings of the National Academy of Sciences*, 92(15), 6689–6696. <https://doi.org/10.1073/pnas.92.15.6689>
- Bak, P. (1996). *How Nature Works: The science of self-organized criticality*, Springer.
- Barabasi, A., & Albert, R. (1999). Emergence of Scaling in Random Networks, *Science*, Vol 286, Issue 5439, 15 October 1999, pages 509-512. DOI: 10.1126/science.286.5439.509.

- Barabasi, A. (2002). *Linked: How Everything Is Connected to Everything Else and What It Means*. Perseus, Cambridge, MA. ISBN: 0-452-28439-2.
- Barabasi, A., Dezso, Z., Ravasz, E., Soon-Hyung Yook, S.H., & Zoltán Oltva, Z. (2003). Scale-Free and Hierarchical Structures in Complex Networks. *AIP Conference Proceedings*, 661, 1–16. <https://doi.org/10.1063/1.1571285>
- Barabasi, A. (2016). *Network Sciences*, Cambridge University Press. ISBN: 978-1107076266.
- Barbut, M. (1988). Des bons et moins bons usages des distributions parélienne en analyse de données. *Histoire et Mesure*, 1988.
- Barrat, A., & Weigt, M. (2000). On the properties of small-world network models. *The European Physical Journal B - Condensed Matter and Complex Systems*, 13(3), 547–560. <https://doi.org/10.1007/s100510050067>
- Barrat, A., Barthélemy, M., & Vespignani, A. (2005). The effects of spatial constraints on the evolution of weighted complex networks. *Journal of Statistical Mechanics: Theory and Experiment*, 2005(05), P05003. <https://doi.org/10.1088/1742-5468/2005/05/P05003>
- Barthélemy, M. (2003). Crossover from scale-free to spatial networks. *Europhysics Letters (EPL)*, 63(6), 915–921. <https://doi.org/10.1209/epl/i2003-00600-6>
- Barthélemy, M. (2011). Spatial Networks. *Physics Reports*, 499(1–3), 1–101. <https://doi.org/10.1016/j.physrep.2010.11.002>
- Bass, F. (1963). A Dynamic Model of Market Share and Sales Behaviour, *Proceedings, Winter Conference American Marketing Association*, Chicago, IL, (Bass Model section starts on page 269).
- Bass, F. (1969). A new product growth for model consumer durables. *Management Science* 15 215-227.
- Bass, F. M. (1980). The Relationship Between Diffusion Rates, Experience Curves, and Demand Elasticities for Consumer Durable Technological Innovations. *The Journal of Business*, 53(S3), S51. <https://doi.org/10.1086/296099>
- Bastian, M., Heymann, S., & Jacomy, M. (2009). Gephi: An Open-Source Software for Exploring and Manipulating Networks. 2.
- Batty, M., & Longley, P.A. (1994). *Fractal Cities: A Geometry of Form and Function*. Academic Press, San Diego, CA
- Batty, M. (2008). Fifty Years of Urban Modeling: Macro-Statics to Micro-Dynamics. In: Albeverio, S., Andrey, D., Giordano, P., Vancheri A. (eds). *The Dynamics of Complex Urban Systems*. Physica-Verlag HD. https://doi.org/10.1007/978-3-7908-1937-3_1
- Beccatini, G. (Ed.). (1987). *Mercato e forze locali: il distretto industriali*, Il Mulino, Bologna 1987.
- Becu, N., Amblard, F., Brax, N., Gaudou, B., & Marilleau, N. (2015). 6—How to Involve Stakeholders in the Modeling Process. In A. Banos, C. Lang, & N. Marilleau (Eds.), *Agent-based Spatial Simulation with NetLogo* (pp. 223–252). Elsevier. <https://doi.org/10.1016/B978-1-78548-055-3.50006-X>
- Beguín, H., Thill, J.C. (1985). Les ires de rayonnement des villes belges : l'utilité d'une approche théorique. *Bulletin du Crédit Communal de Belgique*, n° 154, p. 205-215.
- Belussi, F., & Caldari, K. (2008). At the origin of the industrial district: Alfred Marshall and the Cambridge school. *Cambridge Journal of Economics*, 33(2), 335–355. <https://doi.org/10.1093/cje/ben041>
- Bellet, M., Colletis, G. & Lung, Y. (Eds.). (1993). *Economie de proximités*, *Revue d'économie régionale et urbaine*, 3, special issue.
- Béné, C., Wood, R. G., Newsham, A., & Davies, M. (2012). Resilience: New Utopia or New Tyranny? Reflection about the Potentials and Limits of the Concept of Resilience in Relation to Vulnerability Reduction Programmes. *IDS Working Papers*, 2012(405), 1–61. <https://doi.org/10.1111/j.2040-0209.2012.00405.x>
- Bergek, A., Jacobsson, S., & Sandén, B. A. (2008). 'Legitimation' and 'development of positive externalities': Two key processes in the formation phase of technological innovation systems. *Technology Analysis & Strategic Management*, 20(5), 575–592. <https://doi.org/10.1080/09537320802292768>
- Bernhardt, I., & Mackenzie, K. D. (1972). Some problems in using diffusion models for new products. *Management Science*, 19(2):187-200.

- Berry, B.J.L. (1964) Cities as systems within systems of cities. *Papers and Proceedings of the Regional Science Association* 13: 147-163.
- Berry, B.J.L. (1967). *Geography of market centers and retail distribution*, New Jersey, Prentice Hall.
- Berryman, A. A. (1992). The Orgins and Evolution of Predator-Prey Theory. *Ecology*, 73(5), 1530–1535.
<https://doi.org/10.2307/1940005>
- Bechtel, W., & Abrahamsen, A. (1993). *Connectionism and the mind*. Oxford, UK: Blackwell.
- Benford, F. (1938). The Law of Anomalous Numbers. *Proceedings of the American Philosophical Society*, 78(4), 551-572. Retrieved January 4, 2019, from <http://www.jstor.org/stable/984802>
- Bianchini, F. (1991). The Third Italy: Model or myth? *Ekistics*, 58(350/351), 336-345. <http://www.jstor.org/stable/43646779>
- Bideau, F. G., Pedrazzini, Y., Bordone, L., Herrera, L., & Pieri, F. D. (2014). *SNIS / Project Mapping Controversial memories. Working paper*. 33.
- Binz, C., Truffer, B., Li, L., Shi, Y., & Lu, Y. (2012). Conceptualizing leapfrogging with spatially coupled innovation systems: The case of onsite wastewater treatment in China. *Technological Forecasting and Social Change*, 79(1), 155–171.
<https://doi.org/10.1016/j.techfore.2011.08.016>
- Binz, C., Truffer, B., & Coenen, L. (2016). Path Creation as a Process of Resource Alignment and Anchoring: Industry Formation for On-Site Water Recycling in Beijing. *Economic Geography*, 92(2), 172–200. <https://doi.org/10.1080/00130095.2015.1103177>
- Blaikie, P. (1978). The Theory of the Spatial Diffusion of Innovations: A Spacious Cul-De-Sac. *Progress in Human Geography*, 2(2), 268–295. <https://doi.org/10.1177/030913257800200204>
- Blondel, J., Aronson, J., Bodiou, J.-Y. & Boeuf, G. (2010). *The Mediterranean Region: Biological Diversity in Space and Time*, OUP Oxford, Oxford ; New York, 392 p.
- BMBF. (2016). -Internetredaktion Zukunftsprojekt Industrie 4.0 - BMBF. Retrieved online, November 30, 2018.
- Bodlaj, M., Kadic-Magljalic, S., & Vida, I. (2020). Disentangling the impact of different innovation types, financial constraints and geographic diversification on SMEs' export growth. *Journal of Business Research*, 108, 466–475.
<https://doi.org/10.1016/j.jbusres.2018.10.043>
- Bohlmann, J. D., Calantone, R. J., & Zhao, M. (2010). The Effects of Market Network Heterogeneity on Innovation Diffusion: An Agent-Based Modeling Approach: The Effects of Market Network Heterogeneity on Innovation Diffusion. *Journal of Product Innovation Management*, 27(5), 741–760. <https://doi.org/10.1111/j.1540-5885.2010.00748.x>
- Bollobas, B. (1985) *Random Graphs*. Cambridge: Cambridge University Press. ISBN 10:0121117561. ISBN 13: 9780121117566
- Bolton, R., & Hannon, M. (2016). Governing sustainability transitions through business model innovation: Towards a systems understanding. *Research Policy*, 45(9), 1731–1742. <https://doi.org/10.1016/j.respol.2016.05.003>
- Bonß, W. (2016). 'The notion of Resilience: Trajectories and Social Science Perspectives'. In A. Mauer (Ed.). *New Perspectives on Resilience in Socio-Economic Spheres*. Springer VS. E-book. p. 9–24.
- Bonnardot, V., Carey, V., Madelin, M., Cautenet, S., & Quenol, H., (2012). Using atmospheric and statistical models to understand local climate and assess spatial temperature variability at fine scale over the Stellenbosch wine district, South Africa. *Int. J. Vine Wine Sci.* 46 (1), 1-13.
- Borshchev, A., & Filippov, A. (2004). *From System Dynamics and Discrete Event to Practical Agent Based Modeling: Reasons, Techniques, Tools*. Conference: The 22nd International Conference of the System Dynamics Society, Oxford, England.
- Bourdeau, P. (2009). From après-ski to après-tourism: The Alps in transition?: Reflections based on the French situation. *Revue de Géographie Alpine*, 97–3. <https://doi.org/10.4000/rga.1054>
- Boschma, R. (2004). Competitiveness of Regions from an Evolutionary Perspective. *Regional Studies*, 38(9), 1001–1014.
<https://doi.org/10.1080/0034340042000292601>

- Boschma, R. (2005). Proximity and Innovation: A Critical Assessment. *Regional Studies*, 39(1), 61–74. <https://doi.org/10.1080/0034340052000320887>
- Boschma, R., & Frenken, K. (2006). Why is economic geography not an evolutionary science? Towards an evolutionary economic geography. *Journal of Economic Geography*, 6(3), 273–302. <https://doi.org/10.1093/jeg/lbi022>
- Boschma, R., & Frenken, K. (2009). The Spatial Evolution of Innovation Networks: A Proximity Perspective. Papers in Evolutionary Economic Geography (PEEG) 0905, Utrecht University, Department of Human Geography and Spatial Planning, Group Economic Geography, revised Jun 2009.
- Boschma, R. (2015). Towards an Evolutionary Perspective on Regional Resilience. *Regional Studies*, 49(5), 733–751. <https://doi.org/10.1080/00343404.2014.959481>
- Boschma, R., Coenen, L., Frenken, K., & Truffer, B. (2017). Towards a theory of regional diversification: Combining insights from Evolutionary Economic Geography and Transition Studies. *Regional Studies*, 51(1), 31–45. <https://doi.org/10.1080/00343404.2016.1258460>
- Boschma, R., & R. Martin. (2007). Editorial: Constructing an evolutionary economic geography. *Journal of Economic Geography* 7:537-548.
- Boschma, R., & Martin, R. (Eds.). (2010). *The Handbook of Evolutionary Economic Geography*. Cheltenham, UK: Edward Elgar Publishing. doi: <https://doi.org/10.4337/9781849806497>
- Boudeville, J.R. (Ed.). (1968). *L'espace et les pôles de croissance*. Paris, PUF.
- Box, G. E. P. (1953). Non-normality and tests on variances. *Biometrika*, 40, 318–335
- Boyer, J. (2020). Toward an Evolutionary and Sustainability Perspective of the Innovation Ecosystem: Revisiting the Panarchy Model. *Sustainability*, 12(8), 3232. <https://doi.org/10.3390/su12083232>
- Brand, F., & Jax, K. (2007). Focusing the Meaning(s) of Resilience: Resilience as a Descriptive Concept and a Boundary Object. *Ecology and Society*, 12(1), art23. <https://doi.org/10.5751/ES-02029-120123>
- Bresnahan, T.F., Brynjolfsson, E. & Hitt, L.M. (2002). Information technology, workplace organization, and the demand for skilled labor: Firm-level evidence. *The Quarterly Journal of Economics*, vol. 117, no. 1, pp. 339–376.
- Bridge, G., Bouzarovski, S., Bradshaw, M., & Eyre, N. (2013). Geographies of energy transition: Space, place and the low-carbon economy. *Energy Policy*, 53, 331–340. <https://doi.org/10.1016/j.enpol.2012.10.066>
- Bristow, G. & Healy, A. (2014). Regional Resilience: An Agency Perspective. *Regional Studies*, 48:5, p. 923–935.
- Bristow, G., & Healy, A. (2018). Innovation and regional economic resilience: An exploratory analysis. *The Annals of Regional Science*, 60(2), 265–284. <https://doi.org/10.1007/s00168-017-0841-6>
- Bronnenberg, B. J., & C. F. Mela. (2004). Market roll-out and retailer adoption for new brands. *Marketing Science* 23 (4): 500–18.
- Brown, L. (1981). *Innovation Diffusion*. Methuen, London.
- Brown, S. (1993a). Micro-scale retail location: Cinderella or ugly sister? *International Journal of Retail and Distribution Management*, 21(7).
- Brown, S. (1994). Retail location at the micro-scale: inventory and prospect. *Service Industries Journal*, 14(4), 542-576.
- Broz, J. L., Frieden, J., & Weymouth, S. (2019). Populism in Place: The Economic Geography of the Globalization Backlash. *SSRN Electronic Journal*. <https://doi.org/10.2139/ssrn.3501263>
- Brunet, R., Ferras, R., Thery, H., (1992). *Les mots de la géographie – Dictionnaire critique*, Montpellier, Reclus, 2ème édition, 518 p.
- Brunn, Stanley D., Cutter, Susan L., Harrington Jr., J.W. (2004). *Geography and Technology*. Springer.
- Brusco, S. (1982) The Emilian model: Productive decentralisation and social integration. (1982). *Cambridge Journal of Economics*. <https://doi.org/10.1093/oxfordjournals.cje.a035506>

- Brynjolfsson, E., & McAfee, A. (2011). *Race against the machine: How the digital revolution is accelerating innovation, driving productivity, and irreversibly transforming employment and the economy*. Digital Frontier Press Lexington, ma.
- Bulkeley, H., Castan-Broto, V., Hodson, M. & Marvin, S. (eds.). (2011). *Cities and Low Carbon Transitions*. London: Routledge.
- Bunnell, T. G., & Coe, N. M. (2001). Spaces and scales of innovation. *Progress in Human Geography*, 25(4), 569–589. <https://doi.org/10.1191/030913201682688940>
- Bura, S., Guerin-Pace, F., Mathian, H., Pumain, D., & Sanders, L. (1996). Multi-agents systems and the dynamics of a settlement system. *Geographical Analysis* 28, 2: 161-178.
- Burdekin, R. (1979). A dynamic spatial urban model: A generalization of Forrester's urban dynamics mode. *Urban Systems*, Volume 4, Issue 2, Pages 93-120. [https://doi.org/10.1016/0147-8001\(79\)90010-X](https://doi.org/10.1016/0147-8001(79)90010-X)
- Burks, A. (1970). *Essays on celular automata*. University of Illinois Press, Urbana.
- Camagni, R. (1991). Local 'Milieu', Uncertainty and Innovation Networks: Towards a New Dynamic Theory of Economic Space. In: Camagni, R., Ed., *Innovation Networks: Spatial Perspectives*, Belhaven, London, 121-144.
- Camagni R., Capello R. (2002) Milieux Innovateurs and Collective Learning: From Concepts to Measurement. In: Acs Z.J., de Groot H.L.F., Nijkamp P. (eds) *The Emergence of the Knowledge Economy*. *Advances in Spatial Science*. Springer, Berlin, Heidelberg. https://doi.org/10.1007/978-3-540-24823-1_2
- Cambien, A. (2007). Une introduction à l'approche systémique : Appréhender la complexité. Centre d'Études sur les réseaux, les transports, l'urbanisme et les constructions publiques.
- Cancino, C. A., Merigo, J. M., & Coronado, F. C. (2017). Big Names in Innovation Research: A Bibliometric Overview. *Current Science*, 113(08), 1507. <https://doi.org/10.18520/cs/v113/i08/1507-1518>
- Canton J. (2004). Designing the future: NBIC technologies and human performance enhancement. *Annals of the New York Academy of Sciences*, 1013, 186–198. <https://doi.org/10.1196/annals.1305.010>
- Cantono, S. & Silverberg, G. (2009). A percolation model of eco-innovation diffusion: the relationship between diffusion, learning economies and subsidies. *Technological Forecasting and Social Change*, 76(4):487-496.
- Callon, M. (1994). Is Science a Public Good? Fifth Mullins Lecture, Virginia Polytechnic Institute, 23 March 1993. *Science, Technology, & Human Values*, 19(4), 395–424. <https://doi.org/10.1177/016224399401900401>.
- Caloz, R., Collet, C. (2011). *Analyse spatiale de l'information géographique*. PPUR Presses polytechniques.
- Capasso, M., Hansen, T., Heiberg, J., Klitkou, A., & Steen, M. (2019). Green growth – A synthesis of scientific findings. *Technological Forecasting and Social Change*, 146, 390–402. <https://doi.org/10.1016/j.techfore.2019.06.013>
- Carayannis, E. G., & Campbell, D. F. J. (2009). 'Mode 3' and 'Quadruple Helix': Toward a 21st century fractal innovation ecosystem. *International Journal of Technology Management*, 46(3/4), 201. <https://doi.org/10.1504/IJTM.2009.023374>
- Carpenter, S. R., & K. L. Cottingham. (1997). Resilience and restoration of lakes. *Conservation Ecology*. 1(1): 2. <http://www.consecol.org/vol1/iss1/art2/>
- Carpenter, S., Walker, B., Anderies, J. M., & Abel, N. (2001). From Metaphor to Measurement: Resilience of What to What? *Ecosystems*, 4(8), 765–781. <https://doi.org/10.1007/s10021-001-0045-9>
- Carpenter, S. R., & Folke, C. (2006). Ecology for transformation. *Trends in Ecology & Evolution*, 21(6), 309–315. <https://doi.org/10.1016/j.tree.2006.02.007>
- Carrincazeaux, C., Lung, Y., & Vicente, J. (2008). The Scientific Trajectory of the French School of Proximity: Interaction- and Institution-based Approaches to Regional Innovation Systems. *European Planning Studies*, 16(5), 617–628. <https://doi.org/10.1080/09654310802049117>
- Carvalho, L., Mingardo, G., & Van Haaren, J. (2012). Green Urban Transport Policies and Cleantech Innovations: Evidence from Curitiba, Göteborg and Hamburg. *European Planning Studies*, 20(3), 375–396. <https://doi.org/10.1080/09654313.2012.651801>

- Carver, S.J. (1991). Integrating Multi-Criteria Evaluation with Geographical Information Systems. *International Journal of Geographic Information System* 5(3), 321-339.
- Casti, J.L., & Swain, H. (1975). Catastrophe Theory and Urban processes. *Optimization Techniques* 1975: 388-406
- Charbonnier (2009). Etude de la biomasse agricole et de première transformation mobilisable en région PACA 1 Chambre Régionale d'Agriculture de Provence Alpes Cotes d'Azur – 2008 – 2009 Méthodologie et synthèse.
- Cebrat, K., & Sobczykński, M. (2016). Scaling Laws in City Growth: Setting Limitations with Self-Organizing Maps', *PLoS ONE*, vol. 11, no. 12, p. e0168753, Dec. 2016, DOI: 10.1371/journal.pone.0168753
- CEREMA. (2019). Évaluation macroscopique du potentiel photovoltaïque mobilisable au sol en région Provence-Alpes-Côte d'Azur.
- Cerra, V., Fatas, A., & Saxena, S. (2020). Hysteresis and Business Cycles. *IMF Working Papers*, 20(73). <https://doi.org/10.5089/9781513536996.001>
- CERTU. (2005). L'estimation de la densité par la méthode du noyau. Lyon, France.
- Chatterjee, R., & Eliashberg J. (1990). The innovation diffusion process in a heterogeneous population: a micromodeling approach. *Manag Sci* 36(9):1057–1079.
- Choi, H., Kim, S., & Lee, J. (2010). Role of network structure and network effects in diffusion of innovations. *Industrial Marketing Management*, 39(1):170-177.
- Christaller, W. (1966). *Central Places in Southern Germany*. Prentice-Hall, Englewood Cliffs, NJ (translated from the 1933 German Edition *Die zentralen Orte in Süddeutschland*. Jena: Gustav Fischer Verlag; translated by W. Baskin as *Central Places in Southern Germany*. Englewood Cliffs, NJ: Prentice-Hall.
- CH2018. (2018). *Climate Scenarios for Switzerland*, Technical Report, National Centre for Climate Services, Zurich, 271 pp. ISBN: 978-3-9525031-4-0.
- Clarke, GP. (1996) *Microsimulation for Urban and Regional Policy Analysis*. (Ed.). Pion, London.
- Clauset, A., Shalizi, C. R., & Newman, M. E. J. (2009). Power-law distributions in empirical data. *SIAM Review*, 51(4), 661–703. <https://doi.org/10.1137/070710111>
- Claval, P. (1966). La théorie des lieux centraux, *Revue de géographie de l'est*, n° 2, p 131- 152.
- Claval, P. (1968). La théorie des villes. *Revue Géographique de l'Est*, 8(1), 3–56. <https://doi.org/10.3406/rgest.1968.2008>
- Claval P. (1981). *La logique des villes*. Paris, Litec, 633 p.
- Cliquet, G. (1988). Les modèles gravitaires et leur évolution. *Recherche et Applications en Marketing (French Edition)*, vol. 3, 3: pp. 39-52.
- Coenen, L., Benneworth, P., & Truffer, B. (2012). Toward a spatial perspective on sustainability transitions. *Research Policy*, 41(6), 968–979. <https://doi.org/10.1016/j.respol.2012.02.014>
- Coenen, L., Hansen, T., & Rekers, J. V. (2015). Innovation Policy for Grand Challenges. An Economic Geography Perspective: Grand Challenges and Economic Geography. *Geography Compass*, 9(9), 483–496. <https://doi.org/10.1111/gec3.12231>
- Cohen, W.M., Levinthal, D.A. (1989). Innovation and learning: the two faces of R&D. *Econ. J.* 99 (397), 569–596.
- Cohen, W. M., & Levinthal, D. A. (1990). Absorptive Capacity: A New Perspective on Learning and Innovation. *Administrative Science Quarterly*, 35(1), 128. <https://doi.org/10.2307/2393553>
- Collins, H. M. (1974). The TEA Set: Tacit Knowledge and Scientific Networks. *Science Studies*, 4(2), 165–185. <https://doi.org/10.1177/030631277400400203>.
- Colon, C. (2016). *Modelling Economic Resilience*. Dynamical Systems [math.DS]. Université Paris-Saclay, 2016. Thèse de Doctorat.

- Costanza, R. (2003). A vision of the future of science: Reintegrating the study of humans and the rest of nature. *Futures*, 35(6), 651–671. [https://doi.org/10.1016/S0016-3287\(02\)00105-2](https://doi.org/10.1016/S0016-3287(02)00105-2)
- Contractor, F., & Lorange, P. (1988). Why should firms cooperate? The strategy and economics basis for cooperative ventures. In F. Contractor and P. Lorange (eds.), *Cooperative strategies in international business*. Lexington: Lexington Books, 3-30.
- Converse, P. D (1949). New Laws of Retail Gravitation *Journal of Marketing* Vol. 14, No. 3, pp. 379-384
- Converse, P. D (1943). A Study of Retail Trade Areas in East Central Illinois. Urbana: University of Illinois, Bureau of Economic and Business Research, Business Studies, 2.
- Converse, P. D (1948). Consumer Buying Habits in Selected South Central Illinois Communities (Urbana: University of Illinois, Bureau of Economic and Business Research, Business Studies, 6.
- Cortright, J., & Mayer, H. (2002) *Signs of life: The Growth of Biotechnology Centres in the U.S.*, Washington, DC: Center on Urban and Metropolitan Policy, The Brookings Institution.
- Combes, P. P., Duranton, G., Gobillon, L., Puga, D., & Roux, S. (2012). The productivity advantages of large cities: Distinguishing agglomeration from firm selection, *Econometrica*, 80: 2543–2594. DOI: [stable/23357235](https://doi.org/10.3982/ECTA12001).
- Comfort, L. K., Boin, A., & Demchak, C. (2010). *Designing Resilience. Preparing to extreme events*. Pittsburgh, University of Pittsburgh Press.
- Coquillard P., & Hill D. R. (1997). *Modélisation et simulation d'écosystèmes : des modèles déterministes aux simulations à évènements discrets*. Paris, Masson.
- Corson, N., & Olivier, D. (2015). 5—Dynamical Systems with NetLogo. In A. Banos, C. Lang, & N. Marilleau (Eds.), *Agent-based Spatial Simulation with NetLogo* (pp. 183–221). Elsevier. <https://doi.org/10.1016/B978-1-78548-055-3.50005-8>
- Cowan, R., & Jonard, N. (1999). Network Structure and the Diffusion of Knowledge. MERIT Research Memorandum, n° 99-028.
- Cowan R., Jonard N., & Zimmermann JB. (2003). The Joint Dynamics of Networks and Knowledge. In: Cowan R., Jonard N. (eds.). *Heterogenous Agents, Interactions and Economic Performance*. Lecture Notes in Economics and Mathematical Systems, vol 521. Springer, Berlin, Heidelberg. https://doi.org/10.1007/978-3-642-55651-7_10
- Cowan, R., N. Jonard & J.-B. Zimmermann (2003). La Dynamique Conjointe de la Connaissance et des Réseaux. *Revue d'Economie Industrielle*, 103, 253-274.
- Cowan, R., & Jonard, N. (2004). Network structure and the diffusion of knowledge. *Journal of Economic Dynamics and Control*, 28(8), 1557–1575. <https://doi.org/10.1016/j.jedc.2003.04.002>
- Cowan R., Jonard N., & Zimmermann JB. (2004). On the Creation of Networks and Knowledge. In: Gallegati M., Kirman A.P., Marsili M. (eds.). *The Complex Dynamics of Economic Interaction*. Lecture Notes in Economics and Mathematical Systems, vol 531. Springer, Berlin, Heidelberg. https://doi.org/10.1007/978-3-642-17045-4_20
- Cowan, R., Jonard, N., & Zimmermann, J.B. (2006). Evolving networks of inventors. *Journal of Evolutionary Economics*, Springer, vol. 16(1), pages 155-174, April.
- CREA. (2017). PIB valaisan. Lausanne, Suisse. <https://www.bcn.ch/la-bcn/actualites-et-medias/publications/pib-romand/2016>
- Crevoisier, O. (2001). L'approche par les milieux innovateurs: État des lieux et perspectives. *Revue d'Économie Régionale & Urbaine*, février (1), 153. <https://doi.org/10.3917/reru.011.0153>
- CSO. (2017). Office cantonal de la statistique et de la péréquation. (2017). *Le Valais en chiffres*. Le Valais en chiffres, Canton du Valais. <https://www.vs.ch/web/acf/publications-de-l-ocsp>
- CSO. (2018). Office cantonal de la statistique et de la péréquation. *STATPOP*, <https://www.vs.ch/web/acf/statpop>
- Da Cunha, A., Thomas, I. (2017). Introduction » in *La ville résiliente, comment la construire ?* Collectif, Isabelle Thomas, Antonio Da Cunha, Collection PUM, Montréal (in French).
- Dainton, B., (2001). *Time and Space*. McGill-Queen's University Press, Montreal.

- Dake K., Wildavsky A. (1991) Individual Differences in Risk Perception and Risk-Taking Preferences. In: Garrick B.J., Gekler W.C. (eds) *The Analysis, Communication, and Perception of Risk*. Advances in Risk Analysis, vol 9. Springer, Boston, MA.
https://doi.org/10.1007/978-1-4899-2370-7_2
- Daley, D. J., & Kendall, D. G. (1965). Stochastic Rumours. *IMA Journal of Applied Mathematics*, 1(1), 42–55.
<https://doi.org/10.1093/imamat/1.1.42>
- Dauphiné, A. (1990). Nice : une eurocité méditerranéenne. Nice, Serre.
- Dauphiné A., (1995). Chaos, fractales et dynamiques en géographie. Montpellier. Reclus.
- Dauphiné, A. 2003. Les réseaux urbains: un exemple d'application de la théorie des systèmes auto organisés critiques / Urban networks: a case study of the critical self-organized system theory, geo, vol. 112, no. 631, pp. 227–242, 2003, DOI: 10.3406/geo.2003.912.
- Dauphiné, A., & Provitolo, D. (2007). La résilience : Un concept pour la gestion des risques. *Annales de géographie*, 654(2), 115.
<https://doi.org/10.3917/ag.654.0115>
- Dauphiné, A. (2011). *Fractal Geography*. John Wiley & Sons Publishers.
- Dauphiné, A., & Provitolo, D. (2013). Risques et Catastrophes. Observer, spatialiser, comprendre, gérer
- Dussauge, P., & Garrette, B. (1999). Cooperative strategy - competing successfully through strategic alliances. ISBN: 978-0-471-97492-5 Chichester: Wiley.
- Davoudi, S., Shaw, K., Haider, L. J., Quinlan, A. E., Peterson, G. D., Wilkinson, C., Fünfgeld, H., McEvoy, D., Porter, L., & Davoudi, S. (2012). Resilience: A Bridging Concept or a Dead End? "Reframing" Resilience: Challenges for Planning Theory and Practice Interacting Traps: Resilience Assessment of a Pasture Management System in Northern Afghanistan Urban Resilience: What Does it Mean in Planning Practice? Resilience as a Useful Concept for Climate Change Adaptation? The Politics of Resilience for Planning: A Cautionary Note: Edited by Simin Davoudi and Libby Porter. *Planning Theory & Practice*, 13(2), 299–333.
<https://doi.org/10.1080/14649357.2012.677124>
- David, P.A., 1975. Technical Choice, Innovation and Economic Growth. Cambridge University Press, Cambridge.
- Dawley, S. (2014). Creating new paths? Offshore wind, policy activism, and peripheral region development. *Economic Geography*, 90, 91–112. doi:10.1111/ecge.12028
- Dawson, J. A. & Kirby, D. A. (1980). Urban Retail Provision and Consumer Behaviour: Some Examples From Western Society, in D. '1'. Herbert & R. J. Johnston (eds), *Geography and the Urban Environment: Progress in Research and Applications*, vol. 3, London: John Wiley, 87- 132.
- De Bresson, C., & HU, X. (1999). Identifying Clusters of Innovative Activity: A New Approach and Toolbox, in OCDE 1999.
- De Cian, E., Dasgupta, S., Hof, A. F., van Sluisveld, M. A. E., Köhler, J., Pfluger, B., & van Vuuren, D. P. (2020). Actors, decision-making, and institutions in quantitative system modelling. *Technological Forecasting and Social Change*, 151, 119480.
<https://doi.org/10.1016/j.techfore.2018.10.004>
- Deffuant, G., Huet, S., & Amblard, F. (2005). An individual-based model of innovation diffusion mixing social value and individual benefit. *American Journal of Sociology*, 110(4):1041-1069.
- Delre, S. A., Jager, W., & Janssen, M. A. (2007a). Diffusion dynamics in small-world networks with heterogeneous consumers. *Computational and Mathematical Organization Theory*, 13(2), 185–202. <https://doi.org/10.1007/s10588-006-9007-2>
- Delre, S. A., Jager, W., Bijmolt, T. H. A., & Janssen, M. A. (2007b). Targeting and timing promotional activities: An agent-based model for the takeoff of new products. *Journal of Business Research*, 60(8):826-835.
- Delre, S. A., Jager, W., Bijmolt, T. H. A., & Janssen, M. A. (2010). Will it spread or not? The effects of social influences and network topology on innovation diffusion. *Journal of Product Innovation and Management*, 27(2):267-282.
- Deroian, F. (2002). Formation of social networks and diffusion of innovations. *Research Policy*, 31(5):835-846.

- Derycke, H., Huriot, M., & Pumain, D. (eds.). (1996.) *Penser la ville. Théories et modèles*, 335 p. Anthropos, Paris.
- DREAL (2012). *Schéma régional éolien en en Provence-Alpes-Côte d'Azur*, 70 p.
- DREAL (2019). *Cadre régional pour le développement des projets photovoltaïques en Provence-Alpes-Côte d'Azur*, 101 p.
- Dubus N., C. Helle & M. Masson-Vincent. (2010). De la gouvernance à la géogouvernance : de nouveaux outils pour une démocratie locale renouvelée. *L'Espace Politique. Revue en ligne de géographie politique et de géopolitique*, (10).
- Dubus N., C. Voiron-Canicio-Canicio, K. Emsellem, P. Cicille, J.-C. Loubier & D. Bley (2015). Géogouvernance : l'espace comme médiateur et l'analyse spatiale comme vecteur de communication entre chercheurs et acteurs. In *Colloque International du GIS Démocratie et Participation. Chercheur es et acteur es de la participation : Liaisons dangereuses et relations fructueuses*.
- Dumolard, P. (1999). Accessibilité et diffusion spatiale. *L'espace Géographique* n° 3, 1999, pp. 205-214.
- Durand-Dastès, F. (2003). Les géographes et la notion de causalité. *Enquête sur la notion de causalité*, PUF, pp.145-160.
- Durantou, G., & Puga, D. (2003). *Micro-Foundations of Urban Agglomeration Economies* (No. w9931; p. w9931). National Bureau of Economic Research. <https://doi.org/10.3386/w9931>
- Dutozia, J. (2013). *Espaces à enjeux et effets de réseaux dans les systèmes de risques*. Université Nice-Sopria Antipolis. Thèse de doctorat, 314 pages.
- Dutozia, J., & Voiron-Canicio-Canicio, C. (2018). *La résilience urbaine face aux risques, en contexte de changement climatique*. <https://doi.org/10.13140/RG.2.2.23752.62720>
- EC. (2017). *My Region, My Europe, Our Future. Seventh report on economic, social and territorial cohesion*, ed. L. Dijkstra. Brussels: European Commission.
- Eastman J. R., Jiang H., & Toledano J. (1998). Multi-criteria and multi-objective decision making for land allocation using GIS. *Multicriteria analysis for land-use management*. Springer Netherlands, p. 227-251.
- Eastman, J. R., Solorzano, L., & Van Fossen, M. (2005). Transition Potential Modeling for Land-Cover Change. In *GIS, Spatial Analysis and Modeling*, edited by David J. Maguire, Michael Batty and Michael F. Goodchild, 357-385. Redlands, CA: ESRI Press.
- Eastman, J. R. (2009). *IDRISI Taiga guide to GIS and image processing*. Clark Labs, Clark University. Worcester.
- Edquist, C. (Ed.). 1997. *Systems of Innovation: Technologies, Institutions and Organizations*. Pinter, London.
- Edquist, C., & Hommen, L. (1999). Systems of innovation: Theory and policy for the demand side. *Technology in Society*, 21(1), 63–79. [https://doi.org/10.1016/S0160-791X\(98\)00037-2](https://doi.org/10.1016/S0160-791X(98)00037-2)
- Eek, H., & Swahn, J. *Solstad Goteborg 2050, Project Goteborg 2050*, Available at. www.goteborg2050.nu.
- El Bilali, H. (2019). The Multi-Level Perspective in Research on Sustainability Transitions in Agriculture and Food Systems: A Systematic Review. *Agriculture*, 9(4), 74. <https://doi.org/10.3390/agriculture9040074>
- Ellis, L. (1988). *Les Russes sur la Côte d'Azur*. Nice, Serre
- Elzen, B., Geels, F., & Green, K. (Eds.). (2004). *System Innovation and the Transition to Sustainability. Theory, Evidence and Policy*. Mass: Edward Elgar, ebrary, Inc. Cheltenham, U.K, Northampton.
- Emery, J., Marilleau, N., Martiny, N., & Thévenin, T. (2020). Le modèle SCAUP: Simulation multi-agents à partir de données de Capteurs Urbains pour la Pollution atmosphérique automobile. *Cybergeo: European Journal of Geography*.
- Emsellem, K., Dubus, N., Voiron-Canicio-Canicio, C., Loubier, J.-C., & Cicille, P. (2018). In *Bulletin de la société géographique de Liege*, volume 71. Spatialité et géogouvernance: conceptualisation, expérimentations, évaluations.
- Engler, R., Randin, F., Thuiller, W., Dullinger, S., Zimmermann, E., Araujo B., Pearman, B., Le Lay, G., Piedallu, C., Albert, H., Choler, P., Coldea, G., De Lamo, X., Dirnbock, T., Gegout, J.-C., Gomez, D., Grytnes, J.-A., Heegaard, E., Hoistad, F., & Guisan, A. (2011). 21st century climate change threatens mountain flora unequally across Europe. *Global Change Biology*, 17(7), 2330–2341. <https://doi.org/10.1111/j.1365-2486.2010.02393.x>

- Erdős, P., & Rényi, A. (1959). On the evolution of random graphs. *Publ. Math. Inst. Hungary. Acad. Sci.*
- Erdős, P., & Rényi, A. (1968). On random matrices II. *Studia Sci. Math. Hungary*, 13:459-464.
- ESRI. (2018). ESRI Blog. <https://www.esri.com/arcgis-blog/products/product/analytics/how-to-perform-spatial-analysis/>
- Etzkowitz, H., Leydesdorff, L. (Eds.). 1997. *Universities and the Global Knowledge Economy: A Triple Helix of University-Industry-Government Relations*. Cassel Academic, London.
- Evans, R., & Karecha, J. (2014). Staying on Top: Why is Munich so Resilient and Successful? *European Planning Studies*, 22(6), 1259–1279. <https://doi.org/10.1080/09654313.2013.778958>
- Fagerberg, J. (2003). Schumpeter and the revival of evolutionary economics: An appraisal of the literature. *Journal of Evolutionary Economics*, 13(2), 125–159. <https://doi.org/10.1007/s00191-003-0144-1>
- Fagerberg, J., Mowery, D. C., & Nelson, R. R. (Eds.). 2004. *The Oxford Handbook of Innovation*. Oxford University Press, Oxford.
- Fagerberg, J., & Mowery, D. C. (2009). *Innovation: A Guide to the Literature*. Oxford University Press.
- Fagerberg, J., Fosaas, M., & Sappasert, K. (2012). Innovation: Exploring the knowledge base. *Research Policy*, 41(7), 1132–1153. <https://doi.org/10.1016/j.respol.2012.03.008>
- Farmer, J. D., & Lafond, F. (2016). How predictable is technological progress? *Research Policy*, 45(3), 647–665. <https://doi.org/10.1016/j.respol.2015.11.001>
- Farla, J., Markard, J., Raven, R., & Coenen, L. (2012). Sustainability transitions in the making: A closer look at actors, strategies and resources. *Technological Forecasting and Social Change*, 79(6), 991–998. <https://doi.org/10.1016/j.techfore.2012.02.001>
- Feenstra, R. C., Inklaar, R., & Timmer, M. P. (2015). The Next Generation of the Penn World Table. *American Economic Review*, 105(10), 3150–3182. <https://doi.org/10.1257/aer.20130954>
- Feldman, M. P. (1993). An Examination of the Geography of Innovation. *Industrial and Corporate Change*, 2(3), 451–470. <https://doi.org/10.1093/icc/2.3.451>
- Feldman, M. P. (1994). *The Geography of Innovation*. Kluwer Academic.
- Feldman, M. P. (2001). Where science comes to life: University Bioscience, Commercial Spion-offs, and Regional Economic Development. *Journal of Comparative Policy Analysis: Research and Practce2*: 345-61.
- Ferber, J. (1995). *Les systèmes multi-agents: vers une intelligence collective*, Informatique, Intelligence Artificielle, Interéditions.
- Fingleton, B., Garettsen, H., & Martin, R. (2012) Recessionary shocks and regional employment: evidence on the resilience of UK regions, *Journal of Regional Science* 52, 109–133. <https://doi:10.1111/j.1467-9787.2011.00755.x>
- Fingleton, B., Garettsen, H., & Martin, R. (2015). Shocking aspects of monetary union: the vulnerability of regions in Euroland. *Journal of Economic Geography* 15, 907–934. <https://doi:10.1093/jeg/lbu055>
- Folke, C. (2006). Resilience: The emergence of a perspective for social–ecological systems analyses. *Global Environmental Change*, 16(3), 253–267. <https://doi.org/10.1016/j.gloenvcha.2006.04.002>
- Forrester, J. W. (1961). *Industrial Dynamics*. Waltham, MA: Pegasus Communications.
- Forrester, J. W. (1969). *Urban Dynamics*. Cambridge, Massachussetts., MIT.
- Forrester, J. W. (1971a). Counterintuitive behaviour of social systems. *Theory and Decision*, 2(2), 109–140. <https://doi.org/10.1007/BF00148991>
- Forrester, J. W. (1971b). *World Dynamics*, Wright-Allen Press.
- Forrester, J. W. (1975). *Collected Papers of Jay W. Forrester*, Portland OR: Productivity Press. 284 pp.
- Forrester, J. W., N. Mass, & C. Ryan. (1976). The system dynamics national model: Understanding socio-economic behaviour and policy alternatives, *Technological Forecasting and Social Change* 9(1/2), 51-68.

- Forrester, J. W. (1980). Information Sources for Modeling the National Economy. *Journal of the American Statistical Association*, 75(371), 555-574.
- Forrester, J. W., & Peter M. Senge. (1980). Tests for Building Confidence in System Dynamics Models. In A. A. Legasto Jr. (Eds.). *System Dynamics. Studies in the Management Sciences*. (pp. 209-228). New York: North-Holland.
- Forrester, J. W. (1981). Innovation and economic change. *Futures*, Vol. 13(4), pp. 323-331.
- Forrester, J. W. (1985). *System Dynamics in Management Education (D-3721-1)*. System Dynamics Group, Sloan School. Cambridge, MA. Massachusetts Institute of Technology. June 3. 5 pp.
- Forrester, J. W. (1987). Lessons from System Dynamics Modeling. *System Dynamics Review*, 3(2), 136-149.
- Forrester, J. W. (1988). *Designing Social and Managerial Systems (D-4006-1)*. System Dynamics Group, Sloan School. Cambridge, MA. Massachusetts Institute of Technology. October 20. 10 pp.
- Forrester, J. W. (1990). *System Dynamics as a Foundation for Pre-College Education (D-4133)*. Cambridge, MA 02139. System Dynamics Group, Massachusetts Institute of Technology. April 10. 14 pp.
- Forrester, J.W. (1995). Counterintuitive Behaviour of social systems. *Technology Review*, Association of Massachusetts Institute of Technology.
- Forriez, M. (2010). *Caractérisation formelle des structures multi échelles géographiques en relativité d'échelle*. These, Université d'Avignon.
- Fournier, S. (1986). Dynamics of the urban growth of an average French city: the CARPE model. In *advances in urban advances modelling*.
- Fourt, L., & Woodlock, J. (1960). Early prediction of market success for grocery products. *J Mark* 25(4): 31–38
- Fragnière, E. & Sullivan, G.(2007). *Risk Management, Safeguarding Company Assets*. Thomson.
- Franceschetti, G., & Riccio, D. (2007). Surface Classical Models. In *Scattering, Natural Surfaces, and Fractals* (pp. 21–59). Elsevier. <https://doi.org/10.1016/B978-012265655-2/50002-7>
- Frankhauser, P. (1994). *La Fractalité des Structures urbaines*. Editions Economica, Paris.
- Frankhauser, P. (2008). Fractal Geometry for Measuring and Modelling Urban Patterns. In S. Albeverio, D. Andrey, P. Giordano, & A. Vancheri (Eds.), *The Dynamics of Complex Urban Systems: An Interdisciplinary Approach* (pp. 213–243). Physica-Verlag HD. https://doi.org/10.1007/978-3-7908-1937-3_11
- Franzen, J. (2003). *Future Production of Transport Fuel, Power and Heat from Biomass*. Master thesis, Chalmers University of Technology and Gothenburg University.
- Freeman, C. (1974). *The Economics of Industrial Innovation*, Penguin, Harmondsworth.
- Freeman, L.C. (1977). A set of measures of centrality based on betweenness, *Sociometry*, 40:35-41.
- Freeman, C., J. & Soete, L. (1982). *Unemployment and Technical Innovation: A Study of Long Waves and Economic Development*, Pinter, London.
- Freeman, C. (1987). *Technology and Economic Performance: Lessons From Japan*. Pinter, London.
- Freeman, C., 1988. Japan: a new national system of innovation. In: Dosi, G., Freeman, C., Nelson, R.R., Silverberg, G., Soete, L. (Eds.), *Technical Change and Economic Theory*.
- Freeman, C. (1991). Networks of innovators: A synthesis of research issues, *Research Policy*, 20: 499-514.
- Frenken, K., Van Oort, F., & Verburg, T. (2007). Related Variety, Unrelated Variety and Regional Economic Growth. *Regional Studies*, 41(5), 685–697. <https://doi.org/10.1080/00343400601120296>

- Frey, C. B., & Osborne, M. A. (2017). The future of employment: How susceptible are jobs to computerisation? *Technological Forecasting and Social Change*, 114, 254–280. <https://doi.org/10.1016/j.techfore.2016.08.019>
- Friedman, M. (1988). The ‘plucking model’ of business fluctuations revisited, *Economic Inquiry* 31, 171–177. <https://doi.org/10.1111/j.1465-7295.1993.tb00874.x>
- Friedman, M. (1993). The Plucking Model of Business Fluctuations Revisited. *Economic Enquiry*, 31, pp. 171-177.
- FSO. (2018). Office fédéral de la statistique. STATENT Résultats 2005 - 2016, Emplois et équivalents plein temps par activité économique au niveau établissements et par canton <https://www.bfs.admin.ch/bfs/fr/home/statistiques/>
- Fuller, D. O., Hardiono, M., & Meijaard, E. (2011). Deforestation Projections for Carbon-Rich Peat Swamp Forests of Central Kalimantan, Indonesia. *Environmental Management*. Retrieved from <http://www.ncbi.nlm.nih.gov/pubmed/21359865>
- Fusco, G., & Venerandi, A. (2020). Assessing Morphological Resilience. Methodological Challenges for Metropolitan Areas. In O. Gervasi, B. Murgante, S. Misra, C. Garau, I. Blečić, D. Taniar, B. O. Apduhan, A. M. A. C. Rocha, E. Tarantino, C. M. Torre, & Y. Karaca (Eds.), *Computational Science and Its Applications – ICCSA 2020* (pp. 593–609). Springer International Publishing.
- Garbolino, E., & Voiron-Canicio-Canicio, C. (2020). *Ecosystem and territorial resilience a geopropective approach*. Elsevier. <https://www.sciencedirect.com/science/book/9780128182154>
- Gabaix, X., & Landier, A. (2008). Why Has CEO Pay Increased so Much? *The Quarterly Journal of Economics*, Vol. 123, No. 1, pp. 49-100 Published by: Oxford University Press.
- Gambhir, A., Butnar, I., Li, P.-H., Smith, P., & Strachan, N. (2019). A Review of Criticisms of Integrated Assessment Models and Proposed Approaches to Address These, through the Lens of BECCS. *Energies*, 12(9), 1747. <https://doi.org/10.3390/en12091747>.
- Galderisi, A., Limongi, G., & Salata, K.-D. (2020). Strengths and weaknesses of the 100 Resilient Cities Initiative in Southern Europe: Rome and Athens’ experiences. *City, Territory and Architecture*, 7(1), 16. <https://doi.org/10.1186/s40410-020-00123-w>
- Gardner, M. (1970). The fantastic combinations of John Conway’s new solitaire game ‘life’. *Scientific American*, Vol. 23 N4, p. 120-123.
- Garret, M. (1993). A way through the maze: What futurists do and how they do it. *Futures*, 25, 254-274.
- Garn, H. A., & R. H. Wilson. (1972). A look at the Urban Dynamics. I.E.E. Transactions on System Man and Cybernetics (April).
- Geels, F. W. (2002). Technological transitions as evolutionary configuration processes: A multi-level perspective and a case-study. *Research policy*, 31(8/9), 1257-1274. [https://doi.org/10.1016/S0048-7333\(02\)00062-8](https://doi.org/10.1016/S0048-7333(02)00062-8)
- Geels, F. W. (2005). The dynamics of transitions in socio-technical systems: a multi-level analysis of the transition pathway from horse-drawn carriages to automobiles (1860-1930). *Technology Analysis and Strategic Management*, 17(4), 445-476. <https://doi.org/10.1080/09537320500357319>
- Geels, F.W., & Raven, R. (2006). Non-linearity and expectations in niche-development trajectories: ups and downs in Dutch biogasdevelopment (1973–2003). *Technol. Anal. Strateg. Manag.* 18, 375–392.
- Geels, F. W., & Schot, J. (2007). Typology of sociotechnical transition pathways. *Research Policy*, 36(3), 399–417. <https://doi.org/10.1016/j.respol.2007.01.003>
- Geels, F. W. (2011). The multi-level perspective on sustainability transitions: Responses to seven criticisms. *Environmental Innovation and Societal Transitions*, 1(1), 24–40. <https://doi.org/10.1016/j.eist.2011.02.002>
- Geels, F. W. (2019). Socio-technical transitions to sustainability: A review of criticisms and elaborations of the Multi-Level Perspective. *Current Opinion in Environmental Sustainability*, 39, 187–201. <https://doi.org/10.1016/j.cosust.2019.06.009>
- Gertler, M. S. (2003). Tacit knowledge and the economic geography of context, or The undefinable tacitness of being (there). *Journal of Economic Geography*, 3(1), 75–99. <https://doi.org/10.1093/jeg/3.1.75>
- Gibbs, D. (2002) *Local Economic Development and the Environment*. Routledge, London.

- Gibbs, D. (2006). Prospects for an Environmental Economic Geography: Linking Ecological Modernization and Regulationist Approaches. *Economic Geography*, 82(2), 193–215. <https://doi.org/10.1111/j.1944-8287.2006.tb00296.x>
- Genus, A., & Coles, A.-M. (2008). Rethinking the multi-level perspective of technological transitions. *Research Policy*, 37(9), 1436–1445. <https://doi.org/10.1016/j.respol.2008.05.006>
- Giacometti, A., & Teräs, J. (2019). Regional Economic and Social Resilience: An Exploratory In-Depth Study in the Nordic Countries. *Nordregio*. <https://doi.org/10.6027/R2019:2.1403-2503>
- Gilbert, E. (1959). Random graphs. *The Annals of Mathematical Statistics*, 30:1141-1144.
- Giuliani, E. (2007). The selective nature of knowledge networks in clusters: evidence from the wine industry, *Journal of Economic Geography* 7(2): 139-168.
- Gluckler, J. (2007) .Economic Geography and the Evolution of Networks, *Journal of Economic Geography* 7 (5): 619-634.
- Gluckler, J. (2009). The evolution of a strategic alliance network. Exploring the case of German stock photography, in: R. Boschma & R. Martin (eds.). *Handbook on Evolutionary Economic Geography*, Cheltenham: Edward Elgar.
- Godard, O. (1996). Le développement durable et le devenir des villes: bonnes intentions et fausses bonnes idées. *Futuribles* 1996, 29_35. Available from: ,hal-00624329. (in French).
- Godard, O. (1984). Autonomie socio-économique et externalisation de l'environnement : la théorie néo-classique mise en perspective. *Economie Appliquée XXXVII* (2), 315-345 (in French).
- Godefroy, P., Courbouleix, S., Fourniguet, J., Garcin, M., Gros, Y., & Peaudecerf, P. (1994). Evolution des concepts, méthodes et outils de la géo-prospective. *Colloque Géo-prospective*, 18_19 avril 1994. UNESCO, Paris, pp. 89-91 (in French).
- Goldenberg, J., Libai, B., Solomon, S., Jan, N., & Staffer, D. (2000). Marketing percolation. *Physica A: Statistical Mechanics and its Applications*, 284(1-4):335-347.
- Goldenberg, J., Libai, B., & Muller, E. (2001). Talk of the network: a complex systems look at the underlying process of word-of-mouth. *Marketing Letters*, 12(3):211-223.
- Goldenberg, J., Libai, B., & Muller, E. (2010). The chilling effects of network externalities. *International Journal of Research in Marketing*, 27(1), 4–15. <https://doi.org/10.1016/j.ijresmar.2009.06.006>
- Goldenberg, J., Libai, B., Solomon, S., Jan, N., & Stauffer, D. (2000). Marketing percolation. *Physica A: Statistical Mechanics and Its Applications*, 284(1–4), 335–347. [https://doi.org/10.1016/S0378-4371\(00\)00260-0](https://doi.org/10.1016/S0378-4371(00)00260-0)
- Goldenberg, J., Libai, B., & Muller, E. (2001). Talk of the network: a complex systems look at the underlying process of word-of-mouth. *Marketing Letters*, 12(3):211/223.
- Goldin, C., & Katz, L.F. (2009). *The race between education and technology*. Harvard University Press.
- Golledge, R.G., Rushton, G. & Clark, W.A.V. (1966). Some spatial characteristics of Iowa's dispersed farm population and their implications for the grouping of central place functions, *Economic Geography*, 42: 261-72.
- Golosovsky, M. (2017). Power-law citation distributions are not scale-free. *Phys. Rev. E*, 96(3), 032306. <https://doi.org/10.1103/PhysRevE.96.032306>
- Goodman, M. (1974). *Study Notes in System Dynamics*, Portland OR: Productivity Press. 388 pp.
- Gordon, I. R., & McCann, P. (2000). Industrial Clusters: Complexes, Agglomeration and/or Social Networks? *Urban Studies*, 37(3), 513–532. <https://doi.org/10.1080/0042098002096>
- Gordon J. E., 1978, *Structures*, Penguin Books, Harmondsworth, UK.
- Gordon, D. M. (1980). Stages of Accumulation and Long Economic Cycles. In T. K. Hopkins & I. M. Wallerstein (Eds.), *Processes of the World System*. Beverly Hills: Sage Publications

- Goudet, O., Kant, J.-D., & Ballot, G. (2017). WorkSim: A Calibrated Agent-Based Model of the Labor Market Accounting for Workers' Stocks and Gross Flows. *Computational Economics*, 50(1), 21–68. <https://doi.org/10.1007/s10614-016-9577-0>
- Goyal, S., M. van der Leij, & J.-L. Moraga-González. (2006). Economics: an emerging small world, *Journal of Political Economy*.
- Grabher, G. (1993). The weakness of strong ties; the lock-in of regional development in the Ruhr area. In *The Embedded Firm: On the Socioeconomics of Industrial Networks*, ed. G. Grabher, 255-277. London & New York: Routledge.
- Granovetter, M. (1973). The Strength of Weak Ties. *American Journal of Sociology*, 78(6), 1360-1380., from <http://www.jstor.org/stable/2776392>
- Gray, J. N., D. Pessel, & P.P Varaiya. (1972). A critic of Forrester's Model of an Urban Area. I.E.E.E. Tra Transactions on System Man and Cybernetics (Apri).
- GREC-SUD, (2016). Climat et changement climatique en région Provence-Alpes-Côte d'Azur, 44 p.
- Greene, R., Devillers, R., Luther, J., & Eddy, B. (2011). GIS-based multiple-criteria decision analysis. *Geography Compass*, 5(6), 412–432.
- GREMI, Milieux Innovateurs et Réseaux Transnationaux (1989). Vers une nouvelle théorie du développement spatial, Barcelone, p. 28-29.
- Grin, J., Rotmans, J., & Schot, J.W. (Eds.). (2010). Transitions to Sustainable Development. New Directions in the Study of Long Term Transformative Change. Ebrary, Inc. Routledge, New York (Routledge studies in sustainability transitions).
- Grillitsch, M., & Tripl, M. (2016). Innovation policies and new regional growth paths: A placebased system failure framework. *Papers in Innovation Studies No. 2016/26*.
- Grillitsch, M., Asheim, B., & Tripl, M. (2018). Unrelated knowledge combinations: The unexplored potential for regional industrial path development. *Cambridge Journal of Regions, Economy and Society*, 11, 257–274. doi:10.1093/cjres/rsy012.
- Grillitsch, M., & Hansen, T. (2019). Green industry development in different types of regions. *European Planning Studies*, 27(11), 2163–2183. <https://doi.org/10.1080/09654313.2019.1648385>
- Grillitsch, M., Hansen, T., Coenen, L., Miörner, J., & Moodysson, J. (2019). Innovation policy for system-wide transformation: The case of strategic innovation programmes (SIPs) in Sweden. *Research Policy*, 48(4), 1048–1061. <https://doi.org/10.1016/j.respol.2018.10.004>
- Grillitsch, M., & Sotarauta, M. (2020). Trinity of change agency, regional development paths and opportunity spaces. *Progress in Human Geography*, 44(4), 704–723. <https://doi.org/10.1177/0309132519853870>
- Grillitsch, M. Hansen, T., & Madsen, S. (2020). How novel is Transformative Innovation Policy? 18. Pre-print of a book chapter to be published in the "Handbook - Alternative Theories of Innovation" edited by Benoît Godin, Dominique Vinck and Gerald Gaglio.
- Groffman, P. M., Baron, J. S., Blett, T., Gold, A. J., Goodman, I., Gunderson, L. H., Levinson, B. M., Palmer, M. A., Paerl, H. W., Peterson, G. D., Poff, N. L., Rejeski, D. W., Reynolds, J. F., Turner, M. G., Weathers, K. C., & Wiens, J. (2006). Ecological Thresholds: The Key to Successful Environmental Management or an Important Concept with No Practical Application? *Ecosystems*, 9(1), 1–13. <https://doi.org/10.1007/s10021-003-0142-z>
- Grossman, J. W. (2000). The Evolution of the Mathematical Research Collaboration Graph. *Proceedings of 33rd Southeastern Conference on Combinatorics (Congressus Numerantium, Vol. 158, 2002, pp. 201-212)*.
- Guermond, Y. (1984) *Analyse de système en géographie*. Presses Universitaires de Lyon.
- Gunderson, L. H. (2000). Ecological Resilience—In Theory and Application. *Annual Review of Ecology and Systematics*, 31(1), 425–439. <https://doi.org/10.1146/annurev.ecolsys.31.1.425>
- Gunderson, L., & C, Holling. (2002). Panarchy: understanding transformations in human and natural systems. *Ecological Economics*, 49 (4) 488-491. <https://doi.org/10.1016/j.ecolecon.2004.01.010>

- Gunderson, L., & Pritchard, L. (eds.). (2002). Resilience and the behaviour of large-scale systems. Island Press, Washington, D.C., USA. ISBN: 9781559639712
- Haag, G., & Dendrinos, D. (1983). Towards a stochastic dynamical theory of location: a nonlinear migration process. *Geographical Analysis* 15: 269-286
- Hagedoorn, J. (2002). Inter-firm R&D partnership: An overview of major trends and patterns since 1960. *Research Policy*, 31(4), 477–492. [https://doi.org/10.1016/S0048-7333\(01\)00120-2](https://doi.org/10.1016/S0048-7333(01)00120-2)
- Hägerstrand, T. (1952). The propagation of innovation waves. Lund studies in geography, ser. B, n° 4.
- Hägerstrand, T. (1953). Innovations förloppet ur korologisk synpunkt, C.W.K Gleerup, Lund, Sweden (Translated and edited by Pred A., Innovation Diffusion as a Spatial Process. Chicago, University of Chicago Press. 1967).
- Hägerstrand T., (1965). A Monte Carlo Approach to Diffusion, *European Journal of Sociology*, vol. 63, pp 43-67.
- Hägerstrand, T. (1957). Migration and area. Lund studies in geography, sery. B, no 13.
- Hägerstrand, T. (1991). Tidsgeografi. In G. Carlestam & B. Sollbe (Eds.), Om tidens vidd och tingens ordning. Texter av Torsten Hägerstrand (pp. 133–142).
- Haig, R. M. (1927). Regional survey of New York and its environs. New York: New York City Planning Commission.
- Hansen, T., & Coenen, L. (2015). The geography of sustainability transitions: Review, synthesis and reflections on an emergent research field. *Environmental Innovation and Societal Transitions*, 17, 92–109. <https://doi.org/10.1016/j.eist.2014.11.001>
- Hansen, D. L., Shneiderman, B., & Smith, M. A. (2011). Chapter 7—Clustering and Grouping. In D. L. Hansen, B. Shneiderman, & M. A. Smith (Eds.), *Analyzing Social Media Networks with NodeXL* (pp. 93–102). Morgan Kaufmann. <https://doi.org/10.1016/B978-0-12-382229-1.00007-2>
- Hansen, T. (2015). Substitution or Overlap? The Relations between Geographical and Non-spatial Proximity Dimensions in Collaborative Innovation Projects. *Regional Studies*, 49(10), 1672–1684. <https://doi.org/10.1080/00343404.2013.873120>
- Hansen, T., & Coenen, L. (2015). The geography of sustainability transitions: Review, synthesis and reflections on an emergent research field. *Environmental Innovation and Societal Transitions*, 17, 92–109. <https://doi.org/10.1016/j.eist.2014.11.001>
- Haken, H. (1977). Synergetics: An Introduction. Springer, Heidelberg.
- Hall, O., & Hay, G. J. (2003). A Multiscale Object-Specific Approach to Digital Change Detection. *International Journal of Applied Earth Observation and Geoinformation*, 4(4), 311–327. [https://doi.org/10.1016/S0303-2434\(03\)00010-2](https://doi.org/10.1016/S0303-2434(03)00010-2)
- Hassink, R. (2010). Locked in decline? On the role of regional lock-ins in old industrial areas. In R. Boschma & R. Martin (Eds.). *The handbook of evolutionary economic geography* (pp. 450–468). Cheltenham: Edward Elgar.
- Hassink, R. (2005). How to unlock regional economies from path dependency? From learning region to learning cluster. *European Planning Studies*, 13(4), 521–535. <https://doi.org/10.1080/09654310500107134>
- Haustein, H.-D., & Neuwirth, E. (1982). Long waves in world industrial production, energy consumption, innovations, inventions, and patents and their identification by spectral analysis. *Technological Forecasting and Social Change*, Vol. 22(1), pp. 53-89.
- Havlicek, T. D., & Carpenter, S. R. (2001). Pelagic species size distributions in lakes: Are they discontinuous? *Limnology and Oceanography*, 46(5), 1021–1033. <https://doi.org/10.4319/lo.2001.46.5.1021>
- Hu, X., & Hassink, R. (2015). Overcoming the Dualism between Adaptation and Adaptability in Regional Economic Resilience. *Papers in Evolutionary Economic Geography*.
- Hebb, D.O. (1949) *The organization of behaviour*. New York: Wiley.
- Helmfrid, S. (2004). Geography in Sweden. *Belgeo*, 1, 163–174. <https://doi.org/10.4000/belgeo.10085>
- Heeler, R., & Hustad, T. (1980). Problems in predicting new product growth for consumer durables. *Management Science*, 26(10):1007-1020.

- Higgins, B. (1971). Pôles de croissance et pôles de développement comme concepts Opérationnels. *Cahiers Vilfredo Pareto*, 9(24), 89-108. Retrieved August 18, 2020, from www.jstor.org/stable/40368851.
- Hodson, M., & Marvin, S. (2009). Cities mediating technological transitions: Understanding visions, intermediation and consequences. *Technology Analysis & Strategic Management*, 21(4), 515–534. <https://doi.org/10.1080/09537320902819213>
- Hodson, M., & Marvin, S. (2010). Can cities shape socio-technical transitions and how would we know if they were? *Research Policy*, 39(4), 477–485. <https://doi.org/10.1016/j.respol.2010.01.020>
- Hof A F, van Vuuren D P, Berkhout F, Geels F W, 2019, "Understanding transition pathways by bridging modelling, transition and practice-based studies: Editorial introduction to the special issue" *Technological Forecasting and Social Change* 151 119665, <https://linkinghub.elsevier.com/retrieve/pii/S0040162519309308>.
- Hohnisch, M., Pittnauer, S., & Stauffer, D. (2008). A percolation-based model explaining delayed takeoff in new-product diffusion. *Industrial and Corporate Change*, 17(5), 1001–1017. <https://doi.org/10.1093/icc/dtn031>
- Holling, C. S. (1973). Resilience and Stability of Ecological Systems. *Annual Review of Ecology and Systematics*, 4(1), 1–23. <https://doi.org/10.1146/annurev.es.04.110173.000245>
- Holling, C. S. (1986). The resilience of terrestrial ecosystems, local surprise and global change. Pages 292-317 in W. C. Clark and R. E. Munn, editors. *Sustainable development of the biosphere*. Cambridge University Press, Cambridge, UK.
- Holling, C.S. (1996). Engineering Resilience versus Ecological Resilience. In: Schulze, P.E., Ed., *Engineering within Ecological Constraints*, National Academy Press, Washington DC, 31-43.
- Holling, C. S. (2002). Understanding the Complexity of Economic, Ecological, and Social Systems. *Ecosystems*, 4(5), 390–405. <https://doi.org/10.1007/s10021-001-0101-5>
- Holling, C., Gunderson, L. & Peterson, G. (2002). Chapter 3: Sustainability and Panarchies. In: L. Gunderson & C. Holling, eds., *Panarchy: understanding transformations in human and natural systems*, 1 st ed. Washington: Island Press, pp. 63-102.
- Holm, E., & Sanders, L. (2001). Modèles spatiaux de micro-simulation. In: Sanders L (ed.). *Modèles en analyse spatiale*. Hermès, Paris, pp 187-217
- Holzhauser, S., Krebs, F., & Ernst, A. (2013). Considering baseline homophily when generating spatial social networks for agent-based modelling. *Computational and Mathematical Organization Theory*, 19(2), 128–150. <https://doi.org/10.1007/s10588-012-9145-7>
- Hollnagel, E., Woods, D., & Leveson, N. (2006). *Resilience Engineering: Concepts et Precepts*. Ashgate, 397 p. ISBN-13: 978-0754649045.
- Hoornweg, D. A. (Ed.). (2011). *Cities and climate change: Responding to an urgent agenda*. World Bank.
- Hotelling, H. (1929). Stability in Competition. *The Economic Journal*, 39(153), 41.
- Huff, D. (1963). *A Probabilistic Analysis of Consumer Spatial Behaviour*. University of California.
- Huff, D. (1964). Defining and Estimating a Trade Area. *Journal of Marketing*, Volume 28, 34-38.
- Hughes, T. P., Bellwood, D. R., Folke, C., Steneck, R. S., & Wilson, J. (2005). New paradigms for supporting the resilience of marine ecosystems. *Trends in ecology & evolution*, 20(7), 380–386 <https://doi.org/10.1016/j.tree.2005.03.022>
- Iammarino, S., Rodríguez-Pose, A., & Storper, M. (2017). Why Regional Development matters for Europe's Economic Future. 46.
- IEA - International Energy Agency. *Energy Technology Perspectives 2014*. Tech. rep. IEA - International Energy Agency, 2014.
- IEA - International Energy Agency. *Key World Energy Statistics 2016*. Tech. rep. IEA - International Energy Agency, 2016.
- IEA - International Energy Agency. (2019), *World Energy Model*, IEA, Paris <https://www.iea.org/reports/world-energy-model>
- Iglói, F., & Turban, L. (2002). First- and second-order phase transitions in scale-free networks. *Physical Review E*, 66(3), 036140. <https://doi.org/10.1103/PhysRevE.66.036140>

- Independent Group of Scientists. (2019). *The Future is Now—Science for Achieving Sustainable Development*, Global Sustainable Development Report 2019. United Nations, New York.
- INSEE. (2012). *Portrait de la Region Provence-Alpes-Cote d'Azur*. 48 p.
- Ioannides Y. M., & Overman H, G. (2002). Zipf's law for cities: an empirical examination. *Regional Science and Urban Economics*, vol. 33, no. 2, pp. 127–137, [https://doi.org/10.1016/S0166-0462\(02\)00006-6](https://doi.org/10.1016/S0166-0462(02)00006-6)
- IPCC. (2018a). Global warming of 1.5°C. An IPCC Special Report on the impacts of global warming of 1.5°C above pre-industrial levels and related global greenhouse gas emission pathways, in the context of strengthening the global response to the threat of climate change, sustainable development, and efforts to eradicate poverty [V. Masson-Delmotte, P. Zhai, H. O. Pörtner, D. Roberts, J. Skea, P.R. Shukla, A. Pirani, W. Moufouma-Okia, C. Péan, R. Pidcock, S. Connors, J. B. R. Matthews, Y. Chen, X. Zhou, M. I. Gomis, E. Lonnoy, T. Maycock, M. Tignor, T. Waterfield (eds.)]. In Press.
- IPCC. (2018b). Summary for Policymakers. In: *Global Warming of 1.5°C. An IPCC Special Report on the impacts of global warming of 1.5°C above pre-industrial levels and related global greenhouse gas emission pathways, in the context of strengthening the global response to the threat of climate change, sustainable development, and efforts to eradicate poverty* [Masson-Delmotte, V., P. Zhai, H.-O. Pörtner, D. Roberts, J. Skea, P.R. Shukla, A. Pirani, W. Moufouma-Okia, C. Péan, R. Pidcock, S. Connors, J.B.R. Matthews, Y. Chen, X. Zhou, M.I. Gomis, E. Lonnoy, T. Maycock, M. Tignor, and T. Waterfield (eds.)]. In Press.
- IPCC. (2007). IPCC. *Climate Change: The Physical Science Basis. Summary for Policymakers. Contribution of the Working Group I to the Fourth Assessment of the Intergovernmental Panel on Climate Change*. <https://www.ipcc.ch/report/ar4/wg1/>. (accessed 22.10.20.).
- Isaksen, A. (2015). Industrial development in thin regions: Trapped in path extension? *Journal of Economic Geography*, 15(3), 585–600. <https://doi.org/10.1093/jeg/lbu026>
- Isard, W. (1958). *Location and the Space Economy*. New York: Wiley.
- Isard, W. (1972) *Méthodes d'analyse régionale : une introduction à la science régionale*. Paris, Dunod.
- Jackson, M. O. (2008). *Social and Economic Networks*. Princeton University Press. ISBN: 13-978-0-691-13440-6, 648p.
- Jager, W., Janssen, M. A., De Vries, H. J. M., De Greef, J., & Vlek, C. A. J. (2000). Behaviour in commons dilemmas: Homo economicus and Homo psychologicus in an ecological-economic model. *Ecological Economics*, 35(3), 357–379. [https://doi.org/10.1016/S0921-8009\(00\)00220-2](https://doi.org/10.1016/S0921-8009(00)00220-2)
- Jeong, H., Albert, R., & Barabási, A. (1998). Internet: Diameter of the world-wide web. *Nature*, 401:130-131.
- Jinjarak, Y., Ahmed, R., Nair-Desai, S., Xin, W., & Aizenman, J. (2020). Accounting for Global COVID-19 Diffusion Patterns, January-April 2020 (No. w27185; p. w27185). National Bureau of Economic Research. <https://doi.org/10.3386/w27185>
- Jolly, S., Grillitsch, M., & Hansen, T. (2020). Agency and actors in regional industrial path development. A framework and longitudinal analysis. *Geoforum*, 111, 176–188. <https://doi.org/10.1016/j.geoforum.2020.02.013>
- Juhász, S. (2019). Spinoffs and tie formation in cluster knowledge networks. *Small Business Economics*. <https://doi.org/10.1007/s11187-019-00235-9>
- Kadanoff, L. P., & Weinblatt, H. (1993). *From Order to Chaos: Essays Critical Chaotic and Otherwise*, World Scientific Series on Nonlinear Science Series A: Volume 1 <https://doi.org/10.1142/1853>
- Kadanoff, L. P., & Weinblatt, H. (1972). Public Policy Conclusions from Urban Growth Models. *IEEE Transactions on Systems, Man, and Cybernetics*, SMC-2(2), 159–165. <https://doi.org/10.1109/TSMC.1972.4309087>
- Kaizoji, T. (2003). Scaling behaviour in land markets. *Physica A* 326, 256-264. DOI: 10.1016/S0378-4371(03)00145-6
- Karakaya, E., & Sriwannawit, P. (2015). Barriers to the adoption of photovoltaic systems: The state of the art. *Renewable and Sustainable Energy Reviews*, 49, 60–66. <https://doi.org/10.1016/j.rser.2015.04.058>
- Karinthy, F. (1929). Láncszemek, in *Minden másképpen van*. Budapest, Atheneum Irodai es Nyomdai R.-T. Kiadása, 85–90. English translation in: M.E.J. Newman, A.-L. Barabási, and D. J. Watts. *The Structure and Dynamics of Networks*. Princeton University Press, Princeton, 2006.

- Kates, R. W., Clark, W. C., Corell, R., Hall, J. M., Jaeger, C. C., Lowe, I., McCarthy, J. J., Schellnhuber, H. J., Bolin, B., Dickson, N. M., Faucheux, S., Gallopin, G. C., Grübler, A., Huntley, B., Jäger, J., Jodha, N. S., Kasperson, R. E., Mabogunje, A., Matson, P., Mooney, H., Svedlin, U. (2001). Environment and development. Sustainability science. *Science (New York, N.Y.)*, 292(5517), 641–642. <https://doi.org/10.1126/science.1059386>
- Kavlak, G., McNerney, J., & Trancik, J. E. (2018). Evaluating the causes of cost reduction in photovoltaic modules. *Energy Policy*, 123, 700–710. <https://doi.org/10.1016/j.enpol.2018.08.015>
- Katz, M., L., & Shapiro, C. (1985). Network externalities, competition and compatibility. *American Economic Review*, 75(3).
- Katz, M., L., & Shapiro, C. (1986). Technology adoption in the presence of network externalities. *Journal of Political Economy*, 94(4).
- Katz, E., Levin, M. L., & Hamilton, H. (1963). Traditions of Research on the Diffusion of Innovation. *American Sociological Review*, 28(2), 237. <https://doi.org/10.2307/2090611>
- Keeley, B. (2015). *Income Inequality: the Gap Between Rich and Poor*. OECD (OECD Insights), Paris.
- Kiesling, M. (2011). Planning the market introduction of new products: An agent-based simulation of innovation diffusion. Doctoral dissertation. 244.
- Kiesling, E., Günther, M., Stummer, C., & Wakolbinger, L. M. (2012). Agent-based simulation of innovation diffusion: A review. *Central European Journal of Operations Research*, 20(2), 183–230. <https://doi.org/10.1007/s10100-011-0210-y>
- Kim, L. 1999. *Learning and Innovation in Economic Development*. Edward Elgar, Cheltenham UK.
- Kirat, T., & Lung, Y. (1999). Innovation and Proximity: Territories as Loci of Collective Learning Processes. *European Urban and Regional Studies*, 6(1), 27–38. <https://doi.org/10.1177/096977649900600103>
- Kivell, P. T., Shaw, G., & Dawson, J. A. (1980). *Retail geography*.
- Klein, R., Lankhuizen, M., & Gilsing, V. (2005). A system failure framework for innovation policy design. *Technovation*, 25(6), 609–619. <https://doi.org/10.1016/j.technovation.2003.11.002>
- Klein, R., Nicholls, R., & Thomalla, F. (2003). Resilience to natural hazards: How useful is this concept? *Environmental Hazards*, Volume 5, Issues 1–2, 2003, Pages 35-45. <https://doi.org/10.1016/j.hazards.2004.02.001>
- Kline, S.J., Rosenberg, N. (1986). An overview of innovation. In: Landau, R., Rosenberg, N. (Eds.), *The Positive Sum Strategy: Harnessing Technology for Economic Growth*. National Academic Press, Washington D.C, pp. 275–305.
- Klitkou, A., Bolwig, S., Hansen, T., & Wessberg, N. (2015). The role of lock-in mechanisms in transition processes: The case of energy for road transport. *Environmental Innovation and Societal Transitions*, 16, 22–37. <https://doi.org/10.1016/j.eist.2015.07.005>
- Kochen, M. (ed). (1989). *The Small World*. Ablex Publishing Corporation Norwood, New Jersey.
- Kohli, R., Lehmann, D. R., & Pae, J. (1999). Extent and impact of incubation time in new product diffusion. *Journal of Product Innovation Management*, 16(2):134–144.
- Köhler, J., Geels, F. W., Kern, F., Markard, J., Onsongo, E., Wieczorek, A., Alkemade, F., Avelino, F., Bergek, A., Boons, F., Fünfschilling, L., Hess, D., Holtz, G., Hyysalo, S., Jenkins, K., Kivimaa, P., Martiskainen, M., McMeekin, A., Mühlemaier, M. S., & Wells, P. (2019). An agenda for sustainability transitions research: State of the art and future directions. *Environmental Innovation and Societal Transitions*, 31, 1–32. <https://doi.org/10.1016/j.eist.2019.01.004>
- Kondratiev, N. D. (1925). 'Bol'shie cikly konjunktury [The Major Economic Cycles]'. *Voprosy konjunktury [Problems of Economic Conditions]*, Vol. 1, pp. 28-79.
- Korte, C., & Milgram, S. (1970). Acquaintance networks between racial groups: Application of the small world method. *Journal of Personality and Social Psychology*, 15(2), 101–108. <https://doi.org/10.1037/h0029198>
- Kouzes, J., & Posner, B. (1996). Envisioning your future: imaging ideal scenarios. *The futurist*, 30, 14-19.
- Krueger, A.B. (1993). How computers have changed the wage structure: evidence from microdata, 1984–1989. *The Quarterly Journal of Economics*, vol. 108, no. 1, pp. 33–60.

- Krugman, P. (1991). *Geography and Trade*, MIT Press, Cambridge.
- Kuandykov, L. & Sokolov, M. (2010). Impact of social neighborhood on diffusion of innovation s-curve. *Decision Support Systems*, 48(4):531-535.
- Kuhlmann, S., & Rip, A. (2018). Next-Generation Innovation Policy and Grand Challenges. *Science and Public Policy*, 45(4), 448–454. <https://doi.org/10.1093/scipol/scy011>
- Kunte S. & Damani, O. (2015). Population Projection for India – A System Dynamics Approach. In proceedings of the 33rd International Conference of the System Dynamics Society, Cambridge, Massachusetts, USA. 2015. ISBN: 9781510815056
- Kuznets, S.(1966). *Modern Economic Growth: Rate, Structure and Spread*. New Haven and London: Yale University Press.
- Kuznets, S. (1971). *Economic Growth of Nations: Total Output and Production Structure*, Cambridge, Mass. 1971.
- Kuznets, S. (1973). Modern Economic Growth: Findings and Reflections. *The American Economic Review*, 63(3), 247–258. <http://www.jstor.org/stable/1914358>.
- Lagendijk, A. (2006). Learning from conceptual flow in regional studies: Framing present debates, unbracketing past debates. *Regional Studies*, 40(4), 385–399. <https://doi.org/10.1080/00343400600725202>
- Lammoglia, A., Leturcq, S., & Delay, E. (2019). The VitiTerroir model to simulate the spatial dynamics of vineyards on the long term (1836-2014). Example of application in the department of Indre-et-Loire. *Cybergeo: European Journal of Geography*.
- Langton C. (1989). *Artificial Life 1*, Addison-Wesley.
- Lane, D., Pumain, D., van der Leeuw, S. E., & West, G. (Eds.). (2009). *Complexity Perspectives in Innovation and Social Change*. Springer Netherlands. <https://doi.org/10.1007/978-1-4020-9663-1>
- Lasi, H., Fettke, P., Kemper, H.-G., Feld, T., & Hoffmann, M. (2014). Industry 4.0. *Business & Information Systems Engineering*, 6(4), 239–242. <https://doi.org/10.1007/s12599-014-0334-4>
- Laudet, Claire, & Serge Fournier. (1979). *La simulation de politiques urbaines*. Thèse de Doctorat, U.E.R. de Sciences Economiques, Université Paris X - Nanterre, Paris.
- Lawhon, M., & Murphy, J. T. (2012). Socio-technical regimes and sustainability transitions: Insights from political ecology. *Progress in Human Geography*, 36(3), 354–378. <https://doi.org/10.1177/0309132511427960>
- Lazarsfeld, P., R., Merton (1954) .Friendship as a social process: a substantive and methodological analysis. In *Freedom and Control in Modern Society*, edited by M. Berger, 18.66, New York: Van Nostrand.
- Lazzarato, M (2002). *Puissances de l'invention – la psychologie économique de Gabriel Tarde conte l'économie politique, Les empêcheurs de penser en rond*, Paris, Le Seuil. ISBN-13 : 978-2846710336
- Le Berre M., (1992). Territoires. In *Encyclopédie de Géographie, Economica*, pp. 620-621.
- Lempert, K., & E., Phelps. (2014). Neuroeconomics of emotion and decision-making. In P. W. Glimcher & E. Fehr (Eds.). *Neuroeconomics: Decision-Making and the Brain* (2nd ed.), Chapter 12. Elsevier.
- Lengyel, B., Di Clemente, R., Kertész, J., & González, M. C. (2019). The role of geography in the complex diffusion of innovations. ArXiv:1804.01349 [Physics]. <http://arxiv.org/abs/1804.01349>
- Levin, S.A., Barrett, S., Aniyar, S., Baumol, W., Bliss, C., Bolin, B., Dasgupta, P., Ehrlich, P., Folke, C., Gren, I.-M., et al (1998). Resilience in natural and socioeconomic systems. *Environ. Dev. Econ*, 3, 221–262.
- Levin, S. (1998). Ecosystems and the Biosphere as Complex Adaptive Systems. *Ecosystems*, 1(5), 431–436. <https://doi.org/10.1007/s100219900037>
- Levin, S. (2002). Complex adaptive systems: exploring the known, the unknown and the unknowable. *Bull. Am. Math. Soc.* 40 (1), 3-19. <https://doi.org/10.2307/25606056>

- Lhomme, S. (2012). Les réseaux techniques comme vecteur de propagation des risques en milieu urbain—Une contribution théorique et pratique à l'analyse de la résilience urbaine. 376.
- Lee, D.-S. (2018). Towards urban resilience through inter-city networks of co-invention: A case study of U.S. cities. *Sustainability* 2018, 10, 289.
- Lee N. (2011). Are Innovative Regions More Unequal? Evidence from Europe. *Environment and Planning C: Government and Policy* 29(1) 2–23.
- Lee, N., Rodríguez-Pose, a. (2013). Innovation and spatial inequality in Europe and USA, *Journal of Economic Geography*, Volume 13, Issue 1, Pages 1–22. DOI: 10.1093/jeg/lbs022.
- Lee, N., & Clarke, S. (2019). Do low-skilled workers gain from high-tech employment growth? High-technology multipliers, employment and wages in Britain. *Research Policy*, 48(9), 103803. <https://doi.org/10.1016/j.respol.2019.05.012>
- Walker, B. (1998). Resilience, instability, and disturbance in ecosystem dynamics. *Environ. Dev. Econ.* 3, 259–262.
- Levy, F., & Murnane, R.J. (2004). *The new division of labor: How computers are creating the next job market*. Princeton University Press.
- Leysdon, A., Thrift, N.J. (1997). *Money/Space: Geographies of Monetary Transformation*, London: Routledge.
- Liu, H., Hussain, F., Tan, C. L., & Dash, M. (2002). Discretization: An Enabling Technique. *Data Mining and Knowledge Discovery*, 6(4), 393–423. <https://doi.org/10.1023/A:1016304305535>
- Longhi, C., & Quéré, M. (1993). Innovative Networks and the Technopolis Phenomenon: The Case of Sophia-Antipolis. *Environment and Planning C: Government and Policy*, 11(3), 317–330. <https://doi.org/10.1068/c110317>
- Loorbach., D. (2010). Transition Management for Sustainable Development: A Prescriptive, Complexity-Based Governance Framework. *Governance*, 23(1), 161–183. <https://doi.org/10.1111/j.1468-0491.2009.01471.x>
- Lorius, C., Jouzel, J., Raynaud, D., Hansen, J., & Treut, H. L. (1990). The ice-core record: Climate sensitivity and future greenhouse warming. *Nature*, 347(6289), 139–145. <https://doi.org/10.1038/347139a0>
- Lösch A (1954) *The Economics of Location*. Yale University Press, New Haven, CN (translated from the 1943 German Edition *Die Raumlische Ordnung der Wirtschaft* by W, Woglom).
- Loubier, J.C (2004). Perception et simulation des effets du changement climatique sur l'économie du ski et la biodiversité. Université Joseph Fourier – Grenoble 1, thèse de doctorat.
- Loubier J. C. (2013). L'intérêt des maquettes virtuelles dans la compréhension des enjeux spatiaux. *Géogouvernance : Utilité sociale de l'analyse spatiale*, 119-128.
- Loubier, J.-C., Voiron-Canicio-Canicio, C., Genoud, D., Hunacek, D., & Sant, F. (2017). Modélisation géoprospective et simulation 3D immersive. *Revue Internationale de Géomatique*, 27(4), 547–566. <https://doi.org/10.3166/riig.2017.00042>
- Loubier (2020). The touristic model of Valais facing climate change: geopropective simulations of more environmentally integrated development models. In E, Garbolino., & C, Voiron-Canicio-Canicio. (Eds.), *Ecosystem and Territorial Resilience* (pp. 57–83). Elsevier. <https://doi.org/10.1016/B978-0-12-818215-4.00003-1>
- Louf, R. (2015). *Wandering in cities: A statistical physics approach to urban theory*. Thèse de doctorat, Mathematical Physics. Université Pierre et Marie Curie - Paris VI, 2015.
- Lundquist, K-J. & Olander, L-O. (2001) *Den glömda strukturcykeln. Ny syn på industrins regionala tillväxt och omvandling*, Rapporter och Notiser, Lund: Department of Social and Economic Geography.
- Lundquist, K-J., Olander, L-O., & Martynovich, M. (2017). *The technology shift thesis: Understanding long-term growth and transformation in a regional system*. (1 ed.) Lund: Department of Human Geography, Lund University.
- Lundvall, B.-A. 1988. Innovation as an interactive process: from user-producer interaction to national systems of innovation. In: Dosi, G., Freeman, C., Nelson, R.R., Silverberg, G., Soete, L. (Eds.), *Technical Change and Economic Theory*. Pinter Publishers, London.

- Lundvall, B.-A. (Ed.), 1992. *National Systems of Innovation: Towards a Theory of Innovation and Interactive Learning*. Pinter, London.
- Lundvall, B.-A., Joseph, K.J., Chaminade, C., et al., 2009. *Handbook of Innovation Systems and Developing Countries*. Edward Elgar, Cheltenham UK.
- MacKinnon, D., Dawley, S., Pike, A., & Cumbers, A. (2019). Rethinking Path Creation: A Geographical Political Economy Approach. *Economic Geography*, 95(2), 113–135. <https://doi.org/10.1080/00130095.2018.1498294>
- Mahajan, V., Peterson, R., Jain, A., & Malhotra, N. (1979). A new product growth model with a dynamic market potential. *Long Range Planning*, 12(4):51-58.
- Mahajan, V., Muller, E., & Bass, F. M. (1990). New Product Diffusion Models in Marketing: A Review and Directions for Research. *Journal of Marketing*, 54(1), 1. <https://doi.org/10.2307/1252170>
- Mahajan, V., E. Muller, & J. Wind. (eds). 2000. *New product diffusion models*. Boston: Kluwer Academic Publishers.
- Maier, F. (1998). New product diffusion models in innovation management: a system dynamics perspective. *System Dynamics Review*, 14(4):285–308.
- Manna, S. & Sen, P. (2002). Modulated scale-free network in Euclidean space. *Physical Review E*, 66(6):066114.
- Mandel, E. (1975). *Late Capitalism*. London: New Left Books.
- Manfredo, M.J., Vaske, J.J., Rechkemmer, A., Duke, E.A. (eds). (2014). *Understanding Society and Natural Resources. Forging New Strands of Integration Across the Social Sciences*. Published by Springer.
- Mansfield, E. (1961). Technical Change and the Rate of Imitation. *Econometrica*, 29(4), 741. <https://doi.org/10.2307/1911817>
- Marchetti, C. (1980). Society as a learning system: Discovery, invention, and innovation cycles revisited. *Technological Forecasting and Social Change*, Vol. 18(4), pp. 267-282.
- Markard, J., Raven, R., & Truffer, B. (2012). Sustainability transitions: An emerging field of research and its prospects. *Research Policy*, 41(6), 955–967. <https://doi.org/10.1016/j.respol.2012.02.013>
- Marshall, A. (1920). *Principles of Economics*, Mac Millan, London.
- Marchese, D., Reynolds, E., Bates, M.E., Morgan, H., Clark, S., & Linkov, I.(2018). Resilience and sustainability: Similarities and differences in environmental management applications. *Sci. Total Environ.* 2018, 613–614, 1275–1283. Doi:10.1016/j.scitotenv.2017.09.086
- Martin, R., Sunley, P., Gardiner, B., & Tyler, P. (2016). How Regions React to Recessions: Resilience and the Role of Economic Structure. *Regional Studies*, 50(4), 561–585. <https://doi.org/10.1080/00343404.2015.1136410>
- Martin, R., & Sunley, P. (2015). On the notion of regional economic resilience: Conceptualization and explanation. *Journal of Economic Geography*, 15(1), 1–42. <https://doi.org/10.1093/jeg/lbu015>
- Martin, R., & Moodysson, J. (2013). Comparing knowledge bases: On the geography and organization of knowledge sourcing in the regional innovation system of Scania, Sweden. *European Urban and Regional Studies*, 20(2), 170–187. <https://doi.org/10.1177/0969776411427326>
- Martin, R. (2012a). The evolution of science policy and innovation studies. *Research Policy* 41, 1219-1239.
- Martin, R. (2012b). Regional economic resilience, hysteresis and recessionary shocks. *Journal of Economic Geography*, 12(1), 1–32. <https://doi.org/10.1093/jeg/lbr019>
- Martin, R., & Sunley, P. (2006). Path dependence and regional economic evolution. *Journal of Economic Geography*, 6, 395–437. doi:10.1093/jeg/lbl012
- Maassen, A. (2012). Heterogeneity of Lock-In and the Role of Strategic Technological Interventions in Urban Infrastructural Transformations. *European Planning Studies*, 20(3), 441–460. <https://doi.org/10.1080/09654313.2012.651807>
- Maskell, P. (2001). Future challenges and institutional preconditions for regional development policy, in Feldman, M., Massard, N., *Institutions and systems in the geography of innovation*, Kluwer Academic Publishers, Boston, Dordrecht, London, 341-365.

- Masson-Vincent, M., Dubus, N., Bley, D., Voiron-Canicio, C., Helle, C., Cheylan, J-P., Douart, P., Douguedroit, A., Ferrier, J-P., Jacob, F., Lampin, C., Maignant G., et Piot, J-Y. (2012). La Géogouvernance : un concept novateur ? *Cybergeog.*
<https://doi.org/10.4000/cybergeog.25086>.
- McCarthy, J. (1996). *Defending AI research: A collection of essays and reviews*. CSLI Publications.
- McCollum, D. L., Wilson, C., Pettifor, H., Ramea, K., Krey, V., Riahi, K., Bertram, C., Lin, Z., Edelenbosch, O. Y., & Fujisawa, S. (2016). Improving the behavioural realism of global integrated assessment models: An application to consumers' vehicle choices. *Transportation Research Part D: Transport and Environment*, 55, 322–342. <https://doi.org/10.1016/j.trd.2016.04.003>
- McDonald, A., & Schrattenholzer, L. (2002). Learning curves and technology assessment. *International Journal of Technology Management*, 23(7/8), 718. <https://doi.org/10.1504/IJTM.2002.003035>
- McKinnon, D., Cumbers, A., & Chapman, K. (2003). Learning, innovation and regional development: a critical appraisal of recent debates. *Progress in Human Geography* 2: 293-311
- McPherson, M., Smith-Lovin, L., & Cook, J. M. (2001). Birds of a Feather: Homophily in Social Networks. *Annual Review of Sociology*, 27(1), 415–444. <https://doi.org/10.1146/annurev.soc.27.1.415>
- Meadows, Donella H., Dennis L. Meadows, Jorgen Randers, & William W. Behrens III. (1972). *The Limits to Growth*. New York: Universe Books. 205 pp.
- Meadows, Dennis L. & Donella H. Meadows. (eds.). (1973). *Toward Global Equilibrium: Collected Papers*, Portland OR: Productivity Press, 358 pp.
- Meadows, Dennis L., William W. Behrens, III, Donella H. Meadows, Roger F. Naill, Jørgen Randers, & Erich K. O. Zahn. (1974). *Dynamics of Growth in a Finite World*, Portland OR: Productivity Press. 637 pp.
- Meadows, D. H., D. L. Meadows, & J. Randers. (1992). *Beyond the Limits*. Post Mills, VT Chelsea Green Publishing Company.
- Meadows, D.L., Randers, J., & Meadows, D.L. (2004). *Limits to Growth: The 30-Year Update*. Chelsea Green, White River Junction VT.
- Médail, F. & Quézel, P., (1997), Hot-Spots Analysis for Conservation of Plant Biodiversity in the Mediterranean Basin, *Annals of the Missouri Botanical Garden*, vol. 84, n°1, p. 112-127.
- Meerow, S. (2017) Double exposure, infrastructure planning, and urban climate resilience in coastal megacities: A case study of Manila. *Environ. Plan. A* 2017, 49, 2649–2672.
- Merton, K. (1968). The Matthew Effect in Science. *Science*, Volume 159, Issue 3810, pp. 56-63. [0.1126/science.159.3810.56](https://doi.org/10.1126/science.159.3810.56)
- Metcalfe, S., & Peterson, S. (2018). *Simulation Modeling*. The Geographic Information Science & Technology Body of Knowledge (4th Quarter 2018 Edition), John P. Wilson (Ed.). DOI: [10.22224/gistbok/2018.4.2](https://doi.org/10.22224/gistbok/2018.4.2)
- Metz, R. (1992). A Re-examination of Long Waves in Aggregate Production Series. In A. Kleinknecht, E. Mandel, & I. Wallerstein (Eds.), *New Findings in Long-Wave Research*. London: Palgrave Macmillan UK, pp. 80-119.
- Mileti, D. (1999). *Disasters by Design*, Joseph Henry Press, Washington, D.C.
- Milgram, S. (1967). The Small-World Problem. *Psychology Today*, 2, p. 60-67.
- Moessinger, P. (1996). *Irrationalité individuelle et ordre social*. Droz, Genève, 241 p. DOI : [10.3917/droz.moess.1996.01](https://doi.org/10.3917/droz.moess.1996.01)
- Morecroft, J. (2015). *Strategic Modelling and Business Dynamics: A Feedback Systems Approach*. ISBN-13: 978-0470012864 ; ISBN-10: 0470012862.
- Morin, E. (1974). *La complexité. Colloque sur les interrelations entre la biologie, les sciences sociales et la société*. Organisation des nations unies pour l'éducation, la science et la culture. Paris (in French).
- Morin, E. (1990). *Introduction à la pensée complexe*. Seuil, Paris (in French).
- Morin, E. (1994). *La complexité humaine*. Champs Flammarion, Paris (in French).

- Morgan, K. (1997). The Learning Region: Institutions, Innovation and Regional Renewal, *Regional Studies*, 31:5, 491-503, DOI: 10.1080/00343409750132289.
- Moret., S. (2017). Strategic energy planning under uncertainty. Doctoral Thesis, Ecole Polytechnique Fédérale de Lausanne.
- Morrill, R. (1984). The Responsibility of Geography. *Annals of the Association of American Geographers*, 74(1), 1-8.
- Mundt, C. C., & Sackett, K. E. (2012). Spatial scaling relationships for spread of disease caused by a wind-dispersed plant pathogen. *Ecosphere*, 3(3), art24. <https://doi.org/10.1890/ES11-00281.1>
- Murphy, K.M., Riddell, W.C., & Romer, P.M. (1998). Wages, skills, and technology in the United States and Canada. Tech. Rep., nber Working Paper No. 6638, National Bureau of Economic Research
- Murphy, J.T. (2015). Human geography and socio-technical transition studies: Promising intersections. *Environmental Innovation and Societal Transitions*, 17, 73-91.
- Muštra, V., Šimundić, B., & Kuliš, Z. (2016). Effects of smart specialization on regional economic resilience in EU. First SMARTER Conference on Smart Specialisation and Territorial Development: Changing Patterns of Territorial Policy: Smart Specialisation & Innovation in Europe.
- Myers, N., Mittermeier, R. A., Mittermeier, C. G., Da Fonseca, G., & Kent, J.,(2000), Biodiversity hotspots for conservation priorities, *Nature*, vol. 403, n°6772, p. 853-858.
- Nash, K. L., Allen, C. R., Angeler, D. G., Barichiev, C., Eason, T., Garmestani, A. S., Graham, N. A. J., Granholm, D., Knutson, M., Nelson, R. J., Nyström, M., Stow, C. A., & Sundstrom, S. M. (2014). Discontinuities, cross-scale patterns, and the organization of ecosystems. *Ecology*, 95(3), 654–667. <https://doi.org/10.1890/13-1315.1>
- NBIC Convergence 2003: Converging Technologies for Improving Human Performance. February 5-7, 2003, Los Angeles, California, USA. Proceedings. (2004). *Annals of the New York Academy of Sciences*, 1013, 1–259.
- Neffke, F., Henning, M., & Boschma, R. (2011). How Do Regions Diversify over Time? Industry Relatedness and the Development of New Growth Paths in Regions: ECONOMIC GEOGRAPHY. *Economic Geography*, 87(3), 237–265. <https://doi.org/10.1111/j.1944-8287.2011.01121.x>
- Negro, S. O., Alkemade, F., & Hekkert, M. P. (2012). Why does renewable energy diffuse so slowly? A review of innovation system problems. *Renewable and Sustainable Energy Reviews*, 16(6), 3836–3846. <https://doi.org/10.1016/j.rser.2012.03.043>
- Nekovee, M., Moreno, Y., Bianconi, G., & Marsili, M. (2007). Theory of Rumour Spreading in Complex Social Networks. *Physica A: Statistical Mechanics and Its Applications*, 374(1), 457–470. <https://doi.org/10.1016/j.physa.2006.07.017>
- Nelson, D.R., Adger, W.N., & Brown, K. (2007). Adaptation to Environmental Change: Contributions of a Resilience Framework. *Annu. Rev. Environ. Resour.* 32, 395–419.
- Nelson, R.R. (1959). The simple economics of basic scientific research. *J. Polit. Econ.* 67 (3), 297–306.
- Nelson, R. and Winter, S. (1977). In search of a useful theory of innovation. *Res. Policy*, 6(1), 36–76.
- Nelson, R. R., & Winter, S. G. (2004). An evolutionary theory of economic change. The Belknap Press of Harvard University Press.
- Nelson, R. R. (2006). Evolutionary Social Science and Universal Darwinism, *Journal of Evolutionary Economics*, vol. 16, pp. 491-510.
- Newman, M. E. J. (2001). Scientific collaboration networks. II. Shortest paths, weighted networks, and centrality. *Physical Review E*, 64(1), 016132. <https://doi.org/10.1103/PhysRevE.64.016132>
- Nicolis, G., & I. Prigogine (1977) . Self-organization in Nonequilibrium Systems. New York: Wiley.
- Nijp, J. J., Temme, A. J. A. M., Voorn, G. A. K., Kooistra, L., Hengeveld, G. M., Soons, M. B., Teuling, A. J., & Wallinga, J. (2019). Spatial early warning signals for impending regime shifts: A practical framework for application in real-world landscapes. *Global Change Biology*, 25(6), 1905–1921. <https://doi.org/10.1111/gcb.14591>
- Nilsson, L.J., Khan, J., Andersson, F.N.G., Klintman, M., Hildingsson, R., Kronsell, A., Pettersson, F., Pålsson, H., Smedby, N. (2013). I ljuset av framtiden – styrning mot nollutsläpp 2050, Rapport, Lunds universitet.

- Noble, V., Van E, J., Michaud, H. & Garaud, L. (2015). Liste Rouge de la flore vasculaire de Provence-Alpes-Côte d'Azur, 14 p.
- Norris, F., Stevens, S., Pfefferbaum, B., Wyche, K., Pfefferbaum, R. (2008). Community resilience as a metaphor, theory, set of capacities, and strategy for disaster readiness. *American Journal of Community Psychology* 41: 127-150.
- Nottale, L. (2007). Scale Relativity: A Fractal Matrix for Organization in Nature. In *Electronic Journal of Theoretical Physics*.
- November, V., Penelas, M., Viot, P. (2008). L'effet Lully: un territoire a l'épreuve d'une inondation. *Cosmopolitiques*, vol. 17, pp. 89-106.
- Noyman, A., Doorley, R., Xiong, Z., Alonso, L., Grignard, A., & Larson, K. (2019). Reversed urbanism: Inferring urban performance through behavioural patterns in temporal telecom data. *Environment and Planning B: Urban Analytics and City Science*, 46(8), 1480–1498. <https://doi.org/10.1177/2399808319840668>
- FOEN, (2014). Impacts, Toward Quantitative Scenarios of Climate Change Impacts in Switzerland. Bern, Switzerland, Federal Office for the Environment, 136 pp. Available online at http://www.ch2014-impacts.ch/res/files/CH2014-Impacts_report.pdf
- OECD. 1992. Technology and the economy. Paris: OECD.
- OECD (2014). Guidelines for resilience systems analysis, OECD Publishing.
- OECD. (2015). System Innovation: Synthesis Report. OECD, Paris.
- OECD. (2016). Regions at a Glance 2016, ed. O. Publishing. Paris.
- OECD. (2018). Automation, skills use and training (OECD Social, Employment and Migration Working Papers No. 202; OECD Social, Employment and Migration Working Papers, Vol. 202). (2018). <https://doi.org/10.1787/2e2f4eea-en>.
- OFMC. (2018). Le climat suisse en détail - Cartes mensuelles et annuelles. Office fédéral de la météorologie et de climatologie MétéoSuisse. https://www.meteosuisse.admin.ch/home/climat/le-climat-suisse-en-detail/cartes-mensuelles-et-annuelles.html?filters=sun_mean_2017_yy_1981
- OFMC. (2020). Climate Change in Switzerland. Swiss Federal Office of the Meteorology and Climatology MeteoSwiss. <https://www.meteoswiss.admin.ch/home/climate/climate-change-in-switzerland.html>
- ONERC, Simulateur de climat. (2013) <http://onerc.developpement-durable.gouv.fr/fr/content/le-simulateur-de-climat>.
- Östh, J., Lyhagen, J. Aura, Reggiani. (2016). A new way of determining distance decay parameters in spatial interaction models with application to job accessibility analysis in Sweden.
- Ott, K., & R. Döring. (2004). Theorie und Praxis starker Nachhaltigkeit. Metropolis, Marburg, Germany. ISBN 978-3-89518-695-0
- Ozman, M. (2009). Inter-firm networks and innovation: A survey of literature. *Economics of Innovation and New Technology*, 18(1), 39–67. <https://doi.org/10.1080/10438590701660095>
- Pålsson, H., Lundquist, K-J, Olander, L, Larsson, F., & Hiselius, L. (2013). Target: Low-carbon goods transportation. A growth dynamics perspective on logistics and goods transportation until 2050, International Transport Forum Discussion Paper, No. 2014-14, Organisation for Economic Co-operation and Development (OECD), International Transport Forum, Paris.
- Partridge, M., & Rickman, D. (2005). Regional cyclical asymmetries in an optimal currency area: an analysis using US State data. *Oxford Economic Papers* 57, 373–397. <https://doi:10.1093/oep/gpi022>
- Patrice, L. (2007). Concepts et modélisations de la diffusion géographique - Concepts and modeling of spatial diffusion. 24.
- Patrick, T., Grignard, A., Gaudou, B., & Drogoul, A. (2014). Des données géographiques à la simulation à base d'agents: application de la plate-forme GAMA. Cybergeog: *European Journal of Geography*.
- Paulus, F. (2005). Coévolution dans les systèmes de villes: Croissance et spécialisation des aires urbaines françaises de 1950 à 2000. Université Paris I, thèse de doctorat.
- Péguy, C.-P. (2001). Espace, Temps Complexité : Vers Une Métagéographie. Belin. ISBN : 102701129656. 280 p.

- Pendall, R., Foster, K. A. and Cowell, M. (2008). Resilience and Regions: Building Understanding of the Metaphor. *Cambridge Journal of Regions, Economy and Society* 3: 85-104.
- Pasquier, J.-L. (2010). CO2 et activités économiques de la France Tendances 1990-2007 et facteurs d'évolution. Observation et statistiques. Commissariat Général au Développement Durable. La Défense, France: MEEDDM.
- Peris, M., Ferreira, J., Farinha, L., & Fernandes, N. (2016). Multiple Helix Ecosystems for Sustainable Competitiveness. Springer International Publishing Switzerland. Online ISBN978-3-319-29677-7. DOI: <https://doi.org/10.1007/978-3-319-29677-7>
- Perrings, C., Mäler, K., Folke, C., Holling, C., & Jansson, B. (Eds.) (1995). Biodiversity conservation, problems and policies. Kluwer Academic, Dordrecht, The Netherlands.
- Perruchoud, M., Mabillard, J., & Rojas, D. (2016). Wertschöpfung des Tourismus im Wallis, Analyse des touristischen Angebots und der Nachfrage 2014. Department of Economy, Energy and Territory. Walliser Tourismus Observatorium. <https://www.tourobs.ch/de/artikel-und-news/artikeln/id-3859-wertschopfung-des-tourismus-im-wallis/>.
- Perroux, F. (1961). L'économie du siècle XX^e siècle. Paris PUF, 2^e éd.
- Peters, G. P. (2016). The 'best available science' to inform 1.5 °C policy choices. *Nature Climate Change*, 6(7), 646–649. <https://doi.org/10.1038/nclimate3000>
- Petruszewycz, M. (1972). Loi de Pareto ou Loi log-normale: un choix difficile. *Mathématiques et Sciences Humaines*, N 39.
- Phdungsilp, A. (2011). Futures studies' backcasting method used for strategic sustainable city planning. *Futures*, 43(7), 707–714. <https://doi.org/10.1016/j.futures.2011.05.012>
- Pickett, S. T. A., Cadenasso, M. L., & Grove, J. M. (2004). Resilient cities: Meaning, models, and metaphor for integrating the ecological, socio-economic, and planning realms. *Landscape and Urban Planning*, 69(4), 369–384. <https://doi.org/10.1016/j.landurbplan.2003.10.035>
- Pictet & Cie, J-P. Therre. (2014). Business Continuity Management. [Powerpoint Presentation]. Diploma of Advanced Studies in Enterprise Risk Management. Faculty of Economics, HEC, University of Geneva.
- Piketty, T. (2014). Capital in the twenty-first century. The Belknap Press of Harvard University Press.
- Plouraboué, F., Steyer, A., & Zimmermann, J.-B. (1998). Learning Induced Criticality In Consumers' Adoption Pattern: A Neural Network Approach. *Economics of Innovation and New Technology*, 6(1), 73–90. <https://doi.org/10.1080/10438599800000014>
- Poletto, C., Colizza, V., & Boëlle, P.-Y. (2016). Quantifying spatiotemporal heterogeneity of MERS-CoV transmission in the Middle East region: A combined modelling approach. *Epidemics*, 15, 1–9. <https://doi.org/10.1016/j.epidem.2015.12.001>
- Portugali J. (2008) A Structural-Cognitive Approach to Urban Simulation Models. In: Albeverio S., Andrey D., Giordano P., Vancheri A. (eds) The Dynamics of Complex Urban Systems. Physica-Verlag HD. https://doi.org/10.1007/978-3-7908-1937-3_17
- Potter, R. B. (1980). Spatial and Structural Variations in the Quality Characteristics of Intra-Urban Retailing Centres, *Transactions of the Institute of British Geographers*, 5(2), 207-228.
- Powell, W. W., Koput, K. W., & Smith-Doerr, L. (1996). Interorganizational Collaboration and the Locus of Innovation: Networks of Learning in Biotechnology. *Administrative Science Quarterly*, 41(1), 116. <https://doi.org/10.2307/2393988>
- Price, D.J.S. (1965). Networks of Scientific Papers, *Science*, 149: 510-515.
- Price, D.J.S. (1976) . A General Theory of Bibliometric and Other Cumulative Advantage Processes, *J. Amer. Soc. Inform. Sci.* 27: 292-306.
- Prigogine, I., & Stengers, I. (1979). La nouvelle Alliance. Gallimard, Paris (in French).
- Prigogine, I., P., Allen, & R., Herman. (1977). The Laws of Nature and the Evolution of Complexity. In Goals for a Global community, edited by E. Laszlo and J. Biennan. New York: Pergamon.
- Provotolo D. (2009). Vulnérabilité et résilience : géométrie variable des deux concepts. Séminaire résilience urbaine de l'ENS, Paris.

- Pugh, A. (1986). Professional DYNAMO Plus Reference Manual. 5 Lee St, Cambridge, MA: Pugh-Roberts Associates.
- Pumain, D. (2004a). Spatiality. *Epistemological Foundations*. Hypergeo. <http://www.hypergeo.eu/spip.php?article181#>
- Pumain, D. (2004b). Scaling Laws and Urban Systems. Santa Fe Institute working paper: 2004-02-002 SFI.
- Pumain, D. (2006). Alternative Explanations of Hierarchical Differentiation in Urban Systems. In D. Pumain (Ed.), *Hierarchy in Natural and Social Sciences* (pp. 169–222). Springer Netherlands. https://doi.org/10.1007/1-4020-4127-6_8
- Pumain, D., Paulus, F., Vacchiani-Marcuzzo, C., & Lobo, J. (2006). An evolutionary theory for interpreting urban scaling laws. *Cybergeo*. <https://doi.org/10.4000/cybergeo.2519>
- Pumain, D. (2008). The Socio-Spatial Dynamics of Systems of Cities and Innovation Processes: A Multi-Level Model. In S. Albeverio, D. Andrey, P. Giordano, & A. Vancheri (Eds.), *The Dynamics of Complex Urban Systems: An Interdisciplinary Approach* (pp. 373–389). Physica-Verlag HD. https://doi.org/10.1007/978-3-7908-1937-3_18
- Pumain, D., Paulus, F., & Vacchiani-Marcuzzo, C. (2009). Innovation Cycles and Urban Dynamics. In D. Lane, D. Pumain, S. E. van der Leeuw, & G. West (Eds.), *Complexity Perspectives in Innovation and Social Change* (pp. 237–260). Springer Netherlands. https://doi.org/10.1007/978-1-4020-9663-1_9
- Pumain, D., & Reuillon, R. (2017). *Urban Dynamics and Simulation Models*. Springer International Publishing. <https://doi.org/10.1007/978-3-319-46497-8>
- Queiros-Condé, D., Chaline, Jean., & Dubois, J. (2015). *Le monde des fractales*. La Nature trans-échelles. Ellipses. ISBN-10 : 2340004969. -2e édition (French) Paperback, 480 pages.
- Quenol, H., 2013. Climate analysis at local scale in the context of climate change. *Pollution atmosphérique*.
- Rahmandad, H., & Sterman, J. (2008). Heterogeneity and Network Structure in the Dynamics of Diffusion: Comparing Agent-Based and Differential Equation Models. *Management Science*, 18.
- Rallet A. et Torre A. (2001). Proximité géographique ou proximité organisationnelle? *Économie appliquée*, 54 (1), p. 147-171.
- Rallet, A. (2003). L'économie de proximité. *Propos d'étapes, Etudes et Recherche sur les Systèmes Agraires et le Développement*, 33, pp. 11–23.
- Ramaswamy, V., Collins, W., Haywood, J., Lean, J., Mahowald, N., Myhre, G., Naik, V., Shine, K. P., Soden, B., Stenchikov, G., & Storelvmo, T. (2019). Radiative Forcing of Climate: The Historical Evolution of the Radiative Forcing Concept, the Forcing Agents and their Quantification, and Applications. *Meteorological Monographs*, 59, 14.1-14.101. <https://doi.org/10.1175/AMSMONOGRAPHS-D-19-0001.1>
- Randers, Jørgen. (ed.). (1980). *Elements of the System Dynamics Method*, Portland OR: Productivity Press, 488 pp.
- Raven, R., Schot, J., & Berkhout, F. (2012). Space and scale in socio-technical transitions. *Environmental Innovation and Societal Transitions*, 4, 63–78. <https://doi.org/10.1016/j.eist.2012.08.001>
- Redner, S. (1998). How popular is your paper? An empirical study of the citation distribution. *The European Physical Journal B - Condensed Matter and Complex Systems*, 4(2), 131–134. <https://doi.org/10.1007/s100510050359>
- Reghezza-Zitt, M., Rufat, S., Djament-Tran, G., Le Blanc, A., & Lhomme, S. (2012). What Resilience Is Not: Uses and Abuses. *Cybergeo*. <https://doi.org/10.4000/cybergeo.25554>
- Reggiani, A., P. Bucci, & G. Russo. (2011). Accessibility and impedance forms: empirical applications to the German commuting network, *International Regional Science Review* 34 (2), pp. 230- 252.
- Reggiani, A. (2012). Accessibility, connectivity and resilience in complex networks, in Geurs, K.T., Krizek, K.L., & Reggiani, A (eds.). *Accessibility and Transport Planning: Challenges for Europe and North America*, Cheltenham: Edward Elgar, pp. 15-36.
- Reilly, W. (1929). *Methods for study of retail relationships*. The University of Texas, Bureau of Business Research, Research Monograph, No 4.
- Reilly, W. (1931). *The law of retail gravitation*, New York, Knickerbocker Press, 183 p.
- Return of cybernetics. (2019). *Nature Machine Intelligence*, 1(9), 385–385. <https://doi.org/10.1038/s42256-019-0100-x>

- Ricardo, D. (1891). *Principles of Political Economy and Taxation* (London: G. Bell and Sons).
- Rich, D. C. (1980). Potential models in human geography. *Geo Abstracts.Catmog* 26.
- Richardson, George P., and Alexander L. Pugh, III. (1981). *Introduction to System Dynamics Modeling with DYNAMO*, Portland OR: Productivity Press. 413 pp.
- Richardson, G. (1991). *Feedback Thought in Social Science and Systems Theory*. Philadelphia: University of Pennsylvania Press; also Waltham, MA: Pegasus Communications.
- Richmond, B., Peterson, S., & Vescuso, P. (1987). *An Academic User's Guide to STELLA*. Macintosh computer program, 45 Lyme Road, Hanover, NH 03755: High Performance Systems, 392 pp.
- Rip, A., Kemp, R. P. M., & Kemp, R. (1998). Technological change. In S. Rayner, & E. L. Malone (Eds.), *Human choice and climate change*. Vol. II, *Resources and Technology* (pp. 327-399). Columbus, Ohio: Battelle Press.
- Roberts, N. (1978). Teaching Dynamic Feedback Systems Thinking: an Elementary View. *Management Science*, 24(8), 836-43.
- Roberts, N., Andersen, D., Deal, R., Garet, M., & Shaffer, W. (1983). *Introduction to Computer Simulation: A System Dynamics Modeling Approach*, Portland OR: Productivity Press. 562 pp.
- Robert, K. W., Parris, T. M., & Leiserowitz, A. A. (2005). What is Sustainable Development? Goals, Indicators, Values, and Practice. *Environment: Science and Policy for Sustainable Development*, 47(3), 8–21. <https://doi.org/10.1080/00139157.2005.10524444>
- Rochberg, R. (1972). Some questionable assumptions in the method and model of urban dynamics. In *Urba Dynamics: Extensions and reflections*. Edited by K. Chen. San Francisco PressInc.
- Roco, M. & Bainbridge, W. (2003). *Converging Technologies for Improving Human Performance Nanotechnology, Biotechnology, Information Technology and Cognitive Science* (Eds). Published by Springer. ISBN: 978-94-017-0359-8.
- Rodríguez-Pose, Andrés. (2017). The revenge of the places that don't matter (and what to do about it). *Cambridge Journal of Regions, Economy and Society*, 11 (1). pp. 189-209. ISSN 1752- 1378. DOI: 10.1093/cjres/rsx024.
- Rogers, E.,M. (1962). *Diffusion of innovations*. Free Press, New York.
- Rogers, E.,M. (1983). *Diffusion of innovations*. Third Edition. Free Press, New York.
- Rogers, E. M. (2003). *Difusion of innovations*. Free Press, New York, 5 edition.
- Rogov, M., & Rozenblat, C. (2018). Urban Resilience Discourse Analysis: Towards a Multi-Level Approach to Cities. *Sustainability*, 10(12), 4431. <https://doi.org/10.3390/su10124431>
- Roijakkers, N. (2003). *Inter-firm cooperation in high-tech industries: A study of R&D partnership in pharmaceutical biotechnology*. Universitaire Pers Maastricht. Doctoral thesis.
- Rojas, D., & J.C Loubier. (2017). Analytical Hierarchy Process coupled with GIS for land management purposes: A decision-making application. In *proceedings of the 22nd International Congress on Modelling and Simulation*. Modelling and Simulation Society of Australia and New Zealand. Australia 2017, pp. 1482–1486. DOI: 10.36334/modsim.2017.K7.rojas
- Rojas, D., Doctor, M., & Fragnière. (2018). Is price still the most important factor for making the client to go skiing? A survey study based on conjoint analysis conducted in the Swiss Alps, 68th AIEST Conference. Business models for sustainable growth in tourism co-creating tourism experiences: chances, frontiers and limitations AIEST's *Advances in Tourism Research - Perspectives of Actors, Institutions and Systems*. Italy, 2018.
- Rosenberg, N. (1990). Why do firms do basic research (with their own money). *Res. Policy* 19 (2), 165–174.
- Rosenberg, N. (1962). *Perspectives on Technology*, Cambridge University Press, New York.
- Rosling, H., Rosling Roennlund, A. & Rosling, O. (2018) *Factfulness*. Publisher Hodder & Stoughton General Division, London, UK. ISBN10 1473637465.

- Roy, J. (1990) Spatial interaction modelling: Some interpretations and challenges. *Commentary, Environment and Planning A* 22: 712–716.
- Roy, J. (2004) *Spatial interaction modelling: A regional science context*. Springer, Berlin Heidelberg New York.
- Rozenblat, C. (2010). Opening the Black Box of Agglomeration Economies for Measuring Cities' Competitiveness through International Firm Networks. *Urban Studies*, 47(13), 2841–2865. <https://doi.org/10.1177/0042098010377369>
- Rozenblat, C., & Melancon, G. (2013). *Methods for Multilevel Analysis and Visualisation of Geographical Networks (Methodos Series (11))* 2013th Edition. Springer.
- Rozenblat, C., Pumain, D., & Velasquez, E. (Eds.). (2018). *International and Transnational Perspectives on Urban Systems*. Springer Singapore. <https://doi.org/10.1007/978-981-10-7799-9>
- Rufat, S. (2018). Estimations de la résilience des territoires, sociétés, villes. *Vertigo - la revue électronique en sciences de l'environnement* [En ligne], Hors-série 30 | mai 2018, mis en ligne le 15 mai 2018, consulté le 11 janvier 2019. URL : <http://journals.openedition.org/vertigo/19223> ; DOI : <https://doi.org/10.4000/vertigo.19223>
- Sanders, L., Pumain, D., Mathian, H., Guérin-Pace, F., Bura, S. (1997) SIMPOP, a multi-agents system for the study of urbanism. *Environment and Planning B* 24: 287-305
- Sanders, P., & Sanders, F. (2004). Spatial urban dynamics. A vision on the future of urban dynamics: Forrester revisited", paper presented at the 2004 International System Dynamics Conference at Oxford, UK.
- Sagasti, F.R., 1980. The two civilizations and the process of development. *Prospects (UNESCO)* 10 (2), 123–139.
- Saint-Julien, T. (1985). La diffusion spatiale des innovations. Montpellier GIP RECLUS, coll. RECLUS Modes d'Emploi.
- Saint-Julien, T. (1992). Diffusion spatiale. *Encyclopédie de géographie*. Paris Economica.
- Saint-Julien, T. (2004). Spatial Diffusion. *Spatial Themes*, Hypergeo.
- Salkind, N. J. (2010). *Encyclopedia of research design (Vols. 1-0)*. Thousand Oaks, CA: SAGE Publications, Inc. doi: 10.4135/9781412961288.
- Sangermano, F., Toledano, J., & Eastman, J.R. (2012). Land cover change in the Bolivian Amazon and its implications for REDD+ and endemic biodiversity. *Landscape Ecology* 27(4), 571-584. <http://dx.doi.org/10.1007/s10980-012-9710-y>
- Sapoval, B. (1997). *Universalités et fractales*. Flammarion, Paris.
- Scaglione, M., & Doctor, M. (2011). The impact of Inaccurate Weather forecasts on Cable-car Use. In Weiermair K., Pechlaner H., Strobl A., Elmi M. & Schuckert M. (Eds): *Coping with Global Climate Change. Strategies, Policies and Measures for the Tourism Industry*. Innsbruck University Press, Innsbruck, p. 61-76.
- Scheffer, M., & Carpenter, S. (2003). Catastrophic regime shifts in ecosystems: linking theory to observation. *Trends in Ecology and Evolution* 18(12):848-656.
- Scheffer, M., Bascompte, J., Brock, W. A., Brovkin, V., Carpenter, S. R., Dakos, V., Held, H., van Nes, E. H., Rietkerk, M., & Sugihara, G. (2009). Early-warning signals for critical transitions. *Nature*, 461(7260), 53–59. <https://doi.org/10.1038/nature08227>
- Sen A, & Smith T. (1995). *Gravity models of spatial interaction behaviour*. Springer, Berlin Heidelberg New York.
- Sengers, F., Raven, R.P. (2014). Metering motorbike mobility: informal transport in transition? *Technology Analysis and Strategic Management* 26(4), 453-468.
- Scott, P. (1970). *Geography and retailing* (Hutchinson, London).
- Saviotti, P.P. (2001). Variety, Growth and Demand, *Journal of Evolutionary Economics*, vol. 11 (1), pp. 119-42.
- Schelling, T. (1969). Models of Segregation. *The American Economic Review*, 59(2), 488-493. Retrieved January 8, 2019, from www.jstor.org/stable/1823701
- Schelling, T. (1978). *Micromotives and Macrobehaviour*. New York: Norton. ISBN: 978-0-393-32946-9.

- Scherrer F. (2017). Avant-propos in *La ville résilient, comment la construire?* Collectif, Isabelle Thomas, Antonio Da Cunha, Collection PUM, Montréal (in French).
- Schumpeter, J. (1928). The instability of capitalism. *Econ J* 38(151):361–386.
- Schumpeter, J. (1934). *The Theory of Economic Development*, Cambridge, Mass. Harvard University Press.
- Schumpeter, J. (1939). *BUSINESS CYCLES. A Theoretical, Historical and Statistical Analysis of the Capitalist Process*. New York, McGraw-Hill, 1939, 461 pp. DOI: 10.1522/030021081.
- Schumpeter, J. (1943). *Capitalism, Socialism and Democracy*, Harper and Row, New York.
- Schumpeter, R. (1954). *History of Economic Analysis*, New York: Allen & Unwin.
- Schmookler, J. (1966). *Invention and Economic Growth*, Harvard University Press, Cambridge, MA.
- Schot, J., & Steinmueller, W. E. (2018). Three frames for innovation policy: R&D, systems of innovation and transformative change. *Research Policy*, 47(9), 1554–1567. <https://doi.org/10.1016/j.respol.2018.08.011>.
- Schroeder, W. (1975). Urban dynamics and the suburbs. In *Readings in Urban Dynamics*, edited by W.W. Schroeder, III, R.E. Sweeney & L.E. Alfeld. Cambridge MA: Productivity Press.
- Schroeder, W., III, Robert E. Sweeney, & Louis Edward Alfeld. (Eds.). (1975). *Readings in Urban Dynamics: Volume 2*, Portland OR: Productivity Press, 305 pp.
- Schwoon, M. (2006). Simulating the adoption of fuel cell vehicles. *Journal of Evolutionary Economics*, 16(4), 435–472. <https://doi.org/10.1007/s00191-006-0026-4>
- SEF. (2021) Swiss Energy Foundation: <https://www.energiestiftung.ch/medienmitteilung/energieunabhaengigkeitstag-2021.html>
- Selkoe, K. A., Blenckner, T., Caldwell, M. R., Crowder, L. B., Erickson, A. L., Essington, T. E., Estes, J. A., Fujita, R. M., Halpern, B. S., Hunsicker, M. E., Kappel, C. V., Kelly, R. P., Kittinger, J. N., Levin, P. S., Lynham, J. M., Mach, M. E., Martone, R. G., Mease, L. A., Salomon, A. K., ... Zedler, J. (2015). Principles for managing marine ecosystems prone to tipping points. *Ecosystem Health and Sustainability*, 1(5), 1–18. <https://doi.org/10.1890/EHS14-0024.1>
- Sensier, M., Bristow, G., & Healy, A. (2016). Measuring Regional Economic Resilience across Europe: Operationalizing a complex concept, *Spatial Economic Analysis*, 11:2, 128–151, <https://doi.org/10.1080/17421772.2016.1129435>
- Serre, D., Barroca, B., & Laganier, R. (Eds.). (2012). *Resilience and Urban Risk Management (1st ed.)*. CRC Press. <https://doi.org/10.1201/b12994>
- Sheppard, E. (2018). Heterodoxy as Orthodoxy: Prolegomenon for a Geographical Political Economy in *The New Oxford Handbook of Economic Geography* Edited by Gordon L. Clark, Maryann P. Feldman, Meric S. Gertler, and Dariusz Wójcik.
- Silverman, B. W. (1986). *Density Estimation for Statistics and Data Analysis*. New York: Champan & Hall-CRC.
- Simmie, J., & Martin, R. (2010). The economic resilience of regions: Towards an evolutionary approach. *Cambridge Journal of Regions, Economy and Society*, 3(1), 27–43. <https://doi.org/10.1093/cjres/rsp029>
- Simmie, J. (2017). The evolution of economic resilience in cities: Re-invention versus replication. In *Creating Resilient Economies: Entrepreneurship, Growth and Development in Uncertain Times*; Williams, N., Vorley, T., Eds.; Edward Elgar Publishing Ltd.: Cheltenham, UK, pp. 70–88.
- Simon, H. A. (1955). On a class of skew distribution functions. *Biometrika*, 42(3–4), 425–440. <https://doi.org/10.1093/biomet/42.3-4.425>
- Sinclair, T. M. (2010) Asymmetry in the Business Cycle: Friedman’s Plucking Model with Correlated Innovations, *Studies in Nonlinear Dynamics and Econometrics*, 14, <http://www.bepress.com/snede/vol14/iss1/art3>
- Smith, B. W., Dalen, J., Wiggins, K., Tooley, E., Christopher, P., & Bernard, J. (2008). The brief resilience scale: Assessing the ability to bounce back. *International Journal of Behavioural Medicine*, 15(3), 194–200. <https://doi.org/10.1080/10705500802222972>

- Smith, A., Voß, J.-P., & Grin, J. (2010). Innovation studies and sustainability transitions: The allure of the multi-level perspective and its challenges. *Research Policy*, 39(4), 435–448. <https://doi.org/10.1016/j.respol.2010.01.023>
- Smith, A., & Raven, R. (2012). What is protective space? Reconsidering niches in transitions to sustainability. *Research Policy*, 41(6), 1025–1036. <https://doi.org/10.1016/j.respol.2011.12.012>
- Smith, K. (2000). Innovation as a Systemic Phenomenon: Rethinking the Role of Policy. *Enterprise and Innovation Management Studies*, 1(1), 73–102. <https://doi.org/10.1080/146324400363536>
- Smit B., Burton I., Klein R. T. J. and Wandel J. (2000). An Anatomy of Adaptation to Climate Change and Variability. *Climate Change*, 45, p. 223-251
- Smith, P., Hutchison, D., Sterbenz, J. P. G., Schöller, M., Fessi, A., Karaliopoulos, M., Lac, C., & Plattner, B. (2011). Network resilience: A systematic approach. *IEEE Communications Magazine*, 49(7), 88–97. <https://doi.org/10.1109/MCOM.2011.5936160>
- Solow, Robert. (1956). A contribution to the theory of economic growth. *The Quarterly Journal of Economics*, Vol. 70, No. 1, pp. 65-94 Published by: The MIT Press.
- Soo, K. T. (2005). Zipf's Law for cities: a cross-country investigation. *Regional Science and Urban Economics*, vol. 35, no. 3, pp. 239–263, May 2005, DOI:10.1016/j.regsciurbeco.2004.04.004
- Sornette, D. (2017). *Why stock markets crash: critical events in complex financial systems*. ISBN: 9780691175959. Princeton University Press.
- Soyez, D., & Schulz, C. (2008). Facets of an emerging environmental economic geography (EEG), *Geoforum* 39, 17–19.
- SRADDET. (2018). Regional Scheme of Planning, Sustainable Development and Territorial Equality. https://connaissance-ritoire.maregionsud.fr/fileadmin/user_upload/Annuaire/Ressources/RAPPORT_SRADDET.pdf
- Stephan, P. (1996). The economics of science. *Journal of Economic Literature* 34: 1199–1235.
- Sterman, J. D. (1985). An integrated theory of the economic long wave. *Futures*, Vol. 17(2), pp. 104-131.
- Sterman, J. (1989). Modeling Managerial Behaviour: Misperceptions of Feedback in a Dynamic Decision-Making Experiment. *Management Science*, 35(3), 321–339. <https://doi.org/10.1287/mnsc.35.3.321>
- Sterman, J. (1994). Learning in and about complex systems. *System Dynamics Review*, 10(2–3), 291–330. <https://doi.org/10.1002/sdr.4260100214>
- Sterman, J. (2000). Business Dynamics—Systems Thinking and Modeling for a Complex World. *Journal of the Operational Research Society*, 53(4), 472–473. <https://doi.org/10.1057/palgrave.jors.2601336>
- Sterman, J. D. (2002). All models are wrong: Reflections on becoming a systems scientist. *System Dynamics Review*, 18(4), 501–531. <https://doi.org/10.1002/sdr.261>
- Stern, N., 2016. Economics: current climate models are grossly misleading. *Nature*, 407-409. DOI:10.1038/530407a.
- Stevens, B.H. (1985). Location of economic activities: the JRS contribution to the research literature. *Journal of Regional Science*, 25 (4): 663-85.
- Steyer, A., & Zimmermann, J.-B. (2004). Influence sociale et diffusion de l'innovation. *Mathématiques et sciences humaines*, 168. <https://doi.org/10.4000/msh.2929>
- Steyer, A., & Zimmermann, J.-B. (1996). Externalités de réseau et adoption d'un standard dans une structure résiliable. *Revue d'économie industrielle*, 76(1), 67–90. <https://doi.org/10.3406/rei.1996.1625>
- Steward, F. (2012). Transformative innovation policy to meet the challenge of climate change: Sociotechnical networks aligned with consumption and end-use as new transition arenas for a low-carbon society or green economy. *Technology Analysis & Strategic Management*, 24(4), 331–343. <https://doi.org/10.1080/09537325.2012.663959>.
- Stewart, F. (2008). Technology and underdevelopment. *Dev. Policy Rev.* A 10 (1), 92–105.
- Stewart, J.Q. (1941). An inverse distance variation for certain social influences. *Science*, 93, 89-90.

- Stewart, J.Q. (1942). A measure of the influence of population at a distance. *Sociometry*, 5, 63-71.
- Stewart, J.Q. (1947). Empirical mathematical rules concerning the distribution and equilibrium of population. *Geographical Review*, 37, 461-485.
- Stewart, J.Q. (1948). Demographic gravitation: evidence and applications. *Sociometry*, 11, 31-58.
- Stewart, J.Q. (1952). A basis for social physics. *Impact of Science on Society*, 3, 110-133.
- STRN. (2010). A Research Agenda for the Sustainability Transitions Research Network. Available online at. STRN. https://transitionsnetwork.org/about-strn/research_agenda/
- STRN. (2019). A Research Agenda for the Sustainability Transitions Research Network. Available online at. STRN. https://transitionsnetwork.org/about-strn/research_agenda/
- Suding, K., & Hobbs, R. (2009). Threshold models in restoration and conservation: a developing framework. *Trends in Ecology and Evolution* 24:271–279. <https://doi.org/10.1016/j.tree.2008.11.012>.
- Szendro, P., Vincze, G., & Szasz, A. (2001). Bio-reponse to white noise excitation. *Electro- and Magnetobiology*, 20(2), 215–229. <https://doi.org/10.1081/JBC-100104145>
- Talbot, D., & Kirat, T. (2005). Proximité et institutions : nouveaux éclairages. *Économie et institutions*. URL : <http://ei.revues.org/882>
- Tammiksaar, E., Jauhiainen, J. S., Pae, T., & Ahas, R. (2018). Edgar Kant, Estonian geography and the reception of Walter Christaller's central place theory, 1933–1960. *Journal of Historical Geography*, 60, 77–88. <https://doi.org/10.1016/j.jhg.2018.02.001>
- Tanny, S., & Derzko, N. (1988). Innovators and imitators in innovation diffusion modelling. *Journal of Forecasting* 7(4):225–234.
- Tesfatsion, L. (2002). Agent-Based Computational Economics: Growing Economies from the Bottom Up. 8(1), 30.
- Theys, J., & Vidalenc, E. (2013). *Repenser les villes dans la société post-carbone* Ministère de l'écologie, du Développement, durable et de l'économie et ADEME.
- Thiriot, S., & Kant, J.-D. (2008). Using associative networks to represent adopter's beliefs in a multiagent model of innovation diffusion. *Advances in Complex Systems*, 11(02), 261–272. <https://doi.org/10.1142/S0219525908001611>
- Thom, René (1972). *Stabilité structurelle et morphogénèse. Essai d'une théorie générale des modèles* (2nd edition, revised and augmented 1977), Interéditions, Paris.
- Thormeyer, C., Sasse, J.-P., & Trutnevyte, E. (2020). Spatially-explicit models should consider real-world diffusion of renewable electricity: Solar PV example in Switzerland. *Renewable Energy*, 145, 363–374. <https://doi.org/10.1016/j.renene.2019.06.017>
- Tisue, S., & Wilensky, U. (1999). NetLogo: A Simple Environment for Modeling Complexity.
- Tödting, F., Trippel, M. (2005). "One size fits all?" *Research Policy* 34(8) 1203–1219, DOI: 10.1016/j.respol.2005.01.018.
- Tobler, W. R. (1970). A Computer Movie Simulating Urban Growth in the Detroit Region. *Economic Geography*, 46, 234. <https://doi.org/10.2307/143141>.
- Toth, G., Wachs, J., Clemente, R. D., Kertesz, J., & Lengyel, B. (2019). Inequality is rising where social network segregation interacts with urban topology. *Physics and Society*.
- Torre, A. & Gilly, J. P. (2000) On the analytical dimension of proximity dynamics, *Regional Studies*, 34, pp. 169–180. <https://doi.org/10.1080/00343400050006087>.
- Torre, A., & Rallet, A. (2005). Proximity and Localization. *Regional Studies*, 39(1), 47–59. <https://doi.org/10.1080/0034340052000320842>
- Thünen, V. J., Heinrich, J. (1826). *Der Isolierte Staat in Beziehung auf Landschaft und Nationalökonomie*. Trans. By CM Wartenberg (1966) Von Thünen's Isolated State. Oxford: Pergamon Press.
- Tjahjono, B., Esplugues, C., Ares, E., & Pelaez, G. (2017). What does Industry 4.0 mean to Supply Chain? *Procedia Manufacturing*, 13, 1175–1182. <https://doi.org/10.1016/j.promfg.2017.09.191>

- Travers, J., & Milgram, S. (1969). An Experimental Study of the Small World Problem. *Sociometry*, 32(4), 425. <https://doi.org/10.2307/2786545>
- Truffer, B., Murphy, J. T., & Raven, R. (2015). The geography of sustainability transitions: Contours of an emerging theme. *Environmental Innovation and Societal Transitions*, 17, 63–72. <https://doi.org/10.1016/j.eist.2015.07.004>
- Truffer, B., Markard, J. 2017. Transition Studies: A PhD guide into the wild, 2nd PhDs in Transitions Conference., April, 27, 2017, EPFL Lausanne.
- Tukey J. W. (1977). Exploratory data analysis, Addison-Wesley, Reading, Massachusetts, 688 p.
- Turnheim, B., Berkhout, F., Geels, F., Hof, A., McMeekin, A., Nykvist, B., & van Vuuren, D. (2015). Evaluating sustainability transitions pathways: Bridging analytical approaches to address governance challenges. *Global Environmental Change*, 35, 239–253. <https://doi.org/10.1016/j.gloenvcha.2015.08.010>
- United Nations. (2015). Transforming Our World: The 2030 Agenda for Sustainable Development. In A New Era in Global Health. Springer Publishing Company. <https://doi.org/10.1891/9780826190123.ap02>
- U.S. BEA - Department of Commerce - Bureau of Economic Analysis. Current-Dollar and Real GDP. <http://www.bea.gov/national/index.htm#gdp>. (Visited on 11/12/2017).
- U.S. EIA - Energy Information Administration. (2015). Annual Energy Outlook Retrospective Review: Evaluation of 2014 and Prior Reference Case Projections. Tech. rep. U.S. Department of Energy.
- Valente, T. W., & Vega, G. G. (2020). Diffusion/Contagion Processes on Social Networks. *Health Education & Behaviour*, 47(2), 235–248. <https://doi.org/10.1177/1090198120901497>
- Valente, T. W., Dyal, S. R., Chu, K.-H., Wipfli, H., & Fujimoto, K. (2015). Diffusion of innovations theory applied to global tobacco control treaty ratification. *Social Science & Medicine*, 145, 89–97. <https://doi.org/10.1016/j.socscimed.2015.10.001>
- Valente, T., W. (1995). Social Networks and Health: Models, Methods, and Applications. Oxford University Press.
- Valente, T., W. (1995). Network Models of the Diffusion of Innovations. Computational and Mathematical Organization Theory.
- van Apeldoorn, D., Kok K, Sonneveld, M., & Veldkamp T. (2011). Panarchy rules: rethinking resilience of agroecosystems, evidence from Dutch dairy-farming. *Ecol Soc* 16(1):39. <http://www.ecologyandsociety.org/vol16/iss1/art39/>.
- van Bruggen, A., Nikolic, I., & Kwakkel, J. (2019). Modeling with Stakeholders for Transformative Change. *Sustainability*, 11(3), 825. <https://doi.org/10.3390/su11030825>
- van den Bulte, C., & Lilien, G. L. (1997). Bias and Systematic Change in the Parameter Estimates of Macro-Level Diffusion Models. *Marketing Science*, 16(4), 338–353. <https://doi.org/10.1287/mksc.16.4.338>
- van den Bulte, C., & Stremersch, S. (2004). Social Contagion and Income Heterogeneity in New Product Diffusion: A Meta-Analytic Test. *Marketing Science*, 23(4), 530–544. <https://doi.org/10.1287/mksc.1040.0054>
- van Driel, H., & Schot, J. (2005). Radical innovation as a multi-level process: introducing floating grain elevators in the port of Rotterdam. *Technology and Culture* 46, 51–76.
- van Eck, P. S., Jager, W., & Leeflang, P. S. H. (2011). Opinion Leaders' Role in Innovation Diffusion: A Simulation Study: Opinion Leaders' Role in Innovation Diffusion. *Journal of Product Innovation Management*, 28(2), 187–203. <https://doi.org/10.1111/j.1540-5885.2011.00791.x>
- van Oorschot, J. A. W. H., Hofman, E., & Halman, J. I. M. (2018). A bibliometric review of the innovation adoption literature. *Technological Forecasting and Social Change*, 134, 1–21. <https://doi.org/10.1016/j.techfore.2018.04.032>
- van Sluisveld, M. A. E., Hof, A. F., Carrara, S., Geels, F. W., Nilsson, M., Rogge, K., Turnheim, B., & van Vuuren, D. P. (2018). Aligning integrated assessment modelling with socio-technical transition insights: An application to low-carbon energy scenario analysis in Europe. *Technological Forecasting and Social Change*, 151, 119177. <https://doi.org/10.1016/j.techfore.2017.10.024>
- Veldkamp, A., & Lambin, E. F. (2001). *Predicting land-use change*. Agriculture, Ecosystems and Environment 85 (2001) 1–6. Elsevier.

- Verspagen, B. (2004). Structural Change and Technology: A Long View. *Revue Économique*, 55(6), 1099. <https://doi.org/10.3917/reco.556.1099>.
- Vial, G. (2011). Le système proie-prédateur de Volterra-Lotka, website of l'Ecole Centrale de Lyon, 2011.
- Vignal, M. (2020). L'impact du changement global sur la flore du Sud-Est de la France: Modélisation multiscalaire de la répartition de 25 espèces à l'horizon 2100 par la dynamique de population. Thèse de Doctorat. Université Côte d'Azur.
- Victor, D., 2015. Climate change : embed the social sciences in climate policy. *Nature* 520 (7545), 27–29. DOI: 10.1038/520027a.
- Voiron-Canicio C., & Chéry J., (2005) Espace géographique, spatialisation et modélisation en dynamique des systèmes. *Res-Systemica* 5, 10 p.
- Voiron-Canicio, C. (2012). Forecasting change in prospective and spatial change in Geoprospective. *L'Espace Géographique* 13.
- Voiron-Canicio, C. & Dutozia, J. (2017). Anticiper et simuler les dynamiques de changement pour diagnostiquer et améliorer la résilience d'un système territorial urbain. *Revue: Risques urbains*, numéro 1, volume 1, ISTE OpenScience. DOI : 10.21494/ISTE.OP.2018.0200
- Voiron-Canicio, C., & Fusco, G. (2020). Knowledge challenges of the geoprospective approach applied to territorial resilience. In E. Garbolino & C. Voiron-Canicio-Canicio (Eds.), *Ecosystem and Territorial Resilience* (pp. 57–83). Elsevier. <https://doi.org/10.1016/B978-0-12-818215-4.00003-1>.
- Voiron-Canicio, C., & Voiron, G. (2020). Assessing the territorial adoption potential of electric mobility: geoprospective and scenarios. In E. Garbolino & C. Voiron-Canicio-Canicio (Eds.), *Ecosystem and Territorial Resilience* (pp. 57–83). Elsevier. <https://doi.org/10.1016/B978-0-12-818215-4.00006-7>.
- von Hippel, E. (1994). Sticky information and the locus of problem solving: implications for innovation. *Manag. Sci.* 40 (4), 429–439.
- Walker, B., Holling, C.S., Carpenter, S., Kinzig, A.(2004). Resilience, Adaptability and Transformability in Social–ecological Systems. *Ecol. Soc.* 9, 5.
- Walker, B., Gunderson, L., Kinzig, A., Folke, C., Carpenter, S., & Schultz, L.(2006). A handful of heuristics and some propositions for understanding resilience in social-ecological systems. *Ecol. Soc.* 11, 13.
- Walters, C. (1986). Adaptive management of renewable resources. New York: McGraw Hill.
- Wang, C. C., & Wu, A. (2016). Geographical FDI knowledge spillover and innovation of indigenous firms in China. *International Business Review*, 25(4), 895–906. <https://doi.org/10.1016/j.ibusrev.2015.12.004>
- Watkins, N. W., Pruessner, G., Chapman, S. C., Crosby, N. B., & Jensen, H. J. (2016). 25 Years of Self-organized Criticality: Concepts and Controversies. *Space Science Reviews*, 198(1–4), 3–44. <https://doi.org/10.1007/s11214-015-0155-x>
- Watts, D. J., & Strogatz, S. H. (1998). Collective dynamics of 'small-world' networks. *Nature*, 393(6684), 440–442. <https://doi.org/10.1038/30918>
- Wayens, B. (2006). Structure et dynamique du commerce de détail bruxellois. Une approche sous l'angle des facteurs de localisation différentielle. PhD Dissertation Université Libre de Bruxelles, Belgium.
- Weidlich, W., & Haag, G. (1987a). A dynamic phase transition model for spatial agglomeration processes. *Journal of regional science*, 27(4), 529–569. <https://doi.org/10.1111/j.1467-9787.1987.tb01181.x>
- Weidlich, W. (1987b). Synergetics and Social Science. In: Graham R., Wunderlin A. (eds) *Lasers and Synergetics*. Springer Proceedings in Physics, vol 19. Springer, Berlin, Heidelberg. https://doi.org/10.1007/978-3-642-72758-0_17.
- Weidlich, W., & Munz, M. (1990). Settlement formation. Part 1: A Dynamic Theory; Part 2: Numerical Simulation. *The Annals of Regional Science* 24: 83-106, 177-196.
- White, R., & Engelen, G. (1993). Fractal urban land use patterns: A cellular automata approach. *Environment and Planning A* 25: 1175-1199.

- Westerveld, J. (2014). *The Adaptive Cycle: An Exploratory Study of Uncertainty and Resilience within Organizations*. Master Thesis. Amsterdam: University of Amsterdam.
- Wilensky, U. (1997). NetLogo Segregation model. Center for Connected Learning and Computer-Based Modeling, Northwestern University, Evanston, IL. <http://ccl.northwestern.edu/NetLogo/models/Segregation>.
- Wilensky, U. (1999). NetLogo. Center for Connected Learning and Computer-Based Modeling, Northwestern University, Evanston, IL. <http://ccl.northwestern.edu/NetLogo/>.
- Wilson, G.A. (2018). Constructive tensions in resilience research: Critical reflections from a human geography perspective. *Geogr. J.* 184, 89–99. <https://doi.org/10.1111/geoj.12232>
- Wilson, K. G. (1971a). Renormalization Group and Critical Phenomena. I. Renormalization Group and the Kadanoff Scaling Picture. *Physical Review B*, 4(9), 3174–3183. <https://doi.org/10.1103/PhysRevB.4.3174>
- Wilson, K. G. (1971b). Renormalization Group and Critical Phenomena. II. Phase-Space Cell Analysis of Critical Behaviour. *Physical Review B*, 4(9), 3184–3205. <https://doi.org/10.1103/PhysRevB.4.3184>
- Wilson, C., Pettifor, H., McCollum, D., 2014. Improving the Behavioural Realism of Integrated Assessment Models of Global Climate Change Mitigation: A Research Agenda. ADVANCE Project Deliverable No. 3.2. Tyndall Centre for Climate Change Research, Norwich, UK and International Institute for Applied Systems Analysis (IIASA), Laxenburg, Austria.
- Wissler, C. (1915). The diffusion of horse culture among the North American Indians. *Proceedings of the National Academy of Sciences of the United States of America*, 1(4):254–256.
- Weber, A. (1909). *Über den standort der industrien, Tübingin, traduction anglaise: Theory of the location of industries*, Chicago university press.
- Wickham, H.(2009). *ggplot2: Elegant Graphics for Data Analysis*. Springer-Verlag New York, 2009.
- Wiener, N. (1989). *The human use of human beings: Cybernetics and society*.
- Wildgen, W. (1995). Catastrophe theory. In J. Verschueren, J.-O. Östman, & J. Blommaert (Eds.), *Handbook of Pragmatics* (pp. 95–97). John Benjamins Publishing Company. <https://doi.org/10.1075/hop.m.cat1>
- Wilson, A. (1980). *Catastrophe theory and bifurcation*. Croom Helm, London
- Wolfram, S. (1994). *Cellular automata and complexity*. Addison-Wesley, Reading, MA.
- World Bank. (2017). Energy Use (Kg of Oil Equivalent per Capita) | Data. <http://data.worldbank.org/indicator/EG.USE.PCAP.KG.OE>. (Visited on 10/5/2017).
- World Bank. (2020). Development World Indicators. <http://data.worldbank.org/data-catalog/world-development-indicators>. (Visited on 4/10/2020).
- Xu, L., Marinova, D., Guo, X. (2015). Resilience thinking: A renewed system approach for sustainability science. *Sustain. Sci.*, 10, 123–138.
- Yang, J., Su, J., Chen, F., Xie, P., & Ge, Q. (2016). A Local Land Use Competition Cellular Automata Model and Its Application. *ISPRS International Journal of Geo-Information*, 5(7), 106. <https://doi.org/10.3390/ijgi5070106>
- Yatchew, A. (1998). Nonparametric Regression Techniques in Economics. *Journal of Economic Literature*, 36, 669-721.
- Yook, S.-H., Jeong, H., & Barabasi, A. L. (2002). Modeling the Internet's large-scale topology. *Proceedings of the National Academy of Sciences of the United States of America*, 99(21):13382-13386.
- Yoshimo, M. (1975). *Climate in a Small Area: An Introduction to Local Meteorology*. University of Tokyo Press, Tokyo.
- Yule, G., U. (1925). *A mathematical theory of evolution, based on the conclusions of Dr. J. C. Willis, F. R. S*
Published :01 January 1925<https://doi.org/10.1098/rstb.1925.0002>
- Zarnowitz, V., & Ozyldirim, A. (2006). Time series decomposition and measurement of business cycles, trends and growth cycles, *Journal of Monetary Economics* 53, 1717–1739. <https://doi:10.1016/j.jmoneco.2005.03.015>

- Zeeman, C. (1993). Controversy in Science: on the Ideas of Daniel Bernoulli and René Thom. In: *Nieuw Archief voor Wiskunde*, 11 (3): 257-282).
- Zenou, Y. (2009). *Urban Labor Economics*. Cambridge University Press.
<https://EconPapers.repec.org/RePEc:cup:cbooks:9780521875387>
- Zhang, T., & Nuttall, W. J. (2011). Evaluating Government's Policies on Promoting Smart Metering Diffusion in Retail Electricity Markets via Agent-Based Simulation*: Smart Metering Diffusion in Retail Electricity Markets. *Journal of Product Innovation Management*, 28(2), 169–186. <https://doi.org/10.1111/j.1540-5885.2011.00790.x>
- Zimmermann, J.-B. (2002). « Grappes d'entreprises » et « petits mondes »: Une affaire de proximités. *Revue économique*, 53(3), 517. <https://doi.org/10.3917/reco.533.0517>
- Zimmermann, J.-B., Deroïan, F., & Steyer, A. (2003). Apprentissage social et diffusion de l'innovation: Réseaux critiques et intermédiation. *Revue d'économie industrielle*, 103(1), 71–89. <https://doi.org/10.3406/rei.2003.3109>
- Zimmermann, J.-B. (2008). Le territoire dans l'analyse économique. Proximité géographique et proximité organisée. *Revue française de gestion*, 34(184), 105–118. <https://doi.org/10.3166/rfg.184.105-118>
- Zimmermann, J.-B. (2015). PACA Innovation, un Réseau à la Croisée de Proximités Géographiques et Organisées. Working paper.
- Zipf, G. (1949). *Human Behaviour and the Principle of Least Effort*, Addison-Wesley: Cambridge, MA.
- Zukauskaite, E. (2013). *Institutions and the geography of innovation: A regional perspective*. Doctoral thesis, Lund University.

List of Figures

Figure 1A comparison of long-term price trends for coal, nuclear power and solar photovoltaic modules in the US, source: Farmer & Lafond, 2016. Figure 1B. Module costs and prices since 1975. Costs are shown in orange, and prices are shown in purple, source Kavlak et al., (2018).	16
Figure 2. Productivity ^a per hour worked, 1950 to 2017, source: Feenstra et al., (2015)	17
Figure 3 Productivity per hour worked in the world in 1950. Figure 4 Productivity per hour worked in Europe in 1950.....	18
Figure 5 Productivity per hour worked in the world in 1980. Figure 6 Productivity per hour worked in Europe in 1980.....	18
Figure 7 Productivity ^a per hour worked in the world in 1995. Figure 8 Productivity per hour worked in the Europe in 1995.	22
Figure 9A) Location based on transportation costs. B) Isodapane lines, Weber (1909).	25
Figure 10A) Degrees of Separation by Milgram (1967). B and C Results from Backstrom et al., (2012).	27
Figure 11 Network rewiring interpolation between regularity and randomness in a ring lattice (Watts & Strogatz, 1998).....	28
Figure 12 Characteristic path length $L(p)$ and clustering coefficient $C(p)$ for the family of randomly rewired graphs described in the previous figure.....	29
Figure 13 Local Bridges of Granovetter (1973).....	30
Figure 14.A) Average degree of the network in the (β, θ) -space (left: no learning; right: learning) .B) The emergence of connectedness in the (β, θ) -space (left: no learning; right: learning), Cowan et al., (2006).	35
Figure 15 A) Average distance in the (β, θ) -space (left: no learning; right: learning). B) Cliquishness in the (β, θ) -space (left: no learning; right: learning).	36
Figure 16 Decimal log - log plot of the inverse cumulated distribution of influence sphere sizes, Plouraboué et al., (1998).	38
Figure 17 Scale-free network (Barabasi & Albert, 1999). Simulated on NetLogo.	39
Figure 18 Productivity per hour in the world and in Europe in 2010 and 2017.	42
Figure 19 The distribution of Bureau of Labour Statistics 2010 occupational employment over the probability of computerisation, along with the share in low, medium, and high probability categories. Note that the total area under all curves is equal to total us employment. Source: Frey & Osborne, 2013.	43
Figure 20 The Backcasting methodology. Source: Eek & Swahn (2003).	47
Figure 21 Emission reduction trajectories of CO ₂ by scenario for 2050 in France. Source: Theys & Vidalenc (2013).	48
Figure 22 A) A specific vulnerability in city centres: amplification due to "heat islands" in Paris. Source Theys & Vidalenc (2013). B) Maximal temperature projected for 2050 in France. C) Maximal temperature projected for 2100 in France. Source ORNEC (2013).	49
Figure 23 Number of papers on sustainability transitions in peer reviewed journals and citations. Source: Scopus, January 12, 2019; Köhler et al., (2019).	49
Figure 24 Evolution of research on sustainability transition, source: Markard et al., (2012).	50
Figure 25 Model of Multi-Level Perspective. Source: Geels (2002).	51
Figure 26 . Scientific emphases on sustainability transition studies. Source: Markard (2017).	52
Figure 27 The bell-shaped frequency curve and the s-shaped cumulative curve for an adopter distribution. Source: Rogers (1983).....	58
Figure 28 Adopter categorization based on innovativeness. Source: Rogers (1983).	59
Figure 29 Network representation for Innovators.....	59
Figure 30 Network representation for early adopters.....	60
Figure 31 A Central Node with Low Degree Centrality. Source: adapted from Jackson (2008).	61
Figure 32 Adoptions due to external and internal influence in the Bass model, Source: Mahajan et al., (1990). .	63
Figure 33 Snapshots along the urban modeling timeline. Source: Batty (2008).	66
Figure 34 Map of population potentials in the United States, Stewart (1947).	67
Figure 35 A) Illustration of the estimates of multiple trading areas with the breaking point formula (Reilly, 1927). B) A retail trading area portrayed in terms of probability contours (Huff, 1964).....	69
Figure 36 Nested hexagons in the Central Place Theory proposed by Christaller (1933).	71
Figure 37 The behaviour of the Attractiveness for activity k at i as felt by the population X_i as the size of the center i grows. Source: Allen & Sanglier (1981).	73

Figure 38 Central Place Systems Model from Allen & Sanglier (1981). (Left). Structure (A'B') The urban structure at $t = 42$, when the frontier between A_1 and B_1 was removed at $t = 21$. We have constant total population and "good" transportation. (Right). Structure (AB). The stable state attained at $t = 21$, when the two regions A_1 and B_1 are United at $t = 0$. The population is constant, and we have "good" transportation. ...	75
Figure 39 The law of metropolises revisited. Population of the largest city of systems of cities P_1 versus the total urban population P_u in that system. Source: Louf (2015).	76
Figure 40 To the left, Urban scales, emerging properties and organization level. To the right, Interactions between different urban scales. Source: Pumain (2008).	77
Figure 41A Trajectories of cities in an economic space in France from 1950 to 2000). B) Co-evolution of US with more than 2 million inhabitants. Source: Paulus (2005).	77
Figure 42A GDP growth trends (%) with underlying factors in Sweden ^a , source: Nilsson et al., (2013). B) Long-term employment growth (hours worked), 1950–2009 in the UK, US and Australia. Source: Pålsson et al., (2013).	78
Figure 43. Hydraulic Metaphor, source: Forrester (1961).	81
Figure 44. Forrester's Systems Dynamics representation for car leasing impact, source: Sterman (2000).	82
Figure 45. General Simulation Urban System, source: Forrester (1969).	83
Figure 46. Feedback loop, source: Sterman (2000).	83
Figure 47 The nine levels of Forrester's model. Source: Forrester (1979).	84
Figure 48 Urban system area is a system of interacting sector (Alfeld & Graham, 1976).	85
Figure 49 The development of the spatial dimension in Urban Dynamics. Source: Sanders & Sanders (2004).	86
Figure 50 The difference between the traditional approach of SD and spatial dynamics, source: Sanders & Sanders (2004).	87
Figure 51 The base behaviour comparison with Forrester's model, Sanders & Sanders (2004).	87
Figure 52. World Model, source: Forrester (1971).	88
Figure 53 Markov Chains and Transition Matrix of land used in the canton of Valais-Wallis for 2030.	90
Figure 54 Sketch of mutual competition between different land use type cells in the neighborhood. Source: Yang et al., (2016).	93
Figure 55 Land use maps in 2001 and 2100, class colors Red = Urban; Pink = Agriculture; Green = Forest and Rangeland. Counts of the number of pixels converted to urban during the 2017–2100 simulation by each of the four CA behaviour rules. Far right map is for the total urban growth rate by cells in percentage. Note that the scales vary by behaviour rule. Source: Clarke & Johnson (2020).	94
Figure 56 SimpopLocal Activity Diagram. Source: Pumain & Reuillon (2017).	95
Figure 57 Schelling's segregation model. A) Initial random conditions. B) Results of simulation. Performed on Netogo, Source: Wilensky (1999).	102
Figure 58 Friendships among high school students. Source: Jackson (2008).	103
Figure 59 Spatial Dynamics for Innovation Diffusion	105
Figure 60 Kernel density of solar panels adoption in the canton of Valais, Switzerland.	106
Figure 61 The multidisciplinary aspect of resilience. Source: Lhomme, 2012.	113
Figure 62 (Left) Hysteresis loop for a solenoid's ferromagnetic core. (Right) Types of regime shifts. Phase shifts can be smooth or nonlinear, whereas alternative stable states show discontinuous change with some level of hysteresis. Source: Selkoe et al., (2015).	118
Figure 63 Regional resilience from recessions. Source: Martin et al. (2016).	119
Figure 64 Unification process of Business Continuity Management.	122
Figure 65. (Left) Precursory signs of a crisis. (Right). Evolution of a crisis situation. Source Pictet & Cie, J-P. Therre (2014).	125
Figure 66. Recovery Point Objective & Recovery Time Objective. Source Pictet & Cie, J-P. Therre (2014).	125
Figure 67 Co-occurrences of terms appearing in the abstracts of papers with "Sustainability & Resilience" in their title. Source: Rogov & Rozenblat (2018).	130
Figure 68 To the left: Co-occurrences of terms in the abstracts of papers with "Urban resilience" in their title. To the right: Co-occurrences of terms in the abstracts of papers with "Regional resilience" in the title. Source: Rogov & Rozenblat (2018).	130
Figure 69A Diagram of Panarchy: Complex Systems Dynamics exhibiting adaptive cycles. Source: Angeler et al., (2016), inspired from Gunderson & Holling (2002). B) Representation in three dimensions of the adaptive cycle metaphor with respect to the three properties of systems. Source: Westerveld (2014).	132
Figure 70 (Left). Urban and regional resilience research in a multi-level perspective. Source : Rogov & Rozenblat (2018). (Right). Urban scales, emerging properties and organization level. Source: Pumain (2008).	132

Figure 71 Relationship between adaptive capacity to shocks/stressors and organizational capital: (A) weak organizational capital and (B) strengthened organizational capital. Source: Voiron-Canicio & Fusco (2020).	137
Figure 72 Interdisciplinary scientific position of the doctoral dissertation.	139
Figure 73. Research position on Geel's model of Multi-Level Perspective.	141
Figure 74 Studied regions: South Region of France and the canton of Valais in Switzerland. Generated with Arcgis Pro, 2021.	142
Figure 75. A) Kernel Density of the Population in Valais in 2017, analysis at 100 sq m resolution. B) Optimized Hot Spot Analysis of Population in Valais 2017, at 100 sq m resolution. Data source: FSO (2018), generated with ArcGIS Pro.	143
Figure 76 Evolution of the productivity of the primary sector in Valais from 2005 to 2014. Nominal Gross Value Added divided by the number of full-time equivalent jobs (FTEs). Source: CREA, 2017; FSO, 2018.	144
Figure 77 Productivity trends in the Valais secondary sector and its branches of activity from 2005 to 2014. Nominal GVA divided by the number of FTEs. Source: (FSO, 2018)	144
Figure 78 Productivity trends in the tertiary sector and its industries from 2005 to 2014 (CREA, 2018; FSO, 2018).	145
Figure 79 3D Mapping of the GDP for the canton of Valais in 2016, 3D isometric view of 45° at a 100 sq m resolution. The blue peaks should be understood as high intensities of GDP production.	145
Figure 80 Average annual sunshine duration. Source: Federal Office of Meteorology and Climatology MeteoSwiss (OFMC, 2018).	147
Figure 81 Annual Temperature in Switzerland from 1755 to 2020. Source: OFMC (2020).	148
Figure 82 Temperature evolution from 1864 to 2020. Source: OFMC (2020).	148
Figure 83 Energy use (kg of oil equivalent per capita) - OECD members, World Bank (2020).	150
Figure 84 Fuel shares of TPES from 1973 to 2015, source: IEA (2016).	150
Figure 85 Analysis of errors in the yearly US Energy Information Administration (EIA) Annual Energy Outlook (AEO) energy demand forecasts for the years 1994-2014. Full lines indicate the average of errors in absolute values. The dotted lines indicate errors. Source: Moret, 2017.	151
Figure 86 Natural gas for electricity production price in the US. Comparison between the yearly EIA Annual Energy Outlook (AEO) price forecasts and the actual values for the years 1985-2015. The black lines are the forecasts made in different years. The red line represents the actual NG price. The blue line is the last available forecast. Source: Moret (2017).	151
Figure 87 To the left: Noise protection wall at the train station Münsingen (Bern) with bifacial solar modules (electricity production on both sides). Power 12.8 kW. Photo: TNC Consulting AG. To the right: Floating solar system on the lake Lac des Toules, Bourg-St-Pierre, Valais. Performance approx. 500 kW, Picture: Novelty Energy. Source: SEF (2021).	155
Figure 88 Energy demand (including consumption of large industrial sites) and cumulative renewable production in Valais in GWh/a. Available online at <projections 2015-2060https://www.vs.ch/web/sefh/strategie-energetique>	155
Figure 89 Thermal networks: demand from residential and commercial buildings in 2013. Source: Swiss Federal Office of Energy	156
Figure 90 Wind energy plants. Source: Swiss Federal Office of Energy (2021).	156
Figure 91 A) Statistics on hydropower plants, source: SFOE, 2019. B) Dams under federal supervision, source: SFOE (2020).	156
Figure 92 Climate maps of the study area. Left) Average Annual Temperature (AAT). Right) Cumulative Annual Rainfall (CAR). Source : Vignal (2020). (a) Marseille ; AAT : 15.7 °C ; CAR : 555 mm. (b) Avignon ; AAT : 14.8 °C ; CAR : 677 mm. (c) Nice ; AAT : 16.0 °C ; CAR : 733 mm. (d) Sisteron ; AAT : 11.8 °C ; CAR : 822 mm. (e) Saint-Martin-Vésubie ; AAT : 11.8 °C ; CAR : 1 135 mm. (f) Briançon; AAT : 8.3 °C ; CAR: 759 mm. Source: TOPO data base from IGN , climate data from ALADIN-CLIMAT model (2016).	159
Figure 93 Land-use in the South Region of France: 1. Southern alps and alpine peaks; 2. Haute Provence or middle country; 3. Lower Provence or Provençal hills ; 4. Provençal plains and coastline; 5. Crystalline Provence. Source: Corine Land Cover (2018).	160
Figure 94 Climate change in the South Region over the past 10,000 years. Source: GREC-SUD, 2016.	161
Figure 95 Ground area of the "non-redhibitory" levels of stakes by department, taking into account the critical size of the parcels (1 ha). Source: CEREMA (2019).	162
Figure 96 Assessment of territorial adoption potential of electric mobility. Source: Voiron-Canicio & Voiron (2020).	163
Figure 97 Photovoltaic Power Generated in the South Region in 2018.	164

Figure 98 Evolution of the wind power in the South Region in MW. Source: ORECA.....	164
Figure 99 Random network, generated with Gephi.....	168
Figure 100 Binomial vs. Poisson Degree Distribution (Barabasi, 2016).....	168
Figure 101 Phase Transitions, Barabasi (2016).....	169
Figure 102 Thresholds for Poisson Random Networks, generated with Gephi.....	170
Figure 103 Evolution of a Random Network, Barabasi (2016).....	171
Figure 104 The Topology of the World Wide Web, Source: Jeong et al., (1999)	172
Figure 105 The distribution function of connectivity for various large networks. (A) Actor collaboration, n graph with N = 212, 250 vertices and average connectivity $\langle k \rangle = 28.78$; (B) World wide web, N = 325, 729, $\langle k \rangle = 5.46$ (6); (C) Power grid data, N = 4, 941, $\langle k \rangle = 2.67$. The dashed lines have slopes (A) $\gamma_{actor} = 2.3$, (B) $\gamma_{www} = 2.1$ and (C) $\gamma_{power} = 4$	172
Figure 106, A and B are the degree distribution of the highway system network in the US. C and D are the degree distribution of the airline system network in the US. Source: Barabasi (2002).	175
Figure 107 Poisson vs. Power-law Distributions. Source: Barabasi (2016)	176
Figure 108 Hubs in scale-free networks. Source: Barabasi (2016).....	178
Figure 109 Geographic model for a biofuel application in Austria. To the left: Distribution of 1,571 gas stations. In the center: Population density. To the right: Distribution of 10,000 consumer agents according to population density. Source: Kiesling (2011).	179
Figure 110 Social network detail, $\alpha = -5$, $\beta = 1$ nlinkspatial=3, seed=1299961164. Source: Kiesling (2011).....	180
Figure 111 The various levels of modelling reality, Guermond (1984).	186
Figure 112 General System of Simulation of Renewable Energy Technologies Diffusion and Spatial Resilience to Renewable Energies Diffusion.....	187
Figure 113 Phase 1 of the General System of Simulation	189
Figure 114 Transition Areas in Valais, Switzerland: expected transition from 2006 to 2048, 250 sq m resolution.	192
Figure 115 Phase 2: Gravity Model for the Valais Region, Switzerland.....	192
Figure 116 Conceptual structure of the gravity model for the Valais-Wallis region. Sources: The figures displaying human beings in black was provided by Anylogic.	194
Figure 117 Map of the Potential Field of Innovation at 100 sq m resolution in the Valais region ^a	196
Figure 118 Kernel density for full time equivalent jobs in the canton of Valais-Wallis in 2015 at 100 sq m resolution. The red peaks should be understood as the higher levels of attractiveness.....	197
Figure 119 Distribution of Attractiveness at 100 sq m Resolution in the Valais Region in Switzerland in 2016. .	197
Figure 120 Average Nearest Neighbour Analysis at 100 sq m resolution in Valais, Switzerland. Generated with ArcGIS.	198
Figure 121 Re-Conceptualizing a System Dynamics Model into Agent Based Model. General Scheme. Source: Borshchev & Filippov (2004).	199
Figure 122 Population System. Source: Metcalf & Peterson (2018).	199
Figure 123 Stage Model from Kunte & Damani (2015).....	200
Figure 124 Forecast of population dynamics in Valais-Wallis horizon 2045	202
Figure 125 General Structure of the Population Dynamics Model.	203
Figure 126 Residuals distribution of the simulation of the population 2015 at 100 sq m in the canton of Valais.	205
Figure 127 Representation of Population Dynamics at 100 sq m resolution in the canton of Valais.....	206
Figure 128 Multi-scale Network Modelling & Simulation of Renewable Energy Technologies Diffusion in the Swiss canton of Valais, in Switzerland and in the South Region of France.	206
Figure 129 Overview of the Georeferenced Data of the Swiss Register System of Population, Buildings, Dwellings and Energy.	207
Figure 130 (Left) Rank-Size: number of people per building vs ranking: scaling emergence at building level in Valais, 2016. (Centre) The same chart on a log-log plot. (Right) Logarithmic histogram of permanent residents per building. N= 73,419; $\gamma_{total_residents} = -0.759$; Adjusted-R ² = 0,905.	209
Figure 131 Confusion Matrix. TP= True Positive; FP= False Positive; FN: False Negative; TN: True Negative.	211
Figure 132 Kernel Density. Source: ESRI (2018).....	212
Figure 133 Kernel density and overlay of socio-demographic data and renewable energy technologies, 100 sq m resolution.....	213
Figure 134 Kernel density of Total jobs in Valais in 2015, resolution 100 sq m.	214
Figure 135 Kernel density of solar photovoltaics adoptions for heating and hot water usage in Valais in 2015 at 300 sq m resolution. The red pics represent a high intensity of adoption.	214

Figure 136 Multiscale kernel density of solar photovoltaics for heating in Valais, Switzerland 2015. Y-axis: Kernel Density Estimation, X-axis: Spatial Units' Ranking.....	215
Figure 137 Adjusting and fitting the straight part of the curve. Y-axis: Kernel Density Estimation of solar photovoltaics for heating in Valais, Switzerland 2015. X-axis: Spatial Units' Ranking.	216
Figure 138 Kernel density of solar photovoltaics for hot water in Valais in 2015. Y-axis: KDE, X-axis: Spatial Units' Ranking.	216
Figure 139 Scale dependence of the length and of the effective fractal dimension (minus the topological dimension) in the case of a constant 'scale-force', including a transition to scale independence at large scale. Source: Nottale (2007).	217
Figure 140 Multiscale kernel density of solar photovoltaics for Heating and hot water in Valais, Switzerland 2015. Y-axis: Kernel Density Estimation, X-axis: Spatial Units' Ranking.	217
Figure 141 Average Nearest Neighbour for Solar photovoltaics for heating and hot water in the Valais Region in 2015.	218
Figure 142 Multiscale spatial adoption rate change of solar photovoltaics for heating in Valais between 2014 and 2015. Y-axis: Log of Kernel Density Estimation, Log of X-axis: Spatial Units' Ranking.	219
Figure 143 Multiscale spatial adoption rate change of solar photovoltaics for hot water in Valais between 2014 and 2015. Y-axis: Log of Kernel Density Estimation, Log of X-axis: Spatial Units' Ranking.	220
Figure 144 Multiscale spatial adoption rate change of solar photovoltaics for heating and hot water in Valais between 2014 and 2015. Y-axis: Log of Kernel Density Estimation, X-axis: Log of Spatial Units' Ranking. .	221
Figure 145 (Left) Lin-lin plot of spatial adoption rate change of solar photovoltaics for heating and hot water in Valais between 2014 and 2015. (Centre) Descriptive statistics of the chart in the left. (Right) Lin-lin plot without the largest hub. Y-axis: Kernel Density Estimation, X-axis: Spatial Units' Ranking.	222
Figure 146 Kernel Density for Electric and Hybrid Vehicles Adoption in Switzerland in 2018 at 2700 sq m resolution.....	224
Figure 147 Kernel Density Distributions of Electric Vehicles in Switzerland in 2018.	225
Figure 148 Multiscale spatial adoption rate change of electric vehicles in Switzerland between 2016 and 2018.	225
Figure 149 Multiscale spatial adoption rate change of Hybrid Vehicles in Switzerland between 2016 and 2018.	226
Figure 150 Spatial Preferential Attachment Model (SPA).	227
Figure 151 Weighted overlay of population, jobs solar photovoltaics in the canton of Valais, Switzerland 2015, at 300 sq m resolution.	228
Figure 152 Spatial Preferential Attachment Process.	229
Figure 153 Data structure of the output of algorithm 2 for SPA model.....	231
Figure 154 Distribution of the links' weight derived from the SPA model applied for solar photovoltaics for hot water at a 300, 600 and 1200 sq m resolution in Valais, 2015.....	231
Figure 155 Distribution of the links' weight derived from the SPA model applied for solar photovoltaics for hot water at 300 sq m resolution in Valais, from 2009 to 2015. Year 2009)N= 7394; L= 561,123 and $Y_{solarPV_{hotwater}} \approx -1.3$; Year 2010) N=8523; L= 548,326 and $Y_{solarPV_{hotwater}} \approx -1.3$; Year 2011)N=9131; L= 519,499 and $Y_{solarPV_{hotwater}} \approx -1.3$; Year 2012)N=8523; L= 408,213 and $Y_{solarPV_{hotwater}} \approx -1.4$; Year 2013)N=10035; L= 410,115 and $Y_{solarPV_{hotwater}} \approx -1.3$; Year 2014)N=8431; L= 415,080 and $Y_{solarPV_{hotwater}} \approx 1.3$; Year 2015) N=8059, L= 362,466 and $Y_{solarPV_{hotwater}} \approx -1.3$. Adjusted R-square is larger than 0.96 for all the distributions.....	233
Figure 156 Distribution of the links' weight derived from the SPA model applied for solar photovoltaics for heating and hot water at 600 sq m resolution in Valais, from 2009 to 2015. 2009)N= 2572, L=586193 and $Y_{solarPV_{hww}} \approx -1.58$; 2010) N= 2572; L= 575,850 and $Y_{solarPV_{hww}} \approx -1.56$; 2011) N= 2695; L= 588,033 and $Y_{solarPV_{hww}} \approx -1.56$; 2012) N= 3479; L= 586,384 and $Y_{solarPV_{hww}} \approx -1.51$; 2013) N= 3067; L= 587,681 and $Y_{solarPV_{hww}} \approx -1.57$; 2014) N= 2908; L= 575,139 and $Y_{solarPV_{hww}} \approx -1.58$; 2015) N= 971; L= 523,614 and $Y_{solarPV_{hww}} \approx -1.57$. Adjusted R-square is larger than 0.94 for all the distributions.	234
Figure 157 Lin-lin plot of the yearly delta simulation of the INNOLINKS weight in the diffusion process of solar photovoltaics for heating at 300 sq m resolution from 2009 to 2015.	234
Figure 158 Simulation of the yearly evolution of the links between spatial units in the diffusion process of solar photovoltaics for heating and hot water at 1200 sq m resolution from 2009 to 2015.	235
Figure 159 A) Evolution of changes of solar photovoltaics for heating and hot water at 1200 sq m. B) Evolution of changes in percentage.	235
Figure 160 Evolution of changes of solar photovoltaics for heating at 300 sq m.	236

Figure 161 Spatial Preferential Attachment in solar photovoltaic for heating and hot water at 1200 sq m resolution in the Swiss Alps in 2015. Generated with Gephi.....	237
Figure 162 Scale-free spatial networks of solar photovoltaic diffusion at 300 sq m resolution in 2009, in the Swiss Alps. A) and B Networks of Solar Photovoltaic for heating and hot water in 2009. C) Network partition according to the nodes' degree. D) Application of the Rank Page algorithm from Google (Brin & Page, 1998) to the Solar Photovoltaic Diffusion Network in Valais at 300 sq m resolution in 2009. Generated with Gephi.	238
Figure 163 Wandering in Sustainable Cities: Screenshots of a Statistical Physics Simulation of the Spatial Diffusion of Solar photovoltaics for heating and hot water at 1200 sq m resolution in 2015 in the Swiss Alps. Generated with Gephi.....	239
Figure 164 Virtual Network of Renewable Energy Technologies in 2015 in the Valais Region, 100 sq m resolution.	239
Figure 165 Results of the application of the SPA model to simulate the diffusion of electric vehicles at a 900 sq m resolution in Switzerland from 2010 to 2018. X-axis: Log of kernel density of INNOLINKS; Y-axis= Log of spatial units' rank. A) Year: 2010; $Y_{e\text{-vehicle}} \approx -1.36$; $R^2= 0.9715$; $N= 24,911$; $L= 617,104$. B) Year: 2012; $Y_{e\text{-vehicle}} \approx -1.29$; $R^2= 0.9544$; $N= 40,736$; $L= 708,857$. C) Year:2014; $Y_{e\text{-vehicle}} \approx -1.254$; $R^2= 0.9675$; $N= 45,825$; $L= 646,917$. D) Year:2016; $Y_{e\text{-vehicle}} \approx -1.24$; $R^2= 0.9724$; $N= 48,621$; $L= 646,917$; R. E) Year:2018; $Y_{e\text{-vehicle}} \approx -1.23$; $R^2= 0.9733$; $N= 49,978$; $L= 636,838$	241
Figure 166 Results of the application of the SPA model to simulate the diffusion of electric vehicles at 1800 sq m resolution in Switzerland in 2010 and 2016. X-axis = log of kernel density of INNOLINKS; Y-axis= log of spatial rank. A) Year: 2010; $Y_{e\text{-vehicle}} \approx -1.37$; $R^2= 0.9801$; $L= 712093$. B) Year: 2016; $Y_{e\text{-vehicle}} \approx -1.217$; $R^2=0.9637$; $L= 605,404$	242
Figure 167 INNOLINKS: Multiscale spatial model SPA model applied to the delta distributions of electric vehicles between 2016 and 2018 at 900 sq m, 1800 sq m and 2700 sq m in Switzerland. $Y_{e\text{-vehicle}900} \approx -1.287$; $R^2= 0.9579$; $N= 45,944$; $L=477,206$. $Y_{e\text{-vehicle}1800m} \approx -2.48$; $R^2= 0.9451$; $N=11,501$; $L= 573,221$. $Y_{e\text{-vehicle}2700m} \approx -2.154$; $R^2= 0.9815$; $N= 5096$ $L= 578,380$	242
Figure 168 Results of the application of the SPA model on the delta distributions of hybrid vehicles between 2016 and 2018 at 900 sq m, 1800 sq m and 2700 sq m resolution in Switzerland. A) $Y_{h\text{-vehicle}} \approx -2.294$; $R^2= 0.9559$; $N= 50,898$; $L= 630,679$. B) $Y_{h\text{-vehicle}} \approx -1.79$; $R^2= 0.9626$; $N= 12,740$; $L= 784,151$. C) $Y_{h\text{-vehicle}} \approx -1.91$; $R^2= 0.9574$; $N=5650$; $L= 200,110$	243
Figure 169 Spatial Kernel Density of Energy Production for Electricity in the South Region of France at 3600 sq m resolution in 2017.	247
Figure 170 Multiscale Spatial Statistics of Kernel Density of Energy Production via Solar Photovoltaics in the South Region of France in 2017.	248
Figure 171 Multiscale Kernel Density of Energy Produced by Solar Thermal Collectors in the South Region of France 2017.	248
Figure 172 Delta of the Kernel Density Estimation of the Energy Produced in the South Region of France via Solar Photovoltaics at 900 sq m, 3600 sq m and 8400 sq m between 2016 and 2017.	249
Figure 173 Multiscale spatial rate change of energy produced by solar photovoltaic between 2016 and 2017 in the South Region of France at 900 sq m, 3600 sq m and 8400 sq m respectively.	250
Figure 174 Multiscale spatial rate change of energy produced by solar photovoltaic at 3600 sq m resolution between 2007 and 2017 in the South Region of France.	250
Figure 175 Multiscale spatial adoption rate change of energy produced by solar thermal collectors between 2016 and 2017 in the South Region of France.	251
Figure 176 Distributions of rate change of energy produced by solar thermal collectors between 2016 and 2017 in the South Region of France.	252
Figure 177 Adjustment of the multiscale spatial adoption rate change of energy produced by solar thermal collectors between 2016 and 2017 in the South Region of France.....	252
Figure 178 Change of energy produced by solar thermal collectors in three different time scales in the South Region of France. Left: three years between 2017 and 2010, centre: 2 years between 2010 and 2012 and to the right: 1 year between 2012 and 2013.	253
Figure 179 Distribution of the INNOLINKS' weight derived from the SPA model applied for energy production with solar photovoltaics at 900 sq m resolution in the South Region of France. A) Data from 2012: $Y_{\text{solarPV}} \approx -1.06$; $R\text{-squared}= 0.986$; $N= 27,788$; $L= 441,023$. B) Data from 2016: $Y_{\text{solarPV}} \approx -1.097$; $R\text{-squared}= 0.9758$; $N=24,869$; $L= 650,724$	254
Figure 180 Distribution of the INNOLINKS' weight derived from the SPA model applied for energy production with solar photovoltaics at 3600 sq m resolution in the South Region of France. A) Data from 2016:	

YsolarPV≈-1.68 R-squared= 0.939; N=1551; L= 665,240. B) Data from 2017: YsolarPV≈-1.74; R-squared= 0.9364; N= 1487; L=704,917.	254
Figure 181 Distribution of the INNOLINKS' weight derived from the SPA model applied to the delta of the energy produced with solar photovoltaics at 8400 sq m resolution es in the South Region of France. A) Data from 2007: YsolarPV≈ -1.327639 R-squared = 0.9333 L= 36,586. B) Data from 2013: YsolarPV≈ -1.972108; R-squared= 0.8461 ; L= 45,452.	255
Figure 182 Distribution of the INNOLINKS' weight derived from the SPA model applied to the delta of the energy produced with solar photovoltaics at 3600 sq m in three different time scales in the South Region of France: A) Three years delta between 2007 and 2010: YsolarPV≈ -1.87; R-squared= 0.9785; N=2085; L= 922,000. B) Two years delta between 2010 and 2012: YsolarPV≈-1.783571; R-squared= 0.9629; N= 1417; L= 774,346. C) One year delta between 2016 and 2017: YsolarPV≈-1.850; R-squared= 0.981; N= 829; L= 343,206.	255
Figure 183 Distribution of the INNOLINKS' weight derived from the SPA model applied to heating production by solar thermal collectors at 900 sq m resolution in the South Region of France. A) Data from 2007: YsolarTC≈ -1.18; R-squared= 0.9855; N=41,470; L= 127085. B) Data from 2012: YsolarTC≈ -1.173e+00; R-squared= 0.984; N=39,876; L= 653111. C) Data from 2017: YsolarTC≈ -1.17; R-squared= 0.9845; N= 39,402; L= 390983.	256
Figure 184 Distribution of the INNOLINKS' weight derived from the SPA model applied to heating production by solar thermal collectors at 900 sq m, 3600 sq m and 8400 sq m respectively in 2017 in the South Region of France.	256
Figure 185 Distribution of the INNOLINKS' weight derived from the SPA model applied to energy production for electricity through wind power, small and big hydroelectric power plants, biogas and solar photovoltaics at 900 sq m resolution from 2007 to 2017 in the South Region of France.	257
Figure 186 Distribution of the INNOLINKS' weight derived from the SPA model applied to electricity production by wind power, small and big hydroelectric power plants, biogas and solar photovoltaics at 900 sq m resolution in the South Region of France: A) Year: 2007; YTechmix≈-1.31; R-squared= 0.9817; N= 5300; L= 320430. B) Year: 2010; YTechmix≈ -1.16 ; R-squared= 0.9841;N=20,738; L= 354575; . C) Year: 2012; YTechmix≈ -1.21 ; R-squared= 0.9842; N= 19,418; L= 361974. D) Year: 2013; YTechmix≈ -1.17 ; R-squared= 0.9805; N= 19,625; L= 361974. E) Year: 2014; YTechmix≈ -1.18; R-squared= 0.9831; N= 18,524; L= 364120 . F) Year: 2015; YTechmix≈ -1.107; R-squared= 0.9991;N= 19,403; L= 357234. G) Year: 2016; YTechmix≈-1.19; R-squared= 0.9824; N= 19,225; L= 361124. H) Year: 2017; YTechmix≈-1.19; R-squared= 0.9809; N=18,874; L= 371052.	258
Figure 187 Distribution of the INNOLINKS' weight derived from the SPA model applied to electricity production by wind power, small and big hydroelectric power plants, biogas and solar photovoltaics in the South Region of France. A) Data from 2012; Spatial scale: 3600 sq m; YTechmix≈ -1.40 ; Adjusted R-squared= 0.8816; N= 1214; L= 58997. B) Data from 2014; Spatial scale: 8400 sq m; YTechmix≈ -2.639856; Adjusted R-squared= 0.8631; N= 1166; L=20707. C) Data from 2017; Spatial scale: 900 sq m: YTechmix≈-1.19; R-squared= 0.9809; N=18,874; L= 371052.	259
Figure 188 Distribution of the INNOLINKS' weight derived from the SPA model applied to energy production for heating through biomass and solar TC at 900 sq m resolution from 2007 to 2017 in the South Region of France. A) Year: 2007, YSolarTC≈-1.183; R-squared= 0.9746; N=31,109; L= 121084 . B) Year: 2010, YSolarTC≈ -1.174 ; R-squared= 0.9841; N=29,815; L= 628061; C)Year: 2012, YSolarTC≈ -1.173 ; R-squared= 0.9816; N=21,458; L= 65311; D) Year: 2013, YSolarTC≈ -1.172 ; R-squared= 0.9838; N=29,698; L= 499022; E) Year: 2014, YSolarTC≈ -1.171; R-squared= 0.9754; N=29,947; L= 463225; F) Year: 2015, YSolarTC≈ -1.173; R-squared: 0.9779; N=29,798;N=29,469; L= 346153. G) Year: 2016, YSolarTC≈-1.168; R-squared= 0.9711; L= 392217; H) Year: 2017, YSolarTC≈-1.168; R-squared= 0.9845; N=29,466; L= 390982.	260
Figure 189 Distribution of the INNOLINKS' weight derived from the SPA model applied to energy production for heating through biomass and solar TC at 900 sq m resolution from 2007 to 2017 in the South Region of France.	261
Figure 190 Distribution of the INNOLINKS' weight derived from the SPA model applied to energy production via the mix technologies of: Wind Power, Small and Big Hydroelectric Power Plants, Solar Photovoltaic, Biomass and Solar Thermal Collectors for electricity and heating in the South Region of France from 2007 to 2017 at 900 sq m resolution.	261
Figure 191 Distribution of the INNOLINKS' weight derived from the SPA model applied to energy production via the mix technologies of: Wind Power, Small and Big Hydroelectric Power Plants, Solar Photovoltaic,	

Biomass and Solar Thermal Collectors for electricity and heating in the South Region of France in 2012 at 900 sq m, 3600 sq m and 8400 sq m resolution.	262
Figure 192 Histograms and boxplots of the INNOLINKS' weight derived from the SPA model applied to energy production via the mix technologies of: Wind Power, Small and Big Hydroelectric Power Plants, Solar Photovoltaic, Biomass and Solar Thermal	263
Figure 193 Sensitivity analysis of the Spatial Preferential Attachment model with distance decay parameter $\beta = -2.1$. Applied to the production of electricity and thermic energy with a mix of renewable energy technologies.....	265
Figure 194 From a discrete innovation interruption towards a continuous innovation blackout. Source: Adapted from Lhomme (2012).....	268
Figure 195 Multiscale Spatial Analysis of the INNOLINKS' weight after a shock. These are the results of the application of the SPA model applied to the distributional change of the solar photovoltaics for heating and hot water between 2014 and 2015 at 300 sq m, 600 sq m and 1200 sq in the Valais region.	269
Figure 196 Distribution of the INNOLINKS' weight after a shock at 300 sq m resolution for the years 2014 and 2015 in the Valais region, Switzerland.	270
Figure 197 Kernel density of solar photovoltaics in 2009 and 2015 at 300 sq m resolution in the Valais region, Switzerland.	270
Figure 198 Distribution of the INNOLINKS' weight after a shock. for the years 2014 and 2015 in the Valais region. A) spatial scale: at 600 sq m. B) Spatial scale: 1200 sq m.....	271
Figure 199 Kernel density of solar photovoltaics in 2015 at 300 sq m and 600 sq m resolution in the Valais region, Switzerland.	272
Figure 200 Hubs selected for removal to simulate the resilience of the innovation system.	273
Figure 201 Simulation of shocks to slow down the diffusion of solar photovoltaics in the Valais region. Model A) Adjusted R-square= 0.9663 Model B) Adjusted R-squared = 0.9583. Model C) Adjusted R-squared = 0.9583.	274
Figure 202 A) Relationship between scales of ecological structure and the nested adaptive cycles comprising a panarchy for a pine dominated ecosystem. Where r = growth; k = conservation; Ω = release; α = reorganization. Source: Adapted by Allen et al., (2014) from Holling (1986). B) Domains of scale for adaptive cycles in ecosystems. B) Domains of scale for adaptive cycles in energy transition. Source: Allen et al., (2011).....	277
Figure 203 Towards an Evolutionary Perspective of Sustainability Transition. Top-down representation of the evolution of the self-organization levels of the spatial diffusion of solar photovoltaics in the Valais Region in 2015.	277
Figure 204 Method of the panarchy model application to main cases of innovation ecosystems. Source: Boyer (2020), adapted from Gunderson & Holling (2002).	279
Figure 205 Nested Cycles. Source: Holling et al., (2002)	280

List of Tables

Table 1 The various forms of proximity in the proximity group’s publications source: Carrincazeaux et al., (2008).	24
Table 2 Modelling of agent decision-making and interaction approaches. Source: updated from Kiesling (2011).	65
Table 3 Hägerstrand’s’ four conditions for spatial diffusion of innovations. Source: Hägerstrand, 1952.	99
Table 4 Friendship Frequencies (in percent) by Ethnicities in a Dutch High School; from Baerveldt et al., 2004.	103
Table 5 Eleven definitions of resilience with respect to the degree of normativity. Updated from Brand & Jax, 2007.	110
Table 6 Characteristics of a resilient system in the contexts of climate change adaptation and disaster risk reduction (DRR). Source: Bahadur et al., 2010.	114
Table 7 The contradictions attached to the concept of resilience. Source: Updated from Lhomme, 2012.	115
Table 8 Alternative approaches to measure regional resilience. Source: Martin & Sunley (2015).	120
Table 9 Allocation scheme of systemic problem from Negro et al., (2012).	153
Table 10 Land area of stake levels by department measured in hectares. Source: CEREMA (2019)	162
Table 11 Networks Science or Graph Theory.	167
Table 12 Land-use classified in 9 classes.	190
Table 13 Transition Matrix of land used in the canton of Valais-Wallis.	190
Table 14 Transition Areas: expected transition (cell size: 250 sq m).	190
Table 15 Transition Areas in Valais, Switzerland: expected transition from 2006 to 2048 of (cell size 250 sq m).	191
Table 16 Net Change in Land-use in Valais from 2006 to 2048.	191
Table 17 Application of Huff’s model to a demographic and employment gravity model.	195
Table 18 Variables of the population system categorized by age groups.	201
Table 19 Population Dynamics Simulation with fix births and deaths rate in the canton of Valais-Wallis.	201
Table 20 Population Dynamics Simulation with dynamic fertility, mortality and migration rates in Valais, horizon 2045.	202
Table 21 Housing Geometadata in Switzerland. Source: FSO, 2017.	207
Table 22 Breakdown of Housing Geometadata in Switzerland. Adapted from FSO (2017).	208
Table 23 Petrol-electric vs Diesel-Electric Vehicles.	223
Table 24 Market Share of Vehicles Fleet in Switzerland. Table made by the author on the basis of the data provided by the FSO. Available from: < https://www.bfs.admin.ch/bfs/en/home/statistics/mobility-transport.assetdetail.11407549.html > (Available in French and German).	223
Table 25 Evolution of the Market Share of Vehicles Fleet in Switzerland. Table made by the author on the basis of the data provided by the FSO. Available from: < https://www.bfs.admin.ch/bfs/en/home/statistics/mobility-transport.assetdetail.11407549.html > (Available in French and German).	224
Table 26 Statistics Summary of the SPA model applied to solar photovoltaics for hot water in Valais at 300 sq m, 600sq m and 1200 sq m resolution in 2015.	232
Table 27 Selected results sample of the SPA model.	240
Table 28 Data of Energy Production in the South Region of France. Source: ATMOSUD (2019).	246
Table 29 Statistics summary of the spatial kernel density evolution of energy produced by solar photovoltaics from 2007 to 2017 in the South Region of France.	251
Table 30 Sensitivity analysis for distance decay parameter in the Spatial Preferential Attachment Model at the spatial scale of 8400 sq m. Mix of renewable energy technologies production for electricity and thermal energy usage in the South Region of France 2007 ^a	264
Table 31 Statistics of Multiscale Simulation for Resilience to Renewable Energies Diffusion for the year 2014 and 2015 in the Valais region.	269
Table 32 List of hubs for the delta distribution of solar photovoltaics 2014-2015.	273

List of Acronyms and Abbreviations

ABM	Agent-based Modelling
ACE	Agent-based Computational Economics
AEO	Annual Energy Outlook
AHP	Analytical Hierarchy Process
ANN	Average Nearest Neighbour
ATMOSUD	Air Quality Monitoring Association
BCM	Business Continuity Management
BECCS	Bioenergy with Carbon Capture and Storage
BHP	Big Hydroelectric Power
BRT	Bid Rent Theory
CA	Cellular Automata
CEREMA	Centre for Studies and Expertise on Risks, Environment, Mobility and Development
CRU	Climate Research Unit
CSO	Cantonal Statistics Office
CPT	Central Place Theory
CRU	Climate Research Unit
DC	Damping Coefficient
DOI	Diffusion of Innovations
DE	Diesel-Electric
DREAL	Regional Directorate for the Environment, Planning and Housing
EEG	Evolutionary Economic Geography
EIA	Energy Information Administration
EM	Electric Mobility
EMD	Expected Mean Distance
E-Vehicle	Electric Vehicle
FSO	Federal Statistics Office
FTE	Full-Time Equivalent
INSEE	National Institute of Statistics and Economic Studies
GDP	Gross Domestic Product
GHG	Greenhouse gas
GOI	Geography of Innovation
GST	Geography of Sustainability Transition
HHV	Higher Heating Value
H-Vehicle	Hybrid Vehicle
ICT	Information and Communications Technology
IEA	International Energy Agency
IAM	Integrated Assessment Modelling
IBL	Initiative-Based Learning
ICT	Information and Communications Technology
IPCC	Intergovernmental Panel on Climate Change
ISO	International Organization for Standardization
KDE	Kernel Density Estimation
KPI	Key Performance Indicators
LCM	Land-use Change Models
LHV	Higher Heating Value

MLP	Multi-Level Perspective
MRT	Middle-rang theory
NBIC	Nanotechnology, Biotechnology, Information Technology and Cognitive Science
NNR	Nearest Neighbour Ratio
OMD	Observed Mean Distance
OECD	Organisation for Economic Co-operation and Development
ORECA	Regional Observatory of Energy, Air and Climate of the French Riviera
PDF	Probability Density Function
PE	Petrol-Electric
PIF	Potential Innovation Fields
PPT	Purchasing Parity Power
PV	Photovoltaic
RF	Radiative Forcing
RCP	Representative Concentration Pathway
RIS	Regional Innovation Systems
RPO	Recovery Point Objective
RTO	Recovery Time Objective
ScoT	Territorial Coherence Scheme
SINP	Information System for the Inventory of Natural Heritage
SIT	Spatial Interaction Theory
SD	Systems Dynamics
SDI	Spatial Diffusion of Innovations
SGDs	Sustainable Development Goals
SHP	Small Hydroelectric Power
SMVM	Scheme for the Development of the Sea
SNM	Strategic Niche Management
SOC	Self-Organized Criticality
SPA	Spatial Preferential Attachment
Solar PV	Solar Photovoltaic
Solar TC	Solar Thermal Collector
SRCAE	Regional Climate Air Energy Scheme
SRADDET	Regional Scheme of Planning, Sustainable Development and Territorial Equality
ST	Sustainability Transition
STRN	Sustainability Transitions Research Network
Technix	Technological energy mix
TIS	Technological Innovation System
TPES	Total Primary Energy Supply
URLs	Uniform Resource Locators

APPENDIX A

Nomenclature CLC European Standard (Chapter 5)

The tables below show the nomenclature of the CLC European Standard level-1 and 3 with the procedure of the reclassification in the Canton of Valais, Switzerland, discussed in section 5.3.2.

Code	Nomenclature CLC European Standard	Assigned value	To all values from	To just less than
Nomenclature CLC Level-1				
1	Artificial surfaces	1	1	1
2	Agricultural areas	2	2	2
3	Forest and semi natural areas	3	3	3
4	Wetlands	4	4	4
5	Water bodies	4	5	6
Nomenclature CLC Level-2				
11	Urban fabric	11	11	11
12	Industrial, commercial and transport units	12	12	12
13	Mine, dump and construction sites	13	13	13
14	Artificial non-agricultural vegetated areas	14	14	14
21	Arable land		21	21
22	Permanent crops		22	22
23	Pastures	2	23	23
24	Heterogeneous agricultural areas		24	24
31	Forests		31	31
32	Scrub and/or herbaceous vegetation associations	3	32	32
33	Open spaces with little or no vegetation		33	33
41	Inland wetlands		41	41
42	Coastal wetlands		42	42
51	Inland waters	4	51	51
52	Marine waters		52	52
Nomenclature CLC Level-3				
111	Continuous urban fabric	111	111	111
112	Discontinuous urban fabric	112	112	112
121	Industrial or commercial units and public facilities	121	121	121
122	Road and rail networks and associated land	122	122	122
123	Port areas	123	123	123
124	Airports	124	124	124
131	Mineral extraction sites	131	131	131
132	Dump sites	132	132	132
133	Construction sites	133	133	133
141	Green urban areas	141	141	141
142	Sport and leisure facilities	142	142	142
211	Non-irrigated arable land		211	211
212	Permanently irrigated land		212	212
213	Rice fields		213	213
221	Vineyards		221	221
222	Fruit trees and berry plantations		222	222
223	Olive groves	2	223	223
231	Pastures, meadows and other permanent grasslands under agricultural use		231	231
241	Annual crops associated with permanent crops		241	241
242	Complex cultivation patterns		242	242
243	Land principally occupied by agriculture, with significant areas of natural vegetation		243	243
244	Agro-forestry areas		244	244
311	Broad-leaved forest		311	311
312	Coniferous forest		312	312
313	Mixed forest		313	313
321	Natural grasslands		321	321
322	Moors and heathland		322	322
323	Sclerophyllous vegetation		323	323
324	Transitional woodland-shrub		324	324
331	Beaches, dunes, sands		331	331
332	Bare rocks		332	332
333	Sparsely vegetated areas		333	333
334	Burnt areas		334	334
335	Glaciers and perpetual snow		335	335
411	Inland marshes		411	411
412	Peat bogs		412	412
421	Coastal salt marshes		421	421
422	Salines		422	422
423	Intertidal flats		423	423
511	Water courses		511	511
512	Water bodies		512	512
521	Coastal lagoons		521	521
522	Estuaries		522	522
523	Sea and ocean		523	523

The two following tables below, show the reassignment of land-use classes at CLC level 3 (section 5.3.2)

Level-1	Valais 2006			Recorded Valais 2006			Valais 2012			Recorded Valais 2012			Valais 2018			Recorded Valais 2018			Codes Level 3	CLC Level-3
	Value	Count	Code 2006	Assigned value	To all values from	To just less than	Value	Count	Code 2012	Assigned value	To all values from	To just less than	Value	Count	Code 2018	Assigned value	To all values from	To just less than		
1. Artificial surfaces	1	6	111	1	111	112	1	6	111	1	111	112	1	6	111	1	111	112	111	Continuous urban fabric
	2	1143	112	2	112	113	2	1174	112	2	112	113	2	1176	112	2	112	113	112	Discontinuous urban fabric
	3	97	121	3	121	122	3	125	121	3	121	122	3	125	121	3	121	122	121	Industrial or commercial units and public facilities
	4	3	122	4	122	123	4	7	122	4	122	123	4	7	122	4	122	123	122	Road and rail networks and associated land
	5	30	124	5	124	125	5	30	124	5	124	125	5	30	124	5	124	125	124	Airports
	6	12	131	7	131	132	6	8	131	7	131	132	6	9	131	7	131	132	131	Mineral extraction sites
	7	31	142	6	142	143	7	30	142	6	142	143	7	30	142	6	142	143	142	Sport and leisure facilities
2. Agricultural areas	8	396	211		211	212	8	381	211		211	212	8	380	211		211	212	211	Non-irrigated arable land
	9	470	221		221	222	9	474	221		221	222	9	473	221		221	222	221	Vineyards
	10	299	222	7	222	223	10	307	222	7	222	223	10	307	222	7	222	223	222	Fruit trees and berry plantations
	11	1426	231		231	232	11	1274	231		231	232	11	1273	231		231	232	231	Pastures, meadows and other permanent grasslands under agricultural use
	12	251	242		242	243	12	73	242		242	243	12	73	242		242	243	242	Complex cultivation patterns
	13	439	243		243	244	13	639	243		243	244	13	639	243		243	244	243	Land principally occupied by agriculture, with significant areas of natural vegetation
	14	161			311	312	14	143			311	312	14	143	311		311	312	311	Broad-leaved forest
3. Forest and semi-natural areas	15	7768			312	313	15	6955			312	313	15	6964	312		312	313	312	Coniferous forest
	16	1406			313	314	16	892			313	314	16	892	313		313	314	313	Mixed forest
	17	6372			321	322	17	5938			321	322	17	5938	321		321	322	321	Natural grasslands
	18	1362			322	323	18	1058			322	323	18	1058	322		322	323	322	Moors and heathland
	19	227			324	325	19	2410			324	325	19	2414	324		324	325	324	Transitional woodland-shrub
	20	38			331	332	20	12			331	332	20	12	331		331	332	331	Beaches, dunes, sands
	21	9889			332	333	21	9563			332	333	21	9568	332		332	333	332	Bare rocks
	22	3492			333	334	22	4362			333	334	22	4381	333		333	334	333	Sparsely vegetated areas
	23	5796			335	336	23	18			334	335	23	6	334		334	335	334	Burnt areas
	24	4			411	412	24	5231			335	336	24	5126	335		335	336	335	Glaciers and perpetual snow
4 & 5. Wet lands and water bodies	25	2			511	512	25	4	411		411	412	25	4	411		411	412	411	Inland marshes
	26	236			512	513	26	3	511		511	512	26	3	511		511	512	511	Water courses
	27	50894			0	128	129	27	239	512		512	513	27	239	512		512	513	512
								50894						0	128	129				

Original values order						CLC level-3					2012					2018				
Value	Count	Code 2006	Assigned value	To all values from	To just less than	Value	Count	CODE 2012	Assigned value	To all values from	To just less than	Value	Count	CODE 2018	Assigned value	To all values from	To just less than			
1	6	111	1	1	2	Continuous urban fabric	1	6	111	1	1	2	1	6	111	1	1	2		
2	1143	112	2	2	3	Discontinuous urban fabric	2	1174	112	2	2	3	2	1176	112	2	2	3		
3	1406	313	8	3	4	Mixed forest	3	125	121	3	3	4	3	125	121	3	3	4		
4	161	311	8	4	5	Broad-leaved forest	4	7	122	4	4	5	4	7	122	4	4	5		
5	227	324	8	5	6	Transitional woodland-shrub	5	30	124	5	5	6	5	30	124	5	5	6		
6	9889	332	8	6	7	Bare rocks	6	239	512	9	6	7	6	9	131	7	6	7		
7	97	121	3	7	8	Industrial or commercial units and public facilities	7	30	142	6	7	8	7	30	142	6	7	8		
8	3	122	4	8	9	Road and rail networks and associated land	8	381	211	7	8	9	8	380	211	7	8	9		
9	30	124	5	9	10	Airports	9	474	221	7	9	10	9	473	221	7	9	10		
10	12	131	7	10	11	Mineral extraction sites	10	307	222	7	10	11	10	307	222	7	10	11		
11	31	142	6	11	12	Sport and leisure facilities	11	1274	231	7	11	12	11	1273	231	7	11	12		
12	396	211	7	12	13	Non-irrigated arable land	12	639	243	7	12	13	12	73	242	7	12	13		
13	470	221	7	13	14	Vineyards	13	73	242	7	13	14	13	639	243	7	13	14		
14	299	222	7	14	15	Fruit trees and berry plantations	14	143	311	8	14	15	14	143	311	8	14	15		
15	1426	231	7	15	16	Pastures, meadows and other permanent grasslands under agricultural use	15	6955	312	8	15	16	15	6964	312	8	15	16		
16	439	243	7	16	17	Land principally occupied by agriculture, with significant areas of natural vegetation	16	892	313	8	16	17	16	892	313	8	16	17		
17	7768	312	8	17	18	Coniferous forest	17	5938	321	8	17	18	17	5938	321	8	17	18		
18	6372	321	8	18	19	Natural grasslands	18	1058	322	8	18	19	18	1058	322	8	18	19		
19	251	242	7	19	20	Complex cultivation patterns	19	2410	324	8	19	20	19	2414	324	8	19	20		
20	1362	322	8	20	21	Moors and heathland	20	9563	332	8	20	21	20	12	331	8	20	21		
21	5796	335	8	21	22	Glaciers and perpetual snow	21	12	331	8	21	22	21	9648	332	8	21	22		
22	3492	333	8	22	23	Sparsely vegetated areas	22	4362	333	8	22	23	22	4381	333	8	22	23		
23	38	331	8	23	24	Beaches, dunes, sands	23	5231	335	8	23	24	23	6	334	8	23	24		
24	4	411	9	24	25	Inland marshes	24	4	411	9	24	25	24	5126	335	8	24	25		
25	2	511	9	25	26	Water courses	25	3	511	9	25	26	25	4	411	9	25	26		
26	236	512	9	26	27	Water bodies	26	18	334	8	26	27	26	3	511	9	26	27		

The tables below are additional results of the transition process of land-use in the canton of Valais from 2006 to 2048 calculated via the Land Change Modeller decision support system from IDRIS discussed in section 5.3.3. The spatial units= 250 sqm.

Contributions to net change between 2006 to 2012										
Category	Contributors to net change ↓	Contribution to net change experienced by Continuous urban fabric	Contribution to net change experienced by Discontinuous urban fabric	Contribution to net change experienced by Industrial or commercial units and public facilities	Contribution to net change experienced by Road and rail networks and associated land	Contribution to net change experienced by Airports	Contribution to net change experienced by Sport and leisure facilities	Contribution to net change experienced by Agricultural areas	Contribution to net change experienced by Forest and semi natural areas	Contribution to net change experienced by Wetlands & water bodies
1	Continuous urban fabric	0	0	0	0	0	0	0	0	0
2	Discontinuous urban fabric	0	11	4	0	-1	0	-15	-1	0
3	Industrial or commercial units and public facilities	0	-11	0	0	0	0	0	0	0
4	Road and rail networks and associated land	0	4	0	0	0	0	0	0	0
5	Airports	0	0	1	0	0	0	-1	0	0
6	Sport and leisure facilities	0	1	0	0	0	0	0	0	0
7	Agricultural areas	0	30	15	0	1	0	65	6	0
8	Forest and semi natural areas	0	15	1	0	0	0	-85	0	-2
9	Wetlands & water bodies	0	0	0	0	0	0	-6	2	0

Contributions to net change between 2012 to 2018										
Category	Contributors to net change ↓	Contribution to net change experienced by Continuous urban fabric	Contribution to net change experienced by Discontinuous urban fabric	Contribution to net change experienced by Industrial or commercial units and public facilities	Contribution to net change experienced by Road and rail networks and associated land	Contribution to net change experienced by Airports	Contribution to net change experienced by Sport and leisure facilities	Contribution to net change experienced by Agricultural areas	Contribution to net change experienced by Forest and semi natural areas	Contribution to net change experienced by Wetlands & water bodies
1	Continuous urban fabric	0	0	0	0	0	0	0	0	0
2	Discontinuous urban fabric	0	0	0	0	0	0	-2	0	0
3	Industrial or commercial units and public facilities	0	0	0	0	0	0	0	0	0
4	Road and rail networks and associated land	0	0	0	0	0	0	0	0	0
5	Airports	0	0	0	0	0	0	0	0	0
6	Sport and leisure facilities	0	0	0	0	0	0	0	0	0
7	Agricultural areas	0	2	0	0	0	0	0	0	0
8	Forest and semi natural areas	0	0	0	0	0	0	0	0	0
9	Wetlands & water bodies	0	0	0	0	0	0	0	0	0

Contributions to net change between 2018 to 2030										
Category	Contributors to net change ↓	Contribution to net change experienced by Continuous urban fabric	Contribution to net change experienced by Discontinuous urban fabric	Contribution to net change experienced by Industrial or commercial units and public facilities	Contribution to net change experienced by Road and rail networks and associated land	Contribution to net change experienced by Airports	Contribution to net change experienced by Sport and leisure facilities	Contribution to net change experienced by Agricultural areas	Contribution to net change experienced by Forest and semi natural areas	Contribution to net change experienced by Wetlands & water bodies
1	Continuous urban fabric	0	0	0	0	0	0	0	0	0
2	Discontinuous urban fabric	0	18	6	0	0	0	-9	0	0
3	Industrial or commercial units and public facilities	0	-18	0	0	0	0	-3	1	0
4	Road and rail networks and associated land	0	-6	0	0	0	0	0	0	0
5	Airports	0	0	0	0	0	0	0	0	0
6	Sport and leisure facilities	0	0	0	0	0	0	0	0	0
7	Agricultural areas	0	9	3	0	0	0	0	0	0
8	Forest and semi natural areas	0	0	-1	0	0	0	1467	0	-7
9	Wetlands & water bodies	0	0	0	0	0	0	0	7	0

Contributions to net change between 2030 to 2048										
Category	Contributors to net change ↓	Contribution to net change experienced by Continuous urban fabric	Contribution to net change experienced by Discontinuous urban fabric	Contribution to net change experienced by Industrial or commercial units and public facilities	Contribution to net change experienced by Road and rail networks and associated land	Contribution to net change experienced by Airports	Contribution to net change experienced by Sport and leisure facilities	Contribution to net change experienced by Agricultural areas	Contribution to net change experienced by Forest and semi natural areas	Contribution to net change experienced by Wetlands & water bodies
1	Continuous urban fabric	0	0	0	0	0	0	0	0	0
2	Discontinuous urban fabric	0	6	6	0	0	0	-1	-1	0
3	Industrial or commercial units and public facilities	0	-6	0	0	0	0	-2	0	0
4	Road and rail networks and associated land	0	-6	0	0	0	0	0	0	0
5	Airports	0	0	0	0	0	0	0	0	0
6	Sport and leisure facilities	0	0	0	0	0	0	0	0	0
7	Agricultural areas	0	1	2	0	0	0	0	5	0
8	Forest and semi natural areas	0	1	0	0	0	0	-5	0	6
9	Wetlands & water bodies	0	0	0	0	0	0	0	-6	0

Contributions to net change between 2030 to 2036										
Category	Contributors to net change ↓	Contribution to net change in	Contribution to net change in	Industrial or commercial	Road and rail networks and	Airports	Sport and leisure facilities	Agricultural areas	Forest and semi natural	Wetlands & water bodies
1	Continuous urban fabric	0	0	0	0	0	0	0	0	0
2	Discontinuous urban fabric	0	6	-6	-12	0	0	-6	-1	0
3	Industrial or commercial units and public facilities	0	6	0	0	0	0	1	-1	0
4	Road and rail networks and associated land	0	12	0	0	0	0	0	0	0
5	Airports	0	0	0	0	0	0	0	0	0
6	Sport and leisure facilities	0	0	0	0	0	0	0	0	0
7	Agricultural areas	0	6	-1	0	0	0	0	6	0
8	Forest and semi natural areas	0	1	1	0	0	0	-5	0	-17
9	Wetlands & water bodies	0	0	0	0	0	0	0	17	0

Contributions to net change between 2036 to 2042										
Category	Contributors to net change ↓	Contribution to net change in	Contribution to net change in	Industrial or commercial	Road and rail networks and	Airports	Sport and leisure facilities	Agricultural areas	Forest and semi natural	Wetlands & water bodies
1	Continuous urban fabric		0	0	0	0	0	0	0	0
2	Discontinuous urban fabric	0		6	0	0	0	18	0	0
3	Industrial or commercial units and public facilities	0	-6		0	0	0	-1	0	0
4	Road and rail networks and associated land	0	0	0		0	0	0	0	0
5	Airports	0	0	0	0		0	0	0	0
6	Sport and leisure facilities	0	0	0	0	0		0	0	0
7	Agricultural areas	0	-18	1	0	0	0		-6	0
8	Forest and semi natural areas	0	0	0	0	0	0	6		-6
9	Wetlands & water bodies	0	0	0	0	0	0	0	6	

Contributions to net change between 2042 to 2048										
Category	Contributors to net change ↓	Contribution to net change in	Contribution to net change in	Industrial or commercial	Road and rail networks and	Airports	Sport and leisure facilities	Agricultural areas	Forest and semi natural	Wetlands & water bodies
1	Continuous urban fabric		0	0	0	0	0	0	0	0
2	Discontinuous urban fabric	0		6	0	0	0	0	0	0
3	Industrial or commercial units and public facilities	0	-6		0	0	0	0	0	0
4	Road and rail networks and associated land	0	0	0		0	0	0	0	0
5	Airports	0	0	0	0		0	0	0	0
6	Sport and leisure facilities	0	0	0	0	0		0	0	0
7	Agricultural areas	0	0	0	0	0			-6	0
8	Forest and semi natural areas	0	0	0	0	0	0	6		24
9	Wetlands & water bodies	0	0	0	0	0	0	0	-24	

The following code corresponds to the Algorithm 1 (Gravity Model) discussed in section 5.4.5.2.

Algorithm 1 for the Gravity Model

```

#Compute population and jobs (data protection)
//// POPULATION
double population2012 = 322562; //Population 01.01.2012
double populationMore3 = sumWhere(populations, p -> p.populationTotal, p -> p.populationTotal > 3); //number of people where points has more than 3 people
double populationToDistribute = population2012 - populationMore3; //Population to distribute where data protection is enabled
int AgentsPopLess3 = count(populations, p->p.populationTotal <= 3); //Number of agents having 3 people or less (data protection)
double AveragePopMasse = averageWhere(populations, p->p.masse, p->p.populationTotal <= 3); //Average masse where 3 people or less
//Compute max population per point after re-computing
double maxPop = (1 / AveragePopMasse) * (populationToDistribute / AgentsPopLess3);
//// JOBS
double jobs2012 = 159314; //Number of jobs in 2012
double jobsMore3 = sumWhere(populations, p -> p.emploisPleinTemps, p -> p.emploisPleinTemps > 3); //number of jobs where points has more than 3 jobs
double jobsToDistribute = jobs2012 - jobsMore3; //Jobs to distribute where data protection is enabled
int AgentsJobsLess3 = count(populations, p->p.emploisPleinTemps <= 3); //Number of agents having 3 jobs or less (data protection)
double AverageJobsMasse = averageWhere(populations, p->p.masse, p->p.emploisPleinTemps <= 3); //Average masse where 3 jobs or less
//Compute max population per point after re-computing
double maxJobs = (1 / AverageJobsMasse) * (jobsToDistribute / AgentsJobsLess3);
//Population variables to loop through
String[] variables = new String[] { "b10Bm01", "b10Bm02", "b10Bm03", "b10Bm04", "b10Bm05", "b10Bm06", "b10Bm07", "b10Bm08", "b10Bm09", "b10Bm10", "b10Bm11", "b10Bm12", "b10Bm13", "b10Bm14", "b10Bm15", "b10Bm16", "b10Bm17", "b10Bm18", "b10Bm19", "b10Bw01", "b10Bw02", "b10Bw03", "b10Bw04", "b10Bw05", "b10Bw06", "b10Bw07", "b10Bw08", "b10Bw09", "b10Bw10", "b10Bw11", "b10Bw12", "b10Bw13", "b10Bw14", "b10Bw15", "b10Bw16", "b10Bw17", "b10Bw18", "b10Bw19"};
////Update database values
//Loops through population
for (Population p : populations)
{
java.lang.reflect.Field declaredField = null;
//Check if point has 3 people or less on it
if(p.populationTotal <= 3)
{
p.populationTotal = maxPop * p.masse;
}
//Update population details
//List for variables to update
List varToUpdate = new ArrayList<String>();
double popuMore3 = 0;

```

```

//Population list with variable name where population > 0
for(String var : variables)
{
//Try to access variable via its name
try {
declaredField = Population.class.getDeclaredField(var);
boolean accessible = declaredField.isAccessible();
declaredField.setAccessible(true);
//Compute variable market share
if((double)Population.class.getField(var).get(p) == 3 )
varToUpdate.add(var);
else if ((double)Population.class.getField(var).get(p) > 3 )
popuMore3 += (double)Population.class.getField(var).get(p);
}
catch(Exception e)
{
e.printStackTrace();
}
}
//For each point - Compute population per group (gender / age)
//Value per point (population / number of variables)
double valuePerPoint = (p.populationTotal - popuMore3) / varToUpdate.size();
for (Object var : varToUpdate)
{
//Try to access variable via its name
try {
declaredField = Population.class.getDeclaredField(var.toString());
boolean accessible = declaredField.isAccessible();
declaredField.setAccessible(true);
//Update variable with new value
Population.class.getField(var.toString()).set(p, valuePerPoint);
}
catch(Exception e)
{
e.printStackTrace();
}
}
//Check if point has 3 jobs or less
if (p.emploisPleinTemps <= 3)
{
p.emploisPleinTemps = maxJobs * p.masse;
}
p.pop_0_4 = p.b10Bm01 + p.b10Bw01;
p.pop_5_9 = p.b10Bm02 + p.b10Bw02;
p.pop_10_14 = p.b10Bm03 + p.b10Bw03;
p.pop_15_19 = p.b10Bm04 + p.b10Bw04;
p.pop_20_24 = p.b10Bm05 + p.b10Bw05;
p.pop_25_29 = p.b10Bm06 + p.b10Bw06;
p.pop_30_34 = p.b10Bm07 + p.b10Bw07;
p.pop_35_39 = p.b10Bm08 + p.b10Bw08;
p.pop_40_44 = p.b10Bm09 + p.b10Bw09;
p.pop_45_49 = p.b10Bm10 + p.b10Bw10;
p.pop_50_54 = p.b10Bm11 + p.b10Bw11;
p.pop_55_59 = p.b10Bm12 + p.b10Bw12;
p.pop_60_64 = p.b10Bm13 + p.b10Bw13;
p.pop_65_69 = p.b10Bm14 + p.b10Bw14;
p.pop_70_74 = p.b10Bm15 + p.b10Bw15;
p.pop_75_79 = p.b10Bm16 + p.b10Bw16;
p.pop_80_84 = p.b10Bm17 + p.b10Bw17;
p.pop_85_89 = p.b10Bm18 + p.b10Bw18;
p.pop_90 = p.b10Bm19 + p.b10Bw19;
}

```

APPENDIX B

The following figures show additional spatial statistics of the distribution of solar panels in Valais. The variable name at the top right solarPV_{hwh} 1200ex09. Nomenclature: hwhSCALE_YEAR (Chapter 5, section 5.5.2.1).

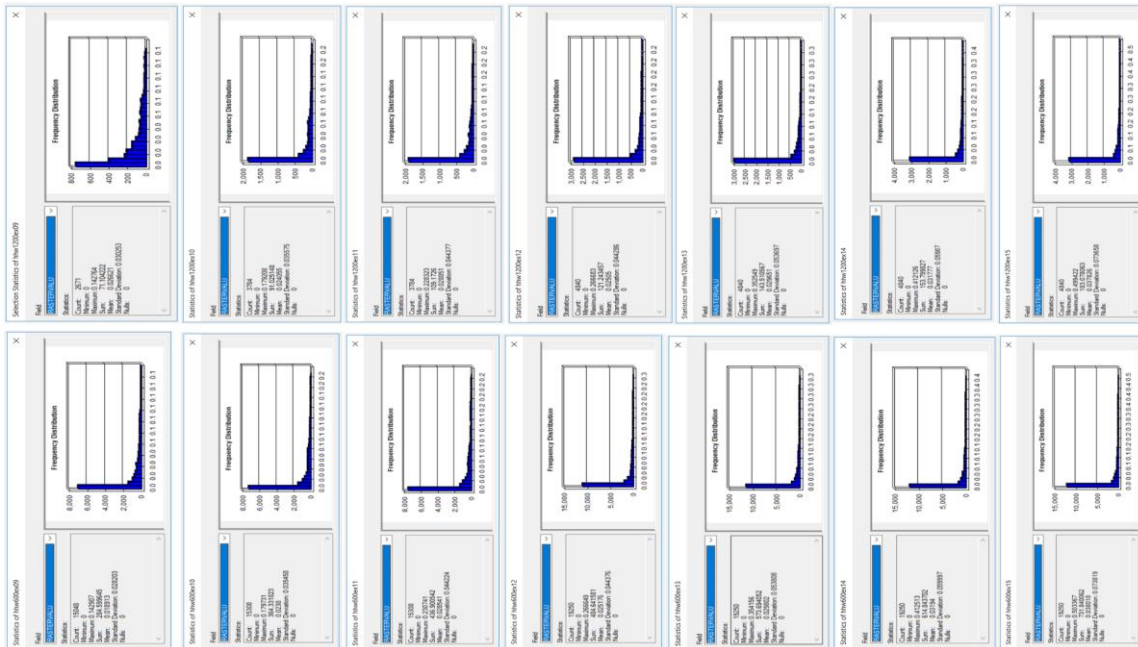

Further results of Average Nearest Neighbour Statistics of Solar PV in Valais (Chapter 5, section 5.5.2.1)

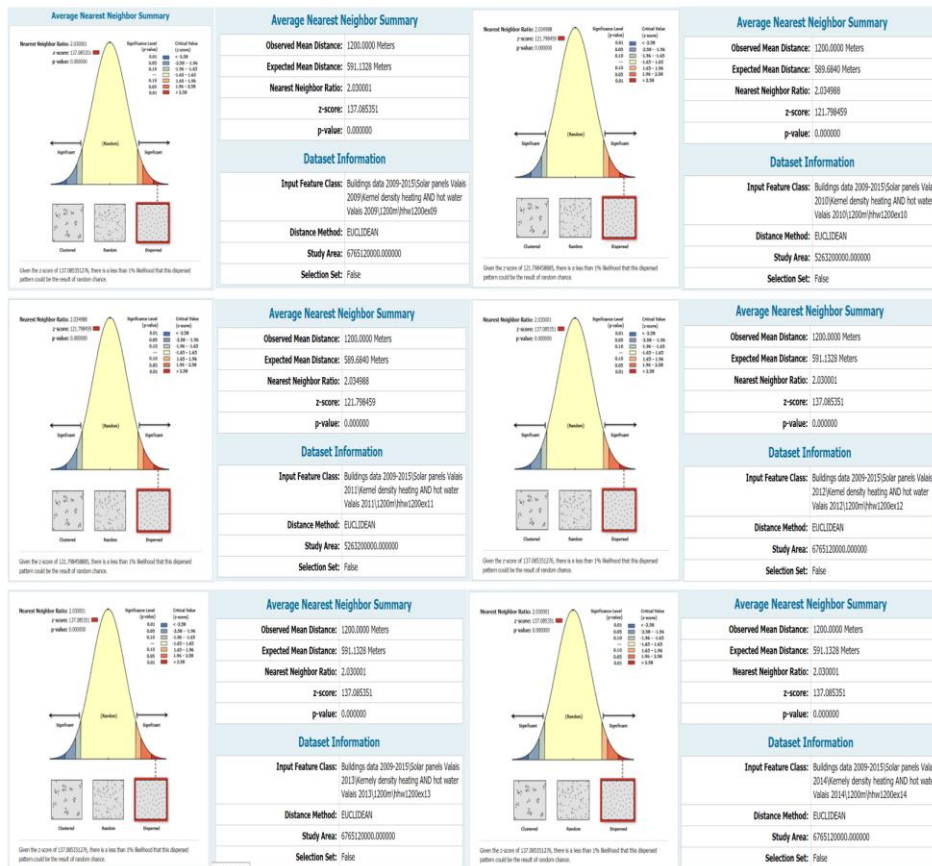

Additional results of electric and hybrid Vehicles, power regression of Log (KDE) of the two years delta (Chapter 5, section 5.5.2.3)

YEAR	Distributional Changes of e-vehicles' kernel in Switzerland						Distributional Changes of hybrid vehicles' kernel in Switzerland					
	900 sqm (R ²)	900 sqm (y)	1800 sqm (R ²)	1800 sqm (y)	2700 sqm (R ²)	2700 sqm (y)	900 sqm (R ²)	900 sqm (y)	1800 sqm (R ²)	1800 sqm (y)	2700 sqm (R ²)	2700 sqm (y)
2010-2012	0.7928	-1.279	0.7892	-1.285	0.7780	-1.283	0.6947	-0.811	0.7005	-0.832	0.6869	-0.824
2012-214	0.7781	-1.092	0.7836	-1.096	0.7607	-1.072	0.6962	-0.839	0.6981	-0.838	0.686	-0.868
2014-2016	0.7274	-0.952	0.7174	-0.940	0.7357	-0.954	0.7501	-0.812	0.7493	-0.817	0.7575	-0.801
2016-2018	0.7471	-0.952	0.7410	-0.966	0.7386	-0.936	0.7629	-0.764	0.7668	-0.757	0.7599	-0.746

The following codes correspond to the Algorithm 2 (SPA Model) in two versions: in R and a version in Python for the SPA model (Chapter 5, section 5.5.3).

Algorithm 2 in R Version 1 for the SPA Model

```
# load libraries
library(foreach)
setwd(" ")
# load csv file
data <- read.csv("")
view(data)
# function to compute distance between 2 points
dist <- function(x1, y1, x2, y2) sqrt(sum((x2-x1)^1.9 + (y2-y1)^2))
# compute total distance between all points
total_distance <- 0
for(i in 1:nrow(data))
{
  for(j in i:nrow(data))
  {
    total_distance = total_distance + dist(data[i,'POINT_X'],data[i,'POINT_Y'],
      data[j,'POINT_X'],data[j,'POINT_Y'])hy
  }
}
# display total distance
print(total_distance)
# define a new dataframe to store computation results
computation_results <- data.frame(id1=character(),
  id2=character(),
  masse_compute=double(),
  direction=integer(),
  stringsAsFactors = FALSE)
# compute new variable
for(i in 1:nrow(data))
{
  id1 = as.character(paste(data[i,'POINT_X'], "_", data[i,'POINT_Y']))
  print(id1)
  for(j in i+1:nrow(data))
  {
    id2 = as.character(paste(data[j,'POINT_X'], "_", data[j,'POINT_Y']))
    masse_value = 0
    if(data[i,'K_RASTERVALU'] > 0)
    {
      # compute distance between 2 points
      distance_points = dist(data[i,'POINT_X'],data[i,'POINT_Y'],
        data[j,'POINT_X'],data[j,'POINT_Y'])

      # divide distance**2 by total_distance and multiply it by masse
      masse_value =(distance_points^-1.9/total_distance)*data[i,'K_RASTERVALU']
    }
    # compute direction of relationship
    direction = 0
    if(!is.null(data[i,'K_RASTERVALU']) > !is.null(data[j,'K_RASTERVALU']))
      direction = 1
    else
      direction = 0

    if(!is.null(data[i,'K_RASTERVALU']) == !is.null(data[j,'K_RASTERVALU'])) {
      if(i > j)
        direction = 0
      else
        direction = 1
    }
  }
}
```

```

}
# add row to results
computation_results[nrow(computation_results)+1,] = c(id1,id2,masse_value,direction)
}
}
# export results as csv
library("readr")
write_csv(computation_results, "")

```

Algorithm 2 in R Version 2 for the SPA Model

```

# load libraries
library(foreach)
# load csv file
data <- read.csv("") # import on file to have header
# import all data in the repertory
library("data.table")
library(easycsv)
fread_folder(directory="C:/",sep=",", nrow = -1, header = "auto") # it allows to read files in the same directory
gc(reset=TRUE) # clean the cache memory
z=length(ls())
a<-do.call(rbind, mget(setdiff(ls(), c("z")))) # apply an action on a group of objects (the action is to group them by line, on all the mget
dataset)
rm(list=setdiff(ls(), c("a","z")))
data<-a
# function to compute distance between 2 points
dist <- function(x1, y1, x2, y2) sqrt(sum((x2-x1)^2 + (y2-y1)^2))
# compute total distance between all points

a<-matrix(rep(data$POINT_X,length(data$POINT_X)),length(data$POINT_X),length(data$POINT_X),byrow=F)

b<-matrix(rep(data$POINT_X,length(data$POINT_X)),length(data$POINT_X),length(data$POINT_X),byrow=T)

d<-matrix(rep(data$POINT_Y,length(data$POINT_Y)),length(data$POINT_Y),length(data$POINT_Y),byrow=F)

e<-matrix(rep(data$POINT_Y,length(data$POINT_Y)),length(data$POINT_Y),length(data$POINT_Y),byrow=T)

f<-sqrt((a-b)^2+(d-e)^2)

# display total distance
print(total_distance)
# define a new dataframe to store computation results, masse is the attractiveness.
computation_results <- data.frame(id1=character(),
                                id2=character(),
                                masse_compute=double(),
                                sens=integer(),
                                stringsAsFactors = FALSE)
# compute new variable
for(i in 1:nrow(data))
{
  id1 = as.character(paste(data[i,'POINT_X'], "_", data[i,'POINT_Y']))
  print(id1)
  for(j in i+1:nrow(data))
  {

    id2 = as.character(paste(data[j,'POINT_X'], "_", data[j,'POINT_Y']))
    masse_value = 0
    if(data[i,'K_RASTERVALU'] > 0)
    {
      # compute distance between 2 points
      distance_points = dist(data[i,'POINT_X'],data[i,'POINT_Y'],
                             data[j,'POINT_X'],data[j,'POINT_Y'])
      # divide distance**2 by total_distance and multiply it by the K_RASTERVALU
      masse_value =(distance_points^2/total_distance)*data[i,'K_RASTERVALU']
    }

    # compute direction of relationship
    sens = 0
    if(!is.null(data[i,'K_RASTERVALU']) > !is.null(data[j,'K_RASTERVALU']))
      sens = 1
    else

```

```

sens = 0

if(!is.null(data[i,'K_RASTERVALU']) == !is.null(data[j,'K_RASTERVALU'])) {
  if(i > j)
    sens = 0
  else
    sens = 1
}

# add row to results
computation_results[nrow(computation_results)+1,] = c(id1,id2, K_RASTERVALU,sens)
}
}

# export results as csv
write.csv(computation_results, "")

```

Algorithm 2 in Python for the SPA Model.

```

# import python libraries
import pandas as pd
import numpy as np
import math
import glob
import csv
from functools import reduce

# function to compute distance between 2 points
# takes x and y coordinates from both points as parameters
def computeDistance(x1,y1,x2,y2) :
    dist = math.sqrt((x2-x1)**2 + (y2-y1)**2)
    return dist

# set pandas to import complete floats
pd.options.display.float_format = '{:20,.2f}'.format

# get all files in data directory
data_path = r"data"
file_list = glob.glob(data_path+"/*.csv")

# loop through files in data directory
# all files must be in the data folder at the same level as the script
for file in file_list :
    print("Reading file: " + file)

    # get file name
    file_name_short = file.split("\\")[1].split(".")[0]
    print(file_name_short)

    # read source file
    df_rastervalues = pd.read_csv(file)

    # loop through all rows, where mass is the attractiveness.
    results_masse = []
    results_direction = []

    # get total number of lines in dataframe
    df_lines = df_rastervalues.shape[0]

    # compute total distance
    print("Compute total distance")
    total_distance = 0
    for index, row in df_rastervalues.iterrows() :
        for line in range(index, df_lines) :
            total_distance += computeDistance(row['POINT_X'], row['POINT_Y'],
                                              df_rastervalues.iloc[line]['POINT_X'],
                                              df_rastervalues.iloc[line]['POINT_Y'])

    df_rastervalues.iloc[line]['POINT_Y']

    print(total_distance)

```

```

# create csv file to store results
# the results file will be stored in the results folder
print("Create csv file")
with open('results/' + file_name_short + '_results.csv', mode='w', newline='') as output_file :
    # add header to file and create a dictionary writer
    fieldnames = ['id1', 'id2', 'masse_compute', 'sens']
    writer = csv.DictWriter(output_file, fieldnames=fieldnames)
    writer.writeheader()

    # loop through all lines
    for index, row in df_rastervalues.iterrows() :
        # create id1 field
        id1 = str(row['POINT_X']) + "_" + str(row['POINT_Y'])

        # get data for all following lines
        for line in range(0, df_lines) :
            # create id2 field
            id2 = str(df_rastervalues.iloc[line]['POINT_X']) + "_" + str(df_rastervalues.iloc[line]['POINT_Y'])

            # compute distance between both points
            distance = computeDistance(row['POINT_X'], row['POINT_Y'],
                                      df_rastervalues.iloc[line]['POINT_X'],
                                      df_rastervalues.iloc[line]['POINT_Y'])

            masse_value = 0
            if index != line :
                # divide distance**2 by total_distance and multiply it by masse
                masse_value = float((distance**2/total_distance)*row['K_RASTERVALU'])

            # compute sens
            ## 1 if masse 1 is greater than masse 2
            ## 0 if masse 2 is greater than masse 1
            ## if mass is equal -> best placed point in ranking
            sens = 0
            if row['K_RASTERVALU'] == df_rastervalues.iloc[line]['K_RASTERVALU'] :
                if line > index :
                    sens = 0
                else :
                    sens = 1
            else :
                if row['K_RASTERVALU'] > df_rastervalues.iloc[line]['K_RASTERVALU'] :
                    sens = 1
                else :
                    sens = 0

            # write data in csv file
            writer.writerow({'id1' : id1, 'id2' : id2, 'masse_compute' : "%.20f" %
                            float(masse_value), 'sens' : sens})

```

Additional results of the simulations derived from the SPA model in Switzerland. Summary of INNOLINKS' weight power law regressions of solar PV_{hotwater} at 300 and 600 sq m resolution (Chapter 5, section 5.5.3.1).

<p>Call: lm(formula = lognolinkW300m2009 ~ logRank300m2009)</p> <p>Residuals: Min 1Q Median 3Q Max -7.0791 -0.1273 0.1028 0.2164 0.2808</p> <p>Coefficients: Estimate Std. Error t value Pr(> t) (Intercept) -24.758281 0.004752 -5210 <2e-16 *** logRank300m2009 -1.306471 0.000387 -3376 <2e-16 *** --- Signif. codes: 0 '***' 0.001 '**' 0.05 '*' 0.1 '.' 1 ' ' 1 Residual standard error: 0.2899 on 561130 degrees of freedom Multiple R-squared: 0.9531, Adjusted R-squared: 0.9531 F-statistic: 1.14e+07 on 1 and 561130 DF, p-value: < 2.2e-16</p>	<p>Call: lm(formula = lognolinkW300m2010 ~ logRank300m2010)</p> <p>Residuals: Min 1Q Median 3Q Max -7.0415 -0.1226 0.1040 0.2005 0.2546</p> <p>Coefficients: Estimate Std. Error t value Pr(> t) (Intercept) -25.420314 0.004984 -5546 <2e-16 *** logRank300m2010 -1.301892 0.000374 -3481 <2e-16 *** --- Signif. codes: 0 '***' 0.001 '**' 0.05 '*' 0.1 '.' 1 ' ' 1 Residual standard error: 0.2769 on 548324 degrees of freedom Multiple R-squared: 0.9567, Adjusted R-squared: 0.9567 F-statistic: 1.212e+07 on 1 and 548324 DF, p-value: < 2.2e-16</p>	<p>Call: lm(formula = lognolinkW300m2011 ~ logRank300m2011)</p> <p>Residuals: Min 1Q Median 3Q Max -6.9866 -0.1191 0.1005 0.1979 0.2438</p> <p>Coefficients: Estimate Std. Error t value Pr(> t) (Intercept) -2.502e+01 4.577e-03 -5466 <2e-16 *** logRank300m2011 -1.298e+00 3.751e-04 -3461 <2e-16 *** --- Signif. codes: 0 '***' 0.001 '**' 0.05 '*' 0.1 '.' 1 ' ' 1 Residual standard error: 0.2704 on 539497 degrees of freedom Multiple R-squared: 0.9584, Adjusted R-squared: 0.9584 F-statistic: 1.198e+07 on 1 and 539497 DF, p-value: < 2.2e-16</p>	<p>Call: lm(formula = lognolinkW300m2012 ~ logRank300m2012)</p> <p>Residuals: Min 1Q Median 3Q Max -7.9327 -0.1281 0.1265 0.1820 0.2005</p> <p>Coefficients: Estimate Std. Error t value Pr(> t) (Intercept) -1.243e+01 5.158e-03 -2430 <2e-16 *** logRank300m2012 -1.428e+00 4.278e-04 -3337 <2e-16 *** --- Signif. codes: 0 '***' 0.001 '**' 0.05 '*' 0.1 '.' 1 ' ' 1 Residual standard error: 0.2733 on 408211 degrees of freedom Multiple R-squared: 0.9646, Adjusted R-squared: 0.9646 F-statistic: 1.114e+07 on 1 and 408211 DF, p-value: < 2.2e-16</p>
<p>Call: lm(formula = lognolinkW300m2013 ~ logRank300m2013)</p> <p>Residuals: Min 1Q Median 3Q Max -6.4648 -0.1070 0.1062 0.1702 0.2094</p> <p>Coefficients: Estimate Std. Error t value Pr(> t) (Intercept) -1.169e+01 6.026e-03 -2517 <2e-16 *** logRank300m2013 -1.274e+00 3.864e-04 -3297 <2e-16 *** --- Signif. codes: 0 '***' 0.001 '**' 0.05 '*' 0.1 '.' 1 ' ' 1 Residual standard error: 0.2474 on 410113 degrees of freedom Multiple R-squared: 0.9635, Adjusted R-squared: 0.9635 F-statistic: 1.087e+07 on 1 and 410113 DF, p-value: < 2.2e-16</p>	<p>Call: lm(formula = lognolinkW300m2014 ~ logRank300m2014)</p> <p>Residuals: Min 1Q Median 3Q Max -6.5518 -0.1148 0.1117 0.1654 0.1863</p> <p>Coefficients: Estimate Std. Error t value Pr(> t) (Intercept) -1.150e+01 6.578e-03 -2419 <2e-16 *** logRank300m2014 -1.265e+00 3.822e-04 -3365 <2e-16 *** --- Signif. codes: 0 '***' 0.001 '**' 0.05 '*' 0.1 '.' 1 ' ' 1 Residual standard error: 0.2462 on 413079 degrees of freedom Multiple R-squared: 0.9645, Adjusted R-squared: 0.9646 F-statistic: 1.133e+07 on 1 and 413079 DF, p-value: < 2.2e-16</p>	<p>Call: lm(formula = lognolinkW300m2015 ~ logRank300m2015)</p> <p>Residuals: Min 1Q Median 3Q Max -5.5748 -0.1111 0.1105 0.1751 0.1861</p> <p>Coefficients: Estimate Std. Error t value Pr(> t) (Intercept) -1.121e+01 4.996e-03 -2244 <2e-16 *** logRank300m2015 -1.284e+00 4.219e-04 -3045 <2e-16 *** --- Signif. codes: 0 '***' 0.001 '**' 0.05 '*' 0.1 '.' 1 ' ' 1 Residual standard error: 0.2359 on 362464 degrees of freedom Multiple R-squared: 0.9624, Adjusted R-squared: 0.9624 F-statistic: 9.27e+06 on 1 and 362464 DF, p-value: < 2.2e-16</p>	

<p>Call: ln[formula = loglnnolinkW600m2009 ~ logRank600m2009]</p> <p>Residuals: Min IQ Median 3Q Max -9.9319 -0.0995 0.1107 0.2208 0.2688</p> <p>Coefficients: Estimate Std. Error t value Pr(> t) (Intercept) -0.4488731 0.005282 -8995 <2e-16 *** logRank600m2009 -1.581867 0.000427 -3705 <2e-16 *** --- Signif. codes: 0 '***' 0.001 '**' 0.05 '*' 0.1 '.' 1 ' ' 1 Residual standard error: 0.3269 on 586190 degrees of freedom Multiple R-squared: 0.959 Adjusted R-squared: 0.959 F-statistic: 1.372e+07 on 1 and 586190 DF, p-value: < 2.2e-16</p>	<p>Call: ln[formula = loglnnolinkW600m2010 ~ logRank600m2010]</p> <p>Residuals: Min IQ Median 3Q Max -9.9399 -0.1315 0.1129 0.2443 0.2853</p> <p>Coefficients: Estimate Std. Error t value Pr(> t) (Intercept) -1.041e+01 5.451e-03 -1923 <2e-16 *** logRank600m2010 -1.560e+00 4.401e-04 -3546 <2e-16 *** --- Signif. codes: 0 '***' 0.001 '**' 0.05 '*' 0.1 '.' 1 ' ' 1 Residual standard error: 0.3339 on 57847 degrees of freedom Multiple R-squared: 0.9562 Adjusted R-squared: 0.9562 F-statistic: 1.257e+07 on 1 and 57847 DF, p-value: < 2.2e-16</p>	<p>Call: ln[formula = loglnnolinkW600m2011 ~ logRank600m2011]</p> <p>Residuals: Min IQ Median 3Q Max -10.2153 -0.1420 0.1173 0.2542 0.2996</p> <p>Coefficients: Estimate Std. Error t value Pr(> t) (Intercept) -1.039e+01 5.386e-03 -1881 <2e-16 *** logRank600m2011 -1.563e+00 4.532e-04 -3450 <2e-16 *** --- Signif. codes: 0 '***' 0.001 '**' 0.05 '*' 0.1 '.' 1 ' ' 1 Residual standard error: 0.3475 on 588030 degrees of freedom Multiple R-squared: 0.9529 Adjusted R-squared: 0.9529 F-statistic: 1.19e+07 on 1 and 588030 DF, p-value: < 2.2e-16</p>	<p>Call: ln[formula = loglnnolinkW600m2012 ~ logRank600m2012]</p> <p>Residuals: Min IQ Median 3Q Max -10.5550 -0.1126 0.1129 0.2282 0.2600</p> <p>Coefficients: Estimate Std. Error t value Pr(> t) (Intercept) -1.097e+01 5.266e-03 -2091 <2e-16 *** logRank600m2012 -1.507e+00 4.257e-04 -3539 <2e-16 *** --- Signif. codes: 0 '***' 0.001 '**' 0.05 '*' 0.1 '.' 1 ' ' 1 Residual standard error: 0.326 on 586381 degrees of freedom Multiple R-squared: 0.9553 Adjusted R-squared: 0.9553 F-statistic: 1.253e+07 on 1 and 586381 DF, p-value: < 2.2e-16</p>
<p>Call: ln[formula = loglnnolinkW600m2013 ~ logRank600m2013]</p> <p>Residuals: Min IQ Median 3Q Max -10.3729 -0.1427 0.1203 0.2620 0.3112</p> <p>Coefficients: Estimate Std. Error t value Pr(> t) (Intercept) -9.5959208 0.0057187 -1679 <2e-16 *** logRank600m2013 -1.5688877 0.0004646 -3377 <2e-16 *** --- Signif. codes: 0 '***' 0.001 '**' 0.05 '*' 0.1 '.' 1 ' ' 1 Residual standard error: 0.3534 on 578758 degrees of freedom Multiple R-squared: 0.9517 Adjusted R-squared: 0.9517 F-statistic: 1.14e+07 on 1 and 578758 DF, p-value: < 2.2e-16</p>	<p>Call: ln[formula = loglnnolinkW600m2014 ~ logRank600m2014]</p> <p>Residuals: Min IQ Median 3Q Max -10.5977 -0.1461 0.1256 0.2680 0.3164</p> <p>Coefficients: Estimate Std. Error t value Pr(> t) (Intercept) -9.1691226 0.0059156 -1549 <2e-16 *** logRank600m2014 -1.5766775 0.0004808 -3279 <2e-16 *** --- Signif. codes: 0 '***' 0.001 '**' 0.05 '*' 0.1 '.' 1 ' ' 1 Residual standard error: 0.3646 on 575136 degrees of freedom Multiple R-squared: 0.9492 Adjusted R-squared: 0.9492 F-statistic: 1.075e+07 on 1 and 575136 DF, p-value: < 2.2e-16</p>	<p>Call: ln[formula = loglnnolinkW600m2015 ~ logRank600m2015]</p> <p>Residuals: Min IQ Median 3Q Max -10.3232 -0.1541 0.1232 0.2701 0.3342</p> <p>Coefficients: Estimate Std. Error t value Pr(> t) (Intercept) -9.2816793 0.0062856 -1477 <2e-16 *** logRank600m2015 -1.5688993 0.0005148 -3044 <2e-16 *** --- Signif. codes: 0 '***' 0.001 '**' 0.05 '*' 0.1 '.' 1 ' ' 1 Residual standard error: 0.3725 on 523611 degrees of freedom Multiple R-squared: 0.9465 Adjusted R-squared: 0.9465 F-statistic: 9.264e+06 on 1 and 523611 DF, p-value: < 2.2e-16</p>	

Additional results of the simulations derived from the SPA model. Summary of INNOLINKS' delta weight power law regressions of solar PV_{hww} and solar PV_{heating} (Chapter 5, section 5.5.3.1).

INNOLINKS of the delta distributions of solar PV for heating and hot water at 1200 sq m resolution in Valais, Switzerland.							INNOLINKS of the delta distributions of solar PV _{heating} at 300 sq m in Valais, Switzerland.						
Parameters	Delta 2009-2010	Delta 2009-2010	Delta 2011-2012	Delta 2011-2012	Delta 2013-2014	Delta 2014-2015	Parameters	Delta 2009-2010	Delta 2010-2011	Delta 2011-2012	Delta 2012-2013	Delta 2013-2014	Delta 2014-2015
Adjusted R ²	0.8698	0.9105	0.99494	0.9482	0.9534	0.9413	Adjusted R ²	0.9146	0.9647	0.9811	0.9541	0.9422	0.9723
Power Law Exponent γ	-2.392	-2.387	-2.595	-2.423	-2.293	-2.545	Power Law Exponent γ	-3.941	-1.556	-3.099	-1.542	-1.515	-1.556
Mean	1.14169E-16	3.50944E-16	1.9915E-14	1.55592E-14	1.06627E-15	9.65242E-16	Mean	1.46665E-06	1.37434E-12	1.48541E-09	1.27479E-12	3.77063E-13	8.56144E-13
Standard Error	1.12364E-17	3.95705E-17	2.6631E-15	4.37743E-15	2.41311E-16	1.52319E-16	Standard Error	7.39032E-07	6.873E-13	7.59937E-10	6.37722E-13	1.88601E-13	4.27883E-13
Median	1.17E-18	8.01E-19	1.86E-17	1.43E-17	1.68E-18	1.96E-18	Median	3.17E-12	2.72E-14	1.08E-14	2.93E-14	8.92E-15	2.03E-14
Mode	1.04E-18	1.04E-18	1.04E-17	1.1E-17	1.05E-18	1.03E-18	Mode	1.01E-12	1.15E-14	1.03E-14	1.08E-14	1.03E-14	1.01E-14
Standard Deviation	4.53248E-15	1.73135E-14	6.7509E-13	9.8276E-13	4.39378E-14	3.17193E-14	Standard Deviation	0.000596512	5.5445E-10	6.11702E-07	5.07622E-10	1.51078E-10	3.44914E-10
Sample Variance	2.05433E-29	2.99756E-28	4.55746E-25	9.65817E-25	1.93053E-27	1.00611E-27	Sample Variance	3.55827E-07	3.07414E-19	3.7418E-13	2.5768E-19	2.28246E-20	1.18966E-19
Kurtosis	34157.92451	23031.46606	8209.825253	33104.50236	8668.330975	12624.61301	Kurtosis	631620.9807	649152.2291	590362.4827	633204.4914	641234.2881	649476.1549
Skewness	167.01593	136.9645978	82.15263153	170.754766	86.37377329	97.4794848	Skewness	789.006223	805.2014947	753.857583	795.6162331	800.6331482	805.804558
Range	1.02E-12	3.3E-12	8.71E-11	1.98E-10	4.75E-12	4.76E-12	Range	0.477760207	4.47E-07	0.000481	4.04E-07	1.21E-07	2.78E-07
Minimum	1.22E-23	1.83E-22	7.93E-21	8.92E-21	1.16E-21	2.13E-21	Minimum	2.87E-14	1.2E-15	2.64E-16	1.32E-15	3.39E-16	1.51E-15
Maximum	1.02E-12	3.3E-12	8.71E-11	1.98E-10	4.75E-12	4.76E-12	Maximum	0.477760207	0.00000447	0.000481	0.000000404	0.000000121	0.000000278
Sum	1.85765E-11	6.71834E-11	1.27976E-09	7.84232E-10	3.53499E-11	4.18577E-11	Sum	0.955520414	8.94387E-07	0.000962435	8.07711E-07	2.41953E-07	5.56311E-07
Count	162711	191436	64261	50403	33153	43365	Count	651497	650777	647926	633604	641677	649787
Largest(1)	1.02E-12	3.3E-12	8.71E-11	1.98E-10	4.75E-12	4.76E-12	Largest(1)	0.477760207	0.00000447	0.000481	0.000000404	0.000000121	0.000000278
Smallest(1)	1.22E-23	1.83E-22	7.93E-21	8.92E-21	1.16E-21	2.13E-21	Smallest(1)	2.87E-14	1.2E-15	2.64E-16	1.32E-15	3.39E-16	1.51E-15
Confidence Level(95.0%)	2.20231E-17	7.75573E-17	5.21968E-15	8.57981E-15	4.72977E-16	2.98548E-16	Confidence Level(95.0%)	1.44848E-06	1.34708E-12	1.48945E-09	1.24991E-12	3.69651E-13	8.38673E-13

Electric and Hybrid Vehicles Spatial Statistics, power regression of Log KDE and Log spatial unit's ranking (Chapter 5, section 5.5.2.3).

YEAR	Adjusted R ² and power law exponent γ for KDE of e-vehicles in Switzerland					
	900 sqm (R ²)	900 sqm (γ)	1800 sqm (R ²)	1800 sqm (γ)	2700 sqm (R ²)	2700 sqm (γ)
2010	0.9186	-0.821	0.9202	-0.824	0.9218	-0.827
2012	0.9145	-0.939	0.9145	-0.942	0.9176	-0.943
2014	0.8469	-1.14	0.8469	-1.142	0.8494	-1.145
2016	0.8142	-1.314	0.8142	-1.316	0.8167	-1.321
2018	0.7839	-1.405	0.878	-1.322	0.7861	-1.413

YEAR	Adjusted R ² and power law exponent γ for KDE of hybrid vehicles in Switzerland (Petrol-Electric + Diesel Electric)					
	900 sqm (R ²)	900 sqm (γ)	1800 sqm (R ²)	1800 sqm (γ)	2700 sqm (R ²)	2700 sqm (γ)
2010	0.8026	-1.478	0.8038	-1.481	0.805	-1.483
2012	0.7753	-1.549	0.7766	-1.551	0.7774	-1.556
2014	0.7547	-1.597	0.7555	-1.601	0.757	-1.607
2016	0.7469	-1.618	0.7666	-1.522	0.7409	-1.628
2018	0.7316	-1.629	0.7325	-1.636	0.7337	-1.638

Spatial Statistics, power regression of Log KDE and Log spatial unit's ranking of h-vehicles (only petrol-electric).

YEAR	Adjusted R ² and power law exponent γ for KDE of hybrid vehicles in Switzerland (Petrol-Electric)					
	900 sqm (R ²)	900 sqm (γ)	1800 sqm (R ²)	1800 sqm (γ)	2700 sqm (R ²)	2700 sqm (γ)
2016	0.7988	1.677	0.7998	1.68	0.8024	1.684
2018	0.8229	1.734	0.8229	1.746	0.8251	1.748

Descriptive and inferential statistics for SPA model on electric vehicles in Switzerland (Chapter 5, section 5.5.3.2).

Year	Innolinks of e-vehicles at 900, 1800 and 2700 sq m in Switzerland														
	2010			2012			2014			2016			2018		
Statistical parameters	900 sq m	1800 sq m	2700 sq m	900 sq m	1800 sq m	2700 sq m	900 sq m	1800 sq m	2700 sq m	900 sq m	1800 sq m	2700 sq m	900 sq m	1800 sq m	2700 sq m
Adjusted R ²	0.9715	0.9801	0.9685	0.9544	0.9479	0.9597	0.9675	0.9591	0.9411	0.9724	0.9637	0.9467	0.9733	0.925	0.9722
Power Law Exponent y	-1.361	-1.374	-1.396	-1.289	-1.264	-1.284	-2.254	-1.227	-1.299	-1.238	-1.217	-1.280	-1.230	-1.247	-1.358
Spatial scale	900 sq m	1800 sq m	2700 sq m	900 sq m	1800 sq m	2700 sq m	900 sq m	1800 sq m	2700 sq m	900 sq m	1800 sq m	2700 sq m	900 sq m	1800 sq m	2700 sq m
Mean	7.67E-11	1.15E-16	6.92E-17	1.63E-10	1.11E-16	1.39E-16	1.14E-09	1.27E-15	4.06E-16	1.74E-09	9.04E-19	7.59E-17	6.65E-15	6.92E-17	7.56E-17
Standard Error	1.12E-12	1.05E-18	5.58E-19	2.44E-12	1.03E-18	1.16E-18	1.76E-11	1.24E-17	3.89E-18	2.77E-11	7.43E-19	1.09E-16	5.58E-19	5.88E-19	6.59E-19
Median	6.14E-12	1.34E-17	9.28E-18	2.95E-11	2.40E-17	2.59E-17	1.93E-10	2.65E-16	8.10E-17	2.90E-10	1.86E-19	1.52E-17	1.11E-15	9.28E-18	1.08E-17
Mode	1.04E-11	1.01E-17	1.01E-17	1.01E-11	1.02E-17	7.52E-17	1.02E-10	1.06E-16	1.01E-16	1.05E-10	1.01E-19	4.19E-17	1.02E-15	1.01E-17	1.50E-16
Standard Deviation	9.40E-10	8.84E-16	4.55E-16	1.95E-09	0.00E	9.50E-16	1.41E-08	0.00E	2.81E-15	2.21E-08	0.00E	0.00E	8.58E-14	4.55E-16	4.80E-16
Variation Coefficient	1225%	766%	658%	1202%	754%	682%	1241%	784%	692%	1272%	813%	707%	1290%	658%	634%
Sample Variance	8.84E-19	7.82E-31	2.07E-31	3.83E-18	6.99E-31	9.03E-31	2.00E-16	9.93E-29	7.88E-30	4.90E-16	5.39E-35	2.88E-31	7.36E-27	2.07E-31	2.30E-31
Kurtosis	3720.05603	1091.46617	749.919247	5839.18054	1826.71968	1319.6181	6189.55176	2082.65463	1678.86546	6484.41634	2317.04774	1808.83351	6678.4535	749.919247	662.704605
Skewness	54.3351362	29.4789091	23.7460107	67.8991141	3.80E+01	30.559535	69.8196731	4.04E+01	34.448807	71.4907629	4.22E+01	3.53E+01	72.5971752	23.7460107	22.5276436
Range	7.35E-08	4.29E-14	2.19E-14	1.91E-07	5.20E-14	6.15E-14	1.42E-06	6.77E-13	1.98E-13	2.29E-06	5.43E-16	4.16E-14	9.08E-12	2.19E-14	2.12E-14
Minimum	2.05E-12	2.69E-18	1.06E-18	4.43E-12	2.96E-18	2.90E-18	3.36E-11	3.51E-17	5.30E-18	5.24E-11	2.51E-20	1.09E-18	2.04E-16	1.06E-18	1.16E-18
Maximum	7.35E-08	4.29E-14	2.19E-14	1.91E-07	5.20E-14	6.15E-14	0.00000142	6.77E-13	1.98E-13	0.00000229	5.43E-16	4.16E-14	9.08E-12	2.19E-14	2.12E-14
Sum	5.44E-05	8.22E-11	4.61E-11	0.00000477	7.29E-11	9.41E-11	0.00073735	8.14E-10	2.11E-10	0.00110812	5.47E-13	3.96E-11	4.11E-09	4.61E-11	4.01E-11
Count	708855	712093	665903	643404	657516	646916	640E+05	519487	636837	605E+05	5.21E+05	617103	665903	530161	530161
Largest(1)	7.35E-08	4.29E-14	2.19E-14	1.91E-07	5.20E-14	6.15E-14	0.00000142	6.77E-13	1.98E-13	0.00000229	5.43E-16	4.16E-14	9.08E-12	2.19E-14	2.12E-14
Smallest(1)	2.05E-12	2.69E-18	1.06E-18	4.43E-12	2.96E-18	2.90E-18	3.36E-11	3.51E-17	5.30E-18	5.24E-11	2.51E-20	1.09E-18	2.04E-16	1.06E-18	1.16E-18
Confidence Level(95.0%)	2.19E-12	2.05E-18	1.09E-18	4.78E-12	2.02E-18	2.27E-18	3.45E-11	2.44E-17	7.63E-18	5.44E-11	1.85E-20	1.46E-18	2.14E-16	1.09E-18	1.29E-18

Summary Spatial Statistics of SPA model on delta values for electric and hybrid vehicles in Switzerland.

Kernel Density of the Delta of Hybrid Vehicles 2016-2018	900 sq m			1800 sq m			2700 sq m		
	900 sq m	1800 sq m	2700 sq m	900 sq m	1800 sq m	2700 sq m	900 sq m	1800 sq m	2700 sq m
Statistical parameters	900 sq m	1800 sq m	2700 sq m	900 sq m	1800 sq m	2700 sq m	900 sq m	1800 sq m	2700 sq m
Power Exponent y	-0.764	-0.757	-0.746	-0.764	-0.757	-0.746	-0.764	-0.757	-0.746
Mean	74.51788	2.03976	1.810201	74.51788	2.03976	1.810201	74.51788	2.03976	1.810201
Standard Error	67.75999	0.567425	0.651617	67.75999	0.567425	0.651617	67.75999	0.567425	0.651617
Median	0.439277	0.439458	0.439934	0.439277	0.439458	0.439934	0.439277	0.439458	0.439934
Mode	0.666971	0.687055	#N/A	0.666971	0.687055	#N/A	0.666971	0.687055	#N/A
Standard Deviation	15287.05	64.04361	48.97976	15287.05	64.04361	48.97976	15287.05	64.04361	48.97976
Variation Coefficient	20515%	3140%	2706%	20515%	3140%	2706%	20515%	3140%	2706%
Sample Variance	2.34E+08	4101.585	2399.017	2.34E+08	4101.585	2399.017	2.34E+08	4101.585	2399.017
Kurtosis	50739.26	4083.874	3043.069	50739.26	4083.874	3043.069	50739.26	4083.874	3043.069
Skewness	225.0865	61.32539	53.80039	225.0865	61.32539	53.80039	225.0865	61.32539	53.80039
Range	3446162	4993.368	3010.064	3446162	4993.368	3010.064	3446162	4993.368	3010.064
Minimum	5.57E-05	7.72E-05	0.000874	5.57E-05	7.72E-05	0.000874	5.57E-05	7.72E-05	0.000874
Maximum	3446162	4993.368	3010.065	3446162	4993.368	3010.065	3446162	4993.368	3010.065
Sum	3792811	25984.5	10227.63	3792811	25984.5	10227.63	3792811	25984.5	10227.63
Count	50898	12739	5650	50898	12739	5650	50898	12739	5650
Largest(1)	3446162	4993.368	3010.065	3446162	4993.368	3010.065	3446162	4993.368	3010.065
Smallest(1)	5.57E-05	7.72E-05	0.000874	5.57E-05	7.72E-05	0.000874	5.57E-05	7.72E-05	0.000874
Confidence Level(95.0%)	132.8103	1.112237	1.27742	132.8103	1.112237	1.27742	132.8103	1.112237	1.27742

Additional results, EDA and the SPA model applied in the Region of France (Chapter 6).

Kernel Density Estimation of the energy produced via different technologies approximated with power laws (section 6.2.2)

RET indicator	Adjusted R ² of a power law applied to the values of the spatial KDE of the renewable energy produced in the French Riviera, France.														
	Solar PV			Solar Thermal			All RET for electricity			All RET for Thermal			All RET for all energy		
Scale/year	900	3600	8400	900	3600	8400	900	3600	8400	900	3600	8400	900	3600	8400
2007	0.8457	0.8551	0.8724	0.8186	0.8243	0.8310	0.8429	0.8680	0.9325	0.6429	0.6339	0.6788	0.7591	0.7542	0.7640
2010	0.7894	0.7965	0.8050	0.8041	0.6691	0.8334	0.7614	0.7786	0.7448	0.6439	0.6691	0.6151	0.7614	0.7786	0.7448
2012	0.8019	0.8103	0.8028	0.8004	0.8078	0.8152	0.8886	0.8927	0.9007	0.7515	0.7496	0.7146	0.7515	0.7496	0.7146
2013	0.7981	0.8151	0.8119	0.7981	0.8042	0.8275	0.7542	0.7591	0.7206	0.6282	0.7495	0.6368	0.7542	0.7591	0.7206
2014	0.7951	0.8080	0.7936	0.7968	0.801	0.8229	0.8711	0.8787	0.8606	0.6358	0.6500	0.6241	0.7562	0.7483	0.7220
2015	0.7935	0.7035	0.7938	0.7975	0.8012	0.8197	0.8550	0.8579	0.8567	0.6355	0.6624	0.6042	0.7416	0.7505	0.7070
2016	0.7886	0.7949	0.7795	0.7966	0.7954	0.8163	0.8512	0.8571	0.8577	0.6280	0.6555	0.6203	0.8512	0.7462	0.7228
2017	0.7884	0.7934	0.7479	0.7958	0.8067	0.8433	0.8491	0.8376	0.6282	0.6580	0.6239	0.7359	0.7224	0.6815	

Summary statistics of the Kernel Density Estimation of the energy produced for heating via solar TC and biomass approximated with power laws (section 6.2.2)

Kernel Density Estimation of energy produced for heating via solar thermal collectors and biomass at 900 sq m resolution in the South Region of France								
Parameters	2007	2010	2012	2013	2014	2015	2016	2017
Adjusted R2	0.6429	0.6429	0.7515	0.6282	0.6358	0.6355	0.628	0.628
Power Law Exponent ?	-1.43	-1.469	-1.956	-1.469	-1.463	-1.47	-1.428	-1.491
Mean	87.1537044	115.23943	115.23943	121.789476	113.932537	117.441433	130.028875	128.152194
Standard Error	1.53519081	1.9904774	1.9904774	1.73454746	1.7621895	1.73809956	1.57699139	1.73984277
Median	34.22	44.05	44.05	49.09	44.95	46.495	51.89	50.91
Mode	0.01	0.01	0.01	0.01	0.01	0.01	0.01	0.01
Standard Deviation	270.77302	343.696142	343.696142	298.916432	304.950444	300.032435	301.563402	298.655554
Sample Variance	73318.0281	118127.038	118127.038	89351.0332	92994.7732	90019.4619	90940.4855	89195.1402
Kurtosis	755.89223	648.33965	648.33965	471.037299	345.440414	260.602238	317.438688	322.237923
Skewness	22.8269409	20.6874604	20.6874604	16.741121	15.3782743	13.3656099	13.7092644	13.9747584
Range	11753.51	14474.61	14474.61	11652.75	9849.93	8930.25	10417.82	10153.73
Minimum	0.01	0.01	0.01	0.01	0.01	0.01	0.01	0.01
Maximum	11753.52	14474.62	14474.62	11652.76	9849.94	8930.26	10417.83	10153.74
Sum	2711264.59	3435863.59	3435863.59	3616903.87	3411937.69	3499519.82	3830520.64	3776132.54
Count	31109	29815	29815	29698	29947	29798	29459	29466
Largest(1)	11753.52	14474.62	14474.62	11652.76	9849.94	8930.26	10417.83	10153.74
Smallest(1)	0.01	0.01	0.01	0.01	0.01	0.01	0.01	0.01
Confidence Level(95.0%)	3.00903578	3.9014224	3.9014224	3.39978912	3.45396755	3.40675091	3.44378135	3.41016926

Summary statistics of the Kernel Density Estimation of the energy produced for electricity via a technological mix (section 6.2.2)

Kernel density estimation of the energy produced for electricity via the technological mix of solar PV, wind power, big and small hydroelectric power plants and biogas at 3600 sq m in the South Region of France								
Parameters	2007	2010	2012	2013	2014	2015	2016	2017
Adjusted R ²	0.868	0.7786	0.8927	0.7591	0.8787	0.8579	0.8571	0.8491
Power Law Exponent γ	-4.683	-1.968	-2.805	-2.013	-2.843	-2.77	-2.73	-2.179
Mean	2103.59231	753.347594	562.725008	906.654567	709.823396	588.742865	618.313502	580.156064
Standard Error	750.762578	124.61897	123.104863	152.101929	137.631244	110.754313	116.985317	98.7566218
Median	0.12	62.02	4.095	79.525	6.175	7.525	8.83	9.73
Mode	0.01	52.34	0.01	0.05	0.02	0.01	0.01	0.02
Standard Deviation	13720.6868	4501.83334	4289.28155	5369.0042	4699.65861	3865.30964	4060.92418	3405.31391
Sample Variance	188257246	20266503.5	18397936.2	28826206.1	22086791.1	14940618.7	16491105.2	11596162.8
Kurtosis	236.466027	163.536152	259.284281	201.295788	161.247538	185.52829	202.917454	118.385012
Skewness	14.4718971	11.7143194	14.6272787	12.7145725	11.6600676	12.4264649	12.9295629	10.1436556
Range	231346.57	81424.54	90715.68	111268.38	84043.04	70981.44	78512.41	49567.67
Minimum	0.01	0.01	0.01	0.01	0.01	0.01	0.01	0.01
Maximum	231346.58	81424.55	90715.69	111268.39	84043.05	70981.45	78512.42	49567.68
Sum	702599.83	983118.61	683148.16	1129691.59	827654.08	717088.81	745067.77	689805.56
Count	334	1305	1214	1246	1166	1218	1205	1189
Largest(1)	231346.58	81424.55	90715.69	111268.39	84043.05	70981.45	78512.42	49567.68
Smallest(1)	0.01	0.01	0.01	0.01	0.01	0.01	0.01	0.01
Confidence Level(95.0%)	1476.83516	244.47561	241.522092	298.404401	270.032825	217.290566	229.517736	193.756823

Power law regression of KDE of Solar TC and Solar PV in multiple spatial scales in the South Region of France. Sections 6.2.2.1 and 6.2.2.2 respectively.

KDE of Energy Produced by Solar Thermal Collectors for heating in 2017 the South Region of France			
Statistical Parameters	900 sq m	3600 sq m	8400 sq m
Power Law Exponent γ	-1.498	-1.507	-1.545
Adjusted R-squared	0.7958	0.8067	0.823
Estimate Std. Error t value Pr(> t)	<2e-16 ***	<2e-16 ***	<2e-16 ***
Mean	0.08255532	83.1111066	71.1960526
Standard Error	0.00148134	5.90658192	9.19376169
Median	0.02115	21.6	18.9
Mode	0.00015	3.3	7.35
Standard Deviation	0.29404431	292.837824	196.325026
Sample Variance	0.08646205	85753.9912	38543.5159
Kurtosis	272.767648	298.979638	105.172925
Skewness	14.067816	14.3607026	8.78834576
Range	8.2074	8083.35	2902.5
Minimum	0.00015	0.15	0.15
Maximum	8.20755	8083.5	2902.65
Sum	3252.8448	204287.1	32465.4
Count	39402	2458	456
Largest(1)	8.20755	8083.5	2902.65
Smallest(1)	0.00015	0.15	0.15
Confidence Level(95.0%)	0.00290346	11.5823935	18.0675017

Year/Scale	Adjusted-R ² Kernel Density Solar PV in the South Region of France		
	900	3600	8400
2007	0.8457	0.8551	0.8724
2010	0.7894	0.7965	0.8050
2012	0.8019	0.8103	0.8028
2013	0.7981	0.8151	0.8119
2014	0.7951	0.8080	0.7936
2015	0.7935	0.7035	0.7938
2016	0.7886	0.7949	0.7795
2017	0.7884	0.7934	0.7479

Results for delta of the SPA model applied to the energy produced in the South Region of France. Section 6.2.3.3

Innolinks derived from the SPA model for solar TC in 2017 in the South Region of France				Innolinks derived from the SPA model for the energy production for electricity via the technological mix of solar PV, wind power, small and big hydroelectric power plants, biogas in the South Region of France						
Parameters	900 sq m	3600 sq m	8400 sq m	Spatial scale	900 sq m		3600 sq m		8400 sq m	
					2010	2012	2010	2012	2010	2012
Adjusted R ²	0.9845	0.9653	0.8821	Adjusted R ²	0.9841	0.9842	0.9557	0.886	0.8787	0.8951
Power Law Exponent γ	-1.168	-1.341	-1.559	Power Law Exponent γ	-1.161	-1.211	-1.750	-1.403	-1.815	-2.559
Mean	7.2815E-18	2.2782E-16	3.0955E-17	Mean	5.4739E-15	5.8675E-14	2.4017E-15	3.8179E-23	4.8682E-16	5.2564E-16
Standard Error	1.7212E-19	3.0461E-18	7.5221E-19	Standard Error	1.6627E-16	1.9892E-15	5.5025E-17	6.8031E-25	3.7696E-17	6.0865E-17
Median	1.18E-18	3.35E-17	4.57E-18	Median	7.59E-16	6.46E-15	1.21E-16	8.28E-24	2.86E-17	3.72E-18
Mode	1.01E-18	1.01E-17	1.08E-17	Mode	1.02E-15	1.01E-14	1.04E-16	1.02E-23	1.11E-17	1.06E-18
Standard Deviation	1.0762E-16	2.4546E-15	2.4228E-16	Standard Deviation	9.8994E-14	1.1894E-12	3.2308E-14	1.6524E-22	6.1973E-15	9.3177E-15
Sample Variance	1.1583E-32	6.0249E-30	5.8698E-32	Sample Variance	9.7998E-27	1.4146E-24	1.0438E-27	2.7305E-44	3.8407E-29	8.682E-29
Kurtosis	5445.59733	12969.209	4001.33956	Kurtosis	5120.88178	5375.93461	8708.50641	495.919774	3127.26496	4081.54222
Skewness	65.8096517	87.8961116	50.8122722	Skewness	63.2401517	64.8691287	75.1544951	17.3879678	48.5881348	56.9503256
Range	1.04E-14	4.91E-13	2.36E-14	Range	1.09E-11	1.32E-10	5.28E-12	8.48E-21	5.24E-13	7.57E-13
Minimum	2.69E-19	3.13E-18	2.32E-21	Minimum	1.1E-16	1.04E-15	6.08E-18	1.2E-26	1.34E-20	9.29E-22
Maximum	1.04E-14	4.91E-13	2.36E-14	Maximum	1.09E-11	1.32E-10	5.28E-12	8.48E-21	5.24E-13	7.57E-13
Sum	2.847E-12	1.4794E-10	3.2113E-12	Sum	1.9404E-09	2.0977E-08	8.28E-10	2.2524E-18	1.3158E-11	1.2319E-11
Count	390982	649347	103740	Count	354474	357506	344758	58996	27028	23436
Largest(1)	1.04E-14	4.91E-13	2.36E-14	Largest(1)	1.09E-11	1.32E-10	5.28E-12	8.48E-21	5.24E-13	7.57E-13
Smallest(1)	2.69E-19	3.13E-18	2.32E-21	Smallest(1)	1.1E-16	1.04E-15	6.08E-18	1.2E-26	1.34E-20	9.29E-22
Confidence Level(95.0%)	3.3735E-19	5.9702E-18	1.4743E-18	Confidence Level(95.0%)	3.2589E-16	3.8987E-15	1.0785E-16	1.3334E-24	7.3886E-17	1.193E-16

Results for delta of the SPA model applied to Solar PV energy for the delta in years 2016 and 2017 in the South Region of France (section 6.2.2.3).

Kernel Density Change of energy produced via solar PV in 2016-2017			
Statistical Parameters	900 sq m	3600 sq m	8400 sq m
Power Law Exponent γ	-1.297413	-1.31352	-1.38838
Adjusted R-squared	0.8453	0.7976	0.8858
Estimate Std. Error t value Pr(> t)	<2e-16 ***	<2e-16 ***	<2e-16 ***
Mean	4.00690714	4.1907282	1.8393109
Standard Error	0.58479925	2.33125709	1.53180972
Median	0.08661583	0.08650271	0.087159
Mode	0.08850536	0.14520971	#N/A
Standard Deviation	66.6619842	67.1223936	18.2536195
Sample Variance	4443.82014	4505.41572	333.194623
Kurtosis	550.345853	453.542079	140.893681
Skewness	22.2784898	20.6524046	11.8489976
Range	2583.16112	1607.58017	217.408753
Minimum	0.00001075	0.00002948	0.00251725
Maximum	2583.16113	1607.5802	217.41127
Sum	52065.7514	3474.11368	261.182148
Count	12994	829	142
Largest(1)	2583.16113	1607.5802	217.41127
Smallest(1)	0.00001075	0.00002948	0.00251725
Confidence Level(95.0%)	1.14629225	4.57586874	3.02828287

Call:	Call:	Call:
lm(formula = logK_RASTERVALU900m2016_2017 ~ logRank900m2016_2017)	lm(formula = logK_RASTERVALU3600m2016_2017 ~ logRank3600m2016_2017)	lm(formula = logK_RASTERVALU8400m2016_2017 ~ logRank8400m2016_2017)
Residuals:	Residuals:	Residuals:
Min 1Q Median 3Q Max	Min 1Q Median 3Q Max	Min 1Q Median 3Q Max
-7.7018 -0.3102 0.1233 0.3823 2.5035	-6.6700 -0.3126 0.1615 0.3947 2.7567	-2.2695 -0.2594 0.1691 0.3192 2.2163
Coefficients:	Coefficients:	Coefficients:
Estimate Std. Error t value Pr(> t)	Estimate Std. Error t value Pr(> t)	Estimate Std. Error t value Pr(> t)
(Intercept) 8.550626 0.041543 205.8 <2e-16 ***	(Intercept) 5.06535 0.13367 37.89 <2e-16 ***	(Intercept) 3.16550 0.17158 18.45 <2e-16 ***
logRank900m2016_2017 -1.297413 0.004869 -266.4 <2e-16 ***	logRank3600m2016_2017 -1.31352 0.02301 -57.08 <2e-16 ***	logRank8400m2016_2017 -1.38838 0.04196 -33.09 <2e-16 ***
---	---	---
Signif. codes: 0 '***' 0.001 '**' 0.01 '*' 0.05 '.' 0.1 ' ' 1	Signif. codes: 0 '***' 0.001 '**' 0.01 '*' 0.05 '.' 0.1 ' ' 1	Signif. codes: 0 '***' 0.001 '**' 0.01 '*' 0.05 '.' 0.1 ' ' 1
Residual standard error: 0.5539 on 12992 degrees of freedom	Residual standard error: 0.6511 on 827 degrees of freedom	Residual standard error: 0.4697 on 140 degrees of freedom
Multiple R-squared: 0.8453, Adjusted R-squared: 0.8453	Multiple R-squared: 0.7976, Adjusted R-squared: 0.7973	Multiple R-squared: 0.8866, Adjusted R-squared: 0.8858
F-statistic: 7.099e+04 on 1 and 12992 DF, p-value: < 2.2e-16	F-statistic: 3258 on 1 and 827 DF, p-value: < 2.2e-16	F-statistic: 1095 on 1 and 140 DF, p-value: < 2.2e-16

Results for delta of the SPA model applied to the adjusted KDE of Solar TC energy for the delta between years 2016 and 2017 in the South Region of France (Figure 177).

Call:	Call:	Call:
lm(formula = logK_RASTERVALU900m2016_2017 ~ logRank900m2016_2017)	lm(formula = logK_RASTERVALU3600m2016_2017 ~ logRank3600m2016_2017)	lm(formula = logK_RASTERVALU8400m2016_2017 ~ logRank8400m2016_2017)
Residuals:	Residuals:	Residuals:
Min 1Q Median 3Q Max	Min 1Q Median 3Q Max	Min 1Q Median 3Q Max
-0.92344 -0.06774 0.03489 0.09042 0.42954	-0.08971 -0.04286 0.01242 0.03666 0.72786	-0.10679 -0.03191 0.00441 0.03284 0.62605
Coefficients:	Coefficients:	Coefficients:
Estimate Std. Error t value Pr(> t)	Estimate Std. Error t value Pr(> t)	Estimate Std. Error t value Pr(> t)
(Intercept) 14.3112437 0.0059372 2410.5 <2e-16 ***	(Intercept) 13.009860 0.009817 1325.3 <2e-16 ***	(Intercept) 12.529746 0.016930 740.10 <2e-16 ***
logRank900m2016_2017 -0.3711164 0.0006341 -585.2 <2e-16 ***	logRank3600m2016_2017 -0.320830 0.001545 -207.7 <2e-16 ***	logRank8400m2016_2017 -0.340973 0.003619 -94.22 <2e-16 ***
---	---	---
Signif. codes: 0 '***' 0.001 '**' 0.01 '*' 0.05 '.' 0.1 ' ' 1	Signif. codes: 0 '***' 0.001 '**' 0.01 '*' 0.05 '.' 0.1 ' ' 1	Signif. codes: 0 '***' 0.001 '**' 0.01 '*' 0.05 '.' 0.1 ' ' 1
Residual standard error: 0.1097 on 29998 degrees of freedom	Residual standard error: 0.05802 on 1442 degrees of freedom	Residual standard error: 0.05614 on 259 degrees of freedom
Multiple R-squared: 0.9195, Adjusted R-squared: 0.9195	Multiple R-squared: 0.9677, Adjusted R-squared: 0.9676	Multiple R-squared: 0.9717, Adjusted R-squared: 0.9715
F-statistic: 3.425e+05 on 1 and 29998 DF, p-value: < 2.2e-16	F-statistic: 4.315e+04 on 1 and 1442 DF, p-value: < 2.2e-16	F-statistic: 8878 on 1 and 259 DF, p-value: < 2.2e-16