



HAL
open science

Models and Tools for the Design, Assessment, and Evolution of Circular Supply Chains

Asiye Kurt

► **To cite this version:**

Asiye Kurt. Models and Tools for the Design, Assessment, and Evolution of Circular Supply Chains. Chemical and Process Engineering. Université Grenoble Alpes [2020-..], 2021. English. NNT : 2021GRALI112 . tel-03615489

HAL Id: tel-03615489

<https://theses.hal.science/tel-03615489>

Submitted on 21 Mar 2022

HAL is a multi-disciplinary open access archive for the deposit and dissemination of scientific research documents, whether they are published or not. The documents may come from teaching and research institutions in France or abroad, or from public or private research centers.

L'archive ouverte pluridisciplinaire **HAL**, est destinée au dépôt et à la diffusion de documents scientifiques de niveau recherche, publiés ou non, émanant des établissements d'enseignement et de recherche français ou étrangers, des laboratoires publics ou privés.

THÈSE

Pour obtenir le grade de

DOCTEUR DE L'UNIVERSITÉ GRENOBLE ALPES

Spécialité : **GI: Génie Industriel: conception et production**

Arrêtée ministériel : 25 mai 2016

Présentée par

Asiye KURT

Thèse dirigée par **Van-Dat CUNG**

et co-encadrée par **Mario CORTES-CORNAX, Agnès FRONT et Fabien MANGIONE**

préparée au sein du **Laboratoire G-SCOP et LIG**

dans **l'École Doctorale I-MEP2 - Ingénierie - Matériaux, Mécanique, Environnement, Énergétique, Procédés, Production**

Modèles et outils pour la conception, l'évaluation et l'évolution des chaînes logistiques circulaires

Models and tools for the design, assessment, and evolution of Circular Supply Chains

Thèse soutenue publiquement le **17 Décembre 2021**,
devant le jury composé de :

Madame Maria DI MASCOLO

DIRECTRICE DE RECHERCHE, CNRS délégation Alpes, Présidente

Monsieur Khaled HADJ-HAMOU

PROFESSEUR DES UNIVERSITES, INSA Lyon, Rapporteur

Madame Dalila TAMZALIT

MAITRE DE CONFERENCES-HDR, IUT Nantes, Rapportrice

Madame Evren SAHIN

PROFESSEURE DES UNIVERSITES, CentraleSupélec, Examinatrice

Monsieur Julien BOISSIERE

MAITRE DE CONFERENCES, Université Savoie Mont-Blanc, Examinateur

Monsieur Van-Dat CUNG

PROFESSEUR DES UNIVERSITES, Grenoble INP, Directeur de thèse

Monsieur Mario CORTES-CORNAX

MAITRE DE CONFERENCES, Université Grenoble Alpes, Co-Encadrant de thèse

Madame Agnès FRONT

PROFESSEURE DES UNIVERSITES, Université Grenoble Alpes, Co-Encadrante de thèse

Monsieur Fabien MANGIONE

MAITRE DE CONFERENCES, Grenoble INP, Co-Encadrant de thèse



Acknowledgments

First and foremost, I would like to express my gratitude to my thesis director Prof. Van-Dat Cung and co-supervisors Prof. Agnès Front, Dr. Mario Cortes-Cornax, and Dr. Fabien Mangione for believing in me and supporting my work during three years. Their deep knowledge and precious experience have supported and encouraged me during my academic research life.

I would also like to thank two reviewers of my thesis Prof. Kaheld Hadj-Hamou and Dr Dalila Tamzalit, for the time they have invested in reading my thesis and for giving constructive criticism. I also wish to thank the other members of the jury, Prof. Evren Sahin, Prof. Maria Di Mascolo and Dr. Julien Boissière, for the precious and insightful discussion during my defense. Special thanks to Prof. Maria Di Mascolo and Dr. Julien Boissière, for having followed my thesis as a part of my CSI.

I would like to thank the founder of this work, the French National Research Agency (ANR) for supporting our work through "Investissements d'avenir program (ANR-15-IDEX-02) - Cross Disciplinary Program CIRCULAR".

I would like to express my sincere gratitude to thank Dr. Nadine Mandran for her precious advice and discussion on the design of experiments.

I would like to thank Liu Zhenyu, Soufiane Kaddouri, Abdessalem Tebbikh, Idir Nait-Ali, and Sami Bouhroum for working with me during their internship. It was a pleasure to work with you.

I also thank the administrative and IT team of G-SCOP and LIG, in particular Marie-Jo, Fadila, Kévin, and Oliver. I would like to offer my special thanks to my lab-mates in G-SCOP, in particular Akash, Bilge, Florian, Lucas, Tamara, and Tatiana, for their friendship.

I wish also to thank my dear friends Alican, Can, and Emre, for their support and friendship during my thesis.

Lastly, I would like to express my gratitude to my family, especially my parents, sisters and nephews for their unconditional support.

Résumé

L'économie circulaire vise à minimiser la consommation des ressources et la production des déchets ainsi que la pollution en maintenant le plus long temps possible les produits, les composants et les matériaux dans la phase d'utilisation. Cela pourrait être obtenu avec des stratégies de conception de produits ou des activités d'économie circulaire liées à la fin de vie des objets telles que la réutilisation, la remise à neuf, la repurposing, le recyclage, etc. Les chaînes logistiques circulaires, qui intègrent l'approche de l'économie circulaire dans la chaîne logistique, soutiennent ces activités et jouent un rôle important dans l'application des principes de l'économie circulaire.

Divers concepts dans la littérature tels que les chaînes logistiques en boucle fermée, la logistique inverse, les chaînes logistiques vertes, etc., ont déjà exploré l'intégration des activités de l'économie circulaire dans les chaînes d'approvisionnement. Cependant, le concept d'économie circulaire apporte de nouvelles approches : (1) appliquer plusieurs activités d'économie circulaire en parallèle plutôt que d'appliquer une seule activité, (2) utiliser des matériaux encore et encore, et (3) promouvoir des boucles ouvertes entre des secteurs distincts par "repurposing". De plus, l'activité de "repurposing" n'est pas suffisamment explorée jusqu'à présent. Cependant, cette activité, qui ajoute de la valeur aux produits usagés en les détournant de leur destination initiale et en les utilisant dans des applications moins exigeantes, pourrait être un nouveau moyen potentiel d'accroître la circularité dans les chaînes logistiques circulaires. En outre, le manque de connaissances et de sensibilisation sur les chaînes logistiques circulaires constitue un obstacle difficile pour les gestionnaires de chaînes d'approvisionnement. Par conséquent, les implications de l'économie circulaire dans les chaînes logistiques doivent être explorées, structurées et formalisées. De nouveaux outils sont également nécessaires pour promouvoir le concept de chaîne logistique circulaire et soutenir sa conception ainsi que son évolution.

L'objectif principal de cette thèse de doctorat est d'explorer et de conceptualiser les structures des chaînes logistiques dans le concept d'économie circulaire. Nous visons à créer des méthodes et des outils pour soutenir la conception et l'évolution de la chaîne logistique circulaire, en considérant la "repurposing" comme une activité d'économie circulaire de premier ordre. Les contributions principales de cette thèse sont :

- un modèle générique formalisé en utilisant le Langage de Modélisation Unifié (UML) pour conceptualiser les chaînes logistiques circulaires,
- un outil de classification des indicateurs de chaîne logistique circulaire où les différentes dimensions de la circularité sont décrites,
- un nouvel indicateur pour évaluer la circularité des chaînes logistiques,
- un jeu sérieux pour promouvoir les chaînes logistiques circulaires et accroître la connaissance ainsi que la sensibilisation sur leurs structures et les activités d'économie circulaire impliquées.

Enfin, en adoptant le cadre As-IS/As-IF, les contributions susmentionnées sont intégrées dans une première version d'une méthode d'évolution continue. Cette méthode aide à identifier d'éventuelles évolutions pour améliorer la circularité des chaînes logistiques.

Mots clés: Économie Circulaire, Chaîne Logistique, Repurposing, Indicateur de Circularité, Jeu Sérieux, Evolution Continue.

Abstract

The Circular Economy aims at minimizing resource inputs, waste, and pollution by keeping as long as possible products, components, and materials in use. This could be reached by product design strategies or E-o-L (End of Life) activities (also called Circular Economy activities), such as reuse, remanufacturing, repurposing, recycling, etc. Circular Supply Chains, which integrate the Circular Economy approach into supply chains, support these activities and play an important role in the application of Circular Economy principles.

Various concepts in the literature such as Closed-Loop Supply Chains, Reverse Logistics, Green Supply Chains, etc., have been already explored the integration of Circular Economy activities in supply chains. However, the Circular Economy concept brings some new approaches: (1) applying multiple Circular Economy activities in parallel rather than applying single activities, (2) using materials over and over again, and (3) promoting open-loops between distinct sectors through repurposing. In addition, repurposing activity has not been sufficiently explored so far. However, this activity adds value to used products by diverting them from their initial purpose and using them in less demanding applications. This could be a new potential mean to increasing circularity in Circular Supply Chains. Besides, the lack of knowledge and awareness about Circular Supply Chains constitutes a challenging barrier for Supply Chain managers. Therefore, the implications of Circular Economy in supply chains need to be explored, structured and formalized. New tools are also needed to promote the Circular Supply Chains and support their design and evolution.

The main objective of this Ph.D. thesis is to explore and conceptualize supply chains structures in the context of Circular Economy. We aim at creating methods and tools to support Circular Supply Chain design and evolution, considering repurposing activity as a first-class Circular Economy strategy. The main contributions of this thesis are:

- A generic model formalized by using the Unified Modeling Language (UML) to design Circular Supply Chains.
- A classification tool for Circular Supply Chain indicators, where different circularity dimensions are described.
- A new indicator to assess the circularity of Supply Chains.
- A serious game to promote Circular Supply Chains and increase knowledge and awareness of their structures and the Circular Economy activities involved.

Finally, adopting As-IS/As-IF framework, the aforementioned contributions are integrated into a first version of a continual evolution method. This method helps identifying possible evolutions to improve the circularity of supply chains.

Keywords: Circular Economy, Supply Chain, Repurposing, Circularity Indicator, Serious Game, Continual Evolution.

Contents

Acknowledgments	i
Résumé	iii
Abstract	v
Table of Contents	vii
1 Introduction	1
1.1 Context	2
1.1.1 Cross-Disciplinary CIRCULAR Project	3
1.1.2 Challenges, Research Gaps and Research Question	3
1.2 Main Contributions	4
1.3 Structure of the manuscript	6
2 The Circular Economy, Supply Chains and Our Positioning	8
2.1 Introduction	9
2.2 The Circular Economy and Supply Chains	9
2.2.1 The Circular Economy	9
2.2.2 Supply Chains	12
2.3 Supply Chains in the CE Context	14
2.3.1 Interrelated concepts in the literature	14
2.3.2 Circular Supply Chains in the Literature	16
2.4 Circular Supply Chain Components	17
2.4.1 Circular Material Flows	17
2.4.2 Circular Economy Activities and Hierarchization	18
2.5 Our Previous Work on Conceptualizing CSCs	21
2.5.1 A Hierarchical Framework for the CE Activities	22
2.5.2 An Extended Model for Circular Supply Chains	23
2.6 Conclusion	24
3 Conceptualizing Circular Supply Chains through a Generic Model	27
3.1 Introduction	28
3.2 Circular Supply Chain Characteristics and Previous Works	29
3.3 Formalization of CSC Model in UML	31
3.4 Use Cases Illustrating the Use of the Generic Model	35
3.4.1 Textile Products	35
3.4.2 Li-Ion Batteries of Electric Vehicles	36
3.5 Conclusion	38

4	A Classification Tool for Circular Supply Chain Indicators	41
4.1	Introduction	42
4.2	Indicators and Classifications considering CE	42
4.3	A Classification Tool for Circular Supply Chain Indicators	44
4.4	Classifying Existing Indicators through our Tool	48
4.5	Conclusion	50
5	Assessing Circularity in Supply Chains: A Global Circularity Indicator	52
5.1	Introduction	53
5.2	Existing indicators and methods for CSCs and our positioning	53
5.3	Mathematical Representation of CSCs	54
5.4	Global Circularity Indicator	55
5.5	Calculation of Circularity Coefficient for Each Loop	60
5.6	A Web-Based Tool for Proposed Indicators: CircuSChain Calculator	63
5.7	Conclusion	64
6	A Serious Game for Circular Supply Chains	67
6.1	Introduction	68
6.2	Background	68
6.2.1	Beer Distribution Game	68
6.2.2	Serious Games related to the Circular Supply Chains	69
6.3	Methodology	69
6.4	CircuSChain Game	71
6.4.1	Game Description	71
6.4.2	Game Flows	72
6.5	Experiment and Analysis	77
6.6	Conclusion	80
7	A Continual Evolution Method for Circular Supply Chains	84
7.1	Introduction	85
7.2	Background	85
7.3	The As-IS/As-IF Framework	87
7.3.1	Process Model of As-IS/As-IF Framework	87
7.3.2	Product Meta-Model of As-IS/As-IF Framework	91
7.4	Circular Supply Chain Continual Evolution Method (CircuSChain)	91
7.4.1	How to Read the Protocols of the Method?	93
7.4.2	Analysis Strategy	93
7.4.3	Diagnosis Strategy	99
7.4.4	Evolution Strategy	101
7.4.5	Product Meta-Model	104
7.5	Conclusion	105
7.5.1	Implications for the practice and the theory	105
7.5.2	Limitations and future works	105
8	General Conclusion	108
	Bibliography	I
	List of figures	XII
	List of Tables	XV

Résumé étendu	XVII
A Abbreviations	XXIII
B Questionnaires	XXIV

1

Introduction

Contents

1.1	Context	2
1.1.1	Cross-Disciplinary CIRCULAR Project	3
1.1.2	Challenges, Research Gaps and Research Question	3
1.2	Main Contributions	4
1.3	Structure of the manuscript	6

1.1 Context

Our economy has been following the “take-make-dispose” model since the industrial revolution (EMF, 2013). In this model, also known as Linear Economy, products are being produced using raw materials, and they are then used and discarded when they become obsolete. Due to overall economic development and population growth, the production activities and the demand for raw materials are also increasing, while the natural resources remain limited. This fact may have significant consequences: natural resource depletion and environmental pollution (Yuan et al., 2006). In addition to the environmental pressure, this situation raises resource prices and price volatility, which are challenging for organizations (EMF, 2014). This situation is not long-term sustainable. A new economic model needs to be designed to ensure our future and solve these problems.

As a potential solution for the challenges mentioned above, the Circular Economy (CE) concept has recently received attention among policymakers, scholars, and industrials (Bocken et al., 2017; Govindan & Hasanagic, 2018; Kirchherr et al., 2017; Masi et al., 2017). The CE is defined as "a regenerative system in which resource input and waste, emission, and energy leakage are minimized by slowing, closing, and narrowing material and energy loops" (Geissdoerfer et al., 2017). This can be achieved through long-lasting design, maintenance, repair, reuse, remanufacturing, refurbishing, and recycling" (Geissdoerfer et al., 2017). In academia, the number of publications has rapidly increased since 2014 (de Sousa Jabbour et al., 2019; Geissdoerfer et al., 2017). In industry, alongside the adoption of the CE principles by existing firms (AFEP, 2017), new players that execute the related activities as a core business have been emerged. For example, in France, BackMarket, a e-commerce website selling refurbished electronics founded in 2014, announced fundraising of 276 million euros in May 2021 (Wikipedia, 2021). Moreover, the European Commission adopted the Circular Economy Action Plan (CEAP) in 2020. In France, the anti-waste law for a Circular Economy is published in 2020. More measures will come into force in the coming years (Ministère de la Transition Ecologique, 2020).

The Circular Economy aims at minimizing resource inputs, waste, and pollution by keeping products, components, and materials in use. This could be obtained by product design strategies or E-o-L (End of Life) activities (also called Circular Economy activities), such as reuse, remanufacturing, refurbishing, repurposing, recycling, etc. Supply chains play an essential role in the application of Circular Economy principles, supporting these activities (Geissdoerfer et al., 2017). Supply chains are described as structures "managing the inputs of goods or services including a range of activities not only within a single department in an organization but also from different departments and outside the organization, for final users from procurement of raw materials through to the end of the products' useful life." (Eng, 2005; Su et al., 2013).

The link between the new Circular Economy approach and supply chains, which is a well-established research discipline, is not well defined in the literature (Homrich et al., 2018). Various concepts in the literature such as Reverse Logistics, Green Supply Chains, Sustainable Supply Chains, and Closed-Loop Supply Chains have already explored the integration of Circular Economy activities in supply chains (Batista et al., 2018; Liu et al., 2018b; Masi et al., 2017). However, the Circular Economy concept brings some new approaches: (1) applying multiple Circular Economy activities in parallel rather than applying single activities (Blomsma & Brennan, 2017), (2) using materials over and over again through consecutive cycles (Genovese et al., 2017), and (3) combining closed-loops and open-loops between distinct sectors through repurposing (Farooque et al., 2019b). Therefore, these implications of Circular Economy in supply chains are needed to be explored considering the existing literature and the new approaches that emerged through Circular Economy philosophy. New tools are also needed to promote the Circular Supply Chain (CSC) concept, defined as "the embodiment of CE principles within supply chains" (De Angelis et al., 2018), and support its design and evolution.

1.1.1 Cross-Disciplinary CIRCULAR Project

In order to support the transition from the linear “take-make-consume-dispose” model (EMF, 2014) towards a circular economic “take-make-consume-reuse” model, the CIRCULAR project is launched in 2017. This thesis is conducted as a part of this project. CIRCULAR is a Cross-Disciplinary Project founded by IDEX/call CDP 2017. It aims at “developing reliable circular industrial systems able to transform post-used products into new added-value products¹”. Moreover, this project highlights repurposing strategy, which deals with the resale of products for different purposes. For this project, diverse hypotheses, related work-packages and their objectives are introduced and summarized in Table 1.1².

Table 1.1: Hypothesis, work packages and related objectives of the CIRCULAR project

Hypothesis	Work-package and its objectives
An agile remanufacturing system requires efficient Human/Machine collaboration.	WP1: Collaborative work for an agile remanufacturing chain <ul style="list-style-type: none"> • Defining new worker roles and skills in a circular industrial system • Developing cobotic systems as a natural collaborative work cell • Creating diagnosis techniques to support decision making
An agile remanufacturing system requires reliable and rapid adaptation of operational processes and work environments.	WP2: Numerical solutions to fit agile remanufacturing processes <ul style="list-style-type: none"> • Designing reconfigurable and shared workspaces that are both safe and efficient • Proposing reliable test benches to assist in product diagnosis • Creating innovative design techniques to match product demands to available resources
Promoting Remanufacturing systems necessitates securing as well as encouraging their implementation.	WP3: Circularity conditions and Value chain <ul style="list-style-type: none"> • Defining the political and industrial conditions for new circular industrial systems • Ensuring new supply chains’ sustainability

In order to reach each objective stated in Table 1.1, a PhD thesis is conducted. Our thesis is included in WP3: Circularity conditions and Value chain, with the objective of “securing the sustainability of the new value chains and their organization”. Our thesis aims at developing new approaches and models to support the design and assessment of CSCs. The second PhD project at the same work-package deals with the institutional and political conditions and relationship between different actors such as companies, NGOs, and political representatives, etc. Our work is focused on supply chains globally, where the PhD projects of other work-packages (WP1 and WP2) are concerned with improving production and remanufacturing activities of supply chains through new technologies such as co-bots or Internet of Things.

1.1.2 Challenges, Research Gaps and Research Question

The transition from linear supply chains towards more circular supply chains brings new challenges to industrials. Moreover, since it is an emerging domain, several research gaps have been

¹<https://circular.univ-grenoble-alpes.fr/en/main-menu/>

²<https://circular.univ-grenoble-alpes.fr/en/main-menu/scientific-programme/>

observed in the literature. These new challenges and research gaps motivate our research work.

Circular Economy requires new supply chain configurations, where multiple CE activities are applied in parallel. In addition, products or materials should be used over and over again through closed and open-loops. Closed-loops consist in collecting used products and integrating them into the original supply chain through circular activities such as direct reuse, reuse with remanufacturing, recycling, etc., while open-loops concern integration used products into different supply chains. Therefore, these complex supply chains need to be conceptualized and modeled first in order to be analyzed and improved. Moreover, supply chains and material flows are needed to be assessed to show the advantages of implementing CE practices (Winans et al., 2017). Blomsma & Brennan (2017) highlight the need for assessment tools for these multiple activity configurations. Indeed, a successful transition to a CSC requires a continual measurement of progress towards circularity (Jain et al., 2018).

One of the challenges to implement CSC or CE practices is the insufficient knowledge and awareness among supply chain members (Govindan & Hasanagic, 2018; Mangla et al., 2018) and customers (Vermunt et al., 2019), as well as the lack of appropriate training and development programs about Circular Economy for supply chain members (Mangla et al., 2018). The inadequacy of scientific skills of supply chain members restricts the adoption of the CE (Mangla et al., 2018).

Besides these challenges, the repurposing activity remains scarcely explored among industrials and scholars. There are limited studies about the adoption of repurposing activity in CSCs. However, this CE activity adds value to used products by diverting them from their initial purpose and using them in less demanding applications. Therefore, it has to be included as a new potential mean to increasing circularity in CSCs.

While our global objective is to support the design and assessment of CSCs, according to the challenges and the research gaps, the following research questions are raised:

- **RQ1:** What are the implications of the CE on supply chains and how to integrate repurposing activity into CSCs?
- **RQ2:** How to conceptualize and model the complex configurations of CSCs?
- **RQ3:** How to assess the circularity of the supply chains?
- **RQ4:** How to raise awareness and increase the knowledge about CSCs using the proposed tools?
- **RQ5:** How to help organizations to support circularity in supply chains continuously?

1.2 Main Contributions

To answer the aforementioned research questions, we develop several tools with different methods. Our contribution and main methodologies are presented below.

Figure 1.1 summarizes our contributions, their relationship, and addressed the research questions.

Firstly, to determine the implications of the CE on supply chains and integrate repurposing activity, a **literature review** is conducted. We explore CE approaches related to supply chains, the interrelated concepts to CSCs and CSC components. Then, we explain our positioning regarding the literature.

Secondly, to conceptualize and model the complex Circular Supply Chains, we rely on the literature in order to propose **the main CSC characteristics**. They constitute the basis for the

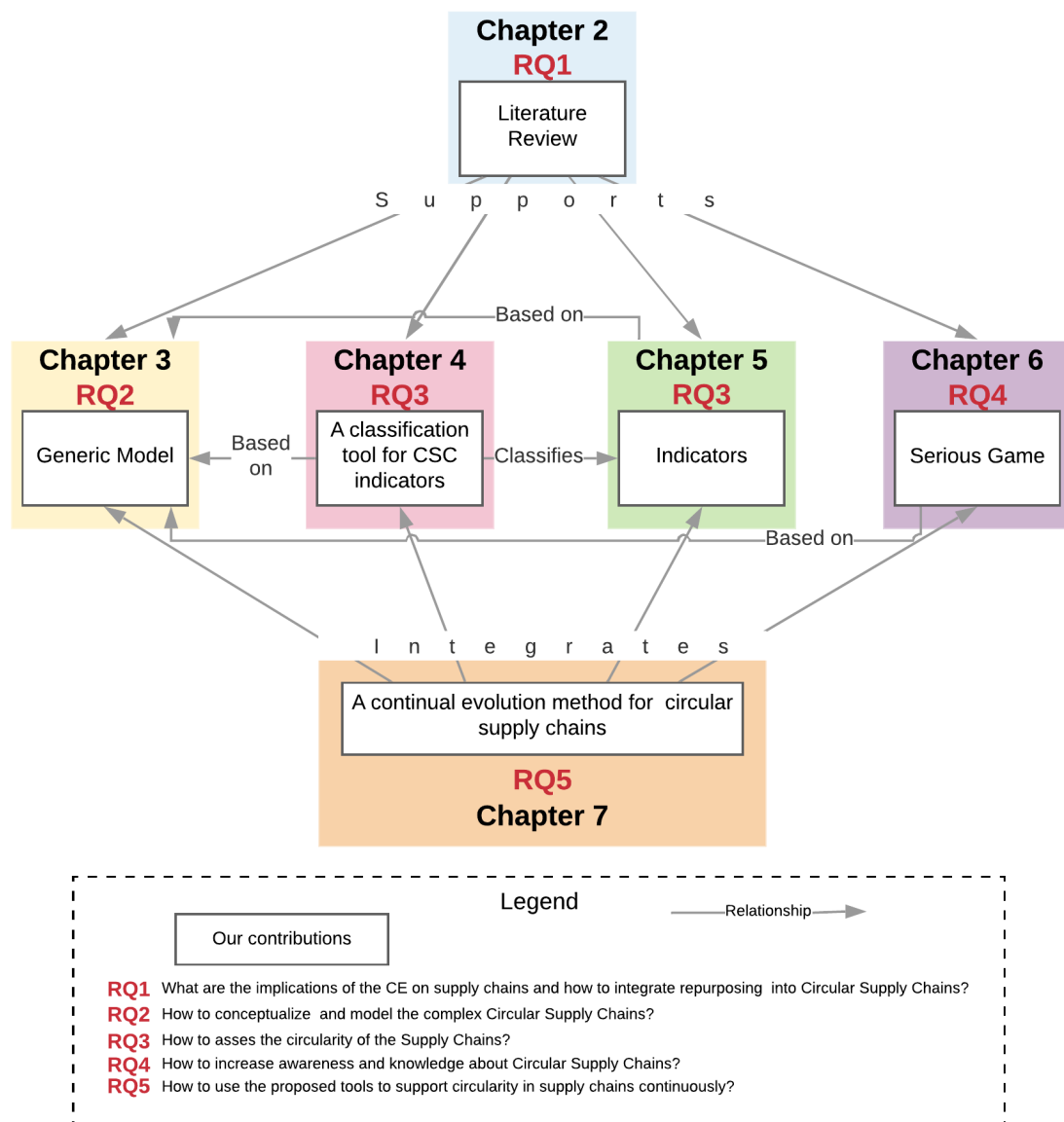

Figure 1.1: Outline of the manuscript

development of our **generic model for CSCs**. The Unified Modeling Language (UML) is used to formalize the generic model.

Thirdly, in order to support the assessment of the circularity in CSCs, we propose a **classification tool for CSC indicators** based on the CSC characteristics. This tool defines the dimensions of circularity to measure. **Some indicators for each dimension along with a composite indicator that considers several dimensions are proposed**. A web-based tool prototype is developed to help to setup a CSC configuration and automatically calculate these related indicators.

Fourthly, in order to contribute to increasing knowledge and awareness about circular supply chains, a **serious game** is proposed. The scenario of the game is designed on the basis of our generic model. This game is experimented with industrial engineering students.

Finally, to explore the use of these tools to support circularity in supply chains in a continuous way, a **preliminary version of a continuous evolution method** for circular supply chains is introduced. This method is developed by adapting As-IS/As-IF framework (Çela et al., 2019).

1.3 Structure of the manuscript

The structure of the thesis is composed of an introduction, a general literature review chapter, five chapters presenting our main contributions and a conclusion.

This introduction chapter has given some insights into the context of the research, which is part of a cross-disciplinary project. Section 1.2 has presented a summary of the challenges and the research gaps completed by five research questions. Our contributions in order to answer the stated research questions are introduced as well.

Literature review chapter (Chapter 2) gives a generic literature background about CE and CSCs. It also introduces the components of CSCs and our positioning regarding the literature. This chapter provides a global basis for all the remaining contributions. A literature background for each tool is then provided in each related chapter.

Chapter 3 introduces the generic model for circular supply chains. The generic model is illustrated by two use cases based on the literature.

Chapter 4 presents the classification tool for circular supply chain indicators. In this chapter, we also present some new potential indicators and classification of existing indicators from the literature through our classification tool.

Chapter 5 presents the Global Circularity Indicator and the web-based tool prototype to calculate proposed indicators in this chapter and Chapter 4.

Chapter 6 introduces the CircusChain Game with game design process, game flows, and the experiment.

Chapter 7 integrates all the proposed tools into a continuous evolution method. This chapter describes the As-IS/As-IF framework and its adaption for CSCs. The protocols explaining how to use our tools within this method is included in this chapter.

Finally, the conclusion chapter (Chapter 8) summarizes our work and gives a general conclusion.

2

The Circular Economy, Supply Chains and Our Positioning

Contents

2.1	Introduction	9
2.2	The Circular Economy and Supply Chains	9
2.2.1	The Circular Economy	9
2.2.2	Supply Chains	12
2.3	Supply Chains in the CE Context	14
2.3.1	Interrelated concepts in the literature	14
2.3.2	Circular Supply Chains in the Literature	16
2.4	Circular Supply Chain Components	17
2.4.1	Circular Material Flows	17
2.4.2	Circular Economy Activities and Hierarchization	18
2.5	Our Previous Work on Conceptualizing CSCs	21
2.5.1	A Hierarchical Framework for the CE Activities	22
2.5.2	An Extended Model for Circular Supply Chains	23
2.6	Conclusion	24

Related publications: Kurt, A., Cung, V.-D., Mangione, F., Cortes-Cornax, M., & Front, A. (2019). An extended circular supply chain model including repurposing activities. In 2019 International Conference on Control, Automation and Diagnosis (ICCAD) (pp. 287–292).: IEEE

Dubois, F., Basia, A., Kurt, A., Bettinelli, M., Zheng, P., Jourdain, V., & Guelle, K. (2019). Production of the future to support circular economy-development of a dedicated platform by means of a multidisciplinary approach. In 2019 International Conference on Control, Automation and Diagnosis (ICCAD) (pp. 144–148).: IEEE

2.1 Introduction

In this chapter, we explore the implications of CE in supply chains and explain our positioning. First, we provide a general background from the literature on the Circular Economy and supply chains (Section 2.2). We also explain our positioning regarding various supply chain and CE themes and present supply chain components. In Section 2.3, CSCs in the literature and its related concepts are introduced. In Section 2.4, CSC components (material flows and activities) are presented. After introducing our positioning, our previous works from the master thesis, which is a preliminary work for this PhD thesis, are presented in Section 2.5.

2.2 The Circular Economy and Supply Chains

In this section, we give a brief background about the CE and supply chains. Since these two concepts contain various themes, we also explain our positioning with the themes on which we have focused our work.

2.2.1 The Circular Economy

The CE concept has been introduced as a potential solution for material depletion and environmental problems. [Stahel \(1982\)](#) proposed a self-replenishing system to extend product life. However, in the literature, the “Circular Economy” term has been introduced first in the book “Environmental economics: an elementary introduction”, by [Pearce & Turner \(1990\)](#).

Moreover, in terms of policy, the CE was initially implemented in Germany in 1996 with a law establishing a closed-loop waste management system ([Su et al., 2013](#)). In 2002, China formally accepted the CE as an economic policy ([Yuan et al., 2006](#)).

In France, the CE has gained attention in the early 2010’s and was formalized by the foundation of l’Institut National de l’Economie Circulaire in 2013 ([Grebert & Mothe, 2019](#)). In 2015, the CE notion appeared for the first time in French law ¹.

In recent years, the Circular Economy concept has received more attention among policymakers, scholars, and industrials ([Bocken et al., 2017](#); [Govindan & Hasanagic, 2018](#); [Kirchherr et al., 2017](#); [Masi et al., 2017](#)). In academia, the number of publications has rapidly increased since 2014 ([de Sousa Jabbour et al., 2019](#); [Geissdoerfer et al., 2017](#)). In industry, CE principles have been adopted by existing firms while new market players have focused their core business on related activities. The Ellen MacArthur Foundation (EMF) has also emerged as a respected reference on this topic and has published different studies about the CE concept since 2013 ([EMF, 2013, 2014, 2015](#)).

According to EMF, the CE is based on three principles.

1. Design out waste and pollution at the product design phase through new technologies and materials.
2. Keep products and materials in use by reuse, repair, remanufacturing, recycling, etc., strategies.
3. Regenerate natural systems by returning valuable nutrients to the ecosystem or using renewable energy instead of relying on fossil fuels.

¹<https://www.ecologie.gouv.fr/loi-transition-energetique-croissance-verte>

Moreover, in addition to these principles, other works are presented in the literature to conceptualize the CE. The related concepts to CE are categorized as "policy instruments and approaches", "value chains, material flows, and products", and "technology, organizational, and social innovation" (Winans et al., 2017). Among these concepts, we focus on "value chains, material flows, and products" topics in this work, since we are interested in supply chains. Considering material flows, based on the existing works, (Bocken et al., 2016) explain the strategies toward the cycling of resources: closing, slowing, and narrowing material loops represented in Figure 2.1.

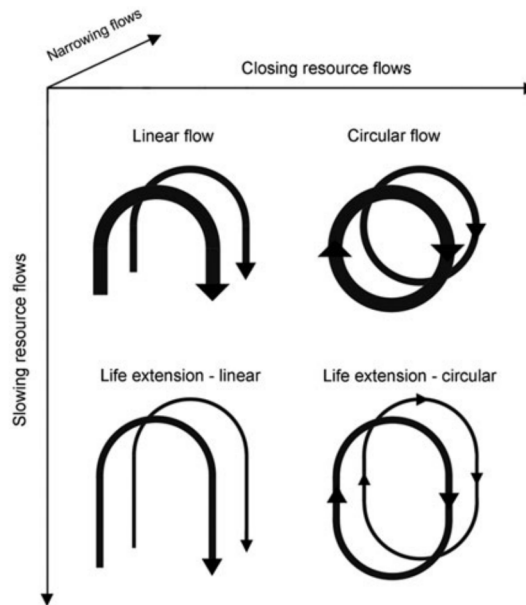

Figure 2.1: Categorization of linear and circular approaches for reducing resource use

Slowing resource loops: It concerns slowing the resource flow by extending or intensifying product life (through product design strategies or CE activities, such as refurbishment, remanufacturing, etc.).

Closing resource loops: The material loop between the post-use and production stages is closed through recycling or Industrial Symbiosis (see Section 2.3.1).

Narrowing resource loops: It refers to increasing resource efficiency by reducing the resource quantity used per product.

This resource flow-based approach considers only one main material flow (Figure 2.1). The flows between different industries or actors and the flows related to different strategies (e.g., reuse, remanufacturing, recycling, etc.) are not represented. Moreover, besides keeping materials in use to solve the material depletion problem, the CE also considers environmental issues such as pollution. Indeed, the CE could be viewed as a more sustainable economic strategy (Yuan et al., 2006). Through the CE strategies, industrials could make savings in terms of energy, labor, and capital besides increasing material efficiency and reducing pollution. Ellen Mac Arthur Foundation introduces a finer terminology considering these concepts (Table 2.1).

The sources of value creation principles proposed by EMF (2013, 2014) are mentioned in earlier academic publications (Chertow, 2000; Stahel, 2010, 1982) and appear in more recent research studies about the circular economy (Cooper et al., 2017; De Angelis et al., 2018; Vegter et al., 2020). Our work is based on these principles while conceptualizing supply chains in the CE context. Furthermore, this approach provides a broader vision of the Circular Economy, considering the different values of applying the CE, such as savings in material, energy, labor, and



Sources of value creation	Illustration
<p>The power of circling longer concerns keeping products, components, and materials in use as long as possible. It could be possible in two ways: firstly, increasing the time of use of a product in one loop (e.g., the extension of use time by design strategies or product sharing) and secondly, increasing the time of use by multiple consecutive loops such as reuse, remanufacturing, recycling, etc. Indeed the CE is described as a system where materials are used over and over again (Genovese et al., 2017).</p>	
<p>The power of inner circle concerns potential savings on different dimensions. This could be possible with short loops. In other words, if the loop is tighter, the less a product has to be changed during reprocessing. Having shorter loops means higher the circularity is. Therefore, it means more potential savings in terms of labor, material, energy, pollution, and capital. For example, the reuse loop is more circular than the recycling loop, as the first one is shorter. Here, a finer representation of flows is provided.</p>	
<p>The power of cascaded use concerns material flow across distinct supply chains. This could be possible by repurposing the products for different purposes or the Industrial Symbiosis strategy.</p>	
<p>The power of pure inputs states that the uncontaminated materials increase the collection efficiency and therefore help extend product longevity.</p>	

Table 2.1: Value creation principles proposed by EMF (2013, 2014)

pollution. The last principle (value creation through the power of pure inputs) relates to product design and collection activities (EMF, 2013, 2014). The product design, which is considered as a strategy of CE (Bocken et al., 2016), is an essential factor. Indeed, the CE is defined "regenerative and restorative by design" (EMF, 2013). However, in this thesis, we do not focus on the product design concept but on the structure of supply chains when products are already designed.

A background about supply chains that support creating circular values (explained through EMF principles) is given in the next section.

2.2.2 Supply Chains

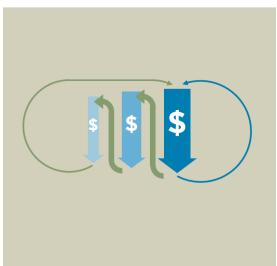
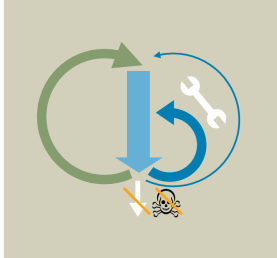
The supply chain concept is a well-established research area. Different definitions of the supply chain can be found in the literature focused on different themes (Stock et al., 2010). The authors identified significant themes of Supply Chain Management (Figure 2.2). Among these themes, *material/ physical flows*, *constituent/component parts*, and *adds value* (highlighted themes in 2.2) are considered in this thesis.

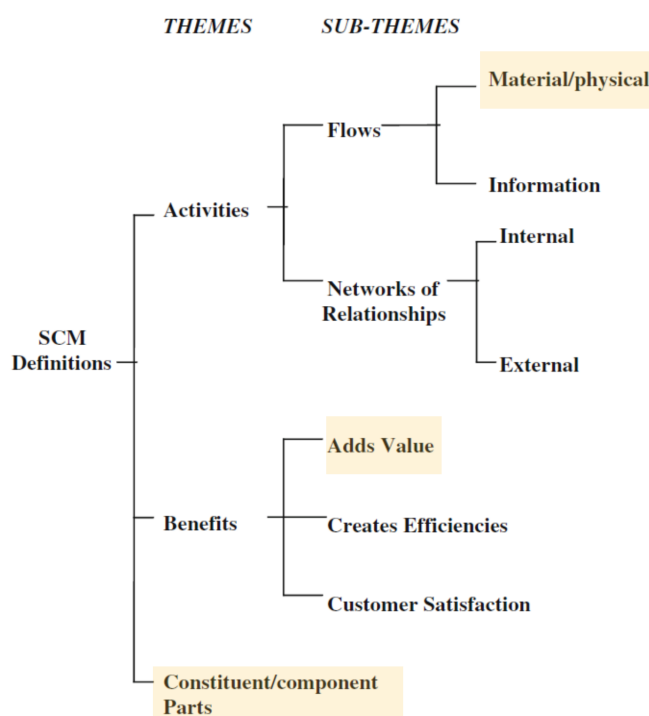

Figure 2.2: Supply Chain Management themes (Stock et al., 2010)

Since the CE strategies and principles are based on keeping products or materials in use and decrease waste and pollution, the *material/ physical flows* theme of Supply Chain Management is considered in our work. Indeed, the CE activities create physical flows of products, components, or materials.

Added value theme considers the value added to product/services through the supply chain. In this thesis, we mainly focus on keeping values instead of adding value, since the CE aims at making savings through keeping products' value.

Constituents or components of supply chains are *functions*, *organizations*, and *processes* that comprise the supply chain (Stock et al., 2010). Chopra et al. (2013) propose a parallel approach and determine main stages (that could be considered as functions) of supply chains: cus-

tomers, retailers, wholesalers/distributors, manufacturers, and component/raw material suppliers (Figure 2.3).

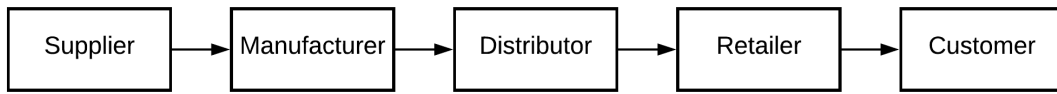

Figure 2.3: Supply Chain stages adopted from *Chopra et al. (2013)*

The *organizations* are the actors that manage these activities. They could vary for different supply chains. The CE activities regarding different modularity of components of products, i.e. parts and modules, require a finer representation of activities such as part manufacturing, module manufacturing, and product manufacturing that could be handled by one organization or distinct organizations. In addition, CE activities could be managed by one organization of SC, such as Original Equipment Manufacturer (OEM) and retailer, or 3rd parties such as collectors and charities (*Ongondo et al., 2011; Savaskan et al., 2004*). For the sake of simplicity but without loss of generality, the organizations having these activities, in other words the notion of actors, and their relationships are not considered in this work to ease to have a global vision and a more nuanced representation of CE activities.

SCOR Process

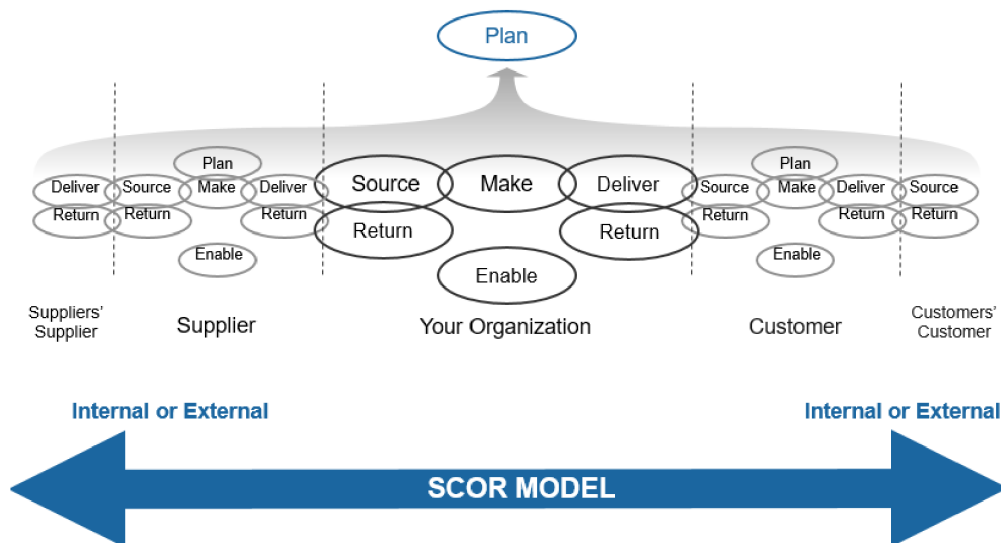

Figure 2.4: Level 1 processes of SCOR (*APICS, 2017*)

Moreover, the organizations have internal *processes* for their activity. Each organization is considered as the customer of the downstream organization, while it is the supplier of the upstream organization (see Figure 2.3). *Chopra et al. (2013)* divided these processes into three groups: Customer Relationship Management, Supplier Relationship Management, and Internal Supply Chain Management. These macro processes concern respectively the interactions between organizations' customer and supplier and the organization itself. *APICS (2017)* proposed a reference model with a parallel approach within three detail levels. Level 1 processes are represented in Figure 2.4. However, in this thesis, we do not consider the processes of organizations.

In our work, we identified the following main *functions* of a CSC (in the remaining of the manuscript, we also call them activities): material extraction, manufacturing, distribution, use,

collection, and CE activities such as reuse, remanufacturing, and recycling, etc. that allows keeping products in use.

Although the other themes exist and they are stated by [Stock et al. \(2010\)](#), such as networks of relationships, efficiencies and, information flows could support the transition towards a CE, these themes are not taken into account in our work neither.

To sum up, in this thesis, we focus on the main components of CSCs - material flows and activities - that will be explored more in details in the next sections. Moreover, considering the CE, we rely on the power of inner circle, the power of circling longer, and the power of cascaded use principles of EMF ([EMF, 2014](#)).

2.3 Supply Chains in the CE Context

The link between the recent Circular Economy approach and supply chains is not well defined in the literature ([Homrich et al., 2018](#)). Therefore, in order to bridge between supply chains and the Circular Economy, several concepts related to CSCs and their links to the CE have been studied in the literature ([Batista et al., 2018](#); [Liu et al., 2018b](#); [Masi et al., 2017](#)) such as reverse logistics ([De Brito & Dekker, 2004](#)), green supply chains ([Srivastava, 2007](#)), sustainable supply chains ([Seuring & Müller, 2008](#)), closed-loop supply chains ([Guide Jr & Van Wassenhove, 2006](#)), and eco-industrial parks ([Côté & Cohen-Rosenthal, 1998](#)). In this section, we first give an overview of these interrelated concepts. Then, we present CSCs in the recent literature. Finally, the aforementioned components of CSCs - material flows and activities - are investigated.

2.3.1 Interrelated concepts in the literature

In this section, we investigate previous interrelated CSC concepts such as Reverse Logistics, Closed-Loop Supply Chains, Green/Sustainable Supply Chains, and Industrial Symbiosis. Some concepts consider the structure of supply chains, while others have a broader approach regarding other strategies, such as procurement, product design, etc.

Reverse Logistics

Reverse Logistics is described as “the process of planning, implementing and controlling the efficient, effective inbound flow and storage of secondary goods and related information, opposite to the traditional supply chain directions for the purpose of recovering value and proper disposal” ([De Brito & Dekker, 2004](#)). "Recovering value" corresponds to CE activities (reuse, remanufacturing, repurposing, etc.). Reverse logistics proposes a specific structure that addresses mainly reverse flows of the supply chain. Figure 2.5 represents Reverse Logistics concept, material flows starting with collection, followed by inspection/selecting/sorting activities and CE activities.

Closed-Loop Supply Chains

The notion of Closed-Loop Supply Chain (CLSC) is described as the integration of forward and reverse flows ([Govindan et al., 2015](#)). Closed-Loop Supply Chains have two objectives: first, to satisfy customers' demands (as like a classic supply chain); second, to collect the used products and reevaluate them in the best way ([Govindan & Soleimani, 2017](#)). An example of CLSC structure is given in Figure 2.6. In addition to the reverse logistics activities, CLSCs consider linear supply chain activities such as material extraction, production, distribution, etc.

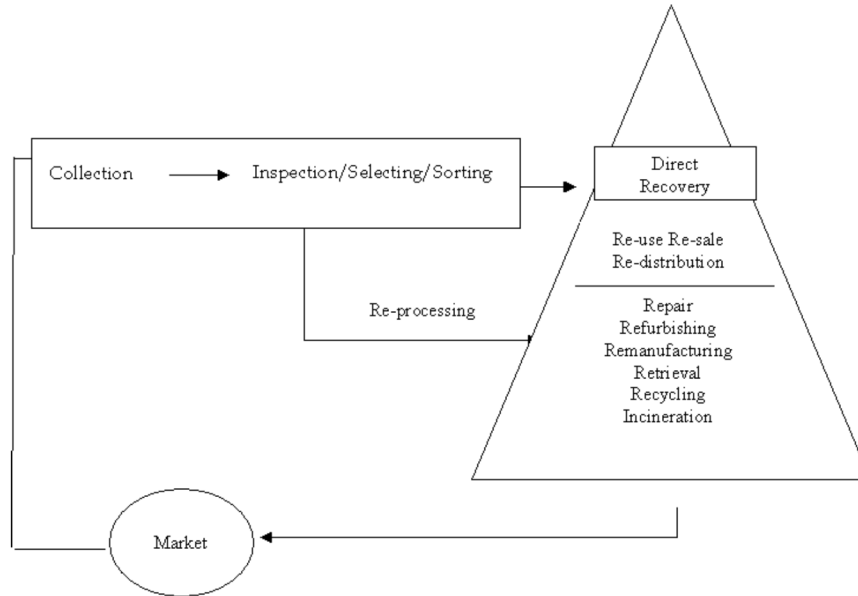

Figure 2.5: Reverse Logistics (De Brito & Dekker, 2004)

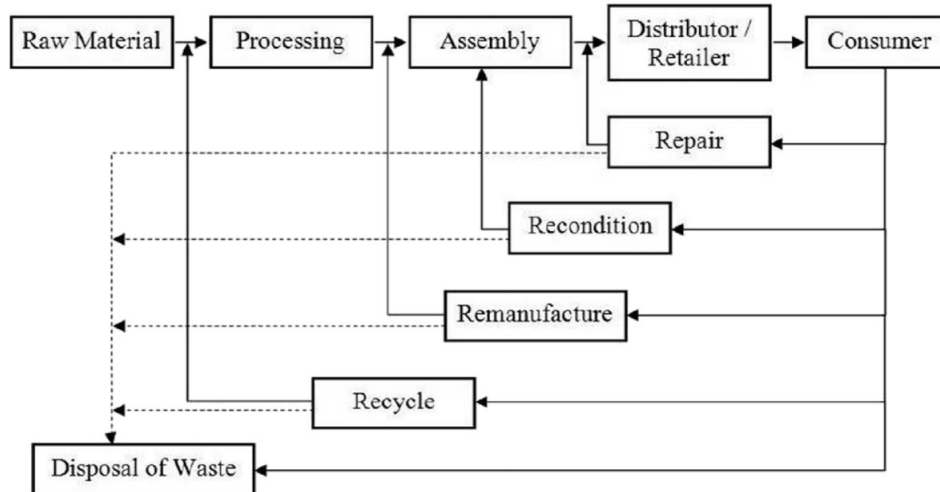

Figure 2.6: Closed-Loop Supply Chain (Khor & Udin, 2012)

Green and Sustainable Supply Chains

Green Supply Chain Management (GSCM) deals with sharing environmental responsibility between organizations (Hervani et al., 2005). Sustainable Supply Chain Management (SSCM) extends the Green Supply Chain approach by adopting the social and economic dimensions of sustainability (Beske & Seuring, 2014). The main strategies of GSCM and SSCM are eco-design, resource saving (Ahi & Searcy, 2015), green purchasing, green logistics (Sarkis et al., 2011), as well as product reuse, remanufacturing, and recycling (Ahi & Searcy, 2015; Srivastava, 2007).

Industrial Ecology, Industrial Symbiosis, and Eco-Industrial Parks

The Industrial Ecology concept explains the interaction between industrial systems (technosphere) and the environment (ecosphere) by using a biological analogy (Despeisse et al., 2012). Lifset & Graedel (2002) propose three models of Industrial Ecology: Linear, quasi-cyclic, and cyclic

material flows models. The purpose of quasi-cyclic and cyclic models has the same approach as CE, aiming to eliminate waste and reduce the use of natural resources (Figure 2.7).

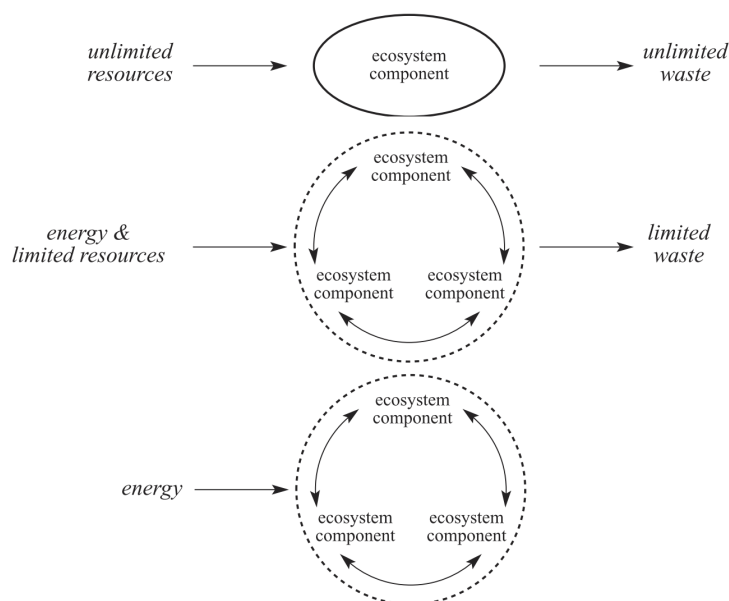

Figure 2.7: Three Models of IE (Lifset & Graedel, 2002)

Industrial Symbiosis, as an implementation of Industrial Ecology, is defined as an engagement of “traditionally separate entities in a collective approach to competitive advantage involving the physical exchange of materials, energy, water, and by-products” (Chertow, 2000). In Industrial Symbiosis systems (Eco-Industrial Parks), the waste or a by-product of a manufacturing process can be utilized as a resource for other processes. Therefore, the manufacturers add value to the waste, which is a core CE principle, by transforming it into a by-product of the production process. Industrial Symbiosis is one of the core topics of CE. However, we do not consider Industrial Symbiosis in this work, further explanations are given in Section 2.4.1.

2.3.2 Circular Supply Chains in the Literature

Besides these related concepts, recent works have been published in order to conceptualize CSCs. For example, Farooque et al. (2019b) recently proposed a definition of CSCs: “Circular supply chain management is the integration of circular thinking into the management of the supply chain and its surrounding industrial and natural ecosystems. It systematically restores technical materials and regenerates biological materials toward a zero-waste vision through system-wide innovation in business models and supply chain functions from product/service design to end-of-life and waste management, involving all stakeholders in a product/service life cycle including parts/product manufacturers, service providers, consumers, and users.”

Moreover, Vegter et al. (2020) propose another definition highlighting Triple Bottom Lines of sustainability (economic, social and environmental). Besides, Batista et al. (2018) highlight the integration of reverse and forward flows as well as closed and open-loops. Furthermore, González-Sánchez et al. (2020) conceptualize CSCs with reverse logistics, closed and open-loops, as well as greener processes. Further analysis of studies on CSCs, according to our positioning, is given in Chapter 3.

2.4 Circular Supply Chain Components

In this section, we explore material flows and activities as CSC components introduced in Section 2.2. First, different types of circular material flows from literature are explained. Second, CE activities and hierarchical frameworks of these activities are presented.

2.4.1 Circular Material Flows

CSC includes different types of material flows. Regarding the origins and the destinations of flows, circular flows have two types: closed and open-loops. CSC is described as a combination of closed and open-loops (Batista et al., 2018; De Angelis et al., 2018; Farooque et al., 2019b).

Closed-Loops

The closed-loops consist in collecting used products and integrating them into the original supply chain through circular activities such as direct reuse, reuse with remanufacturing, recycling, etc.

Open-Loops

The integration of the CE into the supply chain has led to the introduction of the notion of open-loop (Brunoe et al., 2019; Kalverkamp & Young, 2019). The term “open-loop” is used in the literature to represent different types of loops. Open-loops are divided into two branches: open-loops in the same sector and cross-sector open-loops (Weetman, 2016). Open-loops in the same sector exist when materials are recovered by third parties other than the original manufacturer (Aminoff & Kettunen, 2016).

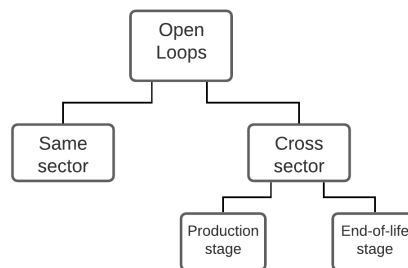

Figure 2.8: The classification of open-loops

Cross-sector open-loops reflect collaboration between distinct supply chains. Cross-sector open-loops could be created during two different product life cycle stages: in the production stage and in the end-of-life stage. The classification of open-loops is represented in Figure 2.8.

Production stage: The waste or the by-product of a process can be used as input for other processes. Here, a material across manufacturers can be observed. In literature, this engagement between traditionally separate organizations is called Industrial Symbiosis (Chertow, 2000).

End-of-life stage / repurposing: The scholars mention the material flows of by-products and wastes across distinct industries only at the production phase (Batista et al., 2018). However, the products at end-of-life can form an open-loop across industries. In this study, we highlight the repurposing strategy that provides open-loop flows between distinct supply chains. Repurposing refers to use a used product for new purposes (Sihvonen & Ritola, 2015). For example, repurposing smartphones in-car parking meters (Sarath et al., 2015; Zink et al.,

2014) or repurposing of electric vehicle batteries in stationary applications (Brissaud & Zwolinski, 2017; Richa et al., 2017; Schulz et al., 2020). Repurposing forms material flows from customers to the distinct supply chains. For example, Nissan and Eaton have a partnership in order to repurpose used electric vehicles batteries of Nissan in a residential energy storage system.

Technical and Biological Cycles

Furthermore, regarding the nature of products, material flows can be divided into two main categories: technical (restorative) and biological (regenerative) cycles (EMF, 2014; Farooque et al., 2019b) (Figure 2.9). Farooque et al. (2019b) indicate that CSC "restores technical materials and regenerates biological materials". They explain also the technical and biological cycles. Technical cycles represent using products or materials as technical nutrients through reuse, remanufacturing, recycling, repurposing, etc., while biological cycles refers using products or materials as biological nutrients, which become a part of the biosphere (Farooque et al., 2019b). Our work investigate only supply chains with technical materials and products.

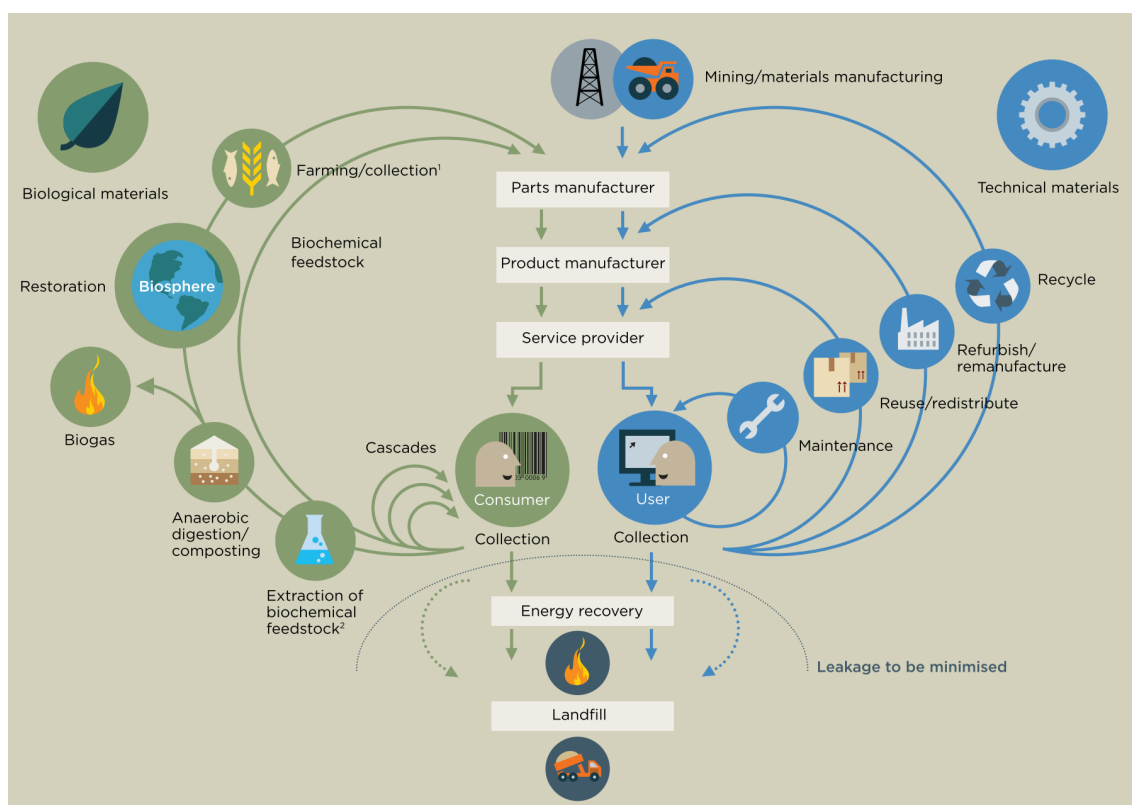

Figure 2.9: Technical and biological cycles (EMF, 2014)

2.4.2 Circular Economy Activities and Hierarchization

Researchers in various domains such as Waste Management, Reverse Logistics, and Closed-Loop Supply Chain Management have contributed to the definition of the CE activities and their hierarchization. For instance, Reike et al. (2018) named these activities as R imperatives. The authors indicate that while the 3R (Reduce, Reuse, and Recycle) framework is an accepted notion of the circular economy, “more nuanced hierarchies” with shorter loops such as refurbish, remanufacture and repurpose need to be considered in order to recover the highest value from products.

Circular Economy Activities

The CE activities found in the literature are explained hereafter.

Refuse is described as “Make product redundant by abandoning its function or by offering the same function with a radically different product” (Potting et al., 2017). This applies both to users and manufacturers. From a consumer perspective, refuse is the tendency of purchasing and consuming less. From the manufacturer point of view, it concerns refusing to use a material or a process (Reike et al., 2018).

Reduce is applied in three ways: reduce the waste production, dematerialization (“consume fewer natural resources or materials”), and life cycle extensions (through product sharing or pooling) (Reike et al., 2018).

Rethink deals with the “intensive use of the product” such as product sharing (Potting et al., 2017), like reduce strategy.

We note that these aforementioned activities are out of our scope of study since they are applied to manufacturers in their product design processes and to customers in the use activity.

The following CE activities are of more interest for us and we consider them as CSC components.

Reuse is described as using the product, which is still in good condition for its original function (Potting et al., 2017). This activity requires minor modifications in the used product.

Repurposing relates to using a used product for new purposes (Sihvonen & Ritola, 2015). For example, repurposing electric vehicle batteries in stationary applications (Brissaud & Zwolinski, 2017; Richa et al., 2017). Besides, this term is also described as using discarded components in a new product with a different purpose (Potting et al., 2017; Reike et al., 2018). Sihvonen & Ritola (2015) use the term “Resynthesise” to describe the latter. This activity is not sufficiently explored in the literature nor adapted in industrial applications. We conduct a research on ScienceDirect and WoS databases within "circular economy AND repurposing" keywords between 2010 and 2020, and obtained only thirty-seven results. Most of the selected studies are based on the repurposing of Electric Vehicle Batteries. Few studies have been found on the applications of repurposing activity in the electronics, plastics, textile, bio-waste, and glass sectors. Repurposing activities have been applied on a small scale, such as repurposing wooden pallets and tires as furniture. Adopting this approach on an industrial scale could be a new opportunity to obtain the highest value from a used product.

Upgrading improves the products’ performance and its functionality is changed. However, an upgraded product belongs to the initial product’s family, its purpose does not change like repurposing (Brissaud & Zwolinski, 2017).

Repair brings the used product to a working state (Thierry et al., 1995), to be used by the current user or new user in a secondary market (Sihvonen & Ritola, 2015). It requires fixing defective parts (King et al., 2006).

Refurbishing (or reconditioning) brings the used product to a particular quality. The expected quality is lower than a new product (Thierry et al., 1995). To provide this specific quality, critical modules are checked and replaced if needed (King et al., 2006; Sihvonen & Ritola, 2015).

Remanufacturing has been used to describe two scenarios in the literature. The first scenario is bringing used products up to new product quality that can require the full disassembly of the product (Ijomah et al., 1999; King et al., 2006; Reike et al., 2018; Thierry et al., 1995).

The second scenario is related to integrating valuable parts of the used product back to the manufacturing activity with the same function (Potting et al., 2017). Thierry et al. (1995) use the term “cannibalization” for the second definition. This activity requires more work than refurbishing (King et al., 2006).

Recycling is transforming used products into materials and reusing them in manufacturing activities. In recycling, the product loses its identity and functionality (Thierry et al., 1995). In recycling, products could be used as materials of lower quality (downcycling) or higher quality (upcycling) (Hofmann, 2019).

Recovery is defined as the “incineration of materials with energy recovery” (Potting et al., 2017). In this activity, the product transforms into energy and loses its identity and functionality.

Re-mine involves “landfill mining” or “urban mining”, which means scrapping valuable materials and from landfills (Reike et al., 2018).

Hierarchization of Circular Economy Activities

In the literature, there are several frameworks containing from 3 to 10 R imperatives (Reike et al., 2018). In addition, some frameworks have a hierarchical structure, where the activities are ranked according to environmental performance (Council of European Union, 2008) (Figure 2.10).

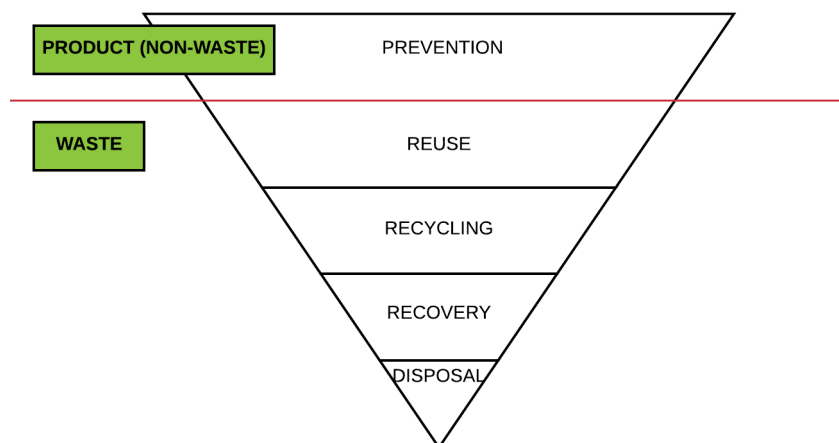

Figure 2.10: EU Waste Hierarchy (Council of European Union, 2008)

Also, the logic behind these hierarchies could be explained by the power of inner circle and the inertia principle (EMF, 2013; Stahel, 2010, 1982). The latter principle consists in replacing or treating the smallest part of a used product in order to maintain value by keeping the loops as short as possible: "do not recondition something that can be repaired, do not recycle a product that can be reconditioned economically" (Stahel, 1982). Considering this inertia principle, Sihvonen & Ritola (2015) show required works for the CE activities. They also consider the performance and warranty of products obtained through the CE activities (Figure 2.11).

Figure 2.12 represents a comparison of several frameworks from the literature. It shows that repurposing appears at different places in the hierarchies. For instance, Sihvonen & Ritola (2015) place repurposing after direct reuse. The authors define the repurposing as “using same product for new purposes without any adjustment” and gather together direct reuse, repurposing, repair, refurbishing, remanufacture and resynthesize under the title of ‘reuse’. In other frameworks (Potting

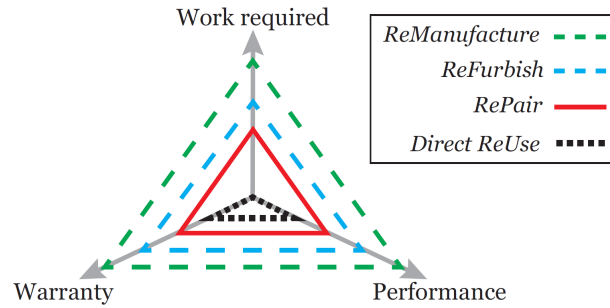

Figure 2.11: Required work, warranty, and performance for CE activities (Sihvonen & Ritola, 2015)

et al., 2017; Reike et al., 2018; Van Buren et al., 2016), repurposing is placed after remanufacturing. Therefore, the repurposing term does not seem to be consensual yet, especially in the way it has to be placed in the different frameworks.

(European Union, 2008)	Prevention			Preparing for Reuse					Recycling	Recovery	Disposal	
(Potting et al., 2017)	Refuse	Rethink	Reduce	Reuse		Repair	Refurbish	Remanufacture	Repurpose	Recycle	Recover	
(Sihvonen & Ritola, 2015)			Reduce	Direct Reuse	Repurpose	Repair	Refurbish	Remanufacture	Resynthesize	Recycle	Recover	
(Reike et al., 2018)	Refuse		Reduce	Reuse		Repair	Refurbish	Remanufacture	Repurpose	Recycle	Recover	Re-mine
(van Buren et al., 2016)	Refuse		Reduce	Reuse		Repair	Refurbish	Remanufacture	Repurpose	Recycle	Recover	

Figure 2.12: CE Activities frameworks

2.5 Our Previous Work on Conceptualizing CSCs

A master thesis (Kurt, 2018) was conducted as a preliminary work to this thesis. In this preliminary work, we proposed an extension of the hierarchical framework from (Potting et al., 2017) and an extended model for CSCs, which will be presented in the next sections. These two contributions have been published during this Ph.D. work Kurt et al. (2019).

2.5.1 A Hierarchical Framework for the CE Activities

In an attempt to correctly place repurposing regarding the other CE activities, we have proposed an extension of the hierarchical framework for CE activities based on (Potting et al., 2017) in order to place different types of repurposing activities. Considering the power of the inner circle and the inertia principles, we can state that repurposing is more circular than recycling. Since the recycling activity recovers only materials from products and destroys the added value of the product, while repurposing preserves added value (Davim, 2013). Also, considering the environmental performance of activities, repurposing is more environmentally friendly than recycling. For example, repurposing electric vehicle batteries postpones the recycling of Li-ion batteries, which is an environmentally hazardous and costly process (Jiao & Evans, 2016). However, considering the environmental performance or ‘the power of the inner circle’ and inertia principles (EMF, 2013; Stahel, 2010, 1982), we consider that it is not possible to compare the circularity of repurposing activities with reuse, remanufacturing, refurbishing activities as long as the required work, environmental and economic aspects of repurposing depend on the characteristics and design of products.

To ease the introduction of repurposing in our framework, the activities of direct reuse, repair, refurbishing, remanufacturing are included under the title ‘reuse’, as in the hierarchy proposed by the European Commission (Council of European Union, 2008). We assume that repurposing and reuse are at the same circularity degree (left part of Figure 2.13). However, reuse and repurposing activities differ in the direction of the material flows. Repurposing activities generate open-loop flows (i.e. different supply chains), while reuse activities generate closed-loop flows (i.e. same supply chain).

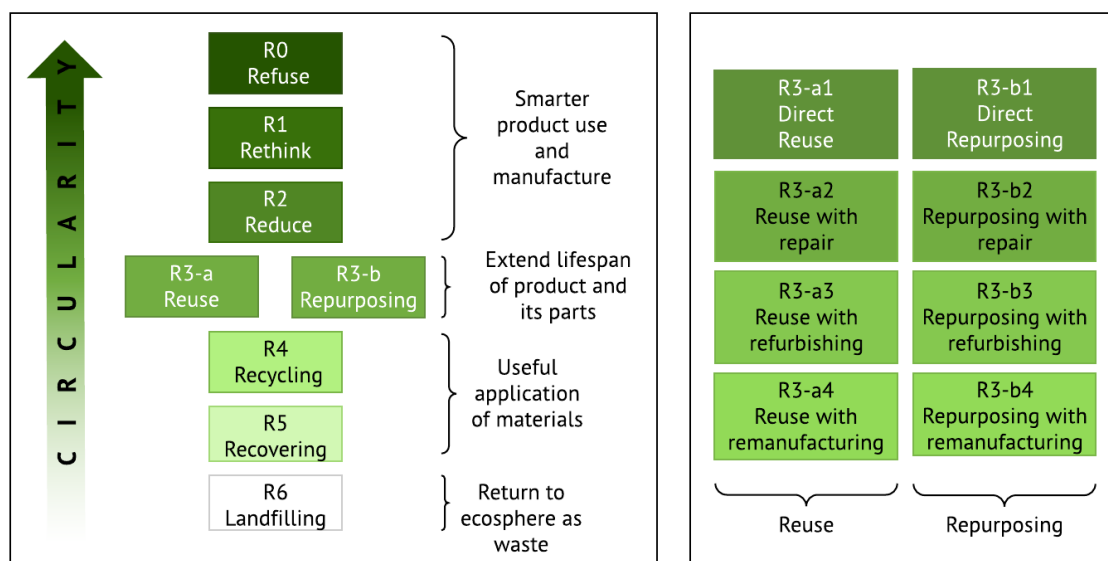

Figure 2.13: Hierarchical Framework of circular economy activities extending Potting et al. (2017)

Our hierarchical framework is represented in Figure 2.13. The circularity of activities is represented by texture gradient (the darker the activity is, the more is circular). The right part of Figure 2.13 gives a more detailed view of the reuse and repurposing activities on the left side. Since the reuse activities are already prioritized in the literature as direct reuse, repair, refurbish and remanufacture, we create a set of repurposing activities with a similar structure. This level of detail is not valid for non-modular products such as glass and textile since the repair, refurbishing, and remanufacturing activities require a disassembly. This fact justifies the grouping of the aforementioned activities in Figure 2.13. Table 2.2 summarizes the definition of the activities found in

the literature and used in our framework regarding reuse. We rely on them to introduce the new repurposing activities. These activities composing the framework are the basis for our extended circular supply chain model presented in the next section.

Table 2.2: Definition of Circular Economy Activities

Circular Economy Activity	Definition
R3-a1 Direct Reuse	Reuse the product with minor changes.
R3-b1 Direct Repurposing	Reuse the product in different functions with minor changes.
R3-a2 Reuse with Repair	Replace the defective parts of a product in order to bring it to a specific quality and reuse for the same purpose (Thierry et al., 1995).
R3-b2 Repurposing with repair	Replace the defective parts of a product in order to bring it to a specific quality and reuse for new purposes.
R3-a3 Reuse with refurbish	Replace the critical parts of a product modules in order to bring them to a specific quality for the same purposes (Thierry et al., 1995).
R3-b3 Repurposing with refurbish	Replace the critical parts of product modules in order to bring them to a specific quality for new purposes.
R3-a4 Reuse with remanufacture	Replace a significant amount of parts of a product, in order to bring it to a like-new quality and reuse for the same purpose (Thierry et al., 1995).
R3-b4 Repurposing with remanufacture	Replace a significant amount of product parts in order to bring it to a like-new quality for new purposes.
R4 Recycling	Transform the product into materials for new products.
R5 Recovering	Incineration of materials with energy recovery (Potting et al., 2017).
R6 Landfilling	Dispose the product into the ecosphere as an ultimate waste.

2.5.2 An Extended Model for Circular Supply Chains

Based on the hierarchical framework presented in Section 2.5.1 and extending the model of Thierry et al. (1995), an extended model is proposed in order to conceptualize the structure of CSCs. In this model, closed-loops and open-loops at the end-of-life stage are represented. This results in a multi-chained supply chain structure as a combination of two distinct supply chains, as illustrated in Figure 2.14.

Regarding on our positioning in Section 2.4, this model represents activities and material flows of circular supply chains. It includes two classic supply chain structures (represented by white blocks) of two different products. We note that at the end of its life, the first product or its components could be used to produce the second product by repurposing activities. Classical 'linear' supply chains start with material extraction, then manufacturing and distribution activities, and end with the use. This CSC structure is followed by the collection activity, which encompasses the product sorting process.

The collection activity consists of the pick-up and transportation of used products (Lambert et al., 2011). During the sorting activity, the collected products are inspected in order to decide how they can be reprocessed. Sorting could involve disassembly in order to test and reprocess parts or modules of a product. Note that the activities presented in the hierarchical framework (Figure 2.13) proposed in Section 2.5.1, represent the CE activities that follow the sorting. The

circularity of activities is represented by texture gradient (the darker the activity is, the more is the contributions to the circularity of the supply chain).

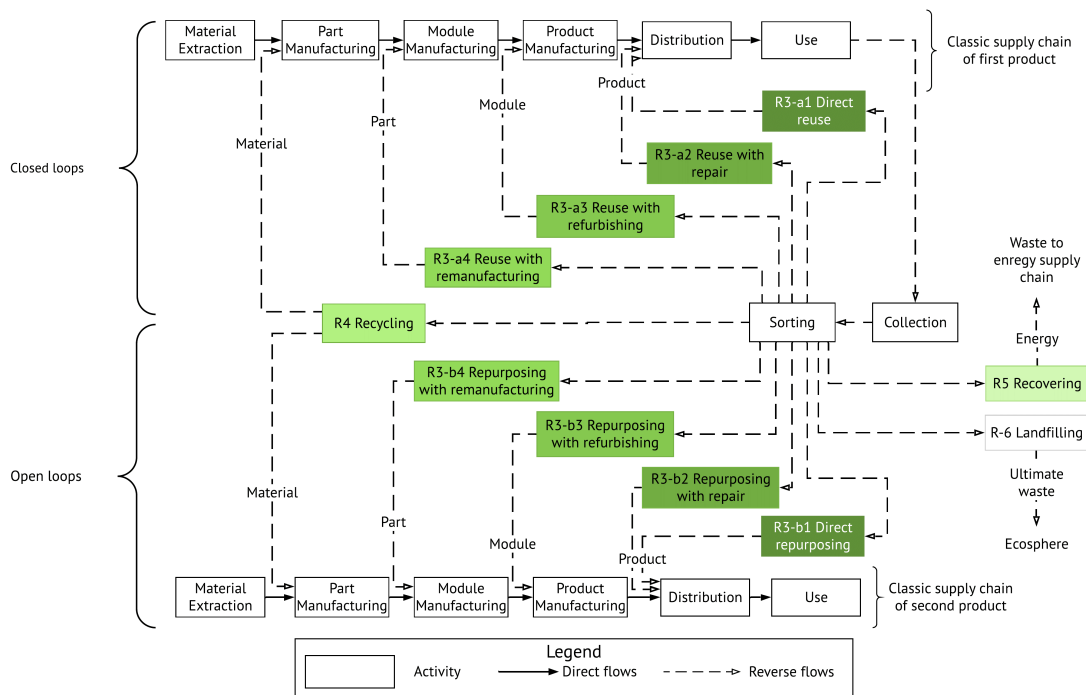

Figure 2.14: An extended model of circular supply chain

As shown in Figure 2.14, there are two kinds of material flows in our extended model of the supply chain: direct and reverse flows. Direct flows represent the material flows between the activities of the classical linear supply chain. Reverse flows concern material flows of used products. Reverse flows generated by reuse activities return to the original classical linear supply chain in distinct points, as in the work of Thierry et al. (1995). These reverse and direct flows constitute the closed-loops. The material flows of the repurposing activities integrate in the classical linear supply chain of the second product. The reverse flows between customers and the classical linear supply chain of the second product constitute the open-loops at the end-of-life stage.

We note that the energy output of recovering activity flows to waste-to-energy supply chains, which are not included in our model. Moreover, the term ecosphere taken from Industrial Ecology is used (Despeisse et al., 2012) to highlight the material flows between the environment and industrial systems. The ultimate wastes are supposed to return to the ecosphere during landfilling activity.

2.6 Conclusion

In this chapter, we have presented a background of CE and supply chains, as well as the implications of the CE on supply chains. Among different themes of supply chains, we have chosen to focus our work on material flows, activities, and keeping value. In the up-coming chapters of this work, we will develop our contributions relying on three circular value creation principles of EMF: the power of inner circle, the power of circling longer, and the power of cascaded use.

Furthermore, as discussed, the repurposing activity is just beginning to be explored by re-

searchers and industrials. Today to the best of our knowledge, there are only a few applications of this activity. Repurposing activities have been applied on a small scale, such as repurposing wooden pallets and tires as furniture. Operating the repurposing activity on an industrial scale could be a new opportunity to obtain the highest value from a used product. In addition, considering environmental performance, repurposing is more environmentally friendly than recycling or discarding. This is the reason why repurposing activity will have an important place in our contributions.

In this chapter, we have presented our positioning on the CE and supply chain concepts, addressing research question RQ1: What are the implications of the CE on supply chains and how to integrate repurposing activity into CSCs?, through a literature review. The positioning and definitions given in this chapter will constitute a basis for the following chapters that addresses other research questions. In the following chapters, more specific literature background is given related to other research questions.

3

Conceptualizing Circular Supply Chains through a Generic Model

Contents

3.1	Introduction	28
3.2	Circular Supply Chain Characteristics and Previous Works	29
3.3	Formalization of CSC Model in UML	31
3.4	Use Cases Illustrating the Use of the Generic Model	35
3.4.1	Textile Products	35
3.4.2	Li-Ion Batteries of Electric Vehicles	36
3.5	Conclusion	38

3.1 Introduction

As mentioned in state of the art (Chapter 2), supply chain management is transitioning from the management and appraisal of single CE activities to complex configurations where multiple CE activities are applied simultaneously (Blomsma & Brennan, 2017). Configuring multiple CE activities within a supply chain makes it possible to choose the most relevant activities for a used product according to its state and thereby prevent value loss. Moreover, the CE brings a scenario where products or materials are used over and over again (Genovese et al., 2017) through closed and open-loops (Farooque et al., 2019b). Therefore, the CE results in a complex structure that needs to be conceptualized at the strategic level in order to be analyzed and improved. Indeed, a model should help to provide a better understanding and management of the different possibilities based on an assessment of circularity.

Furthermore, as mentioned in Chapter 2, a lack of consensus about the needed CE activities has been observed. In particular, concerning the repurposing activity, which is relatively new in the literature and scarcely considered. This notion implies open-loops between distinct supply chains, adding value to used products by diverting them from their initial purpose and using them in less demanding applications (Bauer et al., 2017).

Thus, regarding the research question RQ2, this chapter follows the methodology we have adopted and given in Figure 3.1 which is a zoom in on Figure 1.1. In Section 3.2, we provide the characteristics of a CSC (C0-At least one CE activity, C1-Consecutive material use loops, C2-Several simultaneous CE activity options, C3-Open-loops and integration of distinct supply chains) adapting circular value creation principles of EMF (2013) to supply chain components. An analysis of the related works in the literature according to the four CSC characteristics is carried out. The generic model is presented in Section 3.3. This model generalizes and formalizes using the Unified Modeling Language (UML) the Extended Model (Kurt et al., 2019) given in Chapter 2. We provide use cases illustrating our generic model in Section 3.4. Finally, Section 3.5 gives concluding remarks.

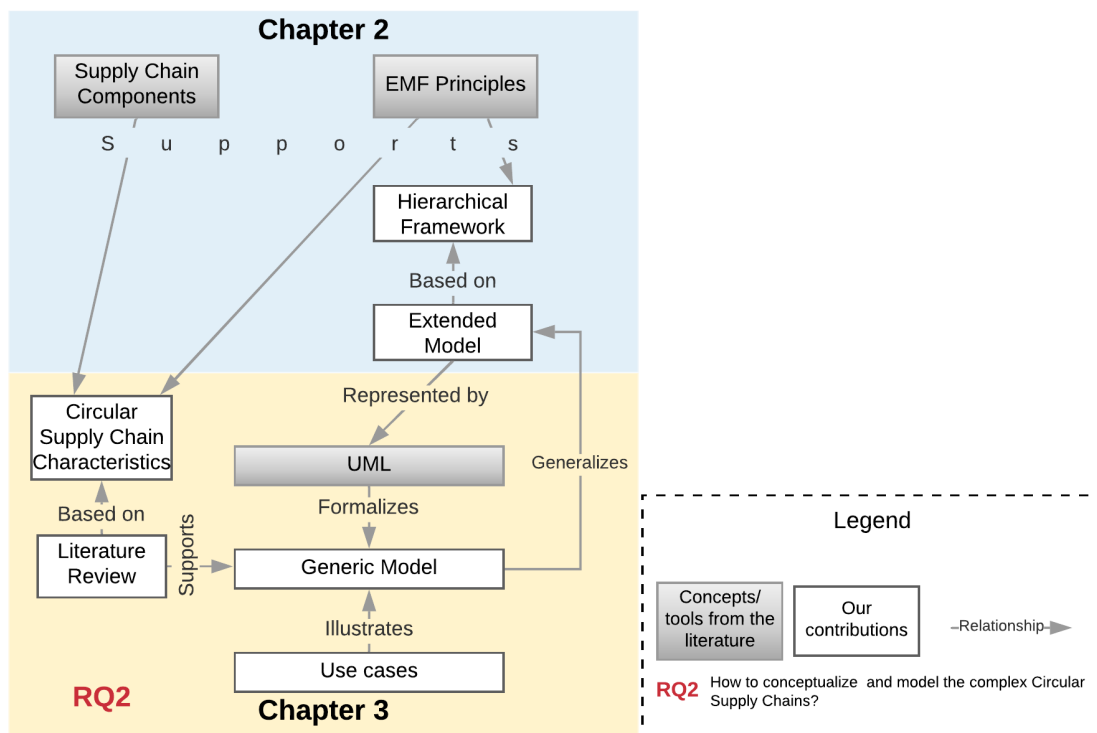

Figure 3.1: Our methodology for the development of a generic model

3.2 Circular Supply Chain Characteristics and Previous Works

In order to characterize CSCs, we apply three out of the four circular economy value creation principles proposed by the EMF (EMF, 2013, 2014)



Considered Characteristic	Illustration
<p>C0- At least one CE activity. A supply chain structure must contain at least one CE activity (reuse, remanufacturing, recycling, etc.) in addition to linear supply chain activities (material extraction, production, distribution, use, collection, and disposal).</p>	
<p>C1- Consecutive material use loops (such as third and fourth uses of the same product). This characteristic is based on the principle of the power of circling longer (EMF, 2013, 2014). According to this principle, consecutive cycles extend the lifetime of products, components, or materials. This characteristic has two dimensions: firstly, an increase in the time of use of a product in one loop (e.g., the extension of use time through design strategies or Product Service Systems (PSS)) and secondly, an increase in the time of use through multiple consecutive loops such as reusing, remanufacturing or recycling a used product repeatedly. The second dimension is the one considered in this study. For instance, at a strategic level, we can define the theoretical number of times that a product or a part can be reused.</p>	
<p>C2- Several simultaneous CE activity options. This characteristic is based on the principle of the power of the inner circle (EMF, 2013, 2014) and the inertia principle (Stahel, 2010, 1982). According to these principles, the tighter the loop, the less a product needs to be changed during reprocessing. Therefore, having shorter loops implies higher circularity. Indeed, returned products and components are not all eligible for CE activities owing to their quality. Having multiple CE activities in a supply chain means that the most appropriate one/ones can be chosen to treat a used product according to its quality. This prevents loss of value in terms of energy, material, labor, and pollution. As mentioned earlier, a CSC involves transitioning from the management and evaluation of single CE activities to a complex configuration where multiple CE activities are applied simultaneously (Blomsma & Brennan, 2017). For example, a supply chain that includes only direct reuse and recycling is less circular than one that additionally considers refurbishing. Indeed, a used product that is not eligible for direct reuse can be refurbished instead of recycled. Recycling is considered to be less circular than refurbishing according to the waste management hierarchy defined by the European Commission (Council of European Union, 2008).</p>	
<p>C3- Open-loops and integration of distinct supply chains. This characteristic is based on the principle of the power of cascaded use (EMF, 2013, 2014). Open-loops across distinct industries at the end-of-life stage are highlighted here. These loops are generated by repurposing activities. The repurposing activities can be at distinct granular levels. Based on this open-loop characteristic, different products can be integrated into distinct supply chains. For example, electric vehicle batteries can be repurposed for use in stationary applications.</p>	

Table 3.1: CSC characterization based on CE value creation sources (EMF, 2013, 2014)

The first characteristic C0 corresponds to the minimum requirement of a supply chain to be considered as a CSC: it must implement at least one CE activity, hence producing a reverse flow. The following characteristics (C1, C2, and C3) are based on the three principles mentioned above. Note that in the illustrations provided in the second column of Table 3.1, the thick arrows represent linear supply chains while the thinner arrows represent reverse flows.

Relying on our characterization, we evaluate related work through a literature review in the field. To perform our analysis, we consult Web of Science database. This database contains the journals with the highest number of publications regarding the CSC literature (Farooque et al., 2019b): *Journal of Cleaner Production*, *Sustainability*, *Resources Conservation and Recycling*, *Journal of Industrial Ecology*, *International Journal of Production Research*, and *Production*

Planning and Control. Recent articles published between 2017 and 2021 were selected. The geographical scope was determined as worldwide. Using "circular supply chain" as a keyword, we obtain 573 papers published in aforementioned journals. We perform title screening and abstract and full-text reading as part of our review. We also identify some other important works found during full-text reading process. Our review aimed to explore generic CSC models and their limits compared with our own characterization. In order to explore the appropriate studies, we select 33 papers supporting at least two of the defined characteristics and/or a CSC model.

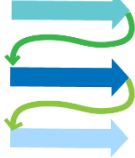
As already stipulated, the characteristics introduced in Section 3.2 were used to analyze the selected studies. The results of this analysis are summarized in Table 3.2. We do not show the C0 in the table, since it is the minimum requirement of a supply chain to be considered as a CSC, and all selected studies mentioned this characteristic. The first column represents characteristic C1: consecutive material-use loops. These loops reflect product multiple-use cycles and were mentioned in 11 of the papers studied. Note that C2 (inclusion of several CE activity options simultaneously) is not found in any of the papers and is therefore not shown in Table 3.2. The second column represents characteristic C3 (open-loops and integration of distinct supply chains). The notion of an open-loop with repurposing appeared in 17 papers. However, the granularity of repurposing activities described in Section 2.5.1 of Chapter 2 is not presented in any paper. In addition, none of these studies includes the integration of several distinct supply chains, which is why this characteristic is considered as only *Partially supported*. The third column represents the formalization level of the proposed models : some models only propose a description or the characteristics of CSCs in natural language (NL), whereas others also offer an informal model (IM). The informal models are examples of CSC representations without any rule or modeling standard underpinning them. Note that any of the analyzed papers proposes a formal model (FM). In all, 28 papers contained such informal models. As shown in Table 3.2, 16 of these studies did not consider characteristic C3 related to open-loops and the integration of distinct supply chains. Therefore, we focus on the 12 studies presenting an informal model and considering characteristic C3.

Table 3.2: Analysis of literature review based on our CSC characteristics (C2 not covered in any paper)

Reference	Consecutive material loops (C1)	Open-loops and integration of distinct supply chains (C3)	Formalization level
de Lima et al. (2021)	x	Partially	NL
Alamerew & Brissaud (2020)		Partially	NL+IM
Alizadeh-Basban & Taleizadeh (2020)			NL+IM
Desing et al. (2020)		Partially	NL+IM
Galvão et al. (2020)			NL+IM
González-Sánchez et al. (2020)		Partially	NL
Julianelli et al. (2020)			NL+IM
Shekarian (2020)			NL+IM
Tseng et al. (2020)	x		NL+IM
Turken et al. (2020)			NL+IM
Vegter et al. (2020)	x	Partially	NL
Werning & Spinler (2020)			NL+IM
Bianchini et al. (2019)		Partially	NL+IM
de Sousa Jabbour et al. (2019)		Partially	NL+IM
Farooque et al. (2019a)		Partially	NL+IM
Farooque et al. (2019b)	x		NL+IM
Hofmann (2019)	x	Partially	NL
Howard et al. (2019)	x	Partially	NL+IM
Kalverkamp & Young (2019)			NL+IM
Kurt et al. (2019) (Our work)		Partially	NL+IM
Lüdeke-Freund et al. (2019)		Partially	NL+IM
Taghikhah et al. (2019)			NL+IM
Batista et al. (2018)		Partially	NL+IM
De Angelis et al. (2018)		Partially	NL
Flygansvær et al. (2018)			NL+IM
Kalmykova et al. (2018)		Partially	NL+IM
Kazancoglu et al. (2018)			NL+IM
Mishra et al. (2018)	x		NL+IM
Reike et al. (2018)	x	Partially	NL+IM

Cooper et al. (2017)			NL+IM
Genovese et al. (2017)	x		NL+IM
Kalverkamp et al. (2017)	x	Partially	NL+IM
Lieder et al. (2017)			NL+IM
Nasir et al. (2017)	x		NL

Among 12 studies analyzed, 6 deal with repurposing (open-loop) in the full text but fail to represent this notion in their model (Bianchini et al., 2019; de Sousa Jabbour et al., 2019; Howard et al., 2019; Julianelli et al., 2020; Kalmykova et al., 2018; Lüdeke-Freund et al., 2019). Most of the studies refer to the EMF model (EMF, 2013). Alamerew & Brissaud (2020) represent repurposing in their model, but the outflow of repurposing is directed to the same supply chain. Desing et al. (2020) represent open-loops as downcycling but do not consider any other supply chain integration. Farooque et al. (2019b) and Reike et al. (2018) include repurposing in their model but do not show integration with a different supply chain. Batista et al. (2018) propose two different diagrams for closed and open-loops instead of one generic model. In the model described by Kalverkamp et al. (2017) the integration of different supply chains can be observed, but their model only supports open-loop recycling.

Furthermore, we also included our previous work (Kurt et al., 2019) in this analysis. Apart from our previous work, none of these studies considers the granular levels of repurposing. The model describes several repurposing degrees inspired by reuse activities' degrees (Direct reuse, reuse with refurbishing, reuse with remanufacturing, etc.) based on our hierarchical framework (see Chapter 2).

However, our extended model does not cover consecutive loops (C1), and does not allow integration of more than two supply chains. However, a product could be repurposed into different products, for instance everyday clothes can be repurposed for cleaning and then for insulation (EMF, 2014). Moreover, the number of activities in the linear supply chain is predefined in this model. However, the model for an electronic device supply chain is different from the model applied to a textile supply chain in terms of the number of activities. Moreover, a supply chain can contain several distribution/retailing activities.

We conclude that the models presented in these papers are not sufficiently generic in order to conceptualize the CSCs in different sectors. The majority are partial or informal, and mainly represent only examples of CSCs. Our aim is to propose a more formal and general CSC model to be able to portray different CSC network possibilities.

3.3 Formalization of CSC Model in UML

Based on the characteristics explained in Section 3.2, the CSC model is presented below by formalizing the Extended Model through the so-called *Class Diagram* of the *Unified Modeling Language* (UML). The model offers two major advantages: (1) it makes it possible to formalize and therefore generalize the CSC concept, (2) it highlights and defines the integration of different supply chains (relating to different products) through repurposing, and (3) it proposes a flexible number of activities allowing to model CSCs from different sectors. Figure 3.2 (top) shows a UML class diagram model presenting the structure of a CSC. In the bottom part of Figure 3.2, a simple example of a CSC composed of two Linear Supply Chains is shown in compliance with the UML model. The UML main notions are explained in Table 3.3^{1 2}.

A CSC is defined as a composition (Composed of) of one or several (1..*) Linear Supply

¹<https://www.uml-diagrams.org/>

²<https://www.visual-paradigm.com/guide/uml-unified-modeling-language/uml-class-diagram-tutorial/>

Notion	Definition	Example in our Model
UML Class Diagram	A class diagram in UML helps to describe the structure of a system by visualizing the classes, their attributes and the relationship among objects.	Our generic model describes the structure of a CSC.
Class	A class describes a set of objects, which have the same attributes and semantics (meaning).	For example, Circular Economy Activity is a class in our UML model.
An object	Object is an instance of a class. Objects of a class must contain values for each attribute related to that class.	Reuse, repair, refurbish, etc., activities (with their respective values for <i>maxNbOfConsecutiveLoops</i> , <i>circularityCoefficient</i> , etc. are objects (and therefore instances) of the <i>Circular Economy Activity</i> class.
Attribute	An attribute describes a range of values that objects of the class may hold. Each attribute has a type. An attribute can be static or calculated, which means that it can be deduced from other model attributes.	For instance, <i>branch</i> is a static attribute of the class <i>Linear Supply Chain</i> . While <i>nbOfBranches</i> (in the class <i>Circular Supply Chain</i>) is an attribute that can be calculated thanks to the aforementioned <i>branch</i> attribute.
Association	Association is a relationship between the objects of classes. The number of the related objects is given by a cardinality	<i>Circular Supply Chain</i> class is related to several (1..*) <i>Linear Supply Chain</i> class. This association, named “composed of”, indicates that <i>Circular Supply Chain</i> is composed of <i>Linear Supply Chains</i> . A <i>Linear Supply Chain</i> is related to only one <i>Circular Supply Chain</i> .
Association end	An association end refers to the role.	The association between <i>Collection Activity</i> and the <i>Circular Economy Activity</i> represents the material flows. In order to represent the direction of the flow, association ends are used. <i>Collection activity</i> has a source role, while <i>Circular Economy Activity</i> is the target.
Association class	An association class represents particular information about the association between two classes	<i>Output Reverse Flow</i> concerns the association between <i>Circular Economy Activity</i> and an <i>Intermediate Activity</i> . The capacity and the unit are particular attributes of that association.

Table 3.3: Definition of UML notions with illustrations from our Model

Chains and at least one CE Activity together with the corresponding reverse flows. Linear Supply Chain is composed of an Extraction Activity, a Collection Activity, a Use Activity, a Disposal Activity, and one or multiple Intermediate Activities. An Intermediate Activity could be Production or Distribution. A Linear Activity is a source or target of Linear Flows except for the Extraction Activity (target only) and the Disposal Activity (source only). Allowing multiple Intermediate Activities gives our model the flexibility that helps supporting supply chains of different sizes from different sectors. For example, supply chains with numerous production activities (part, module, product manufacturing) or distribution activities (wholesaling, retailing, etc.) could be modeled.

A Circular Economy Activity is connected to the Linear Supply Chain through Reverse Flow via a Linear Activity. The source of the Reverse Flow is the Collection Activity, while the target is Intermediate Activity. If the CE Activity is connected to the Intermediate Activity of the same Linear Supply Chain as the Collection Activity, which is the source of the Input Reverse Flow, the LoopType of the CE Activity is closed. On the other hand, if the loop type is open (i.e. repurposing), the Output Reverse Flow relates to an Intermediate Activity of a different supply chain. CE Activity also has a CEActivityType attribute, which can be reuse, repair, refurbish, remanufacture, recycle or recover based on the hierarchy proposed in Section 2.5.1. In this new model, the terms used in this hierarchy, such as direct repurposing, refurbishing with repurposing, etc., have been discarded. Instead, we use for example open-loop reuse and open-loop refurbishing, etc. terms. Here, we also differentiate closed or open-loop recycling and recovering, while in the Extended Model, we assume that there is no need to differentiate the activities where the used products turn into materials or energy for simplicity reasons.

These activities are hierarchized according to the inertia principle (Stahel, 2010, 1982) (See Chapter 2). In addition, we propose a circularity coefficient (*circularityCoefficient*) for each CE Activity to determine their degree of circularity. In the example in Figure 3.2, the CE activities are represented in green squares. Blue squares represent Linear Activities such as extraction, production, distribution, and use. CE Activities such as reuse, remanufacturing, recycling, etc., have different color gradients according to their circularity coefficient. The darker the activities are, the greater their circularity.

A CSC has two attributes according to the type of product (branch) and its requirements (level). Branches refer to the type of products produced along the supply chain. Levels refer to the requirements of the product produced along the related Linear Supply Chain. Since repurposing is the reuse of used products for different applications that are less demanding than the original ones, the products of integrated Linear Supply Chains have lower requirements. Different indicators can express the level of requirements according to product type, such as quality, state of health, capacity, deterioration level, etc. For example, in the bottom part of Figure 3.2, branches are represented along the horizontal axis and levels along the vertical axis. The calculated attribute nbOfBranches is the number of integrated Linear Supply Chains of different products while nbOfLevels is the number of the requirement levels of the integrated Linear Supply Chains.

This model supports the proposed characteristics (see Section 3.2). According to the model, a CSC should contain at least one CE activity, which conforms to the characteristic C0. Characteristic C1 is supported by the attribute maxNbOfConsecutiveLoops. This attribute mainly concerns closed-loop activities as the value for open-loop activities is 1 by default when activated. The flow cascade in the model directly represents the consecutive open-loops. Since our focus is on the strategic level, we consider this characteristic as a projection of the possible capacity of the supply chain. For an operational level, the real value of the number of consecutive loops can then be calculated and compared with the one defined at the strategic level. Figure 3.2 illustrates a closed-loop activity that can be performed five (5) times in a row and where the input capacity is defined as 0.7 (70% of the material flow), and the output capacity is defined as 0.6 (60%).

Since the model proposes numerous options of CE Activities, it also supports characteristic C2 by allowing visualization of a CSC with several simultaneous CE activities. The number of linear activities, as well as CE activities, depends on the type of product managed by the supply

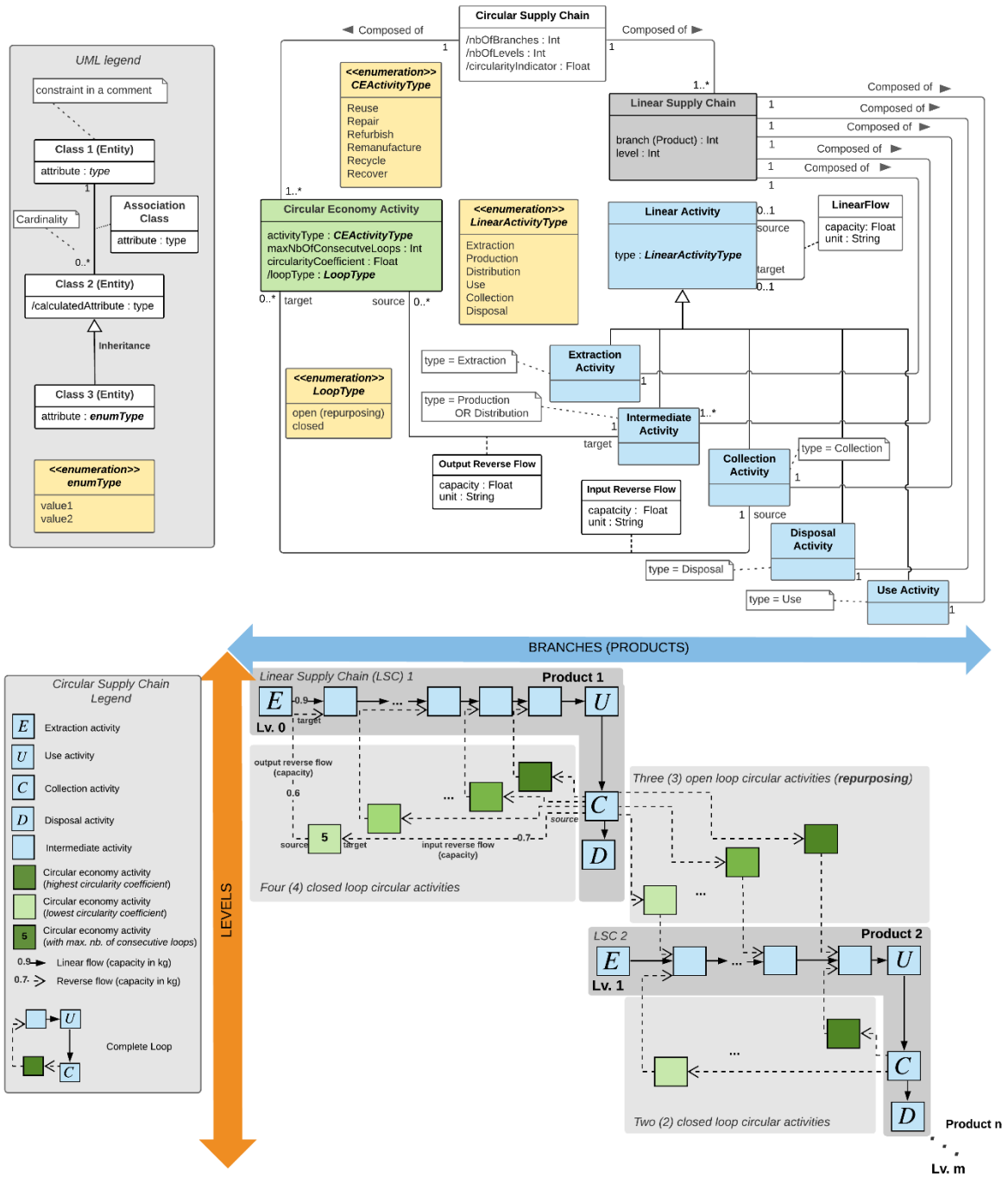

Figure 3.2: Generic model of CSCs with an example

chain. For example, the manufacturing process for a vehicle might have a higher granularity than a textile product, which is a less modular product.

Representing repurposing activities that can result in different branches (corresponding to products) and levels, produces a network with a tree structure. This supports characteristic C3. As can be seen from Figure 3.2, the root of the tree corresponds to the Linear Supply Chain of Level 0 and Product 1. The CSC should be considered as part of the scope of a product. Its related Linear Supply Chain is the root of the CSC considered. When the product is at the end of its first life, it can be repurposed to form a different product (branch) with fewer requirements (levels). Therefore, the integrated Linear Supply Chains of other less demanding products are at a lower level and on a different branch than those of the root. For instance, electric vehicle batteries (Product 1) can be repurposed for other applications such as laptop batteries (Product 2) or electric bicycle batteries (Product 3), both of which have the same requirement level. Therefore, the repurposing of the electric vehicle batteries through either branch can be considered as equally circular (based on this dimension alone). In this case, the electric vehicle battery supply chain is connected to two linear supply chains at the same level but with different branches.

Another example explained in the following section is a Linear Supply Chain connected to others with different levels (through repurposing). For instance, textile products can be repurposed for use as cleaning cloths. Following this second use as cleaning products, they can then be repurposed again as insulation products. The quality requirement level of cleaning cloths is assumed to be higher than insulation products since the first are still fabrics while insulating products are made of textile fibers. The best repurposing route, therefore, puts cleaning products first (Level +1) followed by insulation products (Level +2).

3.4 Use Cases Illustrating the Use of the Generic Model

These product examples are from two different sectors and present different modularity levels. They show that our model is generic and flexible enough to be used for different kinds of products.

3.4.1 Textile Products

The first example outlines the CSC for textile products (Figure 3.3). This CSC is composed of four linear supply chains: clothes, cleaning cloths, insulation material, and waste-to-energy. In this example, product quality is used as an indicator of requirement levels (levels on the diagram).

For the linear parts of the clothing and cleaning cloth supply chains, we refer to the textile supply chain model provided by Nordås (2004). Five activities describe the textile supply chain: material extraction of raw materials, fabric production, clothing production, distribution, retailing, and use.

With respect to Product 1 (clothes), there are various possible CE activities: closed-loop reuse, open-loop reuse (repurposing), closed and open-loop recycling, and open-loop energy recovery. For this product, closed-loop reuse would be the redistribution of the clothes through second-hand shops. This CE activity requires few changes to the main product. The second CE activity is open-loop reuse (repurposing). In this case, used clothes can be repurposed for use as cleaning cloths (EMF, 2014). In this example, the clothes are transformed into the fabric and reused as cleaning cloths. The quality requirement for cleaning cloths is assumed to be lower than that of clothes. The cleaning cloth supply chain is therefore at a lower level. The linear supply chain for insulation products is based on the work of Pavel & Blagoeva (2018). As illustrated in Figure 3, clothes and cleaning cloths can be recycled. This involves transforming them into textile fibers.

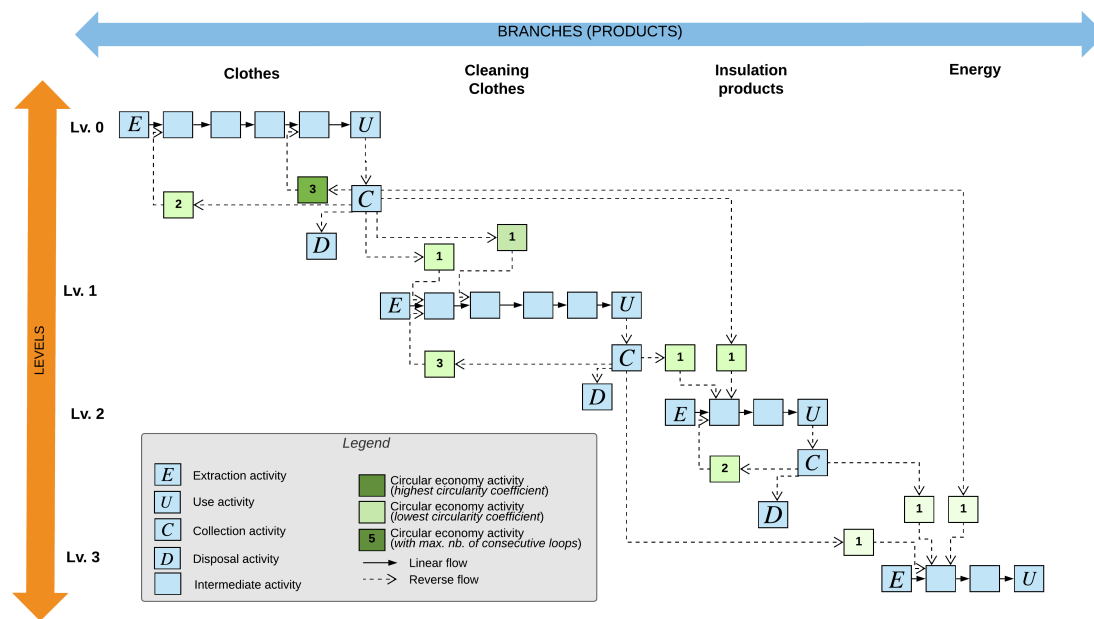

Figure 3.3: Example of textile circular supply chain

Such recycling can be closed or open depending on whether the recycled material is reinjected into the same supply chain or repurposed through the supply chain of another product.

Products that are not eligible for reuse, repurposing, or recycling can be used to produce energy (Level 3 in Figure 3.3). Compared with the other repurposed products, the quality requirement for energy production is the lowest. We can use any textile products to produce energy without any quality limits. Therefore, the textile waste-to-energy supply chain is placed at the lowest level.

Since the structure shown in Figure 3.3 has at least one CE activity, it is considered a CSC (characteristic C0). Characteristic C2 is shown in Figure 3 by the maximum number of consecutive loops (in this case closed) based on random values due to lack of information. This CSC also offers several CE options as befits characteristic C2. Product integration into distinct supply chains (characteristic C3) is ensured through repurposing (creating open-loops). Flow capacities are not represented to keep the diagram simple.

As illustrated in Figure 3.3, the CSC network presented is not limited to one product (clothes). It also considers possible CE activities for cleaning cloths and insulation materials. Cleaning cloths can be recycled through both closed and open-loops and used for energy recovery. In the same way, insulation materials can also be recycled and used to recover energy.

3.4.2 Li-Ion Batteries of Electric Vehicles

Figure 3.4 presents the example of an electric vehicle (EV) battery based on our generic model. The EV battery is a more modular and complex product than the textile product. The EV battery linear supply chain presented is based on the work of Alamerew and Brissaud (Alamerew & Brissaud, 2020). According to the authors, the EV battery linear supply chain covers four intermediate activities: parts manufacture, module assembly, product assembly, and distribution. In order to define the possible CE activities for an EV battery, we refer to the work of Casals et al. (2017). According to the authors, the options are the followings: closed-loop reuse, closed-loop refurbishing, closed-loop remanufacturing, open-loop reuse, open-loop refurbishing, and closed and open-loop recycling.

EV batteries have many possible applications in open-loop CE activities (Törkler, 2014). For a more detailed modeling, the requirement levels need to be determined. The applications can be

divided into three main categories depending on the battery’s state of health (SoH) (Casals et al., 2017). The SoH can be used as an indicator of the applications’ requirement levels. Batteries with an SoH higher than 88% can be treated through closed-loop CE activities, while damaged products can be treated through open or closed-loop recycling (Casals et al., 2017).

- Open-loop reuse: stationary and transport (e.g. designed for urban areas) applications (SoH: 75-88%)
- Open-loop refurbishing: smaller devices (e.g. laptops and electric bicycles) (SoH: < 75%)

According to the SoH, the level for a grid stabilization battery and a hybrid truck battery is assumed to be equal to or higher than the level for laptop and electric bicycle batteries. The possible CE activities for grid stabilization, hybrid truck, laptop, and electric bicycle batteries are assumed to be closed-loop reuse, refurbishing, remanufacturing, and recycling. The linear supply chains for these batteries can be said to have the same granularity as an EV battery supply chain, therefore the same linear activities. Therefore, the intermediate activities for these supply chains are similar to those of an EV battery supply chain. No study indicates a possible consecutive repurposing activity for batteries, such as another form of repurposing for a battery that has already been used in a hybrid truck. This explains why we do not include open-loops for grid stabilization, hybrid truck, laptop, and electric bicycle battery supply chains.

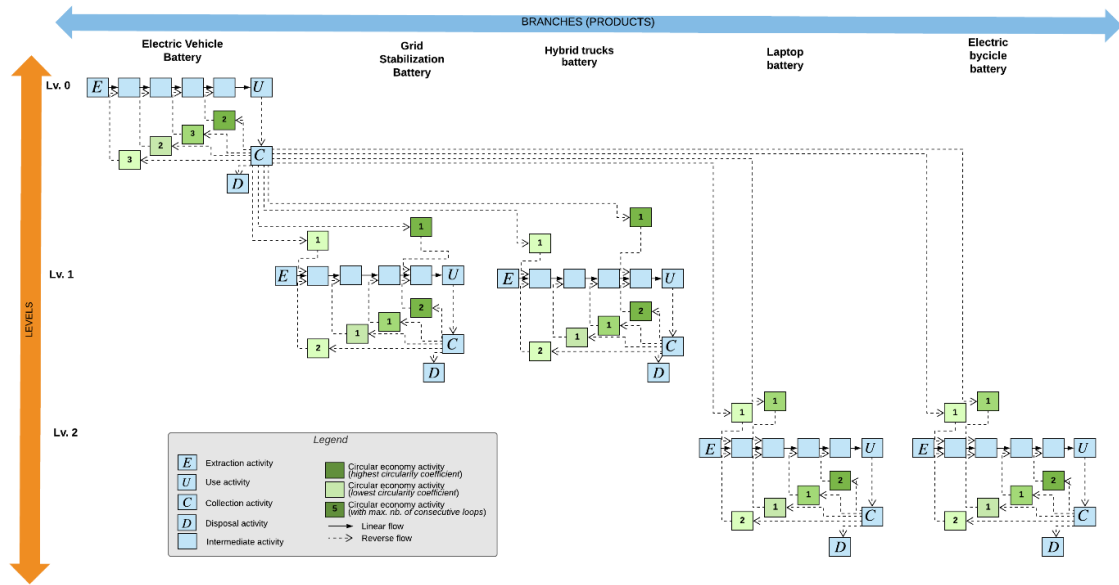

Figure 3.4: Example of EV battery circular supply chain

Since the structure shown in Figure 3.4 has at least one CE activity, it is considered a CSC (characteristic C0). The maximum number of consecutive loops for closed-loop activities (characteristic C1) has been represented. This CSC also offers several CE options in compliance with characteristic C2. It also suggests the integration of distinct supply chains through repurposing hence creating open-loops (characteristic 3). As mentioned above, consecutive open-loops are not represented in this model due to the lack of information. Unlike in the first use case, here, different product branches can be observed at the same level. As in the first use case, the attributes relating to the maximum number of consecutive loops have random values. Flow capacity is not represented to keep the diagram simple.

3.5 Conclusion

Supply chains play a critical role in the transition to a more circular economy. However, the implementation of the CE from a supply chain point of view is still at a nascent stage in practice and in the literature. Moreover, repurposing activity, which is a new potential for CSCs, is scarcely included in the previous studies. To the best of our knowledge, there are no generic modeling tools to help supply chain managers make strategic decisions in this transition to more circular supply chains.

In this chapter, we have first proposed CSC characteristics. Based on these characteristics, we have analyzed the existing works. Our analysis of published studies aimed to determine their limits according to these characteristics. We have observed that the simultaneous use of circular activities is not well supported in current models. In addition, consecutive material-use closed and open-loops are generally only partially supported. Furthermore, the related work models are mainly relied on examples in order to represent CSCs and do not offer any formalization or generalization. Therefore, we have introduced a generic model by generalizing and formalizing the extended model of our previous work. The advantages of our generic model are illustrated through two use cases from different industrial sectors: textiles and Li-Ion batteries.

Implications for theory and practice

First, the proposed CSC characteristics in this work contribute to theory in bridging between the CE and supply chains as well as the conceptualization of CSCs, by clarifying the CSC structures according to the CE principles. Moreover, based on this contribution, a generic model of CSC is proposed. Finally, it provides a basis for developing new indicators (see Chapter 5).

Considering the implications for practice, the generic model helps decision-makers model complex CSCs in a semi-formalized way using CE activities. This model helps conceptualize, formalize and visualize complex CSCs. Even though we do not take into account the actor notion in our model, this representation could be used by different actors of CSCs to have a global vision and support inter-actor communication, especially in the case of repurposing, where the actors from distinct sectors are collaborating.

Moreover, our contributions consider repurposing activities as a first-class citizen, which is scarcely studied in the literature and rarely adopted by industrials. In the future, more products, components, and materials will be designed to be reused and repurposed as much as possible until no further value can be obtained from them. The complex structures of CSCs in the future might be represented through the modeling and visualization tools developed based on our generic model.

Limitations and future works

In order to ensure that CSCs would accommodate the best CE activities, decision-makers need not only a modeling tool to design and structure the CSC networks but also an indication on the CSC circularity and return on investment (ROI). Our generic model can provide a basis to assess CSC circularity and identify vital parameters to be considered, such as flow capacity, the maximum number of consecutive loops, and the circularity coefficient. The assessment of CSCs will be addressed in Chapters 4 and 5.

Furthermore, a proposed product's requirement level is multidimensional and depends on the product type. This can be represented through quality, state of health, capacity, deterioration level, etc. Therefore, further investigations are needed to adapt this dimension to different product types.

Finally, the generic model presented here focuses mainly on activities and material flows. But, of course, supply chains do not consist of material flows and activities alone. They also require collaboration between actors (material extractors, manufacturers, distributors, collectors, users, etc.). Moreover, CSCs require an even greater collaborative effort since, to ensure circularity, they involve actors from traditionally separate sectors. Indeed, the actor dimension is another

important aspect of the CSC, which needs to be further explored. For instance, measuring each actor's contribution to CSC circularity may be a worthwhile goal. In the future, our generic model will include this actor dimension to provide managers with a more nuanced way to design and analyze CSCs and identify and explore potential collaboration. To this end, an integration with the SCOR model ([APICS, 2017](#)), which describes the processes for each supply chain actor, could be investigated.

4

A Classification Tool for Circular Supply Chain Indicators

Contents

4.1 Introduction	42
4.2 Indicators and Classifications considering CE	42
4.3 A Classification Tool for Circular Supply Chain Indicators	44
4.4 Classifying Existing Indicators through our Tool	48
4.5 Conclusion	50

Related publication: Kurt, A., Cortes-Cornax, M., Cung, V.-D., Front, A., & Mangione, F. (2021). A classification tool for circular supply chain indicators. In IFIP International Conference on Advances in Production Management Systems (pp. 644–653).: Springer.

4.1 Introduction

This chapter addresses research question RQ3: How to assess the circularity of the Supply Chains? We introduce a Classification Tool for Circular Supply Chain Indicators to help academics and Supply Chain managers to understand Supply Chain circularity as well as to support the development and the classification of circularity indicators for new CSC structures. Some new potential indicators for each dimension are also proposed. To illustrate the usefulness of this tool, we propose a classification of some existing circularity indicators issued from a literature survey.

While developing this tool, we rely on the value creation principles of EMF. We analyze these principles considering CSC characteristics introduced in Chapter 3 and proposed the corresponding dimensions for each principle. Dimensions constitute the classification criteria for our tool. For each dimension, closed and open-loop attributes are considered. In addition, level and branch notions are taken into account for the power of cascaded use principle. Moreover, potential indicators for each dimension have been proposed. Our methodology is summarized in Figure 4.1 which zooms in on Figure 1.1.

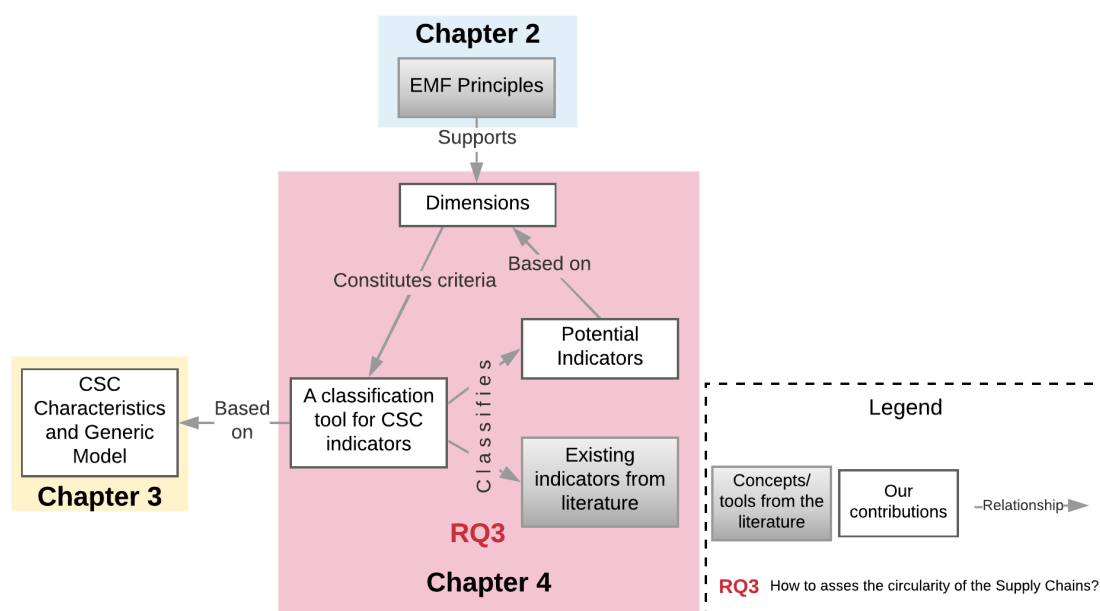

Figure 4.1: Adopted methodology for the development of our classification tool for CSC indicators

Thus, the structure of the chapter is as follows. Section 4.2 provides a literature background of classification works. Section 4.3 introduces our classification tool of CSC indicators illustrated on some CSC structures. Some existing indicators from the literature are classified with our tool in Section 4.4. Finally, Section 4.5 concludes the chapter and gives some insights for future works.

4.2 Indicators and Classifications considering CE

Indicators that are used in performance measurement influence the decisions to be made at the strategic, the tactical, and the operational levels (Gunasekaran et al., 2001). These levels concern respectively long-term, mid-term and short term decisions. In Supply Chain Management literature, indicators are classified according to these decision levels (Gunasekaran et al., 2004).

The strategic level indicators influence the top-level management decisions (Gunasekaran et al., 2004), such as Supply Chain design (Ivanov, 2010) or selection of CE activities (Lambert et al., 2011) that creates closed and open-loops.

From the CE literature, Saidani et al. (2019) developed a taxonomy of circularity indicators with 10 categories. Among others, implementation levels (micro, meso, macro), loops (maintain, reuse, remanufacturing, recycle), or performance (intrinsic, impacts) were proposed. Their indicator category called as 'loops' refers indeed to CE activities. However, they do not include open-loop activities such as repurposing. Their taxonomy does not specifically apply to the indicators of CSCs, but general circularity indicators. However, they state some indicators, which could measure the circularity of CSCs. For example Product-Level Circularity Metric (Linder et al., 2017) and Value-based Resource Efficiency (Di Maio et al., 2017). Moraga et al. (2019) developed a taxonomy of CE indicators based on the reasoning of the CE strategies (equivalent to our CE activities) and the measurement scope of circularity indicators. They do refer to repurposing activity (characteristic C3 in our approach) but they do not explicitly refer to all the CSC characteristics we have provided. The authors also determine the measurement type of circularity indicators. They explore how the indicators measure the circularity and defined measurement scopes: Scope 0- Technological cycles without aspects of LCT (Life Cycle Thinking), Scope 1- Technological cycles with aspects of LCT and Scope 2-Cause-and-effect modelling with/without aspects of LCT. They define LCT as "the capacity to look at products or services over the cycles of design, production, consumption, use, and disposal including interactions with sustainability". We can assume that LCT relates the whole CSCs, which is a complementary effort to our work. The indicators we propose later in Chapter 5 could be included in Scope 1 and Scope 2. Elia et al. (2017) categorized assessment methodologies based on the indexes linked to the CE requirements and parameters like material flow, energy flow, land use and consumption and other life cycle based. Their taxonomy is based on micro level indicators and they basically rely on environmental and resource efficiency indicators. They do not consider savings in labor and length of use dimensions of CE. As in the previous works, this work does not consider CSC characteristics explicitly. However, some indicators could measure the circularity of CSC, e.g. Life Cycle Assessment and Material Inputs per Unit of Service.

Besides the circularity indicators' classifications, other classifications of indicators related to CE from different schools of thought stated in Chapter 2 are found. On the Green Supply Chain Management literature, Kazancoglu et al. (2018) proposed an assessment framework based on six performance criteria: environmental, economic/financial, operational, logistics, organizational and marketing performance. This work develops a new holistic conceptual GSCM (Green Supply Chain Management) performance assessment framework within the CE context. Their performance criteria are a complementary approach to our work with economic/financial, operational, logistics, organizational and marketing performance dimensions. Indeed, they do not explicitly work on the characteristics of CSC design as a network as we propose. The proposed indicators could be able to measure the circularity of a CSC as they are generic but are not designed for a specific Supply Chain structure. For example, "Use of Recycled Materials in Production" indicator could measure the circularity of all types of Supply Chains, including CSCs. Regarding Sustainable Supply Chain, the indicators are usually classified according to Three Bottom Lines (TBL) of sustainability (economic, environmental and social) (Corona et al., 2019; Gómez-Luciano et al., 2018; Moreno-Camacho et al., 2019).

In addition to the TBL of sustainability, some frameworks consider different criteria. For example, Ahi et al. (2016) have centered their work on TBL of sustainability and other characteristics of Sustainable Supply Chain Management such as volunteer focus, resilience focus, long-term focus, flow focus, relationship focus, etc. However, they do not evaluate the CSC structure explicitly. The aforementioned works are summarized in Table 4.1 with the related school of thought and the classification criteria.

We observe that all these works could be considered as complementary approaches to ours

Table 4.1: Classifications considering CE from the literature

Reference	School of Thought	Criteria
Saidani et al. (2019)	CE	Levels, Loops, Performance, Perspective, Usages, Transversality, Dimension, Units, Format
Moraga et al. (2019)	CE	Reasoning (CE strategies), Measurement scope
Elia et al. (2017)	CE	Parameter (Material flow, energy flow, etc.), Type (Single Indicator, Multiple Indicators)
Kazancoglu et al. (2018)	Green Supply Chain	Environmental, Economic/financial, Operational, Logistics, Organizational and Marketing performance
Moreno-Camacho et al. (2019)	Sustainable Supply Chain	TBL of Sustainability (Social, Economical, Environmental)
Corona et al. (2019)	Sustainable Supply Chain	TBL of Sustainability (Social, Economical, Environmental)
Gómez-Luciano et al. (2018)	Sustainable Supply Chain	TBL of Sustainability (Social, Economical, Environmental)
Ahi et al. (2016)	Sustainable Supply Chain	TBL of Sustainability, Volunteer, Resilience, Long-Term, Stakeholder, Flow, Coordination, Relationship, Value, Efficiency, and Performance focus

since they do not consider the structure of CSCs, and they do not handle a Supply Chain as a network. We strongly support that a circularity indicators' taxonomy covering the defined characteristics is needed in order to facilitate the CSC design and its evaluation. This is the reason why we propose in Section 4 a taxonomy and potential indicators based on both the principles of circular value creation of EMF and the structure of a CSC which takes into account all the characteristics of CSCs.

In summary, our proposal complements the aforementioned works by taking into account the structure of CSCs, which provides new value creation potentials by considering CE activities such as repurposing. Indeed, we claim that a classification tool for circularity indicators related to the CSC structures is needed in order to provide a comprehensive tool for academics and practitioners to (1) classify existing indicators according to CSC structures; (2) propose new indicators allowing measuring the created value by CSC structures; and (3) support their choice of indicators while facing a circularity assessment of a CSC.

4.3 A Classification Tool for Circular Supply Chain Indicators

In this section, we introduce a classification tool for CSC indicators relying on the three principles of circular value creation (EMF, 2013, 2014) from EMF and the CSC structure. New circularity indicators and some others taken from the literature are classified with our tool in order to illustrate the purpose of our classification tool. We summarize the classification tool with the potential indicators (bold elements) in Figure 4.2. As mentioned before, the table also includes illustrative examples in the last column. These examples conform to the CSC structure presented

in Chapter 3.

Hereafter, we will elaborate on each value creation principle and the related dimensions. *The power of circling longer* promotes the increase of the time of use of a product within one and/or multiple consecutive loops. This concerns the whole CSC, including closed and open-loops. The determined dimensions for this principle are described as follows:

Number of consecutive loops is the number of consecutive use through a loop. As explained within characteristic C-1, having multiple consecutive uses through a loop brings more circularity as the CE promotes keeping resources in the use phase as long as possible (EMF, 2013, 2014). Figure (a) in Figure 4.2 illustrates a Supply Chain where three (3) consecutive loops are performed. This could correspond to the consecutive recycling of a product in the same Supply Chain.

Another example of an indicator in this dimension is the Circularity (Figge et al., 2018). However, the scope of this indicator of Circularity from the literature is tighter than ours, as it covers only one of our dimensions.

Length of use is the length of use of a product obtained as a result of a CE activity. If a CE activity provides an increase in length of use, this results in a more circularity. This aligns with the CE principle to keep resources in use as long as possible (EMF, 2013, 2014). This dimension takes into account both closed and open-loops. The example of the figure (b) in Figure 4.2 illustrates a scenario where we assume that the closer circular activity to Use adds one (1) unity to the length of use (e.g., years of use) and the other circular activity adds three (3) unities. These values could correspond to a mean of the added value for each activity for a product, known by the Supply Chain manager. Another example of an indicator of this dimension is Longevity (Figge et al., 2018).

The power of inner circle principle relates both closed and open-loops. This principle deals with savings in terms of energy, material, labor, and pollution. These savings are enabled by shortening loops and having multiple loops in the CSC.

Note that other related works treat in much more detail the savings dimension on looking at different levels of performance resulting in some specific saving indicators (Elia et al., 2017; Howard et al., 2019; Kazancoglu et al., 2018). Here, we indicate what would be the place of that indicators in our classification tool. The dimensions related to this principle are described as follows:

Length of loops considers the number of activities of the loop until the Use activity. It is considered that shorter loops result in more circularity (EMF, 2013, 2014). For example, direct reuse (the CE activity that is considered to be "closer" to Use) needs fewer activities to generate new products. This implies that it is more circular than recycling (CE activity "further" from Use) that needs more activities. Recycling has thus a longer length of the loop.

Figure 4.2 illustrates a first Supply Chain where the length of the closed-loop is five (5) (figure (c)) and a second Supply Chain where the length of the loop is four (4) (figure (d)). Note that different potential indicators concerning this dimension could be proposed, such as the maximum length of the loops or the total length of the loops.

Length of loops is calculated for one loop; however, the maximum length of the loops and the total length of the loops could be calculated for a Supply Chain (focusing on the output flows of its collection activity) or the whole CSC network (focusing on all the collection activities of the network).

Number of loops considers the number of closed and open-loops in a specific Supply Chain's product (i.e., not all the network is considered but only the Supply Chain of a specific

product). In parallel with characteristic C2, the increased number of loops results in more circularity in CSCs in general.

Figure 4.2 illustrates two examples of supply chains where the number of closed-loops and the number of open-loops are calculated (figures (e) and (f)). The number is two (2) in both cases, which correspond to the number of simultaneous CE activities involved in each case. The number of open-loops could be calculated for an individual Supply Chain (focusing on the output flows of its collection activity) or for the whole network (focusing on all the collection activities of the network).

Savings refers to savings obtained in terms of energy, material, labor and pollution as a result of a CE activity or a CSC compared to the new production process of a product. This dimension is important since CE seeks to minimize the use of the aforementioned resources (EMF, 2013, 2014) and it is treated in detail in (Elia et al., 2017; Howard et al., 2019; Kazancoglu et al., 2018). Moreover, our classification tool adds savings on the labor dimension, which is scarcely explored in the literature.

A possibility to calculate the savings concerning energy, material, labor, or pollution is illustrated in Figure 4.2 as the ratio between the sum of saving values of the linear path and the sum of values of the circular path. The saving values for each activity regarding energy, material, labor, or pollution should be known by the supply chain designer beforehand. Therefore, savings' values could be calculated for only one loop, for an individual supply chain, or the whole CSC network depending on the quantities of the flows in the considered system. Figure 4.2 illustrates two examples of closed and open-loops (figures (g) and (h)).

The power of cascaded use refers to characteristic C-3: the integration of distinct supply chains. This principle is related to the number of levels and the number of branches introduced in Chapter 3 and relates to open-loops as we focus here on repurposing activities. These dimensions are defined as follows:

Number of branches concerns the number of integrated supply chains with different product branches. Figure 4.2 illustrates an example of a supply chain with two branches (figure (i)), which means that a repurposed product (or material of a product) could be redirected to two different other supply chains.

Number of levels concerns the stages where a product or material could be repurposed with a decreasing requirement level. Figure (j) of Figure 4.2 illustrates an example of a supply chain with two levels. Note that different branches could be placed at the same level since the related products could have the same requirement level.

The indicators considered in our classification tool allow measuring circularity at the strategic level. In addition, some of the indicators could be applied at all levels (Circularity and Longevity (Figge et al., 2018), Added length of use for each activity and savings dimension's indicators). For instance, indicators in savings dimensions could be calculated at the strategic level by using the material flow capacity of CSC, and at the tactical level by using actual material flow quantity.

Figure 4.2 only proposes some examples of potential indicators related to each dimension. Note that some aggregated indicators could consider different dimensions. Our vision is that in order to have a meaningful assessment of CSC, either an appropriate global indicator to measure the circularity of a CSC should cover all the presented dimensions, or a multi-criteria approach is needed. However, the proposed indicators related to only one dimension are also helpful to give some insights in the comparison and assessment of CSCs. Moreover, these indicators could support the selection of CE activities (Lambert et al., 2011) in supply chain design. For example, a supply chain designer could compare the CE activities by the added length of use for each activity (figure (b) of the Figure 4.2).

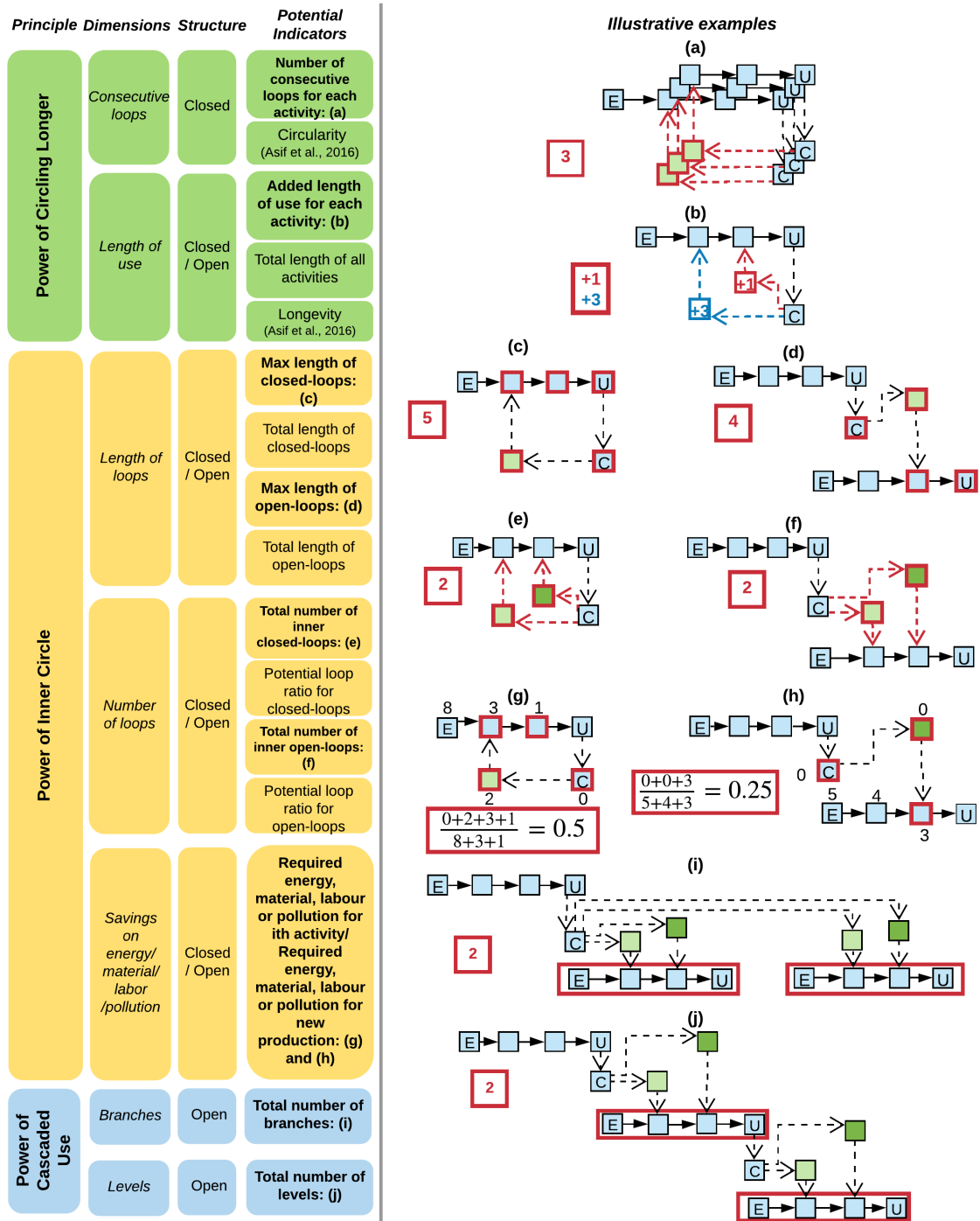

Figure 4.2: The classification tool of circularity indicators for Supply Chains

4.4 Classifying Existing Indicators through our Tool

In this section, we classify indicators from the literature to illustrate our classification tool. Numerous indicators that support only one proposed dimension are found in the literature. Some examples are given below:

- Length of use: Longevity (Figge et al., 2018) and Utility during use phase (Azevedo et al., 2017)
- Consecutive Loops: Circularity (Figge et al., 2018)
- Savings in pollution : Indicators used in LCA method
- Savings in material : Reuse ratio (Osiro et al., 2018) and Reusing rate of products/materials (Bilal et al., 2020)
- Savings in energy : energy consumption (Bilal et al., 2020) and recovered energy returned to the product (Ávila-Gutiérrez et al., 2019)
- Savings in labor: is not sufficiently taken into account. It is considered as the cost of rework in (Kazancoglu et al., 2018).

To the best of our knowledge, there is no indicator considering the length of loops or the number of loops dimensions. In the literature, some of the indicators consider several dimensions. We rely on the work of Saidani et al. (2017) to choose the indicators classified in Table 4.2.

Table 4.2: Classification of indicators that consider several dimensions

Indicator	Reference	The power of circling longer				The power of Inner cycle			
		Length of use	Consecutive loops	Length of loops	Number of loops	Savings on Material	Savings on Energy	Savings on Labor	Savings on Pollution
Resource productivity of industrial process	Liu et al. (2018a)					X	X	X	
Circularity material indicator Circ(T)	Pauliuk et al. (2017)					X			
Product-Level Circularity Metric (PCM)	Linder et al. (2017)					X		X	
Circular Economy Index (CEI)	Di Maio et al. (2015)					X			
Circularity Index (CI)	Cullen (2017)			X				X	
Material Circularity Indicator (MCI)	EMF (2015)			X		X			
Product Circularity Indicator	Bracquené et al. (2020)			X		X		X	
Combining Circularity and Longevity	Figge et al. (2018)			X		X			
Circularity Calculator (CC)	Pauw et al. (2021)					X			X
Hybrid LCA Model (HLCAM)	Genovese et al. (2017)			X		X		X	X

4.5 Conclusion

In this chapter, we have proposed a classification tool for CSC indicators based on EMF circular value creation principles. This tool can help academics to analyze existing or new circularity indicators according to CSC structures by using the proposed dimensions as classification criteria. It also facilitates supply chain managers categorizing and choosing appropriate circularity indicators to assess the circularity of CSCs. Moreover, we have proposed new potential circularity indicators along with some from the literature (e.g., Longevity) for each dimension in order to illustrate our classification tool. The proposed indicators could support strategic decisions such as selecting CE activities in supply chain design.

Nevertheless, this classification tool still needs some improvements. First, while developing this proposal, we do not include the fourth principle of EMF, which is the power of pure inputs. This principle deals with the design process of a product, which we consider out of the scope of the analysis of CSCs. The power of pure inputs also increases collection efficiency (EMF, 2013). Therefore, a new dimension could be set up to consider the collection and sorting efficiency indicators. Moreover, the design of products is a factor that influences the choice of implementation of CE activities. For example, with the eco-conception approach, the products could be designed for some special CE activities. In this context, Asif et al. (2016) proposed product design attributes such as reusability, remanufacturability, and recyclability indexes. These indexes could be helpful to determine a CSC structure as circular as possible (ideal case) according to the design of a product. Second, this classification tool does not include pure economic indicators and social sustainability indicators. Possible integration in the classification tool of these concepts will also be explored.

Moreover, proposed potential indicators consider only one dimension. To better assess the circularity in supply chains, a composite indicator or a multi-criteria approach is needed. In the next chapter (Chapter 5), we will further analyze existing indicators considering several dimensions mentioned in Table 4.2, and propose a composite indicator.

5

Assessing Circularity in Supply Chains: A Global Circularity Indicator

Contents

5.1 Introduction	53
5.2 Existing indicators and methods for CSCs and our positioning	53
5.3 Mathematical Representation of CSCs	54
5.4 Global Circularity Indicator	55
5.5 Calculation of Circularity Coefficient for Each Loop	60
5.6 A Web-Based Tool for Proposed Indicators: CircuSChain Calculator	63
5.7 Conclusion	64

In this chapter, we worked with Liu Zhenyu, who is a Master 1 student, for the development of CircuSChain Calculator, as a part of a research project (TER in french) of Master MIASHS (see: <https://lig-membres.imag.fr/PPerso/membres/pellier/doku.php?id=teaching:projets:ter>) at University Grenoble Alpes.

5.1 Introduction

In previous chapters, we have proposed a generic model for CSCs (Chapter 3) and a classification tool for circularity indicators of supply chains as well as some potential indicators (Chapter 4). In addition to these indicators, in this section, we propose a composite circularity indicator for supply chains considering multiple dimensions stated in Chapter 4. The positioning of this chapter among the rest of manuscript is represented in Figure 5.1, which zooms in on Figure 1.1.

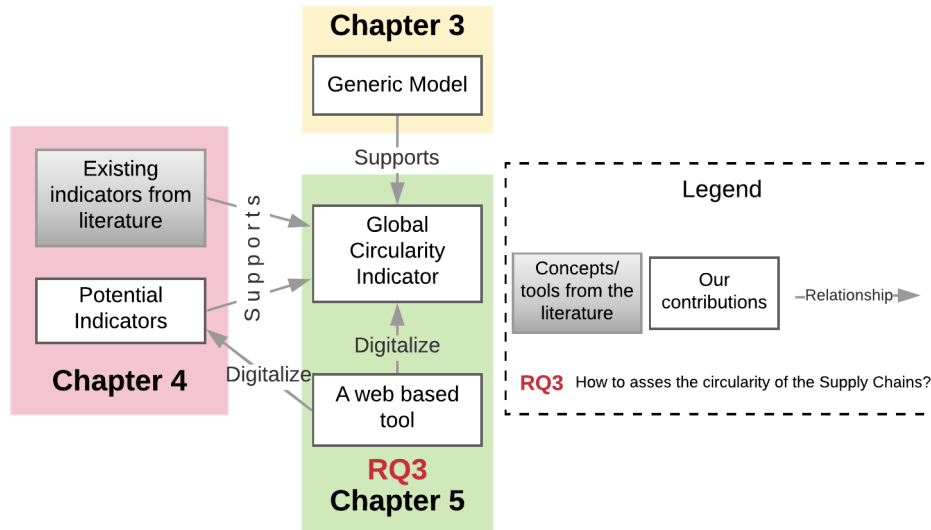

Figure 5.1: Positioning Chapter 5 among the rest of the manuscript

This chapter is structured as follows. Section 5.2 presents existing evaluation methods and indicators, as well as our positioning considering these works. Section 5.3 introduces the mathematical representation of the generic model of CSCs and the Global Circularity Indicator with its different versions. Section 5.6 presents a prototype of a web-based tool to calculate proposed indicators in this chapter and Chapter 4. Finally, Section 5.7 gives concluding remarks.

5.2 Existing indicators and methods for CSCs and our positioning

We first present some principal methods to assess CSCs found during our literature survey. These material-based methods allow modeling the system and are characterized as data acquisition methods (Stindt, 2017). Second, we analyze the indicators classified in Chapter 4, and position our approach.

Material Flow Analysis (MFA): It helps to visualize and account for material inputs and outputs throughout supply chains. This method allows the accounting of a material or substance across the entire system (Pauliuk et al., 2017). Through this method, CSCs with closed or open-loops could be modeled and assessed.

Life Cycle Assessment (LCA): It allows to assess environmental impacts of a product considering its all life cycle stages (from material extraction through disposal, including use stage). It accounts for different materials and resources in each process of the product-system (Pauliuk et al., 2017). It considers flows between processes as well as between the system and nature (e.g., pollution). The length of use dimension is considered in this methodology as a functional unit. Functional unit that quantifies the functionality of a product is used to compare different product-

systems.

Life Cycle Cost Assessment (LCCA) has the same approach as LCA. However, this method allows assessing the cost of a product-service system. It considers savings in material, energy and labor dimensions together by representing the cost of these resources (Barringer et al., 1995). This method also takes into account investment, training, research and development cost, etc.

In addition to these well-known approaches, we also consider some composite indicators based on material flows that allow assessing CSCs. These indicators are also classified in Chapter 4. Some of these indicators allow assessing only a specific scenario of CSC. For instance, Material Circularity Indicator (EMF, 2015), Product Circularity Indicator (Bracquené et al., 2020), Circularity Calculator (Pauw et al., 2021), Circular Economy Index (Di Maio et al., 2015), Circularity Index (Cullen, 2017), as well as Circularity, Longevity (Figge et al., 2018), Circularity Material Indicator (based on MaTrace) (Pauliuk et al., 2017) and Resource Productivity for industrial process (based on MFA) (Liu et al., 2018a) require some modifications in order to assess CSCs that are characterized and modeled in Chapter 3.

Besides, Product-Level Circularity Metric (Linder et al., 2017) is not based on a specific system or supply chain and allows the evaluation of all CSCs configurations. However, while calculating this indicator, the savings in labor, which is considered as a circularity dimension in our work does not influence the circularity. Therefore, this indicator does not sufficiently cover the circularity dimensions we defined. Indeed, none of these indicators considers all dimensions mentioned in Chapter 4.

Furthermore, in these works, open-loops are not sufficiently addressed. For example, material Circularity Indicator (EMF, 2015), Product-Level Circularity Metric (Linder et al., 2017), Circular Economy Index (Di Maio et al., 2015), and Circularity Calculator (Pauw et al., 2021) consider only open-loop recycling among open-loop activities.

Therefore, a new material flow-based indicator that supports all dimensions of circularity and allows the assessment of all CSC configurations, including open-loops, is needed. In this chapter, we propose the Global Circularity Indicator, which considers the length of use, length of loops, and savings dimensions.

We define a circularity coefficient for each CE activity considering one product and obtain the circularity of the supply chain by multiplying it by the number of products revaluated through the CE activity (flow capacity or flow quantity). Some existing indicators have the same approach. For example, Material Circularity Indicator (EMF, 2015) considers the number of produced products, while Circularity and Longevity (Figge et al., 2018) take into account the percentage of products that returned and revaluated through CE activities.

While defining circularity coefficient for savings dimension, we account resources for each activity in the loop, inspiring from LCA, MFA or LCCA. We take into account the amount of required resources to reevaluate a product by a CE activity, like Product-Level Circularity (Linder et al., 2017). Some existing indicators such as Circularity and Longevity (Figge et al., 2018), Circularity Calculator (Pauw et al., 2021) consider the amount of revaluated material, while some others take into account both required resources and the amount of revaluated material, such as Circularity Index (Cullen, 2017), Circular Economy Index (Di Maio et al., 2015), Material Circularity Indicator (EMF, 2015), Resource Productivity for industrial process (Liu et al., 2018a), Circularity Material Indicator (Pauliuk et al., 2017).

5.3 Mathematical Representation of CSCs

In this section, based on the generic model introduced in Chapter 3, we propose a mathematical representation of CSCs. This representation allows calculating the Global Circularity Indicator.

Here we do not use the names of activities anymore; we express them with parameters. Let A_j^i be the intermediate activity j of the supply chain of product i . Let $A_j^{i_1 i_2}$ be the CE activity j that provides to manufacture the product i_2 from the product i_1 , such that $(i_1, i_2) \in I^2$ and $j \in J$. If i_1 is equal to i_2 , the LoopType of the CE Activity $A_j^{i_1 i_2}$ is of closed type. Otherwise, the LoopType of the CE Activity is of open type, where product i_1 is repurposed in product i_2 . While I stands for the set of products/branches, J is the set of activities, and it determines the CEActivityType. For example, according to our hierarchy, A_1^{11} is more circular than A_2^{11} . The remaining mathematical notions are described in Table 5.1 and an example of CSC with its mathematical representation is given in Figure 5.2.

Mathematical Notion	Description
$I = \{1, \dots, m\}$	Set of products/branches
$J = \{1, \dots, n\}$	Set of activities
A_j^i	The intermediate activity j of the linear supply chain whose <i>branch</i> = i
$A_j^{i_1 i_2}$	The CE activity j (CEActivityType) that provides to manufacture the product of the supply chain with <i>branch</i> = i_2 from the product collected in the linear supply chain with <i>branch</i> = i_1 , such that $(i_1, i_2) \in I^2$ and $j \in J$.
C_i	Collection activity of the linear supply chain with <i>branch</i> = i
U_i	Use activity of the linear supply chain with <i>branch</i> = i
E_i	Extraction activity of the linear supply chain with <i>branch</i> = i
D_i	Disposal activity of the linear supply chain with <i>branch</i> = i
$L_j^{i_1 i_2}$	The loop starting with the collection activity C_{i_1} , including $A_j^{i_1 i_2}$, and connecting with $A_{j_2}^i$
$K_j^{i_1 i_2}$	<i>CircularityCoefficient</i> of the CE activity $A_j^{i_1 i_2}$.
K	Matrix of <i>CircularityCoefficient</i> such that $K_j^{i_1 i_2} \in K$
$z_j^{i_1 i_2}$	<i>Capacity</i> or <i>quantity</i> of the input reverse flow between C_{i_1} and $A_j^{i_1 i_2}$
Z	Matrix of flow <i>Capacity</i> or <i>quantity</i> , such that $z_j^{i_1 i_2} \in Z$
z_D^i	<i>Capacity</i> or <i>quantity</i> of the LinearFlow between C_i and D_i

Table 5.1: Mathematical Notions to represent CSCs

5.4 Global Circularity Indicator

Now, based on this mathematical representation of CSCs and on material flows, we can introduce the **Global Circularity Indicator (GCI)**. We define a circularity coefficient as stated in Chapter 3, for each CE activity considering one product, and obtain the circularity of the supply chain by multiplying it with the number of products reevaluated through the CE activity (flow capacity or quantity).

$z_j^{i_1 i_2}$, which represents the *capacity* or *quantity* of the input reverse flow between the collection C_{i_1} and CE activity $A_j^{i_1 i_2}$, is the element of the matrix Z . Matrix Z is represented in Figure 5.3. The horizontal ax represents activities $j \in J$. The diagonal ax called "Branches (S)" represents the branch of the linear supply chain source, where the products are collected. The vertical ax called "Branch (T)" is the branch of the linear supply chain target, where the return products are integrated into it. The size of the matrix is $m * n * m$. In this matrix, m is defined by the number of integrated linear supply chains in the CSC. The number n represents the number of potential CE activities of a linear supply chain. n depends on the number of intermediate activities of the target

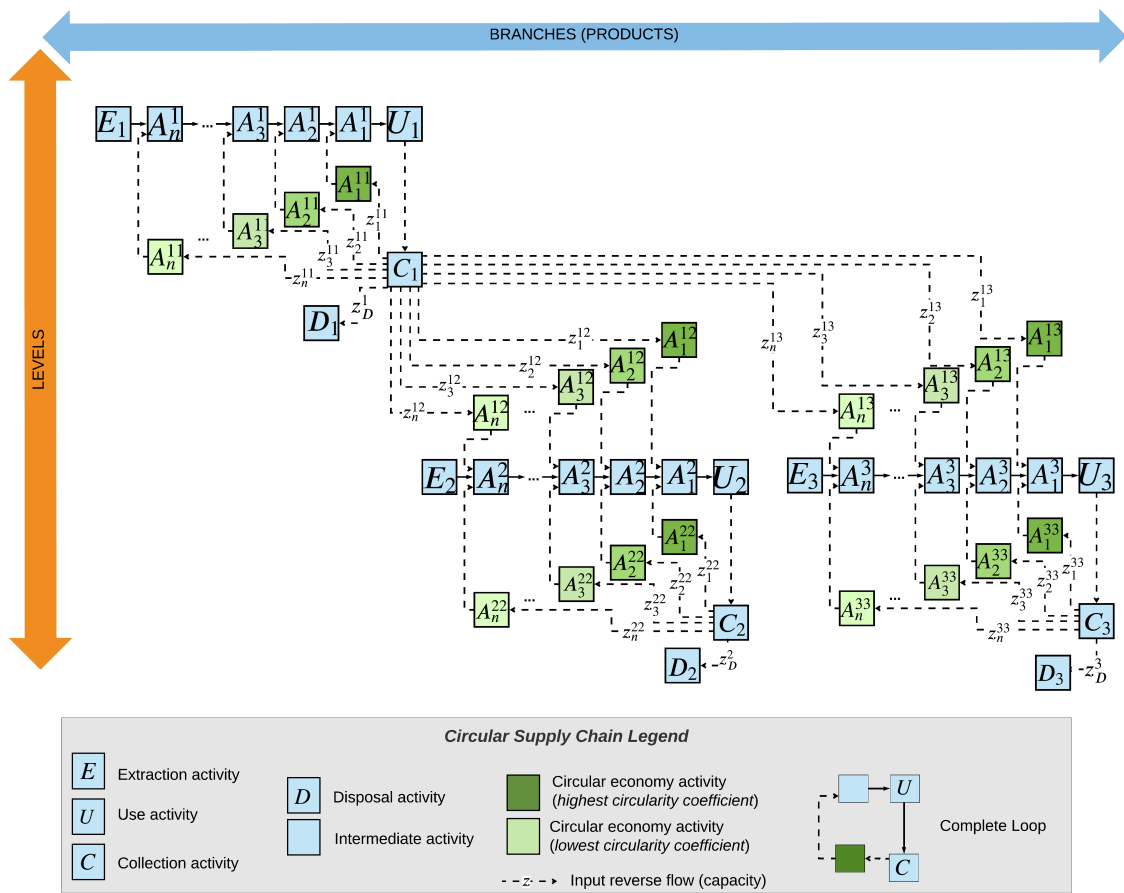

Figure 5.2: An example of mathematical representation of CSC

linear supply chain. Therefore, n is defined as the number of intermediate activities of the longest linear supply chain of within a global CSC.

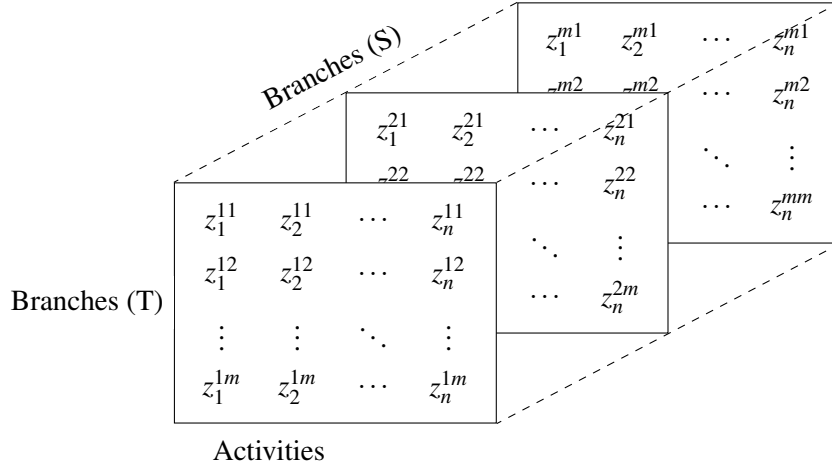

Figure 5.3: Matrix Z

Let K be the matrix of the *circularityCoefficient* of each CE activity $A_j^{i_1 i_2}$. $K_j^{i_1 i_2}$ represents the elements of matrix K . Matrix K is introduced in Figure 5.4, with the same axes as matrix z .

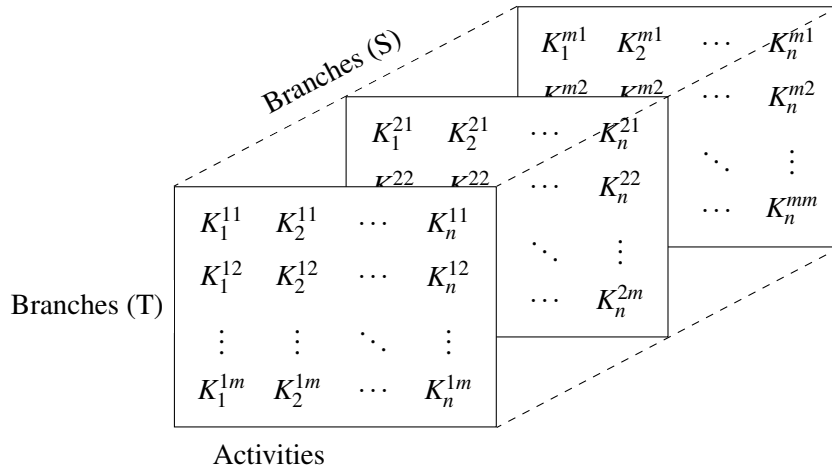

Figure 5.4: Matrix K

Let function $g_j^{i_1 i_2}$ describe the circularity of a loop $L_j^{i_1 i_2}$ based on the material flows (Matrix Z) and the circularity coefficient of activities (Matrix K). We assume that the relationship between the flow quantity or capacity and the circularity is linear; therefore, $g_j^{i_1 i_2}$ is expressed by Equation 5.1, where the $K_j^{i_1 i_2}$ is defined as a circularity coefficient for the CE activity $A_j^{i_1 i_2}$ and $z_j^{i_1 i_2}$ the material flow which goes through this CE activity.

$$g_j^{i_1 i_2} = K_j^{i_1 i_2} * z_j^{i_1 i_2} \quad (5.1)$$

In order to obtain the contribution of a loop $L_j^{i_1 i_2}$ to the circularity of the whole CSC, instead of evaluating each loop separately, we divide $g_j^{i_1 i_2}$ by the total quantity of all flows (N). The function $f_j^{i_1 i_2}$ that represents the contribution of a loop $L_j^{i_1 i_2}$ to the circularity of the whole CSC is expressed by Equation 5.2.

$$f_j^{i_1 i_2} = \frac{g_j^{i_1 i_2}}{N} = \frac{K_j^{i_1 i_2} * z_j^{i_1 i_2}}{N} \quad (5.2)$$

The factor N , which is the total amount of collected products, is expressed by Equation 5.3. The flows coming from the collection is split among the CE activities and the disposal activity. However, the disposal activity that brings any value is not considered in matrix K ; its circularity coefficient is considered null. Therefore, when we calculate N , we consider z_D^i the flow between C_i and D_i .

$$N = \sum_{i_1 \in I} \left(\sum_{i_2 \in I} \sum_{j \in J} z_j^{i_1 i_2} + z_D^{i_1} \right) \quad (5.3)$$

Thus, the f function is represented with the matrix $F = [f_j^{i_1 i_2}]$, where $f_j^{i_1 i_2}$ are elements of the matrix (Figure 5.5).

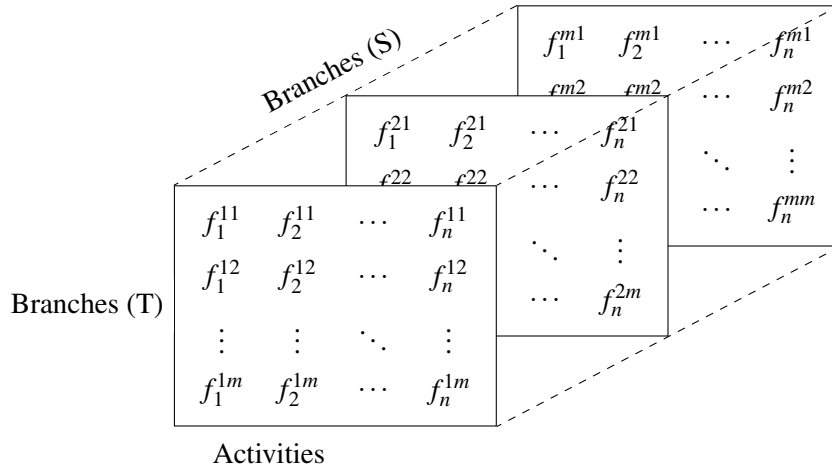

Figure 5.5: Matrix $[f_j^{i_1 i_2}]$

Function $f_j^{i_1 i_2}$ represents the contribution of loop $L_j^{i_1 i_2}$ to the circularity of CSC. Moreover, the function $f_*^{i_1}$ covers all the loops initiated from the collection activity C_{i_1} of source branch (S) i_1 . It considers the sum of the contribution of closed and open-loops sourced by the linear supply chain i_1 towards all other linear supply chains considered in the CSC. For each linear supply chain $i_1 \in I$, function $f_*^{i_1}$ is expressed by Equation 5.4.

$$f_*^{i_1} = \sum_{i_2 \in I} \sum_{j \in J} f_j^{i_1 i_2} \quad (5.4)$$

If we aim to calculate the contribution of all loops sourced by each linear supply chain, we could use vector $[f_*^{i_1}]$ (Figure 5.6).

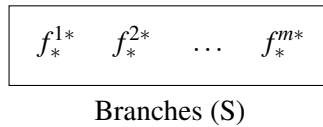

Figure 5.6: Vector $[f_*^{i_1}]$

If we aim at evaluating the whole CSC, we could use f_*^{**} . This function (expressed by Equation 5.5) creates a global circularity score for the whole CSC, by summing up the contribution of each loop to the circularity.

$$f_*^{**} = \sum_{i_1 \in I} \sum_{i_2 \in I} \sum_{j \in J} f_j^{i_1 i_2} \quad (5.5)$$

Average-Global Circularity Indicator

A CSC could consist of the integration of different supply chains. While calculating the GCI the contribution of the supply chains to the circularity of CSC is affected by the amount of the collected products. The reason for this effect is the N factor, which is considered as the denominator in function $f_j^{i_1 i_2}$. The quantity of collected products depends on many factors, such as product design and the performance of collection methods. In a scenario where the collected product amount varies significantly for the collection activities, we could use Average-Global Circularity Indicator (A-GCI), which is a version of GCI, in order to eliminate the effect of the collected product quantity.

A-GCI relies on function $g_j^{i_1 i_2}$ that represents the circularity of the loop $L_j^{i_1 i_2}$ (see Equation 5.1). The circularity of the supply chain part related to C_{i_1} is represented by function $g_*^{i_1}$ expressed by Equation 5.6.

$$g_*^{i_1} = \frac{\sum_{i_2 \in I} \sum_{j \in J} K_j^{i_1 i_2} * z_j^{i_1 i_2}}{N_{i_1}} = \frac{\sum_{i_2 \in I} \sum_{j \in J} g_j^{i_1 i_2}}{N_{i_1}} = \frac{f_*^{i_1}}{N_{i_1}} * N \quad (5.6)$$

In Equation 5.6, N_{i_1} is the total amount of products collected through C_{i_1} . This factor is expressed by Equation 5.7.

$$N_{i_1} = \sum_{j \in J} \sum_{i_2 \in I} z_j^{i_1 i_2} + z_D^{i_1} \quad (5.7)$$

Through function $g_*^{i_1}$, we obtain the circularity of the supply chain part related to C_{i_1} independently. The Circularity of the whole CSC through A-GCI is calculated as the average of the circularity of all CSC parts. Function g_*^{**} that represents A-GCI is calculated by summing the circularity of each CSC part related to C_{i_1} and dividing by the number of branches (m). Therefore, the circularity of each CSC part contributes equally to the global circularity of CSC; it is not affected by the amount of collected products. Function g_*^{**} is expressed by Equation 5.8.

$$g_*^{**} = \frac{\sum_{i_1 \in I} g_*^{i_1}}{m} \quad (5.8)$$

Example

In order to illustrate the differences between GCI and A-GCI, an example is given in Figure 5.7, where the matrices K and Z are also represented.

The circularity of the CSC part related to C_1 is 0.84 calculated through function g_*^{1*} as expressed by Equation 5.9.

$$g_*^{1*} = \frac{5 + 1.6 + 1.8 + 0.8}{2 + 5 + 1 + 2 + 1} = 0.84. \quad (5.9)$$

The circularity of the CSC part related to C_2 is 0.23 calculated through function g_*^{2*} as expressed in Equation 5.10.

$$g_*^{2*} = \frac{300 + 0 + 0 + 0}{1000 + 300} = 0.23. \quad (5.10)$$

The A-GCI of the whole CSC is 0.54, calculated as the mean of g_*^{1*} and g_*^{2*} (see Equation 5.11). Within this approach, each CSC part contributes equally to the circularity of the whole CSC.

$$g_*^{**} = \frac{0.84 + 0.23}{2} = 0.54. \quad (5.11)$$

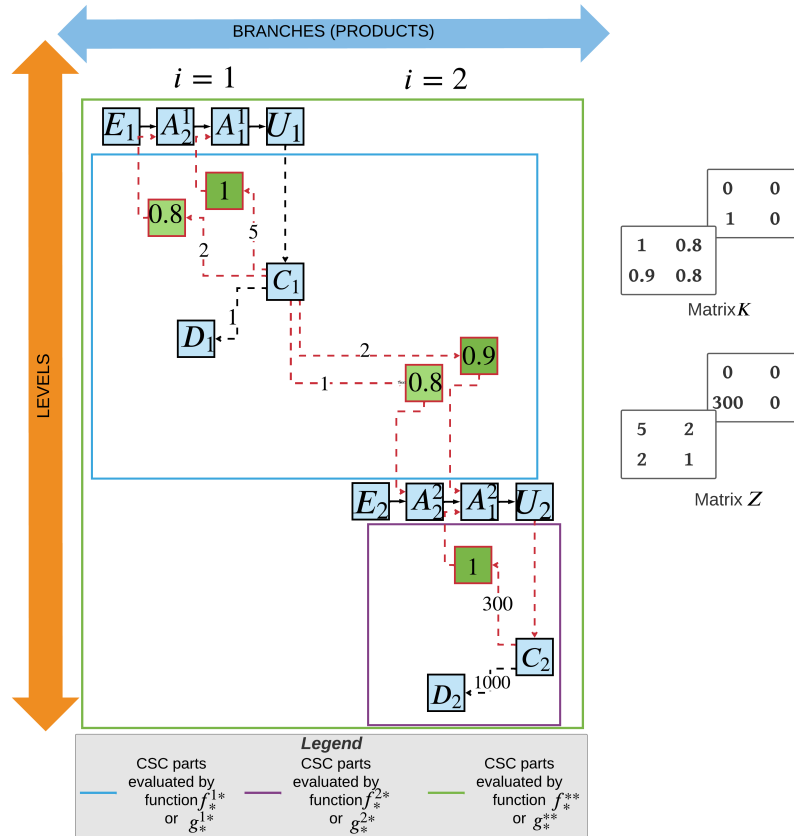

Figure 5.7: Example

Moreover, the GCI of the whole CSC is 0.24 calculated using Equation 5.12. Within this approach, the global circularity of the entire CSC is very close to the circularity of the CSC part related to C_2 (calculated through g_2^{2*}), since the contribution to the circularity of CSC parts is affected by the amount of collected products. In this example, the collected product quantity through C_2 is much more than C_1 .

$$f_3^{3*} = \frac{5 + 1.6 + 1.8 + 0.8 + 300}{2 + 5 + 1 + 2 + 1 + 300 + 1000} = 0.24. \quad (5.12)$$

5.5 Calculation of Circularity Coefficient for Each Loop

The circularity coefficient K could be expressed in different ways. In the generic model proposed in Chapter 3, the circularity coefficient is expressed by green gradient based on the Hierarchical Framework. According to this hierarchy, we could grade the CE activities and define a value for them (e.g. 1 for reuse activity, 0.8 for refurbishing activity, etc.). However, in order to give a more precise value for the circularity coefficient, we rely on proposed dimensions for the power of inner circle principle in Chapter 4. We explain how to express the circularity coefficient based on savings, length of use and length of loops dimension since these three concerns directly the CE activity. The other dimensions proposed in Chapter 4.2 relate to the whole supply chain structure, i.e., consecutive loops, number of loops, branches, and levels.

Circularity Coefficient Based on Savings Dimensions

Parameter	Description
m_c^i	The required amount of material for C_i
m_e^i	The required amount of material for E_i
m_j^i	The required amount of material for A_j^i
$m_j^{i_1 i_2}$	The required amount of material for $A_j^{i_1 i_2}$
e_c^i	The required amount of energy for C_i
e_e^i	The required amount of energy for E_i
e_j^i	The required amount of energy for A_j^i
$e_j^{i_1 i_2}$	The required amount of energy for $A_j^{i_1 i_2}$
w_c^i	The required amount of labor (work) for C_i
w_e^i	The required amount of labor (work) for E_i
w_j^i	The required amount of labor (work) for A_j^i
$w_j^{i_1 i_2}$	The required amount of labor (work) for $A_j^{i_1 i_2}$
p_c^i	The amount of pollution emitted by C_i
p_e^i	The amount of pollution emitted by E_i
p_j^i	The amount of pollution emitted by A_j^i
$p_j^{i_1 i_2}$	The amount of pollution emitted by $A_j^{i_1 i_2}$
u^i	The length of use of a new product produced in linear supply chain i
$u_j^{i_1 i_2}$	The length of use of the new product produced through the loop $L_j^{i_1 i_2}$

Table 5.2: Variables to calculate Circularity Coefficient

Here, the circularity coefficient of each CE activity is calculated based on savings in terms of material, energy, labor and pollution, and length of use. In order to calculate the circularity coefficient, we introduce more parameters represented in Table 5.2.

We suppose that each activity in a CSC (except use activity) requires some resources (material, energy and labor) and emits pollution. The circularity coefficient is expressed as the savings made by producing a product through a CE activity instead of producing a product from zero. These savings are normalized by dividing by required resources or emitted pollution for a product produced from zero. Because in a CSC we consider different product types that could require a different amount of resources and emit a different quantity of pollution.

For each aforementioned dimension, a separate indicator is calculated. For instance, savings in materials is calculated by the difference between the required material for a new production of product i_2 and the required material for the loop $L_j^{i_1 i_2}$ that allows producing product i_2 by revaluing used product i_1 . Moreover, we divide this difference by the required material amount (product weight) for a new production of product i_2 in order to normalize it and eliminate the effect of product weight. For example, in order to calculate GCI_{energy} , we determine K for each activity $A_j^{i_1 i_2}$ as follows.

$$K_j^{i_1 i_2} = \frac{e_e^{i_1} + \sum_{j \in J} e_j^{i_1} - (e_c^{i_1} + e_j^{i_1 i_2} + \sum_{j=1}^{j'} e_j^{i_2})}{e_e^{i_1} + \sum_{j \in J} e_j^{i_1}} \quad (5.13)$$

An example is given in Figure 5.8, with one closed and one open-loop. K value is calculated for savings on energy. The values are created arbitrarily. K_1^{11} is calculated as follows:

$$K_1^{11} = \frac{5 + 6 + 2 - (2 + 1 + 2)}{5 + 6 + 2} = 0.62. \quad (5.14)$$

K_3^{12} is calculated as follows:

$$K_3^{12} = \frac{6 + 2 + 2 + 1 - (2 + 2 + 2 + 2 + 1)}{6 + 2 + 2 + 1} = 0.18. \quad (5.15)$$

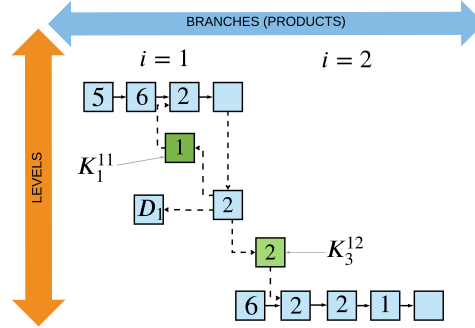

Figure 5.8: An example illustrating calculation of K based on savings on energy

While calculating the required amount for loop $L_{j'}^{i_1 i_2}$, we consider the required resources (material, energy, or labor) or emitted pollution related to the collection activity of linear supply chain i_1 (C_{i_1}) and the CE activity ($A_{j'}^{i_1 i_2}$), whose circularity coefficient is aimed to calculate. In addition, the required amount for some of the intermediate activities of linear supply chain i_2 is included. Since the CE activity $A_{j'}^{i_1 i_2}$ integrates into the linear supply chain i_2 at the intermediate activity $A_{j'}^{i_2}$, the intermediate activities such that $j \leq j'$ are added in the formula. Since the smaller required resource for CE activity brings more circularity, the smaller the K value, the greater the circularity.

However, $K_j^{i_1 i_2}$ value could be negative when the required resource for new production is smaller than the required resource to reevaluate the used product. In a scenario where the CSC is evaluated according to only one savings dimension, having a CE activity who has a negative $K_j^{i_1 i_2}$ is nonsense. However, for a scenario where the CSC is evaluated according to multiple dimensions, a CE activity could have a negative $K_j^{i_1 i_2}$ value for a dimension, while it has positive $K_j^{i_1 i_2}$ values for other dimensions.

Contrary to MCI or Circularity Calculator, while calculating savings in material, we do not consider the material quantity that is kept in use. In our indicator, the amount of required material to reevaluate a used product is taken into account. We suppose that each activity could require an amount of material in addition to the main material flow starting from material extraction through use activity. For instance, in order to reuse a product, packaging material could be required. In the generic model, these flows are not represented due to simplicity reasons.

Circularity Coefficient Based on the Length of Use Dimension

Circularity Coefficient based on length of use dimension ($K_{lengthofuse}$) is calculated differently since the length of use concerns only the use activity. Here, we use the added length of use for each activity indicator proposed in Chapter 4. $K_{lengthofuse}$ is expressed as the ratio of the length of use of the product produced through linear supply chain i_2 to the length of use obtained through $A_j^{i_1 i_2}$ (added length of use). Contrary to the K calculated based on savings, the value for CE activity is the denominator in this formula. Because, the more added length of use, the greater the circularity. The formula is represented as follows:

$$K_j^{i_1 i_2} = \frac{u_j^{i_1 i_2}}{u^{i_2}}. \quad (5.16)$$

Circularity Coefficient based on Length of Loops Dimension

Considering the power of inner circle principle, the circularity coefficient of a CE activity could be expressed by the length of the loop related to this activity. In case of a lack of the required data (e.g. required resources for each activity, length of use, etc.), the circularity coefficient could be determined by the length of the loop. In Section 4.3, the maximum length of loops is proposed as a potential indicator, calculated by counting the number of activities in each loop. Here, we can use the same approach to express the circularity coefficient of each activity.

The CE activity $A_j^{i_1 i_2}$ integrates into the linear supply chain i_2 at the intermediate activity $A_j^{i_2}$. Therefore, the intermediate activities $A_j^{i_2}$, such that $j \in \{1, 2, \dots, j\}$ are included in the loop $L_j^{i_1 i_2}$. Apart from these linear activities, three activities $A_j^{i_1 i_2}$, C_{i_2} , and U_{i_2} (see Table 5.1) are added to the corresponding loop. Therefore, the length of loop of the $L_j^{i_1 i_2}$ could be expressed as $j + 3$. However, since a higher number of activities implies less circularity, we use the multiplicative inverse of the length of the loop. Therefore, the circularity coefficient of activity $A_j^{i_1 i_2}$ ($K_j^{i_1 i_2}$) is expressed as follows:

$$K_j^{i_1 i_2} = \frac{1}{j + 3} \quad (5.17)$$

After defining K for all CE activities, the Global Circularity Indicator for one dimension is calculated in the manner explained above.

5.6 A Web-Based Tool for Proposed Indicators: CircuSChain Calculator

In this section, we present a prototype of a web-based tool to calculate the proposed circularity indicators presented in Chapter 4 and using the mathematical formulas given in the previous sections of this chapter.

As a part of a research project (TER in french) of Master MIASHS¹ at University Grenoble Alpes, we worked with Liu Zhenyu, who is a Master 1 student, for the development of CircuSChain Calculator.

CircuSChain (Circular Supply Chain) Calculator allows two main functions: (1) configuration of CSCs and (2) calculation of selected indicators. In order to configure a CSC, the user was asked to insert the number of linear supply chains that are integrated (number of branches). Here, for simplicity reasons, we do not include the levels. Then, the user inserts the number of intermediate activities for each linear supply chain. The program shows a CSC network with all the possible CE activities at the end of these steps. For instance, a CSC with two linear supply chains, which have respectively two and three intermediate activities, is represented as in Figure 5.9.

Here, the user could further modify the CSC by choosing the CE activities present in the CSC to be evaluated. By clicking on (x) buttons (Figure 5.9), the user can deactivate the CE activity that does not exist in the CSC to be evaluated.

After configuring the CSC, the CircuSChain Calculator allows the calculation of the proposed circularity indicators. The indicators proposed in Chapter 4 are regrouped under the name 'Structural Indicators' in the calculator. These indicators could express the circularity of a CSC by only examining the created structure of CSC. Moreover, the Global Circularity Indicator based on length of loops dimension is considered in this group.

¹<https://lig-membres.imag.fr/PPerso/membres/pellier/doku.php?id=teaching:projets:ter>

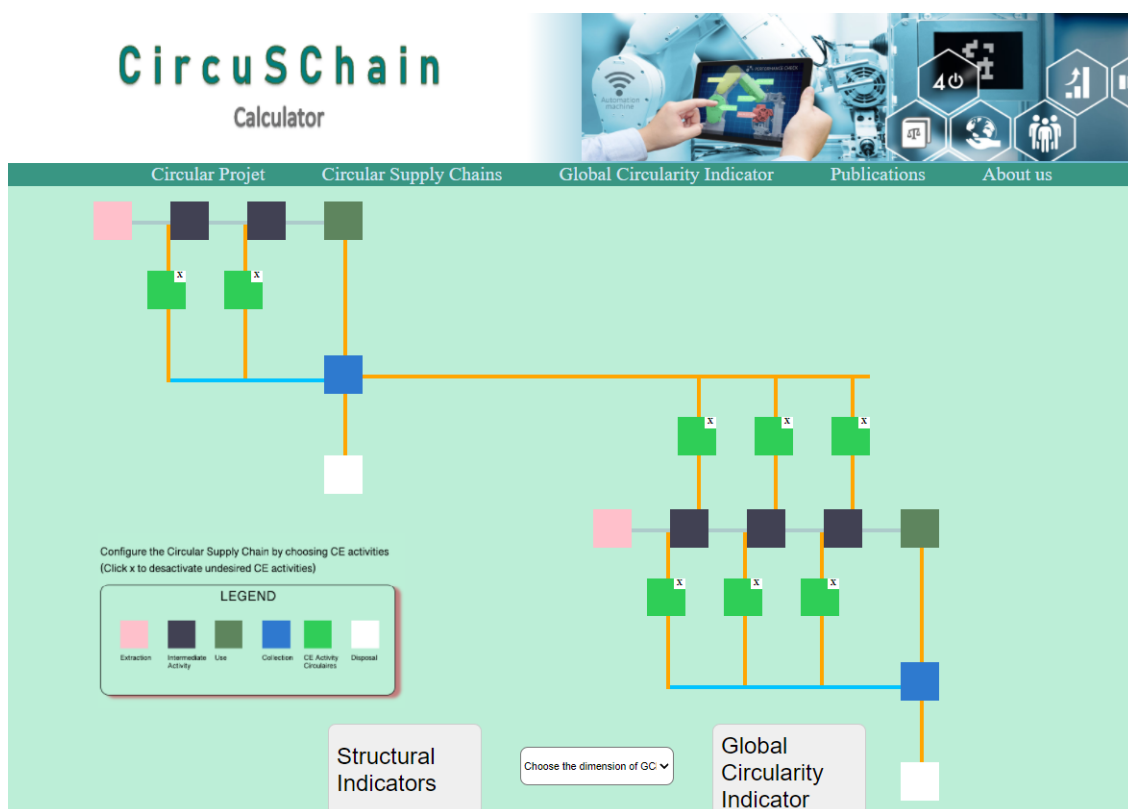

Figure 5.9: A CSC with two linear supply chains with all possible CE activities

In order to calculate the Global Circularity Indicator within savings and length of use dimensions, the user should select the dimension and insert values. However, Structural Indicators can be calculated automatically on demand.

5.7 Conclusion

In this chapter, we have proposed a GCI in order to assess the circularity of supply chains. This indicator is based on the circularity coefficient of a CE activity for one product and the number of products reevaluated through this activity. The circularity coefficient is calculated relying on savings and length of use dimensions. It is also possible to calculate it considering the length of loops dimension. We also propose a prototype of web-based tool for GCI and potential indicators proposed in Chapter 4.

Implications for theory and practice

The Global Circularity Indicator is based on our generic model 3 and allows assessing different CSC configurations without requiring modifications in the formulas. CSCs could then be modeled through the generic model and assessed through the GCI. Our indicator supports also all potential open-loop CE activities. In addition, through the circularity coefficients, the GCI could also support the selection of CE activities, which is a strategic level decision for supply chains (Lambert et al., 2011). It supports the length of use and length of loops dimensions as well as all savings dimensions.

Limitations and future works

However, our GCI has some limitations. It does not allow yet measuring the contribution of each actor to the circularity of a CSC, although it gives insights into the contribution of different CSC parts. It does not take into account consecutive loops dimension. However, this dimension could be considered in the formula inspiring from (Figue et al., 2018). Furthermore, we can currently calculate a separate GCI indicator for each dimension. In order to have a global vision, a multi-criteria approach or an aggregation method could be helpful. Finally, an experimental study is needed in order to evaluate and validate our indicator.

6

A Serious Game for Circular Supply Chains

Contents

6.1	Introduction	68
6.2	Background	68
6.2.1	Beer Distribution Game	68
6.2.2	Serious Games related to the Circular Supply Chains	69
6.3	Methodology	69
6.4	CircuSChain Game	71
6.4.1	Game Description	71
6.4.2	Game Flows	72
6.5	Experiment and Analysis	77
6.6	Conclusion	80

In this chapter, we worked with Soufiane Kaddouri, as a part of a research internship of Industrial Engineering Master at Grenoble INP ([Kaddouri, 2021](#)), as well as Abdessalem Tebbikh, Idir Nait-Ali, and Sami Bouhroum as a part of excellence internship at Univeristé Grenoble Alpes.

Related publication: Kurt, A., Cortes-Cornax, M., Cung, V.-D., Mangione, F., & Kaddouri, S. (2022). CircuSChain Game: A serious game to explore circular supply chains. In Handbook of Research on Promoting Economic and Social Development Through Serious Games. IGI Globale. (Accepted).

6.1 Introduction

This chapter addresses research question RQ4: How to raise awareness and increase the knowledge about CSCs using the proposed tools? The transition from linear supply chains to CSCs is challenging for companies due to the insufficient knowledge and awareness among supply chain members (Govindan & Hasanagic, 2018; Mangla et al., 2018) and customers (Vermunt et al., 2019), as well as lack of appropriate training and development programs about CE for supply chain members (Mangla et al., 2018).

Besides, serious games have been used in training in business and management areas since the 1950s and 1960s (Qualters et al., 2008). The serious games that combine gaming and learning (Neck & Greene, 2011) help participants learn decision-making in complex systems (Qualters et al., 2008). Scholars stated as well the advantages of serious games for attracting students' attention and helping them retain the acquired knowledge (Madani et al., 2017). Moreover, serious games could be a way to increase environmental awareness (Ponce et al., 2020).

Therefore, in order to overcome the challenges due to the insufficient knowledge and awareness about CSCs, we develop a serious game named CircuSChain (Circular Supply Chain) Game, based on the well-known Beer Distribution Game (Sternan, 1989). The game is tested by an experiment with industrial engineering students. CircuSChain Game considers proposed CSC characteristics and the Generic Model (Chapter 3).

This chapter is structured as follows. Section 6.2 presents the background of the work. Section 6.3 gives the adopted methodology. The CircuSChain Game is introduced in Section 6.4 with its characteristics and the game flows. Section 6.5 presents the experiment, as well as its analysis. Finally, Section 6.6 gives some concluding remarks.

6.2 Background

First, the Beer Distribution Game is introduced since the CircuSChain Game is based on this game. Second, some related serious games about CSCs from literature are presented to show that there are only a few Serious Games related to CSC, and none of them consider all the CSCs characteristics we have defined in our generic model in Chapter 3.

6.2.1 Beer Distribution Game

The serious game developed in this chapter is based on the « Beer Distribution Game » created in the 1960s. The Beer Distribution Game has board and computer game versions. This game illustrates the bullwhip effect in supply chains. Through this game, material and information flow in a linear supply chain are simulated (Metters, 1997).

The Beer Distribution Game is played by four players: a retailer, a wholesaler, a distributor, and a factory. Final customer orders are satisfied by the retailer, who receives products from the wholesaler. The wholesaler orders from the distributor and sends products to the retailer. The distributor, who is supplied from the factory, ships products to the wholesaler. The factory produces the products. In each period, the supply chain members decide the quantity to order from their suppliers, and the factory decides how much to produce. Players take into consideration the inventory and backlog cost. There is one period of shipping and order receiving delays. In the Beer Distribution Game, materials flow from upstream to downstream actors, and information moves in the reverse direction via material flows, like real supply chains.

6.2.2 Serious Games related to the Circular Supply Chains

Some Serious Games from related concepts, such as Closed-Loop Supply Chains or Sustainable Supply Chains are also included in this section. Table 6.1 presents selected serious games and their contents.

Serious Game	Reference	Concept
Chain of Command and Looper	Aguiar et al. (2018); Cuesta & Nakano (2017)	Environment: Closed-loop Supply Chain, recycle remanufacturing, CO ² emissions, government environmental regulations, and investment in green technologies. Economic: Supply chain optimization through lead times and production efficiency Social: Ethics between firms Risk management: Supply risk mitigation
In The Loop	Whalen et al. (2018)	Material criticality CE concepts (Product as service, maintenance, repair, reuse, remanufacturing, refurbishing) Other potential solutions (Diversify supply chain or increase supply chain transparency, material substitution, invest in new technologies, etc.)
Shortfall	Sivak et al. (2007)	Environment: Waste disposal, recovery, and recycling
CircuSChain Game	Our proposition	Economic: Profit CE concepts: CO ² emissions, reuse, refurbishing, remanufacturing, recycling, and repurposing Material scarcity Economic: Profit

Table 6.1: Serious games about the CE

As seen in Table 6.1, repurposing activities or open-loops are not considered by these games. However, repurposing activities and their related open-loops constitute a new potential for CSCs. Moreover, these works complement our work since they consider other approaches, such as social, risk (Aguiar et al., 2018; Cuesta & Nakano, 2017), new technologies, and material substitution (Whalen et al., 2018).

6.3 Methodology

CircuSChain Game is designed based on Beer Distribution Game and our generic model. Our methodology is represented in Figure 6.1, which zooms in on Figure 1.1.

As suggested by Carrión-Toro et al. (2020), the development of serious games requires a specific design methodology. In this article, the authors mentioned several serious game design methodologies, such as (Avila-Pesantez et al., 2019; Jiménez-Hernández et al., 2016; Marfisi-Schottman et al., 2010). Since the CircuSChain Game is a board game, the seven steps methodology proposed by Marfisi-Schottman et al. (2010) that is designed for both digital and board games has been chosen. The other methodologies mainly target video/digital games. Besides, this methodology suits CircuSChain Game better because it contains a pedagogical quality control step for board games that allows determining the game parameters and testing the game during the design phase.

Since the developed game is based on the Beer Distribution Game, the elements of this previous game are maintained in some steps. The seven steps of the adopted methodology can be stated as follows:

Step 1: concerns the determination of the pedagogical objectives. Note that the objectives of the CircuSChain Game are different from those of the Beer Distribution Game (bullwhip effect, inventory management, order and transport lead-times, etc.). Through the CircuSChain

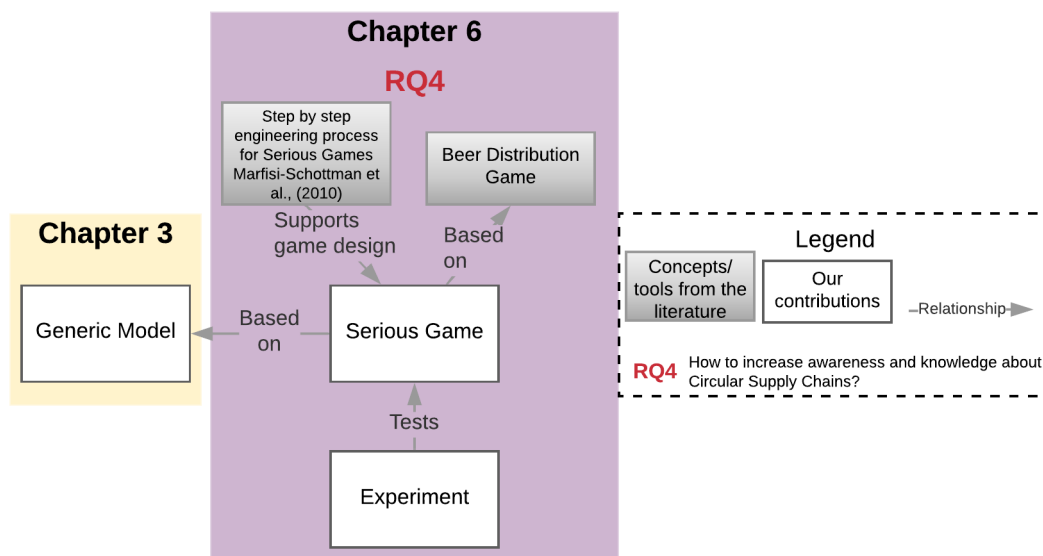

Figure 6.1: Our methodology for the development of the CircuSChain Game

Game, we aim to raise knowledge and awareness of: (1) circularity and the importance of circular activities in CSCs, (2) natural resource depletion, and (3) CO² footprints.

- Step 2: is about choosing a predefined model for serious games such as board games, investigation games, puzzles, etc. We chose a board game (Figure 6.2) supported by a shared calculation spreadsheet as in the Beer Distribution Game.
- Step 3: gives the general description of the scenario and the virtual environment. This step determines the elements such as characters, storyline, etc. For example, compared with the Beer Distribution Game, we change the storyline by adding circular scenarios (i.e., closed-loop and open-loop reuse, refurbishing, remanufacturing, and recycling) and a new character who manages reverse logistics related to circular scenarios.
- Step 4: is about searching for reusable software components. For the moment, the only software component of this game is a shared calculation spreadsheet inspired by [Aguiar et al. \(2018\)](#) that manages the players' decisions and compute indicators. However, for the development of the digital version of the game, this step would be further considered to increase automation.
- Step 5: consists of describing the details of the scenario. Here, the flows and the players' interactions with the game are described. For instance, how to simulate the uncertain quantity of raw materials and collected products, the uncertain quality of the collected products, as well as what and in which order will be players' decisions are determined.
- Step 6: addresses pedagogical quality control, which aims at minimizing the testing processes. In this step, simulate different scenarios are simulated using the calculation spreadsheets in order to define the initial state of the game as well as to define the different thresholds concerning parameters of the game, players' decisions, and adequacy to the pedagogical objectives.
- Step 7: precises game specifications for subcontractors of the game development process such as graphic designer, sound manager, etc. We are currently developing a tool prototype to study the possibility of providing more flexibility to the supply chain configuration and the game rounds. Since the game is still a prototype, we still do not have subcontractors. This step will be completed when a digital version of the game will be established.

6.4 CircuSChain Game

In this section, the CircuSChain Game is described within its key characteristics and the game flow is explained.

6.4.1 Game Description

In order to present the CircuSChain Game, we rely on the characterization proposed by [Madani et al. \(2017\)](#), diving it into different vital points such as the theme, the player's role, or the number of players. Below, the different characteristics of the CircuSChain Game are presented:

Theme: The theme of the CircuSChain Game is CSCs. The game is based on a modular product CSC, such as electric and electronic equipment. Therefore, this supply chain is composed of activities such as material extraction, part manufacturing, module manufacturing, product manufacturing, distribution, use, collection, and the different closed or open-loop CE activities (reuse, refurbishing, remanufacturing, and recycling). The CSC structure is based on the Generic Model (Chapter 3).

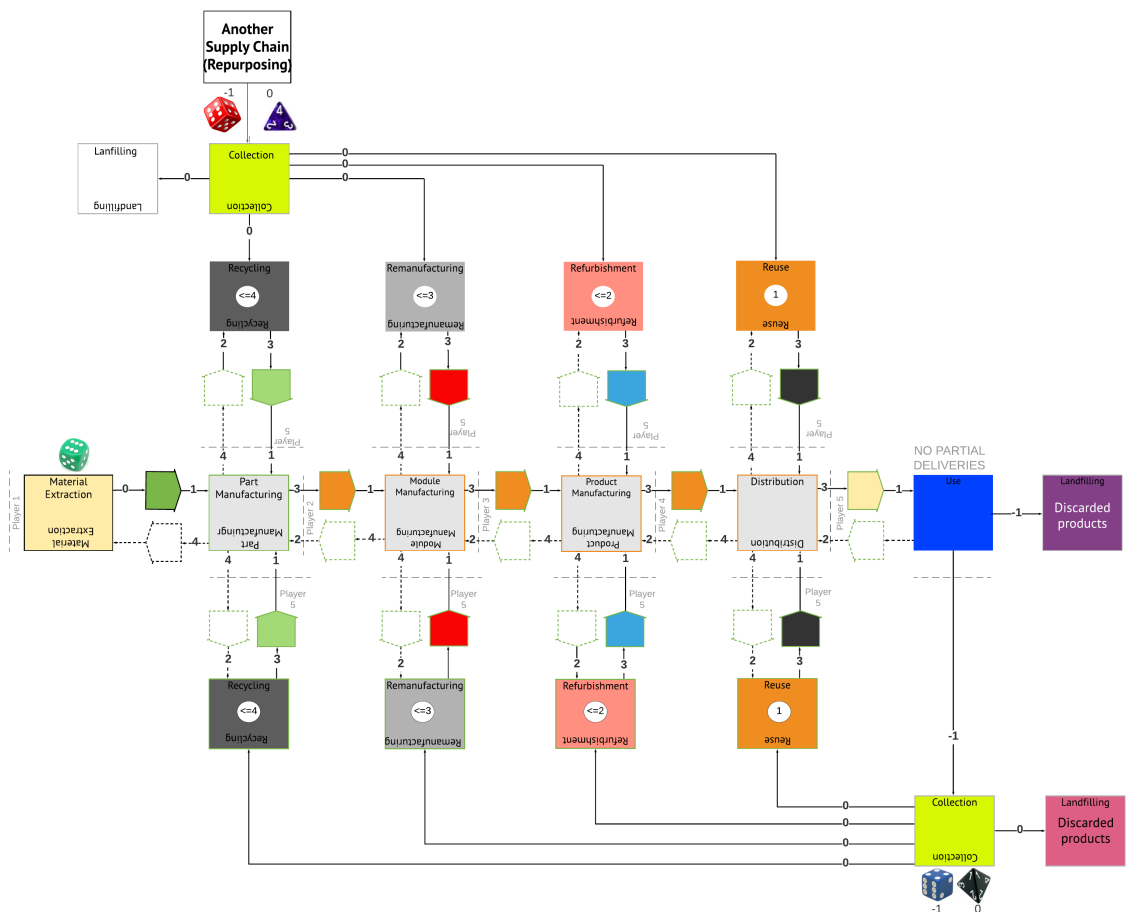

Figure 6.2: Board of the CircuSChain Game with all possible CE activities

Player's role: The players' roles vary slightly from the Beer Distribution Game. They represent supply chain actors: the material extractor, the part manufacturer, the module manufacturer, the product manufacturer, the user. Note that the actors map with the aforementioned activities, each player is considered to be the customer of the player on upstream of the material flow. Reversely, each player is the supplier of the downstream player. Like in the Beer Dis-

tribution Game, the players control the material flow (production and transportation) and information flow (demands).

Number of players: The CircuSChain Game is designed as a team game. Each team is constituted of at most five members.

Game objective: Each team has a global but multi-criteria objective, which is to minimize CO² emissions, extracted natural resources and discarded products, as well as make an economic profit by fulfilling user orders and minimizing costs. While selecting indicators, we exploit the indicators classified with our classification tool in Chapter 5. The selected indicators are the profit, the circularity rate (Cullen, 2017), the quantity of CO² emissions, the quantity of natural resources consumed, and the quantity of discarded products. The profit is calculated considering inventory, production, shipping, missing sales, and inventory costs, as well as revenue coming from sold products.

Participants: Our main target groups are students and supply chain professionals. Potentially, the game could target other persons interested in the role of CSC within the CE.

Type of game: Our game is designed as a board game supported by a collaborative calculation spreadsheet. Thanks to the latter, players indicate in their own tab their respective demands to suppliers. Moreover, different automatic calculations provide the computation of the aforementioned indicators based on production and inventory management. Indeed, it could be considered as a hybrid simulation game since it is designed as a board game that uses computer simulation to obtain results.

Graphics: A playing board is designed for CircuSChain Game. As seen in Figure 6.2, the board contains an inventory-manufacturing rectangle for each player. These rectangles are called with the name of the activity, such as material extraction, use landfilling, etc. Between these inventory-manufacturing rectangles of each player, the transport and demand arrows are placed to simulate material and information flows between the CSC actors. We design a game board with a modular structure in order to modify the structure of the supply chain. This structure eases transforming the linear supply chain in CSC by plugging the collection and the selected CE activities into the linear supply chain.

6.4.2 Game Flows

As Beer Distribution Game, there is one period of delay in material and information flows. In the CircuSChain Game, in order to simulate the products, tokens are used. The total raw materials available for the extraction are limited for the whole game. Additionally, the available quantity of raw materials is considered limited and uncertain for each round. It is simulated by a 6-sided dice. The demands are represented by cards filled by players (and noted in their respective calculation spreadsheet's tab). Final customer order quantities represented by order cards are drawn at random and unknown to the players at the beginning of each round, represented by order cards.

The first version of the CircuSChain Game is played in three years. Each year has six rounds that represent a period of two months. This division is justified thanks to previous simulations and tests in order to fit in a three-hour session. During each year, the players manage the material and information flows (demands). The game flows in each year are explained below.

First Year Simulation: Linear Supply Chain

In the first year, the players manage a linear supply chain as in the Beer Distribution Game. The game board of this year is represented in Figure 6.3. This year is designed in order to learn the game flows and raise awareness of natural resource depletion and CO² emissions.

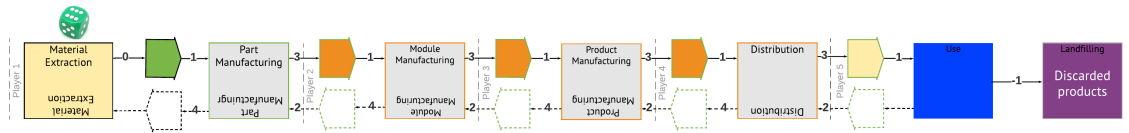

Figure 6.3: The game board for the first year of CircuSChain Game

The steps to follow in each round are explained in round flow cards (Figure 6.4). In order to facilitate the game, the steps described in these cards are also represented by numbers on the board (Figure 6.3).

At each round, each player takes the delivery of the products that are waiting in the transport arrow (colorful arrows) by shifting the tokens towards their procurement-manufacturing rectangle (Step 1). Then, each player checks her/his customer's demand card (Step 2) that is located in the demand arrow (white arrows) and sends the products towards the transport arrow between the player and her/his customer (Step 3). Afterwards, each player fills the demand card and puts it to the demand arrow (Step 4) as a demand order for her/his supplier. The member (Player 1) who plays the material extractor role has an additional step, which is to determine the raw material availability of the round by rolling the dice (Step 0). Player 5, who plays the user role, has only one step this year, which consists in receiving materials from the supplier (Step 1).

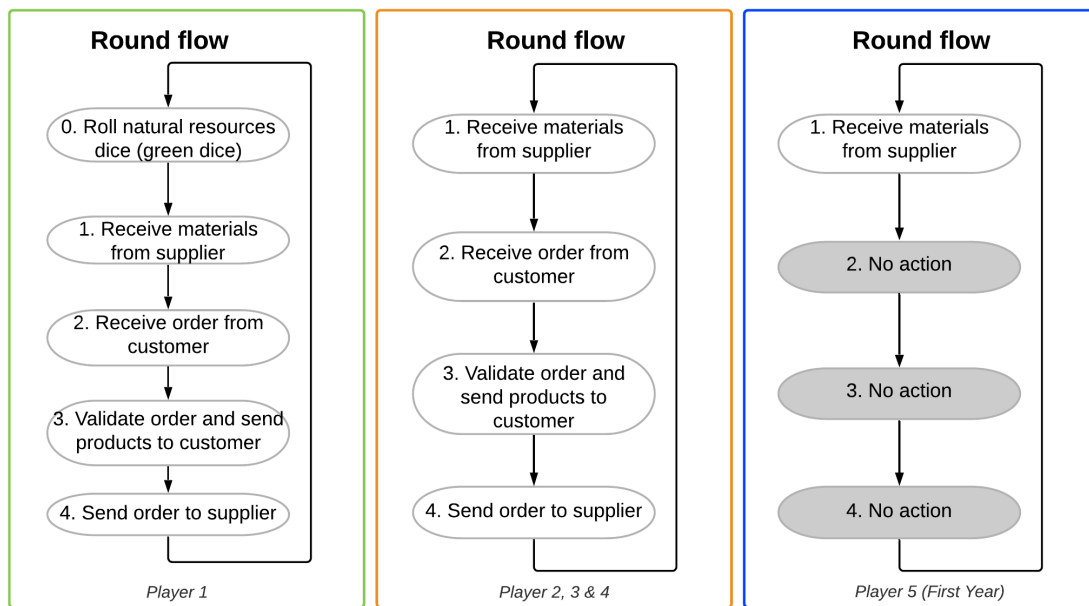

Figure 6.4: Round flow cards

Partial deliveries are possible between players 1, 2, 3, and 4. When a supplier sends less product than the actual demand to their customer, there are no penalties. The missing orders are not expected to be satisfied in the next round. In other words, there are no demand backlogs; they are ignored for simplicity reasons. However, the final customer order should be satisfied entirely; no partial deliveries are allowed. In other words, if the distributor's (Player 4) inventory is lesser than the demand, they cannot ship the final customer order and keep the products in their stock. In that case, a penalty is applied according to the missed order quantity and missed orders are not expected to send in the next round; they are considered as lost.

The players fill collaboratively a record sheet that contains different tabs for each player at the end of each round (Figure 6.5). In order to simplify the game, some cases, such as the order received from the customer, are filled automatically according to the cases in the other tabs.

Moreover, the quantity sent to the customer is filled automatically, since the players send either the quantity ordered by the customer (if they have enough products in stock) or all products in the stock (if they have less products than the ordered quantity). In addition, at the end of each year, indicators of the game objective are calculated automatically.

1										
		Team number:								
	Round	Raw material availability (green dice)	Quantity received from extractor	Quantity received from reverse logistics provider	Order received from customer	Quantity sent to customer	Order sent to extractor	Order sent to reverse logistics provider	Quantity in stock at the end of the round	
Year 1	0	4	4		4	4	4		0	
	1		4		4	4			0	
	2									
	3									
	4									
	5									
Year 2	6									
	7			0						
	8									
	9									
	10									
	11									
Year 3	12									
	13									
	14									
	15									
	16									
	17									
	18									
			Initialization boxes (do not touch)							
			Boxes filled automatically							
			Boxes to fill							
			Boxes not taken into account for the year							

Figure 6.5: Record Sheet (Tab for Player 1)

Second Year Simulation: Closed-Loop Supply Chain

Before starting the second year, all team members decide together to invest in a closed-loop CE activity to invest. This decision leads players to discuss the CE activities, which is one of the game’s objectives. The CE activities to invest in are presented to players by the so-called strategy cards (Figure 6.6). These cards show information about the corresponding CE activities, such as the investment cost, potential CO² reduction, and the returned product availability.

The investment cost (\$ symbol on the cards) is supposed to be the highest for recycling activity, which requires specific technologies to transform used products into materials, and the lowest for reuse, which is reselling used products with minor changes. The investment cost for open-loop activities is considered slightly higher than closed-loop ones since open-loop activities prepare the used product for a different function.

The CE activities allow a reduction in CO² by skipping some linear activities. For instance, when a used product is recycled, the extraction activity is skipped; while a used product is reused, even more activities are skipped. Therefore, reuse activity has the most potential of reduction in CO². Indeed, the shorter the loop, the more savings are in emissions (EMF, 2014)

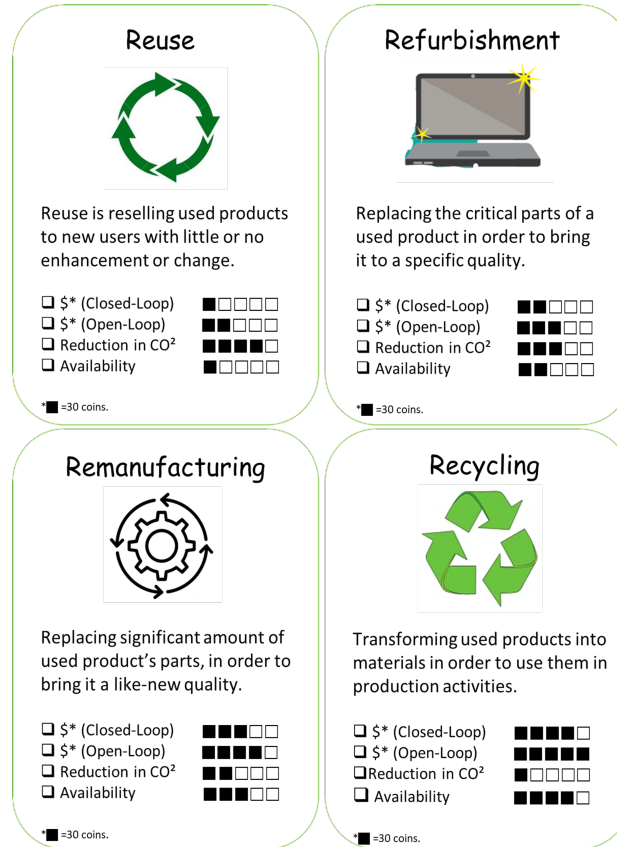

Figure 6.6: Strategy Cards

The availability of products is related to the used products state. We suppose that the returned products are not all eligible for all CE activities. For instance, reuse activity requires a good product state, while recycling does not have any requirement. Therefore, all collected products are supposed to be recyclable. In other words, it is considered that all products, even the most damaged ones, could be recycled. Therefore, the availability is the highest for recycling and the lowest for reuse. Through the modular structure of the board, the collection activity and the selected CE activity are added to the board. In the second year, the member who plays the user role (Player 5) also under-takes the reverse logistics provider role and manages the added collection and CE activities.

In order to simulate the uncertainties of the quantity and the quality state of the returned products, which are the biggest challenges in reverse logistics (Werning & Spinler, 2020), a 6-sided and a 4-sided dice are used, respectively. For instance, reuse requires a good product state (represented by 1 on the 4-sided dice), while the others have less stringent requirements, such as refurbishing (≤ 2 on the 4-sided dice), remanufacturing (≤ 3 on the 4-sided dice), and recycling (≤ 4 on the 4-sided dice). In order to remind the quality state requirements of each CE activity, numbers from 1 to 4 are indicated on each CE activity rectangle on the game board.

Collection and sorting of the used products are simulated by Player 5 (reverse logistics provider). The round flow card for Player 5 designed for the second and third years is represented by Figure 6.7. First, player 5 rolls the 6-sided dice in order to determine the quantity of the collected product (Step -1) and then the 4-sided dice to determine the state of the returned products (Step 0). If the products' state is eligible for the selected CE activity, s/he moves the products through the corresponding CE activity's rectangle (Step 0). In the other cases, products are moved to landfill rectangle. Then, s/he checks the customer's order (Step 2) and sends products to their customer (Step 3). The customer of Player 5 is one of the other players, who manage the linear supply chain.

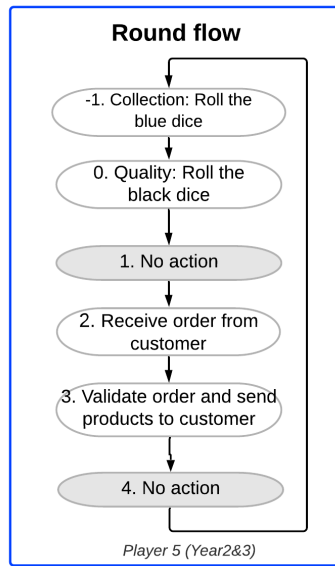

Figure 6.7: Round flow card of Player 5 for the second and third years

Furthermore, according to the selected CE activity, a player among players 1, 2, 3 and 4 gets another supplier from a CE activity in addition to their supplier in the first year. This player sends demand to their two suppliers and receives products from each of them. For example, Figure 6.8 represents the scenario where reuse activity is selected. In that case, Player 4, with the distributor role, needs to receive products from her/his two suppliers (products at the orange arrow and black arrow) and send an order to her/his two suppliers.

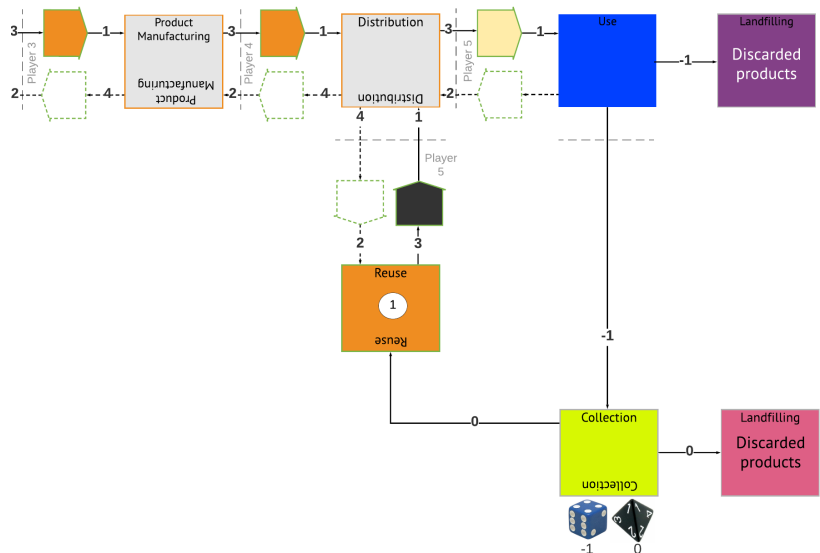

Figure 6.8: The scenario where reuse activity is selected

At the end of each round, players fill the calculation sheet collaboratively. In this year, Player 5 and the player who gets a second supplier have an additional case to fill, which is “Order sent to reverse logistics provider” (Figure 6.5). At the end of this second year, through the calculation sheet, the indicators are calculated again. The players are invited to discuss the evolution of indicators and the benefits of adding a CE activity.

Third Year Simulation: Multiple-Loop Supply Chain

After playing the second year, the players are asked to invest in an additional CE activity. The selected activity is added to the board through the board's modular structure. For the third year, two versions of the game are proposed. As in the second year, Player 5 and another player (related to chosen CE activity) have more steps to execute and more cases to fill in the calculation sheet.

Open-loop version: Players invest in another CE activity, which will be open-loop for this version. Another collection activity and selected open-loop CE activity will be added to the board. Reverse Logistics Provider (Player 5) will manage these activities as in the second year. Through the indicators calculated at the end of the third year, the players will be able to observe the benefits of adding an open-loop CE activity to the supply chain built in the second year simulation with only one closed-loop CE activity.

Closed-loop version: Players of the team invest in another closed-loop CE activity. In this version, the reverse logistics provider should decide the CE activity when the returned products' state is eligible for both CE activities. It is expected that the player chooses the activity that creates the shortest loop. Through the indicators calculated at the end of the year, the players will be able to observe the benefits of adding a second closed-loop CE activity.

6.5 Experiment and Analysis

An experiment has been conducted to test the design as well as the entertainment and educational values of the game. The CircuSChain Game is tested by forty-two first-year master's students of industrial engineering at Université Grenoble Alpes¹. Because of the simplicity and time limitation reasons, the third year of the game is played with closed-loops. In order to design the experiment, we rely on THEDRE methodology (Mandran, 2018; Mandran & Dupuy-Chessa, 2018). Through this methodology, the experiment's objectives, the hypotheses to test, and the questions to answer are determined. This methodology also helped us to develop an animation guide to manage better the experiment's timing. In addition, pre and post-questionnaires (See Annex B) are provided to the participants in order to observe several criteria: (1) educational value, (2) the pace, (3) the entertainment value, and (4) the simplicity of the game.

The game is tested with forty-two students, and the 3 hours are allocated for the experiment. The experiment is carried out over three stages, one stage per year. Each stage contains the presentation of the concepts, playing one year of the game and discussions on the indicators. During the first stage, the considered linear supply chain and the game rules for the first year are explained through a slide presentation. After playing the first year, the participants are invited to discuss their obtained results. The second stage of the experiment starts with the presentation of the CSC (with only closed-loops), followed by the distribution of strategy cards. Then, each team discusses the proposed CE activities and decides to invest in one of them. After playing the second year of the game, the results are discussed. During the third stage of the experiment, the closed-loop version of the game is played. First, the players discuss the CE activities and they are asked to choose a second CE activity and invest in it. Then, players play the third year of the game. The third stage of the experiment also ends with a discussion.

Moreover, pre and post-questionnaires are provided to assess the educational value, the pace, the entertainment value, and the simplicity of the game. The participants were asked to evaluate the game on a scale from 1 to 10, according to the aforementioned criteria in the post questionnaire. The results are shown in Figure 6.9. According to the results, participants have enjoyed their experience with the CircuSChain Game (average: 7.40) and found the pace suitable (average: 7.35). However, more works are needed to make the game simpler (average: 6.92). However, this

result has to be nuanced by the fact that the students have already played the Beer Distribution Game. Besides, the average educational value given is 6.93.

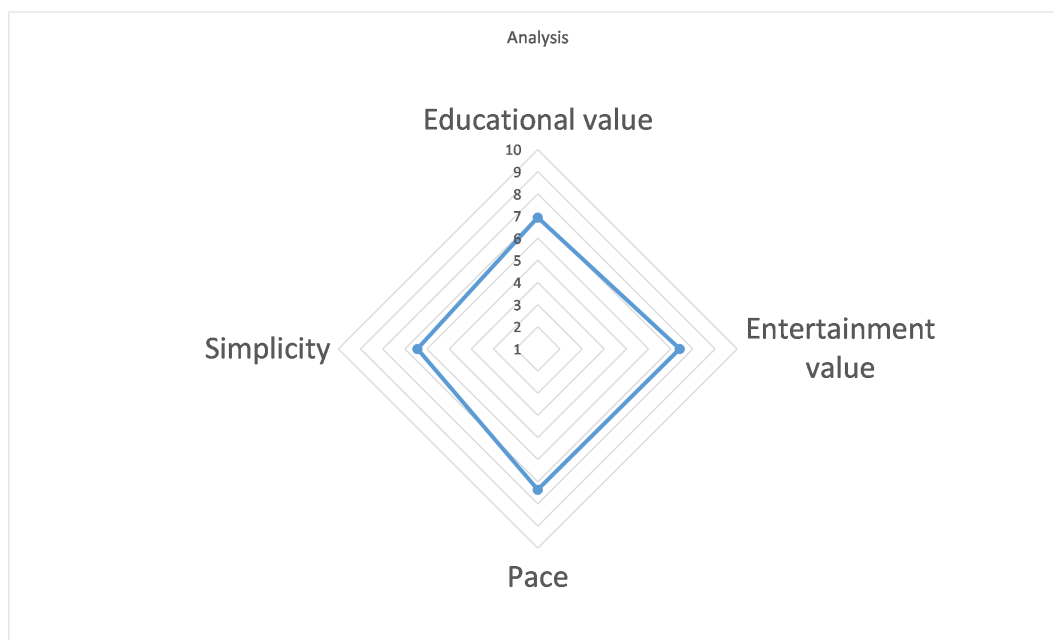

Figure 6.9: Evaluation of the educational value, entertainment value, simplicity, and pace of the game through post-questionnaire.

In addition, in order to further analyze the educational value, the participants were asked to answer questions about the CSC and the CE activities in the pre and post-questionnaires to assess their knowledge after playing the game. We grade their answers and then the results of both questionnaires are compared in order to check and validate the knowledge acquisition. Note that the students did not answer all the questions since they were informed that their answers would not be marked.

The participants were asked to define the CE and CSCs. The answers are expected to include cyclic structure or return flows, waste management, pollution (CO²), end-of-life and revaluation notions. Approximately 15% of the participants gained knowledge about these concepts; they mentioned them in the post-questionnaires, while they did not mention them in the pre-questionnaire.

The participants were also asked to define CE activities (reuse, refurbishing, remanufacturing and recycling). The answers were expected to include two notions: revaluation of used products and level of modification or product state. The results in each concept are represented in Figure 6.9, with the percentage of the participants that acquired knowledge, the participants that acquired any knowledge and the participants that have already knowledge. The participants who did not indicate these notions correctly both in pre and in post-questionnaires are considered as “Participants acquired any knowledge” (gray columns). “Participants acquired knowledge” are the participants who could not answer correctly in the pre-questionnaire, but provided a correct answer in post-questionnaire. The participants who provided a correct answer in pre-questionnaires are considered as “Participants already have knowledge”.

Concerning revaluation of used products, most of the participants have already aware of reuse (69%) and recycling (50%) activities. They mentioned the revaluation of used products notion in the post-questionnaires. However, approximately 14% of participants had knowledge about refurbishing and remanufacturing activities. After playing the game, respectively, 23% and 19% of participants gained knowledge about refurbishing and remanufacturing. Concerning the level of modification or product state, percentage of knowledge before the game (average 7% for all

activities except repurposing), and 20% of participants gained knowledge through the game. The gained knowledge is the lowest for repurposing as it is expected since, in this experiment, it is not included. The repurposing activity is only presented at the end of the game. Moreover, the percentage of participants that have indicated changing used products' function through repurposing is low (11%), which shows the lack of knowledge about this activity.

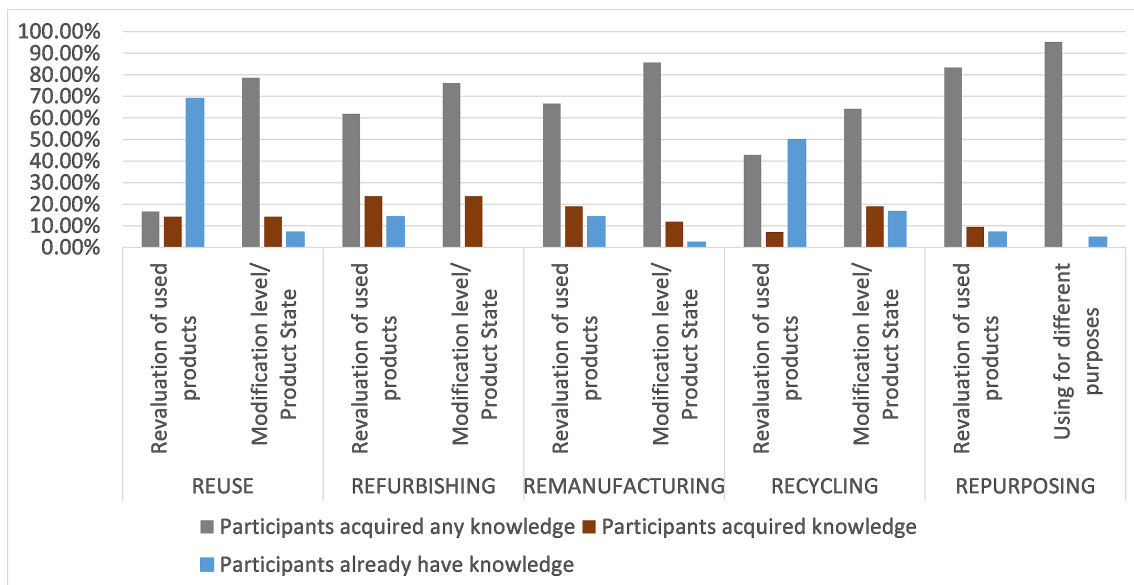

Figure 6.10: Knowledge Acquisition about CE Activities

Moreover, through this game, we aim to show participants the length of loops and the number of loops dimensions proposed in Section 4.3. Therefore, two multiple-choice questions with supply chain figures are included in the questionnaires to evaluate the knowledge about the benefits of having shorter and multiple loops (Figure 6.11). The results related to these two questions are represented in Figure 6.12.

For the first question then participants were supposed to choose the supply chain with the shortest loop as the most circular one (option C). However, 45% of the participants marked the supply chain with recycling (option A) as the most circular. Since when they invest in only reuse activity (option C), the team made less profit due to the low availability of reusable products (25% of availability with 4-sided dice).

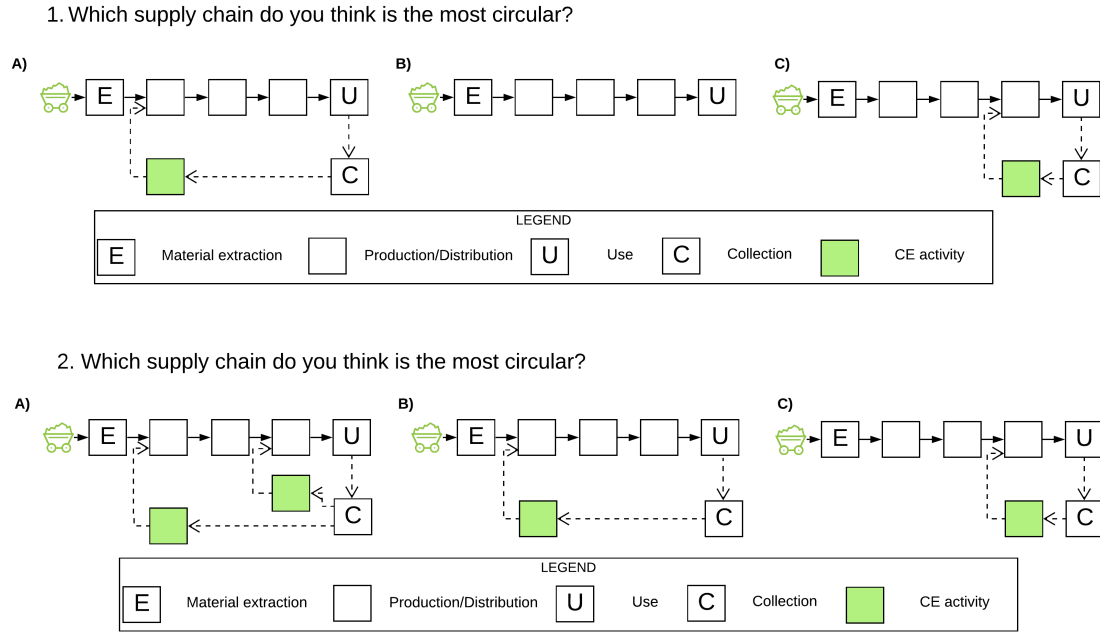

Figure 6.11: Questions about having multiple and shorter loops

For the second question, the participants were supposed to choose option A since it has more loops than the other options. 81% of participants answered this question in the pre-questionnaires correctly before playing the game. The rest of the participants gained knowledge through the game and answered the question correctly in the post-questionnaires. Therefore, concerning the shorter loops, 19% of the participants gained knowledge.

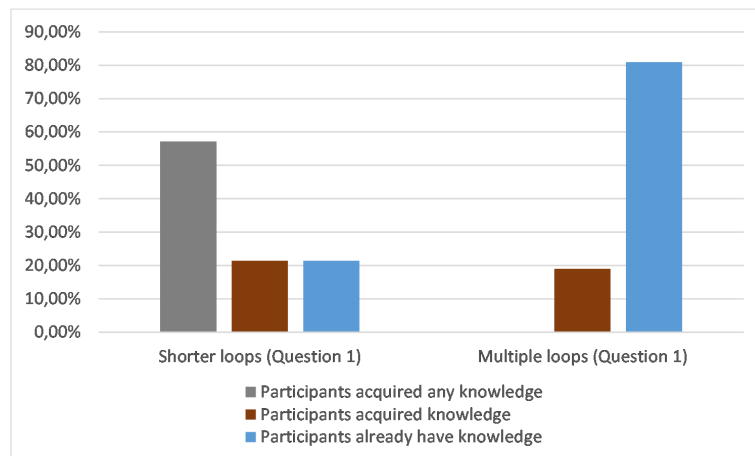

Figure 6.12: Knowledge acquisition about shorter and multiple loops

6.6 Conclusion

The CSCs play a critical role in the transition towards CE, which is proposed as a sustainable solution for pollution and resource depletion problems. The insufficient knowledge and awareness about CSCs do not ease the adoption of CSCs. In order to overcome these challenges, the

CircuSChain Game is introduced. This game is developed based on the well-known Beer Distribution Game. Concepts related to CSCs, such as reuse, refurbishing, remanufacturing, and recycling activities within closed and open-loops, as well as CO² emissions and material scarcity, are considered in this game.

The game is tested by an experiment with forty-two industrial engineering students. Participants were asked to fill pre and post-questionnaires in order to evaluate the game and observe the knowledge acquired through the game.

The implications for the theory and practice of this study, as well as its limitations and related future works, are discussed in the next subsections.

Implications for theory and practice

The CircuSChain Game is designed in order to contribute to raising awareness and knowledge about CSCs. It proposes a complementary approach to existing serious games, taking repurposing and open-loops concepts into account. In order to highlight the learning outcomes of the CircuSChain Game, we rely on learning principles and orientations presented in (Madani et al., 2017). Our game adopts constructivism as a learning orientation and situated cognition principle. Constructivism concerns learning by constructing meaning from experience. Our game works well for constructivism since it represents reality by a simulation (Madani et al., 2017).

Moreover, situated cognition is experiencing scenarios in a contextualized environment. According to this principle, players receive feedback related to their actions. For example, our game provides a supply chain environment, where players experience a supply chain management process. The players have feedbacks such as indicators calculated at the end of each year that correspond to their strategic decisions (selection of CE activities). Through this feedback, the players are expected to gain knowledge about increasing CO₂ emissions and natural resource depletion, as well as the benefits of setting up CE activities and managing CSCs to reduce them.

Limitations and Future Works

Since the CircuSChain Game is designed as a board game, the simulation of the supply chain operations is conducted by players. Therefore, in order to make the game simple for players, some aspects are not taken into consideration. For example, no modular tokens are chosen to represent products, despite the modular nature of the considered products. In a future version of the CircuSChain Game, modular tokens (using Lego blocks, for instance) could be considered to have a more realistic simulation of the manufacturing processes. In that case, an indicator that considers the recirculated product quantity, such as the product level circularity metric (Linder et al., 2017), could be used. Through this indicator, each team member's contribution to circularity could be calculated. Thus, each player could have a local objective additionally to a global objective for the whole team.

Moreover, while designing the experiment, we include a closed-loop activity instead of an open-loop activity in the third year for time limitation and simplicity reasons. However, repurposing activities and their related open-loops constitute a new potential for CSCs. In addition, this concept is new among scholars and industrials. Therefore, future validation experiments, including the open-loops, are needed.

Furthermore, according to the experiment's analysis, the game is not efficient enough to help players gaining knowledge about shorter and multiple loops. Therefore, the game parameters need to be better tuned, and the questions about these concepts are needed to be detailed in the questionnaires.

Moreover, as seen in Figures 6.10 and 6.12, the participants could not answer most of the questions correctly in pre and post-questionnaires. Most of these questions were left blank. Therefore, an online questionnaire, where questions are compulsory to answer, could be needed to have more answers to analyze.

In order to include the aforementioned concepts in the CircuSChain Game and keep it simple to manage and play at the same time, we are working on a digital version of the game. This could permit: (1) a physically decentralized but collaborative game through a web interface, (2) more flexible management of the time horizon as well as the computation of indicators, and (3) the automation of the material and information flow control. In this context, a prototype is proposed with -names of excellence interns-, which are license 2 students in computer science at Université Grenoble Alpes through an internship (See Figure 6.13).

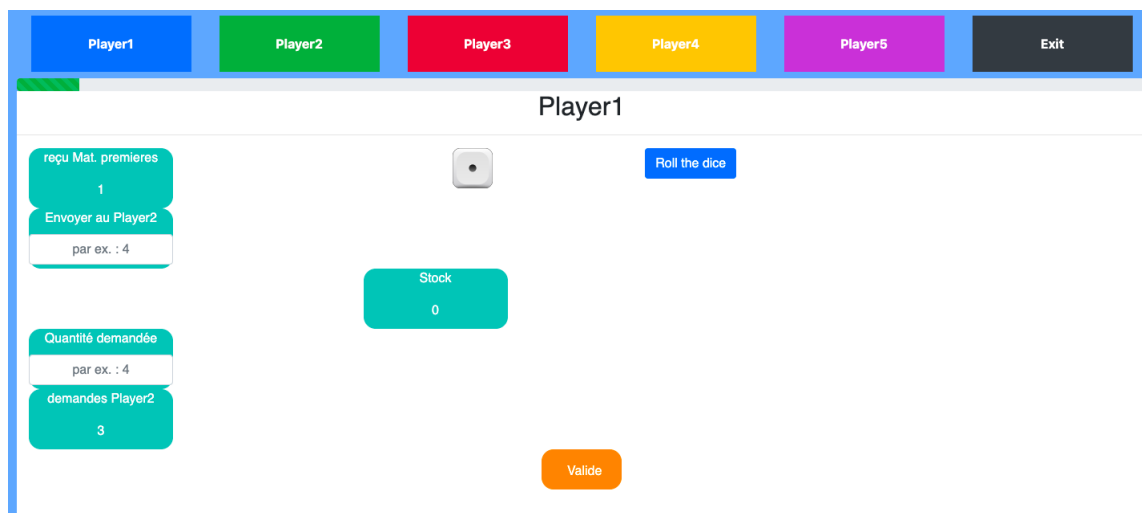

Figure 6.13: Player 1's screen at the prototype of the digital version of the game

Through this game, it is aimed that the participants gain knowledge about savings in pollution, length of loops, and the number of loops dimensions. The other dimensions could be included by considering the other indicators proposed in Chapters 4 and 5. Utilizing our indicators in CircuSChain Game, could allow to test and validate these indicators through game experiment. Moreover, the Global Circularity Indicator proposed in Chapter 5, could be used as a software component for the digital version of the CircuSChain Game.

Finally, the experiment has been conducted solely with forty-two industrial engineering students. More experiments are needed with more participants and of different audiences, such as supply chain professionals, final clients, CE experts, and public authorities.

7

A Continual Evolution Method for Circular Supply Chains

Contents

7.1	Introduction	85
7.2	Background	85
7.3	The As-IS/As-IF Framework	87
7.3.1	Process Model of As-IS/As-IF Framework	87
7.3.2	Product Meta-Model of As-IS/As-IF Framework	91
7.4	Circular Supply Chain Continual Evolution Method (CircuSChain)	91
7.4.1	How to Read the Protocols of the Method?	93
7.4.2	Analysis Strategy	93
7.4.3	Diagnosis Strategy	99
7.4.4	Evolution Strategy	101
7.4.5	Product Meta-Model	104
7.5	Conclusion	105
7.5.1	Implications for the practice and the theory	105
7.5.2	Limitations and future works	105

7.1 Introduction

In previous chapters, we propose different tools that help to analyze, visualize, evaluate and manage CSCs. As a final work of our research project, we integrate these tools into a method to support the continual evolution of CSCs (Figure 7.1). Indeed, we state that a successful transition to a CSC requires continual measurement of progress towards circularity (Jain et al., 2018). Therefore, this method could support transforming linear supply chains into CSCs and then improve the circularity of CSCs.

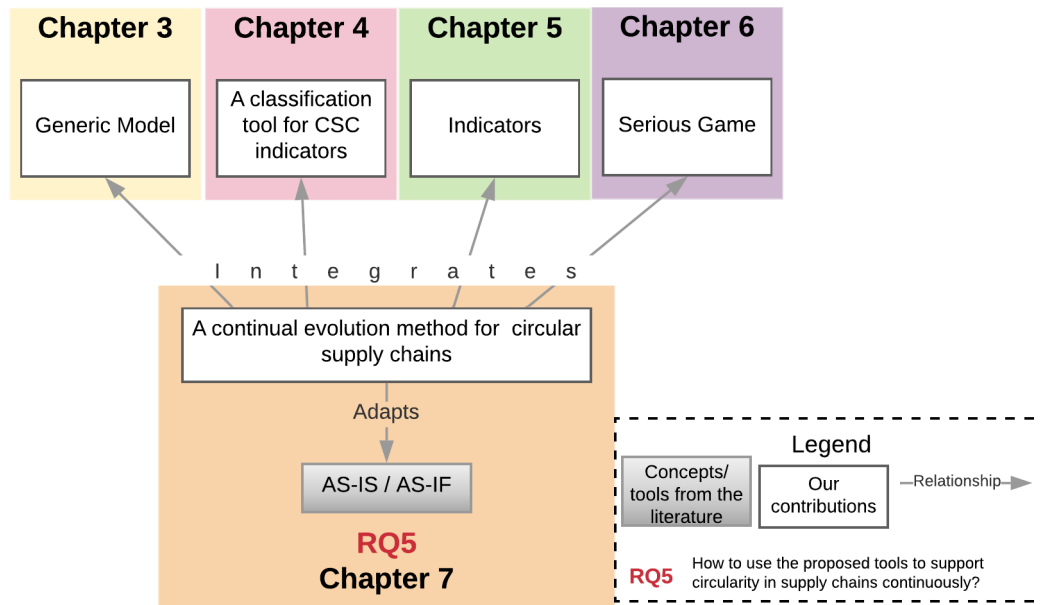

Figure 7.1: Positioning the CircuSChain Method among the rest of the manuscript

Through this integration, we will show the potential implications of our works in practice. In order to develop this method, we adapt the As-IS/As-IF framework (Çela, 2021; Çela et al., 2019). The latter facilitates the construction of a continual evolution method, playing the role of a template on which a target method can rely. This chapter is structured as follows. Section 7.2 presents the background about the continual evolution and its applications on supply chain. Section 7.3 explains the As-IS/As-IF framework that we adopt. Section 7.4 introduces the CircuSChain (Circular Supply Chain) Method, which is an adaptation of the As-IS/As-IF framework on Supply Chains. Finally, Section 7.5 concludes the chapter with the implications and the future works.

7.2 Background

Pressure from laws, stakeholders and customers leads companies to review their practices to adopt the CE or improve their circularity. Moreover, a successful transition to a CSC requires continual measurement of progress towards circularity (Jain et al., 2018).

Continual evolution methods address various needs for improvement ranging from minor improvements to radical changes (Çela, 2021). Different examples can be found in the literature. For instance, the PDCA (Plan, Do Check, Act) (Deming, 2000) cycle introduces four steps to manage continuous improvement. DMAIC (Define, Measure, Analyze, Improve, Control) method (Lynch

et al., 2003) containing five steps is a project improvement method. Moreover, problem-solving techniques like A3 (Bassuk & Washington, 2013) and 8D (8 Disciplines) (Kaplík et al., 2013) have a continuous improvement approach. In addition, UN Global Compact Business for Social Responsibility (2015) proposes a report titled "Supply Chain Sustainability: A Practical Guide for Continuous Improvement" containing six steps: Commit, Assess, Define, Implement, Measure, and Communicate.

These methods and the CircuSChain Method proposed in this chapter are compared in Table 7.1. We investigate whether these methods are applied in supply chains, green or sustainable applications, and CSCs. Moreover, we suppose that a continual evolution method for CSCs should promote as much as possible the active and collective participation of actors of the organization, who will “take the method experts’ place”. Therefore, we explore the participation of actors in these methods in Table 7.1. Participatory methods allow actors to be involved in the evolution, which enriches the evolution and helps to construct consensus between CSC actors. Moreover, we took into account the level of formalization of the method, which may assist tool support to actually orchestrate the method. For instance, the proposition of a product meta-model can define the different method components and their relations. Indeed, the formalization allows reusing the methods by different actors and helps to disambiguate the description of the method.

Table 7.1: Comparison of methods from the literature

Criteria	Continuous Improvement Methods		Problem Solving Techniques		Target Methods	
	PDCA	DMAIC	8D	A3	A Practical Guide for Continuous Improvement	CircuSChain Method
Applied in supply chains	x	x (Mishra & Sharma, 2014)	x (Behrens et al., 2007)		x	x
Applied in green/ sustainable applications	x (Garza-Reyes et al., 2018)	x (Jamil et al., 2020)		x (Lenort et al., 2017)	x	x
Applied in CSCs						x
Formalization		Formalized by meta-model and integrated tool (Deeb et al., 2018)				Formalized by meta-model, but no integrated tool
Participatory Approach					x	x

PDCA, DMAIC, 8D, and A3 are generic methods, although most of them have been applied to improve green/sustainable applications or supply chains. Besides, A Practical Guide for Continuous Improvement is designed to improve supply chain sustainability, which provides a participatory approach. However, no method is applied in CSCs. Furthermore, among these methods, no method is formalized, except DMAIC Deeb et al. (2018).

Note that the continual evolution is the effort to "evolve a system and combine improvement to innovation cycle", while continuous improvement is defined as the effort "to improve products,

services, or processes" (Çela, 2021). In this chapter, we propose a continual evolution method called CircuSChain and constructed by adapting the As-IS/As-IF framework that targets to integrate or improve the circularity in supply chains through innovations. The CircuSChain Method is a participatory approach formalized through a meta-model.

7.3 The As-IS/As-IF Framework

This section presents the As-IS/As-IF framework that we adapted. As mentioned before, our view is that a continual evolution method should be based on continual evolution cycles, (by opposition to project-based approaches that have delimited budget and dates), promote as much as possible the active and collective participation of actors of the organization. We also take into account the level of formalization of the method and domain-specificity. As-IS/As-IF framework aims at helping method engineers to develop continual evolution methods for a system acting as a template that can be adapted for a specific domain. It is based on continual evolution cycles and allows to formalize these methods. The As-IS/As-IF framework could be considered to be positioned on the Plan step of the Deming Cycle.

As-IS/As-IF proposes two models to formalize continual evolution methods: the Process Model and the Product Meta-Model (Figure 7.2). The Product Meta-Model describes the elements needed to characterize the As-IS system and imagine the As-IF systems. The Process Model describes the main strategies and intentions of the continual evolution process (Çela et al., 2019). As-IS system is the current state of the system, while As-IF is described as "an evolution scenario imagined as if a change is deployed over the current system" (Çela, 2021).

7.3.1 Process Model of As-IS/As-IF Framework

The Process Model is represented using the intentional map formalism (Rolland et al., 1999) through a general map and three sub-maps. In these maps, the ellipses represent the intentions as well as the start and points, while arrows represent the strategies to reach these intentions. The general map represents the core strategy. The core strategy characterizes the As-IS System and imagines As-IF System (Çela, 2021).

Core process model is represented in Figure 7.3. This map presents three main strategies to "Characterize As-IS System" and "Imagine As-IF System": analysis, diagnosis, and evolution. It starts with the characterization of the As-IS System by diagnosis and analysis strategies. Then, the As-IS system evolves into an As-IF system through evolution strategy. Finally, the imagined As-IF system could be deployed and becomes the next As-IS system of continual evolution. If the imagined scenario is not suitable, it is possible to go back by failure analysis strategy and review the As-IS system to imagine other As-IF systems. It is also possible to stop the project with by choice strategy at any moment.

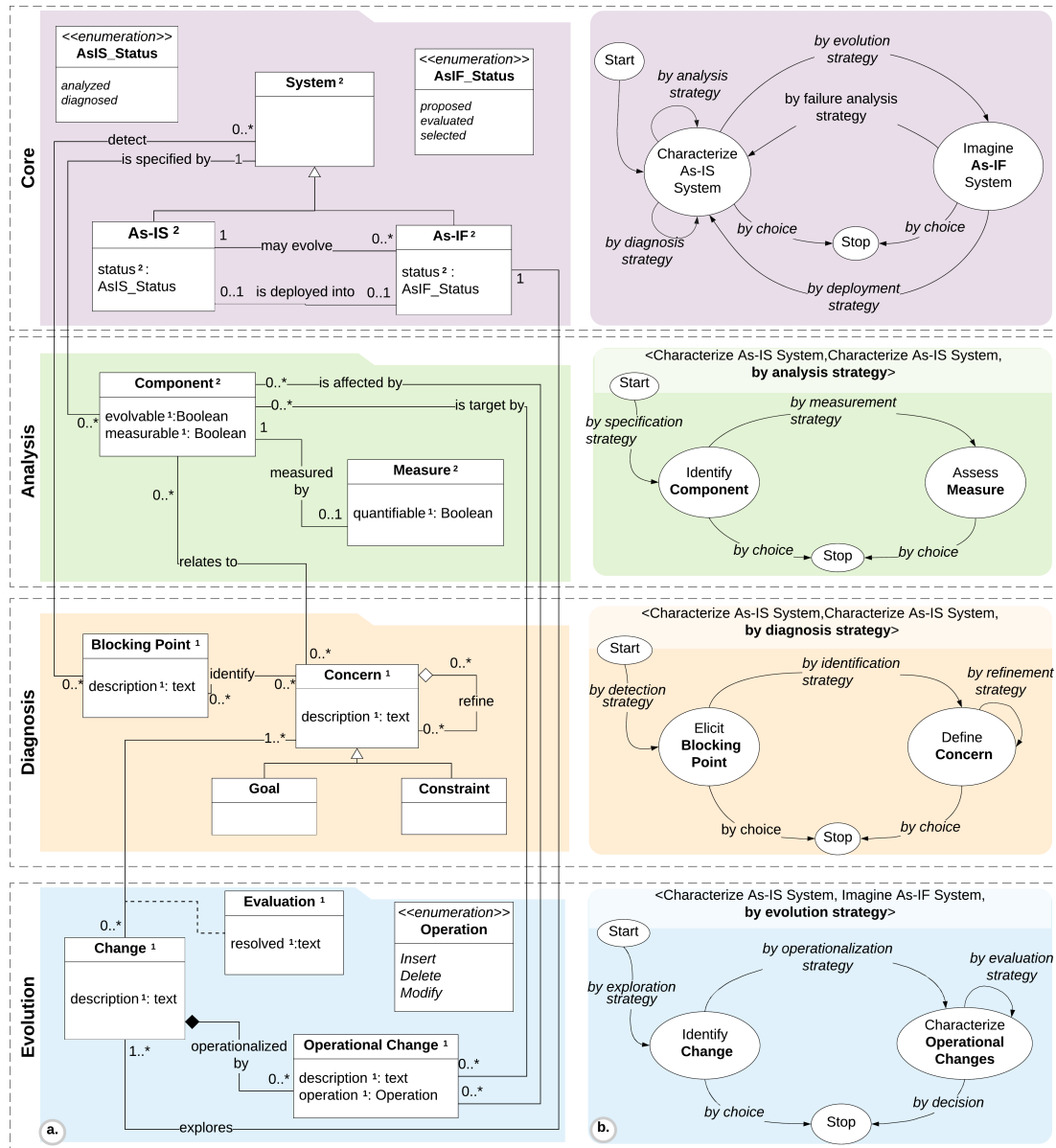

Figure 7.2: Product Meta-Model (a) and Process Model (b) of As-IS/As-IF Framework (Çela, 2021)

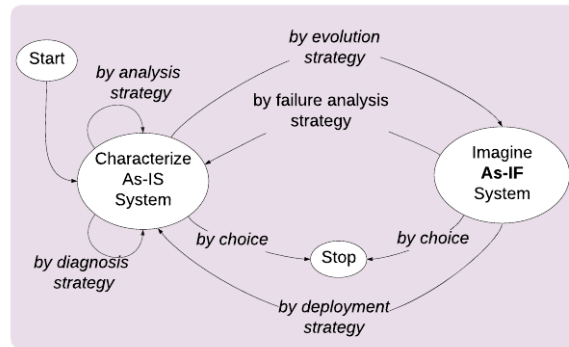

Figure 7.3: Process model of the Core strategy of As-IS/As-IF framework (Çela, 2021)

Analysis process model is a refinement of <Characterize As-IS System, Characterize As-IS System, by analysis strategy>. This strategy concerns two intentions "identify component" and "assess measure". The components of the system are identified by specification strategy. Components are evaluated by measures through the measurement strategy. Here, it is possible to stop the process by choice strategy.

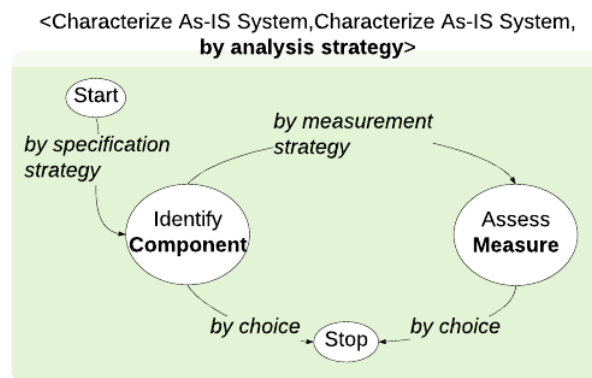

Figure 7.4: Process model of the Analysis strategy of As-IS/As-IF framework (Çela, 2021)

Diagnosis process model is a refinement of <Characterize As-IS System, Characterize As-IS System, by diagnosis strategy>. It has two intentions "Elicit Blocking Point" and "Define Concern". Blocking Point is an issue or a problem in the system that brings the need for evolution. The concern could be a goal or a constraint. The diagnosis starts with eliciting blocking points by detection strategy. Then related concerns are defined through identification strategy. The process could be stopped by choice strategy.

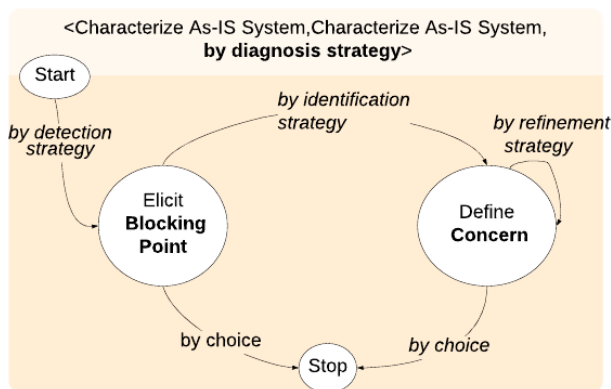

Figure 7.5: Process model of the Diagnosis strategy of As-IS/As-IF framework (Çela, 2021)

Evolution process model is a refinement of <Characterize As-IS System, Imagine As-IF System, by evolution strategy>. It has two intentions: "Identify Change" and "Characterize Operational Changes". The process starts by identifying changes through exploration strategy. The operational changes to implement identified change are characterized by operationalization strategy. Operationalization allows imagining the As-IF system. The changes are evaluated by evaluation strategy to see whether the changes help to solve system concerns defined in the diagnosis process. Here, it is also possible to stop the process by choice strategy.

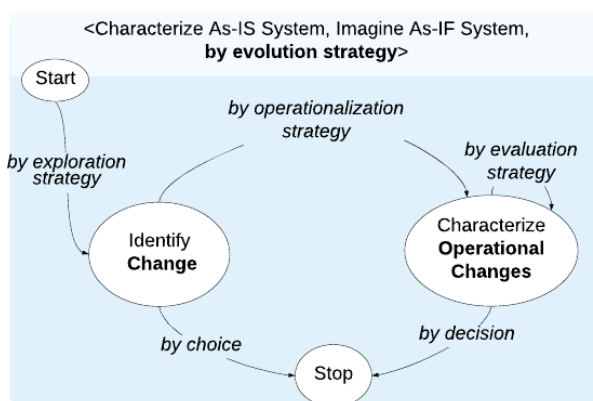

Figure 7.6: Process model of the Evolution strategy of As-IS/As-IF framework (Çela, 2021)

The Process Model constitutes a base for a method engineer to construct a continual evolution method. The maps could be adopted or refined using the following heuristics (Çela et al., 2019):

1. No intention could be removed or added, but it may be renamed.
2. The proposed strategies could be renamed but not removed. Additional strategies could be introduced between existing intentions if necessary.
3. The analysis, diagnosis, and evolution strategies could be refined through sub-maps.

The aforementioned heuristics are used to create the process model of our method.

7.3.2 Product Meta-Model of As-IS/As-IF Framework

In order to formalize As-IS/As-IF framework, a product meta-model is introduced using the UML diagram class (Çela, 2021) (See part (a) of Figure 7.2). The intentions of the process model (See part (b) of Figure 7.2) are transformed into meta-classes in the product meta-model, where the strategies of the process model are represented by associations.

The **core package** contains three meta-classes, which are System meta-class and its two sub-classes: As-IS and As-IF. As explained before, an As-IS system could evolve into one or several As-IF systems by evolution strategy (may evolve association), where an As-IF system could be transformed into the next As-IS system by deployment strategy (deployed into association). As-IS system could be analyzed associated with the elements of **analysis package**.

The **analysis package** is composed of two meta-classes: Component and Measure. Component meta-class covers all elements to specify a system, which are evolvable and measurable. Components of As-IS system are measured by Measure meta-class (measured by association).

Moreover, As-IS system could be diagnosed as associated with the elements of **diagnosis package**. This package contains Blocking Point and Concern meta-classes. Blocking Point represent a problem in the system that requires the evolution of the system. Concern represents Goals or Constraints of the system.

As-IS system could be evolved into an As-IF system. The latter is associated with the elements of **evolution package**. This package contains three meta-classes: Change, Operational Change, and Evaluation. Change meta-class represents the evolution proposed to solve one or several Concerns. Change is operationalized by Operational Change associated with Component. The Component of As-IS is affected by the change and the As-IF component is targeted by. The changes are evaluated, in order to determine whether the concerns are resolved.

The product meta-model could be adapted by using the following heuristics (Çela, 2021; Çela et al., 2019):

1. The elements of core package cannot be extended.
2. It is possible to rename the meta-classes, but no class can be deleted or added. The meta-classes of the analysis, diagnosis and evolution packages could be refined into class diagrams.
3. It is possible to rename the associations and add new ones.
4. It is allowed to enrich or add enumerations and attributes, but they cannot be removed.

The aforementioned heuristics are used to create the product meta-model of our method. Note that the first one is not totally respected. In section 7.5, we discuss this fact that may imply a revision of the framework.

In the next section, we construct the CircuSChain Method to improve the circularity in supply chains by adapting As-IS/As-IF framework.

7.4 Circular Supply Chain Continual Evolution Method (CircuSChain)

In this section, we adapt As-IS/As-IF Framework to propose the CircuSChain Method aimed to improve circularity in supply chains. In our work, the system to evolve is Supply Chains: either a linear supply chain, in which the goal is to integrate circularity, either a CSC in which the goal is to improve circularity. Therefore, the intentions are renamed into "Characterize As-IS Supply

Chain" and "Imagine As-IF Supply Chain" in the core process. According to the framework, further modifications are not allowed in the core process.

In the next sections, the adaptation of main strategies is presented. We are inspired by (Çela, 2021) to refine some of the sub-maps. We integrate the tools proposed in previous sections into the strategies. We also provide the protocols to explain how to use these tools in CircuSChain. The structure of protocols is explained in the next sub-section.

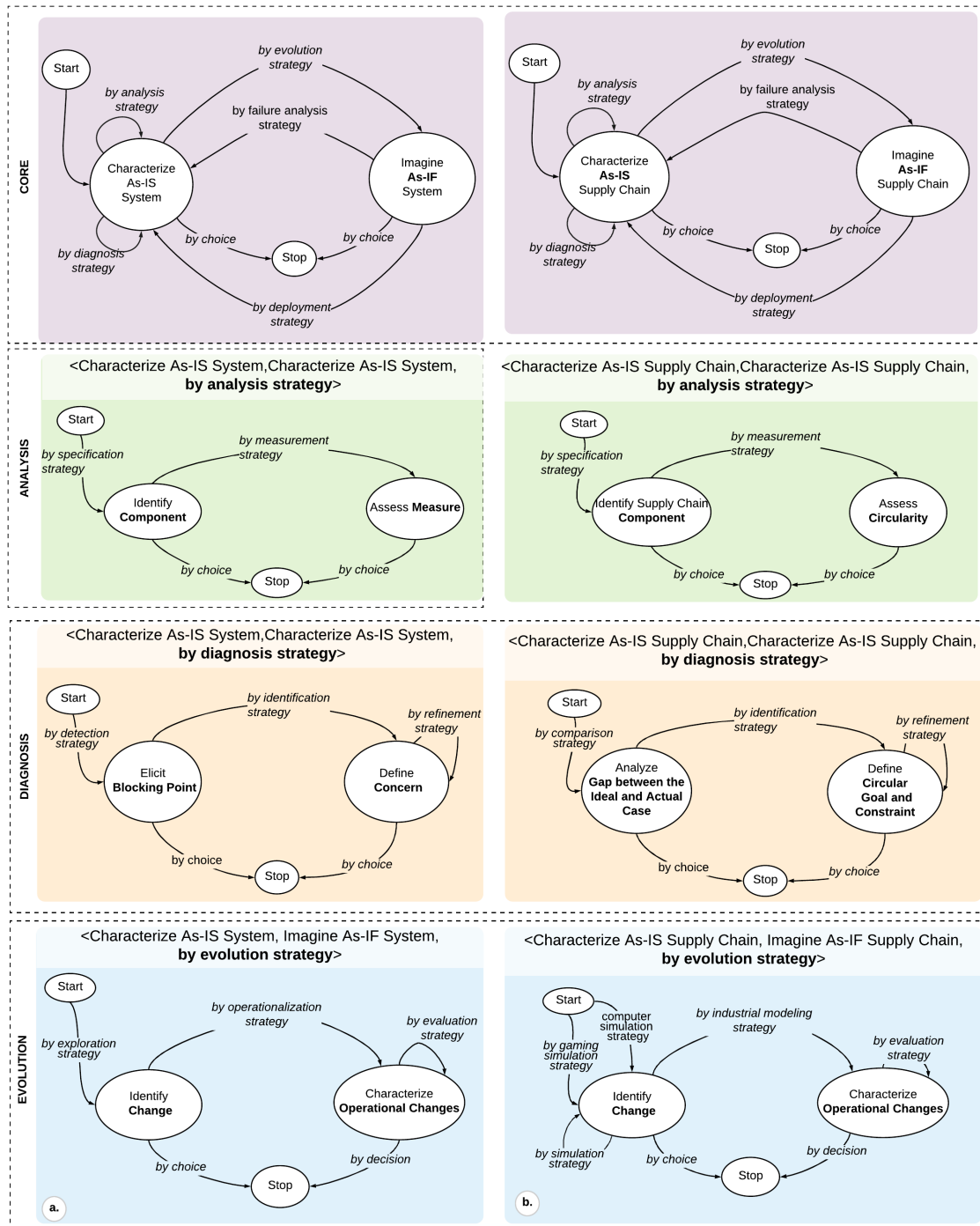

Figure 7.7: Process model of As-IS/As-IF framework (a) and Process model of CircuSChain Method (b)

7.4.1 How to Read the Protocols of the Method?

The strategies of CircuSChain Method are implemented through sessions. We propose protocols explaining these sessions (See tables in the next sections). In this section, we explain how to interpret these tables (Table 7.2).

At the top of Table 7.2, general information about the protocol is given. The name of the strategy and two associated intentions are expressed as <intention, intention, by strategy>. The type of session is also given. Three section types are proposed: telephone interview, focus group and individual work. Individual work is done by the animator. Focus group and telephone interviews are led by an animator within the participation of actors. Participants for each session are stated at the top of the tables. Moreover, a figure representing the strategy is given. The strategy implemented in the session is highlighted with bold letters and arrows in the figures.

Protocol: < Intention, Intention, by strategy >

Session Type: Telephone interview, Focus group, or Individual work

Participants:

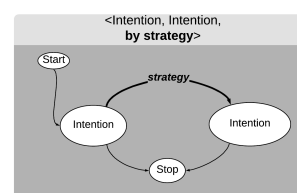

N°	Step	Description	Participants' role	Supports	Dur. (in min)
1	Step name	Brief description of the step. Questions asked by animator are represented as follows: • <i>Questions asked by animator?</i>	Passive or Active/Collective or Active/Individual	Tools proposed in this thesis, Other tools and supports	10

Table 7.2: Protocol example

Furthermore, each step in the session is detailed in the protocol. The first column (N°) shows the sequence of steps, while the second one (Step) represents the step's name (Table 7.2). A brief description of the step is given in the third column (Description). In this column, the questions asked by the animator are highlighted by italic letters.

In the fourth column (Participants' role), the role of participants is described. Participants could participate in the sessions passively. For example, when the animator explains the context or the tools, the role of participants is passive. Participants could be included in sessions actively. For example, during the telephone interview, the participants' role is active/individual. However, during focus groups, participants could be included actively and collectively (active/collective).

The fifth column (Supports) represents the supports needed in each step. The tools proposed in previous chapters are used as supports and highlighted with bold letters in this column. The animator is supposed to have knowledge about the tools beforehand. The last column (Dur.) expresses the duration in minutes of each step.

7.4.2 Analysis Strategy

Analysis strategy aims to characterize the As-IS supply chain. In this strategy, the first intention aims to "Identify Supply Chain Component". Since the objective is to improve circularity in a continuous way, the measure is changed to circularity. Here we also refine specification and measurement strategies through sub-maps.

A. <Start, Identify Supply Chain Components, by specification strategy >

Through specification strategy (Figure 7.8), Supply Chain Components are identified. The components to be identified are activities and flows (stated in Chapter 2) as well as actors and product

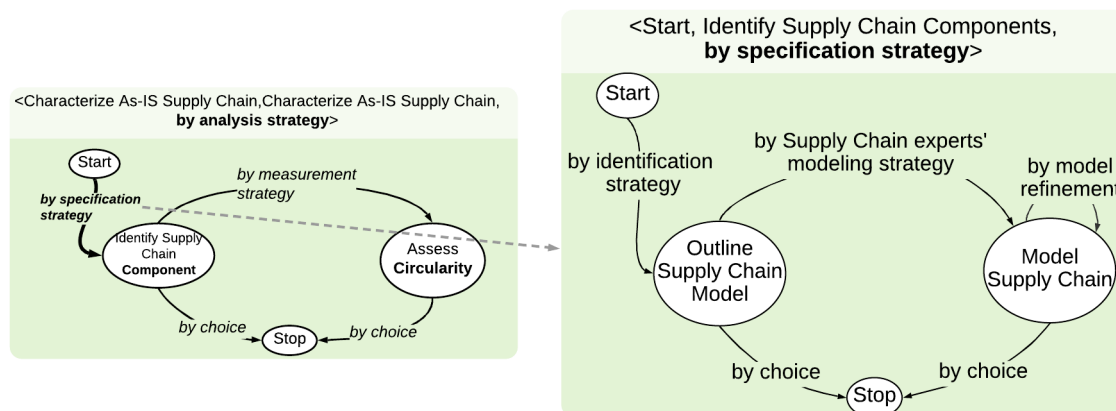

Figure 7.8: Process map of specification strategy

type. Since CircuSChain is a participatory method, the identification of actors is essential. Moreover, the product type that defines the granularity of the supply chain helps the animator to model the supply chain correctly.

The specification process starts with outlining Supply Chain Model by identification strategy. Then, the supply chain is modeled by Supply Chain experts' modeling strategy. The obtained model could be improved by model refinement strategy. Identification and Supply chain experts' modeling strategies are explained through protocols (Table 7.3 and 7.4) and detailed below.

A1. < Start, Outline Supply Chain Model, by identification strategy>

Identification strategy is explained through Protocol 1 (Table 7.3). It consists of an interview between the animator and the Original Equipment Manufacturer, who is the main responsible for the products' end-of-life for some sectors, such as plastics and electronics (Wikipedia, 2021).

The generic model proposed in Chapter 3 is used in this strategy. Animator asks the Supply Chain Manager of Original Equipment Manufacturer to state the principal activities and the suppliers as well as customers. Therefore, the other actors are identified to be interviewed next. At the end of these interviews, the animator obtains the actors who will participate in the next sessions and their principal activities. The relationship between actors gives insights into the necessity of actors' participation in the next sessions. For instance, the presence of a subcontractor would not be required. Through the interviews, the animator outlines Supply Chain Model step by step and constructs SC Model V0. An example is given from the textile sector. Figure 7.9 shows the construction of SC Model V0 step by step after each interview. Here, during the interview with Manufacturer A, the animator outlines a part of CSC and identify some other actors: Retailer A and Manufacturer B that produces fabrics. After interviewing Manufacturer B, some other activities and actors are added. Finally, after three interviews, SC Model V0 is developed.

Protocol 1: < Start, Outline Supply Chain Model, by identification strategy>

Session Type: Telephone interview

Participants: SC manager of Original Equipment Manufacturer or identified actor

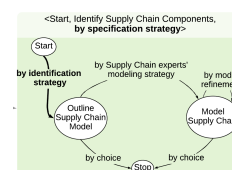

N°	Step	Description	Participants' role	Supports	Dur.
1	Presentation of SC Generic Model	Animator presents the main aspects of the SC Generic model.	Passive	Interview guide, Generic Model	10 SC

7.4. Circular Supply Chain Continual Evolution Method (CircuSChain)

2	Specification of product	Animator asks participants to define the product and its main characteristics. S/he asks the following question: <ul style="list-style-type: none"> • <i>What is the product concerned by the supply chain that you would like to improve?</i> 	Active/ Individual	Interview guide	30
3	Determination of main activities	Animator gives participants the SC Generic model, asks the following questions: <ul style="list-style-type: none"> • <i>What are the principal activities that you manage on the SC Generic Model?</i> • <i>Where is your position in the Supply Chain?</i> 	Active/ Individual	SC Model, Interview guide	20
4	Determination of actors	Animator asks the following questions to determine the actors who manage defined activities and relationship types. <ul style="list-style-type: none"> • <i>Which suppliers, customers or service providers are you working with?</i> • <i>For each actor, what is the relationship type?</i> <p>Thanks to all the interviews, animator builds SC Model V0.</p>	Active/ Individual	SC Model, Interview guide	30

Table 7.3: Protocol 1: < Start, Outline Supply Chain Model, by identification strategy>

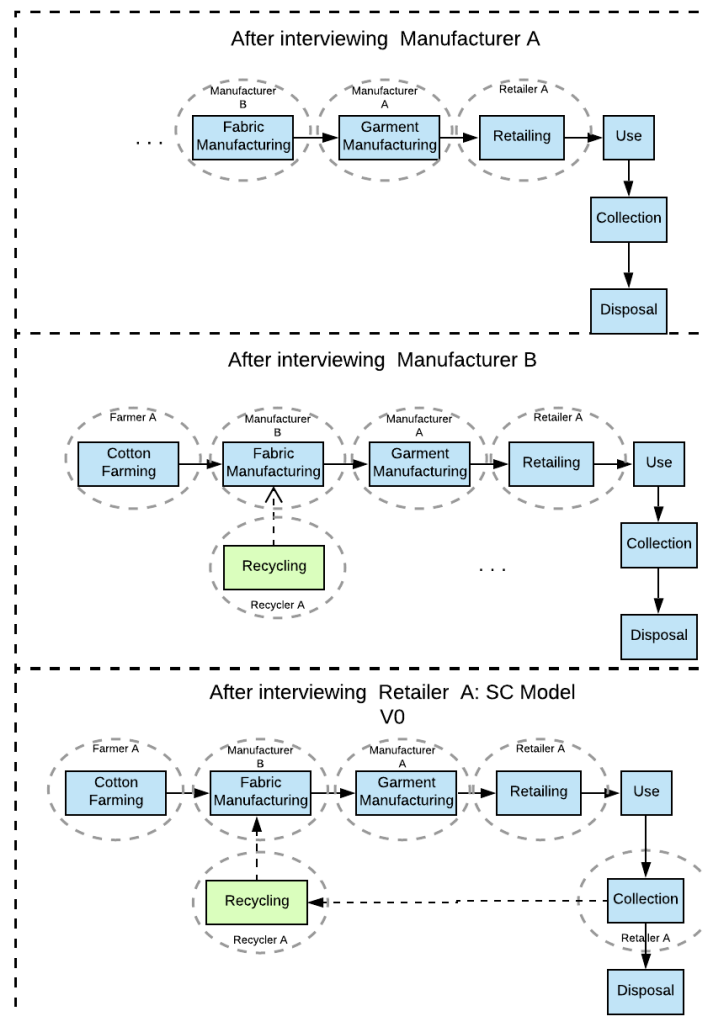
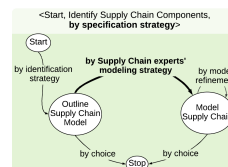

Figure 7.9: Outlining SC Model through Protocol 1

A2. < Outline Supply Chain Model, Model Supply Chain, by expert modeling strategy>

After outlining the Supply Chain model (SC Model V0), the supply chain is modeled by Supply Chain experts modeling strategy. This strategy is explained by Protocol 2 (Table 7.4). The session is realized with the actors defined within the telephone interview. Here, the animator explains the generic model in detail. For instance, the possible decomposition of the activities according to product modularity and presents SC Model V0.

Protocol 2: < Outline Supply Chain Model, Model Supply Chain, by expert modeling strategy>



Session Type: Focus Group

Participants: SC manager of Original Equipment Manufacturer and selected actors

N° Step	Description	Participants' role	Supports	Dur.
1	Presentation of SC Generic Model	Passive	Presentation slides, SC Generic Model	20
2	Presentation of the SC Model V0	Passive	SC model V0	10
3	Modelling SC Model V1	Active/Collective	SC model V0, Construction of SC model V1	30

- Position yourself on the SC Model V0 by surrounding the related activities.
- Is there any missing actors? If so, please add it to the model.
- Do the activities of the SC Model V0 (especially the intermediate activities) correspond to your actual activities?
- Do the flows of the SC Model V0 correspond to your actual flows?
- Do the collaboration types (branches and levels) of the SC Model V0 correspond to your actual collaborations?

Table 7.4: Protocol 2: < Outline Supply Chain Model, Model Supply Chain, by expert modeling strategy>

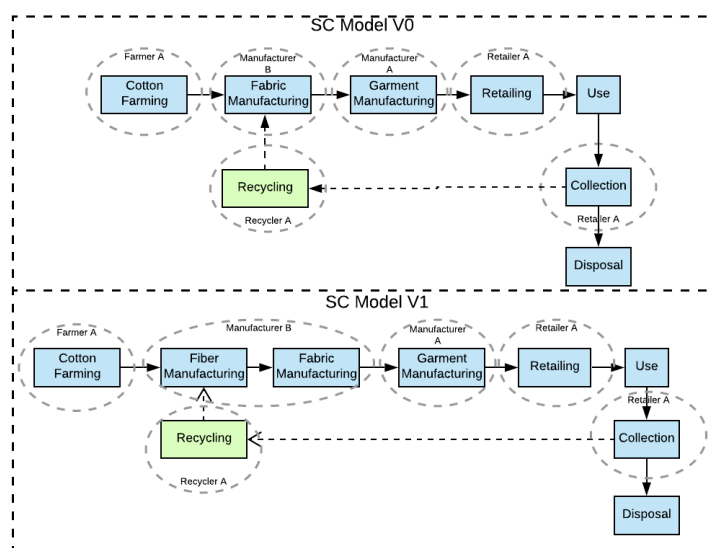

Figure 7.10: SC Model V1 and SC Model V0

Through the questions stated in Protocol 2 (Table 7.4), SC Model V1 is constructed by modifying V0. For instance, we suppose that SC Model V0 in Figure 7.9 does not sufficiently represent the modularity of production activities. Therefore, by expert modeling strategy, the supply chain is correctly modeled, adding the fiber manufacturing activity.

B. <Identify Supply Chain Components, Assess Circularity, by measurement strategy>

In addition to the specification strategy, the measurement strategy is also refined (Figure 7.11). It aims at assessing the circularity of the As-IS supply chain. Measurement strategy starts with choosing circularity indicators by elicitation strategy. Then, supply chain circularity is calculated by computation strategy with chosen indicators.

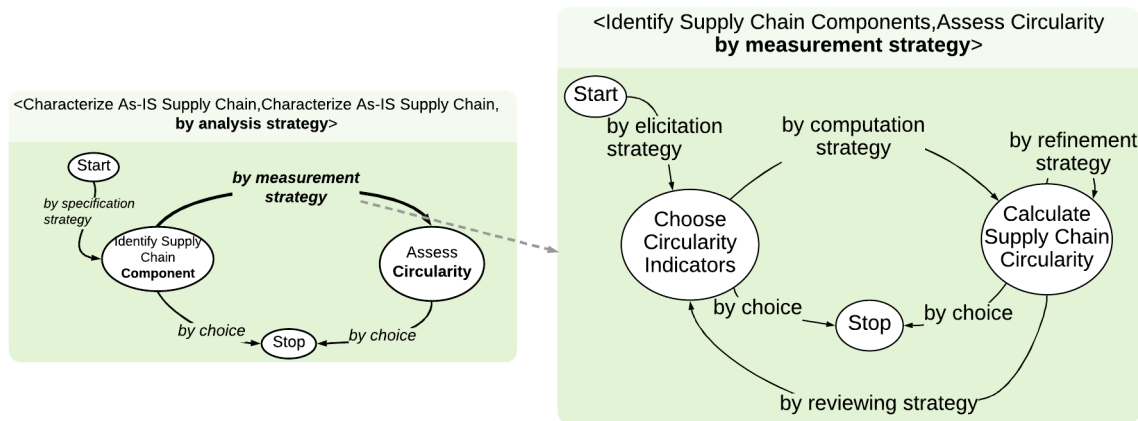

Figure 7.11: Measurement strategy

B1. <Start, Choose Circularity Indicators, by elicitation strategy>

The elicitation strategy is detailed through Protocol 3 (Table 7.5). The objective is to select circularity indicators to assess the supply chain. Here, the circularity dimensions aimed to be improved are presented by using the classification tool proposed in Chapter 4. Then, the participants are asked to choose the dimensions to improve. In addition, the animator gives some information about indicators related to chosen dimensions, such as indicator type (quantitative/qualitative). To do this, the animator could use the taxonomy proposed by Saidani et al. (2019). The participants are also invited to select indicators. Moreover, participants discuss how to collect the required data for selected indicators. In our example, we suppose that participants choose *savings in pollution* as a dimension and *GCI* (See Chapter 5) as an indicator.

Protocol 3: <Start, Choose Circularity Indicators, by elicitation strategy>

Session Type: Focus Group

Participants: SC manager of Original Equipment Manufacturer and selected actors

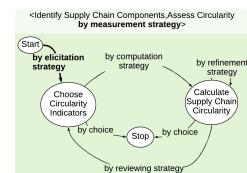

N°	Step	Description	Participants' role	Supports	Dur.
1	Presentation of CE principles and circularity dimensions	Animator presents the dimensions proposed in classification tool.	Passive	Presentation slides, Classification Tool for Circularity Indicators of Supply Chains	20

2	Selection of circularity dimensions	Animator asks participants to choose the circularity dimensions they would like to improve within their supply chains.	Active/ Collective	Post-its	10
3	Presentation of circularity indicators related to selected dimensions	Animator gives a short presentation about circularity indicators (type: qualitative/ quantitative, required data, etc.).	Passive	Classification Tool for Indicators of Supply Chains, CE indicators Taxonomy (Saidani et al., 2019), Presentation slides	20
4	Selection of circularity indicators	Animator asks participants to choose the suitable indicator to their supply chain.	Active/ Collective		20
5	Discussion on data collection	Animator asks participants to describe how and where to collect required data (flow quantity, consumed resources, product utility). The animator asks participants to send the required data in a calculation sheet in order to calculate the selected indicators.	Active/ Collective		20

Table 7.5: Protocol 3: <Start, Choose Circularity Indicators, by elicitation strategy>

B2. <Choose Circularity Indicators, Calculate Supply Chain circularity, by computation strategy>

The selected indicators through elicitation strategy are calculated by computation strategy to indicate the circularity of SC V1, which is considered as As-IS Supply Chain. In this strategy, the CircuSChain Calculator is used. The strategy is explained through Protocol 4 in Table 7.6. The animator implements this strategy; the participation of the SC actors is not required. Therefore, the participants should send the required data to the animator beforehand. Figure 7.12 represents an example of collected data for GCI. Equation 7.1 expresses circularity coefficient (K_3^{11}) of recycling activity. The GCI is calculated as 0.03 using Equation 7.2 (see Chapter 5 for more details).

$$K_3^{11} = \frac{20 + 40 + 30 + 30 + 20 - (5 + 10 + 40 + 30 + 30 + 20)}{20 + 40 + 30 + 30 + 20} = 0.04 \tag{7.1}$$

$$GCI = \frac{0.04 * 100}{100 + 50} = 0.03 \tag{7.2}$$

Protocol 4: < Choose Circularity Indicators, Calculate Supply Chain circularity, computation strategy>

Session Type: Individual work

Participants: Animator

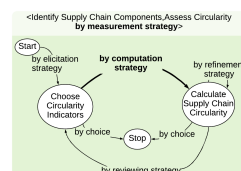

N°	Step	Description	Supports
1	Data collection	Animator collects the data from the actors.	Calculation Sheet, CircuSChain Calculator , SC Model V1
2	Calculation of circularity	Animator inserts the data and calculates the circularity indicators of SC Model V1 using the CircuSChain Calculator.	

Table 7.6: Protocol 4: < Choose Circularity Indicators, Calculate Supply Chain circularity, by computation strategy>

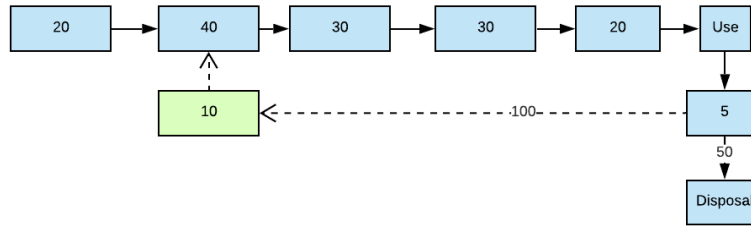

Figure 7.12: Example for Computation Strategy for GCI

7.4.3 Diagnosis Strategy

In this strategy, the intentions are Analyze Gap between the Ideal SC and As-IS SC and Define Circular Goal and Constraint (Figure 7.13). The diagnosis process starts with the detection strategy to Analyze Gap between the Ideal SC and As-IS SC. It consists of the ideal supply chain according to product type. In order to determine Gap, we introduce the model of the ideal state of the supply chain (SC Model V_{Ideal}) and analyze the gap between the Ideal SC and the As-IS SC.

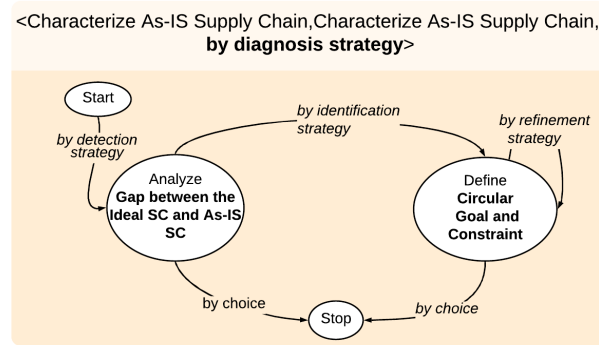

Figure 7.13: Process map of diagnosis strategy

A. <Start, Analyze Gap between the Ideal and As-IS SC, by detection strategy>

The detection strategy is explained by Protocol 5 (Table 7.7). In this process, in order to create SC Model V_{Ideal}, the animator needs to collect some information from the literature. For instance, S/he identifies all the possible CE activities for the product type. Indeed, some CE activities are not applicable for some types of products. For instance, clothes are not remanufacturable. Moreover, in order to calculate the Circularity Indicator, the required quantity of resources (material, energy, labor) and emitted pollution for each activity as well as the quantity of collected products and their repartition among the CE activities are needed. The optimal quantity of these factors is related to product characteristics. An average value could be extracted from the literature, or the indicators, such as product design attributes (Asif et al., 2016), could be used. For our example, we suppose that according to literature, the percentage of used clothes that are eligible for each activity and the circularity coefficient of each activity is determined. According to this information, the model of the ideal supply chain (SC Model V_{Ideal}) is constructed (Figure 7.14). SC Model V_{Ideal} contains closed-loop reuse activity and open-loop activities (such as repurposing in cleaning clothes and open-loop energy recovery), while SC Model V₁ contains only recycling activity. Circularity coefficients for the added activities (K_1^{11} , K_2^{12} , and K_2^{13}) are calculated through Equations 7.3, 7.4, and 7.5. The GCI for the Ideal SC is 0.43, calculated through Equation 7.6.

$$K_1^{11} = \frac{20 + 40 + 30 + 30 + 20 - (5 + 5 + 20)}{20 + 40 + 30 + 30 + 20} = 0.79 \quad (7.3)$$

$$K_2^{12} = \frac{20 + 40 + 30 + 35 + 20 - (5 + 10 + 25 + 20)}{20 + 40 + 30 + 35 + 20} = 0.56 \quad (7.4)$$

$$K_2^{13} = \frac{20 + 30 + 30 - (5 + 5 + 30 + 30)}{20 + 30 + 30} = 0.13 \quad (7.5)$$

$$GCI = \frac{0.04 * 10 + 0.79 * 40 + 0.56 * 50 + 0.13 * 30}{40 + 10 + 50 + 30 + 20} = 0.43 \quad (7.6)$$

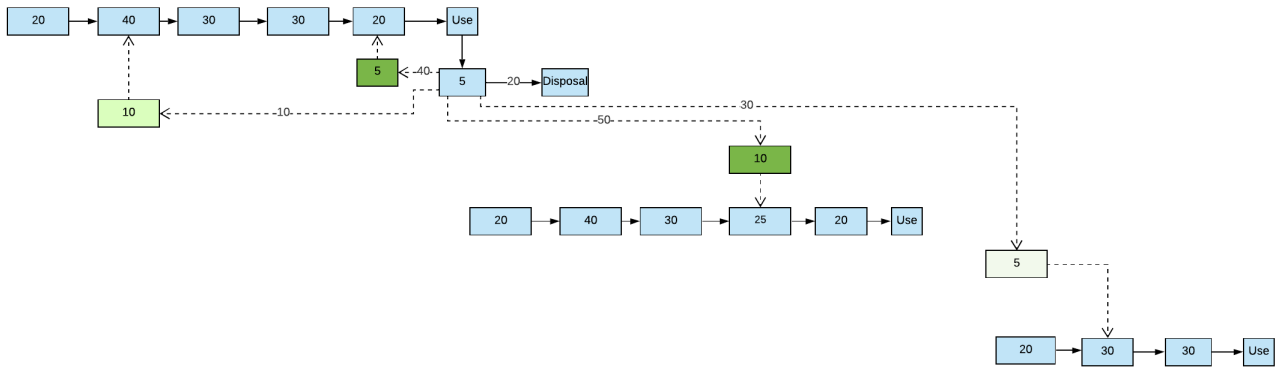

Figure 7.14: Example of SC Videal

After the calculation of the circularity of the Ideal SC, the gap between the Ideal SC and the As-IS SC is analyzed.

Protocol 5: <Start, Analyze Gap between the Ideal SC and As-IS SC, by detection strategy>

Session Type: Focus Group

Participants: SC manager of Original Equipment Manufacturer and selected actors

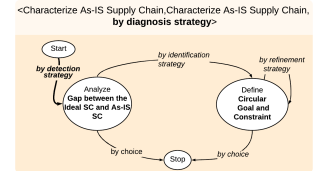

N° Step	Description	Participants' role	Supports	Dur.
1	Data Collection	Animator collects data from SC actors or from literature according to product type.	-	-
2	Modelling the SC model of the Ideal SC	Animator models the SC Model Videal according to collected data through SC Generic Model.	-	-
3	Calculation of the indicators of Ideal SC	Animator calculates the circularity indicators of the SC Model Videal through CircuSChain Calculator.	-	-
4	Reminding product specifications and the ideal data related to product type	Animator reminds the Ideal SC, product specifications, the ideal data related to product type and the indicators of SC Model Videal.	Passive	10
5	Calculation of the indicators of SC Model V1	Animator reminds SC Model V1, makes a demo of the CircuSChain Calculator, and calculates the indicators of SC Model V1.	Passive	15
6	Determination of gaps	Animator starts the discussion about the comparison. S/he asks the following questions: <ul style="list-style-type: none"> • What are the significant gaps between the two SCs? • Which dimensions are related to these gaps? 	Active/Collective	20

Table 7.7: Protocol 5: <Start, Analyze Gap between the Ideal SC and As-IS SC, by detection strategy>

B. <Analyze Gap between the Ideal SC and As-IS SC, Define Circular Goals and Constraints by identification strategy>

After analyzing Gap between the Ideal SC and As-IS SC, Circular Goal and Constraint are defined by identification strategy. In order to explain the identification strategy, Protocol 6 (Table 7.8) is introduced. By identification strategy, participants are invited to discuss about their goals and constraints.

Protocol 6: <Analyze Gap between Ideal SC and As-IS SC, Define Circular Goal and Constraint, by identification strategy>

Session Type: Focus Group

Participants: SC manager of Original Equipment Manufacturer and selected actors

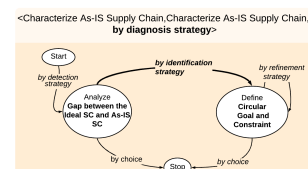

N° Step	Description	Participants' role	Supports	Dur.
1	Reminding the main gaps between the Ideal SC and As-IS SC	Passive	Circularity indicators of SC Model VIdeal and SC Model V1	10
2	Discussion about the constraints Animator starts a discussion about the constraints to reach each goal through the following questions: <ul style="list-style-type: none"> • What are the economic constraints? • Is there any need for a new actor? If so, what are the constraints about these actors? • What are the flows' capacities? • What are the market constraints? 	Active/Collective	Post-its stating constraint types	30
3	Determination of goals considering the constraints Animator starts a discussion about the goals related to the gaps, considering the constraints, in order to achieve the Ideal SC through the following question: <ul style="list-style-type: none"> • What is the goal you aim to reach? 	Active/Collective	Post-its	10
4	Synthesis Animator summarizes the goals and the constraints and establishes priorities with the participants.	Active/Collective		10

Table 7.8: Protocol 6: <Analyze Gap between Ideal SC and As-IS SC, Define Circular Goal and Constraint, by identification strategy>

For our example, the new open-loop activities that exist in SC Model VIdeal requires collaboration with new actors. Therefore, the lack of actors could be a constraint (Figure 7.15). The goal could be defined lower than the Ideal SC.

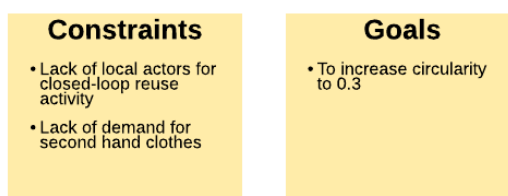

Figure 7.15: Example of identified goals and constraints

7.4.4 Evolution Strategy

Evolution strategy has two intentions: Identify Change and Characterize Operational changes. Gaming simulation and computer simulation strategies are introduced to identify change. The

identified changes could be improved by simulation strategies. Operational changes are characterized through industrial modeling strategy.

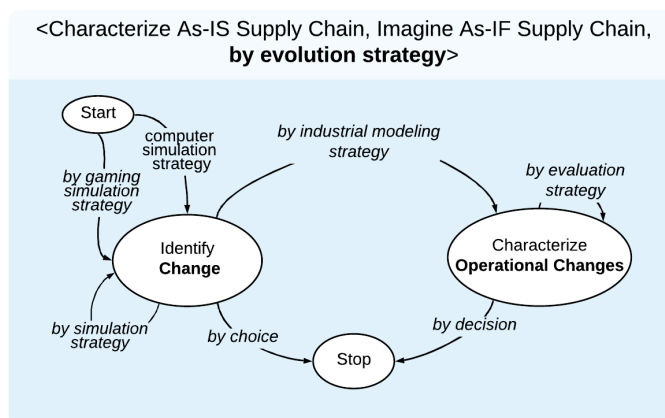

Figure 7.16: Process map of Evolution strategy

A. <Start, Identify changes, by gaming simulation strategy> and <Start, Identify changes, by computer simulation strategy>

The evolution process starts with gaming simulation or computer simulation strategies to identify changes that help to reach the identified goal. These strategies are detailed in Protocols 7 and 8, respectively (Tables 7.9 and 7.10).

Protocol 7: <Start, Identify changes, by gaming simulation strategy>

Session Type: Focus Group

Participants: SC manager of Original Equipment Manufacturer and selected actors

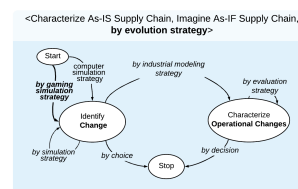

N° Step	Description	Participants' role	Supports	Dur.
1	Introduction	Passive	Presentation slides	10
2	Playing Phase 1 Game	Active/Collective	CircuSChain Game	20
3	Discussion and modifying the SC Model V1	Active/Collective	Strategy Cards, Post-its	10
4	Playing Phase 2 Game	Active/Collective	CircuSChain Game	20
5	Iterative Steps	Active/Collective	CircuSChain Game , Post-its	-

Table 7.9: Protocol 7: <Start, Identify changes by gaming simulation strategy>

An example of the gaming simulation strategy is given in Figure 7.17. These protocols have iterative steps that allow modifying the supply chain structure to reach the goal. Through gaming strategy that uses CircuSChain Game, participants are included in the testing of the proposed changes. Gaming simulation strategy, which is a participatory approach, provides an entertaining experience. However, simulation strategy using simulation tools, such as ARENA allows a further parameterization of the supply chain.

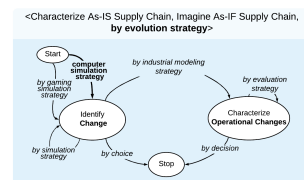

Figure 7.17: Example for gaming simulation strategy

Protocol 8: <Start, Identify changes, by simulation strategy>

Session Type: Focus Group

Participants: SC manager of Original Equipment Manufacturer and selected actors



N° Step	Description	Participants' role	Supports	Dur.	
1	Context	Animator reminds the context and the indicators	Passive	CircuSChain Calculator	10
2	Simulation As-IS SC model	Animator explains the model with hypotheses and used data. Then, s/he shows the simulation.	Active/Collective	Simulation tool	20
3	Discussion and modifying the SC Model V1	Animator presents the strategy card to participants. S/he starts the discussion through the following question: <ul style="list-style-type: none"> Which are the activities you would like to invest in to improve the circularity of your supply chain? 	Active/Collective	Strategy Cards, Post-its	10
4	Simulation As-IF SC model	Animator modifies the model and launches the simulation.	Passive	Simulation tool	30
5	Iterative Steps	Animator repeats 3rd and 4th steps till the value of indicators reach identified goals	Active/Collective	Simulation tool, Post-its, Strategy Cards	-

Table 7.10: Protocol 8: <Start, Identify changes by computer simulation strategy>

7.4.5 Product Meta-Model

In order to formalize CircuSChain, we propose a product meta-model by adapting the product meta-model of the As-IS/As-IF framework, explained in Section 7.3.2. Figure 7.18 represents process model (a) and product meta-model (b) of CircuSChain. The product meta-model describes all the elements required for continual evolution of supply chain circularity.

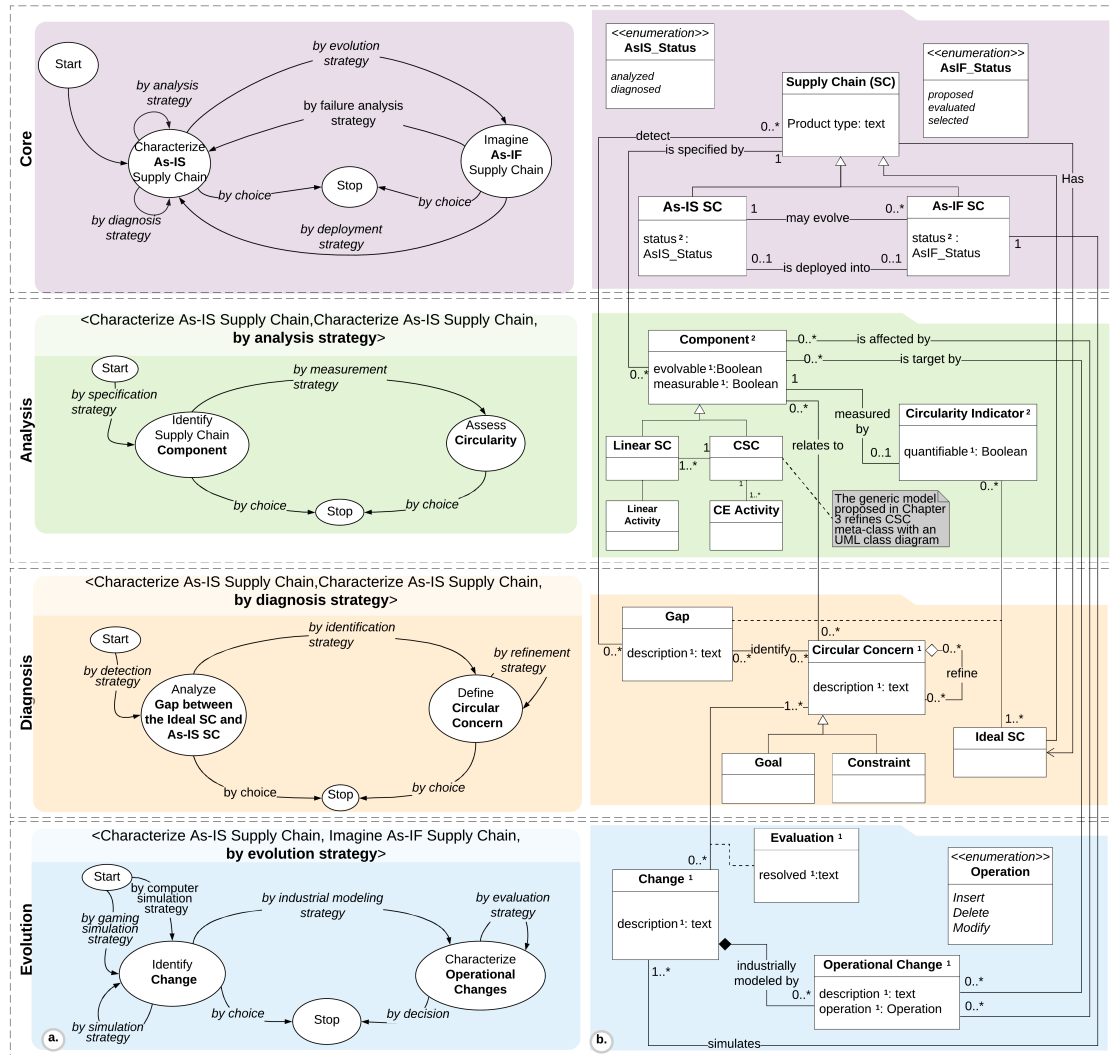

Figure 7.18: Process model (a) and product meta-model (b) of CircuSChain

The **core package** contains Supply Chain (SC) meta-class and its two sub-classes: As-IS SC and As-IF SC. An As-IS SC could evolve into one or several As-IF SC through evolution strategy (may evolve association). An As-IF SC could be transformed into the next As-IS SC by deployment strategy (deployed into association) and the evolution could continue. As-IS SC is analyzed associated with the elements of analysis package.

The **analysis package** is composed of two meta-classes: Component and Circularity Indicator. Component meta-class covers all elements to specify a system. Supply Chain is specified by Component (is specified by association). Component has two sub-classes Linear SC and CSC. As explained in the generic model (Chapter 3), a CSC contains one or several linear supply chains and at least one CE activity. Moreover, a linear supply chain is composed of linear activities. A more detailed representation of CSC components is given in the generic model in Chapter 3. Component of Supply Chain is measured by Circularity Indicator meta-class (measured by association).

Moreover, As-IS SC is diagnosed as associated with the elements of **diagnosis package**. This package contains Gap, Circular Concern, and Ideal SC meta-classes. Ideal SC is a subclass of Supply Chain Meta-class and Supply Chain has an Ideal SC associated with Circularity Indicator. Gap between the Ideal and As-IS SC is detected (detect association). Gaps identify Circular Concern, which represents Goal or Constraint of the supply chain.

As previously stated, As-IS SC could be evolved into an As-IF SC, associated with the elements of **evolution package**. Change, Operational Change, and Evaluation are the three meta-classes of this package. The Change meta-class represents the suggested evolution to address one or more Concerns. Change is industrially modeled by Operational Change (industrially modeled by association). Change is evaluated in order to determine whether the related Concern is resolved (Evolution meta-class).

7.5 Conclusion

In this chapter, we have adapted As-IS/As-IF framework for supply chain circularity improvement. This framework guides the creation of a continual evolution method for a chosen system. Here our system is a supply chain whose circularity needs to be improved. While adapting this framework, some modifications have been made in the analysis, diagnosis, and evolution strategies. Some strategies in these packages are refined by sub-maps. The proposed tools in the previous chapters are integrated into the CircuSChain Method. Protocols explain the use of these tools.

7.5.1 Implications for the practice and the theory

This work proposes preliminary work to develop a continual evolution method for CSCs. It enhances the tools proposed previously and shows a potential way to use these tools in an integrated way. While adapting this tool, we propose the notion of the Ideal SC and add it into the process model and product meta-model. Note that the As-IS/As-IF heuristics do not allow to the add new meta-classes in the meta-model. However, this notion is considered here important, and this change will help evolving the framework itself so other adaptation could benefit of the ideal case notion.

This method would help Supply Chain managers to transform their linear Supply Chain into a CSC and then improve its circularity in a continuous way.

7.5.2 Limitations and future works

In this work, we have not focus on the deployment strategy. Indeed, the framework is still not precise on this aspect. Future works could permit to develop this strategy to deploy the imagined As-IF Supply Chain. Developing this part focusing on supply chains could also help to develop this part of the framework in a bottom-up approach.

Furthermore, we have not refine the industrial modeling strategy. This strategy attains characterization of Operational Changes. Future works are needed to explore possible strategies and tools to characterize operational changes. As explained in Chapter 2, our work is based on the activities, not processes of supply chains. SCOR model (stated in Chapter 2) allowing model the processes within actors could be used.

Moreover, some tools are needed to be selected or developed for some strategies. For instance, for Protocol 1, an interview guide needs to be developed. Considering the elicitation strategy, (Protocol 3) our classification tool does not provide some information (e.g. required data, indicator

type (quantitative, qualitative), etc.) to help participants choose circularity indicators. [Saidani et al. \(2019\)](#) proposed a taxonomy providing this information. Our classification tool could be extended inspired by this work.

Concerning the calculation strategy (Protocol 5), the animator needs to collect data of the Ideal SC that depends on the product design from the literature. New indicators are needed to define the products' attributes, such as the product design attributes of ([Asif et al., 2016](#)). For example, for a product type, the percentage of the collected products, which are reusable, remanufacturable, etc., could be defined. Moreover, for the simulation strategy (Protocol 9), suitable simulation tools are needed to be selected to simulate Supply Chains.

Finally, a tool to integrate all the tools used in the CircuSChain Method is needed to further formalize the method. This will be very helpful in order to guide participants of the method to implement the different strategies and use the tools to reach the different goals.

8

General Conclusion

The Circular Economy concept is introduced as a potential solution for material depletion and environmental problems. The Circular Economy aims at minimizing resource inputs, waste, and pollution by keeping products, components, and materials in use. This could be obtained by CE activities, such as reuse, remanufacturing, repurposing, recycling, etc. Supply chains play an essential role in the application of CE principles by supporting these activities.

The CE brings some new implications on supply chains: (1) applying multiple CE activities in parallel rather than applying single activities, (2) using materials over and over again through consecutive cycles, and (3) combining closed and open-loops between distinct supply chains through reuse and repurposing. Therefore CE requires new CSC structures that need to be conceptualized and modeled. Furthermore, one of the challenges of implementing CSC or CE practices is the insufficient knowledge and awareness among supply chain members. Moreover, a successful transition to a CSC requires continuous measurement of progress towards circularity. In addition, the repurposing activity, which could be a new potential mean to increasing circularity in CSCs, remains scarcely explored among scholars and industrials.

Five key research questions (RQ1 to RQ5) have been formulated according to the challenges mentioned above. Therefore, in this thesis, efforts have been made to address these research questions.

First, RQ1 has been addressed in Chapter 2 through a literature review in order to establish a link between the CE and supply chain concepts and clarify our positioning. The repurposing activities have been integrated into a hierarchical framework of CE activities and defined as open-loops in an extended model of CSCs developed during our previous work.

Then, in order to answer RQ2, in Chapter 3, we have proposed CSC characteristics to define the scope of CSCs. The proposed characteristics in this work contribute to the theory in constructing the bridge between the CE and supply chains as well as the conceptualization of CSCs, by clarifying the CSC structures according to the CE principles. Based on these characteristics, a generic model is constructed using the Unified Modeling Language (UML). The generic model helps decision-makers model complex CSCs in a standard way. This model helps to conceptualize, formalize and visualize complex CSCs. This standard representation could be used by different actors of CSCs, and it supports inter-actor communication, especially in the case of repurposing, where the actors from distinct sectors are collaborating.

In response to RQ3, first, in Chapter 4, we have developed a classification tool for CSC indicators based on EMF circular value creation principles. This tool can help to analyze existing or new circularity indicators according to CSC structures by using the proposed dimensions as

classification criteria. It also facilitates supply chain managers to categorize and choose appropriate circularity indicators to assess the circularity of CSCs. Moreover, we propose new potential circularity indicators for each dimension that could support strategic decisions such as selecting CE activities in supply chain design. Second, in Chapter 5, we have defined a Global Circularity Indicator (GCI) in order to evaluate the circularity of CSCs. It relies on our generic model and allows the evaluation of different CSC configurations, without requiring modifications in the formula. CSCs could be modeled through a generic model and evaluated through this GCI. It also supports the different dimensions that constitute the classification tool.

To overcome the challenges stated in RQ4 regarding to the insufficient knowledge and awareness about CSCs, the CircuSChain Game is introduced in Chapter 6. This game is developed based on the well-known Beer Distribution Game. The game has been tested by an experiment with forty-two industrial engineering students.

Finally, in Chapter 7, we have integrated these contributions into a preliminary version of a continual evolution method to help organizations to support circularity in supply chains continuously to address RQ5. To develop the CircuSChain Method, we have adapted the As-IS/As-IF framework for supply chains. The used framework guides the creation of our continual evolution method. CircuSChain Method integrates previously proposed tools and shows a potential way to use them in an industrial scenario. This method would help supply chain managers to transform their linear supply chain into a CSC and then improve its circularity in a continuous way.

All of our contributions support various repurposing activities that create open-loops. These activities have been scarcely explored in the literature, while related industrial applications remain limited. This activity adds value to used products in a different way could be a new potential for CSCs. Note that the product design is a critical factor for the implementation of repurposing activities. In future, where the products will be designed to be repurposed over and over again in different applications, our contributions would be more valuable.

Our works have contributed to bring these first bricks to support the design, assessment, and evolution of CSCs. However, we are aware that limits exist as mentioned in each chapter but they constitute future research opportunities, such as the inclusion of the actor dimension in the generic model, the introduction of TBL -especially social and economic aspects- of the sustainability in the classification tool, the adoption of a multi-criteria approach for our Global Circularity Indicator, the validation of the CircuSChain Game through more exhaustive user experiments, and the refinement of deployment strategy in CircuSChain Method.

Related own publications

- Kurt, A., Cortes-Cornax, M., Cung, V.-D., Front, A., & Mangione, F. (2021). A classification tool for circular supply chain indicators. In *IFIP International Conference on Advances in Production Management Systems* (pp. 644–653).: Springer.
- Kurt, A., Cortes-Cornax, M., Cung, V.-D., Mangione, F., & Kaddouri, S. (2022). CircuSChain Game: A serious game to explore circular supply chains. In *Handbook of Research on Promoting Economic and Social Development Through Serious Games*. IGI Globale. (Accepted).
- Kurt, A., Cung, V.-D., Mangione, F., Cortes-Cornax, M., & Front, A. (2019). An extended circular supply chain model including repurposing activities. In *2019 International Conference on Control, Automation and Diagnosis (ICCAD)* (pp. 287–292).: IEEE
- Dubois, F., Basia, A., Kurt, A., Bettinelli, M., Zheng, P., Jourdain, V., & Guelle, K. (2019). Production of the future to support circular economy-development of a dedicated platform by means of a multidisciplinary approach. In *2019 International Conference on Control, Automation and Diagnosis (ICCAD)* (pp. 144–148).: IEEE

Bibliography

- AFEP (2017). Trajectoires économie circulaire. Available online: https://afep.com/wp-content/uploads/2017/05/AFEP_100_Engagements_economie_circulaire_-33_entreprises.pdf. Accessed: 04/10/21.
- Aguiar, V. A. C., Rosly, M. M., & Nakano, M. (2018). A single player serious game for sustainable supply chain management. *STUDIES IN SIMULATION AND GAMING*, 28(1), 60–72.
- Ahi, P., Jaber, M. Y., & Searcy, C. (2016). A comprehensive multidimensional framework for assessing the performance of sustainable supply chains. *Applied Mathematical Modelling*, 40(23–24), 10153–10166.
- Ahi, P. & Searcy, C. (2015). An analysis of metrics used to measure performance in green and sustainable supply chains. *Journal of Cleaner Production*, 86, 360–377.
- Alamerew, Y. A. & Brissaud, D. (2020). Modelling reverse supply chain through system dynamics for realizing the transition towards the circular economy: A case study on electric vehicle batteries. *Journal of Cleaner Production*, 254, 120025.
- Alizadeh-Basban, N. & Taleizadeh, A. A. (2020). A hybrid circular economy-game theoretical approach in a dual-channel green supply chain considering sale's effort, delivery time, and hybrid remanufacturing. *Journal of Cleaner Production*, 250, 119521.
- Aminoff, A. & Kettunen, O. (2016). Sustainable supply chain management in a circular economy—towards supply circles. In *International Conference on Sustainable Design and Manufacturing* (pp. 61–72).: Springer.
- APICS (2017). Supply chain operations reference model (scor) version 12.0. Available online: <http://www.apics.org/docs/default-source/scor-training/scor-v12-0-framework-introduction.pdf?sfvrsn=2>. Accessed: 17/09/21.
- Asif, F. M., Lieder, M., & Rashid, A. (2016). Multi-method simulation based tool to evaluate economic and environmental performance of circular product systems. *Journal of Cleaner Production*, 139, 1261–1281.
- Ávila-Gutiérrez, M. J., Martín-Gómez, A., Aguayo-González, F., & Córdoba-Roldán, A. (2019). Standardization framework for sustainability from circular economy 4.0. *Sustainability*, 11(22), 6490.
- Avila-Pesantez, D., Delgadillo, R., & Rivera, L. A. (2019). Proposal of a conceptual model for serious games design: A case study in children with learning disabilities. *IEEE Access*, 7, 161017–161033.
- Azevedo, S. G., Godina, R., & Matias, J. C. d. O. (2017). Proposal of a sustainable circular index for manufacturing companies. *Resources*, 6(4), 63.
- Barringer, H. P., Weber, D. P., Westside, M. H., et al. (1995). Life-cycle cost tutorials. In *Fourth International Conference on Process Plant Reliability*, Gulf Publishing Company: Citeseer.

- Bassuk, J. A. & Washington, I. M. (2013). The a3 problem solving report: a 10-step scientific method to execute performance improvements in an academic research vivarium. *PloS one*, 8(10), e76833.
- Batista, L., Bourlakis, M., Liu, Y., Smart, P., & Sohal, A. (2018). Supply chain operations for a circular economy. *Production Planning & Control*, 29(6), 419–424.
- Bauer, T., Brissaud, D., & Zwolinski, P. (2017). Design for high added-value end-of-life strategies. In *Sustainable Manufacturing* (pp. 113–128). Springer, Cham.
- Behrens, B.-A., Wilde, I., & Hoffmann, M. (2007). Complaint management using the extended 8d-method along the automotive supply chain. *Production Engineering*, 1(1), 91–95.
- Beske, P. & Seuring, S. (2014). Putting sustainability into supply chain management. *Supply Chain Management: an international journal*, 19(3), 322–331.
- Bianchini, A., Rossi, J., & Pellegrini, M. (2019). Overcoming the main barriers of circular economy implementation through a new visualization tool for circular business models. *Sustainability*, 11(23), 6614.
- Bilal, M., Khan, K. I. A., Thaheem, M. J., & Nasir, A. R. (2020). Current state and barriers to the circular economy in the building sector: Towards a mitigation framework. *Journal of Cleaner Production*, 276, 123250.
- Blomsma, F. & Brennan, G. (2017). The emergence of circular economy: a new framing around prolonging resource productivity. *Journal of Industrial Ecology*, 21(3), 603–614.
- Bocken, N. M., De Pauw, I., Bakker, C., & Van Der Grinten, B. (2016). Product design and business model strategies for a circular economy. *Journal of industrial and production engineering*, 33(5), 308–320.
- Bocken, N. M., Ritala, P., & Huotari, P. (2017). The circular economy: exploring the introduction of the concept among s&p 500 firms. *Journal of Industrial Ecology*, 21(3), 487–490.
- Bracquen , E., Dewulf, W., & Duflou, J. R. (2020). Measuring the performance of more circular complex product supply chains. *Resources, Conservation and Recycling*, 154, 104608.
- Brissaud, D. & Zwolinski, P. (2017). The scientific challenges for a sustainable consumption and production scenario: the circular reuse of materials for the upgrading and repurposing of components. *Procedia CIRP*, 61, 663–666.
- Brunoe, T. D., Andersen, A.-L., & Nielsen, K. (2019). Changeable manufacturing systems supporting circular supply chains. *Procedia CIRP*, 81, 1423–1428.
- Carri n-Toro, M., Santorum, M., Acosta-Vargas, P., Aguilar, J., & P rez, M. (2020). iplus a user-centered methodology for serious games design. *Applied Sciences*, 10(24), 9007.
- Casals, L. C., Garc a, B. A., & Cremades, L. V. (2017). Electric vehicle battery reuse: Preparing for a second life. *Journal of Industrial Engineering and Management*, 10(2), 266–285.
-  ela, O. (2021). *A General Framework for the Continual Evolution Methods; Adaptation to the Continual Evolution of Organization's Business Processes*. PhD thesis, Universite Grenoble Alpes.
-  ela, O., Cortes-Cornax, M., Rieu, D., et al. (2019). Methodological framework to guide the development of continual evolution methods. In *International Conference on Advanced Information Systems Engineering* (pp. 48–63).: Springer.

-
- Chertow, M. R. (2000). Industrial symbiosis: literature and taxonomy. *Annual review of energy and the environment*, 25(1), 313–337.
- Chopra, S., Meindl, P., & Kalra, D. V. (2013). *Supply chain management: Strategy, planning, and operation*, volume 232. Pearson Boston, MA.
- Cooper, S. J., Giesekam, J., Hammond, G. P., Norman, J. B., Owen, A., Rogers, J. G., & Scott, K. (2017). Thermodynamic insights and assessment of the ‘circular economy’. *Journal of Cleaner Production*, 162, 1356–1367.
- Corona, B., Shen, L., Reike, D., Carreón, J. R., & Worrell, E. (2019). Towards sustainable development through the circular economy—a review and critical assessment on current circularity metrics. *Resources, Conservation and Recycling*, 151, 104498.
- Côté, R. P. & Cohen-Rosenthal, E. (1998). Designing eco-industrial parks: a synthesis of some experiences. *Journal of cleaner production*, 6(3-4), 181–188.
- Council of European Union (2008). Directive 2008/98/ec of the european parliament and of the council of 19 november 2008 on waste and repealing certain directives.
- Cuesta, V. & Nakano, M. (2017). Chain of command: a sustainable supply chain management serious game. *International Journal of Automation Technology*, 11(4), 552–562.
- Cullen, J. (2017). Circular economy: theoretical benchmark or perpetual motion machine? *Journal of Industrial Ecology*, 21(3), 483–486.
- Davim, J. P. (2013). *Sustainable manufacturing*. John Wiley & Sons.
- De Angelis, R., Howard, M., & Miemczyk, J. (2018). Supply chain management and the circular economy: towards the circular supply chain. *Production Planning & Control*, 29(6), 425–437.
- De Brito, M. P. & Dekker, R. (2004). A framework for reverse logistics. In *Reverse logistics* (pp. 3–27). Springer.
- de Lima, F. A., Seuring, S., & Sauer, P. C. (2021). A systematic literature review exploring uncertainty management and sustainability outcomes in circular supply chains. *International Journal of Production Research*, (pp. 1–34).
- de Sousa Jabbour, A. B. L., Luiz, J. V. R., Luiz, O. R., Jabbour, C. J. C., Ndubisi, N. O., de Oliveira, J. H. C., & Junior, F. H. (2019). Circular economy business models and operations management. *Journal of cleaner production*, 235, 1525–1539.
- Deeb, S., Bril-El Haouzi, H., Aubry, A., & Dassisti, M. (2018). A generic framework to support the implementation of six sigma approach in smes. *IFAC-PapersOnLine*, 51(11), 921–926.
- Deming, W. E. (2000). *Out of the Crisis*. MIT press.
- Desing, H., Brunner, D., Takacs, F., Nahrath, S., Frankenberger, K., & Hischier, R. (2020). A circular economy within the planetary boundaries: towards a resource-based, systemic approach. *Resources, Conservation and Recycling*, 155, 104673.
- Despeisse, M., Ball, P. D., Evans, S., & Levers, A. (2012). Industrial ecology at factory level—a conceptual model. *Journal of cleaner production*, 31, 30–39.
- Di Maio, F., Rem, P. C., Baldé, K., & Polder, M. (2017). Measuring resource efficiency and circular economy: A market value approach. *Resources, Conservation and Recycling*, 122, 163–171.

Bibliography

- Di Maio, F., Rem, P. C., et al. (2015). A robust indicator for promoting circular economy through recycling. *Journal of Environmental Protection*, 6(10), 1095.
- Elia, V., Gnani, M. G., & Tornese, F. (2017). Measuring circular economy strategies through index methods: A critical analysis. *Journal of Cleaner Production*, 142, 2741–2751.
- EMF (2013). Towards the circular economy volume 1: An economic and business rationale for an accelerated transition.
- EMF (2014). Towards the circular economy—vol 3: Accelerating the scale-up across global supply chains.
- EMF (2015). Circularity indicators: An approach to measuring circularity.
- Eng, T.-Y. (2005). The influence of a firm's cross-functional orientation on supply chain performance. *Journal of Supply Chain Management*, 41(4), 4–16.
- Farooque, M., Zhang, A., & Liu, Y. (2019a). Barriers to circular food supply chains in china. *Supply Chain Management: An International Journal*, 24(5), 677–696.
- Farooque, M., Zhang, A., Thürer, M., Qu, T., & Huisingh, D. (2019b). Circular supply chain management: A definition and structured literature review. *Journal of Cleaner Production*, 228, 882–900.
- Figge, F., Thorpe, A. S., Givry, P., Canning, L., & Franklin-Johnson, E. (2018). Longevity and circularity as indicators of eco-efficient resource use in the circular economy. *Ecological economics*, 150, 297–306.
- Flygansvær, B., Dahlstrom, R., & Nygaard, A. (2018). Exploring the pursuit of sustainability in reverse supply chains for electronics. *Journal of Cleaner Production*, 189, 472–484.
- Galvão, G. D. A., Homrich, A. S., Geissdoerfer, M., Evans, S., Scoleze Ferrer, P. S., & Carvalho, M. M. (2020). Towards a value stream perspective of circular business models. *Resources, Conservation and Recycling*, 162, 105060.
- Garza-Reyes, J. A., Romero, J. T., Govindan, K., Cherrafi, A., & Ramanathan, U. (2018). A pdca-based approach to environmental value stream mapping (e-vsm). *Journal of Cleaner Production*, 180, 335–348.
- Geissdoerfer, M., Savaget, P., Bocken, N. M., & Hultink, E. J. (2017). The circular economy—a new sustainability paradigm? *Journal of cleaner production*, 143, 757–768.
- Genovese, A., Acquaye, A. A., Figueroa, A., & Koh, S. L. (2017). Sustainable supply chain management and the transition towards a circular economy: Evidence and some applications. *Omega*, 66, 344–357.
- Gómez-Luciano, C. A., Domínguez, F. R. R., González-Andrés, F., & De Meneses, B. U. L. (2018). Sustainable supply chain management: Contributions of supplies markets. *Journal of cleaner production*, 184, 311–320.
- González-Sánchez, R., Settembre-Blundo, D., Ferrari, A. M., & García-Muiña, F. E. (2020). Main dimensions in the building of the circular supply chain: A literature review. *Sustainability*, 12(6), 2459.
- Govindan, K. & Hasanagic, M. (2018). A systematic review on drivers, barriers, and practices towards circular economy: a supply chain perspective. *International Journal of Production Research*, 56(1-2), 278–311.

-
- Govindan, K. & Soleimani, H. (2017). A review of reverse logistics and closed-loop supply chains: a journal of cleaner production focus. *Journal of Cleaner Production*, 142, 371–384.
- Govindan, K., Soleimani, H., & Kannan, D. (2015). Reverse logistics and closed-loop supply chain: A comprehensive review to explore the future. *European journal of operational research*, 240(3), 603–626.
- Grebert, F. & Mothe, C. (2019). Les conditions d'émergence et de développement des projets d'économie circulaire.
- Guide Jr, V. D. R. & Van Wassenhove, L. N. (2006). Closed-loop supply chains: an introduction to the feature issue (part 1). *Production and Operations Management*, 15(3), 345–350.
- Gunasekaran, A., Patel, C., & McGaughey, R. E. (2004). A framework for supply chain performance measurement. *International journal of production economics*, 87(3), 333–347.
- Gunasekaran, A., Patel, C., & Tirtiroglu, E. (2001). Performance measures and metrics in a supply chain environment. *International journal of operations & production Management*, 21(1/2), 71–87.
- Hervani, A. A., Helms, M. M., & Sarkis, J. (2005). Performance measurement for green supply chain management. *Benchmarking: An international journal*, 12(4), 330–353.
- Hofmann, F. (2019). Circular business models: business approach as driver or obstructor of sustainability transitions? *Journal of Cleaner Production*, 224, 361–374.
- Homrich, A. S., Galvao, G., Abadia, L. G., & Carvalho, M. M. (2018). The circular economy umbrella: Trends and gaps on integrating pathways. *Journal of Cleaner Production*, 175, 525–543.
- Howard, M., Hopkinson, P., & Miemczyk, J. (2019). The regenerative supply chain: a framework for developing circular economy indicators. *International Journal of Production Research*, 57(23), 7300–7318.
- Ijomah, W. L., Bennett, J. P., & Pearce, J. (1999). Remanufacturing: evidence of environmentally conscious business practice in the uk. In *Proceedings first international symposium on environmentally conscious design and inverse manufacturing* (pp. 192–196).: IEEE.
- Ivanov, D. (2010). An adaptive framework for aligning (re) planning decisions on supply chain strategy, design, tactics, and operations. *International journal of production research*, 48(13), 3999–4017.
- Jain, S., Jain, N. K., & Metri, B. (2018). Strategic framework towards measuring a circular supply chain management. *Benchmarking: An International Journal*, 25(8), 3238–3252.
- Jamil, N., Gholami, H., Mat Saman, M. Z., Streimikiene, D., Sharif, S., & Zakuan, N. (2020). Dmaic-based approach to sustainable value stream mapping: towards a sustainable manufacturing system. *Economic research-Ekonomska istraživanja*, 33(1), 331–360.
- Jiao, N. & Evans, S. (2016). Business models for sustainability: the case of second-life electric vehicle batteries. *Procedia Cirp*, 40, 250–255.
- Jiménez-Hernández, E. M., Oktaba, H., Piattini, M., Díaz-Barriga, F. F., Revillagigedo-Tulais, A. M., & Flores-Zarco, S. V. (2016). Methodology to construct educational video games in software engineering. In *2016 4th International Conference in Software Engineering Research and Innovation (CONISOFT)* (pp. 110–114).: IEEE.
-

Bibliography

- Julianelli, V., Caiado, R. G. G., Scavarda, L. F., & Cruz, S. P. d. M. F. (2020). Interplay between reverse logistics and circular economy: critical success factors-based taxonomy and framework. *Resources, Conservation and Recycling*, 158, 104784.
- Kaddouri, S. (2021). Development of a serious game in the transition towards circular economy . Master's thesis, INP Grenoble, France.
- Kalmykova, Y., Sadagopan, M., & Rosado, L. (2018). Circular economy—from review of theories and practices to development of implementation tools. *Resources, conservation and recycling*, 135, 190–201.
- Kalverkamp, M., Pehlken, A., & Wuest, T. (2017). Cascade use and the management of product lifecycles. *Sustainability*, 9(9), 1540.
- Kalverkamp, M. & Young, S. B. (2019). In support of open-loop supply chains: Expanding the scope of environmental sustainability in reverse supply chains. *Journal of Cleaner Production*, 214, 573–582.
- Kaplík, P., Prístavka, M., Bujna, M., & Viderňan, J. (2013). Use of 8d method to solve problems. In *Advanced Materials Research*, volume 801 (pp. 95–101).: Trans Tech Publ.
- Kazancoglu, Y., Kazancoglu, I., & Sagnak, M. (2018). A new holistic conceptual framework for green supply chain management performance assessment based on circular economy. *Journal of Cleaner Production*, 195, 1282–1299.
- Khor, K. S. & Udin, Z. M. (2012). Impact of reverse logistics product disposition towards business performance in malaysian e&e companies. *Journal of Supply Chain and Customer Relationship Management*, 2012, 1.
- King, A. M., Burgess, S. C., Ijomah, W., & McMahon, C. A. (2006). Reducing waste: repair, recondition, remanufacture or recycle? *Sustainable development*, 14(4), 257–267.
- Kirchherr, J., Reike, D., & Hekkert, M. (2017). Conceptualizing the circular economy: An analysis of 114 definitions. *Resources, conservation and recycling*, 127, 221–232.
- Kurt, A. (2018). A Generic Framework to Model and Assess the Circularity of Supply Chains . Master's thesis, INP Grenoble, France.
- Kurt, A., Cung, V.-D., Mangione, F., Cortes-Cornax, M., & Front, A. (2019). An extended circular supply chain model including repurposing activities. In *2019 International Conference on Control, Automation and Diagnosis (ICCAD)* (pp. 287–292).: IEEE.
- Lambert, S., Riopel, D., & Abdul-Kader, W. (2011). A reverse logistics decisions conceptual framework. *Computers & Industrial Engineering*, 61(3), 561–581.
- Lenort, R., Staš, D., Holman, D., & Wicher, P. (2017). A3 method as a powerful tool for searching and implementing green innovations in an industrial company transport. *Procedia engineering*, 192, 533–538.
- Lieder, M., Asif, F. M., Rashid, A., Mihelič, A., & Kotnik, S. (2017). Towards circular economy implementation in manufacturing systems using a multi-method simulation approach to link design and business strategy. *The International Journal of Advanced Manufacturing Technology*, 93(5), 1953–1970.
- Lifset, R. & Graedel, T. E. (2002). Industrial ecology: goals and definitions. In *A handbook of industrial ecology* (pp. 3–15). Edward Elgar Cheltenham, UK.

-
- Linder, M., Sarasini, S., & van Loon, P. (2017). A metric for quantifying product-level circularity. *Journal of Industrial Ecology*, 21(3), 545–558.
- Liu, B., Chen, D., Zhou, W., Nasr, N., Wang, T., Hu, S., & Zhu, B. (2018a). The effect of remanufacturing and direct reuse on resource productivity of china's automotive production. *Journal of Cleaner Production*, 194, 309–317.
- Liu, J., Feng, Y., Zhu, Q., & Sarkis, J. (2018b). Green supply chain management and the circular economy: Reviewing theory for advancement of both fields. *International Journal of Physical Distribution & Logistics Management*, 48(8), 794–817.
- Lüdeke-Freund, F., Gold, S., & Bocken, N. M. (2019). A review and typology of circular economy business model patterns. *Journal of Industrial Ecology*, 23(1), 36–61.
- Lynch, D. P., Bertolino, S., & Cloutier, E. (2003). How to scope dmaic projects. *Quality progress*, 36(1), 37–41.
- Madani, K., Pierce, T. W., & Mirchi, A. (2017). Serious games on environmental management. *Sustainable Cities and Society*, 29, 1–11.
- Mandran, N. (2018). *THEDRE : langage et méthode de conduite de la recherche : Traceable Human Experiment Design Research*. PhD thesis, Université Grenoble Alpes.
- Mandran, N. & Dupuy-Chessa, S. (2018). Supporting experimental methods in information system research. In *2018 12th International Conference on Research Challenges in Information Science (RCIS)* (pp. 1–12): IEEE.
- Mangla, S. K., Luthra, S., Mishra, N., Singh, A., Rana, N. P., Dora, M., & Dwivedi, Y. (2018). Barriers to effective circular supply chain management in a developing country context. *Production Planning & Control*, 29(6), 551–569.
- Marfisi-Schottman, I., George, S., & Tarpin-Bernard, F. (2010). Tools and methods for efficiently designing serious games. In *Proceedings of the 4th European Conference on Games Based Learning ECGBL* (pp. 226–234).
- Masi, D., Day, S., & Godsell, J. (2017). Supply chain configurations in the circular economy: A systematic literature review. *Sustainability*, 9(9), 1602.
- Metters, R. (1997). Quantifying the bullwhip effect in supply chains. *Journal of operations management*, 15(2), 89–100.
- Ministère de la Transition Ecologique (2020). The anti waste law in the daily lives of the french people. Available online:https://www.ecologie.gouv.fr/sites/default/files/en_DP%20PJL.pdf. Accessed: 04/10/21.
- Mishra, J. L., Hopkinson, P. G., & Tidridge, G. (2018). Value creation from circular economy-led closed loop supply chains: a case study of fast-moving consumer goods. *Production Planning & Control*, 29(6), 509–521.
- Mishra, P. & Sharma, R. K. (2014). A hybrid framework based on sipoc and six sigma dmaic for improving process dimensions in supply chain network. *International Journal of Quality & Reliability Management*, 31(5), 522–546.
- Moraga, G., Huysveld, S., Mathieux, F., Blengini, G. A., Alaerts, L., Van Acker, K., De Meester, S., & Dewulf, J. (2019). Circular economy indicators: What do they measure? *Resources, Conservation and Recycling*, 146, 452–461.

- Moreno-Camacho, C. A., Montoya-Torres, J. R., Jaegler, A., & Gondran, N. (2019). Sustainability metrics for real case applications of the supply chain network design problem: A systematic literature review. *Journal of cleaner production*, 231, 600–618.
- Nasir, M. H. A., Genovese, A., Acquaye, A. A., Koh, S., & Yamoah, F. (2017). Comparing linear and circular supply chains: A case study from the construction industry. *International Journal of Production Economics*, 183, 443–457.
- Neck, H. M. & Greene, P. G. (2011). Entrepreneurship education: known worlds and new frontiers. *Journal of small business management*, 49(1), 55–70.
- Nordås, H. K. (2004). *The global textile and clothing industry post the agreement on textiles and clothing*. Number 5. WTO discussion paper.
- Ongondo, F. O., Williams, I. D., & Cherrett, T. J. (2011). How are weee doing? a global review of the management of electrical and electronic wastes. *Waste management*, 31(4), 714–730.
- Osiro, L., Lima-Junior, F. R., & Carpinetti, L. C. R. (2018). A group decision model based on quality function deployment and hesitant fuzzy for selecting supply chain sustainability metrics. *Journal of Cleaner Production*, 183, 964–978.
- Pauliuk, S., Kondo, Y., Nakamura, S., & Nakajima, K. (2017). Regional distribution and losses of end-of-life steel throughout multiple product life cycles—insights from the global multiregional matrace model. *Resources, Conservation and Recycling*, 116, 84–93.
- Pauw, I. D., Grinten, B. V. D., Flipsen, B., & Alvarez-mendez, L. (2021). The Circularity Calculator , a Tool For Circular Product Development with Circularity and Potential Value Capture Indicators . In *PLATE: Product Lifetimes And The Environment*.
- Pavel, C. & Blagoeva, D. (2018). *Competitive landscape of the EU's insulation materials industry for energy-efficient buildings*. Technical report.
- Pearce, D. W. & Turner, R. K. (1990). *Economics of natural resources and the environment*. JHU press.
- Ponce, P., Meier, A., Méndez, J. I., Peffer, T., Molina, A., & Mata, O. (2020). Tailored gamification and serious game framework based on fuzzy logic for saving energy in connected thermostats. *Journal of Cleaner Production*, 262, 121167.
- Potting, J., Hekkert, M., Worrell, E., & Hanemaaijer, A. (2017). *Circular economy: measuring innovation in the product chain*. Number 2544. PBL Publishers.
- Qualters, D. M., Isaacs, J. A., Cullinane, T. P., Laird, J., & McDonald, A. (2008). A game approach to teach environmentally benign manufacturing in the supply chain. *International Journal for the Scholarship of Teaching and Learning*, 2(2), n2.
- Reike, D., Vermeulen, W. J., & Witjes, S. (2018). The circular economy: new or refurbished as ce 3.0?—exploring controversies in the conceptualization of the circular economy through a focus on history and resource value retention options. *Resources, Conservation and Recycling*, 135, 246–264.
- Richa, K., Babbitt, C. W., & Gaustad, G. (2017). Eco-efficiency analysis of a lithium-ion battery waste hierarchy inspired by circular economy. *Journal of Industrial Ecology*, 21(3), 715–730.
- Rolland, C., Prakash, N., & Benjamen, A. (1999). A multi-model view of process modelling. *Requirements engineering*, 4(4), 169–187.

-
- Saidani, M., Yannou, B., Leroy, Y., & Cluzel, F. (2017). How to assess product performance in the circular economy? proposed requirements for the design of a circularity measurement framework. *Recycling*, 2(1), 6.
- Saidani, M., Yannou, B., Leroy, Y., Cluzel, F., & Kendall, A. (2019). A taxonomy of circular economy indicators. *Journal of Cleaner Production*, 207, 542–559.
- Sarath, P., Bonda, S., Mohanty, S., & Nayak, S. K. (2015). Mobile phone waste management and recycling: Views and trends. *Waste management*, 46, 536–545.
- Sarkis, J., Zhu, Q., & Lai, K.-h. (2011). An organizational theoretic review of green supply chain management literature. *International journal of production economics*, 130(1), 1–15.
- Savaskan, R. C., Bhattacharya, S., & Van Wassenhove, L. N. (2004). Closed-loop supply chain models with product remanufacturing. *Management science*, 50(2), 239–252.
- Schulz, M., Bey, N., Niero, M., & Hauschild, M. (2020). Circular economy considerations in choices of lca methodology: How to handle ev battery repurposing? *Procedia CIRP*, 90, 182–186.
- Seuring, S. & Müller, M. (2008). From a literature review to a conceptual framework for sustainable supply chain management. *Journal of cleaner production*, 16(15), 1699–1710.
- Shekarian, E. (2020). A review of factors affecting closed-loop supply chain models. *Journal of Cleaner Production*, 253, 119823.
- Sihvonen, S. & Ritola, T. (2015). Conceptualizing rex for aggregating end-of-life strategies in product development. *Procedia Cirp*, 29, 639–644.
- Sivak, S., Sivak, M., Isaacs, J., Laird, J., & McDonald, A. (2007). Managing the tradeoffs in the digital transformation of an educational board game to a computer-based simulation. In *Proceedings of the 2007 ACM SIGGRAPH symposium on Video games* (pp. 97–102).
- Srivastava, S. K. (2007). Green supply-chain management: a state-of-the-art literature review. *International journal of management reviews*, 9(1), 53–80.
- Stahel, W. (2010). *The performance economy*. Springer.
- Stahel, W. R. (1982). The product life factor. *An Inquiry into the Nature of Sustainable Societies: The Role of the Private Sector (Series: 1982 Mitchell Prize Papers)*, NARC.
- Sterman, J. D. (1989). Modeling managerial behavior: Misperceptions of feedback in a dynamic decision making experiment. *Management science*, 35(3), 321–339.
- Stindt, D. (2017). A generic planning approach for sustainable supply chain management-how to integrate concepts and methods to address the issues of sustainability? *Journal of cleaner production*, 153, 146–163.
- Stock, J. R., Boyer, S. L., & Harmon, T. (2010). Research opportunities in supply chain management. *Journal of the Academy of Marketing Science*, 38(1), 32–41.
- Su, B., Heshmati, A., Geng, Y., & Yu, X. (2013). A review of the circular economy in china: moving from rhetoric to implementation. *Journal of cleaner production*, 42, 215–227.
- Taghikhah, F., Voinov, A., & Shukla, N. (2019). Extending the supply chain to address sustainability. *Journal of cleaner production*, 229, 652–666.

Bibliography

- Thierry, M., Salomon, M., Van Nunen, J., & Van Wassenhove, L. (1995). Strategic issues in product recovery management. *California management review*, 37(2), 114–136.
- Törkler, A. (2014). Electrodes and cells manufacturing white paper: Batteries refurbishing & reuse. *Boulogne-Billancourt, European Li-Ion Battery Advanced Manufacturing (ELIBAMA)*.
- Tseng, M.-L., Chiu, A. S., Liu, G., & Jantaralolica, T. (2020). Circular economy enables sustainable consumption and production in multi-level supply chain system. *Resources, Conservation and Recycling*, 154, 104601.
- Turken, N., Cannataro, V., Geda, A., & Dixit, A. (2020). Nature inspired supply chain solutions: definitions, analogies, and future research directions. *International Journal of Production Research*, 58(15), 4689–4715.
- UN Global Compact Business for Social Responsibility (2015). *Supply Chain Sustainability: A Practical Guide for Continuous Improvement (Second Edition)*. Technical report.
- Van Buren, N., Demmers, M., Van der Heijden, R., & Witlox, F. (2016). Towards a circular economy: The role of dutch logistics industries and governments. *Sustainability*, 8(7), 647.
- Vegter, D., van Hillegersberg, J., & Olthaar, M. (2020). Supply chains in circular business models: processes and performance objectives. *Resources, Conservation and Recycling*, 162, 105046.
- Vermunt, D., Negro, S., Verweij, P., Kuppens, D., & Hekkert, M. (2019). Exploring barriers to implementing different circular business models. *Journal of Cleaner Production*, 222, 891–902.
- Weetman, C. (2016). *A circular economy handbook for business and supply chains: Repair, remake, redesign, rethink*. Kogan Page Publishers.
- Werning, J. P. & Spinler, S. (2020). Transition to circular economy on firm level: Barrier identification and prioritization along the value chain. *Journal of Cleaner Production*, 245, 118609.
- Whalen, K. A., Berlin, C., Ekberg, J., Barletta, I., & Hammersberg, P. (2018). ‘all they do is win’: Lessons learned from use of a serious game for circular economy education. *Resources, Conservation and Recycling*, 135, 335–345.
- Wikipedia (2021). Back market. Available online: https://fr.wikipedia.org/wiki/Back_Market. Accessed: 04/10/21.
- Wikipedia (2021). Extended producer responsibility. Available online: https://en.wikipedia.org/wiki/Extended_producer_responsibility. Accessed: 07/10/21.
- Winans, K., Kendall, A., & Deng, H. (2017). The history and current applications of the circular economy concept. *Renewable and Sustainable Energy Reviews*, 68, 825–833.
- Yuan, Z., Bi, J., & Moriguichi, Y. (2006). The circular economy: A new development strategy in china. *Journal of Industrial Ecology*, 10(1-2), 4–8.
- Zink, T., Maker, F., Geyer, R., Amirtharajah, R., & Akella, V. (2014). Comparative life cycle assessment of smartphone reuse: repurposing vs. refurbishment. *The International Journal of Life Cycle Assessment*, 19(5), 1099–1109.

List of Figures

1.1	Outline of the manuscript	5
2.1	Categorization of linear and circular approaches for reducing resource use	10
2.2	Supply Chain Management themes (Stock et al., 2010)	12
2.3	Supply Chain stages adopted from Chopra et al. (2013)	13
2.4	Level 1 processes of SCOR (APICS, 2017)	13
2.5	Reverse Logistics (De Brito & Dekker, 2004)	15
2.6	Closed-Loop Supply Chain (Khor & Udin, 2012)	15
2.7	Three Models of IE (Lifset & Graedel, 2002)	16
2.8	The classification of open-loops	17
2.9	Technical and biological cycles (EMF, 2014)	18
2.10	EU Waste Hierarchy (Council of European Union, 2008)	20
2.11	Required work, warranty, and performance for CE activities (Sihvonon & Ritola, 2015)	21
2.12	CE Activities frameworks	21
2.13	Hierarchical Framework of circular economy activities extending Potting et al. (2017)	22
2.14	An extended model of circular supply chain	24
3.1	Our methodology for the development of a generic model	28
3.2	Generic model of CSCs with an example	34
3.3	Example of textile circular supply chain	36
3.4	Example of EV battery circular supply chain	37
4.1	Adopted methodology for the development of our classification tool for CSC indicators	42
4.2	The classification tool of circularity indicators for Supply Chains	47
5.1	Positioning Chapter 5 among the rest of the manuscript	53
5.2	An example of mathematical representation of CSC	56
5.3	Matrix Z	57
5.4	Matrix K	57
5.5	Matrix $[f_j^{i_1 i_2}]$	58
5.6	Vector $[f_*^{i_1*}]$	58
5.7	Example	60
5.8	An example illustrating calculation of K based on savings on energy	62
5.9	A CSC with two linear supply chains with all possible CE activities	64
6.1	Our methodology for the development of the CircuSChain Game	70
6.2	Board of the CircuSChain Game with all possible CE activities	71
6.3	The game board for the first year of CircuSChain Game	73
6.4	Round flow cards	73
6.5	Record Sheet (Tab for Player 1)	74

6.6	Strategy Cards	75
6.7	Round flow card of Player 5 for the second and third years	76
6.8	The scenario where reuse activity is selected	76
6.9	Evaluation of the educational value, entertainment value, simplicity, and pace of the game through post-questionnaire.	78
6.10	Knowledge Acquisition about CE Activities	79
6.11	Questions about having multiple and shorter loops	80
6.12	Knowledge acquisition about shorter and multiple loops	80
6.13	Player 1's screen at the prototype of the digital version of the game	82
7.1	Positioning the CircuSChain Method among the rest of the manuscript	85
7.2	Product Meta-Model (a) and Process Model (b) of As-IS/As-IF Framework (Çela, 2021)	88
7.3	Process model of the Core strategy of As-IS/As-IF framework (Çela, 2021)	89
7.4	Process model of the Analysis strategy of As-IS/As-IF framework (Çela, 2021)	89
7.5	Process model of the Diagnosis strategy of As-IS/As-IF framework (Çela, 2021)	90
7.6	Process model of the Evolution strategy of As-IS/As-IF framework (Çela, 2021)	90
7.7	Process model of As-IS/As-IF framework (a) and Process model of CircuSChain Method (b)	92
7.8	Process map of specification strategy	94
7.9	Outlining SC Model through Protocol 1	95
7.10	SC Model V1 and SC Model V0	96
7.11	Measurement strategy	97
7.12	Example for Computation Strategy for GCI	99
7.13	Process map of diagnosis strategy	99
7.14	Example of SC VIdeal	100
7.15	Example of identified goals and constraints	101
7.16	Process map of Evolution strategy	102
7.17	Example for gaming simulation strategy	103
7.18	Process model (a) and product meta-model (b) of CircuSChain	104
8.1	Le plan du manuscrit	XIX

List of Tables

1.1	Hypothesis, work packages and related objectives of the CIRCULAR project . . .	3
2.1	Value creation principles proposed by EMF (2013, 2014)	11
2.2	Definition of Circular Economy Activities	23
3.1	CSC characterization based on CE value creation sources (EMF, 2013, 2014) . . .	29
3.2	Analysis of literature review based on our CSC characteristics (C2 not covered in any paper)	30
3.3	Definition of UML notions with illustrations from our Model	32
4.1	Classifications considering CE from the literature	44
4.2	Classification of indicators that consider several dimensions	49
5.1	Mathematical Notions to represent CSCs	55
5.2	Variables to calculate Circularity Coefficient	61
6.1	Serious games about the CE	69
7.1	Comparison of methods from the literature	86
7.2	Protocol example	93
7.3	Protocol 1: < Start, Outline Supply Chain Model, by identification strategy> . . .	95
7.4	Protocol 2: < Outline Supply Chain Model, Model Supply Chain, by expert modeling strategy>	96
7.5	Protocol 3: <Start, Choose Circularity Indicators, by elicitation strategy>	98
7.6	Protocol 4: < Choose Circularity Indicators, Calculate Supply Chain circularity, by computation strategy>	98
7.7	Protocol 5: <Start, Analyze Gap between the Ideal SC and As-IS SC, by detection strategy>	100
7.8	Protocol 6: <Analyze Gap between Ideal SC and As-IS SC, Define Circular Goal and Constraint, by identification strategy>	101
7.9	Protocol 7: <Start, Identify changes by gaming simulation strategy>	102
7.10	Protocol 8: <Start, Identify changes by computer simulation strategy>	103

Résumé étendu

Notre économie suivait le modèle linéaire depuis la révolution industrielle (EMF, 2013). Dans un tel modèle, les produits qui sont fabriqués à partir de matières premières, sont jetés après leur utilisation, lorsqu'ils deviennent obsolètes. En raison du développement économique et de la croissance démographique, les activités de production et la demande de matières premières augmentent sans cesse, tandis que les ressources naturelles restent limitées. Cela peut avoir des conséquences importantes, comme l'épuisement des ressources naturelles et la pollution de l'environnement (Yuan et al., 2006). En plus de la pression sur l'environnement, cette situation est susceptible de provoquer une augmentation et une volatilité importante des prix des ressources. Elle engendre ainsi des difficultés pour les organisations (EMF, 2014) et ne permet pas une durabilité à long terme. C'est pourquoi, un nouveau modèle économique doit être conçu pour assurer notre avenir et résoudre ces problèmes. En tant qu'une solution potentielle aux défis mentionnés ci-dessus, le concept d'économie circulaire a récemment retenu l'attention des responsables politiques, des chercheurs académiques et des industriels (Bocken et al., 2017; Govindan & Hasanagic, 2018; Kirchherr et al., 2017; Masi et al., 2017).

L'économie circulaire vise à minimiser la consommation des ressources et la production des déchets ainsi que la pollution en maintenant le plus long temps possible les produits, les composants et les matériaux dans la phase d'utilisation. Cela pourrait être obtenu avec des stratégies de conception de produits ou des activités d'économie circulaire liées à la fin de vie des objets telles que la réutilisation, la remise à neuf, la "repurposing", le recyclage, etc. Les chaînes logistiques circulaires, qui intègrent l'approche de l'économie circulaire dans la chaîne logistique, soutiennent ces activités et jouent un rôle important dans l'application des principes de l'économie circulaire.

Divers concepts dans la littérature tels que les chaînes logistiques en boucle fermée, la logistique inverse, les chaînes logistiques vertes, etc., ont déjà exploré l'intégration des activités de l'économie circulaire dans les chaînes logistiques. Cependant, le concept d'économie circulaire apporte de nouvelles approches : (1) appliquer plusieurs activités d'économie circulaire en parallèle plutôt que d'appliquer une seule activité (Blomsma & Brennan, 2017), (2) utiliser des matériaux encore et encore (Genovese et al., 2017), et (3) promouvoir des boucles ouvertes entre des secteurs distincts par "repurposing" (Farooque et al., 2019b). De plus, l'activité de repurposing n'est pas suffisamment explorée jusqu'à présent. Cependant, cette activité, qui ajoute de la valeur aux produits usagés en les détournant de leur destination initiale et en les utilisant dans des applications moins exigeantes, pourrait être un nouveau moyen potentiel d'accroître la circularité dans les chaînes logistiques circulaires. En outre, le manque de connaissances et de sensibilisation sur les chaînes logistiques circulaires constitue un obstacle difficile pour les gestionnaires de chaînes logistiques (Govindan & Hasanagic, 2018; Mangla et al., 2018).

Par conséquent, les implications de l'économie circulaire dans les chaînes logistiques doivent être explorées, structurées et formalisées. De nouveaux outils sont également nécessaires pour promouvoir le concept de chaîne logistique circulaire et soutenir sa conception ainsi que son évolution.

L'objectif principal de cette thèse de doctorat est d'explorer et de conceptualiser les structures des chaînes logistiques dans le concept d'économie circulaire. En considérant les enjeux et les pistes de recherche inexplorées précitées, les questions de recherche suivantes se posent :

- **QR1** : Quelles sont les implications de l'économie circulaire sur les chaînes logistiques et comment intégrer l'activité de repurposing dans les chaînes logistiques circulaires ?
- **QR2** : Comment conceptualiser et modéliser les configurations complexes des chaînes logistiques circulaires ?
- **QR3** : Comment évaluer la circularité des chaînes logistiques ?
- **QR4** : Comment sensibiliser les décideurs et accroître leurs connaissances sur les chaînes logistiques circulaires à l'aide des outils proposés ?
- **QR5** : Comment aider les organisations à soutenir de manière continue la circularité dans les chaînes logistiques ?

Pour répondre aux questions de recherche susmentionnées, nous développons plusieurs outils avec diverses méthodes. La Figure 8.1 résume nos contributions, les relations entre ces contributions et les questions de recherche abordées.

Premièrement, dans le Chapitre 2, nous adressons la **QR1**. Dans ce chapitre, une **revue de la littérature** est menée pour déterminer les implications de l'économie circulaire sur les chaînes logistiques et intégrer l'activité de repurposing. D'abord, nous explorons les approches de l'économie circulaire liées aux chaînes logistiques et les concepts principaux de la littérature de chaînes logistiques. Ensuite, nous expliquons les concepts interdépendants des chaînes logistiques circulaires tels que les chaînes logistiques en boucle fermée, la logistique inverse, les chaînes logistiques vertes, etc. Par rapport à ces concepts de la littérature, nous expliquons le positionnement de nos travaux de recherche.

Nous considérons les flux de matière et les activités comme des composants principales des chaînes logistiques circulaires. Dans ce chapitre, nous déterminons ces composants: des boucles fermées et ouvertes, les activités d'économie circulaire telles que la réutilisation, la remise à neuf, la repurposing, le recyclage, etc.

Par ailleurs, nous déterminons les composants des chaînes logistiques circulaires comme des boucles fermées et ouvertes, ainsi que les activités d'économie circulaire telles que la réutilisation, la remise à neuf, la repurposing, le recyclage, etc.

Nous présentons aussi le modèle hiérarchique des activités d'économie circulaire et le modèle étendu des chaînes logistiques circulaires fondés sur un précédent de travail de Master ([Kurt, 2018](#); [Kurt et al., 2019](#)) que nous avons mené. Ces deux modèles aident à l'intégration de l'activité repurposing dans les chaînes logistiques circulaires à des niveaux de circularité différents.

Dans le Chapitre 3, nous adressons la **QR2**. D'abord, nous nous appuyons sur la littérature ([EMF, 2013, 2014](#)) et les composants des chaînes logistiques circulaires, afin de proposer les principales **caractéristiques des chaînes logistiques circulaires**. Ces caractéristiques aidant à conceptualiser les chaînes logistiques circulaires sont listées ci-dessous :

- **C0** : au moins une activité d'économie circulaire,
- **C1** : boucles consécutives d'utilisation du matériel,
- **C2** : plusieurs options d'activité d'économie circulaire simultanées,
- **C3** : boucles ouvertes et intégration de chaînes logistiques distinctes.

La première caractéristique C0 correspond à l'exigence minimale d'une chaîne logistique pour être considérée comme une chaîne logistique circulaire. Cette caractéristique a été déjà mentionnée dans la littérature des chaînes logistiques en boucle fermée, de la logistique inverse, des chaînes logistiques vertes, etc. Les trois autres caractéristiques sont spécifiques aux chaînes logistiques circulaires.

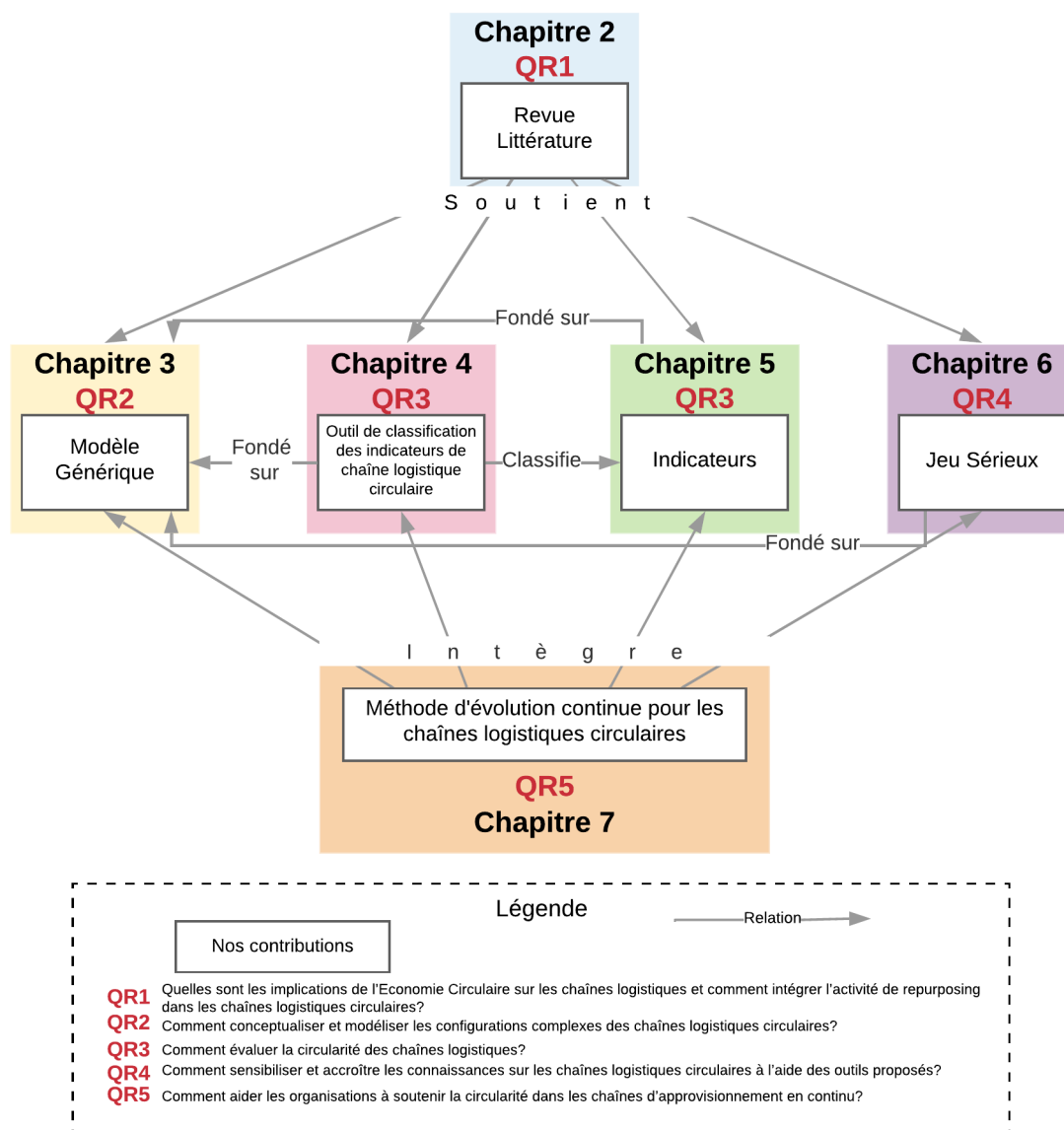

Figure 8.1: Le plan du manuscrit

Ensuite, nous menons une revue littéraire pour analyser les majeurs travaux récents en considérant nos caractéristiques et le niveau de formalisation. Avec cette analyse et les caractéristiques proposées ainsi que notre travail préliminaire (le modèle hiérarchique et le modèle étendu des chaînes logistiques circulaires), nous avons une base pour formaliser en UML notre **modèle générique**. Ce modèle semi-formel soutient toutes les caractéristiques proposées. Avec ce modèle générique, nous présentons deux structures originales des chaînes logistiques circulaires liées à l'activité repurposing : branche (qui représente le type de produit des chaînes logistiques linéaires intégrées par l'activité de repurposing) et niveau (qui représente le niveau d'exigence du type de produit liée à une chaîne logistique linéaire intégrée). Nous présentons également deux exemples d'utilisation du modèle appliqué aux divers secteurs (textile et batterie de véhicule électrique). Le modèle générique sert à conceptualiser, visualiser et modéliser des chaînes logistiques circulaires.

Dans les Chapitres 4 et 5, nous adressons la **QR3**. D'abord, nous proposons dans le Chapitre 4 un **outil de classification des indicateurs de circularité** pour les chaînes logistiques fondé sur les caractéristiques proposées. Cet outil détermine des dimensions de circularité à mesurer afin

d'évaluer des chaînes logistiques circulaires. Nous proposons les dimensions suivantes en considérant les caractéristiques des chaînes logistiques circulaires : le nombre des boucles consécutives, la longueur d'utilisation, la longueur des boucles, le nombre des boucles, les économies en termes de matière, les économies en termes d'énergie, les économies en termes de main d'œuvre, les économies en termes de pollution, le nombre de branches et le nombre de niveaux. Dans ce chapitre, nous proposons également des indicateurs potentiels qui mesurent chaque dimension individuellement. Finalement, nous classifions des indicateurs importants qui existent dans la littérature pour illustrer l'utilisation de notre outil. Ce dernier peut également permettre d'analyser et classifier des nouveaux indicateurs et aider à choisir des indicateurs pertinents pour évaluer les chaînes logistiques circulaires.

Ensuite, dans le Chapitre 5, nous proposons un **indicateur global de circularité** (appelé GCI *Global Circularity Indicator*) pour évaluer la circularité des chaînes logistiques, en s'appuyant sur les dimensions de circularité et notre modèle générique. Dans ce chapitre, nous détaillons la construction de notre indicateur en nous appuyant sur le modèle générique. Ici, nous introduisons les notions mathématiques accompagnant notre modèle générique, comme le coefficient de circularité de chaque activité d'économie circulaire et le nombre de produits qui sont revalorisés par cette activité. Un GCI peut être calculé pour diverses dimensions comme les économies en termes de matières, énergie, main d'œuvre, pollution ainsi que la longueur d'utilisation et la longueur des boucles. Une méthode d'agrégation ou une approche multi-critère pourrait alors être utilisée pour évaluer ensemble ces dimensions des chaînes logistiques circulaires. Par ailleurs, nous présentons aussi un outil Web qui sert à configurer des chaînes logistiques circulaires en considérant le modèle générique et calculer l'indicateur global de circularité ainsi que les indicateurs proposés dans le Chapitre 4 d'une manière automatique.

Dans le Chapitre 6, nous traitons la **QR4**. Nous proposons un **jeu sérieux**, baptisé **CircuSChain**, pour promouvoir les chaînes logistiques circulaires et accroître la connaissance ainsi que la sensibilisation sur leurs structures et les activités d'économie circulaire impliquées. Le jeu CircuSChain, fondé sur Beer Distribution Game ([Sternan, 1989](#)), est conçu de manière cohérente avec les caractéristiques et le modèle générique proposés. Nous utilisons la méthode de [Marfisi-Schottman et al. \(2010\)](#) pour la conception du jeu. Le jeu CircuSChain considère des divers concepts des chaînes logistiques circulaires comme la pollution (émission de CO₂), les activités de l'économie circulaire et l'épuisement de matières. Sur la forme du jeu CircuSChain, il est conçu comme un jeu de société de 5 joueurs. Les joueurs doivent coopérer pour faire fonctionner une chaîne logistique linéaire pour satisfaire les demandes et évaluer sa performance. Puis, les joueurs peuvent ajouter au fur et à mesure des activités d'économie circulaire et d'évaluer ses nouvelles performances circulaires quant à celle de la chaîne linéaire.

Le jeu est testé par des étudiants en Génie Industriel de niveau Master pour une première expérimentation. Grâce à cette expérimentation, nous observons le rythme, les valeurs pédagogique et ludique et le niveau de complexité des règles régissant le jeu. A travers ce jeu sérieux permettant l'apprentissage par la pratique, nous essayons de promouvoir les chaînes logistiques circulaires et accroître la connaissance de ces chaînes. Une version numérique du jeu pourrait aider à améliorer la gestion du jeu en simplifiant d'une part le paramétrage du jeu; et d'autre part, en automatisant la synchronisation des flux informationnels et physiques entre joueurs. Des expérimentations avec d'autres publics, comme des experts de l'économie circulaire et des industriels, sont également envisagés afin de consolider la validation du jeu.

Finalement, la **QR5** est abordée dans le Chapitre 7. En adoptant le cadre As-IS/As-IF ([Çela et al., 2019](#)), les contributions susmentionnées sont intégrées dans une première version d'une **méthode d'évolution continue**, que nous appelons **Méthode CircuSChain**. Dans ce chapitre, nous présentons le cadre utilisé As-IS/As-IF, qui guide la création des méthodes participatives d'évolution continue pour un système spécifique. Le cadre As-IS/As-IF permet de représenter des méthodes d'évolution continue par un modèle de processus ([Rolland et al., 1999](#)) et de les formaliser par un méta-modèle de produit. Nous montrons comment notre méthode CircuSChain

peut aider à identifier les évolutions potentielles pour transformer les chaînes logistiques linéaires en chaînes logistiques circulaires ou améliorer la circularité des chaînes logistiques déjà circulaires. En effet, la méthode CircuSChain permet d'abord d'analyser et de diagnostiquer la chaîne logistique circulaire telle qu'elle est (chaîne logistique actuelle ou *As-IS Supply Chain* en anglais). Ensuite, une *As-IS Supply Chain* pourrait évoluer en un ou plusieurs *As-IF Supply Chains* (chaînes logistiques potentielles dans le futur) grâce à la stratégie d'évolution. Une *As-IF Supply Chain* pourrait être transformée en la prochaine *As-IS Supply Chain* par la stratégie de déploiement et c'est ainsi que l'évolution pourrait se poursuivre.

Les stratégies de la méthode CircuSChain sont mises en œuvre à travers des sessions. Afin de faciliter et de guider l'animation des sessions, nous proposons des protocoles pour les stratégies majeures. Grâce aux protocoles, nous précisons les types de sessions (travail individuel, focus group ou groupe de discussion, et entretien téléphonique), les participants, les étapes de la stratégie, la durée des étapes et les outils nécessaires pour chaque stratégie. Cette méthode propose une approche préliminaire pour développer une méthode d'évolution continue des chaînes logistiques circulaires. Elle complète les outils proposés dans cette thèse et montre une possibilité de les utiliser de manière intégrée.

Pour conclure, nous avons développé un ensemble d'outils méthodologiques et pratiques pour aider à la conception, l'évaluation et l'évolution des chaînes logistiques circulaires. Tout d'abord, nous avons exploré et intégré l'activité de repurposing dans les chaînes logistiques circulaires en proposant des activités de repurposing dans différents niveaux. Ces activités, qui créent des boucles ouvertes, ont été peu explorées jusqu'à présent dans la littérature et leurs applications industrielles restent encore limitées. Ces activités, valorisant différemment les produits usagés, pourraient constituer un élément intéressant pour accroître la circularité des chaînes logistiques. Toutes nos contributions proposées dans cette thèse considèrent diverses activités de repurposing. Notez que la conception du produit est un facteur critique pour la mise en œuvre des activités de repurposing. Dans le futur, si les produits seront pensés et conçus pour être revalorisés par des activités de repurposing dans différentes applications industrielles, nos outils pourraient facilement prendre en compte ces activités.

Nos travaux ont contribué à apporter les premières briques pour aider à la conception, l'évaluation et l'évolution des chaînes logistiques circulaires. Nous sommes conscients que des limites existent comme mentionnées dans chaque chapitre. Cependant, elles constituent des opportunités pour des travaux de recherche futurs, telles que l'inclusion de la dimension acteur dans le modèle générique, l'introduction des aspects sociaux et économiques du développement durable dans l'outil de classification, l'adoption d'une approche multi-critère pour notre indicateur global de circularité, la version numérique du jeu CircuSChain, sa validation par des expérimentations utilisateurs plus exhaustives et l'affinement de la stratégie de déploiement dans la méthode CircuSChain.



Abbreviations

- A-GCI:** Average-Global Circularity Indicator
- CE:** Circular Economy
- CSC:** Circular Supply Chain
- DMAIC:** Define, Measure, Analyze, Improve, Control
- EMF:** Ellen MacArthur Foundation
- GCI:** Global Circularity Indicator
- IM:** Informal Model
- LCA:** Life Cycle Assessment
- LCC:** Life Cycle Cost
- LCT:** Life Cycle Thinking
- MFI:** Material Flow Analysis
- NL:** Natural Language
- PDCA:** Plan, Do, Act, Check
- PSS:** Product Service Systems
- SC:** Supply Chain
- SoH:** State of the Health
- TBL:** Triple Bottom Line
- UML:** Unified Modeling Language

B

Questionnaires

Pre-questionnaire

(Can be answered in French)

1. How do you consider your knowledge in circular economy?

Limited knowledge Medium knowledge High knowledge

2. What would be your definition of Circular economy?

3. What do you think is the difference between a linear and a circular supply chain?

4. Among the following, what are the circular supply chain activities that you know? Check and give a simple definition.

- Reuse _____
- Refurbishment _____
- Remanufacturing _____
- Recycling _____
- Repurposing _____
- Other _____

5. Which supply chain do you think is the most circular?

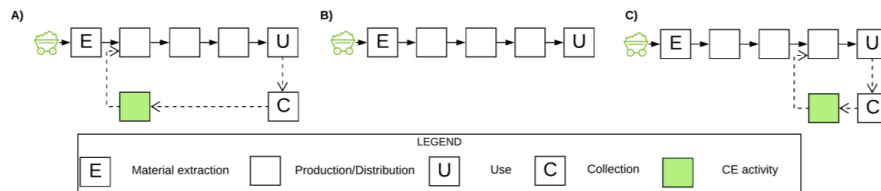

A

B

C

6. Which supply chain do you think is the most circular?

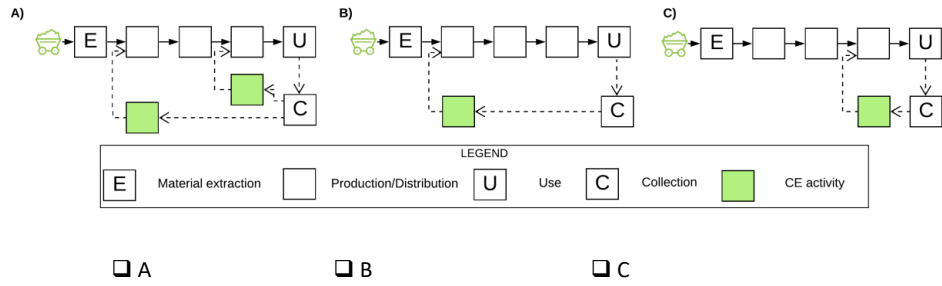

Post-questionnaire

(Can be answered in French)

7. After playing the serious game, how now you consider your knowledge in circular economy?

- Limited knowledge Medium knowledge High knowledge

8. What would be your definition of circular economy?

9. What do you think is the difference between a linear and a circular supply chain?

10. Among the following, what are the circular supply chain activities that you know? Check and give a simple definition.

- Reuse _____
- Refurbishment _____
- Remanufacturing _____
- Recycling _____
- Repurposing _____
- Other _____

11. Which supply chain do you think is the most circular?

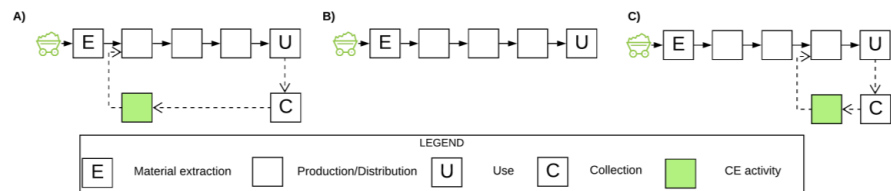

A

B

C

12. Which supply chain do you think is the most circular?

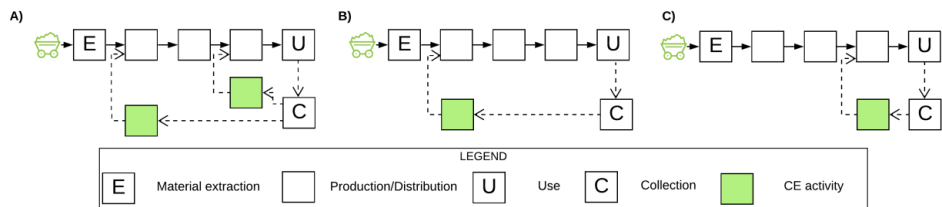

A

B

C

13. Rate from 0 to 10 (0 being poor 10 being excellent) the educational value provided by the game.

Comments (optional):

14. Rate from 0 to 10 (0 being poor 10 being excellent) your enjoyment playing the game.

Comments (optional):

15. Rate from 0 to 10 (0 being poor 10 being excellent) the adequacy of the pace (speed) of the game.

Comments (optional):

16. Rate from 0 to 10 (0 being poor 10 being excellent) the simplicity of the game.

Comments (optional):

17. How can you advise us to improve the game?

Modèles et outils pour la conception, l'évaluation et l'évolution des chaînes logistiques circulaires

Models and tools for the design, assessment, and evolution of Circular Supply Chains

Résumé

L'économie circulaire vise à minimiser la consommation des ressources et la production des déchets ainsi que la pollution en maintenant les produits, les composants et les matériaux dans le phase d'utilisation. Cela pourrait être atteint par des stratégies de conception de produits ou des activités d'économie circulaire telles que la réutilisation, la remise à neuf, la repurposing, le recyclage, etc. Les chaînes logistiques circulaires, qui intègrent l'approche de l'économie circulaire dans la chaîne logistique, soutiennent ces activités et jouent un rôle important dans l'application des principes de l'économie circulaire. Divers concepts dans la littérature tels que les chaînes logistiques en boucle fermée, la logistique inverse, les chaînes logistiques vertes, etc., ont déjà exploré l'intégration des activités de l'économie circulaire dans les chaînes d'approvisionnement. Cependant, le concept d'économie circulaire apporte de nouvelles approches : (1) appliquer plusieurs activités d'économie circulaire en parallèle plutôt que d'appliquer d'une seule activité, (2) utiliser des matériaux encore et encore, et (3) promouvoir des boucles ouvertes entre des secteurs distincts par repurposing. De plus, l'activité de repurposing n'est pas suffisamment explorée. Cependant, cette activité ajoute de la valeur aux produits usagés en les détournant de leur destination initiale et en les utilisant dans des applications moins exigeantes, pourrait être un nouveau moyen potentiel d'accroître la circularité dans les chaînes logistiques circulaires. Par conséquent, les implications de l'économie circulaire dans les chaînes logistiques doivent être explorées, structurées et formalisées. De nouveaux outils sont également nécessaires pour promouvoir le concept de chaîne logistique circulaire et soutenir sa conception ainsi que son évolution. L'objectif principal de cette thèse de doctorat est d'explorer et de conceptualiser les structures des chaînes logistiques dans le concept d'économie circulaire. Nous visons à créer des méthodes et des outils pour soutenir la conception et l'évolution de la chaîne logistique circulaire, en considérant la repurposing comme une stratégie d'économie circulaire de premier ordre. Les contributions principales de cette thèse sont: (1) Un modèle générique formalisé en utilisant le Langage de Modélisation Unifié (UML) pour conceptualiser les chaînes logistiques circulaires, (2) Un outil de classification des indicateurs de la chaîne logistique circulaire où différentes dimensions de la circularité sont décrites, (3) Un nouvel indicateur pour évaluer la circularité des chaînes logistiques, (4) Un jeu sérieux pour promouvoir les chaînes logistiques circulaires. Enfin, en adoptant le cadre As-IS/As-IF, les contributions susmentionnées sont intégrées dans une première version d'une méthode d'évolution continue. Cette méthode aide à identifier d'éventuelles évolutions pour améliorer la circularité des chaînes logistiques.

Mots-clés : Economie Circulaire, Chaîne Logistique, Repurposing, Modèle, Indicateur de Circularité, Jeu Sérieux, Evolution Continue.

Abstract

The Circular Economy aims at minimizing resource inputs, waste, and pollution by keeping as long as possible products, components, and materials in use. This could be reached by product design strategies or E-o-L (End of Life) activities (also called Circular Economy activities), such as reuse, remanufacturing, repurposing, recycling, etc. Circular Supply Chains, which integrate the Circular Economy approach into supply chains, support these activities and play an important role in the application of Circular Economy principles.

Various concepts in the literature such as Closed-Loop Supply Chains, Reverse Logistics, Green Supply Chains, etc., have been already explored the integration of Circular Economy activities in supply chains. However, the Circular Economy concept brings some new approaches: (1) applying multiple Circular Economy activities in parallel rather than applying single activities, (2) using materials over and over again, and (3) promoting open-loops between distinct sectors through repurposing. In addition, repurposing activity has not been sufficiently explored so far. However, this activity adds value to used products by diverting them from their initial purpose and using them in less demanding applications. This could be a new potential mean to increasing circularity in Circular Supply Chains. Besides, the lack of knowledge and awareness about Circular Supply Chains constitutes a challenging barrier for Supply Chain managers. Therefore, the implications of Circular Economy in supply chains need to be explored, structured and formalized. New tools are also needed to promote the Circular Supply Chains and support their design and evolution. The main objective of this Ph.D. thesis is to explore and conceptualize supply chains structures in the context of Circular Economy. We aim at creating methods and tools to support Circular Supply Chain design and evolution, considering repurposing activity as a first-class Circular Economy strategy. The main contributions of this thesis are: (1) A generic model formalized by using the Unified Modeling Language (UML) to design Circular Supply Chains, (2) A classification tool for Circular Supply Chain indicators, where different circularity dimensions are described, (3) A new indicator to assess the circularity of Supply Chains, and (4) A serious game to promote Circular Supply Chains and increase knowledge and awareness about their structures and Circular Economy activities involved. Finally, adopting As-IS/As-IF framework, the aforementioned contributions are integrated into a first version of a continual evolution method. This method helps identifying possible evolutions to improve the circularity of supply chains.

Keywords : Circular Economy, Supply Chain, Repurposing, Circularity Indicator, Serious Game, Continual Evolution.

