



HAL
open science

Flight behaviours in birds: studying aerial insectivores at a local scale using 3D trajectometry

Geoffrey Ruaux

► **To cite this version:**

Geoffrey Ruaux. Flight behaviours in birds: studying aerial insectivores at a local scale using 3D trajectometry. *Neurons and Cognition [q-bio.NC]*. Université de Rennes, 2022. English. NNT : 2022REN1B076 . tel-04050891

HAL Id: tel-04050891

<https://theses.hal.science/tel-04050891>

Submitted on 29 Mar 2023

HAL is a multi-disciplinary open access archive for the deposit and dissemination of scientific research documents, whether they are published or not. The documents may come from teaching and research institutions in France or abroad, or from public or private research centers.

L'archive ouverte pluridisciplinaire **HAL**, est destinée au dépôt et à la diffusion de documents scientifiques de niveau recherche, publiés ou non, émanant des établissements d'enseignement et de recherche français ou étrangers, des laboratoires publics ou privés.

THESE DE DOCTORAT DE

L'UNIVERSITÉ DE RENNES 1

ÉCOLE DOCTORALE N° 605

Biologie-Santé

Spécialité : Neurosciences, Éthologie

Par

Geoffrey RUAUX

Comportements de vol chez les oiseaux : approche de trajectométrie 3D à l'échelle locale chez les insectivores aériens

Thèse présentée et soutenue à Rennes, le 15 décembre 2022.

Unité de recherche : UMR 6552 EthoS

Composition du jury :

Président

Ludovic Dickel

Professeur des Universités
Université de Caen,
UMR 6552 EthoS

Rapporteurs

Emily Shepard

Professor
Swansea University
Directeur de recherche
CNRS, UMR 5169 CRCA

Vincent Fourcassié

Examinatrice

Andréa Thiebault

Chargée de recherche
CNRS, UMR 9197 NeuroPSI

Directrice de thèse

Sophie Lumineau

Maîtresse de conférences
Université de Rennes 1,
UMR 6552 EthoS

Co-directeur de thèse

Emmanuel de Margerie

Chargé de recherche
CNRS, UMR 6552 EthoS

**“No bird soars too high if he
soars with his own wings.”**

William Blake

Remerciements

Un merci, ça n'est pas grand-chose, mais ça veut dire beaucoup. Cette section qui vient au début de toutes les thèses est la moins riche en informations scientifiques, mais la plus riche en émotions et en informations sur la personne qui a écrit cette thèse. C'est parfois la seule section qu'on lit, ou la seule qu'on ne lit pas. Toujours est-il que je tiens à m'en servir pour remercier sincèrement chaque personne qui m'a aidé, de près ou de loin, à avancer et à me construire durant ce projet de trois ans. Je m'excuse d'avance pour les personnes que j'aurais pu oublier, sachez que c'est uniquement dû au fait que cette section est rédigée en dernier, dans le sprint final. N'hésitez pas à me contacter si vous jugez que vous méritez un merci, je serai toujours ravi d'en envoyer davantage.

Merci à ma directrice de thèse, **Sophie Lumineau**, et à mon co-directeur, **Emmanuel de Margerie**. Vous avez su me guider et m'accompagner durant ce projet de longue haleine, vous avez su me soutenir lorsque des imprévus venaient perturber nos plans, et vous avez su me témoigner votre confiance. Vous êtes les mieux placés pour savoir toutes les difficultés auxquelles nous avons dû faire face, et je vous remercie de m'avoir aidé à les surmonter une par une. Sophie, merci pour votre patience, votre calme et votre optimisme en toutes circonstances, je retiendrai aussi votre goût remarquable pour la transmission et l'enseignement que je ne peux qu'admirer. Emmanuel, merci pour ton aide presque quotidienne, que ce soit au bord de la Vilaine ou entre des lignes de code Matlab. Merci de m'avoir appris à développer mon esprit critique et à ne pas me satisfaire des explications toutes faites.

Merci à **Vincent Fourcassié** d'avoir accepté d'être rapporteur de cette thèse, and I also warmly thank **Emily Shepard** for accepting to be a rapporteur. Je remercie également **Andréa Thiebault** et **Ludovic Dickel** d'avoir accepté d'être les examinateurs de mes travaux.

Merci à **Nicolas Bideau**, **Ludovic Calandreau**, **Sébastien Dugravot** et **Denis Poinot** d'avoir fait partie de mon comité de thèse. J'ai beaucoup apprécié nos échanges qui m'ont permis de réfléchir sous un angle nouveau.

Merci à **Ameline Roger** d'avoir été une stagiaire agréable, sérieuse, appliquée et toujours curieuse. Je te souhaite plein de réussite pour tes futurs projets.

Merci à **Alban Lemasson** de m'avoir accueilli au sein du laboratoire EthoS et pour sa bienveillance et sa compréhension face aux difficultés que j'ai pu rencontrer en cours de thèse.

I would also like to thank **Tyson Hedrick**, with whom it has been a pleasure to interact throughout my research work. You have helped me more than once to use daunting biomechanical concepts.

Merci à **Kyra**, qui a été d'un soutien et d'une aide incroyables durant notre travail de terrain. Merci de m'avoir aidé à filmer ces oiseaux dont le passe-temps favori était de sortir du cadre. Ils avaient bien du mal à échapper à ton regard vif !

Merci aux membres rennais du laboratoire EthoS pour votre soutien et pour votre gentillesse en toutes circonstances. Merci à : **Anne, Cécilia, Géraldine Legoff, Géraldine Moy, Hugo, Isabelle, Justine, Lou, Ludovic, Marie, Valérie, Véronique et Virginie.**

Merci aux amis du midi pour ces discussions parfois profondes, parfois sans queue ni tête, et pour toutes ces parties de « cul de chouette » et autres jeux aux noms flatteurs. Merci à **Antoine** pour ses réflexions toujours bien senties et pleines de bon sens sur des sujets variés et à **Tiffany** pour ses anecdotes sur la vie rurale. Merci aux doctorants rennais, anciens et actuels, pour leur bonne humeur en toutes circonstances : **Bastien**, qui a toujours le mot pour rire, **Christiane**, qui va de l'avant quoi qu'il arrive, **Delphine**, toujours souriante et agréable, **Marion**, toujours prête à aider les autres. Merci également à **Francis** qui a été un sympathique stagiaire de Master et qui s'est à présent métamorphosé en doctorant en suivant le cycle ontogénétique du chercheur. Merci à ton œil de lynx qui a su scanner la mise en forme de ce manuscrit, et je te souhaite un bon voyage de trois années !

Merci aux doctorants paimpontais : **Juliette, Loïc et Noémie** ainsi qu'aux doctorants caennais : **François, Lisa et Manon** pour ces quelques bons moments passés ensemble. Merci également à **Pablo** pour sa bonne humeur à toute épreuve et ses visites qui avaient le don d'égayer les journées les plus maussades.

J'aimerais aussi remercier quelques amis qui m'ont aidé et accompagné durant ce projet. Merci à **Matthieu** pour ces discussions toujours passionnées sur l'ornithologie et plus généralement sur l'environnement. Tes réflexions toujours pleines de bon sens ont été une source d'inspiration à de nombreuses reprises dans mes questionnements, scientifiques ou non. Merci à **Sylvie** pour ces cours de physique improvisés qui m'ont aidé à me mettre dans le bain en début de thèse. Merci à **Marc** pour son soutien continu, ainsi qu'à **Filipe** pour ses cours d'épistémologie qui arrivent même à vous faire remettre en cause les principes de la gravitation.

Merci à mes dinos préférés : **Alyssa, Armande, Caille, Camille, Chloé, Jade, Lucie Pigeon, Lucie Pousse d'arbre, Marianne, Mayrice, Noémie, Sarah** et **Sasha**. La force de notre collectif et votre soutien quotidien m'ont aidé à grandir en tant que traducteur et en tant que personne, et m'ont apporté beaucoup plus que je n'aurais pu l'imaginer. Nous sommes bien placés pour connaître les forces et les limites des mots, et c'est une chose que les mots ne pourront pas exprimer.

Je tiens également à remercier tous les membres de ma famille pour leur soutien en toutes circonstances, je n'en citerai que quelques-uns, mais tous ont contribué d'une manière ou d'une autre. Merci à **Fabien**, pour ces longues marches en forêt et ces heures passées à observer les urubus à tête rouge et les roseaux pensants. Ces moments ont toujours eu un effet thérapeutique même dans les périodes les plus tendues. Merci à mes grands-parents, **Albert** et **Denise** qui étaient toujours intéressés et curieux d'en apprendre plus sur mes « ouézios ». Ils auraient été les premiers à se réjouir sincèrement de l'accomplissement de cette thèse. Merci à **Quentin** et **Cassandre** pour leur aide et leur soutien en toutes circonstances, et merci à **Oliver** d'être un rayon de soleil dans ma vie. Enfin, je pense qu'il n'existe aucun mot dans aucune langue capable de témoigner de la gratitude que je porte à mes parents pour tout ce qu'ils m'ont aidé à traverser dans ce long et tortueux parcours qu'est la vie, alors je me contenterai de celui-ci : merci.

Pour finir, merci à vous, qui avez lu ou allez lire ce manuscrit. J'espère que vous apprécierez ce voyage merveilleux au pays fascinant des oiseaux.

Contents

Chapter 1: General introduction.....	12
I. Flight in birds	14
A) Functions	14
B) Basic flight mechanics	15
1) Basic principles of physics	15
2) Forces acting on a gliding animal	16
3) Forces acting on a flapping animal.....	19
C) Evolutionary origins	20
1) Trees-down (arboreal) theory	20
2) Ground-up (cursorial) theory	21
3) Beyond the traditional dichotomy	23
D) Anatomical adaptations.....	26
E) Physiological adaptations.....	30
II. Flight modes	32
A) Flapping	32
B) Gliding.....	33
C) Intermittent flight	33
1) Flap-gliding	34
2) Flap-bounding	34
D) Soaring.....	34
1) Slope soaring	35
2) Thermal soaring.....	35
3) Dynamic soaring	37
E) Hovering.....	39
III. Cost of transport	40
A) Power curve in flapping flight.....	40
B) Glide polar.....	42
C) Effect of wind speed and direction	43
IV. Flight ontogeny.....	44
Article 1: The development of flight behaviours in birds.....	45
Résumé en français	46
Article	47
V. How to study flight?.....	62

A) Global movements.....	63
B) Local movements.....	66
C) Studying flight in the laboratory.....	69
VI. Flight in the context of aeroecology.....	70
A) The aerosphere as a habitat.....	71
B) Foraging flight in aerial insectivores.....	72
VII. Objectives.....	74
A) Description of flight behaviours at a local scale in aerial insectivores.....	74
B) Energy savings and expenditures.....	74
C) Flight ontogeny.....	75
Chapter 2: General methods.....	78
I. Study species.....	80
A) Common swift.....	80
1) Phylogeny and distribution.....	80
2) Morphology and ecology.....	82
3) Breeding and population dynamics.....	84
A) Common house martin.....	86
1) Phylogeny and distribution.....	86
2) Morphology and ecology.....	87
3) Breeding and population dynamics.....	88
II. Rotational stereo-videography.....	90
A) Recording device and basic principles.....	90
B) Calibration of distance measurement.....	93
C) Smoothing, output trajectory and behavioural observations.....	93
D) Weather data.....	95
Chapter 3: Drinking flight in the common swift.....	98
Article 2: Drink safely: common swifts (<i>Apus apus</i>) dissipate mechanical energy to decrease flight speed before touch-and-go drinking.....	100
Résumé en français.....	101
Complete summary.....	102
Article.....	103
Chapter 4: Foraging flight in the house martin.....	144
Article 3: Flight behaviours and energy savings in adult and juvenile house martins (<i>Delichon urbicum</i>) foraging near their breeding colony.....	146

Résumé en français	147
Complete summary	148
Article	149
Chapter 5: General discussion	192
I. Main results	194
II. Ecological and evolutionary aspects	195
A) Common swifts and the importance of water resources	195
B) House martins and external energy sources.....	196
III. Social aspects of drinking and foraging.....	198
IV. Ontogeny of flight behaviours.....	200
V. Perspectives	201
Bibliography	204

Chapter 1: General introduction

Flight can be broadly defined as a prolonged movement through the air, without any contact with a solid substrate. With this definition, many animals can be considered as “fliers”, even all the organisms which constitute the aeroplankton passively floating in the air. Flying animals are generally divided between passive fliers and active fliers.

Passive fliers include small organisms floating in the air, such as spiders “ballooning” with silk threads (Weyman, 1993), and even bacteria, fungi and protists (Després et al., 2012). Other organisms are only able to use flight temporarily to move between branches or slow down a fall, and can be considered as gliders when their descendent angle is less than 45°, or parachuters when it is more than 45° (Norberg, 1990). Examples of gliders include flying fishes of the family Exocoetidae (Park and Choi, 2010), *Glaucomys* flying squirrels (Vernes, 2001), or *Draco* lizards (Khandelwal and Hedrick, 2020), while parachuters include *Rhacophorus* frogs (O’Connell et al., 2018), or *Aneides* salamanders (Brown et al., 2022).

Active fliers are animals capable of flapping their wings. They are only found in three extant animal groups: insects, bats and birds. This manuscript will mainly focus on active fliers, and more particularly on birds.

I. Flight in birds

Flight is a locomotion mode which deeply influences the anatomy, physiology and behaviour of most bird species. Bird flight is a complex phenomenon which can be understood using basic principles of flight mechanics that will be introduced in this section.

A) Functions

Active flight is a huge evolutionary advantage. The only three extant groups capable of active flight are characterised by their great species diversity. Insects are the most diverse and numerous class of animals with more than 1 million species described (Stork, 2018), birds have approximately 11,000 species (Gill and Donsker, 2019), and bats comprise 25% of mammal species with approximately 1,300 species (Burgin et al., 2018).

Flying animals are able to colonize remote places, forage on extensive areas and migrate long distances. Migration allows birds to occupy habitats that are only temporarily suitable (e.g. during the breeding season) and then to migrate to other habitats sometimes located several thousands of kilometres apart. Flight is also a huge advantage for any prey to escape their predators, and for any predator to catch their prey.

Flapping flight requires high energy expenditures per unit of time, but is very advantageous when considering the distance travelled for each unit of energy (Norberg, 1990). Moreover, some flight modes are especially energy-efficient, such as soaring, which will be discussed in more details later in the manuscript (see Section II.D). Efficient flight modes can “unlock” new foraging strategies which would otherwise be unprofitable. For example, the 23 species of vultures are specialised in soaring, and they are the only obligate scavengers amongst vertebrates. Energetic modelling shows that this strategy requiring long distance travels in search of an unpredictable food source would be much less profitable for terrestrial animals (Ruxton and Houston, 2004).

B) Basic flight mechanics

1) Basic principles of physics

To understand flight mechanics principles, it is firstly important to remind some basic principles of physics. According to Newton’s second law of motion, the acceleration (a) of an object is proportional to the net force (F , i.e. sum of forces) applied to the object, and the acceleration happens in the direction of the net force. The proportionality factor between F and a is the object’s mass (m , Equation 1).

$$\vec{F} = m \vec{a} \tag{1}$$

Hence, a body for which the net force is 0 (no force or compensating forces) is either not moving, or in constant motion (acceleration is 0).

Another fundamental principle to understand when studying motion is that any physical body is characterized by its mechanical energy (E_m), which is the sum of its kinetic energy (E_k) and potential energy (E_p , Equation 2):

$$E_m = E_k + E_p \tag{2}$$

where E_k depends on the mass (m) and the speed (v) of the body (Equation 3), and E_p depends on its mass (m), its height (z), and the gravitational constant (g , Equation 4).

$$E_k = \frac{1}{2} m v^2 \tag{3}$$

$$E_p = m g z \tag{4}$$

According to the principle of energy conservation, mechanical energy will stay constant in a system that is free of friction forces. However, energy can be transferred between different forms. Thus, any decrease in potential energy should cause an increase in kinetic energy, and reciprocally. It can be illustrated by the fact that an object in free fall (no external force other than gravity) has a decreasing potential energy (altitude decreases) and increasing kinetic energy (speed increases). In real life, dissipative forces such as air friction dissipate some mechanical energy during a fall, but mechanical energy conservation remains a major guide to the study of falling and gliding animals.

2) Forces acting on a gliding animal

When an animal is gliding, several forces are acting concurrently. The three most important ones are: **weight**, **lift** and **drag** (Fig. 1).

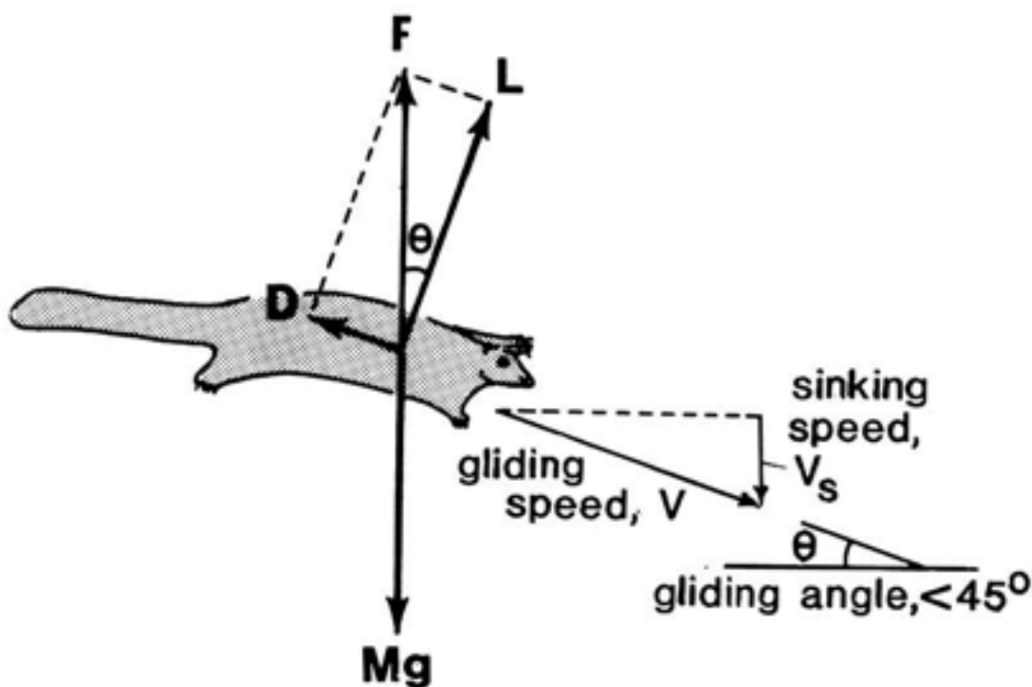

Figure 1: Main forces acting on a gliding animal (Norberg, 1990). Weight (Mg), lift (L), drag (D). At equilibrium gliding, the sum of lift and drag (F) is equal to weight, and is thus called “weight support”. The gliding angle is established by the lift:drag ratio (L/D). More lift and less drag mean a shallower glide, while less lift and more drag mean a steeper glide. This ratio can be influenced by the shape of the wings (see Section 1.D).

Below, a description of these three forces, adapted from Able (2004) and Rüppell (1977):

- **Weight:** a force caused by gravity, which attracts any object towards the centre of the Earth, with a strength proportional to its mass. For an animal to stay aloft, it must overcome this force.

- **Lift:** this is the main aerodynamic force acting against gravity. In many flying animals, lift is provided by the shape of the wing, which can be called an airfoil: it is convex on top, concave below, and narrows at the rear edge. When moving through the air, the airfoil divides the air into two separate airstreams, one on the top and one on the bottom (Fig. 2). Each airstream acts differently because of the shape of the wing. The air forced over the convex surface of the wing is “constricted” to an area near the upper wing surface, which increases its speed. Thus, the air flows more quickly over the wing than under it. To understand why this phenomenon produces lift, it is important to understand the two components of pressure in any gas: static pressure (the force produced by the random motion of molecules, exerted uniformly in all directions) and dynamic pressure (the pressure of movement). According to Bernoulli’s law, these two components must always add up to a constant. The constricted airstream flows more quickly on the upper part of the airfoil, hence its dynamic pressure increases and its static pressure decreases. Since the static pressure of the air is lower on the upper part of the airfoil than on the lower part, it creates lift: a force perpendicular to the flow of air. A flying animal can vary the amount of lift that its wings generate by changing the angle between the wing and the airstream, an angle known as the angle of attack. For example, lowering the front edge of the wing below the horizontal so that airflow strikes the upper wing surface generates a downward force. On the other hand, elevating the wing's front edge increases lift, up to a certain point. An angle of attack which is too steep causes turbulence. When this occurs, the requirements for lift are no longer met, and the animal stalls and falls vertically. For lift to keep a bird airborne, air must flow over its wings at a certain rate.
- **Drag:** this force is slowing down any flying animal and is mostly caused by air friction. It is directed in the opposite direction of motion, increases with air speed and is also influenced by the size, shape and surface of the airfoil.

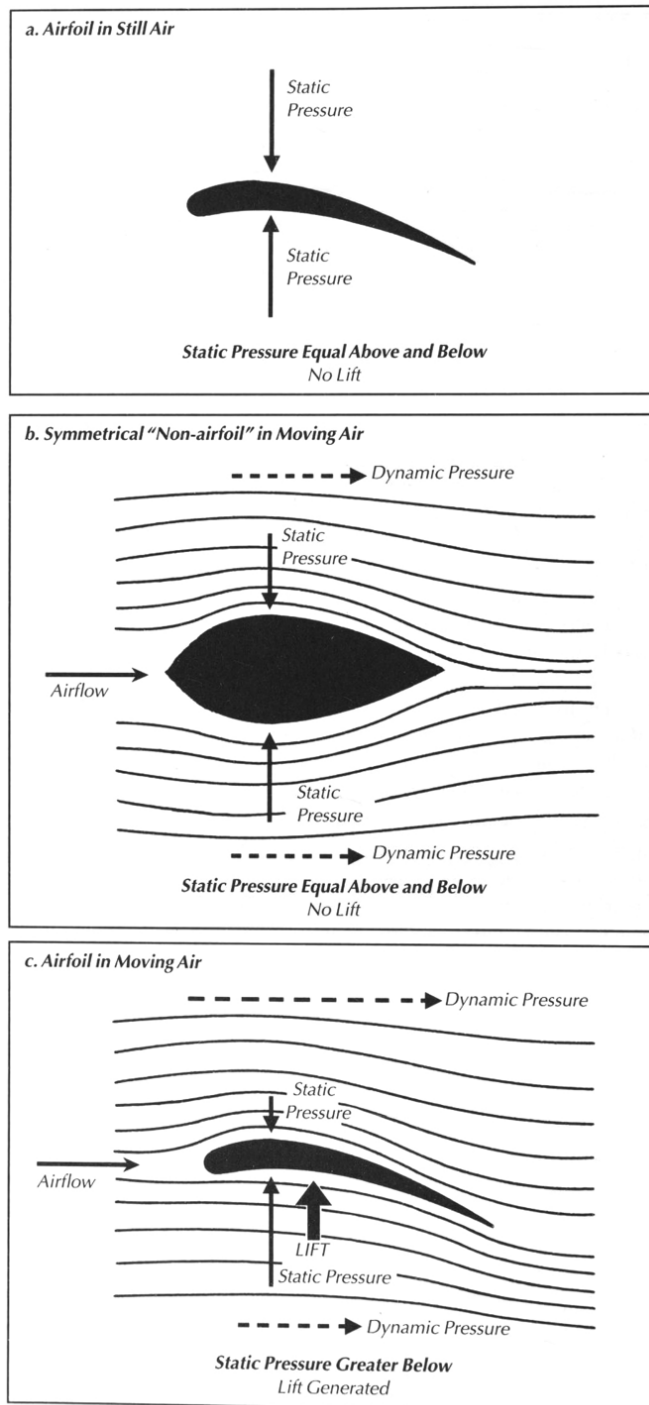

Figure 2: Production of lift by an airfoil (Able, 2004). Horizontal lines represent airstream; lengths or arrows indicate relative magnitudes of the forces. a. Airfoil in still air: static pressure is equal above and below the airfoil. b. Symmetrical "Non-airfoil" in moving air: the symmetrical shape in this airstream constricts the air equally above and below. Therefore, the dynamic pressure (and static pressure) above and below are the same, and no lift is created. c. Airfoil in Moving Air: the airfoil constricts only the air flowing above it, increasing the speed and thus the dynamic pressure above the airfoil. Because the dynamic pressure increases, static pressure must decrease (Bernoulli's law). The result is higher static pressure below the airfoil, creating an upward force known as lift, which keeps a flying animal aloft.

3) Forces acting on a flapping animal

An animal gliding without any external energy source will eventually reach the ground, as only a descending flight trajectory can allow lift and drag to compensate weight (see Fig.1). However, flapping animals are able to produce a fourth, additional force which propels them forward in the air: **thrust**. Flapping wings can generate both lift and thrust to counteract weight and drag (Fig. 3).

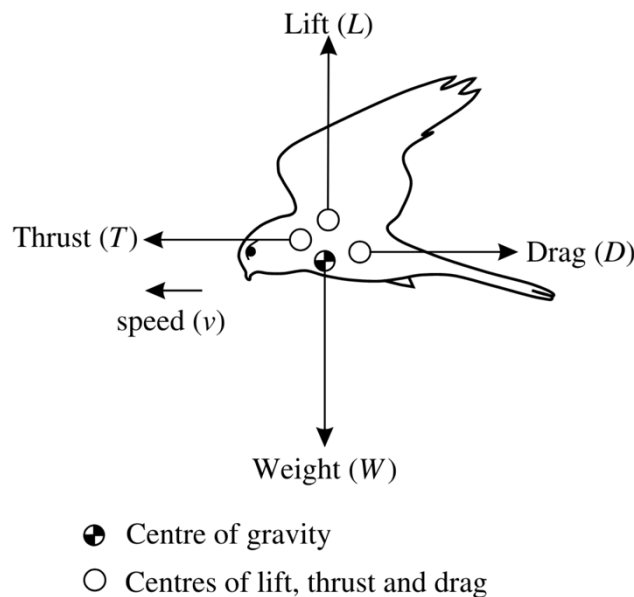

Figure 3: Main forces acting on a flapping bird (modified from Videler, 2005). According to Newton's second law, if the bird flies at a constant altitude and at a constant speed: lift must equal weight, and thrust must equal drag.

In birds, different parts of the wing make different contributions to lift and thrust. Thrust is produced mainly by the movement of the primary feathers attached to the manus (the outer portion) of the wing. In contrast, the proximal portion of the wing, with the secondary feathers attached, provides most of the lift (Able, 2004).

In flapping flight, each wingbeat is divided in two phases: downstroke and upstroke. Fig. 4 shows the positions of the primary feathers during these two phases. The individual primaries are shaped such that each behaves as an individual airfoil generating some lift, as does the wing as a whole. In addition, their asymmetrical shape and directional flexibility cause them to twist such that on the downstroke, the air pressure pushes the inner edge of each primary up against the outer edge of the feather over it. This produces an unbroken surface moving through the air. On the upstroke, air pressure twists the primaries, opening them, so that air may pass through, thus reducing drag. This arrangement of the primaries generates a downstroke having about ten times as much air resistance as the upstroke (Able, 2004).

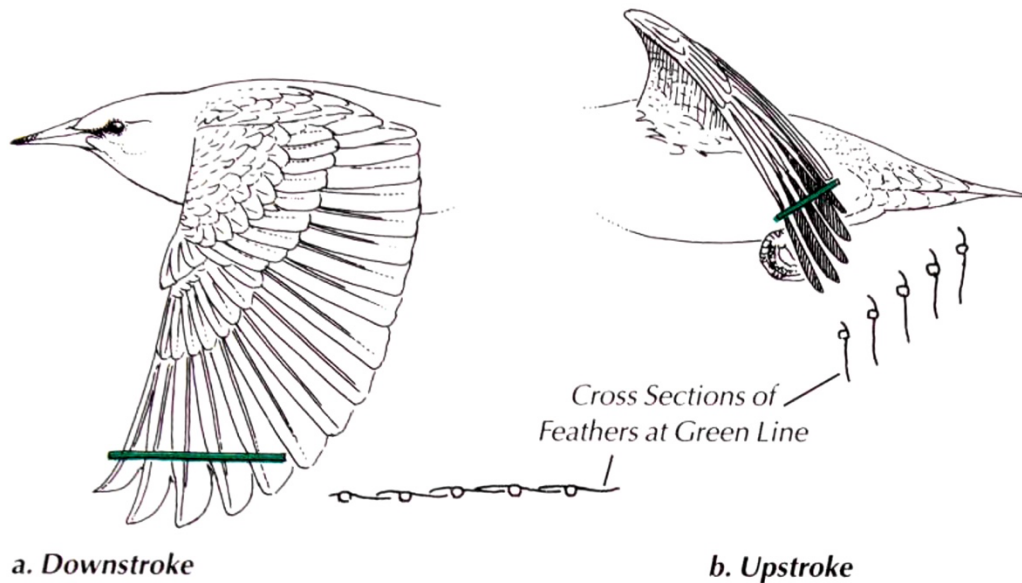

Figure 4: Twisting of primary feathers during flapping flight (Able, 2004). Because the primary feathers have a narrower vane on the outer edge than on the inner edge, they tend to twist as the wing moves through the air during flapping flight.

C) Evolutionary origins

Evolutionary changes operate in small steps over long timescales, and for a long time, it was difficult to imagine how the set of very specialized anatomical and physiological structures allowing flight could have evolved in birds if intermediate steps would be useless. Two traditional theories have been competing for more than a century to explain the origins of avian flight: the ground-up theory and the trees-down theory.

1) *Trees-down (arboreal) theory*

This theory proposed by Marsh (1880) starts with an arboreal protobird that was originally leaping from tree to tree, gradually started gliding, then reached the stage of weak flapping, and finally became capable of fully powered flight (Fig. 5). As modelled by Norberg (1981, 1983), it costs less energy for an animal to climb a tree and then glide to the next tree than to climb up and down in a tree and then run to the next. Moreover, Norberg (1990) has shown with an aerodynamic model that the transition to active, powered flight from gliding is both mechanically and aerodynamically feasible, because every step along this hypothetical route would be an advantage over the previous stages in terms of length and control of the flight path.

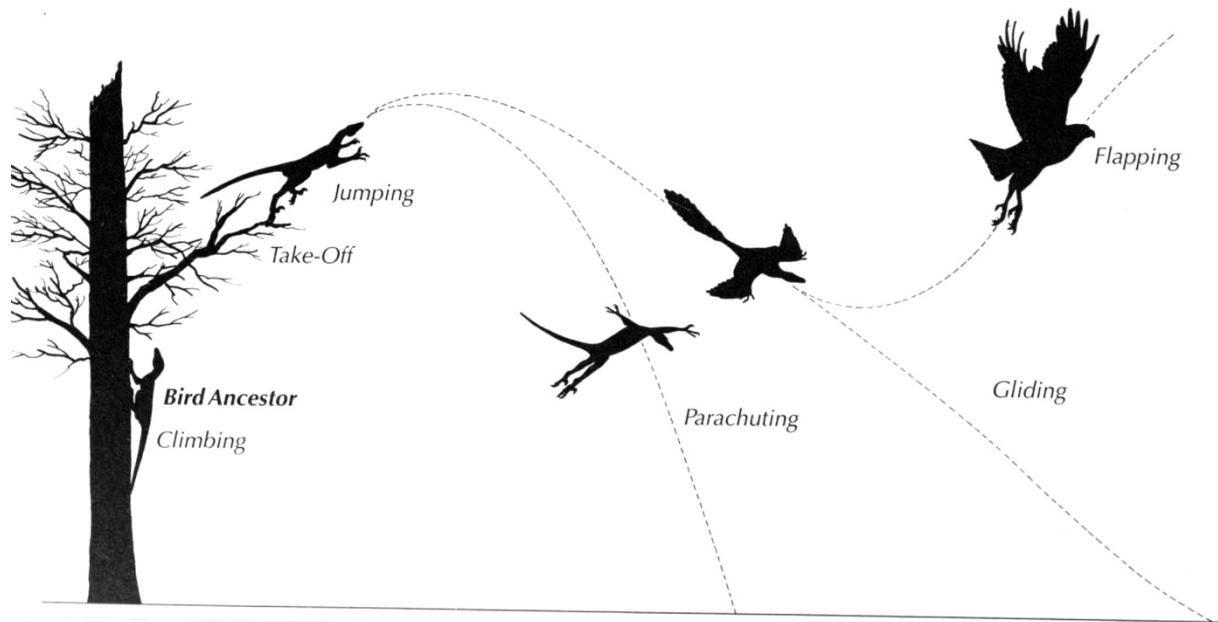

Figure 5: Summary of the trees-down theory of the evolution of avian flight (Feduccia, 2004; after Chatterjee, 1997).

2) Ground-up (cursorial) theory

This theory includes various ideas on the intermediary forms, but generally starts with a fast, bipedal runner. Some ideas state that it could have evolved aerodynamic surfaces on its arms to improve its balance or to stabilize turns while running, because calculations show that small increments in lift due to enlarged forelimbs would dramatically increase body orientation control (Caple et al., 1983). These surfaces would then enlarge and allow a bit of gliding during leaps. Besides, flapping would have evolved initially for thrust only, to increase running speed (Nopcsa, 1907, 1923). It would then gradually become strong enough to turn leaps into short flights and eventually into fully powered flight (Fig. 6). In this theory, the gliding stage can even be considered as optional, since flapping for thrust (to increase running speed) can be sufficiently beneficial by itself to directly evolve into flapping flight (Burgers and Chiappe, 1999). This theory has gained more support when paleontological discoveries led scientists to classify birds as close relatives of the theropod dinosaurs which were known to be bipedal runners (Alexander and Toliaferro, 2015).

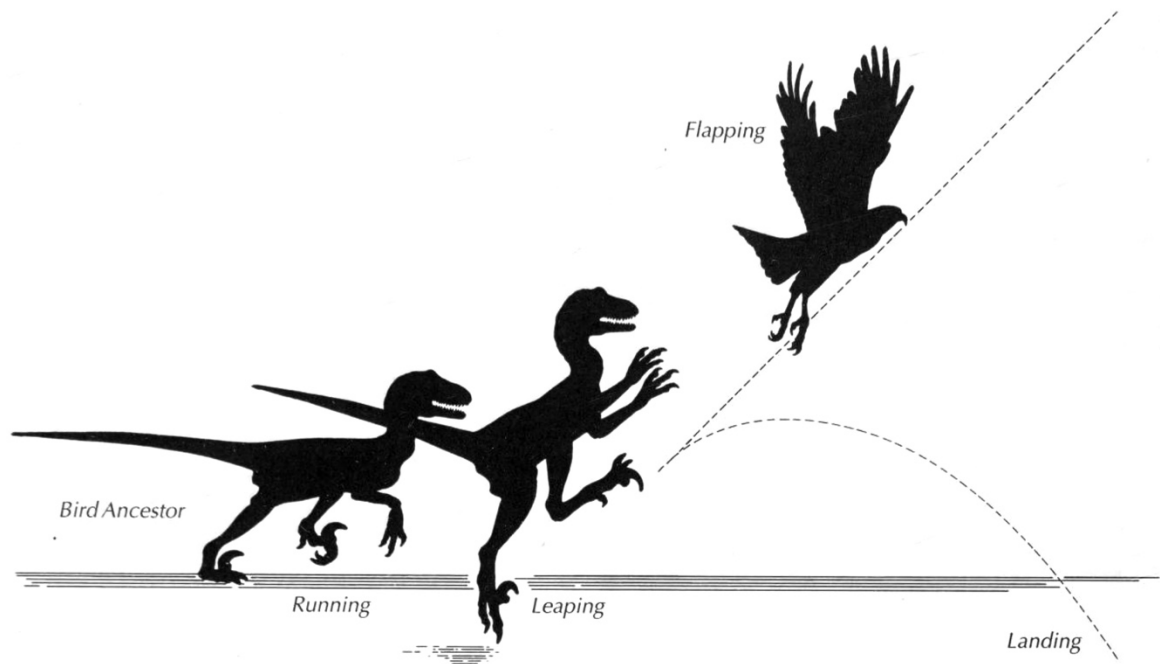

Figure 6: Summary of the ground-up theory of the evolution of avian flight (Feduccia, 2004; after Chatterjee, 1997).

Some counterarguments to this theory include the observation that, although using flapping wings to run faster is possible, evolving these organs just for that purpose seems unlikely, as they would have to get quite big, and flapping muscles would have to get very strong before they could produce enough thrust to help run faster (Alexander and Taliaferro, 2015). This would be a very large hurdle to overcome, and evolving longer legs could have the same result. Moreover, extant flightless cursorial birds like ostriches and emus are excellent runners and are descended from flapping flyers, but they do not use their wings to increase running speed, and these organs evolved to become vestigial (Alexander and Taliaferro, 2015). More recent advances in the fossil record, such as the description of *Microraptor*, a four-winged and feathered theropod with an arboreal way of life and capable of gliding (Fig 7; Chatterjee and Templin, 2007), proved that not all theropods were bipedal runners, so the phylogenetic link between birds and theropods is not necessarily in favour of the cursorial theory.



Figure 7: Reconstruction of *Microraptor* (Li et al., 2012).

3) *Beyond the traditional dichotomy*

Neither of the two traditional theories were able to gather enough evidence to be entirely accepted, and recent advances in the fossil record, as well as observations on extant birds, have led to new theories on the origin of avian flight.

Garner et al. (1999) have compared the sequence of character acquisition predicted by the two major theories with the empirical sequence provided by phylogenetic data, and have shown that both theories incorrectly predicted the sequence of character acquisition for several key features of avian evolution. Instead, they proposed the “pouncing proavis” model, in which the ancestors of birds were predators specialized in ambush from elevated perches. If these predators used their hindlimbs to pounce on their prey, their forelimbs could be used to improve balance and body control during the aerial part of the attack. At first, feathered hands could have evolved solely under selection for increased drag in order to help steer during leaps. Stiffer feathers produced by this process could then be fully aerodynamic and capable of producing some lift for turning a pounce into a swoop. Garner et al. (1999) showed that some extinct species like *Caudipteryx* (Fig. 8) fit into this scenario because the feathers on their hands are not well shaped or correctly oriented for flapping or gliding, but they could be quite effective for producing drag to steer in mid-air. Once these feathered “control surfaces” started to provide

lift as a by-product, extending leaps, selection for longer swoops would lead to more effective wings, then glides, and eventually flapping.



Figure 8: Reconstruction of *Caudipteryx* (by Christophe Hendricks).

Other researches in the field of flight evolution are based on extinct-extant comparisons, following the idea that “ontogeny recapitulates phylogeny”. Even if a literal comparison of the ontogeny of a species and its evolutionary history is unfounded, studying immature organisms may be a good way to understand how transitional morphologies and behaviours could be viable in ancestral forms (Heers and Dial, 2012). In the case of avian flight, this framework has been applied to the study of a specific behaviour called “wing-assisted incline running”, or WAIR (Bundle and Dial, 2003). Experimental studies have shown that young chukar partridges (*Alectoris chukar*) flap their poorly developed wings when they run up steep slopes, and that they can climb steeper slopes when flapping. These birds can progressively ascend increasingly steeper slopes as their wings grow (Fig. 9; Dial et al., 2006). Moreover, aerodynamic experiments have shown that lift from the wings is responsible for accelerating the body towards the substrate to improve feet traction (Tobalske and Dial, 2007). Dial et al. (2008) have shown that the “fundamental” wing stroke pattern used in WAIR is very similar to the one used in flapping flight by adult birds. Dial (2003) suggested that flapping flight could have arisen if a small theropod with incipiently feathered forelimbs gained an advantage avoiding predators

or pursuing prey if it could better run up steep slopes. Flapping would thus have evolved at first for improving traction rather than for faster running or for flight. Once such flapping evolved, converting it to active flight would just require to enlarge the wings and to refine the stroke pattern.

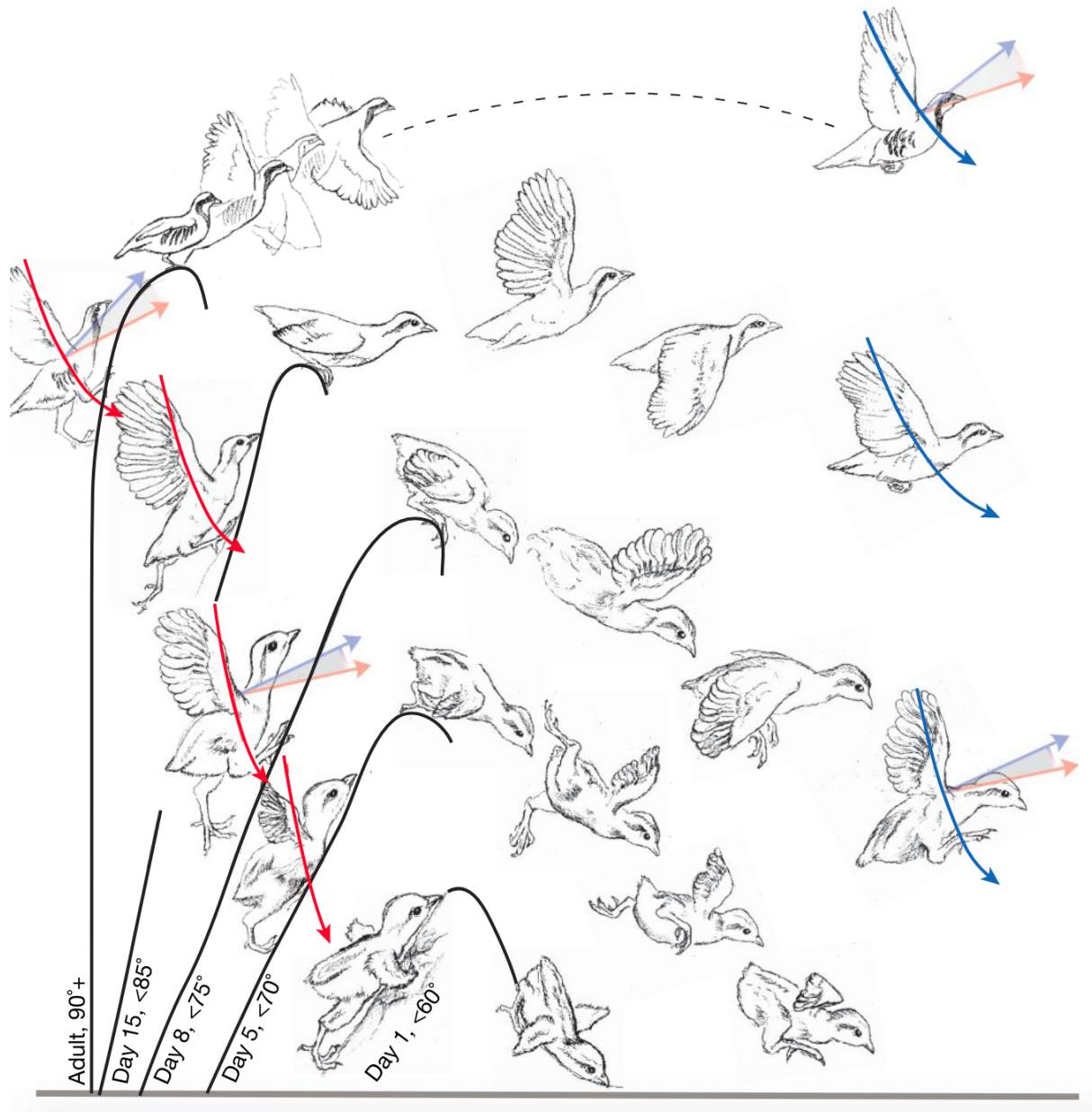

Figure 9: Locomotor development during ontogeny in the chukar partridge (Dial et al., 2008). Red arrows represent wing strokes in WAIR, and blue arrows represent wing strokes during descending and level flight.

However, a weakness of this theory is that, even if young partridges have small wings with poorly developed feathers, they have the highly specialized shoulder joints of a fully aerial

species (Alexander and Taliaferro, 2015). Hence, whether an ancestral theropod with unspecialized shoulder joint could have evolved this behaviour remains an open question.

D) Anatomical adaptations

Flight is a unique locomotion mode requiring various anatomical adaptations. The anatomy of birds exhibits a set of adaptations allowing them to fly, which could be described as “the flight syndrome” (Evans and Heiser, 2004). Some of these adaptations will be presented here.

Firstly, the skeleton of a flying bird must be both light, to enable flight, and strong, to withstand the stresses placed upon it. In flying birds, anterior limb bones are characterised by a reduced cortical thickness (i.e. thin bone walls) to reduce their mass (Voeten et al., 2018). Compared with the bones of terrestrial vertebrates, bird bones also contain much more air. Skeletal pneumaticity is a condition in which extensions from the respiratory system (lungs and air sacs) called pneumatic diverticula enter bones and replace marrow and other internal bone tissue with a thin lining of epithelium and air (O’Connor, 2006). Pneumaticity exhibits a strong phylogenetic signal within birds and is frequently related to body mass or other aspects of ecology (O’Connor, 2004, 2009; Smith, 2012; Gutherz and O’Connor, 2021, 2022). For example, the number of individual elements pneumatized generally increases with body mass, whereas certain locomotor behaviours are consistently associated with extreme pneumaticity phenotypes (e.g., subsurface divers either lacking or exhibiting greatly restricted pneumaticity, soarers exhibiting hyperpneumaticity; O’Connor, 2004, 2009; Smith, 2012).

Besides, skeletal rigidity is achieved by the fusion of many bones, those of the hand and most fingers, most of the wrist bones, and elements in the pectoral and pelvic girdles. The avian sternum (breastbone) is greatly enlarged and has a large keel to which the major flight muscles are attached. In poor fliers, the keel and associated flight muscles are smaller, and the sternum of flightless birds lacks a keel altogether (Evans and Heiser, 2004). Figure 10 summarises the main skeletal adaptations to flight in birds.

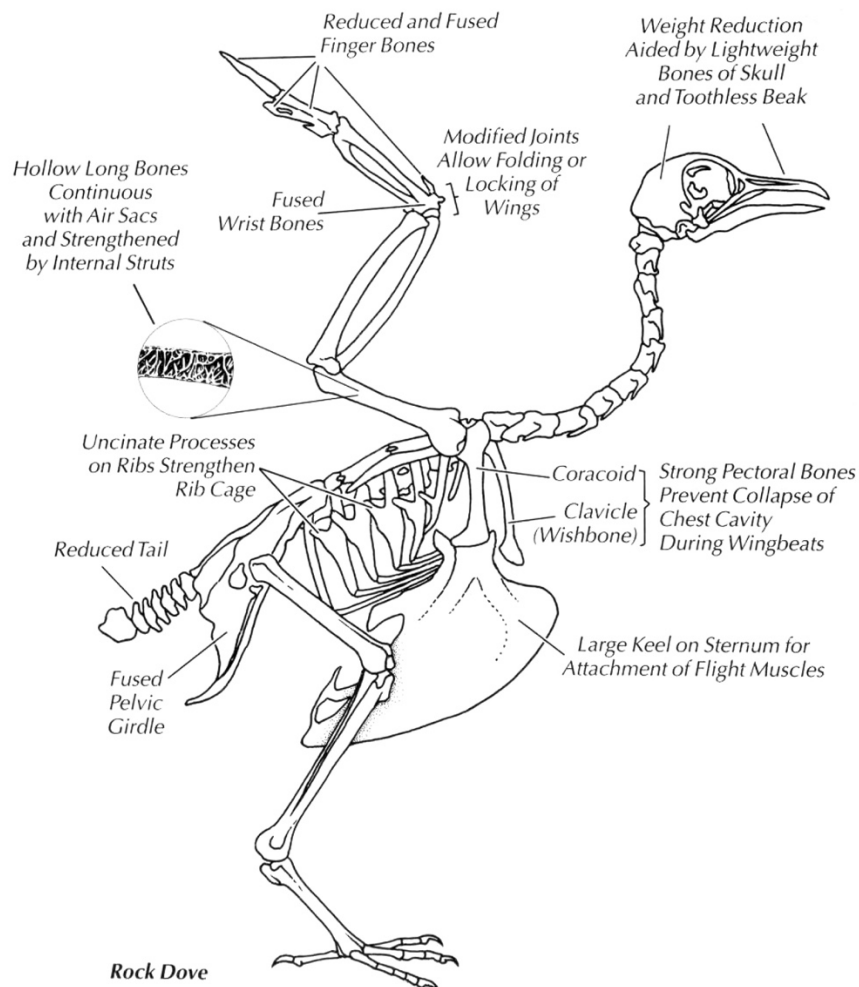

Figure 10: Skeletal adaptations to flight in birds (Evans and Heiser, 2004). Exemplified with a rock dove (*Columba livia*) skeleton.

Then, a flying bird also needs large and powerful flight muscles. A bird's major flight muscles are the pectoralis (used in downstroke) and supracoracoideus (used in upstroke). The larger pectoralis is proportionately the most massive paired muscle in any tetrapod. It accounts for as much as 15 to 25 percent of a flying bird's total body mass (Evans and Heiser, 2004).

Feathers are an anatomical characteristic of birds with a variety of forms and functions (thermal insulation, protection from water, mating display) but one of their prominent role in most birds is flight. A typical pennaceous feather consists of a stiff axial shaft (rachis) with a hollow proximal quill (calamus) and a distal vane (Fig. 11). The vane is composed of a series of parallel barbs on each side, and each barb bears two rows of small barbules. The barbules on the outer side bear hooklets which hold together the adjacent barbs, and the result is a strong, light and flexible web covering the body and shaping the wings and tail (Norberg, 1990).

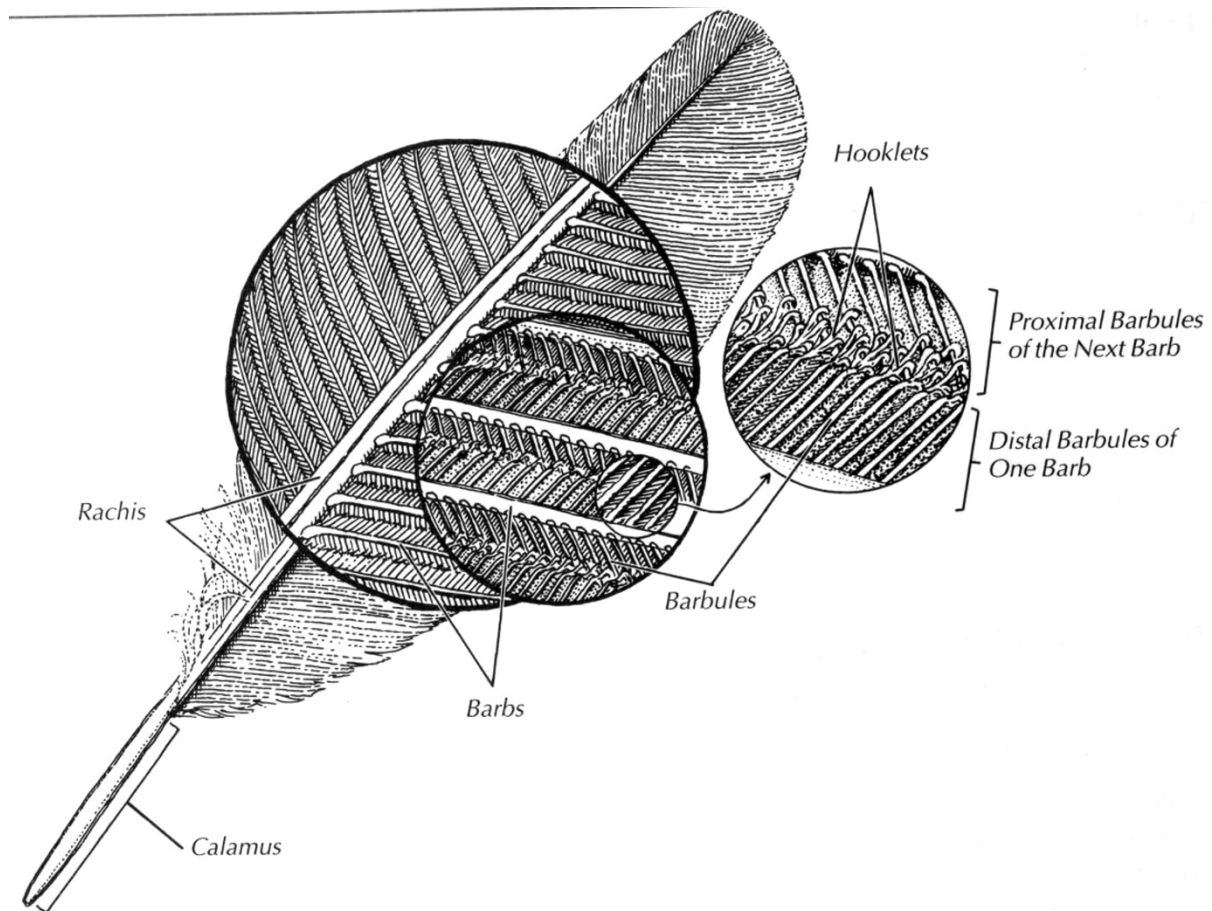

Figure 11: Structural details of a typical pennaceous feather (Clark, Jr., 2004; adapted from Faaborg and Chaplin, 1988).

The wing feathers (remiges) are divided into two groups: the handwing feathers (primaries) attaching to the manus and the armwing feathers (secondaries) attaching to the forearm. When the wing spreads, as in the downstroke, the feathers are hooked together by the interlocking barbs, and they form a streamlined, more or less cambered, surface that prevents air from penetrating it. During the upstroke, and particularly in slow flight and hovering, the feathers rotate as a rigid unit when the wing flexes and air spills through the wing with reduction of drag (see Fig. 4). The body feathers have symmetrical or almost symmetrical vanes, while strongly asymmetric vanes appear in the wing and tail feathers (Norberg, 1990).

The question of the origin of feathers and of their initial function is still debated, but discoveries of flightless bipedal dinosaurs exhibiting different types of feathers (short, fluffy, filamentous or down-like feathers and longer pennaceous feathers) showed that feathers evolved well before flight (Alexander and Taliaferro, 2015). Early feathers were probably undifferentiated cylinders and could have functioned in communication, defence, thermal insulation, or water repellence (Prum, 1999). Barbs, rachis and barbules would have evolved

later, eventually forming pennaceous feathers with a closed vane, and only these pennaceous feathers could have had an aerodynamic function.

Finally, two other anatomical parameters related to wing shape have a crucial importance for bird flight: wing loading and wing aspect ratio. Wing loading is a parameter equal to the body mass divided by wing area (Fig. 12), while wing aspect ratio represents the narrowness of a wing and is equal to the wingspan divided by mean wing chord (Fig. 13). Birds exhibit a wide diversity of wing shapes, and while some species have broad wings of large areas, others have narrow wings of high aspect ratio (Norberg, 1990). The geometry of a wing determines a lot of flight parameters such as flight speed and manoeuvrability. Higher aspect ratios allow a higher lift-to-drag ratio, and hence greater aerodynamical efficiency and lower energy loss in flight, while higher wing loadings allow greater speeds. Wing aspect ratio is important to consider in tandem with wing loading, as the mass of the bird will also influence flight performance (Lovette and Fitzpatrick, 2016). The optimal wing morphology is dictated not only by foraging behaviour and habitat selection but also by size of prey and migratory habits, as well as flight display. As a broad rule, fast-flying species should benefit from short, narrow, high-aspect-ratio wings and slow-flying species should have larger wings (lower wing loadings) but with no particular demands on the aspect ratio (Norberg, 1995).



Figure 12: Example of a low wing loading: the magnificent frigatebird (*Fregata magnificens*; Lovette and Fitzpatrick, 2016; photograph by Brendan Ryan). This species has a large wing area relative to its weight, resulting in a very low wing loading of $\sim 3.7 \text{ kg.m}^{-2}$, compared to 5.9 kg.m^{-2} for the brown pelican *Pelecanus occidentalis*, another species of comparable wingspan; Pennycuick, 1983.

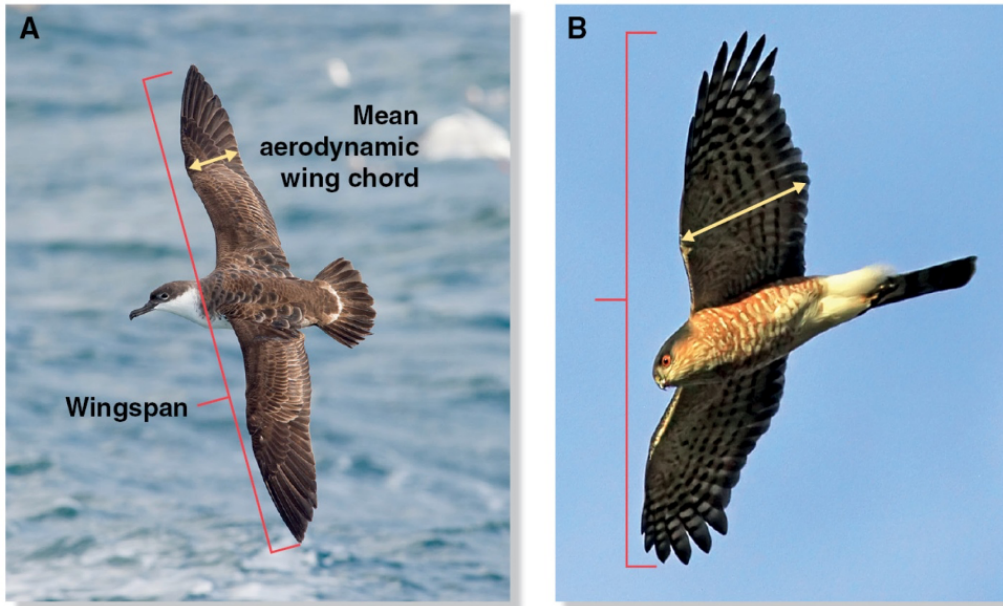

Figure 13: Wing aspect ratio (Lovette and Fitzpatrick, 2016; photographs by A. Ray Hennessey and B. Beth Hamel). Aspect ratio is the wingspan (red brackets) divided by mean wing chord (yellow arrows). (A) The great shearwater (*Ardenna gravis*) has long and narrow wings with a high aspect ratio, providing greater efficiency via a high lift-to-drag ratio, thus requiring less energy for flight. (B) The sharp-shinned hawk (*Accipiter striatus*) has shorter and wider wings with a low aspect ratio. Flight efficiency is traded for manoeuvrability and rapid take-off.

E) Physiological adaptations

Just like their anatomy, birds' physiology exhibits a number of adaptations to flight.

Some flight modes are very energetically demanding (e.g. flapping-flight take off, high speed forward flight, hovering) and birds need to exchange gas very rapidly and efficiently. Their respiratory system is adapted to this constraint and is characterized by a number of air sacs connected to a pair of lungs (Fig. 14). During inspiration air passes through the trachea, bronchi and lungs into the air sacs. The air sacs have no blood vessels and play no direct part in the exchange of oxygen and carbon dioxide, but they serve as bellows to bring air into the bird and store it until expiration. Gas exchange occurs in the parabronchi which contain a dense network of air capillaries and blood capillaries. During expiration, this stored air flows into the parabronchi to interact with the respiratory surfaces. Thus birds get fully oxygenated air into the lungs on both inspiration and expiration, and consequently have the most efficient respiratory system of all vertebrates (Scheid, 1979; Evans and Heiser, 2004).

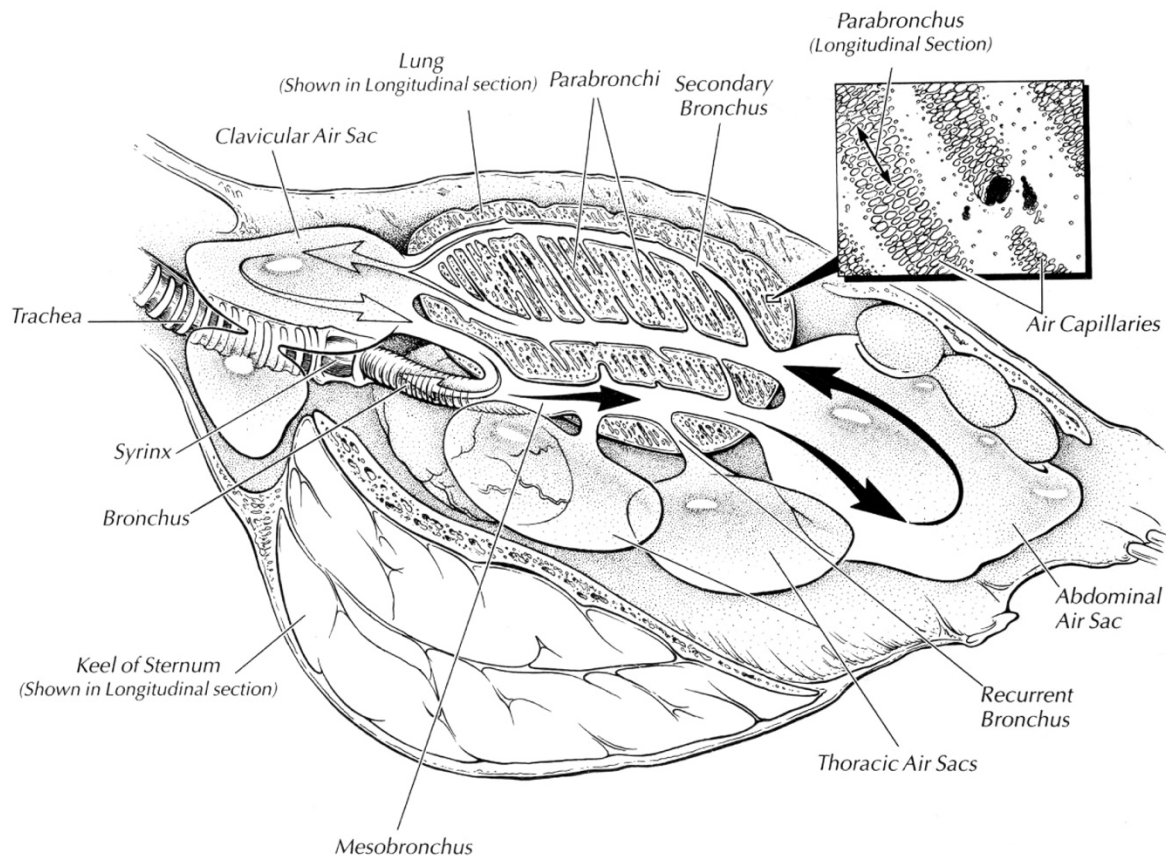

Figure 14: Avian respiratory system (Evans and Heiser, 2004; adapted from Proctor and Lynch, 1993). For clarity, air sacs have been simplified and drawn much smaller than in a live bird. In their natural state, air sacs completely surround the abdominal organs and overlap each other extensively, forming a complex system with connections to air spaces within the bones.

Oxygen extraction by muscles is also important, and depends to a large extent on the density of blood capillaries in those muscles; the greater the capillary density, the greater the surface area for gas exchange. Comparative studies show that the flight muscles of passerines that migrate long distances have a greater capillary density (~ 1900 capillaries mm^{-2}) than those of species that are only partially migratory or do not migrate at all (~ 1600 capillaries mm^{-2} ; Lundgren and Kiessling, 1988). The rufous hummingbird (*Selasphorus rufus*) is an extreme example: due to its very demanding flight mode (hovering) and its migratory behaviour (it migrates from North America to Mexico each year, a distance of approximately 3500 km), its flight muscles have an extremely high capillary density (7000 capillaries mm^{-2} ; Mathieu-Costello et al., 1992).

The maximum amount of oxygen that can be carried in the blood is largely influenced by the concentration of haemoglobin, and some species of birds can vary this concentration. When bar-tailed godwits (*Limosa lapponica*) arrive at their stopover point in the Netherlands after flying around 4500 km from their overwintering site in West Africa, their haemoglobin

concentration is lower than when they set off after refuelling (Landys-Ciannelli et al., 2002). This increase in haemoglobin concentration could be a way to raise the maximum oxygen carrying capacity of the blood in anticipation of the increased aerobic demands of the migratory flight in conjunction with an increased body mass. Other studies also reported a tendency for the masses of the heart and flight muscles to increase during the pre-migratory period in some long-distance migrants such as red knot (*Calidris canutus*), and these changes relate directly to the overall increase in body mass, which is mainly the result of the accumulation of fat stores (Piersma, 1998; Piersma et al., 1999).

During migration, oxygen intake can become more difficult at higher altitudes, where air pressure is lower. Most species of birds fly below an altitude of 1 km above ground level during their migrations (Bishop and Butler, 2015), but a number of species fly above this altitude to select favourable wind directions or air temperatures, or when they have to negotiate large mountain barriers during their migration (Liechti, 2006; Bishop and Butler, 2015). The bar-headed goose (*Anser indicus*) is known for being able to fly above 6000 m during its migration crossing the Himalayas (Hawkes et al., 2011, 2013). A lot of studies investigated how they might survive at such high altitudes, and how they manage to perform a high level of aerobic exercise as flapping flight under hypoxic conditions (reviewed in Butler, 2010), and it was found that one of the most important adaptations in bar-headed geese is the possession of haemoglobin that has a higher affinity for oxygen than that of other species of birds.

II. Flight modes

Flight behaviours in birds exhibit a great diversity of forms and functions, various bird species are specialized in some flight modes in accordance with their ecology. Their anatomy and their physiology can thus be adapted to a specific flight mode. Wing loading and wing aspect ratio often indicate the flight modes for which a bird is more adapted (Norberg, 1990).

A) Flapping

As explained earlier, this flight mode characterizes “active flight” and is exhibited by most birds. Some species are specialized in steep take-offs from the ground and need rapid flapping bursts. The majority of these birds have a high wing loading (fast flight) and a low aspect ratio. The very short wingspan in these species may be an adaptation for flight within dense vegetation.

In these birds, muscular adaptations are also visible. For example, white fibres (used for fast and short contractions) are predominant in the pectoral muscle of gallinaceous birds. White fibres are also found in several other birds that often perform power bursts, such as herons, geese, ducks, mergansers, and grouse (Chandra-Bose and George, 1965a; b; Rosser and George, 1986). For example, in the spruce grouse (*Canachites canadensis*) and the ring-necked pheasant (*Phasianus colchicus torquatus*), the white fibres constitute more than 80% of the fibres in the pectoral muscle. In species such as gallinaceous birds, the abundance of muscle fibres specialized in short burst, together with their expensive flight (because of the high wing loading and low aspect ratio) make them unable to fly long distances.

B) Gliding

During gliding, birds trade altitude against forward speed. The higher their lift:drag ratio, the shallower their gliding angle, and the further they can glide from a given altitude (Fig. 1). Gliding is very cheap compared with flapping. Physiological measurements indicate that gliding herring gulls (*Larus argentatus*) consume only two times more oxygen than when resting (Baudinette and Schmidt-Nielsen, 1974), compared to laughing gulls (*Larus atricilla*) in flapping flight, which consume about seven times more oxygen than their resting level (Tucker, 1972). This is because the flight muscles do not perform any mechanical work during gliding, but only produce static forces to keep the wings on the horizontal plane (Meyers, 1993). Albatrosses even have a “shoulder lock”, a tendinous sheet which passively maintains horizontal wing posture during extended periods of gliding and soaring (Meyers and Stakebake, 2004).

Gliding and other passive flight modes (e.g. soaring, see Section II.D) are more profitable for larger birds needing to stay aloft for a long time at a minimum energetic cost, because the power requirements for flapping increase steeply with body mass, while gliding costs are often about three times the basal metabolic costs, irrespective of body mass (Shepard, 2022).

Birds with low wing loadings (large relative wing areas) can glide slowly with low sinking speed.

C) Intermittent flight

In intermittent flight, bursts of active flapping are alternated with passive phases. There are two types of intermittent flight strategies: flap-gliding (or undulating) flight and flap-bounding flight (Rayner, 1985).

1) Flap-gliding

In flap-gliding flight, the active phase is a climb in a straight path, while the passive phase consists of gliding in a straight path. Flap-gliding is more commonly associated with larger birds, but this is not an absolute rule, since starlings (Tobalske, 1995), swifts (Muijres et al., 2012a; Sachs, 2017), swallows and martins (Bruderer et al., 2001), and even dragonflies (Wakeling and Ellington, 1997) also frequently exhibit periods of gliding between flaps.

Among larger birds, seabirds such as albatrosses, petrels and gannets characteristically use flap-gliding in cruising flight, by alternating short glides with short bursts of flapping (Norberg, 1990).

2) Flap-bounding

Flap-bounding flight consists of a few metres of flapping flight alternating with a few metres of passive flight with folded wings, making the flying bird rise and fall in a ballistic path. Generally, flap-bounding is limited to small birds, and their bounds are more notable at higher speeds (Tobalske, 1995). Small passerines (such as tits, finches and wagtails) and birds up to the size of the green woodpecker (*Picus viridis*) use this kind of flight (Norberg, 1990).

However, flap-bounding departs considerably from any aerodynamic or purely mechanical optimum, because aerodynamically economical flight should be steady and level (Rayner, 1985; Usherwood, 2016). Rather, this flight mode might be a trade-off between conflicting demands of aerodynamic performance and flight muscle physiology (Goldspink, 1977; Rayner, 1977).

Rayner (1985) considered the hypothesis that bounding flight results from constraints on muscular efficiency. Similarly, Usherwood (2016) studied this flight mode through a physiological cost parameter of muscles: the cost of activation. Small birds, with brief downstrokes, experience disproportionately high costs due to muscle activation for power during contraction. Thus, bounding flight may be an adaptation to modulate mean aerodynamic force production. This flight mode allowing intermittent rest periods seems to be the only way for smaller birds to keep muscle contraction dynamics close to optimum while obtaining a low mean power output.

D) Soaring

Soaring is one of the most energy-efficient flight modes, because it consists in extracting external energy from the environment (wind or air current) and converting it in potential or kinetic energy. A soaring bird is usually gliding while extracting environmental energy. Soaring

can be divided in different categories, and the following ones were defined by Pennycuick (1975) according to the exploited meteorological process.

1) Slope soaring

In slope soaring (Fig. 15), a bird flies in a region of rising air caused by upward deflection of the wind over a slope, a forest edge, or another landscape feature (slope lift). Slope soaring is also possible along ocean waves and is frequently used by petrels and albatrosses (Pennycuick, 1982a), but also pelicans (Stokes and Lucas, 2021).



Figure 15: Slope soaring (Pennycuick, 1975). The best lift is found over a smooth slope (left), while vertical cliffs can produce more complicated flow patterns but sometimes give useable lift when facing downwind (right).

2) Thermal soaring

Thermal soaring occurs in thermal updrafts, which are rising volumes of warm air moving because of thermal instability in the atmosphere. Thermals vary in form and structure but one of the most common forms is a bubble or vortex ring (Fig. 16; Norberg, 1990). Vortex-ring thermals may be triggered directly from the heated ground, and rise through the atmosphere as bubbles. The lift is confined to a central core that is limited outwards by a zone of sinking air. A vortex ring has a life of about half an hour or more, so that birds may climb more than 2500 m in such a thermal. Vultures, eagles, buzzards, and storks can use thermals to travel by climbing in a thermal to some height and then gliding off, losing height until they meet the next thermal (Cone, 1962; Norberg, 1990).

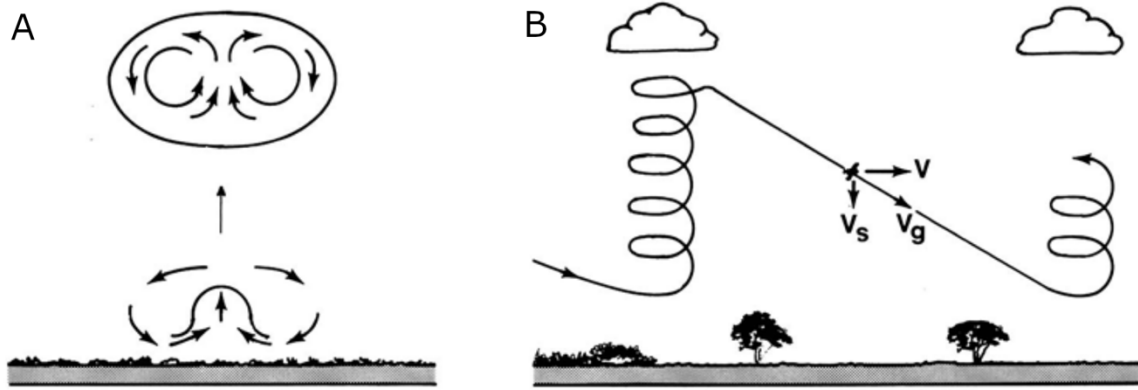

Figure 16: Thermal soaring (Pennycuick, 1975). (A) Vortex-ring, triggered from heated ground and rising as a bubble. (B) Trajectory of a soaring bird, climbing in a thermal, gliding off, and climbing in a new thermal again. V is forward speed, V_g is gliding speed, and V_s is vertical sink speed.

Birds that use thermal soaring as their main means of locomotion typically have relatively short soaring wings with low aspect ratios, large wing areas, and hence low wing loadings (Fig. 17; Pennycuick, 1971a).



Figure 17: Griffon vulture (*Gyps fulvus*; photograph by Imran Shah). This species has wide wings with a low aspect ratio, adapted to thermal soaring.

Considering the nature and shape of thermal updrafts, it is not only important for soaring birds to be able to rise quickly in these currents, but also to be able to soar in small circles in order to stay in the zone of best lift (Pennycuick, 1983). Pennycuick (1971b) has shown that

this important constraint prevents large birds specialized in soaring from having longer wings. He made circling performance estimates for an imaginary "albatross-shaped vulture", and showed that vultures having longer wings would climb faster in wider thermals, but would struggle to circle in narrow thermals because their longer wings would induce higher turning radiuses.

Real vultures must be able to soar in very small thermals to be able to begin patrolling early in the morning when the thermals are weak and narrow (Pennycuick, 1971b). The earlier in the day that the vultures can start searching for carrions, the better their chances of successful foraging. This is particularly important, since the mammalian scavengers usually dominate the vultures, keeping them away from carcasses.

Lower circling radiuses may be more important for soaring scavengers, but other soaring birds, like storks, may also benefit from low aspect-ratio wings as an adaptation to the requirements of take-off from the ground or trees, which calls for more wing area than taking off from a cliff (Pennycuick, 1971b).

Thermal updrafts can be considered as an important non-food form of energy for large scavenger birds, and the patchy distribution of this resource influences their foraging behaviour. Shepard et al. (2011) have studied the foraging flight of the Andean condor (*Vultur gryphus*) and have shown that the soaring behaviour of this bird was modulated by the need to reconcile differing mechanical energy and food energy distributions. In other words, their foraging pattern is influenced by the distribution of thermal updrafts as well as by their need to find food in the form of carrions. The Andean condor can also use slope lift, and it is so effective at switching between slope soaring and thermal soaring that it manages to only flap for 1% of its foraging flight (specifically during take-off and when flying close to the ground; Williams et al., 2020).

3) Dynamic soaring

Dynamic soaring does not depend on vertical air movements but on variations in horizontal wind speed, or wind gradient. Dynamic soaring is more efficient in the wind shear that occurs over a flat surface, such as the ocean. Near the surface the wind speed is slowed down by friction, forming a wind gradient.

Dynamic soaring involves converting kinetic energy to potential energy, and reciprocally. When a bird glides downward in a downwind direction, it gains airspeed (kinetic energy). At sea level it soars in slope lift along the windward face of a wave and uses some

kinetic energy for manoeuvring, and when it has used most of this energy the bird climbs into the wind. Although it tends to slow down (relative to the water) now because it is working against gravity, the bird gains airspeed (kinetic energy) as it climbs into the wind because the wind is blowing progressively faster with increasing altitude (Fig. 18). When the wind gradient becomes too weak to allow further climbing, the bird turns downward and downwind again, using the gained potential and kinetic energy for manoeuvring and horizontal progression (Norberg, 1990). Using only these techniques, albatrosses zigzag over the ocean, only occasionally flapping their wings (Richardson, 2011; Sakamoto et al., 2013).

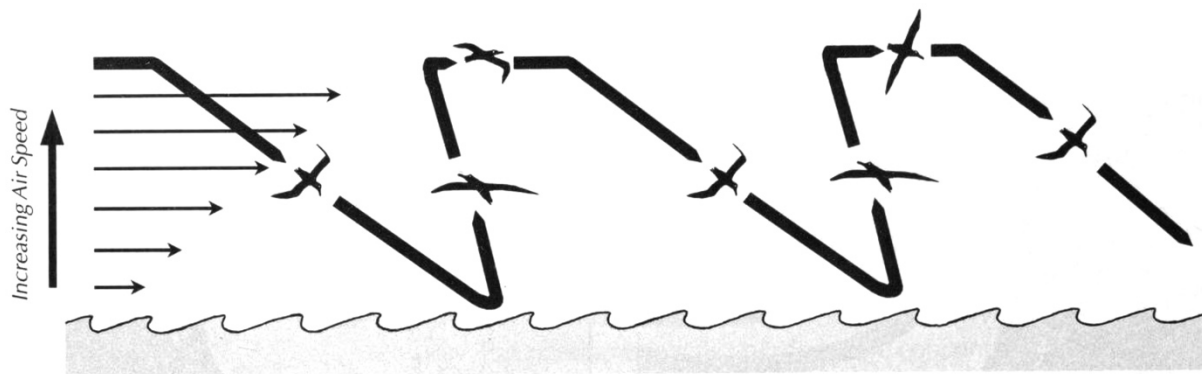

Figure 18: Dynamic soaring in an albatross (Podulka et al., 2004).

The efficiency of dynamic soaring is influenced by wind speed and direction, and Kempton et al. (2022) have shown that Manx shearwaters (*Puffinus puffinus*) adapt their large scale feeding distribution at sea depending on wind to optimize dynamic soaring.

Birds adapted to dynamic soaring have long and narrow wings with large aspect ratios, allowing them to glide with great aerodynamic efficiency (Fig. 19).

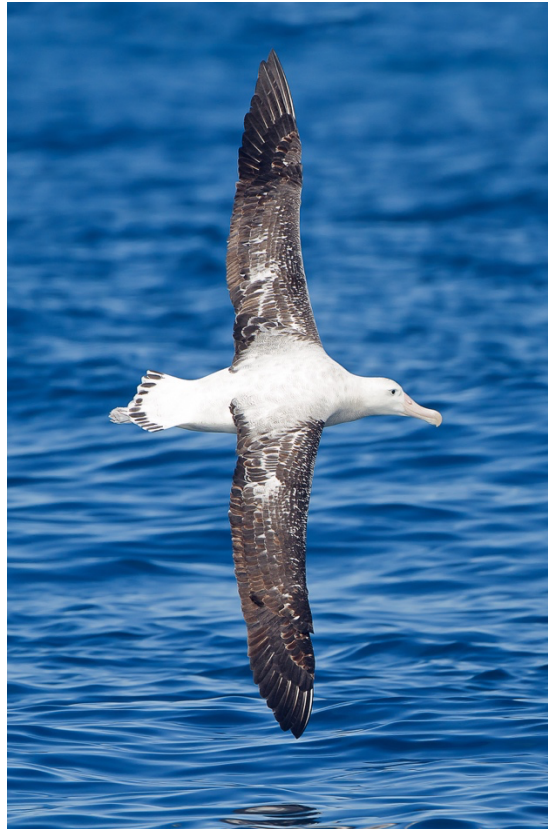

Figure 19: Wandering albatross (*Diomedea exulans*; photograph by J.J. Harrison). This species has long and narrow wings with a large aspect ratio, adapted to dynamic soaring. It is also known to have the longest wingspan of all extant birds (reaching 3.5 m).

E) Hovering

Hovering flapping flight is the most expensive flight mode, because it involves no forward speed component. This means that the area through which air is accelerated in a unit of time is much less than for forward flight. In spite of the costs it involves, hovering is performed by most insects and by many small birds and bats (Norberg, 1990). Hovering allows animals to forage in places otherwise inaccessible, for example, in front of flowers and fruits at plants that are too weak to support the animal's mass. Pyke (1981) observed that a hovering hummingbird can forage more quickly between flowers than one that perches, resulting in maximized net energy gain in spite of the higher flight costs. Hovering becomes a more effective behaviour to maximize rate of net energy gain as distance between food patches decreases (Wolf and Hainsworth, 1983; Hainsworth, 1986).

Hummingbirds perform symmetrical hovering, they hover with fully extended wings during the entire wingbeat cycle and elicit lift also during the upstroke. On the other hand, many small passerine birds (for example: fly-catchers, Muijres et al., 2012b; or white-eyes, Su et al., 2012; Chang et al., 2013) and sunbirds (Wolf and Hainsworth, 1983; Janeček et al., 2011;

Padyšáková and Janeček, 2016) perform asymmetrical hovering by flexing their wings during the upstroke to reduce drag forces and any negative lift forces.

III. Cost of transport

Reducing energy expenditures in flight is a major selective pressure across most bird species, so it is important to understand how energy is spent in flight. To estimate the energy expenditures of birds in flight, power (rate of energy transfer per unit of time, in W) is often calculated.

A) Power curve in flapping flight

For a bird flapping in level flight, aerodynamic theory predicts that the relationship between power and flight speed will be U-shaped (Fig. 20). Indeed, a bird flying very slowly needs more energy to stay aloft than a bird flying at intermediate speeds, and higher speeds also require high energy expenditures. The bottom point of the power curve defines the minimum power speed (V_{mp}) at which the bird can fly the longest time on a given amount of energy. The maximum range speed (V_{mr}) where the power/speed ratio (or energy/distance ratio) reaches its minimum is found by drawing a tangent to the curve from the origin, and should be used for maximization of flight distance on a given amount of energy (Pennycuick, 1969, 1975).

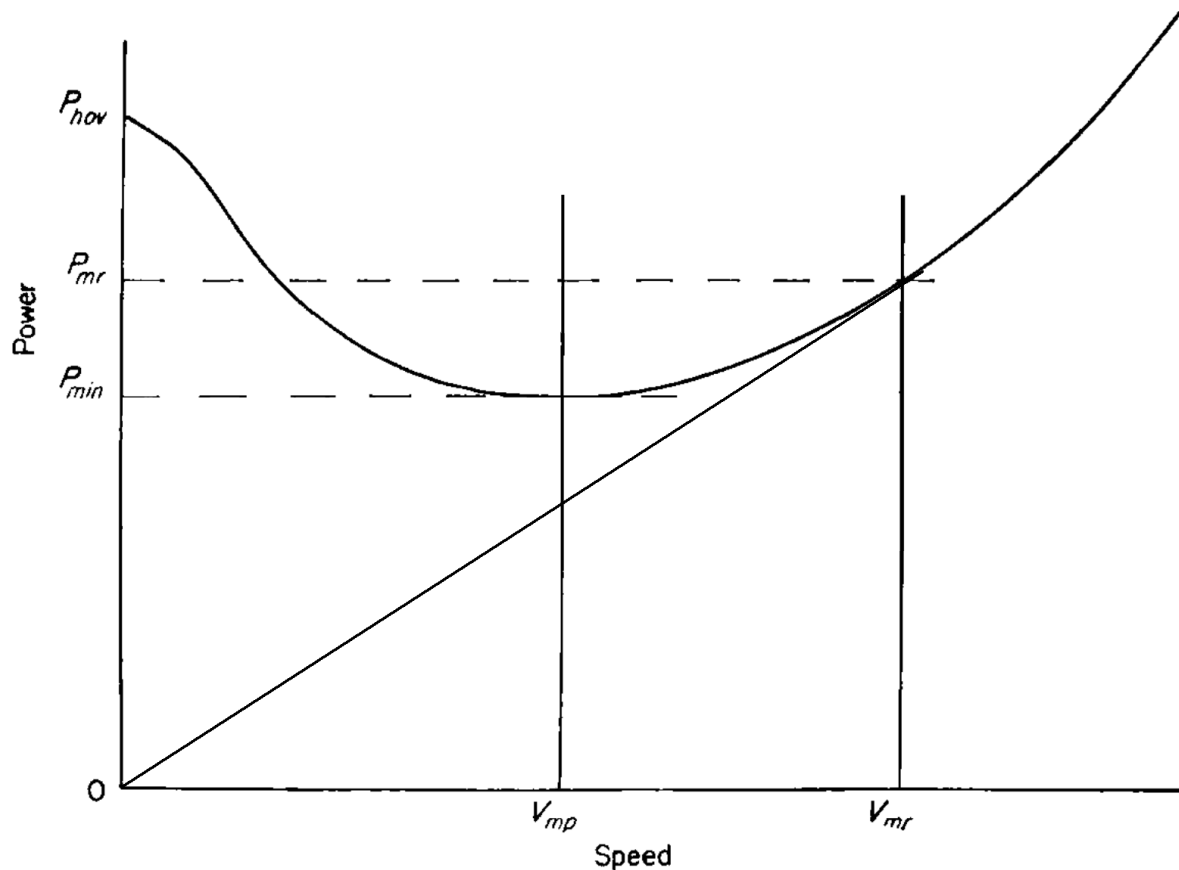

Figure 20: Power versus speed curve for a bird flapping in level flight (after Pennycuick, 1969). The power required to fly is minimum (P_{min}) at the speed marked V_{mp} . Maximum range is achieved at a power of P_{mr} at the speed marked V_{mr} . P_{hov} is the power required to hover (speed = 0).

The shape and position of the curve differ according to behavioural (e.g. wingbeat frequency) and morphological (e.g. wing aspect ratio) parameters specific to each bird. For example, a low power curve can be obtained with high aspect ratio (long, narrow) wings and is advantageous for enduring flight (Norberg, 1990).

Based on the hypothesis that the pectoralis is the primary muscle supplying the mechanical power output required for flight, some studies have measured muscular power on birds flying in wind tunnels (e.g. Tobalske et al., 2003) and have shown that it varied in a U-shaped curve with some interspecific variations (Fig. 21). Tobalske et al. (2003) have compared muscular power in the cockatiel (*Nymphicus hollandicus*), ringed turtle-dove (*Streptopelia risoria*) and the black-billed magpie (*Pica hudsonia*). Amongst other differences, they observed a lower and flatter power curve for the magpie, which can be partly explained by its intermittent flight style compared to the continuous flapping of the two other birds.

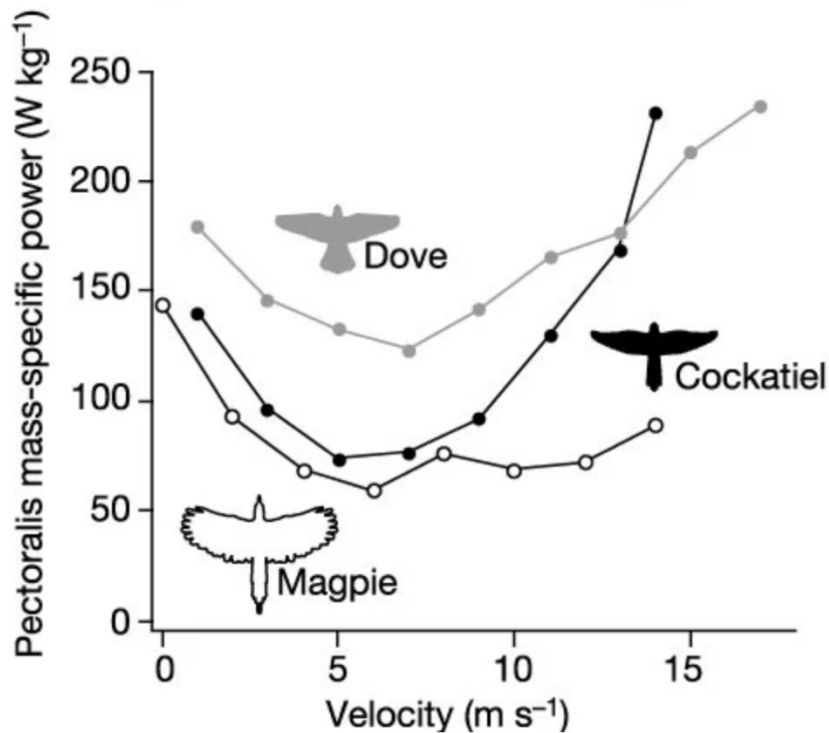

Figure 21: Three power curves measured in wind tunnel (Tobalske et al., 2003). *In vivo* mechanical power output from wind tunnel flight across flight speeds as measured using strain gauges, sonomicrometry and wing and body kinematics in ringed turtle-dove (*Streptopelia risoria*), cockatiel (*Nymphicus hollandicus*) and black-billed magpie (*Pica hudsonia*).

B) Glide polar

Gliding birds exhibit minimal energy output, but constantly lose altitude (in the absence of external energy sources) so aerodynamic efficiency in gliding flight is calculated differently. The glide polar, which is obtained by plotting sinking speed against horizontal speed (Fig. 22), can be used to summarize the gliding performance of a gliding animal (Norberg, 1990). The glide angle for any speed combination can be found by drawing a line from the origin to the curve. Just like flapping flight, remarkable values can be extracted from this curve. The speed for minimum sink (V_{ms}) corresponds to the minimum power speed, and the speed for best glide ratio (V_{bg}), or minimum glide angle, corresponds to the maximum range speed and is also found by drawing a tangent to the curve from the origin. Besides, all gliding animals have a stalling speed below which they cannot glide.

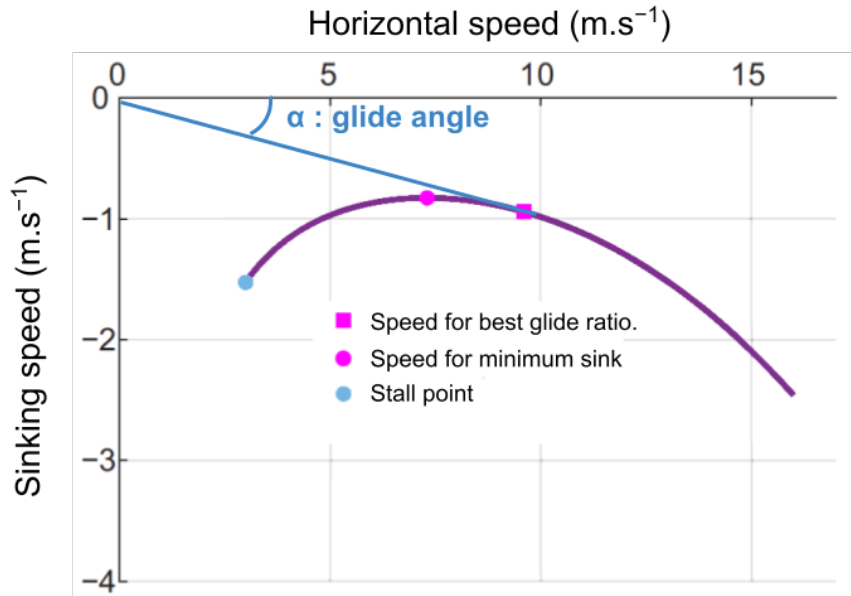

Figure 22: Glide polar showing the relationship between horizontal speed and sinking speed in gliding flight. Glide angle is minimal at the speed for best glide ratio, while sinking speed is minimal at the speed for minimum sink. The bird cannot glide at speeds lower than the stall point.

C) Effect of wind speed and direction

In this section, power output and glide polar have been considered in static air, but wind often occurs in nature, and it is important to understand that all the above relationships are only valid in the air reference frame. A bird flapping downwind at 5 m.s^{-1} with a 5 m.s^{-1} tailwind will fly at 10 m.s^{-1} in the ground reference frame, but will only expend energy equivalent to its airspeed of 5 m.s^{-1} . Similarly, a bird gliding upwind at 5 m.s^{-1} against a 5 m.s^{-1} headwind will appear to have a zero horizontal velocity in the ground reference frame, but it will not stall and fall because its airspeed will still be sufficient to glide.

However, the maximum range speed of a travelling bird is dependent on distance travelled in the ground reference frame since birds often have to move from one ground point to another. It can thus be defined as the airspeed at which the distance travelled for a given amount of energy consumed is maximised, or the airspeed maximizing the groundspeed/energy ratio. Consequently, the maximum range speed of a traveling bird is modified by wind speed and direction, whether the bird is flapping or gliding. Theory predicts that headwind should increase maximum range speed while tailwind should decrease it. Thus, birds should adjust their airspeed according to wind speed and direction for energetically optimal cost of transport in the ground reference frame (Pennycuick, 1978). Birds optimising their energy expenditure per unit of distance should increase their airspeed when flying upwind, and decrease it when flying downwind. This phenomenon has been confirmed in migrating or commuting birds such

as terns (Wakeling and Hodgson, 1992), various birds migrating in the Arctic (Fig. 23; Hedenström et al., 2002), shags (Kogure et al., 2016), or thrushes (Sinelschikova et al., 2019).

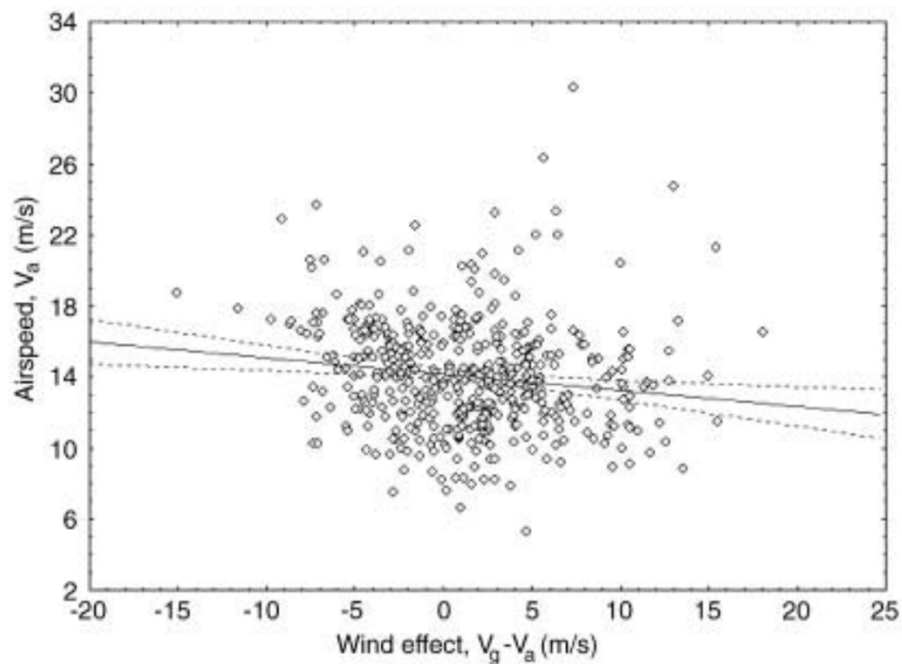

Figure 23: Airspeed in relation to wind effect (ground speed – airspeed) for radar tracks of migrating birds (Hedenström et al., 2002). Negative wind effect corresponds to headwind and positive wind effect corresponds to tailwind. The solid line indicates the significant linear regression between airspeed and wind effect, while the dotted lines indicate the 95% confidence interval.

IV. Flight ontogeny

Article 1:

The development of flight behaviours in birds

Résumé en français

Le vol est une adaptation unique et indispensable à de nombreux comportements chez la plupart des oiseaux, que ce soit la recherche alimentaire, la migration ou la reproduction. Les oiseaux ont développé des modes de vol variés (ex : vol battu, vol plané, vol à voile, vol stationnaire) qui impliquent des comportements très spécialisés. Un problème central dans l'étude des comportements de vol est la compréhension de leur développement durant l'ontogenèse des oiseaux, depuis l'embryon jusqu'à l'adulte volant. Cette question renvoie typiquement aux débats classiques sur le comportement animal et l'importance de la maturation et de l'expérience. Dans cet article, nous passons en revue la littérature sur le développement des comportements de vol chez les oiseaux. Premièrement, nous nous focalisons sur la période précoce, quand les jeunes oiseaux ne sont pas encore capables de voler : nous étudions des exemples et montrons comment des processus endogènes (ex : battements d'ailes au nid, période de développement du vol) et des facteurs environnementaux (ex : stress maternel, stress nutritionnel) peuvent influencer le développement des comportements de vol. Ensuite, nous passons en revue plusieurs exemples illustrant les processus impliqués dans le développement du vol chez les juvéniles volants (ex : pratique, apprentissage par essai-erreur, apprentissage social). Malgré la rareté des études expérimentales se focalisant sur cette question à différents stades de développement, nous montrons que plusieurs patterns peuvent être identifiés, et nous soulignons que le développement de nouvelles techniques de suivi devrait permettre d'étudier cette question plus en détails chez davantage d'espèces d'oiseaux.

Review



Cite this article: Raux G, Lumineau S, de Margerie E. 2020 The development of flight behaviours in birds. *Proc. R. Soc. B* **287**: 20200668.
<http://dx.doi.org/10.1098/rspb.2020.0668>

Received: 2 April 2020

Accepted: 4 June 2020

Subject Category:

Behaviour

Subject Areas:

behaviour, biomechanics, developmental biology

Keywords:

juvenile, maturation, experience, foraging flight, altricial–precocial spectrum

Author for correspondence:

Emmanuel de Margerie
 e-mail: emmanuel.demargerie@univ-rennes1.fr

Electronic supplementary material is available online at <https://doi.org/10.6084/m9.figshare.c.5025731>.

The development of flight behaviours in birds

Geoffrey Raux, Sophie Lumineau and Emmanuel de Margerie

Univ Rennes, Normandie Univ, CNRS, EthoS (Éthologie animale et humaine) - UMR 6552, F-35000 Rennes, France

SL, 0000-0002-2076-9947; EdM, 0000-0002-5380-3355

Flight is a unique adaptation at the core of many behaviours in most bird species, whether it be foraging, migration or breeding. Birds have developed a wide diversity of flight modes (e.g. flapping, gliding, soaring, hovering) which involves very specialized behaviours. A key issue when studying flight behaviours is to understand how they develop through all the ontogenetic stages of birds, from the embryo to the flying adult. This question typically involves classical debates on animal behaviour about the importance of maturation and experience. Here, we review the literature available on the development of flight behaviours in birds. First, we focus on the early period when young birds are not yet capable of flight. We discuss examples and show how endogenous processes (e.g. wing flapping in the nest, flight development timing) and environmental factors (e.g. maternal stress, nutritional stress) can influence the development of flight behaviours. Then, we review several examples showing the different processes involved in the development of flight in flight-capable juveniles (e.g. practice, trial and error learning, social learning). Despite the lack of experimental studies investigating this specific question at different developmental stages, we show that several patterns can be identified, and we anticipate that the development of new tracking techniques will allow us to study this question more thoroughly in more bird species.

1. Introduction

Flight is a unique adaptation which has allowed some taxonomic groups to undergo dramatic adaptive radiations. The three main groups using flight are insects, the most diverse and numerous class of animals (greater than 1 million species described; [1]), birds (approx. 11 000 species; [2]) and bats which comprise 25% of mammal species (approx. 1300 species; [3]). Birds, particularly, are a group whose evolution has been largely influenced by flight. Their anatomy, physiology and behaviour are adapted to this complex mode of locomotion [4]. Flight is a very efficient way to transport a unit of mass over a unit of distance [5]. Using flight, birds are able to forage on extensive areas, they can migrate over long distances and they were able to colonize all terrestrial habitats on Earth including high elevations, polar regions and distant islands. Birds are able to use various flight modes, from passive flight (i.e. without wingstrokes) to active flight (i.e. flapping). Passive flight includes gliding, where the bird trades height to maintain forward speed, and soaring, where the bird uses wind and aerological gradients to maintain or gain height (slope soaring [6]; thermal soaring [7]; dynamic soaring [8]). Active flight includes level flapping flight, ascending flapping flight such as performed after take-off [9], and hovering [10]. Active flight requires high power output, i.e. high energy expenditure per unit of time [5]. Some flight modes are called intermittent flight [11,12] and imply an alternation of flapping and passive flight, with extended (flap-gliding flight) or folded wings (flap-bounding flight).

Flight behaviours are extremely diversified in birds, within and among species, and it is legitimate to wonder how these complex behaviours develop within an individual bird. A spontaneous question would be: are flight behaviours innate in birds, or is learning necessary? The role of nature versus nurture has been a

classic debate when investigating the development of behaviour [13]. Schneirla [14] stated that the distinction between the ‘unlearned’ and the ‘learned’ was unrealistic, and instead proposed that all behaviours are developed under the combined influence of two concepts: maturation and experience. Here, Schneirla defines ‘maturation’ as ‘the contributions of tissue growth and differentiation’ and ‘experience’ as ‘the contributions of stimulation from the developmental medium’. These two processes are not additive but inseparably coalescent, and considering one or the other in isolation would be equivalent to studying the effect of just the length or the width of a rectangle on its area [15]. Moreover, when studying locomotor behaviours such as flight, it is useful to further subdivide experience into learning and practice. Learning is defined as an irreversible change in response to particular stimuli, excluding ontogenetic processes such as maturation, injury and ageing [16]. Besides, practice is defined as an aspect of ontogeny in which repeated movements accelerate the development of behaviour [16]. Behaviours developing through practice improve as they are performed and do not simply improve with time. Unlike learning, practice depends upon experience but not upon specific consequences of the behaviour.

Based on Schneirla’s point of view, modern theories on the development of behaviour, like probabilistic epigenesis [17], emphasize the reciprocity of influences within and between levels of an organism’s developmental manifold (genetic activity, neural activity, behaviour and the physical, social and cultural influences of the external environment). Thus, all behaviour is influenced to some extent by the animal’s genetic make-up and, at the same time, by the environmental conditions that exist during development. The extent to which the different influences determine the outcome varies greatly from species to species, and from activity to activity within a species [16]. Hence, when studying the development of flight behaviours in birds, a—reformulated—central question is to determine whether maturation or experience is more important.

Flight behaviours develop in juvenile birds, and this life stage is crucial in the population dynamics of most birds: many species suffer high juvenile mortality through predation and starvation [18–21]. Therefore, selection on juvenile anatomy and behaviour may be very intense and have important consequences for the adult phenotype [22–25]. Consequently, determining the importance of maturational and environmental factors in the development of various flight behaviours may give new insights into selective pressures acting on juvenile birds. Birds show a great diversity of developmental strategies from altricial birds, which hatch naked and stay in the nest, to precocial birds, which hatch covered with down and rapidly leave the nest [25]. Given the high diversity of life-history traits combinations in birds, understanding the development of flight behaviours in various species may enable a consistent picture to be drawn across a number of bird groups.

Here, we aim to review how different flight behaviours develop through the ontogenetic stages of birds, from embryo to adult. Studies on the growth of flight organs *per se* (e.g. limb skeleton, muscles, feathers), without any explicit link with behaviour, are out of the scope of this literature review. Moreover, questions regarding orientation and navigation, especially in the context of migratory behaviours, constitute an extensive field of research and are also out of the scope of this review.

When studying a specific behaviour, it may be useful to refer to Tinbergen’s four questions [26], allowing us to

delineate logically complementary ways of understanding this behaviour: causation, survival value, ontogeny and evolution. Our review will mainly focus on the ontogeny of flight behaviours, but relevant aspects of causation (e.g. internal determinism) and consequences of flight behaviours on survival (e.g. energy expenditure, escape from predators) will also be discussed.

2. Terminology

When studying the development of birds, it is common to come across some terms such as ‘chicks’, ‘young’, ‘fledglings’, sometimes used interchangeably without being defined, which does not facilitate the understanding of the developmental processes. The developmental stages used in this review will be defined below.

First, the altricial–precocial spectrum is an important concept in bird development (see [25]). Altricial species typically hatch with their eyes closed, absent or sparse down, almost immobile, very dependent on their parents and do not leave the nest until they approach adult size and are able to fly. Precocial species typically hatch with their eyes open, already covered with down, are able to walk and/or swim and rapidly leave the nest, long before being adult-sized and capable of flight. The altricial–precocial spectrum is a continuum, many categories can be defined within this spectrum (see electronic supplementary material, SA and [25]), and each species present a different mix of developmental features (e.g. [27]).

In order to study behavioural development across this spectrum, it is important to use words applicable to all flight-capable bird species. When studying flight behaviour, the pre-fledging and post-fledging periods might represent a convenient abstraction. The term ‘fledging’ is often used to indicate the moment when a bird becomes capable of flight [28]. However, the ‘post-fledging period’, or ‘post-fledging dependence period’ [29], is commonly defined as the time between fledging and family break-up [18,19]. This definition would thus not be applicable to species without parental care after fledging, which are found among precocial (e.g. megapodes; [30]) but also altricial birds (e.g. swifts; [31]).

In this review, we choose to base the terminology on the word ‘juvenile’, defined by Howell [32] as a bird in juvenile plumage. This is the first plumage of ‘true’ or vanned (non-downy) feathers, often the plumage in which a bird takes flight. This period thus extends from the acquisition of the first true plumage to the subsequent moult. It lasts several weeks for some passerines, to several months for large birds like raptors. This definition is objectively based on anatomy and applicable to all species, altricial and precocial. Consequently, we introduce the term ‘pre-juvenile period’ to describe the period extending from the embryo to the acquisition of the first true plumage. The pre-juvenile period thus includes life in the nest (‘nestlings’ of altricial species) or an early life in the nest followed by a period of terrestrial and/or aquatic locomotion before fledging (‘chicks’ of precocial species). The correspondence and relationships between these terms are detailed in figure 1. With these two distinct periods: pre-juvenile period and juvenile period, the ontogeny of flight-capable birds can be conveniently classified in order to understand better the timing of different influences on the development of flight behaviour.

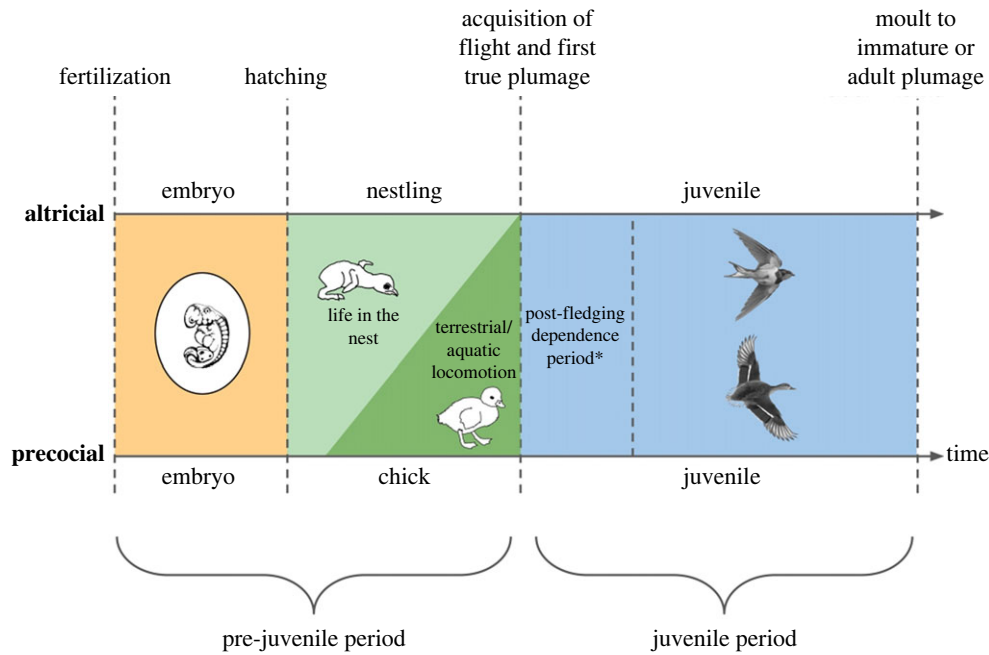

Figure 1. Summary of the altricial–precocial developmental spectrum in birds, and of the terminology used in this review. Orange, life in the egg; light green, life in the nest, outside the egg; dark green, terrestrial/aquatic life outside the nest; blue, aerial life. *The post-fledging dependence period does not exist in all species. (Online version in colour.)

3. Pre-juvenile development of flight behaviours

The pre-juvenile period, extending from the embryo to the acquisition of the first true plumage allowing flight, is likely to be a sensitive period where maturational and experiential effects play a crucial role in shaping flight behaviours.

(a) Wing flapping before flight

Wing flapping of young birds before they can fly has been observed in many bird species [31,33–36], and consists of repeated wing movements mimicking active flight, often performed in the nest. The role of this early behaviour has been tested in several experiments.

An early experiment was carried out by Spalding [37], who reared a group of barn swallows (*Hirundo rustica*) in a space so small that they could not fully extend their wings. The birds were released at the age when swallows normally fly, and they flew at the first opportunity. Similarly, Grohmann [38] reared pigeons (*Columba livia*) in narrow tubes, and they flew normally when released. Krischke [39] also observed that pigeons raised in a narrow box developed the basic motor patterns of flight, but juvenile pigeons whose movements had been hindered showed differences in manoeuvrability compared to unhindered ones. In precocial species, few studies exist on these questions. Provine [40] found that domestic chicks (*Gallus gallus domesticus*) whose wings were immobilized by bandages from hatching until 13 days old could achieve rates of wing flapping similar to adults and normal flight distances. In a more dramatic demonstration of maturation of wing flapping without practice, Provine [41] also found that domestic chicks whose wings were amputated at hatching flapped wing prostheses at normal rates. Neither postnatal practice nor sensory and trophic feedback from the wings could contribute to the development of flapping behaviour in these wingless chicks. However, these prostheses were ‘soda straws’, likely to offer less air resistance and inertia than normal wings. Moreover, an uncontrolled factor in all these experiments is the spontaneous motility of embryo’s

wings in the egg, which was observed, for example, in the domestic chick [42], and could potentially play a role in muscle and joint development [43].

These different pieces of evidence tend to indicate that the development of flight behaviours does not heavily depend on post-hatching wing flapping before flight. This early flapping behaviour could simply be due to the premature expression of an instinctive urge. Against this hypothesis, in common swift (*Apus apus*) nestlings, Lack [31] showed that wing movements were not just incipient flying movements. Indeed, nestlings perform ‘press-ups’, the wings partly extended and pressed down on the floor while the body is raised above the ground. According to Lack, these specialized movements could have been specially evolved. Their function could be to exercise muscles [31], but more recently, Wright *et al.* [44] hypothesized that these ‘press-ups’ could allow swifts to assess their body mass relative to their wing area in order to adjust food intake and thus wing loading at fledging. Consequently, in altricial species, even if wing flapping before flight may have originated through premature development of flight behaviours, the persistence and specialization of this behaviour in some species suggests that it has some adaptive value for nestlings. It should be noted that common swift fledglings fly continuously immediately after leaving the nest (i.e. without resting on a nearby branch), a particular case that might have put higher pressure on functional flapping practice in the nest.

A few studies focusing on developing pre-juveniles [45,46] or pre-migratory adults [46,47] analysed the relationship between wing exercise and fine metabolic and anatomic changes, shedding light on overlooked processes, like an increase in muscular enzyme activity during development [45], or an increase in fatty acid binding protein concentration before long distance migratory flights [46].

(b) Environmental influences

Assessing the effects of pre-juvenile environment on flight behaviours is only possible in experimental studies analysing the complete development of individuals from embryonic

development to after fledging. Several studies have attempted to modify pre-hatching or post-hatching environmental factors and to measure various parameters relevant to flight behaviour.

(i) Pre-hatching

Few studies have investigated the effect of pre-hatching environment on the development of flight in birds, but significant findings were made. Coslovsky & Richner [48] tested for maternal effects on great tits (*Parus major*) by exposing females before and during ovulation to stuffed models and sounds of a predator. Offspring of exposed mothers were then raised by foster parents subjected to no treatment in order to separate pre- and post-hatching environmental effects. They found that nestlings of predator-stressed mothers were smaller than those of control mothers but showed higher growth rates of the wings. First-year recruits from the predator treatment thus had longer wings at maturity. The authors hypothesized that this effect may be a consequence of higher circulating stress hormone levels in mothers, which would result in eggs enriched in these hormones. Indeed, Love & Williams [49] found that female European starlings (*Sturnus vulgaris*) of one group hatching from corticosterone-injected eggs had longer wings than controls. In the case of great tits, the accelerated wing growth could just be compensatory growth occurring at the cost of body mass, or it could be adaptive since longer wings and lower weight may modify flight behaviour and facilitate predator evasion and dispersal. However, no behavioural experiment was carried out to demonstrate that flight behaviour could be modified by these anatomic differences. In another experiment manipulating pre-hatching environment, Chin *et al.* [50] directly measured behavioural traits by measuring flight performance of juvenile European starlings. They found that juveniles exposed to increased corticosterone in their egg performed better during flight performance trials (measured through mechanical energy output during the birds' first flights). They also exhibited lower wing loading and heavier and more mature flight muscles. These two experiments suggest that pre-hatching stress might trigger some adapted responses in offspring, modifying flight behaviour to be able to cope with a stressful environment.

(ii) Post-hatching

More studies investigated the effect of post-hatching environment in birds, and several have found negative consequences of developmental stress for flight performance. These are examples of a 'silver spoon' effect [51] where individuals born in favourable conditions develop improved phenotypes later in life, and those born in adverse conditions develop disadvantaged phenotypes. Here, developmental stress is defined with a broad sense, including nutritional stress due to low feeding rates or low-quality food. For example, O'Hagan *et al.* [52] cross-fostered starlings to nests where they were either slightly larger (advantaged treatment) or slightly smaller (disadvantaged treatment) than the other nestlings. The treatment had no effect on growth, but it affected performance in escape flights a year later. Disadvantaged birds faced a steeper trade-off between take-off speed and take-off angle: they had to sacrifice more take-off speed for every degree of take-off angle gained.

In another experimental study on European starlings, Verspoor *et al.* [53] manipulated maternal care by clipping wing and tail feathers in some mothers, which consequently decreased their provisioning rate. Although the manipulation

decreased body mass and structural size (tarsus, wing length) in daughters, only the flight performance (speed and mechanical energy output) of sons was negatively affected. Males are the larger sex in starlings and size is important in male competition, which suggests that there could be a trade-off between flight performance and body size, favouring the latter in males growing in a poor environment.

Several other studies have shown an effect of post-hatching nutritional conditions on flight behaviour. Criscuolo *et al.* [54] have shown that female zebra finch (*Taeniopygia guttata*) nestlings experiencing a switch from low- to high-quality food recovered in body size, but showed a steeper decline in escape flight performance over the breeding period. This suggests that diet-induced rapid recovery of body size can carry locomotory costs in later life. This may relate to the need for breeding females to use proteins from their flight muscles to produce eggs, with a consequent impact on flying ability [55,56]. Similarly, Miller [57] showed an effect of rearing conditions on the take-off speed of mourning doves (*Zenaidura macroura*). An increased brood size during the nestling stage had delayed effects on flight performance: juvenile doves were able to minimize the effects of nutritional stress on take-off speed at early ages, when escape ability from predators is especially important. However, at the age of 90 days, birds from enlarged broods were slower at take-off. Thus, this early manipulation of nutrition had long-term effects on the flight performance of these birds.

(iii) Pre-juvenile environment: synthesis

Overall, the different experimental manipulations of pre-juvenile environment seem to draw a consistent picture. The two studies modifying the pre-hatching environment reported positive effects of environmental stress on flight performance, while all studies modifying the post-hatching environment reported negative effects. Obviously, the nature of the stressors was different (predator and corticosterone exposure for pre-hatching, nutritional stress for post-hatching), but these findings still suggest a consistent pattern. The pre-hatching experiments would be examples of adaptive developmental plasticity, where an early stressor triggers an evolved anticipatory response to adverse situations later in life, and thus improves some traits [58]. However, post-hatching studies are more consistent with the 'silver spoon' effect where developmental stress imposes constraints on adult phenotypic quality [51]. In several pre- and post-hatching studies, the existence of developmental trade-offs is highlighted. The development of flight performance (through the maturation of muscles or wing length) may occur at the cost of body mass [48], or reciprocally [53,54], and early flight performance may be privileged over later flight performance [57]. Such trade-offs are more apparent in stressful environments and show which selective pressures act on the development of flight in different bird species, revealing sex-specific effects in some species [53].

In addition to wing flapping before flight and environmental factors, the timing of flight development is also influenced by species-specific growth dynamics strategies, in both precocial and altricial birds (see electronic supplementary material, SB and SC).

4. Juvenile development of flight behaviours

Once birds acquire their first true plumage and become capable of flight, they have to go through further developmental steps

in order to develop a mature flight apparatus (see electronic supplementary material, SD) and to master all the flight behaviours of their species.

(a) Development of flight modes

Flapping flight seems to be the first flight mode to develop in many species, and flapping is often practised before flying, as previously discussed. When other flight modes are required, their acquisition is, most of the time, gradual. In many raptors, a transition from flapping to gliding was reported in juveniles. For example, in juvenile red kites (*Milvus milvus*), Bustamante [29] observed an increase in time spent flying and a gradual transition from flapping to gliding and soaring. Similar transitions are widespread in many juvenile diurnal raptors (e.g. [34,59,60]). In griffon vultures (*Gyps fulvus*), juveniles are as efficient as adults in selecting favourable thermals for soaring, presumably because they forage in mixed-age groups [61]. However, adults have a better capacity to sharp-turn within thermals, and thus juveniles exhibit a higher proportion of flapping flight, and higher energy expenditure. A gradual change in flight mode was also observed in other bird groups. In brown boobies (*Sula leucogaster*), juveniles gradually increase the proportion of time spent gliding during flight, as well as flight speed, trip duration and distance [62,63]. Overall, these observations indicate that gliding and soaring efficiently may require additional skills compared to flapping and that it takes time for juvenile birds to develop these techniques. While flapping may develop mainly through maturational processes and practice, the importance of learning may be greater in flight modes which require taking advantage of environmental phenomena (thermal uplift, wind).

Contrarily to this general tendency, complex flight modes in some pelagic seabirds seem to develop more rapidly, and are sometimes fully developed at the first flight. Recently, Corbeau *et al.* [64] reported that juvenile great frigatebirds (*Fregata minor*) gradually increase the proportion of time spent at sea, flight speed and travelled distance during a four to eight month-long dependence period. However, juvenile frigatebirds rapidly equal or even surpass gliding and soaring performance of adults (within a few days or immediately at the first flight), and do not expend more energy than adults using these flight modes. Similarly, juvenile wandering albatrosses (*Diomedea exulans*) were reported to increase travelled distance during development, but they are almost as effective as adults in their use of tail and side winds immediately after fledging [65]. These examples show that, in the case of some seabird species having to travel long distances rapidly after fledging and with fewer opportunities to train over land, even more complex flight modes may be well developed immediately after fledging, and more innate components are exhibited.

(b) Development of migratory flight

Migration is a large-scale movement which often requires specific flight skills, and mastering flight techniques to save energy during these long flights is important for the survival of juvenile birds. In several species, juveniles were reported to migrate less efficiently than adults. In white storks (*Ciconia ciconia*), Rotics *et al.* [66] reported that juveniles used less soaring flight and more flapping flight than adults during migration, which resulted in greater energy expenditures, and this may be one of the major factors explaining the lower survival rate of juvenile storks during migration. However,

juveniles showed an improvement in flight efficiency during migration (decreasing flapping/gliding time ratio and consequently decreasing flight energy expenditure), suggesting that they learnt to use thermals more efficiently. Similarly, juvenile golden eagles (*Aquila chrysaetos*) were reported to migrate less efficiently than adults in autumn, with juveniles using more slope soaring and less thermal soaring than adults [6]. Age differences were also observed in passerines, as in savannah sparrows (*Passerculus sandwichensis*) where it was found that juveniles departed under wind conditions that were less supportive, resulting in a longer time to complete the same flight routes as adults [67]. In fact, in long-lived species where the migratory flight involves highly complex techniques, flight behaviour may continue to develop well beyond the juvenile period, as was shown in black kites (*Milvus migrans*) where the ability to cope with wind drift and to exploit tail winds during migration improves until about 7 years old [68].

(c) Development of foraging flight

In many bird species, flight is an important component of foraging behaviours. Predators, especially, may use complex flight techniques whose development is more likely to involve learning.

(i) Development of foraging flight with no apparent learning

In some species, juveniles do not appear to learn foraging flight techniques. For example, in red kites, Bustamante [29] observed that juveniles do not follow their parents to hunting areas and do not appear to practise hunting techniques during the post-fledging dependence period. The same phenomenon was observed in black kites [59], and Bustamante [29] suggested that the absence of a gradual development of hunting techniques can be related to the generalist feeding habits of the genus *Milvus*: habitual preys (carrion, insects and young animals) do not require very specialized capture techniques or manipulation, and a progressive development before independence may not be necessary. Similarly, Bustamante & Negro [69] observed that juvenile lesser kestrels (*Falco naumanni*) do not appear to learn or practise hunting skills during the post-fledging dependence period, which could be related to their diet almost exclusively composed of abundant and easily caught insects. However, in the previous examples, it remains unclear if juveniles' foraging was as efficient as adults' foraging immediately after independence or if they needed some later learning, for example, by trial and error.

(ii) Development of foraging flight while learning alone

In several passerine species, the development of foraging flight was observed, and trial and error learning seems to be the prevalent process. For example, Baker & Ferree [70] studied the foraging development of juvenile black phoebes (*Sayornis nigricans*), which pursue and catch insects in flight. The proportion of successful foraging attempts increased gradually to reach the same level as adults at the age of seven weeks. This increase is potentially due to trial and error learning, but the maturation of cognitive or visual system cannot be ruled out [71,72]. In northern wheatears (*Oenanthe oenanthe*), Moreno [73] also found a gradual development of foraging efficiency. However, foraging techniques that require flight (aerial hawking, perch-to-ground sallying) took longer to develop

than ground-based foraging (ground-gleaning). Similar results were reported in spotted flycatchers (*Muscicapa striata*; [74]).

In many raptors, juveniles were observed to perform some predatory attempts on small animals during the post-fledging dependence period, while parents were temporarily away [34,35,60,75]. Such observations cannot rule out the existence of social learning, but at least indicate that some juvenile raptors are able to practise hunting techniques alone.

In all the previous examples where the flight skills of juveniles progressively increase, it is not possible to determine the importance of maturational processes relative to learning solely with observations. Experimental studies are needed to determine the relative importance of those different processes.

(iii) Development of foraging flight through social learning

The development of various foraging flight behaviours may involve interactions with conspecifics. Social learning typically involves a 'demonstrator', which performs a behaviour to be learnt by an 'observer' [76]. In this context, the demonstrator does not necessarily perform the behaviour for the observer's sake. Different forms of social learning of flight can be hypothesized in birds, mainly imitation and teaching.

Imitation occurs when an individual copies the behaviour of another individual in order to obtain the same consequences [77]. This type of social learning could possibly exist in several raptor species which require complex flight behaviours for hunting. Varland *et al.* [78] reported social hunting in juvenile American kestrels (*Falco sparverius*), which was defined as hunting activity by an individual occurring less than 3 m from one or more individuals that also hunt. The authors described this social foraging as imitative rather than cooperative because group members did not directly communicate and did not coordinate their movements. American kestrels foraged in groups composed of juveniles and adults often belonging to the same family, but sometimes unrelated. During this period, juveniles gradually increased their capture rate (captures per hour) and may have learnt hunting techniques by imitation. Similar interactions were observed in common kestrels (*Falco tinnunculus*; [79]), in Montagu's harriers (*Circus pygargus*; [80]) and in western marsh harriers (*Circus aeruginosus*; [81]). Moreover, it was shown in western marsh harriers that juveniles hunting in groups where adults were present performed more predatory attempts and had a higher hunting efficiency (more hunting sessions yielded at least one prey item) than juveniles hunting in juvenile-only groups [81].

Teaching is a specific type of social learning where a knowledgeable individual engages in some costly behaviour without immediate self-benefit, but which helps a naive individual to acquire some skill more rapidly [82]. In the context of foraging flight learning in birds, behaviours evoking teaching have been observed almost exclusively in raptors. The most widespread teaching behaviour in raptors is observed when adults release a live prey, often injured, near juveniles in order to allow them to practise hunting. For example, in Montagu's harriers, Kitowski [83] reported that adults dropped grasshoppers near juveniles and repeated the process until juveniles performed predatory flights and caught their prey on the ground. Similar teaching behaviours were reported in other raptor species (see [84]). A remarkable example was observed in peregrine falcons (*Falco peregrinus*), where adults can release a live bird in front of juveniles in order to encourage them to pursue it (Sherrod, 1983; cited in [84]). If the prey escapes, an adult may recapture it, carry it back and release it again.

A detailed example of teaching was described in ospreys (*Pandion haliaetus*) by Meinertzhagen [85], where adults dropped fish in the water in front of juveniles in order to motivate predatory flights, and these juveniles became able to dive and catch live fish within a few days. However, some hand-raised juvenile ospreys successfully caught fish within three weeks after release in the wild, in the absence of parental teaching [86], confirming that teaching would only accelerate the learning process in this case.

(iv) Development of foraging flight: synthesis

Observations of the development of foraging flight behaviour are scarce in smaller and less conspicuous birds, but a general pattern seems to emerge in raptors. Learning of foraging flight techniques (through trial and error, imitation or teaching) may be most important in agile and highly manoeuvrable raptors which capture elusive prey such as small mammals, reptiles, birds and fish [83]. By contrast, as noted by Kitowski [83], learning of flight foraging techniques seems less important in raptors whose habitual food is either widely available and easy to obtain (e.g. carrion) or highly abundant (e.g. lagomorphs or insects). Food generalist scavengers do not need highly specialized hunting techniques, because their foraging techniques are closer to gleaning. For raptors exhibiting teaching, the importance of this process is questionable, as predatory techniques were shown to develop even without teaching in some species. The fact that this kind of costly behaviour evolved would still indicate that it has some adaptive value, for example, by allowing juveniles to learn faster, thus increasing their survival chances.

5. Conclusion and perspectives

The development of flight behaviours in birds involves multiple processes at all ontogenetic stages. The pre-juvenile environment can influence the development of flight behaviours, either via a 'silver spoon' effect or via adaptive developmental plasticity. Wing flapping before flight could enhance initial performances and have additional functions in particular bird species. However, experimental studies modifying pre-juvenile environment vary in their measures of flight performance. Standardized comparisons are difficult and it is not yet possible to have a holistic vision of the effect of pre-juvenile conditions on the development of flight behaviours. Studies investigating possible interactions between the environment encountered during the pre- and post-hatching periods would also be needed.

In juveniles, flapping flight seems to be acquired mainly through practice and maturation while more complex flight modes like efficient gliding and soaring may require some learning. In species exhibiting highly complex foraging flight techniques, trial and error learning or social learning (through imitation and/or teaching) may be more important, especially when predation is involved.

The literature reveals that the juvenile flight of large conspicuous birds like raptors and seabirds was much more studied, and that considerably less data are available for smaller birds, probably due to difficulties to describe their flight behaviours in the wild. Similarly, precocial birds represent a small part of this literature compared to altricial birds, and the development of their flight behaviours is consequently less understood. Few experimental studies modifying the environmental conditions in which juvenile birds develop

exist, and conclusions are essentially based on observations and correlations. In many observational studies, it is difficult to differentiate the effects of maturational processes from the effects of different types of learning. Moreover, improvements of flight skills beyond the juvenile period were documented [68], but few studies were able to monitor the flight behaviour of several individuals of known age over successive years and some long-term developmental patterns may have been overlooked. Besides, it is worth noting that some types of flight behaviours were, to our knowledge, not studied in the context of behavioural ontogeny, for example, flight courtship display. Early practice of courtship dances in immatures has been reported in several birds [87–90], and learning of a courtship display involving coordinated vocalisations and dance has been studied in Java sparrows (*Lonchura oryzivora*; [91]). Thus, learning of flight courtship display is probably present in some species, and would deserve further investigation. Another aspect rarely broached in the flight development literature is the inter-individual coordination necessary for some species during particular flocking flights [92,93], which could be hypothesized to require some learning.

Finally, it is worthwhile to note that, in some species, even adult birds may provide useful information about the development of flight, especially in species exhibiting simultaneous flight feather moult. This moult strategy, seen in waterbirds such as ducks [94], geese [95,96] or grebes [97–99], leaves the birds flightless for up to several months. Important anatomical

and behavioural changes are observed during this period. For example, breast muscle atrophy has been observed during simultaneous moult, along with leg muscle hypertrophy in some species [94–98]. All these changes are reversed after moult, showing a temporary shift in locomotor strategy. Furthermore, flapping exercises were observed during the muscle rebuilding period [99]. Thus, adult birds have to regain flight through this moult process, making an interesting comparison to early-life onset of flight.

Overall, even if insightful tendencies seem to emerge, the available literature on the development of flight behaviours in birds is still too scarce to establish a comprehensive framework which would summarize the influence of different life-history traits on this locomotor ontogeny. In this perspective, comparative studies investigating the ontogeny of flight behaviours using standardized methods for different species showing contrasted life-history traits will be useful. Three-dimensional optical tracking tools have recently been developed in order to describe more accurately the flight behaviours of birds in the wild [100–102], and their use along an ontogenetic dimension might be a key step towards a better understanding of birds' flight development.

Data accessibility. This article has no additional data.

Competing interests. We declare we have no competing interests.

Funding. We received no funding for this study.

References

- Stork NE. 2018 How many species of insects and other terrestrial arthropods are there on earth? *Annu. Rev. Entomol.* **63**, 31–45. (doi:10.1146/annurev-ento-020117-043348)
- Gill F, Donsker D. 2019 IOC World Bird List (v9.2). (doi:10.14344/IOC.ML.9.2).
- Burgin CJ, Colella JP, Kahn PL, Upham NS. 2018 How many species of mammals are there? *J. Mammal.* **99**, 1–14. (doi:10.1093/jmammal/gyx147)
- Podulka S, Rohrbaugh Jr RW, Bonney R (eds). 2004 *Handbook of bird biology*, 2nd edn. Ithaca, NY: Cornell Lab of Ornithology in association with Princeton University Press.
- Norberg UM. 1990 *Vertebrate flight: mechanics, physiology, morphology, ecology and evolution*. New York, NY: Springer.
- Duerr AE, Miller TA, Lanzone M, Brandes D, Cooper J, O'Malley K, Maisonneuve C, Tremblay JA, Katzner T. 2015 Flight response of slope-soaring birds to seasonal variation in thermal generation. *Funct. Ecol.* **29**, 779–790. (doi:10.1111/1365-2435.12381)
- Cone Jr CD. 1962 Thermal soaring of birds. *Am. Sci.* **50**, 180–209.
- Sachs G, Traugott J, Nesterova AP, Dell'Omo G, Kümmeth F, Heidrich W, Vysotski AL, Bonadonna F. 2012 Flying at no mechanical energy cost: disclosing the secret of wandering albatrosses. *PLoS ONE* **7**, e41449. (doi:10.1371/journal.pone.0041449)
- Simpson SF. 1983 The flight mechanism of the pigeon *Columbia livia* during take-off. *J. Zool.* **200**, 435–443. (doi:10.1111/j.1469-7998.1983.tb02322.x)
- Warrick DR, Tobalske BW, Powers DR. 2005 Aerodynamics of the hovering hummingbird. *Nature* **435**, 1094–1097. (doi:10.1038/nature03647)
- Rayner JMV. 1985 Bounding and undulating flight in birds. *J. Theor. Biol.* **117**, 47–77. (doi:10.1016/S0022-5193(85)80164-8)
- Usherwood JR. 2016 Physiological, aerodynamic and geometric constraints of flapping account for bird gaits, and bounding and flap-gliding flight strategies. *J. Theor. Biol.* **408**, 42–52. (doi:10.1016/j.jtbi.2016.07.003)
- Barlow GW. 1991 Nature–nurture and the debates surrounding ethology and sociobiology. *Am. Zool.* **31**, 286–296. (doi:10.1093/icb/31.2.286)
- Schneirla TC. 1965 Aspects of stimulation and organization in approach/withdrawal processes underlying vertebrate behavioral development. In *Advances in the study of behavior* (eds DS Lehrman, RA Hinde, E Shaw), pp. 1–74. New York, NY: Academic Press.
- Richard G. 1974 *Les comportements instinctifs*. Paris, France: Presses universitaires de France.
- McFarland D. 2006 *A dictionary of animal behaviour*. Oxford, NY: Oxford University Press.
- Gottlieb G. 2007 Probabilistic epigenesis. *Dev. Sci.* **10**, 1–11. (doi:10.1111/j.1467-7687.2007.00556.x)
- Naef-Daenzer B, Gruebler MU. 2016 Post-fledging survival of altricial birds: ecological determinants and adaptation. *J. Field Ornithol.* **87**, 227–250. (doi:10.1111/jfo.12157)
- Remeš V, Matysioková B. 2016 Survival to independence in relation to pre-fledging development and latitude in songbirds across the globe. *J. Avian Biol.* **47**, 610–618. (doi:10.1111/jav.00841)
- Wunderle JM. 1991 Age-specific foraging proficiency in birds. *Curr. Ornithol.* **8**, 273–324.
- Heers AM. 2016 New perspectives on the ontogeny and evolution of avian locomotion. *Integr. Comp. Biol.* **56**, 428–441. (doi:10.1093/icb/icw065)
- Carrier DR. 1996 Ontogenetic limits on locomotor performance. *Physiol. Zool.* **69**, 467–488. (doi:10.1086/physzool.69.3.30164211)
- Herrel A, Gibb AC. 2006 Ontogeny of performance in vertebrates. *Physiol. Biochem. Zool.* **79**, 1–6. (doi:10.1086/498196)
- Martin TE. 1995 Avian life history evolution in relation to nest sites, nest predation, and food. *Ecol. Monogr.* **65**, 101–127. (doi:10.2307/2937160)
- Starck JM, Ricklefs RE. 1998 *Avian growth and development*. Oxford, NY: Oxford University Press.
- Tinbergen N. 1963 On aims and methods of ethology. *Z. Tierpsychol.* **20**, 410–433. (doi:10.1111/j.1439-0310.1963.tb01161.x)
- Dial TR, Carrier DR. 2012 Precocial hindlimbs and altricial forelimbs: partitioning ontogenetic strategies in mallards (*Anas platyrhynchos*). *J. Exp. Biol.* **215**, 3703–3710. (doi:10.1242/jeb.057380)
- Moreau RE. 1940 The recording of incubation and fledging period. *Br. Birds* **39**, 66–70.

29. Bustamante J. 1993 Post-fledging dependence period and development of flight and hunting behaviour in the red kite *Milvus milvus*. *Bird Study* **40**, 181–188. (doi:10.1080/00063659309477181)
30. Wesolowski T. 1994 On the origin of parental care and the early evolution of male and female parental roles in birds. *Am. Nat.* **143**, 39–58. (doi:10.1086/285595)
31. Lack D. 1956 *Swifts in a tower*. London, UK: Chapman and Hall.
32. Howell SNG. 2010 *Molt in north American birds*. Boston, MA: Houghton Mifflin Harcourt.
33. Aumann T. 1988 Breeding behaviour of the brown goshawk *Accipiter fasciatus*. *Aust. Bird Watcher* **12**, 258–267.
34. Debus SJS, Ley AJ, Tremont S, Tremont R. 1991 Breeding behaviour and diet of the Australian hobby *Falco longipennis* in Northern New South Wales. *Aust. Bird Watcher* **14**, 123–137.
35. Delannoy CA, Cruz A. 1988 Breeding biology of the Puerto Rican sharp-shinned hawk (*Accipiter striatus venator*). *Auk* **105**, 649–662. (doi:10.1093/auk/105.4.649)
36. Heers AM, Tobalske BW, Dial KP. 2011 Ontogeny of lift and drag production in ground birds. *J. Exp. Biol.* **214**, 717–725. (doi:10.1242/jeb.051177)
37. Spalding D. 1875 Instinct and acquisition. *Nature* **12**, 507–508. (doi:10.1038/012507a0)
38. Grohmann J. 1939 Modifikation oder Funktionsreifung? Ein Beitrag zur Klärung der wechselseitigen Beziehungen zwischen Instinkthandlung und Erfahrung. *Z. Tierpsychol.* **2**, 132–144. (doi:10.1111/j.1439-0310.1939.tb01571.x)
39. Kriskche N. 1983 Beiträge Zur Ontogenese Der Flug- Und Manövrierfähigkeit Der Haustaube (*Columba livia* var. *domestica*). *Behaviour* **84**, 265–286. (doi:10.1163/156853983X00525)
40. Provine RR. 1981 Development of wing-flapping and flight in normal and flap-deprived domestic chicks. *Dev. Psychobiol.* **14**, 279–291. (doi:10.1002/dev.420140317)
41. Provine RR. 1979 'Wing-flapping' develops in wingless chicks. *Behav. Neural Biol.* **27**, 233–237. (doi:10.1016/S0163-1047(79)91885-5)
42. Hamburger V, Oppenheim R. 1967 Prehatching motility and hatching behavior in the chick. *J. Exp. Zool.* **166**, 171–203. (doi:10.1002/jez.1401660203)
43. Drachman DB, Sokoloff L. 1966 The role of movement in embryonic joint development. *Dev. Biol.* **14**, 401–420. (doi:10.1016/0012-1606(66)90022-4)
44. Wright J, Markman S, Denney SM. 2006 Facultative adjustment of pre-fledging mass loss by nestling swifts preparing for flight. *Proc. R. Soc. B* **273**, 1895–1900. (doi:10.1098/rspb.2006.3533)
45. Bishop CM, Butler PJ, Egginton S, el Haj AJ, Gabrielsen GW. 1995 Development of metabolic enzyme activity in locomotor and cardiac muscles of the migratory barnacle goose. *Am. J. Physiol. Regul. Integr. Comp. Physiol.* **269**, R64–R72. (doi:10.1152/ajpregu.1995.269.1.R64)
46. Pelsers MMAL, Butler PJ, Bishop CM, Glatz JFC. 1999 Fatty acid binding protein in heart and skeletal muscles of the migratory barnacle goose throughout development. *Am. J. Physiol. Regul. Integr. Comp. Physiol.* **276**, R637–R643. (doi:10.1152/ajpregu.1999.276.3.R637)
47. Portugal SJ, Green JA, White CR, Guillemette M, Butler PJ. 2012 Wild geese do not increase flight behaviour prior to migration. *Biol. Lett.* **8**, 469–472. (doi:10.1098/rsbl.2011.0975)
48. Coslovsky M, Richner H. 2011 Predation risk affects offspring growth via maternal effects. *Funct. Ecol.* **25**, 878–888. (doi:10.1111/j.1365-2435.2011.01834.x)
49. Love OP, Williams TD. 2008 The adaptive value of stress-induced phenotypes: effects of maternally derived corticosterone on sex-biased investment, cost of reproduction, and maternal fitness. *Am. Nat.* **172**, E135–E149. (doi:10.1086/590959)
50. Chin EH, Love OP, Verspoor JJ, Williams TD, Rowley K, Burness G. 2009 Juveniles exposed to embryonic corticosterone have enhanced flight performance. *Proc. R. Soc. B* **276**, 499–505. (doi:10.1098/rspb.2008.1294)
51. Monaghan P. 2008 Early growth conditions, phenotypic development and environmental change. *Phil. Trans. R. Soc. B* **363**, 1635–1645. (doi:10.1098/rstb.2007.0011)
52. O'Hagan D, Andrews CP, Bedford T, Bateson M, Nettle D. 2015 Early life disadvantage strengthens flight performance trade-offs in European starlings, *Sturnus vulgaris*. *Anim. Behav.* **102**, 141–148. (doi:10.1016/j.anbehav.2015.01.016)
53. Verspoor JJ, Love OP, Rowland E, Chin EH, Williams TD. 2007 Sex-specific development of avian flight performance under experimentally altered rearing conditions. *Behav. Ecol.* **18**, 967–973. (doi:10.1093/beheco/arm089)
54. Criscuolo F, Monaghan P, Proust A, Škorpilová J, Laurie J, Metcalfe NB. 2011 Costs of compensation: effect of early life conditions and reproduction on flight performance in zebra finches. *Oecologia* **167**, 315–323. (doi:10.1007/s00442-011-1986-0)
55. Houston DC, Donnan D, Jones P, Hamilton I, Osborne D. 2008 Changes in the muscle condition of female zebra finches *Poephila guttata* during egg laying and the role of protein storage in bird skeletal muscle. *Ibis* **137**, 322–328. (doi:10.1111/j.1474-919X.1995.tb08028.x)
56. Veasey JS, Houston DC, Metcalfe NB. 2000 Flight muscle atrophy and predation risk in breeding birds. *Funct. Ecol.* **14**, 115–121. (doi:10.1046/j.1365-2435.2000.00391.x)
57. Miller DA. 2011 Immediate and delayed effects of poor developmental conditions on growth and flight ability of juvenile mourning doves *Zenaida macroura*. *J. Avian Biol.* **42**, 151–158. (doi:10.1111/j.1600-048X.2010.05124.x)
58. Nettle D, Bateson M. 2015 Adaptive developmental plasticity: what is it, how can we recognize it and when can it evolve? *Proc. R. Soc. B* **282**, 20151005. (doi:10.1098/rspb.2015.1005)
59. Bustamante J, Hiraldo F. 1989 Post-fledging dependence period and maturation of flight skills in the black kite *Milvus migrans*. *Bird Study* **36**, 199–204. (doi:10.1080/00063658909477025)
60. Walker DG. 1987 Observations on the post-fledging period of the golden eagle *Aquila chrysaetos* in England. *Ibis* **129**, 92–96. (doi:10.1111/j.1474-919X.1987.tb03163.x)
61. Harel R, Horvitz N, Nathan R. 2016 Adult vultures outperform juveniles in challenging thermal soaring conditions. *Sci. Rep.* **6**, 27865. (doi:10.1038/srep27865)
62. Kohno H, Yoda K. 2011 The development of activity ranges in juvenile brown boobies *Sula leucogaster*. *Ibis* **153**, 611–615. (doi:10.1111/j.1474-919X.2011.01128.x)
63. Yoda K, Kohno H, Naito Y. 2004 Development of flight performance in the brown booby. *Proc. R. Soc. Lond. B* **271**, 20030157. (doi:10.1098/rsbl.2003.0157)
64. Corbeau A, Prudor A, Kato A, Weimerskirch H. 2019 Development of flight and foraging behaviour in a juvenile seabird with extreme soaring capacities. *J. Anim. Ecol.* 1365-2656.13121. (doi:10.1111/1365-2656.13121)
65. Riotte-Lambert L, Weimerskirch H. 2013 Do naive juvenile seabirds forage differently from adults? *Proc. R. Soc. B* **280**, 20131434. (doi:10.1098/rspb.2013.1434)
66. Rotics S *et al.* 2016 The challenges of the first migration: movement and behaviour of juvenile vs. adult white storks with insights regarding juvenile mortality. *J. Anim. Ecol.* **85**, 938–947. (doi:10.1111/1365-2656.12525)
67. Mitchell GW, Woodworth BK, Taylor PD, Norris DR. 2015 Automated telemetry reveals age specific differences in flight duration and speed are driven by wind conditions in a migratory songbird. *Mov. Ecol.* **3**, 19. (doi:10.1186/s40462-015-0046-5)
68. Sergio F, Tanferna A, De Stephanis R, Jiménez LL, Blas J, Tavecchia G, Preatoni D, Hiraldo F. 2014 Individual improvements and selective mortality shape lifelong migratory performance. *Nature* **515**, 410–413. (doi:10.1038/nature13696)
69. Bustamante J, Negro JJ. 1994 The post-fledging dependence period of the lesser kestrel (*Falco naumanni*) in southwestern Spain. *J. Raptor Res.* **28**, 158–163.
70. Baker J, Ferree ED. 2016 Foraging ontogeny in a suburban population of black phoebes (*Sayornis nigricans*). *Wilson J. Ornithol.* **128**, 368. (doi:10.1676/wils-128-02-368-377.1)
71. Gall MD, Hough LD, Fernández-Juricic E. 2013 Age-related characteristics of foraging habitats and foraging behaviors in the black phoebe (*Sayornis nigricans*). *Southwest. Nat.* **58**, 41–49. (doi:10.1894/0038-4909-58.1.41)
72. Marchetti K, Price T. 1989 Differences in the foraging of juvenile and adult birds: the importance of developmental constraints. *Biol. Rev.* **64**, 51–70. (doi:10.1111/j.1469-185X.1989.tb00638.x)
73. Moreno J. 1984 Parental care of fledged young, division of labor, and the development of foraging techniques in the northern wheatear (*Oenanthe*

- oenanthe* L.). *Auk* **101**, 741–752. (doi:10.2307/4086901)
74. Davies NB. 1976 Parental care and the transition to independent feeding in the young spotted flycatcher (*Muscicapa striata*). *Behaviour* **59**, 280–294. (doi:10.1163/156853976X00415)
75. Mueller HC, Mueller NS, Parker PG. 1981 Observation of a brood of sharp-shinned hawks in Ontario, with comments on the functions of sexual dimorphism. *Wilson Bull.* **93**, 85–92.
76. Heyes CM. 1994 Social learning in animals: categories and mechanisms. *Biol. Rev.* **69**, 207–231. (doi:10.1111/j.1469-185X.1994.tb01506.x)
77. Whiten A, Ham R. 1992 On the nature and evolution of imitation in the animal kingdom: reappraisal of a century of research. *Adv. Study Behav.* **21**, 239–283. (doi:10.1016/S0065-3454(08)60146-1)
78. Varland DE, Klaas EE, Loughin TM. 1991 Development of foraging behavior in the American kestrel. *J. Raptor Res.* **25**, 9–17.
79. Bustamante J. 1994 Behavior of colonial common kestrels (*Falco tinnunculus*) during the post-fledging dependence period in southwestern Spain. *J. Raptor Res.* **28**, 79–83.
80. Kitowski I. 2003 Differences between social and non-social hunting of juvenile Montagu's harriers *Circus pygargus* in the post-fledging dependence period. *Ornithologischer Anzeiger* **42**, 147–152.
81. Kitowski I. 2009 Social learning of hunting skills in juvenile marsh harriers *Circus aeruginosus*. *J. Ethol.* **27**, 327–332. (doi:10.1007/s10164-008-0123-y)
82. Caro TM, Hauser MD. 1992 Is there teaching in nonhuman animals? *Q. Rev. Biol.* **67**, 151–174. (doi:10.1086/417553)
83. Kitowski I. 2005 Play behaviour and active training of Montagu's harrier (*Circus pygargus*) offspring in the post-fledging period. *J. Ethol.* **23**, 3–8. (doi:10.1007/s10164-004-0120-8)
84. Spofford WR, Amadon D. 1993 Live preys to young raptors—incidental or adaptive? *J. Raptor Res.* **27**, 180–184.
85. Meinertzhagen R. 1954 The education of young ospreys. *Ibis* **96**, 153–155. (doi:10.1111/j.1474-919X.1954.tb04120.x)
86. Schaadt CP, Rymon LM. 1982 Innate fishing behavior of osprey. *Raptor Res.* **16**, 61–62.
87. Dinets V. 2013 Crane dances as play behaviour. *Ibis* **155**, 424–425. (doi:10.1111/ibi.12037)
88. Frith CB, Cooper WT. 1996 Courtship display and mating of Victoria's riflebird *Ptiloris victoriae* with notes on the courtship displays of congeneric species. *Emu—Austral Ornithol.* **96**, 102–113. (doi:10.1071/MU9960102)
89. Durães R. 2009 Lek structure and male display repertoire of blue-crowned manakins in eastern Ecuador. *Condor* **111**, 453–461. (doi:10.1525/cond.2009.080100)
90. Collis K, Borgia G. 2010 The costs of male display and delayed plumage maturation in the satin bowerbird (*Ptilonorhynchus violaceus*). *Ethology* **94**, 59–71. (doi:10.1111/j.1439-0310.1993.tb00547.x)
91. Soma M, Iwama M, Nakajima R, Endo R. 2019 Early-life lessons of the courtship dance in a dance-duetting songbird, the Java sparrow. *R. Soc. Open Sci.* **6**, 190563. (doi:10.1098/rsos.190563)
92. Davis JM. 1980 The coordinated aerobatics of dunlin flocks. *Anim. Behav.* **28**, 668–673. (doi:10.1016/S0003-3472(80)80127-8)
93. Yomosa M, Mizuguchi T, Vásárhelyi G, Nagy M. 2015 Coordinated behaviour in pigeon flocks. *PLoS ONE* **10**, e0140558. (doi:10.1371/journal.pone.0140558)
94. Portugal SJ, Isaac R, Quinton KL, Reynolds SJ. 2010 Do captive waterfowl alter their behaviour patterns during their flightless period of moult? *J. Ornithol.* **151**, 443–448. (doi:10.1007/s10336-009-0474-3)
95. Portugal SJ, Green JA, Butler PJ. 2007 Annual changes in body mass and resting metabolism in captive barnacle geese (*Branta leucopsis*): the importance of wing moult. *J. Exp. Biol.* **210**, 1391–1397. (doi:10.1242/jeb.004598)
96. Portugal SJ, Thorpe SKS, Green JA, Myatt JP, Butler PJ. 2009 Testing the use/disuse hypothesis: pectoral and leg muscle changes in captive barnacle geese *Branta leucopsis* during wing moult. *J. Exp. Biol.* **212**, 2403–2410. (doi:10.1242/jeb.021774)
97. Piersma T. 1988 Breast muscle atrophy and constraints on foraging during the flightless period of wing molting great crested grebes. *Ardea* **76**, 96–106. (doi:10.1007/BF00397858)
98. Jehl JR. 1997 Cyclical changes in body composition in the annual cycle and migration of the eared grebe *Podiceps nigricollis*. *J. Avian Biol.* **28**, 132. (doi:10.2307/3677306)
99. Gaunt AS, Hikida RS, Jehl, JR. 1990 Rapid atrophy and hypertrophy of an avian flight muscle. *Auk* **107**, 649–659. (doi:10.2307/4087994)
100. de Margerie E, Simonneau M, Caudal J-P, Houdelier C, Lumineau S. 2015 3D tracking of animals in the field using rotational stereo videography. *J. Exp. Biol.* **218**, 2496–2504. (doi:10.1242/jeb.118422)
101. Jackson BE, Evangelista DJ, Ray DD, Hedrick TL. 2016 3D for the people: multi-camera motion capture in the field with consumer-grade cameras and open source software. *Biol. Open* **5**, 1334–1342. (doi:10.1242/bio.018713)
102. Theriault DH, Fuller NW, Jackson BE, Bluhm E, Evangelista D, Wu Z, Betke M, Hedrick TL. 2014 A protocol and calibration method for accurate multi-camera field videography. *J. Exp. Biol.* **217**, 1843–1848. (doi:10.1242/jeb.100529)

Electronic supplementary material for the review “The development of flight behaviours in birds”

Authors: Geoffrey Ruaux¹, Sophie Lumineau¹ and Emmanuel de Margerie¹.

¹Univ Rennes, Normandie Univ, CNRS, EthoS (Éthologie animale et humaine) - UMR 6552, F-35000 Rennes, France.

Journal: *Proceedings of the Royal Society B*
<https://doi.org/10.1098/rspb.2020.0668>

A – Altricial-precocial spectrum

Many categories can be defined within the altricial-precocial spectrum [1]. A simplified classification used by Ricklefs [2], adapted from Nice [3], is presented here. In this classification, four categories can be defined: (i) Altricial birds hatch with their eyes closed, with little or no down, and unable to leave the nest (e.g. Passeriformes). (ii) Semi-altricial birds hatch covered with down but are unable to leave the nest. Their eyes may be open at hatching, e.g. herons (Ardeidae) and hawks (Falconiformes), or closed, e.g. owls (Strigiformes). (iii) Semi-precocial birds hatch covered with down and with their eyes open, they are able to walk but remain in the nest until they can fly and are fed by their parents, e.g. gulls and terns (Laridae). (iv) Precocial chicks hatch covered with down, with their eyes open, and leave the nest during the first day or two, e.g. ducks (Anatidae) and shorebirds (Charadriidae). For each category, an example species at the pre-juvenile and adult stage is presented in Figure S1.

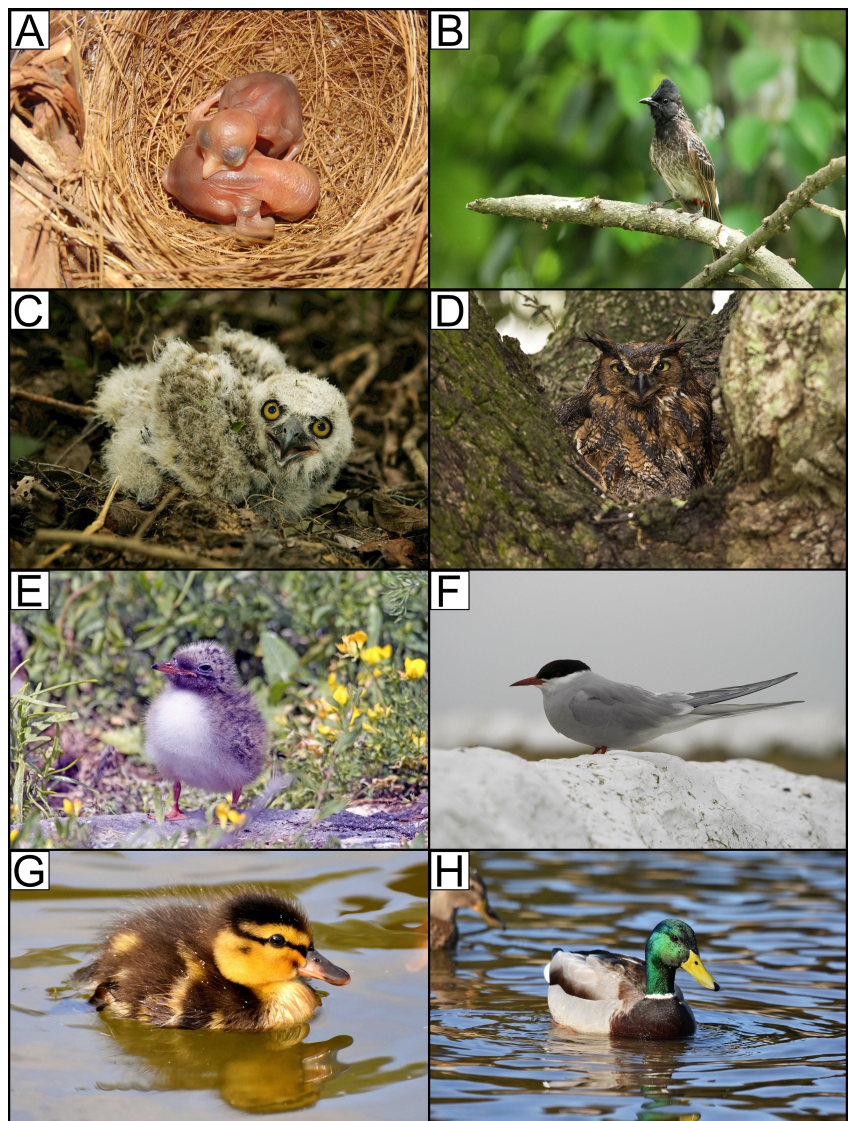

Figure S1. Pre-juvenile and adult birds belonging to different categories of the altricial-precocial spectrum, following Nice’s classification [3]. Altricial pre-juvenile (A) and adult (B) red-vented bulbul (*Pycnonotus cafer*); semi-altricial pre-juvenile (C) and adult (D) great horned owl (*Bubo virginianus*); Semi-precocial pre-juvenile (E) and adult (F) river tern (*Sterna aurantia*); precocial pre-juvenile (G) and adult (H) mallard (*Anas platyrhynchos*).

B - Developmental timing of flight in precocial birds

In most altricial species, flight becomes possible at the end of the nestling period. Pre-juvenile altricial birds do not have to search for food in an environment where they would be exposed to adverse conditions and predators, something that most precocial birds have to do. Therefore, selection may act more prominently on parental care for altricial birds, but on pre-juvenile anatomy and performance for precocial birds [4]. Indeed, precocial species rapidly leave the nest and have to rely on terrestrial and/or aquatic locomotion before flight. Resource allocation to different locomotor modules varies during ontogeny, so the timing of flight development in these species is likely to reveal developmental trade-offs shaped by selective pressures.

The development of several precocial species illustrates how the behavioural development of flight is constrained by anatomical development. For example, in mallards (*Anas platyrhynchos*), walking and swimming are prioritised early in development through musculoskeletal growth of hindlimbs during the first month post-hatching, while wings grow mainly during the next month, allowing flight only in 2-month-old mallards [5,6]. In other precocial species, hindlimbs and forelimbs may be used more concurrently during development. For example, pre-juvenile chukar partridges (*Alectoris chukar*) use their wings and legs cooperatively to crawl up slopes when they are just 4 days [7]. Then, flight feathers begin to unfurl and these birds start to engage in wing-assisted incline running through inconsistent, asymmetrical flapping. This behaviour allows them to access elevated refuges and has been extensively studied in the context of flight ontogeny and evolution [4,7–12]. Afterwards, pre-juvenile chukars use symmetrical flapping during wing-assisted incline running and engage in controlled flapping descents [13]. Finally, sustained level flight becomes possible later in ontogeny. In these birds, the transition is mainly due to maturation of feathers. Older wings with stiffer and more asymmetrical feathers generate greater lift than younger wings with flexible and relatively symmetrical feathers. Thus, feather morphology and flapping behaviour may be developmentally “tuned” to one another [7]. These differences of timing between mallards and chukars were hypothesised to be due to different escape strategy, with mallards swimming to safety and chukars flap-running up slopes to take refuge [5].

As an extreme example, in Australian brush turkeys (*Alectura lathami*), chicks hatch with fully developed forelimbs and are immediately able to practice true flight and wing-assisted incline running [14]. Yet, as brush turkeys grow, their forelimb-dependent locomotor performance declines. This ontogenetic decline in incline running performance is accompanied by an increased wing-loading. Thus, Dial and Jackson [14] hypothesised that Australian brush turkeys develop from forelimb-dominated young exploiting a variable terrain (e.g. mound nests, boulders, bushes, trees) into hindlimb-dominated adults dependent on size and running speed to avoid predation.

In all the previous examples, the developmental trade-offs on flight development were hypothesised to be linked with predator escape, which seems to be a ubiquitous and strong selective pressure amongst pre-juvenile precocial birds. Precocial species exhibit various developmental strategies to allow free-living pre-juveniles to escape predation. This affects resource allocation dynamics between hindlimbs and forelimbs, and consequently influences the developmental timing of flight behaviour.

Hoatzins (*Opisthocomus hoazin*) are another particular case of locomotory development. According to Starck and Ricklefs [1], they are difficult to classify as altricial or precocial because they hatch with sparse down, but their eyes are wide open 24 hours after hatching. When disturbed, chicks as young as 5 days can jump out of the nest into the water, swim and climb trees using their characteristic wing claws [15]. This behaviour allows them to escape nest predators. Abourachid et al. [16] have

studied the locomotion of hoatzin nestlings and have shown that they were able to perform synchronous movements of the forelimbs while swimming, and asynchronous movements while climbing a slope. This asynchronous movement is typical of quadrupedal walking coordination and would thus represent the reappearance of a trait lost during bipedal saurischian dinosaur evolution [17]. This trait is not present in adult hoatzins which lose their claws and only use synchronous movements of the forelimbs for flight.

It is rare to have a broad picture encompassing the great diversity of developmental processes involved in flight development (kinematics, morphology, anatomy). The most studied case is arguably the chukar partridge, for which these different aspects have been studied independently and interactively through the study of its wing-assisted incline running and flight behaviours. First, kinematics of flight development have been studied and it was demonstrated that variables like stroke amplitude, stroke angles, wing-beat frequency, wing loading and disc loading showed a coordinated developmental pattern allowing 8 days old birds to perform wing-dependent behaviours and 20 days old birds to achieve adult escape performance at just a fraction of adult size [13]. Skeletal development has also been studied, and it was shown that developing chukars acquire an “avian” flight stroke despite their non-ossified bones, by using their wings and legs cooperatively [8]. Pre-juveniles and adults demonstrated similar patterns but different magnitudes of joint movements, with pre-juveniles having more exaggerated and more extreme movements than adults, for example with a greater stroke amplitude and more extended wings during the downstroke. Neuromuscular control and contractile dynamics were also described in developing chukars, and it was shown that neuromuscular recruitment is disorganized in early development with nearly-continuous low-level activation of the muscle, but develop more adult-like electromyographic bursts of activity by day 12 [18]. Pre-juveniles exhibited less pectoralis strain (relative change in length), fractional shortening and contractile velocity compared with adults, and these differences are consistent with external wing kinematics described above [13]. Together, these studies provide a useful template for specific studies investigating the timing and relative importance of different developmental mechanisms involved in the development of flight. Such researches should be particularly encouraged in altricial species for which these developmental dynamics appear less known.

C - Fledging timing in altricial birds

Even if the development of locomotor modules seems to be under strong selection pressures in precocial birds, altricial species also have to cope with predation, inside and outside the nest, and variable predation constraints might favour different developmental strategies in the fledging timing of altricial birds. For example, Martin et al. [19] have shown that offspring of songbird species suffering greater mortality in the nest leave the nest at a younger age and have less developed wings that cause poorer flight performance and greater mortality after fledging. Yet, staying in the nest for longer may not offer greater fitness benefits for species exposed to nest predation, because predation in the nest often results in the loss of the entire brood, while predation outside the nest often results in the loss of an individual offspring. A trade-off has to be found between mortality in and outside the nest, and this influences patterns of wing growth and flight development. Tropical birds resolve this trade-off in a different way. Indeed, tropical birds’ nestlings become mobile more rapidly due to faster wing growth [20]. Thus, they are able to leave the nest early without sacrificing a lot of locomotor performance. This strategy is facilitated by smaller clutch sizes, allowing higher provisioning of offspring.

These studies show how predation is a crucial selection pressure influencing the development of flight organs and flight behaviours, even in altricial birds, and studies focusing on a wide range of species exhibiting diverse gradients of life history traits allow to draw meaningful patterns.

D - Anatomical differences of the flight apparatus between juveniles and adults

Juvenile birds often reach the size and body mass of adults. However, some anatomical differences may last much longer. Behavioural development is often constrained by anatomical development, so understanding the differences between the flight apparatus of juveniles and adults may indirectly help to explain the development of some flight behaviours.

In many bird species, a shorter wing length was reported for juveniles compared to adults [21,22]. Several hypotheses were proposed to explain this difference. Some authors [23,24] have suggested that wing length is probably influenced by food conditions, which means that juvenile birds cannot grow primary feathers as long as older birds because of nutritional constraints. For other authors [21], this explanation alone is not convincing. The fact that the phenomenon is so widespread would mean that the majority of juvenile birds are undernourished. These authors suggested a different explanation of shorter wings: juvenile birds would benefit from the possession of short wings through increased manoeuvrability. Increased manoeuvrability for inexperienced birds may increase survival in response to several selection pressures, such as predator avoidance and prey capture. For example, Mueller et al. [25] suggested that the shorter wings of juvenile sharp-shinned hawks (*Accipiter striatus*) were an adaptation to compensate for less prey capture experience, potentially offering a greater manoeuvrability. However, long wings allow higher speeds for adults, which strike prey more strongly. Thus, shorter wings exist at the expense of high speed, longer distance flight, and this affects juvenile foraging behaviour.

Figuerola & Gutiérrez [26] studied this age-related difference in wing length in moustached warblers (*Acrocephalus melanopogon*), and proposed an additional explanation. The difference could be the result of two distinct processes: a lower migratory return rate of short-winged individuals and an age-related increase in wing-length. Indeed, in migratory species, wing length is especially important for migration speed and distance [21]. Thus, short-winged juveniles would be counter-selected during migration, which would cause a lower return rate of short-winged individuals during the following breeding season.

In addition to shorter wings, juveniles usually have more rounded wings than adults, especially in passerines [27,28]. Similarly, rounded wings in juveniles would favour a greater manoeuvrability for predator escape and foraging, while pointed wings in adults would improve endurance during migration. In pied flycatchers (*Ficedula hypoleuca*), a migratory species, longitudinal data have shown that the wings of juveniles are more rounded and become longer and more pointed as they grow [28]. The importance of these features for migration was further demonstrated in blackcaps (*Sylvia atricapilla*), where this age difference in wing length and shape was only visible in migratory populations, and absent from a sedentary population [27]. Overall, migratory adult blackcaps have longer and more pointed wings than sedentary blackcaps.

In summary, anatomical differences of the flight apparatus between juveniles and adults seem extremely widespread in birds. The dominant selective pressure in juvenile birds seems to be predation pressure, which would favour short and rounded wings for manoeuvrability. In adult birds, migration speed and distance may become greater constraints, and the wings may grow longer and more pointed. When they are present, these differences undoubtedly constrain and influence the development of flight behaviours in juvenile birds.

References

1. Starck JM, Ricklefs RE. 1998 *Avian Growth and Development*. Oxford, New York: Oxford University Press.
2. Ricklefs RE. 1973 Patterns of growth in birds. II. Growth rate and mode of development. *Ibis* **115**, 177–201. (doi:10.1111/j.1474-919X.1973.tb02636.x)
3. Nice MM. 1962 *Development of behavior in precocial birds*. Transactions of the Linnaean Society of New York.
4. Heers AM. 2016 New Perspectives on the Ontogeny and Evolution of Avian Locomotion. *Integr. Comp. Biol.* **56**, 428–441. (doi:10.1093/icb/icw065)
5. Dial TR, Heers AM, Tobalske BW. 2012 Ontogeny of aerodynamics in mallards: comparative performance and developmental implications. *Journal of Experimental Biology* **215**, 3693–3702. (doi:10.1242/jeb.062018)
6. Dial TR, Carrier DR. 2012 Precocial hindlimbs and altricial forelimbs: partitioning ontogenetic strategies in mallards (*Anas platyrhynchos*). *Journal of Experimental Biology* **215**, 3703–3710. (doi:10.1242/jeb.057380)
7. Heers AM, Tobalske BW, Dial KP. 2011 Ontogeny of lift and drag production in ground birds. *Journal of Experimental Biology* **214**, 717–725. (doi:10.1242/jeb.051177)
8. Heers AM, Baier DB, Jackson BE, Dial KP. 2016 Flapping before Flight: High Resolution, Three-Dimensional Skeletal Kinematics of Wings and Legs during Avian Development. *PLoS ONE* **11**, e0153446. (doi:10.1371/journal.pone.0153446)
9. Heers AM, Dial KP. 2012 From extant to extinct: locomotor ontogeny and the evolution of avian flight. *Trends in Ecology & Evolution* **27**, 296–305. (doi:10.1016/j.tree.2011.12.003)
10. Bundle MW, Dial KP. 2003 Mechanics of wing-assisted incline running (WAIR). *Journal of Experimental Biology* **206**, 4553–4564. (doi:10.1242/jeb.00673)
11. LeBlanc C, Tobalske B, Szkotnicki B, Harlander-Matauschek A. 2018 Locomotor behavior of chickens anticipating incline walking. *Front. Vet. Sci.* **4**, 233. (doi:10.3389/fvets.2017.00233)
12. Dial KP, Jackson BE, Segre P. 2008 A fundamental avian wing-stroke provides a new perspective on the evolution of flight. *Nature* **451**, 985–989. (doi:10.1038/nature06517)
13. Jackson BE, Segre P, Dial KP. 2009 Precocial development of locomotor performance in a ground-dwelling bird (*Alectoris chukar*): negotiating a three-dimensional terrestrial environment. *Proc. R. Soc. B.* **276**, 3457–3466. (doi:10.1098/rspb.2009.0794)
14. Dial KP, Jackson BE. 2011 When hatchlings outperform adults: locomotor development in Australian brush turkeys (*Alectura lathami*, Galliformes). *Proc. R. Soc. B* **278**, 1610–1616. (doi:10.1098/rspb.2010.1984)
15. Strahl SD. 1988 The social organization and behaviour of the Hoatzin *Opisthocomus hoazin* in central Venezuela. *Ibis* **130**, 483–502. (doi:10.1111/j.1474-919X.1988.tb02714.x)
16. Abourachid A, Herrel A, Decamps T, Pages F, Fabre A-C, Van Hoorebeke L, Adriaens D, Garcia Amado MA. 2019 Hoatzin nestling locomotion: Acquisition of quadrupedal limb coordination in birds. *Sci. Adv.* **5**, eaat0787. (doi:10.1126/sciadv.aat0787)
17. Gatesy SM, Dial KP. 1996 Locomotor modules and the evolution of avian flight. *Evolution* **50**, 331–340. (doi:10.1111/j.1558-5646.1996.tb04496.x)
18. Tobalske BW, Jackson BE, Dial KP. 2017 Ontogeny of flight capacity and pectoralis function in a precocial ground bird (*Alectoris chukar*). *Integrative and Comparative Biology* **57**, 217–230. (doi:10.1093/icb/icx050)
19. Martin TE, Tobalske B, Riordan MM, Case SB, Dial KP. 2018 Age and performance at fledging are a cause and consequence of juvenile mortality between life stages. *Sci. Adv.* **4**, eaar1988. (doi:10.1126/sciadv.aar1988)
20. Martin TE. 2015 Age-related mortality explains life history strategies of tropical and temperate songbirds. *Science* **349**, 966–970. (doi:10.1126/science.aad1173)
21. Alatalo RV, Gustafsson L, Lundbkrig A. 1984 Why do young passerine birds have shorter wings than older birds? *Ibis* **126**, 410–415. (doi:10.1111/j.1474-919X.1984.tb00264.x)
22. Marchetti K, Price T. 1989 Differences in the foraging of juvenile and adult birds: the importance of developmental constraints. *Biological Reviews* **64**, 51–70. (doi:10.1111/j.1469-185X.1989.tb00638.x)
23. Slagsvold T. 1982 Sex, size, and natural selection in the hooded crow *Corvus corone cornix*. *Ornis Scandinavica* **13**, 165. (doi:10.2307/3676294)
24. van Balen JH. 1967 The significance of variations in body weight and wing length in the great tit, *Parus major*. *Ardea* **55**, 1–59. (doi:10.5253/arde.v55.p1)
25. Mueller HC, Berger DD, Allez G. 1981 Age and sex differences in wing loading and other aerodynamic characteristics of sharp-shinned hawks. *The Wilson Bulletin* **93**, 491–499.
26. Figuerola J, Gutiérrez R. 2000 Why do juvenile Moustached Warbler have shorter wings? *Ornis Fennica* **77**, 183–187.
27. Perez-Tris J, Telleria JL. 2001 Age-related variation in wing shape of migratory and sedentary Blackcaps *Sylvia atricapilla*. *Journal of Avian Biology* **32**, 207–213.
28. de la Hera I, Pulido F, Visser ME. 2014 Longitudinal data reveal ontogenetic changes in the wing morphology of a long-distance migratory bird. *Ibis* **156**, 209–214. (doi:10.1111/ibi.12112)

V. How to study flight?

Bird flight is a very wide field of research, and various questions can be investigated (e.g. behaviour, orientation, energy expenditures) at a number of different scales. The primary function of flight is locomotion, so movement is the main focus when studying bird flight. Nathan et al. (2008) proposed a paradigm for movement ecology integrating conceptual, theoretical, methodological and empirical frameworks for studying movements of all organisms (Fig. 24). They described the interplay between four basic mechanistic components of organismal movement: the internal state (why move?), motion (how to move?), navigation (when and where to move?), and the external factors affecting movement. This framework integrates eclectic research on movement into a structured paradigm and provides a basis for hypothesis generation.

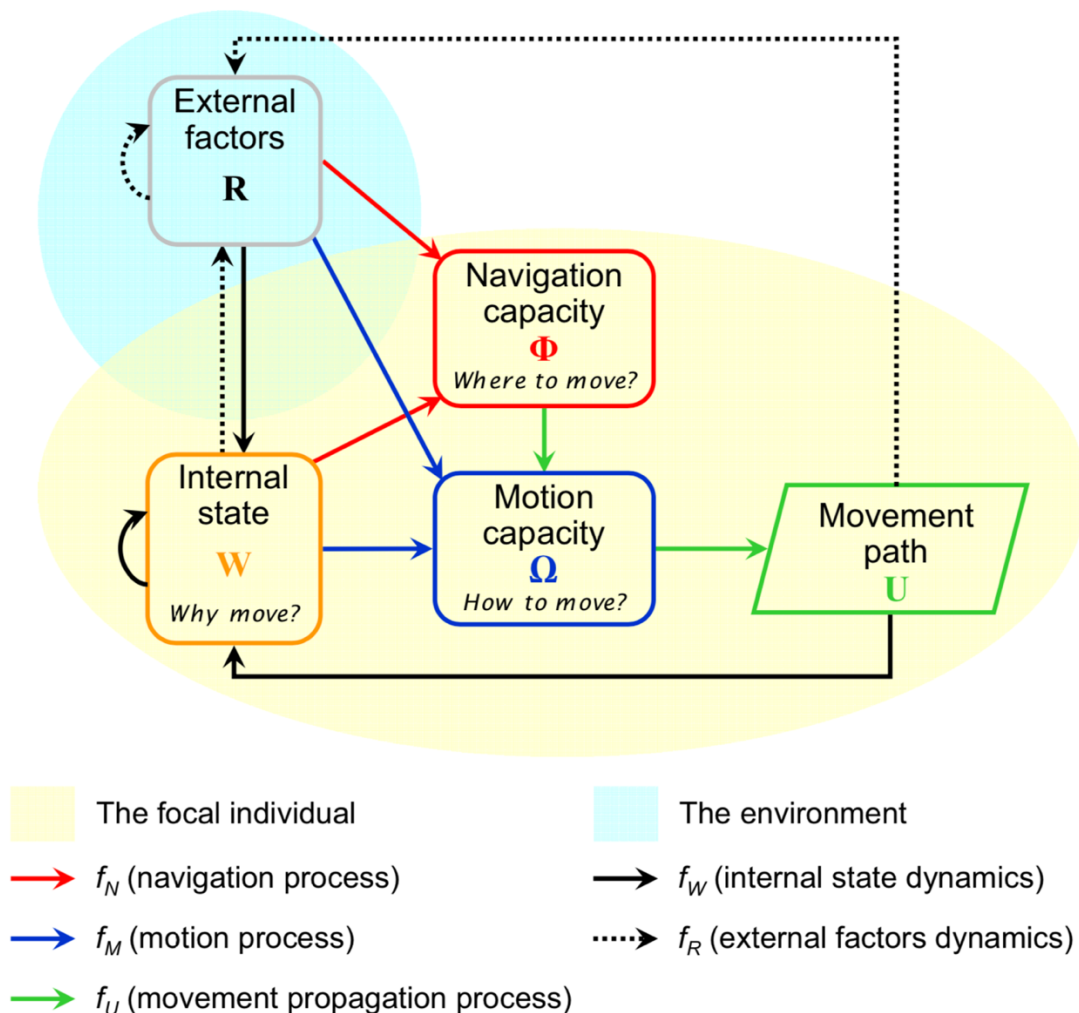

Figure 24: A general conceptual framework for movement ecology (Nathan et al., 2008). It is composed of three basic components (yellow background) related to the individual (internal state, motion capacity, and navigation capacity) and a fourth basic component (turquoise background) related to external factors affecting the movement. Relationships among components are represented with arrows indicating the direction of impact.

Studying bird flight allows to investigate different aspects of this framework depending on the research question and the scale at which movement is studied. Bird flight can be studied in the field at a global scale, a local scale, or in laboratory experiments. Various experimental processes and technologies have been developed to study each aspect of bird flight.

A) Global movements

When studying bird movements at a global scale, telemetry is one of the most widely used technique (Cagnacci et al., 2010). This technique requires to capture an animal and to tag it with a specific device, often a GPS tag, and then to recapture it to recover data. The main benefit of GPS is its unlimited, global range. It has been used successfully to track large-scale and long-term movements, and has allowed to identify migration routes, wintering sites (García-Ripollés et al., 2010) and to study migration phenology (Soriano-Redondo et al., 2020). However, tags should have a limited mass in order to avoid any negative effect on bird flight and survival, and a limit of 3% of the bird's body mass is often recommended (Kenward, 2001). Thus, the smallest birds cannot carry sophisticated tags, or cannot be tagged at all. Even so, more miniaturized technologies are being developed, and it is now possible to tag birds as small as the black-headed grosbeak (*Pheucticus melanocephalus*, 40 g) with simple GPS tags (Siegel et al., 2016). Smaller GPS tags come with their limitations, and necessarily have a shorter battery life, so a trade-off has to be found between tag longevity and sampling frequency (Brown et al., 2012). For example, the frequency was only of one location every 2–6 weeks for the 2 g tags in Siegel et al. (2016).

Besides, the two main problems in GPS datasets are spatial inaccuracy of the acquired locations and missing data in the form of failed location attempts (Frair et al., 2004). Their combined effect can lead to mistaken inferences on animal spatial behaviour, especially those involving movement paths and habitat selection (Frair et al., 2010). Position uncertainty of GPS is about 6.5 m in 2D and more than 10 m in 3D (Seeber, 2003). It can be increased by various environmental factors (canopy closure, topography, tag orientation), and field errors of 30 m are often assumed (Frair et al., 2010). Sampling frequency of GPS tags can reach 1 Hz (Dell'Ariceia et al., 2008; Vyssotski et al., 2009), but they are often used at much lower frequencies to preserve tags' battery life (Debeffe et al., 2013). These specifications make GPS tracking well adapted to large-scale and long-term tracking, but less so to study fine-scale local path (Frair et al., 2010; Rowcliffe et al., 2012).

Telemetry was originally only used to measure animal's position at fixed intervals, but biotelemetry devices are becoming more sophisticated and nowadays allow sampling of environmental variables around tagged animals (Hooker et al., 2007). For example, Shepard et al. (2011) have equipped Andean condors (*Vultur gryphus*) with a set of loggers including a GPS and devices measuring barometric pressure (to infer altitude), compass heading and triaxial acceleration (to count wingbeats), allowing them to track and describe more precisely the foraging behaviour of a condor and to identify when it was soaring (Fig. 25).

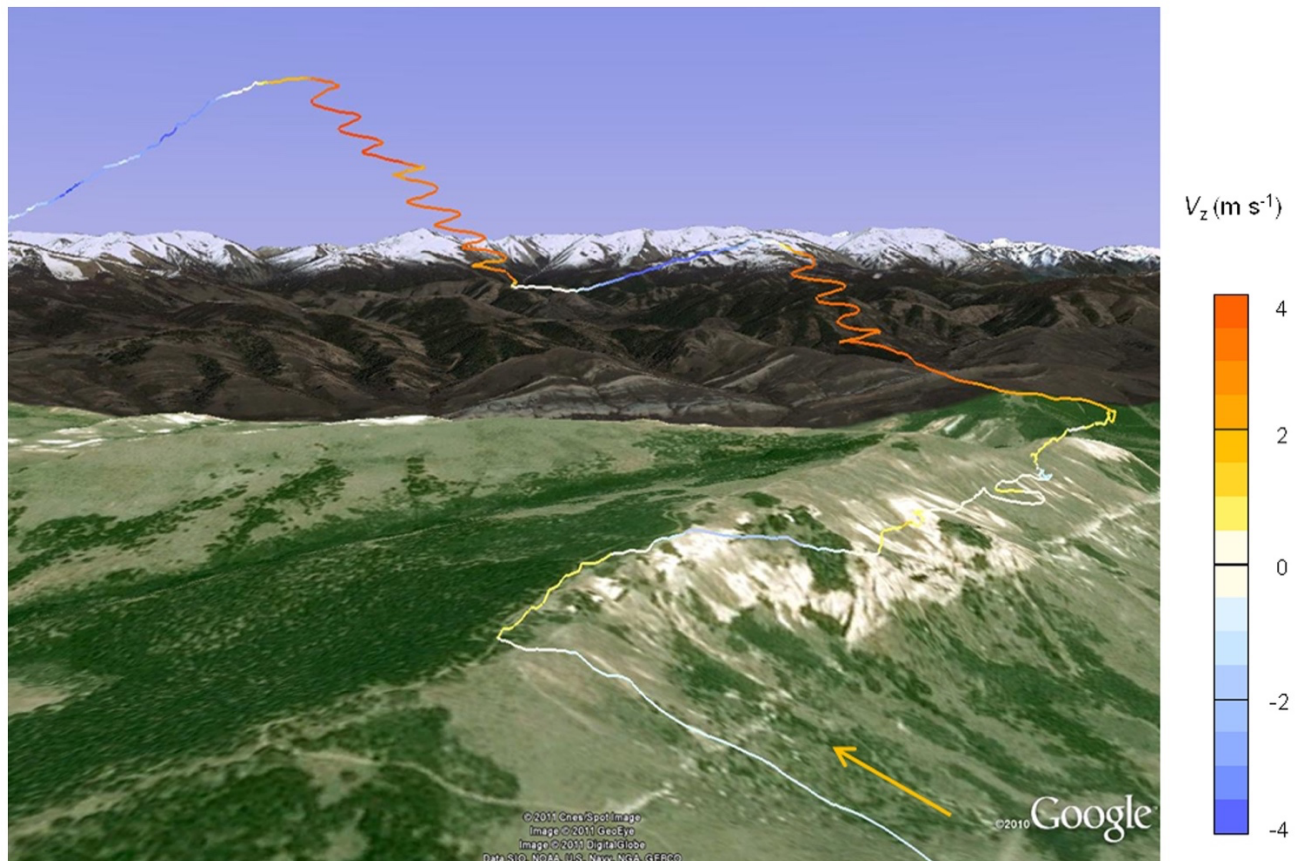

Figure 25: Andean condor 3-dimensional flight path (Shepard et al., 2011). A section of a condor flight path shown in Google Earth. The orange arrow indicates the direction of travel, and the vertical velocity (V_z) is shown by the colour of the path.

Hedenström et al. (2016) have equipped common swifts (*Apus apus*) with micro data loggers with an accelerometer to record flight activity and a light-level sensor for geolocation, and have shown with this experimental design that swifts stay airborne for more than 99% of the time during their 10-month non breeding period, with some individuals never roosting in this interval (Fig. 26).

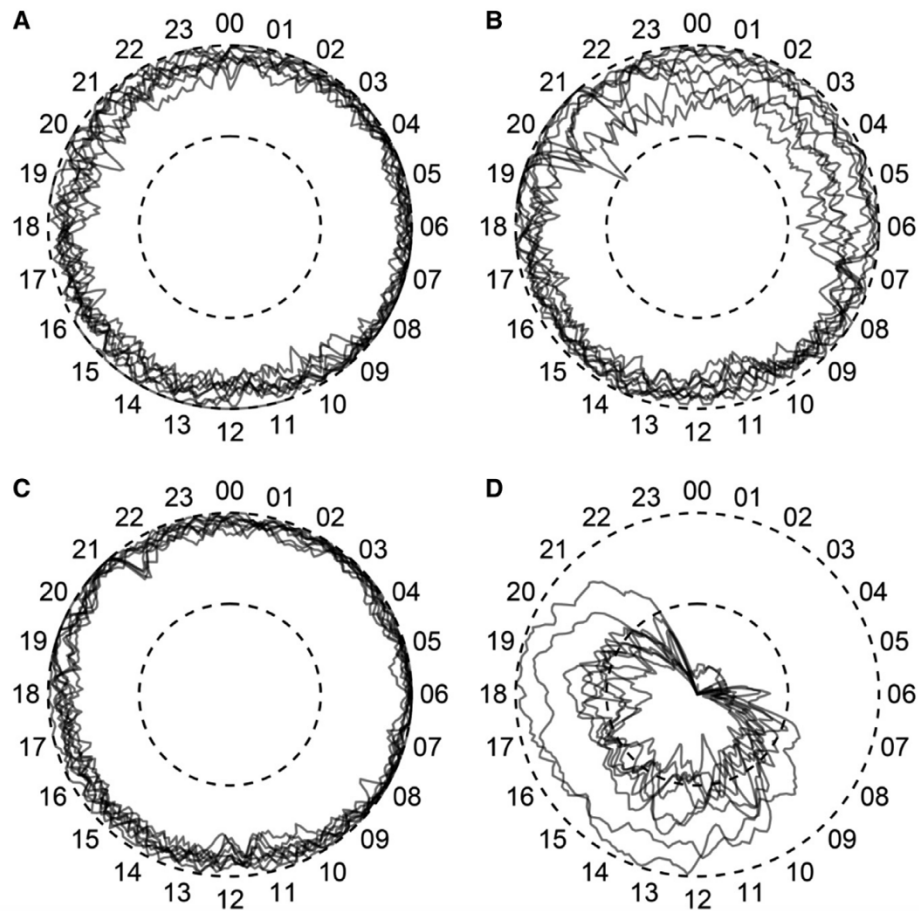

Figure 26: Seasonal flight activity in common swifts (Hedenström et al., 2016). Daily flight activity patterns recorded on nine individuals. (A) Autumn migration (September), (B) winter residency (February), (C) spring migration (April) and (D) breeding (June). The circles show hourly means of flight activity, the dashed lines denote the 50% and 100% activity levels, respectively.

In addition to GPS tags, micro video cameras can even be attached to large enough birds (Fig. 27), greatly enriching positional data with information about the surroundings of a given individual (e.g. the presence of conspecifics). Using such methods, Thiebault et al. (2014a) have shown that Cape gannets (*Morus capensis*) foraging at sea react to predator aggregations (conspecifics, other seabirds, marine mammals, boats) to find food patches from long distances (local enhancement). To find a food patch, gannets can also follow conspecifics flying outwards the colony, or fly in the opposite direction of conspecifics flying towards the colony (Thiebault et al., 2014b).

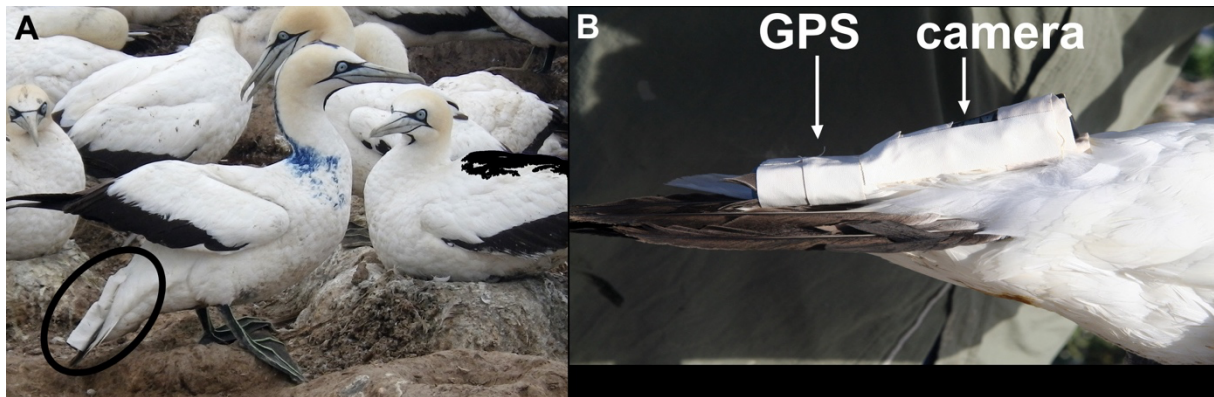

Figure 27: Photographs of the devices attached to Cape gannets (Thiebault et al., 2014b). (A) The devices are located on the lower-back and tail feathers of the bird. (B) A closer view, showing both the GPS device and the micro video camera.

B) Local movements

Animal tracking at a local scale can use very high-frequency radio (VHF) technology: animals are equipped with transmitters emitting at radio frequencies that can be received by radio receivers (Cagnacci et al., 2010). VHF technology requires receivers to be close enough to the animals to triangulate its positions. Therefore, this technique has traditionally relied on researchers to be in the field, with the potential to affect animal behaviour (Cooke et al., 2004).

Whether it be GPS, VHF or other biologging techniques, all methods involving animal tagging can potentially impact the behaviour, reproduction, and survival of the animal. Two kinds of effects are rarely separated when studying the impact of tagging on birds: handling effect and tagging effect. Sun et al. (2020) have separated these effects by tagging rhinoceros auklets (*Cerorhinca monocerata*) with tags of appropriate mass (2.3% of the bird's mass) and by handling birds without tagging them. Handling doubled the nest abandonment rate compared to control birds, while tagging doubled the nest abandonment rate compared to birds that were handled but not tagged. Thus, both handling and tagging can have separate negative effects, even when the tag has an appropriate mass.

To track and study the behaviour of birds and other animals at a local scale without any tagging or interference, various optical methods have been developed. Image-based tracking using fixed cameras is a widespread method which has been used in various contexts. A single fixed camera can record 2D movements of flying animals in the field (e.g. orientation in bumblebees; Collett et al., 2013). 3D flight tracks have also been measured in the field using multiple fixed cameras (e.g. Fig. 28). Several questions related to flocking behaviours have been studied with such methods (e.g. flock structure in starlings and dunlins; Major and Dill, 1978; Ballerini et al., 2008; turning in rock dove flocks; Pomeroy and Heppner, 1992; bird

flocks and aircraft strikes; Budgey, 1998). Similar systems have also been used to study territory encroachment and defence in ruby-throated hummingbirds (*Archilochus colubris*; Sholtis et al., 2015), tandem flight in cliff swallows (*Petrochelidon pyrrhonota*; Shelton et al., 2014), and foraging in barn swallows (*Hirundo rustica*; Warrick et al., 2016), allowing to precisely measure biomechanical variables for short flight bouts. These 3D trajectories can be combined with the measurements of other variables, such as wind speed, which allowed to demonstrate, for example, that barn swallows exploit the wind speed gradient near the ground to gain kinetic and potential energy during both flapping and gliding turns (Warrick et al., 2016).

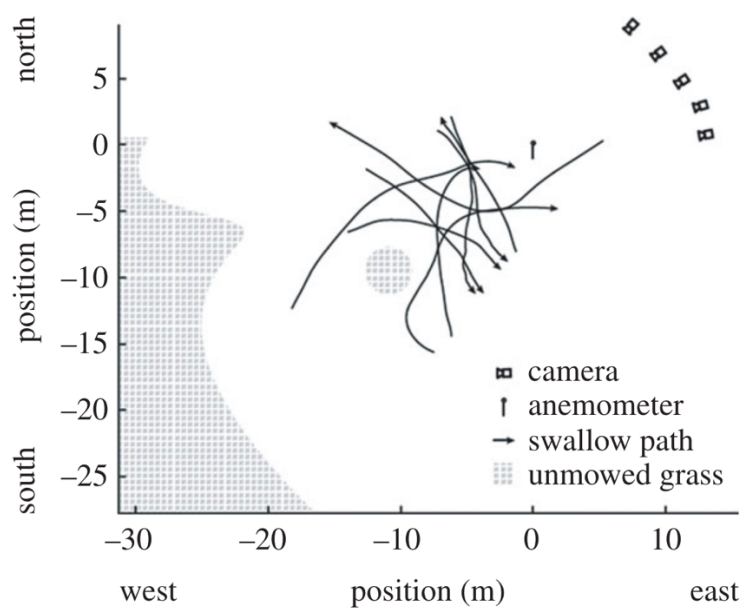

Figure 28: Aerial view of typical experimental setup of a fixed multi-camera system (Warrick et al., 2016). The flight path of each swallow begins and ends according to either the recording duration limits of the cameras or the edges of the volume seen by two or more cameras.

Multi-camera systems have a fixed “volume of interest” at the intersection of cameras’ fields of view. To cover a large volume, a large distance between cameras is required, which can limit the system’s portability (Cavagna et al., 2008) even if some progress has been made on portability (Theriault et al., 2014). Recent studies have often monitored volumes of interest from 100 m³ (Corcoran and Conner, 2012) to 10,000 m³ (Shelton et al., 2014; Theriault et al., 2014), but sometimes up to 1,000,000 m³ (Ballerini et al., 2008; Cavagna et al., 2008). Due to the limited volume in most studies, recorded flight bouts rarely exceed a few seconds. Larger filming volumes can increase flight bouts duration, but the image projected by the animal on the camera sensor can become smaller, which limits positional and behavioural analysis

(Theriault et al., 2014). On the other hand, fixed cameras capture the entire volume of interest continuously, hence multiple animals can be tracked simultaneously.

Other local tracking methods are based on a tracking device operated by a single person in the field. One of the first of these methods, the “ornithodolite” (Fig. 29; Pennycuick, 1982b), is an instrument composed of a rangefinder mounted on an alt-azimuth mount with angular encoders providing measurements of azimuth, elevation and range, allowing to follow the position of a flying bird. Several systems were used with the same principles to track birds in the field (Tucker, 1995; Hedenström et al., 1999). The flight trajectories recorded with such devices can be longer than fixed cameras systems (for example going up to 795 s in Hedenström et al., 1999), as long as the operator does not lose the bird. However, the distance measure has to be adjusted manually by the operator, so the tracking accuracy depends on the operator skill in aiming exactly at the moving bird, while simultaneously adjusting the distance measure. Another downside of the ornithodolite is that it does not record animal behaviour, so it has to be supplemented with another device (e.g. video camera) to allow behavioural data collection.

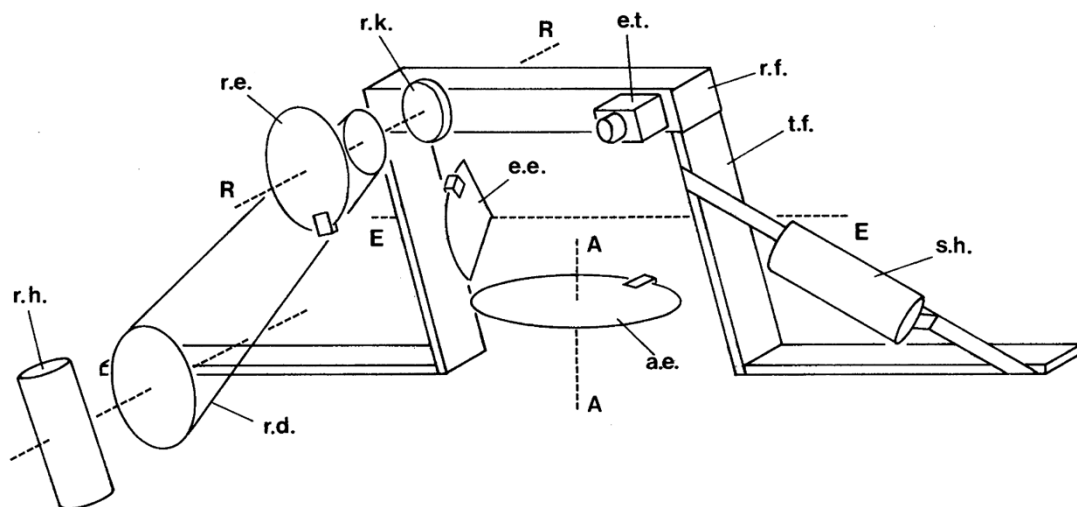

Figure 29: Diagram of the ornithodolite (Pennycuick, 1982b). The whole instrument rotates about the azimuth axis AA. The azimuth encoder disc (a.e.) rotates, while the sensing head remains fixed. The rangefinder (r.f.) is carried on the tilting frame (t.f.), which tilts about the elevation axis EE. This movement is sensed by the elevation encoder (e.e.). The rangefinder knob (r.k.) is mounted on a common shaft with the range encoder (r.e.). It is driven by a sprocket-and-chain drive (r.d.) from the ranging handle (r.h.). In use the operator views the bird through the eyepiece telescope (e.t.) and follows it by steering the instrument with the steering handle (s.h.), simultaneously adjusting the rangefinder with the ranging handle.

More recently, Pennycuick et al. (2013) used a pair of military binoculars equipped with a laser rangefinder, a magnetic compass and an inclinometer. However, this system has a limited sampling frequency (< 0.5 Hz) compared to other optical methods.

Rotational stereo-videography (RSV; de Margerie et al., 2015), is another optical technique, recently developed at the CNRS and University of Rennes 1, allowing to track birds at a local scale in the field. It is based on a set of mirrors projecting a stereo image of the animal on the sensor of a single camera (see Chapter 2 for more details). The distance to the animal is measured by analysing the lateral shift between animal image pairs. The rigid assembly of camera and mirrors is rotated horizontally and vertically on a tripod and fluid video head. While the operator rotates the device to keep the moving animal's image within the sensor frame, the aiming angles are recorded by angular encoders. The geometrical combination of distance and aiming angles yields a 3D record of the animal's movement. Contrarily to systems based on the ornithodolite, the operator does not have to aim exactly at the moving bird: aiming errors are corrected as long as the animal remains within the recorded images. This system allows high sampling frequency (up to 60 Hz or more depending on the camera) and low spatial uncertainty (e.g. from ~5 to 50 cm positioning error depending on bird distance, see Articles 2 and 3). Also, because it uses narrow field of view (i.e. telephoto) lenses, RSV usually offers a higher magnification of the animal image than with wide-angle fixed cameras, allowing an easier behavioural analysis. On the other hand, a narrow field of view complicates multiple-animal tracking with RSV.

C) Studying flight in the laboratory

Flight experiments in the laboratory allow to study many biomechanical variables in order to answer precise questions which would be very difficult to study in the field. Wind tunnels are a widespread system used to study flight kinematics in trained birds with controlled flight angles and speeds (Fig. 30). Wind tunnel experiments were carried out on various trained birds, for example to study gliding flight in the pigeon (Pennycuick, 1968), the herring gull (Baudinette and Schmidt-Nielsen, 1974), and the common swift (Henningsson and Hedenström, 2011), or intermittent flight in the barn swallow and the house martin (Bruderer et al., 2001). Birds can even be equipped with devices measuring biological variables, such as ventilated head masks to measure oxygen consumption (Baudinette and Schmidt-Nielsen, 1974), or surgically implanted strain gauges and sonomicrometry crystals to measure bone strain and muscle strain (Tobalske et al., 2003). It is also possible to use preserved specimens or wings to study specific questions such as the aerodynamism of a wing (Lentink et al., 2007; Lentink and de Kat, 2014).

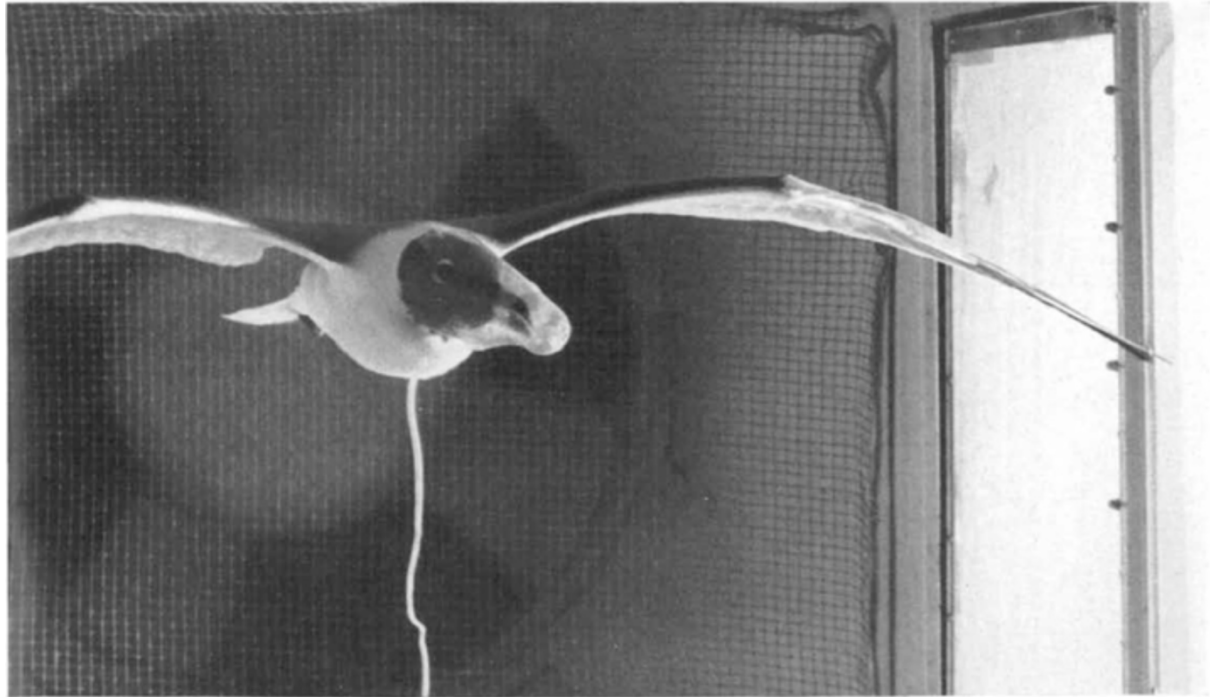

Figure 30: Laughing gull flying in a wind tunnel with a head mask (Tucker, 1969).

Wind tunnel experiments are one of the main methods to study the link between flight behaviour and energy expenditures, so they are often used to determine power curves in flapping flight, or glide polars (see section III).

Overall, the wide diversity of technologies and methodologies used to study bird flight at various scales allow to gain a more holistic view of bird flight as an integrated behaviour by studying the four basic mechanistic components of the movement ecology framework formulated by Nathan et al. (2008): the internal state (e.g. laboratory experiments), motion (e.g. local tracking or wind tunnel experiments), navigation (e.g. global tracking), and the external factors affecting movement (e.g. local tracking with observations of the surrounding environment or global tracking with attached biologgers or cameras).

VI. Flight in the context of aeroecology

Flying animals are moving in the aerosphere, the relatively thin sub-stratum of the troposphere closest to the Earth's surface (Kunz et al., 2008). Many organisms (animals, plants, fungi and even bacteria) depend on the aerosphere as a fluid medium for movement (e.g. dispersal, foraging, and migration) or as a source of food and nutrients. Compared to strictly terrestrial and aquatic organisms, species that regularly occupy the aerosphere are almost immediately influenced by changing atmospheric conditions (e.g. pressure, wind, air density,

precipitation, temperature), and other physical factors (e.g. solar radiation, polarized light, moon light, and geomagnetic and gravitational forces). Aeroecology is a discipline that embraces and integrates the domains of atmospheric science, ecology, earth science, geography, computer science, computational biology, and engineering to study the functioning of the aerosphere and of all the organisms that depend upon this environment (Kunz et al., 2008).

A) The aerosphere as a habitat

Habitat is a difficult notion to define in ecology, and earlier definitions were describing habitat as a “fixed” station characterised by some geographical features or plant communities, an idea originally formulated by Linnæus (1754). However, more recent and more generalizable definitions of habitat offer some reference to occupancy or resources that promote occupancy (e.g. Hall et al., 1997; Dennis et al., 2006). The definition given by Morrison et al. (2006) is among the more precise and generalizable, calling habitat an “area with a combination of resources and environmental conditions that promotes occupancy by individuals of a given species that allows individuals to survive and reproduce.” The airspace satisfies criteria in this broad definition of habitat in that it contains resources that promote occupancy. These include food, mates, opportunities to avoid predators, and a low friction, relatively uncluttered medium enabling efficient travel (Diehl, 2013; Diehl et al., 2017).

As discussed earlier, the common swift can stay completely airborne for 10 months (Hedenström et al., 2016), which means that the aerosphere alone provides all the resources required to sustain the swift’s biology, including food (aerial arthropods) and sleep. Just like a terrestrial amphibian only uses the water to breed, common swifts appear to need land almost only to support their nests and eggs, an extreme example of adaptation to life in the aerosphere (Diehl et al., 2017). At microscopic scale, the aerosphere is also full of pollen, bacteria, fungi, and protists (Després et al., 2012). The airspace is also a habitat for microbial communities that spend generations aloft before settling back to the surface after metabolizing, undergoing selection, and reproducing (Womack et al., 2010).

As for any other habitat, birds living and moving in the aerosphere are able to select favourable habitats providing resources in support of some critical behaviours such as foraging or migration. For example, migrating birds choose routes and weather conditions that allow them to manage the conflicting goals of minimizing travel time, energy expenditure, and risk (Alerstam and Lindström, 1990). These birds often respond to wind support more than temperature and humidity when selecting the routes and altitudes for their movements (Liechti et al., 2000). For example, to assist their long-distance migrations over the Pacific Ocean, bar-

tailed godwits time their departure to coincide with weather likely to produce tailwinds (Gill et al., 2009). Some soaring birds, such as the golden eagle (*Aquila chrysaetos*), react to increasing wind speeds by switching from thermal soaring to slope soaring, and by restricting their flight to a narrow range of speed and altitude (Lanzone et al., 2012).

Habitat selection results from the relationship between the costs and benefits of occupancy. For instance, during nocturnal migration, birds appear to select the lowest altitude where they first encounter supportive wind conditions even if better winds occur at higher altitudes (Mateos-Rodríguez and Liechti, 2012). Birds are probably unwilling to spend more energy to seek out potentially more advantageous flying conditions, suggesting that frequent altitude changes in search of optimal flying conditions may be costly.

Birds flying through the aerosphere are thus experiencing a wide diversity of habitats with specific costs and benefits. Their environment can be understood as an “energy landscape” (Shepard et al., 2013) where heterogeneous localities offer different costs of transport. The aerosphere is an environment varying extremely quickly compared to terrestrial habitats, and the organisms occupying it have to be very flexible in order to adapt to these changes. In terms of the impact on organismal movement, still air rapidly changing to a strong wind is comparable to a grassland switching to a mature forest within a few hours (Shepard, 2022).

B) Foraging flight in aerial insectivores

Aerial insectivores (such as swifts, swallows and martins) catch most of their prey in flight, their foraging behaviour should thus be very sensitive to atmospheric conditions. For example, temperature, solar radiation and humidity influence the availability and movement patterns of aerial insect prey (Lack and Owen, 1955; Bryant, 1973b; Wainwright et al., 2017). Besides, aerial insectivores are able to extract energy from aerial habitats, such as barn swallows gaining kinetic and potential energy with wind gradients (Warrick et al., 2016), or common swifts using thermal updrafts while foraging (Hedrick et al., 2018). The availability of external energy sources such as thermal updrafts is also influenced by atmospheric conditions (Poessel et al., 2018), so it appears that the aerial environment provides both food and non-food sources of energy for aerial insectivores.

Aerial prey can also occur in patches, and a “volume-concentrated” search strategy has been shown in the common swift (Fig. 31; de Margerie et al., 2018), similar to the area-concentrated search classically described in terrestrial species. Indeed, common swifts adopt a tortuous path when they capture prey in order to take advantage of the patchy distribution of aerial arthropods, for example in thermal updrafts.

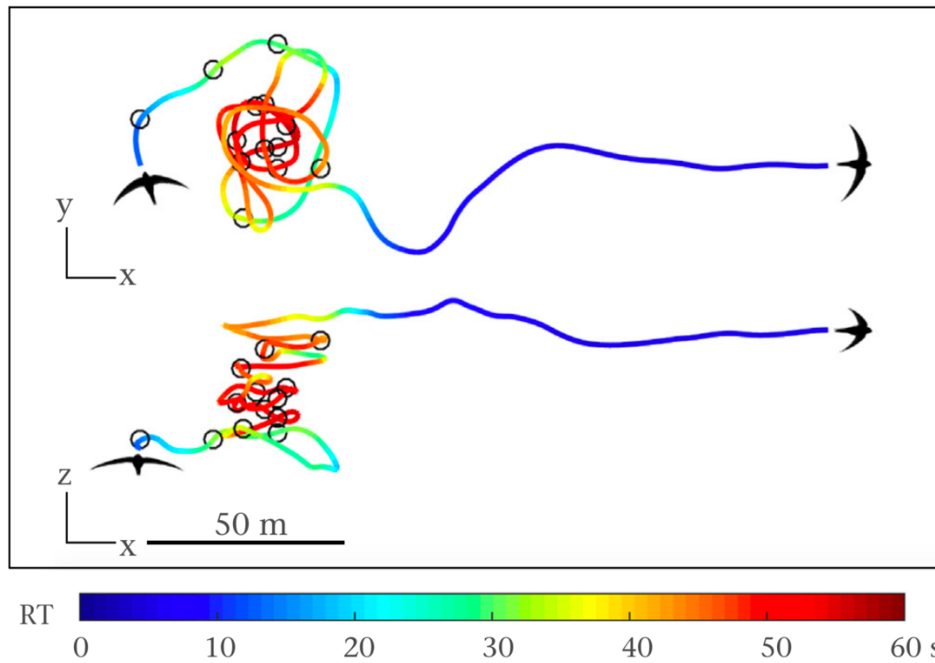

Figure 31: Volume-concentrated search in the common swift (de Margerie et al., 2018). Top view (x/y) and side view (x/z) of a trajectory. Black circles indicate atypical postures associated with putative prey captures. Residence time (RT) is a measure of path tortuosity. Swifts increase their path tortuosity when they find a prey, thus exploiting the patchy distribution of aerial arthropods.

However, some resources may be more difficult to obtain for species almost exclusively living in the aerosphere. For example, liquid water is not readily accessible in the air, and common swifts would have troubles to land on the bank of a waterbody to simply drink like most birds do, because their short legs make them especially clumsy and vulnerable on the ground, and they would have to spend a lot of energy to take flight again from flat ground by pushing on their long wings (Lack, 1956). Instead, swifts are able to drink by swallowing rain drops (Bersot, 1931), but more generally they are often seen descending to waterbodies and gliding over them until they get close enough to open their beak and skim over the surface to get some water. This behaviour requires a very precise control of the flight trajectory, and this example shows how an extreme adaptation to the aerosphere can complicate some behaviours considered to be basic in most terrestrial species, calling for even more refined adaptations and flight behaviours.

VII. Objectives

A) Description of flight behaviours at a local scale in aerial insectivores

Flight behaviours have been studied at a global scale in a variety of contexts and species. Comparatively, quantitative studies investigating biomechanical and energetic questions at a local scale and higher spatio-temporal resolution remain underrepresented in the bird flight literature, possibly due to the technical challenges of conducting such studies in the field. In this manuscript, our first goal is to describe the flight behaviours of two aerial insectivores at a local scale: the common swift and the house martin. These aerial insectivores spend most of their life on the wing, and studying their local behaviours should give significant insights on behavioural adaptations to flight.

During the breeding season, both of these species are colonial and nest in large numbers at specific sites (see Chapter 2 for more details). They also occur in large groups during foraging or drinking behaviours, allowing to sample large numbers of individuals in predictable places.

Using the rotational stereo-videography technique (RSV; see Chapter 2 for more details), we studied the flight behaviours of common swifts when they drink on the wing, by skimming over the water surface, and the foraging flight of house martins near their colony. This technique allowed us to obtain 3D flight trajectories where various biomechanical variables could be calculated, allowing to quantitatively describe these flight behaviours and to study energy savings and expenditures during critical behaviours.

B) Energy savings and expenditures

As described in Section VI.B, aerial insectivores use various mechanisms to reduce their energy expenditures in flight, and studying local flight behaviours in the common swift and the house martin can help us to understand if different species fit within this general adaptation to aerial habitats in different contexts, and how energy savings could be modulated by other constraints.

For the common swift, the goal was to test the following hypothesis: do swifts use an energetically optimal strategy when drinking? The drinking behaviour of swifts often starts with a gliding descent, so if they minimize their energy expenditures, they should efficiently convert their potential energy to kinetic energy, and should thus reach water surface at high speed. After contact with water, this kinetic energy would help the bird to regain height with less energy expenditures and a minimal need to use flapping flight.

Alternatively, swifts may not benefit from conserving their mechanical energy efficiently, if approaching water at high speeds reduces their manoeuvrability or increases the risk of falling into water. To test this alternative hypothesis, we also investigated possible braking methods (sharp turns, use of headwind) in order to understand if braking occurs and how it may occur.

For the house martin, the aim was to test whether they use external energy sources during foraging to save energy (e.g. common swifts use thermals; Hedrick et al., 2018; and barn swallows use wind gradients; Warrick et al., 2016). Besides, the effect of wind speed and direction on the airspeed of foraging house martins was also studied in order to test whether they fit within the general theory of optimal cost of transport (described in Section III.C), increasing their airspeed when flying upwind and decreasing it when flying downwind.

C) Flight ontogeny

As explained in Section IV (Article 1), the ontogeny of flight behaviours remains understudied in the field, and another goal of our study was to combine the biomechanical measurements allowed by the RSV with an identification of juvenile individuals.

House martins were recorded near their breeding colony, and our study included the fledging period, when juveniles take flight for the first time. Our aim was to identify juvenile house martins and to compare their flight behaviours with adults in order to identify potential differences due to an immature flight anatomy or a lack of experience.

These three main objectives combined were chosen to obtain a more comprehensive view of flight behaviours in aerial insectivores at a local scale, and of their development within an individual.

Chapter 2: General methods

I. Study species

A) Common swift

1) Phylogeny and distribution

The common swift (*Apus apus*), belongs to the family Apodidae, comprising 112 species separated in 18 genera, which are all characterised by an aerial lifestyle (Winkler et al., 2020a). The genus *Apus* includes 21 species of swifts (Winkler et al., 2020a). Apodidae have traditionally been placed in the order Apodiformes (including swifts and hummingbirds), but recent phylogenetic studies have placed Apodiformes, along with Caprimulgiformes (nightjars and allies), in a more monophyletic superorder named Strisores (Barrowclough et al., 2006; Braun and Huddleston, 2009; Mayr, 2010, 2011; White and Braun, 2019). Most species of Apodidae occupy tropical regions, only 3 species breed in Europe (the common swift; the pallid swift, *Apus pallidus*; and the alpine swift, *Apus melba*), and only the common swift reaches Northern Europe (Lack, 1956; Chantler et al., 2020a; b; c; Winkler et al., 2020a).

Even if swifts, swallows and martins have some similarities in their morphology and behaviours, they are not closely related species (Fig. 32), and their similarities can be explained by an evolutionary convergence due to the way of life of these aerial insectivores.

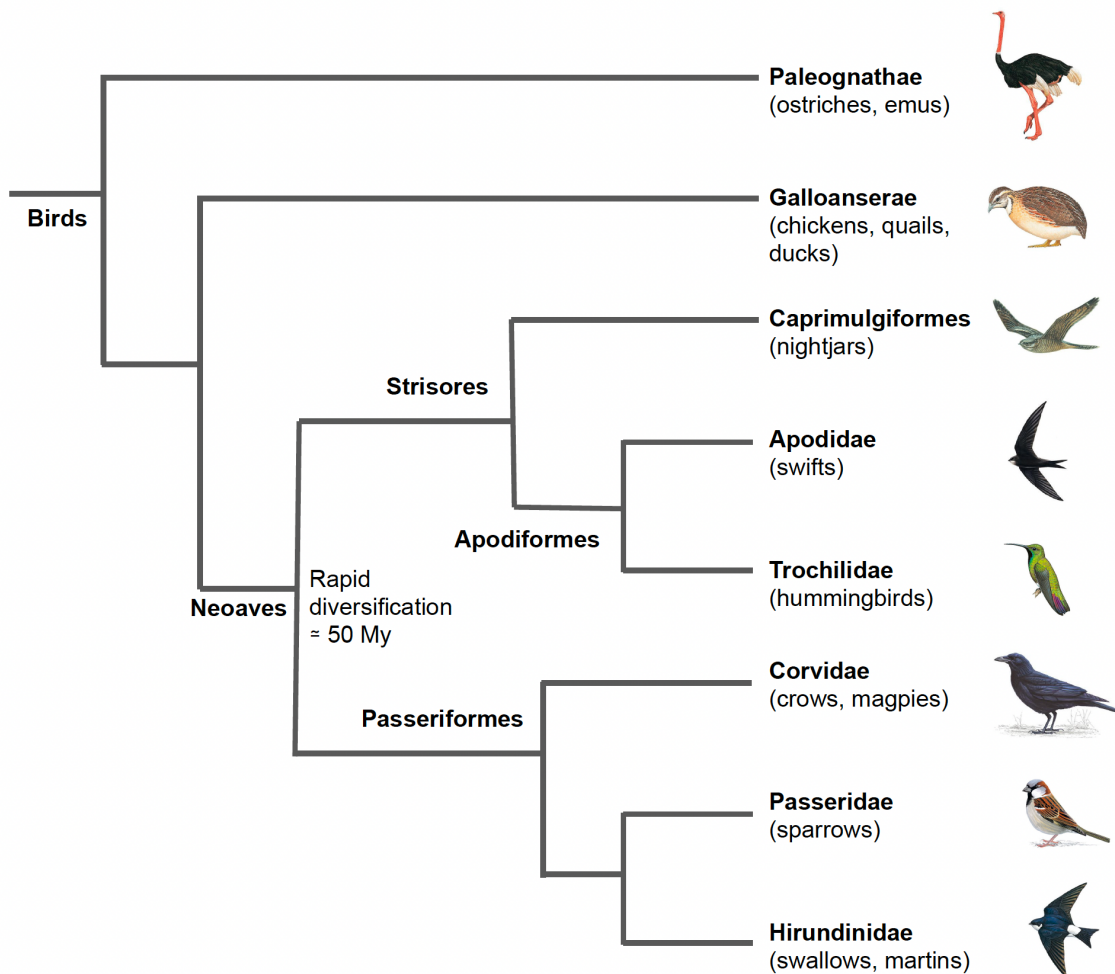

Figure 32: Simplified phylogeny of the two study species (Ericson et al., 2006; White and Braun, 2019). Despite their relative similarity in terms of morphology and lifestyle, the common swift and the house martin belong to two different orders, and their most recent common ancestor might be as old as 50 My. This is a case of evolutionary convergence.

The common swift's breeding range extends from Northern Africa to Fennoscandia by covering most of Europe. It extends eastwards into Russia, Mongolia and China (Fig. 33). The common swift is further subdivided into 2 subspecies: *A. a. apus* in the western part of its range (Europe and Africa), and *A. a. pekinensis* in the eastern part (Asia). The common swift is a migratory bird, and its wintering range covers most of subtropical Africa, but *A. a. apus* winters primarily from DR Congo and Tanzania to Zimbabwe and Mozambique, while *A. a. pekinensis* winters primarily in Namibia and Botswana (Chantler et al., 2020a).



Figure 33: Distribution of the common swift (Chantler and Boesman, 2013; BirdLife International, 2016).

2) Morphology and ecology

The common swift has a body length from 16 to 18 cm and weights between 31 and 52 g with a wingspan between 42 and 48 cm in adult birds. Its main morphological characteristics are its forked tail, long and pointed wings, and a predominantly black-brown plumage with paler inner wings and a white patch on the throat (Fig. 34). The common swift has no sexual dimorphism, but juveniles exhibit a more defined white throat-patch (Chantler et al., 2020a).



Figure 34: Common swift in flight (photograph by Pau Artigas).

The common swift has a wide range of habitats and can occupy Mediterranean, temperate and boreal zones, occurring from sea level to altitudes higher than 3,000 m. This bird nests mainly in holes in walls or under the roof of buildings, but sometimes in tree hollows and rock crevices (Fossé and Roger, 2001). It often nests colonially, but solitary nests are not infrequent. This aerial insectivore feeds on various invertebrates taken in flight, mainly Homoptera (aphids), Diptera (flies) and Coleoptera (beetles; Lack and Owen, 1955; Gory, 2008). The common swift is also characterised by an extremely aerial lifestyle, with almost all of its behaviours being performed in flight: food and nest materials (Gory, 1994) are captured in the air, water is taken in flight by skimming over the surface of a body of water (Bersot, 1931), and even mating can occur in the air (Lack, 1956). In the breeding season, non-breeding individuals spend the night in the air (Bäckman and Alerstam, 2001, 2002), while breeding adults roost in the nest (Lack, 1956). Outside of the breeding season, the common swift may spend 10 months on the wing, most probably sleeping in flight (Hedenström et al., 2016). On the ground, however, the common swift is much less agile because of its long wings and short legs, so it is only able to crawl when moving in the nest cavity (Lack, 1956). Some individuals sometimes roost for the night by clinging on walls or trees, most often newly fledged juveniles constrained by harsh and cold weather (Fig. 35; Lack, 1956; Holmgren, 2004).



Figure 35: Juvenile common swift clinging on a wall (photograph by Miroslav Hlavko).

3) Breeding and population dynamics

The breeding season ranges from mid-February to June in southern latitudes like Israel (Amichai and Kronfeld-Schor, 2019), and from late May to August in northern latitudes like Fennoscandia (Lack, 1951; Tigges, 2007). Hence, the duration of stay is shorter in northern regions (Tigges, 2007). In northern France, the first migrating individuals are seen in mid-April, and the breeding season usually starts in May. The common swift is socially monogamous and usually breeds in colony. Swifts are sexually mature at the age of 2 or (more often) 3 years, but non-breeding birds are faithful to a colony throughout the breeding period, and potentially search for available nest holes. They are also involved in “screaming parties”, a social behaviour where they fly at high speeds around the colony with loud vocalizations, probably to defend it against intruders from other colonies (Farina, 1988). In all parts of its range, the common swift usually lays one clutch per year, but sometimes lays a second clutch when the first one is lost (Lack, 1956). Each breeding pair lays 1 to 4 eggs, incubated for about 20 days (Gory, 1992). One egg is laid every two to three days, and the parents start to actively incubate

their clutch after the last egg has been laid (Lack, 1951). However, earlier eggs are warmed by their parents during the night, so there is often a difference of one day between the hatching date of each egg (Lack, 1951). After hatching, nestlings (Fig. 36) are fed by both parents with invertebrate food balls (Carere and Alleva, 1998). If the weather is good, swifts may fledge as early as 37 days after hatching, but they can also stay in the nest until 56 days in bad weather conditions (Lack, 1951). Juvenile swifts leave the nest on their own and do not receive post-fledging parental care (Lack, 1956).



Figure 36: Common swift nestlings (photograph by Tonio Schaub).

The common swift is classified as a Least Concern (LC) due to its wide range and large populations (BirdLife International, 2022a). Between 1980 and 2019, the European population trend was estimated as stable (EBCC, 2021), but breeding populations have been reported to decrease in several European countries (Eaton et al., 2009; Crowe et al., 2010), possibly due to a reduction of nesting sites caused by modern building techniques, which has been associated with local declines (Braun, 1999; cited in Schaub et al., 2016). Installing nest boxes has been suggested as a compensatory measure for nest-sites loss (Schaub et al., 2016).

A) Common house martin

1) Phylogeny and distribution

The common house martin (*Delichon urbicum*) belongs to the genus *Delichon* which comprises 3 species of house martins (Winkler et al., 2020b). The two other species of *Delichon* (Asian house martin, *Delichon dasypus*; and Nepal house martin, *Delichon nipalense*) are found in Asia and do not breed in Europe. This genus is included in the family Hirundinidae, comprising 86 species of swallows and martins separated in 19 genera, which are all aerial insectivores (Winkler et al., 2020b). This family belongs to the order Passeriformes, the largest bird order comprising more than half of bird species (Frank et al., 2020). The greatest number of Hirundinidae species is found in Africa, which is probably the place where swallows and martins originated, but only the barn swallow (*Hirundo rustica*) and the sand martin (*Riparia riparia*) have colonised both sides of the Atlantic (Turner and Rose, 2010).

The house martin's breeding range extends from Northern Africa to Fennoscandia by covering most of Europe. It extends eastwards into Russia, Mongolia and China (Fig. 37). The house martin has two Western subspecies: *D. u. urbicum* (Europe and Siberia) and *D. u. meridionale* (Southern Europe, Northern Africa and Western Asia), and an Eastern subspecies *D. u. lagopodum* (Eastern Asia). The house martin is a migratory bird, and the Western subspecies winters mainly in sub-Saharan Africa, while the Eastern subspecies probably winters mainly in Southeast Asia (del Hoyo et al., 2020).



Figure 37: Distribution of the common house martin (Turner, 2004; BirdLife International, 2017).

2) Morphology and ecology

Adult house martins have a body length of 13 to 14 cm, weight between 10 and 23 g, and have a wingspan between 26 and 29 cm. They are characterised by a moderately forked tail, glossy blue crown and back (especially in breeding males), black tail and wings, white rump and wholly white below (Fig. 38). Females have greyer underparts than males, and juveniles are duller and browner (del Hoyo et al., 2020).



Figure 38: Common house martin in flight (photograph by Eric Francois Roualet / Macaulay Library at the Cornell Lab of Ornithology; ML205007451).

The house martin occupies various habitats: mainly open areas, coastal cliffs, cultivated lands, towns and cities, but also mountainous areas up to 4,500 m in Asia (del Hoyo et al., 2020).

3) Breeding and population dynamics

The breeding season starts in March in Southern Spain and Northern Africa, in May in most of Europe, and ends in September (del Hoyo et al., 2020). In urban environments, house martins often build their nest on buildings (under eaves, under the ledges of balconies or directly on window frames) and they tend to select areas with a larger proportion of open space, and closer to the nearest source of food or mud (Murgui, 2002). The nest is a cup made of mud pellets with a small entrance hole near the top (Fig. 39). The house martin is socially monogamous and nest in colonies, in which both sexes build the nest and incubate (Bryant, 1979; Whittingham and Lifjeld, 1995; del Hoyo et al., 2020). They lay up to three clutches per year, and each clutch is composed of one to seven (most often four to five) eggs (del Hoyo et al., 2020).



Figure 39: House martin nests (photograph by Frederik Albrecht / Macaulay Library at the Cornell Lab of Ornithology; ML488869251).

Incubation lasts around 15 days and hatching is often asynchronous, but most clutches completely hatch within one or two days (Bryant, 1973a). Both parents feed the chicks with invertebrates mostly taken in flight (Bryant and Turner, 1982). Fledging occurs between 22 and 32 days after hatching, depending on brood size and weather. Juveniles (Fig. 40) are still fed by their parents several days after fledging, and they return to the nest to roost for several days (del Hoyo et al., 2020).



Figure 40: Juvenile house martins (photograph by Greg Baker / Macaulay Library at the Cornell Lab of Ornithology; ML365922781).

The house martin is classified as a Least Concern (LC) due to its wide range and large populations (BirdLife International, 2022b). Between 1980 and 2019, the European population was estimated to be in moderate decline, but was stable between 1996 and 2019 (EBCC, 2021). Breeding populations have been reported to decrease in some European countries, such as the United Kingdom (Harris et al., 2020). Mechanisms underlying these declines remain largely speculative, although they are probably related to a decrease in insect food availability (Kettel et al., 2021).

II. Rotational stereo-videography

A) Recording device and basic principles

Rotational stereo-videography (RSV) is an optical tracking technique based on a set of mirrors projecting a stereo image of the animal on the sensor of a single camera (Fig. 41; de Margerie et al., 2015). The camera and mirrors can rotate horizontally and vertically on a tripod and fluid video head. While the operator rotates the device to keep the moving animal's image within the sensor frame, the aiming angles are recorded by angular encoders. The analysis of

the lateral shift between animal image pairs provides a measure of the distance to the animal. The mathematical combination of distance, aiming angles and angular deviation from the optical axis yields a 3D record of the animal's movement (Fig. 42).

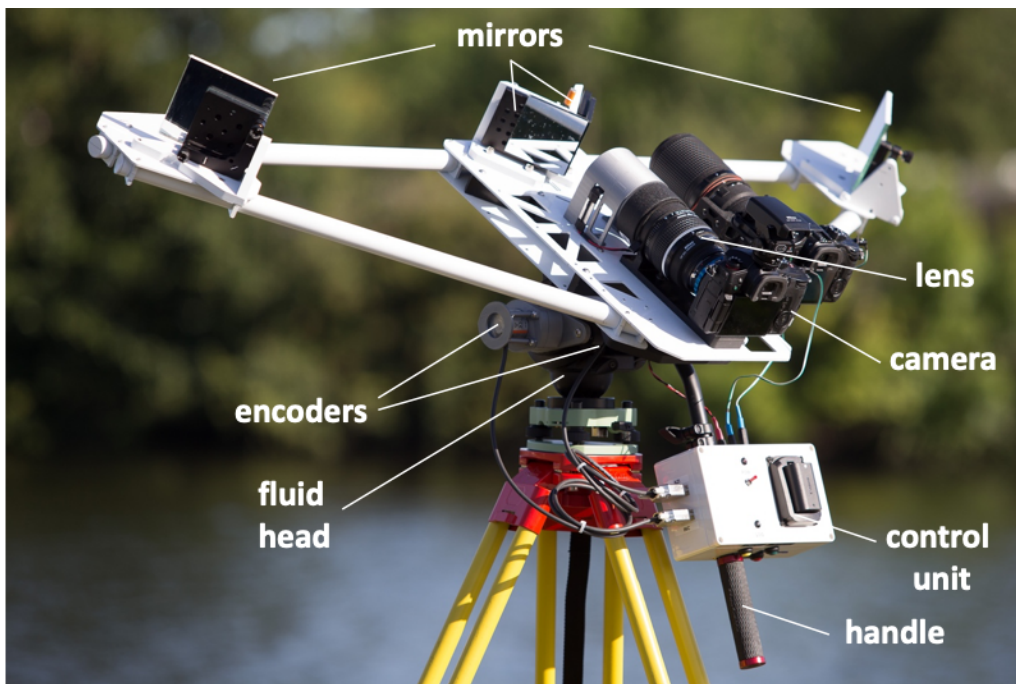

Figure 41: Rotational stereo-videography (RSV) device. Rigid assembly of a camera and a set of mirrors rotating on a tripod with a fluid video head equipped with angular encoders. A second camera is visible on the right side, and was used to take pictures of the filmed birds with a greater magnification.

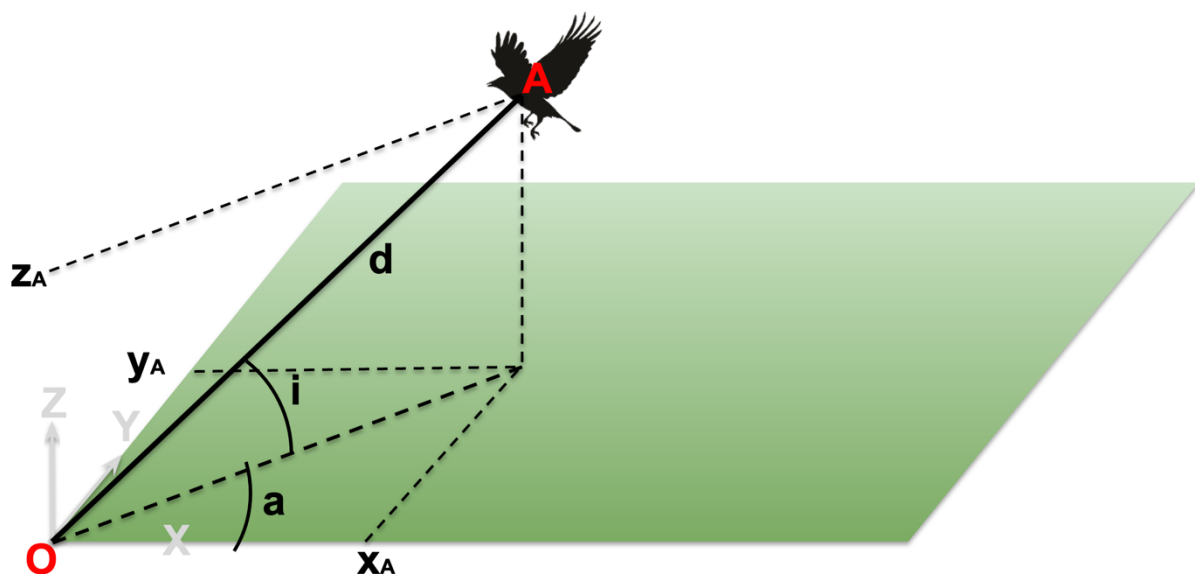

Figure 42: Schematic of the measurements of coordinates using RSV. The coordinates of the animal (A) are measured relative to the observer (O). Circular coordinates are distance (d , in m), inclination (i , in rad) and azimuth (a , in rad). The circular coordinates of the animal can then be converted to Cartesian coordinates on the X, Y and Z axes (x_A , y_A and z_A), allowing to reconstruct 3D trajectories.

Azimuth and inclination angles are measured by the angular encoders, and later corrected according to the animal's position in the frame. However, the distance measurement relies on the animal's image shift between left and right images (ΔX). Thus, the precise position of the bird needs to be defined twice on each frame (left and right position, Fig. 43). To digitize the bird's locations in the video frames, the pixel at the centroid of the bird's body in the left half of each video frame was selected as the left point of interest (POI), either manually or with the help of semi-automatic tracking (DLTdv; Hedrick, 2008). Fully automated selection of left POI was initially tested, but appeared to be inefficient because of highly variable image backgrounds (sky, foliage, water). Then, automated normalized cross-correlation between a defined area around the left POI and the right image was used to find the corresponding right POI. Automated matching of right POI could also be misled by variable backgrounds, and thus was visually checked and manually corrected when needed.

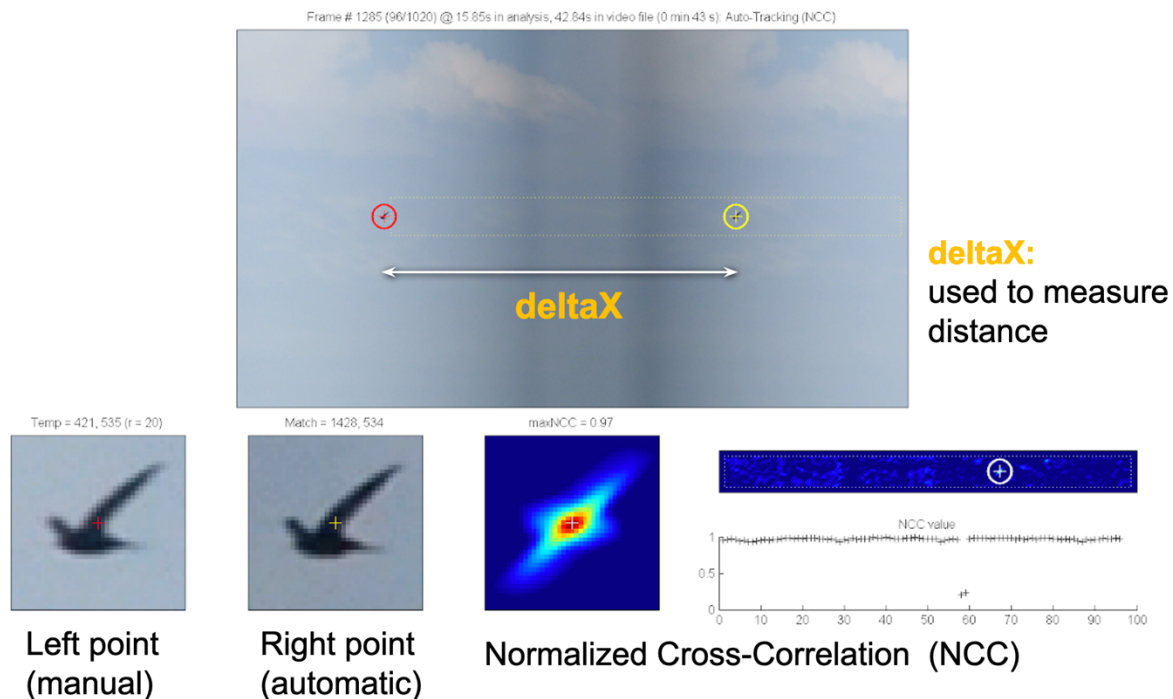

Figure 43: Example of lateral shift (ΔX) calculation using left and right images. The top panel is an example of a video recording of a common swift, with the left and right parts of the image (stereo-video). The left point is defined manually, and the right point is automatically matched by maximising normalized cross-correlation. The bottom left panels show a magnified view of the left and right points, and the bottom right panels show NCC values calculated on each pixel (warmer colours correspond to higher values). The pixel with the highest NCC is designated as the right point of interest. ΔX (the number of pixels separating the two points in the horizontal axis) is then calculated.

As explained in Chapter 1, RSV allows high sampling frequencies (up to 60 Hz or more depending on the camera's frame rate). However, more frames per second mean more points to digitize manually (longer time for analysis), and very high sampling frequencies do not necessarily improve the 3D trajectory significantly (oversampling). Thus, a trade-off has to be

found between temporal resolution and analysis time. For both studies, the sampling frequency was adapted depending on the specific questions and the total duration of each set of trajectories (respectively 60 and 10 Hz sampling frequencies, see Articles 2 and 3).

B) Calibration of distance measurement

The distance measurement needs to be calibrated in order to convert the lateral shift (ΔX) of each position to a real distance. For this purpose, we recorded four or five conspicuous targets on each recording site (signs, street lamps, structures on building roofs) located at fixed and known distances (measured with a Nikon Forestry Pro laser rangefinder). Theory shows that the relationship between ΔX and distance is an inverse curve (de Margerie et al., 2015), so from the 4 or 5 calibration points, we fitted an inverse model that served as a reference curve for computing distance from ΔX for each bird position (Fig. 44).

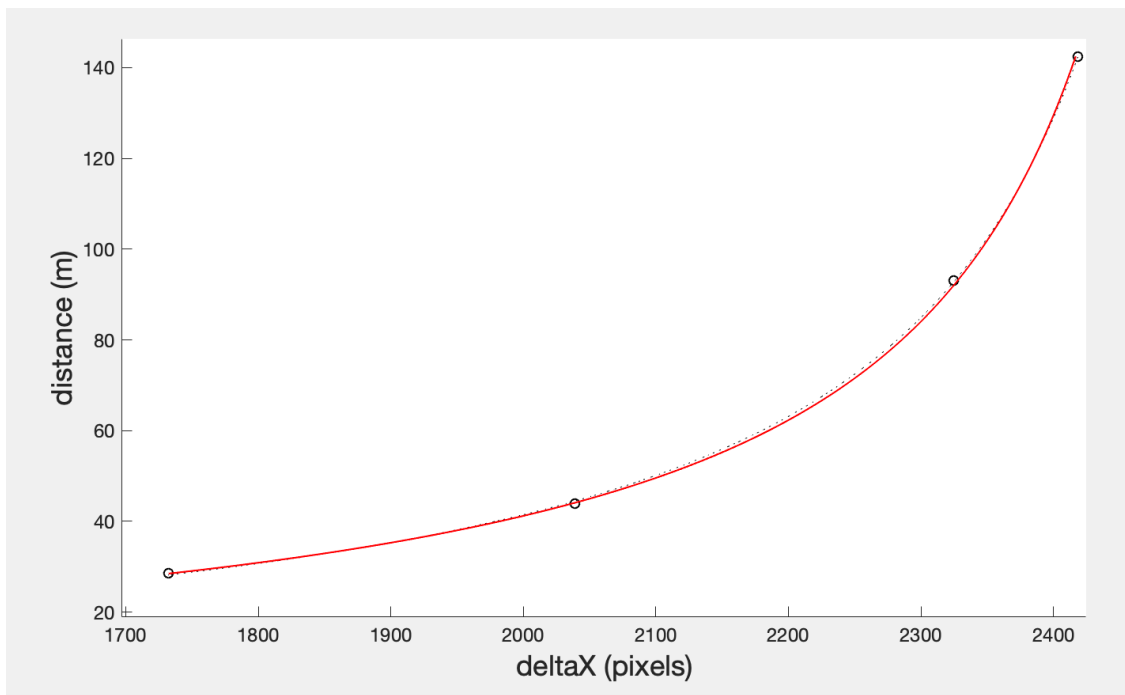

Figure 44: Example of a reference curve constructed from four calibration points. The graph represents the link between ΔX measured on a recorded picture (horizontal axis) and the real distance to the object (vertical axis). 4 calibration points (black circles) are used, for which both ΔX and the real distance are known. An inverse-curve model is fitted to the points to construct a reference curve for the recording session (red). Note that measured distance grows non-linearly with increasing ΔX , limiting the range of precise tracking. The further away the animal is, the greater the distance quantum represented by one pixel in ΔX .

C) Smoothing, output trajectory and behavioural observations

After spherical coordinates calculation, the time series of raw spatial positions contains some noise due to theoretical positioning uncertainty from space quantization (uncertainty

increasing with distance, see Fig. 44), and from random error. This random error is partly explained by slight mismatches between the left and right points (for example due to a textured background). Positional data containing noise can be an even greater problem when studying speed (more noise with first derivative) and acceleration (even more noise with second derivative). Hence, we smoothed the raw spherical coordinate series using quintic splines. These splines also interpolated short (≤ 10 frames) track bouts where the bird was out of frame. Smoothing techniques are often applied on kinematic and biomechanical datasets recorded in field or laboratory conditions (Bundle and Dial, 2003; Warrick et al., 2016; Hedrick et al., 2018). This smoothing step was done in collaboration with Prof. T.L. Hedrick from the University of North Carolina.

A major concern when smoothing positional data is over-smoothing, which could artificially erase real turns in the trajectories. Thus, in both studies, we carried out all our graphical and statistical analyses using three different smoothing tolerance values: a “low smoothing” where the trajectories were efficiently smoothed, but where significant noise remained in speed and acceleration, an “intermediate smoothing” where noise was decreased in speed and acceleration while still fitting closely to the raw track, and a “high smoothing” where noise was even more reduced but where trajectories showed some signs of over-smoothing. We retained the intermediate smoothing for all flight trajectories, as a reasonable compromise between a preserved positional signal and a realistic speed signal. However, the choice of the smoothing tolerance had no effect on our main graphical and statistical results (see Articles 2 and 3), which indicates the robustness of our results.

Smoothed spherical coordinates were then converted to Cartesian coordinates (X, Y, Z) without additional smoothing. The 3D trajectories were reconstructed using these coordinates, and these trajectories were used to study primary variables (e.g. altitude) or secondary variables derived from calculations (e.g. speed, power). Behavioural information could be extracted from the video recordings, such as flight mode (flapping or gliding, e.g. Fig. 45).

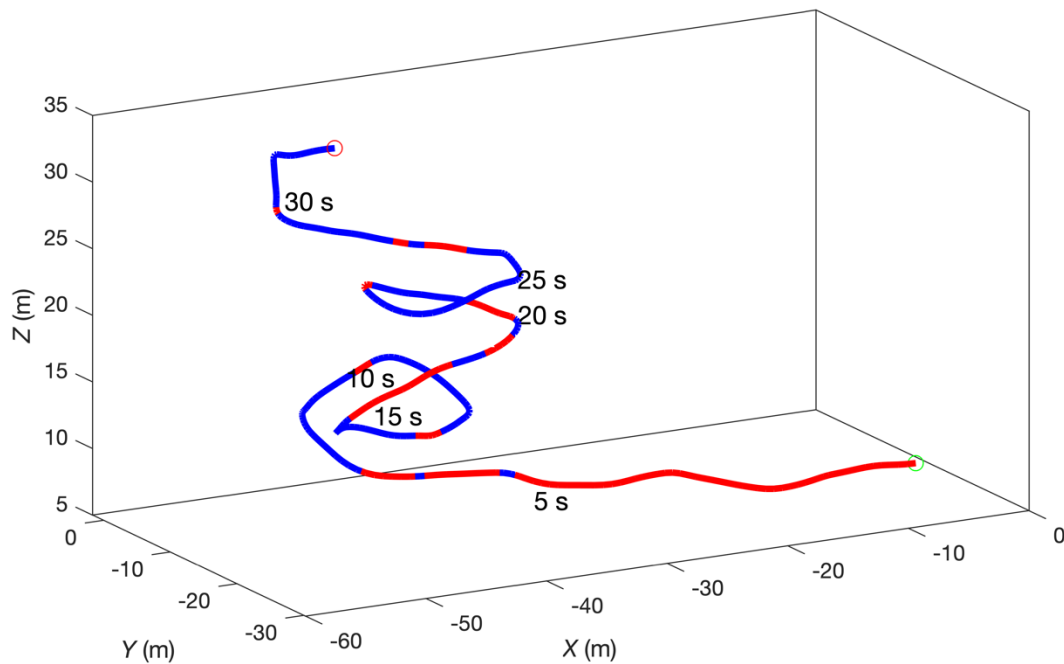

Figure 45: Example of the 3D view of a house martin's trajectory. Gliding is represented by blue segments and flapping by red segments. A temporal indication is shown every 5 s. The green circle is the beginning of the trajectory, and the red circle is the end.

D) Weather data

As described in Chapter 1, environmental variations in the aerosphere (for example due to weather variations) have important implications for birds, especially aerial insectivores. In order to study the effect of wind (Articles 2 and 3) and other weather variables (Article 3) on flight behaviours of the study species, a weather station with ultrasonic anemometer was set up on a tripod during each field session (Fig. 46). The anemometer was placed at 2 m height above the ground, in an open area with no major obstacle to the wind. The weather station recorded wind speed, wind direction, temperature, solar radiation, humidity and atmospheric pressure. All variables were recorded at 1 Hz, and were averaged over the duration of each trajectory.



Figure 46: Weather station during a field session.

Chapter 3: Drinking flight in the common swift

Article 2:

**Drink safely: common swifts
(*Apus apus*) dissipate
mechanical energy to
decrease flight speed before
touch-and-go drinking**

Résumé en français

Le vol est un mode de déplacement efficace quand on considère la distance parcourue par rapport à l'énergie dépensée, mais il peut être très coûteux pour chaque unité de temps. Ainsi, réduire les dépenses énergétiques en vol est une pression sélective majeure chez les oiseaux. Le martinet noir (*Apus apus*) est un des oiseaux les plus aériens, presque tous ses comportements se font en vol. Il effectue sa recherche alimentaire en volant, peut dormir en volant, et peut même boire en volant. Les martinets descendent en effet régulièrement sur des plans d'eau et en effleurent la surface avec leur bec pour boire. Pour réaliser un tel comportement sans dépenser trop d'énergie, les martinets devraient s'efforcer de conserver leur énergie mécanique en transformant leur énergie potentielle en énergie cinétique, ce qui leur permettrait de toucher l'eau à grande vitesse et de regagner de l'altitude avec un travail musculaire minimal.

En utilisant une méthode de suivi optique 3D, nous avons enregistré 163 trajectoires de boisson de martinets noirs sur trois plans d'eau autour de Rennes. Contrairement à l'hypothèse de conservation de l'énergie, nous montrons que les martinets qui approchent un plan d'eau avec une énergie mécanique plus élevée (altitude ou vitesse plus élevée 5 s avant le contact avec l'eau) ne touchent pas l'eau à une vitesse plus élevée, mais montrent des signes de freinage (dissipation d'énergie mécanique pour perdre à la fois de l'altitude et de la vitesse). Le freinage est en partie lié à des virages serrés et à l'utilisation du vent de face, mais des virages moins marqués et des ajustements posturaux, trop fins pour être détectés avec la résolution de nos données, pourraient aussi être impliqués.

Nous émettons l'hypothèse que ce comportement étonnamment coûteux est le résultat d'un trade-off entre la performance énergétique en vol et la sécurité, car approcher la surface de l'eau demande un contrôle moteur précis, et une vitesse élevée augmente le risque de tomber à l'eau, ce qui représenterait un surcoût significatif en énergie et un risque pour la survie d'un martinet.

Complete summary

Context

- The common swift (*Apus apus*) is an aerial insectivore performing most of its behaviours in flight (foraging, sleeping, drinking).
- Various strategies are known in aerial insectivores to reduce energy expenditures in a variety of contexts (e.g. energy extraction from thermal updrafts or wind gradients).
- In order to drink, swifts descend to waterbodies and skim over the surface, a behaviour which probably requires fine motor control.
- If they prioritize energy savings, swifts should conserve their mechanical energy by transforming potential energy to kinetic energy during the gliding descent, touching water at high speed, and regaining height with minimal muscular work.



(Photograph by Emmanuel de Margerie).

Methods

- RSV device to record 3D trajectories.
- 25 field sessions from May to July 2020.
- 3 waterbodies around Rennes.
- **163 trajectories.**
- Wind speed and direction.

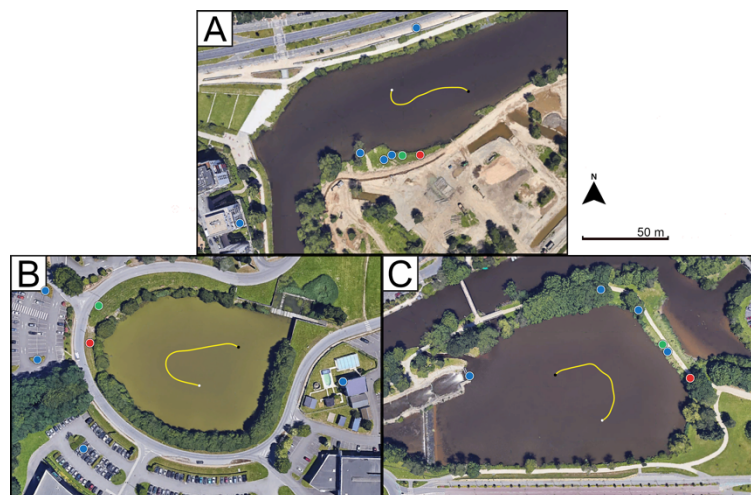

Aerial view of recording sites.

Main results

- Swifts approaching drinking site with a higher mechanical energy (higher height and/or speed 5 s before contact) do not reach water at higher speeds, but do brake, i.e. dissipate mechanical energy to lose both height and speed.
- Braking is linked with sharp turns and the use of headwind to some extent.

Conclusions

- Swifts do not use an energetically optimal strategy when drinking, possibly due to a trade-off between energy expenditure and safety.
- Approaching water surface requires fine motor control, and high speed increases the risk of falling into water, which would have serious energetic and survival costs for a swift.

Article

Drink safely: common swifts (*Apus apus*) dissipate mechanical energy to decrease flight speed before touch-and-go drinking

Geoffrey Ruaux¹, Kyra Monmasson¹, Tyson L. Hedrick², Sophie Lumineau¹ and Emmanuel de Margerie¹

¹Univ Rennes, Normandie Univ, CNRS, EthoS (Éthologie animale et humaine) - UMR 6552, F-35000 Rennes, France.

²University of North Carolina at Chapel Hill, Chapel Hill, NC 27599, USA.

Corresponding author: Emmanuel de Margerie

e-mail: emmanuel.demargerie@univ-rennes1.fr

Article submitted to *The Journal of Experimental Biology*.

Keywords: air-brake, wind, kinematics.

Summary statement: This study shows that common swifts actively dissipate their mechanical energy before touching water when they drink in flight, possibly due to a trade-off between energy expenditures and safety.

Abstract

Flight is an efficient way of transport over a unit of distance, but it can be very costly over each unit of time, and reducing flight energy expenditures is a major selective pressure in birds. The common swift (*Apus apus*) is one of the most aerial bird species, performing most behaviours in flight: foraging, sleeping, and also drinking by regularly descending to various waterbodies and skimming over the surface. An energy-saving way to perform such touch-and-go drinking would be to strive to conserve mechanical energy, by transforming potential energy to kinetic energy during the gliding descent, touching water at high speed, and regaining height with minimal muscular work. Using 3D optical tracking, we recorded 163 swift drinking trajectories, over three waterbodies near Rennes, France. Contrarily to the energy conservation hypothesis, we show that swifts approaching a waterbody with a higher mechanical energy (higher height and/or speed 5 s before contact) do not reach water at higher speeds, but do brake, i.e. dissipate mechanical energy to lose both height and speed. Braking seemed to be linked with sharp turns and the use of headwind to some extent, but finer turns and postural adjustments, beyond the resolving power of our tracking data, could also be involved. We hypothesize that this surprisingly costly behaviour results from a trade-off between energy expenditure and safety, because approaching water surface requires fine motor control, and high speed increases the risk of falling into water, which would have serious energetic and survival costs for a swift.

Introduction

Flight is a locomotion mode which deeply influences the anatomy and behaviour of many bird species (Norberg, 1990; Podulka et al., 2004; Ruaux et al., 2020). While flight is a very efficient way to transport a unit of mass over a unit of distance, it can still be very costly over each unit of time, especially when directly powered by muscle via flapping (Norberg, 1990; Nudds and Bryant, 2000). In order to reduce energy expenditures associated with flight, birds have evolved a large diversity of anatomical and behavioural adaptations. For example, drag is an aerodynamic force opposite to the motion of any flying organism, and birds show various anatomical adaptations allowing them to reduce drag (e.g. feather structure; Chen et al., 2011; Feng et al., 2015; shape of wings; Tucker, 1993, 1995; or tail; Maybury and Rayner, 2001). Some species also show behavioural adaptations to extract energy from their environment (e.g. thermals; Cone, 1962; Shepard et al., 2011; or wind gradients; Warrick et al., 2016). Thus, reducing flight energy expenditures seems to be a major and prevalent selective pressure across bird species.

The common swift (*Apus apus*, hereafter called “swift”) is a coursing insectivore with an extremely aerial way of life. Swifts can perform most of their behaviours in flight: foraging, mating and even sleeping (Lack and Owen, 1955; Lack, 1956; Bäckman and Alerstam, 2001, 2002; Gory, 2008). Some individuals were reported to stay airborne for 10 consecutive months (Hedenström et al., 2016), and swifts touch the ground almost only for egg laying and chick rearing (Lack, 1951). For such an aerial species, flying at a low cost is an important adaptation. Flight behaviours in swifts have motivated numerous studies, whether it be in laboratories using wind tunnels with living specimens (Henningsson and Hedenström, 2011; Henningsson et al., 2014) or preserved wings (Lentink et al., 2007; Lentink and de Kat, 2014), or in the field with various tracking techniques (Bäckman and Alerstam, 2001; Henningsson et al., 2009, 2010; Hedenström and Åkesson, 2017; de Margerie et al., 2018; Hedrick et al., 2018), and swifts’ abilities to reduce flight energy expenditures have been demonstrated in several contexts. For example, Hedrick et al. (2018) have shown that foraging swifts adjust their airspeed to optimize cost of transport over distance, and that they manage to glide during most of their foraging flight by extracting energy from their environment. Besides, swifts often use flap-gliding during cruising flight, i.e. when migrating, commuting and roosting (Bäckman and Alerstam, 2001; Henningsson et al., 2009). Muijres et al. (2012) built a model showing that flap-gliding swifts could save up to 15% energy compared to a continuously flapping swift. These examples show how the swift is adapted to its aerial lifestyle, but some of its flight behaviours have not been studied yet.

One of the few behaviours tying swifts to the Earth’s surface is drinking. It was reported that swifts are able to drink by swallowing rain drops (Bersot, 1931), but more generally they are often seen descending to waterbodies and gliding over them until they get close enough to open their beak and skim over the surface to get some water. This behaviour, while spectacular and not commonly observed amongst birds, has not been formally described yet.

In this study, we analysed swifts’ drinking trajectories in order to determine if this behaviour fits within the general adaptation towards low-energy flight behaviours observed in this species. We digitized 3D trajectories of drinking swifts on three different waterbodies by using rotational stereo videography (RSV), a technique involving a device made of a camera and a set of mirrors to combine two different views into one image, all mounted on an instrumented pivot to track individual birds during flight (de Margerie et al., 2015). Depending on the distance between the camera and the animal, this technique enables measurements of 3D trajectories with centimetric to metric spatial resolution, without the need to capture or tag animals (see Methods section and Fig. S1 for details on positioning error).

A first hypothesis would be that swifts minimize their energy expenditures and that they strive to conserve their mechanical energy during their gliding descent, converting potential energy to kinetic energy, thus reaching water surface at high speed. After contact with water, such kinetic energy would help the bird to regain height with less muscular work (i.e. flapping flight).

Alternatively, swifts may not conserve their energy as efficiently if they want to avoid reaching high speeds because of other constraints. Indeed, approaching and touching water surface at high speed must be demanding in terms of flight motor control, and increasing speed may reduce manoeuvrability (Wilson et al., 2015; Wynn et al., 2015). Besides, fluids dynamics predict that destabilising forces generated by water contact will increase with the square of speed (Norberg, 1990). Hence, we assume that the risk of falling into water increases with flight speed. It is not reported in the literature whether falling into water would represent a significant survival risk for a common swift, but it certainly would cost the bird a considerable amount of energy to escape from such an incident and leave the bird vulnerable to aquatic and terrestrial predators. Hence, aside from energy conservation, we also investigated possible braking methods (sharp turns, use of headwind) in order to understand if braking occurs and how it may occur.

Materials and Methods

List of symbols and abbreviations	
\mathbf{a}	acceleration vector in the ground reference frame
d	track direction in horizontal plane
d_w	wind direction in horizontal plane
d_d	angular difference between track direction and wind direction
E	mechanical energy (kinetic energy + potential energy)
E_k	kinetic energy
E_p	potential energy
g	magnitude of gravitational acceleration
L	resultant vector length for a set of d_d values
P	mass-specific kinematic power
P_{1s}	mass-specific kinematic power calculated over 1 s during the approach
P_{5s}	mass-specific kinematic power calculated over the whole 5 s approach
r	instantaneous radius of curvature
RSV	rotational stereo-videography
s	bird speed in the ground reference frame
s_h	headwind speed
s_w	wind speed
\mathbf{v}	velocity vector in the ground reference frame

X	ground reference Cartesian position in the X direction, computed from smoothed inputs
Y	ground reference Cartesian position in the Y direction, computed from smoothed inputs
Z	ground reference Cartesian position in the Z direction, computed from smoothed inputs (height)
α	mean direction for a set of d_d values
Θ	azimuthal angle measurement from RSV
P	radial distance measurement from RSV
Φ	elevation angle measurement from RSV
ω	Rate of change in heading
ω_{1s}	Rate of change in heading averaged over 1 s
.	dot-over character, indicating first derivative with respect to time
..	double dot-over character, indicating second derivative with respect to time
Subscript -5	variable calculated 5 s before water contact
Subscript 0	variable calculated at the instant of water contact
Subscript 1	variable calculated 1 second after water contact

Recording sites and times

In order to study the drinking behaviour of common swifts in different landscape contexts, birds were recorded on three different waterbodies, hereafter called “site 1”, “site 2” and “site 3”. Recording swifts in various landscape contexts was deemed appropriate to identify the aspects of their drinking behaviour that are generalizable and the ones that are specific to the surrounding landscape. The three sites were located in Rennes Métropole, France. Site 1 was located on a segment of the Vilaine river (Fig. 1A, see also Fig. S2 for a ground view of the experimental setup). The river was around 70 m wide on this segment, and the RSV device was located on the south bank (48°06'34.3"N 1°39'04.4"W). Site 2 was located on a relatively small pond surrounded by trees from 6 to 9 m high (Fig. 1B). The longest distance between two banks was around 100 m, and the RSV device was located on the west bank (48°05'04.5"N 1°37'59.8"W). Site 3 was located on a wider pond surrounded by sparse trees from 10 to 20 m high (Fig. 1C). The greatest distance between two banks was around 170 m, and the RSV device was located on the east bank (48°06'54.0"N 1°36'15.8"W). The landscape surrounding the three sites was urban or suburban, with mainly buildings, roads, lawns and tree patches.

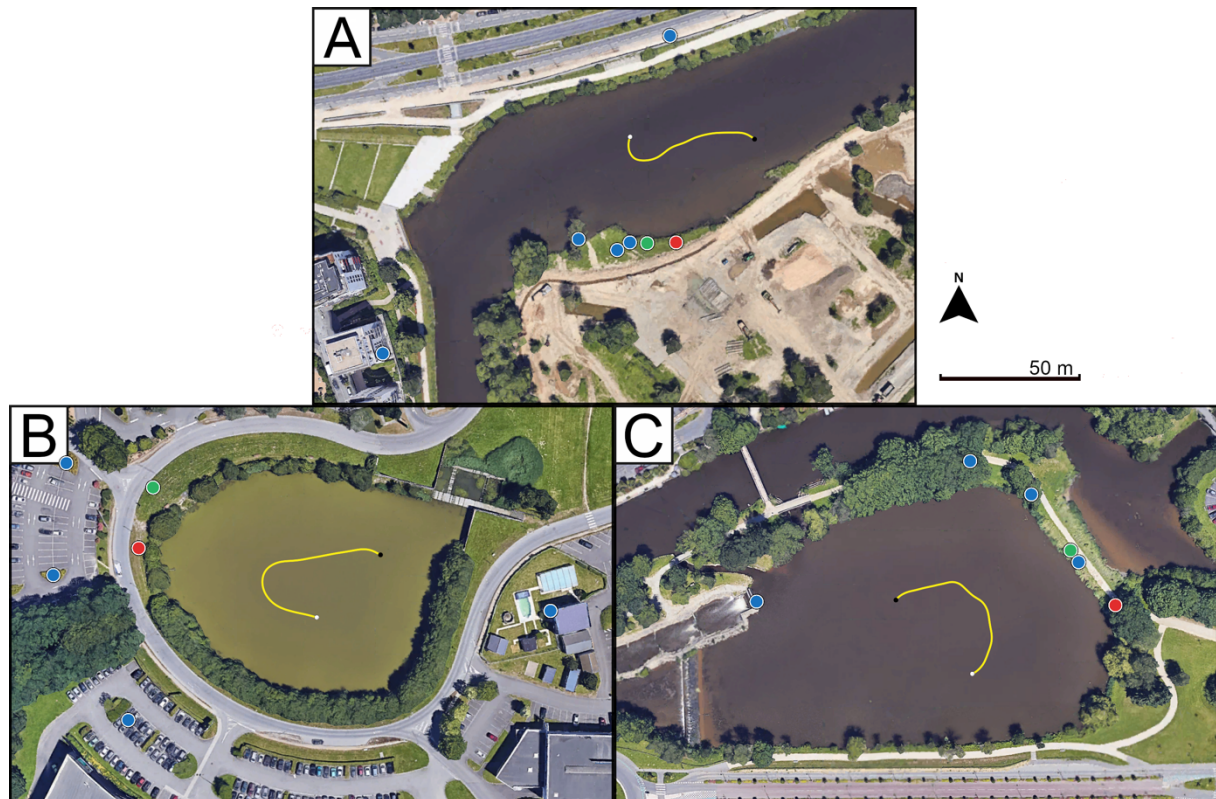

Figure 1: Aerial view of recording sites. (A) Site 1, a river surrounded by open landscape. (B) Site 2, a small pond surrounded by trees. (C) Site 3, a large pond surrounded by sparse trees. On each site, the red dot indicates the location of the RSV device, the green dot indicates the location of the weather station, and blue dots indicate the location of calibration points. The yellow lines show examples of swifts drinking trajectories, with the white dot marking the beginning and the black dot marking the end on each track. Source for aerial view: Google Earth.

Recordings took place from May to July 2020, corresponding to the time when swifts are breeding in this region of France. 23 field sessions were carried out on this period, 7 on site 1, 8 on site 2 and 8 on site 3. Recordings took place in the morning between 9:30 h and 12:00 h, when swifts were observed to be active over the three waterbodies during preliminary observations.

Rotational stereo-videography (RSV)

RSV is an optical tracking technique based on a set of mirrors projecting a stereo image of the animal on the sensor of a single camera (de Margerie et al., 2015). The analysis of the lateral shift between animal image pairs provides a measure of the distance to the animal. The rigid assembly of camera and mirrors can rotate horizontally and vertically on a tripod and fluid video head. While the operator rotates the device to keep the moving animal's image within the sensor frame, the aiming angles are recorded by angular encoders. The mathematical combination of distance, aiming angles and angular deviation from the optical axis yields a 3D record of the animal's movement.

We used an updated RSV device (Fig. S3) with a 1 m base length between the lateral mirrors, a Manfrotto 504HD fluid head (Cassola, Italy) equipped with 17-bit digital angular encoders (Kübler Sendix F3673, Villingen-Schwenningen, Germany), recording aiming angles at 200 Hz through an Arduino Mega microcontroller (www.arduino.cc) and an Adafruit Data logging shield (New York, USA). The device was equipped with a Panasonic DC-GH5S camera (Osaka, Japan) recording 4096×2160 -pixel frames at 60 Hz (150 Mbps H.264 compression) from a 19×10 mm sensor area, and a Nikon AF 105 mm f/2 lens (Tokyo, Japan), providing a 5.2° horizontal field of view. To get well exposed and sharp images, we used a 1/1300–1/640 s shutter speed and f/11 aperture, with ISO 1000–3200, depending on available light conditions. In order to help tracking the fast-flying birds, the camera was equipped with a Nikon DF-M1 dot sight viewfinder (Osaka, Japan).

Calibration and location error

The RSV distance measure, based on the lateral offset between left and right images of the bird, needs to be calibrated. For this purpose, we recorded four (site 2 and 3) or five (site 1) conspicuous targets on each site (signs, street lamps, structures on building roofs) located at fixed distances (range of distances from the RSV device: 20–143 m for site 1, 34–150 m for site 2, and 27–156 m for site 3). The real distance to these targets was measured with a Nikon Forestry Pro hand laser rangefinder (Tokyo, Japan).

The random positioning error was approximately 0.04 m at 25 m, 0.11 m at 50 m and 0.45 m at 100 m (Fig. S1).

Recording methods and wind measurements

During each fixed-duration 2.5 h field session, we attempted to record every individual swift approaching the waterbody (i.e. convenience sampling) and only retained recordings where the bird performed a descent towards water surface. In order to avoid pseudoreplication, we made sure to record a different individual after each drinking behaviour. Despite this precaution, pseudoreplication may be present to some extent in our data if (1) the same individuals came back at a drinking spot from a recording session to the next session and (2) if swifts performed several drinking behaviours during a given field session and were recorded several times. However, we estimate pseudoreplication to be quite marginal, especially on site 1 and 2 where large numbers of swifts were regularly present (up to ~30 individuals simultaneously).

An initial total of 767 descending trajectories were recorded during our 23 field sessions (448 in site 1, 256 in site 2 and 63 in site 3, where swifts were less frequently observed). As some swifts occasionally glided over water without touching it, we only kept recordings where a contact with water was visible on video frames (foam at the water surface). In order to analyse a sufficient and comparable portion of drinking trajectories, recordings starting less than 5 s before, or ending less than 1 s after water contact were removed. Moreover, recordings where the swift was out of frame during more than 10 consecutive frames (i.e. more than 0.18 s missing at 60 Hz) were also removed (with a relatively narrow field of view, the RSV operator often struggled to continuously follow the swift's path with the camera). The resulting sample had 163 trajectories: 70 for site 1, 72 for site 2, and 21 for site 3. On each recording, the first frame on which the swift touched water was labelled, and all recordings were trimmed to keep only 5 s before water contact, and 1 s after. Thus, each recording had a duration of 6 s at 60 Hz.

During each field session, a GILL Instruments MaxiMet GMX501 weather station (Lymington, UK) with ultrasonic anemometer was set up on a tripod, in order to measure the approximate wind speed and direction experienced by swifts approaching the waterbody. We placed the anemometer at 2 m height above the ground, as near as possible to the waterbody, and we also minimised proximity with any nearby tree (see Fig. 1). Wind speed and direction were recorded at 1 Hz, and were averaged over the 6 s of each trajectory.

Track processing

Stereo videos and angular records were processed with MATLAB r2018b (The Mathworks, Natick, MA, USA). To digitize the bird's locations in the video frames, the pixel at the centroid of the bird's body in the left half of each video frame was selected as the left point of interest (POI), either manually or with the help of semi-automatic tracking (DLTdv; Hedrick, 2008). Fully automated selection of left POI was initially tested, but appeared to be inefficient because of highly variable image backgrounds (sky, foliage, water). On the other hand, automated normalized cross-correlation between a 41×41 -pixel area around the left POI and the right image was used to find the corresponding right POI. Automated matching of right POI could also be misled by variable backgrounds, and thus was visually checked and manually corrected when needed. The bird's distance was then computed based on the site calibration reference.

RSV tracking yields spherical coordinates of the bird for each video frame (i.e. azimuth angle, elevation angle and distance from the device; Θ , Φ and P respectively). Raw coordinate

series contain noise, due to (i) theoretical positioning uncertainty (increasing with P^2 , see de Margerie et al., 2015) and (ii) POI random positioning error in stereo images, which was exacerbated in the present study due to variable image backgrounds. Hence, we smoothed the raw spherical coordinate series using quintic splines, with an error tolerance based on the sum of (i) the per-point theoretical positioning uncertainty and (ii) the amplitude of high-frequency signal present in the coordinate series (as measured with 5 Hz filtering). These splines also interpolated short (≤ 10 frames) track bouts where the bird was out of frame. Smoothed spherical coordinates were then converted to cartesian coordinates (X, Y, Z) without additional smoothing. Similarly, smoothed cartesian speeds and accelerations (i.e. $\dot{X}, \dot{Y}, \dot{Z}$ and $\ddot{X}, \ddot{Y}, \ddot{Z}$) were computed from the first and second derivatives of the spherical coordinate smoothing spline functions (Hedrick et al., 2018). An initial examination of smoothing results showed that high frequency noise was efficiently removed from position series, but remained present in speed and acceleration data, an issue that could partly be improved by increasing the smoothing tolerance by 20 % (See details in Fig. S4). We also performed a sensitivity analysis, where the base smoothing tolerance was increased by 0% and 40%, with little effect on the results presented below (Table S1).

Biomechanical variables

In order to precisely describe and study drinking trajectories, a set of biomechanical variables was calculated. Firstly, to assess mechanical energy expenditure, the variables shown below were calculated.

Flight speed in the ground reference frame ($\text{m}\cdot\text{s}^{-1}$):

$$s = |\mathbf{v}| \quad (1)$$

where \mathbf{v} is the velocity vector ($\dot{X}, \dot{Y}, \dot{Z}$).

Mass-specific potential energy ($\text{J}\cdot\text{kg}^{-1}$):

$$E_p = gZ \quad (2)$$

Mass-specific kinetic energy ($\text{J}\cdot\text{kg}^{-1}$):

$$E_k = \frac{1}{2} s^2 \quad (3)$$

Mass-specific mechanical energy ($\text{J}\cdot\text{kg}^{-1}$):

$$E = E_p + E_k \quad (4)$$

Mass-specific kinematic power ($\text{W}\cdot\text{kg}^{-1}$):

$$P = \dot{E}$$

(5)

Note that energy and power values are mass-specific because the body masses of individual swifts are unknown.

In the following analyses involving mass-specific power, a guide value of -20 W.kg^{-1} was used as a typical gliding power to illustrate our results. This value reflects the mass-specific power observed for swifts performing efficient gliding at speeds around $13\text{--}16 \text{ m.s}^{-1}$ (Hedrick et al., 2018). As expected from the glide polar curves estimates (Henningsson and Hedenström, 2011; Hedrick et al., 2018), swift gliding at lower or higher speeds will have slightly less or more negative power values (from ~ -10 to -30 W.kg^{-1}), but power values much below this -20 W.kg^{-1} standard would indicate fast energy dissipation, i.e. aerodynamically inefficient gliding.

Secondly, to measure flight turns in trajectories, we calculated the rate of change in heading (deg.s^{-1}):

$$\omega = \frac{|v|}{r} \quad (6)$$

where r is the instantaneous radius of curvature (m):

$$r = \frac{|v|^3}{\sqrt{|v|^2|a|^2 - (v \cdot a)^2}} \quad (7)$$

where \mathbf{a} is the acceleration vector (\ddot{X} , \ddot{Y} , \ddot{Z}).

Note that r and ω measure flight direction changes in any plane, not limited to horizontal turns.

Finally, to test if wind speed and direction could influence drinking trajectories, the following variables were also calculated.

Track direction in the horizontal plane (deg):

$$d = \arctan(\dot{X}, \dot{Y}) \quad (8)$$

Angular difference between track direction and wind direction (deg):

$$d_d = d - d_w \quad (9)$$

Headwind speed (m.s^{-1}):

$$s_h = s_w \cos(d_d) \quad (10)$$

It should be noted that track direction (d) designates the direction where the bird is heading, while wind direction (d_w) designates the direction from which the wind is coming. Hence, an

angular difference of 0° is observed for a bird flying perfectly upwind (i.e. $s_h = s_w$), while a difference of 180° is observed for a bird flying perfectly downwind (i.e. $s_h = -s_w$).

Statistical analysis

All statistical analyses were performed in MATLAB r2018b. Linear models were created for each site to analyse the relationships between E_{-5} (mass-specific mechanical energy 5 seconds before water contact) and s_0 (speed at water contact), and between E_{-5} and P_{5s} (mass-specific kinematic power over the whole 5 s approach).

P was also calculated over each second before water contact (P_{1s}), yielding 5 power values for each trajectory. The distribution of these values for each site was visualised using violin plots created with the `violinplot` function in MATLAB (Bechtold, 2016), and the medians for each second were compared within each site using non-parametric Friedman tests (as the resulting distributions were not normal and not independent). Significant Friedman tests were followed by pairwise Wilcoxon tests with Bonferroni correction for 10 comparisons.

The link between ω_{1s} (mean rate of change in heading over 1 s) and P_{1s} was studied for each site using linear mixed-effects models with trajectory ID as a random effect.

Circular statistics were performed to analyse the distribution of the angular difference between track direction at water contact and wind direction (d_{d0}) using the `CircStat` toolbox in MATLAB (Berens, 2009). Mean direction (α) and resultant vector length (L) were calculated for all d_{d0} values on each site, along with a Rayleigh test for non-uniformity of circular data (Fisher, 1993). Linear models were also created for each site to study the link between headwind speed (s_w) and the bird's speed at water contact (s_0).

Finally, to check for differences between the three sites, ANOVA were carried out to compare Z_{-5} , Z_1 , s_{-5} , s_0 , and s_1 . Significant ANOVA were followed by Tukey-Kramer post hoc tests.

Results

General description of drinking trajectories

Figure 2 shows average patterns of height (Fig. 2A–C), speed (Fig. 2D–F) and mass-specific mechanical energy (Fig. 2G–I) variations through time in our 3 study sites. Flight trajectories were variable within each site (as shown by the large standard deviations), and some tendencies also differed between sites. Differences between waterbodies will be discussed later and here we firstly focus on congruent aspects that help understand the general drinking behaviour of swifts.

Five s before water contact, swifts fly at a mean height of 9.3, 11.6 and 12.7 m (for site 1–3 respectively) and descend towards water surface. As expected from energy conservation principle, the ground speed of swifts initially increases as they lose height, from approximately $12 \text{ m}\cdot\text{s}^{-1}$ up to 13.0, 13.7 or $14.6 \text{ m}\cdot\text{s}^{-1}$ depending on site. However, starting around -1.5 s , mean speed decreases to 11.0, 12.2 and $11.9 \text{ m}\cdot\text{s}^{-1}$ at water contact. Such deceleration, happening while birds are still losing height is not consistent with a basic hypothesis of energy conservation, and suggests that braking may occur before water contact.

Note that the average mechanical energy, summing potential and kinetic energy, is decreasing during descent (Fig. 2G–I) because swifts were gliding during most of their approach, and any gliding bird loses energy due to drag. However, the energy slope (i.e. power) becomes more negative as time passes, suggesting energy is dissipated more rapidly as the birds approach water. Following water contact, mechanical energy increases as the birds flap their wings to regain height.

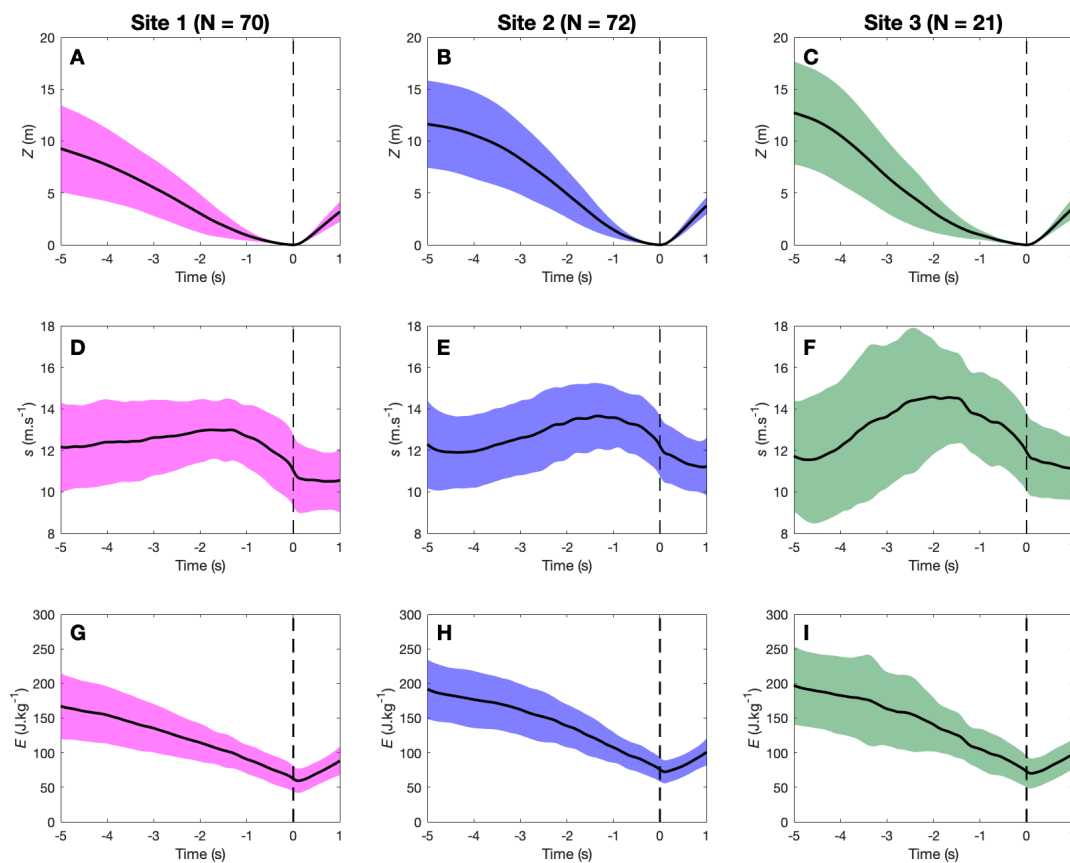

Figure 2: Mean height (Z), ground speed (s) and mass-specific mechanical energy (E) versus time to water contact on each site. The coloured zones represent ± 1 standard deviation. The vertical dashed lines show the time of water contact ($t = 0$). Site 1: $N = 70$, site 2: $N = 72$, site 3: $N = 21$.

Energy conservation vs. dissipation

A more specific approach to test for energy conservation is based on the observed within-site variability of biomechanical variables during approaches. If swifts strive to conserve their mechanical energy, birds that have a higher energy level 5 s before water contact (higher height and/or higher speed at -5 s) should touch water at a higher speed, once potential energy has been converted to kinetic energy. Contrarily to this prediction, there was no significant relationship between E_{-5} and s_0 , in any of the 3 sites (Fig. 3A–C). This means that the speed of a swift at water contact is independent from its mechanical energy 5 s earlier, which would not be expected if swifts did conserve their energy. Conversely, there was a very significant relationship between E_{-5} and P_{5s} (Fig. 3D–F), showing that swifts having more mechanical energy 5 s before water contact do not try to save this energy (by transforming E_p into E_k), but rather dissipate excess energy during descent, by generating a more negative power. This result demonstrates that swifts do brake, in proportion to their mechanical energy 5 s before water contact. Note that here we use the verb “brake” in an “air-brake” sense, i.e. decreasing lift/drag ratio, which can result in decreasing speed and/or losing height (Norberg, 1990).

If swifts converted potential energy to kinetic energy, only losing energy at a rate of about -20 W.kg^{-1} while gliding, points in Fig. 3 would scatter along blue dotted lines. Most notably, speed at water contact (s_0) should increase steeply with E_{-5} (Fig. 3A–C), exceeding 20 m.s^{-1} for the birds approaching the waterbody from the highest observed height and speed at -5 s. This is not what we observed, with birds drinking water at $11.7 \pm 1.7 \text{ m.s}^{-1}$ (mean \pm SD for all sites), irrespective of energy level 5 s before drinking. To achieve this, swifts can generate power as negative as -50 or even -70 W.kg^{-1} (averaged over 5 s), several times the power observed during typical gliding.

On each site, the observed relationship between P_{5s} and E_{-5} is almost parallel to the black dashed line representing the relationship which would be observed if swifts dissipated all their mechanical energy during descent ($P_{5s} = -0.2 E_{-5}$). The observed slopes are all close to -0.2 , and only the intercept of the equation explains the vertical shift between the observed and theoretical relationships. For example, on site 1 (Fig. 3D), a trajectory following the prediction of the linear model would have a power on average 13 W.kg^{-1} higher than a trajectory dissipating all of its energy, thus saving 13 J.kg^{-1} at each second and 65 J.kg^{-1} over the complete 5 s descent. This estimate closely matches the average value for E_0 in Fig. 2G (63 J.kg^{-1}). This observation shows that, on average, swifts act as if they targeted an approximate range of E_0 values and dissipated all the extra energy. The variable on which swifts can act is speed at water

contact, and a favoured s_0 value can be derived from the above values using the following formula:

$$E_0 = E_{p0} + E_{k0} = E_{k0} = \frac{1}{2} s_0^2 \quad (11)$$

Hence:

$$s_0 = \sqrt{2E_0} \quad (12)$$

which would give $s_0 = 11.4 \text{ m.s}^{-1}$ for $E_0 = 65 \text{ J.kg}^{-1}$, which falls right in the middle of the observed range of s_0 values in site 1 (Fig. 3A). These different relationships between the biomechanical variables would suggest that swifts may dissipate all of their extra energy in order to reach a favoured range of s_0 .

It is also worth noting that some trajectories show a P_{5s} value superior to the typical gliding value of -20 W.kg^{-1} (Fig. 3D–F), which reflects that slow gliding flight (nearer to the minimum sink rate speed, dissipating around -10 W.kg^{-1} , Hedrick et al. 2018) or even short bouts of flapping flight ($P > 0$) were involved in these cases. This is mostly observed for trajectories with a value of E_{-5} lower than 175 J.kg^{-1} . A swift with this amount of mechanical energy gliding according to the reference value would dissipate 100 J.kg^{-1} during the descent (-20 W.kg^{-1} over 5 s), thus reaching $E_0 = 75 \text{ J.kg}^{-1}$, which is close to the favoured value discussed above. Hence, swifts having a value of E_{-5} even lower than 175 J.kg^{-1} (because they approach the waterbody at low height or fly slowly) probably have to flap at some point of their approach in order to keep s_0 in their comfort zone.

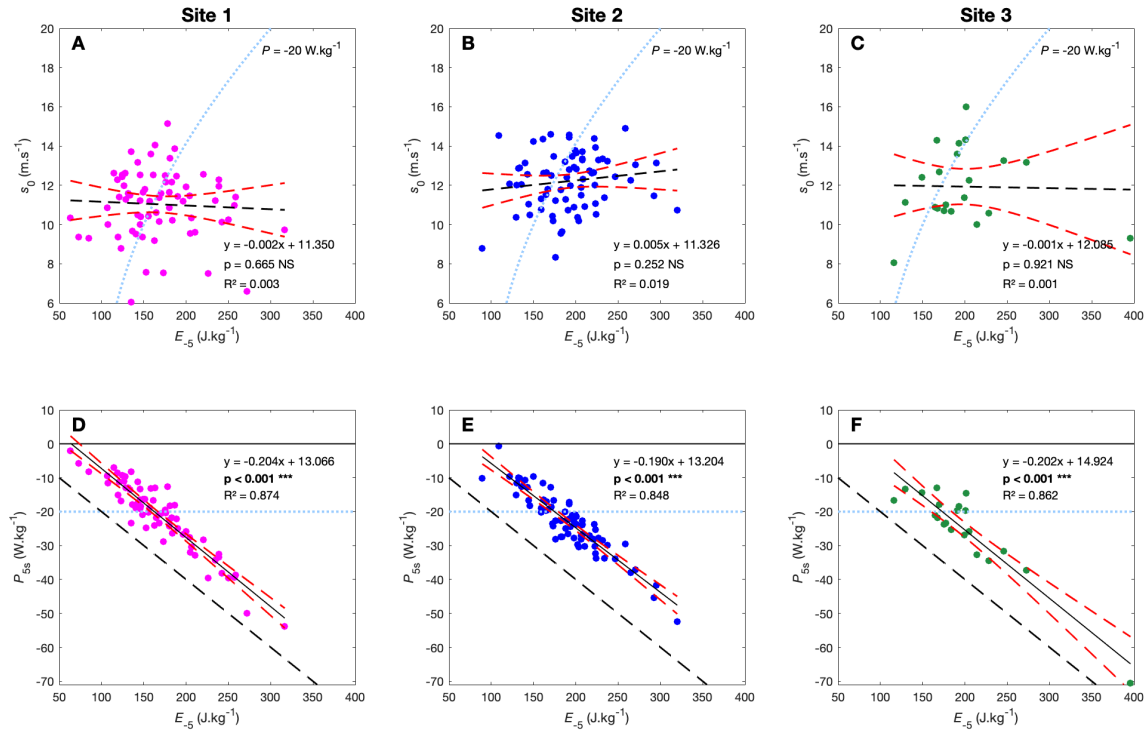

Figure 3: Speed at water contact (s_0) and kinematic power over 5 s (P_{5s}) versus mechanical energy 5 s before water contact (E_{-5}) on each site. The formula of each linear model, its p-value and R^2 are indicated in each panel. The red dashed lines represent the 95% confidence interval of the slope. The blue dotted line represents the expected relationships for energy conservation, minus a kinematic power equal to -20 W.kg^{-1} , a typical value for a gliding swift. The black dashed line (D–F) represents the relationship which would be observed for a swift dissipating all its mechanical energy during the 5 s approach. Site 1: $N = 70$, site 2: $N = 72$, site 3: $N = 21$.

Investigation of energy dissipation patterns

In order to better understand how swifts brake, we first looked at the variations of dissipative power through time. As explained in the methods section, smoothed speed data still contained some noise, which prevented us from computing reliable instantaneous power values. As a second-best option, we relied on power values computed from energy gain/loss over 1 s intervals (P_{1s} , Fig. 4A–C). A feature common to all sites is that energy dissipation is stronger during the last second before water contact (median $P_{1s} = -27, -30$ and -29 W.kg^{-1} on site 1, 2 and 3 respectively, compared to $-12, -13$ and -13 W.kg^{-1} between -5 and -4 s). On site 1 and site 2 (Fig. 4A and 4B), power is also significantly more negative between -2 and -1 s before water contact than earlier in the approach. In other words, P_{1s} is close or above the typical value of -20 W.kg^{-1} at the beginning of the recorded approach, indicating efficient gliding and conversion of potential energy to kinetic energy, but falls below -20 W.kg^{-1} near the end of the descent on all sites. Thus, braking seems to occur mainly in the last portion of the approach, which is consistent with the speed curves showing a deceleration about 1.5 s before water

contact (Fig. 2D–F). Note that P_{1s} was sometimes positive, which reflects portions of trajectories where some flapping occurred. Also note that, as expected, P_{1s} values were particularly high during the second following water contact (which is not presented here) when birds continuously and vigorously flap their wings to regain height (medians of +25, +25 and +28 $\text{W}\cdot\text{kg}^{-1}$ respectively).

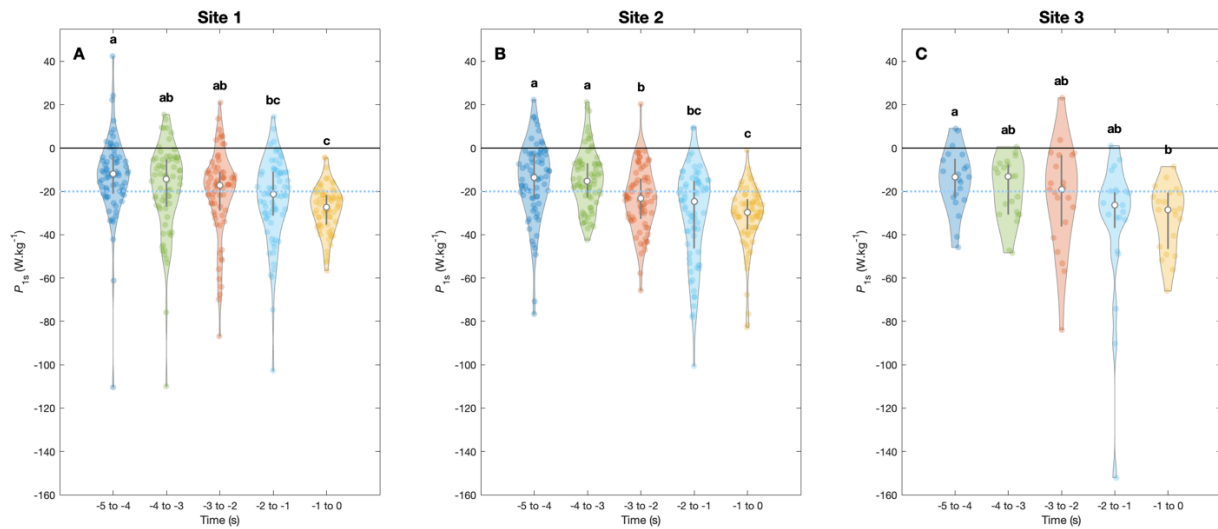

Figure 4: Distribution of kinematic power (P_{1s}) versus time to water contact on each site. White dots represent the medians, vertical bars represent the ranges from the 25th to the 75th percentiles, and coloured zones represent the kernel density distributions of each category. Lowercase letters (a, b and c) indicate significant differences after a significant Friedman test followed by pairwise Wilcoxon tests with Bonferroni correction for 10 comparisons. The blue dotted line indicates a kinematic power value of $-20 \text{ W}\cdot\text{kg}^{-1}$. Site 1: $N = 350$ (from 70 trajectories), site 2: $N = 360$ (from 72 trajectories), site 3: $N = 105$ (from 21 trajectories).

Another interesting question is whether energy dissipation is linked to turning behaviours of birds approaching water. An aerial view of all trajectories shows the great diversity of approaches during the 5 s before water contact (Fig. 5). Overall, sinuous trajectories are the rule, and a few direct approaches are only seen on site 1 and site 3 (Fig. 5A and 5C) as expected for a river and a wide pond offering a greater freedom of approach. Prolonged turns can be seen in most trajectories, and all of them converge to a straight line before water contact.

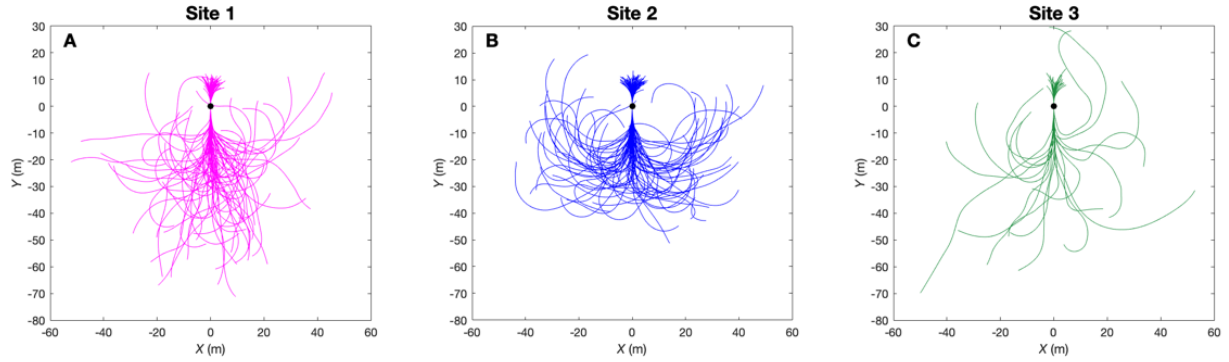

Figure 5: Top view of all trajectories on each site. The black dot is the point of water contact. Trajectories were moved and rotated so that they all had the same point of water contact and all faced north. Site 1: $N = 70$, site 2: $N = 72$, site 3: $N = 21$.

In Fig. 6, we studied the relationship between turning (measured through mean 3D rate of change in heading, ω_{1s}) and P_{1s} , both averaged over 1 s intervals. Results suggest that swifts do not use a single strategy to brake, and that turning is not necessarily a cause of energy dissipation. Indeed, even if a significant negative relationship can be observed on site 1 (Fig. 6A), suggesting that swifts brake more during sharp turns, the explanatory power remains weak ($R^2 = 0.086$). Moreover, the relationship is not significant on site 2 and site 3 (Fig. 6B and 6C). The wide scattering of power values on each panel reveals that, even if braking during sharp turns is visible on some portions of trajectories (strongly negative P_{1s} values for high ω_{1s} values), other portions also show strong braking without sharp turns (strongly negative P_{1s} values for low to intermediate ω_{1s} values), or even sharp turns without braking (high ω_{1s} values with P_{1s} close to -20 W.kg^{-1}). Overall, this great dispersion suggests a wide diversity of strategies used by swifts when approaching water, and sharp turns alone cannot explain all braking events. And indeed, if the timing of braking (Fig. 4) is compared with the aerial view of trajectories (Fig. 5), it appears that the portion of trajectories where the strongest braking occurs (the last second) may actually be close to a straight line for many trajectories.

Note that averaging power and rate of change in heading over 1 s is limiting here, as very short turning manoeuvres (and the possibly associated energy dissipation bursts) can remain unnoticed. Careful frame-by-frame observation of individual trajectories (e.g. Movies 1–3) suggests that braking might indeed rely on a variety of postural changes (including alternating banking, wing dihedral, high incidence of body or tail, and even leg trailing), that happen at a much shorter timescale, and not necessarily associated with strong, prolonged heading change.

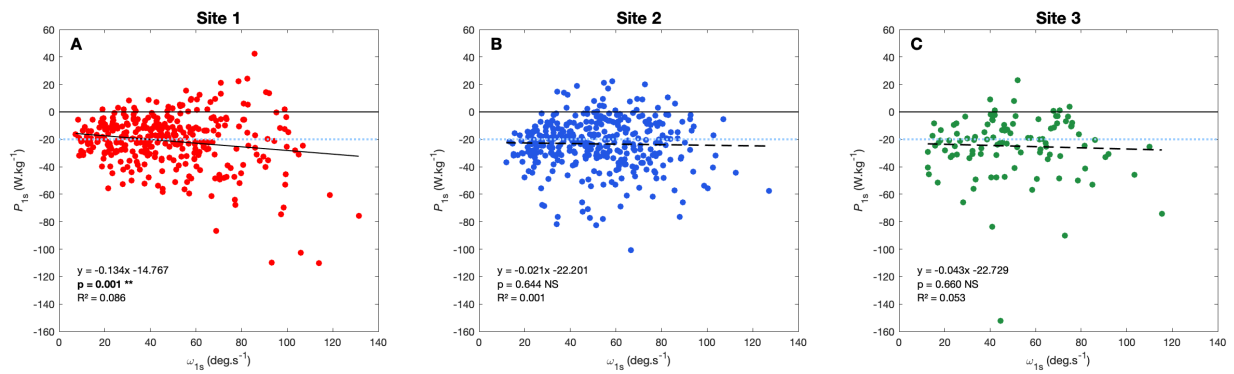

Figure 6: Kinematic power (P_{1s}) versus rate of change in heading (ω_{1s}). Each data point represents a mean value over a period of one second during the approach to water. Each trajectory thus has 5 data points. The formula of each linear mixed-effects model, its p-value and R^2 are indicated in each panel. The blue dotted line indicates a kinematic power value of $-20 \text{ W}\cdot\text{kg}^{-1}$. Site 1: $N = 350$ (from 70 trajectories), site 2: $N = 360$ (from 72 trajectories), site 3: $N = 105$ (from 21 trajectories).

A third question regarding braking behaviour is whether swifts use wind to help them lower their kinetic energy in the ground reference frame before water contact. Although we did not experience strong winds (maximum of $3.9 \text{ m}\cdot\text{s}^{-1}$), and most of our field sessions occurred on days of weak wind ($< 2 \text{ m}\cdot\text{s}^{-1}$ for 90% of trajectories), we tested whether swift prefer to drink in an upwind direction, as this strategy could help them to lower their ground speed, while preserving their airspeed. Angular differences between track direction at water contact and wind direction show a strongly skewed distribution (Fig. 7). On all sites, most swifts preferentially touch water while flying upwind, and tailwind is rarely observed. Note that as our anemometer was not placed exactly at the point of water contact, but necessarily at some distance, on the water bank, differences between wind experienced by the birds and measured wind exist, and might account for some of the dispersion observed in Fig. 7.

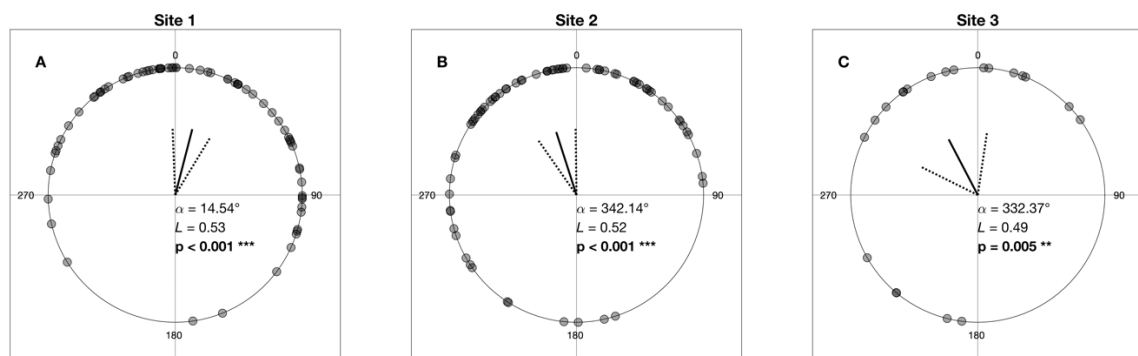

Figure 7: Angular difference (α) between track direction at water contact and wind direction on each site. An angular difference of 0° is observed for a bird flying perfectly upwind, while a difference of 180° is observed for a bird flying perfectly downwind. Mean angles (α) and vector lengths (L) are given together with p-values for departure from random circular distributions according to the Rayleigh test. Dotted lines represent the 95% confidence intervals. Site 1: $N = 70$, site 2: $N = 72$, site 3: $N = 21$.

A more detailed understanding of how swifts use wind can be obtained from the relationship between bird ground speed at water contact (s_0) and headwind speed (s_h , Fig. 8). Note that negative s_h (i.e. tailwind drinking) was rare and mainly observed for low wind speeds. On all sites, when wind was absent, s_0 was centred around 12 $\text{m}\cdot\text{s}^{-1}$. This “comfort” speed might be a trade-off between the need to avoid the dangers of high-speed contact with water, and the urge to conserve mechanical energy (i.e. brake less during approach). When headwind is present, ground speed and airspeed should be distinguished, and there are two opposite hypotheses:

(i) swift may maintain the same $\sim 12 \text{ m}\cdot\text{s}^{-1}$ airspeed, and simply use headwind to lower the ground speed of contact with water below $12 \text{ m}\cdot\text{s}^{-1}$. In this scenario, which would appear as a -1 slope on Fig. 8 (black dash-dotted line), swifts would use headwind only to lower the dangers of high-speed water contact.

(ii) Alternatively, swift may increase airspeed at water contact by the amount of headwind, i.e. brake less during approach, while keeping ground speed at water contact near $12 \text{ m}\cdot\text{s}^{-1}$, irrespective of headwind. This scenario would appear as a 0 slope in Fig 8, and suggest that swift use headwind to save some mechanical energy.

s_0 and s_h show a significant relationship on site 1 (Fig. 8A), with a slope of -0.72 ± 0.17 (SE) which suggests that swifts might behave between the two above hypotheses, i.e. they used headwind mainly to lower the ground speed of water contact, but also partly to brake less, increasing airspeed by a small amount and saving some energy. In site 2 and 3, the relationship was not significant, but the slopes were also between -1 and 0. It is worth noting that wind speed values superior to $2 \text{ m}\cdot\text{s}^{-1}$ were only rarely encountered outside of site 1, which could make it more difficult to detect a relationship on site 2 and site 3.

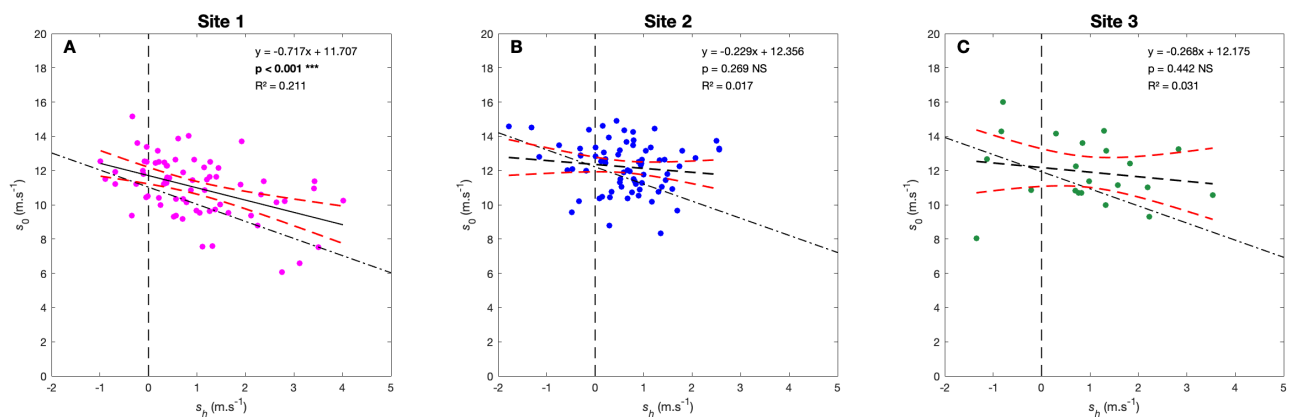

Figure 8: Ground speed at water contact (s_0) versus headwind speed (s_h) on each site. The formula of each linear model, its p-value and R^2 are indicated in each panel. The red dashed lines represent the 95% confidence interval of the slope. The black dash-dotted line represents the equation $y = \bar{y} - x$ (where \bar{y} is the mean of y over the whole distribution) which would be expected if all swifts maintained the same airspeed irrespective of wind. Site 1: $N = 70$, site 2: $N = 72$, site 3: $N = 21$.

Additional influences of local landscape

Finally, even if congruent general tendencies could be observed in swifts' drinking behaviour across the three study sites, some differences were still present. ANOVA followed by Tukey-Kramer tests (Table 1) show that average height 5 s before contact (Z_{-5}) is significantly lower on site 1 compared to the other sites. Other significant differences could be detected between site 1 and site 2: The average speed at which swifts touch water (s_0) is lower, and average speed (s_1) and height (Z_1) 1 s after water contact are lower on site 1 compared to site 2.

The fact that swifts fly, on average, at a lower height 5 s before, and 1 s after contact on site 1 could be linked to the more open landscape surrounding this river and the absence of high trees (see Fig. 1), offering a greater freedom to approach water and climb back.

Also observed on site 1 is a lower speed at water contact. The difference with site 2 amounts to $1.18 \text{ m}\cdot\text{s}^{-1}$ for s_0 in Table 1 (reduced to $0.65 \text{ m}\cdot\text{s}^{-1}$ when there is no headwind, i.e. intercept values in Fig. 8A–B). Swifts approaching the waterbody at a lower height would gain less speed during descent and would thus need to brake less to keep their speed in their comfort zone. However, as this lower height observed on site 1 is also associated with a lower speed at water contact, this suggests that swifts drinking on site 1 do not necessarily take advantage of this open landscape to brake less, but rather prioritise safety, by drinking at a slightly lower speed on average.

These differences across drinking sites suggest that landscape, by constraining the height of approach and the space available to climb back, might shift the local ideal drinking speed, i.e. the flight speed that balances energetic cost (braking during descent implies work during subsequent climb, and a steeper climb requires greater muscle power) and the risks of high-speed water contact. In other words, waterbodies surrounded by tall trees (sites 2 and 3), requiring a steep climb after water contact, would urge swifts to brake less and to favour slightly higher, less safe water contact speeds.

Table 1: Results of ANOVA followed by Tukey-Kramer *post-hoc* tests comparing speed and height variables at -5 s, 0 s, and 1 s between the three sites. Mean \pm SD. Site 1: N = 70, site 2: N = 72, site 3: N = 21.

Variable	Site 1	Site 2	Site 3	ANOVA (p)	Tukey-Kramer (p)
Z ₋₅ (m)	9.29 \pm 4.21	11.64 \pm 4.23	12.73 \pm 5.11	< 0.001 (***)	1:2 (0.004) / 1:3 (0.004) / 2:3 (0.57)
Z ₁ (m)	3.19 \pm 0.97	3.77 \pm 0.83	3.56 \pm 1.03	0.001 (**)	1:2 (<0.001) / 1:3 (0.25) / 2:3 (0.63)
s ₋₅ (m.s ⁻¹)	12.17 \pm 2.19	12.30 \pm 2.14	11.74 \pm 2.76	0.598	
s ₀ (m.s ⁻¹)	11.03 \pm 1.73	12.21 \pm 1.46	11.93 \pm 1.93	< 0.001 (***)	1:2 (<0.001) / 1:3 (0.07) / 2:3 (0.77)
s ₁ (m.s ⁻¹)	10.56 \pm 1.56	11.22 \pm 1.39	11.15 \pm 1.56	0.025 (*)	1:2 (0.02) / 1:3 (0.25) / 2:3 (0.98)

Discussion

Our study is the first quantitative and spatial description of the drinking behaviour of the common swift, and our dataset provides an opportunity to test hypotheses related to energy conservation. Our results show that swifts do not strive to conserve their mechanical energy when they approach water. Indeed, for a given water body, swifts having a higher mechanical energy 5 s before water contact do not reach water at higher speeds (Fig. 3A–C) but do brake more strongly (Fig. 3D–F). Mechanical energy dissipation is especially strong during the last seconds (Fig. 4), and as a result, average speed shows a marked decrease during the last 1–2 s (Fig. 2D–F). On top of this general drinking behaviour, consistent across the three study sites, local landscape structure influences drinking trajectories to some extent (Table 1), since a more open landscape seems to allow swifts to approach water at lower heights and to drink at lower speeds.

How do swifts dissipate their mechanical energy?

Our results show that swifts do dissipate mechanical energy during descent, but the underlying methods of braking (i.e. increase drag and/or reduce lift) are not completely understood. Braking with sharp turns is used to some extent, but does not constitute the full picture (Fig. 6). A more general way for swifts to control lift/drag ratio is to modify the position and shape of various parts of their flight apparatus (wings, tail, body) while gliding (Norberg, 1990; Lentink et al., 2007; Henningsson and Hedenström, 2011), and we qualitatively observed examples of such postural change in our video records (Movies 1–3). Some of these braking manoeuvres implied alternating banking (see e.g. Movie 3) that might be similar to “sideslipping” described in bats (Norberg, 1976). Moreover, leg trailing was sometimes

observed in our video records before water contact (Movie 3) and could be another way to increase drag as shown in other birds by Pennycuick (1968, 1971). It is also probable that the wide opening of the beak before water contact increases drag to some extent.

Describing braking (both postural changes and the associated energy dissipation) at a very fine temporal scale is beyond the reach of our approach. Due to the amount of noise in our trajectometry data, power and rate of change in heading were averaged over intervals of 1 s, and very short manoeuvres may have been overlooked. Moreover, in our study, swifts are considered as a point in 3D space, and RSV spatial resolution (median random positioning error of ~0.15 m) is not sufficient to study the effect of different body parts on braking. Future studies could consider looking more precisely at the kinematics of each body part in order to better understand braking techniques.

In addition to braking techniques, we showed that swifts preferentially drink in an upwind direction (Fig. 7). Flying upwind may be a way to increase manoeuvrability when approaching water, as was observed in several species of terns (Wakeling and Hodgson, 1992), where fishing individuals always turned into the wind before hovering and diving, probably to achieve more aerodynamic control. Besides, flying upwind is another way to reduce swifts' ground speed, and it seems that headwind can be used to reduce their need to brake, at least to some extent (Fig. 8). However, it is worth noting that the wind speeds measured by our weather station 2 m above the waterbody bank, differ from the wind speeds encountered by a swift flying close to the water surface because of the wind gradient in the boundary layer (Ruggles, 1970; Warrick et al., 2016). When a bird flying headwind is losing altitude, headwind speed should gradually decrease, and hence the ground speed of the bird should increase, which calls for more braking. Consequently, headwind should be less useful for the birds to brake in the last meters before touching water. Studying the exact contribution of wind gradient to drinking flight behaviour would require more refined wind measurements than what we recorded for the present study, i.e. horizontally closer to the water contact position, and at several heights above water.

Besides, ground effect, which can be defined as a reduction of induced drag when flying close to a surface, could also have some influence on drinking swifts approaching water, but it is considered to be only significant when a bird flies at a height below half of its wingspan (Norberg, 1990), which would be around 24 cm for a swift with a wingspan of 48 cm (Chantler et al., 2020). Thus, the influence of ground effect can be considered to be minor, and could only occur less than half a second before the impact in most trajectories.

Trade-off between flight performance and safety

Even if the common swift is known for its various aerodynamic and energy-saving behaviours, mechanical energy can be dissipated to a great extent while approaching water. We estimated power values as negative as -70 W.kg^{-1} when averaged over 5 s, and down to -190 W.kg^{-1} during isolated braking manoeuvres (Movie 2). These rates are much more negative than the approximately -20 W.kg^{-1} typical gliding power at similar speeds (Hedrick et al., 2018). As a result, swifts have to output a greater amount of muscular energy after drinking to regain altitude with flapping flight (which occurred at a rate around $+25 \text{ W.kg}^{-1}$). The main hypothesis to explain this counter-intuitive waste of energy during descent to the water body is that, in this case, other constraints might be more important for the swift than reducing energy expenditure. Touching water at very high speeds could be a danger for a drinking swift, because the contact would be more violent. Indeed, the drag force induced by water increases with the square of speed (Norberg, 1990), quickly increasing the risk of destabilisation (hydrodynamic drag on the bird's lower beak is not applied along the body axis). The bird's beak should penetrate water with a depth of only a few millimetres, and a very fine motor control and manoeuvrability are necessary for this behaviour. Moreover, as swifts approach water surface, flapping their long wings becomes more and more difficult, so they have to rely on postural adjustments while gliding. It is generally considered that such very fine control is more difficult to achieve at higher speeds (Wilson et al., 2015; Wynn et al., 2015).

These results suggest that swifts may have a “comfort zone” for their speed at water contact, braking when they approach water too quickly, and actively flapping when they approach it too slowly (keeping speed higher than stall speed is another constraint). This observation is consistent with the “speed-choice” framework proposed by Wilson et al. (2015), which states that animals choose specific speeds for specific behaviours depending on biomechanical trade-offs between speed and various factors such as energetic constraints, manoeuvrability, and motor control. Mistakes can have varying energetic or even survival costs depending on the behaviour, and the consequences of any inaccurate movement (wasted energy, injury, death) can deeply influence this trade-off. In the case of drinking swifts, mistakes could result in a fall into water. Even if it is rarely observed and, to our knowledge, not reported in the literature on common swift, we can hypothesize that falling into water would be an important survival risk and energetic cost for a swift, because it would not be able to take flight easily. Brunton (2019) reported an observation of a white-throated swift (*Aeronautes saxatilis*)

that had fallen into a lake. The bird vigorously swam for 10 minutes, synchronously stroking its long and narrow wings, before reaching the lakeshore, approximately 85 m away. Its body feathers were soaked and it remained inactive for 45 minutes. The observers then decided to keep it overnight in a cardboard box, and the stranded bird successfully took flight in the following morning, showing that it was apparently not injured. Similar swimming behaviours were also reported in the barn swallow (*Hirundo rustica*; Jackson, 1970; Brown and Brown, 2020), the tree swallow (*Tachycineta bicolor*; Winkler et al., 2020), the cliff swallow (*Petrochelidon pyrrhonota*; Brown et al., 2020), and the bank swallow (*Riparia riparia*; Garrison and Turner, 2020). From these observations, we can hypothesize that such an incident would involve similar consequences for a common swift, which would be associated with large energy expenditures and a long period of vulnerability to predators. Thus, a trade-off seems to exist between lower energy expenditure in flight and higher safety in close proximity of the ground, and this trade-off can be shifted by environmental conditions such as wind or landscape structure.

When temperatures exceed 30°C, a similar trade-off can be observed, this time between flight performance and cooling. Indeed, in hot conditions, common swifts can be observed trailing their legs below their body to favour heat loss, which increases drag (Neumann, 2016). As noted above, leg trailing was sometimes observed just before water contact in the present study (e.g. Movie 3), and may be used when a particularly strong braking is needed.

It is worthwhile to note that, during field sessions, some swifts were sometimes seen approaching water surface in a typical way similar to a drinking behaviour, but glided close to the surface without touching it, regaining height and sometimes performing another descent right after. This behaviour could be considered as an “aborted” drinking behaviour where, for some reason (lack of balance, excessive speed, proximity of other individuals or of landscape elements), the individual decided to regain height without taking the risk to touch water. If these behaviours really are aborted attempts, they show that swifts sometimes prefer sacrificing a large amount of energy by regaining height and performing another approach, rather than touching water in a risky situation.

Braking control

Braking in flying animals approaching a fixed point or surface was already studied in the context of landing on a solid substrate, and the visual mechanisms regulating this behaviour were described. Optic flow is used by various organisms to measure how quickly objects and

patterns shift on the retina, enabling them to measure how quickly they are moving relative to their environment (Gibson, 1958; Koenderink, 1986). This phenomenon has been shown to be very important in the regulation of flight speed and movements in birds (Bhagavatula et al., 2011; Dakin et al., 2016; Schiffner and Srinivasan, 2016), including Apodidae (Parikh et al., 2019). Thus, a widely used framework in the context of landing is based on a visually regulated constant braking strategy where the key parameter is τ , the ratio between the distance to the point of collision and the relative approach velocity (Lee, 1976; Lee et al., 2009; Whitehead, 2020). The drinking behaviour of swifts differ from these landing behaviours because swifts do not want to reach a null speed after collision, and our results suggest that braking is generally not constant for a swift approaching water. Still, optic flow could also be used by swifts to regulate braking, even if the target speed and the braking dynamics differ. Optic flow from featureless surfaces such as water is poor, and can sometimes mislead birds and cause drowning (Parker and Graham, 2018), but the waterbodies used by the swifts recorded in our study were probably small enough to allow them to rely on nearby landscape features.

A risky but essential behaviour

Even if the common swift is extremely adapted to an aerial lifestyle (Lack, 1956; Bäckman and Alerstam, 2001), and is often considered to be tied to Earth only during the breeding period (Lack, 1951; Hedenström et al., 2016), a regular contact with the Earth's surface for drinking still constrains its way of life. Taking into account the fact that flying close to the ground in relatively cluttered environments might represent an increased collision risk for such an aerial species, and adding potential survival and energetic costs of falling into water, water intake probably represents an important motivation. Insectivorous birds are predicted to obtain sufficient water from their invertebrate prey (Bartholomew and Cade, 1963), and are consequently rarely observed drinking at waterbodies, even in arid environments (Lee et al., 2017). Swallows and swifts represent notable exceptions to this trend and often drink surface water, and one explanation could be that these very aerial birds lose more water by evaporation than more terrestrial birds due to their greater energy expenditure in flight (Salt and Zeuthen, 1960; Bartholomew and Cade, 1963). This hypothesis is also consistent with observations that swifts strive to retain water and limit evaporation, by prioritizing non-evaporative cooling (leg trailing) over evaporative cooling (gaping), the latter being very rarely observed even in hot weather (Neumann, 2016). Thus, even if swifts are able to obtain water from rain drops (Bersot, 1931), from nestlings faecal sacs (Dell'Omo et al., 1998), and probably from invertebrate prey

(Bartholomew and Cade, 1963), their water needs still seem high enough to motivate them to perform this unique drinking behaviour over various waterbodies.

In many bird species, juveniles are not able to perform specific flight behaviours as successfully as adults (see review in Ruaux et al., 2020), and understanding how this complex and essential behaviour develops within an individual swift would be an interesting question. Juvenile swifts do not receive parental care after they leave the nest (Lack, 1956), but they might improve the performance and safety of their drinking behaviour with practice, and social learning could be possible in large flocks such as those observed over waterbodies. For example, it has been hypothesized that juvenile ospreys (*Pandion haliaetus*) learn to catch fish by observing adults and practicing (Meinertzhagen, 1954), and this behaviour could be compared to swifts' drinking behaviour to some extent, because it involves a precise approach towards water, braking, and regaining height. Juvenile swifts are recognizable by slight differences in plumage (Blasco-Zumeta and Heinze, 2014; Jukema et al., 2015), and we took pictures of the recorded swifts at a greater magnification using a second camera mounted on the RSV device, but we were not able to identify any juvenile on the pictures with sufficient sharpness and resolution.

To conclude, our study describes an energetically suboptimal behaviour in the common swift, under the influence of a trade-off between energy expenditures and safety. When they have to drink, fast-flying swifts brake before water contact, probably to reduce the risk of touching water at speeds too demanding for their motor control skills, which could cause a fall into water. It is a well-known fact that birds regularly brake and dissipate some mechanical energy when interrupting their flight for landing or perching (Norberg, 1990). Although common swifts are known as “continuous fliers” and rarely land or perch, it seems that their dependence on waterbodies for drinking still calls for frequent mechanical energy dissipation.

Acknowledgements

We would like to thank J.-F. Cornuet for our fruitful and interesting discussions about the flight behaviours of the common swift. We also warmly thank the EthoS laboratory for supporting our field work, which has been somewhat disrupted in 2020 by a global pandemic. Finally, we thank J.J. Young and S. Windsor (Bristol Univ., UK) who greatly improved our original RSV device design (de Margerie et al., 2015), and designed a second-generation device, upon which the present RSV device is based.

Competing interests

No competing interests declared.

Funding

Research on bird flight supervised by E. de Margerie was supported by a grant from the *Mission for Transversal and Interdisciplinary Initiatives* at the CNRS in 2018, and an *Emerging scientific challenge* grant from the Rennes University in 2020, which made it possible to acquire some of the material used in this study.

Data availability

The flight trajectory and environmental data used as a basis for this analysis are publicly available from the figshare digital repository:

<https://doi.org/10.6084/m9.figshare.20931934.v1>

References

- Bäckman, J. and Alerstam, T.** (2001). Confronting the winds: orientation and flight behaviour of roosting swifts, *Apus apus*. *Proc. R. Soc. Lond. B* **268**, 1081–1087.
- Bäckman, J. and Alerstam, T.** (2002). Orientation of swifts in roosting flights. *The Journal of Experimental Biology* **205**, 905–910.
- Bartholomew, G. A. and Cade, T. J.** (1963). The Water Economy of Land Birds. *The Auk* **80**, 504–539.
- Bechtold, B.** (2016). Violin Plots for Matlab, Github Project.
- Berens, P.** (2009). **CircStat**: A *MATLAB* Toolbox for Circular Statistics. *J. Stat. Soft.* **31**,
- Bersot, E.** (1931). Comment boivent les martinets. *Nos Oiseaux* **11**, 106–107.

- Bhagavatula, P. S., Claudianos, C., Ibbotson, M. R. and Srinivasan, M. V.** (2011). Optic Flow Cues Guide Flight in Birds. *Current Biology* **21**, 1794–1799.
- Blasco-Zumeta, J. and Heinze, G.-M.** (2014). Atlas de Identificación de las Aves de Aragón.
- Brown, M. B. and Brown, C. R.** (2020). Barn Swallow (*Hirundo rustica*), version 1.0. In *Birds of the World* (ed. Billerman, S. M.), Keeney, B. K.), Rodewald, P. G.), and Schulenberg, T. S.), p. Ithaca, NY, USA: Cornell Lab of Ornithology.
- Brown, C. R., Brown, M. B., Pyle, P. and Patten, M. A.** (2020). Cliff Swallow (*Petrochelidon pyrrhonota*), version 1.0. In *Birds of the World* (ed. Billerman, S. M.), Keeney, B. K.), Rodewald, P. G.), and Schulenberg, T. S.), p. Ithaca, NY, USA: Cornell Lab of Ornithology.
- Brunton, D. F.** (2019). Swimming as a potentially important emergency capability of Whitethroated Swifts (*Aeronautes saxatalis*) engaged in aerial mating. *Can Field Nat* **132**, 386–388.
- Chantler, P., Boesman, P. F. D., A. and Kirwan, G. M.** (2020). Common Swift (*Apus apus*), version 1.0. In *Birds of the World*, p. Ithaca, NY, USA: Cornell Lab of Ornithology.
- Chen, I.-C., Hill, J. K., Ohlemuller, R., Roy, D. B. and Thomas, C. D.** (2011). Rapid range shifts of species associated with high levels of climate warming. *Science* **333**, 1024–1026.
- Cone, C. D. Jr.** (1962). Thermal soaring of birds. *American Scientist* **50**, 180–209.
- Dakin, R., Fellows, T. K. and Altshuler, D. L.** (2016). Visual guidance of forward flight in hummingbirds reveals control based on image features instead of pattern velocity. *Proc Natl Acad Sci USA* **113**, 8849–8854.
- de Margerie, E., Simonneau, M., Caudal, J.-P., Houdelier, C. and Lumineau, S.** (2015). 3D tracking of animals in the field using rotational stereo videography. *Journal of Experimental Biology* **218**, 2496–2504.
- de Margerie, E., Pichot, C. and Benhamou, S.** (2018). Volume-concentrated searching by an aerial insectivore, the common swift, *Apus apus*. *Animal Behaviour* **136**, 159–172.
- Dell’Omo, G., Alleva, E. and Carere, C.** (1998). Parental recycling of nestling faeces in the common swift. *Animal Behaviour* **56**, 631–637.
- Feng, B., Chen, D., Wang, J. and Yang, X.** (2015). Bionic Research on Bird Feather for Drag Reduction. *Advances in Mechanical Engineering* **7**, 849294.
- Fisher, N. I.** (1993). *Statistical Analysis of Circular Data*. 1st ed. Cambridge University Press.
- Garrison, B. A. and Turner, A.** (2020). Bank Swallow (*Riparia riparia*), version 1.0. In *Birds of the World* (ed. Billerman, S. M.), Keeney, B. K.), Rodewald, P. G.), and Schulenberg, T. S.), p. Ithaca, NY, USA: Cornell Lab of Ornithology.
- Gibson, J. J.** (1958). Visually controlled locomotion and visual orientation in animals. *British Journal of Psychology* **49**, 182–194.

- Gory, G.** (2008). Le régime alimentaire du martinet noir *Apus apus* en région méditerranéenne. *Revue d'écologie – la Terre et la Vie* **63**, 251–260.
- Hedenström, A. and Åkesson, S.** (2017). Adaptive airspeed adjustment and compensation for wind drift in the common swift: differences between day and night. *Animal Behaviour* **127**, 117–123.
- Hedenström, A., Norevik, G., Warfvinge, K., Andersson, A., Bäckman, J. and Åkesson, S.** (2016). Annual 10-Month Aerial Life Phase in the Common Swift *Apus apus*. *Current Biology* **26**, 3066–3070.
- Hedrick, T. L.** (2008). Software techniques for two- and three-dimensional kinematic measurements of biological and biomimetic systems. *Bioinspir. Biomim.* **3**, 034001.
- Hedrick, T. L., Pichot, C. and de Margerie, E.** (2018). Gliding for a free lunch: biomechanics of foraging flight in common swifts (*Apus apus*). *J Exp Biol* **221**, jeb186270.
- Henningsson, P. and Hedenström, A.** (2011). Aerodynamics of gliding flight in common swifts. *Journal of Experimental Biology* **214**, 382–393.
- Henningsson, P., Karlsson, H., Bäckman, J., Alerstam, T. and Hedenström, A.** (2009). Flight speeds of swifts (*Apus apus*): seasonal differences smaller than expected. *Proc. R. Soc. B* **276**, 2395–2401.
- Henningsson, P., Johansson, L. C. and Hedenström, A.** (2010). How swift are swifts *Apus apus*? *J Avian Biol* **41**, 94–98.
- Henningsson, P., Hedenström, A. and Bomphrey, R. J.** (2014). Efficiency of Lift Production in Flapping and Gliding Flight of Swifts. *PLoS ONE* **9**, e90170.
- Jackson, H. D.** (1970). Swimming Ability of the Barn Swallow. *The Auk* **87**, 577.
- Jukema, J., van de Wetering, H. and Klaassen, R. H. G.** (2015). Primary moult in non-breeding second-calendar-year Swifts *Apus apus* during summer in Europe. *Ringing & Migration* **30**, 1–6.
- Koenderink, J. J.** (1986). Optic flow. *Vision Research* **26**, 161–179.
- Lack, E.** (1951). The breeding biology of the swift *Apus apus*. *Ibis* **93**, 501–546.
- Lack, D.** (1956). *Swifts in a tower*. Chapman and Hall.
- Lack, D. and Owen, D. F.** (1955). The Food of the Swift. *The Journal of Animal Ecology* **24**, 120.
- Lee, D. N.** (1976). A Theory of Visual Control of Braking Based on Information about Time-to-Collision. *Perception* **5**, 437–459.
- Lee, D. N., Bootsma, R. J., Land, M., Regan, D. and Gray, R.** (2009). Lee's 1976 Paper. *Perception* **38**, 837–858.

- Lee, A. T. K., Wright, D. and Barnard, P.** (2017). Hot bird drinking patterns: drivers of water visitation in a fynbos bird community. *Afr. J. Ecol.* **55**, 541–553.
- Lentink, D. and de Kat, R.** (2014). Gliding Swifts Attain Laminar Flow over Rough Wings. *PLoS ONE* **9**, e99901.
- Lentink, D., Müller, U. K., Stamhuis, E. J., de Kat, R., van Gestel, W., Veldhuis, L. L. M., Henningson, P., Hedenström, A., Videler, J. J. and van Leeuwen, J. L.** (2007). How swifts control their glide performance with morphing wings. *Nature* **446**, 1082–1085.
- Maybury, W. J. and Rayner, J. M. V.** (2001). The avian tail reduces body parasite drag by controlling flow separation and vortex shedding. *Proc. R. Soc. Lond. B* **268**, 1405–1410.
- Meinertzhagen, R.** (1954). The education of young ospreys. *Ibis* **96**, 153–155.
- Muijres, F. T., Henningson, P., Stuiver, M. and Hedenström, A.** (2012). Aerodynamic flight performance in flap-gliding birds and bats. *Journal of Theoretical Biology* **306**, 120–128.
- Neumann, C.** (2016). Behavioural thermoregulation in the Common Swift during flight. *British Birds* **8**.
- Norberg, U. M.** (1976). Some Advanced Flight Manoeuvres of Bats. *Journal of Experimental Biology* **64**, 489–495.
- Norberg, U. M.** (1990). *Vertebrate flight: mechanics, physiology, morphology, ecology and evolution*. New York: Springer Berlin Heidelberg.
- Nudds, R. L. and Bryant, D. M.** (2000). The energetic cost of short flights in birds. *Journal of Experimental Biology* **203**, 1561–1572.
- Parikh, M. B., Corcoran, A. J. and Hedrick, T. L.** (2019). Competition and cooperation among chimney swifts at roost entry. *Bioinspir. Biomim.* **14**, 055005.
- Parker, I. and Graham, A.** (2018). A note on flight disorientation over smooth water. *Scopus: Journal of East African Ornithology* **38**, 24–29.
- Pennycuik, C. J.** (1968). A Wind-Tunnel Study of Gliding Flight in the Pigeon *Columba Livia*. *Journal of Experimental Biology* **49**, 509–526.
- Pennycuik, C. J.** (1971). Control of gliding angle in Rueppell's griffon vulture *Gyps rueppellii*. *Journal of Experimental Biology* **55**, 39–46.
- Podulka, S., Rohrbaugh Jr., R. W. and Bonney, R. eds.** (2004). *Handbook of Bird Biology*. Cornell Lab of Ornithology in association with Princeton University Press, 2nd ed.
- Ruau, G., Lumineau, S. and de Margerie, E.** (2020). The development of flight behaviours in birds. *Proceedings of the Royal Society B: Biological Sciences* **287**, 20200668.
- Ruggles, K. W.** (1970). The Vertical Mean Wind Profile Over the Ocean for Light to Moderate Winds. *J. Appl. Meteor.* **9**, 389–395.

- Salt, G. W. and Zeuthen, E.** (1960). The Respiratory System. In *Biology and Comparative Physiology of Birds*, pp. 363–409. Elsevier.
- Schiffner, I. and Srinivasan, M. V.** (2016). Budgerigar flight in a varying environment: flight at distinct speeds? *Biol. Lett.* **12**, 20160221.
- Shepard, E. L. C., Lambertucci, S. A., Vallmitjana, D. and Wilson, R. P.** (2011). Energy Beyond Food: Foraging Theory Informs Time Spent in Thermals by a Large Soaring Bird. *PLoS ONE* **6**, e27375.
- Tucker, V. A.** (1993). Gliding birds: reduction of induced drag by wing tip slots between the primary feathers. *The Journal of Experimental Biology* **180**, 285–310.
- Tucker, V. A.** (1995). Drag reduction by wing tip slots in a gliding Harris' hawk, *Parabuteo unicinctus*. *The Journal of Experimental Biology* **198**, 775–781.
- Wakeling, J. M. and Hodgson, J.** (1992). Short communication: optimisation of the flight speed of the little, common and sandwich tern. *Journal of Experimental Biology* **169**, 261–266.
- Warrick, D. R., Hedrick, T. L., Biewener, A. A., Crandell, K. E. and Tobalske, B. W.** (2016). Foraging at the edge of the world: low-altitude, high-speed manoeuvring in barn swallows. *Phil. Trans. R. Soc. B* **371**, 20150391.
- Whitehead, J. G.** (2020). An examination of the kinematics and behavior of mallards (*Anas platyrhynchos*) during water landings. 96.
- Wilson, R. S., Husak, J. F., Halsey, L. G. and Clemente, C. J.** (2015). Predicting the Movement Speeds of Animals in Natural Environments. *Integrative and Comparative Biology* **55**, 1125–1141.
- Winkler, D. W., Hallinger, K. K., Ardia, D. R., Robertson, R. J., Stutchbury, B. J. and Cohen, R. R.** (2020). Tree Swallow (*Tachycineta bicolor*), version 1.0. In *Birds of the World* (ed. Billerman, S. M.), Keeney, B. K.), Rodewald, P. G.), and Schulenberg, T. S.), p. Ithaca, NY, USA: Cornell Lab of Ornithology.
- Wynn, M. L., Clemente, C., Nasir, A. F. A. A. and Wilson, R. S.** (2015). Running faster causes disaster: trade-offs between speed, manoeuvrability and motor control when running around corners in northern quolls (*Dasyurus hallucatus*). *Journal of Experimental Biology* **218**, 433–439.

Electronic supplementary material for the article
“Drink safely: common swifts (*Apus apus*) dissipate
mechanical energy to decrease flight speed before touch-
and-go drinking”

by Geoffrey Ruaux, Kyra Monmasson, Tyson L. Hedrick, Sophie Lumineau and Emmanuel de Margerie.

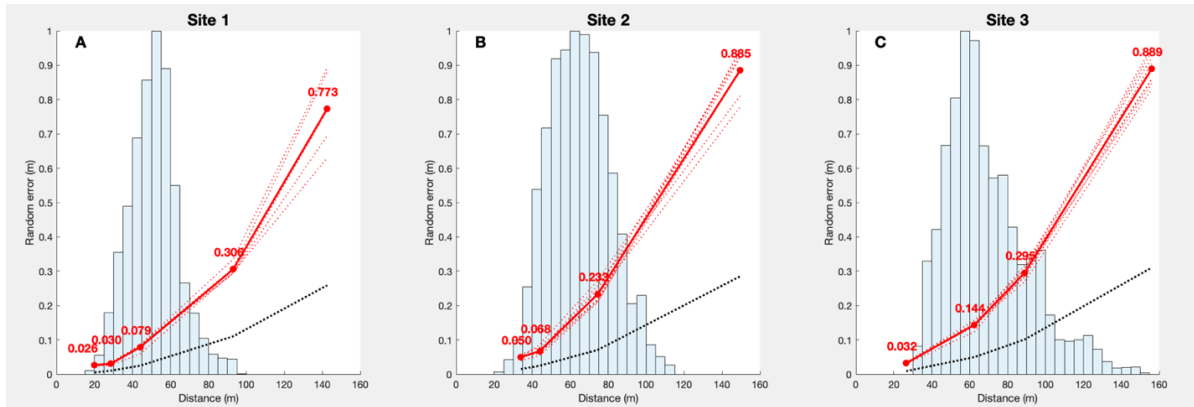

Figure S1: Random error in 3D location reconstruction, as a function of distance from the RSV device on each site.

Red dots: mean error for calibration points. Red dotted lines: error for individual calibrations. Black dotted line: theoretical random error from 3D space quantization only. The background histogram shows the distance distribution for all sampled bird locations on each site.



Figure S2: RSV device and weather station on site 1.



Figure S3: RSV device used for tracking drinking swifts.

Rigid assembly of a camera and a set of mirrors rotating on a tripod with a fluid video head equipped with angular encoders. See Methods section for details on components. A second camera visible on the right side is not used for tracking, but to take pictures of the filmed birds with a greater magnification.

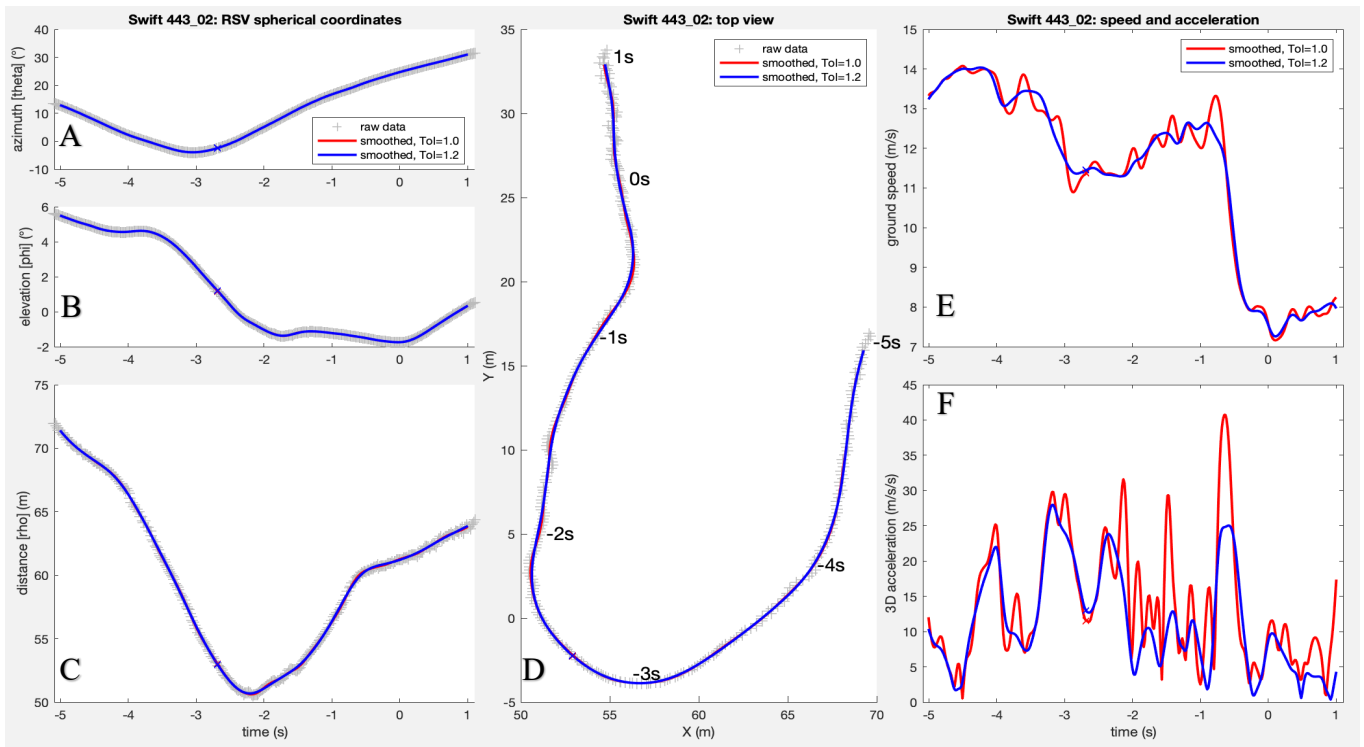

Figure S4: Example of raw and smoothed flight trajectory (for the bird shown in Movie 1).

Spherical coordinates from the RSV device (A-C: azimuth angle, elevation angle, radial distance) were smoothed using quintic splines. In order to remove noise, while avoiding over-smoothing, spline tolerance should ideally be set to a value based on an estimation of the real positioning error. In the present case, estimation was not straightforward, because (i) the base theoretical RSV error (from space quantization, see de Margerie et al. 2015) varies with distance to the bird, and (ii) accuracy of bird image digitization in video frames was affected by variable natural backgrounds (sky vs. foliage vs. water surface, see supplementary videos). To reflect this « hybrid » error, our approach was to sum, for each recorded position in the series, the base theoretical RSV positioning error, and the amplitude of high-frequency signal (≥ 5 Hz) present in the raw coordinate series. This high-frequency signal was assumed to be noise caused by random error in bird image digitization, and should hence be removed. This hybrid tolerance value allowed a first smoothing attempt (shown in red in panels A-C above, Tol=1.0), which was efficient at removing noise in positional data (noise was stronger in distance signal C, see also flight trajectory top view D). However, high-frequency noise (~ 5 Hz) remained present in the transformed derivatives of smoothed coordinates, i.e. bird speed (E) and acceleration (F). Increasing the smoothing tolerance by 20% (blue fits in panels A-C, Tol =1.2) reduced the noise issue for derivatives (E, F), while still fitting closely to the raw track positions (A-D). As increasing the tolerance further caused evidence of position oversmoothing (visible cut-off turns), we retained the 1.2 tolerance value for all flight trajectories, as a reasonable compromise between a preserved positional signal and a realistic speed signal. Note that choosing alternative tolerance values (Tol=1.0 or Tol=1.4) did not change the main results of the study (see. Table S1).

Note : the trajectory top view in panel D is rotated compared to Movie 1, because here raw coordinates are in the study site calibration frame, not yet aligned to geographic North.

Table S1: Sensitivity analysis for smoothing tolerance.

The results of the main statistical tests carried out in our analyses are presented for each site and for the three values of smoothing tolerance considered. The value of 1.2 was used in our final analyses. Overall, results are very similar, except a non-significant Friedman test on site 3 for a smoothing tolerance of 1.4, and a non-significant ANOVA for s_1 values for a smoothing tolerance of 1.0.

Statistical test	Site 1 (1.0)	Site 2 (1.0)	Site 3 (1.0)	Site 1 (1.2)	Site 2 (1.2)	Site 3 (1.2)	Site 1 (1.4)	Site 2 (1.4)	Site 3 (1.4)
S_0 vs E_{-5} (linear model, Fig. 3)	$y = -0.003x$ ($p = 0.518$) NS	$y = 0.006x$ ($p = 0.155$) NS	$y = 0.001x$ ($p = 0.856$) NS	$y = -0.002x$ ($p = 0.665$) NS	$y = 0.005x$ ($p = 0.252$) NS	$y = -0.001x$ ($p = 0.921$) NS	$y = -0.002x$ ($p = 0.694$) NS	$y = 0.005x$ ($p = 0.258$) NS	$y = -0.001x$ ($p = 0.856$) NS
P_{5s} vs E_{-5} (linear model, Fig. 3)	$y = -0.206x$ ($p < 0.001$) ***	$y = -0.187x$ ($p < 0.001$) ***	$y = -0.195x$ ($p < 0.001$) ***	$y = -0.204x$ ($p < 0.001$) ***	$y = -0.190x$ ($p < 0.001$) ***	$y = -0.202x$ ($p < 0.001$) ***	$y = -0.203x$ ($p < 0.001$) ***	$y = -0.190x$ ($p < 0.001$) ***	$y = -0.203x$ ($p < 0.001$) ***
P_{1s} values (Friedman test, Fig. 4)	($p < 0.001$) ***	($p < 0.001$) ***	($p = 0.023$) *	($p < 0.001$) ***	($p < 0.001$) ***	($p = 0.013$) *	($p < 0.001$) ***	($p < 0.001$) ***	($p = 0.093$) NS
P_{1s} vs ω_{1s} (mixed model, Fig. 6)	$y = -0.118x$ ($p = 0.006$) **	$y = 0.007x$ ($p = 0.881$) NS	$y = -0.082x$ ($p = 0.441$) NS	$y = -0.134x$ ($p = 0.001$) **	$y = -0.021x$ ($p = 0.644$) NS	$y = -0.043x$ ($p = 0.660$) NS	$y = -0.136x$ ($p < 0.001$) ***	$y = -0.042x$ ($p = 0.375$) NS	$y = -0.025x$ ($p = 0.801$) NS
d_{d0} values (Rayleigh test, Fig. 7)	$\alpha = 14.33^\circ$ ($p < 0.001$) ***	$\alpha = 341.84^\circ$ ($p < 0.001$) ***	$\alpha = 333.33^\circ$ ($p = 0.005$) **	$\alpha = 14.54^\circ$ ($p < 0.001$) ***	$\alpha = 342.14^\circ$ ($p < 0.001$) ***	$\alpha = 332.37^\circ$ ($p = 0.005$) **	$\alpha = 14.59^\circ$ ($p < 0.001$) ***	$\alpha = 342.23^\circ$ ($p < 0.001$) ***	$\alpha = 332.36^\circ$ ($p = 0.005$) **
S_0 vs S_h (linear model, Fig. 8)	$y = -0.739x$ ($p < 0.001$) ***	$y = -0.229x$ ($p = 0.268$) NS	$y = -0.302x$ ($p = 0.376$) NS	$y = -0.717x$ ($p < 0.001$) ***	$y = -0.229x$ ($p = 0.269$) NS	$y = -0.268x$ ($p = 0.442$) NS	$y = -0.711x$ ($p < 0.001$) ***	$y = -0.216x$ ($p = 0.306$) NS	$y = -0.237x$ ($p = 0.483$) NS
Z_{-5} values (ANOVA, Table 1)	(p < 0.001) ***			(p < 0.001) ***			(p < 0.001) ***		
Z_1 values (ANOVA, Table 1)	(p = 0.001) **			(p = 0.001) **			(p = 0.001) **		
S_{-5} values (ANOVA, Table 1)	(p = 0.620) NS			(p = 0.598) NS			(p = 0.585) NS		
S_0 values (ANOVA, Table 1)	(p < 0.001) ***			(p < 0.001) ***			(p < 0.001) ***		
S_1 values (ANOVA, Table 1)	(p = 0.084) NS			(p = 0.025) *			(p = 0.009) **		

SUPPLEMENTARY MOVIES

Each of the 3 supplementary movies shows a single flight trajectory, from study sites 1, 2 and 3 respectively. They were chosen to illustrate a variety of braking strategies, and identify corresponding manoeuvres and body postures, when visible on video extracts. To better visualize the birds' trajectories and local landscapes, below are Google Earth™ 3D renderings of the flight trajectories in their surrounding landscapes.



Swift 443_01, site 1 (river)



pond)

Swift 236_01, site 2 (small



pond)

Swift 269_01, site 3 (large

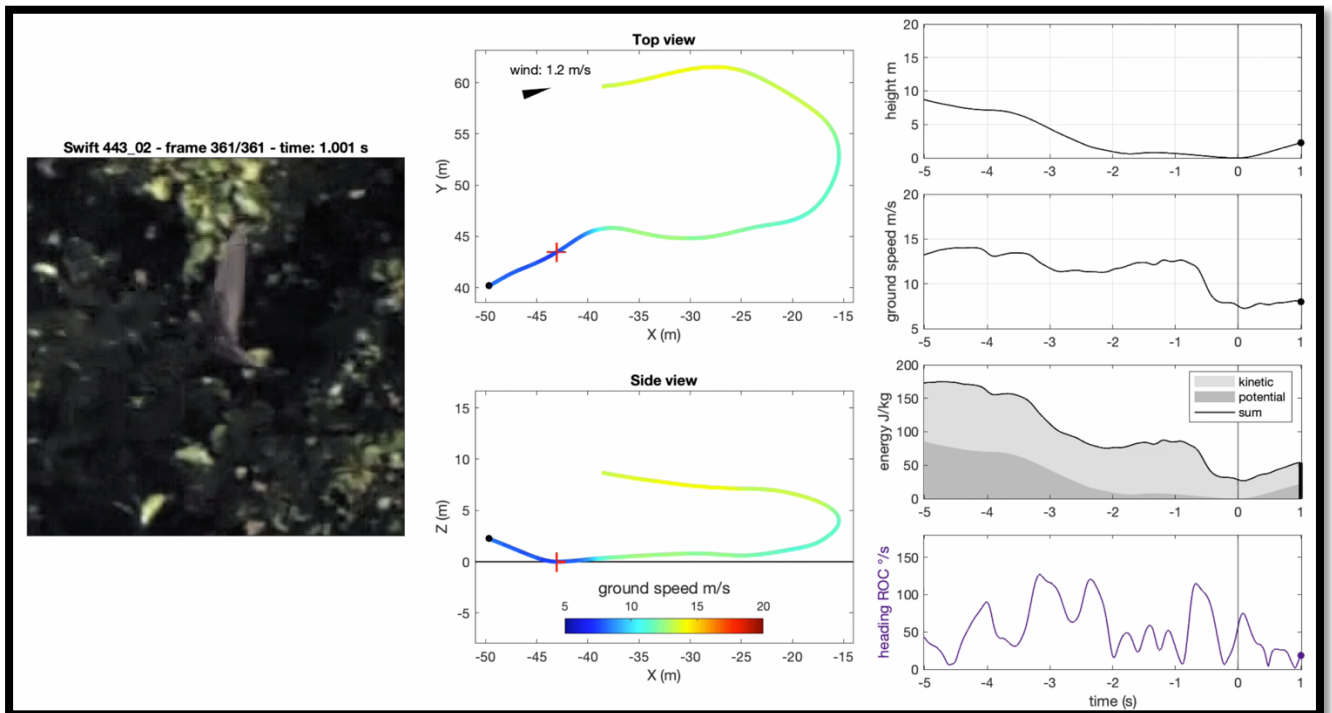

Movie 1 (file: V1_443_02_track.mp4)

For this first track, recorded on site 1 (river), the 5 s approach to water surface can be divided in 5 main phases, based on mechanical energy profile:

- From -5 to -3.5 s the swift glides at ~ 13.5 m/s ground speed, while also turning right by $\sim 45^\circ$. Height decreases from 8.7 to 6.5 m (sink rate -1.5 m/s). During this phase, gliding is efficient and energy dissipation is low (-12.8 W/kg power, average over 1.5 s duration).
- From -3.5 to -2s, the swift executes a sustained, descending right turn, diving from 6.5 to 0.9 m height (-3.7 m/s sink rate). This turn is not associated with an increase in ground speed. In fact, ground speed decreases by 1.8 m/s (from 13.4 to 11.6 m/s), partly due to the bird turning in an upwind direction (wind speed estimation: 1.2 m/s). This **descending turn** manoeuvre allows the bird to dissipate 77.6 J/kg (-51.7 W/kg power). This phase is an interesting example where the bird achieves **losing height at a high rate without gaining speed**, i.e. can sometimes dissipate potential energy without first converting it to kinetic energy.
- Between -2 and -0.9 s, the bird executes a short flapping flight phase, with slight decrease in height (from 0.9 to 0.6 m), and increase in speed (11.6 to 12.6 m/s). Power is positive for this phase (+8.6 W/kg), reflecting that the bird produces muscular work.
- An interesting final braking phase is observed between -0.9 and -0.3s : the bird makes a quick $\sim 45^\circ$ left turn, followed by a striking posture with **high wing dihedral and high body-and-tail incidence**, clearly visible on the video extract. During this 0.6 s phase, the bird loses 4.6 m/s in speed (from 12.6 to 8.0 m/s), in addition to descending 0.5 m (from 0.6 to 0.1 m), which results in a **-87.9 W/kg** dissipative power.
- The last 0.3 s of approach are a straight (in the horizontal plane), efficient gliding flight to water surface (power -15.2 W/kg), with reduced wing dihedral and open gape (Note that heading ROC peak at water contact reflects the vertical pitch up inflexion).

After water contact, the swift actively flaps its wings, with an average climb rate of +2.2 m/s over the first second, while also slightly accelerating (average power +25.3 W/kg).

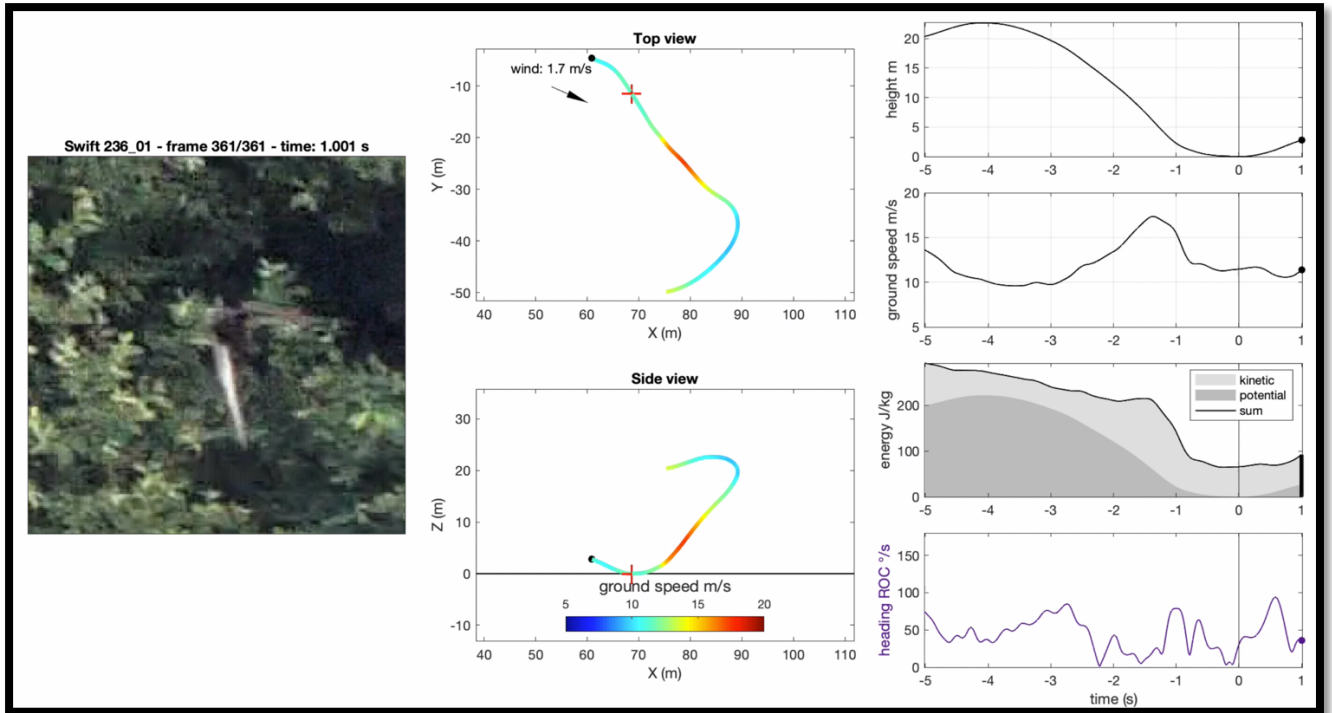

Movie 2 (file: V2_236_01_track.mp4)

In this track recorded on site 2 (small pond), the approach can be divided in 4 phases:

- From -5 to -4s, the bird climbs 2.2 m, while decelerating from 13.6 to 10 m/s. The bird also produces 4 wing strokes. However, power over this phase is negative at -19 W/kg.
- From -4 to -1.4s, the swift dives from 22.6 to 6.4m height (-6.2 m/s average sink rate). Simultaneously, **conversion from potential energy to kinetic energy** occurs and the bird accelerates from 10.0 to 17.3 m/s. The -23.0 W/kg power over this phase suggests that the conversion is quite efficient, as energy dissipation rate remains similar to a typical gliding flight (~ -20 W/kg). Note that a $\sim 90^\circ$ turn into a ~ 1.7 m/s wind occurs during this phase, without a clear effect in energy dissipation.
- Most interestingly, between -1.4 and -0.7s, **energy dissipation occurs in a very abrupt way**: the swift loses another 5.5 m in height (from 6.4 to 0.9 m, 7.9 m/s sink rate), but **simultaneously violently decelerates** from 17.3 to 12 m/s. Overall, mass-specific mechanical energy drops from 213 to 81 J/kg, which corresponds to a **-189 W/kg power**, more than 9 times the typical gliding power. Looking at the video extract (of limited image quality because of heavy cropping in compressed 4K frames), it appears the bird uses **high body-and-tail incidence**, followed by **high wing dihedral** during braking. Note that, in the present case, braking occurs without any significant horizontal heading change (see track top view).
- During the last 0.7 s before contact, the swift descends the last 0.9 m to the water surface (sink rate -1.2 m/s), with a small decrease in speed (from 12.0 to 11.5 m/s). The power is back to a standard gliding power of -21.7 W/kg.

After water contact, this swift actively climbs at an average +2.8 m/s (power +26.6 W/kg).

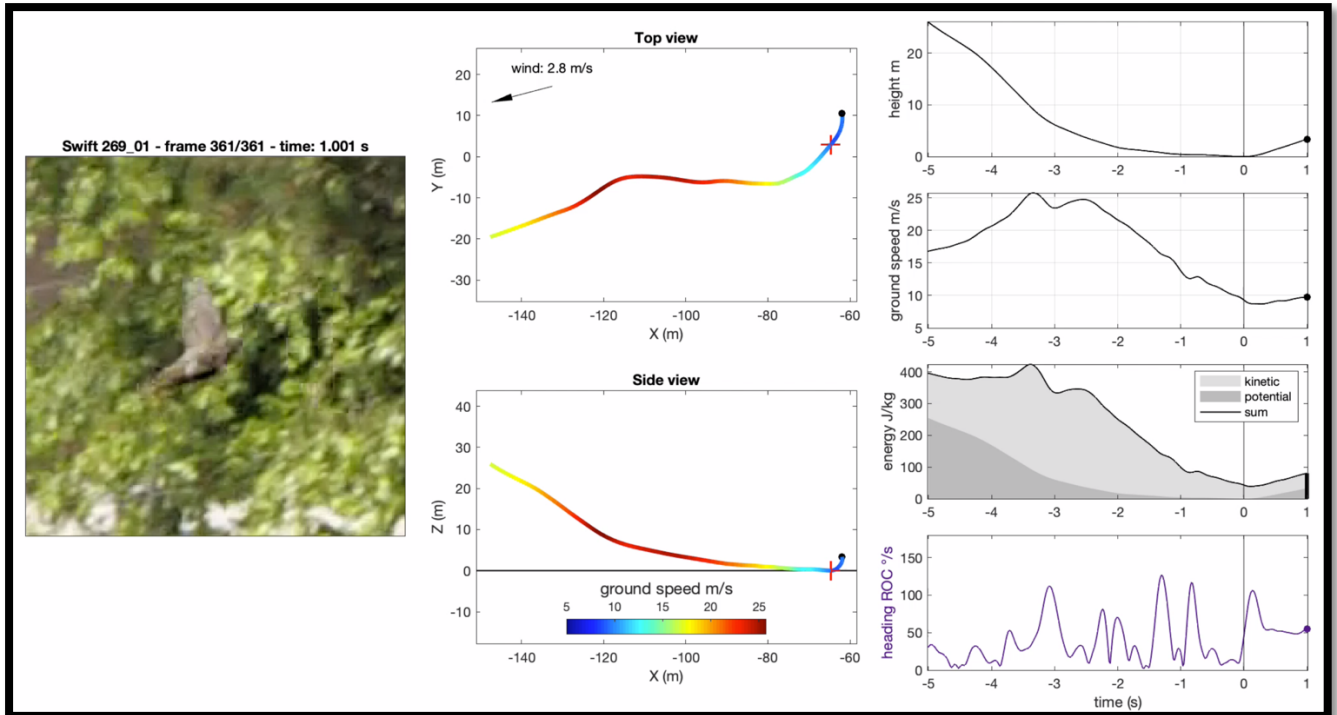

Movie 3 (file: V3_269_01_track.mp4)

This track recorded on site 3 (large pond) shows an example of high, sustained mechanical energy dissipation. From an energy level of 396 J/kg at -5 s, to only 43 J/kg at water contact, the bird produces an average dissipative power of -70.6 W/kg over 5s (minimal value in Fig. 3F). The approach can be divided in 2 main phases, based on energy profile :

- From -5 to -2.5s, the bird steeply dives from 26.0 to 3.6 m (-9.0 m/s sink rate), and converts this large amount of potential energy into very high speed, accelerating from 16.8 to 24.7 m/s. This conversion is efficient, with a typical gliding power of -21.6 W/kg power over this first phase.
- On the contrary, in the last 2.5s before water contact, the swift **brakes from 24.7 to 9.3 m/s**, while still losing 3.6 m in height. Over this second phase, mechanical energy is dissipated at a rate of -**119.4 W/kg**. Looking at bird heading rate of change, and bird flight posture in video extract, braking appears to be associated with **short alternating banking manoeuvres**, with short peaks in heading change. These rapid “**zigzag**” manoeuvres are barely visible on the track top view, as they are not sustained turns, and the swift maintains an overall upwind heading. In the last second before water contact, complementary manoeuvres, such as **high-incidence body-and-tail** posture and **leg trailing** (from around -0.4 s) are also visible on this video extract. Unfortunately, our tracking data was too noisy (and hence required significant smoothing) to precisely assess the contribution of each of these transient manoeuvres to braking.

After water contact, the swift actively climbs at a rate of +3.4 m/s over the first second, while also slightly accelerating (average power +37.1 W/kg).

Chapter 4: Foraging flight in the house martin

Article 3:

Flight behaviours and energy savings in adult and juvenile house martins (*Delichon urbicum*) foraging near their breeding colony

Résumé en français

La recherche alimentaire est un comportement fondamental pour les oiseaux, plus encore durant la période de reproduction, car ils doivent assumer le coût énergétique de l'incubation et de l'élevage des jeunes, en plus de leurs propres besoins énergétiques. Les insectivores aériens effectuent le plus souvent leur recherche alimentaire en vol, ils ont donc évolué pour acquérir de nombreuses adaptations pour minimiser les dépenses d'énergie tout en maximisant leurs apports en énergie durant cette période critique.

Dans cette étude, nous avons enregistré les trajectoires de vol en 3D de 100 hirondelles de fenêtre (*Delichon urbicum*) près de leur colonie durant la période de reproduction, à Rennes. Nous faisons une première description de la distribution de plusieurs variables cinématiques et biomécaniques (vitesse horizontale et verticale, taux de variation de l'énergie cinétique et potentielle, rayon de courbure et force centripète), nous comparons le vol battu et le vol plané, et nous décrivons différentes stratégies utilisées par les hirondelles de fenêtre pour économiser de l'énergie, comme l'extraction d'énergie dans l'environnement (vol thermique) et l'optimisation de la vitesse de vol en fonction de la vitesse et de la direction du vent. Nous montrons également un effet de la température, des radiations solaires et de l'humidité sur la vitesse verticale moyenne des oiseaux en vol plané, ce qui souligne l'effet de la météo sur la disponibilité des sources d'énergie externe comme les courants ascendants. Enfin, nous comparons la distribution des vitesses horizontales et verticales entre cinq juvéniles (identifiés sur des photographies agrandies) et 20 adultes filmés durant les mêmes sessions de terrain.

Nous montrons ainsi que les juvéniles ont une vitesse de vol plus variable que celle des adultes, possiblement car leurs comportements de vol ne sont pas immédiatement optimaux après la sortie du nid.

Complete summary

Context

- Foraging is a critical behaviour for aerial insectivores during the breeding season.
- Reducing energy expenditures in flight should be essential (e.g. extraction of environmental energy, optimisation of the cost of transport according to wind.)
- We recorded house martins (*Delichon urbicum*) foraging near their colony, described the distribution of several biomechanical variables, and quantified gliding and flapping flight.
- We also recorded juveniles in order to study if they differ from adults in some aspects of their flight behaviours.



(Photograph by Nick Vorobey).

Methods

- RSV device to record 3D trajectories.
- 9 field sessions from May to July 2021.
- One recording site near a colony.
- **100 trajectories.**
- Wind and other weather variables.

Main results

- House martins do exploit external energy sources such as thermal updrafts (positive power often observed in gliding flight).
- Effect of temperature, solar radiation and humidity on the mean vertical speed of gliding birds: weather has an effect on the availability of external energy sources.
- They decrease their airspeed when flying downwind, and increase it when flying upwind, following the general tendency for optimisation of cost of transport.
- Juveniles exhibit more variable flight speeds than adults.

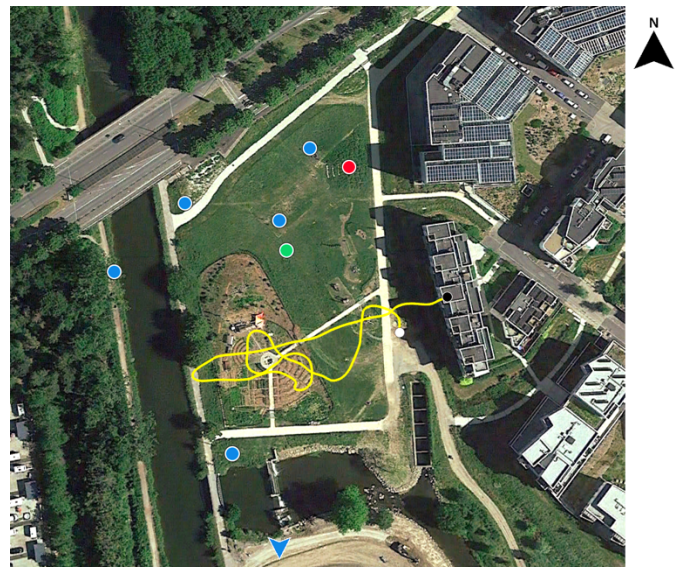

50 m
Aerial view of the recording site..

Conclusions

- House martins use several strategies to minimise energy output while maximising energy input when foraging during this critical period.
- Juveniles might not be as precise as adults in controlling their flight speed, and would thus need more efforts to adjust their speed and their trajectory. In house martins, post-fledging locomotor ontogeny may consist in a reduction of speed variability (i.e. improvement of flight speed control) in order to converge towards the most energy-efficient speeds in a given context.

Article

Flight behaviours and energy savings in adult and juvenile house martins (*Delichon urbicum*) foraging near their breeding colony

Geoffrey Ruaux¹, Kyra Monmasson¹, Tyson L. Hedrick², Sophie Lumineau¹ and Emmanuel de Margerie¹

¹Univ Rennes, Normandie Univ, CNRS, EthoS (Éthologie animale et humaine) - UMR 6552, F-35000 Rennes, France.

²University of North Carolina at Chapel Hill, Chapel Hill, NC 27599, USA.

Corresponding author: Emmanuel de Margerie

e-mail: emmanuel.demargerie@univ-rennes1.fr

Article submitted to *Behavioural Ecology and Sociobiology*.

Abstract

Foraging is an extremely important behaviour for birds, especially during the breeding season, when they have to carry the cost of incubation and chick rearing, in addition to their own energy needs. Aerial insectivores perform most of their foraging behaviours in flight, so they have evolved various adaptations to reduce energy output while increasing energy input during this critical period. In this study, we recorded the 3D flight behaviours of 100 house martins (*Delichon urbicum*) flying near their colony during the breeding season in Rennes, France. We give a first description of the distribution of several kinematic and biomechanical variables (horizontal and vertical speed, rates of change in kinetic and potential energy, turning radius of curvature and centripetal force), compare flapping and gliding flight, and describe several strategies used by flying house martins to save energy, such as environmental energy extraction (thermal soaring) and optimisation of flight speed according to wind speed and direction. We also report an effect of temperature, solar radiation and humidity on the mean vertical speed of gliding birds, highlighting the effect of weather on the availability of external energy sources such as thermal updrafts. Finally, we compare the distribution of flight speed

and vertical speed between 5 juveniles identified using magnified photographs and 20 adults recorded during the same field sessions, and we show that juveniles exhibit more variable flight speeds than adults, possibly because their flight behaviours are not immediately optimised after leaving the nest.

Keywords: energy, wind, kinematics, ontogeny

Significance statement

Aerial insectivores use various strategies to reduce the cost of foraging flight. Using an optical tracking method, we recorded the 3D flight behaviours of house martins (*Delichon urbicum*) flying near their colony during the breeding season. We describe the distribution of several biomechanical variables and show that house martins use external energy sources such as thermal updrafts and also adapt their airspeed to wind speed and direction, supporting the predictions on optimal cost of transport in birds. Moreover, juveniles were also recorded, and they show a greater variability in flight speed, possibly because they may not be as accurate as adults in finely adjusting their speed and altitude. Our findings add to the existing literature showing energy saving strategies in aerial insectivores, and also study an ontogenetical aspect rarely explored.

Introduction

Foraging is a behaviour of crucial importance in the life cycle of birds, especially during the breeding season. During incubation, depending on the species' mode of parental care, a parent may have to cope with different constraints. If both parents incubate, each one has to dedicate some time to incubation with a reduced time frame to satisfy its own needs (Shaffer et al., 2003). If only one parent incubates while being fed by its mate, the other one has to find food for itself and its mate (Martin and Ghalambor, 1999; Matysioková and Remeš, 2014). Alternatively, if one parent has to incubate without the assistance of its mate, it must cover the entire cost of incubation while having to meet its own needs (Green et al., 1990; Jia et al., 2010). When chicks hatch, parents still have to dedicate some time to warm or protect them in many species, and they additionally have to cover the food needs of an entire brood (Ydenberg, 1994; Markman et al., 2002).

Aerial insectivores, like swifts, swallows and martins, have to fly continuously and to perform flight manoeuvres while foraging (Bryant and Turner, 1982; Kacelnik and Houston, 1984). Swifts, swallows and martins feed their chicks with a food bolus constituted of tens to

hundreds of arthropods (Bryant and Turner, 1982; Gory, 2008), which avoids having to fly back and forth between the nest and the foraging patches for each individual prey. During foraging, maximisation of energy intake per unit time is obviously important, but energy consumed during flight is considerable, and the foraging strategy must be a balance between the energy output during flight and the energy intake from feeding (Rayner, 1982). Thus, flying at a low cost is of paramount importance for foraging aerial insectivores.

Various behavioural adaptations exist to reduce flight energy expenditures. For example, some aerial insectivores are able to extract energy from their environment during foraging. Common swifts (*Apus apus*) can glide in thermal updrafts and use wind gusts and wind gradients to save energy (de Margerie et al., 2018; Hedrick et al., 2018), while barn swallows (*Hirundo rustica*) also use wind gradients to gain potential and kinetic energy during turns (Warrick et al., 2016).

Additionally, wind speed and direction may also influence the flight behaviours of foraging aerial insectivores. Indeed, theory predicts that birds should adjust their airspeed when flying upwind or downwind for energetically optimal cost of transport in the ground reference frame (Pennycuik, 1978). The maximum range speed of birds (the airspeed at which the distance travelled for a given amount of energy consumed is maximised) is influenced by wind, and birds optimising their energy expenditure per unit of distance should increase their airspeed when flying upwind, and decrease it when flying downwind. This phenomenon has been confirmed in migrating or commuting birds (Wakeling and Hodgson, 1992; Hedenström et al., 2002; Kogure et al., 2016; Sinelschikova et al., 2019), and also in the common swift while foraging on aerial insect prey (Hedrick et al., 2018), probably because of the presence of its nest at a fixed ground position.

In addition to wind, other weather variables might have an effect on the flight behaviours of aerial insectivores, such as temperature, solar radiation or humidity, because they influence the availability and movement patterns of aerial insect prey (Lack and Owen, 1955; Bryant, 1973; Wainwright et al., 2017), and also the availability of external energy sources such as thermal updrafts (Poessel et al., 2018).

Finally, very little is known about the ontogeny of foraging and energy-saving flight behaviours within an individual. Since foraging flight is a complex behaviour, it is possible to hypothesize that juvenile birds may not be as efficient as adults in all aspects immediately after fledging, as is the case in many species for various flight behaviours (see review in Ruaux et al., 2020).

The house martin (*Delichon urbicum*) is a socially monogamous coursing insectivore nesting in colonies, in which both sexes incubate and feed the chicks (Bryant, 1979; Whittingham and Lifjeld, 1995; del Hoyo et al., 2020). They lay up to three clutches per year, and each clutch is composed of one to seven (most often four to five) eggs (del Hoyo et al., 2020). Bryant & Westerterp (2002) studied the energy budget of breeding house martins and calculated that each parent spent around 6 h per day away from the nest during incubation, and that a bird foraging at the highest observed rate in optimal conditions during this time would gather energy only 6% in excess of its requirements, leaving little margin for other activities and lower foraging rates in poorer conditions. When feeding chicks, parents spend more time in flight but have to meet the energy needs of their brood in addition to their own needs. Thus, breeding house martins should spend most of their time actively foraging, and should mostly be traveling or searching for food otherwise. In this context, studying the flight behaviours of house martins near a colony during the breeding period may improve understanding of the characteristics of flight during this crucial period, and identify possible means by which these birds reduce their energy expenditures.

In the present study, we measured the 3D flight trajectories of house martins using rotational stereo videography (RSV; de Margerie et al., 2015), in order to describe biomechanical characteristics of their flight. One of our goals was to give a first description of the “flight envelope” of house martins in a field study, in order to understand how they use the aerial habitat near their colony during the breeding period. We also tested some of the hypotheses related to energy savings in aerial insectivores: we studied the gliding and flapping behaviours of house martins in order to determine if they use external energy sources such as thermal currents, wind gusts and wind gradients, and if weather conditions could influence these behaviours. Then, we tested if house martins change their airspeed depending on wind direction in order to optimise their energy expenditure in the ground reference frame. Finally, we investigated if juvenile house martins differ from adults in some aspects of their flight behaviours.

Materials and methods

Table 1: List of symbols and abbreviations.

a	bird acceleration vector in the ground reference frame
a_z	bird vertical acceleration
A	wind speed vector

F	mass-specific centripetal force
g	magnitude of gravitational acceleration
P	mass-specific kinematic power (sum of rates of change in mass-specific kinetic and potential energy)
P_k	mass-specific rate of change in kinetic energy
P_p	mass-specific rate of change in potential energy
R	instantaneous radius of curvature
RSV	rotational stereo-videography
s_a	bird speed in the air reference frame
s_{ha}	bird horizontal speed in the air reference frame
s_w	wind speed
s_z	bird vertical speed
\mathbf{v}	bird velocity vector in the ground reference frame
\mathbf{v}_a	bird velocity vector in the air reference frame
X, Y, Z	bird cartesian coordinates in the ground reference frame
Θ	azimuthal angle measurement from RSV
P	radial distance measurement from RSV
Φ	elevation angle measurement from RSV
.	dot-over character, indicating first derivative with respect to time
..	double dot-over character, indicating second derivative with respect to time
Subscript 1s	variable averaged over 1 second (10 consecutive frames where flight behaviour did not change)

All symbols and abbreviations used in our analyses can be found in Table 1.

Recording site and time

House martins were recorded near a colony located in Rennes, France (Fig. 1, see also Fig. S1 for a ground view of the experimental setup). The breeding house martins are present in the colony from May to September, and the colony is composed of several tens of nests built on buildings (3 to 6-floor), surrounded by an urban landscape, with mainly roads, a wide lawn and urban gardens. The RSV device was located on a small hill to the northwest of the colony (48°07'45.55"N 1°40'42.88"W), with a panoramic view over the wide lawn and urban gardens above which the house martins were often flying.

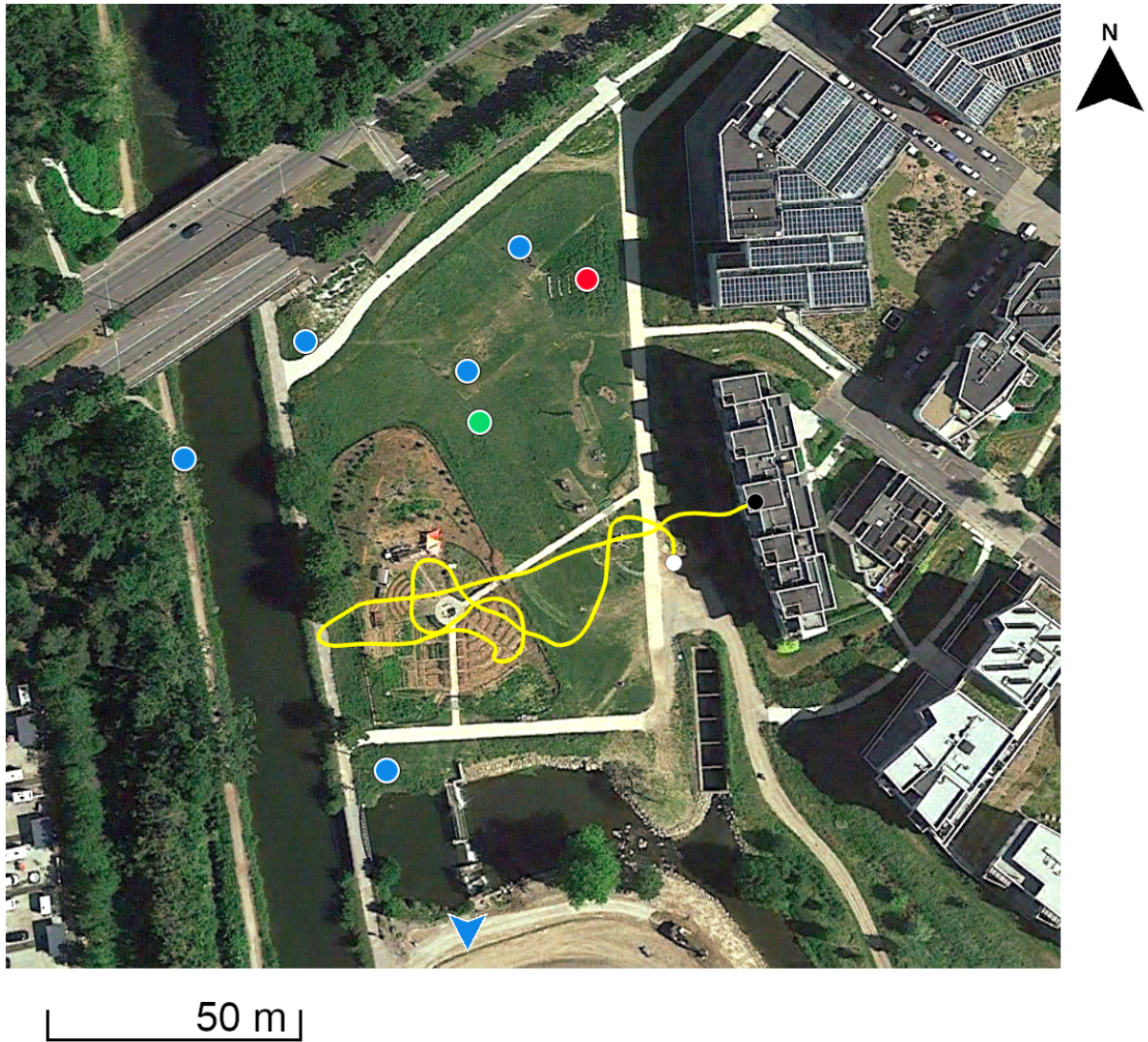

Figure 1: Aerial view of the recording site. The red dot indicates the location of the RSV device, the green dot indicates the location of the weather station, and blue dots indicate the location of calibration points. The blue arrow indicates the direction of the sixth calibration point, located 410 m away from the RSV device and not represented here for legibility. The yellow line shows an example of a trajectory, with the white dot marking the beginning and the black dot marking the end. The colony is located on all the buildings on the right side of the aerial view (e.g. where the example trajectory ends). Source for aerial view: Google Earth.

Nine recording sessions took place from May to July 2021, corresponding to the time when house martins are raising their first brood in this region of France (del Hoyo et al., 2020). Recordings took place in the morning between 9:30 h and 12:00 h, when house martins were regularly observed flying near the colony.

During each field session, a GILL Instruments MaxiMet GMX501 weather station (Lymington, UK) with ultrasonic anemometer was set up on a tripod, in order to measure the approximate wind speed and direction experienced by house martins flying near the colony. We placed the anemometer at 2 m height above the ground, in the wide lawn located west to the colony in order to minimise proximity with any tree or building (see Fig. 1). The weather

station also recorded temperature, solar radiation, humidity and atmospheric pressure. All variables were recorded at 1 Hz, and were averaged over the duration of each trajectory.

Rotational stereo-videography (RSV)

RSV is an optical tracking technique based on a set of mirrors projecting a stereo image of the animal on the sensor of a single camera (de Margerie et al., 2015). The distance to the animal is measured by analysing the lateral shift between animal image pairs. The rigid assembly of camera and mirrors can rotate horizontally and vertically on a tripod and fluid video head. While the operator rotates the device to keep the moving animal's image within the sensor frame, the aiming angles are recorded by angular encoders. The geometrical combination of distance and aiming angles (corrected for the position of the animal image on the sensor) yields a 3D record of the animal's movement.

We used an updated RSV device (Fig. S2) with a 1 m base length between the lateral mirrors, a Manfrotto 504HD fluid head (Cassola, Italy) equipped with 17-bit digital angular encoders (Kübler Sendix F3673, Villingen-Schwenningen, Germany), recording aiming angles at 200 Hz through an Arduino Mega microcontroller (www.arduino.cc) and an Adafruit Data logging shield (New York, USA). The device was equipped with a Panasonic DC-GH5S camera (Osaka, Japan) recording 4096×2160 -pixel frames at 60 Hz (150 Mbps H.264 compression) from a 19×10 mm sensor area. We used a Nikon AF 105 mm f/2 lens (Tokyo, Japan), providing a 5.2° horizontal field of view for each side of the stereo image. To get well exposed and sharp images, we used a $1/1300$ – $1/640$ s shutter speed and f/11 aperture, with ISO 1000–2500, depending on available light conditions. In order to help tracking the fast-flying birds, the camera was equipped with a Nikon DF-M1 dot sight viewfinder (Osaka, Japan).

Calibration and location error

In order to calibrate the distance measure, which is based on the lateral offset between left and right images of the bird, we recorded six conspicuous targets (signs, street lamps, trees) located at fixed distances from the RSV device, from 16 to 410 m. The real distance to these targets was measured with a Nikon Forestry Pro hand laser rangefinder (Tokyo, Japan).

The random positioning error was approximately 0.04 m at 25 m, 0.10 m at 50 m and 0.34 m at 100 m (Fig. S3).

Recording methods and data classification

During each field session, we recorded any house martins seen flying at 25–100 m from the RSV device (i.e. convenience sampling), and each individual was followed until it was lost by the operator. In order to minimize pseudoreplication, we made sure to record a different individual at the end of each recording. Despite this precaution, pseudoreplication may be present to some extent in our data since many individuals were flying back and forth between their nest and the nearby gardens. However, we estimate pseudoreplication to be modest, since we recorded 100 trajectories near the colony composed of several tens of pairs.

In order to analyse a sufficient and comparable portion of trajectories, recordings lasting less than 30 s were removed. Retained videos were subsampled from 60 to 10 Hz to ensure that the number of frames was manageable for digitizing, yet still appropriate to describe flight behaviours at a fine temporal scale.

Moreover, recordings where the bird was out of frame during more than 10 consecutive frames (i.e. more than 1 s missing at 10 Hz) were also removed (with a 5.2° field of view, the operator occasionally struggled to continuously follow the bird's path with the camera). The resulting sample had 97 trajectories with a homogeneous distribution over the nine field sessions (between 9 and 12 trajectories per session).

During each recording, photographs were taken with a greater magnification using a second camera mounted on the RSV device (Panasonic DMC-GH4 with a Nikon AF 200 mm f/4 lens), in order to have a clearer view of the plumage of each bird and to be able to identify juveniles, which are recognized mainly by the white tips of their tertials (Blasco-Zumeta and Heinze, 2014). Five juveniles could be identified during two field sessions in the first half of July, consistent with the breeding phenology of house martins (del Hoyo et al., 2020). Three of these juveniles had trajectories lasting less than 30 s (15, 23 and 29 s). These juveniles were added to the dataset in order to ensure a minimal sample size for juveniles, increasing the total to 100 trajectories (95 adults and 5 juveniles), with a median duration of 37.5 s and a total duration of 4512 s.

In order to study the link between house martins' behaviours and biomechanical variables, the flapping behaviour was labelled on each frame by direct observation of the recorded videos, as either “gliding”, “flapping” or “not visible” when the bird was too far or flew in front of a very textured background (foliage). Only birds performing at least one full downstroke and upstroke cycle were categorized as flapping, because they occasionally performed short manoeuvring wing movements during gliding.

Track processing

Stereo videos and angular records were processed with MATLAB r2018b (The Mathworks, Natick, MA, USA). To digitize the bird's locations in each video frame, the pixel at the centroid of the bird's body in the left half of the frame was selected as the left point of interest (POI), either manually or with the help of semi-automatic tracking (DLTdv version 8a; Hedrick, 2008). Then, automated normalized cross-correlation between a 31×31 -pixel area around the left POI and the right half of the image was used to find the corresponding right POI. Automated matching of right POI was sometimes misled by variable backgrounds (sky, foliage, buildings), and thus was visually checked and manually corrected when needed. The bird's distance from the RSV device was then computed based on the calibration reference.

RSV tracking yields spherical coordinates of the bird for each video frame (i.e. azimuth angle, elevation angle and distance from the device; Θ , Φ and P respectively). Raw coordinate series contain noise, due to (i) theoretical positioning uncertainty (increasing with P^2 , see de Margerie et al., 2015) and (ii) POI random positioning error in stereo images, which was exacerbated by variable image backgrounds. Consequently, we smoothed the raw spherical coordinate series using quintic splines, with an error tolerance based on the sum of (i) the per-point theoretical positioning uncertainty and (ii) the amplitude of high-frequency signal present in the coordinate series (as measured with 3 Hz high-pass filtering). These splines also interpolated short (≤ 10 frames) track bouts where the bird was out of frame. Smoothed spherical coordinates were then converted to cartesian coordinates (X , Y , Z) without additional smoothing. Similarly, smoothed cartesian speeds and accelerations (i.e. \dot{X} , \dot{Y} , \dot{Z} and \ddot{X} , \ddot{Y} , \ddot{Z}) were computed from the first and second derivatives of the spherical coordinate smoothing spline functions (Hedrick et al., 2018). An initial examination of smoothing results showed that high frequency noise was efficiently removed from position series, but remained present in speed and acceleration data, an issue that could partly be improved by increasing the smoothing tolerance by 20 %. In order to ensure that the smoothing tolerance value did not affect our results, we performed a sensitivity analysis, where the base smoothing tolerance was increased by 0% and 40%, with no significant effect on the results presented below (see Table S1 and Fig. S7).

Biomechanical variables

A set of biomechanical variables was calculated to describe the flight behaviours of house martins:

Flight speed in the air reference frame ($\text{m}\cdot\text{s}^{-1}$):

$$s_a = |\mathbf{v}_a| = |\mathbf{v} - \mathbf{A}| \quad (1)$$

where \mathbf{v}_a is the velocity vector in the air reference frame, computed by subtracting wind speed vector \mathbf{A} , calculated from weather station data averaged over the duration of each trajectory, from \mathbf{v} , the bird velocity vector ($\dot{X}, \dot{Y}, \dot{Z}$). The norms of the horizontal and vertical components of \mathbf{v}_a , s_{ha} (horizontal speed in the air reference frame) and s_z (vertical speed) were also calculated. Note that we measured wind speed and direction in the horizontal plane only, hence \mathbf{A} has no vertical component and s_z values are equal in the ground and air reference frames.

Mass-specific rate of change in potential energy ($\text{W}\cdot\text{kg}^{-1}$):

$$P_p = g s_z \quad (2)$$

where g is the magnitude of gravitational acceleration.

Mass-specific rate of change in kinetic energy ($\text{W}\cdot\text{kg}^{-1}$):

$$P_k = \mathbf{v}_a \cdot \mathbf{a} \quad (3)$$

where \mathbf{a} is the acceleration vector ($\ddot{X}, \ddot{Y}, \ddot{Z}$).

Mass-specific kinematic power ($\text{W}\cdot\text{kg}^{-1}$):

$$P = P_p + P_k \quad (4)$$

Note that power values are mass-specific, as the body masses of individual birds are unknown.

Finally, to measure flight turns in trajectories, we calculated the following variables:

Instantaneous radius of curvature (m):

$$R = \frac{|\mathbf{v}_a|^3}{\sqrt{|\mathbf{v}_a|^2 |\mathbf{a}'|^2 - (\mathbf{v}_a \cdot \mathbf{a}')^2}} \quad (5)$$

where \mathbf{a}' is the transpose of \mathbf{a} .

Note that R is a measure of flight direction change in any plane, not limited to horizontal turns.

Mass-specific centripetal force ($\text{m}\cdot\text{s}^{-2}$):

$$F = \frac{|\mathbf{v}_a|^2}{R} \quad (6)$$

Statistical analysis

Most graphical representations and associated statistical analyses were performed in MATLAB r2018b. In order to visualize the flight envelope of the recorded house martins, several pairs of variables were represented: s_{ha} (horizontal airspeed) vs s_z (vertical speed), P_{p1s} (rate of change in potential energy) vs P_{k1s} (rate of change in kinetic energy) and s_a (airspeed) vs R (instantaneous radius of curvature). Rates of change in kinetic and potential energy were averaged over 1 s (10 frames) segments because these derivative variables are more susceptible to noise, even after smoothing. Moreover, they were only averaged over 1 s segments where the flight behaviour (gliding or flapping) did not change in order to be able to classify each 1 s segment as entirely gliding or flapping. For each pair of variables, the distribution of all data points was visualized by creating a kernel density estimation of the bivariate distribution, by plotting the contours containing 50% and 90% of this estimated distribution, and then by only displaying individual data points if they were outliers, i.e. outside of the 90% contours. For each pair of variables, this process was repeated for flapping data points and gliding data points in order to separate the two distributions. The univariate distributions of each variable, divided by gliding and flapping, were then statistically compared. The R software v4.1.2 (R Core Team, 2021) with the forecast package v8.16 (Hyndman and Khandakar, 2008; Hyndman et al., 2022) were used to inspect the autocorrelograms and partial autocorrelograms of the initial time series, which revealed that all variables were temporally autocorrelated, but that keeping one point out of five was enough to remove temporal autocorrelation for all tested variables (P , s_a , s_z , R) in most trajectories. Autocorrelation was removed independently in each time series (gliding points series and flapping points series) by keeping a minimum interval of 5 frames between each point (except for P_{p1s} and P_{k1s} for which averaging over 1 s already removed autocorrelation). The means of these resulting distributions were then compared using t-tests.

To test for the effect of wind on flight speed, data points were divided into three directional bins based on the angle between the bird's instantaneous horizontal direction and the wind vector direction: downwind (0–60 deg), crosswind (60–120 deg) and upwind (120–180 deg). The directional bins were separated between gliding and flapping, totalling to six bins. For each trajectory, a mean airspeed value was calculated for each bin, and statistical comparisons were carried out on the 95 trajectories having at least one point classified into every bin. The distributions of the six bins were visualized using violin plots created with the violinplot function in MATLAB (Bechtold, 2016), and the means of each directional bin were

compared within each behavioural category using ANOVA. Significant ANOVA were followed by Tukey-Kramer post hoc tests. Furthermore, a linear model was created for each directional bin to analyse the relationship between wind speed (s_w) and bird's airspeed (s_a).

The link between weather variables and vertical speed (s_z) was studied by dividing data points into flapping or gliding and then by averaging vertical speed over all the data points of both behavioural categories for each trajectory. Three weather variables were also averaged over the entire trajectory: temperature, solar radiation and humidity. Six linear models were then created to analyse the relationship between mean vertical speed and these three weather variables for each behavioural category.

Finally, vertical speed (s_z), airspeed (s_a) and mass-specific power averaged over 10 consecutive frames where flight behaviour did not change (P_{1s}) were analysed in order to test if their distributions differed between juveniles and adults. Only the 25 adult individuals recorded during the two field sessions when juveniles were observed were retained to ensure that all individuals were recorded in similar conditions (same weather and same period in the breeding season). For each variable and each behavioural category (gliding or flapping), the distributions of the minimums, first quartiles, medians, third quartiles and maximums were compared between age groups using Mann-Whitney U tests.

Results

General description of flight behaviour

Figure 2 shows a first estimate of the flight speed distribution of house martins flying near their colony by comparing the distribution of vertical speed and horizontal airspeed for all data points ($N = 45,170$, Fig. 2A) or by comparing gliding and flapping flight ($N = 25,414$ and $15,810$ respectively, Fig. 2B). Note that gliding and flapping totals do not add up to the total number of data points, because flight mode was not visible for 8.7% of video frames. The 90% area for all data points (Fig. 2A) shows that most of the time, house martins have a vertical speed between -4 and 4 m.s^{-1} , and an horizontal airspeed between 3 and 11 m.s^{-1} . The data points also show the most extreme values exhibited by the recorded house martins, with vertical speeds higher than 6 m.s^{-1} and lower than -8 m.s^{-1} , and horizontal airspeeds near 15 m.s^{-1} . Dividing the data points into gliding and flapping flight (Fig. 2B) reveals that both vertical speed and horizontal airspeed are significantly higher when house martins are flapping (vertical speed: $-0.36 \pm 1.63 \text{ m.s}^{-1}$ for gliding vs $0.85 \pm 1.45 \text{ m.s}^{-1}$ for flapping, $p < 0.001$; horizontal airspeed: $6.77 \pm 1.62 \text{ m.s}^{-1}$ for gliding vs $7.21 \pm 1.64 \text{ m.s}^{-1}$ for flapping, $p < 0.001$; t-test, mean

\pm SD of data points with autocorrelation removed). It is expected to find that flapping birds have more positive vertical speeds since flapping is often used to gain altitude, but it is worthwhile to note that a significant proportion of data points associated with gliding show a positive vertical speed, as even the 50% area contains points with positive vertical speeds. Positive vertical speeds while gliding can be associated with the use of external energy sources (thermal soaring, slope soaring, wind gradients) but also with a decelerating ascent. It is necessary to study the rates of change in kinetic and potential energy in order to discriminate between these two scenarios.

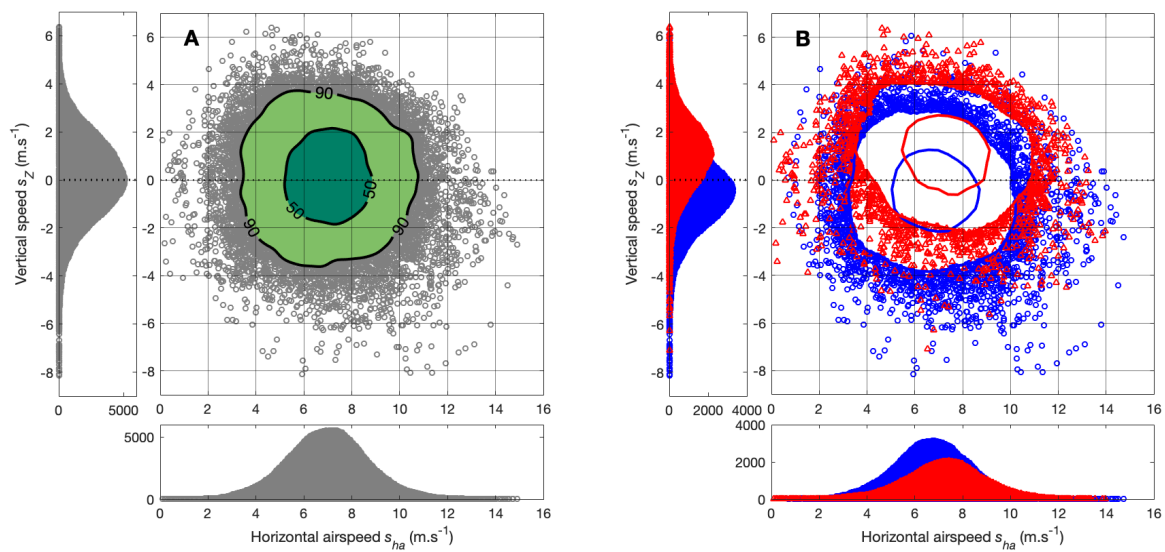

Figure 2: Distribution of vertical speed (s_z) versus horizontal speed in the air reference frame (s_{ha}). (A) All data points are represented by grey circles, with two contours indicating the areas containing 50% and 90% of the kernel density distribution. (B) gliding is represented by blue circles and contours, and flapping by red triangles and contours. 50% and 90% contours are also represented, and only data points outside the 90% areas appear. The univariate distributions of data points are represented along the axes of each panel.

Figure 3 shows the distribution of rates of change in potential and kinetic energy averaged over 1 s for all data points (Fig. 3A) or by comparing gliding and flapping flight (Fig. 3B), with isolines corresponding to several kinematic power values (i.e. the sum of rates of change in potential and kinetic energy, see Eq. 4). The 90% area for all data points (Fig. 3A) shows that house martins have power values between -25 and 30 W.kg⁻¹ during most of their flight behaviours near the colony. When comparing gliding and flapping flight (Fig. 3B), the rate of change in potential energy is significantly higher when house martins are flapping (t-test, mean \pm SD; -6.00 ± 11.92 W.kg⁻¹ for gliding vs 10.35 ± 10.84 W.kg⁻¹ for flapping, $p < 0.001$). The difference is less noticeable for the rate of change in kinetic energy, but it is significantly higher for gliding flight (t-test, mean \pm SD; 1.57 ± 10.73 W.kg⁻¹ for gliding vs

$0.53 \pm 10.55 \text{ W.kg}^{-1}$ for flapping, $p = 0.018$). Kinematic power values exhibited by gliding house martins are usually negative (as expected due to adverse air friction and drag), but a significant portion of the gliding distribution shows positive power values, and the $P = 0 \text{ W.kg}^{-1}$ isoline even crosses the 50% area of the distribution. This demonstrates that the use of external energy sources is common for gliding house martins in this context. The magnified view of the kernel contours for gliding (Fig. 3C) and flapping (Fig. 3D) allows to identify several kinds of flight behaviours. As stated above, gliding flight (Fig. 3C) in the zone above the $P = 0 \text{ W.kg}^{-1}$ isoline is not uncommon and reflects mechanical energy gain, i.e. the use of external energy sources, which can be divided in several categories: data points where P_{p1s} (and consequently s_z) is positive while P is also positive corresponds to soaring house martins (thermal soaring, slope soaring, zone 1 in Fig 3C) which can be associated with a decreasing ($P_{k1s} < 0$) or increasing speed ($P_{k1s} > 0$). Gliding flight with positive P can also happen for house martins losing altitude ($P_{p1s} < 0$) and accelerating ($P_{k1s} > 0$, zone 2), which could reflect that birds can also use downward or forward wind gusts to accelerate and gain some energy. At the opposite, gliding flight is often associated with a negative P and a descent ($P_{p1s} < 0$), as expected for typical, passive gliding (zone 3). Note that negative P while gliding can also be observed with positive P_{p1s} , (zone 4) which reflects passive ascents, implying deceleration ($P_{k1s} < 0$) and some expected energy loss ($P < 0$). Regarding flapping flight (Fig. 3D), it is obviously most of the time associated with positive P , whether it be for ascending (bird accelerates or decelerates, zone 1) or descending flight (bird accelerates, zone 2). However, it is worthwhile to note that a part of the 90% area of the flapping distribution surprisingly shows negative power values. Data points with negative P in ascent (zone 4 in Fig. 3D) could be associated with cases when the bird is struggling to gain altitude and is losing more kinetic energy than the gain in potential energy. Finally, data points with negative P in descent ($P_{p1s} < 0$, zone 3) could be associated with flapping birds encountering an unfavourable downward wind gust that results in mechanical energy loss, despite the flapping muscular work. It is also possible that house martins sometimes flapped their wings to brake (i.e. dissipate energy) and/or to generate lateral forces and perform sharper turns in front of an obstacle (e.g. building wall) or to catch prey. Finally, as the wind measurement method had several limitations (constant wind speed and direction were assumed during each recording and wind was only measured at a single point in space), we cannot exclude that the speeds and accelerations we measured are slightly different compared to the real airspeeds experienced by the birds if the wind varied in space and time during our recordings. This could influence the positions and spread of individual points in Fig. 3 to some extent.

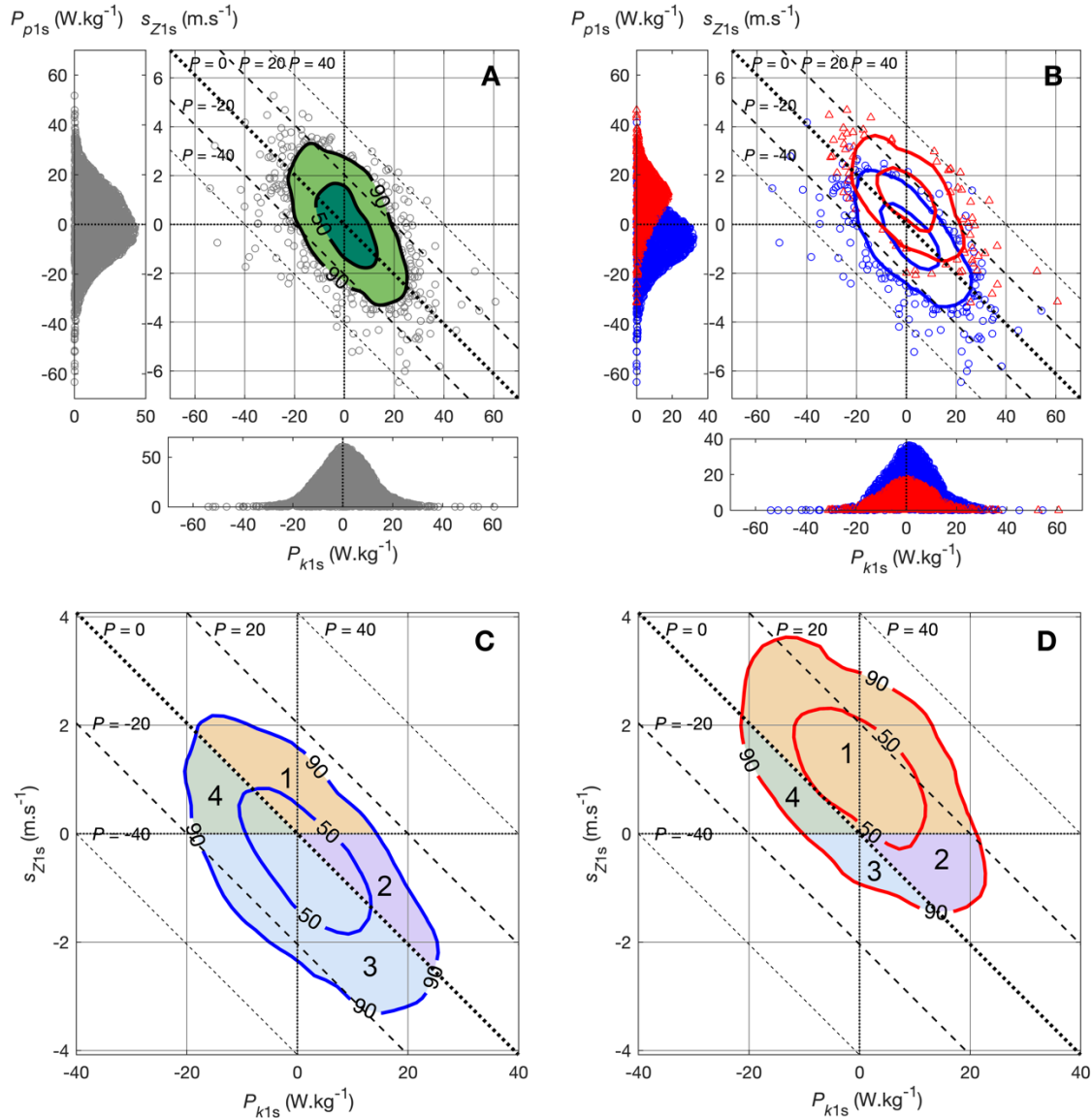

Figure 3: Distribution of rate of change in potential energy over 1 s (P_{p1s}) versus rate of change in kinetic energy over 1 s (P_{k1s}). (A) All data points are represented by grey circles, with two contours indicating the areas containing 50% and 90% of the kernel density distribution. (B) gliding is represented by blue circles and contours, and flapping by red triangles and contours. 50% and 90% contours are also represented, and only data points outside the 90% areas appear. Equivalent values of vertical speed averaged over 1 s (s_{z1s}) are given in the y axis. The univariate distributions of data points are represented along the axes of the upper panels. The dashed lines are isolines for power values from -40 to 40 W.kg^{-1} . The lower panels are magnified views of only the kernel contour of gliding (C) or flapping flight (D).

Flight turns

Figure 4 helps to understand the turning behaviours of house martins by showing the distribution of airspeed and instantaneous radius of curvature for all data points (Fig. 4A) or by comparing gliding and flapping flight (Fig. 4B), with isolines corresponding to several centripetal force values. The 90% area for all data points (Fig. 4A) shows that house martins

have a radius of curvature comprised between 1 and 100 m most of the time, associated with a centripetal force comprised between 0.1 and 2 g. Smaller radius of curvature was usually associated with lower airspeed, which always maintained centripetal forces below 5 g. Exceptionally small radiuses of curvature (near 10^{-1} m in Fig. 4A) show that house martins are occasionally able to perform decimetre-scale turns (mostly u-turns in front of nests), but at very low airspeeds ($< 1 \text{ m.s}^{-1}$) and hence low centripetal forces ($< 2 \text{ g}$). At the opposite, very large radiuses of curvature (above 100 m) are also uncommon, which suggests that, in this behavioural context, house martins are turning most of the time and rarely fly in straight line. The most common radiuses of curvature were comprised in the interval 2–20 m (50% area in Fig. 4A), clearly indicating a tortuous flight behaviour. Comparing gliding and flapping turns (Fig. 4B) does not show strong differences in distributions, but flapping is associated with significantly higher airspeeds and radiuses of curvature (t-test, mean \pm SD of data points where autocorrelation was removed; airspeed: $6.98 \pm 1.60 \text{ m.s}^{-1}$ for gliding vs $7.42 \pm 1.58 \text{ m.s}^{-1}$ for flapping, $p < 0.001$; log10 of radius of curvature: 0.89 ± 0.35 for gliding vs 0.99 ± 0.37 for flapping, $p < 0.001$). Centripetal force was significantly higher in gliding, but the differences were again small (t-test, mean \pm SD of data points where autocorrelation was removed; $0.73 \pm 0.41 \text{ g}$ for gliding vs $0.68 \pm 0.42 \text{ g}$ for flapping, $p < 0.001$).

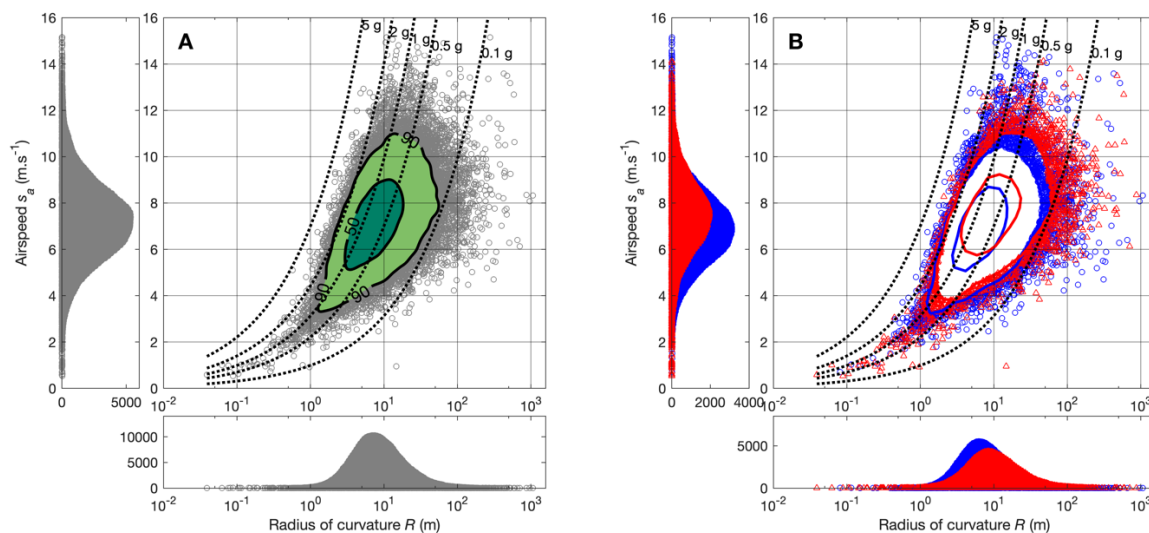

Figure 4: Distribution of airspeed (s_a) versus instantaneous radius of curvature (R). R is represented in logarithmic scale. (A) All data points are represented by grey circles, with two contours indicating the areas containing 50% and 90% of the kernel density distribution. (B) gliding is represented by blue circles and contours, and flapping by red triangles and contours. 50% and 90% contour are also represented, and only data points outside the 90% areas appear. The univariate distributions of data points are represented along the axes of each panel. The dotted lines are isolines for centripetal force values from 0.1 to 5 g.

Notable behaviours

Figure 3 allowed to identify several types of flight behaviours exhibited by house martins, which may be more clearly understood by looking at individual trajectories. Figures S4, S5 and S6 show the 3D views of trajectories, along with several biomechanical variables. Several types of notable flight behaviours can be identified on these trajectories.

Firstly, thermal soaring is visible on some trajectories (e.g. Fig. S4), when a positive power is observed for a gliding bird gaining altitude. Long sequences with birds rising and circling in thermal updrafts, as can be seen for large soaring birds, were rarely observed for house martins. Rather, they seem to frequently extract environmental energy in small bursts while they fly near the colony. In addition to thermal soaring, slope soaring was also occasionally observed for birds flying near high buildings where upward wind gusts could occur.

Secondly, a temporal oscillation of vertical speed appeared on several trajectories (e.g. Fig. S5). While the bird is mostly gliding, it is alternatively ascending and descending, again probably using external energy sources since power is often positive. During these sequences, vertical acceleration shows negative values that are regularly close to -1 g (-9.81 m.s^{-2}) which is observed for an object in free fall. This suggests that the gliding bird is alternating sequences of ascensions and free falls.

Finally, some atypical flight behaviours described in Figure 3 can be seen on individual trajectories, such as birds with a positive power during gliding descents (e.g. Fig. S5), which is probably due to downward wind gusts, and birds with a negative power during flapping descents (e.g. Fig. S6), which suggests that flapping is sometimes used to generate adverse forces used for braking or to perform a sharp turn (e.g. for prey capture), or even for a purpose other than transport (e.g. in-flight preening).

Effect of wind on flight speed

Figure 5 shows a comparison of the distributions of bird mean airspeed according to the wind direction relative to the bird's direction, for gliding flight (Fig. 5A) and flapping flight (Fig. 5B). Significant differences were only observed for flapping flight, where mean airspeed is significantly higher (ANOVA, $p < 0.001$) for birds flying upwind ($7.67 \pm 1.01\text{ m.s}^{-1}$, mean \pm SD) compared to birds flying downwind ($7.10 \pm 0.99\text{ m.s}^{-1}$) and crosswind ($7.32 \pm 0.92\text{ m.s}^{-1}$). However, linear models studying the link between airspeed and wind speed show that wind has a significant effect on both gliding (Fig. 6A–C) and flapping flight (Fig. 6D–F). Birds

flying downwind show a significant decrease in airspeed with increasing wind speeds for gliding (Fig. 6A) and a non-significant decrease for flapping (Fig. 6D), while birds flying upwind show a significant increase of their airspeed with windspeed for both flight behaviours (Fig. 6C and 6E). These results suggest that, overall, house martins adjust their flight speed, reducing their airspeed when wind is pushing them, and increasing it when they have to fly against the wind.

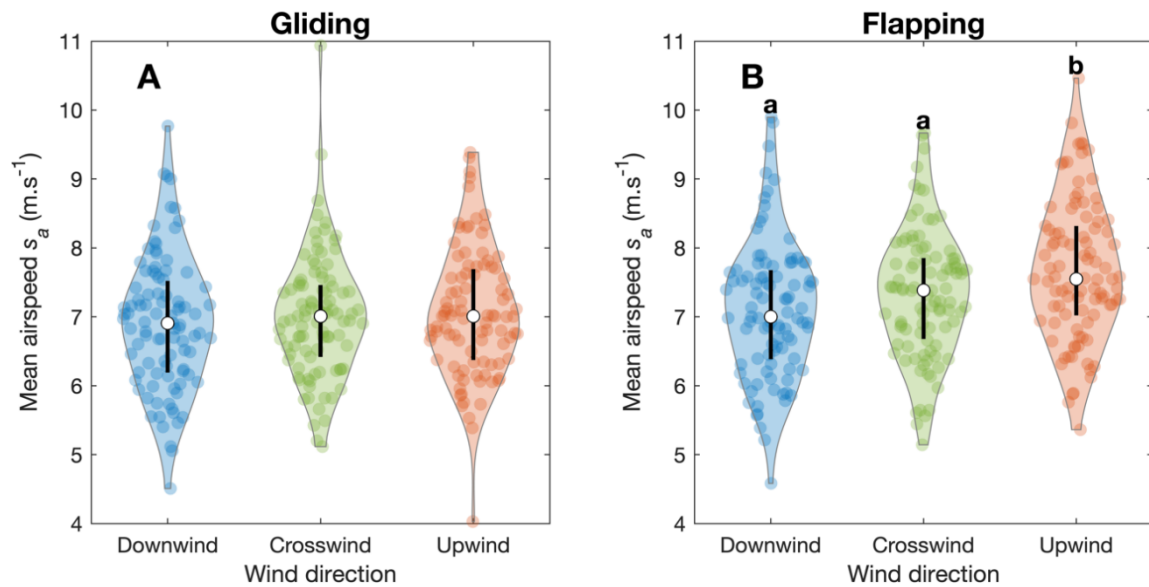

Figure 5: Distribution of mean airspeed (s_a) versus wind direction category. Each dot represents the mean vertical speed for all downwind/crosswind/upwind flight bouts in a given trajectory. (A) Gliding. (B) Flapping. White dots represent the medians, vertical bars represent the ranges from the 25th to the 75th percentiles, and coloured zones represent the kernel density distributions of each category. Lowercase letters (a and b) indicate significant differences after a significant single-factor ANOVA followed by Tukey-Kramer tests. Data for 95 trajectories for which at least one data point was available in each category.

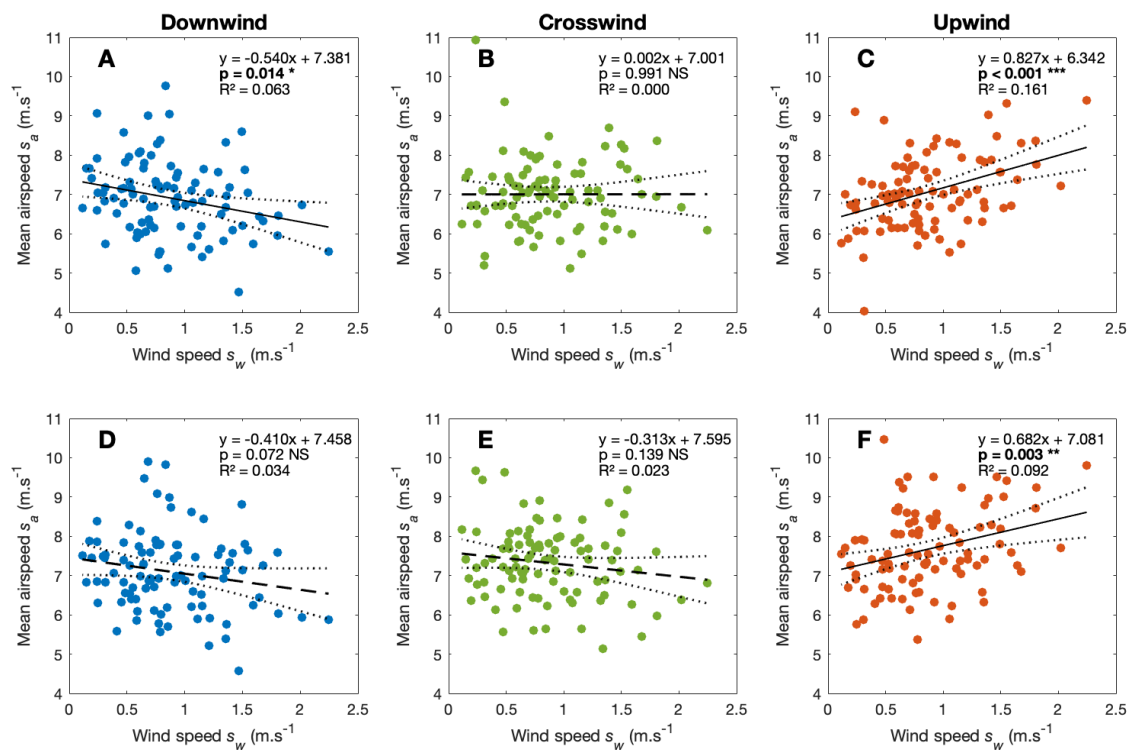

Figure 6: Mean airspeed (s_a) versus wind speed (s_w) divided by wind direction category (downwind in blue, crosswind in green and upwind in red). (A–C) Gliding flight. (D–F) Flapping flight. The formula of each linear model, its p-value and R^2 are indicated in each panel. The black dotted lines represent the 95% confidence interval of the slope. Data for 95 trajectories for which at least one data point was available in each category.

Effect of weather on flight behaviours

Studying the effect of several weather variables on vertical speed (Fig. 7) shows that only the vertical speed in gliding flight increases with temperature and solar radiation (Fig. 7A–B) and decreases with humidity (Fig. 7C), while there is no significant effect on the vertical speed in flapping flight. Hot and sunny conditions are favourable to the formation of thermal updrafts, and they are associated with less negative or even positive vertical speeds for gliding house martins (note that here each point represents the mean vertical speed for a given trajectory, i.e. is a sum of sequences of thermal/slope soaring and descending gliding flight bouts). This observation is consistent with the use of thermal updrafts by house martins, and this confirms that this behaviour is frequent and important for these birds near their colony since it is still visible at the scale of whole trajectories.

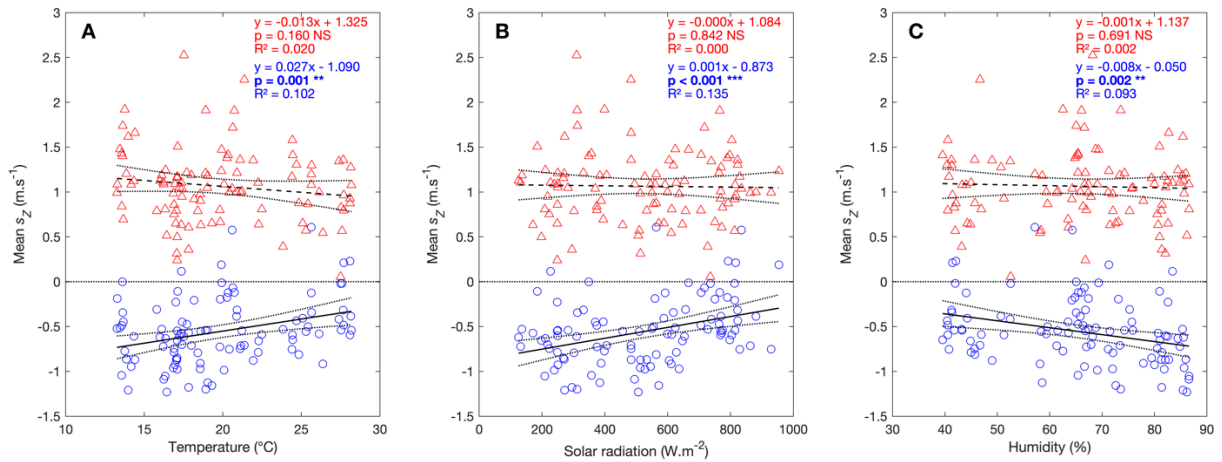

Figure 7: Mean vertical speed (s_z) versus temperature (A), solar radiation (B), and humidity (C). Each dot represents the mean vertical speed of all gliding/flapping bouts in a given trajectory. Gliding is represented by blue circles, and flapping by red triangles. The formula of each linear model, its p-value and R^2 are indicated in each panel. The black dotted lines represent the 95% confidence interval of the slope.

Differences between juveniles and adults

Figure 8 shows the distribution of airspeed (Fig. 8A and 8C) and vertical speed (Fig. 8B and 8D) for gliding and flapping flight for the 5 juveniles and the 20 adults recorded during two field sessions (8th and 15th of July). While Figure 8 summarizes the distribution of all instantaneous speed values exhibited by the recorded individuals pooled together, Table 2 accounts for individual distributions of speed, by comparing the values of each bird's minimum, first quartile, median, third quartile and maximum according to age group. Overall, there were no significant differences on median speeds, but juveniles tended to exhibit slightly flatter speed distributions: During gliding, juvenile airspeed distribution did not significantly differ from adults, but high vertical speeds were observed more often than in adults ($Q3 = 0.74 \text{ m.s}^{-1}$ in juveniles vs. 0.18 m.s^{-1} in adults). When actively flapping, juveniles produced high airspeed more often than adults, as well as low and high vertical speeds. This could be explained by the fact that juveniles may not be as accurate as adults in finely adjusting their flight speed and altitude. It is worthwhile to note that more frequent positive vertical speeds shown by gliding juveniles do not seem to be caused by a more efficient use of external energy sources, because no significant difference was found when comparing the quartiles of P according to age group (Table S1). Rather, these more frequent positive vertical speed in gliding juveniles would reflect decelerating ascents, possibly airspeed-correcting manoeuvres.

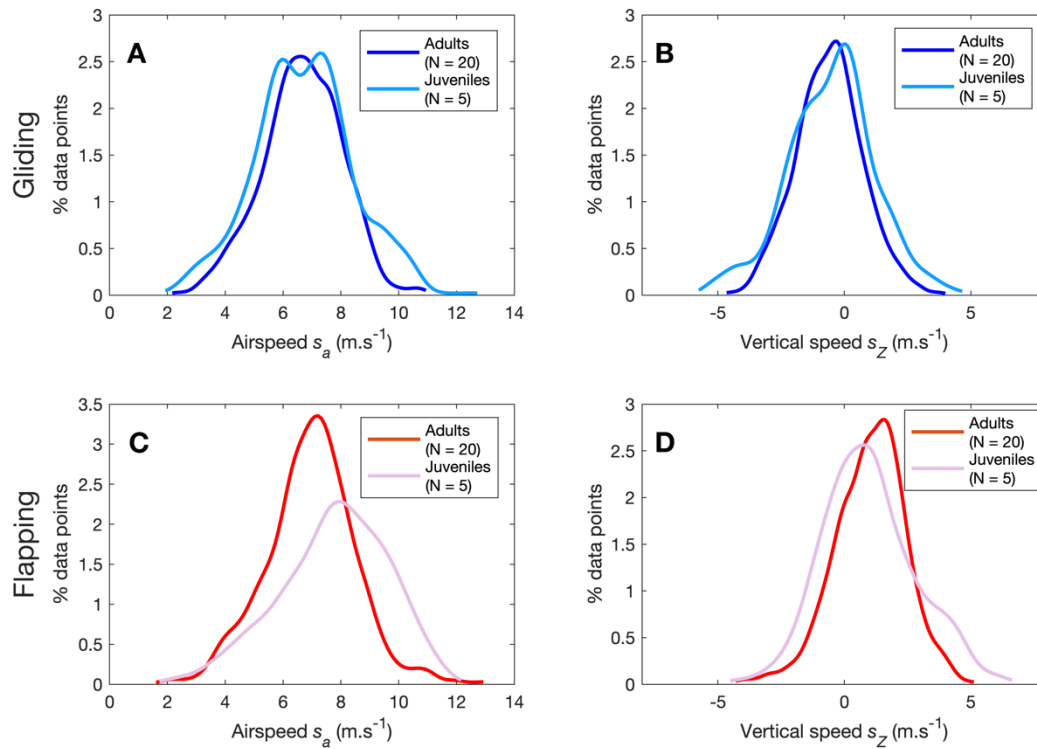

Figure 8: Distribution of airspeed (s_a) and vertical speed (s_z) values according to age class for the 25 birds recorded during sessions 7 and 8 (8th and 15th of July). (A–B) Gliding. (C–D) Flapping.

Table 2: Results of the Mann-Whitney U tests comparing the distribution of the minimums, first quartiles, medians, third quartiles and maximums of airspeed (s_a) and vertical speed (s_z) for flapping and gliding flight according to age group during sessions 7 and 8.

Behaviour	Airspeed (s_a)				Vertical speed (s_z)		
	Value	Median for adults ($m.s^{-1}$)	Median for juveniles ($m.s^{-1}$)	p	Median for adults ($m.s^{-1}$)	Median for juveniles ($m.s^{-1}$)	p
Gliding	Min	3.56	2.97	0.8120	-3.59	-5.05	0.0718
	Q1	5.97	5.72	0.9188	-1.51	-1.83	0.4756
	Median	6.70	6.87	0.6104	-0.60	-0.22	0.1637
	Q3	7.56	8.38	0.2923	0.18	0.74	0.0159 (*)
	Max	9.54	9.56	0.5636	2.89	3.22	0.9729
Flapping	Min	3.93	4.93	0.3591	-2.25	-3.10	0.3591
	Q1	6.37	6.67	0.3958	0.16	-0.29	0.0191 (*)
	Median	7.13	7.80	0.2923	1.18	0.81	0.0832
	Q3	7.97	9.22	0.0089 (**)	1.96	2.06	0.4756
	Max	9.86	10.84	0.0832	4.04	4.72	0.0383 (*)

Discussion

Our study gives a quantitative description of the flight behaviours of the house martin near the colony during the breeding season at fine spatial and temporal scales. Our results show that house martins do use some strategies to save energy during this critical period of their life cycle, such as extraction of environmental energy (Fig. 3), or optimisation of their cost of transport in the ground reference frame (Fig. 5–6).

Distribution of biomechanical variables

The 90% area for horizontal and vertical speed (Fig. 2) was rather large (3–11 m.s⁻¹ for horizontal speed and -4–4 m.s⁻¹ for vertical speed), showing that house martins perform a wide diversity of flight behaviours near the colony, whether it be fast traveling, or slow manoeuvring. The total range of airspeeds (including horizontal and vertical components) was 0.5–15.1 m.s⁻¹. This speed range is quite similar to those observed in other hirundine species, such as foraging barn swallows (3.7–19.4 m.s⁻¹; Warrick et al., 2016) and cliff swallows performing intraspecific chases (2.8–14.0 m.s⁻¹; Shelton et al., 2014).

The distribution of rates of change in kinetic and potential energy (Fig. 3) highlighted the use of external energy sources by house martins (discussed in a later section), but some parts were rather unexpected, such as the positive power values exhibited by some house martins in gliding descent, or the negative power values of some individuals during active flapping. These unexpected behaviours can be associated with specific purposes (e.g. braking in the case of flapping with negative power) but could also be associated with specific environmental conditions (e.g. favourable wind gust in the case of gliding descent with positive power, or adverse wind gust in the case of flapping with negative power). The difference between gliding and flapping flight is not as clear-cut as expected with regards to vertical speed and power, and house martins are able to exhibit a wide diversity of behaviours in both flight modes.

House martins only performed the sharpest turns at low speeds, so their centripetal force never exceeded 5 g (Fig. 4) and was most of the time below 2 g, a value consistent with the average maximum centripetal force of 1.38 g found in foraging common swifts (Hedrick et al., 2018). By contrast, other aerial insectivores perform sharp turns with higher centripetal forces, such as cliff swallows reaching 8 g during intraspecific chases (Shelton et al., 2014), or foraging barn swallows performing 7 g turns (Warrick et al., 2016). These differences are consistent with the contrasting foraging behaviours of house martins and barn swallows, since the former often

forage at higher altitudes in more open spaces (del Hoyo et al., 2020), while the latter often forage near the ground in relatively cluttered environments (Brown and Brown, 2020). In this regard, foraging house martins may be more comparable to common swifts and could thus rely on “gleaning” unsuspecting prey rather than catching evasive prey with sharp turns.

Environmental energy extraction

In our study, positive power values are often observed in gliding house martins (Fig. 3), which shows that they regularly use external energy sources such as thermal updrafts, upward wind gusts and wind gradients. Most of the time, they apparently only use these energy sources in short bursts, and individuals circling in thermal updrafts for an extended period were rarely observed. Even when a house martin uses a thermal updraft for a longer duration, vertical speed is not constantly positive and often shows temporal oscillations (see Fig. S5) which could be associated either with prey capture, or with aerial preening (the latter behaviour was clearly visible on some video recordings). Thermal soaring may be the main source of energy extraction, as shown by the significant effects of temperature, solar radiation and humidity on vertical speed (Fig. 7), but other strategies were occasionally observed such as slope soaring along the high buildings on which the colony was based, or occasional extraction of environmental energy during accelerating gliding descent, presumably from downward wind gusts (Fig. S5).

The use of thermal updrafts was also commonly observed in foraging common swifts (Hedrick et al., 2018), and these updrafts may be an important environmental feature for foraging aerial insectivores, both as a source of mechanical energy and as a substrate for patches of aerial arthropods (de Margerie et al., 2018), because rising air currents can contain a wide diversity of floating prey (Geerts and Miao, 2005; Wainwright et al., 2017). For large soaring raptors feeding on the ground, a framework suggested by Shepard et al. (2011) considers that the distribution of mechanical energy sources (thermal updrafts) may be an important constraint in the foraging behaviour of these species. Even if soaring *per se* is not as vital for aerial insectivores, which can flap their wings at a much lower cost than large raptors (Pennycuik, 2008), here thermal updrafts can be considered as a source of both types of energy (mechanical energy and food energy), so their spatial and temporal distribution may also have drastic consequences on the foraging behaviour of aerial insectivores. Consequently, atmospheric conditions may strongly impact the availability of resources for aerial insectivores, and rapidly changing conditions could impact their foraging and breeding success.

Effect of wind on flight speed

House martins follow the general tendency to reduce cost of transport, observed in migrating and commuting birds (Wakeling and Hodgson, 1992; Hedenström et al., 2002; Kogure et al., 2016; Sinelschikova et al., 2019), and also in foraging swifts (Hedrick et al., 2018), decreasing their airspeed when flying downwind, and increasing it when flying upwind (Fig. 5–6). This tendency was visible on gliding flight, and partly on flapping flight, despite a relatively narrow range of wind speed variation during our field sessions (mean wind speed over a trajectory never exceeded $2.5 \text{ m}\cdot\text{s}^{-1}$). It is also worth noting that our method of averaging wind speed and direction over a complete trajectory cannot detect more subtle effects of wind variation at finer temporal scales, such as wind gusts. Moreover, we only measured wind speed and direction at one fixed position, which does not take into account wind variations caused by height and the presence of obstacles. Even so, our results suggest that house martins optimise their movements in the ground reference frame, probably because of the presence of their nest at a fixed ground position (central-place foraging; Bryant and Turner, 1982).

Differences between adults and juveniles

Although the number of trajectories from clearly identified juvenile birds was small, some significant differences with adults were found in the distributions of airspeed and vertical speed. Even though the median flight speeds were not significantly different from adult birds, values departing from the central tendency were observed more often in juveniles (Fig. 8; Table 2), especially for vertical speed in flapping flight (lower Q1 and higher maximum). In other words, flight speeds were more variable in juveniles. The recorded juveniles were likely performing some of their first flights, so they might not be as precise as adults in controlling their flight speed and altitude, and would thus need more efforts to adjust their speed and their trajectory. In house martins, post-fledging locomotor ontogeny may consist in a reduction of speed variability (i.e. improvement of flight speed control) in order to converge towards the most energy-efficient speeds in a given context.

From these differences, it is reasonable to hypothesise that juveniles may be less effective aerial foragers than adults, because of a lower energy intake from feeding and/or because of a higher energy output in flight. Indeed, catching arthropods in flight is a complex behaviour, and for example, it has been shown in juvenile black phoebes (*Sayornis nigricans*) that the proportion of successful foraging attempts increased gradually in juveniles to reach the

same level as adults at the age of seven weeks. This increase is potentially due to trial and error learning, but the maturation of cognitive or visual systems cannot be ruled out (Marchetti and Price, 1989; Gall et al., 2013). Juvenile house martins return to the nest to roost and are still fed by their parents for a few days after fledging (del Hoyo et al., 2020), which suggests that they are not immediately as efficient as adults in catching prey. During this period, juvenile house martins likely benefit from social learning when foraging near the colony (Varland et al., 1991; Bustamante, 1994; Heyes, 1994; Kitowski, 2009). Further studies comparing the energy intake and energy expenditure of juvenile and adult house martins could clarify these potential differences.

To conclude, our study gives a first general description of the flight behaviours of house martins near the colony during the breeding season, and suggests several mechanisms by which they might save energy. House martins have little margin for lower energy intake and higher energy expenditure during this critical period, so their flight behaviours reflect a set of adaptations to optimise energy gain. Juveniles may not be immediately as efficient as adults in maximising their energy input while minimising their output, so parental care and social learning potentially play a critical role during the first few days out of the nest.

Acknowledgment

We would like to thank J. Blasco-Zumeta who helped us to confirm our identifications of juvenile house martins. We also thank J. J. Young and S. Windsor (Bristol Univ., UK) who greatly improved our original RSV device design (de Margerie et al., 2015), and designed a second-generation device, upon which the present RSV device is based.

Competing interests

No competing interests declared.

Funding

Research on bird flight supervised by E. de Margerie was supported by a grant from the *Mission for Transversal and Interdisciplinary Initiatives* at the CNRS in 2018, and an *Emerging scientific challenge* grant from the Rennes University in 2020, which made it possible to acquire some of the material used in this study.

Data availability

The flight trajectory and environmental data used as a basis for this analysis are publicly available from the figshare digital repository:

<https://doi.org/10.6084/m9.figshare.21118408.v1>

References

- Bechtold, B.** (2016). Violin Plots for Matlab, Github Project.
- Blasco-Zumeta, J. and Heinze, G.-M.** (2014). Atlas de Identificación de las Aves de Aragón.
- Brown, M. B. and Brown, C. R.** (2020). Barn Swallow (*Hirundo rustica*), version 1.0. In *Birds of the World* (ed. Billerman, S. M.), Keeney, B. K.), Rodewald, P. G.), and Schulenberg, T. S.), p. Ithaca, NY, USA: Cornell Lab of Ornithology.
- Bryant, D. M.** (1973). The Factors Influencing the Selection of Food by the House Martin (*Delichon urbica* (L.)). *The Journal of Animal Ecology* **42**, 539–564.
- Bryant, D. M.** (1979). Reproductive Costs in the House Martin (*Delichon urbica*). *The Journal of Animal Ecology* **48**, 655.
- Bryant, D. M. and Turner, A. K.** (1982). Central place foraging by swallows (Hirundinidae): The question of load size. *Animal Behaviour* **30**, 845–856.
- Bryant, D. M. and Westerterp, K. R.** (2002). The Energy Budget of the House Martin (*Delichon urbica*). *Ardea* **38–90**, 91–102.

- Bustamante, J.** (1994). Behavior of colonial common kestrels (*Falco tinnunculus*) during the post-fledging dependence period in southwestern Spain. *Journal of Raptor Research* **28**, 79–83.
- de Margerie, E., Simonneau, M., Caudal, J.-P., Houdelier, C. and Lumineau, S.** (2015). 3D tracking of animals in the field using rotational stereo videography. *Journal of Experimental Biology* **218**, 2496–2504.
- de Margerie, E., Pichot, C. and Benhamou, S.** (2018). Volume-concentrated searching by an aerial insectivore, the common swift, *Apus apus*. *Animal Behaviour* **136**, 159–172.
- del Hoyo, J., Turner, A., Kirwan, G. M. and Collar, N.** (2020). Common House-Martin (*Delichon urbicum*), version 1.0. In *Birds of the World*, p. Ithaca, NY, USA: Cornell Lab of Ornithology.
- Gall, M. D., Hough, L. D. and Fernández-Juricic, E.** (2013). Age-Related Characteristics of Foraging Habitats and Foraging Behaviors in the Black Phoebe (*Sayornis nigricans*). *The Southwestern Naturalist* **58**, 41–49.
- Geerts, B. and Miao, Q.** (2005). Airborne Radar Observations of the Flight Behavior of Small Insects in the Atmospheric Convective Boundary Layer. *Environ Entomol* **34**, 361–377.
- Gory, G.** (2008). Le régime alimentaire du martinet noir *Apus apus* en région méditerranéenne. *Revue d'écologie – la Terre et la Vie* **63**, 251–260.
- Green, R. E., Hirons, G. J. M. and Cresswell, B. H.** (1990). Foraging Habitats of Female Common Snipe *Gallinago gallinago* During the Incubation Period. *The Journal of Applied Ecology* **27**, 325.
- Hedenström, A., Alerstam, T., Green, M. and Gudmundsson, G.** (2002). Adaptive variation of airspeed in relation to wind, altitude and climb rate by migrating birds in the Arctic. *Behavioral Ecology and Sociobiology* **52**, 308–317.
- Hedrick, T. L.** (2008). Software techniques for two- and three-dimensional kinematic measurements of biological and biomimetic systems. *Bioinspir. Biomim.* **3**, 034001.
- Hedrick, T. L., Pichot, C. and de Margerie, E.** (2018). Gliding for a free lunch: biomechanics of foraging flight in common swifts (*Apus apus*). *J Exp Biol* **221**, jeb186270.
- Heyes, C. M.** (1994). Social learning in animals: categories and mechanisms. *Biological Reviews* **69**, 207–231.
- Hyndman, R. J. and Khandakar, Y.** (2008). Automatic Time Series Forecasting: The forecast Package for *R. J. Stat. Soft.* **27**,.
- Hyndman, R. J., Athanasopoulos, G., Bergmeir, C., Caceres, G., Chhay, L., O'Hara-Wild, M., Petropoulos, F., Razbash, S., Wang, E. and Yasmeeen, F.** (2022). `_forecast`: Forecasting functions for time series and linear models. R package version 8.16.
- Jia, C.-X., Sun, Y.-H. and Swenson, J. E.** (2010). Unusual Incubation Behavior and Embryonic Tolerance of Hypothermia by the Blood Pheasant (*Ithaginis cruentus*). *The Auk* **127**, 926–931.

- Kacelnik, A. and Houston, A. I.** (1984). Some effects of energy costs on foraging strategies. *Animal Behaviour* **32**, 609–614.
- Kitowski, I.** (2009). Social learning of hunting skills in juvenile marsh harriers *Circus aeruginosus*. *J Ethol* **27**, 327–332.
- Kogure, Y., Sato, K., Watanuki, Y., Wanless, S. and Daunt, F.** (2016). European shags optimize their flight behavior according to wind conditions. *Journal of Experimental Biology* **219**, 311–318.
- Lack, D. and Owen, D. F.** (1955). The Food of the Swift. *The Journal of Animal Ecology* **24**, 120.
- Marchetti, K. and Price, T.** (1989). Differences in the foraging of juvenile and adult birds: the importance of developmental constraints. *Biological Reviews* **64**, 51–70.
- Markman, S., Pinshow, B. and Wright, J.** (2002). The manipulation of food resources reveals sex-specific trade-offs between parental self-feeding and offspring care. *Proc. R. Soc. Lond. B* **269**, 1931–1938.
- Martin, T. E. and Ghalambor, C. K.** (1999). Males Feeding Females during Incubation. I. Required by Microclimate or Constrained by Nest Predation? *The American Naturalist* **153**, 131–139.
- Matysioková, B. and Remeš, V.** (2014). The importance of having a partner: male help releases females from time limitation during incubation in birds. *Front Zool* **11**, 24.
- Pennycuik, C. J.** (1978). Fifteen Testable Predictions about Bird Flight. *Oikos* **30**, 165.
- Pennycuik, C. J.** (2008). *Modelling the flying bird*. Academic Press.
- Poessel, S. A., Brandt, J., Miller, T. A. and Katzner, T. E.** (2018). Meteorological and environmental variables affect flight behaviour and decision-making of an obligate soaring bird, the California Condor *Gymnogyps californianus*. *Ibis* **160**, 36–53.
- R Core Team** (2021). *R: A Language and Environment for Statistical Computing*. Vienna, Austria: R Foundation for Statistical Computing.
- Rayner, J. M. V.** (1982). Avian Flight Energetics. *Annu. Rev. Physiol.* **44**, 109–119.
- Ruaux, G., Lumineau, S. and de Margerie, E.** (2020). The development of flight behaviours in birds. *Proceedings of the Royal Society B: Biological Sciences* **287**, 20200668.
- Shaffer, S. A., Costa, D. P. and Weimerskirch, H.** (2003). Foraging effort in relation to the constraints of reproduction in free-ranging albatrosses: *Foraging effort of free-ranging albatrosses*. *Functional Ecology* **17**, 66–74.
- Shelton, R. M., Jackson, B. E. and Hedrick, T. L.** (2014). The mechanics and behavior of Cliff Swallows during tandem flights. *Journal of Experimental Biology* jeb.101329.

- Shepard, E. L. C., Lambertucci, S. A., Vallmitjana, D. and Wilson, R. P.** (2011). Energy Beyond Food: Foraging Theory Informs Time Spent in Thermals by a Large Soaring Bird. *PLoS ONE* **6**, e27375.
- Sinelschikova, A., Griffiths, M., Vorotkov, M., Bulyuk, V. and Bolshakov, C.** (2019). Airspeed of the Song Thrush in relation to the wind during autumnal nocturnal migration. *Ornis Fennica* **96**, 64–76.
- Varland, D. E., Klaas, E. E. and Loughin, T. M.** (1991). Development of foraging behavior in the American kestrel. *Journal of Raptor Research* **25**, 9–17.
- Wainwright, C. E., Stepanian, P. M., Reynolds, D. R. and Reynolds, A. M.** (2017). The movement of small insects in the convective boundary layer: linking patterns to processes. *Sci Rep* **7**, 5438.
- Wakeling, J. M. and Hodgson, J.** (1992). Short communication: optimisation of the flight speed of the little, common and sandwich tern. *Journal of Experimental Biology* **169**, 261–266.
- Warrick, D. R., Hedrick, T. L., Biewener, A. A., Crandell, K. E. and Tobalske, B. W.** (2016). Foraging at the edge of the world: low-altitude, high-speed manoeuvring in barn swallows. *Phil. Trans. R. Soc. B* **371**, 20150391.
- Whittingham, L. A. and Lifjeld, J. T.** (1995). High paternal investment in unrelated young: extra-pair paternity and male parental care in house martins. *Behavioral Ecology and Sociobiology* **37**, 103–108.
- Ydenberg, R. C.** (1994). The behavioral ecology of provisioning in birds. *Écoscience* **1**, 1–14.

Electronic supplementary material for the article
“Flight behaviours and energy savings in adult and juvenile
house martins (*Delichon urbicum*) foraging near their
breeding colony”

by Geoffrey Ruaux, Kyra Monmasson, Tyson L. Hedrick, Sophie Lumineau and Emmanuel de Margerie.



Figure S1: RSV device in the field, in front of the wide lawn and urban gardens where house martins were recorded.



Figure S2: RSV device.

Rigid assembly of a camera and a set of mirrors rotating on a tripod with a fluid video head equipped with angular encoders. A second camera is visible on the right side, and was used to take pictures of the filmed birds with a greater magnification.

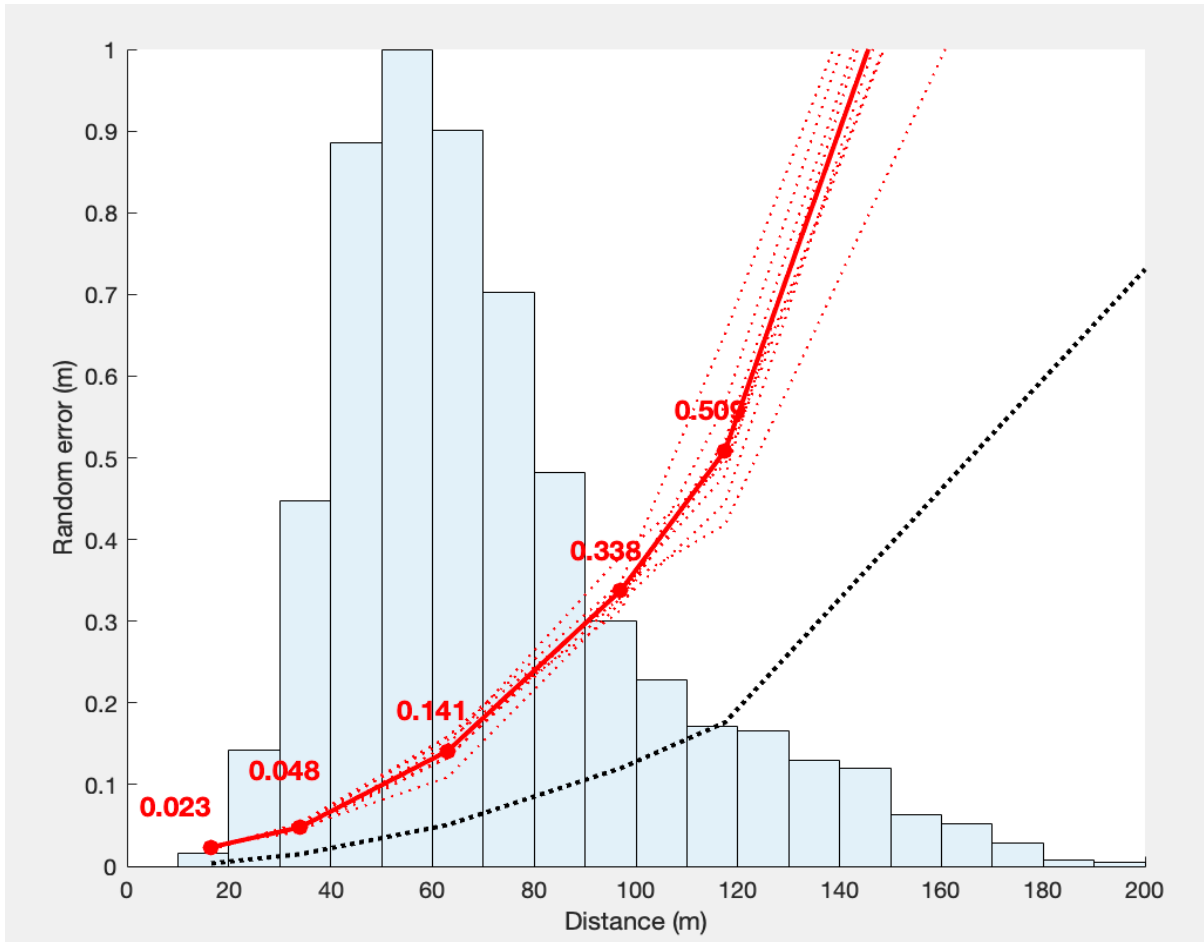

Figure S3: Random error in 3D location reconstruction, as a function of distance from the RSV device. Red dots: mean error for calibration points. Red dotted lines: error for individual calibrations. Black dotted line: theoretical random error (from 3D space quantization only – see Methods section and de Margerie et al. (2015) for additional sources of error). The background histogram shows the distance distribution for all sampled bird locations.

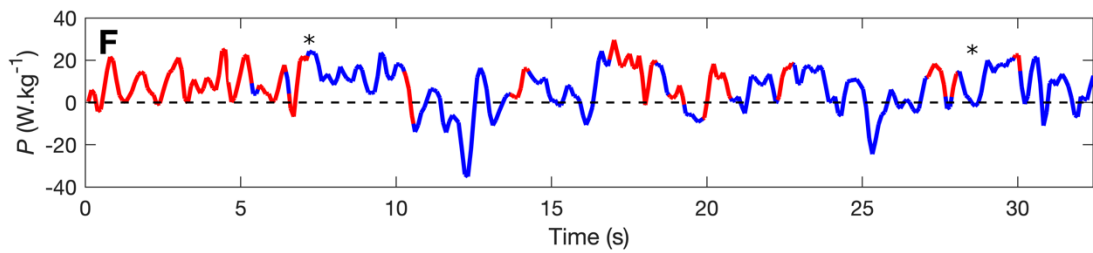
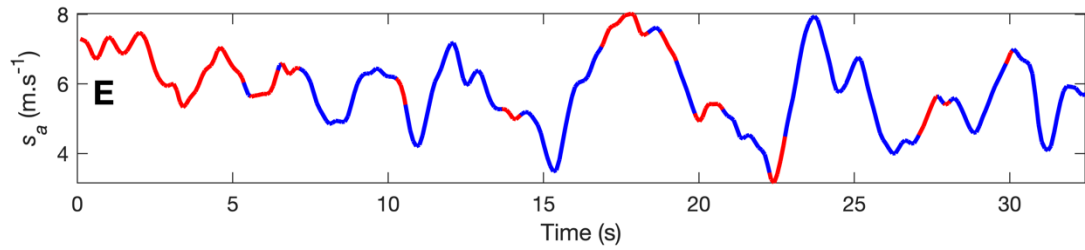
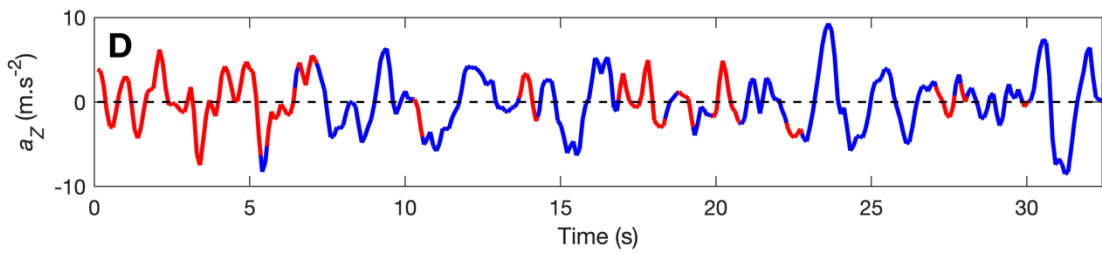
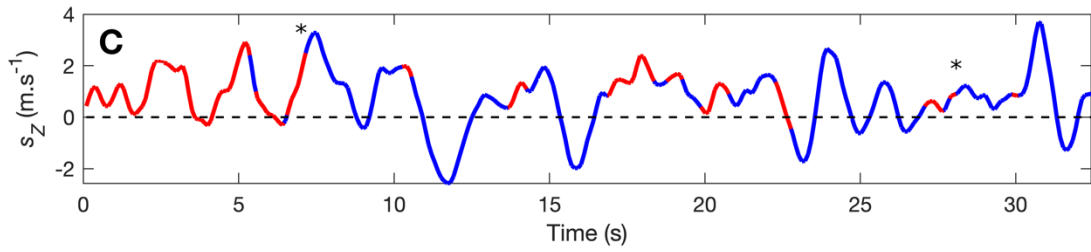
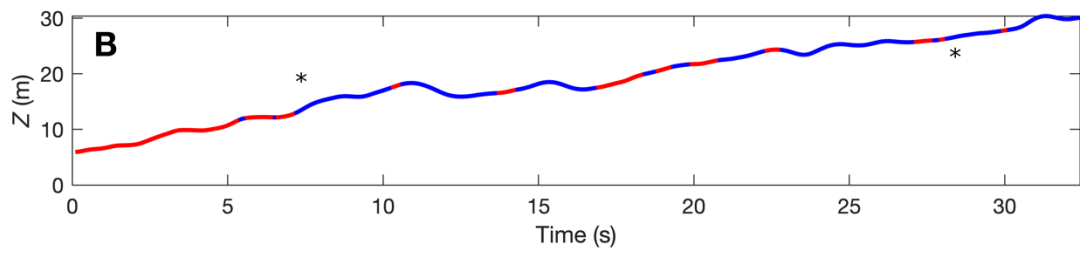
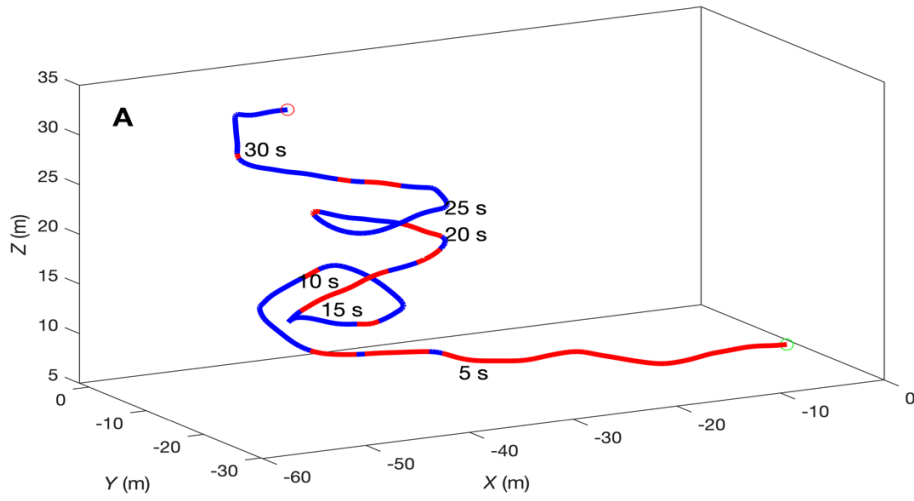

Figure S4: 3D view of a house martin's trajectory exhibiting thermal soaring, along with several biomechanical variables versus time. On all panels, gliding is represented by blue segments, flapping by red segments, and undetermined behaviours by black thin segments (wing movement not visible on video record). (A) 3D view of the trajectory with temporal indications every 5 s. (B) Height (Z) versus time. (C) Vertical speed (s_z) versus time. (D) Vertical acceleration (a_z) versus time. (E) Airspeed (s_a) versus time. (F) Mass-specific power (P) versus time. Asterisks indicate specific moments described in the text.

Figure S4 shows the 3D view of a trajectory where thermal soaring is apparent. Indeed, several sequences show positive vertical speeds (Fig. S4C) with positive powers (Fig. S4F) while the bird is gliding, for example between 7 and 10 s, or between 28 and 30 s. Each time, the gliding bird is gaining a few meters in altitude (Fig. S4B).

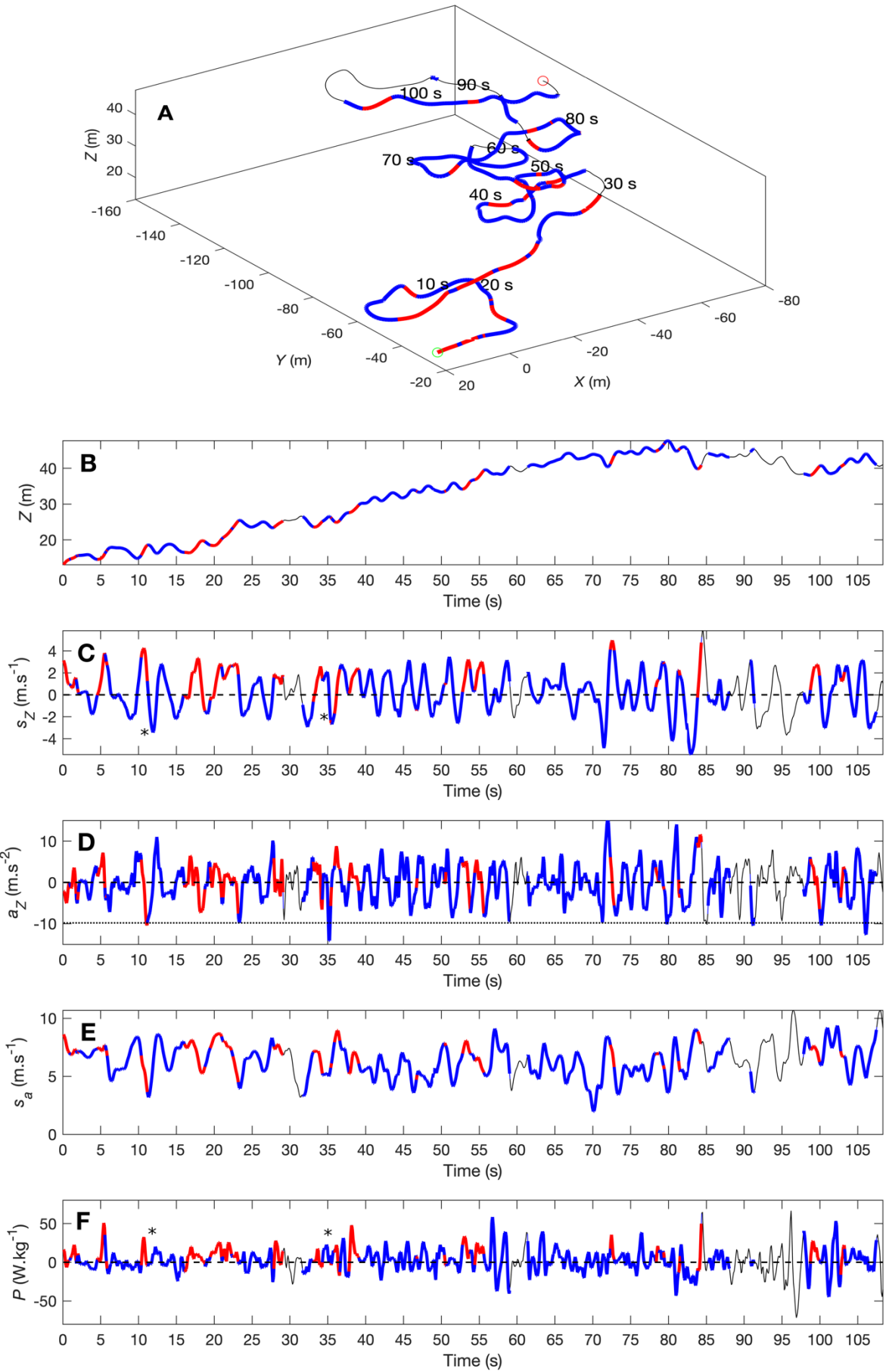

Figure S5: 3D view of a house martin's trajectory exhibiting temporal oscillations in vertical speed and gliding descents with positive power values, along with several biomechanical variables versus time. On all panels, gliding is represented by blue segments, flapping by red segments, and undetermined behaviours by black thin segments (wing movement not visible on video record). (A) 3D view of the trajectory with temporal indications every 5 s. (B) Height (Z) versus time. (C) Vertical speed (s_z) versus time. (D) Vertical acceleration (a_z) versus time. (E) Airspeed (s_a) versus time. (F) Mass-specific power (P) versus time. Asterisks indicate specific moments described in the text.

Figure S5 shows the 3D view of a trajectory where several phenomena are visible. Firstly, vertical speed (Fig S5C) shows temporal oscillations, mostly between -2 and $2 \text{ m}\cdot\text{s}^{-1}$. While the bird is mostly gliding, it is alternatively ascending and descending, again probably using external energy sources as $P > 0$ during gliding is often observed (Fig. S5F). Vertical acceleration (Fig. S5D) shows negative values that are regularly close to -1 g ($-9.81 \text{ m}\cdot\text{s}^{-2}$) which is observed for an object in free fall. Thus, this suggests that the bird is alternating sequences of ascensions and free falls while gliding. Besides, another phenomenon is visible on this trajectory: some birds have a positive power during gliding descents (e.g. at 11 s or at 35 s), which means that it is accelerating more than what its altitude loss would imply. This could be due to downward wind gusts.

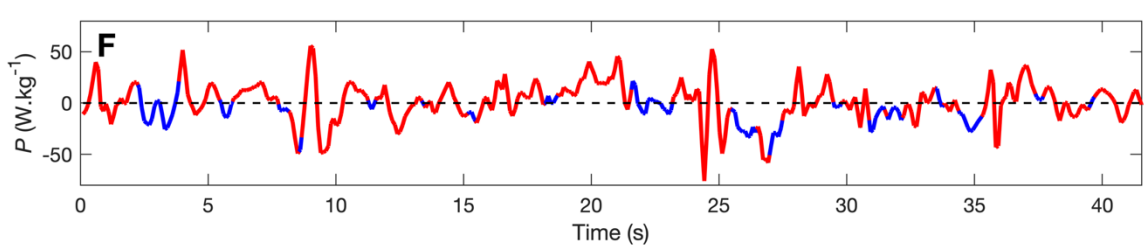
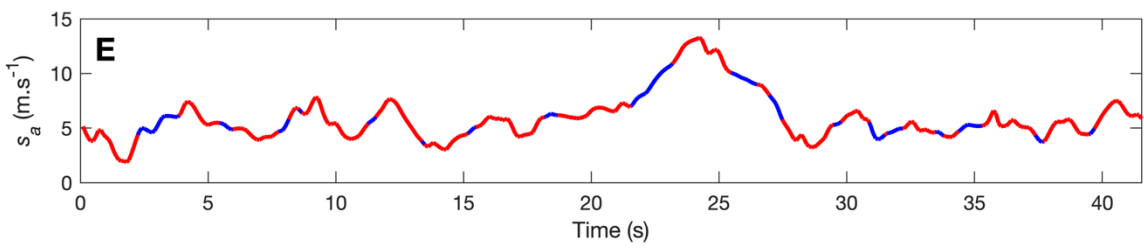
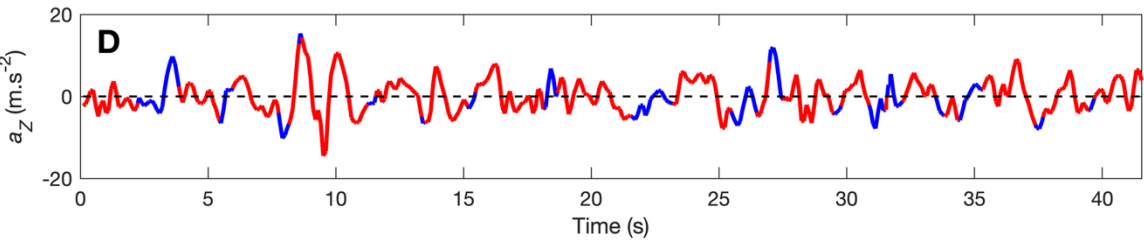
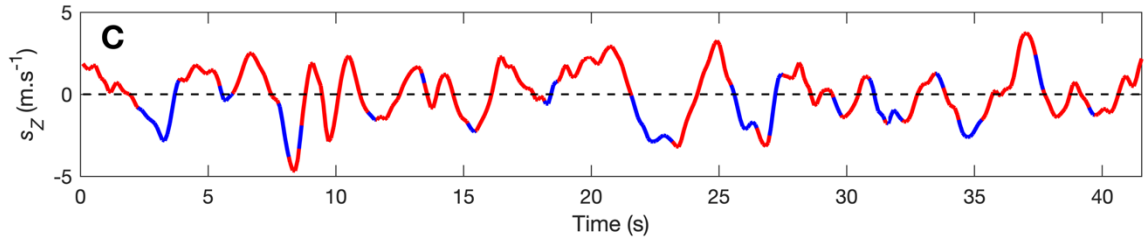
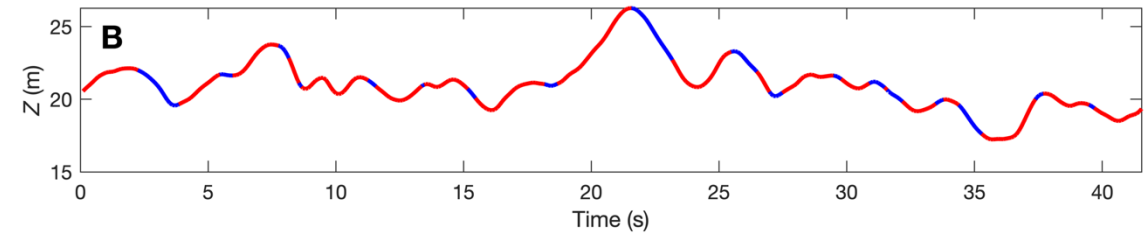
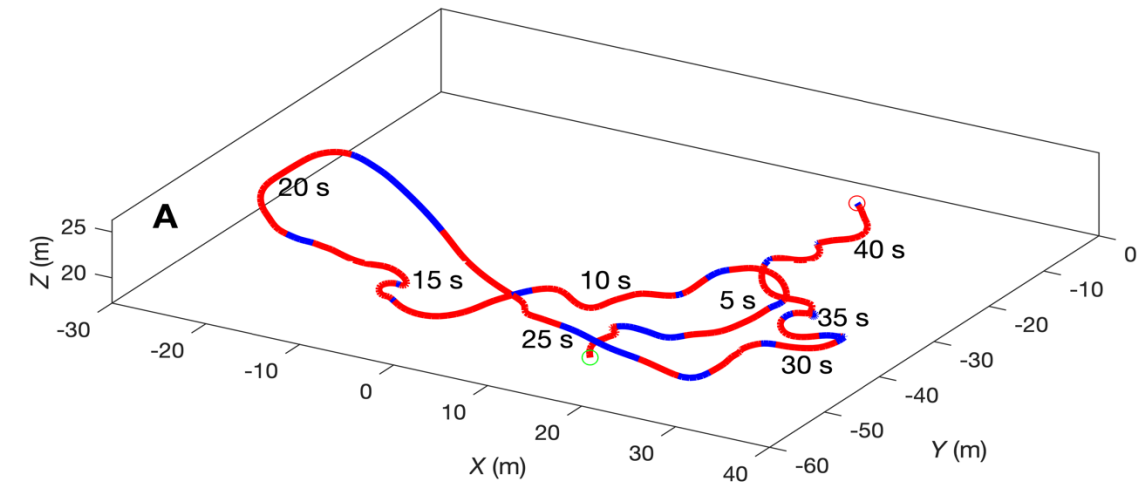

Figure S6: 3D view of a house martin's trajectory exhibiting flapping descents negative power values, along with several biomechanical variables versus time. On all panels, gliding is represented by blue segments, flapping by red segments, and undetermined behaviours by black thin segments (wing movement not visible on video record). (A) 3D view of the trajectory with temporal indications every 5 s. (B) Height (Z) versus time. (C) Vertical speed (s_z) versus time. (D) Vertical acceleration (a_z) versus time. (E) Airspeed (s_a) versus time. (F) Mass-specific power (P) versus time.

Figure S6 shows the 3D view of a trajectory where the bird, contrary to previous examples, does not seem to use thermal updrafts, performs most ascents with active flapping, and gliding is limited to descent (Fig. S6B). In fact, this bird shows a peculiar behaviour: mechanically efficient flapping should be associated with positive mechanical power (as is the case in previous examples, see Fig. S4F and Fig. S5F where red bouts are mostly above zero power), but here the bird often used flapping flight during descents (red bouts below 0 in Fig. S6C), sometimes resulting in negative power (fig. S6F). Although surprising, it is possible that house martins can use active flapping to generate adverse forces used for braking or to perform a sharp turn (e.g. for prey capture), or even for a purpose other than transport (e.g. in-flight preening).

Table S1: Sensitivity analysis for smoothing tolerance.

The results of the main statistical tests carried out in our analyses are presented for the three values of smoothing tolerance considered. The value of 1.2 was used in our final analyses. Overall, the significance of results is not influenced by smoothing tolerance.

Statistical test	Statistical test	Smoothing tolerance		
		1.0	1.2	1.4
s_z glide vs flap	t-test	$t(9561) = -37.09$ p < 0.001 ***	$t(9561) = -37.22$ p < 0.001 ***	$t(9561) = -37.33$ p < 0.001 ***
s_{ha} glide vs flap	t-test	$t(9561) = -12.79$ p < 0.001 ***	$t(9561) = -12.94$ p < 0.001 ***	$t(9561) = -12.95$ p < 0.001 ***
P_{p1s} glide vs flap	t-test	$t(2703) = -34.40$ p < 0.001 ***	$t(2703) = -34.43$ p < 0.001 ***	$t(2703) = -34.48$ p < 0.001 ***
P_{k1s} glide vs flap	t-test	$t(2703) = 2.07$ p = 0.039 *	$t(2703) = 2.38$ p = 0.018 *	$t(2703) = 2.61$ p = 0.009 **
s_a glide vs flap	t-test	$t(9561) = -13.08$ p < 0.001 ***	$t(9561) = -13.25$ p < 0.001 ***	$t(9561) = -13.27$ p < 0.001 ***
$\log_{10}(R)$ glide vs flap	t-test	$t(9561) = -12.89$ p < 0.001 ***	$t(9561) = -13.19$ p < 0.001 ***	$t(9561) = -13.24$ p < 0.001 ***
F glide vs flap	t-test	$t(9561) = 4.87$ p < 0.001 ***	$t(9561) = 5.70$ p < 0.001 ***	$t(9561) = 6.17$ p < 0.001 ***
Gliding s_a , downwind (DW) vs crosswind (CW) vs upwind (UW) (ANOVA)	ANOVA	$p = 0.499$ NS	$p = 0.872$ NS	$p = 0.529$ NS
Flapping s_a , DW vs CW vs UW (ANOVA)	ANOVA	p < 0.001 ***	p < 0.001 ***	p < 0.001 ***
Flapping s_a , Pairwise comparisons (Tukey post-hoc test)	Tukey post-hoc test	DW vs CW: $p = 0.2239$ NS DW vs UW: p < 0.001 *** CW vs UW: p = 0.0365 *	DW vs CW: $p = 0.2622$ NS DW vs UW: p < 0.001 *** CW vs UW: p = 0.0355 *	DW vs CW: $p = 0.2766$ NS DW vs UW: p < 0.001 *** CW vs UW: p = 0.0317 *
s_a vs s_w , gliding (linear model)	linear model	DW: $y = -0.534x$ p = 0.014 * CW: $y = 0.005x$ $p = 0.982$ NS UW: $y = 0.830x$ p < 0.001 ***	DW: $y = -0.540x$ p = 0.014 * CW: $y = 0.002x$ $p = 0.991$ NS UW: $y = 0.827x$ p < 0.001 ***	DW: $y = -0.542x$ p = 0.014 * CW: $y = -0.004x$ $p = 0.985$ NS UW: $y = 0.817x$ p < 0.001 ***
s_a vs s_w , flapping (linear model)	linear model	DW: $y = -0.410x$ $p = 0.078$ NS CW: $y = -0.310x$ $p = 0.149$ NS UW: $y = 0.672x$ p = 0.003 **	DW: $y = -0.410x$ $p = 0.072$ NS CW: $y = -0.312x$ $p = 0.139$ NS UW: $y = 0.682x$ p = 0.003 **	DW: $y = -0.411x$ $p = 0.070$ NS CW: $y = -0.316x$ $p = 0.138$ NS UW: $y = 0.699x$ p = 0.002 **
s_z vs weather variables, gliding	linear model	Temperature: $y = 0.027x$ p = 0.001 **	Temperature: $y = 0.027x$ p = 0.001 **	Temperature: $y = 0.027x$ p = 0.001 **

(linear model)		Solar rad.: $y = 0.001x$ p < 0.001 *** Humidity: $y = -0.008x$ p = 0.002 **	Solar rad.: $y = 0.001x$ p < 0.001 *** Humidity: $y = -0.008x$ p = 0.002 **	Solar rad.: $y = 0.001x$ p < 0.001 *** Humidity: $y = -0.008x$ p = 0.002 **
s_z vs weather variables, flapping (linear model)	linear model	Temperature: $y = -0.013x$ $p = 0.155$ NS Solar rad.: $y = -0.000x$ $p = 0.818$ NS Humidity: $y = -0.001x$ $p = 0.711$ NS	Temperature: $y = -0.013x$ $p = 0.150$ NS Solar rad.: $y = -0.000x$ $p = 0.842$ NS Humidity: $y = -0.001x$ $p = 0.691$ NS	Temperature: $y = -0.013x$ $p = 0.159$ NS Solar rad.: $y = -0.000x$ $p = 0.855$ NS Humidity: $y = -0.001x$ $p = 0.685$ NS
s_a adults vs s_a juveniles, gliding (Mann-Whitney U test)	Mann-Whitney U test	Min: 0.973 NS Q1: $p = 0.973$ NS Median: $p = 0.519$ NS Q3: $p = 0.324$ NS Max: $p = 0.519$ NS	Min: $p = 0.812$ NS Q1: $p = 0.919$ NS Median: $p = 0.610$ NS Q3: $p = 0.292$ NS Max: $p = 0.564$ NS	Min: 0.919 NS Q1: $p = 0.973$ NS Median: $p = 0.659$ NS Q3: $p = 0.359$ NS Max: $p = 0.610$ NS
s_z adults vs s_z juveniles, gliding (Mann-Whitney U test)	Mann-Whitney U test	Min: 0.072 NS Q1: $p = 0.519$ NS Median: $p = 0.164$ NS Q3: $p = 0.011$ * Max: $p = 0.865$ NS	Min: $p = 0.072$ NS Q1: $p = 0.476$ NS Median: $p = 0.164$ NS Q3: $p = 0.016$ * Max: $p = 0.973$ NS	Min: $p = 0.072$ NS Q1: $p = 0.292$ NS Median: $p = 0.164$ NS Q3: $p = 0.019$ * Max: $p = 0.918$ NS
P_{15} adults vs P_{15} juveniles, gliding (Mann-Whitney U test)	Mann-Whitney U test	Min: 0.519 NS Q1: $p = 0.476$ NS Median: $p = 0.164$ NS Q3: $p = 0.185$ NS Max: $p = 0.262$ NS	Min: 0.435 NS Q1: $p = 0.760$ NS Median: $p = 0.292$ NS Q3: $p = 0.292$ NS Max: $p = 0.262$ NS	Min: $p = 0.359$ NS Q1: $p = 0.709$ NS Median: $p = 0.325$ NS Q3: $p = 0.325$ NS Max: $p = 0.234$ NS
s_a adults vs s_a juveniles, flapping (Mann-Whitney U test)	Mann-Whitney U test	Min: 0.564 NS Q1: $p = 0.359$ NS Median: $p = 0.292$ NS Q3: $p = 0.009$ ** Max: $p = 0.083$ NS	Min: $p = 0.359$ NS Q1: $p = 0.396$ NS Median: $p = 0.292$ NS Q3: $p = 0.009$ ** Max: $p = 0.083$ NS	Min: 0.209 NS Q1: $p = 0.435$ NS Median: $p = 0.292$ NS Q3: $p = 0.006$ ** Max: $p = 0.096$ NS
s_z adults vs s_z juveniles, flapping (Mann-Whitney U test)	Mann-Whitney U test	Min: 0.359 NS Q1: $p = 0.019$ * Median: $p = 0.083$ NS Q3: $p = 0.610$ NS Max: $p = 0.038$ *	Min: $p = 0.359$ NS Q1: $p = 0.019$ * Median: $p = 0.083$ NS Q3: $p = 0.476$ NS Max: $p = 0.038$ *	Min: $p = 0.359$ NS Q1: $p = 0.019$ * Median: $p = 0.072$ NS Q3: $p = 0.476$ NS Max: $p = 0.038$ *
P_{15} adults vs P_{15} juveniles, flapping (Mann-Whitney U test)	Mann-Whitney U test	Min: 0.919 NS Q1: $p = 0.126$ NS Median: $p = 0.865$ NS Q3: $p = 0.812$ NS Max: $p = 1$ NS	Min: 0.973 NS Q1: $p = 0.292$ NS Median: $p = 1$ NS Q3: $p = 0.709$ NS Max: $p = 0.919$ NS	Min: $p = 1$ NS Q1: $p = 0.209$ NS Median: $p = 0.919$ NS Q3: $p = 0.812$ NS Max: $p = 1$ NS

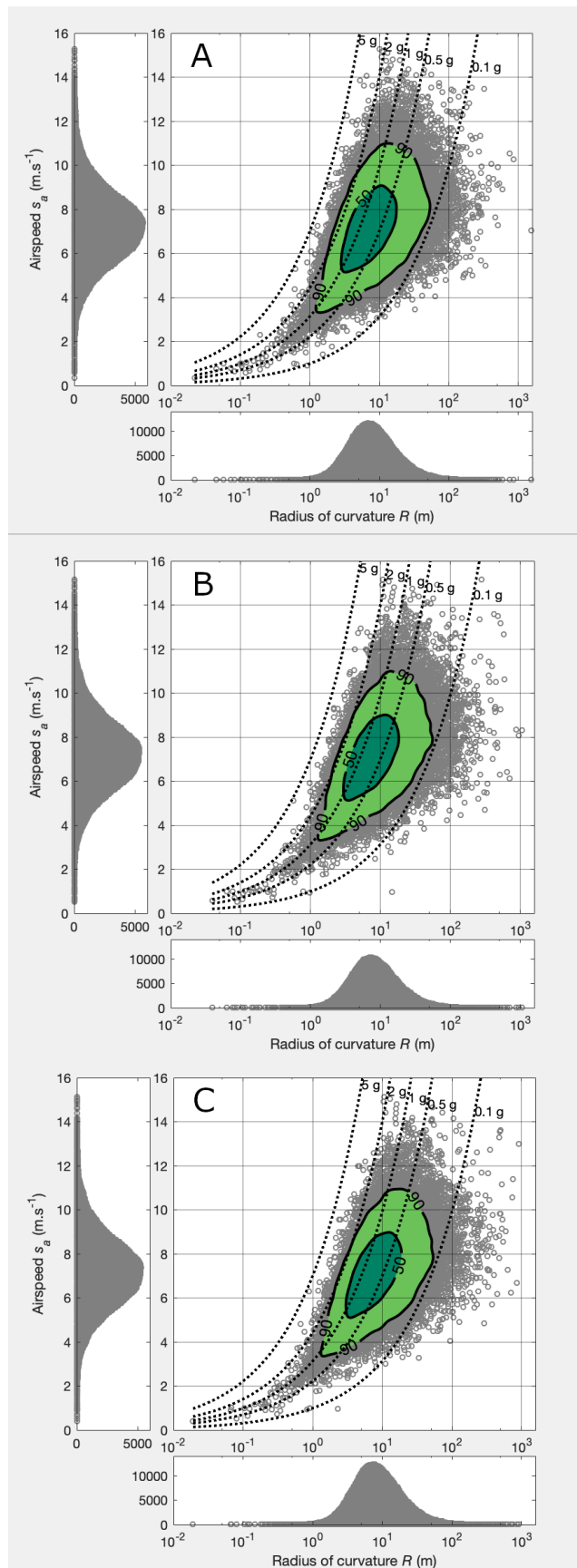

Figure S7: Example of the minor influence of smoothing tolerance on the graphical results: distribution of airspeed (s_a) versus instantaneous radius of curvature (R). Three values of smoothing tolerance were tested: (A) 1.0, (B) 1.2 and (C) 1.4.

Chapter 5: General discussion

I. Main results

Our two studies give quantitative descriptions of the flight behaviours of aerial insectivores in two critical contexts: drinking and foraging. We showed that swifts do not use an energetically optimal strategy when drinking, dissipating mechanical energy to touch water at lower speeds, possibly to increase safety. On the other hand, house martins use various strategies to save energy during foraging, such as environmental energy extraction (e.g. thermal soaring) or optimisation of the cost of transport by adjusting their airspeed depending on wind speed and direction. Swifts are also known to use energy saving strategies when foraging (Hedrick et al., 2018), so this illustrates the contrasting constraints imposed by these two behaviours.

Aerial insectivores are deeply adapted to life in the aerosphere, as shown by their various adaptations to save energy in flight. However, the drinking behaviour of swifts takes place at the interface between two environments: the aerial and the aquatic environments. Swifts have to cope with new constraints such as increased drag forces in water, and additional risks if they fall in this environment for which they are less adapted, or if they strike another obstacle when flying at low altitude. Energy savings no longer constitute a top priority during this behaviour, as opposed to foraging in open aerial environments with less physical constraints.

Our local scale approach using optical tracking has allowed us to study these two behaviours at very fine spatial and temporal scales. We measured strongly negative power values during the last few seconds before water contact in the common swift (Article 2) which would not have been detectable with techniques using a coarser resolution. This resolution also allowed us to show that house martins used thermal updrafts and other energy sources during very short bursts lasting a few seconds (Article 3). However, our approach still had some limitations, and an even greater spatial resolution would have been needed to study the fine postural adjustments of gliding swifts in order to precisely understand how they brake. To study this question, the kinematics of each body part should have been studied independently, which is more feasible in laboratory conditions (Jackson et al., 2009), but could be achievable with the RSV device by individually marking each body part (see for example Clifton et al., 2015). Such strategy would however require close animals to avoid that spatial uncertainty becomes greater than the distance between each body part, and would also be very time consuming as each body part would have to be manually selected on each frame (see Chapter 2). In addition, it is likely that not all body parts would be visible on each frame, depending on the perspective, which would further complicate the analysis.

II. Ecological and evolutionary aspects

A) Common swifts and the importance of water resources

In Article 2, we suggested that swifts have a strong motivation to drink considering the energetic costs and the risks of this behaviour. Even if these birds are able to obtain water from rain drops (Bersot, 1931), from nestlings faecal sacs (Dell’Omo et al., 1998), and probably from invertebrate prey (Bartholomew and Cade, 1963), their water needs still seem high enough to motivate them to drink surface water with this unique behaviour. As discussed in Article 2, this significant water need observed in aerial insectivores could be explained by higher water loss due to their greater energy expenditure in flight (Salt and Zeuthen, 1960; Bartholomew and Cade, 1963). Hence, it is possible to hypothesize that future climate changes could have important consequences on swifts and other aerial insectivores, for example with more frequent droughts. However, it is worthwhile to note that common swifts are able to breed successfully in arid regions such as Northern Africa and Israel (Amichai and Kronfeld-Schor, 2019), so it seems unlikely that climate change could soon make temperate regions inhospitable for swifts. This breeding range extending to arid regions also asks the question of the importance of surface water for swifts. Water is likely to be much scarcer in some parts on the common swift’s range compared to France, so it is difficult to assert that a regular access to surface water is indispensable for swifts. Rather, it may be considered as a useful habitat feature, both as a source of water and of aquatic invertebrates (Lack and Owen, 1955). Hence, climate change still could impact the common swift’s breeding range at the southern limit, by increasing landscape aridification and decreasing water and invertebrate resources.

When considering the global distribution of a migratory bird, the breeding range is only a part of the issue, and migratory routes have to be considered, as well as wintering range. A recent study focusing on the migratory route of the Asian subspecies of the common swift (*A. a. pekinensis*) has shown that individuals breeding in Beijing use migratory routes covering to a large extent semi-arid habitats in Continental Asia, and generally winter in areas of Southern Africa with less rainfalls compared to the European subspecies, which may indicate that *A. a. pekinensis* might have adapted to different climatic zones or have different patterns of food resource utilization during non-breeding period (Zhao et al., 2022). On the other hand, the European subspecies has to cross the Sahara desert during migration, but mostly takes advantage of stopovers in coastal zones or regions showing a seasonal increase in rainfall, providing good foraging conditions (Åkesson et al., 2012, 2016). The use of regions with higher

rainfalls during migration and wintering by the European subspecies suggests that a minimum amount of rainfall may also be required in the breeding range, even in the southern part of its range. However, it is difficult to disentangle to what extent the importance of rainfall and water is related to water needs, or to the availability of invertebrate prey.

The effect of climate on a species distribution is multimodal and complex, and swifts are likely to be impacted primarily through the effect on the availability of aerial arthropods. Even if a minimal amount of rainfalls may be required to ensure prey availability, long periods of continuing rain during the breeding season may cause high mortality in nestlings by immobilizing aerial prey on the ground, making it almost impossible for adult to catch enough prey (Lack, 1951). On the other hand, species distribution models have shown that the wintering range of the common swift has been expanding in South Africa, following a warming trend over the past 50 years (Guo et al., 2016), which shows that climate change can cause range contractions in some places, and range expansions in other places. Whether drinking surface water on the wing is an indispensable behaviour throughout the whole life cycle of the common swift (and more particularly the European subspecies) remains an open question, but our study shows that this behaviour is still important enough for swifts to take risks and to expend energy.

B) House martins and external energy sources

In Article 3, we showed that house martins often take advantage of external energy sources during foraging to save energy through thermal soaring and slope soaring. A first observation that can be made is that these energy sources can be attributed to urban landscape features. Indeed, slope lift usually occurs along high buildings forming artificial cliffs (Shepard et al., 2016), while thermal updrafts can originate from buildings heating the air more quickly than their surroundings (Sage et al., 2022). Hence, these observations show that the urban environment can provide external energy sources to house martins, in addition to nesting sites.

An interesting question would be to understand how aerial insectivores detect these energy sources that are mostly invisible to the human eye. Slope lift can be predicted to occur along high buildings, but thermal updrafts are less predictable, as even good thermal sources do not generate continuous streams of rising air, but rather sequences of bubbles (see Chapter 1). The locations of thermals can often be inferred with cumulus clouds, which form as the warm air rises, cools and dumps its moisture at altitude (Shepard, 2022). This large-scale information may be more useful to detect the biggest thermal updrafts, and could thus be more profitable for soaring raptors foraging on wide areas than for aerial insectivores using small thermals for a very short time. Another method to detect thermal updrafts is to use social

information from other conspecifics. Williams et al. (2018) have shown that freely flying *Gyps* vultures were more likely to fly towards a thermal and use it when another bird was recently seen soaring in it. House martins forage in large groups near their colony and could also use this social information to detect environmental energy and/or food resources. For aerial insectivores, aerial arthropods floating in thermal updrafts might be an important clue, and possibly the primary motivation to exploit thermals.

Taking into consideration the importance of atmospheric conditions in the aerial environment for house martins' foraging, climate change could also strongly impact their foraging and breeding success. Similarly to the common swift, prolonged rainfalls can slow nestlings growth and eventually increase mortality in house martins by decreasing the availability of aerial prey (Bryant, 1973a), but other changes could disturb their foraging behaviour and decrease their breeding success, for example more frequent extreme events such as storms.

Overall, climate seems to be an important factor influencing the distribution and life cycle of the common swift and the house martin. To better understand this relationship, field studies will not be enough, and future studies could focus on species distribution modelling, where environmental variables and species distribution are correlated in order to understand which variables influence and limit the distribution of the species (Austin, 2007; Franklin, 2009). These models can focus on climatic variables to identify a species' "bioclimate envelope" (also called "climate space" or "climatic niche"), which represents the climatic conditions suitable for the survival of a given species (Huntley et al., 1995). Modelling the bioclimate envelope of other bird species has allowed to gain useful insights on their ecology (Engler et al., 2017; Sutton and Puschendorf, 2018). Such models can also be used to forecast how future climate changes will impact the distribution of a given species (Hijmans and Graham, 2006; Huntley et al., 2008).

Aerial insectivores provide important ecosystem services, such as pest control. They are able to regulate the population of many aerial arthropods, but also of terrestrial arthropods with a short aerial phase in their life cycle, such as ants and aphids. For example, Helms et al. (2016) have shown that purple martins (*Progne subis*) feed primarily on mating queens and males of fire ants (*Solenopsis invicta*), and they measured that each parent captured around 30 queens per day. Throughout their distribution range, purple martins likely eat billions of fire ant queens each year, potentially impacting the spread of this invasive species through the USA. Besides, aphids are a major agricultural pest and can constitute up to 85% of the arthropods in a food bolus captured by the common swift (Gory, 2008). However, bioclimate envelope models have

predicted that pest control ecosystem services could be negatively affected by climate change (Civantos et al., 2012). Hence, understanding the environmental factors influencing the breeding success and the distribution of aerial insectivores will be an important contribution to their conservation.

III. Social aspects of drinking and foraging

The drinking behaviour of common swifts and the foraging behaviour of house martins both occur in social groups, which raises several questions related to the interactions between individuals.

Firstly, swifts usually forage near their colony during the breeding season (Lack and Owen, 1955), but it is unclear whether they would fly over longer distances to find a waterbody to drink. During our recording sessions when the weather was hot and sunny, several individuals could be seen drinking almost continuously throughout the morning, especially on the river site. From these observations, it is possible to hypothesize that swifts drinking on waterbodies came from various colonies scattered in the surroundings. Swifts are known to perform several group behaviours such as screaming parties (a social flight, mainly performed by non-breeding individuals, where they fly at high speeds around the colony with loud vocalizations, probably to defend it against intruders from other colonies; Farina, 1988) and twilight ascents during which swifts are thought to acquire orientation cues, to sample weather conditions and to exchange information (Dokter et al., 2013; Nilsson et al., 2019).

To investigate if swifts were using waterbodies in groups, we recorded the number of individuals over each waterbody at fixed intervals, and studied how it was temporally organised (Roger et al., unpublished). We found that the number of swifts was temporally aggregated and that they did not come randomly, but in successive “waves”. However, it is unclear whether each wave of drinking swifts was coming from only one colony and/or if the presence of conspecifics acted as a cue to indicate the presence of water. It is likely that breeding swifts have a good knowledge of the landscape surrounding their colony and that they would not necessarily need additional cues to find a fixed waterbody.

Vocal behaviours were rarely heard in drinking swifts, except in a few nearby screaming parties, so it seems that swifts do not commonly use vocalizations to interact near waterbodies. The main effect of conspecifics could actually be negative. Indeed, as explained in Article 2, some drinking attempts were “aborted” (i.e. some swifts approached water surface in a typical

way similar to a drinking behaviour, but glided close to the surface without touching it). These swifts regained height and sometimes performed another descent right after. Using our data on the temporal abundance of swifts over each waterbody, we found that the percentage of recorded trajectories which were aborted attempts increased in field sessions during which more swifts were present (Roger et al., unpublished). On some videos, we saw two or three individuals gliding very close to each other while approaching water, and some of these attempts were aborted. This suggests that other individuals could interfere with the drinking behaviour, inducing higher energy expenditures by forcing a swift to regain height and to perform another attempt in safer conditions. Despite this apparent interference, the tendency to come in successive waves over waterbodies could be motivated by a strong social behaviour, or possibly by an antipredator behaviour. Indeed, swifts are extremely difficult to catch in flight for raptors (Hedenström and Rosén, 2001), but are sometimes caught (for example by common kestrels) when they fly in or out of the nest, a moment when they are more vulnerable and predictable for a short time (Mikula et al., 2013; Olo, 2017). Swifts flying over water could also be considered more vulnerable since they have limited options to escape, so this might be a situation where staying in group is advantageous.

However, it is difficult to ascertain whether drinking was really the goal of all aborted attempts. Swifts are known to sometimes catch prey over waterbodies during mass emergences of aquatic insects, especially when the weather is wet and windy (Lack and Owen, 1955), so it is possible to imagine that a swift gliding low over water with the beak wide open could be foraging. However, we did not identify high insect abundances around the recording sites, and did not see any prey capture on the recorded trajectories. Moreover, aborted attempts were observed in all weather conditions, and some of them were immediately followed by successful drinking trajectories, so it seems reasonable to assume that most of these behaviours really were aborted drinking attempts.

Just like common swifts, house martins forage in groups near their colony (del Hoyo et al., 2020), so the question of the role of this grouping behaviour may also be asked. Although this aggregation may be partly passive due to the spatial aggregation of prey and the need to stay close to the colony to minimize energy expenditures and travel time, foraging house martins were much more vocal than drinking swifts, so a frequent communication between individuals can be hypothesized. It is known that male house martins sing to attract a mate during pair formation (del Hoyo et al., 2020), but to our knowledge, the role of vocalizations during foraging was not studied. It is possible to hypothesize that some of these vocalizations are contact calls, which are common in birds to keep a link between members of the same group

or family. Other types probably include alarm calls, since high-pitched vocalizations were occasionally heard, for example when an observer was approaching a nest. These different calls may be especially important during the post-fledging dependence periods, when parents keep feeding the flight-capable juveniles for a few days, and could use vocalizations to stay in contact and to recognize them.

Future studies using optical tracking at a local scale could consider using audio recording devices in addition to tracking devices in order to identify the context associated with each type of call. However, this experimental setup would be especially challenging for animals foraging in dense groups, since it would be difficult to identify the individual emitting each sound. Some solutions could include the use of directional microphones which would ensure to record the individual aimed by the tracking device.

IV. Ontogeny of flight behaviours

One of the objectives of this research work was to study the ontogeny of flight behaviours in aerial insectivores. In both studies, the dates of our recording sessions covered the fledging period in order to increase our chances to film juveniles. Moreover, the RSV device was equipped with a second camera to take photographs of the recorded birds at a greater magnification to allow age identification.

In the common swift, differences between adults and juveniles are subtle. In flight, the most reliable detail is the white edge of body, tail and wing feathers in juveniles, mainly visible on the wings (Blasco-Zumeta and Heinze, 2014; Jukema et al., 2015). However, despite our photographs at a greater magnification, most recorded swifts were too far to allow the identification of this fine detail, and the swifts flying close enough to be identified were all adults. It is possible to hypothesize that no juvenile was present on the waterbodies, as juveniles probably start migration as soon as they leave the nest (Lack, 1956). Contrarily to swallows and martins, juvenile swifts do not receive parental care after leaving the nest, and their flight behaviours might have to improve more quickly to reach adults' skills. The drinking behaviour seems to require high accuracy and coordination, and it can be hypothesized that juveniles are not as efficient fliers as adults right after fledging, because juveniles performing their first migration are more often seen roosting for the night by clinging on walls or trees, especially during harsh and cold weather (Lack, 1956; Holmgren, 2004). Since the drinking behaviour is performed in groups, juveniles may take advantage of social learning, watching other

individuals in order to improve their own drinking behaviour (see Article 1 for examples of social learning). Trial and error learning is likely involved in the development of foraging behaviours in many birds, but the cost of any error is very high for the drinking behaviour, so natural selection on the innate acquisition of this particular technique should be stricter than for other behaviours. In order to understand if juvenile swifts use different sites than adults to forage and drink before and during migration, biologging studies could be useful. Such studies could allow the identification of sites of interest where optical tracking at a local scale could complement these large-scale studies by precisely comparing the flight behaviours of juveniles and adults.

In the house martin, we were able to record and identify a few juveniles during the fledging period near the breeding colony, and we showed that they have more variable flight speeds than adults, possibly because their flight behaviours are not immediately optimised after leaving the nest. Juvenile house martins are still fed by their parents for several days after leaving the nest, which shows that they are not immediately able to catch enough food to meet their energy needs. During this period, they could also benefit from social learning when flying near the colony.

V. Perspectives

Our study gives a first quantitative description of two crucial behaviours in the common swift and the house martin, we also show how energy savings can be modulated by different constraints and trade-offs. Future research could focus on the comparative aspect of these findings, by studying the same behaviour with the same method in two species of aerial insectivores. In addition to the common swift, drinking could be studied in other aerial insectivores that also commonly drink surface water in flight, such as the house martin or the barn swallow. Trade-offs and constraints are likely to be different in swallows and martins, since they are able to easily land on the ground. Moreover, they are more manoeuvrable than swifts and can make very sharp turns when flying close to water, so they should have a less “ballistic” trajectory and braking should be less important than in swifts.

Drinking in flight could also be studied in other species much closer to the common swift phylogenetically, such as nightjars (Caprimulgiformes). Nightjars are also able to drink surface water by skimming in flight (Fisher et al., 1972). Tracking the flight behaviours of nightjars at a local scale would pose additional challenges because these birds are essentially

nocturnal. Nevertheless, fixed infrared cameras positioned near waterbodies could be used, as was already done to study bats (Corcoran and Conner, 2012).

Our work also shows the importance of considering atmospheric conditions at a local scale when studying flight behaviours, as shown by the impact of wind speed and direction on the drinking behaviour of swifts, and the effect of weather variables on the availability of external energy sources for foraging house martins. The aerial habitat is constantly varying and imposes constraints but also offers opportunities to birds, and many flight behaviours likely evolved to take advantage of environmental variations in the aerosphere.

We also give a first comparison between the flight behaviour of juvenile and adult birds, rarely done at a local scale. This comparison is an additional step towards the understanding of flight ontogeny, but could be complemented by comparative approaches focusing more on the ontogenetical aspect. Comparing the development of flight performance and energy savings between juveniles and adults in bird species with different developmental modes could give useful insights. The common swift and the house martin are both altricial species, but the altricial-precocial spectrum (see Article 1) could be explored further by studying semi-altricial (e.g. Falconiformes), semi-precocial (e.g. Laridae) and precocial species (e.g. Anatidae).

In conclusion, this work shows the importance of a local-scale approach in understanding the biomechanics of bird flight in the field. We show that energy savings in flight are crucial for aerial insectivores, but that the need to spend less energy can be modulated under the influence of several trade-offs. In the future, comparative studies using similar methodologies for different species showing contrasted life-history traits will be important. Overall, new insights on flight behaviours in birds and other flying animals, as well as their ontogeny, are a critical step towards a better understanding of flight ecology and of the evolution of this unique mode of locomotion.

Bibliography

- Able, K. P.** (2004). Birds on the Move: Flight and Migration. In *Handbook of Bird Biology*, pp. 466–565. Cornell Lab of Ornithology in association with Princeton University Press, 2nd ed.
- Åkesson, S., Klaassen, R., Holmgren, J., Fox, J. W. and Hedenström, A.** (2012). Migration Routes and Strategies in a Highly Aerial Migrant, the Common Swift *Apus apus*, Revealed by Light-Level Geolocators. *PLoS ONE* **7**, e41195.
- Åkesson, S., Bianco, G. and Hedenström, A.** (2016). Negotiating an ecological barrier: crossing the Sahara in relation to winds by common swifts. *Phil. Trans. R. Soc. B* **371**, 20150393.
- Alerstam, T. and Lindström, A.** (1990). Optimal bird migration: the relative importance of time, energy, and safety. In *Bird migration.*, pp. 331–351. Springer, Berlin.
- Alexander, D. E. and Taliaferro, S. L.** (2015). *On the wing: insects, pterosaurs, birds, bats and the evolution of animal flight*. New York, NY: Oxford University Press.
- Amichai, E. and Kronfeld-Schor, N.** (2019). Artificial light at night promotes activity throughout the night in nesting common swifts (*Apus apus*). *Sci Rep* **9**, 11052.
- Austin, M. P.** (2007). Species distribution models and ecological theory: A critical assessment and some possible new approaches. *Ecological Modelling* **200**, 1–19.
- Bäckman, J. and Alerstam, T.** (2001). Confronting the winds: orientation and flight behaviour of roosting swifts, *Apus apus*. *Proc. R. Soc. Lond. B* **268**, 1081–1087.
- Bäckman, J. and Alerstam, T.** (2002). Orientation of swifts in roosting flights. *The Journal of Experimental Biology* **205**, 905–910.
- Ballerini, M., Cabibbo, N., Candelier, R., Cavagna, A., Cisbani, E., Giardina, I., Orlandi, A., Parisi, G., Procaccini, A., Viale, M., et al.** (2008). Empirical investigation of starling flocks: a benchmark study in collective animal behaviour. *Animal Behaviour* **76**, 201–215.
- Barrowclough, G. F., Groth, J. G. and Mertz, L. A.** (2006). The RAG-1 exon in the avian order Caprimulgiformes: Phylogeny, heterozygosity, and base composition. *Molecular Phylogenetics and Evolution* **41**, 238–248.
- Bartholomew, G. A. and Cade, T. J.** (1963). The Water Economy of Land Birds. *The Auk* **80**, 504–539.
- Baudinette, R. V. and Schmidt-Nielsen, K.** (1974). Energy cost of gliding flight in herring gulls. *Nature* **248**, 83–84.
- Bersot, E.** (1931). Comment boivent les martinets. *Nos Oiseaux* **11**, 106–107.
- BirdLife International** (2016). *Apus apus*. The IUCN Red List of Threatened Species 2016: e.T22686800A86111691. <https://dx.doi.org/10.2305/IUCN.UK.2016-3.RLTS.T22686800A86111691.en>. Accessed on 26 September 2022.

- BirdLife International** (2017). *Delichon urbicum* (amended version of 2016 assessment). The IUCN Red List of Threatened Species 2017: e.T103811886A118748864. <https://dx.doi.org/10.2305/IUCN.UK.2017-3.RLTS.T103811886A118748864.en>. Accessed on 26 September 2022.
- BirdLife International** (2022a). Species factsheet: *Apus apus*. Downloaded from <http://www.birdlife.org> on 26/09/2022.
- BirdLife International** (2022b). Species factsheet: *Delichon urbicum*. Downloaded from <http://www.birdlife.org> on 26/09/2022.
- Bishop, C. M. and Butler, P. J.** (2015). Flight. In *Sturkie's Avian Physiology*, pp. 919–974. Elsevier.
- Blasco-Zumeta, J. and Heinze, G.-M.** (2014). Atlas de Identificación de las Aves de Aragón.
- Braun, M. J. and Huddleston, C. J.** (2009). A molecular phylogenetic survey of caprimulgiform nightbirds illustrates the utility of non-coding sequences. *Molecular Phylogenetics and Evolution* **53**, 948–960.
- Brown, D. D., LaPoint, S., Kays, R., Heidrich, W., Kümme, F. and Wikelski, M.** (2012). Accelerometer-informed GPS telemetry: Reducing the trade-off between resolution and longevity. *Wildlife Society Bulletin* **36**, 139–146.
- Brown, C. E., Sathe, E. A., Dudley, R. and Deban, S. M.** (2022). Gliding and parachuting by arboreal salamanders. *Current Biology* **32**, R453–R454.
- Bruderer, L., Liechti, F. and Bilo, D.** (2001). Flexibility in flight behaviour of barn swallows (*Hirundo rustica*) and house martins (*Delichon urbica*) tested in a wind tunnel. *Journal of Experimental Biology* **204**, 1473–1484.
- Bryant, D. M.** (1973a). Breeding Biology of House Martins *Delichon urbica* in Relation to Aerial Insect Abundance. *Ibis* **117**, 180–216.
- Bryant, D. M.** (1973b). The Factors Influencing the Selection of Food by the House Martin (*Delichon urbica* (L.)). *The Journal of Animal Ecology* **42**, 539–564.
- Bryant, D. M.** (1979). Reproductive Costs in the House Martin (*Delichon urbica*). *The Journal of Animal Ecology* **48**, 655.
- Bryant, D. M. and Turner, A. K.** (1982). Central place foraging by swallows (Hirundinidae): The question of load size. *Animal Behaviour* **30**, 845–856.
- Budgey, R.** (1998). Three dimensional bird flock structure and its implications for birdstrike tolerance in aircraft. *International Bird Strike Committee, Stara Lesna, Slovakia*.
- Bundle, M. W. and Dial, K. P.** (2003). Mechanics of wing-assisted incline running (WAIR). *Journal of Experimental Biology* **206**, 4553–4564.
- Burgers, P. and Chiappe, L. M.** (1999). The wing of Archaeopteryx as a primary thrust generator. *Nature* **399**, 60–62.

- Burgin, C. J., Colella, J. P., Kahn, P. L. and Upham, N. S.** (2018). How many species of mammals are there? *Journal of Mammalogy* **99**, 1–14.
- Butler, P. J.** (2010). High fliers: The physiology of bar-headed geese. *Comparative Biochemistry and Physiology Part A: Molecular & Integrative Physiology* **156**, 325–329.
- Cagnacci, F., Boitani, L., Powell, R. A. and Boyce, M. S.** (2010). Animal ecology meets GPS-based radiotelemetry: a perfect storm of opportunities and challenges. *Phil. Trans. R. Soc. B* **365**, 2157–2162.
- Caple, G., Balda, R. P. and Willis, W. R.** (1983). The Physics of Leaping Animals and the Evolution of Preflight. *The American Naturalist* **121**, 455–476.
- Carere, C. and Alleva, E.** (1998). Sex differences in parental care in the common swift (*Apus apus*): effect of brood size and nestling age. **76**, 6.
- Cavagna, A., Giardina, I., Orlandi, A., Parisi, G., Procaccini, A., Viale, M. and Zdravkovic, V.** (2008). The STARFLAG handbook on collective animal behaviour: Part I, empirical methods. *Animal Behaviour* **76**, 217–236.
- Chandra-Bose, D. A. and George, J. C.** (1965a). Studies on the structure and physiology of the flight muscles of birds. 13. Characterization of the avian pectoralis. *Pavo* **3**, 14–22.
- Chandra-Bose, D. A. and George, J. C.** (1965b). Studies on the structure and physiology of the flight muscles of birds. 14. Characterization of the avian supracoracoideus. *Pavo* **3**, 23–28.
- Chang, Y.-H., Ting, S.-C., Su, J.-Y., Soong, C.-Y. and Yang, J.-T.** (2013). Ventral-clap modes of hovering passerines. *Phys. Rev. E* **87**, 022707.
- Chantler, P. and Boesman, P.** (2013). Common Swift (*Apus apus*). In *Handbook of the Birds of the World Alive* (ed. del Hoyo, J.), Elliott, A.), Sargatal, J.), Christie, D. A.), and de Juana, E.), p. Lynx Edicions, Barcelona.
- Chantler, P., Boesman, P. F. D., A. and Kirwan, G. M.** (2020a). Common Swift (*Apus apus*), version 1.0. In *Birds of the World*, p. Ithaca, NY, USA: Cornell Lab of Ornithology.
- Chantler, P., Bonan, A. and Boesman, P. F. D.** (2020b). Pallid Swift (*Apus pallidus*), version 1.0. In *Birds of the World*, p. Ithaca, NY, USA: Cornell Lab of Ornithology.
- Chantler, P., de Juana, E., Kirwan, G. M. and Boesman, P. F. D.** (2020c). Alpine Swift (*Apus melba*), version 1.0. In *Birds of the World*, p. Ithaca, NY, USA: Cornell Lab of Ornithology.
- Chatterjee, S.** (1997). *The rise of birds: 225 million years of evolution*. Baltimore, MD: Johns Hopkins University Press.
- Chatterjee, S. and Templin, R. J.** (2007). Biplane wing planform and flight performance of the feathered dinosaur *Microraptor gui*. *Proc. Natl. Acad. Sci. U.S.A.* **104**, 1576–1580.

- Civantos, E., Thuiller, W., Maiorano, L., Guisan, A. and Araújo, M. B.** (2012). Potential Impacts of Climate Change on Ecosystem Services in Europe: The Case of Pest Control by Vertebrates. *BioScience* **62**, 658–666.
- Clark, Jr., G. A.** (2004). Form and function: the external bird. In *Handbook of Bird Biology*, pp. 466–565. Cornell Lab of Ornithology in association with Princeton University Press, 2nd ed.
- Clifton, G. T., Hedrick, T. L. and Biewener, A. A.** (2015). Western and Clark’s grebes use novel strategies for running on water. *Journal of Experimental Biology* **218**, 1235–1243.
- Collett, T. S., de Ibarra, N. H., Riabinina, O. and Philippides, A.** (2013). Coordinating compass-based and nest-based flight directions during bumblebee learning and return flights. *Journal of Experimental Biology* **216**, 1105–1113.
- Cone, C. D. Jr.** (1962). Thermal soaring of birds. *American Scientist* **50**, 180–209.
- Cooke, S. J., Hinch, S. G., Wikelski, M., Andrews, R. D., Kuchel, L. J., Wolcott, T. G. and Butler, P. J.** (2004). Biotelemetry: a mechanistic approach to ecology. *Trends in Ecology & Evolution* **19**, 334–343.
- Corcoran, A. J. and Conner, W. E.** (2012). Sonar jamming in the field: effectiveness and behavior of a unique prey defense. *The Journal of Experimental Biology* **215**, 4278–4287.
- Crowe, O., Coombes, R. H., Lysaght, L., O’Brien, C., Choudhury, K. R., Walsh, A. J., Wilson, J. H. and O’Halloran, J.** (2010). Population trends of widespread breeding birds in the Republic of Ireland 1998–2008. *Bird Study* **57**, 267–280.
- de Margerie, E., Simonneau, M., Caudal, J.-P., Houdelier, C. and Lumineau, S.** (2015). 3D tracking of animals in the field using rotational stereo videography. *Journal of Experimental Biology* **218**, 2496–2504.
- de Margerie, E., Pichot, C. and Benhamou, S.** (2018). Volume-concentrated searching by an aerial insectivore, the common swift, *Apus apus*. *Animal Behaviour* **136**, 159–172.
- Debeffe, L., Morellet, N., Cargnelutti, B., Lourtet, B., Coulon, A., Gaillard, J. M., Bon, R. and Hewison, A. J. M.** (2013). Exploration as a key component of natal dispersal: dispersers explore more than philopatric individuals in roe deer. *Animal Behaviour* **86**, 143–151.
- del Hoyo, J., Turner, A., Kirwan, G. M. and Collar, N.** (2020). Common House-Martin (*Delichon urbicum*), version 1.0. In *Birds of the World*, p. Ithaca, NY, USA: Cornell Lab of Ornithology.
- Dell’Ariccia, G., Dell’Omo, G., Wolfer, D. P. and Lipp, H.-P.** (2008). Flock flying improves pigeons’ homing: GPS track analysis of individual flyers versus small groups. *Animal Behaviour* **76**, 1165–1172.
- Dell’Omo, G., Alleva, E. and Carere, C.** (1998). Parental recycling of nestling faeces in the common swift. *Animal Behaviour* **56**, 631–637.

- Dennis, R. L. H., Shreeve, T. G. and Van Dyck, H.** (2006). Habitats and Resources: The Need for a Resource-based Definition to Conserve Butterflies. *Biodivers Conserv* **15**, 1943–1966.
- Després, Viviane R., Huffman, J. A., Burrows, S. M., Hoose, C., Safatov, Aleksandr S., Buryak, G., Fröhlich-Nowoisky, J., Elbert, W., Andreae, Meinrat O., Pöschl, U., et al.** (2012). Primary biological aerosol particles in the atmosphere: a review. *Tellus B: Chemical and Physical Meteorology* **64**, 15598.
- Dial, K. P.** (2003). Evolution of avian locomotion: correlates of flight style, locomotor modules, nesting biology, body size, development, and the origin of flapping flight. *Perspectives in Ornithology* **120**, 941–952.
- Dial, K. P., Randall, R. J. and Dial, T. R.** (2006). What Use Is Half a Wing in the Ecology and Evolution of Birds? *BioScience* **56**, 437.
- Dial, K. P., Jackson, B. E. and Segre, P.** (2008). A fundamental avian wing-stroke provides a new perspective on the evolution of flight. *Nature* **451**, 985–989.
- Diehl, R. H.** (2013). The airspace is habitat. *Trends in Ecology & Evolution* **28**, 377–379.
- Diehl, R. H., Peterson, A. C., Bolus, R. T. and Johnson, D. H.** (2017). Extending the Habitat Concept to the Airspace. In *Aeroecology* (ed. Chilson, P. B.), Frick, W. F.), Kelly, J. F.), and Liechti, F.), pp. 47–69. Cham: Springer International Publishing.
- Dokter, A. M., Åkesson, S., Beekhuis, H., Bouten, W., Buurma, L., van Gasteren, H. and Holleman, I.** (2013). Twilight ascents by common swifts, *Apus apus*, at dawn and dusk: acquisition of orientation cues? *Animal Behaviour* **85**, 545–552.
- Eaton, M. A., Brown, A. F., Noble, D. G., Musgrove, A. J., Hearn, R. D., Aebischer, N. J., Gibbons, D. W., Evans, A. and Gregory, R. D.** (2009). Birds of Conservation Concern 3. *British Birds* **102**, 296–341.
- EBCC** (2021). *Pan-European Common Bird Monitoring Scheme*. Available at: <https://pecbms.info/>.
- Engler, J. O., Stiels, D., Schidelko, K., Strubbe, D., Quillfeldt, P. and Brambilla, M.** (2017). Avian SDMs: current state, challenges, and opportunities. *Journal of Avian Biology* **48**, 1483–1504.
- Ericson, P. G. P., Anderson, C. L., Britton, T., Elzanowski, A., Johansson, U. S., Källersjö, M., Ohlson, J. I., Parsons, T. J., Zuccon, D. and Mayr, G.** (2006). Diversification of Neoaves: integration of molecular sequence data and fossils. *Biol. Lett.* **2**, 543–547.
- Evans, H. E. and Heiser, J. B.** (2004). What's Inside: Anatomy and Physiology. In *Handbook of Bird Biology*, pp. 304–465. Cornell Lab of Ornithology in association with Princeton University Press, 2nd ed.
- Faaborg, J. and Chaplin, S. B.** (1988). *Ornithology: an ecological approach*. Prentice Hall, Inc., Englewood Cliffs, NJ.

- Farina, A.** (1988). Observations on the swift's *Apus apus* (L.) social flights at the breeding sites. *Monitore Zoologico Italiano* **22**, 255–261.
- Feduccia, A.** (2004). Evolution of Birds and Avian Flight. In *Handbook of Bird Biology*, pp. 466–565. Cornell Lab of Ornithology in association with Princeton University Press, 2nd ed.
- Fisher, C. D., Lindgren, E. and Dawson, W. R.** (1972). Drinking Patterns and Behavior of Australian Desert Birds in Relation to Their Ecology and Abundance. *The Condor* **74**, 111–136.
- Fossé, A. and Roger, T.** (2001). Nidifications arboricole et rupestre du Martinet noir *Apus apus* en Maine-et-Loire. *Crex* **6**, 21–29.
- Frair, J. L., Nielsen, S. E., Merrill, E. H., Lele, S. R., Boyce, M. S., Munro, R. H. M., Stenhouse, G. B. and Beyer, H. L.** (2004). Removing GPS collar bias in habitat selection studies. *J Appl Ecology* **41**, 201–212.
- Frair, J. L., Fieberg, J., Hebblewhite, M., Cagnacci, F., DeCesare, N. J. and Pedrotti, L.** (2010). Resolving issues of imprecise and habitat-biased locations in ecological analyses using GPS telemetry data. 14.
- Frank, G., David, D. and Rasmussen, P.** (2020). 'Family Index'. *IOC World Bird List Version 10.1*. International Ornithologists' Union.
- Franklin, J.** (2009). *Mapping species distributions: spatial inference and prediction*. Cambridge, New York, 320 p.: Cambridge University Press.
- García-Ripollés, C., López-López, P. and Urios, V.** (2010). First description of migration and wintering of adult Egyptian Vultures *Neophron percnopterus* tracked by GPS satellite telemetry. *Bird Study* **57**, 261–265.
- Garner, J. P., Taylor, G. K. and Thomas, A. L. R.** (1999). On the origins of birds: the sequence of character acquisition in the evolution of avian flight. *Proc. R. Soc. Lond. B* **266**, 1259–1266.
- Gill, F. and Donsker, D.** (2019). *IOC World Bird List (v9.2)*.
- Gill, R. E., Tibbitts, T. L., Douglas, D. C., Handel, C. M., Mulcahy, D. M., Gottschalck, J. C., Warnock, N., McCaffery, B. J., Battley, P. F. and Piersma, T.** (2009). Extreme endurance flights by landbirds crossing the Pacific Ocean: ecological corridor rather than barrier? *Proc. R. Soc. B.* **276**, 447–457.
- Goldspink, G.** (1977). Design in muscles in relation to locomotion. In *Mechanics and energetics of animal locomotion.*, pp. 1–22. London: Chapman and Hall.
- Gory, G.** (1992). Activité au nid du Martinet noir *Apus apus* (L.), durant la période de couvainon. *Alauda* **60**, 134–142.
- Gory, G.** (1994). Recherche et utilisation des matériaux nécessaires à la construction de nid du martinet noir *Apus apus*. *Alauda* **62**, 117–122.

- Gory, G.** (2008). Le régime alimentaire du martinet noir *Apus apus* en région méditerranéenne. *Revue d'écologie – la Terre et la Vie* **63**, 251–260.
- Guo, D., Zietsman, G. and Hockey, P. A. R.** (2016). Climate Change Impacts on the Common Swift in South Africa. *IJESD* **7**, 306–311.
- Gutherz, S. B. and O'Connor, P. M.** (2021). Postcranial Skeletal Pneumaticity in Cuculidae. *Zoology* **146**, 125907.
- Gutherz, S. B. and O'Connor, P. M.** (2022). Postcranial skeletal pneumaticity in NON-AQUATIC neoavians: Insights from accipitrimorphae. *Journal of Anatomy* joa.13742.
- Hainsworth, F. R.** (1986). Why Hummingbirds Hover: A Commentary. *The Auk* **103**, 832–833.
- Hall, L. S., Krausman, P. R. and Morrison, M. L.** (1997). The Habitat Concept and a Plea for Standard Terminology. *Wildlife Society Bulletin* **25**, 173–182.
- Harris, S. J., Massimino, D., Balmer, D. E., Eaton, M. A., Noble, D. G., Pearce-Higgins, J. W., Woodcock, P. and Gillings, S.** (2020). *The Breeding Bird Survey 2019. BTO Research Report 726*. Thetford: British Trust for Ornithology.
- Hawkes, L. A., Balachandran, S., Batbayar, N., Butler, P. J., Frappell, P. B., Milsom, W. K., Tseveenmyadag, N., Newman, S. H., Scott, G. R., Sathiyaselvam, P., et al.** (2011). The trans-Himalayan flights of bar-headed geese (*Anser indicus*). *Proc. Natl. Acad. Sci. U.S.A.* **108**, 9516–9519.
- Hawkes, L. A., Balachandran, S., Batbayar, N., Butler, P. J., Chua, B., Douglas, D. C., Frappell, P. B., Hou, Y., Milsom, W. K., Newman, S. H., et al.** (2013). The paradox of extreme high-altitude migration in bar-headed geese *Anser indicus*. *Proc. R. Soc. B.* **280**, 20122114.
- Hedenström, A. and Rosén, M.** (2001). Predator versus prey: on aerial hunting and escape strategies in birds. *Behavioral Ecology* **12**, 150–156.
- Hedenström, A., Rosén, M., Åkesson, S. and Spina, F.** (1999). Flight performance during hunting excursions in Eleonora's falcon *Falco eleonora*. *The Journal of Experimental Biology* **202**, 2029–2039.
- Hedenström, A., Alerstam, T., Green, M. and Gudmundsson, G.** (2002). Adaptive variation of airspeed in relation to wind, altitude and climb rate by migrating birds in the Arctic. *Behavioral Ecology and Sociobiology* **52**, 308–317.
- Hedenström, A., Norevik, G., Warfvinge, K., Andersson, A., Bäckman, J. and Åkesson, S.** (2016). Annual 10-Month Aerial Life Phase in the Common Swift *Apus apus*. *Current Biology* **26**, 3066–3070.
- Hedrick, T. L.** (2008). Software techniques for two- and three-dimensional kinematic measurements of biological and biomimetic systems. *Bioinspir. Biomim.* **3**, 034001.
- Hedrick, T. L., Pichot, C. and de Margerie, E.** (2018). Gliding for a free lunch: biomechanics of foraging flight in common swifts (*Apus apus*). *J Exp Biol* **221**, jeb186270.

- Heers, A. M. and Dial, K. P.** (2012). From extant to extinct: locomotor ontogeny and the evolution of avian flight. *Trends in Ecology & Evolution* **27**, 296–305.
- Helms, J. A., Godfrey, A. P., Ames, T. and Bridge, E. S.** (2016). Are invasive fire ants kept in check by native aerial insectivores? *Biol. Lett.* **12**, 20160059.
- Henningsson, P. and Hedenström, A.** (2011). Aerodynamics of gliding flight in common swifts. *Journal of Experimental Biology* **214**, 382–393.
- Hijmans, R. J. and Graham, C. H.** (2006). The ability of climate envelope models to predict the effect of climate change on species distributions. *Global Change Biology* **12**, 2272–2281.
- Holmgren, J.** (2004). Roosting in tree foliage by Common Swifts *Apus apus*. *Ibis* **146**, 404–416.
- Hooker, S. K., Biuw, M., McConnell, B. J., Miller, P. J. O. and Sparling, C. E.** (2007). Bio-logging science: Logging and relaying physical and biological data using animal-attached tags. *Deep Sea Research Part II: Topical Studies in Oceanography* **54**, 177–182.
- Huntley, B., Berry, P. M., Cramer, W. and McDonald, A. P.** (1995). Modelling present and potential future ranges of some European higher plants using climate response surfaces. *Journal of Biogeography* **22**, 967–1001.
- Huntley, B., Collingham, Y. C., Willis, S. G. and Green, R. E.** (2008). Potential Impacts of Climatic Change on European Breeding Birds. *PLoS ONE* **3**, e1439.
- Jackson, B. E., Segre, P. and Dial, K. P.** (2009). Precocial development of locomotor performance in a ground-dwelling bird (*Alectoris chukar*): negotiating a three-dimensional terrestrial environment. *Proc. R. Soc. B.* **276**, 3457–3466.
- Janeček, Š., Patáčová, E., Bartoš, M., Padyšáková, E., Spitzer, L. and Tropek, R.** (2011). Hovering sunbirds in the Old World: occasional behaviour or evolutionary trend? *Oikos* **120**, 178–183.
- Jukema, J., van de Wetering, H. and Klaassen, R. H. G.** (2015). Primary moult in non-breeding second-calendar-year Swifts *Apus apus* during summer in Europe. *Ringing & Migration* **30**, 1–6.
- Kempton, J. A., Wynn, J., Bond, S., Evry, J., Fayet, A. L., Gillies, N., Guilford, T., Kavelaars, M., Juarez-Martinez, I., Padget, O., et al.** (2022). Optimization of dynamic soaring in a flap-gliding seabird affects its large-scale distribution at sea. *Sci. Adv.* **8**, eabo0200.
- Kenward, R.** (2001). *A manual for wildlife radio tagging*. Rev. ed. San Diego, CA ; London: Academic Press.
- Kettel, E. F., Woodward, I. D., Balmer, D. E. and Noble, D. G.** (2021). Using citizen science to assess drivers of Common House Martin *Delichon urbicum* breeding performance. *Ibis* **163**, 366–379.

- Khandelwal, P. C. and Hedrick, T. L.** (2020). How biomechanics, path planning and sensing enable gliding flight in a natural environment. *Proc. R. Soc. B.* **287**, 20192888.
- Kogure, Y., Sato, K., Watanuki, Y., Wanless, S. and Daunt, F.** (2016). European shags optimize their flight behavior according to wind conditions. *Journal of Experimental Biology* **219**, 311–318.
- Kunz, T. H., Jr, S. A. G., Hristov, N. I., Horn, J. W., Jones, G., Kalko, E. K. V., Larkin, R. P., McCracken, G. F., Swartz, S. M., Srygley, R. B., et al.** (2008). Aeroecology: probing and modeling the aerosphere. *Integrative and Comparative Biology* **48**, 1–11.
- Lack, E.** (1951). The breeding biology of the swift *Apus apus*. *Ibis* **93**, 501–546.
- Lack, D.** (1956). *Swifts in a tower*. Chapman and Hall.
- Lack, D. and Owen, D. F.** (1955). The Food of the Swift. *The Journal of Animal Ecology* **24**, 120.
- Landys-Ciannelli, M. M., Jukema, J. and Piersma, T.** (2002). Blood parameter changes during stopover in a long-distance migratory shorebird, the bar-tailed godwit *Limosa lapponica taymyrensis*. *Journal of Avian Biology* **33**, 451–455.
- Lanzone, M. J., Miller, T. A., Turk, P., Brandes, D., Halverson, C., Maisonneuve, C., Tremblay, J., Cooper, J., O'Malley, K., Brooks, R. P., et al.** (2012). Flight responses by a migratory soaring raptor to changing meteorological conditions. *Biol. Lett.* **8**, 710–713.
- Lentink, D. and de Kat, R.** (2014). Gliding Swifts Attain Laminar Flow over Rough Wings. *PLoS ONE* **9**, e99901.
- Lentink, D., Müller, U. K., Stamhuis, E. J., de Kat, R., van Gestel, W., Veldhuis, L. L. M., Henningsson, P., Hedenström, A., Videler, J. J. and van Leeuwen, J. L.** (2007). How swifts control their glide performance with morphing wings. *Nature* **446**, 1082–1085.
- Li, Q., Gao, K.-Q., Meng, Q., Clarke, J. A., Shawkey, M. D., D'Alba, L., Pei, R., Ellison, M., Norell, M. A. and Vinther, J.** (2012). Reconstruction of *Microraptor* and the Evolution of Iridescent Plumage. *Science* **335**, 1215–1219.
- Liechti, F.** (2006). Birds: blowin' by the wind? *J Ornithol* **147**, 202–211.
- Liechti, F., Klaassen, M. and Bruderer, B.** (2000). Predicting Migratory Flight Altitudes by Physiological Migration Models. *The Auk* **117**, 205–214.
- Linnæus, C.** (1754). *Genera plantarum*. 5th edition.
- Lovette, I. J. and Fitzpatrick, J. W. eds.** (2016). *Cornell Lab of Ornithology's handbook of bird biology*. Third edition. Chichester, West Sussex: John Wiley & Sons, Inc.
- Lundgren, B. O. and Kiessling, K.-H.** (1988). Comparative aspects of fibre types, areas, and capillary supply in the pectoralis muscle of some passerine birds with differing migratory behaviour. *J Comp Physiol B* **158**, 165–173.

- Major, P. F. and Dill, L. M.** (1978). The three-dimensional structure of airborne bird flocks. *Behav. Ecol. Sociobiol.* **4**, 111–122.
- Marsh, O. C.** (1880). Odontornithes: a Monograph of the Extinct Toothed Birds of North America. *Nature* **22**, 457–458.
- Mateos-Rodriguez, M. and Liechti, F.** (2012). How do diurnal long-distance migrants select flight altitude in relation to wind? *Behavioral Ecology* **23**, 403–409.
- Mathieu-Costello, O., Suarez, R. K. and Hochachka, P. W.** (1992). Capillary-to-fiber geometry and mitochondrial density in hummingbird flight muscle. *Respiration Physiology* **89**, 113–132.
- Mayr, G.** (2010). Phylogenetic relationships of the paraphyletic ‘caprimulgiform’ birds (nightjars and allies). *Journal of Zoological Systematics and Evolutionary Research* **48**, 126–137.
- Mayr, G.** (2011). Metaves, Mirandornithes, Strisores and other novelties - a critical review of the higher-level phylogeny of neornithine birds: Higher-level phylogeny of birds. *Journal of Zoological Systematics and Evolutionary Research* **49**, 58–76.
- Meyers, R. A.** (1993). Gliding flight in the American Kestrel (*Falco sparverius*): An electromyographic study. *J. Morphol.* **215**, 213–224.
- Meyers, R. A. and Stakebake, E. F.** (2004). Anatomy and histochemistry of spread-wing posture in birds. 3. Immunohistochemistry of flight muscles and the “shoulder lock” in albatrosses. *Journal of Morphology* **263**, 12–29.
- Mikula, P., Hromada, M. and Tryjanowski, P.** (2013). Bats and Swifts as food of the European Kestrel (*Falco tinnunculus*) in a small town in Slovakia. *Ornis Fennica* **90**, 178–185.
- Morrison, M. L., Marcot, B. G. and Mannan, R. W.** (2006). *Wildlife-habitat relationships: concepts and applications*. 3rd ed. Washington: Island Press.
- Muijres, F. T., Henningson, P., Stuiver, M. and Hedenström, A.** (2012a). Aerodynamic flight performance in flap-gliding birds and bats. *Journal of Theoretical Biology* **306**, 120–128.
- Muijres, F. T., Johansson, L. C. and Hedenström, A.** (2012b). Leading edge vortex in a slow-flying passerine. *Biol. Lett.* **8**, 554–557.
- Murgui, E.** (2002). Breeding Habitat Selection in the House Martin *Delichon urbica* in the City Of Valencia (Spain). *Acta Ornithologica* **37**, 75–83.
- Nathan, R., Getz, W. M., Revilla, E., Holyoak, M., Kadmon, R., Saltz, D. and Smouse, P. E.** (2008). A movement ecology paradigm for unifying organismal movement research. *Proc. Natl. Acad. Sci. U.S.A.* **105**, 19052–19059.
- Nilsson, C., Bäckman, J. and Dokter, A. M.** (2019). Flocking behaviour in the twilight ascents of Common Swifts *Apus apus*. *Ibis* **161**, 674–678.

- Nopcsa, B. F.** (1907). Ideas on the Origin of Flight. *Proceedings of the Zoological Society of London* **77**, 223–236.
- Nopcsa, B. F.** (1923). On the Origin of Flight in Birds. *Proceedings of the Zoological Society of London* **93**, 463–477.
- Norberg, R. Å.** (1981). Why foraging birds in tree should climb and hop upwards rather than downwards. *Ibis* **123**, 281–288.
- Norberg, R. Å.** (1983). Optimal locomotion modes of foraging birds in trees. *Ibis* **125**, 172–180.
- Norberg, U. M.** (1990). *Vertebrate flight: mechanics, physiology, morphology, ecology and evolution*. New York: Springer Berlin Heidelberg.
- Norberg, U. M.** (1995). How a Long Tail and Changes in Mass and Wing Shape Affect the Cost for Flight in Animals. *Functional Ecology* **9**, 48.
- O’Connell, K. A., Hamidy, A., Kurniawan, N., Smith, E. N. and Fujita, M. K.** (2018). Synchronous diversification of parachuting frogs (Genus *Rhacophorus*) on Sumatra and Java. *Molecular Phylogenetics and Evolution* **123**, 101–112.
- O’Connor, P. M.** (2004). Pulmonary pneumaticity in the postcranial skeleton of extant Aves: A case study examining Anseriformes. *J. Morphol.* **261**, 141–161.
- O’Connor, P. M.** (2006). Postcranial pneumaticity: An evaluation of soft-tissue influences on the postcranial skeleton and the reconstruction of pulmonary anatomy in archosaurs. *J. Morphol.* **267**, 1199–1226.
- O’Connor, P. M.** (2009). Evolution of archosaurian body plans: skeletal adaptations of an air-sac-based breathing apparatus in birds and other archosaurs. *J. Exp. Zool.* **311A**, 629–646.
- Olo, G.** (2017). Is “banging” an antipredator behavior in Common Swift (*Apus apus*)? **94**, 8.
- Padyšáková, E. and Janeček, Š.** (2016). Sunbird hovering behavior is determined by both the forager and resource plant. *Biotropica* **48**, 687–693.
- Park, H. and Choi, H.** (2010). Aerodynamic characteristics of flying fish in gliding flight. *Journal of Experimental Biology* **213**, 3269–3279.
- Pennycuick, C. J.** (1968). A Wind-Tunnel Study of Gliding Flight in the Pigeon *Columba Livia*. *Journal of Experimental Biology* **49**, 509–526.
- Pennycuick, C. J.** (1969). The mechanics of bird migration. *Ibis* **111**, 525–556.
- Pennycuick, C. J.** (1971a). Control of gliding angle in Rueppell’s griffon vulture *Gyps rueppellii*. *Journal of Experimental Biology* **55**, 39–46.
- Pennycuick, C. J.** (1971b). Gliding flight of the white-backed vulture *Gyps africanus*. *Journal of Experimental Biology* **55**, 13–38.

- Pennycuik, C. J.** (1975). Mechanics of flight. In *Avian Biology*, pp. 1–75. Academic Press, New York and London.
- Pennycuik, C. J.** (1978). Fifteen Testable Predictions about Bird Flight. *Oikos* **30**, 165.
- Pennycuik, C. J.** (1982a). The flight of petrels and albatrosses (procellariiformes), observed in South Georgia and its vicinity. *Phil. Trans. R. Soc. Lond. B* **300**, 75–106.
- Pennycuik, C. J.** (1982b). The ornithodolite: An instrument for collecting large samples of bird speed measurements. *Phil. Trans. R. Soc. Lond. B* **300**, 61–73.
- Pennycuik, C. J.** (1983). Thermal Soaring Compared in Three Dissimilar Tropical Bird Species, *Fregata magnificens*, *Pelecanus occidentals* and *Coragyps atratus*. *Journal of Experimental Biology* **102**, 307–325.
- Pennycuik, C. J., Åkesson, S. and Hedenström, A.** (2013). Air speeds of migrating birds observed by ornithodolite and compared with predictions from flight theory. *Journal of The Royal Society Interface* **10**, 20130419.
- Piersma, T.** (1998). Phenotypic Flexibility during Migration: Optimization of Organ Size Contingent on the Risks and Rewards of Fueling and Flight? *Journal of Avian Biology* **29**, 511.
- Piersma, T., Gudmundsson, G. A. and Lilliendahl, K.** (1999). Rapid Changes in the Size of Different Functional Organ and Muscle Groups during Refueling in a Long-Distance Migrating Shorebird. *Physiological and Biochemical Zoology* **72**, 405–415.
- Podulka, S., Rohrbaugh Jr., R. W. and Bonney, R. eds.** (2004). *Handbook of Bird Biology*. Cornell Lab of Ornithology in association with Princeton University Press, 2nd ed.
- Poessel, S. A., Brandt, J., Miller, T. A. and Katzner, T. E.** (2018). Meteorological and environmental variables affect flight behaviour and decision-making of an obligate soaring bird, the California Condor *Gymnogyps californianus*. *Ibis* **160**, 36–53.
- Pomeroy, H. and Heppner, F.** (1992). Structure of Turning in Airborne Rock Dove (*Columba livia*) Flocks. *The Auk* **109**, 256–267.
- Proctor, N. S. and Lynch, P. J.** (1993). *Manual of ornithology: avian structure & function*. New Haven: Yale Univ. Press.
- Prum, R. O.** (1999). Development and evolutionary origin of feathers. *J. Exp. Zool.* **285**, 291–306.
- Pyke, G. H.** (1981). Why hummingbirds hover and honeyeaters perch. *Animal Behaviour* **29**, 861–867.
- Rayner, J. M. V.** (1977). The intermittent flight of birds. In *Scale effects in animal locomotion.*, pp. 437–443. Academic Press, New York and London.
- Rayner, J. M. V.** (1985). Bounding and undulating flight in birds. *Journal of Theoretical Biology* **117**, 47–77.

- Richardson, P. L.** (2011). How do albatrosses fly around the world without flapping their wings? *Progress in Oceanography* **88**, 46–58.
- Rosser, B. W. C. and George, J. C.** (1986). The avian pectoralis: histochemical characterization and distribution of muscle fiber types. *Can. J. Zool.* **64**, 1174–1185.
- Rowcliffe, M. J., Carbone, C., Kays, R., Kranstauber, B. and Jansen, P. A.** (2012). Bias in estimating animal travel distance: the effect of sampling frequency: *Estimating animal travel distance. Methods in Ecology and Evolution* **3**, 653–662.
- Rüppell, G.** (1977). *Bird flight*. New York: Van Nostrand Reinhold Co.
- Ruxton, G. D. and Houston, D. C.** (2004). Obligate vertebrate scavengers must be large soaring fliers. *Journal of Theoretical Biology* **228**, 431–436.
- Sachs, G.** (2017). Energy saving of aerial roosting Swifts by dynamic flap-gliding flight. *J Ornithol* **158**, 943–953.
- Sage, E., Bouten, W., van Dijk, W., Camphuysen, K. C. J. and Shamoun-Baranes, J.** (2022). Built up areas in a wet landscape are stepping stones for soaring flight in a seabird. *Science of The Total Environment* **852**, 157879.
- Sakamoto, K. Q., Takahashi, A., Iwata, T., Yamamoto, T., Yamamoto, M. and Trathan, P. N.** (2013). Heart rate and estimated energy expenditure of flapping and gliding in black-browed albatrosses. *Journal of Experimental Biology* jeb.079905.
- Salt, G. W. and Zeuthen, E.** (1960). The Respiratory System. In *Biology and Comparative Physiology of Birds*, pp. 363–409. Elsevier.
- Schaub, T., Meffert, P. J. and Kerth, G.** (2016). Nest-boxes for Common Swifts *Apus apus* as compensatory measures in the context of building renovation: efficacy and predictors of occupancy. *Bird Conservation International* **26**, 164–176.
- Scheid, P.** (1979). Mechanisms of gas exchange in bird lungs. In *Reviews of Physiology, Biochemistry and Pharmacology, Volume 86*, pp. 137–186. Berlin, Heidelberg: Springer Berlin Heidelberg.
- Seeber, G.** (2003). *Satellite geodesy*. 2nd completely rev. and extended ed. Berlin ; New York: Walter de Gruyter.
- Shelton, R. M., Jackson, B. E. and Hedrick, T. L.** (2014). The mechanics and behavior of Cliff Swallows during tandem flights. *Journal of Experimental Biology* jeb.101329.
- Shepard, E. L. C.** (2022). Energy economy in flight. *Current Biology* **32**, R672–R675.
- Shepard, E. L. C., Lambertucci, S. A., Vallmitjana, D. and Wilson, R. P.** (2011). Energy Beyond Food: Foraging Theory Informs Time Spent in Thermals by a Large Soaring Bird. *PLoS ONE* **6**, e27375.
- Shepard, E. L. C., Wilson, R. P., Rees, W. G., Grundy, E., Lambertucci, S. A. and Vosper, S. B.** (2013). Energy Landscapes Shape Animal Movement Ecology. *The American Naturalist* **182**, 298–312.

- Shepard, E. L. C., Williamson, C. and Windsor, S. P.** (2016). Fine-scale flight strategies of gulls in urban airflows indicate risk and reward in city living. *Phil. Trans. R. Soc. B* **371**, 20150394.
- Sholtis, K. M., Shelton, R. M. and Hedrick, T. L.** (2015). Field Flight Dynamics of Hummingbirds during Territory Encroachment and Defense. *PLoS ONE* **10**, e0125659.
- Siegel, R. B., Taylor, R., Saracco, J. F., Helton, L. and Stock, S.** (2016). GPS-tracking reveals non-breeding locations and apparent molt migration of a Black-headed Grosbeak. *J. Field Ornithol.* **87**, 196–203.
- Sinelschikova, A., Griffiths, M., Vorotkov, M., Bulyuk, V. and Bolshakov, C.** (2019). Airspeed of the Song Thrush in relation to the wind during autumnal nocturnal migration. *Ornis Fennica* **96**, 64–76.
- Smith, N. D.** (2012). Body mass and foraging ecology predict evolutionary patterns of skeletal pneumaticity in the diverse “waterbird” clade. *Evolution* **66**, 1059–1078.
- Soriano-Redondo, A., Acácio, M., Franco, A. M. A., Herlander Martins, B., Moreira, F., Rogerson, K. and Catry, I.** (2020). Testing alternative methods for estimation of bird migration phenology from GPS tracking data. *Ibis* **162**, 581–588.
- Stokes, I. A. and Lucas, A. J.** (2021). Wave-slope soaring of the brown pelican. *Mov Ecol* **9**, 13.
- Stork, N. E.** (2018). How many species of insects and other terrestrial arthropods are there on earth? *Annu. Rev. Entomol.* **63**, 31–45.
- Su, J.-Y., Ting, S.-C., Chang, Y.-H. and Yang, J.-T.** (2012). A passerine spreads its tail to facilitate a rapid recovery of its body posture during hovering. *J. R. Soc. Interface.* **9**, 1674–1684.
- Sun, A., Whelan, S., Hatch, S. and Elliott, K.** (2020). Tags below three percent of body mass increase nest abandonment by rhinoceros auklets, but handling impacts decline as breeding progresses. *Mar. Ecol. Prog. Ser.* **643**, 173–181.
- Sutton, L. J. and Puschendorf, R.** (2018). Climatic niche of the Saker Falcon *Falco cherrug* : predicted new areas to direct population surveys in Central Asia. *Ibis* 10.1111/ibi.12700.
- Theriault, D. H., Fuller, N. W., Jackson, B. E., Bluhm, E., Evangelista, D., Wu, Z., Betke, M. and Hedrick, T. L.** (2014). A protocol and calibration method for accurate multi-camera field videography. *Journal of Experimental Biology* **217**, 1843–1848.
- Thiebault, A., Mullers, R. H. E., Pistorius, P. A. and Tremblay, Y.** (2014a). Local enhancement in a seabird: reaction distances and foraging consequence of predator aggregations. *Behavioral Ecology* **25**, 1302–1310.
- Thiebault, A., Mullers, R., Pistorius, P., Meza-Torres, M. A., Dubroca, L., Green, D. and Tremblay, Y.** (2014b). From colony to first patch: Processes of prey searching and social information in Cape Gannets. *The Auk* **131**, 595–609.

- Tigges, U.** (2007). The phenology of the Common Swift *Apus apus* in Eurasia and the problem of defining the duration of their stay. *Podoces* **2**, 127–140.
- Tobalske, B.** (1995). Neuromuscular control and kinematics of intermittent flight in the European starling (*Sturnus vulgaris*). *Journal of Experimental Biology* **198**, 1259–1273.
- Tobalske, B. W. and Dial, K. P.** (2007). Aerodynamics of wing-assisted incline running in birds. *Journal of Experimental Biology* **210**, 1742–1751.
- Tobalske, B. W., Hedrick, T. L., Dial, K. P. and Biewener, A. A.** (2003). Comparative power curves in bird flight. *Nature* **421**, 363–366.
- Tucker, V. A.** (1969). The Energetics of Bird Flight. *Sci Am* **220**, 70–78.
- Tucker, V. A.** (1972). Metabolism during flight in the laughing gull, *Larus atricilla*. *American Journal of Physiology-Legacy Content* **222**, 237–245.
- Tucker, V. A.** (1995). An optical tracking device for recording the three-dimensional paths of flying birds. *Review of Scientific Instruments* **66**, 3042–3047.
- Turner, A.** (2004). Northern House Martin (*Delichon urbicum*). In *Handbook of the Birds of the World Alive* (ed. del Hoyo, J., Elliott, A.), Sargatal, J.), Christie, D. A.), and de Juana, E.), p. Lynx Edicions, Barcelona.
- Turner, A. and Rose, C.** (2010). *A Handbook to the Swallows and Martins of the World*. Helm.
- Usherwood, J. R.** (2016). Physiological, aerodynamic and geometric constraints of flapping account for bird gaits, and bounding and flap-gliding flight strategies. *Journal of Theoretical Biology* **408**, 42–52.
- Vernes, K.** (2001). Gliding performance of the Northern flying squirrel (*Glaucomys sabrinus*) in mature mixed forest of Eastern Canada. *Journal of Mammalogy* **82**, 1026–1033.
- Videler, J. J.** (2005). *Avian flight*. Oxford ; New York: Oxford University Press.
- Voeten, D. F. A. E., Cubo, J., de Margerie, E., Röper, M., Beyrand, V., Bureš, S., Tafforeau, P. and Sanchez, S.** (2018). Wing bone geometry reveals active flight in *Archaeopteryx*. *Nat Commun* **9**, 923.
- Vyssotski, A. L., Dell’Omo, G., Dell’Ariccia, G., Abramchuk, A. N., Serkov, A. N., Latanov, A. V., Loizzo, A., Wolfer, D. P. and Lipp, H.-P.** (2009). EEG Responses to Visual Landmarks in Flying Pigeons. *Current Biology* **19**, 1159–1166.
- Wainwright, C. E., Stepanian, P. M., Reynolds, D. R. and Reynolds, A. M.** (2017). The movement of small insects in the convective boundary layer: linking patterns to processes. *Sci Rep* **7**, 5438.
- Wakeling, J. and Ellington, C.** (1997). Dragonfly flight. I. Gliding flight and steady-state aerodynamic forces. *Journal of Experimental Biology* **200**, 543–556.

- Wakeling, J. M. and Hodgson, J.** (1992). Short communication: optimisation of the flight speed of the little, common and sandwich tern. *Journal of Experimental Biology* **169**, 261–266.
- Warrick, D. R., Hedrick, T. L., Biewener, A. A., Crandell, K. E. and Tobalske, B. W.** (2016). Foraging at the edge of the world: low-altitude, high-speed manoeuvring in barn swallows. *Phil. Trans. R. Soc. B* **371**, 20150391.
- Weyman, G. S.** (1993). A review of the possible causative factors and significance of ballooning in spiders. *Ethology Ecology & Evolution* **5**, 279–291.
- White, N. D. and Braun, M. J.** (2019). Extracting phylogenetic signal from phylogenomic data: Higher-level relationships of the nightbirds (Strisores). *Molecular Phylogenetics and Evolution* **141**, 106611.
- Whittingham, L. A. and Lifjeld, J. T.** (1995). High paternal investment in unrelated young: extra-pair paternity and male parental care in house martins. *Behavioral Ecology and Sociobiology* **37**, 103–108.
- Williams, H. J., King, A. J., Duriez, O., Börger, L. and Shepard, E. L. C.** (2018). Social eavesdropping allows for a more risky gliding strategy by thermal-soaring birds. *J. R. Soc. Interface*. **15**, 20180578.
- Williams, H. J., Shepard, E. L. C., Holton, M. D., Alarcón, P. A. E., Wilson, R. P. and Lambertucci, S. A.** (2020). Physical limits of flight performance in the heaviest soaring bird. *Proc. Natl. Acad. Sci. U.S.A.* **117**, 17884–17890.
- Winkler, D. W., Billerman, S. M. and Lovette, I. J.** (2020a). Swifts (Apodidae), version 1.0. In *Birds of the World*, p. Ithaca, NY, USA: Cornell Lab of Ornithology.
- Winkler, D. W., Billerman, S. M. and Lovette, I. J.** (2020b). Swallows (Hirundinidae), version 1.0. In *Birds of the World*, p. Ithaca, NY, USA: Cornell Lab of Ornithology.
- Wolf, L. L. and Hainsworth, F. R.** (1983). Economics of foraging strategies in sunbirds and hummingbirds. In *Behavioral energetics: The cost of survival in vertebrates.*, pp. 223–264. Ohio State Univ Press, Columbus.
- Womack, A. M., Bohannon, B. J. M. and Green, J. L.** (2010). Biodiversity and biogeography of the atmosphere. *Phil. Trans. R. Soc. B* **365**, 3645–3653.
- Zhao, Y., Zhao, X., Wu, L., Mu, T., Yu, F., Kearsley, L., Liang, X., Fu, J., Hou, X., Peng, P., et al.** (2022). A 30,000-km journey by *Apus apus pekinensis* tracks arid lands between northern China and south-western Africa. *Mov Ecol* **10**, 29.

Comportements de vol chez les oiseaux : approche de trajectométrie 3D à l'échelle locale chez les insectivores aériens

par Geoffrey Ruaux

Résumé élargi en français

Chapitre 1 : Introduction générale

Le vol actif est une adaptation unique qui a permis la radiation évolutive des insectes, des chauve-souris, et des oiseaux. Ce comportement a de nombreuses fonctions, et permet notamment la colonisation d'environnements isolés (comme les îles), la migration ou la recherche alimentaire sur de longues distances.

Après avoir abordé les fonctions du vol chez les oiseaux, ce chapitre présente les principes physiques de base nécessaires à la compréhension du vol (deuxième loi de Newton, énergie mécanique), puis détaille les forces qui s'appliquent à un animal en vol plané (poids, portance et traînée) ainsi que celles qui s'appliquent à un animal en vol battu (la poussée s'ajoute aux forces précédentes).

Plusieurs théories sur l'origine du vol chez les oiseaux sont détaillées : les théories classiques (*trees-down* et *ground-up*) ainsi que des théories plus récentes comme celle basée sur l'observation du *wing-assisted incline running* chez les oiseaux juvéniles actuels. Les adaptations anatomiques (pneumatisation et rigidité du squelette, muscles du vol, structure des plumes, forme des ailes) et physiologiques (système respiratoire, oxygénation du sang et des muscles) sont ensuite détaillées.

Le vol chez les oiseaux prend de multiples formes, appelées « modes de vol ». La partie suivante détaille les spécificités de chaque mode de vol (vol battu, vol plané, vol intermittent, vol thermique, vol de pente, vol de gradient, vol stationnaire) et donne des exemples d'espèces spécialisées. La diversité de ces modes de vol témoigne de l'adaptation des oiseaux à des contraintes environnementales variées, et de leurs capacités à extraire de l'énergie dans l'environnement (courants thermiques, gradients de vent) afin d'économiser de l'énergie.

Le coût du transport est ensuite abordé, d'abord pour des oiseaux en vol battu (courbe en U de la puissance en fonction de la vitesse) puis en vol plané (polaire de plané). Cette partie souligne l'existence de valeurs de vitesse « optimales » pour parcourir la distance la plus longue

(*maximum range speed* en vol battu et *speed for best glide ratio* en vol plané) ou voler le plus longtemps (*minimum power speed* en vol battu et *speed for minimum sink* en vol plané). L'effet de la vitesse et de la direction du vent sur cet équilibre est détaillé : un oiseau souhaitant optimiser ses déplacements par rapport au sol devrait ainsi augmenter sa vitesse air avec le vent de face, et diminuer sa vitesse air avec le vent dans le dos. Ce phénomène a été montré chez de nombreux oiseaux en migration ou en recherche alimentaire.

La partie suivante présente l'état des connaissances sur le développement du vol chez les oiseaux à travers une synthèse bibliographique publiée dans la revue *Proceedings of the Royal Society B: Biological Sciences*. Premièrement, nous nous focalisons sur la période précoce, quand les jeunes oiseaux ne sont pas encore capables de voler : nous étudions des exemples et montrons comment des processus endogènes (ex : battements d'ailes au nid, période de développement du vol) et des facteurs environnementaux (ex : stress maternel, stress nutritionnel) peuvent influencer le développement des comportements de vol. Ensuite, nous passons en revue plusieurs exemples illustrant les processus impliqués dans le développement du vol chez les juvéniles volants (ex : pratique, apprentissage par essai-erreur, apprentissage social). Malgré la rareté des études expérimentales se focalisant sur cette question à différents stades de développement, nous montrons que plusieurs patterns peuvent être identifiés, et nous soulignons que le développement de nouvelles techniques de suivi devrait permettre d'étudier cette question plus en détails chez davantage d'espèces d'oiseaux.

Ensuite, une partie dresse une synthèse des différentes questions qui se posent dans l'étude du vol, et des méthodes pour y répondre. Les mouvements globaux (migration, recherche alimentaire sur de longues distances) sont principalement étudiés à l'aide de balises GPS, parfois associées à d'autres appareils mesurant les variables environnementales autour de l'oiseau. Ces techniques globales permettent de comprendre les mouvements à grande échelle et sur de longues durées, mais sont moins adaptées pour l'étude des mouvements à une échelle plus locale. Pour étudier le vol à une échelle plus fine, des méthodes telles que les caméras fixes permettent de filmer et décrire le vol de tous les oiseaux passant dans un volume défini. D'autres méthodes sont basées sur des appareils maniés par un seul opérateur qui doit garder l'oiseau dans son champ de vision, l'angle de visée et la distance de l'oiseau sont ensuite utilisés pour calculer ses coordonnées dans l'espace et reconstituer sa trajectoire en 3D. Le système RSV (*rotational stereo-videography*) utilisé dans cette thèse se base sur ce principe.

La partie suivante aborde des concepts d'aéroécologie, et souligne qu'il est important de considérer l'espace aérien comme un habitat, car de nombreuses espèces y passent la majeure partie leur existence, s'y nourrissent et s'y reproduisent. Les oiseaux insectivores aériens,

notamment, effectuent un grand nombre de comportements en vol, comme la recherche alimentaire, et sont donc très dépendants des conditions environnementales de ce milieu aérien.

Enfin, les objectifs de ce travail de thèse sont détaillés. Le premier objectif est la description des comportements de vol de deux insectivores aériens, le martinet noir (*Apus apus*) et l'hirondelle de fenêtre (*Delichon urbicum*), à une échelle locale afin de mieux comprendre leurs adaptations au vol. L'étude du martinet noir se focalise sur son comportement de prise de boisson en vol, tandis que celle de l'hirondelle de fenêtre s'intéresse à son comportement de recherche alimentaire. Le second objectif est de comprendre comment ces deux insectivores gèrent leurs dépenses énergétiques en vol, et quelles stratégies ils utilisent pour économiser de l'énergie. Le dernier objectif est de décrire comment ces comportements de vol s'affinent au cours du développement d'un individu. Ces trois objectifs ont été définis pour obtenir une meilleure compréhension des comportements de vol chez les insectivores aériens à une échelle locale.

Chapitre 2 : Méthodes générales

Ce chapitre présente tout d'abord des éléments de biologie et d'écologie sur les deux espèces étudiées : le martinet noir (*Apus apus*) et l'hirondelle de fenêtre (*Delichon urbicum*). Le fonctionnement et la mise en place du système RSV sont ensuite détaillés, ainsi que l'analyse des données qui en découlent.

Chapitre 3 : Prise de boisson chez le martinet noir

Ce chapitre est constitué d'un article en cours de soumission dans la revue *Journal of Experimental Biology*. Il se focalise sur le comportement de boisson chez le martinet noir.

Le martinet noir est un des oiseaux les plus aériens, presque tous ses comportements se font en vol. Il effectue sa recherche alimentaire en volant, peut dormir en volant, et peut même boire en volant. Les martinets descendent en effet régulièrement sur des plans d'eau et en effleurent la surface avec leur bec pour boire. Pour réaliser un tel comportement sans dépenser trop d'énergie, les martinets devraient s'efforcer de conserver leur énergie mécanique en transformant leur énergie potentielle en énergie cinétique, ce qui leur permettrait de toucher l'eau à grande vitesse et de regagner de l'altitude avec un travail musculaire minimal.

En utilisant une méthode de suivi optique 3D, nous avons enregistré 163 trajectoires de boisson de martinets noirs sur trois plans d'eau autour de Rennes. Contrairement à l'hypothèse

de conservation de l'énergie, nous montrons que les martinets qui approchent un plan d'eau avec une énergie mécanique plus élevée (altitude ou vitesse plus élevée 5 s avant le contact avec l'eau) ne touchent pas l'eau à une vitesse plus élevée, mais montrent des signes de freinage (dissipation d'énergie mécanique pour perdre à la fois de l'altitude et de la vitesse). Le freinage est en partie lié à des virages serrés et à l'utilisation du vent de face, mais des virages moins marqués et des ajustements posturaux, trop fins pour être détectés avec la résolution de nos données, pourraient aussi être impliqués.

Nous émettons l'hypothèse que ce comportement étonnamment coûteux est le résultat d'un trade-off entre la performance énergétique en vol et la sécurité, car approcher la surface de l'eau demande un contrôle moteur précis, et une vitesse élevée augmente le risque de tomber à l'eau, ce qui représenterait un surcoût significatif en énergie et un risque pour la survie d'un martinet.

Chapitre 4 : Recherche alimentaire chez l'hirondelle de fenêtre

Ce chapitre est constitué d'un article en cours de soumission dans la revue *Behavioral Ecology and Sociobiology*. Il se focalise sur le comportement de recherche alimentaire chez l'hirondelle de fenêtre.

La recherche alimentaire est un comportement fondamental pour les oiseaux, plus encore durant la période de reproduction, car ils doivent assumer le coût énergétique de l'incubation et de l'élevage des jeunes, en plus de leurs propres besoins énergétiques. Les insectivores aériens effectuent le plus souvent leur recherche alimentaire en vol, ils ont donc évolué pour acquérir de nombreuses adaptations pour minimiser les dépenses d'énergie tout en maximisant leurs apports en énergie durant cette période critique.

Dans cette étude, nous avons enregistré les trajectoires de vol en 3D de 100 hirondelles de fenêtre près de leur colonie durant la période de reproduction, à Rennes. Nous faisons une première description de la distribution de plusieurs variables cinématiques et biomécaniques (vitesse horizontale et verticale, taux de variation de l'énergie cinétique et potentielle, rayon de courbure et force centripète), nous comparons le vol battu et le vol plané, et nous décrivons différentes stratégies utilisées par les hirondelles de fenêtre pour économiser de l'énergie, comme l'extraction d'énergie dans l'environnement (vol thermique) et l'optimisation de la vitesse de vol en fonction de la vitesse et de la direction du vent. Nous montrons également un effet de la température, des radiations solaires et de l'humidité sur la vitesse verticale moyenne des oiseaux en vol plané, ce qui souligne l'effet de la météo sur la disponibilité des sources

d'énergie externe comme les courants ascendants. Enfin, nous comparons la distribution des vitesses horizontales et verticales entre cinq juvéniles (identifiés sur des photographies agrandies) et 20 adultes filmés durant les mêmes sessions de terrain.

Nous montrons ainsi que les juvéniles ont une vitesse de vol plus variable que celle des adultes, possiblement car leurs comportements de vol ne sont pas immédiatement optimaux après la sortie du nid.

Chapitre 5 : Discussion générale

Ce dernier chapitre fait le bilan des résultats de cette thèse, et les place dans une perspective écologique et évolutive. La question de l'importance des ressources en eau est posée pour le martinet noir, ainsi que l'impact potentiel de futurs changements climatiques. Pour l'hirondelle de fenêtre, des questions sont soulevées quant à l'importance des sources d'énergie environnementale (courants thermiques, gradients de vent) dans ses dépenses énergétiques et son succès reproducteur.

L'aspect social de ces comportements est également abordé. Nos observations montrent que les martinets fréquentent les plans d'eau par vagues successives, ce qui peut laisser penser à un avantage procuré par ces regroupements, potentiellement un comportement anti-prédateur. Pour les hirondelles de fenêtre, nous soulignons la variété des vocalisations entendues durant la recherche alimentaire près de la colonie, et proposons de futures perspectives impliquant des enregistrements audio. L'ontogénèse de ces comportements est aussi évoquée, en contrastant l'absence de soins parentaux après l'envol chez le martinet noir avec les soins parentaux continuant plusieurs semaines après l'envol chez l'hirondelle de fenêtre.

En conclusion, ce travail montre l'importance d'une approche à l'échelle locale pour comprendre la biomécanique du vol des oiseaux en conditions naturelles. Les économies d'énergie sont cruciales pour les insectivores aériens, mais le besoin de réduire les dépenses d'énergie peut être modulé par plusieurs trade-offs. Ce travail souligne l'importance de futures études comparatives utilisant la même méthodologie pour différentes espèces présentant des traits d'histoire de vie différents.

Titre : Comportements de vol chez les oiseaux : approche de trajectométrie 3D à l'échelle locale chez les insectivores aériens

Mots clés : martinet noir, hirondelle de fenêtre, recherche alimentaire, énergie, biomécanique

Résumé : Le vol est un mode de locomotion qui présente de nombreux avantages et a permis la radiation évolutive des oiseaux. Cette adaptation influence profondément leur anatomie, leur physiologie et leur comportement. Ce manuscrit présente tout d'abord les principes physiques et biologiques permettant une compréhension basique du vol. Nous effectuons ensuite une synthèse de la littérature scientifique sur le développement du vol, et décrivons les différentes méthodes utilisées pour étudier le vol chez les oiseaux. Pour approfondir la compréhension actuelle des comportements de vol, nous nous focalisons sur deux espèces d'insectivores aériens : le martinet noir (*Apus apus*) et l'hirondelle de fenêtre (*Delichon urbicum*) qui réalisent presque tous leurs comportements en vol. Nous utilisons une méthode de trajectométrie 3D à l'échelle locale afin de décrire des comportements vitaux chez ces deux espèces et de comprendre comment des économies d'énergie peuvent s'opérer et être modulées par différents trade-offs. Dans un premier temps, nous étudions la prise de boisson chez le martinet noir, et nous montrons que les martinets dissipent activement leur énergie mécanique durant l'approche d'un plan d'eau afin de réduire leur vitesse d'impact, en partie via des virages serrés et

l'utilisation du vent de face. Ce comportement étonnamment coûteux pourrait être le résultat d'un trade-off entre la dépense d'énergie et la sécurité, car approcher la surface de l'eau à une vitesse élevée représente un risque. Dans un second temps, nous décrivons différentes stratégies utilisées par les hirondelles de fenêtre pour économiser de l'énergie durant leur recherche alimentaire, comme l'extraction d'énergie dans l'environnement (vol thermique) et l'optimisation de la vitesse de vol en fonction de la vitesse et de la direction du vent. Enfin, nous comparons la distribution des vitesses entre des individus juvéniles et adultes, et montrons ainsi que les juvéniles ont une vitesse de vol plus variable que celle des adultes, possiblement car leurs comportements de vol ne sont pas immédiatement optimaux après la sortie du nid. Ces résultats apportent à la compréhension globale des comportements de vol chez ces espèces très adaptées au milieu aérien. Des études comparatives se focalisant sur le même comportement chez des espèces présentant un gradient de variation dans leurs traits d'histoire de vie pourraient apporter une compréhension supplémentaire des adaptations au vol.

Title: Flight behaviours in birds: studying aerial insectivores at a local scale using 3D trajectometry

Keywords: common swift, house martin, foraging, energy, biomechanics

Abstract: Flight is a locomotion mode offering numerous advantages, and has allowed birds to undergo a dramatic evolutionary radiation. This adaption deeply influences their anatomy, their physiology, and their behaviour. This manuscript firstly describes the main physical and biological principles necessary to understand flight. Then, we make a literature review on the development of flight behaviours, and describe the methods used to study flight in birds. To allow a deeper understanding of flight behaviours, we focus on two aerial insectivores: the common swift (*Apus apus*) and the house martin (*Delichon urbicum*) which perform almost all of their behaviours in flight. We use a 3D trajectometry method at a local scale in order to describe vital behaviours in these two species, and to understand how energy economy is made and modulated by specific trade-offs. Firstly, we study how common swifts drink on the wing, and we show that they actively dissipate mechanical energy when approaching a waterbody in order to reduce their impact speed, partly through sharp

turns and the use of headwind. This surprisingly costly behaviour might be the result of a trade-off between energy expenditure and safety, because approaching water at a high speed is risky. Secondly, we describe several strategies used by house martins to save energy during foraging, such as the extraction of environmental energy (thermal soaring) and the optimisation of their flight speed depending on wind speed and direction. Finally, we compare the distribution of speeds between juvenile and adult individuals, and we show that juveniles exhibit more variable flight speeds than adults, possibly because their flight behaviours are not immediately optimal after leaving the nest. These results benefit to the general understanding of flight behaviours in these species very adapted to the aerial environment. Comparative studies focusing on the same behaviour in several species exhibiting a gradient in some life history traits could allow a deeper understanding of these adaptations to flight.