



HAL
open science

Patchworking, tropical homology, and Betti numbers of real algebraic hypersurfaces

Charles Arnal

► **To cite this version:**

Charles Arnal. Patchworking, tropical homology, and Betti numbers of real algebraic hypersurfaces. Algebraic Geometry [math.AG]. Sorbonne Université, 2020. English. NNT : 2020SORUS479 . tel-04471371

HAL Id: tel-04471371

<https://theses.hal.science/tel-04471371v1>

Submitted on 21 Feb 2024

HAL is a multi-disciplinary open access archive for the deposit and dissemination of scientific research documents, whether they are published or not. The documents may come from teaching and research institutions in France or abroad, or from public or private research centers.

L'archive ouverte pluridisciplinaire **HAL**, est destinée au dépôt et à la diffusion de documents scientifiques de niveau recherche, publiés ou non, émanant des établissements d'enseignement et de recherche français ou étrangers, des laboratoires publics ou privés.



École Doctorale 386
Sciences Mathématiques de Paris Centre

THÈSE DE DOCTORAT

Discipline : Mathématiques

présentée par

Charles A. ARNAL

Patchworking, tropical homology, and Betti numbers of real algebraic hypersurfaces

dirigée par Ilia ITENBERG

Soutenue le 28 septembre 2020 devant le jury composé de

M. Omid AMINI	École Polytechnique, CNRS	rapporteur
M. Antoine DUCROS	Sorbonne Université	examinateur
M ^{me} Hannah MARKWIG	Universität Tübingen	examinatrice
M. Ilia ITENBERG	Sorbonne Université	directeur
M. Ilya TYOMKIN	Ben Gurion University of the Negev	rapporteur

Cette thèse fut financée par le Domaine d'Intérêt Majeur (DIM) Math
Innov de la Région Île-de-France

Institut de mathématiques de Jussieu -
Paris Rive gauche. UMR 7586.
Boîte courrier 247
4 place Jussieu
75 252 Paris Cedex 05

Sorbonne Université.
École doctorale de sciences
mathématiques de Paris centre.
Boîte courrier 290
4 place Jussieu
75 252 Paris Cedex 05

Cela ne veut rien dire.

Camus, *L'Étranger*

Infiniment plus qu'à tout autre, ma gratitude va à mon directeur de thèse, Ilia Itenberg, dont la compétence et la bienveillance n'ont jamais failli. Je suis toujours sorti de son bureau empli d'une passion que je n'avais parfois plus en y entrant.

Patchworking, tropical homology, and Betti numbers of real algebraic hypersurfaces

Abstract

In this thesis, we investigate the Betti numbers of the real part of real algebraic hypersurfaces in relation to the homology of the complex part, as well as to the tropical homology of tropical hypersurfaces.

In particular, we develop a technique, based on Viro's patchworking method, for constructing high-dimensional real algebraic hypersurfaces, and use it to build families of hypersurfaces whose real parts have asymptotically large Betti numbers. We also prove tropical analogs to Lefschetz's hyperplane section theorem, and show that the homology of non-singular projective tropical hypersurfaces is torsion-free. Finally, we study the action of the complex conjugation on the homology of some elementary real algebraic hypersurfaces that serve as building blocks in Viro's method, and derive the conditions under which they are Galois maximal.

Keywords

Real algebraic hypersurfaces, toric varieties, Betti numbers, asymptotic Betti numbers, tropical geometry, tropical homology, tropical Lefschetz hyperplane theorem, Kalinin spectral sequence, patchworking.

Contents

Introduction	13
I	19
1 Topology of real algebraic varieties	21
1.1 Definitions and basic concepts	21
1.1.1 Real projective algebraic hypersurfaces	21
1.1.2 Toric varieties and real hypersurfaces in toric varieties	22
1.2 Some classical results	24
2 Viro’s patchworking method	31
2.1 Chapter introduction	31
2.2 General case	32
2.3 Combinatorial case	34
3 Tropical geometry	37
3.1 Introduction and basic notions	37
3.1.1 Tropical operations and tropical polynomials	37
3.2 Tropical toric varieties and tropical hypersurfaces	38
3.2.1 Tropical toric varieties	38
3.2.2 Tropical hypersurfaces	40
3.2.3 A duality theorem	42
3.3 Definition of tropical homology	44
3.3.1 The tropical (co)sheaves \mathcal{F}_p and \mathcal{F}^p	45
3.3.2 The tropical homology groups	48
4 Tropical homology, Betti numbers and Kalinin’s spectral sequence	53
4.1 Chapter introduction	53
4.2 Tropical hypersurfaces as limits of families of patchworked real algebraic hypersurfaces	54
4.3 The Leray-Serre spectral sequence of the fibration	58

4.4	Kalinin's spectral sequence	60
4.5	Bounds on the homology of $\mathbb{R}X_t$	61
II		65
5	A flexible construction method	67
5.1	Chapter introduction	67
5.2	The construction method	69
5.2.1	Preliminaries	69
5.2.2	A convex triangulation of S_d^n	70
5.2.3	Choosing the coefficients of \tilde{Q}_d^n	76
5.2.4	Defining Q_d^n using the Patchwork	77
5.3	Computing asymptotic Betti numbers	80
5.3.1	Preliminaries	80
5.3.2	Finding cycles in a suspension	86
5.3.3	Finding cycles in a join	93
5.3.4	Counting cycles	102
6	Asymptotically large Betti numbers	109
6.1	Chapter introduction	109
6.2	Asymptotically large Betti numbers in arbitrary dimension and index	111
6.2.1	Asymptotic Hodge numbers and combinatorics	112
6.2.2	Notations and known results	116
6.2.3	The first construction	119
6.2.4	The second construction	123
6.3	Some explicit computations	134
6.4	Chapter conclusion	135
7	A tropical analog to Lefschetz's section theorem	139
7.1	Chapter introduction	139
7.2	Preliminaries	145
7.2.1	Definitions and observations	145
7.2.2	Counterexamples	148
7.3	Tropical Lefschetz hyperplane section theorems	151
7.3.1	Preliminary results	151
7.3.2	The main proof	159
7.4	Torsion-freeness	164
7.5	Computations with the χ_y genus	167

8 Homology of simplicial real algebraic hypersurfaces	175
8.1 Chapter introduction	175
8.2 Definitions and notations	177
8.3 Coamoebas	178
8.3.1 Definition and description of \mathcal{C}_X	178
8.3.2 A more explicit description of \mathcal{C}_X	180
8.4 Homological computations	182
8.4.1 Action of the conjugation on the zonotopes	182
8.4.2 Homology of \mathcal{C}_X	183
8.4.3 Image of $1 + c_*$	184
8.4.4 Rank of $1 + c_*$	186
8.5 Galois maximality	187
9 Additional constraints on the topology of hypersurfaces obtained by combinatorial patchworking	191
9.1 Chapter introduction	191
9.2 The case of surfaces	193
9.3 Higher dimensions	196

Introduction

A real algebraic variety is an algebraic object defined by equations with real coefficients. Such equations naturally have real and complex solutions, and the complex conjugation acts on those solutions as an involution. What we call "topology of real algebraic varieties" is the study of the topological properties of the conjugation. This thesis inscribes itself in this field of study.

Understanding the topology of the real part of real algebraic varieties is surprisingly difficult - much more than that of the complex part. The classification of smooth real plane projective curves up to isotopy (which is the focus of D. Hilbert's 16th problem), for example, was only completed up to degree 6 in the late sixties by D. Gudkov, and in degree 7 by O. Viro in 1979. Regarding real algebraic surfaces in the projective space of dimension 3, even the topology of those of degree 5 has not yet been completely understood.

There are two main directions in which research can advance: new topological constraints may be found, and interesting varieties, realizing "extreme" topological types, may be constructed. Major progress was made in that second direction when Viro invented the patchworking method, also called Viro's method, which allows one to build varieties with complicated prescribed topology by gluing ("patchworking") together simpler varieties.

The patchworking method proved to be very powerful and allowed for the construction of a diversity of interesting varieties; in particular, Viro used it to disprove V. Ragsdale's famous conjecture regarding real projective curves, and I. Itenberg to further show that the conjecture was wrong by a large asymptotic margin. It was also one of the sources of tropical geometry, a relatively new domain with strong links to real algebraic geometry whose main objects of study are certain polyhedral complexes.

In this thesis, we restrict ourselves to the study of the homology of real algebraic hypersurfaces in toric varieties, and in particular of the dimension of their homology groups with coefficients in \mathbb{Z}_2 .

In general, the well-known Smith-Thom inequality gives us an upper bound on the dimension of the total homology of the real part $\mathbb{R}X$ of a real algebraic variety X in terms of the dimension of the total homology of its complex part $\mathbb{C}X$ (where $\mathbb{Z}_2 := \mathbb{Z}/2\mathbb{Z}$):

$$\dim_{\mathbb{Z}_2} H_*(\mathbb{R}X; \mathbb{Z}_2) \leq \dim_{\mathbb{Z}_2} H_*(\mathbb{C}X; \mathbb{Z}_2). \quad (0.0.1)$$

However, other bounds can often be found. There is a certain principle that suggests that the q -th Betti number of the real part of a real algebraic hypersurface should be upper-bounded by the sum over p of the (q, p) -th Hodge numbers of its complex part, *i.e.*

$$\dim_{\mathbb{Z}_2} H_q(\mathbb{R}X; \mathbb{Z}_2) \leq \sum_p h^{q,p}(\mathbb{C}X). \quad (0.0.2)$$

In general, it is incorrect, but it does hold under certain conditions, and it provides us with a guideline of sorts. Varieties for which Inequality (0.0.2) is an equality should be considered as "standard", and we naturally compare more exotic varieties to them.

For instance, the only examples that we had of families of projective hypersurfaces in general dimension whose Betti numbers are asymptotically maximal in the sense of Inequality (0.0.1) also verify Inequality (0.0.2) asymptotically - those were constructed by Itenberg and Viro using a special case of the patchworking method, called combinatorial patchworking.

Our first result is inspired by their construction. They recursively build a family of hypersurfaces in ambient dimension n by suspending the hypersurfaces of the family that they had found in ambient dimension $n - 1$, starting with points in the projective line.

We, on the other hand, build a family in ambient dimension n using any families $\{X_d^k\}_{d \in \mathbb{N}}$ of real projective hypersurfaces in ambient dimensions $k = 1, \dots, n - 1$ (where d is the degree of X_d^k); we combine them all together and suspend them, and the asymptotic Betti numbers of the real parts of the resulting family $\{Y_d^n\}_{d \in \mathbb{N}}$ of projective hypersurfaces in ambient dimension n can be computed from the Betti numbers of the real parts of the "ingredients" $\{X_d^k\}_{d \in \mathbb{N}}$ (as is the case in Itenberg and Viro's original construction).

More precisely, if for each $k = 1, \dots, n - 1$ and $j = 0, \dots, k - 1$,

$$b_j(\mathbb{R}X_d^k) = x_j^k \cdot d^k + \mathcal{O}(d^{k-1})$$

for some $x_j^k \in \mathbb{R}_{\geq 0}$, then

$$b_q(\mathbb{R}Y_d^n) \geq \frac{1}{n} \left(x_q^{n-1} + x_{q-1}^{n-1} + \sum_{k=1}^{n-2} \sum_{j=0}^{q-1} x_j^k \cdot x_{q-1-j}^{n-1-k} \right) \cdot d^n + \mathcal{O}(d^{n-1}), \quad (0.0.3)$$

for $q = 0, \dots, n - 1$, where x_j^k is set to be 0 for $j \notin \{0, \dots, k - 1\}$.

This allows for a lot of flexibility, since we can use any preexisting results in low dimensions and simply "feed them" to the algorithm in order to get results in any dimension, by applying the process repeatedly.

We use this method on previous results by E. Brugallé and F. Bihan in ambient dimension 3, as well as on Itenberg and Viro's aforementioned families of hypersurfaces, to obtain two collections of families of real projective hypersurfaces.

Note that the (q, p) -th Hodge number $h^{q,p}(\mathbb{C}X)$ of a smooth real projective algebraic

hypersurface of degree d in ambient dimension n is a polynomial in d of degree n (the same for any such hypersurface). Let a_q^n be the dominant coefficient of $\sum_p h^{q,p}(\mathbb{C}X_d^n)$; in other words, $\sum_p h^{q,p}(\mathbb{C}X_d^n) = a_q^n \cdot d^n + \mathcal{O}(d^{n-1})$.

Our first collection is as follows: for each $n \geq 3$ and each $q = 0, \dots, n-1$, we build a family $\{Y_d^n\}_{d \in \mathbb{N}}$ of (asymptotically maximal) real projective hypersurfaces such that

$$b_q(\mathbb{R}Y_d^n) = s_q^n \cdot d^n + \mathcal{O}(d^{n-1}),$$

for some $s_q^n > a_q^n$. In other words, $b_q(\mathbb{R}Y_d^n)$ grows asymptotically (in d) faster than the corresponding sum $\sum_p h^{q,p}(\mathbb{C}Y_d^n)$ of Hodge numbers from Inequality (0.0.2), though we cannot expect $s_q^n - a_q^n$ to be particularly large.

Our second collection remedies that problem, at least asymptotically in n : for each $n \geq 3$ and $\lambda \in \{-\frac{1}{120}, \frac{1}{24}\}$, we build a family $\{Z_d^n\}_{d \in \mathbb{N}}$ of (asymptotically maximal) real projective hypersurfaces such that for each $q = 0, \dots, n-1$,

$$b_q(\mathbb{R}Z_d^n) = t_q^n \cdot d^n + \mathcal{O}(d^{n-1}),$$

for some $t_q^n \geq 0$ that verifies

$$\frac{t_q^n}{a_q^n} = \frac{\sqrt{\frac{1}{12}}}{\sqrt{\frac{1}{12} + \lambda}} \exp\left(-\frac{x^2}{2} \left(\frac{1}{\frac{1}{12} + \lambda} - \frac{1}{\frac{1}{12}}\right)\right) + o(1),$$

where the error term $o(1)$ is uniform in x .

This means that $b_{\lfloor \frac{n-1}{2} + x\sqrt{n} \rfloor}(\mathbb{R}Z_d^n)$ can be made (depending on the choice of λ) to grow asymptotically (in d) faster than the corresponding sum $\sum_p h^{p, \lfloor \frac{n-1}{2} + x\sqrt{n} \rfloor}(\mathbb{C}Z_d^n)$ of Hodge numbers, by a margin that is asymptotically (in n) significant.

One of the main difficulties resided in understanding the asymptotic behavior of multi-indexed sequences arising from the repeated application of Formula (0.0.3), from which those asymptotic results stem. We managed to do so by associating probabilistic objects to those sequences, so that we could study them using classical tools from probability theory.

Regarding constraints on the homology of real algebraic hypersurfaces, we are mostly interested in the case of hypersurfaces X obtained via combinatorial patchworking. Indeed, those naturally have a tropical hypersurface X^{trop} associated to them, and there is an interesting fibration from the complex part of X to X^{trop} . This gives rise to connections between the homology of the complex part $\mathbb{C}X$, the tropical homology of X^{trop} (a type of homology well-suited to tropical varieties), and the homology of the real part $\mathbb{R}X$. Crucial results in that direction were recently obtained in Itenberg's, L. Katzarkov's, G. Mikhalkin's and I. Zharkov's [IKMZ16].

One can in fact see the tropical homology of X^{trop} appear on the second page of the Leray-Serre spectral sequence of the fibration, which converges to the homology of $\mathbb{C}X$. We can connect that second page to the homology of the real part $\mathbb{R}X$ using another spectral sequence developed by I. Kalinin.

When X was obtained from a primitive triangulation, this allowed K. Shaw and A. Renaudineau to prove in [RS18] that

$$\dim_{\mathbb{Z}_2} H_q(\mathbb{R}X; \mathbb{Z}_2) \leq \sum_p \dim_{\mathbb{Z}_2} H_q(X^{\text{trop}}; \mathcal{F}_p^{X^{\text{trop}}, \mathbb{Z}_2}) \quad (0.0.4)$$

where $H_q(X^{\text{trop}}; \mathcal{F}_p^{X^{\text{trop}}, \mathbb{Z}_2})$ is the (q, p) -th tropical homology group with coefficients in \mathbb{Z}_2 of X^{trop} .

To link this bound to the homology of $\mathbb{C}X$, some results regarding the torsion of the tropical homology of non-singular tropical hypersurfaces in tropical toric varieties were needed.

Shaw, Renaudineau and the author proved in [ARS19] a tropical analog to Lefschetz's hyperplane section theorem stating that given a non-singular tropical hypersurface X^{trop} with full-dimensional Newton polytope in a reasonable tropical toric variety Y^{trop} , the map induced by inclusion

$$i_* : H_q(X^{\text{trop}}; \mathcal{F}_p^{X^{\text{trop}}, \mathbb{Z}}) \rightarrow H_q(Y^{\text{trop}}; \mathcal{F}_p^{Y^{\text{trop}}, \mathbb{Z}})$$

on their tropical homology groups with coefficients in \mathbb{Z} is an isomorphism when $p + q < \dim X^{\text{trop}}$ and a surjection when $p + q = \dim X^{\text{trop}}$. It remains true with coefficients in \mathbb{R} even if we do not require X^{trop} to be non-singular.

This, in addition to some results regarding the tropical homology of tropical toric varieties, allowed the three of us to show that the tropical homology of non-singular tropical hypersurfaces in non-singular toric varieties was torsion-free. We also re-obtain through purely combinatorial means some statements from [IKMZ16] by considering tropical Euler characteristics and E-polynomials, in the same spirit as V. Danilov's and A. Khovanskii's [DK86]. All of this enables us to show that $\dim_{\mathbb{Z}_2} H_q(X^{\text{trop}}; \mathcal{F}_p^{X^{\text{trop}}, \mathbb{Z}_2}) = h^{q,p}(\mathbb{C}X)$ which, combined with Inequality (0.0.4), implies that hypersurfaces obtained using a primitive triangulation do verify Inequality (0.0.2).

In order to generalize this result, we ("we" being from now on once again a pedantic synonym for "the author") also investigate a class of varieties (which we call "simplicial hypersurfaces") that naturally appear as building blocks in the combinatorial case of the patchworking method, and derive the conditions under which they are Galois maximal, a property that greatly simplifies the situation with regard to the Leray-Serre and Kalinin spectral sequences mentioned above.

Finally, we explore the ways in which this could be applied to generalize Inequality

(0.0.2) to hypersurfaces in toric varieties obtained by non-primitive combinatorial patchworking, and detail some intermediary results.

All notions alluded to here are properly defined - and all necessary references given - in the main text, which is organized as follows.

The first part, consisting of Chapters 1 to 4, mainly covers relevant definitions and preexisting results. More precisely, we define in Chapter 1 real algebraic varieties, focusing in particular on real algebraic hypersurfaces in toric varieties. We also state some classical theorems regarding the topology of these hypersurfaces.

In Chapter 2, we describe Viro's patchworking method, with some additional explanations regarding the combinatorial case.

Some principles of tropical geometry are exposed in Chapter 3; in particular, tropical hypersurfaces, tropical toric varieties and tropical homology.

In Chapter 4, the links between the homology of the real part of a hypersurface obtained using combinatorial patchworking, the homology of its complex part and the tropical homology of the associated tropical hypersurface are explained using Leray-Serre and Kalinin's spectral sequences. This chapter is more "experimental" than the previous ones, as some of the ideas detailed there might be new, or at least very recent.

In the second part, consisting of Chapters 5 to 9, we describe the new results that we have managed to obtain.

The general construction method allowing us to construct families of real projective algebraic hypersurfaces from lower-dimensional families is described in Chapter 5.

In Chapter 6, we apply this method to build families of real projective algebraic hypersurfaces with large asymptotic Betti numbers.

The results of the author's joint work with Shaw and Renaudineau can be found in Chapter 7; in particular, the tropical analog to Lefschetz's hyperplane theorem, as well as the torsion-freeness of the tropical homology of non-singular tropical hypersurfaces.

In Chapter 8, we study the conditions under which simplicial hypersurfaces are Galois maximal.

Finally, in Chapter 9, we consider possible generalizations of Inequality 0.0.2 to the case of real algebraic hypersurfaces in toric varieties obtained via non-primitive combinatorial patchworking.

Part I

Chapter 1

Topology of real algebraic varieties

1.1 Definitions and basic concepts

A real algebraic variety can be vaguely defined as an algebraic object over the real field \mathbb{R} . Though this general principle can be turned into more precise definitions, we restrict ourselves (both in this section and throughout this text) almost exclusively to the special cases of toric varieties and real algebraic hypersurfaces in toric varieties.

We define real projective algebraic hypersurfaces in Subsection 1.1.1 and make a few observations, before considering toric varieties and their real algebraic hypersurfaces in Subsection 1.1.2.

1.1.1 Real projective algebraic hypersurfaces

A *real projective algebraic variety* X in the n -dimensional projective space \mathbb{P}^n is a radical homogeneous ideal $I = (f_1, \dots, f_k) \subset \mathbb{R}[X_0, \dots, X_n]$ different from the maximal homogeneous ideal. In particular, real projective algebraic varieties are complex projective algebraic varieties.

One can consider the set of real points of X ,

$$\mathbb{R}X := \{[x_0, \dots, x_n] \in \mathbb{R}\mathbb{P}^n \mid f([x_0, \dots, x_n]) = 0 \text{ for each } f \in I\},$$

as well as its set of complex points,

$$\mathbb{C}X := \{[x_0, \dots, x_n] \in \mathbb{C}\mathbb{P}^n \mid f([x_0, \dots, x_n]) = 0 \text{ for each } f \in I\}.$$

We sometimes improperly call $\mathbb{R}X$ or $\mathbb{C}X$ real algebraic varieties, implicitly referring to the underlying variety X .

When the ideal I is generated by a single homogeneous polynomial P of degree d , we call X a *real projective algebraic hypersurface*. We say that P gives rise to X .

In what follows, we mostly consider *smooth* real projective algebraic hypersurfaces, *i.e.* real projective algebraic hypersurfaces generated by polynomials P such that

$$\{[x_0, \dots, x_n] \in \mathbb{C}\mathbb{P}^n \mid \partial_i P([x_0, \dots, x_n]) = 0 \quad i = 0, \dots, n\} = \emptyset.$$

Note that as P is homogeneous, we have that

$$\sum_{i=0}^n \partial_i P(X_0, \dots, X_n) \cdot X_i = \deg(P) \cdot P(X_0, \dots, X_n),$$

hence if $[x_0, \dots, x_n]$ is such that $\partial_i P([x_0, \dots, x_n]) = 0$ for $i = 0, \dots, n$, we automatically have $P([x_0, \dots, x_n]) = 0$.

This definition of smoothness coincides with the one from differential geometry. In particular, the set of real (respectively, complex) points of a smooth real projective algebraic hypersurface is a compact manifold of real codimension one in $\mathbb{R}\mathbb{P}^n$ (respectively, of complex codimension one in $\mathbb{C}\mathbb{P}^n$).

The topology of the complex points $\mathbb{C}X$ of a smooth real projective algebraic hypersurface X of degree d in \mathbb{P}^n depends only on d and n . Indeed, the space C_d^n of all complex projective algebraic hypersurfaces of degree d in the projective space of dimension n can be identified with the projective space $\mathbb{C}\mathbb{P}^N$, where $N = \binom{d+n}{n} - 1$ and the projective coordinates of a point correspond to the coefficients of the homogeneous polynomial that defines (up to multiplication by a non-zero scalar) the associated hypersurface. The real projective algebraic hypersurfaces correspond to the subspace $\mathbb{R}\mathbb{P}^N \subset \mathbb{C}\mathbb{P}^N$. In C_d^n , the set of all singular hypersurfaces is a (singular) hypersurface; their complement in C_d^n is path-connected, and we can see (by continuous deformation) that the set of complex points of any two smooth complex projective algebraic hypersurfaces (hence, of any two smooth real projective algebraic hypersurfaces) are homeomorphic.

On the contrary, the topology of the real part of a real projective algebraic hypersurface can be much more varied. In fact, even in low dimensions, very little is known. For example, we do not yet have a topological classification of smooth surfaces of degree 5 in the projective space of dimension 3, and the author spent a significant amount of time trying to prove that such a surface cannot be homeomorphic to the disjoint union of 23 spheres, a genus 2 surface and a copy of $\mathbb{R}\mathbb{P}^2$, to no avail.

1.1.2 Toric varieties and real hypersurfaces in toric varieties

Toric varieties are a natural generalization of the projective case. We only briefly introduce them here; a much more in-depth exposition can be found in W. Fulton's book [Ful93]. One can also read O. Viro's article [Vir06] for a shorter account focusing on the type of questions treated in this text.

We choose $N := \mathbb{Z}^n$ as a lattice and consider the associated vector space $N_{\mathbb{R}} := N \otimes \mathbb{R} \cong$

\mathbb{R}^n , as well as its dual $M \cong \mathbb{Z}^n$ and its associated vector space $M_{\mathbb{R}} := M \otimes \mathbb{R} \cong \mathbb{R}^n$.

We say that a cone in $N_{\mathbb{R}}$ is a *rational polyhedral cone* if it is generated by a finite number of integer vectors (*i.e.* vectors in N), and that it is *strongly convex* if it does not contain any non-trivial vector subspace of $N_{\mathbb{R}}$. Given a strongly convex rational polyhedral cone C in $N_{\mathbb{R}}$, we can consider the (full-dimensional) dual cone

$$C' := \{u \in M_{\mathbb{R}} \mid u \cdot v \geq 0 \quad \forall v \in C\}$$

and the semigroup $C' \cap M$ associated to it. It is easy to see that this semigroup is finitely generated (this fact is known as Gordan's lemma); hence the ring $\mathbb{C}[C' \cap M]$ is finitely generated. We call the n -dimensional complex variety $\text{Spec}(\mathbb{C}[C' \cap M])$ the *affine toric variety* associated to C , as it can be represented as an algebraic subvariety of \mathbb{C}^N , for some $N \in \mathbb{N}$.

For example, the dual cone of the trivial cone $0 \subset N$ is the entire space $M_{\mathbb{R}}$, and the associated affine toric variety is the *algebraic torus* $(\mathbb{C}^*)^n$. The affine toric variety associated to the cone C spanned by the canonical basis e_1, \dots, e_n of $N_{\mathbb{R}} \cong \mathbb{R}^n$ (whose dual cone is the cone spanned by the canonical basis e_1^*, \dots, e_n^* of $M_{\mathbb{R}} \cong \mathbb{R}^n$) is the affine space \mathbb{C}^n .

Conventions can slightly vary from one author to the other; for example, Viro directly defines in [Vir06] the affine toric variety associated to a cone C as $\text{Spec}(\mathbb{C}[C \cap N])$, without considering the dual cone. Here, we mostly follow Fulton's exposition.

Now let Σ be a *strongly convex rational polyhedral fan* in $N_{\mathbb{R}}$, *i.e.* a collection of strongly convex rational polyhedral cones in $N_{\mathbb{R}}$ such that every face of a cone in Σ is also in Σ and that the intersection of two cones in Σ is a face of each.

If we consider two cones $\rho \subset \eta \in \Sigma$, we get a reversed inclusion $\mathbb{C}[\eta' \cap M] \hookrightarrow \mathbb{C}[\rho' \cap M]$, which in turn induces a morphism (in fact an embedding) $\text{Spec}(\mathbb{C}[\rho' \cap M]) \longrightarrow \text{Spec}(\mathbb{C}[\eta' \cap M])$. It is then possible to glue the affine toric varieties associated to the cones of Σ along those morphisms, in order to get the *toric variety* $\mathbb{C}Y_{\Sigma}$. It can be shown that $\mathbb{C}Y_{\Sigma}$ is non-singular if and only if the fan Σ is *simplicial unimodular*, *i.e.* if and only if each cone $C \in \Sigma$ is generated by a collection of vectors in N that can be completed into a basis of N . The variety $\mathbb{C}Y_{\Sigma}$ is compact if and only if the fan Σ is *complete*, *i.e.* if the union of its cones is equal to the entire ambient space $N_{\mathbb{R}}$.

For example, the complete fan whose only 1-dimensional cones (called *rays*) are $\mathbb{R}_{\geq 0} \cdot (0, 1)$, $\mathbb{R}_{\geq 0} \cdot (1, 0)$ and $\mathbb{R}_{\geq 0} \cdot (-1, -1)$ gives rise, as a toric variety, to the projective plane $\mathbb{C}P^2$. More generally, the n -dimensional projective space is a toric variety.

Given a toric variety $\mathbb{C}Y_{\Sigma}$, the algebraic torus $(\mathbb{C}^*)^n$ is naturally embedded in $\mathbb{C}Y_{\Sigma}$ as the affine subspace $\text{Spec}(\mathbb{C}[M_{\mathbb{R}} \cap M]) = \text{Spec}(\mathbb{C}[M])$ associated to the trivial cone 0 (whose dual is the entire dual space $M_{\mathbb{R}}$). This is, in fact, whence the very name "toric variety" comes. The embedding depends on the initial choice of the lattice $N = \mathbb{Z}^n$, which

corresponds to a choice of coordinates. Moreover, the action of the algebraic torus on itself naturally extends to an action of the algebraic torus on $\mathbb{C}Y_\Sigma$. The variety $\mathbb{C}Y_\Sigma$ can be written as the disjoint union of the orbits of this action, and is stratified along the closure (in $\mathbb{C}Y_\Sigma$ itself) of those orbits. There is an inclusion-reversing bijection between the poset of those strata and the cones of the fan Σ .

Let Δ be a *rational polytope* in $M_{\mathbb{R}}$, *i.e.* the bounded intersection of a finite number of rational half-planes. If Δ is full-dimensional, its normal fan Σ in $N_{\mathbb{R}}$ defines a toric variety $\mathbb{C}Y_\Sigma$. Such a $\mathbb{C}Y_\Sigma$ is always compact, as Σ is complete. If the normal fan Σ of Δ is simplicial unimodular, we say that Δ is *non-singular*, *regular* or *simple*.

Affine toric varieties have a natural real structure, *i.e.* an antiholomorphic involution called a *conjugation*; moreover, this real structure is compatible with the inclusion morphisms $\text{Spec}(\mathbb{C}[\rho' \cap M]) \rightarrow \text{Spec}(\mathbb{C}[\eta' \cap M])$ defined above. Hence a toric variety $\mathbb{C}Y_\Sigma$ is a real algebraic variety, and $\mathbb{C}Y_\Sigma$ and $\mathbb{R}Y_\Sigma$ can be seen as the sets of complex and real points of the same real algebraic structure Y_Σ (which we also call a toric variety), where $\mathbb{R}Y_\Sigma \subset \mathbb{C}Y_\Sigma$ denotes the set of the fixed points of the conjugation. The variety $\mathbb{R}Y_\Sigma$ can also be obtained by following the same procedure as for $\mathbb{C}Y_\Sigma$, except that one considers the affine spaces $\text{Spec}(\mathbb{R}[C' \cap M])$ instead of $\text{Spec}(\mathbb{C}[C' \cap M])$.

Let us now define real algebraic hypersurfaces in toric varieties. A real Laurent polynomial $P \in \mathbb{R}[X_0^\pm, \dots, X_n^\pm]$ gives rise, *via* its zero locus, to a real algebraic hypersurface with complex points in the algebraic torus $(\mathbb{C}^*)^n$ and real points in $(\mathbb{R}^*)^n$, which we denote as $V_{(\mathbb{C}^*)^n}(P)$ and $V_{(\mathbb{R}^*)^n}(P)$, respectively. Note that the product of P and a non-zero monomial defines the same real algebraic hypersurface.

Given a toric variety Y , we define $V_{\mathbb{C}Y}(P)$ (respectively, $V_{\mathbb{R}Y}(P)$) as the closure of $V_{(\mathbb{C}^*)^n}(P) \subset (\mathbb{C}^*)^n \subset \mathbb{C}Y$ (respectively, $V_{(\mathbb{R}^*)^n}(P) \subset (\mathbb{R}^*)^n \subset \mathbb{R}Y$) in $\mathbb{C}Y$ (respectively, $\mathbb{R}Y$) in the Zariski topology. Once again, $V_{\mathbb{C}Y}(P)$ and $V_{\mathbb{R}Y}(P)$ can be seen as the complex and real points of the same real algebraic object $V_Y(P)$, the *real algebraic hypersurface in Y* associated to P .

Given such a polynomial $P(X) = \sum_{\lambda=(\lambda_1, \dots, \lambda_n) \in \Lambda} c_\lambda X_1^{\lambda_1} \dots X_n^{\lambda_n}$, where Λ is a finite subset of $M \cong \mathbb{Z}^n$ and $c_\lambda \in \mathbb{R}^*$ for all $\lambda \in \Lambda$, we call the convex hull in $M_{\mathbb{R}} \cong \mathbb{R}^n$ of Λ the *Newton polytope* of P , and denote it by $\Delta(P)$. If we let Σ be the normal fan of $\Delta(P)$, the hypersurface $V_{Y_\Sigma}(P)$ in the associated toric variety Y_Σ is a natural compactification of the hypersurface in the algebraic torus to which P gives rise, for reasons that are detailed in [Vir06].

1.2 Some classical results

Below are listed some classical theorems on the topology of real algebraic varieties - more specifically, these theorems all express constraints on their topology. The other side of the classification problem, *i.e.* showing that non-prohibited topologies are actually realizable,

is explored in Chapter 2.

We mostly take inspiration from G. Wilson's excellent short survey [Wil78], where proofs can be found. One can also read the more recent and much more in-depth account [DK00] by A. Degtyarev and V. Kharlamov.

Most of the results below are expressed in terms of the homology of the considered varieties. Finer observations can be made in low dimensions, but as we mostly focus on high-dimensional results in the rest of this text, we only mention a few regarding curves at the end of this section, for their historical significance.

Given a topological space X , we define its i -th *Betti number* as $b_i(X) := \dim_{\mathbb{Z}_2} H_i(X; \mathbb{Z}_2)$, with the common notation $\mathbb{Z}_2 := \mathbb{Z}/2\mathbb{Z}$. We also write $H_*(X; \mathbb{Z}_2)$ for its total homology with coefficients in \mathbb{Z}_2 .

Historically, the first major result in topology of real algebraic varieties was obtained by A. Harnack in 1876.

Theorem 1.2.1 (Harnack). *The set of real points of a smooth real projective algebraic curve of degree d in $\mathbb{R}\mathbb{P}^2$ has at most $\frac{(d-1)(d-2)}{2} + 1$ connected components.*

Harnack also showed that this bound was optimal by constructing for any degree a curve realizing it; the curves he built are called *Harnack curves*.

Harnack's inequality was in fact a special case of a more general result, the *Smith-Thom inequality*.

Theorem 1.2.2 (Smith-Thom inequality). *Let Z be a topological space with a finite CW-complex structure, $c : Z \rightarrow Z$ be a continuous involution compatible with the cell structure, and F be the set of fixed points of c in Z . Then*

$$\dim_{\mathbb{Z}_2} H_*(F; \mathbb{Z}_2) \leq \dim_{\mathbb{Z}_2} H_*(Z; \mathbb{Z}_2).$$

If this inequality is an equality, Z (considered with the involution c) is said to be *maximal*; we also call Z an *M -variety*. Such varieties are of particular importance. We are specially interested in the situation where Z is the set $\mathbb{C}X$ of complex points of a real algebraic variety, c is the complex conjugation on $\mathbb{C}X$, and F is the set of real points $\mathbb{R}X$, in which case we get

$$\dim_{\mathbb{Z}_2} H_*(\mathbb{R}X; \mathbb{Z}_2) \leq \dim_{\mathbb{Z}_2} H_*(\mathbb{C}X; \mathbb{Z}_2). \quad (1.2.1)$$

Harnack's inequality is, indeed, a special case of the Smith-Thom inequality, as it is easy to show that the set $\mathbb{C}X \subset \mathbb{C}\mathbb{P}^2$ of complex points of a smooth degree d complex curve X is a (connected) surface of genus $\frac{(d-1)(d-2)}{2}$. Hence, we get using Formula (1.2.1) that

$$2b_0(\mathbb{R}X) = b_0(\mathbb{R}X) + b_1(\mathbb{R}X) = \dim_{\mathbb{Z}_2} H_*(\mathbb{R}X; \mathbb{Z}_2) \leq \dim_{\mathbb{Z}_2} H_*(\mathbb{C}X; \mathbb{Z}_2) = 2 + (d-1)(d-2).$$

The Smith-Thom inequality is relatively easy to prove by considering an appropriate cell structure on Z and a well-chosen short exact sequence of complexes (see [Wil78] or [DK00]). The proof shows that the difference $\dim_{\mathbb{Z}_2} H_*(Z; \mathbb{Z}_2) - \dim_{\mathbb{Z}_2} H_*(F; \mathbb{Z}_2)$ is even. If that difference is equal to $2l \in 2\mathbb{N}$, we say that Z (considered with the involution c) is an $(M - l)$ -variety (with l being often equal to 0, 1 or 2).

The same proof also yields the *Borel-Swann inequality*, which in fact implies the Smith-Thom inequality.

Theorem 1.2.3 (Borel-Swann inequality). *Let Z be a topological space with a finite CW-complex structure, $c : Z \rightarrow Z$ be a continuous involution compatible with the cell structure, and F be the set of fixed points of c in Z . Then*

$$\dim_{\mathbb{Z}_2} H_*(F; \mathbb{Z}_2) \leq \dim_{\mathbb{Z}_2} \left(\frac{\text{Ker}(1 + c_*)}{\text{Im}(1 + c_*)} \right),$$

where $1 + c_* : H_*(Z; \mathbb{Z}_2) \rightarrow H_*(Z; \mathbb{Z}_2)$ and 1 stands for the identity.

When this inequality is an equality, Z (considered with the involution c) is called *Galois maximal* (see [DIK00] for additional details). As above, this directly translates in the real algebraic case to the following inequality:

$$\dim_{\mathbb{Z}_2} H_*(\mathbb{R}X; \mathbb{Z}_2) \leq \dim_{\mathbb{Z}_2} \left(\frac{\text{Ker}(1 + c_*)}{\text{Im}(1 + c_*)} \right), \quad (1.2.2)$$

where $1 + c_* : H_*(\mathbb{C}X; \mathbb{Z}_2) \rightarrow H_*(\mathbb{C}X; \mathbb{Z}_2)$ and c is the complex conjugation.

The notion has been considered of interest in itself; it will prove to be of importance in Chapter 4. See for example Krasnov [Kra84], where the Galois maximality of various families of varieties is proved. Somewhat surprisingly, there are very elementary cases in which the rank of $1 + c_* : H_*(\mathbb{C}X; \mathbb{Z}_2) \rightarrow H_*(\mathbb{C}X; \mathbb{Z}_2)$ is not known. One such case was that of simplicial hypersurfaces, which we define in Chapter 8 and whose Galois maximality we investigate there.

Galois maximality is equivalent to a condition of degeneration on the second page of a certain associated spectral sequence, called Kalinin spectral sequence, which was introduced by I. Kalinin in [Kal92] - further explanations can also be found in [Deg92]. Smith-Thom maximality is equivalent to degeneration on the first page of this spectral sequence. We return to those questions in Chapter 4.

Let us give a few more classical results pertaining to complex varieties on which a conjugation (*i.e.* an antiholomorphic involution) acts.

Given a complex manifold Z of real dimension $4n$, the cup product defines a quadratic form on $H^{2n}(Z; \mathbb{R})$. We denote the signature of this intersection form by $\sigma(Z)$. If Z is a complex manifold of real dimension not divisible by 4, we let $\sigma(Z)$ be 0. As always, the Euler characteristic of a topological space X is denoted as $\chi(X)$.

Theorem 1.2.4 (Rokhlin). *Let X be a complex manifold of real dimension $4n$, let c be a conjugation on X and $\mathbb{R}X$ be the set of fixed points of c . If (X, c) is an M -variety, we have*

$$\chi(\mathbb{R}X) \equiv \sigma(X) \pmod{16}.$$

Theorem 1.2.5 (Kharlamov, Gudkov, Krakhnov). *Let X be a complex manifold of real dimension $4n$, let c be a conjugation on X and $\mathbb{R}X$ be the set of fixed points of c . If (X, c) is an $(M - 1)$ -variety, we have*

$$\chi(\mathbb{R}X) \equiv \sigma(X) \pm 2 \pmod{16}.$$

We can also mention S. Lefschetz's well-known fixed point theorem.

Theorem 1.2.6 (Lefschetz's fixed point Theorem). *Let Z be a compact topological manifold, $c : Z \rightarrow Z$ be a continuous involution, and F be the set of fixed points of c in Z . Let c^* be the map induced on cohomology by c . Then we have*

$$\chi(F) = \sum_i (-1)^i \operatorname{tr}(c^* | H^i(Z, \mathbb{R})).$$

As a last example, let us state the following result, due to V. Kharlamov, which requires the complex variety Z to be Kähler.

Theorem 1.2.7 (Kharlamov). *Let X be a compact Kähler manifold of real dimension $4n$, let c be a conjugation on X and $\mathbb{R}X$ be the set of fixed points of c . Then we have*

$$|\chi(\mathbb{R}X) - 1| \leq h^{n,n}(X) - 1,$$

where $h^{n,n}(X)$ is the (n, n) -th Hodge number of X .

Interestingly, there exists a purely topological proof by A. Comessatti of this theorem (which makes no use of the Kähler structure on X) in the case of real projective surfaces.

All those results are very powerful in low dimension, but they yield comparatively less information in higher dimensions.

Though they are not our main focus in the rest of this text, we still choose to say a few words regarding real algebraic projective curves in particular, because of their historical and continued importance in the field.

The topology of the real part $\mathbb{R}X$ of a smooth real algebraic curve X in the projective plane cannot be, in itself, very rich, as $\mathbb{R}X$ is a compact manifold of dimension 1, hence a collection of circles. In a sense, Harnack's inequality from Theorem 1.2.1 tells us all that there is to know. What is usually considered instead is the topology of the pair $(\mathbb{TP}^2, \mathbb{R}X)$.

Figure 1.1¹ shows all three configurations for M -curves of degree 6 in \mathbb{RP}^2 (one can see it as depicting a contractible open subset of \mathbb{RP}^2). The configuration on the left was

¹Picture from [IV96]

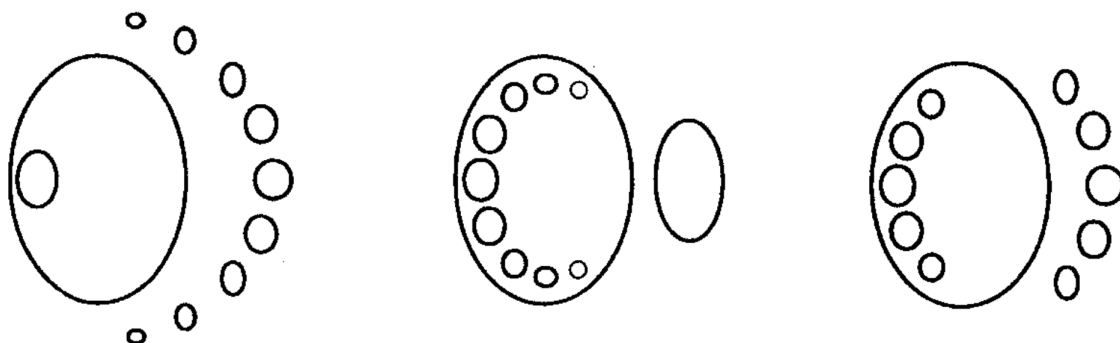

Figure 1.1: Maximal projective curves of degree 6.

obtained by A. Harnack, the middle one by D. Hilbert and the one on the right by D. Gudkov.

One can check, using elementary methods, that each connected component of $\mathbb{R}X$ either partitions $\mathbb{R}P^2$ into a disk and a Möbius strip, in which case we call it an *oval*, or its complement in $\mathbb{R}P^2$ is connected (and homeomorphic to a disk), in which case we call it a *pseudo-line*. When the degree of X is odd, there is exactly one pseudo-line among the connected components of $\mathbb{R}X$; when it is even, there are none.

Therefore, the main question regarding the topology of $(\mathbb{R}P^2, \mathbb{R}X)$ is the number of ovals and their arrangement. We say that an oval C_1 lies inside another oval C_2 if C_1 is contained in the connected component of $\mathbb{R}P^2 \setminus C_2$ homeomorphic to a disk. An oval is *even* if it lies inside an even number of ovals, and *odd* otherwise. As an example, the curve in Figure 1.2² has 5 even ovals and 3 odd ones.

For a given curve X , let p be the number of even ovals in its real part, and n the number of odd ovals. The following theorems can be obtained from Theorems 1.2.4, 1.2.5 and 1.2.7 by considering a double covering of $\mathbb{C}P^2$ ramified along $\mathbb{C}X$.

Theorem 1.2.8 (Gudkov, Rokhlin). *Let X be a smooth real M -curve of degree $2k$ in the projective plane. Then*

$$p - n \equiv k^2 \pmod{8}.$$

Theorem 1.2.9 (Gudkov, Kharlamov, Krakhnov). *Let X be a smooth real $(M - 1)$ -curve of degree $2k$ in the projective plane. Then*

$$p - n \equiv k^2 \pm 1 \pmod{8}.$$

Theorem 1.2.10 (Petrovsky). *Let X be a smooth real curve of degree $2k$ in the projective plane. Then*

$$-\frac{3}{2}k(k-1) \leq p - n \leq \frac{3}{2}k(k-1) + 1.$$

²Picture from [IV96]

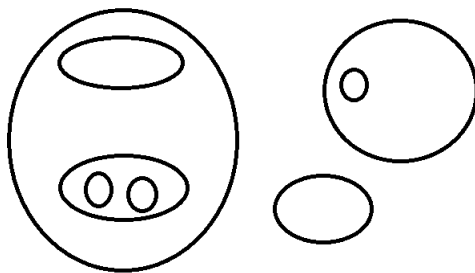

Figure 1.2: 5 even ovals, 3 odd ovals.

V. Ragsdale conjectured in [Rag04] that an even stronger bound holds.

Conjecture 1.2.11 (Ragsdale's Conjecture). *Let X be a smooth real curve of degree $2k$ in the projective plane. Then*

$$p \leq \frac{3}{2}k(k-1) + 1,$$

$$n \leq \frac{3}{2}k(k-1).$$

However, Viro showed in [Vir80] that the second inequality was wrong by at least 1. Later, Itenberg used the patchworking method (see Chapter 2) to show in [Ite93] that both inequalities were in general dramatically wrong (by a quadratic margin). However, whether they are true (up to a correction of 1 in the case of the inequality on n) for M -curves is still an open question.

Chapter 2

Viro's patchworking method

2.1 Chapter introduction

In Section 1.2, we have seen some constraints on the topology of real algebraic varieties. Complementary to finding new restrictions, constructing real algebraic varieties that show the sharpness of those restrictions is the other component of the classification effort.

Various construction methods have been historically used; one can for example perturb a union of algebraic varieties that intersect in a certain way.

A particularly efficient technique was developed by Viro in the late 70s. That technique, often called *Viro's method* or *patchworking method*, allows one to obtain families of real algebraic hypersurfaces $\{X_t\}_{t \in \mathbb{R}_{>0}}$ in a given toric variety, such that X_t can be seen as a gluing ("patchworking") of simpler hypersurfaces for t small enough (or large enough, depending on the chosen convention). This can be used to build real algebraic hypersurfaces with prescribed and interesting topologies. We describe this process in Section 2.2.

There exists a simpler, more combinatorial special case of the method, called *combinatorial patchworking*, which we detail in Section 2.3. Though it is strictly speaking less flexible than the general case, the increased simplicity often allows one to have a better grasp of the situation.

Viro's method is strongly linked to tropical geometry, and was one of its sources of inspiration. Some of those connections are considered in Chapter 4.

The patchworking method has enjoyed considerable success over the years. It was used by Viro himself to further the classification up to isotopy of smooth real projective algebraic curves of degree 7, which he completed in [Vir80], as well as to disprove Ragsdale's conjecture 1.2.11 in the same article.

Itenberg later used combinatorial patchworking in [Ite93] to show that the conjecture was also asymptotically wrong. His construction was improved on by E. Brugallé in [Bru06], using the general case of the patchworking method.

Itenberg and Viro also used combinatorial patchworking in [IV07] to build in each

dimension n a family of asymptotically maximal real projective algebraic hypersurfaces; this construction was the main inspiration behind the author's own results in Chapters 5 and 6 (where more details can be found), which rely on Viro's method as well.

Many others, such as F. Bihan in [Bih03], B. Bertrand in [Ber06] or A. Renaudineau in his thesis [Ren15], have also successfully made use of this powerful tool.

One naturally wonders about the limitations of the method: for example, what bounds can be found on the Betti numbers of varieties obtained by combinatorial patchworking, or under even stricter conditions?

Bounds were found in ambient dimension 3 by Itenberg in [Ite97] using relatively elementary methods, as well as by Itenberg and Shustin using more sophisticated ones in [IS03].

New constraints were later found, in particular by Renaudineau and K. Shaw (see [RS18]), using the connections between real and tropical hypersurfaces and the properties of tropical homology. This is the main subject of Chapters 4 and 9.

2.2 General case

We give a quick description of Viro's method so as to have the necessary definitions, using notations and concepts from Subsection 1.1.2 and mostly paraphrasing Viro's own exposition in [Vir06]. All omitted details can be found there, or in Itenberg's, G. Mikhalkin's and E. Shustin's notes on Tropical Algebraic Geometry [IMS09]. See [Ful93] for more on toric varieties.

In what follows, K can be either \mathbb{R} or \mathbb{C} . Let $U_{\mathbb{C}}^1 \subset \mathbb{C}$ be the unit circle, $U_{\mathbb{R}}^1$ be $\{1, -1\}$ and define $U_K^n := (U_K^1)^n$ for $n \in \mathbb{N}$.

As explained in Subsection 1.1.2, a real Laurent polynomial

$$P(z) = \sum_{\lambda=(\lambda_1, \dots, \lambda_n) \in \Lambda} c_{\lambda} z_1^{\lambda_1}, \dots, z_n^{\lambda_n},$$

where Λ is a finite subset of \mathbb{Z}^n and $c_{\lambda} \in \mathbb{R}^*$ for all $\lambda \in \Lambda$, defines a real algebraic hypersurface $V_{(\mathbb{C}^*)^n}(P)$ in the complex torus $(\mathbb{C}^*)^n$. From now on, we use the notation $z^{\lambda} := z_1^{\lambda_1} \dots z_n^{\lambda_n}$, where $z = (z_1, \dots, z_n) \in \mathbb{C}^n$ and $\lambda = (\lambda_1, \dots, \lambda_n) \in \mathbb{Z}^n$.

In Subsection 1.1.2, given a full-dimensional polytope with integer vertices $\Delta \subset \mathbb{R}^n$, we denoted by KY_{Σ} the toric variety to which Δ gave rise via its normal fan Σ . In this chapter, as well as in Chapter 5, let us call that toric variety $K\Delta$ in order to shorten notations. The embedding $\Delta \subset \mathbb{R}^n$ determines an embedding $(K^*)^n \subset K\Delta$, and there is a natural action of the torus $(K^*)^n \subset K\Delta$ on itself by multiplication, which can be naturally extended to an action $S : K\Delta \times (K^*)^n \rightarrow K\Delta$ on $K\Delta$, as was mentioned in Subsection 1.1.2. Moreover, remember that $K\Delta$ is stratified along the closures of the orbits of the action of the algebraic torus, and that those strata are in (inclusion-preserving) bijection

with the faces of Δ . Let Γ be a face of Δ , and denote by $K\Gamma$ the corresponding stratum of $K\Delta$. It can be shown that $K\Gamma$ is isomorphic to the toric variety to which Γ , seen as a full-dimensional polytope in the vector space that it spans, gives rise, which justifies the notation.

There is a stratified (along its intersections with the strata $K\Gamma$) subspace of $K\Delta$, denoted as $\mathbb{R}_+\Delta$, which corresponds to the points in $K\Delta$ with real nonnegative coordinates (this can be given precise meaning with the definition of $K\Delta$). We can see $K\Delta$ as a quotient of $\mathbb{R}_+\Delta \times U_K^n$ via the map $S : \mathbb{R}_+\Delta \times U_K^n \longrightarrow K\Delta$.

As stratified topological spaces, $\mathbb{R}_+\Delta$ and the polytope Δ are homeomorphic, for example via the Atiyah moment map $M : \mathbb{R}_+\Delta \longrightarrow \Delta$ (see [Ati81]). If $x \in (\mathbb{R}_+)^n \subset \mathbb{R}_+\Delta$ and $w_1, \dots, w_k \in \mathbb{Z}^n$ are such that their convex hull is Δ , then

$$M(x) = \frac{\sum_{i=1}^k |x^{w_i}| w_i}{\sum_{i=1}^k |x^{w_i}|}.$$

Thus we have the following map

$$\Phi : \Delta \times U_K^n \xrightarrow{M^{-1} \times id} \mathbb{R}_+\Delta \times U_K^n \xrightarrow{S} K\Delta$$

through which $K\Delta$ is seen as a quotient of $\Delta \times U_K^n$ (when $K = \mathbb{R}$, this quotient can in fact be quite nicely described in terms of an appropriate gluing of the faces of $\mathbb{R}_+\Delta \times U_{\mathbb{R}}^n$ - see [Vir06]). It restricts to a homeomorphism from $\overset{\circ}{\Delta} \times U_K^n$ to $(K^*)^n \subset K\Delta$.

Let P be as above a real Laurent polynomial in n variables and $\Delta \subset \mathbb{R}^n$ be a full-dimensional polytope with integer vertices. The stratified topological pair $(\Delta \times U_K^n, v)$, where $v = \Phi^{-1}(V_{K\Delta}(P))$, is called a *chart* of P . A slightly different definition exists, where M can be replaced in the definition of Φ by any "nice enough" homeomorphism.

When there is no possible confusion, we sometimes refer to v itself as the chart (as opposed to the pair $(\Delta \times U_K^n, v)$), and we denote it as $Chart_{\Delta \times U_K^n}(P)$. By extension, we also write $Chart_{\overset{\circ}{\Delta} \times U_K^n}(P) := Chart_{\Delta \times U_K^n}(P) \cap (\overset{\circ}{\Delta} \times U_K^n)$, where $\overset{\circ}{\Delta}$ is the relative interior of Δ in \mathbb{R}^n .

Let $P(z) = \sum_{\lambda \in \Lambda} c_\lambda z^\lambda$ as above and $\Gamma \subset \mathbb{R}^n$. We define the *truncation* P^Γ as the polynomial $P^\Gamma(z) = \sum_{\lambda \in \Gamma \cap \Lambda} c_\lambda z^\lambda$.

The real Laurent polynomial P is *completely nondegenerate* over K if $V_{(K^*)^n}(P^\Gamma)$ is a nonsingular hypersurface for any face Γ of its Newton polytope $\Delta(P)$ (including $\Delta(P)$ itself).

A *convex subdivision* (or *regular subdivision*) T of an n -dimensional convex polytope $\Delta \subset \mathbb{R}^n$ with integer vertices is a finite family $\{\Delta_i\}_{i \in I}$ of n -dimensional convex polytopes with integer vertices such that:

- $\bigcup_{i \in I} \Delta_i = \Delta$.

- For all indices $i, j \in I$, the intersection $\Delta_i \cap \Delta_j$ is either empty or a face of both Δ_i and Δ_j .
- There is a piecewise linear convex function $\mu : \Delta \rightarrow \mathbb{R}$ such that the domains of linearity of μ are exactly the polytopes Δ_i .

If each polytope Δ_i in the subdivision is a simplex, we say that T is a *convex triangulation*. Moreover, if each Δ_i is a simplex of minimum volume $\frac{1}{n!}$, we call T a *convex primitive triangulation*.

All is set to state the Main Patchwork Theorem: let $\Delta \subset \mathbb{R}^n$ be a convex polytope with integer vertices and let Q_1, \dots, Q_s be completely nondegenerate real Laurent polynomials in n variables such that $\{\Delta(Q_1), \dots, \Delta(Q_s)\}$ is a convex subdivision of Δ . Suppose moreover that $Q_i^{\Delta(Q_i) \cap \Delta(Q_j)} = Q_j^{\Delta(Q_i) \cap \Delta(Q_j)}$ for all $i, j \in \{1, \dots, s\}$. This means that there exists a unique real Laurent polynomial $P(z) = \sum_{\lambda \in \Delta \cap \mathbb{Z}^n} c_\lambda z^\lambda$ such that $P^{\Delta(Q_i)} = Q_i$ for all i . Let $\mu : \Delta \rightarrow \mathbb{R}$ be a piecewise linear function certifying the convexity of the subdivision, and consider the family of real Laurent polynomials $\{P_t\}_{t \in \mathbb{R}_{>0}}$, where $P_t(z) := \sum_{\lambda \in \Delta \cap \mathbb{Z}^n} c_\lambda t^{\mu(\lambda)} z^\lambda$. Let $(\Delta(Q_i) \times U_K^n, v_i)$ be the chart of Q_i , and $(\Delta \times U_K^n, v_t)$ be the chart of P_t .

Theorem 2.2.1 (Main Patchwork Theorem). *The union $\bigcup_{i=1}^s v_i$ is a submanifold of $\Delta \times U_K^n$, smooth in $\overset{\circ}{\Delta} \times U_K^n$ and with boundary in $\partial\Delta \times U_K^n$ (and corners in the boundary for $n \geq 3$).*

Moreover, for any $t > 0$ small enough, $\bigcup_{i=1}^s v_i$ is isotopic to v_t in $\Delta \times U_K^n$ by an isotopy which leaves $\Gamma \times U_K^n$ invariant for each face $\Gamma \subset \Delta$.

We say that such a polynomial P_t (with $t > 0$ small enough) has been obtained by patchworking the polynomials Q_1, \dots, Q_s , or that it is a patchwork of them.

In particular, Theorem 2.2.1 allows us to recover the topology of the pairs $((K^*)^n, V_{(K^*)^n}(P_t))$ and $(K_\Delta, V_{K_\Delta}(P_t))$ from that of the pairs $(K_{\Delta(Q_i)}, V_{K_{\Delta(Q_i)}}(Q_i))$.

Note that though the function μ plays an important role in the definition of the family of polynomials $\{P_t\}_{t \in \mathbb{R}_{>0}}$, its choice (among the piecewise linear functions inducing the same convex subdivision) does not affect the topology of $(K_\Delta, V_{K_\Delta}(P_t))$.

Viro's method has been generalized by B. Sturmfels in [Stu94] to complete intersections in the combinatorial case (see Section 2.3 below), and then to complete intersections in the general case by Bihan in [Bih02].

2.3 Combinatorial case

In this section, we present a special case of Theorem 2.2.1 which is often distinguished. We retain the notations of Section 2.2.

Let P be a real Laurent polynomial in n variables. If P has exactly $n+1$ monomials with non-zero coefficients and if its Newton polytope $\Delta(P)$ is a non-degenerate n -dimensional

simplex, we call P a *simplicial* real polynomial. In particular, the monomials of P and the vertices of $\Delta(P)$ are in bijection. Such polynomials are considered in more detail in Chapter 8.

If the real polynomials Q_1, \dots, Q_s that are being patchworked are all simplicial, which in particular implies that the convex subdivision $\{\Delta(Q_1), \dots, \Delta(Q_s)\}$ is a triangulation, the construction is called a *combinatorial patchworking*. If it is a primitive triangulation, we call the construction a *primitive combinatorial patchworking*.

What makes this case special is that the real chart $\text{Chart}_{\Delta(P) \times U_{\mathbb{R}}^n}(P)$ of a real simplicial polynomial P admits a very simple description, which depends only on the signs of the coefficients of P .

Let us write P as $P(z) = \sum_{\lambda} a_{\lambda} \delta(\lambda) z^{\lambda}$, where the sum is over the vertices λ of the Newton polytope $\Delta(P)$ of P , $a_{\lambda} \in \mathbb{R}_{>0}$ and $\delta(\lambda) \in \mathcal{U}_{\mathbb{R}}^1 = \{1, -1\}$ for all λ .

We now define a sign distribution $\tilde{\delta}$ on the $2^n(n+1)$ vertices of $\Delta(P) \times U_{\mathbb{R}}^n$ in the following way:

$$\tilde{\delta}(\lambda, \epsilon) := \delta(\lambda) \epsilon^{\lambda} \in \{1, -1\},$$

where $\lambda = (\lambda_1, \dots, \lambda_n) \in \mathbb{Z}^n$ is a vertex of $\Delta(P)$, $\epsilon = (\epsilon_1, \dots, \epsilon_n) \in U_{\mathbb{R}}^n$ and $\epsilon^{\lambda} = \epsilon_1^{\lambda_1} \cdot \dots \cdot \epsilon_n^{\lambda_n} \in \{1, -1\}$.

Then the real chart $(\Delta(P) \times U_{\mathbb{R}}^n, \text{Chart}_{\Delta(P) \times U_{\mathbb{R}}^n}(P))$ can be described as follows: for $\epsilon \in U_{\mathbb{R}}^n$, the intersection $\text{Chart}_{\Delta(P) \times U_{\mathbb{R}}^n}(P) \cap (\Delta(P) \times \{\epsilon\})$ is empty if $\tilde{\delta}$ takes the same value on all vertices of $\Delta(P) \times \{\epsilon\}$. Otherwise, it is isotopic to an $(n-1)$ -dimensional polyhedron that separates the vertices of $\Delta(P) \times \{\epsilon\}$ on which $\tilde{\delta}$ is positive from those on which it is negative, by an isotopy which leaves $\Gamma \times U_{\mathbb{R}}^n$ invariant for each face Γ of $\Delta(P)$. This can be shown using arguments similar to those from Lemma 8.5.1, as well as the fact that the intersection of the chart $\text{Chart}_{\Delta(P) \times U_{\mathbb{R}}^n}(P)$ with $\Gamma \times U_{\mathbb{R}}^n$, for some face Γ of $\Delta(P)$, is described by the chart of the truncation $P|_{\Gamma}$ (see [IMS09, Lemma 2.16]). Note that the same algorithm describes (up to isotopy) the intersection of $\text{Chart}_{\Delta(P) \times U_{\mathbb{R}}^n}(P)$ with the subsets $\sigma \times \{\epsilon\}$, where σ is a face of $\Delta(P)$.

A simple example of combinatorial patchworking in dimension $n=2$ is given in Figure 2.1; the orange set is (up to isotopy) a patchworked chart in $\Delta \times U_{\mathbb{R}}^2$.

This shows that for any $t > 0$ small enough, the topology of the pair $(\Delta(P_t) \times U_{\mathbb{R}}^n, \text{Chart}_{\Delta(P_t) \times U_{\mathbb{R}}^n}(P_t))$, where P_t results from the application of Theorem 2.2.1 to a family Q_1, \dots, Q_s of real simplicial polynomial, only depends on the signs of the coefficients of the polynomials Q_i - hence the appellation "combinatorial".

In fact, this allows for a change in perspective: instead of starting with a family Q_1, \dots, Q_s of polynomials and patchworking them, one can start with a convex triangulation T of a polytope $\Delta \subset \mathbb{R}^n$ with integer vertices, then choose a sign for each vertex appearing in the triangulation. One then applies the algorithm described above to obtain a piecewise linear hypersurface X in $\Delta \times U_{\mathbb{R}}^n$. As simplicial polynomials are always completely non-degenerate (see Remark 8.2.1 in Chapter 8), one can always find polyno-

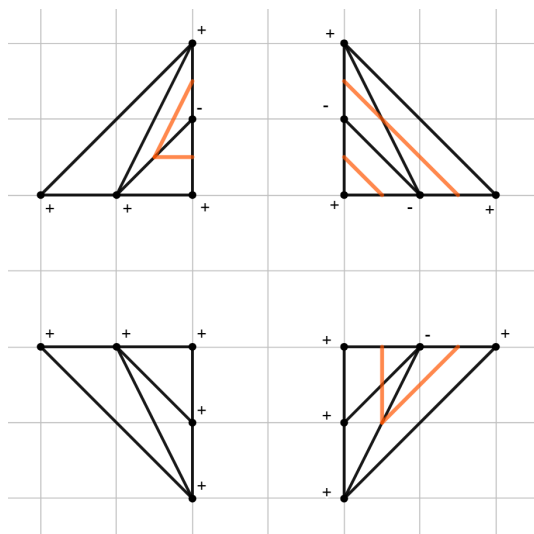

Figure 2.1: A patchworked chart (up to isotopy) in ambient dimension 2.

mials Q_1, \dots, Q_s such that $(\Delta \times U_{\mathbb{R}}^n, X)$ is (stratified) isotopy equivalent to the chart of a polynomial P_t obtained by patchworking Q_1, \dots, Q_s .

Chapter 3

Tropical geometry

3.1 Introduction and basic notions

Tropical geometry is a relatively recent field. It can be grossly described as the study of some piecewise linear objects that are naturally related to other, more algebraic objects. In particular, there are strong connections to real algebraic varieties and the patchworking method (which was one of the historical inspirations for the development of tropical geometry) described in Chapter 2, as is shown later in Chapter 4.

In this chapter, we cover some of the basic notions of tropical geometry. In particular, tropical operations and polynomials are introduced in this section, tropical hypersurfaces and tropical toric varieties in Section 3.2, and tropical homology in Section 3.3.

A short introduction to the field can be found in [BIMS15]. For a more complete exposition, read [IMS09], [MS15] or [MR].

3.1.1 Tropical operations and tropical polynomials

We consider the set of tropical numbers $\mathbb{T} := \mathbb{R} \cup \{-\infty\}$ equipped with the so called *tropical addition* and *tropical multiplication*, which we denote by “+” and “ \cdot ” and define as follows: for all $x, y \in \mathbb{T}$,

$$"x + y" = \max(x, y), \quad "x \cdot y" = x + y.$$

Those operations are associative and commutative, and satisfy the distributive property.

The neutral element for the addition is $-\infty$, and the neutral element for the multiplication is 0. Each element $x \in \mathbb{T} \setminus \{-\infty\}$ admits a multiplicative inverse, which is $-x$, but there is no additive inverse. Because of these properties, \mathbb{T} is called a *semifield*. Topologically, we identify \mathbb{T} with the line segment $[0, 1[$.

This naturally leads to the notion of *tropical polynomial*. Let $n \geq 1$. We can consider

$P \in \mathbb{T}[X_1, \dots, X_n]$, abstractly defined as

$$P(X) = \sum_{\lambda \in \Lambda} s_\lambda X^\lambda$$

for some finite subset Λ of \mathbb{Z}^n and some coefficients $s_\lambda \in \mathbb{R}$, where $X^\lambda := X_1^{\lambda_1} \dots X_n^{\lambda_n}$. The set Λ corresponds to the non-trivial monomials of P (as $-\infty$ is the tropical analog of the classical trivial coefficient 0). As with classical polynomials, we call $\text{Conv}(\Lambda)$ the *Newton polytope* of P .

As with classical Laurent polynomials, such a tropical polynomial P gives rise to a well-defined function on the tropical torus \mathbb{R}^n (\mathbb{R} corresponds to \mathbb{T}^*), which takes values in \mathbb{R} if P is non-trivial:

$$\begin{aligned} P : \mathbb{R}^n &\longrightarrow \mathbb{T} \\ x = (x_1, \dots, x_n) &\longmapsto P(x) = \sum_{\lambda \in \Lambda} s_\lambda x^\lambda = \max_{\lambda \in \Lambda} \{s_\lambda + \lambda^\perp \cdot x\}, \end{aligned}$$

where $\lambda^\perp \cdot x = \sum_{i=1}^n x_i \lambda_i$. The induced function is piecewise linear on \mathbb{R}^n .

Observe that two distinct tropical polynomials can give rise to the same function: for example,

$$"0 + x + x^2 = 0 + x^2" \quad \text{for any } x \in \mathbb{T}.$$

3.2 Tropical toric varieties and tropical hypersurfaces

There are intrinsic definitions of *tropical spaces* and *tropical manifolds*, involving balanced polyhedral complexes and matroidal fans, which can for example be found in [BIMS15] or in [Mik06].

Here, we only concern ourselves with two particular types of tropical spaces: tropical toric varieties, and tropical hypersurfaces in tropical toric varieties.

3.2.1 Tropical toric varieties

The description below is dependant on the choice of a lattice in \mathbb{R}^n . We always use the standard lattice $\mathbb{Z}^n \subset \mathbb{R}^n$.

Let Σ be a strongly convex rational polyhedral fan in \mathbb{R}^n (see Subsection 1.1.2). Just as with classical toric varieties, the fan Σ gives rise to an n -dimensional tropical toric variety. For any cone ρ of Σ , denote by $\mathbb{L}(\rho)$ the subspace of \mathbb{R}^n spanned by ρ , and set $\mathbb{L}_{\mathbb{Z}}(\rho) := \mathbb{L}(\rho) \cap \mathbb{Z}^n$. As Σ is rational, we have an isomorphism $\mathbb{L}_{\mathbb{Z}}(\rho) \cong \mathbb{Z}^{\dim \rho}$. As a set,

the *tropical toric variety* associated to the fan Σ is

$$Y_\Sigma := \bigsqcup_{\rho \in \Sigma} \mathbb{R}^n / \mathbb{L}(\rho).$$

There is a unique topology on Y_Σ such that

- The inclusions $\mathbb{R}^n / \mathbb{L}(\rho) \hookrightarrow Y_\Sigma$ are continuous for any cone $\rho \in \Sigma$.
- For any $x \in \mathbb{R}^n$ and any $v \in \mathbb{R}^n$, the sequence $(x + nv)_{n \in \mathbb{N}} \in \mathbb{R}^n \cong \mathbb{R}^n / \mathbb{L}(\{0\})$ converges in Y_Σ if and only if v is contained in the support of the fan Σ .

Given a toric variety Y and a cone ρ of the associated fan, we denote by Y_ρ the *stratum* $\mathbb{R}^n / \mathbb{L}(\rho) \subset Y$ (using the same notations as above). There is an inclusion-reversing isomorphism of posets $\bar{\rho} \mapsto \overline{Y_\rho}$ between the set of closed cones of the fan Σ and the closures in Y of its strata; in particular, for two cones ρ and ρ' of Σ we have $Y_{\rho'} \subset \overline{Y_\rho}$ if and only if ρ is a face of ρ' in Σ . We say that a point $y \in Y$ is of *sedentarity* k if it belongs to a stratum Y_ρ such that $\dim \rho = k$; we write $\text{sed}(y) = k$. This description corresponds to the decomposition into orbits of classical toric varieties.

A tropical toric variety is naturally equipped with a lattice on each stratum. More precisely, the stratum Y_ρ is equipped with the lattice $\mathbb{Z}^n / \mathbb{L}_{\mathbb{Z}}(\rho)$. When ρ is of dimension k , there is a lattice preserving isomorphism of vector spaces $Y_\rho \cong \mathbb{R}^{n-k}$. If ρ is a cone of Σ , then there is a projection map $\pi_\rho: \mathbb{R}^n \rightarrow Y_\rho$. If ρ' is a face of ρ in the fan Σ , then $\mathbb{L}(\rho') \subseteq \mathbb{L}(\rho)$ and there is a projection map $\pi_{\rho', \rho}: Y_{\rho'} \rightarrow Y_\rho$. The tropical toric variety Y is compact if and only if the associated fan Σ is complete. In what follows, we mostly focus on compact tropical toric varieties.

Proofs and details can be found in [MR, Section 3.2] and [MS15, Sections 6.2 and 6.3]. An equivalent definition, in terms of gluing of affine tropical spaces via appropriate tropical maps, also exists.

Just as is the case over a field, a tropical toric variety is *non-singular* if it is built from a simplicial unimodular rational polyhedral fan.

Given a full-dimensional rational polytope $\Delta \subset \mathbb{R}^n$, its normal fan Σ allows us to define a tropical toric variety Y , which will be non-singular if and only if Δ is a simple polytope.

Example 3.2.1. The tropical projective space $\mathbb{T}P^n$ is the tropical toric variety constructed from the fan Σ consisting of cones

$$\mathbb{R}_{\geq 0}e_{i_1} + \cdots + \mathbb{R}_{\geq 0}e_{i_k},$$

for all $\{i_1 \cdots i_k\} \subsetneq \{0, \dots, n\}$, where e_1, \dots, e_n is the standard basis of \mathbb{R}^n and $e_0 = -\sum_{k=1}^n e_k$. It is non-singular as a tropical toric variety.

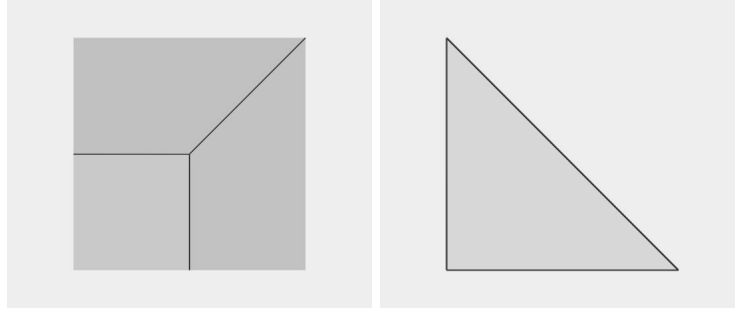

Figure 3.1: The fan Σ on the left and tropical projective plane $\mathbb{T}P^2$ to which it gives rise on the right.

It can also be described as the quotient

$$\frac{\mathbb{T}^{n+1} \setminus (-\infty, \dots, -\infty)}{[x_0 : \dots : x_n] \sim [a + x_0 : \dots : a + x_n]},$$

where $a \in \mathbb{T} \setminus -\infty$. The stratification of $\mathbb{T}P^n$ can be described using homogeneous coordinates. For a subset $I \subset \{0, \dots, n\}$ define

$$\mathbb{T}P_I^n = \{x \in \mathbb{T}P^n \mid x_i = -\infty \text{ if and only if } i \in I\}.$$

The set $\mathbb{T}P_I^n$ corresponds to the cone

$$\sum_{i \in I} \mathbb{R}_{\geq 0} e_i.$$

The order of sedentarity of a point $x = [x_0 : \dots : x_n] \in \mathbb{T}P^n$ is $\text{sed}(x) = \#\{i \mid x_i = -\infty\}$.

Note that though $\mathbb{T}P^2$ is isomorphic as a stratified topological space to the triangle on the right of Figure 3.1 (and similarly for $\mathbb{T}P^n$ and a n -simplex), its metric is not what one would expect from such a comparison; for example, the sequence of points $\{(n, 2n)\}_{n \in \mathbb{N}} \subset \mathbb{R}^2 \subset \mathbb{T}P^2$ converges to the upper left vertex. More details on that can be found in [MR, Section 3.2].

3.2.2 Tropical hypersurfaces

As in Subsection 3.1.1, let $n \geq 1$ and

$$P(X) = \sum_{\lambda \in \Lambda} s_\lambda X^\lambda$$

be a tropical polynomial, for some finite subset Λ of \mathbb{Z}^n and some coefficients $s_\lambda \in \mathbb{R}$.

We define the *tropical hypersurface* $X_P \subset \mathbb{R}^n$ associated to P to be the corner locus of

the function $\mathbb{R}^n \mapsto \mathbb{T}$ associated to P , *i.e.* the set

$$X_P := \{x \in \mathbb{R}^n \mid \exists \lambda_1 \neq \lambda_2 \in \Lambda \text{ s.t. } P(x) = s_{\lambda_1} + \lambda_1^\perp \cdot x = s_{\lambda_2} + \lambda_2^\perp \cdot x\}.$$

It corresponds to the set of points in $x \in \mathbb{R}^n$ such that the function associated to P is not affine in any neighborhood of x . See Example 3.2.3 for an elementary example where P is of degree 1, and the right part of Figure 3.2¹ for the tropical conic defined by the polynomial " $3 + 2x + 2y + 3xy + y^2 + x^2$ ".

Just as two distinct tropical polynomials can give rise to the same function, two distinct functions can give to the same hypersurface: consider for example P as above and some $s \in \mathbb{R} \setminus \{0\}$, and define $\tilde{P}(X) := \sum_{\lambda \in \Lambda} \tilde{s}_\lambda X^\lambda$, where for each λ we set $\tilde{s}_\lambda = s_\lambda + s$.

We then simply define a *tropical hypersurface* X in a *tropical toric variety* Y to be the closure in Y of a tropical hypersurface $X_0 \subset \mathbb{R}^n \subset Y$ (where \mathbb{R}^n corresponds to the top-dimensional stratum of Y).

As is the case in the classical setting, if P is a tropical polynomial with full-dimensional Newton polytope Δ , the most natural tropical toric variety in which to take the closure of the tropical hypersurface $X_0 \subset \mathbb{R}^n$ to which P gives rise is the n -dimensional tropical variety Y generated by the normal fan of the polytope Δ .

By extension, given a tropical polynomial P defining a tropical hypersurface X , we sometimes write "the Newton polytope of X " to mean the Newton polytope of P .

A tropical hypersurface $X_0 \subset \mathbb{R}^n$ has a natural structure of rational polyhedral complex induced by its definition as the corner locus of the function induced by a tropical polynomial; each of its faces can be described as $\sigma_I = \{x \in \mathbb{R}^n \mid s_{\lambda_1} + \lambda_1^\perp \cdot x = s_{\lambda_2} + \lambda_2^\perp \cdot x \ \forall \lambda_1, \lambda_2 \in I, s_{\lambda_1} + \lambda_1^\perp \cdot x > s_{\lambda_2} + \lambda_2^\perp \cdot x \ \forall \lambda_1 \in I, \lambda_2 \in \Lambda \setminus I\}$ for some set $I \subset \Lambda$ (though not all $I \subset \Lambda$ give rise to a face). The same is true of tropical hypersurfaces in tropical toric varieties. Moreover, a tropical hypersurface X in a toric variety Y naturally induces a structure of polyhedral complex on Y , in which each face either belongs to the polyhedral complex X , or is the intersection of a connected component of $Y \setminus X$ with a stratum Y_ρ of Y . Let us call this subdivision $S_P(Y)$.

Remark 3.2.2. *There is an alternative definition of tropical hypersurfaces in \mathbb{R}^n in terms of polyhedral complexes satisfying a certain balancing condition. Those two definitions turn out to be equivalent, see [MR, Section 2.4].*

Example 3.2.3. Consider the tropical affine function $P(X) = "0 + X_1 + \dots + X_{n+1}"$, and denote as $H_n \subset \mathbb{R}^{n+1}$ the associated tropical hypersurface. We call it the *standard tropical hyperplane* in \mathbb{R}^{n+1} . The case $n = 2$ is illustrated on the left of Figure 3.2.

The hyperplane H_n is a fan of dimension n which has exactly $n+2$ rays, in the directions $-e_1, \dots, -e_{n+1}$, and $e_1 + \dots + e_{n+1}$. Every subset of the rays of size less than or equal to

¹Picture from [BIMS15]

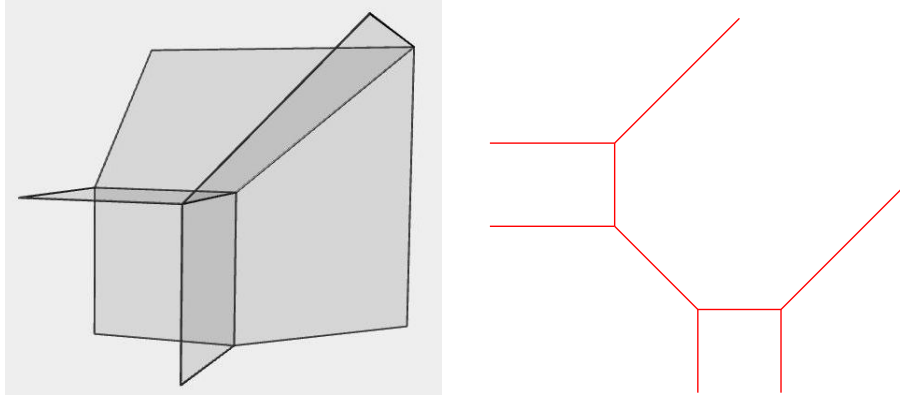

Figure 3.2: On the left, the standard tropical hyperplane in \mathbb{R}^3 . On the right, a tropical conic in \mathbb{R}^2 .

n spans a cone of H_n . Its Newton polytope is the standard simplex in \mathbb{R}^{n+1} .

3.2.3 A duality theorem

Given as above $n \geq 1$ and

$$P(X) = \sum_{\lambda \in \Lambda} s_\lambda X^\lambda$$

a tropical polynomial, for some finite subset Λ of \mathbb{Z}^n and some coefficients $s_\lambda \in \mathbb{R}$, we consider the function $s : \Lambda \rightarrow \mathbb{R}$ and the Newton polytope $\Delta = \text{Conv}(\Lambda)$ of P . We also define $\Phi(s) : \Delta \rightarrow \mathbb{R}$ as the function whose graph is the upper convex hull in \mathbb{R}^{n+1} of the graph of s . We define the *convex subdivision of Δ induced by P* as the integer subdivision of Δ such that its cells are the domains of linearity of $\Phi(s)$, which is a piecewise linear function (see also Chapter 2). Denote it by $S^P(\Delta)$. For each closed face F of Δ (of its original structure as a polytope, before being further subdivided by $S^P(\Delta)$), denote by $S^P(F)$ the restriction of $S^P(\Delta)$ to F .

Consider the hypersurface $X_0 \subset \mathbb{R}^n$ to which P gives rise, and let Y be a tropical toric variety generated by a fan Σ . Let $X \subset Y$ be the closure of X_0 in Y , and let as above $S_P(\mathbb{R}^n)$ be the subdivision of \mathbb{R}^n induced by X_0 , $S_P(Y)$ be the subdivision of Y induced by X , and $S_P(Y_\rho)$ be the subdivision of the stratum Y_ρ induced by $X_\rho := Y_\rho \cap X$ (for some cone $\rho \in \Sigma$). There is a duality theorem between the cells of $S^P(\Delta)$ and those of $S_P(\mathbb{R}^n)$, which can be extended to $S_P(Y)$ under reasonable hypotheses.

Theorem 3.2.4 (Duality Theorem). *Using the above notations, there is an inclusion-reversing bijection of cells given by*

$$\begin{aligned} \Psi : S_P(\mathbb{R}^n) &\longrightarrow S^P(\Delta) \\ \sigma &\longmapsto \Psi(\sigma) := \text{Conv}(\{\lambda \in \Lambda \mid P(x) = s_\lambda + \lambda^\perp \cdot x \ \forall x \in \sigma\}). \end{aligned}$$

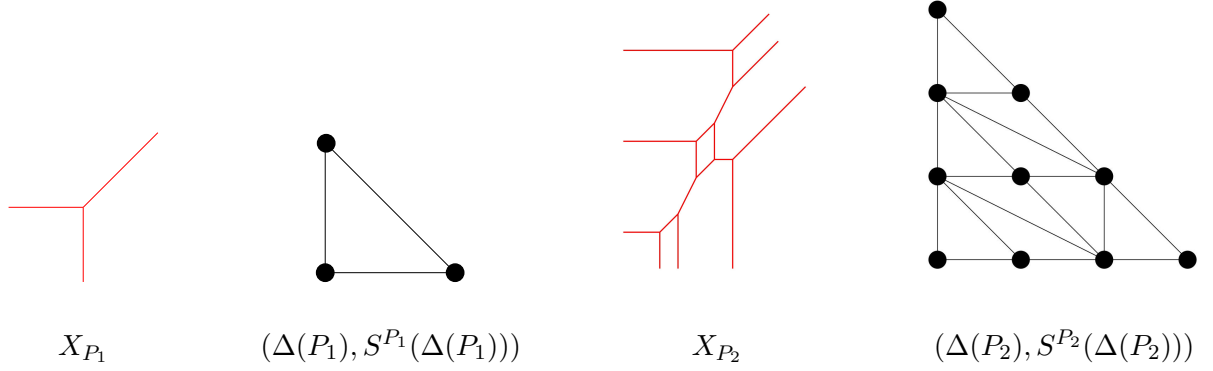
Figure 3.3: Duality for $n = 2$.

Moreover, we have $\dim(\sigma) + \dim(\Psi(\sigma)) = n$ for all $\sigma \in S_P(\mathbb{R}^n)$, and the vector space $\mathbb{L}(\sigma)$ spanned by σ is perpendicular to the vector space $\mathbb{L}(\Psi(\sigma))$ spanned by $\Psi(\sigma)$. The cells of $S_P(\mathbb{R}^n)$ that belong to X correspond to cells of $S^P(\Delta)$ of dimension greater than or equal to 1. Additionally, the cells of $S_P(\mathbb{R}^n)$ that are unbounded (for the usual Euclidian metric) are in bijection (via Ψ) with the cells of $S^P(\Delta)$ that belong to the boundary $\partial\Delta$ of $\Delta \subset \mathbb{R}^n$.

If Δ is full-dimensional and the fan Σ that gives rise to Y is its normal fan, we can extend this bijection thus: let $F : \rho \mapsto F(\rho)$ be the inclusion-reversing bijection that maps the cones of Σ to the faces of Δ to which they are normal.

Let $\rho \in \Sigma$. The hypersurface $X_\rho \subset Y_\rho \cong \mathbb{R}^n/\mathbb{L}(\rho)$ is defined by the restriction $P|^{F(\rho)}$ of the polynomial P to the face $F(\rho)$ (as in Chapter 2), and there is an inclusion-reversing bijection of cells given by

$$\begin{aligned} \Psi_\rho : S_P(Y_\rho) &\longrightarrow S^P(F(\rho)) \\ \sigma &\longmapsto \Psi_\rho(\sigma). \end{aligned}$$

We have $\dim(\sigma) + \dim(\Psi_\rho(\sigma)) = \dim(Y_\rho) = n - \dim(\rho)$ for all $\sigma \in S_P(Y_\rho)$ and the vector space $\mathbb{L}(\sigma)$ is perpendicular (in $Y_\rho \cong \mathbb{R}^n/\mathbb{L}(\rho)$) to the vector space $\mathbb{L}(\Psi_\rho(\sigma))$.

Moreover, given $\rho_1, \rho_2 \in \Sigma$ and $\sigma_1 \in S_P(Y_{\rho_1})$, $\sigma_2 \in S_P(Y_{\rho_2})$, we have that σ_1 is a face of the closure of σ_2 in Y if and only if $\Psi_{\rho_2}(\sigma_2)$ is a face of the closure of $\Psi_{\rho_1}(\sigma_1)$ in Δ and ρ_2 is a subcone of ρ_1 .

Proof. See [MR, Theorem 2.3.7] (or [Arn17] for a tediously detailed proof in French) for the first part of the statement; the second part can easily be deduced from the first part and from [MR, Section 3.2].

□

The situation gets slightly more complicated when the fan that gives rise to Y is not the dual fan of Δ . We will not consider that case here.

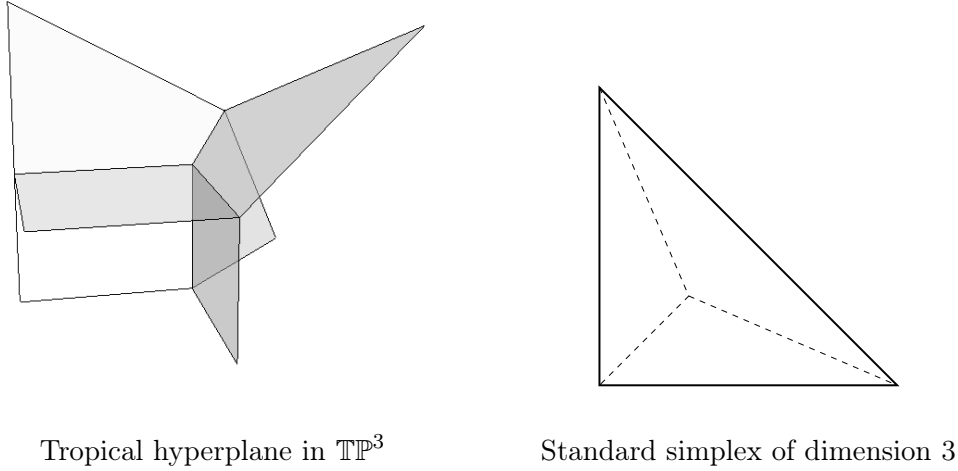
Figure 3.4: Duality for $n = 3$.

The theorem is illustrated in Figure 3.3², where one can see two curves X_{P_1} and X_{P_2} with the corresponding subdivisions $S^{P_1}(\Delta(P_1))$ and $S^{P_2}(\Delta(P_2))$ of their respective Newton polygons, as well as in Figure 3.4, where one can see the standard tropical plane in \mathbb{TP}^3 .

Let P be a tropical polynomial in n variables. If the induced subdivision $S^P(\Delta(P))$ of its Newton polytope is a primitive triangulation (see Chapter 2), we say that the tropical hypersurface $X_0 \subset \mathbb{R}^n$ to which P gives rise is *non-singular*.

If additionally the Newton polytope $\Delta(P)$ is full-dimensional and its normal fan is simplicial unimodular, and if Y is the (non-singular, compact) tropical toric variety generated by this fan, we say that the induced tropical hypersurface X is *non-singular in Y* .

Note that given such a non-singular hypersurface $X \subset Y$, the hypersurface $X_\rho = X \cap Y_\rho \subset Y_\rho$ is also non-singular (via the identification $Y_\rho \cong \mathbb{R}^{n-\dim \rho}$) for any cone ρ in the normal fan of $\Delta(P)$.

As mentioned at the beginning of this section, there are more intrinsic definitions of non-singularity; we do not need them here.

3.3 Definition of tropical homology

Tropical (co)homology is a type of (co)homology on polyhedral complexes computed using (co)sheaves that are well-suited to their structure. The pivotal article regarding tropical homology is Itenberg's, Katzarkov's, Mikhalkin's and Zharkov's [IKMZ16]. Details can also be found in [BIMS15] or [MZ14]. For a purely sheaf-theoretic approach, see [GS19].

In what follows, we restrict ourselves to cellular tropical (co)homology, though there is also a notion of singular tropical (co)homology (see the references above). They predictably turn out to be equivalent.

²Picture from [BIMS15]

The definition of cellular (co)homology that we use is slightly different from the usual one, which relies on CW-complex. The reason for this is that the one we choose is more adapted to the natural cell decomposition of the tropical toric varieties and tropical hypersurfaces that we consider (since their cells cannot be expected to be compact).

3.3.1 The tropical (co)sheaves \mathcal{F}_ρ and \mathcal{F}^p

In this section, we define a rational polyhedral complex in \mathbb{R}^n as a finite collection C of rational polyhedra (*i.e.* intersections of a finite number of rational half-spaces) such that any face of any polyhedron of C is also in C , and that the intersection of any two polyhedra in C is a face of both polyhedra. We do not ask for the polyhedra to be compact.

We define a rational polyhedron in Y to be the closure in Y of a rational polyhedron of some stratum $Y_\rho \cong \mathbb{R}^n/\mathbb{L}(\rho)$ (remember that each cone ρ of the fan generating Y is rational). We define a rational polyhedral complex in a tropical toric variety Y to be a finite collection C of rational polyhedra of Y , such that as above any face of any polyhedron of C is also in C , and that the intersection of any two polyhedra in C is a face of both polyhedra. Notice that the restriction of C to any stratum Y_ρ is a rational polyhedral complex of $\mathbb{R}^{n-\dim \rho} \cong Y_\rho$.

In particular, tropical toric varieties and tropical hypersurfaces in toric varieties are rational polyhedral complexes.

A polyhedral complex Z has the structure of a category. The objects of this category are the cells of Z and there is a morphism $\tau \rightarrow \sigma$ if the cell τ is included in σ . We use the notation Z^{op} to denote the category that has the same objects as Z , and with morphisms corresponding to the morphisms of Z but with their directions reversed. Let A be a commutative ring (for us, A will typically be either \mathbb{Z} , \mathbb{Z}_2 , \mathbb{Q} or \mathbb{R}) and let Mod_A denote the category of modules over A .

Given a polyhedral complex Z , a *cellular cosheaf* \mathcal{G} of A -modules on Z is a functor

$$\mathcal{G}: Z^{\text{op}} \rightarrow \text{Mod}_A.$$

More explicitly, a cellular cosheaf consists of a A -module $\mathcal{G}(\sigma)$ for each cell σ in Z together with a morphism $\iota_{\sigma,\tau}: \mathcal{G}(\sigma) \rightarrow \mathcal{G}(\tau)$ for each pair τ, σ when τ is a face of σ . Since \mathcal{G} is a functor, for any triple of cells $\gamma \subset \tau \subset \sigma$ the morphisms ι commute in the sense that

$$\iota_{\sigma,\gamma} = \iota_{\tau,\gamma} \circ \iota_{\sigma,\tau}.$$

Dually, a cellular sheaf \mathcal{H} of A -modules on Z is a morphism $\mathcal{H}: Z \rightarrow \text{Mod}_A$. Therefore, for each σ there is a A -module $\mathcal{H}(\sigma)$ and there are morphisms $\rho_{\tau,\sigma}: \mathcal{H}(\tau) \rightarrow \mathcal{H}(\sigma)$ when τ is a face of σ .

Let us now define the tropical cellular sheaves and cosheaves on tropical toric varieties

and hypersurfaces.

Let Y be the tropical toric variety corresponding to a fan $\Sigma \subset \mathbb{R}^n$. Let ρ be a simplicial cone of Σ which has rays in primitive integer directions r_1, \dots, r_s . Then we define the *tangent space*

$$T_{\mathbb{Z}}(Y_{\rho}) := \frac{\mathbb{Z}^n}{\mathbb{Z} \cdot \langle r_1, \dots, r_s \rangle},$$

and more generally

$$T_A(Y_{\rho}) := \frac{A \otimes \mathbb{Z}^n}{A \otimes \mathbb{Z} \cdot \langle r_1, \dots, r_s \rangle} = A \otimes T_{\mathbb{Z}}(Y_{\rho}),$$

where A is as above a commutative ring and $A \otimes \mathbb{Z} \cdot \langle r_1, \dots, r_s \rangle$ is the sub- A -module of $A \otimes \mathbb{Z}^n \cong A^n$ equal to the image of $\mathbb{Z} \cdot \langle r_1, \dots, r_s \rangle \subset \mathbb{Z}^n$ by the application $\mathbb{Z}^n \rightarrow A \otimes \mathbb{Z}^n$ (in particular, it need not be isomorphic to the abstract tensor product of A and $\mathbb{Z} \cdot \langle r_1, \dots, r_s \rangle$, though it is whenever Σ is unimodular).

If Y_{ρ} and Y_{η} are a pair of strata such that $Y_{\eta} \subset \overline{Y_{\rho}}$, then the generators of the cone η contain the generators of the cone ρ and thus we get projection maps

$$\pi_{\rho, \eta}: T_A(Y_{\rho}) \rightarrow T_A(Y_{\eta}). \quad (3.3.1)$$

Now let Z be a rational polyhedral complex in Y . In what follows, Z is usually a tropical hypersurface $X \subset Y$ with its natural cell structure, or Y itself with the natural cell structure induced by its strata or the cell structure induced by X .

For each cell σ in Z , its relative interior relint σ is contained in some stratum Y_{ρ} of Y . Let $T_{\mathbb{R}}(\sigma)$ denote the tangent space to relint σ in $T_{\mathbb{R}}(Y_{\rho})$. Since σ is rational, there is a full rank lattice $T_{\mathbb{Z}}(\sigma) \subset T_{\mathbb{R}}(\sigma)$. We can, as above, define the *tangent space* $T_A(\sigma) := A \otimes T_{\mathbb{Z}}(\sigma)$.

Now for each $p \geq 0$, we define the *integral p -multi-tangent space*

$$\mathcal{F}_p^{Z,A}(\sigma) = \sum_{\sigma \subset \tau \subset Z_{\rho}} \bigwedge^p T_A(\tau),$$

where we sum the spaces $\bigwedge^p T_A(\tau)$ (for each cell τ of $Z_{\rho} := Z \cap Y_{\rho}$ containing σ) as subspaces of the ambient p -multi-tangent space $\bigwedge^p T_A(Y_{\rho})$.

For $\tau \subset \sigma$, the maps of the cellular cosheaf $i_{\sigma, \tau}: \mathcal{F}_p^{Z,A}(\sigma) \rightarrow \mathcal{F}_p^{Z,A}(\tau)$ are induced by natural inclusions when relint(σ) and relint(τ) are in the same stratum of Y , and are induced by the quotients $\pi_{\rho, \eta}$ composed with inclusions when relint(σ) $\subset Y_{\rho}$ and relint(τ) $\subset Y_{\eta}$.

We can likewise define a collection of cellular sheaves $\mathcal{F}_{Z,A}^p$ from the cosheaves $\mathcal{F}_p^{Z,A}$. For a face σ of Z , set $\mathcal{F}_{Z,A}^p(\sigma) = \text{Hom}(\mathcal{F}_p^{Z,A}(\sigma), A)$. For τ a face of σ , the map $\rho_{\tau, \sigma}: \mathcal{F}_{Z,A}^p(\tau) \rightarrow \mathcal{F}_{Z,A}^p(\sigma)$ is given by dualizing the corresponding map from the cosheaf $\mathcal{F}_p^{Z,A}$.

Example 3.3.1. Let Y be a tropical toric variety. Consider the polyhedral structure on

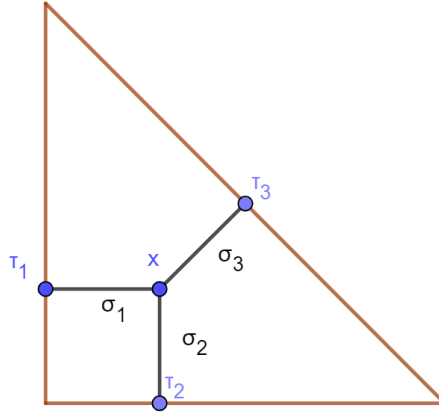

Figure 3.5: The tropical line X in \mathbb{TP}^2 from Example 3.3.2

Y given by $Y = \bigcup \bar{Y}_\rho$ induced by the toric stratification. One has

$$\mathcal{F}_p^Y(\bar{Y}_\rho, \mathbb{Z}) = \bigwedge^p T_{\mathbb{Z}}(Y_\rho) \cong \bigwedge^p \mathbb{Z}^{\text{codim} \rho},$$

and the cosheaf maps are the maps induced by the projection maps $\pi_{\rho, \eta}$ defined in (3.3.1).

Example 3.3.2. Figure 3.5 shows a tropical line X contained in the tropical projective plane \mathbb{TP}^2 from Example 3.2.1. The polyhedral structure on \mathbb{TP}^2 induced by X has 7 vertices, 9 edges, and 3 faces of dimension 2.

For any face σ of this polyhedral structure on \mathbb{TP}^2 , the rank of $\mathcal{F}_p^{\mathbb{TP}^2, \mathbb{Z}}(\sigma)$ depends only on the dimension of the stratum of \mathbb{TP}^2 which contains the relative interior $\text{relint}(\sigma)$. If $\text{relint}(\sigma)$ is contained in a stratum of \mathbb{TP}^2 of dimension k then $\mathcal{F}_p^{\mathbb{TP}^2, \mathbb{Z}}(\sigma) \cong \bigwedge^p \mathbb{Z}^k$.

The directions of the rays of the fan for \mathbb{TP}^2 are

$$v_1 = (-1, 0), \quad v_2 = (0, -1), \quad \text{and} \quad v_3 = (1, 1).$$

Referring to the labeling in Figure 3.5, we have

$$\mathcal{F}_1^{X, \mathbb{Z}}(x) = \langle v_1, v_2, v_3 \rangle \cong \mathbb{Z}^2, \quad \mathcal{F}_1^{X, \mathbb{Z}}(\sigma_i) = \langle v_i \rangle, \quad \text{and} \quad \mathcal{F}_1^{X, \mathbb{Z}}(\tau_i) = 0.$$

When $p = 0$, we have $\mathcal{F}_0^{X, \mathbb{Z}}(\gamma) = \mathbb{Z}$ for all γ in X and $\mathcal{F}_p^{X, \mathbb{Z}}(\gamma) = 0$ for all γ in X when $p \geq 2$.

Example 3.3.3. Let as before $H_n \subset \mathbb{R}^{n+1}$ denote the standard tropical hyperplane in \mathbb{R}^{n+1} . If v is the vertex of H_n , then $\mathcal{F}_p^{H_n, \mathbb{Z}}(v) = \bigwedge^p \mathbb{Z}^{n+1}$ for $0 \leq p \leq n$, and $\mathcal{F}_p^{H_n, \mathbb{Z}}(v) = 0$ otherwise.

3.3.2 The tropical homology groups

In order to define the cellular tropical homology and cohomology groups of a polyhedral complex Z , we must fix an orientation for each of its cells. Let Z^q denote the cells of dimension q of Z . We define an *orientation map* $\mathcal{O}: Z^q \times Z^{q-1} \rightarrow \{0, 1, -1\}$ on pairs of cells by:

$$\mathcal{O}(\sigma, \tau) := \begin{cases} 0 & \text{if } \tau \not\subset \sigma, \\ 1 & \text{if the orientation of } \tau \text{ coincides with its orientation in } \partial\sigma, \\ -1 & \text{if the orientation of } \tau \text{ differs from its orientation in } \partial\sigma. \end{cases}$$

Let Z be a polyhedral complex and \mathcal{G} a cellular cosheaf on Z . The groups of *cellular q -chains in Z with coefficients in \mathcal{G}* are

$$C_q(Z; \mathcal{G}) = \bigoplus_{\substack{\dim \sigma = q \\ \sigma \text{ compact}}} \mathcal{G}(\sigma).$$

Note that we do not ask that the cells be compact, and simply ignore those that aren't (more on this below). The boundary maps $\partial: C_q(Z; \mathcal{G}) \rightarrow C_{q-1}(Z; \mathcal{G})$ are given by the direct sums of the cosheaf maps $i_{\sigma, \tau}$ for $\tau \subset \sigma$ tensorized by the orientation maps $\mathcal{O}(\sigma, \tau)$ for all τ and σ . The *q -th homology group of \mathcal{G}* is

$$H_q(Z; \mathcal{G}) = H_q(C_\bullet(Z; \mathcal{G})).$$

Similarly, let Z be a polyhedral complex and \mathcal{G} a cellular cosheaf on Z . The groups of *Borel-Moore cellular q -chains in Z with coefficients in \mathcal{G}* are

$$C_q^{BM}(Z; \mathcal{G}) = \bigoplus_{\dim \sigma = q} \mathcal{G}(\sigma).$$

The boundary maps $\partial: C_q^{BM}(Z; \mathcal{G}) \rightarrow C_{q-1}^{BM}(Z; \mathcal{G})$ are given by the direct sums of the cosheaf maps $i_{\sigma, \tau}$ for $\tau \subset \sigma$ tensorized by the orientation maps $\mathcal{O}(\sigma, \tau)$ for all τ and σ . The *q -th Borel-Moore homology group of \mathcal{G}* is

$$H_q^{BM}(Z; \mathcal{G}) = H_q(C_\bullet^{BM}(Z; \mathcal{G})).$$

In particular, we define the *(p, q) -th tropical homology group with coefficients in A* of a rational polyhedral complex Z in a tropical toric variety Y to be

$$H_q(Z; \mathcal{F}_p^{Z, A}) = H_q(C_\bullet(Z; \mathcal{F}_p^{Z, A})).$$

We sometimes refer to it as a *standard* tropical homology group, to better distinguish it from the (p, q) -th *Borel-Moore tropical homology group with coefficients in A* , which we define as

$$H_q^{BM}(Z; \mathcal{F}_p^{Z,A}) = H_q(C_\bullet^{BM}(Z; \mathcal{F}_p^{Z,A})).$$

Of course, both coincide if Z is compact.

Likewise, if \mathcal{G} is a cellular sheaf on a polyhedral complex Z , then the group of q cochains and q cochains with compact support of \mathcal{G} are respectively

$$C^q(Z; \mathcal{G}) = \bigoplus_{\substack{\dim \sigma = q \\ \sigma \text{ compact}}} \mathcal{G}(\sigma) \quad \text{and} \quad C_c^q(Z; \mathcal{G}) = \bigoplus_{\dim \sigma = q} \mathcal{G}(\sigma).$$

The complex of cochains and cochains with compact support of \mathcal{G} are formed from the cochain groups together with the restriction maps $r_{\tau, \sigma}$ combined with the orientation map \mathcal{O} as in the case of cosheaves. The cohomology groups and cohomology groups with compact support of \mathcal{G} are respectively,

$$H^q(Z; \mathcal{G}) := H^q(C^\bullet(Z; \mathcal{G})) \quad \text{and} \quad H_c^q(Z; \mathcal{G}) := H^q(C_c^\bullet(Z; \mathcal{G})).$$

In particular, we have

$$C^q(Z; \mathcal{F}_{Z,A}^p) = \text{Hom}(C_q(Z; \mathcal{F}_p^{Z,A}), A) \quad \text{and} \quad C_c^q(Z; \mathcal{F}_{Z,A}^p) = \text{Hom}(C_q^{BM}(Z; \mathcal{F}_p^{Z,A}), A),$$

and we define the *(standard) tropical cohomology groups with coefficients in A* and *tropical cohomology groups with compact support and coefficients in A* of a rational polyhedral complex Z in a tropical toric variety Y to be respectively

$$H^q(Z; \mathcal{F}_{Z,A}^p) := H^q(C^\bullet(Z; \mathcal{F}_{Z,A}^p))$$

and

$$H_c^q(Z; \mathcal{F}^p Z, A) := H^q(C_c^\bullet(Z; \mathcal{F}_{Z,A}^p)).$$

Remark 3.3.4. *Observe that when $p = 0$, the sheaf $\mathcal{F}_{Z,A}^0$ is simply the constant sheaf associated to the ring A (and similarly for the cosheaf $\mathcal{F}_0^{Z,A}$).*

Remark 3.3.5. *Note that this definition is dependent on the ambient space Y in which the rational polyhedral complex is embedded.*

The Borel-Moore tropical cellular homology groups and tropical cellular cohomology groups with compact support of a rational polyhedral complex in a tropical toric variety Y hence defined are independent from the cell structure considered (and equal to the corresponding singular (co)homology groups).

On the other hand, an additional assumption needs to be made in the standard case.

Following J. Curry in [Cur13, Chapter 4], we define a *regular cell complex* to be a space X equipped with a partition into cells $\{X_\alpha\}_{\alpha \in A}$ such that

1. Each point $x \in X$ admits an open neighborhood intersecting only finitely many X_α .
2. For any $\alpha \in A$, the open cell X_α is homeomorphic to \mathbb{R}^k for some k .
3. If $\overline{X_\alpha} \cap X_\beta \neq \emptyset$, then $X_\beta \subset \overline{X_\alpha}$.
4. For any $\alpha \in A$, the pair $(\overline{X_\alpha}, X_\alpha)$ is homeomorphic to the pair (B^k, \mathring{B}^k) , where B^k is the closed k -dimensional ball and \mathring{B}^k the open k -dimensional ball.

Note that this is a stricter definition than what is common for regular CW-complexes.

Curry also defines a *cell complex* to be a space X equipped with a partition into cells $\{X_\alpha\}_{\alpha \in A}$ satisfying the first three conditions of the definition of a regular cell complex, and such that its one-point compactification, with the cell decomposition $\{X_\alpha\}_{\alpha \in A} \cup \{\{\infty\}\}$, is a regular cell complex.

Then Curry shows that the cellular (in the usual sense, *i.e.* computed using a CW-complex structure) homology of a cosheaf (respectively, the cellular cohomology of a sheaf) on a space with a cell complex structure can be computed using that cell decomposition and considering only compact cells (even though that cell decomposition does not necessarily satisfy the conditions to be a regular CW-complex), as we did above (see [Cur13, Chapter 6] or [Cur14, Chapter 7]).

As a rational polyhedral complex in a tropical toric variety automatically satisfies the first three conditions of the definition of a regular cell complex, we only have to ask that its one-point compactification (with the induced cell structure) be a regular cell complex for it to be a cell complex. Hence, under that assumption, we know that the standard tropical (co)homology groups $H_q(Z; \mathcal{F}_p^{Z,A})$ and $H^q(Z; \mathcal{F}_{Z,A}^p)$ are independent of the chosen decomposition (and in fact equal to the corresponding singular (co)homology groups).

In what follows, we will only ever compute the standard tropical (co)homology of cell complexes.

The following lemma helps us characterize tropical hypersurfaces in \mathbb{R}^n that are cell complexes.

Lemma 3.3.6. *Let P be a non-trivial tropical polynomial in n variables, Δ be its Newton polytope, and X be the induced tropical hypersurface in \mathbb{R}^n . Then \mathbb{R}^n , equipped with the natural cell decomposition induced by X , is a cell complex if and only if Δ is full-dimensional.*

Proof. Suppose first that Δ is of dimension $k < n$. Then one can find a cell σ of X of dimension $n - k$ that is homeomorphic to \mathbb{R}^{n-k} , and such that its closure $\tilde{\sigma}$ in the one-point compactification of \mathbb{R}^n is homeomorphic to the $(n - k)$ -sphere (and thus not homeomorphic to the $(n - k)$ -closed ball).

Conversely, suppose that Δ is full-dimensional. The recession cone of a cell σ is the set

$$C_\sigma := \{v \in \mathbb{R}^n \mid x + \lambda v \in \sigma \text{ for any } x \in \sigma \text{ and any } \lambda \in \mathbb{R}_{\geq 0}\}.$$

For any cell σ of X , it is easy to show (by considering the cell of the subdivision of Δ induced by P that is dual to σ under the Duality Theorem 3.2.4) that the recession cone of σ is such that its intersection with the $(n-1)$ -sphere $\{x \in \mathbb{R}^n \mid |x| = 1\}$ is contractible. One can then consider a first compactification of \mathbb{R}^n as the ball B^n (where we identify its interior with \mathbb{R}^n). In this compactification, the closure $\tilde{\sigma}$ of σ is such that the pair $(\tilde{\sigma}, \sigma)$ is homeomorphic to $(B^{\dim \sigma}, \mathring{B}^{\dim \sigma})$. We can then quotient B^n by its boundary $B^n \setminus \mathbb{R}^n$ to obtain the one-point compactification of \mathbb{R}^n . As the intersection $C_\sigma \cap S^{n-1}$ was contractible, it is easy to see that the closure $\bar{\sigma}$ of σ in this new compactification is such that the pair $(\bar{\sigma}, \sigma)$ is homeomorphic to $(B^{\dim \sigma}, \mathring{B}^{\dim \sigma})$. \square

Observe that if \mathbb{R}^n with the cell structure induced by X is a cell complex, then so is X .

Under reasonable conditions, many well-known results regarding classical homology also carry over to tropical homology, such as the Mayer-Vietoris sequence (see [JRS17]), an analog to one of the corollaries of Lefschetz's hyperplane section theorem (see Chapter 7), Künneth's formula (see [GS19]) or Poincaré duality with integer coefficients, which is stated below.

Theorem 3.3.7. *Let Z be either an n -dimensional non-singular tropical toric variety, a non-singular tropical hypersurface in \mathbb{R}^{n+1} , or an n -dimensional non-singular tropical hypersurface in a (non-singular compact) tropical toric variety. Then for all q, p , we have a canonical isomorphism*

$$H^q(Z; \mathcal{F}_{Z, \mathbb{Z}}^p) \cong H_{n-q}^{BM}(Z; \mathcal{F}_{n-p}^{Z, \mathbb{Z}}).$$

Proof. See either [JRS17] or [GS19]. \square

Poincaré duality with coefficients in \mathbb{Q} or \mathbb{R} immediately follows.

The statement is in fact stated in both [JRS17] and [GS19] for tropical manifolds, which we have not defined here. Non-singular tropical toric varieties and non-singular tropical hypersurfaces are special cases of tropical manifolds.

We further study the links between the tropical homology of a tropical variety and the usual homology of related real algebraic varieties in Chapters 4, 7 and 9.

Chapter 4

Tropical homology, Betti numbers and Kalinin's spectral sequence

4.1 Chapter introduction

In this chapter, we detail some connections between the algebraic and the tropical worlds; in particular, we relate the homology of the real and complex parts of a real algebraic hypersurface obtained by combinatorial patchworking and the homology of some tropical cosheaf on an associated tropical hypersurface. This also allows us to explain the motivations behind the results of Chapter 7.

This principle can be traced back to I. Itenberg's, L. Katzarkov's, G. Mikhalkin's and I. Zharkov's major article [IKMZ16], which shows that the (p, q) -th tropical homology group with coefficients in \mathbb{Q} of a non-singular projective tropical variety obtained as the tropical limit (more on this below) of a one-parameter family of complex projective algebraic varieties is equal to the (p, q) -th Hodge number of a general member of that family.

Roughly summarized, the core idea that we develop here (which is also present in the aforementioned article) is that a patchworked hypersurface can be seen as a fibration of sorts on a related tropical hypersurface; we can then consider an analog of the Leray-Serre spectral sequence associated to that fibration, whose second page-terms will be homology groups on the tropical hypersurface, with coefficients in the homology of the fibers. Under certain circumstances, those homology groups coincide with the tropical homology groups defined in Chapter 3.

The content of this chapter belongs to a gray area of sorts, in the sense that we do not expose new results or entirely new concepts, but rather a point of view which, as far as the author is aware, does not appear in this level of generality in the literature (as an example, both [IKMZ16] and [RS18] only consider the non-singular case). That is not to say that no one else is familiar with that point of view, but it is nonetheless more "experimental"

than the rest of Part I. As it is still a work in progress, we allow ourselves a slightly lesser degree of rigour here than in the rest of this text. The same applies to Chapter 9, which is the direct continuation of this chapter.

4.2 Tropical hypersurfaces as limits of families of patchworked real algebraic hypersurfaces

We use the concepts and notations of Chapter 2.

Consider the map

$$\begin{aligned} \text{Log}_t : (\mathbb{C}^*)^n &\longrightarrow \mathbb{R}^n \\ (z_1, \dots, z_n) &\longmapsto (\log_t(|z_1|), \dots, \log_t(|z_n|)), \end{aligned}$$

for some $t \in \mathbb{R}_{>0}$.

Given a Laurent polynomial P in n variables, we call $\text{Log}_t(V_{(\mathbb{C}^*)^n}(P)) \subset \mathbb{R}^n$ the *amoeba* of $V_{(\mathbb{C}^*)^n}(P)$. Note that the amoeba only retains information on the amplitude of the coordinates of the points of $V_{(\mathbb{C}^*)^n}(P)$; their argument appears in the definition of the coamoeba, which can be found in Chapter 8. Together, they can be used to define the *phase tropical variety* - see [KZ16].

Consider also a family of real Laurent polynomials

$$P_t(z) := \sum_{\lambda \in \Delta \cap \mathbb{Z}^n} c_\lambda t^{\mu(\lambda)} z^\lambda$$

indexed by a real parameter $t > 0$, where Λ is a finite subset of \mathbb{Z}^n and we have $c_\lambda \in \mathbb{R}^*$ and $\mu(\lambda) \in \mathbb{R}$ for all $\lambda \in \Lambda$.

Then it can be shown (see for example [Mik04]) that $\text{Log}_{t^{-1}}(V_{(\mathbb{C}^*)^n}(P_t))$ converges, with respect to the Hausdorff distance on closed sets, to the tropical hypersurface $X_P \subset \mathbb{R}^n$ to which the tropical polynomial $P(X) := \sum_{\lambda \in \Delta \cap \mathbb{Z}^n} -\mu(\lambda) X^\lambda$ gives rise, as $t \xrightarrow{\geq} 0$. We say that P is the *tropical limit* of the polynomials P_t , and that X_P is the *tropical limit* of the hypersurfaces $V_{(\mathbb{C}^*)^n}(P_t)$. This process is illustrated in Figure 4.1¹. Similar statements can be made using a toric variety (and the associated tropical toric variety) as the ambient space of the hypersurfaces induced by the polynomials P_t .

Such a family $\{P_t\}_{t>0}$ of real Laurent polynomials can for example be obtained as the result of a patchworking of polynomials Q_1, \dots, Q_s , where μ is assumed to be the restriction to Λ of a piecewise linear convex function on the Newton polytope $\Delta = \text{Conv}(\Lambda)$ whose domains of linearity are the Newton polytopes $\Delta(Q_i)$. In that context, we refer to X_P as to the tropical hypersurface associated to the real hypersurface P_t of the algebraic torus,

¹Images from [BIMS15]

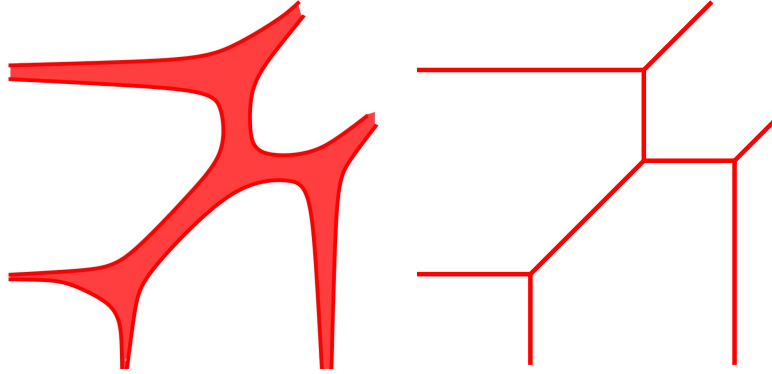

Figure 4.1: An amoeba in \mathbb{R}^2 , and the associated tropical limit.

for any $t > 0$ small enough that the conclusions of the Main Patchwork Theorem 2.2.1 apply.

We consider such a tropical hypersurface X_P and such real hypersurfaces P_t for the rest of the chapter.

Note that if $\{P_t\}_{t>0}$ was obtained using a primitive triangulation, the associated hypersurface X_P is non-singular. In that special case, interesting computations can already be made. Indeed, using a cell structure on $V_{\mathbb{R}P^n}(P_t)$ (for $t > 0$ small enough) suggested by the description of (a piecewise linear hypersurface isotopic to) its chart in Subsection 2.3, one can easily compute the Euler characteristic of $V_{\mathbb{R}P^n}(P_t)$. Likewise, there is a relatively simple combinatorial description of the tropical characteristics $\chi(C_{\bullet}^{BM}(X_P; \mathcal{F}_p^{X_P}))$ (see Chapter 7 for more on those). Using the main result from [IKMZ16], the author was then able to find (in his Master thesis [Arn17]) a purely combinatorial proof of a result by B. Bertrand (see [Ber10]), which stated that under those assumptions,

$$\chi(V_{\mathbb{R}P^n}(P_t)) = \sigma(V_{\mathbb{C}P^n}(P_t)),$$

where $\sigma(V_{\mathbb{C}P^n}(P_t))$ is the signature of the intersection form on $H^{n-1}(V_{\mathbb{C}P^n}(P_t))$. In fact, both proofs generalize to complete intersections in non-singular toric varieties (see [Arn17] and [BB07]).

To simplify notations, let us call X_t the real algebraic hypersurface induced by the polynomial P_t in either the algebraic torus or a reasonable toric variety, and X the associated tropical variety (in either the tropical torus \mathbb{R}^n or the corresponding tropical toric variety). When $t > 0$ is small enough, it can be shown, as in Mikhalkin's [Mik04], that there is a continuous surjection

$$F : \mathbb{C}X_t \longrightarrow X$$

which respects the natural cell structure on X in the following sense: let σ be a k -dimensional cell of sedentarity 0 of X , dual to some face γ of dimension $n - k$ of the associ-

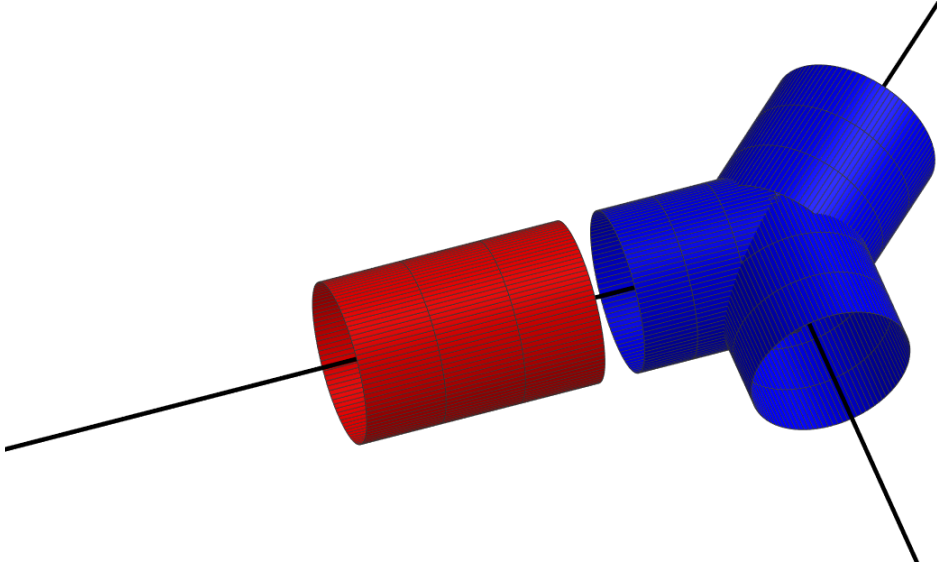
Figure 4.2: The stratified fibration F .

ated subdivision of the Newton polytope Δ of P (see the Duality Theorem 3.2.4). Then the corestriction of F to the relative interior of σ is a trivial fibration, whose fiber is diffeomorphic to $\mathbb{C}X_\sigma \times (S^1)^k$, where S^1 is the unit circle and X_σ is the $(n-k-1)$ -dimensional real algebraic hypersurface in the algebraic torus induced by $P_t|_\sigma$, seen (via a change of coordinates) as a polynomial in $n-k$ variables. We define $\mathbb{C}O_\sigma := F^{-1}(\text{relint}(\sigma)) \cong \mathbb{C}X_\sigma \times (\mathbb{C}^*)^k$, and $\mathbb{R}O_\sigma \subset \mathbb{R}X_t$ as the real part of $\mathbb{C}O_\sigma \subset \mathbb{C}X_t$.

When $\tau \subset \sigma$ is face of sedentarity 0 of σ in X , there is a morphism $i_{\sigma,\tau} : O_\sigma \rightarrow O_\tau$, which is the composition of a homotopy equivalence and an inclusion. Those morphisms are natural, in the sense that if $\tau \subset \sigma \subset \eta$, we have $i_{\sigma,\tau} \circ i_{\eta,\sigma} = i_{\eta,\tau}$.

In the primitive case, for a cell σ of dimension k , each $\mathbb{C}X_\sigma$ (respectively, $\mathbb{R}X_\sigma$) is a generic hyperplane in $(\mathbb{C}^*)^{n-k}$ (respectively, in $(\mathbb{R}^*)^{n-k}$), or equivalently the complement of a generic arrangement of $n-k+1$ hyperplanes in $\mathbb{C}\mathbb{P}^{n-k-1}$ (respectively, in $\mathbb{R}\mathbb{P}^{n-k-1}$). Following Mikhalkin, we call it the $(n-k+1)$ -dimensional *pair of pants*, and denote it as $\mathbb{C}\mathcal{P}^{n-k-1}$ (and $\mathbb{R}\mathcal{P}^{n-k-1}$ for its real points). The topology of the real part $\mathbb{R}\mathcal{P}^l$ of an l -dimensional pair of pants is not very interesting, as it is simply a disjoint union of $2^l - 1$ contractible connected components. The topology of the complex part is more complicated (see for example [OT92]).

This is illustrated in Figure 4.2, where X is a tropical curve, σ is one of its edges and $\tau \subset \sigma$ one of its vertices. In red, $\mathbb{C}O_\sigma$ is diffeomorphic to \mathbb{C}^* . In blue, $\mathbb{C}O_\tau$ is diffeomorphic to the 1-dimensional pair of pants, which is in fact the usual pair of pants (*i.e.* a sphere minus three points).

The situation is similar when considering cells of nonzero sedentarity. Suppose that the ambient tropical toric variety is non-singular and spanned by the Newton polytope of P

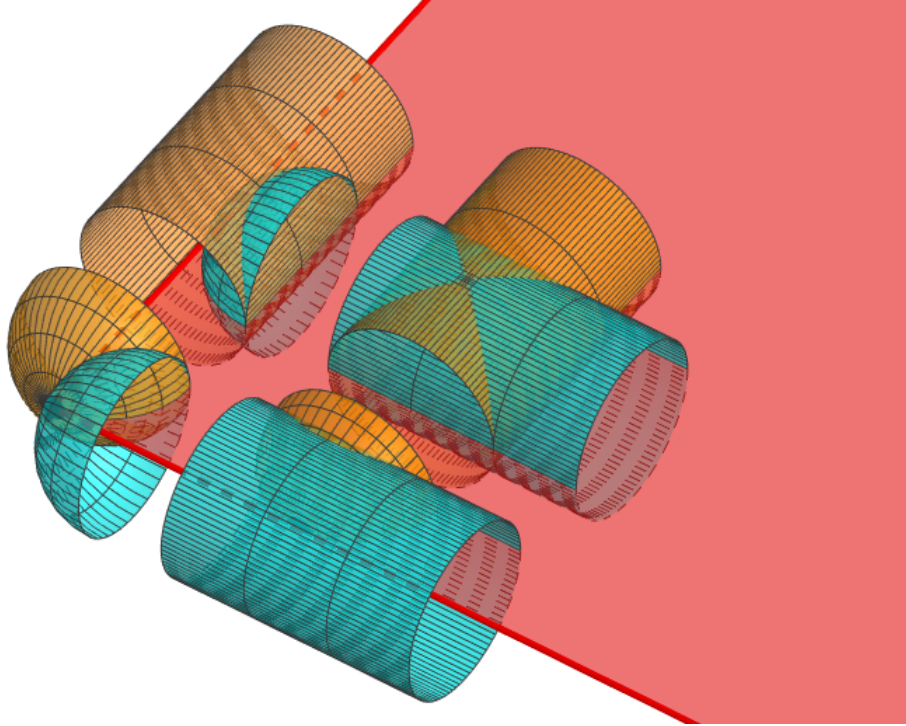

Figure 4.3: The stratified fibration F in nonzero sedentarity.

(so that the Duality Theorem 3.2.4 applies). Let σ be a k -dimensional cell of sedentarity i of X , dual to some face γ of dimension $n - i - k$ of the associated subdivision of the Newton polytope Δ of P (see the Duality Theorem 3.2.4). Then we can assume (if we are careful in our definition of F) that the corestriction of F to the relative interior of σ is a trivial fibration, whose complex fiber is diffeomorphic to $\mathbb{C}X_\sigma \times \mathbb{C}^i \times (S^1)^k$, where as above S^1 is the unit circle and X_σ is the $(n - i - k - 1)$ -dimensional real algebraic hypersurface induced by $P_i|_\gamma$. We also have $\mathbb{C}O_\sigma = F^{-1}(\text{relint}(\sigma)) \cong \mathbb{C}X_\sigma \times \mathbb{C}^i \times (\mathbb{C}^*)^k$.

This is illustrated in Figure 4.3. In red, we see an open set of X , homeomorphic (as a stratified space) to \mathbb{T}^2 . There is a 0-dimensional cell τ of sedentarity 2, two 1-dimensional cells σ_1, σ_2 of sedentarity 1 and a 2-dimensional cell η of sedentarity 0. Above η , we have $\mathbb{C}O_\eta \cong (\mathbb{C}^*)^2$, represented as the product of two cylinders (a blue one and an orange one). Above each cell σ_i , we can see $\mathbb{C}O_{\sigma_i} \cong \mathbb{C}^* \times \mathbb{C}$, represented as the product of a cylinder and a half-sphere, and above τ , we have $\mathbb{C}O_\tau \cong \mathbb{C}^2$, represented as the product of two half-spheres. The morphism $i_{\eta, \sigma_i} : \mathbb{C}O_\eta \rightarrow \mathbb{C}O_{\sigma_i}$ is homotopically equivalent to $i \times \text{id} : \mathbb{C}^* \times \mathbb{C}^* \rightarrow \mathbb{C} \times \mathbb{C}^*$, where $i : \mathbb{C}^* \rightarrow \mathbb{C}$ is the inclusion. Increasing the sedentarity corresponds to "closing holes".

This decomposition of the hypersurface induced by X_t into simpler pieces (the spaces O_σ) is, in a sense, nothing more than the statement of the Main Patchwork Theorem; the piece O_σ corresponds to the chart of the polynomial $Q_i|_\gamma$, where γ belongs to the Newton

polytope $\Delta_i \subset \Delta$ of Q_i and is the cell of Δ dual to σ (see for example [IMS09, Lemma 2.17]).

4.3 The Leray-Serre spectral sequence of the fibration

Let A be a commutative ring. In this section, we suppose that X is compact and make no distinction between Borel-Moore and standard homology in order to simplify notations. Otherwise, one can simply proceed as in Section 3.3. We also assume that $t > 0$ is small enough for the situation to be as described in the previous section.

For each $p \in \mathbb{N}$, we define two cellular cosheaves $\mathbb{C}\mathcal{U}_p^A$ and $\mathbb{R}\mathcal{U}_p^A$ on X (as we defined the tropical cosheaves \mathcal{F}_p in Section 3.3) in the following way : for a cell σ in X and $K \in \{\mathbb{C}, \mathbb{R}\}$, we set

$$K\mathcal{U}_p^A(\sigma) := H_p(KO_\sigma; A).$$

When $\tau \subset \sigma$, the morphism $i_{\sigma,\tau} : KO_\sigma \rightarrow KO_\tau$ induces morphisms $K\mathcal{U}_p^A(\sigma) \rightarrow K\mathcal{U}_p^A(\tau)$. This allows us to define the cellular chain groups

$$C_q(X; K\mathcal{U}_p^A) := \bigoplus_{\dim \sigma = q} K\mathcal{U}_p^A(\sigma)$$

and (tensorizing with the orientation morphisms between the cells) the associated cellular chain complexes $C_\bullet(X; K\mathcal{U}_p^A)$ and homology groups

$$H_q(X; K\mathcal{U}_p^A) := H_q(C_\bullet(X; K\mathcal{U}_p^A)).$$

The cosheaves $\mathbb{C}\mathcal{U}_p^A$ could also be considered tropical cosheaves of sorts, and perhaps more legitimately (as is shown below) than the usual cosheaves \mathcal{F}_p^A defined in Section 3.3. To better distinguish them, we introduce the following convention: we call $\mathbb{C}\mathcal{U}_p^A$ (respectively $\mathbb{R}\mathcal{U}_p^A$) the p -th *round* tropical cosheaf with coefficients in A (respectively, the p -th *real round* tropical cosheaf with coefficients in A), and $\mathcal{F}_p^{X,A}$ the p -th *pointy* tropical cosheaf with coefficients in A . The former are round because U is a round letter, and the latter is pointy because it is defined using exterior products of vector spaces, and both vectors and the \wedge symbol are well-known to be pointy.

When X_t is the result of a primitive combinatorial patchworking, and thus O_σ is a higher-dimensional pair of pants for each cell σ in X , it can be shown (see [Mik04] or [Zha13] for inspiration) that we have an isomorphism $\mathcal{F}_p^{X,A} \cong \mathbb{C}\mathcal{U}_p^A$ as cosheaves, which immediately implies an isomorphism of homology groups. If X_t is the result of a non-primitive patchworking, however, this is not the case. For example, if σ is an n -dimensional simplex of volume $\frac{k}{n!}$ (with $k > 1$) in the subdivision of Δ , and if the associated polynomial Q_i (such that σ is the Newton polytope of Q_i) is simplicial, it is known (see for example [DK86] or [GKZ94]) that $\mathbb{C}O_\sigma = V_{(\mathbb{C}^*)^n}(Q_i)$ is such that $\mathbb{C}\mathcal{U}_{n-1}^A(\sigma) = H_{n-1}(\mathbb{C}O_\sigma; A)$ is of

rank $n - 1 + k$. On the other hand, $\mathcal{F}_{n-1}^{X,A}(\sigma) \subset \bigwedge^{n-1} \mathbb{R}^n$ is of rank at most n .

Now consider the k -skeleton $X^k \subset X$, where the cell structure on X is the natural one (see Chapter 3), and define $\mathbb{C}Y^k := F^{-1}(X^k)$ and $\mathbb{R}Y^k := \mathbb{C}Y^k \cap \mathbb{R}X_t$. Let $K \in \{\mathbb{C}, \mathbb{R}\}$.

There is an induced filtration of topological spaces $\emptyset \subset KY^0 \subset \dots \subset KY^{n-2} \subset KY^{n-1} = KX_t$, which in turn induces an analog (as the fiber is not constant) of the Leray-Serre spectral sequence, whose terms we denote as $E_{p,q}^{r,LS,K}$ (where $r \geq 0$ is the number of the page). Both the chosen coefficients ring A and the spaces X and X_t are implicit; however, we add "LS" as an index, as this is not the only spectral sequence that we will be considering.

This spectral sequence has the following properties:

- $E_{p,q}^{1,LS,K} = C_q(X; KU_p^A)$, and ∂_1 coincides with the differentials of the cellular round tropical homology complexes $C_\bullet(X; KU_p^A)$.
- $E_{p,q}^{2,LS,K} = H_q(X; KU_p^A)$.
- The spectral sequence converges (in a finite number of steps) to $H_*(KX_t; A)$, *i.e.* there exists a filtration $\emptyset = F_{-1}H_{p+q}(KX_t; A) \subset F_0H_{p+q}(KX_t; A) \subset \dots \subset F_{p+q}H_{p+q}(KX_t; A) = H_{p+q}(KX_t; A)$ such that $E_{p,q}^{\infty,LS,K} \cong F_pH_{p+q}(KX_t; A)/F_{p-1}H_{p+q}(KX_t; A)$.

The existence and properties of $E_{\bullet,\bullet}^{\bullet,LS,K}$ can be proved by choosing a cell structure on $\mathbb{C}X_t$ compatible with the stratified fibration F and the real structure, and in the same way as for the usual Leray-Serre spectral sequence (see the chapter on spectral sequences in [FF16]).

The appearance of round tropical homology groups on the second page of the complex spectral sequence $E_{\bullet,\bullet}^{\bullet,LS,\mathbb{C}}$ is the reason why we described them as "better" than the pointy tropical homology groups, which do not enjoy that connection to the homology of the complex part $\mathbb{C}X_t$ (nor to the homology of the real part - see the next section).

In the case of a primitive combinatorial patchworking, we know from [IKMZ16] that the spectral sequence $E_{\bullet,\bullet}^{\bullet,LS,\mathbb{C}}$ degenerates on the second page, and that if we let $A = \mathbb{Q}$, we have

$$\dim E_{p,q}^{2,LS,\mathbb{C}} = \dim H_q(X; \mathbb{C}U_p^{\mathbb{Q}}) = h^{p,q}(\mathbb{C}X_t),$$

where $h^{p,q}(\mathbb{C}X_t)$ is the (p, q) -th Hodge number of $\mathbb{C}X_t$. When X is a tropical hypersurface (as opposed to a more general tropical variety), we recover this result through purely combinatorial means in Chapter 7 (see Corollary 7.1.9).

In general, it is not as clear whether the Leray-Serre spectral sequence degenerates on the second page, or later.

The spectral sequence $E_{\bullet,\bullet}^{\bullet,LS,\mathbb{R}}$ of the real part is simpler. In fact, when X_t has been obtained as the result of a (non-necessarily primitive) combinatorial patchworking, which is the case in which we are most interested, the spaces $\mathbb{R}O_\sigma$ are unions of contractible components (see Lemma 8.5.1). Hence $\mathbb{R}U_p^A(\sigma) = H_p(\mathbb{R}O_\sigma; A) = 0$ if $p \neq 0$ for every cell

σ . Moreover, the first line $E_{0,q}^{1,LS,\mathbb{R}} = C_q(X; K\mathcal{U}_0^A)$ of the first page of the spectral sequence (which is the only non-trivial line) associated to the real part is simply a cellular chain complex (for the usual, non-tropical constant cosheaf \underline{A}) corresponding to a certain cell structure on $\mathbb{R}X_t$ (the one induced by the fibration F , where each cell in $\mathbb{R}X_t$ is a copy in a certain quadrant of a cell of X). Hence the spectral sequence always degenerates on the second page, $E_{p,q}^{2,LS,\mathbb{R}} = 0$ for $p \neq 0$ and $E_{0,q}^{2,LS,\mathbb{R}} = H_q(X; \mathbb{R}\mathcal{U}_0^A) = H_q(\mathbb{R}X_t; A)$.

As there is not much else to say about the spectral sequence $E_{\bullet,\bullet}^{\bullet,LS,\mathbb{R}}$, we do not refer to it from now on; the only thing of importance to remember is the equality $H_q(X; \mathbb{R}\mathcal{U}_0^A) = H_q(\mathbb{R}X_t; A)$ (in the combinatorial patchworking case). Therefore, we simply write $E_{\bullet,\bullet}^{\bullet,LS}$ instead of $E_{\bullet,\bullet}^{\bullet,LS,\mathbb{C}}$ from now on.

4.4 Kalinin's spectral sequence

We now have two important types of cosheaves on X : the cosheaf $\mathbb{R}\mathcal{U}_0^A$, which allows us to directly compute (in the combinatorial case, which we consider) the homology of $\mathbb{R}X_t$, as $H_q(X; \mathbb{R}\mathcal{U}_0^A) = H_q(\mathbb{R}X_t; A)$, and the cosheaves $\{\mathbb{C}\mathcal{U}_p^A\}_p$, which allow us to indirectly compute the homology of $\mathbb{C}X_t$ through the spectral sequence $E_{\bullet,\bullet}^{\bullet,LS}$. We naturally want to establish a connection between them, and *Kalinin's spectral sequence* allows us to do so. From now on, we let the ring of coefficients A be equal to \mathbb{Z}_2 , as Kalinin's spectral sequence is only defined over \mathbb{Z}_2 .

Our three main references here are I. Kalinin's original articles [Kal05] and [Kal92], A. Degtyarev's [Deg92], and the more sheaf-theoretic [Kra84] by V. Krasnov. All details are to be found there.

Let Y be an n -dimensional real algebraic variety. We denote the terms of the Kalinin spectral sequence in homology associated to Y as $E_q^{r,Ka}(Y)$, where $r \geq 0$ is the number of the page. We write the differentials as $\partial_r : E_q^{r,Ka}(Y) \rightarrow E_{q+r-1}^{r,Ka}(Y)$. There is a single index q , as opposed to a couple (p, q) as one would expect, because it is a *stabilized spectral sequence*, *i.e.* that it is obtained by taking a certain projective limit (in "the direction p ") associated to a certain classical spectral sequence.

The spectral sequence has the following properties (up to an isomorphism of spectral sequences):

- $E_q^{1,Ka}(Y) = H_q(\mathbb{C}Y; \mathbb{Z}_2)$, and $\partial_1 : H_q(\mathbb{C}Y; \mathbb{Z}_2) \rightarrow H_q(\mathbb{C}Y; \mathbb{Z}_2)$ coincides with $1 + c_* : H_q(\mathbb{C}Y; \mathbb{Z}_2) \rightarrow H_q(\mathbb{C}Y; \mathbb{Z}_2)$, where 1 is the identity and c_* is induced by the conjugation.
- As a consequence, $E_q^{2,Ka}(Y) = \frac{Ker(1+c_*)}{Im(1+c_*)}$.
- The spectral sequence converges (in a finite number of steps) to $H_*(\mathbb{R}X; \mathbb{Z}_2)$, *i.e.* there exists a (decreasing) filtration $\emptyset = F_{n+1}H_*(\mathbb{R}Y; \mathbb{Z}_2) \subset F_nH_*(\mathbb{R}Y; \mathbb{Z}_2) \subset \dots \subset F_0H_*(\mathbb{R}Y; \mathbb{Z}_2) = H_*(\mathbb{R}Y; \mathbb{Z}_2)$ such that $E_p^{\infty,Ka}(Y) \cong F_pH_*(\mathbb{R}Y; \mathbb{Z}_2)/F_{p+1}H_*(\mathbb{R}Y; \mathbb{Z}_2)$.

We immediately see that Y is (Smith-Thom) maximal (see Formula 1.2.1) if and only if its Kalinin spectral sequence degenerates on the first page, and Galois maximal (see Formula 1.2.2) if and only if its Kalinin spectral sequence degenerates on the second page.

Note that the filtration on $H_*(\mathbb{R}X; \mathbb{Z}_2)$ does not need to respect the natural grading induced by the degree on $H_*(\mathbb{R}X; \mathbb{Z}_2)$. The higher-dimensional pair of pants illustrates this, as it is maximal (we discuss this further below), the homology of its real part is entirely concentrated in degree 0, but the homology of its complex part is not.

The Kalinin spectral sequence is functorial; a continuous map $Y_1 \rightarrow Y_2$ of real algebraic varieties induces morphisms $E_q^{r, Ka}(Y_1) \rightarrow E_q^{r, Ka}(Y_2)$ which coincide with those induced by the morphisms $H_q(\mathbb{C}Y_1; \mathbb{Z}_2) \rightarrow H_q(\mathbb{C}Y_2; \mathbb{Z}_2)$ on the first page.

There is also a Kalinin spectral sequence for cohomology, and they both have many interesting properties, such as a multiplicative structure, connections to Steenrod squares, etc. However, they are not needed for our purpose here.

What matters to us is that it yields a non-trivial filtration on the homology of the real part of a real algebraic variety which is connected to the homology of the complex part.

4.5 Bounds on the homology of $\mathbb{R}X_t$

For each cell σ in X , we can consider the Kalinin spectral sequence of O_σ . As we are still restricting ourselves to the combinatorial case, we have as mentioned before that $H_*(\mathbb{R}O_\sigma; \mathbb{Z}_2) = H_0(\mathbb{R}O_\sigma; \mathbb{Z}_2) = \mathbb{R}\mathcal{U}_0^{\mathbb{Z}_2}(\sigma)$. The spectral sequence yields a filtration $\emptyset = F_n \mathbb{R}\mathcal{U}_0^{\mathbb{Z}_2}(\sigma) \subset F_{n-1} \mathbb{R}\mathcal{U}_0^{\mathbb{Z}_2}(\sigma) \subset \dots \subset F_0 \mathbb{R}\mathcal{U}_0^{\mathbb{Z}_2}(\sigma) = H_0(\mathbb{R}O_\sigma; \mathbb{Z}_2)$ such that $E_p^{\infty, Ka}(O_\sigma) \cong F_p \mathbb{R}\mathcal{U}_0^{\mathbb{Z}_2}(\sigma) / F_{p+1} \mathbb{R}\mathcal{U}_0^{\mathbb{Z}_2}(\sigma)$.

Since the Kalinin spectral sequence is functorial, we can define for each p the cellular cosheaves $\sigma \mapsto F_p \mathbb{R}\mathcal{U}_0^{\mathbb{Z}_2}(\sigma)$ and $\sigma \mapsto E_p^{\infty, Ka}(O_\sigma)$, as well as the corresponding cellular chain groups $C_q(X; F_p \mathbb{R}\mathcal{U}_0^{\mathbb{Z}_2}) := \bigoplus_{\dim \sigma = q} F_p \mathbb{R}\mathcal{U}_0^{\mathbb{Z}_2}(\sigma)$ and $C_q(X; E_p^{\infty, Ka}) := \bigoplus_{\dim \sigma = q} E_p^{\infty, Ka}(\sigma)$, cellular chain complexes $C_\bullet(X; F_p \mathbb{R}\mathcal{U}_0^{\mathbb{Z}_2})$ and $C_\bullet(X; E_p^{\infty, Ka})$, and homology groups $H_q(X; F_p \mathbb{R}\mathcal{U}_0^{\mathbb{Z}_2}) := H_q(C_\bullet(X; F_p \mathbb{R}\mathcal{U}_0^{\mathbb{Z}_2}))$ and $H_q(X; E_p^{\infty, Ka}) := H_q(C_\bullet(X; E_p^{\infty, Ka}))$.

We obtain a filtration of cellular chain complexes

$$C_\bullet(X; F_{n-1} \mathbb{R}\mathcal{U}_0^{\mathbb{Z}_2}) \subset \dots \subset C_\bullet(X; F_1 \mathbb{R}\mathcal{U}_0^{\mathbb{Z}_2}) \subset C_\bullet(X; F_0 \mathbb{R}\mathcal{U}_0^{\mathbb{Z}_2}) = C_\bullet(X; \mathbb{R}\mathcal{U}_0^{\mathbb{Z}_2}), \quad (4.5.1)$$

such that we have

$$C_\bullet(X; F_p \mathbb{R}\mathcal{U}_0^{\mathbb{Z}_2}) / C_\bullet(X; F_{p+1} \mathbb{R}\mathcal{U}_0^{\mathbb{Z}_2}) \cong C_\bullet(X; E_p^{\infty, Ka})$$

as complexes.

Such a filtration gives rise to yet another spectral sequence, whose terms we denote as $E_{q,p}^{r, HA}$ ("HA" for Homological Algebra), as a matter of pure homological algebra. We do not study that spectral sequence in detail here, though it can be used to figure out

maximality conditions on X_t (see [RS18]). What matters to us is that it automatically implies the following inequality for each q :

$$\dim_{\mathbb{Z}_2} H_q(\mathbb{R}X_t; A) = \dim_{\mathbb{Z}_2} H_q(X; \mathbb{R}\mathcal{U}_0^A) \leq \sum_p \dim_{\mathbb{Z}_2} H_q(X; E_p^{\infty, Ka}). \quad (4.5.2)$$

All the relations that we have established are summarized in the pseudo-diagram (4.5.3). In the upper left corner, we have the groups $C_q(X; \mathcal{C}\mathcal{U}_p^{\mathbb{Z}_2})$, which can be seen as the first page of the Leray-Serre spectral sequence of $\mathbb{C}X_t$ described in Section 4.3. By taking their homology with respect to the differential of that spectral sequence, we find the groups $H_q(X; \mathcal{C}\mathcal{U}_p^{\mathbb{Z}_2})$, on the second page of the Leray-Serre spectral sequence. It converges to the homology of $\mathbb{C}X_t$, with a filtration $F_\bullet H_l(\mathbb{C}X_t; \mathbb{Z}_2) \subset H_l(\mathbb{C}X_t; \mathbb{Z}_2)$ such that $E_{p,l-p}^{\infty, LS, \mathbb{Z}_2} \cong F_p H_l(\mathbb{C}X_t; \mathbb{Z}_2) / F_{p-1} H_l(\mathbb{C}X_t; \mathbb{Z}_2)$.

We can also go vertically from $C_q(X; \mathcal{C}\mathcal{U}_p^{\mathbb{Z}_2})$, and progress in the Kalinin spectral sequence of each O_σ (while simply summing over the cells σ); we find $C_q(X; \frac{Ker(1+c_*)}{Im(1+c_*)})$, where $\frac{Ker(1+c_*)}{Im(1+c_*)}$ is the cosheaf $\sigma \mapsto E_p^{2, Ka}(O_\sigma)$. On the last page of this "cell-wise" spectral sequence, we find the groups $C_q(X; E_p^{\infty, Ka})$, which appear on the 0-th page of the "Homological Algebra" spectral sequence mentioned above. By progressing in that spectral sequence, we find on the first page $H_q(X; E_p^{\infty, Ka})$, and it converges to $H_q(\mathbb{R}X_t; \mathbb{Z}_2)$, with a decreasing filtration $F_\bullet H_q(\mathbb{R}X_t; \mathbb{Z}_2) \subset H_q(\mathbb{R}X_t; \mathbb{Z}_2)$ such that $E_{q,p}^{\infty, HA} \cong F_p H_q(\mathbb{R}X_t; \mathbb{Z}_2) / F_{p+1} H_q(\mathbb{R}X_t; \mathbb{Z}_2)$.

$$\begin{array}{ccc} C_q(X; \mathcal{C}\mathcal{U}_p^{\mathbb{Z}_2}) & \xrightarrow{\sim LS} & H_q(X; \mathcal{C}\mathcal{U}_p^{\mathbb{Z}_2}) \xrightarrow[\Sigma_{p+q=l}]{LS} H_l(\mathbb{C}X_t; \mathbb{Z}_2) \\ & \downarrow \text{\scriptsize } Ka & \\ C_q(X; \frac{Ker(1+c_*)}{Im(1+c_*)}) & & \\ & \downarrow \text{\scriptsize } Ka & \\ C_q(X; E_p^{\infty, Ka}) & \xrightarrow{\sim HA} & H_q(X; E_p^{\infty, Ka}) \xrightarrow[\Sigma_p]{HA} H_q(\mathbb{R}X_t; \mathbb{Z}_2) \end{array} \quad (4.5.3)$$

Ideally, we would like to find relations between the homology $H_l(\mathbb{C}X_t; \mathbb{Z}_2)$ of the complex part, and the homology $H_q(\mathbb{R}X_t; \mathbb{Z}_2)$ of the real part.

In the case of a primitive combinatorial patchworking, the situation greatly simplifies. As stated before, one can use the theorems from Chapter 7 to see that the Leray-Serre spectral sequence degenerates on the second page, and that $\dim_{\mathbb{Z}_2} H_q(X; \mathcal{C}\mathcal{U}_p^{\mathbb{Z}_2}) = h^{q,p}(\mathbb{C}X_t)$; in fact, this was the primary motivation behind those results.

Moreover, if (and only if) the triangulation is primitive, each O_σ is maximal and the associated spectral sequence $E_p^{r, Ka}(O_\sigma)$ degenerates on the first page. Hence we have an isomorphism of cosheaves $\mathcal{C}\mathcal{U}_p^{\mathbb{Z}_2} \cong E_p^{\infty, Ka}$, and isomorphisms of groups $H_q(X; \mathcal{C}\mathcal{U}_p^{\mathbb{Z}_2}) \cong H_q(X; E_p^{\infty, Ka})$. As we mentioned earlier that in the primitive case, we have an isomorphism $\mathcal{C}\mathcal{U}_p^{\mathbb{Z}_2} \cong \mathcal{F}_p^{X, \mathbb{Z}_2}$ between the round and pointy tropical cosheaves, this yields (using the bound from Formula (4.5.2)) the following statement, which was the main result from

Renaudineau's and Shaw's [RS18].

Theorem 4.5.1.

$$\dim_{\mathbb{Z}_2} H_q(\mathbb{R}X_t; \mathbb{Z}_2) \leq \sum_{p=0}^{\dim X} \dim_{\mathbb{Z}_2} H_q(X; \mathcal{F}_p^{X, \mathbb{Z}_2}).$$

As they directly and exclusively considered the primitive case, they did not need to go into the details of the various spectral sequences appearing in Diagram (4.5.3).

As said above, this implies (thanks to the results from Chapter 7, which were obtained as a joint work with Renaudineau and Shaw) that

$$\dim_{\mathbb{Z}_2} H_q(\mathbb{R}X_t; \mathbb{Z}_2) \leq h^{q, n-1-q}(\mathbb{C}X) + 1 - \delta_{i, \frac{n-1}{2}}, \quad (4.5.4)$$

where X_t is as before of dimension $n - 1$, and $\delta_{i, \frac{n-1}{2}}$ is 1 if $i = \frac{n-1}{2}$ and 0 otherwise.

Itenberg had already proved this bound for $n = 3$ in [Ite97], and conjectured that it held in general dimension in [Ite17]. This was a refinement of a conjecture by Viro, which stated that $b_1(\mathbb{R}Z) \leq h^{1,1}(\mathbb{C}Z)$ for a non-singular simply connected compact real surface Z (without requiring that it come from a primitive patchworking) and turned out to be false (see [Ite97] again). In other words, real algebraic hypersurfaces obtained using primitive combinatorial patchworking do obey the principle expressed in the Introduction in Formula (0.0.2) (as $h^{q,p}(\mathbb{C}X) = 0$ if $q \neq p$ and $h^{q,q}(\mathbb{C}X) = 1$ if $q \neq \frac{n-1}{2}$, see for example [DK86]).

As a bonus of sorts, observe that in the primitive case, the filtration of chain complexes

$$C_\bullet(X; F_{n-1}\mathbb{R}\mathcal{U}_0^{\mathbb{Z}_2}) \subset \dots \subset C_\bullet(X; F_1\mathbb{R}\mathcal{U}_0^{\mathbb{Z}_2}) \subset C_\bullet(X; F_0\mathbb{R}\mathcal{U}_0^{\mathbb{Z}_2}) = C_\bullet(X; \mathbb{R}\mathcal{U}_0^{\mathbb{Z}_2})$$

from Formula (4.5.1) directly implies that

$$\begin{aligned} \sum_{p,q} (-1)^p h^{q,p}(\mathbb{C}X_t) &= \sum_{p,q} (-1)^q \dim_{\mathbb{Z}_2} \left(H_q(X; \mathbb{C}\mathcal{U}_p^{\mathbb{Z}_2}) \right) = \sum_{p,q} (-1)^q \dim_{\mathbb{Z}_2} \left(C_q(X; \mathbb{C}\mathcal{U}_p^{\mathbb{Z}_2}) \right) = \\ &= \sum_{p,q} (-1)^q \left[\dim_{\mathbb{Z}_2} \left(C_q(X; F_p\mathbb{R}\mathcal{U}_0^{\mathbb{Z}_2}) \right) - \dim_{\mathbb{Z}_2} \left(C_q(X; F_{p+1}\mathbb{R}\mathcal{U}_0^{\mathbb{Z}_2}) \right) \right] = \\ &= \sum_q (-1)^q \dim_{\mathbb{Z}_2} \left(C_q(X; \mathbb{R}\mathcal{U}_0^{\mathbb{Z}_2}) \right) = \sum_q (-1)^q \dim_{\mathbb{Z}_2} \left(H_q(X; \mathbb{R}\mathcal{U}_0^{\mathbb{Z}_2}) \right) = \chi(\mathbb{R}X_t), \end{aligned}$$

and as it is well-known that $\sum_{p,q} (-1)^p h^{q,p}(\mathbb{C}X_t)$ is equal to the signature $\sigma(\mathbb{C}X_t)$ of the intersection form on $H^{n-1}(\mathbb{C}X_t)$ (see for example [Voi07]), this allows us to painlessly recover the equality

$$\chi(\mathbb{R}X_t) = \sigma(\mathbb{C}X_t)$$

from [Arn17] and [Ber10] that was cited in Section 4.2.

In Chapter 9, we discuss possible applications of the concepts exposed above, and in particular ways in which one could hope to generalize Theorem 4.5.1 and Formula (4.5.4).

Part II

Chapter 5

A flexible construction method

5.1 Chapter introduction

In this chapter, we describe a new construction method for real projective algebraic hypersurfaces. It relies on Viro's method, which is described in details in Chapter 2, as well as related notions used below, such as *complete nondegeneracy*. Chapter 6 is the direct continuation of this chapter, where the methods developed here are applied to build families of real projective algebraic hypersurfaces with asymptotically large Betti numbers.

In given ambient dimension n , the dimension of the total homology of the complex part of a smooth projective real algebraic hypersurface X_d^n of degree d satisfies

$$\dim_{\mathbb{Z}_2}(H_*(\mathbb{C}X_d^n)) = \frac{(d-1)^{n+1} - (-1)^{n+1}}{d} + n + (-1)^{n+1}. \quad (5.1.1)$$

In particular, it is a polynomial of degree n in d , with 1 as its leading coefficient (see [DK86]). Moreover, for $i = 0, \dots, n-1$, the $(i, n-1-i)$ -th Hodge number $h^{i, n-1-i}(\mathbb{C}X_d^n)$ is also a polynomial of degree n in d (the same for any such hypersurface). Denote its leading coefficient by a_i^n (see Subsection 6.2.1 for more details). As $h^{p,q}(\mathbb{C}X_d^n) \in \{0, 1\}$ if $p+q \neq n-1$ (see for example [DK86]), the sum $\sum_p h^{i,p}(\mathbb{C}X_d^n)$ from Inequality (0.0.2) which played an important role in the Introduction is asymptotically equal to $h^{i, n-1-i}(\mathbb{C}X_d^n)$; in particular, the coefficient a_i^n that we have just defined coincides with the similarly named coefficient from the Introduction.

If $f, g : \mathbb{N} \rightarrow \mathbb{N}$ are such that $f(d) \leq g(d) + \mathcal{O}(d^{n-1})$, using the usual convention for the \mathcal{O} notation, we write $f \stackrel{n}{\leq} g$. If both $f \stackrel{n}{\leq} g$ and $f \stackrel{n}{\geq} g$, we say that $f \stackrel{n}{=} g$. We naturally extend this notation to the case where f and g are both defined on the same infinite subset of \mathbb{N} . Using that notation, we already know from the Smith-Thom inequality (1.2.1) and (5.1.1) that

$$\sum_i b_i(\mathbb{R}X_d^n) \stackrel{n}{\leq} d^n,$$

where X_d^n is as above.

It is then natural to ask what the maximal value $B_i^n(d)$ of the i -th Betti number $b_i(\mathbb{R}X_d^n) = \dim_{\mathbb{Z}_2}(H_i(\mathbb{R}X_d^n))$ of the real part of a smooth real algebraic hypersurface $X_d^n \subset \mathbb{P}^n$ of degree d is; Itenberg and V. Kharlamov proved (according to [Bih03], where a proof in dimension $n = 3$ can be found) that for $i = 0, \dots, n-1$, there exists $\beta_i^n \in \mathbb{R}_{>0}$ such that $B_i^n(d) = \beta_i^n \cdot d^n + o(d^n)$. The same question can be asked about linear combinations of Betti numbers, or under additional conditions.

A family of real algebraic hypersurfaces $\{X_d^n\}_{d \in \mathbb{N}}$ in \mathbb{P}^n is *asymptotically maximal* if $\dim_{\mathbb{Z}_2}(H_*(\mathbb{R}X_d^n)) \stackrel{n}{\approx} \dim_{\mathbb{Z}_2}(H_*(\mathbb{C}X_d^n)) \stackrel{n}{\approx} d^n$. We also say that a family of real Laurent polynomials in n variables is *asymptotically standard* (this is, ironically, non-standard terminology) if the associated family of projective hypersurfaces verifies $b_i(V_{\mathbb{R}\mathbb{P}^n}(P_d^n)) \stackrel{n}{\approx} a_i^n \cdot d^n$ (which implies asymptotic maximality) - in particular, they asymptotically obey the principle enounced in the Introduction, which suggested that real projective algebraic hypersurfaces should be expected to verify

$$\dim_{\mathbb{Z}_2} H_q(\mathbb{R}X; \mathbb{Z}_2) \leq \sum_p h^{q,p}(\mathbb{C}X).$$

Asymptotically standard families are in a sense the baseline examples of asymptotically maximal families, since they are the easiest to build and the "least singular". It is natural to compare the asymptotic Betti numbers of any asymptotic family of real projective hypersurfaces to the asymptotically standard case.

In [IV07], Itenberg and Viro constructed for any n an asymptotically standard family of real algebraic hypersurfaces $\{X_d^n\}_{d \in \mathbb{N}}$ in \mathbb{P}^n , as was mentioned in the Introduction. B. Bertrand achieved similar results with general toric varieties, as well as complete intersections, in [Ber06]. In [Bih03], F. Bihan gave good lower bounds on the values of β_i^n for $n = 3$, which E. Brugallé further improved in [Bru06] using the same method. A. Renaudineau also worked on related problems in his thesis [Ren15]. All of these results made use of the patchworking method.

In the same spirit, we develop a construction technique based on Viro's method and inspired by [IV07] such that, given for each $k = 1, \dots, n-1$ a family of projective smooth real algebraic hypersurfaces in \mathbb{P}^k , which we call "ingredients", we can use them to "cook" (construct) a family $\{Y_d^n\}_{d \in \mathbb{N}}$ of smooth real algebraic hypersurfaces in \mathbb{P}^n such that the asymptotic Betti numbers of $\{\mathbb{R}Y_d^n\}_{d \in \mathbb{N}}$ can be computed from those of the real parts of the hypersurfaces used ingredients.

More precisely, we have the following "cooking" theorem, where we let $S_d^k := \{(x_1, \dots, x_k) \in \mathbb{R}^k \mid x_i \geq 0 \forall i, \sum_{i=1}^k x_i \leq d\}$ be the simplex of side d and dimension k :

Theorem 5.1.1 (Cooking Theorem). *Let $n \geq 2$. For $k = 1, \dots, n-1$, let $\{P_d^k\}_{d \in \mathbb{N}}$ be a family of completely nondegenerate real Laurent polynomials in k variables, such that P_d^k is of degree d and that the Newton polytope $\Delta(P_d^k)$ of P_d^k is S_d^k . Suppose additionally that*

for $k = 1, \dots, n-1$ and $i = 0, \dots, k-1$,

$$b_i(V_{\mathbb{R}\mathbb{P}^k}(P_d^k)) \geq x_i^k \cdot d^k$$

for some $x_i^k \in \mathbb{R}_{\geq 0}$. Then there exists a family $\{Q_d^n\}_{d \in \mathbb{N}}$ of completely nondegenerate real Laurent polynomials in n variables such that $\Delta(Q_d^n) = S_d^n$ and such that for $i = 0, \dots, n-1$

$$b_i(V_{\mathbb{R}\mathbb{P}^n}(Q_d^n)) \geq \frac{1}{n} \left(x_i^{n-1} + x_{i-1}^{n-1} + \sum_{k=1}^{n-2} \sum_{j=0}^{i-1} x_j^k \cdot x_{i-1-j}^{n-1-k} \right) \cdot d^n, \quad (5.1.2)$$

where x_j^k is set to be 0 for $j \notin \{0, \dots, k-1\}$.

Moreover, if the families $\{P_d^k\}_{d \in \mathbb{N}}$ were obtained using a combinatorial patchworking for all k , then the family $\{Q_d^n\}_{d \in \mathbb{N}}$ can also be obtained by combinatorial patchworking.

If each family $\{P_d^k\}_{d \in \mathbb{N}}$ (for $k = 1, \dots, n-1$) is such that the associated family of projective hypersurfaces is asymptotically maximal, then the family of projective hypersurfaces associated to $\{Q_d^n\}_{d \in \mathbb{N}}$ is also asymptotically maximal.

Remark 5.1.2. In light of Lemma 5.3.1 and Remark 5.3.2 below, the expressions $b_i(V_{\mathbb{R}\mathbb{P}^k}(P_d^k))$ for $k = 1, \dots, n-1$ and $b_i(V_{\mathbb{R}\mathbb{P}^n}(Q_d^n))$ can be indifferently (and independently) replaced in the statement by $b_i(V_{(\mathbb{R}^*)^k}(P_d^k))$ and $b_i(V_{(\mathbb{R}^*)^n}(Q_d^n))$ respectively.

For the same reasons, one can see that the polynomials P_d^k do not actually need to be completely nondegenerate; we only need the associated hypersurfaces $V_{(\mathbb{C}^*)^k}(P_d^k)$ in the complex torus to be smooth.

Regarding the plan of this chapter, the construction method is described in details in Section 5.2; proof of Formula (5.1.2) and related remarks are found in Section 5.3. This is arguably the most technical part of this thesis; please bear with us.

5.2 The construction method

5.2.1 Preliminaries

Let $n \geq 2$. As in the hypotheses of Theorem 5.1.1, for $k = 1, \dots, n-1$, consider a family $\{P_d^k\}_{d \in \mathbb{N}}$ of completely nondegenerate real Laurent polynomials such that $\Delta(P_d^k) = S_d^k$.

As above, let $S_d^k = \{(x_1, \dots, x_k) \in \mathbb{R}^k \mid x_i \geq 0 \ \forall i, \sum_{i=1}^k x_i \leq d\}$ denote the simplex of side d and dimension k . Let $H_i^k := \{(x_1, \dots, x_k) \in \mathbb{R}^k \mid x_i = 0\}$ for $i = 1, \dots, k$ and $H_{d,0}^k := \{(x_1, \dots, x_k) \in \mathbb{R}^k \mid \sum_{i=1}^k x_i = d\}$. For any set of indices $I \subset \{0, 1, \dots, k\}$, define $S_{d,I}^k := S_d^k \cap (\bigcap_{i \in I} H_i^k)$ if $0 \notin I$ and $S_{d,I}^k := S_d^k \cap H_{d,0}^k \cap (\bigcap_{i \in I \setminus \{0\}} H_i^k)$ if $0 \in I$.

We first define in Subsection 5.2.2 a specific convex triangulation of S_d^{n-1} , which we extend to a convex triangulation of S_d^n .

In Subsection 5.2.3, we then define a family $\{\tilde{Q}_d^n\}_{d \in \mathbb{N}}$ of real Laurent polynomials such that $\Delta(\tilde{Q}_d^n) = S_d^n$. Moreover, for any $m = 0, \dots, d-n$ and any $I \subsetneq \{0, 1, \dots, n-m\}$

1}, the homology of the family of real projective hypersurfaces in $\mathbb{P}^{n-1-|I|}$ associated to the truncation of the polynomials $\{\tilde{Q}_d^n\}_{d \in \mathbb{N}}$ to the simplices $S_{d,I}^n \cap \{x_n = m\}$ behaves asymptotically as the homology of the family of hypersurfaces associated to $\{P_d^{n-1-|I|}\}_{d \in \mathbb{N}}$ (this will be given more precise meaning later on).

Finally, applying Viro's method to $\{\tilde{Q}_d^n\}_{d \in \mathbb{N}}$ and the convex triangulation we devised, we obtain in Subsection 5.2.4 a family $\{Q_d^n\}_{d \in \mathbb{N}}$ of real Laurent polynomials that fulfills the conditions of Theorem 5.1.1 (which is proved in Section 5.3).

5.2.2 A convex triangulation of S_d^n

Given a finite set $\Lambda \subset \mathbb{Z}^k$ and a function $f : \Lambda \rightarrow \mathbb{R}$, we define $\tilde{\Phi}(f) : \text{Conv}(\Lambda) \rightarrow \mathbb{R}$ as the function whose graph is the lower convex hull in \mathbb{R}^{k+1} of the graph of f (in Chapter 3, we considered a similar map Φ , except that it was based on the upper convex hull). Note that $\tilde{\Phi}(f)$ always defines a convex subdivision of $\text{Conv}(\Lambda)$.

We define by induction a convex subdivision of S_d^{n-1} .

Lemma 5.2.1. *For any $n \geq 2$ and any $d \geq n$, there exists a piecewise linear convex function $\mu_d^{n-1} : S_d^{n-1} \rightarrow \mathbb{R}$ with the following properties:*

- *It defines a convex triangulation of S_d^{n-1} .*
- *The sub-simplex $\{(x_1, \dots, x_{n-1}) \in \mathbb{R}^{n-1} \mid x_i \geq 1 \forall i, \sum_{i=1}^{n-1} x_i \leq d-1\} \subset S_d^{n-1}$ is one of the (maximal) linearity domains of μ_d^{n-1} .*
- *More generally, let Γ be any of the faces of dimension k of S_d^{n-1} , and let $\Psi : \mathbb{R}^k \rightarrow \mathbb{R}^{n-1}$ be any affine embedding that maps bijectively the vertices of S_d^k to those of Γ . Then the pullback to S_d^k by Ψ of the restriction of μ_d^{n-1} to Γ is such that the sub-simplex $\{(x_1, \dots, x_k) \in \mathbb{R}^k \mid x_i \geq 1 \forall i, \sum_{i=1}^k x_i \leq d-1\} \subset S_d^k$ is one of its (maximal) linearity domains.*

Proof. Starting from $k = 0$, we will recursively build piecewise linear functions μ_k with the following properties: μ_k is defined on the union of the faces of S_d^{n-1} of dimension less than or equal to k , the function μ_k is strictly positive, the restriction of μ_k to any face Γ of dimension $i \leq k$ is convex and induces a convex triangulation of Γ , and if $\Psi : \mathbb{R}^i \rightarrow \mathbb{R}^{n-1}$ is any affine embedding that maps bijectively the vertices of S_d^i to those of Γ (such an embedding maps integer points to integer points), then the pullback to S_d^i by Ψ of the restriction of μ_k to Γ is such that the sub-simplex $\{(x_1, \dots, x_i) \in \mathbb{R}^i \mid x_j \geq 1 \forall j, \sum_{j=1}^i x_j \leq d-1\} \subset S_d^i$ is one of its (maximal) linearity domains.

Let μ_0 be constant and equal to 1 on the vertices of S_d^{n-1} .

Suppose that μ_{k-1} has been defined, and let us define μ_k (for $k \leq n-1$).

Let Γ be any face of dimension k of S_d^{n-1} , and choose an affine embedding $\Psi : \mathbb{R}^k \rightarrow \mathbb{R}^{n-1}$ that maps bijectively the vertices of S_d^k to those of Γ . The function μ_{k-1} is defined on

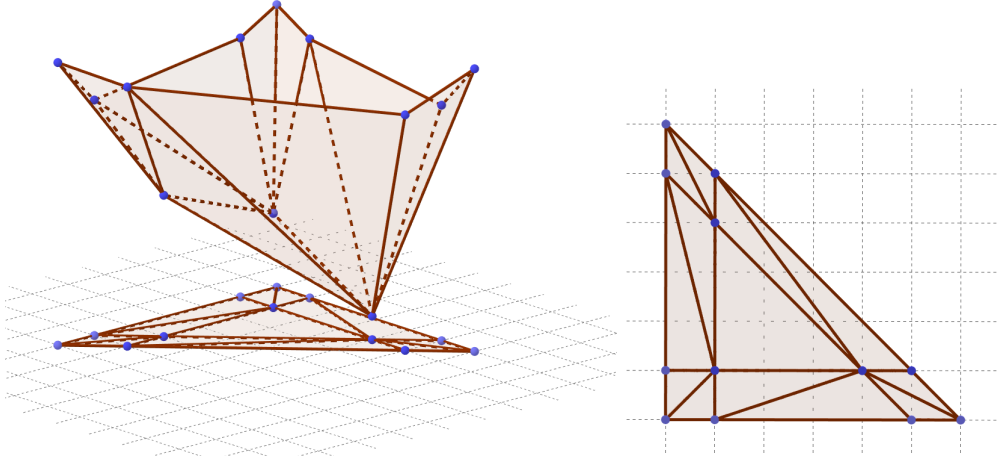

Figure 5.1: For $k = 2$ and $d = 6$, the graph of μ on the face Γ and the induced triangulation of Γ .

the faces of dimension $i \leq k - 1$ of Γ . Through Ψ we identify S_d^k to Γ for the remainder of this paragraph in order to simplify notations (in particular, we see μ_{k-1} as being defined on the faces of dimension $i \leq k - 1$ of S_d^k). Define $\tilde{\mu}$ as taking generic, strictly positive and very small values on the $k + 1$ vertices of $\{(x_1, \dots, x_k) \in \mathbb{R}^k | x_j \geq 1 \forall j, \sum_{j=1}^k x_j \leq d - 1\} \subset S_d^k$, and equal to μ_{k-1} on the faces of dimension $i \leq k - 1$ of S_d^k . Define $\mu := \tilde{\Phi}(\tilde{\mu}) : S_d^k \rightarrow \mathbb{R}$. The function μ coincides with μ_{k-1} on the faces of dimension $i \leq k - 1$ of S_d^k - in particular, it induces the same triangulation of those faces. The convex subdivision that it induces on S_d^k is a triangulation, and for small enough values of $\tilde{\mu}$ on its vertices, $\{(x_1, \dots, x_k) \in \mathbb{R}^k | x_j \geq 1 \forall j, \sum_{j=1}^k x_j \leq d - 1\} \subset S_d^k$ is one of its (maximal) linearity domains (see Figure 5.1). We define μ_k on the face Γ as the pushforward of μ to Γ (via the identification $\Gamma \cong S_d^k$ used at the beginning of the paragraph).

We proceed similarly on all other faces of dimension k of S_d^{n-1} ; hence we have defined μ_k .

We let μ_d^{n-1} be equal to μ_{n-1} .

□

We now extend the convex triangulation on S_d^{n-1} induced by μ_d^{n-1} to S_d^n in the following sense:

For $m = 0, \dots, d - 1$, define $S_{d,m}^n := S_d^n \cap \{x_n = m\}$ and $S_{d,m+}^n := S_d^n \cap \{x_n \in [m, m + 1]\}$.

For $m = 1, \dots, d - n$ odd and $i = 1, \dots, n - 1$, denote by $R_{d,m,i}^n = \{(x_1, \dots, x_i, 0, \dots, 0, m) \in \mathbb{R}^n | x_j \geq 1 \forall j = 1, \dots, i, \sum_{j=1}^{n-1} x_j \leq d - m - 1\} \subset S_{d,m}^n$.

For $m = 0, \dots, d - n$ even and $i = 1, \dots, n - 2$, denote by $R_{d,m,i}^n = \{(0, \dots, 0, x_{n-i-1}, \dots, x_{n-1}, m) \in \mathbb{R}^n | x_j \geq 1 \forall j = n - i - 1, \dots, n - 1, \sum_{j=1}^{n-1} x_j = d - m\} \subset S_{d,m}^n$. Define also $R_{d,m,n-1}^n = \{(x_1, \dots, x_{n-1}, m) \in \mathbb{R}^n | x_j \geq 1 \forall j = 1, \dots, n - 1, \sum_{j=1}^{n-1} x_j \leq d - m - 1\} \subset S_{d,m}^n$. This is

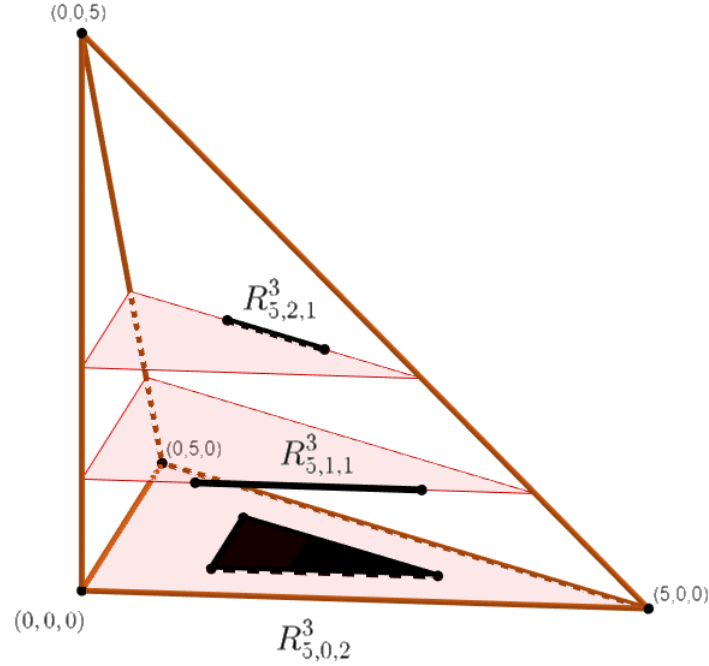

Figure 5.2: The sets $R_{5,0,2}^3$, $R_{5,1,1}^3$, and $R_{5,2,1}^3$ in S_5^3 .

illustrated in Figure 5.2.

Let also $O_{d,m,i}^n \in \mathbb{R}^n$ be the point $(0, \dots, 0, d-m, 0, \dots, 0, m)$ if $i = 1, \dots, n-1$, where $d-m$ appears as the i -th coordinate, and let it be the point $(0, \dots, 0, m)$ if $i = 0$ (for $m = 0, \dots, n$).

Lemma 5.2.2. *For $n \geq 2$, there exists a triangulation T of S_d^n that has the following properties:*

- For $m = 1, \dots, d-n$ odd, the cone of $R_{d,m,n-1}^n$ with the vertex $O_{d,m+1,n-1}^n$ and the cone $R_{d,m,n-1}^n$ with the vertex $O_{d,m-1,n-1}^n$ appear in T .
- For $m = 0, \dots, d-n$ even, the cone of $R_{d,m,n-1}^n$ with the vertex $O_{d,m+1,0}^n$ and the cone $R_{d,m,n-1}^n$ with the vertex $O_{d,m-1,0}^n$ appear in T .
- For $m = 0, \dots, d-n-1$ and $i = 1, \dots, n-2$, the join of $R_{d,m,i}^n$ with $R_{d,m+1,n-1-i}^n$ appears in T .

Proof. If $d < n+1$, choose any convex subdivision on S_d^n (all conditions are automatically satisfied and it matters not, as we are only interested in asymptotic behaviors).

If $d \geq n+1$, for $m = 0, \dots, d-n$, choose functions μ_{d-m}^{n-1} satisfying the conditions of Lemma 5.2.1, and triangulate $S_{d,m}^n$ with the convex subdivision induced by μ_{d-m}^{n-1} (via the natural identification between $S_{d,m}^n$ and S_{d-m}^{n-1} given by the projection on the first $n-1$ coordinates).

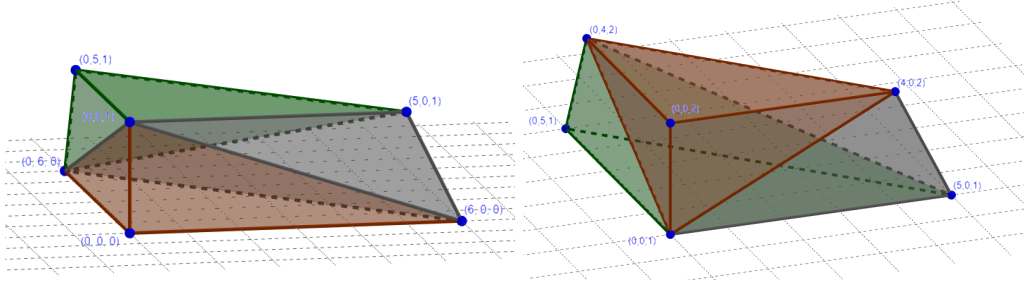

Figure 5.3: For $n = 3$ and $d = 6$: on the left, the subdivision \tilde{T} restricted to $S_{6,0+}^3$, on the right, the subdivision \tilde{T} restricted to $S_{6,1+}^3$.

Then for $m = 0, \dots, d - n - 1$ even, triangulate $S_{d,m+}^n$ thus: subdivide it into the n simplices $\text{Conv}(O_{d,m+1,0}^n, O_{d,m,0}^n, \dots, O_{d,m,n-1}^n)$, $\text{Conv}(O_{d,m+1,0}^n, O_{d,m+1,1}^n, O_{d,m,1}^n, \dots, O_{d,m,n-1}^n)$, \dots , $\text{Conv}(O_{d,m+1,0}^n, \dots, O_{d,m+1,n-1}^n, O_{d,m,n-1}^n)$ (this is a classical way to triangulate the topological product of a simplex and a closed interval). Each of these simplices S is obtained as the join of a k -dimensional face Γ_k of $S_{d,m+1}^n$ with a $n - k - 1$ -dimensional face Γ_{n-k-1} of $S_{d,m}^n$, for $k = 0, \dots, n - 1$. See the left side of Figure 5.3.

For $m = 1, \dots, d - n - 1$ odd, subdivide $S_{d,m+}^n$ as the union of the n simplices $\text{Conv}(O_{d,m,0}^n, O_{d,m+1,0}^n, \dots, O_{d,m+1,n-1}^n)$, $\text{Conv}(O_{d,m,0}^n, O_{d,m,1}^n, O_{d,m+1,1}^n, \dots, O_{d,m+1,n-1}^n)$, \dots , $\text{Conv}(O_{d,m,0}^n, \dots, O_{d,m,n-1}^n, O_{d,m+1,n-1}^n)$ (the roles of m and $m + 1$ have been reversed). See the right side of Figure 5.3.

Call the triangulation thus defined \tilde{T} (see Figure 5.4).

We further triangulate each simplex obtained as the join of a k -dimensional face Γ_k of $S_{d,m+1}^n$ with a $n - k - 1$ -dimensional face Γ_{n-k-1} of $S_{d,m}^n$ using the join of the triangulations of Γ_k and Γ_{n-k-1} .

Choose any triangulation of $S_d^n \cap \{x_n \in [d - n, d]\}$ which extends that on $S_{d,d-n}^n$.

Any triangulation T built this way clearly satisfies the conditions of the Lemma. \square

It remains to show that such triangulations can be required to be convex, which is the case.

Lemma 5.2.3. *For any $n \geq 2$ and any $d \geq n$, there exists a piecewise linear convex function $\tilde{\mu}_d^n : S_d^n \rightarrow \mathbb{R}$ such that it gives rise to a convex triangulation T of S_d^n which satisfies the conditions of Lemma 5.2.2.*

Proof. We first consider a convex subdivision of $S_d^n \cap \{x_n \in [d - n, d]\}$ such that the domains of linearity are exactly the slices $S_{d,m+}^n$ for $m = 0, \dots, d - n - 1$ (a function identically equal to m^2 on $S_{d,m}^n$ does the trick).

Now consider on each $S_{d,m+}^n$ (for $m = 0, \dots, d - n - 1$) the convex triangulation into n simplices described in the proof of Lemma 5.2.2. If m is even, let f be defined on the $2n$

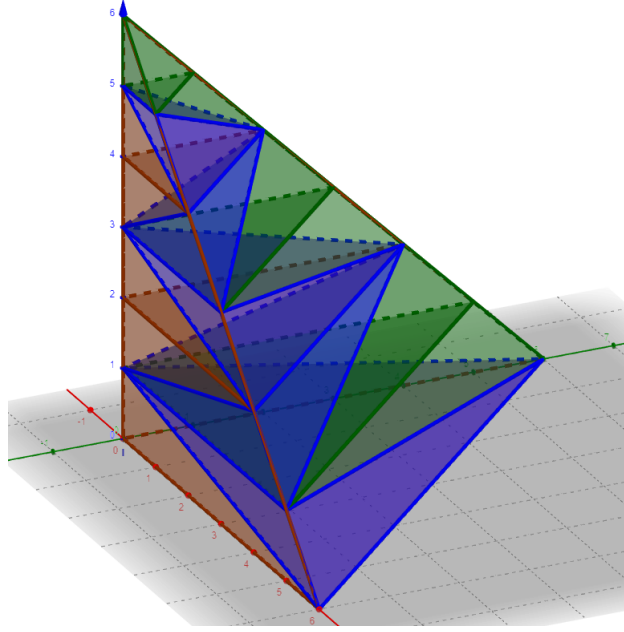
Figure 5.4: The triangulation \tilde{T} on S_6^3 .

vertices of $S_{d,m+}^n$ as being identically equal to 0 on $S_{d,m}^n$, and equal to i on $O_{d,m+1,i}^n$ (for $i = 0, \dots, n-1$). Then $\tilde{\Phi}(f) : S_{d,m+}^n \rightarrow \mathbb{R}$ gives the desired triangulation (and similarly for m odd).

Using that and applying repeatedly the technical Lemma 5.2.4 (in the notations of the Lemma, Δ is $S_d^n \cap \{x_n \in [d-n, d]\}$ and Γ is $S_{d,m+}^n$, for successive $m = 0, \dots, d-n-1$), we obtain a convex triangulation \tilde{T} of $S_d^n \cap \{x_n \in [d-n, d]\}$ as built in the proof of Lemma 5.2.2.

For $m = 0, \dots, d-n$, let $\mu_{d-m}^{n-1} : S_{d,m}^n \rightarrow \mathbb{R}$ be a function satisfying the conditions of Lemma 5.2.1 (where we have identified $S_{d,m}^n$ with S_{d-m}^n via the projection on the first $n-1$ coordinates).

We need to further subdivide the simplices obtained as joins (see the proof of Lemma 5.2.2) along the triangulations induced by the functions μ_{d-m}^{n-1} .

Once again, we apply repeatedly Lemma 5.2.4, this time to $S_d^n \cap \{x_n \in [d-n, d]\}$ and $S_{d,m}^n$ (as Δ and Γ , respectively, in the notations of the Lemma) for $m = 0, \dots, d-n$.

We get a convex triangulation of $S_d^n \cap \{x_n \in [d-n, d]\}$ which is a refinement of \tilde{T} and which coincides with the triangulation induced by the functions μ_{d-m}^{n-1} on $S_{d,m}^n$, and a piecewise linear convex function $\mu : S_d^n \cap \{x_n \in [d-n, d]\} \rightarrow \mathbb{R}$ certifying the convexity of this triangulation. Define $\tilde{\mu}_d^n : \{O_{d,d,0}^n\} \cup (S_d^n \cap \{x_n \in [d-n, d]\}) \rightarrow \mathbb{R}$ as being equal to μ on $S_d^n \cap \{x_n \in [d-n, d]\}$ and equal to some large enough $R \in \mathbb{R}$ on $\{O_{d,d,0}^n\}$. Then $\tilde{\Phi}(\tilde{\mu}_d^n)$ extends the triangulation induced by μ to a convex triangulation T on S_d^n , which is as wanted.

□

The technical result used in the proof of Lemma 5.2.3:

Lemma 5.2.4 (Technical Lemma). *Let $\Delta \subset \mathbb{R}^n$ be a convex (bounded) polytope with integer vertices, and let $\mu : \Delta \rightarrow \mathbb{R}$ be such that $\mu = \tilde{\Phi}(\mu|_{\Delta \cap \mathbb{Z}^n})$. Let $\Gamma \subset \Delta$ be a (not necessarily top-dimensional) face of the convex subdivision induced by μ on Δ . Let $\nu : \Gamma \rightarrow \mathbb{R}$ be such that $\nu = \tilde{\Phi}(\nu|_{\Gamma \cap \mathbb{Z}^n})$. Then there exists a function $\xi : \Delta \rightarrow \mathbb{R}$ so that:*

1. $\xi = \tilde{\Phi}(\xi|_{\Delta \cap \mathbb{Z}^n})$ (hence ξ is piecewise linear convex and gives rise to a convex subdivision of Δ).
2. $\xi|_{(\Delta \setminus \Gamma)} = \mu|_{(\Delta \setminus \Gamma)}$.
3. The convex subdivision induced by ξ on Δ is a refinement of the one induced by μ .
4. The convex subdivision induced by ξ on Γ is the same as the one induced by ν .

Proof. By adding a large enough constant, we can assume that ν is strictly positive. Let $\tilde{\nu}$ be equal to ν on Γ , and 0 everywhere else. Define $\xi_\epsilon := \mu + \epsilon\tilde{\nu}$, for $\epsilon > 0$.

For any $\epsilon > 0$, ξ_ϵ satisfies condition 2 by definition, and if it fulfills condition 1, then it also satisfies condition 4.

We have $\xi_\epsilon = \tilde{\Phi}(\xi_\epsilon|_{\Delta \cap \mathbb{Z}^n})$ if and only if for each $p \in \Delta \cap \mathbb{Z}^n$, we have $\xi_\epsilon(p)$ smaller or equal to $\tilde{\Phi}(\xi_\epsilon|_{\Delta \setminus \{p\}})(p)$. For any $\epsilon > 0$ and any $p \in (\Delta \setminus \Gamma) \cap \mathbb{Z}^n$, this condition is automatically satisfied as $\xi_\epsilon(p) = \xi(p) \leq \tilde{\Phi}(\xi|_{\Delta \setminus \{p\}})(p) \leq \tilde{\Phi}(\xi_\epsilon|_{\Delta \setminus \{p\}})(p)$.

We want to show that for every $p \in \Gamma \cap \mathbb{Z}^n$, there exists $\epsilon_p > 0$ such that for every $\epsilon_p > \epsilon > 0$, $\xi_\epsilon(p) \leq \tilde{\Phi}(\xi_\epsilon|_{\Delta \setminus \{p\}})(p)$. Then for every $0 < \epsilon < \epsilon_0 := \min\{\epsilon_p | p \in \Gamma \cap \mathbb{Z}^n\}$, ξ_ϵ satisfies condition 1.

Suppose that there exists $p \in \Gamma$ for which this is not true. Without loss of generality, by subtracting from μ an affine function corresponding to a support hyperplane of $Graph(\mu|_\Gamma) \subset Graph(\mu)$, we can assume that $\mu|_\Gamma$ is identically 0, and that there exists $M > 0$ such that $\mu|_{(\Delta \setminus \Gamma) \cap \mathbb{Z}^n} > M$. Let $(\Delta \setminus \Gamma) \cap \mathbb{Z}^n = \{x_1, \dots, x_l\}$ and $(\Gamma \setminus \{p\}) \cap \mathbb{Z}^n = \{y_1, \dots, y_m\}$. There exists a sequence $(\epsilon_k)_k$ such that $\epsilon_k \xrightarrow{k \rightarrow \infty} 0$ and for every $k \in \mathbb{N}$, there are coefficients $\alpha_k^1, \dots, \alpha_k^l \geq 0$ and $\beta_k^1, \dots, \beta_k^m \geq 0$ such that $\sum_{i=1}^l \alpha_k^i + \sum_{j=1}^m \beta_k^j = 1$ for all k and such that

$$\sum_{i=1}^l \alpha_k^i x_i + \sum_{j=1}^m \beta_k^j y_j = p$$

and

$$\xi_{\epsilon_k}(p) = \mu(p) + \epsilon_k \tilde{\nu}(p) = \epsilon_k \nu(p) > \sum_{i=1}^l \alpha_k^i \xi_{\epsilon_k}(x_i) + \sum_{j=1}^m \beta_k^j \xi_{\epsilon_k}(y_j) = \sum_{i=1}^l \alpha_k^i \mu(x_i) + \sum_{j=1}^m \beta_k^j \epsilon_k \nu(y_j). \quad (5.2.1)$$

For any k , we must have $\sum_{i=1}^l \alpha_k^i > 0$ (as otherwise, everything happens within Γ , and a contradiction arises from the convexity of ν). Moreover, for k large enough, we must also have $\sum_{j=1}^m \beta_k^j > 0$, as otherwise $\sum_{i=1}^l \alpha_k^i \mu(x_i) > M$ and $M > \epsilon_k \nu(p)$ as k goes to infinity. Assume this to be the case from now on. We can write $\alpha_k := \sum_{i=1}^l \alpha_k^i > 0$ and $\beta_k := \sum_{j=1}^m \beta_k^j > 0$, and define $\tilde{\alpha}_k^i := \frac{\alpha_k^i}{\alpha_k}$ and $\tilde{\beta}_k^j := \frac{\beta_k^j}{\beta_k}$. Define also $X_k := \sum_{i=1}^l \tilde{\alpha}_k^i x_i \in \Delta$ and $Y_k := \sum_{j=1}^m \tilde{\beta}_k^j y_j \in \Gamma$. Hence we write $p = \alpha_k X_k + \beta_k Y_k$.

We see that

$$\begin{aligned} \sum_{i=1}^l \alpha_k^i \xi_{\epsilon_k}(x_i) + \sum_{j=1}^m \beta_k^j \xi_{\epsilon_k}(y_j) &= \alpha_k \sum_{i=1}^l \tilde{\alpha}_k^i \mu(x_i) + \beta_k \sum_{j=1}^m \tilde{\beta}_k^j \epsilon_k \nu(y_j) \\ &\geq \alpha_k M + \beta_k \epsilon_k \nu(Y_k) = \epsilon_k \nu(Y_k) + \alpha_k (M - \epsilon_k \nu(Y_k)) \end{aligned}$$

by convexity of ν and the lower bound on $\mu|_{(\Delta \setminus \Gamma) \cap \mathbb{Z}^n}$ (and $\alpha_k + \beta_k = 1$).

As ν is piecewise linear on the compact set Γ , there exists $C > 0$ such that ν is C -Lipschitz continuous. Let D be the diameter of Δ .

We can now write

$$\begin{aligned} \epsilon_k \nu(p) &= \epsilon_k \nu(Y_k) + \epsilon_k (\nu(p) - \nu(Y_k)) \leq \epsilon_k \nu(Y_k) + \epsilon_k C |p - Y_k| \\ &= \epsilon_k \nu(Y_k) + \epsilon_k C \alpha_k |X_k - Y_k| \leq \epsilon_k \nu(Y_k) + \alpha_k \epsilon_k C D. \end{aligned}$$

But as ν is bounded, we have for any k large enough $\epsilon_k C D < M - \epsilon_k \nu(Y_k)$, which gives a contradiction to Equation (5.2.1).

Only condition 3 remains. Consider the set $\Omega = \{\text{Conv}(p_1, \dots, p_k) \mid k \geq 1, p_1, \dots, p_k \in \Delta \cap \mathbb{Z}^n\}$ of all (not necessarily top-dimensional) non-empty polytopes in Δ with integer vertices. Consider $A \in \Omega$ such that μ is not affine over A . Then for ϵ small enough, ξ_ϵ won't be affine over A either. If $A \subset \Delta \setminus \Gamma$, this is clear. If not, there are $x_1, \dots, x_k \in A \cap \mathbb{Z}^n$ linearly independent in \mathbb{R}^n and $x \in A \cap \mathbb{Z}^n$ such that $(x, \mu(x)) \in \mathbb{R}^n \times \mathbb{R}$ does not belong to the affine space $\text{Vect}((x_1, \mu(x_1)), \dots, (x_k, \mu(x_k))) \subset \mathbb{R}^n \times \mathbb{R}$. As $(x, \xi_\epsilon(x))$ converges to $(x, \mu(x))$ and $\text{Vect}((x_1, \xi_\epsilon(x_1)), \dots, (x_k, \xi_\epsilon(x_k)))$ converges to $\text{Vect}((x_1, \mu(x_1)), \dots, (x_k, \mu(x_k)))$ (for example in a Grassmannian sense) when $\epsilon \rightarrow 0$, we see that for any $\epsilon > 0$ small enough, $(x, \xi_\epsilon(x))$ does not belong to the affine space $\text{Vect}((x_1, \xi_\epsilon(x_1)), \dots, (x_k, \xi_\epsilon(x_k)))$ either. As Ω is a finite set, there exists $\epsilon_1 > 0$ such that ξ_ϵ satisfies condition 3 for any $\epsilon_1 > \epsilon > 0$.

We finally define $\xi := \xi_\epsilon$ for an arbitrary $0 < \epsilon < \min(\epsilon_0, \epsilon_1)$. \square

5.2.3 Choosing the coefficients of \tilde{Q}_d^n

For any Laurent polynomial P in k variables, we write $P(z) = \sum_{\lambda \in \Delta(P) \cap \mathbb{Z}^k} c_P(\lambda) z^\lambda$ (where some coefficients $c_P(\lambda) \in \mathbb{R}$ can be 0). We use the notations of Chapter 2. In particular, given two real Laurent polynomials in k variables P_1 and P_2 , we say that their charts are homeomorphic if there is a homeomorphism of stratified topological spaces between the

pairs $(\Delta(P_1) \times U_{\mathbb{R}}^k, \text{Chart}_{\Delta(P_1) \times U_{\mathbb{R}}^k}(P_1))$ and $(\Delta(P_2) \times U_{\mathbb{R}}^k, \text{Chart}_{\Delta(P_2) \times U_{\mathbb{R}}^k}(P_2))$ - remember that the chart of P_i is actually defined as the pair $(\Delta(P_i) \times U_{\mathbb{R}}^k, \text{Chart}_{\Delta(P_i) \times U_{\mathbb{R}}^k}(P_i))$.

Lemma 5.2.5. *Let $n \geq 2$ and $d \geq n$. Given a convex triangulation T of S_d^n that satisfies the conditions of Lemma 5.2.2 and completely nondegenerate real Laurent polynomials $\{P_i^k\}_{i=0}^{d-1-k}$ such that $\Delta(P_i^k) = S_i^k$ (for $k = 1, \dots, n-1$), there exists a real Laurent polynomial \tilde{Q}_d^n such that:*

1. $\Delta(\tilde{Q}_d^n) = S_d^n$.
2. For each simplex S of the triangulation T , the truncation $\tilde{Q}_d^n|_S$ is completely nondegenerate.
3. For $m = 0, \dots, d-n$ and $k = 1, \dots, n-1$ and for any lattice respecting identification $R_{d,m,k}^n \cong S_{d-m-1-k}^k$ which lets us see $\tilde{Q}_d^n|_{R_{d,m,k}^n}$ as a polynomial G in k variables, the charts of G and $P_{d-m-1-k}^k$ are homeomorphic.
4. For $m = 0, \dots, d-n$ even, the monomial $\tilde{Q}_d^n|_{O_{d,m,n-1}^n}$ is a strictly positive constant.
5. For $m = 1, \dots, d-n$ odd, the monomial $\tilde{Q}_d^n|_{O_{d,m,0}^n}$ is a strictly positive constant.

Proof. We define a function $\tilde{c} : S_d^n \cap \mathbb{Z}^n \rightarrow \mathbb{R}$.

Set $\tilde{c}(O_{d,m,n-1}^n) = 1$ for $m = 0, \dots, d-n$ even and $\tilde{c}(O_{d,m,0}^n) = 1$ for $m = 1, \dots, d-n$ odd.

For $m = 0, \dots, d-n$ and $k = 1, \dots, n-1$, choose a lattice respecting identification $R_{d,m,k}^n \cong S_{d-m-1-k}^k$, and via this identification, set $\tilde{c}(x) = c_{P_{d-m-1-k}^k}(x)$ for any $x \in R_{d,m,k}^n \cap \mathbb{Z}^n$.

For any other $x \in S_d^n$, pick an arbitrary non-zero value for $\tilde{c}(x)$.

All conditions, except a priori Condition 2, are satisfied by polynomial $P(z) := \sum_{\lambda \in S_d^n \cap \mathbb{Z}^n} \tilde{c}(\lambda) z^\lambda$.

As observed in [Vir06], among all polynomials with a given Newton polytope, nondegenerate polynomials form an (Zariski) open set. Moreover, as each P_i^k is nondegenerate, the hypersurface $V_{K\Delta(P_i^k)}(P_i^k)$ is smooth, and a small perturbation of the coefficients of P_i^k will not change the topology of its chart.

With those two observations in mind, we can define c as a small generic perturbation of \tilde{c} such that all conditions are fulfilled by $\sum_{\lambda \in S_d^n \cap \mathbb{Z}^n} c(\lambda) z^\lambda$, and set $\tilde{Q}_d^n := \sum_{\lambda \in S_d^n \cap \mathbb{Z}^n} c(\lambda) z^\lambda$. \square

5.2.4 Defining Q_d^n using the Patchwork

Making use of the results of the two previous subsections, we get the following proposition.

Proposition 5.2.6. *Let $n \geq 2$. For $k = 1, \dots, n-1$, consider a family $\{P_d^k\}_{d \in \mathbb{N}}$ of completely nondegenerate real Laurent polynomials $\{P_i^k\}_{i=0}^{d-1-k}$ such that $\Delta(P_i^k) = S_i^k$.*

Then for all $d \geq n$, there exists a completely nondegenerate real Laurent polynomial Q_d^n , with $\Delta(Q_d^n) = S_d^n$, such that:

1. Q_d^n is obtained via a patchworking of a family Σ of completely nondegenerate real Laurent polynomials.
2. For $m = 0, \dots, d - n - 1$ and $k = 1, \dots, n - 2$, there are polynomials $F_m^k \in \Sigma$ such that the chart of F_m^k is homeomorphic to the chart of G , for some polynomial

$$G : (x_1, \dots, x_{n-1}, x_n) \mapsto \tilde{P}_{d-m-1-k}^k(x_1, \dots, x_k) + x_n \tilde{P}_{d-m-n+k}^{n-1-k}(x_{k+1}, \dots, x_{n-1}),$$

where each \tilde{P}_i^k is itself such that $\Delta(\tilde{P}_i^k)$ is a translate of S_i^k and that its chart is homeomorphic to the chart of P_i^k .

3. For $m = 1, \dots, d - n - 1$, there are polynomials $G_m^+, G_m^- \in \Sigma$ such that the n -dimensional simplices $\Delta(G_m^+)$ and $\Delta(G_m^-)$ have a $(n - 1)$ -dimensional face in common, and such that the gluing of their charts

$$((\Delta(G_m^+) \cup \Delta(G_m^-)) \times U_{\mathbb{R}}^n, \text{Chart}_{\Delta(G_m^+) \times U_{\mathbb{R}}^n}(G_m^+) \cup \text{Chart}_{\Delta(G_m^-) \times U_{\mathbb{R}}^n}(G_m^-))$$

is homeomorphic as a (stratified) pair to the gluing of charts

$$((\Delta(\tilde{G}_m^+) \cup \Delta(\tilde{G}_m^-)) \times U_{\mathbb{R}}^n, \text{Chart}_{\Delta(\tilde{G}_m^+) \times U_{\mathbb{R}}^n}(\tilde{G}_m^+) \cup \text{Chart}_{\Delta(\tilde{G}_m^-) \times U_{\mathbb{R}}^n}(\tilde{G}_m^-)),$$

where

$$\tilde{G}_m^+ : (x_1, \dots, x_{n-1}, x_n) \mapsto \tilde{P}_{d-m-n}^{n-1}(x_1, \dots, x_{n-1}) + \gamma_m^+ \cdot x_n,$$

$$\tilde{G}_m^- : (x_1, \dots, x_{n-1}, x_n) \mapsto \tilde{P}_{d-m-n}^{n-1}(x_1, \dots, x_{n-1}) + \gamma_m^- \cdot x_n^{-1},$$

γ_m^+ and γ_m^- are some strictly positive constant, and each \tilde{P}_i^{n-1} is itself such that $\Delta(\tilde{P}_i^{n-1})$ is a translate of S_i^{n-1} and that its chart is homeomorphic to the chart of P_i^{n-1} .

4. The interiors of the simplices $\Delta(F_m^k)$, $\Delta(G_l^+)$ and $\Delta(G_p^-)$ are disjoint for all k, m, l and p .

Additionally, if each P_d^k was obtained by combinatorial patchworking, there exists such a polynomial Q_d^n that can also be obtained by combinatorial patchworking.

Proof. By Lemma 5.2.3, there exists a convex triangulation T that satisfies the conditions of Lemma 5.2.2 and a convex function $\tilde{\mu}_d^n : S_d^n \rightarrow \mathbb{R}$ which certifies its convexity.

The triangulation T and the polynomials $\{P_i^k\}_{i=0}^{d-1-k}$ satisfy the hypotheses of Lemma 5.2.5, which yields a polynomial \tilde{Q}_d^n satisfying its conditions. We can apply Viro's Patchwork Theorem 2.2.1 to T , $\tilde{\mu}_d^n$ and \tilde{Q}_d^n (playing the role of P in the notations of Section 2.2) to get a family of polynomials $\{P_t\}_{t \in \mathbb{R}_{>0}}$, and let Q_d^n be any P_t with t small enough for the conclusions of Theorem 2.2.1 to apply. Let us show that Q_d^n satisfies all required conditions.

Condition 1 is trivially satisfied.

For $m = 0, \dots, d - n - 1$ and $k = 1, \dots, n - 2$, polynomial F_m^k is defined as the truncation $\tilde{Q}_d^n|^{R_{d,m,k}^n \star R_{d,m+1,n-1-k}^n}$, where \star denotes the join. Observe that $F_m^k = \tilde{Q}_d^n|^{R_{d,m,k}^n} + \tilde{Q}_d^n|^{R_{d,m+1,n-1-k}^n}$.

A suitable affine isomorphism $\mathbb{Z}^n \rightarrow \mathbb{Z}^n$, extended to \mathbb{R}^n , will map $R_{d,m,k}^n$ to $\{(x_1, \dots, x_k, 0, \dots, 0, m) \in \mathbb{R}^n | x_j \geq 1 \forall j = 1, \dots, k, \sum_{j=1}^{n-1} x_j \leq d - m - 1\} \subset S_{d,m}^n$ and $R_{d,m+1,n-1-k}^n$ to $\{(0, \dots, 0, x_{k+1}, \dots, x_{n-1}, m+1) \in \mathbb{R}^n | x_j \geq 1 \forall j = k+1, \dots, n-1, \sum_{j=1}^{n-1} x_j \leq d - m - 2\} \subset S_{d,m+1}^n$. This linear transformation induces an isomorphic change of coordinates $(K^*)^n \rightarrow (K^*)^n$. In particular, that change of coordinates maps $\tilde{Q}_d^n|^{R_{d,m,k}^n}$ (respectively, $\tilde{Q}_d^n|^{R_{d,m+1,n-1-k}^n}$) to $x_n^m \cdot \tilde{P}_{d-m-1-k}^k$, where $\tilde{P}_{d-m-1-k}^k$ is a polynomial in k variables (respectively, $x_n^{m+1} \cdot \tilde{P}_{d-m-n+k}^{n-1-k}$ with $\tilde{P}_{d-m-n+k}^{n-1-k}$ a polynomial in $n-1-k$ variables), and $\tilde{Q}_d^n|^{R_{d,m,k}^n \star R_{d,m+1,n-1-k}^n}$ to $x_n^m \cdot \tilde{P}_{d-m-1-k}^k + x_n^{m+1} \cdot \tilde{P}_{d-m-n+k}^{n-1-k}$.

Now $\tilde{P}_{d-m-1-k}^k$ has been obtained from $\tilde{Q}_d^n|^{R_{d,m,k}^n}$ via an isomorphic change of coordinates, and $\tilde{Q}_d^n|^{R_{d,m,k}^n}$ itself was obtained from $P_{d-m-1-k}^k$ via an isomorphic change of coordinates (since \tilde{Q}_d^n satisfies to Condition 3 of Lemma 5.2.5) and a small generic perturbation, so that the topology of the associated (via the change of coordinates) hypersurface would not change. Hence the chart of $\tilde{P}_{d-m-1-k}^k$ is homeomorphic to the chart of $P_{d-m-1-k}^k$. The same applies to $\tilde{P}_{d-m-n+k}^{n-1-k}$.

Finally, there is a trivial homeomorphism of pairs between the toric variety and hypersurface induced by F_m^k and those induced by $\tilde{P}_{d-m-1-k}^k + x_n \tilde{P}_{d-m-n+k}^{n-1-k}$, hence between the corresponding charts and ambient spaces as well. This proves Condition 2.

For $m = 2, \dots, d - n - 1$ even, polynomial G_m^+ (respectively, G_m^-) is defined as the truncation $\tilde{Q}_d^n|^{O_{d,m+1,0}^n \star R_{d,m,n-1}^n}$ (respectively, the truncation $\tilde{Q}_d^n|^{O_{d,m-1,0}^n \star R_{d,m,n-1}^n}$).

For $m = 1, \dots, d - n - 1$ odd, polynomial G_m^+ (respectively, G_m^-) is defined as the truncation $\tilde{Q}_d^n|^{O_{d,m+1,n-1}^n \star R_{d,m,n-1}^n}$ (respectively, the truncation $\tilde{Q}_d^n|^{O_{d,m-1,n-1}^n \star R_{d,m,n-1}^n}$).

The same type of arguments as above yield Condition 3.

Condition 4 is an evident consequence of the definitions of the polynomials F_m^k , G_m^+ and G_m^- .

If each $P_{d-m-1-k}^k$ was obtained by combinatorial patchworking, it is easy to show, using repeatedly Lemma 5.2.4, that the triangulation T can be refined to a convex triangulation T' such that its restriction to each $R_{d,m,k}^n$ corresponds to the triangulation used to define the corresponding polynomial $P_{d-m-1-k}^k$ (via the proper identifications). Likewise, the proof of Lemma 5.2.5 only has to be adapted in that the coefficients of \tilde{Q}_d^n have to be chosen so that the truncation $\tilde{Q}_d^n|_S$ is completely nondegenerate for each simplex of the refined triangulation T' , which is once again a condition generically satisfied.

Then the Patchwork can be applied to T' and \tilde{Q}_d^n , and the same conclusions as above stand for the resulting polynomial Q_d^n . \square

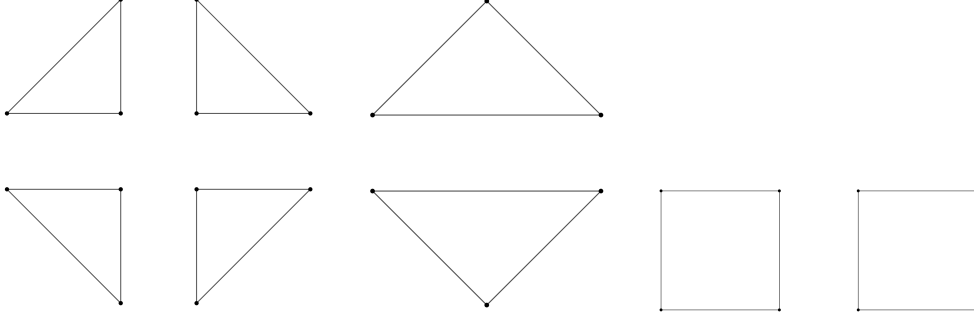

Figure 5.5: From left to right, $S_d^2 \times U_{\mathbb{R}}^d$, $(S_d^2 \times U_{\mathbb{R}}^d)_{\sim\{1\}}$ and $(S_d^2 \times U_{\mathbb{R}}^d)_{\sim\{0\}}$.

5.3 Computing asymptotic Betti numbers

In this section, we are proving Theorem 5.1.1; more specifically, that families of real Laurent polynomials obtained in Proposition 5.2.6 using the ingredients in the statement of Theorem 5.1.1 do satisfy Formula 5.1.2.

5.3.1 Preliminaries

We first prove a useful simplifying result. As described in Chapter 2, the projective space \mathbb{RP}^k can be obtained as an appropriate quotient of $S_d^k \times U_{\mathbb{R}}^k$. In this paragraph and the following Lemma, we consider intermediate quotients in the following sense: for any $J \subset \{0, 1, \dots, k\}$, we define $(S_d^k \times U_{\mathbb{R}}^k)_{\sim J}$ as $S_d^k \times U_{\mathbb{R}}^k$ quotiented by the equivalence relation $\sim J$ generated by:

- For $i \in J$ and $i > 0$, $((x_1, \dots, x_{i-1}, 0, x_{i+1}, \dots, x_k), (\epsilon_1, \dots, \epsilon_{i-1}, \epsilon_i, \epsilon_{i+1}, \dots, \epsilon_k)) \sim ((x_1, \dots, x_{i-1}, 0, x_{i+1}, \dots, x_k), (\epsilon_1, \dots, \epsilon_{i-1}, -1 \cdot \epsilon_i, \epsilon_{i+1}, \dots, \epsilon_k))$
for all $((x_1, \dots, x_{i-1}, 0, x_{i+1}, \dots, x_k), (\epsilon_1, \dots, \epsilon_{i-1}, \epsilon_i, \epsilon_{i+1}, \dots, \epsilon_k)) \in S_d^k \times U_{\mathbb{R}}^k$.
- If $0 \in J$, $((x_1, \dots, x_k), (\epsilon_1, \dots, \epsilon_k)) \sim ((x_1, \dots, x_k), (-\epsilon_1, \dots, -\epsilon_k))$
for all $((x_1, \dots, x_k), (\epsilon_1, \dots, \epsilon_k)) \in S_d^k \times U_{\mathbb{R}}^k$ such that $\sum_{j=1}^k x_j = d$.

See also Figure 5.5.

By extension, for any $B \subset S_d^k \times U_{\mathbb{R}}^k$, we define $B_{\sim J}$ as the quotient of B by the restriction of the relation $\sim J$. Given a completely nondegenerate real Laurent polynomial P in k variables and degree d such that $\Delta(P) = S_d^k$, we had defined in Chapter 2 its chart $(S_d^k \times U_{\mathbb{R}}^k, \text{Chart}_{S_d^k \times U_{\mathbb{R}}^k}(P))$. By extension, we let $\text{Chart}_{(S_d^k \times U_{\mathbb{R}}^k)_{\sim J}}(P) := (\text{Chart}_{S_d^k \times U_{\mathbb{R}}^k}(P))_{\sim J}$.

We know from the definition of the charts that the pairs $((S_d^k \times U_{\mathbb{R}}^k)_{\sim\{0,1,\dots,k\}}, \text{Chart}_{(S_d^k \times U_{\mathbb{R}}^k)_{\sim\{0,1,\dots,k\}}}(P))$, $((S_d^k \times U_{\mathbb{R}}^k)_{\sim\{1,\dots,k\}}, \text{Chart}_{(S_d^k \times U_{\mathbb{R}}^k)_{\sim\{1,\dots,k\}}}(P))$ and $(\overset{\circ}{S}_d^k \times U_{\mathbb{R}}^k, \text{Chart}_{\overset{\circ}{S}_d^k \times U_{\mathbb{R}}^k}(P))$ are homeomorphic to the pairs $(\mathbb{RP}^k, V_{\mathbb{RP}^k}(P))$, $(\mathbb{R}^k, V_{\mathbb{R}^k}(P))$ and $(\mathbb{R}^k, V_{\mathbb{R}^k}(P))$ respectively.

We also know that the pairs $(S_d^k \times U_{\mathbb{R}}^k, \text{Chart}_{S_d^k \times U_{\mathbb{R}}^k}(P))$ and $(S_d^k \times U_{\mathbb{R}}^k, \text{Chart}_{S_d^k \times U_{\mathbb{R}}^k}(P))$ are homotopy equivalent.

Lemma 5.3.1. *For all $k \geq 1$, there is a constant $C(k) > 0$ such that for all completely nondegenerate polynomials P in k variables and degree $d \geq 1$ such that $\Delta(P) = S_d^k$, set of indices $J \subset \{0, 1, \dots, k\}$ and index $i \in \{0, 1, \dots, k-1\}$, we have the following inequality:*

$$|b_i(\text{Chart}_{S_d^k \times U_{\mathbb{R}}^k}(P)) - b_i(\text{Chart}_{(S_d^k \times U_{\mathbb{R}}^k) \sim J}(P))| \leq C(k)d^{k-1}. \quad (5.3.1)$$

Proof. We proceed by induction on k . The result is trivial for $k = 1$, as $\text{Chart}_{S_d^1 \times U_{\mathbb{R}}^1}$ is a set of disjoint points, none of which belonging to the boundary of $S_d^1 \times U_{\mathbb{R}}^1$.

Assume that it has been proven for $1, \dots, k-1$. If $|J| = 0$, it is trivial. Otherwise, let $j \in J$. We first consider the case $|J| < k+1$. Via an appropriate isomorphic change of coordinates (which corresponds to an affine isomorphism from S_d^n to itself), we can assume that $j = 1$ and $0 \notin J$.

The space $\text{Chart}_{(S_d^k \times U_{\mathbb{R}}^k) \sim J}(P)$ is a quotient of $\text{Chart}_{(S_d^k \times U_{\mathbb{R}}^k) \sim (J \setminus \{1\})}(P)$ by identifying some points in the subsets

$$A^+ := \left((\{x_1 = 0\} \cap S_d^k) \times \{1, \pm 1, \dots, \pm 1\} \right) \sim (J \setminus \{1\}) \cap \text{Chart}_{(S_d^k \times U_{\mathbb{R}}^k) \sim (J \setminus \{1\})}(P)$$

and

$$A^- := \left((\{x_1 = 0\} \cap S_d^k) \times \{-1, \pm 1, \dots, \pm 1\} \right) \sim (J \setminus \{1\}) \cap \text{Chart}_{(S_d^k \times U_{\mathbb{R}}^k) \sim (J \setminus \{1\})}(P).$$

As $0 \notin J$, A^+ and A^- are disjoint sets, each homeomorphic to the quotient by $\sim J \setminus \{1\}$ of the chart $\text{Chart}_{S_d^{k-1} \times U_{\mathbb{R}}^{k-1}}(P|_{\{x_1=0\} \cap S_d^k})$, where $P|_{\{x_1=0\} \cap S_d^k}$ is seen as a polynomial in variables x_2, \dots, x_k . By induction, we know that

$$|b_*(A^\pm) - b_*(\text{Chart}_{S_d^{k-1} \times U_{\mathbb{R}}^{k-1}}(P|_{\{x_1=0\} \cap S_d^k}))| \leq C(k-1)d^{k-2}$$

and

$$|b_*(\text{Chart}_{S_d^{k-1} \times U_{\mathbb{R}}^{k-1}}(P|_{\{x_1=0\} \cap S_d^k})) - b_*(\text{Chart}_{(S_d^{k-1} \times U_{\mathbb{R}}^{k-1}) \sim (\{0, 1, \dots, k-1\})}(P|_{\{x_1=0\} \cap S_d^k}))| \leq C(k-1)d^{k-2},$$

where b_* denotes the rank over \mathbb{Z}_2 of the total homology. Moreover, using both the Smith-Thom inequality 1.2.1, Formula 5.1.1 and the fact that $\text{Chart}_{(S_d^{k-1} \times U_{\mathbb{R}}^{k-1}) \sim (\{0, 1, \dots, k-1\})}(P|_{\{x_1=0\} \cap S_d^k})$ is homeomorphic to $V_{\mathbb{R}\mathbb{P}^{k-1}}(P|_{\{x_1=0\} \cap S_d^k})$, we see that

$$b_*(\text{Chart}_{S_d^{k-1} \times U_{\mathbb{R}}^{k-1}}(P|_{\{x_1=0\} \cap S_d^k})) \leq 2d^{k-1} + k.$$

Hence,

$$b_*(A^+ \sqcup A^-) \leq 2(2d^{k-1} + k + 2C(k-1)d^{k-2}).$$

For any pair of spaces $X \subset Y$, we denote $b_i(Y, X) := \dim_{\mathbb{Z}_2}(H_i(Y, X))$. By looking at the long exact sequence of the homology of the pair, we get that

$$|b_i(\text{Chart}_{(S_d^k \times U_{\mathbb{R}}^k) \sim (J \setminus \{1\})}(P)) - b_i(\text{Chart}_{(S_d^k \times U_{\mathbb{R}}^k) \sim (J \setminus \{1\})}(P), A^+ \sqcup A^-)| \leq b_*(A^+ \sqcup A^-).$$

The pair $(\text{Chart}_{(S_d^k \times U_{\mathbb{R}}^k) \sim (J \setminus \{1\})}(P), A^+ \sqcup A^-)$ is a good pair, so

$$|b_i(\text{Chart}_{(S_d^k \times U_{\mathbb{R}}^k) \sim (J \setminus \{1\})}(P), A^+ \sqcup A^-) - b_i(\text{Chart}_{(S_d^k \times U_{\mathbb{R}}^k) \sim (J \setminus \{1\})}(P)/(A^+ \sqcup A^-))| \leq 1$$

(the difference of at most 1 coming from the transition between regular homology and reduced homology).

But $\text{Chart}_{(S_d^k \times U_{\mathbb{R}}^k) \sim (J \setminus \{1\})}(P)/(A^+ \sqcup A^-)$ is trivially homeomorphic to $\text{Chart}_{(S_d^k \times U_{\mathbb{R}}^k) \sim J}(P)/A$, where $A := (A^+ \sqcup A^-)_{\sim \{1\}}$ (with a small extension of notation) is homeomorphic to A^{\pm} .

Hence once again,

$$|b_i(\text{Chart}_{(S_d^k \times U_{\mathbb{R}}^k) \sim J}(P), A) - b_i(\text{Chart}_{(S_d^k \times U_{\mathbb{R}}^k) \sim J}(P)/A)| \leq 1$$

and

$$|b_i(\text{Chart}_{(S_d^k \times U_{\mathbb{R}}^k) \sim J}(P)) - b_i(\text{Chart}_{(S_d^k \times U_{\mathbb{R}}^k) \sim J}(P), A)| \leq b_*(A) \leq 2d^{k-1} + k + 2C(k-1)d^{k-2}.$$

Putting all of it together, we get that

$$|b_i(\text{Chart}_{(S_d^k \times U_{\mathbb{R}}^k) \sim (J \setminus \{1\})}(P)) - b_i(\text{Chart}_{(S_d^k \times U_{\mathbb{R}}^k) \sim J}(P))| \leq 3(2d^{k-1} + k + 2C(k-1)d^{k-2}) + 2.$$

We can define $C_1(k) := 8 + k + 2C(k-1)$ and simplify $3(2d^{k-1} + k + 2C(k-1)d^{k-2}) + 2 \leq C_1(k)d^{k-1}$.

The same type of reasoning can be used in the case where $|J| = k + 1$ (and 0 cannot be assumed not to belong to J), except that the sets A^+ and A^- are not disjoint anymore, but are rather two copies of the quotient by $\sim J \setminus \{0, 1\}$ of the chart $\text{Chart}_{S_d^{k-1} \times U_{\mathbb{R}}^{k-1}}(P|_{\{x_1=0\} \cap S_d^k})$ glued along their boundary by the relation generated by the index 0 to form a set B . By a similar induction argument, it can easily be shown that there exists another constant $C_2(k)$ (depending only on k) such that $b_*(B) \leq C_2(k)d^{k-1}$. Similarly, $B_{\sim \{1\}}$ is homeomorphic to the chart in \mathbb{P}^{k-1} of a polynomial in $k-1$ variables of degree d , hence $B_{\sim \{1\}} \leq 2d^{k-1} + k$. Then as above, one can write

$$\begin{aligned} & |b_i(\text{Chart}_{(S_d^k \times U_{\mathbb{R}}^k) \sim (J \setminus \{1\})}(P)) - b_i(\text{Chart}_{(S_d^k \times U_{\mathbb{R}}^k) \sim J}(P))| \leq \\ & |b_i(\text{Chart}_{(S_d^k \times U_{\mathbb{R}}^k) \sim (J \setminus \{1\})}(P)) - b_i(\text{Chart}_{(S_d^k \times U_{\mathbb{R}}^k) \sim (J \setminus \{1\})}(P, B))| + \\ & |b_i(\text{Chart}_{(S_d^k \times U_{\mathbb{R}}^k) \sim (J \setminus \{1\})}(P, B) - b_i(\text{Chart}_{(S_d^k \times U_{\mathbb{R}}^k) \sim (J \setminus \{1\})}(P)/B)| + \\ & |b_i(\text{Chart}_{(S_d^k \times U_{\mathbb{R}}^k) \sim (J \setminus \{1\})}(P)/B) - b_i(\text{Chart}_{(S_d^k \times U_{\mathbb{R}}^k) \sim J}(P)/B_{\sim \{1\}})| + \end{aligned}$$

$$|b_i(\text{Chart}_{(S_d^k \times U_{\mathbb{R}}^k) \sim J}(P)/B_{\sim \{1\}}) - b_i(\text{Chart}_{(S_d^k \times U_{\mathbb{R}}^k) \sim J}(P), B_{\sim \{1\}})| + \\ |b_i(\text{Chart}_{(S_d^k \times U_{\mathbb{R}}^k) \sim J}(P), B_{\sim \{1\}}) - b_i(\text{Chart}_{(S_d^k \times U_{\mathbb{R}}^k) \sim J}(P))| \leq C_3(k)d^{k-1}$$

for some constant $C_3(k)$ which depends only on k .

Hence, by starting from the empty set and proceeding by induction on the cardinal of J , we can show that

$$|b_i(\text{Chart}_{S_d^k \times U_{\mathbb{R}}^k}(P)) - b_i(\text{Chart}_{(S_d^k \times U_{\mathbb{R}}^k) \sim J}(P))| \leq (k+1)\max(C_1(k), C_3(k))d^{k-1}.$$

By setting $C(k) := (k+1)\max(C_1(k), C_3(k))$, we can conclude. □

Remark 5.3.2. *This immediately implies corresponding statements regarding the homology of the hypersurfaces associated to P in \mathbb{RP}^k , \mathbb{R}^k and $(\mathbb{R}^*)^k$.*

As we are only interested in the asymptotical behavior in d (in the sense described in Section 5.1) of the Betti numbers, Lemma 5.3.1 means that we can often ignore the distinction between the homology of a given hypersurface in $(\mathbb{R}^*)^k$ and that of the corresponding hypersurface in \mathbb{RP}^k .

Let $k, i \geq 0$, and X be a submanifold of \mathbb{R}^k . Given homology classes $\alpha \in \tilde{H}_i(X)$ and $\beta \in \tilde{H}_{k-1-i}(\mathbb{R}^k \setminus X)$ (where \tilde{H} indicates the reduced homology), the linking number $l(\alpha, \beta)$ is well defined as the transversal intersection (in \mathbb{R}^k) number (in \mathbb{Z}_2) of any cycle $a \in \alpha$ and any $k-i$ chain m in \mathbb{R}^k , called a *membrane*, such that $\partial m = b$, where b is a cycle in β (a membrane can always be found, since any cycle is a boundary in the trivial reduced homology of \mathbb{R}^k). It can be shown that $l(\alpha, \beta) = l(\beta, \alpha)$. We can adapt this operation to the non-reduced homology by taking the exact same definition when $i, k-1-i \neq 0$, and restricting the linking number to $\ker(H_0(X) \rightarrow H_0(\mathbb{R}^k)) \times H_{k-1}(\mathbb{R}^k \setminus X)$ when $i = 0$ (respectively, $H_{k-1}(X) \times \ker(H_0(\mathbb{R}^k \setminus X) \rightarrow H_0(\mathbb{R}^k))$ when $k-1-i = 0$), as any cycle in X whose class belongs to $\ker(H_0(X) \rightarrow H_0(\mathbb{R}^k))$ admits a membrane in \mathbb{R}^k . In fact, $\ker(H_0(X) \rightarrow H_0(\mathbb{R}^k))$ and $\tilde{H}_0(X)$ are naturally isomorphic (and similarly for $\mathbb{R}^k \setminus X$). See [FF16] for more details on linking numbers.

This definition can be easily generalized, in our particular case to pairs (Y, X) where $X \subset Y$ and Y is a disjoint union of convex subsets of \mathbb{R}^k .

Given such a pair (Y, X) and a collection of homology classes $\alpha_1, \dots, \alpha_r$ in $H_i(X)$ (respectively, in $\ker(H_0(X) \rightarrow H_0(Y))$ if $i = 0$), we say that classes β_1, \dots, β_r in $H_{k-1-i}(Y \setminus X)$ (respectively, in $\ker(H_0(Y \setminus X) \rightarrow H_0(Y))$ if $k-1-i = 0$) are *axes* for the collection $\alpha_1, \dots, \alpha_r$ if for any i, j we have $l(\alpha_i, \beta_j) = \delta_{i,j} \in \mathbb{Z}_2$. As the linking number is a \mathbb{Z}_2 -bilinear product, this implies, in particular, that the classes $\alpha_1, \dots, \alpha_r$ are linearly independent.

To help us prove lower bounds on the Betti numbers of the hypersurfaces obtained

using Proposition 5.2.6 by finding enough cycles and axes, in the spirit of [IV07], we need the following result:

Lemma 5.3.3. *For all $k \geq 1$, there is a constant $D(k) > 0$ with the following property:*

Let P be a completely nondegenerate polynomial in k variables and degree $d \geq 1$ such that $\Delta(P) = S_d^k$, and let $i \in \{0, 1, \dots, k-1\}$. Then there exists

$$r \geq b_i(V_{(\mathbb{R}^*)^k}(P)) - D(k)d^{k-1}$$

such that we can find classes $\alpha_1, \dots, \alpha_r$ in $H_i(\text{Chart}_{\mathring{S}_d^k \times U_{\mathbb{R}}^k}(P))$ and β_1, \dots, β_r in $H_{k-1-i}((S_d^k \times U_{\mathbb{R}}^k) \setminus \text{Chart}_{\mathring{S}_d^k \times U_{\mathbb{R}}^k}(P))$ (respectively, in $\ker(H_0((S_d^k \times U_{\mathbb{R}}^k) \setminus \text{Chart}_{\mathring{S}_d^k \times U_{\mathbb{R}}^k}(P)) \rightarrow H_0(S_d^k \times U_{\mathbb{R}}^k))$ if $k-1-i=0$) whose linking numbers in $\mathring{S}_d^k \times U_{\mathbb{R}}^k$ satisfy $l(\alpha_s, \beta_t) = \delta_{s,t} \in \mathbb{Z}_2$ (the classes β_t are axes for the classes α_s).

Moreover, we can ask that there be cycles $b_1 \in \beta_1, \dots, b_r \in \beta_r$ and $a_1 \in \alpha_1, \dots, a_r \in \alpha_r$ such that the sign of P is constant on each b_j (when evaluated via the identification $\mathring{S}_d^k \times U_{\mathbb{R}}^k \cong (\mathbb{R}^)^k$) and such that each b_j and each a_j is contained in a single connected component of $\mathring{S}_d^k \times U_{\mathbb{R}}^k$.*

Proof. We know that the inclusion $(\mathring{S}_d^k \times U_{\mathbb{R}}^k, \text{Chart}_{\mathring{S}_d^k \times U_{\mathbb{R}}^k}(P)) \xrightarrow{\text{in}} (S_d^k \times U_{\mathbb{R}}^k, \text{Chart}_{S_d^k \times U_{\mathbb{R}}^k}(P))$ is a homotopy equivalence of pairs. In particular, $H_i(\text{Chart}_{\mathring{S}_d^k \times U_{\mathbb{R}}^k}(P)) \xrightarrow{\text{in}_*} H_i(\text{Chart}_{S_d^k \times U_{\mathbb{R}}^k}(P))$ is an isomorphism.

Let $\epsilon \in U_{\mathbb{R}}^k$ and consider the quadrant $\Delta_\epsilon := S_d^k \times \{\epsilon\}$, which is one of the 2^k connected components of $S_d^k \times U_{\mathbb{R}}^k$. Let also $X_\epsilon := \text{Chart}_{S_d^k \times U_{\mathbb{R}}^k}(P) \cap \Delta_\epsilon$.

See Δ_ϵ as a subset of \mathbb{R}^k (for example by identifying it with $S_d^k \subset \mathbb{R}^k$), and see \mathbb{R}^k as a subset of the sphere S^k (via Alexandroff's compactification). Consider

$$U := S^k \setminus (\{(x_1, \dots, x_k) \in \mathbb{R}^k \mid x_j \geq \delta \ \forall j = 1, \dots, k, \sum_{j=1}^k x_j \leq d - \delta\} \cup \text{Chart}_{S_d^k \times U_{\mathbb{R}}^k}(P))$$

for some $\delta > 0$ (see Figure 5.6). If δ is small enough (as X_ϵ is a manifold with boundaries in $\partial\Delta_\epsilon$, which it intersects transversally), which we assume to be the case, U can be retracted to $S^k \setminus S_d^k$ and is thus contractible. We can also assume that $U \cap (\mathring{\Delta}_\epsilon \setminus X_\epsilon)$ is homotopically equivalent to $\partial\Delta_\epsilon \setminus X_\epsilon$.

By considering the Mayer-Vietoris sequence of the sets U , $\mathring{\Delta}_\epsilon \setminus X_\epsilon$, $U \cup \mathring{\Delta}_\epsilon \setminus X_\epsilon = S^k \setminus X_\epsilon$ and $U \cap (\mathring{\Delta}_\epsilon \setminus X_\epsilon) \cong \partial\Delta_\epsilon \setminus X_\epsilon$, we see that the morphism

$$j_* : H_{k-1-i}(\mathring{\Delta}_\epsilon \setminus X_\epsilon) \longrightarrow H_{k-1-i}(S^k \setminus X_\epsilon) \longrightarrow \tilde{H}_{k-1-i}(S^k \setminus X_\epsilon)$$

induced by the inclusion and the natural morphism from regular to reduced homology has a cokernel of dimension at most $b_*(\partial\Delta_\epsilon \setminus X_\epsilon) + 1$.

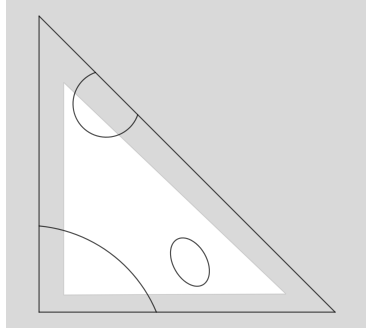
Figure 5.6: In light grey, the set U illustrated.

Alexander duality (see [FF16]), which is the main tool in this demonstration, can be applied to $X_\epsilon \subset S^k$, as it is compact and locally contractible. It states that the product

$$l : \tilde{H}_{k-1-i}(S^k \setminus X_\epsilon) \times \tilde{H}_i(X_\epsilon) \longrightarrow \mathbb{Z}_2$$

where as above l is the linking number (defined as in \mathbb{R}^k), is non-degenerate.

Hence $\tilde{H}_{k-1-i}(S^k \setminus X_\epsilon)$ and $\tilde{H}_i(X_\epsilon)$ are of the same dimension, and we can find $s_\epsilon \geq b_i(X_\epsilon) - (b_*(\partial \Delta_\epsilon \setminus X_\epsilon) + 2)$ classes $\beta_1^\epsilon, \dots, \beta_{s_\epsilon}^\epsilon \in H_{k-1-i}(\mathring{\Delta}_\epsilon \setminus X_\epsilon)$ such that the classes $j_*(\beta_1^\epsilon), \dots, j_*(\beta_{s_\epsilon}^\epsilon) \in \tilde{H}_{k-1-i}(S^k \setminus X_\epsilon)$ are linearly independent.

If $k-1-i > 0$, let $b_{t,1} + \dots + b_{t,i_t}$ be a chain representing β_t^ϵ (for $t = 1, \dots, s_\epsilon$), where each $b_{t,j}$ is connected. As each $b_{t,j}$ is also a cycle, and since the subspace of $\tilde{H}_{k-1-i}(S^k \setminus X_\epsilon)$ generated by $\{j_*[b_{t,j}] | t = 1, \dots, s_\epsilon, j = 1, \dots, i_t\}$ contains the subspace generated by $\{j_*(\beta_1^\epsilon), \dots, j_*(\beta_{s_\epsilon}^\epsilon)\}$, we can redefine the classes β_t^ϵ and assume that they can each be represented by a connected cycle $b_t^\epsilon \in \beta_t^\epsilon$. In particular, P has constant sign on each cycle b_t^ϵ . As $H_{k-1-i}(\mathring{\Delta}_\epsilon)$ is trivial, each b_t^ϵ also admits a membrane in Δ_ϵ .

If $k-1-i = 0$, we can likewise assume that each β_t^ϵ can be represented by a point p_t in $\mathring{\Delta}_\epsilon \setminus X_\epsilon$. Denote by $\delta_t \in \{+, -\}$ the sign of $P(p_t)$. Choose $p_+, p_- \in \mathring{\Delta}_\epsilon \setminus X_\epsilon$ such that P takes positive value on p_+ and negative value on p_- (if P has constant sign on $\mathring{\Delta}_\epsilon$, then $X_\epsilon = \emptyset$, $s_\epsilon = 0$ and we have nothing to do).

Now consider the family of classes $[p_1 + p_{\delta_1}], \dots, [p_{s_\epsilon} + p_{\delta_{s_\epsilon}}] \in H_0(\mathring{\Delta}_\epsilon \setminus X_\epsilon)$. The family $j_*[p_1 + p_{\delta_1}], \dots, j_*[p_{s_\epsilon} + p_{\delta_{s_\epsilon}}] \in \tilde{H}_0(S^k \setminus X_\epsilon)$ has rank at least $s_\epsilon - 2$; by taking out two elements (without loss of generality, those numbered $s_\epsilon - 1$ and s_ϵ), we can once again assume that it is independent. Redefine $\beta_t^\epsilon := [p_t + p_{\delta_t}]$ for $t = 1, \dots, s_\epsilon - 2$. Now $\beta_t^\epsilon \in \ker(H_0((\mathring{S}_d^k \times U_{\mathbb{R}}^k) \setminus \text{Chart}_{\mathring{S}_d^k \times U_{\mathbb{R}}^k}(P)) \longrightarrow H_0(\mathring{S}_d^k \times U_{\mathbb{R}}^k))$ (hence we can use it to compute linking numbers) and it can be represented by cycles on which P has constant sign.

Applying Alexander duality, and using the fact that $H_i(\mathring{\Delta}_\epsilon \cap X_\epsilon) \xrightarrow{in_*} H_i(X_\epsilon)$ is an isomorphism (as is the case when considering the entire space $S_d^k \times U_{\mathbb{R}}^k = \bigcup_\epsilon \Delta_\epsilon$), we can now find classes $\alpha_1^\epsilon, \dots, \alpha_{s_\epsilon-2}^\epsilon \in \tilde{H}_i(\mathring{\Delta}_\epsilon \cap X_\epsilon)$ such that their linking number in S^k verifies $l_{S^k}(in_*(\alpha_s^\epsilon), j_*(\beta_t^\epsilon)) = \delta_{s,t}$ for $s, t \in \{1, \dots, s_\epsilon - 2\}$.

Now consider the sets $B := \bigcup_{\epsilon \in U_{\mathbb{R}}^k} \{\beta_1^\epsilon, \dots, \beta_{s_\epsilon-2}^\epsilon\} \subset H_{k-1-i}(\mathring{S}_d^k \times U_{\mathbb{R}}^k) \setminus \text{Chart}_{\mathring{S}_d^k \times U_{\mathbb{R}}^k}(P)$ and $A := \bigcup_{\epsilon \in U_{\mathbb{R}}^k} \{\alpha_1^\epsilon, \dots, \alpha_{s_\epsilon-2}^\epsilon\} \subset H_i(\text{Chart}_{\mathring{S}_d^k \times U_{\mathbb{R}}^k}(P))$.

Let us compute the linking number of $\beta \in B$ and $\alpha \in A$ in $\mathring{S}_d^k \times U_{\mathbb{R}}^k$. There exists $\epsilon_1, \epsilon_2 \in U_{\mathbb{R}}^k$ and indices s, t such that $\alpha = \alpha_s^{\epsilon_1}$ and $\beta = \beta_t^{\epsilon_2}$. As explained above, β can be represented by a chain b such that it is the boundary of a membrane m in $\mathring{\Delta}_{\epsilon_2}$. Let $a \in \alpha$ be a cycle in $\mathring{\Delta}_{\epsilon_1}$. The linking number in $\mathring{S}_d^k \times U_{\mathbb{R}}^k$ of β and α is the (transversal) intersection number of m and a . If $\epsilon_1 \neq \epsilon_2$, this intersection is necessarily empty. If $\epsilon_1 = \epsilon_2$, m is also a membrane for b in S^k (via the inclusion $\Delta_{\epsilon_1} \subset S^k$), so the linking number in $\mathring{S}_d^k \times U_{\mathbb{R}}^k$ is the same as in S^k (the intersection number of a and m), and thus equal to $\delta_{s,t}$.

We can rename the elements of B (respectively, A) as β_1, \dots, β_r (respectively, $\alpha_1, \dots, \alpha_r$), where $r := \sum_{\epsilon \in U_{\mathbb{R}}^k} (s_\epsilon - 2)$. We have shown that the elements of the sets B and A are as required in the statement of the lemma. We only have to show that we have enough of them.

We see that

$$r = \sum_{\epsilon} (s_\epsilon - 2) \geq \sum_{\epsilon} (b_i(X_\epsilon) - (b_*(\partial\Delta_\epsilon \setminus X_\epsilon) + 4)) = b_i(V_{(\mathbb{R}^*)^k}(P)) - 4 \cdot 2^k - \sum_{\epsilon} b_*(\partial\Delta_\epsilon \setminus X_\epsilon).$$

For a given $\epsilon \in U_{\mathbb{R}}^k$, $\partial\Delta_\epsilon$ is homeomorphic to the $(k-1)$ -sphere. We can once again apply Alexander duality to see that $b_*(\partial\Delta_\epsilon \setminus X_\epsilon) \leq b_*(\partial\Delta_\epsilon \cap X_\epsilon) + 1$. Moreover, using arguments similar to those in the proof of Lemma 5.3.1, one can show that there exists $D_1(k)$, depending only on k , such that $b_*(\partial\Delta_\epsilon \cap X_\epsilon) \leq D_1(k)d^{k-1}$.

Hence

$$r \geq b_i(V_{(\mathbb{R}^*)^k}(P)) - 4 \cdot 2^k - \sum_{\epsilon} b_*(\partial\Delta_\epsilon \setminus X_\epsilon) \geq b_i(V_{(\mathbb{R}^*)^k}(P)) - 2^k(5 + D_1(k)d^{k-1}).$$

By setting $D(k) := 2^k(5 + D_1(k))$, we can conclude. □

Remark 5.3.4. *In the light of Lemma 5.3.1 and Remark 5.3.2, the condition $r \geq b_i(V_{(\mathbb{R}^*)^k}(P)) - D(k)d^{k-1}$ in the statement can be indifferently replaced by $r \geq b_i(V_{\mathbb{R}P^k}(P)) - D(k)d^{k-1}$.*

Remark 5.3.5. *This can easily be generalized to polynomials whose Newton polytope is not a simplex.*

5.3.2 Finding cycles in a suspension

The next two propositions are based on rather simple ideas, but the many indices and small technical details involved make for long demonstrations. We include a short summary of each proof at their beginning.

We want to find a lower bound on the number of cycles and axes associated to each of the "pieces" G_m^+ , G_m^- and F_m^k from Proposition 5.2.6 using Lemma 5.3.3. We start with the case corresponding to G_m^\pm . The case corresponding to F_m^k is considered in the next subsection.

Proposition 5.3.6. *For all $k \geq 1$, there is a constant $E(k) > 0$ with the following property: Let P be a completely nondegenerate polynomial in k variables and degree $d \geq 1$ such that $\Delta(P)$ is a translate of S_d^k , and let $i \in \{0, 1, \dots, k\}$. Let $\lambda^+, \lambda^- \in \mathbb{R}_{>0}$. Write*

$$G^+ : (x_1, \dots, x_k, x_{k+1}) \mapsto P(x_1, \dots, x_k) + \lambda^+ \cdot x_{k+1}$$

and

$$G^- : (x_1, \dots, x_k, x_{k+1}) \mapsto P(x_1, \dots, x_k) + \lambda^- \cdot x_{k+1}^{-1}.$$

Define $X := (\text{Chart}_{\Delta(G^+) \times U_{\mathbb{R}}^{k+1}}(G^+) \cup (\text{Chart}_{\Delta(G^-) \times U_{\mathbb{R}}^{k+1}}(G^-)) \cap \text{Int}(\Delta(G^+) \cup \Delta(G^-)) \times U_{\mathbb{R}}^{k+1})$ (here, $\Delta(G^+)$ and $\Delta(G^-)$ are seen as subsets of the same ambient space \mathbb{R}^{k+1} ; they are $(k+1)$ -simplices with a common k -face $\Delta(P)$).

Then there exists

$$r \geq b_i(V_{(\mathbb{R}^*)^k}(P)) + b_{i-1}(V_{(\mathbb{R}^*)^k}(P)) - E(k)d^{k-1}$$

such that we can find classes $\alpha_1, \dots, \alpha_r$ in $H_i(X)$ and β_1, \dots, β_r in $H_{k-i}(\text{Int}(\Delta(G^+) \cup \Delta(G^-)) \times U_{\mathbb{R}}^{k+1} \setminus X)$ (respectively, in $\ker(H_0(\text{Int}(\Delta(G^+) \cup \Delta(G^-)) \times U_{\mathbb{R}}^{k+1} \setminus X) \rightarrow H_0(\text{Int}(\Delta(G^+) \cup \Delta(G^-)) \times U_{\mathbb{R}}^{k+1}))$ if $k-i=0$) whose linking numbers in $\text{Int}(\Delta(G^+) \cup \Delta(G^-)) \times U_{\mathbb{R}}^{k+1}$ verifies $l(\alpha_s, \beta_t) = \delta_{s,t} \in \mathbb{Z}_2$ (the classes β_t are axes for the classes α_s).

Proof. The main idea here is that for each class of degree j in $V_{(\mathbb{R}^*)^n}(P)$, there is a class of degree j in the hypersurface corresponding to the patchworking of G^+ and G^- (which comes from the inclusion of the original class), and another class of degree $j+1$ corresponding to some kind of suspension of a cycle representing the original class. The same can be said of the classes in the complement of the hypersurface that we use as axes. By proceeding carefully, we can make it so that those new classes still have the right linking numbers properties.

Define $X_0 := X \cap (\Delta(P) \times U_{\mathbb{R}}^{k+1}) \subset \text{Int}(\Delta(G^+) \cup \Delta(G^-)) \times U_{\mathbb{R}}^{k+1}$, as well as $X_0^+ := X \cap (\Delta(P) \times U_{\mathbb{R}}^k \times \{1\})$ and $X_0^- := X \cap (\Delta(P) \times U_{\mathbb{R}}^k \times \{-1\})$. Both X_0^+ and X_0^- are copies of $\text{Chart}_{\Delta(P) \times U_{\mathbb{R}}^k}(P)$, and $X_0 = X_0^+ \cup X_0^-$.

Observe that if $\Delta(P)$ is a translate of S_d^k rather than S_d^k itself, there is a monomial x^ω such that $\Delta(x^\omega P) = S_d^k$. Moreover, $x^\omega P$ and P give rise to the same hypersurface in $(\mathbb{R}^*)^k$, hence in the toric varieties $\mathbb{R}\Delta(x^\omega P)$ and $\mathbb{R}\Delta(P)$; finally, the pairs $(\Delta(x^\omega P) \times U_{\mathbb{R}}^k, \text{Chart}_{\Delta(x^\omega P) \times U_{\mathbb{R}}^k}(x^\omega P))$ and $(\Delta(P) \times U_{\mathbb{R}}^k, \text{Chart}_{\Delta(P) \times U_{\mathbb{R}}^k}(P))$ are trivially isomorphic. This nuance has no impact on the rest of the proof either.

Using an isomorphic change of variables, we can assume λ^\pm to be equal to 1.

Under the above assumption, note also that the change of variables $(x_1 \dots, x_k, x_{k+1}) \mapsto (x_1 \dots, x_k, x_{k+1}^{-1})$ (well defined on $(\mathbb{R}^*)^{k+1}$) induces an homeomorphism of pairs between $(\Delta(G^+) \times U_{\mathbb{R}}^{k+1}, \text{Chart}_{\Delta(G^+) \times U_{\mathbb{R}}^{k+1}}(G^+))$ and $(\Delta(G^-) \times U_{\mathbb{R}}^{k+1}, \text{Chart}_{\Delta(G^-) \times U_{\mathbb{R}}^{k+1}}(G^-))$ (corresponding simply to a vertical symmetry of $\Delta(G^+)$).

Using Lemma 5.3.3, we can produce:

- classes $\tilde{\alpha}_1, \dots, \tilde{\alpha}_{r_1} \in H_i(\text{Chart}_{\dot{\Delta}(P) \times U_{\mathbb{R}}^k}(P))$ and $\tilde{\beta}_1, \dots, \tilde{\beta}_{r_1}$ in $H_{k-1-i}((\dot{\Delta}(P) \times U_{\mathbb{R}}^k) \setminus \text{Chart}_{\dot{\Delta}(P) \times U_{\mathbb{R}}^k}(P))$ (respectively, in $\ker(H_0((\dot{\Delta}(P) \times U_{\mathbb{R}}^k) \setminus \text{Chart}_{\dot{\Delta}(P) \times U_{\mathbb{R}}^k}(P)) \rightarrow H_0(\dot{\Delta}(P) \times U_{\mathbb{R}}^k))$ if $k-1-i=0$), as well as cycles $\tilde{a}_1 \in \tilde{\alpha}_1, \dots, \tilde{a}_{r_1} \in \tilde{\alpha}_{r_1}$ and $\tilde{b}_1 \in \tilde{\beta}_1, \dots, \tilde{b}_{r_1} \in \tilde{\beta}_{r_1}$
- classes $\tilde{\gamma}_1, \dots, \tilde{\gamma}_{r_2} \in H_{i-1}(\text{Chart}_{\dot{\Delta}(P) \times U_{\mathbb{R}}^k}(P))$ and $\tilde{\delta}_1, \dots, \tilde{\delta}_{r_2}$ in $H_{k-i}((\dot{\Delta}(P) \times U_{\mathbb{R}}^k) \setminus \text{Chart}_{\dot{\Delta}(P) \times U_{\mathbb{R}}^k}(P))$ (respectively, in $\ker(H_0((\dot{\Delta}(P) \times U_{\mathbb{R}}^k) \setminus \text{Chart}_{\dot{\Delta}(P) \times U_{\mathbb{R}}^k}(P)) \rightarrow H_0(\dot{\Delta}(P) \times U_{\mathbb{R}}^k))$ if $k-i=0$), as well as cycles $\tilde{c}_1 \in \tilde{\gamma}_1, \dots, \tilde{c}_{r_2} \in \tilde{\gamma}_{r_2}$ and $\tilde{d}_1 \in \tilde{\delta}_1, \dots, \tilde{d}_{r_2} \in \tilde{\delta}_{r_2}$

where each pair of families of classes and associated cycles verifies the conditions of Lemma 5.3.3 (the classes $\tilde{\beta}_j$ are axes to the classes $\tilde{\alpha}_j$, P has constant sign over each cycle \tilde{b}_j or \tilde{d}_j , each cycle \tilde{a}_j , \tilde{b}_j , \tilde{c}_j or \tilde{d}_j is contained in a single quadrant $\dot{\Delta}(P) \times \{\epsilon\}$, etc.), $r_1 = \max(b_i(V_{(\mathbb{R}^*)^k}(P)) - D(k)d^{k-1}, 0)$ and $r_2 = \max(b_{i-1}(V_{(\mathbb{R}^*)^k}(P)) - D(k)d^{k-1}, 0)$.

Moreover, if $i-1 > 0$, observe that each \tilde{c}_t is a boundary in $\dot{\Delta}(P) \times U_{\mathbb{R}}^k$. If $i-1 = -1$, $r_2 = 0$ and it is also (trivially) true. If $i-1 = 0$, we can still assume this to be the case thus: choose a membrane \tilde{o}_s in $\dot{\Delta}(P) \times U_{\mathbb{R}}^k$ for each \tilde{d}_s . Each \tilde{c}_t is contained by definition in a single quadrant $\dot{\Delta}(P) \times \{\epsilon_t\}$ (for some $\epsilon_t \in U_{\mathbb{R}}^k$). Choose a point p_t in $\text{Chart}_{\dot{\Delta}(P) \times U_{\mathbb{R}}^k}(P) \cap (\dot{\Delta}(P) \times \{\epsilon_t\})$ close enough to the boundary $\partial\Delta(P) \times \{\epsilon_t\}$ that it doesn't intersect any \tilde{o}_s (which is possible by compacity of the membranes). For each cycle \tilde{c}_t , we leave it untouched if it is already a boundary in $\dot{\Delta}(P) \times U_{\mathbb{R}}^k$, and redefine it as $\tilde{c}_t + p_t$ otherwise (and we redefine $\gamma_t := [\tilde{c}_t + p_t]$). It is now a boundary, and the linking numbers remain unchanged by that modification.

We also define

- classes $\alpha_1^\pm, \dots, \alpha_{r_1}^\pm \in H_i(X_0^\pm)$ and $\beta_1^\pm, \dots, \beta_{r_1}^\pm$ in $H_{k-1-i}((\dot{\Delta}(P) \times U_{\mathbb{R}}^k \times \{\pm 1\}) \setminus X_0^\pm)$ (respectively, in $\ker(H_0((\dot{\Delta}(P) \times U_{\mathbb{R}}^k \times \{\pm 1\}) \setminus X_0^\pm) \rightarrow H_0(\dot{\Delta}(P) \times U_{\mathbb{R}}^k \times \{\pm 1\}))$ if $k-1-i=0$) as well as cycles $a_1^\pm \in \alpha_1^\pm, \dots, a_{r_1}^\pm \in \alpha_{r_1}^\pm$ and $b_1^\pm \in \beta_1^\pm, \dots, b_{r_1}^\pm \in \beta_{r_1}^\pm$ as copies of $\tilde{\alpha}_t, \tilde{\beta}_t, \tilde{a}_t$ and \tilde{b}_t in X_0^\pm and $(\dot{\Delta}(P) \times U_{\mathbb{R}}^k \times \{\pm 1\}) \setminus X_0^\pm$ via the identification of $(\dot{\Delta}(P) \times U_{\mathbb{R}}^k \times \{\pm 1\}, X_0^\pm)$ with $(\dot{\Delta}(P) \times U_{\mathbb{R}}^k, \text{Chart}_{\dot{\Delta}(P) \times U_{\mathbb{R}}^k}(P))$.
- classes $\gamma_1^\pm, \dots, \gamma_{r_2}^\pm \in H_{i-1}(X_0^\pm)$ and $\delta_1^\pm, \dots, \delta_{r_2}^\pm$ in $H_{k-i}((\dot{\Delta}(P) \times U_{\mathbb{R}}^k \times \{\pm 1\}) \setminus X_0^\pm)$ (respectively, in $\ker(H_0((\dot{\Delta}(P) \times U_{\mathbb{R}}^k \times \{\pm 1\}) \setminus X_0^\pm) \rightarrow H_0(\dot{\Delta}(P) \times U_{\mathbb{R}}^k \times \{\pm 1\}))$ if $k-i=0$) as well as cycles $c_1^\pm \in \gamma_1^\pm, \dots, c_{r_2}^\pm \in \gamma_{r_2}^\pm$ and $d_1^\pm \in \delta_1^\pm, \dots, d_{r_2}^\pm \in \delta_{r_2}^\pm$ as copies of $\tilde{\gamma}_t, \tilde{\delta}_t, \tilde{c}_t$ and \tilde{d}_t in X_0^\pm and $(\dot{\Delta}(P) \times U_{\mathbb{R}}^k \times \{\pm 1\}) \setminus X_0^\pm$ via the identification of $(\dot{\Delta}(P) \times U_{\mathbb{R}}^k \times \{\pm 1\}, X_0^\pm)$ with $(\dot{\Delta}(P) \times U_{\mathbb{R}}^k, \text{Chart}_{\dot{\Delta}(P) \times U_{\mathbb{R}}^k}(P))$.

Consider the sets $\Gamma_{\pm}^{\pm} = (\text{Int}(\Delta(G^+) \cup \Delta(G^-)) \cap \Delta(G^{\pm})) \times U_{\mathbb{R}}^k \times \{\pm\}$ and $\Gamma_{\pm}^{\mp} = (\text{Int}(\Delta(G^+) \cup \Delta(G^-)) \cap \Delta(G^{\mp})) \times U_{\mathbb{R}}^k \times \{\pm\}$ and notice that there are pair homeomorphisms (coming from the definitions of charts and toric varieties)

$$\bullet \phi_{+}^{+} : (\Gamma_{+}^{+}, \Gamma_{+}^{+} \cap X) \longrightarrow ((\mathbb{R}^*)^k \times \mathbb{R}_{\geq 0}, V_{(\mathbb{R}^*)^k \times \mathbb{R}_{\geq 0}}(G^+)),$$

$$\bullet \phi_{-}^{+} : (\Gamma_{-}^{+}, \Gamma_{-}^{+} \cap X) \longrightarrow ((\mathbb{R}^*)^k \times \mathbb{R}_{\leq 0}, V_{(\mathbb{R}^*)^k \times \mathbb{R}_{\leq 0}}(G^+)),$$

as well as

$$\bullet \phi_{+}^{-} : (\Gamma_{+}^{-}, \Gamma_{+}^{-} \cap X) \longrightarrow (\mathbb{R}^*)^k \times \mathbb{R}_{\geq 0}, V_{(\mathbb{R}^*)^k \times \mathbb{R}_{\geq 0}}(G^+),$$

$$\bullet \phi_{-}^{-} : (\Gamma_{-}^{-}, \Gamma_{-}^{-} \cap X) \longrightarrow (\mathbb{R}^*)^k \times \mathbb{R}_{\leq 0}, V_{(\mathbb{R}^*)^k \times \mathbb{R}_{\leq 0}}(G^+)$$

induced the change of variables $(x_1 \dots, x_k, x_{k+1}) \mapsto (x_1 \dots, x_k, x_{k+1}^{-1})$ aforementioned. We use the same notation for the restriction of these homeomorphisms to one of the elements of the corresponding pair.

Each of our r homology classes in $H_i(X)$ will be of one of two types: either the image in $H_i(X)$ of a class of $H_i(X_0)$ (with the suspension of the associated axis), or the suspension of a class of $H_{i-1}(X_0)$ (with the associated axis remaining the same). We proceed in that order.

Let $t \in \{1, \dots, r_1\}$. By definition, P has constant sign $\epsilon_t \in \{+, -\}$ when evaluated over the cycles b_t^+ and b_t^- via the proper identifications. Let m_t be a $(k-i)$ -membrane in $X_0^{\epsilon_t}$ whose boundary is $b_t^{\epsilon_t}$. We define a chain $\tilde{S}b_t^+$ in $((\mathbb{R}^*)^k \times \{\epsilon_t x_{k+1} \geq 0\}) \setminus V_{(\mathbb{R}^*)^k \times \{\epsilon_t x_{k+1} \geq 0\}}(G^+)$ as

$$\begin{aligned} & \{(x_1, \dots, x_k, x_{k+1}) | (x_1, \dots, x_k, 0) \in \phi_{\epsilon_t}^+(b_t^{\epsilon_t}), \epsilon_t x_{k+1} \in [0, R]\} \\ & \bigcup \{(x_1, \dots, x_k, \epsilon_t R) | (x_1, \dots, x_k, 0) \in \phi_{\epsilon_t}^+(m_t)\}, \end{aligned}$$

for $R > 0$ large enough that $\tilde{S}b_t^+$ does not intersect $V_{(\mathbb{R}^*)^k \times \{\epsilon_t x_{k+1} \geq 0\}}(G^+)$ (indeed, we have that $\epsilon_t G^+(x_1, \dots, x_k, \epsilon_t R) = \epsilon_t (P(x_1, \dots, x_k) + \epsilon_t R)$ is strictly positive for any $(x_1, \dots, x_k, 0) \in \phi_{\epsilon_t}^+(m_t)$ for R large enough, as m_t is compact). We let the $(k-i)$ -chain Sb_t^+ in $\Gamma_{\epsilon_t}^+ \setminus X$ be $(\phi_{\epsilon_t}^+)^{-1}(\tilde{S}b_t^+)$. We also define the $(k-i+1)$ -chain

$$M_t^+ := (\phi_{\epsilon_t}^+)^{-1}(\{(x_1, \dots, x_k, x_{k+1}) | (x_1, \dots, x_k, 0) \in \phi_{\epsilon_t}^+(m_t), \epsilon_t x_{k+1} \in [0, R]\})$$

where R is the same as above.

We apply the exact same procedure in $\Gamma_{\epsilon_t}^-$ to get the $(k-i)$ -chain Sb_t^- in $\Gamma_{\epsilon_t}^- \setminus X$ and the $(k-i+1)$ -chain M_t^- in $\Gamma_{\epsilon_t}^-$.

Now we define $Sb_t := Sb_t^+ + Sb_t^-$ (seen as a chain in $(\text{Int}(\Delta(G^+) \cup \Delta(G^-)) \times U_{\mathbb{R}}^{k+1}) \setminus X$) and $M_t := M_t^+ + M_t^-$ (seen as a chain in $\text{Int}(\Delta(G^+) \cup \Delta(G^-)) \times U_{\mathbb{R}}^{k+1}$). The chain Sb_t is a $(k-i)$ -cycle in $(\text{Int}(\Delta(G^+) \cup \Delta(G^-)) \times U_{\mathbb{R}}^{k+1}) \setminus X$, and $\partial M_t = Sb_t$, hence M_t can be used as a membrane for Sb_t . See Figure 5.7 for an illustration of this procedure.

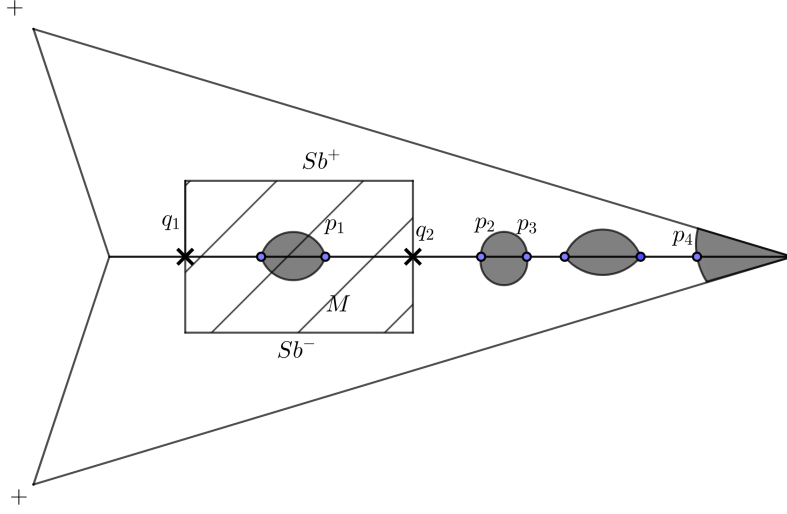

Figure 5.7: For $k = 1$ and $i = 0$, the suspension of the axis $\beta = [b] = [q_1 + q_2]$ in $\Delta(G^+) \cup \Delta(G^-) \times \{1\} \times \{1\}$. The cycle is $\alpha = [a] = [p_1 + p_2 + p_3 + p_4]$. In light grey, the preimage by ϕ_{\pm}^{\pm} of $(G^{\pm})^{-1}\{y \leq 0\}$. The hatched area corresponds to the membrane M .

We set $A := \{[a_1^{\epsilon_1}], \dots, [a_{r_1}^{\epsilon_{r_1}}]\} \subset H_i(X)$ (where we see the cycle $a_t^{\epsilon_t}$ as a cycle in X via the inclusion $X_0^{\epsilon_t} \hookrightarrow X$) and $B := \{[Sb_1], \dots, [Sb_{r_1}]\} \subset H_{k-i}(\text{Int}(\Delta(G^+) \cup \Delta(G^-)) \times U_{\mathbb{R}}^{k+1} \setminus X)$. The elements of B are axes to the elements of A : indeed, let $s, t \in \{1, \dots, r_1\}$. The linking number $l([a_t^{\epsilon_t}], [Sb_s])$ is equal to the intersection number of $a_t^{\epsilon_t}$ and M_s . As $a_t^{\epsilon_t}$ is contained in X_0 , this number is equal to the intersection number of $a_t^{\epsilon_t}$ and $M_s \cap X_0 = m_s$, which is by definition equal to $\delta_{s,t}$.

We now define the classes of degree i obtained by suspending $(i-1)$ -cycles. Let $t \in \{1, \dots, r_2\}$, and \tilde{n}_t be a i -membrane in $\mathring{\Delta}(P) \times U_{\mathbb{R}}^k$ for \tilde{c}_t . Name n_t^+ and n_t^- the copies of \tilde{n}_t in X_0^+ and X_0^- respectively; we have $\partial n_t^{\pm} = c_t^{\pm}$.

We define four i -chains $Sc_t^{\epsilon_1, \epsilon_2} \subset \Gamma_{\epsilon_2}^{\epsilon_1} \cap X$ (for $\epsilon_1, \epsilon_2 \in \{+, -\}$) as

$$Sc_t^{\epsilon_1, \epsilon_2} := (\phi_{\epsilon_2}^{\epsilon_1})^{-1}(\{(x_1, \dots, x_k, -P(x_1, \dots, x_k)) | (x_1, \dots, x_k, 0) \in \phi_{\epsilon_2}^{\epsilon_1}(n_t^{\epsilon_2}), \epsilon_2 P(x_1, \dots, x_k) \leq 0\})$$

as well as four corresponding $(i+1)$ -chains $N_t^{\epsilon_1, \epsilon_2} \subset \Gamma_{\epsilon_2}^{\epsilon_1}$ as

$$N_t^{\epsilon_1, \epsilon_2} := (\phi_{\epsilon_2}^{\epsilon_1})^{-1}(\{(x_1, \dots, x_k, x_{k+1}) | (x_1, \dots, x_k, 0) \in \phi_{\epsilon_2}^{\epsilon_1}(n_t^{\epsilon_2}), \epsilon_2 P(x_1, \dots, x_k) \leq -\epsilon_2 x_{k+1} \leq 0\}).$$

We define $Sc_t := Sc_t^{+,+} + Sc_t^{+,-} + Sc_t^{-,+} + Sc_t^{-,-}$ (seen as a chain in X) and $N_t := N_t^{+,+} + N_t^{+,-} + N_t^{-,+} + N_t^{-,-}$ (seen as a chain in $\text{Int}(\Delta(G^+) \cup \Delta(G^-)) \times U_{\mathbb{R}}^{k+1}$). Note that Sc_t is a cycle and that $\partial N_t = Sc_t$, hence N_t can be used as a membrane for Sc_t . See Figure 5.8 for an illustration of this procedure.

By definition, P has constant sign $\rho_t \in \{+, -\}$ when evaluated over the cycles d_t^+ and d_t^- . Define $C := \{[Sc_1], \dots, [Sc_{r_2}]\} \subset H_i(X)$ and $D := \{[d_1^{-\rho_1}], \dots, [d_{r_2}^{-\rho_{r_2}}]\} \subset$

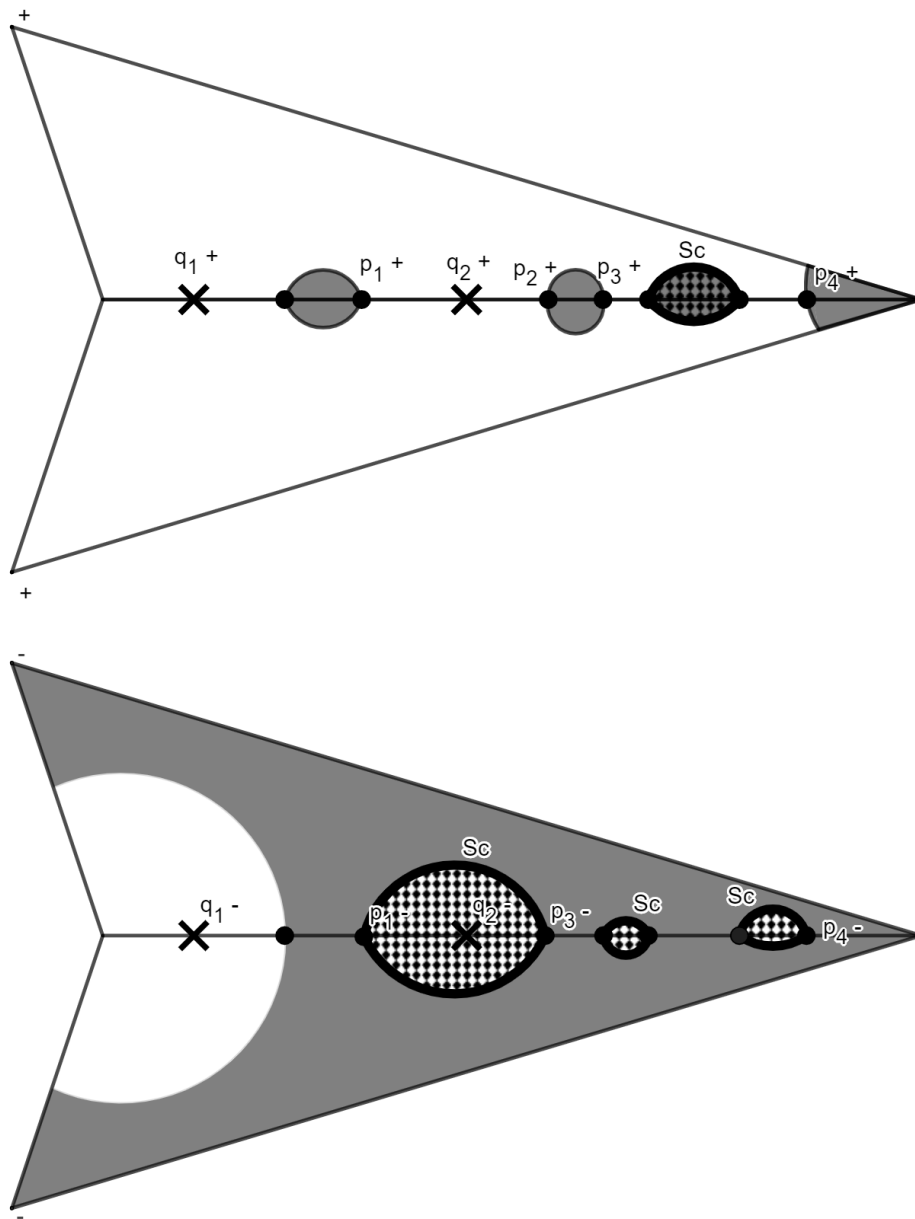

Figure 5.8: For $k = 1$ and $i = 1$, the thick black line is the suspension of the cycle $\gamma = [c] = [p_1 + p_2 + p_3 + p_4]$ in $\Delta(G^+) \cup \Delta(G^-) \times \{1\} \times \{1, -1\}$. The axis is $\delta = [d] = [q_1 + q_2]$. In light grey, the preimage by ϕ_{\mp}^{\pm} of $(G^{\pm})^{-1}\{y \leq 0\}$. The dotted areas correspond to the membrane N .

$H_{k-i}((Int(\Delta(G^+) \cup \Delta(G^-)) \times U_{\mathbb{R}}^{k+1}) \setminus X)$. The elements of D are axes to the elements of C : indeed, let $s, t \in \{1, \dots, r_2\}$. The linking number $l([Sc_s], [d_t^{-\rho_t}])$ is equal to the intersection number of N_s and $d_t^{-\rho_t}$. As $d_t^{-\rho_t}$ is contained in $(\phi_{-\rho_t}^+)^{-1}(\{(x_1, \dots, x_k, 0) | \rho_t P(x_1, \dots, x_k) \geq 0\}) \subset X_0^{-\rho_t}$, this number is equal to the intersection number of $d_t^{-\rho_t}$ and

$$\begin{aligned} N_s \cap (\phi_{-\rho_t}^+)^{-1}(\{(x_1, \dots, x_k, 0) | \rho_t P(x_1, \dots, x_k) \geq 0\}) = \\ n_s^{-\rho_t} \cap (\phi_{-\rho_t}^+)^{-1}(\{(x_1, \dots, x_k, 0) | \rho_t P(x_1, \dots, x_k) \geq 0\}), \end{aligned}$$

which is by definition equal to $\delta_{s,t}$.

We now want to show that the linking number of any element in A and any element in D , as well as any element in B and any element in C , is 0.

First, let $[a_t^{\epsilon_t}] \in A$ and $[d_s^{-\rho_s}] \in D$. Let o be a membrane for $d_s^{-\rho_s}$ in $X_0^{-\rho_s}$. We can slightly rise o and $d_s^{-\rho_s}$ in the following sense: Let

$$o_\lambda := (\phi_{-\rho_s}^+)^{-1}(\{(x_1, \dots, x_k, \lambda) | (x_1, \dots, x_k, 0) \in \phi_{-\rho_s}^+(o)\})$$

and

$$(d_s^{-\rho_s})_\lambda := (\phi_{-\rho_s}^+)^{-1}(\{(x_1, \dots, x_k, \lambda) | (x_1, \dots, x_k, 0) \in \phi_{-\rho_s}^+(d_s^{-\rho_s})\}).$$

We have $\partial o_\lambda = (d_s^{-\rho_s})_\lambda$ and for $\lambda > 0$ small enough, we have $[(d_s^{-\rho_s})_\lambda] = [d_s^{-\rho_s}] \in H_{k-i}((Int(\Delta(G^+) \cup \Delta(G^-)) \times U_{\mathbb{R}}^{k+1}) \setminus X)$ (observe that if $k-i=0$, we have $A = \emptyset$). For such a small λ , the linking number of $[a_t^{\epsilon_t}]$ and $[d_s^{-\rho_s}]$ is equal to the intersection number of o_λ and $a_t^{\epsilon_t}$, which is 0 as $a_t^{\epsilon_t}$ is contained in X_0 and o_λ does not intersect X_0 .

Then, let $[Sb_t] \in B$ and $[Sc_s] \in C$. As above, N_s is a membrane for Sc_s . Let ϵ_t be as in the definition of Sb_t , and observe that $Sb_t \subset \Gamma_{\epsilon_t}^+ \cup \Gamma_{\epsilon_t}^-$. Observe moreover that

$$Sb_t \cap \Gamma_{\epsilon_t}^\pm \subset (\phi_{\epsilon_t}^\pm)^{-1}((G^\pm)^{-1}(\{\epsilon_t y > 0\})).$$

On the other hand,

$$N_s \cap \Gamma_{\epsilon_t}^\pm \subset (\phi_{\epsilon_t}^\pm)^{-1}((G^\pm)^{-1}(\{\epsilon_t y \leq 0\})).$$

Hence, the intersection number of N_s and Sb_t , which is equal to the linking number of $[Sc_s]$ and $[Sb_t]$, is 0.

Note finally that the axes of D were left untouched, and the axes of B are of degree at least 1; hence, if $k-1-i=0$, all axes in $B \cup D$ automatically belong to $\ker(H_0(Int(\Delta(G^+) \cup \Delta(G^-)) \times U_{\mathbb{R}}^{k+1} \setminus X) \rightarrow H_0(Int(\Delta(G^+) \cup \Delta(G^-)) \times U_{\mathbb{R}}^{k+1}))$.

Hence the classes of $A \cup C \subset H_i(X)$ and of $B \cup D \subset H_{k-i}(Int(\Delta(G^+) \cup \Delta(G^-)) \times U_{\mathbb{R}}^{k+1} \setminus X)$ (respectively, $D \subset \ker(H_0(Int(\Delta(G^+) \cup \Delta(G^-)) \times U_{\mathbb{R}}^{k+1} \setminus X) \rightarrow H_0(Int(\Delta(G^+) \cup \Delta(G^-)) \times U_{\mathbb{R}}^{k+1}))$ if $k-i=0$) satisfy all the conditions of the Proposition. We only have to verify that we have enough of them.

We have found $r_1 + r_2 = \max(b_i(V_{(\mathbb{R}^*)^k}(P)) - D(k)d^{k-1}, 0) + \max(b_{i-1}(V_{(\mathbb{R}^*)^k}(P)) -$

$D(k)d^{k-1}, 0) \geq b_i(V_{(\mathbb{R}^*)^k}(P)) + b_{i-1}(V_{(\mathbb{R}^*)^k}(P)) - 2D(k)d^{k-1}$ such pair of classes. By setting $E(k) := 2D(k)$, we can conclude. \square

5.3.3 Finding cycles in a join

We prove a similar result concerning the join of two polynomials (corresponding to the polynomials F_m^k from Proposition 5.2.6):

Proposition 5.3.7. *For all $n \geq 3$, there is a constant $F(n) > 0$ with the following property: Let $k_1, k_2 \geq 1$ be such that $k_1 + k_2 = n - 1$, and let $i \in \{0, \dots, n - 1\}$.*

Let also P_1 (respectively, P_2) be a completely nondegenerate polynomials in k_1 variables (respectively, k_2 variables) and degree $d_1 \geq 1$ (respectively, $d_2 \geq 1$) such that $\Delta(P_1)$ is a translate of $S_{d_1}^{k_1}$ (respectively, $\Delta(P_2)$ is a translate of $S_{d_2}^{k_2}$).

Write

$$P : (x_1, \dots, x_{k_1}, y_1, \dots, y_{k_2}, z) \mapsto P_1(x_1, \dots, x_{k_1}) + z \cdot P_2(y_1, \dots, y_{k_2}).$$

Define $\Delta_1 := \Delta((x_1, \dots, x_{k_1}, y_1, \dots, y_{k_2}, z) \mapsto P_1(x_1, \dots, x_{k_1})) \subset \mathbb{R}^n$,

$\Delta_2 := \Delta((x_1, \dots, x_{k_1}, y_1, \dots, y_{k_2}, z) \mapsto z \cdot P_2(y_1, \dots, y_{k_2})) \subset \mathbb{R}^n$ and $\Delta := \Delta(P) \subset \mathbb{R}^n$.

Observe that $\Delta = \Delta_1 \star \Delta_2$, where \star is as above the join.

Define $X := \text{Chart}_{(\mathring{\Delta}_1 \star \mathring{\Delta}_2) \times U_{\mathbb{R}}^n}(P)$.

Then there exists

$$r \geq \sum_{j=0}^{i-1} b_j(V_{(\mathbb{R}^*)^{k_1}}(P_1)) \cdot b_{i-1-j}(V_{(\mathbb{R}^*)^{k_2}}(P_2)) - F(n) \max(d_1, d_2)^{n-2} \quad (5.3.2)$$

such that we can find classes $\alpha_1, \dots, \alpha_r$ in $H_i(X)$ and β_1, \dots, β_r in $H_{n-1-i}(\mathring{\Delta} \times U_{\mathbb{R}}^n \setminus X)$ such that their linking numbers in $(\mathring{\Delta}_1 \star \mathring{\Delta}_2) \times U_{\mathbb{R}}^n$ verifies $l(\alpha_s, \beta_t) = \delta_{s,t} \in \mathbb{Z}_2$ (the classes β_t are axes for the classes α_s).

Remark 5.3.8. *Remark that the sum in Formula (5.3.2) is trivial if $i = 0, n - 1$. Hence, unlike in previous statements, we do not ask that the axes belong to $\ker(H_0((\mathring{\Delta}_1 \star \mathring{\Delta}_2) \times U_{\mathbb{R}}^n \setminus X) \rightarrow H_0((\mathring{\Delta}_1 \star \mathring{\Delta}_2) \times U_{\mathbb{R}}^n))$ if $n - 1 - i = 0$.*

Proof. The main idea here is that for each j -cycle in $V_{(\mathbb{R}^*)^{k_1}}(P_1)$ and $(i - j - 1)$ -cycle in $V_{(\mathbb{R}^*)^{k_2}}(P_2)$, we can build a j -cycle in X by taking the join of the two cycles. If we are cautious enough, we can proceed similarly with the cycles used as axes, and have all classes built in that fashion have the required linking numbers properties. The proof is somewhat hard to read because there are many copies of the same spaces, which makes keeping track of the indices difficult.

As in the proof of Proposition 5.3.6, whether the polytopes $\Delta(P_i)$ are equal to the simplices $S_{d_i}^{k_i}$ or mere translates of them matters not.

Define $X_1 := \text{Chart}_{\hat{\Delta}(P_1) \times U_{\mathbb{R}}^{k_1}}(P_1)$ and $X_2 := \text{Chart}_{\hat{\Delta}(P_2) \times U_{\mathbb{R}}^{k_2}}(P_2)$. Let $M : \mathbb{R}_+ \Delta \longrightarrow \Delta$ be the moment map described in Chapter 2, and $\phi := M \times \text{id}_{U_{\mathbb{R}}^n} : \mathbb{R}_+ \Delta \times U_{\mathbb{R}}^n \longrightarrow \Delta \times U_{\mathbb{R}}^n$. We know that ϕ induces a stratified homeomorphism between the pairs $(\mathbb{R}_+ \Delta \times U_{\mathbb{R}}^n, \overline{V_{(\mathbb{R}^*)^n}(P)})$ and $(\Delta \times U_{\mathbb{R}}^n, \text{Chart}_{\Delta \times U_{\mathbb{R}}^n}(P))$, which restricts to a homeomorphism $\hat{\phi} : ((\mathbb{R}^*)^n, V_{(\mathbb{R}^*)^n}(P)) \longrightarrow (\hat{\Delta} \times U_{\mathbb{R}}^n, \text{Chart}_{\hat{\Delta} \times U_{\mathbb{R}}^n}(P))$ (via the trivial identification $\mathbb{R}_{>0}^n \times U_{\mathbb{R}}^n \cong (\mathbb{R}^*)^n$).

Explicitly, let $q_0^1, \dots, q_{k_1}^1 \in \mathbb{Z}^{k_1}$ be the vertices of $\Delta(P_1)$ and $q_0^2, \dots, q_{k_2}^2 \in \mathbb{Z}^{k_2}$ be the vertices of $\Delta(P_2)$. Then for any $(x_1, \dots, x_{k_1}, y_1, \dots, y_{k_2}, z) \in (\mathbb{R}^*)^n$, which we also write as $(x, y, z) \in (\mathbb{R}^*)^{k_1} \times (\mathbb{R}^*)^{k_2} \times \mathbb{R}^*$, we have an explicit formula

$$M(x, y, z) = \frac{\sum_{s=0}^{k_1} |x^{q_s^1}| (q_s^1, 0, \dots, 0, 0) + \sum_{t=0}^{k_2} |y^{q_t^2} z| (0, \dots, 0, q_t^2, 1)}{\sum_{s=0}^{k_1} |x^{q_s^1}| + \sum_{t=0}^{k_2} |y^{q_t^2} z|} \quad (5.3.3)$$

where $(q_s^1, 0, \dots, 0, 0) \in \mathbb{Z}^n$ is the point whose first k_1 coordinates are those of $q_s^1 \in \mathbb{Z}^{k_1}$ and whose coordinates $k_1 + 1$ to n are 0, and $(0, \dots, 0, q_t^2, 1) \in \mathbb{Z}^n$ is the point whose coordinates 0 to k_1 are 0, whose coordinates $k_1 + 1$ to $k_1 + k_2$ are those of $q_t^2 \in \mathbb{Z}^{k_2}$ and whose last coordinate is 1 (see Chapter 2).

We decompose $U_{\mathbb{R}}^n$ as $U_{\mathbb{R}}^{k_1} \times U_{\mathbb{R}}^{k_2} \times \{1, -1\}$.

Via the trivial identifications $\Delta_1 \cong \Delta(P_1)$ and $\Delta_2 \cong \Delta(P_2)$, we have $X_1 \times U_{\mathbb{R}}^{k_2} \times \{1, -1\} \subset X$ and $X_2 \times U_{\mathbb{R}}^{k_1} \times \{1, -1\} \subset X$.

The moment map restricts to $\mathbb{R}_+ \Delta_1 \longrightarrow \Delta_1 \subset \Delta$ and $\mathbb{R}_+ \Delta_2 \longrightarrow \Delta_2 \subset \Delta$. It gives rise to pair homeomorphisms $(\mathbb{R}_+ \Delta_1 \times U_{\mathbb{R}}^{k_1} \times U_{\mathbb{R}}^{k_2} \times \{1, -1\}, V_{\mathbb{R}_+ \Delta_1 \times U_{\mathbb{R}}^{k_1}}(P_1) \times U_{\mathbb{R}}^{k_2} \times \{1, -1\}) \longrightarrow (\Delta_1 \times U_{\mathbb{R}}^{k_1} \times U_{\mathbb{R}}^{k_2} \times \{1, -1\}, X_1 \times U_{\mathbb{R}}^{k_2} \times \{1, -1\})$ and $(\mathbb{R}_+ \Delta_2 \times U_{\mathbb{R}}^{k_1} \times U_{\mathbb{R}}^{k_2} \times \{1, -1\}, V_{\mathbb{R}_+ \Delta_2 \times U_{\mathbb{R}}^{k_2}}(P_2) \times U_{\mathbb{R}}^{k_1} \times \{1, -1\}) \longrightarrow (\Delta_2 \times U_{\mathbb{R}}^{k_1} \times U_{\mathbb{R}}^{k_2} \times \{1, -1\}, X_2 \times U_{\mathbb{R}}^{k_1} \times \{1, -1\})$ (where for a polynomial Q in l variables, we let $V_{\mathbb{R}_+ \Delta(Q) \times U_{\mathbb{R}}^l}(Q)$ be the preimage of $V_{\mathbb{R} \Delta(Q)}(Q)$ by $S : \mathbb{R}_+ \Delta(Q) \times U_{\mathbb{R}}^l \longrightarrow \mathbb{R} \Delta(Q)$).

There are embeddings $(\mathbb{R}_{>0})^{k_1} \subset \mathbb{R}_+ \Delta_1$ (induced by the embedding of Δ_1 in \mathbb{R}^n) and $(\mathbb{R}_{>0})^{k_2} \subset \mathbb{R}_+ \Delta_2$ (induced by the embedding of Δ_2 in \mathbb{R}^n). The space $(\mathbb{R}_{>0})^{k_1} \subset \mathbb{R}_+ \Delta_1$ is actually the space $(\mathbb{R}_{>0})^{k_1} \times \{0\}^{k_2} \times \{0\} \subset \mathbb{R}_+ \Delta$ with the parametrization of $\mathbb{R}_+ \Delta$ induced by the canonical basis of \mathbb{Z}^n , and the space $(\mathbb{R}_{>0})^{k_2} \subset \mathbb{R}_+ \Delta_2$ can be seen as $\{0\}^{k_1} \times (\mathbb{R}_{>0})^{k_2} \times \{\infty\} \subset \mathbb{R}_+ \Delta$ in the same system of coordinates, or more rigorously as $\{0\}^{k_1} \times (\mathbb{R}_{>0})^{k_2} \times \{0\} \subset \mathbb{R}_+ \Delta$ via the change of coordinates $(x, y, z) \mapsto (x, y, z^{-1})$.

Let $(x, 0, 0) \in (\mathbb{R}_{>0})^{k_1} \times \{0\}^{k_2} \times \{0\} \subset \mathbb{R}_+ \Delta$. Then we have

$$M(x, 0, 0) = \frac{\sum_{s=0}^{k_1} |x^{q_s^1}| (q_s^1, 0, \dots, 0, 0)}{\sum_{s=0}^{k_1} |x^{q_s^1}|} = (M_1(x), 0, 0) \in \Delta_1 \subset \Delta,$$

where $M_1 : \mathbb{R}_+ \Delta(P_1) \longrightarrow \Delta(P_1)$.

Likewise, let $(0, y, \infty) \in \{0\}^{k_1} \times (\mathbb{R}_{>0})^{k_2} \times \{\infty\} \subset \mathbb{R}_+ \Delta$. Then we have

$$M(0, y, \infty) = \frac{\sum_{t=0}^{k_2} |y^{q_t^2}| (0, \dots, 0, q_t^2, 1)}{\sum_{t=0}^{k_2} |y^{q_t^2}|} = (0, M_2(y), 1) \in \Delta_2 \subset \Delta,$$

where $M_2 : \mathbb{R}_+ \Delta(P_2) \longrightarrow \Delta(P_2)$.

Hence we can rewrite Formula (5.3.3) as

$$M(x, y, z) = \frac{\sum_{s=0}^{k_1} |x^{q_s^1}| (q_s^1, 0, \dots, 0, 0) + \sum_{t=0}^{k_2} |y^{q_t^2} z| (0, \dots, 0, q_t^2, 1)}{\sum_{s=0}^{k_1} |x^{q_s^1}| + \sum_{t=0}^{k_2} |y^{q_t^2} z|} = \tag{5.3.4}$$

$$\left(\frac{\sum_{s=0}^{k_1} |x^{q_s^1}|}{\sum_{s=0}^{k_1} |x^{q_s^1}| + |z| \cdot \sum_{t=0}^{k_2} |y^{q_t^2}|} M_1(x), \frac{|z| \cdot \sum_{t=0}^{k_2} |y^{q_t^2}|}{\sum_{s=0}^{k_1} |x^{q_s^1}| + |z| \cdot \sum_{t=0}^{k_2} |y^{q_t^2}|} M_2(y), \frac{|z| \cdot \sum_{t=0}^{k_2} |y^{q_t^2}|}{\sum_{s=0}^{k_1} |x^{q_s^1}| + |z| \cdot \sum_{t=0}^{k_2} |y^{q_t^2}|} \right).$$

For each $(\epsilon_1, \epsilon_2, \epsilon) \in U_{\mathbb{R}}^{k_1} \times U_{\mathbb{R}}^{k_2} \times \{1, -1\}$, define

$$J_{(\epsilon_1, \epsilon_2, \epsilon)} := \{((\lambda x, (1-\lambda)y, 1-\lambda), (\epsilon_1, \epsilon_2, \epsilon)) \in \Delta \times U_{\mathbb{R}}^n \mid \lambda \in [0, 1], (x, \epsilon_1) \in X_1, (y, \epsilon_2) \in X_2\}.$$

It is clearly homeomorphic to the "abstract" topological join $((X_1 \cap (\mathring{\Delta}(P_1) \times \{\epsilon_1\})) \times (X_2 \cap (\mathring{\Delta}(P_2) \times \{\epsilon_2\}))) \times [0, 1] / \{(x, y_1, 0) \sim (x, y_2, 0), (x_1, y, 1) \sim (x_2, y, 1)\}$ of $X_1 \cap (\mathring{\Delta}(P_1) \times \{\epsilon_1\})$ and $X_2 \cap (\mathring{\Delta}(P_2) \times \{\epsilon_2\})$.

Define the pseudo-join

$$J := \bigsqcup_{(\epsilon_1, \epsilon_2, \epsilon) \in U_{\mathbb{R}}^n} J_{(\epsilon_1, \epsilon_2, \epsilon)}.$$

It is NOT homeomorphic to the "abstract" join $(X_1 \times X_2 \times [0, 1]) / \{(x, y_1, 0) \sim (x, y_2, 0), (x_1, y, 1) \sim (x_2, y, 1)\}$ (a quotient of J is). Observe that by definition of P , we have $V_{(\mathbb{R}^*)^{k_1}}(P_1) \times V_{(\mathbb{R}^*)^{k_2}}(P_2) \times \mathbb{R}^* \subset V_{(\mathbb{R}^*)^n}(P)$. Using Formula (5.3.4), we see that it is mapped to \mathring{J} by ϕ , which shows that $\mathring{J} \subset X$. Taking the closure of \mathring{J} in $(\mathring{\Delta}_1 \star \mathring{\Delta}_2) \times U_{\mathbb{R}}^n$, we see that $J \subset X$.

Now let $j \in \{0, \dots, i-1\}$. We will build i -cycles and $(n-1-i)$ -axes from j - and $(i-1-j)$ -cycles and (k_1-1-j) - and (k_2-i+j) -axes by taking their join.

Using Lemma 5.3.3, we can produce:

- classes $\tilde{\alpha}_1^j, \dots, \tilde{\alpha}_{r_1}^j \in H_j(X_1)$ and $\tilde{\beta}_1^{k_1-1-j}, \dots, \tilde{\beta}_{r_1}^{k_1-1-j}$ in $H_{k_1-1-j}((\mathring{\Delta}(P_1) \times U_{\mathbb{R}}^{k_1}) \setminus X_1)$ (respectively, in $\ker(H_0((\mathring{\Delta}(P_1) \times U_{\mathbb{R}}^{k_1}) \setminus X_1) \longrightarrow H_0(\mathring{\Delta}(P_1) \times U_{\mathbb{R}}^{k_1}))$ if $k_1-1-j=0$), as well as cycles $\tilde{a}_1^j \in \tilde{\alpha}_1^j, \dots, \tilde{a}_{r_1}^j \in \tilde{\alpha}_{r_1}^j$ and $\tilde{b}_1^{k_1-1-j} \in \tilde{\beta}_1^{k_1-1-j}, \dots, \tilde{b}_{r_1}^{k_1-1-j} \in \tilde{\beta}_{r_1}^{k_1-1-j}$.
- classes $\tilde{\gamma}_1^{i-1-j}, \dots, \tilde{\gamma}_{r_2}^{i-1-j} \in H_{i-1-j}(X_2)$ and $\tilde{\delta}_1^{k_2-i+j}, \dots, \tilde{\delta}_{r_2}^{k_2-i+j}$ in $H_{k_2-i+j}((\mathring{\Delta}(P_2) \times U_{\mathbb{R}}^{k_2}) \setminus X_2)$ (respectively, in $\ker(H_0((\mathring{\Delta}(P_2) \times U_{\mathbb{R}}^{k_2}) \setminus X_2) \longrightarrow H_0(\mathring{\Delta}(P_2) \times U_{\mathbb{R}}^{k_2}))$ if $k_2-i+j=0$), as well as cycles $\tilde{c}_1^{i-1-j} \in \tilde{\gamma}_1^{i-1-j}, \dots, \tilde{c}_{r_2}^{i-1-j} \in \tilde{\gamma}_{r_2}^{i-1-j}$ and $\tilde{d}_1^{k_2-i+j} \in \tilde{\delta}_1^{k_2-i+j}, \dots, \tilde{d}_{r_2}^{k_2-i+j} \in \tilde{\delta}_{r_2}^{k_2-i+j}$.

where each pair of families of classes and associated cycles verifies the conditions of Lemma 5.3.3 (the classes $\tilde{\beta}_s^{k_1-1-j}$ are axes to the classes $\tilde{\alpha}_s^j$, P_1 has constant sign over the cycles

$\tilde{b}_s^{k_1-1-j}$, each cycle is contained in a single quadrant, etc.), $r_1^j = \max(b_j(V_{(\mathbb{R}^*)^{k_1}}(P_1)) - D(k_1)d_1^{k_1-1}, 0)$ and $r_2^{i-1-j} = \max(b_{i-1-j}(V_{(\mathbb{R}^*)^{k_2}}(P_2)) - D(k_2)d_2^{k_2-1}, 0)$.

We also define

- for each $\epsilon_2 \in U_{\mathbb{R}}^{k_2}$ and $\epsilon \in \{1, -1\}$, classes $\alpha_{1,\epsilon_2,\epsilon}^j, \dots, \alpha_{r_1^j,\epsilon_2,\epsilon}^j \in H_j(X_1 \times \{\epsilon_2\} \times \{\epsilon\})$ and $\beta_{1,\epsilon_2,\epsilon}^{k_1-1-j}, \dots, \beta_{r_1^j,\epsilon_2,\epsilon}^{k_1-1-j}$ in $H_{k_1-1-j}(((\mathring{\Delta}_1 \times U_{\mathbb{R}}^{k_1}) \setminus X_1) \times \{\epsilon_2\} \times \{\epsilon\})$ (respectively, in $\ker(H_0(((\mathring{\Delta}_1 \times U_{\mathbb{R}}^{k_1}) \setminus X_1) \times \{\epsilon_2\} \times \{\epsilon\}) \rightarrow H_0(\mathring{\Delta}_1 \times U_{\mathbb{R}}^{k_1} \times \{\epsilon_2\} \times \{\epsilon\}))$ if $k_1 - 1 - j = 0$) as well as cycles $a_{1,\epsilon_2,\epsilon}^j \in \alpha_{1,\epsilon_2,\epsilon}^j, \dots, a_{r_1^j,\epsilon_2,\epsilon}^j \in \alpha_{r_1^j,\epsilon_2,\epsilon}^j$ and $b_{1,\epsilon_2,\epsilon}^{k_1-1-j} \in \beta_{1,\epsilon_2,\epsilon}^{k_1-1-j}, \dots, b_{r_1^j,\epsilon_2,\epsilon}^{k_1-1-j} \in \beta_{r_1^j,\epsilon_2,\epsilon}^{k_1-1-j}$ as copies of $\tilde{\alpha}_t^j, \tilde{\beta}_t^{k_1-1-j}, \tilde{a}_t^j$ and $\tilde{b}_t^{k_1-1-j}$ in $X_1 \times \{\epsilon_2\} \times \{\epsilon\}$ and $(\mathring{\Delta}_1 \times U_{\mathbb{R}}^{k_1}) \setminus X_1 \times \{\epsilon_2\} \times \{\epsilon\}$ via the identification of $(\mathring{\Delta}(P_1) \times U_{\mathbb{R}}^{k_1}, X_1)$ with $(\mathring{\Delta}_1 \times U_{\mathbb{R}}^{k_1} \times \{\epsilon_2\} \times \{\epsilon\}, X_1 \times \{\epsilon_2\} \times \{\epsilon\})$.
- for each $\epsilon_1 \in U_{\mathbb{R}}^{k_1}$ and $\epsilon \in \{1, -1\}$, classes $\gamma_{1,\epsilon_1,\epsilon}^{i-1-j}, \dots, \gamma_{r_2^{i-1-j},\epsilon_1,\epsilon}^{i-1-j} \in H_{i-1-j}(X_2 \times \{\epsilon_1\} \times \{\epsilon\})$ and $\delta_{1,\epsilon_1,\epsilon}^{k_2-i+j}, \dots, \delta_{r_2^{i-1-j},\epsilon_1,\epsilon}^{k_2-i+j}$ in $H_{k_2-i+j}(((\mathring{\Delta}_2 \times U_{\mathbb{R}}^{k_2}) \setminus X_2) \times \{\epsilon_1\} \times \{\epsilon\})$ (respectively, in $\ker(H_0(((\mathring{\Delta}_2 \times U_{\mathbb{R}}^{k_2}) \setminus X_2) \times \{\epsilon_1\} \times \{\epsilon\}) \rightarrow H_0(\mathring{\Delta}_2 \times \{\epsilon_1\} \times U_{\mathbb{R}}^{k_2} \times \{\epsilon\}))$ if $k_2 - i + j = 0$) as well as cycles $c_{1,\epsilon_1,\epsilon}^{i-1-j} \in \gamma_{1,\epsilon_1,\epsilon}^{i-1-j}, \dots, c_{r_2^{i-1-j},\epsilon_1,\epsilon}^{i-1-j} \in \gamma_{r_2^{i-1-j},\epsilon_1,\epsilon}^{i-1-j}$ and $d_{1,\epsilon_1,\epsilon}^{k_2-i+j} \in \delta_{1,\epsilon_1,\epsilon}^{k_2-i+j}, \dots, d_{r_2^{i-1-j},\epsilon_1,\epsilon}^{k_2-i+j} \in \delta_{r_2^{i-1-j},\epsilon_1,\epsilon}^{k_2-i+j}$ as copies of $\tilde{\gamma}_t^{i-1-j}, \tilde{\delta}_t^{k_2-i+j}, \tilde{c}_t^{i-1-j}$ and $\tilde{d}_t^{k_2-i+j}$ in $X_2 \times \{\epsilon_1\} \times \{\epsilon\}$ and $(\mathring{\Delta}_2 \times U_{\mathbb{R}}^{k_2}) \setminus X_2 \times \{\epsilon_1\} \times \{\epsilon\}$ via the identification of $(\mathring{\Delta}(P_2) \times U_{\mathbb{R}}^{k_2}, X_2)$ with $(\mathring{\Delta}_2 \times \{\epsilon_1\} \times U_{\mathbb{R}}^{k_2} \times \{\epsilon\}, X_2 \times \{\epsilon_1\} \times \{\epsilon\})$.

Let $t \in \{1, \dots, r_1^j\}$ and $s \in \{1, \dots, r_2^{i-1-j}\}$. By definition, the cycles \tilde{a}_t^j and $\tilde{b}_t^{k_1-1-j}$ are contained in a single quadrant $\mathring{\Delta}(P_1) \times \{\epsilon_t^j\}$ (for some $\epsilon_t^j \in U_{\mathbb{R}}^{k_1}$), and the cycles \tilde{c}_s^{i-1-j} and $\tilde{d}_s^{k_2-i+j}$ are also contained in a single quadrant $\mathring{\Delta}(P_2) \times \{\zeta_s^{i-1-j}\}$ (for some $\zeta_s^{i-1-j} \in U_{\mathbb{R}}^{k_2}$).

By definition, P_1 takes constant sign ϵ_1 over $\tilde{b}_t^{k_1-1-j}$ and P_2 takes constant sign ϵ_2 over $\tilde{d}_s^{k_2-i+j}$ (when evaluated via the isomorphism $\mathring{\Delta}(P_l) \times U_{\mathbb{R}}^{k_l} \cong (\mathbb{R}^*)^{k_l}$, for $l = 1, 2$). Let $\epsilon(j, t, s)$ be 1 if $\epsilon_1 = \epsilon_2$, and -1 otherwise.

Then the join $a_{t,\zeta_s^{i-1-j},\epsilon(j,t,s)}^j \star c_{s,\epsilon_t^j,\epsilon(j,t,s)}^{i-1-j}$ of $a_{t,\zeta_s^{i-1-j},\epsilon(j,t,s)}^j$ and $c_{s,\epsilon_t^j,\epsilon(j,t,s)}^{i-1-j}$ is a i -cycle in $J_{(\epsilon_t^j,\zeta_s^{i-1-j},\epsilon(j,t,s))} \subset (\mathring{\Delta}_1 \star \mathring{\Delta}_2 \times \{\epsilon_t^j\} \times \{\zeta_s^{i-1-j}\} \times \{\epsilon(j, t, s)\}) \cap X$.

Now consider the join $b_{t,\zeta_s^{i-1-j},\epsilon(j,t,s)}^{k_1-1-j} \star d_{s,\epsilon_t^j,\epsilon(j,t,s)}^{k_2-i+j}$ of $b_{t,\zeta_s^{i-1-j},\epsilon(j,t,s)}^{k_1-1-j}$ and $d_{s,\epsilon_t^j,\epsilon(j,t,s)}^{k_2-i+j}$. It is a $(n-1-i)$ -cycle in $\mathring{\Delta}_1 \star \mathring{\Delta}_2 \times \{\epsilon_t^j\} \times \{\zeta_s^{i-1-j}\} \times \{\epsilon(j, t, s)\}$. Furthermore, the intersection of $b_{t,\zeta_s^{i-1-j},\epsilon(j,t,s)}^{k_1-1-j} \star d_{s,\epsilon_t^j,\epsilon(j,t,s)}^{k_2-i+j}$ with $\mathring{\Delta}_1 \times \{\epsilon_t^j\} \times \{\zeta_s^{i-1-j}\} \times \{\epsilon(j, t, s)\}$ is $b_{t,\zeta_s^{i-1-j},\epsilon(j,t,s)}^{k_1-1-j}$, which does not intersect X , and the intersection of $b_{t,\zeta_s^{i-1-j},\epsilon(j,t,s)}^{k_1-1-j} \star d_{s,\epsilon_t^j,\epsilon(j,t,s)}^{k_2-i+j}$ with $\mathring{\Delta}_2 \times \{\epsilon_t^j\} \times \{\zeta_s^{i-1-j}\} \times \{\epsilon(j, t, s)\}$ is $d_{s,\epsilon_t^j,\epsilon(j,t,s)}^{k_2-i+j}$, which does not intersect X either. Finally, any point in the intersection of $b_{t,\zeta_s^{i-1-j},\epsilon(j,t,s)}^{k_1-1-j} \star d_{s,\epsilon_t^j,\epsilon(j,t,s)}^{k_2-i+j}$ and $\mathring{\Delta} \times \{\epsilon_t^j\} \times \{\zeta_s^{i-1-j}\} \times \{\epsilon(j, t, s)\}$ can be written as $((\lambda M_1(x), (1-\lambda)M_2(y), 1-\lambda), (\{\epsilon_t^j\} \times \{\zeta_s^{i-1-j}\} \times \{\epsilon(j, t, s)\}))$, for some $\lambda \in]0, 1[$, some $x \in (\mathbb{R}_{>0})^{k_1}$ such that $x\epsilon_t^j := (x_1(\epsilon_t^j)_1, \dots, x_{k_1}(\epsilon_t^j)_{k_1}) \in (\mathbb{R}^*)^{k_1} \setminus V_{(\mathbb{R}^*)^{k_1}}(P_1)$ and some $y \in (\mathbb{R}_{>0})^{k_2}$ such that $y\zeta_s^{i-1-j} := (y_1(\zeta_s^{i-1-j})_1, \dots, y_{k_2}(\zeta_s^{i-1-j})_{k_2}) \in (\mathbb{R}^*)^{k_2} \setminus V_{(\mathbb{R}^*)^{k_2}}(P_2)$.

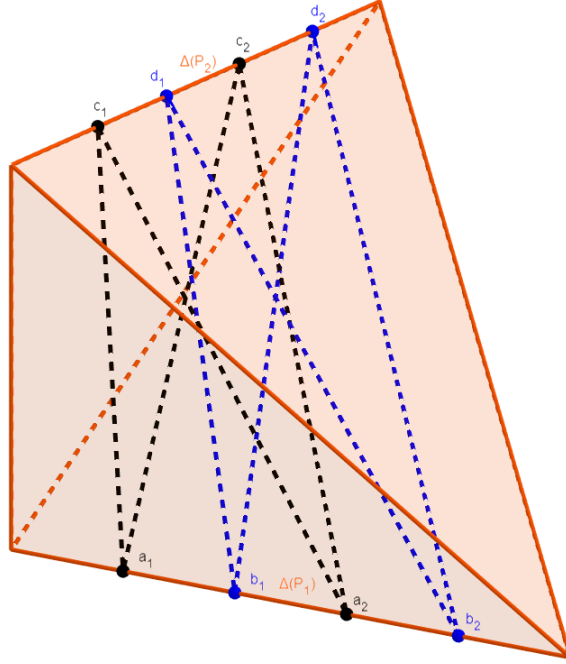

Figure 5.9: For $k_1 = k_2 = 1$, $i = 1$ and $j = 0$, the join of cycles $a = a_1 + a_2$ and $c = c_1 + c_2$ and the join of axes $b = b_1 + b_2$ and $d = d_1 + d_2$.

But this is equal to the image of $((x, y, z), (\{\epsilon_t^j\} \times \{\zeta_s^{i-1-j}\} \times \{\epsilon(j, t, s)\})) \in (\mathbb{R}_{>0})^n \times U_{\mathbb{R}}^n$ by ϕ (see Formula (5.3.4)), for some $z \in \mathbb{R}_{>0}$.

Then

$$P(x\epsilon_t^j, y\zeta_s^{i-1-j}, z\epsilon(j, t, s)) = P_1(x\epsilon_t^j) + z\epsilon(j, t, s)P_2(y\zeta_s^{i-1-j})$$

is different from zero, as each term is different from zero and of the same sign (by definition of $\epsilon(j, t, s)$). Hence $(x\epsilon_t^j, y\zeta_s^{i-1-j}, z\epsilon(j, t, s)) \notin V_{(\mathbb{R}^*)^n}(P)$ and we see, via the isomorphism ϕ , that the intersection of $b_{t, \zeta_s^{i-1-j}, \epsilon(j, t, s)}^{k_1-1-j} \star d_{s, \epsilon_t^j, \epsilon(j, t, s)}^{k_2-i+j}$ and X is trivial: $b_{t, \zeta_s^{i-1-j}, \epsilon(j, t, s)}^{k_1-1-j} \star d_{s, \epsilon_t^j, \epsilon(j, t, s)}^{k_2-i+j}$ is a cycle in $(\mathring{\Delta}_1 \star \mathring{\Delta}_2 \times \{\epsilon_t^j\} \times \{\zeta_s^{i-1-j}\} \times \{\epsilon(j, t, s)\}) \setminus X$. See also Figure 5.9.

Let us show that for any $t_1, t_2 \in \{1, \dots, r_1^j\}$ and $s_1, s_2 \in \{1, \dots, r_2^{i-1-j}\}$, the linking number of $[a_{t_1, \zeta_{s_1}^{i-1-j}, \epsilon(j, t_1, s_1)}^j \star c_{s_1, \epsilon_{t_1}^j, \epsilon(j, t_1, s_1)}^{i-1-j}] \in H_i(X)$ and $[b_{t_2, \zeta_{s_2}^{i-1-j}, \epsilon(j, t_2, s_2)}^{k_1-1-j} \star d_{s_2, \epsilon_{t_2}^j, \epsilon(j, t_2, s_2)}^{k_2-i+j}] \in H_{n-1-i}((\mathring{\Delta}_1 \star \mathring{\Delta}_2) \times U_{\mathbb{R}}^n) \setminus X$ is equal to $\delta_{t_1, t_2} \delta_{s_1, s_2}$.

Let m be a membrane for $b_{t_2, \zeta_{s_2}^{i-1-j}, \epsilon(j, t_2, s_2)}^{k_1-1-j}$ in $\mathring{\Delta}_1 \times \{\epsilon_{t_2}^j\} \times \{\zeta_{s_2}^{i-1-j}\} \times \{\epsilon(j, t_2, s_2)\}$, i.e. a $(k_1 - j)$ -chain in $\mathring{\Delta}_1 \times \{\epsilon_{t_2}^j\} \times \{\zeta_{s_2}^{i-1-j}\} \times \{\epsilon(j, t_2, s_2)\}$ such that $\partial m = b_{t_2, \zeta_{s_2}^{i-1-j}, \epsilon(j, t_2, s_2)}^{k_1-1-j}$. We can also assume that m intersects $a_{t_1, \zeta_{s_1}^{i-1-j}, \epsilon(j, t_1, s_1)}^j$ transversally. Then it is easy to see that $m \star d_{s_2, \epsilon_{t_2}^j, \epsilon(j, t_2, s_2)}^{k_2-i+j}$ is a membrane for $b_{t_2, \zeta_{s_2}^{i-1-j}, \epsilon(j, t_2, s_2)}^{k_1-1-j} \star d_{s_2, \epsilon_{t_2}^j, \epsilon(j, t_2, s_2)}^{k_2-i+j}$ in $(\mathring{\Delta}_1 \star \mathring{\Delta}_2) \times U_{\mathbb{R}}^n$.

The linking number will be equal to the transversal intersection number of $m \star d_{s_2, \epsilon_{t_2}^j, \epsilon(j, t_2, s_2)}^{k_2-i+j}$

and $a_{t_1, \zeta_{s_1}^{i-1-j}, \epsilon(j, t_1, s_1)}^j \star c_{s_1, \epsilon_{t_1}^j, \epsilon(j, t_+, s_1)}^{i-1-j}$ in $(\overset{\circ}{\Delta}_1 \star \overset{\circ}{\Delta}_2) \times U_{\mathbb{R}}^n$. Note that it is necessarily trivial if we don't have $\epsilon_{t_1}^j = \epsilon_{t_2}^j$, $\zeta_{s_1}^{i-1-j} = \zeta_{s_2}^{i-1-j}$ and $\epsilon(j, t_1, s_1) = \epsilon(j, t_2, s_2)$. Assuming from now on that we do, we write $\epsilon_1 := \epsilon_{t_1}^j$, $\epsilon_2 := \zeta_{s_1}^{i-1-j}$ and $\epsilon := \epsilon(j, t_2, s_2)$ to shorten notations.

As above, any point in $m \star d_{s_2, \epsilon_1, \epsilon}^{k_2-i+j}$ (respectively, in $a_{t_1, \epsilon_2, \epsilon}^j \star c_{s_1, \epsilon_1, \epsilon}^{i-1-j}$) can be written as $((\lambda x, (1-\lambda)y, 1-\lambda), (\epsilon_1, \epsilon_2, \epsilon))$ for some $((x, 0, 0), (\epsilon_1, \epsilon_2, \epsilon)) \in m$, $((0, y, 1), (\epsilon_1, \epsilon_2, \epsilon)) \in d_{s_2, \epsilon_1, \epsilon}^{k_2-i+j}$ (respectively, $((x, 0, 0), (\epsilon_1, \epsilon_2, \epsilon)) \in a_{t_1, \epsilon_2, \epsilon}^j$ and $((0, y, 1), (\epsilon_1, \epsilon_2, \epsilon)) \in c_{s_1, \epsilon_1, \epsilon}^{i-1-j}$) and $\lambda \in [0, 1]$. As the intersection of $c_{s_1, \epsilon_1, \epsilon}^{i-1-j}$ and $d_{s_2, \epsilon_1, \epsilon}^{k_2-i+j}$ is trivial, we see that set-wise, we have

$$m \star d_{s_2, \epsilon_1, \epsilon}^{k_2-i+j} \cap a_{t_1, \epsilon_2, \epsilon}^j \star c_{s_1, \epsilon_1, \epsilon}^{i-1-j} = m \star d_{s_2, \epsilon_1, \epsilon}^{k_2-i+j} \cap a_{t_1, \epsilon_2, \epsilon}^j \star c_{s_1, \epsilon_1, \epsilon}^{i-1-j} \cap \Delta_1 \times \{\epsilon_1\} \times \{\epsilon_2\} \times \{\epsilon\} = m \cap a_{t_1, \epsilon_2, \epsilon}^j,$$

but this intersection is not transversal.

We slightly deform $b_{t_2, \epsilon_2, \epsilon}^{k_1-1-j} \star d_{s_2, \epsilon_1, \epsilon}^{k_2-i+j}$ to make it transversal. We are computing an intersection number in $(\overset{\circ}{\Delta}_1 \star \overset{\circ}{\Delta}_2) \times \{\epsilon_1\} \times \{\epsilon_2\} \times \{\epsilon\}$; from now on, we identify it with $\overset{\circ}{\Delta}_1 \star \overset{\circ}{\Delta}_2$, and embed it in \mathbb{R}^n - the intersection number in \mathbb{R}^n is the same.

For $\rho > 0$, define $(b_{t_2, \epsilon_2, \epsilon}^{k_1-1-j})_{\rho} := b_{t_2, \epsilon_2, \epsilon}^{k_1-1-j} + \rho e_n = \{(x, 0, \rho) | (x, 0, 0) \in b_{t_2, \epsilon_2, \epsilon}^{k_1-1-j}\}$ and similarly $m_{\rho} := m + \rho e_n$. For ρ small enough, $(b_{t_2, \epsilon_2, \epsilon}^{k_1-1-j})_{\rho} \star d_{s_2, \epsilon_1, \epsilon}^{k_2-i+j}$ does not intersect X and induces the same class as $b_{t_2, \epsilon_2, \epsilon}^{k_1-1-j} \star d_{s_2, \epsilon_1, \epsilon}^{k_2-i+j}$ in $H_{n-1-i}(\mathbb{R}^n \setminus X)$. The chain $m_{\rho} \star d_{s_2, \epsilon_1, \epsilon}^{k_2-i+j}$ is a membrane for $(b_{t_2, \epsilon_2, \epsilon}^{k_1-1-j})_{\rho} \star d_{s_2, \epsilon_1, \epsilon}^{k_2-i+j}$, and for ρ generic enough, it intersects $a_{t_1, \epsilon_2, \epsilon}^j \star c_{s_1, \epsilon_1, \epsilon}^{i-1-j}$ transversally. Let us count these intersection points.

Any point in $m_{\rho} \star d_{s_2, \epsilon_1, \epsilon}^{k_2-i+j}$ can be written as $(\lambda x, (1-\lambda)y, 1-\lambda(1-\rho))$ for $x \in m$, $y \in d_{s_2, \epsilon_1, \epsilon}^{k_2-i+j}$ and $\lambda \in [0, 1]$, or equivalently as $(\frac{\mu}{1-\rho}x, (1-\frac{\mu}{1-\rho})y, 1-\mu)$ for $\mu \in [0, 1-\rho]$. The points in $a_{t_1, \epsilon_2, \epsilon}^j \star c_{s_1, \epsilon_1, \epsilon}^{i-1-j}$ can be written as $(\mu v, (1-\mu)w, 1-\mu)$ for some $v \in a_{t_1, \epsilon_2, \epsilon}^j$, $w \in c_{s_1, \epsilon_1, \epsilon}^{i-1-j}$ and $\mu \in [0, 1]$. For $\rho > 0$ small enough, we can assume that the intersection of m and $a_{t_1, \epsilon_2, \epsilon}^j$ is equal to the intersection of $\frac{1}{1-\rho} \cdot m$ and $a_{t_1, \epsilon_2, \epsilon}^j$ (since m was assumed to be generically positioned with respect to $a_{t_1, \epsilon_2, \epsilon}^j$). See Figure 5.10.

Hence for each $\mu \in [0, 1-\rho]$, we have $|m \cap a_{t_1, \epsilon_2, \epsilon}^j| \cdot |(1-\frac{\mu}{1-\rho}) \cdot d_{s_2, \epsilon_1, \epsilon}^{k_2-i+j} \cap (1-\mu) \cdot c_{s_1, \epsilon_1, \epsilon}^{i-1-j}| \in \mathbb{Z}_2$ intersection points (mod 2) with last coordinate $1-\mu$ (where $|\cdot|$ denotes the cardinality modulo 2) and $|m \cap a_{t_1, \epsilon_2, \epsilon}^j|$ is equal to the linking number of $[a_{t_1, \epsilon_2, \epsilon}^j]$ and $[b_{t_2, \epsilon_2, \epsilon}^{k_1-1-j}]$, which is by construction $\delta_{t_1, t_2} \in \mathbb{Z}_2$. Moreover, $|(1-\frac{\mu}{1-\rho}) \cdot d_{s_2, \epsilon_1, \epsilon}^{k_2-i+j} \cap (1-\mu) \cdot c_{s_1, \epsilon_1, \epsilon}^{i-1-j}| = |\frac{1}{1-\rho} \frac{1-\mu-\rho}{1-\mu} \cdot d_{s_2, \epsilon_1, \epsilon}^{k_2-i+j} \cap c_{s_1, \epsilon_1, \epsilon}^{i-1-j}|$. As $\mu \mapsto \frac{1}{1-\rho} \frac{1-\mu-\rho}{1-\mu}$ maps bijectively $[0, 1-\rho]$ to $[0, 1]$, the sum over all $\mu \in [0, 1-\rho]$ of $|\frac{1}{1-\rho} \frac{1-\mu-\rho}{1-\mu} \cdot d_{s_2, \epsilon_1, \epsilon}^{k_2-i+j} \cap c_{s_1, \epsilon_1, \epsilon}^{i-1-j}|$ is equal to the intersection number in \mathbb{R}^{k_2} of $c_{s_1, \epsilon_1, \epsilon}^{i-1-j}$ with the cone

$$C d_{s_2, \epsilon_1, \epsilon}^{k_2-i+j} := \{r \cdot y | y \in d_{s_2, \epsilon_1, \epsilon}^{k_2-i+j}, t \in [0, 1]\} \subset \mathbb{R}^{k_2}.$$

See also Figure 5.11. As $C d_{s_2, \epsilon_1, \epsilon}^{k_2-i+j}$ is a membrane for $d_{s_2, \epsilon_1, \epsilon}^{k_2-i+j}$, this is equal to the linking number of $[d_{s_2, \epsilon_1, \epsilon}^{k_2-i+j}]$ and $[c_{s_1, \epsilon_1, \epsilon}^{i-1-j}]$, which is by construction $\delta_{s_1, s_2} \in \mathbb{Z}_2$. Hence we have proved that the linking number of $[a_{t_1, \zeta_{s_1}^{i-1-j}, \epsilon(j, t_1, s_1)}^j \star c_{s_1, \epsilon_{t_1}^j, \epsilon(j, t_+, s_1)}^{i-1-j}]$ and $[b_{t_2, \zeta_{s_2}^{i-1-j}, \epsilon(j, t_2, s_2)}^{k_1-1-j} \star d_{s_2, \epsilon_{t_2}^j, \epsilon(j, t_2, s_2)}^{k_2-i+j}]$ is equal to $\delta_{t_1, t_2} \delta_{s_1, s_2} \in \mathbb{Z}_2$.

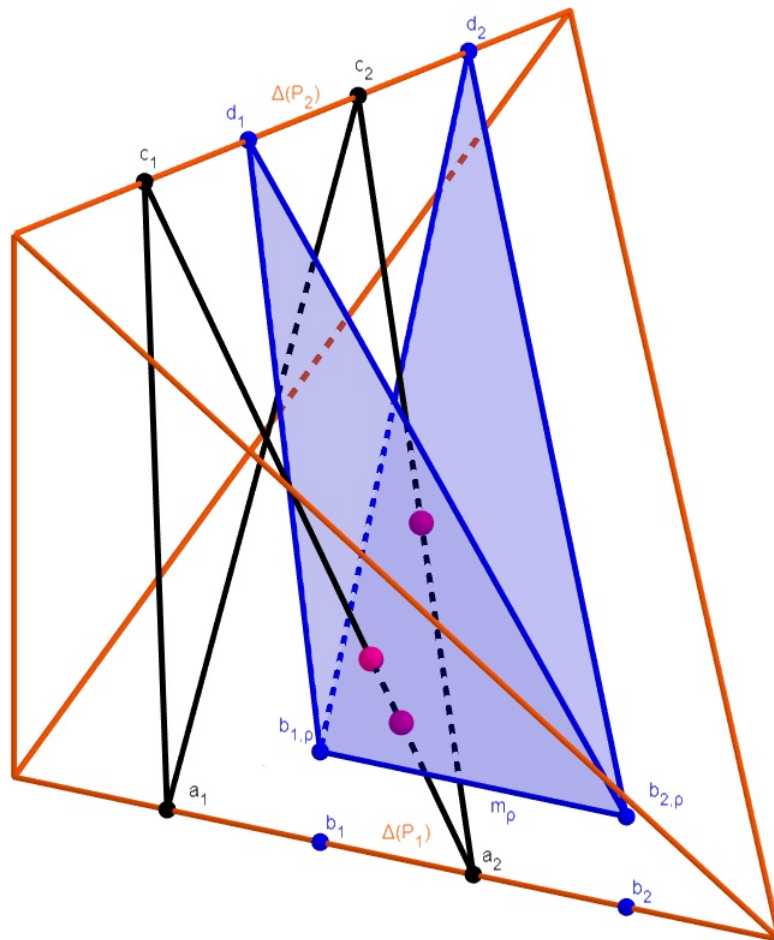

Figure 5.10: For $k_1 = k_2 = 1$, $i = 1$ and $j = 0$, a transversal intersection of the joins $m_\rho \star d$ and $a \star c$. The big purple points are the intersection points.

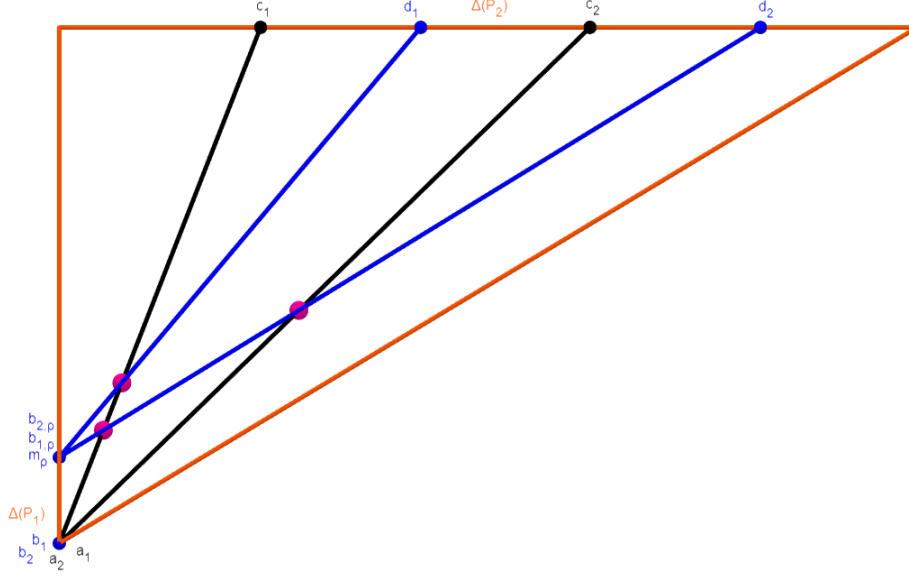

Figure 5.11: The same situation as in Figure 5.10, projected along the direction e_1 .

Now let us show that for $0 \leq j_1 < j_2 \leq i - 1$, $t_1 \in \{1, \dots, r_1^{j_1}\}$, $s_1 \in \{1, \dots, r_2^{i-1-j_1}\}$, $t_2 \in \{1, \dots, r_1^{j_2}\}$ and $s_2 \in \{1, \dots, r_2^{i-1-j_2}\}$, the linking numbers of $[a_{t_1, \zeta_{s_1}^{i-1-j_1}, \epsilon(j_1, t_1, s_1)}^{j_1} \star c_{s_1, \epsilon_{t_1}^{j_1}, \epsilon(j_1, t_1, s_1)}^{i-1-j_1}]$ and $[b_{t_2, \zeta_{s_2}^{i-1-j_2}, \epsilon(j_2, t_2, s_2)}^{k_1-1-j_2} \star d_{s_2, \epsilon_{t_2}^{j_2}, \epsilon(j_2, t_2, s_2)}^{k_2-i+j_2}]$, as well as that of $[a_{t_2, \zeta_{s_2}^{i-1-j_2}, \epsilon(j_2, t_2, s_2)}^{j_2} \star c_{s_2, \epsilon_{t_2}^{j_2}, \epsilon(j_2, t_2, s_2)}^{i-1-j_2}]$ and $[b_{t_1, \zeta_{s_1}^{i-1-j_1}, \epsilon(j_1, t_1, s_1)}^{k_1-1-j_1} \star d_{s_1, \epsilon_{t_1}^{j_1}, \epsilon(j_1, t_1, s_1)}^{k_2-i+j_1}]$, is 0.

We start with the linking numbers of $[a_{t_1, \zeta_{s_1}^{i-1-j_1}, \epsilon(j_1, t_1, s_1)}^{j_1} \star c_{s_1, \epsilon_{t_1}^{j_1}, \epsilon(j_1, t_1, s_1)}^{i-1-j_1}]$ and $[b_{t_2, \zeta_{s_2}^{i-1-j_2}, \epsilon(j_2, t_2, s_2)}^{k_1-1-j_2} \star d_{s_2, \epsilon_{t_2}^{j_2}, \epsilon(j_2, t_2, s_2)}^{k_2-i+j_2}]$; as before, it is necessarily trivial if we don't have $\epsilon_{t_1}^{j_1} = \epsilon_{t_2}^{j_2}$, $\zeta_{s_1}^{i-1-j_1} = \zeta_{s_2}^{i-1-j_2}$ and $\epsilon(j_1, t_1, s_1) = \epsilon(j_2, t_2, s_2)$. Assuming from now on that we do, we write $\epsilon_1 := \epsilon_{t_1}^{j_1}$, $\epsilon_2 := \zeta_{s_1}^{i-1-j_1}$ and $\epsilon := \epsilon(j_1, t_1, s_1)$ to shorten notations.

We consider a $(k_1 - j_2)$ -chain m in $\Delta_1 \times \{\epsilon_1\} \times \{\epsilon_2\} \times \{\epsilon\}$ such that it is a membrane for $b_{t_2, \epsilon_2, \epsilon}^{k_1-1-j_2}$. As before, the chain $m \star_{s_2, \epsilon_1, \epsilon}^{k_2-i+j_2}$ is a membrane for $b_{t_2, \epsilon_2, \epsilon}^{k_1-1-j_2} \star d_{s_2, \epsilon_1, \epsilon}^{k_2-i+j_2}$, and the intersection of $m \star_{s_2, \epsilon_1, \epsilon}^{k_2-i+j_2}$ and $a_{t_1, \epsilon_2, \epsilon}^{j_1} \star c_{s_1, \epsilon_1, \epsilon}^{i-1-j_1}$ is contained in $\Delta_1 \times \{\epsilon_1\} \times \{\epsilon_2\} \times \{\epsilon\}$ and equal, set-wise, to $m \cap a_{t_1, \epsilon_2, \epsilon}^{j_1}$. As $j_2 > j_1$, we have $(k_1 - j_2) + j_1 < k_1$ and the intersection $m \cap a_{t_1, \epsilon_2, \epsilon}^{j_1}$ in $\Delta_1 \times \{\epsilon_1\} \times \{\epsilon_2\} \times \{\epsilon\}$ is empty (for m generic enough). Hence the linking number of $[a_{t_1, \epsilon_2, \epsilon}^{j_1} \star c_{s_1, \epsilon_1, \epsilon}^{i-1-j_1}]$ and $[b_{t_2, \epsilon_2, \epsilon}^{k_1-1-j_2} \star d_{s_2, \epsilon_1, \epsilon}^{k_2-i+j_2}]$ is 0.

The same reasoning applies to the linking number of $[a_{t_2, \epsilon_2, \epsilon}^{j_2} \star c_{s_2, \epsilon_1, \epsilon}^{i-1-j_2}]$ and $[b_{t_1, \epsilon_2, \epsilon}^{k_1-1-j_1} \star d_{s_1, \epsilon_1, \epsilon}^{k_2-i+j_1}]$, by taking $b_{t_1, \epsilon_2, \epsilon}^{k_1-1-j_1} \star n$ as a membrane for $b_{t_1, \epsilon_2, \epsilon}^{k_1-1-j_1} \star d_{s_1, \epsilon_1, \epsilon}^{k_2-i+j_1}$, where n is a membrane for $d_{s_1, \epsilon_1, \epsilon}^{k_2-i+j_1}$.

Define the sets $A := \{[a_{1, \zeta_s^{i-1-j}, \epsilon(j, t, s)}^j \star c_{s, \epsilon_t^j, \epsilon(j, t, s)}^{i-1-j}]\} | j = 0, \dots, i-1, t = 1, \dots, r_1^j, s = 1, \dots, r_2^{i-1-j}\} \subset H_i(X)$ and $\tilde{B} := \{[b_{t, \zeta_s^{i-1-j}, \epsilon(j, t, s)}^{k_1-1-j} \star d_{s, \epsilon_t^j, \epsilon(j, t, s)}^{k_2-i+j}]\} | j = 0, \dots, i-1, t =$

$1, \dots, r_1^j, s = 1, \dots, r_2^{i-1-j}\} \subset H_{n-1-i}((\mathring{\Delta}_1 \star \mathring{\Delta}_2) \times U_{\mathbb{R}}^n \setminus X)$. By slightly perturbing the cycles $b_{t, \zeta_s^{i-1-j}, \epsilon(j, t, s)}^{k_1-1-j} \star d_{s, \epsilon_t^j, \epsilon(j, t, s)}^{k_2-i+j}$ representing the elements of \tilde{B} , we can assume that they are actually contained in $\mathring{\Delta} \times U_{\mathbb{R}}^n \setminus X$ without changing the linking number of their homology class with the elements of A . Let $B \subset H_{n-1-i}(\mathring{\Delta} \times U_{\mathbb{R}}^n \setminus X)$ be the set of the classes of those slightly modified cycles. Then the elements of A and B satisfy the required conditions. We only have to check that there are enough of them.

By construction,

$$|A| = \sum_{j=0}^{i-1} r_1^j \cdot r_2^{i-1-j} = \sum_{j=0}^{i-1} \max(b_j(V_{(\mathbb{R}^*)^{k_1}}(P_1)) - D(k_1)d_1^{k_1-1}, 0) \cdot \max(b_{i-1-j}(V_{(\mathbb{R}^*)^{k_2}}(P_2)) - D(k_2)d_2^{k_2-1}, 0).$$

Using Formulas (1.2.1) and (5.1.1) and Remark 5.3.2, we know that there exists a constant $\tilde{C}(n)$, depending only on n , such that $b_*(V_{(\mathbb{R}^*)^k}(\tilde{P})) \leq \tilde{C}(n)d^k$ for every $k \leq n-1$ and every completely nondegenerate real Laurent polynomial \tilde{P} in k variables of degree d . Set also $\tilde{D}(n) := \max\{D(k) | k \leq n-1\}$, where D is as above (and thus as in Lemma 5.3.3).

Then for $j = 0, \dots, i-1$, if $b_j(V_{(\mathbb{R}^*)^{k_1}}(P_1)) - D(k_1)d_1^{k_1-1} \leq 0$, we have

$$b_j(V_{(\mathbb{R}^*)^{k_1}}(P_1)) \cdot b_{i-1-j}(V_{(\mathbb{R}^*)^{k_2}}(P_2)) \leq D(k_1)d_1^{k_1-1} \cdot b_{i-1-j}(V_{(\mathbb{R}^*)^{k_2}}(P_2)) \leq D(k_1)d_1^{k_1-1} \cdot \tilde{C}(n)d_2^{k_2} \leq D(k_1)\tilde{C}(n) \max(d_1, d_2)^{n-2}.$$

In particular, $r_1^j \cdot r_2^{i-1-j} = 0 \geq b_j(V_{(\mathbb{R}^*)^{k_1}}(P_1)) \cdot b_{i-1-j}(V_{(\mathbb{R}^*)^{k_2}}(P_2)) - \tilde{D}(n)\tilde{C}(n) \max(d_1, d_2)^{n-2}$. We find the same inequality if $b_{i-1-j}(V_{(\mathbb{R}^*)^{k_2}}(P_2)) - D(k_2)d_2^{k_2-1} \leq 0$.

If we have both $b_{i-1-j}(V_{(\mathbb{R}^*)^{k_2}}(P_2)) - D(k_2)d_2^{k_2-1} \geq 0$ and $b_j(V_{(\mathbb{R}^*)^{k_1}}(P_1)) - D(k_1)d_1^{k_1-1} \geq 0$, we find

$$r_1^j \cdot r_2^{i-1-j} = (b_j(V_{(\mathbb{R}^*)^{k_1}}(P_1)) - D(k_1)d_1^{k_1-1})(b_{i-1-j}(V_{(\mathbb{R}^*)^{k_2}}(P_2)) - D(k_2)d_2^{k_2-1}) \geq b_j(V_{(\mathbb{R}^*)^{k_1}}(P_1))b_{i-1-j}(V_{(\mathbb{R}^*)^{k_2}}(P_2)) - \tilde{D}(n)(b_j(V_{(\mathbb{R}^*)^{k_1}}(P_1))d_2^{k_2-1} + b_{i-1-j}(V_{(\mathbb{R}^*)^{k_2}}(P_2))d_1^{k_1-1}).$$

Then we have

$$\tilde{D}(n)(b_j(V_{(\mathbb{R}^*)^{k_1}}(P_1))d_2^{k_2-1} + b_{i-1-j}(V_{(\mathbb{R}^*)^{k_2}}(P_2))d_1^{k_1-1}) \leq \tilde{D}(n)(n)(\tilde{C}(n)d_1^{k_1}d_2^{k_2-1} + \tilde{C}(n)d_2^{k_2}d_1^{k_1-1}) \leq 2\tilde{D}(n)\tilde{C}(n) \max(d_1, d_2)^{n-2}.$$

Summing over all $j = 0, \dots, i-1$ and setting $F(n) := 2n\tilde{D}(n)\tilde{C}(n)$, we get

$$|A| = \sum_{j=0}^{i-1} r_1^j \cdot r_2^{i-1-j} \geq \left(\sum_{j=0}^{i-1} b_j(V_{(\mathbb{R}^*)^{k_1}}(P_1)) \cdot b_{i-1-j}(V_{(\mathbb{R}^*)^{k_2}}(P_2)) \right) - F(n) \max(d_1, d_2)^{n-2},$$

which allows us to conclude. □

5.3.4 Counting cycles

We are now ready to prove the Cooking Theorem, which we state again.

Theorem 5.1.1 (Cooking Theorem). *Let $n \geq 2$. For $k = 1, \dots, n-1$, let $\{P_d^k\}_{d \in \mathbb{N}}$ be a family of completely nondegenerate real Laurent polynomials in k variables, such that P_d^k is of degree d and that the Newton polytope $\Delta(P_d^k)$ of P_d^k is S_d^k . Suppose additionally that for $k = 1, \dots, n-1$ and $i = 0, \dots, k-1$,*

$$b_i(V_{\mathbb{R}P^k}(P_d^k)) \geq x_i^k \cdot d^k$$

for some $x_i^k \in \mathbb{R}_{\geq 0}$. Then there exists a family $\{Q_d^n\}_{d \in \mathbb{N}}$ of completely nondegenerate real Laurent polynomials in n variables such that $\Delta(Q_d^n) = S_d^n$ and such that for $i = 0, \dots, n-1$

$$b_i(V_{\mathbb{R}P^n}(Q_d^n)) \geq \frac{1}{n} (x_i^{n-1} + x_{i-1}^{n-1} + \sum_{k=1}^{n-2} \sum_{j=0}^{i-1} x_j^k \cdot x_{i-1-j}^{n-1-k}) \cdot d^n,$$

where x_j^k is set to be 0 for $j \notin \{0, \dots, k-1\}$.

Moreover, if the families $\{P_d^k\}_{d \in \mathbb{N}}$ were obtained using the combinatorial case of the Patchwork for all k , then the family $\{Q_d^n\}_{d \in \mathbb{N}}$ can also be obtained by combinatorial patchworking.

If each family $\{P_d^k\}_{d \in \mathbb{N}}$ (for $k = 1, \dots, n-1$) is such that the associated family of projective hypersurfaces is asymptotically maximal, then the family of projective hypersurfaces associated to $\{Q_d^n\}_{d \in \mathbb{N}}$ is also asymptotically maximal.

Proof. We simply need to apply Propositions 5.3.6 and 5.3.7 to the polynomials appearing in Proposition 5.2.6. This gives us a collection of cycles and axes, and by showing that there are enough of them, we prove the statement.

More precisely, for $d \leq n+1$, let Q_d^n be any completely nondegenerate real Laurent polynomial obtained by combinatorial patchworking such that $\Delta(Q_d^n) = S_d^n$ (the choice of Q_d^n matters not, as we are only interested in asymptotic properties), and let $\{Q_d^n\}_{d > n+1}$ be a family of completely nondegenerate real Laurent polynomials such that $\Delta(Q_d^n) = S_d^n$ and satisfying the conclusions of Proposition 5.2.6 with regard to the polynomials P_d^k (for $k = 1, \dots, n-1$). We use the same notations as there.

As stated in Proposition 5.2.6, if the families $\{P_d^k\}_{d \in \mathbb{N}}$ were obtained using combinatorial patchworking, we can assume this to also be the case for $\{Q_d^n\}_{d \in \mathbb{N}}$.

We will show that $\{Q_d^n\}_{d \in \mathbb{N}}$ is as wanted. Let $\tilde{C} \geq 0$ be such that for all $j = 0, \dots, n-1$ and all $k = 1, \dots, n-1$, we have

$$b_j(V_{\mathbb{R}\mathbb{P}^k}(P_d^k)) \geq x_j^k \cdot d^k - \tilde{C}d^{k-1},$$

where we set x_j^k to be 0 if $j \geq k$. Let also $i \in \{0, \dots, n-1\}$.

We know, from the Main Patchwork Theorem 2.2.1, that the topology of the pairs $(S_d^n \times U_{\mathbb{R}}^n, \text{Chart}_{S_d^n \times U_{\mathbb{R}}^n}(Q_d^n))$ is the same as that of $(S_d^n \times U_{\mathbb{R}}^n, v)$, where $v \subset S_d^n \times U_{\mathbb{R}}^n$ is obtained by appropriately gluing the charts of all polynomials $P_i \in \Sigma$ appearing in the patchworking.

For $m = 0, \dots, d-n-1$ and $k = 1, \dots, n-2$, we consider the polynomial $F_m^k \in \Sigma$. Based on Condition 2 of Proposition 5.2.6, we know that the chart of F_m^k is homeomorphic to the chart of some polynomial P which satisfies the hypotheses of Proposition 5.3.7, with some polynomials $\tilde{P}_{d-m-1-k}^k$ and $\tilde{P}_{d-m-n+k}^{n-1-k}$ (whose charts are homeomorphic to those of $P_{d-m-1-k}^k$ and $P_{d-m-n+k}^{n-1-k}$) playing the roles of P_1 and P_2 in the notations of Proposition 5.3.7. In other words and loosely speaking, F_m^k is the join of $\tilde{P}_{d-m-1-k}^k$ and $\tilde{P}_{d-m-n+k}^{n-1-k}$.

Then the proposition implies that there exists

$$\begin{aligned} r(F_m^k) &\geq \sum_{j=0}^{i-1} b_j(V_{(\mathbb{R}^*)^k}(\tilde{P}_{d-m-1-k}^k)) \cdot b_{i-1-j}(V_{(\mathbb{R}^*)^{n-1-k}}(\tilde{P}_{d-m-n+k}^{n-1-k})) \\ &\quad - F(n) \max(d-m-1-k, d-m-n+k)^{n-2} \end{aligned} \quad (5.3.5)$$

such that we can find classes $\tilde{\alpha}_1, \dots, \tilde{\alpha}_{r(F_m^k)}$ in $H_i(\text{Chart}_{\Delta(G) \times U_{\mathbb{R}}^n}(G))$ and $\tilde{\beta}_1, \dots, \tilde{\beta}_{r(F_m^k)}$ in $H_{n-1-i}(\dot{\Delta}(G) \times U_{\mathbb{R}}^n \setminus \text{Chart}_{\Delta(G) \times U_{\mathbb{R}}^n}(G))$ such that their linking numbers in $\Delta(G) \times U_{\mathbb{R}}^n$ verifies $l(\tilde{\alpha}_s, \tilde{\beta}_t) = \delta_{s,t} \in \mathbb{Z}_2$.

We pull back these classes via the pair homeomorphism to get classes $\alpha_1^{F_m^k}, \dots, \alpha_{r(F_m^k)}^{F_m^k}$ in $H_i(\text{Chart}_{\Delta(F_m^k) \times U_{\mathbb{R}}^n}(F_m^k))$ and $\beta_1^{F_m^k}, \dots, \beta_{r(F_m^k)}^{F_m^k}$ in $H_{n-1-i}(\dot{\Delta}(F_m^k) \times U_{\mathbb{R}}^n \setminus \text{Chart}_{\Delta(F_m^k) \times U_{\mathbb{R}}^n}(F_m^k))$ such that their linking numbers in $\Delta(F_m^k) \times U_{\mathbb{R}}^n$ verifies $l(\alpha_s^{F_m^k}, \beta_t^{F_m^k}) = \delta_{s,t} \in \mathbb{Z}_2$.

Moreover, observe that by the definition of polynomials $\tilde{P}_{d-m-1-k}^k$ and $\tilde{P}_{d-m-n+k}^{n-1-k}$ from Condition 2 of Proposition 5.2.6 (whose charts were assumed to be homeomorphic to those of $P_{d-m-1-k}^k$ and $P_{d-m-n+k}^{n-1-k}$), we have $b_j(V_{(\mathbb{R}^*)^k}(\tilde{P}_{d-m-1-k}^k)) = b_j(V_{(\mathbb{R}^*)^k}(P_{d-m-1-k}^k))$ and $b_{i-1-j}(V_{(\mathbb{R}^*)^{n-1-k}}(\tilde{P}_{d-m-n+k}^{n-1-k})) = b_{i-1-j}(V_{(\mathbb{R}^*)^{n-1-k}}(P_{d-m-n+k}^{n-1-k}))$, which means that we can rewrite Inequality (5.3.5) as

$$\begin{aligned} r(F_m^k) &\geq \sum_{j=0}^{i-1} b_j(V_{(\mathbb{R}^*)^k}(\tilde{P}_{d-m-1-k}^k)) \cdot b_{i-1-j}(V_{(\mathbb{R}^*)^{n-1-k}}(\tilde{P}_{d-m-n+k}^{n-1-k})) \\ &\quad - F(n) \max(d-m-1-k, d-m-n+k)^{n-2} = \end{aligned}$$

$$\begin{aligned}
& \sum_{j=0}^{i-1} b_j(V_{(\mathbb{R}^*)^k}(P_{d-m-1-k}^k)) \cdot b_{i-1-j}(V_{(\mathbb{R}^*)^{n-1-k}}(P_{d-m-n+k}^{n-1-k})) \\
& - F(n) \max(d-m-1-k, d-m-n+k)^{n-2} \geq \\
& \left[\sum_{j=0}^{i-1} (x_j^k \cdot (d-m-1-k)^k - \tilde{C} \cdot (d-m-1-k)^{k-1}) \cdot \right. \\
& \quad \left. \cdot (x_{i-1-j}^{n-1-k} \cdot (d-m-n+k)^{n-1-k} - \tilde{C} \cdot (d-m-n+k)^{n-2-k}) \right] \\
& - F(n) \max(d-m-1-k, d-m-n+k)^{n-2}
\end{aligned}$$

for any d large enough that $x_j^k \cdot (d-m-1-k)^k \geq \tilde{C} \cdot (d-m-1-k)^{k-1}$ and $x_{i-1-j}^{n-1-k} \cdot (d-m-n+k)^{n-1-k} \geq \tilde{C} \cdot (d-m-n+k)^{n-2-k}$ for all $j = 0, \dots, i-1$.

Define $C_1 := n(2\tilde{C} \max\{x_j^l | l = 1, \dots, n-1, j = 0, \dots, l-1\} + F(n))$.

Then we have

$$\begin{aligned}
r(F_m^k) & \geq \left(\sum_{j=0}^{i-1} x_j^k x_{i-1-j}^{n-1-k} \cdot (d-m-1-k)^k (d-m-n+k)^{n-1-k} \right) \quad (5.3.6) \\
& - C_1 \max(d-m-1-k, d-m-n+k)^{n-2} \geq \\
& \left(\sum_{j=0}^{i-1} x_j^k x_{i-1-j}^{n-1-k} \right) \cdot (d-m-n)^{n-1} - C_1 (d-m-1)^{n-2}
\end{aligned}$$

for all d large enough; if we replace C_1 by $\tilde{C}_1 \geq C_1$ large enough, we can assume this to be the case for all d (and we do).

For $m = 1, \dots, d-n-1$, we also consider the pair of polynomials $G_m^+, G_m^- \in \Sigma$ (still using the notations of Proposition 5.2.6).

We know that there exist polynomials $\tilde{G}_m^+, \tilde{G}_m^-$ and \tilde{P}_{d-m-n}^{n-1} (with the chart of \tilde{P}_{d-m-n}^{n-1} homeomorphic to the chart of P_{d-m-n}^{n-1}) that satisfy the hypotheses of Proposition 5.3.6 (where \tilde{G}_m^+ and \tilde{G}_m^- correspond to G^+ and G^- and \tilde{P}_{d-m-n}^{n-1} to P in the notations of the proposition) such that the pair $((\Delta(G_m^+) \cup \Delta(G_m^-)) \times U_{\mathbb{R}}^n, \text{Chart}_{\Delta(G_m^+) \times U_{\mathbb{R}}^n}(G_m^+) \cup \text{Chart}_{\Delta(G_m^-) \times U_{\mathbb{R}}^n}(G_m^-))$ is homeomorphic to $((\Delta(\tilde{G}_m^+) \cup \Delta(\tilde{G}_m^-)) \times U_{\mathbb{R}}^n, \text{Chart}_{\Delta(\tilde{G}_m^+) \times U_{\mathbb{R}}^n}(\tilde{G}_m^+) \cup \text{Chart}_{\Delta(\tilde{G}_m^-) \times U_{\mathbb{R}}^n}(\tilde{G}_m^-))$. Loosely speaking, this gluing of charts is homeomorphic to a suspension of the chart of P_{d-m-n}^{n-1} .

Then the proposition implies that there exists

$$s(G_m) \geq b_i(V_{(\mathbb{R}^*)^{n-1}}(\tilde{P}_{d-m-n}^{n-1})) + b_{i-1}(V_{(\mathbb{R}^*)^{n-1}}(\tilde{P}_{d-m-n}^{n-1})) - E(n-1)(d-m-n)^{n-2} \quad (5.3.7)$$

such that we can find classes $\tilde{\alpha}_1, \dots, \tilde{\alpha}_{s(G_m)}$ in

$$H_i \left(\text{Chart}_{\Delta(\tilde{G}_m^+) \times U_{\mathbb{R}}^n}(\tilde{G}_m^+) \cup \text{Chart}_{\Delta(\tilde{G}_m^-) \times U_{\mathbb{R}}^n}(\tilde{G}_m^-) \right)$$

and $\tilde{\beta}_1, \dots, \tilde{\beta}_{s(G_m)}$ in

$$H_{n-1-i} \left(\left[\text{Int}(\Delta(\tilde{G}_m^+) \cup \Delta(\tilde{G}_m^-)) \times U_{\mathbb{R}}^n \right] \setminus \left[\text{Chart}_{\Delta(\tilde{G}_m^+) \times U_{\mathbb{R}}^n}(\tilde{G}_m^+) \cup \text{Chart}_{\Delta(\tilde{G}_m^-) \times U_{\mathbb{R}}^n}(\tilde{G}_m^-) \right] \right)$$

(respectively, in the kernel of

$$\begin{aligned} H_0 \left(\left[\text{Int}(\Delta(\tilde{G}_m^+) \cup \Delta(\tilde{G}_m^-)) \times U_{\mathbb{R}}^n \right] \setminus \left[\text{Chart}_{\Delta(\tilde{G}_m^+) \times U_{\mathbb{R}}^n}(\tilde{G}_m^+) \cup \text{Chart}_{\Delta(\tilde{G}_m^-) \times U_{\mathbb{R}}^n}(\tilde{G}_m^-) \right] \right) \\ \longrightarrow H_0 \left(\text{Int}(\Delta(\tilde{G}_m^+) \cup \Delta(\tilde{G}_m^-)) \times U_{\mathbb{R}}^n \right) \end{aligned}$$

if $n-1-i=0$) whose linking numbers in $\text{Int}(\Delta(\tilde{G}_m^+) \cup \Delta(\tilde{G}_m^-)) \times U_{\mathbb{R}}^n$ verifies $l(\tilde{\alpha}_s, \tilde{\beta}_t) = \delta_{s,t} \in \mathbb{Z}_2$.

We pull back these classes via the pair homeomorphism to get classes $\alpha_1^{G_m}, \dots, \alpha_{s(G_m)}^{G_m}$ in

$$H_i \left(\text{Chart}_{\Delta(G_m^+) \times U_{\mathbb{R}}^n}(G_m^+) \cup \text{Chart}_{\Delta(G_m^-) \times U_{\mathbb{R}}^n}(G_m^-) \right)$$

and $\beta_1^{G_m}, \dots, \beta_{s(G_m)}^{G_m}$ in

$$H_{n-1-i} \left(\left[\text{Int}(\Delta(G_m^+) \cup \Delta(G_m^-)) \times U_{\mathbb{R}}^n \right] \setminus \left[\text{Chart}_{\Delta(G_m^+) \times U_{\mathbb{R}}^n}(G_m^+) \cup \text{Chart}_{\Delta(G_m^-) \times U_{\mathbb{R}}^n}(G_m^-) \right] \right)$$

(respectively, in the kernel of

$$\begin{aligned} H_0 \left(\left[\text{Int}(\Delta(G_m^+) \cup \Delta(G_m^-)) \times U_{\mathbb{R}}^n \right] \setminus \left[\text{Chart}_{\Delta(G_m^+) \times U_{\mathbb{R}}^n}(G_m^+) \cup \text{Chart}_{\Delta(G_m^-) \times U_{\mathbb{R}}^n}(G_m^-) \right] \right) \\ \longrightarrow H_0 \left(\text{Int}(\Delta(G_m^+) \cup \Delta(G_m^-)) \times U_{\mathbb{R}}^n \right) \end{aligned}$$

if $n-1-i=0$) such that their linking numbers in $\text{Int}(\Delta(G_m^+) \cup \Delta(G_m^-)) \times U_{\mathbb{R}}^n$ verifies $l(\alpha_s^{G_m}, \beta_t^{G_m}) = \delta_{s,t} \in \mathbb{Z}_2$.

Moreover, observe that by the definition of polynomials \tilde{P}_{d-m-n}^{n-1} (whose charts were assumed to be homeomorphic to those of the polynomials P_{d-m-n}^{n-1}) from Condition 3 of Proposition 5.2.6, we have $b_i(V_{(\mathbb{R}^*)}^{n-1}(\tilde{P}_{d-m-n}^{n-1})) = b_i(V_{(\mathbb{R}^*)}^{n-1}(P_{d-m-n}^{n-1}))$ and $b_{i-1}(V_{(\mathbb{R}^*)}^{n-1}(\tilde{P}_{d-m-n}^{n-1})) = b_{i-1}(V_{(\mathbb{R}^*)}^{n-1}(P_{d-m-n}^{n-1}))$, which means that we can rewrite Inequality (5.3.7) as

$$\begin{aligned} s(G_m) &\geq b_i(V_{(\mathbb{R}^*)}^{n-1}(\tilde{P}_{d-m-n}^{n-1})) + b_{i-1}(V_{(\mathbb{R}^*)}^{n-1}(\tilde{P}_{d-m-n}^{n-1})) - E(n-1)(d-m-n)^{n-2} = \\ &b_i(V_{(\mathbb{R}^*)}^{n-1}(P_{d-m-n}^{n-1})) + b_{i-1}(V_{(\mathbb{R}^*)}^{n-1}(P_{d-m-n}^{n-1})) - E(n-1)(d-m-n)^{n-2} \geq \\ &x_i^{n-1} \cdot (d-m-n)^{n-1} - \tilde{C}(d-m-n)^{n-2} + x_{i-1}^{n-1} \cdot (d-m-n)^{n-1} - \tilde{C}(d-m-n)^{n-2} \\ &\quad - E(n-1)(d-m-n)^{n-2} = \tag{5.3.8} \\ &(x_i^{n-1} + x_{i-1}^{n-1}) \cdot (d-m-n)^{n-1} - (2\tilde{C} + E(n-1)) \cdot (d-m-n)^{n-2} = \\ &(x_i^{n-1} + x_{i-1}^{n-1}) \cdot (d-m-n)^{n-1} - C_2 \cdot (d-m-n)^{n-2} \end{aligned}$$

by setting $C_2 := 2\tilde{C} + E(n-1)$.

Now consider the image of the classes $\alpha_s^{F_m^k}$ and $\alpha_s^{G_m}$ (for all s, k, m for which they were defined) in $H_i(v)$ (via the inclusion), where $v \subset S_d^n$ is as above a gluing of the charts of the polynomials of Σ . Similarly, consider the image of the axes $\beta_t^{F_m^k}$ and $\beta_t^{G_m}$ in $H_{n-1-i}(\mathring{S}_d^n \times U_{\mathbb{R}}^n \setminus v)$ via the inclusion (respectively, in $\ker(H_0(\mathring{S}_d^n \times U_{\mathbb{R}}^n \setminus v) \rightarrow H_0(\mathring{S}_d^n \times U_{\mathbb{R}}^n))$ if $n-1-i=0$). We keep the same notations for the images of the classes by the inclusion.

As each axis $\beta_t^{F_m^k}$ or $\beta_t^{G_m}$ is contained in the interior of $\Delta(F_m^k) \times U_{\mathbb{R}}^n$ or $\Delta(G_m^+) \cup \Delta(G_m^-) \times U_{\mathbb{R}}^n$ and is a boundary in that interior, we can find for each a membrane also contained in that interior. As the interiors of these polytopes are all disjoint (see Condition 4 of Proposition 5.2.6), this shows that the linking number in $S_d^n \times U_{\mathbb{R}}^n$ of $\beta_t^{F_{m_1}^{k_2}}$ with any $\alpha_s^{F_{m_2}^{k_2}}$ is $\delta_{t,s} \delta_{m_1, m_2} \delta_{k_1, k_2}$, and its linking number with any $\alpha_s^{G_m}$ is 0. Similarly, the linking number in $S_d^n \times U_{\mathbb{R}}^n$ of $\beta_t^{G_{m_1}}$ with any $\alpha_s^{G_{m_2}}$ is $\delta_{t,s} \delta_{m_1, m_2}$, and its linking number with any $\alpha_s^{F_{m_2}^k}$ is 0.

This shows that the elements of $B := \{\beta_t^{F_m^k} | t = 1, \dots, r(F_m^k), m = 0, \dots, d-n-1, k = 1, \dots, n-2\} \cup \{\beta_t^{G_m} | t = 1, \dots, s(G_m), m = 1, \dots, d-n-1\}$ (with $B \subset H_{n-1-i}(\mathring{S}_d^n \times U_{\mathbb{R}}^n \setminus v)$, respectively $B \subset \ker(H_0(\mathring{S}_d^n \times U_{\mathbb{R}}^n \setminus v) \rightarrow H_0(\mathring{S}_d^n \times U_{\mathbb{R}}^n))$ if $n-1-i=0$) are axes to the elements of $A := \{\alpha_t^{F_m^k} | t = 1, \dots, r(F_m^k), m = 0, \dots, d-n-1, k = 1, \dots, n-2\} \cup \{\alpha_t^{G_m} | t = 1, \dots, s(G_m), m = 1, \dots, d-n-1\} \subset H_i(v)$. In particular, this implies that $b_i(v) \geq |A|$.

We know that v is homeomorphic to $\text{Chart}_{S_d^n \times U_{\mathbb{R}}^n}(Q_d^n)$, which is itself homotopy equivalent to $V_{(\mathbb{R}^*)^n}(Q_d^n)$. Finally, we know from Lemma 5.3.1 that there is a constant $C(n)$ (dependent only on n) such that $b_i(V_{\mathbb{R}P^n}(Q_d^n)) \geq b_i(V_{(\mathbb{R}^*)^n}(Q_d^n)) - C(n)d^{n-1}$. Hence we get that

$$\begin{aligned} b_i(V_{\mathbb{R}P^n}(Q_d^n)) &\geq |A| - C(n)d^{n-1} = \\ &\sum_{m=1}^{d-n-1} s(G_m) + \sum_{m=0}^{d-n-1} \sum_{k=1}^{n-2} r(F_m^k) - C(n)d^{n-1}. \end{aligned}$$

Using the fact that for all $l, p \geq 1$, we have $\sum_{q=1}^p q^l \geq \frac{p^{l+1}}{l+1} - C_3(l)p^l$ for some constant $C_3(l) > 0$, and going back to Inequality (5.3.8), we get

$$\begin{aligned} \sum_{m=1}^{d-n-1} s(G_m) &\geq \sum_{m=1}^{d-n-1} (x_i^{n-1} + x_{i-1}^{n-1}) \cdot (d-m-n)^{n-1} - C_2 \cdot (d-m-n)^{n-2} \geq \\ &\frac{x_i^{n-1} + x_{i-1}^{n-1}}{n} (d-n-1)^n - (x_i^{n-1} + x_{i-1}^{n-1}) C_3(n-1) \cdot (d-n-1)^{n-1} - C_2 \cdot (d-n-1)^{n-1}. \end{aligned}$$

Observe that each x_j^s is less than, or equal to 1. Moreover, $(d-n)^n \geq (d-n-1)^n \geq d^n - C_4(n)d^{n-1}$ for some constant $C_4(n) > 0$. We can also set $C_5(n) := \frac{2}{n}C_4(n) + 2C_3(n-1) + C_2$, and have

$$\sum_{m=1}^{d-n-1} s(G_m) \geq \frac{x_i^{n-1} + x_{i-1}^{n-1}}{n} d^n - C_5(n)d^{n-1}.$$

Going back to Inequality (5.3.6), we get

$$\begin{aligned} \sum_{m=0}^{d-n-1} \sum_{k=1}^{n-2} r(F_m^k) &\geq \sum_{m=0}^{d-n-1} \sum_{k=1}^{n-2} \left(\left(\sum_{j=0}^{i-1} x_j^k x_{i-1-j}^{n-1-k} \right) \cdot (d-m-n)^{n-1} - \tilde{C}_1 \cdot (d-m-1)^{n-2} \right) \geq \\ &\sum_{k=1}^{n-2} \left(\left(\sum_{j=0}^{i-1} x_j^k x_{i-1-j}^{n-1-k} \right) \left(\frac{1}{n} (d-n)^n - C_3(n-1) \cdot (d-n)^{n-1} \right) - \tilde{C}_1 \cdot (d-1)^{n-1} \right). \end{aligned}$$

Set $C_6(n) := nC_4(n) + n^2C_3(n-1) + n\tilde{C}_1$. We can write

$$\sum_{m=0}^{d-n-1} \sum_{k=1}^{n-2} r(F_m^k) \geq \left(\sum_{k=1}^{n-2} \sum_{j=0}^{i-1} x_j^k x_{i-1-j}^{n-1-k} \frac{d^n}{n} \right) - C_6(n)d^{n-1}.$$

Hence we can conclude that

$$\begin{aligned} b_i(V_{\mathbb{R}P^n}(Q_d^n)) &\geq \sum_{m=1}^{d-n-1} s(G_m) + \sum_{m=0}^{d-n-1} \sum_{k=1}^{n-2} r(F_m^k) - C(n)d^{n-1} \geq \\ &\frac{d^n}{n} (x_i^{n-1} + x_{i-1}^{n-1} + \sum_{k=1}^{n-2} \sum_{j=0}^{i-1} x_j^k x_{i-1-j}^{n-1-k}) - (C_5(n) + C_6(n) + C(n))d^{n-1}, \end{aligned}$$

which is what we wanted to prove.

The statement regarding asymptotic maximality is a direct application of Lemma 6.2.4 below.

□

Chapter 6

Asymptotically large Betti numbers

6.1 Chapter introduction

This Chapter is the direct continuation of Chapter 5, whose notations and definitions we retain.

One can get varying, and potentially interesting, families of real projective algebraic hypersurfaces in high ambient dimension by starting with various low-dimensional families of hypersurfaces and applying the Cooking Theorem 5.1.1 recursively: each application yields a new family in some dimension n , which can then serve as an ingredient for higher dimensional constructions. One advantage of that method is that each new family in ambient dimension N with "good" asymptotic Betti numbers obtained using other means can potentially automatically give rise, through repeated applications of the Cooking Theorem, to new interesting families in all dimensions greater than N .

In particular, we make use of already existing families of projective smooth real algebraic hypersurfaces in \mathbb{P}^3 designed using Bihan's results from [Bih03] by Brugallé in [Bru06] to prove the two following theorems.

Theorem 6.1.1. *For any $n \geq 3$ and any $i = 0, \dots, n-1$, there exists $c_i^n > a_i^n$ and a family $\{Q_d^n\}_{d \in \mathbb{N}}$ of completely nondegenerate real Laurent polynomials in n variables such that $\Delta(Q_d^n) = S_d^n$, that the associated family of real projective hypersurfaces is asymptotically maximal and that*

$$b_i(V_{\mathbb{R}\mathbb{P}^n}(Q_d^n)) \stackrel{n}{\geq} c_i^n \cdot d^n.$$

In other words, $b_i(V_{\mathbb{R}\mathbb{P}^n}(Q_d^n))$ grows asymptotically strictly faster than the corresponding Hodge number $h^{i, n-1-i}(V_{\mathbb{C}\mathbb{P}^n}(Q_d^n))$, though c_i^n cannot be expected to be particularly large compared to a_i^n (see the end of Subsection 6.2.3 for more details on that). As far as the author is aware, this had not yet been achieved.

The second theorem, which we prove using probabilistic methods, allows us to find asymptotic (in the degree d) results that are asymptotically (as the ambient dimension n goes to infinity) much better.

Theorem 6.1.2. *Let $N \geq 1$. For $k = 1, \dots, N$, let $\{P_d^k\}_{d \in \mathbb{N}}$ be a family of completely nondegenerate real Laurent polynomials in k variables such that the Newton polytope $\Delta(P_d^k)$ of P_d^k is S_d^k . Suppose additionally that for $k = 1, \dots, N$ and $i = 0, \dots, k-1$,*

$$b_i(V_{\mathbb{R}P^k}(P_d^k)) \stackrel{k}{=} x_i^k \cdot d^k$$

for some $x_i^k \in \mathbb{R}_{\geq 0}$ such that $\sum_{i=0}^{k-1} x_i^k = 1$ (in particular, the family of projective hypersurfaces associated to each family $\{P_d^k\}_{d \in \mathbb{N}}$ is asymptotically maximal). Set also x_i^k to be 0 for $i \notin \{0, \dots, k-1\}$.

Define

$$\sigma^2 := \frac{2}{(N+1)(N+2)} \left(\frac{1}{4} + \sum_{k=1}^N \sum_{i=0}^{k-1} x_i^k \left(i - \frac{k-1}{2} \right)^2 \right).$$

Then for every $n \geq N+1$ and any $i \in \mathbb{Z}$, there exist $x_i^n \in \mathbb{R}_{\geq 0}$ and a family $\{Q_d^n\}_{d \in \mathbb{N}}$ of completely nondegenerate real Laurent polynomials in n variables such that $\Delta(Q_d^n) = S_d^n$, that for $i \in \mathbb{Z}$

$$b_i(V_{\mathbb{R}P^n}(Q_d^n)) \stackrel{n}{=} x_i^n \cdot d^n$$

and such that for any $m \in \mathbb{Z}$ we have

$$x_m^n = \frac{1}{\sigma\sqrt{2\pi}} \frac{1}{\sqrt{n}} \exp\left(-\frac{\left(\frac{n-1}{2} - m\right)^2}{2n\sigma^2}\right) + o\left(n^{-\frac{1}{2}}\right), \quad (6.1.1)$$

where the $o(1)$ error term is uniform in m . The family of projective hypersurfaces associated to each family $\{Q_d^n\}_{d \in \mathbb{N}}$ is also asymptotically maximal.

As it is known (see Formula (6.2.9)) that

$$a_{\lfloor \frac{n-1}{2} + x\sqrt{n} \rfloor}^n = \sqrt{\frac{6}{\pi(n+1)}} \exp(-6x^2) + \mathcal{O}\left(n^{-\frac{3}{2}}\right), \quad (6.1.2)$$

this direct corollary of the theorem clearly shows its usefulness.

Theorem 6.1.3. *For any $n \geq 3$ and any $i \in \mathbb{Z}$, there exist $c_i^n, d_i^n \in \mathbb{R}$ and families $\{F_d^{+,n}\}_{d \in \mathbb{N}}$ and $\{F_d^{-,n}\}_{d \in \mathbb{N}}$ of completely nondegenerate real Laurent polynomials in n variables such that the Newton polytope $\Delta(F_d^{\pm,n})$ is S_d^n , that for $i = 0, \dots, n-1$, we have*

$$b_i(V_{\mathbb{R}P^n}(F_d^{+,n})) \stackrel{n}{=} c_i^n \cdot d^n$$

and

$$b_i(V_{\mathbb{R}P^n}(F_d^{-,n})) \stackrel{n}{=} d_i^n \cdot d^n$$

and such that we have, for all $x \in \mathbb{R}$, that

$$c_{\lfloor \frac{n-1}{2} + x\sqrt{n} \rfloor}^n = \frac{2}{\sqrt{\pi}} \frac{1}{\sqrt{n}} \exp(-4x^2) + o\left(n^{-\frac{1}{2}}\right)$$

and

$$d_{\lfloor \frac{n-1}{2} + x\sqrt{n} \rfloor}^n = \frac{\sqrt{20}}{\sqrt{3\pi}} \frac{1}{\sqrt{n}} \exp\left(\frac{-20x^2}{3}\right) + o\left(n^{-\frac{1}{2}}\right),$$

where the error terms $o\left(n^{-\frac{1}{2}}\right)$ are uniform in x . The family of projective hypersurfaces associated to each family $\{F_d^{\pm, n}\}_{d \in \mathbb{N}}$ is also asymptotically maximal.

Remark 6.1.4. In particular, for $x = 0$, compare with Formula (6.1.2) and see that for n odd,

$$\frac{d_{\frac{n-1}{2}}^n}{a_{\frac{n-1}{2}}^n} = \frac{\sqrt{10}}{3} + o(1),$$

which is strictly greater than 1 for n large enough.

These results are currently the only known "counterexamples" in general dimension to the principle presented in the Introduction, which suggested that real projective algebraic hypersurfaces should be expected to verify

$$\dim_{\mathbb{Z}_2} H_q(\mathbb{R}X; \mathbb{Z}_2) \leq \sum_p h^{q,p}(\mathbb{C}X).$$

This chapter is organized as follows: the proofs of Theorems 6.1.1, 6.1.2 and 6.1.3, as well as some observations regarding Hodge numbers and their relations to more combinatorial objects, such as Eulerian numbers and hypercube slices, are to be found in Section 6.2.

Explicit approximations of the largest c_i^n (using the notations of Theorem 6.1.1) that we were able to get for small n are given in Section 6.3.

Finally, some closing observations are made in Section 6.4.

6.2 Asymptotically large Betti numbers in arbitrary dimension and index

Before proceeding with the proof of Theorems 6.1.1 and 6.1.2, we make in Subsection 6.2.1 a few observations concerning Hodge numbers and their relations to some combinatorial concepts; there are indeed many connections between Hodge numbers of algebraic varieties and interesting objects in combinatorics, some of which can be found in M. Baker's survey [Bak18]. We also prove results which we later use in Subsection 6.2.3 to show that some families of real projective algebraic hypersurfaces that we define using the Cooking Theorem

have appropriately large asymptotic Betti numbers, thereby proving Theorems 6.1.1 and 6.1.2.

6.2.1 Asymptotic Hodge numbers and combinatorics

Let X_d^n be a completely nondegenerate real algebraic hypersurface of degree d in $\mathbb{C}\mathbb{P}^n$. Then we have

$$h^{p,n-1-p}(\mathbb{C}X_d^n) = \sum_{i=0}^{n+1} (-1)^i \binom{n+1}{i} \binom{d(p+1) - (d-1)i - 1}{n} + \delta_{n-1,2p} \quad (6.2.1)$$

for $p = 0, \dots, n-1$, where $h^{p,n-1-p}(\mathbb{C}X_d^n)$ is the $(p, n-1-p)$ -th Hodge number of $\mathbb{C}X_d^n$ and $\binom{k_1}{k_2} = 0$ if $k_1 < k_2$ (see [DK86]).

Note that $\sum_{i=0}^{n+1} (-1)^i \binom{n+1}{i} \binom{d(p+1) - (d-1)i - 1}{n}$ is also equal to the number of ordered $(n+1)$ -partitions of $d(p+1)$ such that each of the summands belongs to $\{1, \dots, d-1\}$. Indeed, the sum can be interpreted as the number of ordered $(n+1)$ -partitions of $d(p+1)$ such that each of the summands is greater than or equal to 1, minus the number of ordered $(n+1)$ -partitions of $d(p+1)$ such that each of the summand is greater than or equal to 1 and at least one of the summand is greater than or equal to d . This is expressed using the inclusion-exclusion formula applied to the sets A_I , where A_I (for $I \subset \{1, \dots, n+1\}$) is the set of ordered $(n+1)$ -partitions of $d(p+1)$ such that each of the summand is greater than or equal to 1 and the summands a_j are greater than or equal to d for any $j \in I$ (in the formula, i corresponds to $|I|$).

The asymptotic behavior of such expressions is an interesting topic in itself, related to lattice paths, hypergeometric functions and some probabilistic notions (see for example [MPP19]). Note that a more geometric interpretation of Formula (6.2.1) can also be given, as $\sum_{i=0}^{n+1} (-1)^i \binom{n+1}{i} \binom{d(p+1) - (d-1)i - 1}{n}$ is equal to the number of interior integer points in the section of the cube $[0, d]^{n+1} \subset \mathbb{R}^{n+1}$ by the hyperplane $\{\sum_{i=0}^{n+1} x_i = (p+1)d\} \subset \mathbb{R}^{n+1}$.

For $n \in \mathbb{N}$, $p \in \{0, \dots, n-1\}$ and $i \in \{0, \dots, n-1\}$ given, the expression $\binom{d(p+1) - (d-1)i - 1}{n} = \binom{d(p+1-i) + i - 1}{n}$ is a polynomial in d of degree n whose monomial of highest degree is $d^n \frac{(p+1-i)^n}{n!}$ if $i < p+1$, and a constant (in d) for d large enough otherwise. Hence, as d goes to infinity, $h^{p,n-1-p}(\mathbb{C}X_d^n)$ is a polynomial in degree n whose monomial of highest degree is

$$\frac{d^n}{n!} \left(\sum_{i=0}^p (-1)^i \binom{n+1}{i} (p+1-i)^n \right). \quad (6.2.2)$$

As in Section 5.1, we define $a_p^n := \frac{1}{n!} \left(\sum_{i=0}^p (-1)^i \binom{n+1}{i} (p+1-i)^n \right)$ for $p \in \{0, \dots, n-1\}$. For convenience, we also define $a_p^n := 0$ for any $p \in \mathbb{Z} \setminus \{0, \dots, n-1\}$. Observe that Formula (5.1.1) implies that $\sum_{p \in \mathbb{Z}} a_p^n = 1$ for any $n \geq 1$.

The theory of Ehrhart polynomials tells us that the number of interior integer points in the section of the cube $[0, d]^{n+1} \subset \mathbb{R}^{n+1}$ by the hyperplane $\{\sum_{i=0}^{n+1} x_i = (p+1)d\}$ is

a polynomial in d of degree n whose leading coefficient is equal to the n -volume of the section of the cube $[0, 1]^{n+1} \subset \mathbb{R}^{n+1}$ by the hyperplane $\{\sum_{i=0}^{n+1} x_i = p + 1\}$ normalized by the lattice volume of $\{\sum_{i=0}^{n+1} x_i = p + 1\}$ (which is $\sqrt{n+1}$). In other words, we have

$$a_p^n = \frac{1}{\sqrt{n+1}} \text{Vol}_n \left([0, 1]^{n+1} \cap \left\{ \sum_{i=0}^{n+1} x_i = p + 1 \right\} \right).$$

Interesting questions can be asked about the volumes of high dimensional polytopes obtained in similar ways (see for example [CK15]).

Consider also that the (n, p) -th Eulerian number $E(n, p)$ (which is equal to the number of permutations of the set $\{1, \dots, n\}$ in which exactly p elements are greater than the previous element) admits the explicit expression

$$E(n, p) = \sum_{i=0}^p (-1)^i \binom{n+1}{i} (p+1-i)^n. \quad (6.2.3)$$

Hence we have $a_p^n = \frac{1}{n!} E(n, p)$ for $n \geq 1$ and $p \geq 0$.

A function $p : \mathbb{Z} \rightarrow \mathbb{R}_{\geq 0}$ is called *log-concave* if $p(m)^2 \geq p(m-1)p(m+1)$ for all $m \in \mathbb{Z}$, and if its support is a contiguous interval, *i.e.* if there exist $m_1, m_2 \in \mathbb{Z}$ such that $m_1 < m_2$, $p(m) = 0$ for all $m \leq m_1$ and all $m \geq m_2$, and $p(m) > 0$ for all $m_1 < m < m_2$. The second condition is sometimes omitted. As is shown, for example, in [Mez19] (Section 6.5), the sequence of Eulerian numbers $\{E(n, p)\}_{p \in \mathbb{Z}}$ (for a given $n \geq 1$) is symmetric in $\frac{n-1}{2}$ and log-concave; moreover, it is 0 for $p < 0$, strictly increasing from $p = 0$ to $p = \frac{n-1}{2}$ and strictly decreasing from $p = \frac{n-1}{2}$ to $p = n-1$ for n odd (respectively, strictly increasing from $p = 0$ to $p = \frac{n}{2} - 1$, strictly decreasing from $p = \frac{n}{2}$ to $p = n-1$, and $E(n, \frac{n}{2} - 1) = E(n, \frac{n}{2})$ for n even), and 0 for $p > n-1$. This naturally implies the corresponding statements for the sequence $\{a_p^n\}_{p \in \mathbb{Z}}$.

Log-concavity is an interesting notion, though we make no use of it here; a survey of some of the properties of log-concave functions and sequences (some of which are related to algebraic geometry) can be found in [SW14].

We want to consider the second order central finite differences of the coefficients a_p^n , *i.e.* the sequence

$$D^2 a_p^n := a_{p+1}^n - 2a_p^n + a_{p-1}^n,$$

as it proves a useful notion in Subsection 6.2.3.

Eulerian numbers are known to satisfy the recursive relation

$$E(n, p) = (n-p)E(n-1, p-1) + (p+1)E(n-1, p)$$

for all $n \geq 1$ and $p \in \mathbb{Z}$.

Hence we can see that

$$\begin{aligned}
n!D^2a_p^n &= E(n, p+1) - 2E(n, p) + E(n, p-1) = \\
&((n-p-1)E(n-1, p) + (p+2)E(n-1, p+1)) \\
&- 2((n-p)E(n-1, p-1) + (p+1)E(n-1, p)) \\
&+ ((n-p+1)E(n-1, p-2) + pE(n-1, p-1)) = \\
&(n-p+1)(E(n-1, p) - 2E(n-1, p-1) + E(n-1, p-2)) \\
&+ (p+2)(E(n-1, p+1) - 2E(n-1, p) + E(n-1, p-1)) = \\
&(n-p+1)(n-1)!D^2a_{p-1}^{n-1} + (p+2)(n-1)!D^2a_p^{n-1}.
\end{aligned}$$

Therefore the finite difference $D^2a_p^n$ satisfies the following recursive relation:

$$D^2a_p^n = \frac{n-p+1}{n}D^2a_{p-1}^{n-1} + \frac{p+2}{n}D^2a_p^{n-1}. \quad (6.2.4)$$

Interestingly (though we make no use of that fact), we also see that the finite differences $E(n, p+1) - 2E(n, p) + E(n, p-1)$ obey the same recursive relation as the Eulerian numbers themselves, up to a shift in parameter $p \rightarrow p+1$.

We already know that for $n \geq 1$, the sequence $\{D^2a_p^n\}_{p \in \mathbb{Z}}$ is symmetric in $\frac{n-1}{2}$. The following lemma gives us more precise information:

Lemma 6.2.1. *Let $n \geq 3$. If n is odd (respectively, even), there exists $0 \leq \tilde{p}_n < \frac{n-1}{2}$ (respectively, $0 \leq \tilde{p}_n < \frac{n}{2} - 1$) such that the sequence $\{D^2a_p^n\}_{p \in \mathbb{Z}}$ satisfies:*

1. $D^2a_p^n = 0$ for $p \leq -2$ and $p \geq n+1$.
2. $D^2a_p^n > 0$ for $-1 \leq p \leq \tilde{p}_n$ and $n-1-\tilde{p}_n \leq p \leq n$.
3. $D^2a_p^n \leq 0$ for $p \in \{\tilde{p}_n+1, n-2-\tilde{p}_n\}$.
4. $D^2a_p^n < 0$ for $\tilde{p}_n+2 \leq p \leq n-3-\tilde{p}_n$.

Moreover, there cannot be two consecutive integers $n \geq 3$ such that $D^2a_{\tilde{p}_n+1}^n = D^2a_{n-2-\tilde{p}_n}^n = 0$.

Proof. We proceed by induction. The case $n=3$ can be directly computed (we have $a_0^3 = a_2^3 = \frac{1}{6}$ and $a_1^3 = \frac{2}{3}$).

Suppose the statement true for $n-1$, and express $D^2a_p^n$ as $\frac{n-p+1}{n}D^2a_{p-1}^{n-1} + \frac{p+2}{n}D^2a_p^{n-1}$ using Formula (6.2.4). By symmetry, we only need to consider $p \leq \frac{n-1}{2}$. Condition 1 is clearly satisfied.

If $D^2a_{\tilde{p}_{n-1}+1}^{n-1} = 0$, we set $\tilde{p}_n = \tilde{p}_{n-1} + 1$. Then we have $D^2a_p^n > 0$ for $-1 \leq p \leq \tilde{p}_n$ and $n-1-\tilde{p}_n \leq p \leq n$, and $D^2a_p^n < 0$ for $\tilde{p}_n+1 < p < n-2-\tilde{p}_n$. Note in particular that $D^2a_{\tilde{p}_n+1}^n = D^2a_{n-2-\tilde{p}_n}^n \neq 0$.

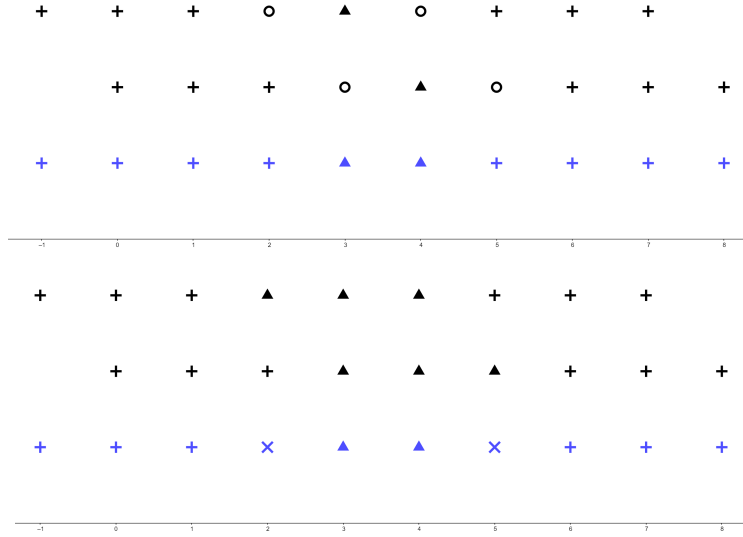

Figure 6.1:

If $D^2 a_{\tilde{p}_{n-1}+1}^{n-1} < 0$, set $\tilde{p}_n = \tilde{p}_{n-1}+1$ if $D^2 a_{\tilde{p}_{n-1}+1}^n = \frac{n-\tilde{p}_{n-1}}{n} D^2 a_{\tilde{p}_{n-1}}^{n-1} + \frac{\tilde{p}_{n-1}+3}{n} D^2 a_{\tilde{p}_{n-1}+1}^{n-1} > 0$ and set $\tilde{p}_n = \tilde{p}_{n-1}$ if $D^2 a_{\tilde{p}_{n-1}+1}^n \leq 0$. Then we have $D^2 a_p^n > 0$ for $-1 \leq p \leq \tilde{p}_n$, $D^2 a_p^n \leq 0$ for $p = \tilde{p}_n + 1$, and $D^2 a_p^n < 0$ for $\tilde{p}_n + 2 \leq p \leq n - 3 - \tilde{p}_n$ (see Figure 6.1).

In both cases, we have $\tilde{p}_n \geq \tilde{p}_{n-1} \geq 0$, and \tilde{p}_n is necessarily strictly smaller than $\frac{n}{2} - 1$, as $D^2 a_{\tilde{p}_n}^n > 0$ and $D^2 a_{\frac{n}{2}-1}^n < 0$ if n is even, as we know that $a_{\frac{n}{2}-2}^n < a_{\frac{n}{2}-1}^n = a_{\frac{n}{2}}^n > a_{\frac{n}{2}+1}^n$ (respectively, $D^2 a_{\frac{n-1}{2}}^n < 0$ if n is odd, as we know that $a_{\frac{n-1}{2}-1}^n < a_{\frac{n-1}{2}}^n > a_{\frac{n-1}{2}+1}^n$). □

Remark 6.2.2. *Computations carried out on a computer suggest that $D^2 a_p^n$ is in fact never 0 between -1 and n ; it admits two (symmetric) global maxima, and one global minimum in $p = \frac{n-1}{2}$ if n is odd (respectively, two global minima in $p = \frac{n}{2} - 1, \frac{n}{2}$ if n is even).*

It should be possible to prove it directly, though it does not appear to be a direct consequence of the log-concavity of the sequence .

Remark 6.2.3. *We can describe more precisely the asymptotic behaviour of $D^2 a_p^n$, though only its sign matters to us. Indeed, for any $s \in \mathbb{R}$, we have*

$$D^2 a_{\lfloor \frac{n-1}{2} + s\sqrt{n} \rfloor}^n = \sqrt{\frac{6}{\pi}} \frac{12}{(n+1)^{\frac{3}{2}}} \exp(-6s^2) (12s^2 - 1) + \mathcal{O}\left(n^{-\frac{5}{2}}\right). \quad (6.2.5)$$

This can be proved by modifying the proof of Formula (6.2.9) below given in [XW11] (Theorem 3.1 of that article), which rests on some properties of B-splines, in order to get a higher order estimate for the coefficients a_p^n , then write out $D^2 a_p^n = a_{p+1}^n - 2a_p^n + a_{p-1}^n$.

Before ending this subsection, we formulate one last recursive relation related to the

coefficients a_p^n (for $n \geq 1$ and $p = 0, \dots, n-1$), which we need later on. It can be immediately deduced from Itenberg's and Viro's work in [IV07] that we have

$$a_p^n = \frac{1}{n} \left(a_p^{n-1} + a_{p-1}^{n-1} + \sum_{k=1}^{n-2} \sum_{j=0}^{p-1} a_j^k \cdot a_{p-1-j}^{n-1-k} \right). \quad (6.2.6)$$

Observe that this means that if every family of polynomials $\{P_d^k\}_{d \in \mathbb{N}}$ in Theorem 5.1.1 is asymptotically standard, *i.e.* $b_i(V_{\mathbb{R}\mathbb{P}^k}(P_d^k)) \stackrel{k}{\approx} a_i^k \cdot d^k$, then so is $\{Q_d^n\}_{d \in \mathbb{N}}$ (the asymptotic inequality in Formula (5.1.2) must be an equality because of the Smith-Thom inequality). This is the case considered in [IV07].

In Theorem 6.1.2 below, we compute the asymptotics of various families of coefficients obeying the same recursive relation (6.2.6) as the coefficients a_p^n for n large enough, but with different initial parameters.

6.2.2 Notations and known results

In this subsection, we define some notations, prove a useful lemma, and quote the results from Brugallé, Itenberg and Viro that will provide us with the main ingredients for our constructions.

When considering in what follows the asymptotic Betti numbers of the projective hypersurfaces associated to a family of completely nondegenerate real Laurent polynomials $\{Q_d^n\}_{d \in \mathbb{N}}$, it is slightly more convenient to use the following notation: if $b_i(V_{\mathbb{R}\mathbb{P}^n}(Q_d^n)) \stackrel{n}{\geq} x_i^n \cdot d^n$ for some $x_i^n \geq 0$, we instead write $b_i(V_{\mathbb{R}\mathbb{P}^n}(Q_d^n)) \stackrel{n}{\geq} (a_i^n + t_i^n) \cdot d^n$, where $t_i^n = x_i^n - a_i^n$.

If we rewrite the statement of Theorem 5.1.1 with that convention, we get that for families $\{P_d^k\}_{d \in \mathbb{N}}$ of completely nondegenerate real Laurent polynomials in k variables (for $k = 1, \dots, n-1$), such that P_d^k is of degree d and that the Newton polytope $\Delta(P_d^k)$ of P_d^k is S_d^k and such that for $i = 0, \dots, k-1$,

$$b_i(V_{\mathbb{R}\mathbb{P}^k}(P_d^k)) \stackrel{k}{\geq} (a_i^k + t_i^k) \cdot d^k$$

for some $t_i^k \in \mathbb{R}$, there exists a family $\{Q_d^n\}_{d \in \mathbb{N}}$ of completely nondegenerate real Laurent polynomials in n variables such that $\Delta(Q_d^n) = S_d^n$ and such that for $i = 0, \dots, n-1$

$$b_i(V_{\mathbb{R}\mathbb{P}^n}(Q_d^n)) \stackrel{n}{\geq} \left(a_i^n + \frac{1}{n} \left(t_i^{n-1} + t_{i-1}^{n-1} + \sum_{k=1}^{n-2} \sum_{j=0}^{i-1} 2(t_j^k \cdot a_{i-1-j}^{n-1-k}) + t_j^k \cdot t_{i-1-j}^{n-1-k} \right) \right) \cdot d^n, \quad (6.2.7)$$

where t_j^k is set to be 0 for $j \notin \{0, \dots, k-1\}$.

Remember that a family of real smooth algebraic projective hypersurfaces $\{X_d^n\}_{d \in \mathbb{N}}$ is asymptotically maximal if $b_*(\mathbb{R}X_d^n) \stackrel{n}{=} b_*(\mathbb{C}X_d^n)$. In particular, if $b_i(\mathbb{R}X_d^n) \stackrel{n}{\geq} (a_i^n + t_i^n) \cdot d^n$ and $\sum_{i=0}^{n-1} t_i^n = 0$, we have $b_*(\mathbb{R}X_d^n) \stackrel{n}{\geq} \sum_{i=0}^{n-1} (a_i^n + t_i^n) \cdot d^n = d^n \stackrel{n}{=} b_*(\mathbb{C}X_d^n)$, hence

$b_*(\mathbb{R}X_d^n) \stackrel{n}{=} b_*(\mathbb{C}X_d^n)$ (because of the Smith-Thom inequality) and $\{X_d^n\}_{d \in \mathbb{N}}$ is asymptotically maximal.

We can now prove the following lemma regarding asymptotic maximality :

Lemma 6.2.4. *Let $n \geq 2$. For $k = 1, \dots, n-1$, let $\{P_d^k\}_{d \in \mathbb{N}}$ be a family of completely nondegenerate real Laurent polynomials in k variables such that P_d^k is of degree d and that the Newton polytope $\Delta(P_d^k)$ of P_d^k is S_d^k and such that for $i = 0, \dots, k-1$,*

$$b_i(V_{\mathbb{R}\mathbb{P}^k}(P_d^k)) \stackrel{k}{\geq} (a_i^k + t_i^k) \cdot d^k \quad (6.2.8)$$

for some $t_i^k \in \mathbb{R}$, as in the Cooking Theorem 5.1.1. Let $\{Q_d^n\}_{d \in \mathbb{N}}$ be a family of polynomials cooked with the ingredients $\{P_d^k\}_{d \in \mathbb{N}}$ using the Cooking Theorem.

Suppose additionally that each family $\{P_d^k\}_{d \in \mathbb{N}}$ is such that $\sum_{i=0}^{k-1} t_i^k = 0$, hence the associated family of projective hypersurfaces $\{V_{\mathbb{P}^k}(P_d^k)\}_{d \in \mathbb{N}}$ is asymptotically maximal. Then the sum over $i = 0, \dots, n-1$ of the coefficients

$$\frac{1}{n} \left(t_i^{n-1} + t_{i-1}^{n-1} + \sum_{k=1}^{n-2} \sum_{j=0}^{i-1} 2(t_j^k \cdot a_{i-1-j}^{n-1-k}) + t_j^k \cdot t_{i-1-j}^{n-1-k} \right)$$

from Formula 6.2.7 is also 0; in particular, the family of hypersurfaces $\{V_{\mathbb{P}^k}(Q_d^n)\}_{d \in \mathbb{N}}$ associated to $\{Q_d^n\}_{d \in \mathbb{N}}$ is also asymptotically maximal, and the asymptotic inequality (6.2.8) is an asymptotic equality.

Proof. We know that for $i = 0, \dots, n-1$,

$$b_i(V_{\mathbb{R}\mathbb{P}^n}(Q_d^n)) \stackrel{n}{\geq} \left(a_i^n + \frac{1}{n} \left(t_i^{n-1} + t_{i-1}^{n-1} + \sum_{k=1}^{n-2} \sum_{j=0}^{i-1} 2(t_j^k \cdot a_{i-1-j}^{n-1-k}) + t_j^k \cdot t_{i-1-j}^{n-1-k} \right) \right) \cdot d^n,$$

where t_j^k and a_j^k are set to be 0 for $j \notin \{0, \dots, k-1\}$. Set

$$t_i^n := \frac{1}{n} \left(t_i^{n-1} + t_{i-1}^{n-1} + \sum_{k=1}^{n-2} \sum_{j=0}^{i-1} 2(t_j^k \cdot a_{i-1-j}^{n-1-k}) + t_j^k \cdot t_{i-1-j}^{n-1-k} \right)$$

for $i \in \mathbb{Z}$; observe that $t_i^n = 0$ if $i \notin \{0, \dots, n-1\}$.

Showing that $\sum_{i=0}^{n-1} t_i^n = \sum_{i \in \mathbb{Z}} t_i^n = 0$ is enough to conclude (using as above the Smith-Thom inequality).

Indeed, we have

$$\begin{aligned} \sum_{i=0}^{n-1} t_i^n &= \sum_{i \in \mathbb{Z}} \frac{1}{n} \left(t_i^{n-1} + t_{i-1}^{n-1} + \sum_{k=1}^{n-2} \sum_{j=0}^{i-1} 2(t_j^k \cdot a_{i-1-j}^{n-1-k}) + t_j^k \cdot t_{i-1-j}^{n-1-k} \right) = \\ &= \frac{1}{n} \left(\left(\sum_{i \in \mathbb{Z}} t_i^{n-1} \right) + \left(\sum_{i \in \mathbb{Z}} t_{i-1}^{n-1} \right) + \sum_{k=1}^{n-2} \sum_{j \in \mathbb{Z}} t_j^k \cdot \left(2 \sum_{i \in \mathbb{Z}} a_{i-1-j}^{n-1-k} + \sum_{i \in \mathbb{Z}} t_{i-1-j}^{n-1-k} \right) \right) = \end{aligned}$$

$$\frac{1}{n} \left(0 + 0 + \sum_{k=1}^{n-2} \sum_{j \in \mathbb{Z}} t_j^k \cdot (2 + 0) \right) = \frac{2}{n} \sum_{k=1}^{n-2} \sum_{j \in \mathbb{Z}} t_j^k = 0.$$

□

We now quote (using our notations) two results that attest the existence of families of polynomials which we later use as ingredients for the Cooking Theorem to prove Theorem 6.1.1. The first one was proved by Itenberg and Viro in [IV07], and alluded to in Section 5.1.

Theorem 6.2.5 (Itenberg, Viro). *Let $k \geq 1$. There exists a family $\{I_d^k\}_{d \in \mathbb{N}}$ of completely nondegenerate real Laurent polynomials in k variables obtained by combinatorial Patchwork such that I_d^k is of degree d and that the Newton polytope $\Delta(I_d^k)$ of I_d^k is S_d^k and such that for $i = 0, \dots, k-1$,*

$$b_i(V_{\mathbb{R}\mathbb{P}^k}(I_d^k)) \stackrel{k}{=} a_i^k \cdot d^k.$$

In particular, the families $\{V_{\mathbb{P}^k}(I_d^k)\}_{d \in \mathbb{N}}$ are asymptotically maximal.

The hypersurfaces associated to the polynomials I_d^k are asymptotically standard in the same sense as above. They serve as "neutral" ingredients in what follows, in that they do not contribute to any difference from the asymptotically standard case.

The second result comes from [Bru06], where Brugallé builds two families of completely nondegenerate real Laurent polynomials in 3 variables such that the associated surfaces in \mathbb{P}^3 have exceptionally large asymptotic b_0 (respectively, b_1) using a method from Bihan's [Bih03].

Theorem 6.2.6 (Brugallé). *There exist families $\{B_d^+\}_{d \in \mathbb{N}}$ and $\{B_d^-\}_{d \in \mathbb{N}}$ of completely nondegenerate real Laurent polynomials in 3 variables such that B_d^\pm is of degree d and that the Newton polytope $\Delta(B_d^\pm)$ of B_d^\pm is S_d^3 and such that*

$$b_0(V_{\mathbb{R}\mathbb{P}^3}(B_d^+)) \stackrel{3}{=} \frac{3}{8} \cdot d^3 = \left(\frac{1}{6} + \frac{5}{24} \right) \cdot d^3 = \left(a_0^3 + \frac{5}{24} \right) \cdot d^3,$$

$$b_1(V_{\mathbb{R}\mathbb{P}^3}(B_d^+)) \stackrel{3}{=} \frac{1}{4} \cdot d^3 = \left(\frac{2}{3} - \frac{5}{12} \right) \cdot d^3 = \left(a_1^3 - \frac{5}{12} \right) \cdot d^3,$$

$$b_0(V_{\mathbb{R}\mathbb{P}^3}(B_d^-)) \stackrel{3}{=} \frac{1}{8} \cdot d^3 = \left(\frac{1}{6} - \frac{1}{24} \right) \cdot d^3 = \left(a_0^3 - \frac{1}{24} \right) \cdot d^3$$

and

$$b_1(V_{\mathbb{R}\mathbb{P}^3}(B_d^-)) \stackrel{3}{=} \frac{3}{4} \cdot d^3 = \left(\frac{2}{3} + \frac{1}{12} \right) \cdot d^3 = \left(a_1^3 + \frac{1}{12} \right) \cdot d^3.$$

In particular, the families $\{V_{\mathbb{P}^3}(B_d^\pm)\}_{d \in \mathbb{N}}$ are asymptotically maximal.

Remark 6.2.7. *Of course, Poincaré duality applies, as homology is considered with coefficients in \mathbb{Z}_2 .*

Remark 6.2.8. *As far as the author is aware, these are the largest asymptotic values for each respective Betti numbers of a smooth real projective algebraic surface to have been obtained to this day, which is why we choose to use them as ingredients in what follows.*

Remark 6.2.9. *It is not particularly hard, though somewhat tedious, to show that for any $a \in [-\frac{1}{24}, \frac{5}{24}]$, we can build (using the families $\{B_d^\pm\}_{d \in \mathbb{N}}$) a family $\{P_d^3\}_{d \in \mathbb{N}}$ of completely nondegenerate real Laurent polynomials in 3 variables such that the Newton polytope $\Delta(P_d^3)$ is S_d^3 and that for $i = 0, \dots, 2$, we have*

$$b_i(V_{\mathbb{R}\mathbb{P}^n}(P_d^3)) \stackrel{n}{=} x_i^3 \cdot d^n$$

with $x_0^3 = x_2^3 = \frac{1}{6} + a$ and $x_1^3 = \frac{4}{6} - 2a$. The idea is to partition S_d^3 (for very large degrees d) into smaller, albeit still very large, simplices corresponding either to $B_{\tilde{d}}^+$ or to $B_{\tilde{d}}^-$, for some $\tilde{d} < d$ (with some interstitial space of asymptotically negligible volume). The proportion $\lambda_d \in [0, 1]$ (respectively, $1 - \lambda_d \in [0, 1]$) of the total volume of S_d^3 filled by simplices corresponding to $B_{\tilde{d}}^+$ (respectively, to $B_{\tilde{d}}^-$) must be such that $\lambda_d \frac{5}{24} - (1 - \lambda_d) \frac{1}{24}$ converges to a as $d \rightarrow \infty$.

6.2.3 The first construction

In this subsection, we describe the first of our two main families of constructions. It allows us to find for every dimension and index Betti numbers that are asymptotically (in d) strictly superior to the standard case, but not by a large margin: this enables us to prove Theorem 6.1.1. The other one is described in Subsection 6.2.4 and provides much better asymptotic (in d) lower bounds on the chosen Betti numbers, but only asymptotically (in n); it allows us to prove Theorem 6.1.2.

The idea is to carefully pick families of polynomials $\{P_d^k\}_{d \in \mathbb{N}}$ in k variables (with k small) as ingredients for the Cooking Theorem 5.1.1 in order to get families of polynomials $\{Q_d^n\}_{d \in \mathbb{N}}$ (with n large) with interesting properties.

Given $n \geq 3$ and $i = 0, \dots, n - 1$, the polynomials $\{P_d^k\}_{d \in \mathbb{N}}$ (for $k = 1, \dots, n - 1$) must be chosen so that the asymptotic Betti numbers of the associated families of projective hypersurfaces are such that the right-hand term of Formula (6.2.7) is large.

As far as the author knows, few interesting (in that regard) families have yet been constructed in high ambient dimension. Hence, we must work our way up from dimension 3, where we have Theorem 6.2.6, by recursively applying the Cooking Theorem: a family $\{Q_d^n\}_{d \in \mathbb{N}}$ that we get as the result of one application of the theorem can serve as an ingredient for a construction in higher dimension.

Note that should a new family of hypersurfaces with interesting asymptotic Betti number be developed in a given dimension n , we could immediately use it as an ingredient to hopefully get new and interesting results in dimension $\tilde{n} > n$.

Observe also that since there is only one non-trivial Betti number in ambient dimension 1, and two that are equal in ambient dimension 2 (and hence both asymptotically smaller than or equal to $\frac{d^2}{2}$), nothing interesting can a priori be expected from the direct use of non-asymptotically standard families in ambient dimension 1 and 2.

In general, it is unclear how to choose the ingredients $\{P_d^k\}_{d \in \mathbb{N}}$ so that a given Betti number is maximized in the resulting family of hypersurfaces, as Formula (6.2.7) is fairly complicated; the trick we use in the first construction, which is described in the proof of the following lemma, is to make it so that most terms in the formula are trivial, so that we can understand it better. The results are most likely, in a sense, suboptimal, but they suffice for our purpose here.

Lemma 6.2.10. *For each $n \geq 8$, there exist families $\{H_d^{+,n}\}_{d \in \mathbb{N}}$ and $\{H_d^{-,n}\}_{d \in \mathbb{N}}$ of completely nondegenerate real Laurent polynomials in n variables such that $H_d^{\pm,n}$ is of degree d and that the Newton polytope $\Delta(H_d^{\pm,n})$ is S_d^n and such that for $i = 0, \dots, n-1$, we have*

$$b_i(V_{\mathbb{R}P^n}(H_d^{+,n})) \stackrel{n}{=} \left(a_i^n + \frac{2}{n} \frac{5}{24} D^2 a_{i-2}^{n-4} \right) \cdot d^n$$

and

$$b_i(V_{\mathbb{R}P^n}(H_d^{-,n})) \stackrel{n}{=} \left(a_i^n - \frac{2}{n} \frac{1}{24} D^2 a_{i-2}^{n-4} \right) \cdot d^n$$

Moreover, the family of hypersurfaces associated to each family is asymptotically maximal.

Remark 6.2.11. *The coefficients $\frac{1}{24}$ and $\frac{5}{24}$ come from Theorem 6.2.6; should we get better asymptotic results than in Theorem 6.2.6, we would be able to immediately "plug" them in and improve the asymptotics of Lemma 6.2.10.*

Proof. We define $\{H_d^{+,n}\}_{d \in \mathbb{N}}$ first.

We apply the Cooking Theorem to the following ingredients $\{P_d^k\}_{d \in \mathbb{N}}$: let P_d^k be equal to I_d^k from Theorem 6.2.5 for $k \in \{1, 2, 4, 5, \dots, n-1\}$, and let P_d^3 be equal to B_d^+ from Theorem 6.2.6. Following the notations introduced with Formula (6.2.7), we get that $t_0^3 = t_2^3 = \frac{5}{24}$ and $t_1^3 = -\frac{5}{12}$, and $t_j^k = 0$ for all other k, j (by definition of the polynomials P_d^k). Note in particular that as $n > 7$, $t_j^{n-1} = 0$ and $t_j^k \cdot t_{i-1-j}^{n-1-k} = 0$ for all k, j .

Hence application of Theorem 5.1.1 yields a family $\{H_d^{+,n}\}_{d \in \mathbb{N}}$ such that

$$\begin{aligned} b_i(V_{\mathbb{R}P^n}(H_d^{+,n})) &\stackrel{n}{\geq} \left(a_i^n + \frac{1}{n} \left(t_i^{n-1} + t_{i-1}^{n-1} + \sum_{k=1}^{n-2} \sum_{j=0}^{i-1} 2(t_j^k \cdot a_{i-1-j}^{n-1-k}) + t_j^k \cdot t_{i-1-j}^{n-1-k} \right) \right) \cdot d^n = \\ &\left(a_i^n + \frac{1}{n} \left(\sum_{j=0}^{i-1} 2(t_j^3 \cdot a_{i-1-j}^{n-4}) \right) \right) \cdot d^n = \left(a_i^n + \frac{2}{n} \frac{5}{24} (a_{i-1}^{n-4} - 2a_{i-2}^{n-4} + a_{i-3}^{n-4}) \right) \cdot d^n = \\ &\left(a_i^n + \frac{2}{n} \frac{5}{24} D^2 a_{i-2}^{n-4} \right) \cdot d^n \end{aligned}$$

for $i = 0, \dots, n-1$.

As the sum $\sum_{j \in \mathbb{Z}} D^2 a_j^m$ of second order finite differences is 0 for any $m \geq 1$, and in particular for $m = n - 4$, we have as above that the family is asymptotically maximal because of the Smith-Thom inequality, and that the asymptotic inequality $b_i(V_{\mathbb{R}P^n}(H_d^{+,n})) \stackrel{n}{\geq} (a_i^n + \frac{2}{n} \frac{5}{24} D^2 a_{i-2}^{n-4}) \cdot d^n$ is in fact an asymptotic equality $b_i(V_{\mathbb{R}P^n}(H_d^{+,n})) \stackrel{n}{=} (a_i^n + \frac{2}{n} \frac{5}{24} D^2 a_{i-2}^{n-4}) \cdot d^n$.

The exact same proof, with B_d^- replacing B_d^+ and $-\frac{1}{24}$ replacing $\frac{5}{24}$, yields the other case. \square

As will become apparent in the proof of Theorem 6.1.1, we also need the following lemma.

Lemma 6.2.12. *For any $n \geq 3$, there exists a family $\{L_d^n\}_{d \in \mathbb{N}}$ of completely nondegenerate real Laurent polynomials in n variables such that $\Delta(L_d^n) = S_d^n$, that the associated family of real projective hypersurfaces is asymptotically maximal and that*

$$b_0(V_{\mathbb{R}P^n}(L_d^n)) = b_{n-1}(V_{\mathbb{R}P^n}(L_d^n)) \stackrel{n}{\geq} \left(a_0^n + \frac{5}{24} \frac{3!}{n!} \right) \cdot d^n.$$

Proof. We proceed by induction on n . The case $n = 3$ is simply Theorem 6.2.6.

Now let $n \geq 4$ and suppose that $\{L_d^{n-1}\}_{d \in \mathbb{N}}$ has been defined. We apply Theorem 5.1.1 to the following families of polynomials $\{P_d^k\}_{d \in \mathbb{N}}$: let P_d^k be equal to I_d^k from Theorem 6.2.5 for $k \in \{1, \dots, n-2\}$, and let P_d^{n-1} be equal to L_d^{n-1} . Following the notations introduced with Formula (6.2.7), we have $t_0^{n-1} \geq \frac{5}{24} \frac{3!}{(n-1)!}$, and $t_j^k = 0$ for all other $k < n-1$ (by definition of the polynomials P_d^k).

Hence application of Theorem 5.1.1 yields a family $\{L_d^n\}_{d \in \mathbb{N}}$ such that

$$b_0(V_{\mathbb{R}P^n}(L_d^n)) \stackrel{n}{\geq} \left(a_0^n + \frac{1}{n} \left(t_0^{n-1} + t_{0-1}^{n-1} + \sum_{k=1}^{n-2} \sum_{j=0}^{0-1} 2(t_j^k \cdot a_{0-1-j}^{n-1-k}) + t_j^k \cdot t_{0-1-j}^{n-1-k} \right) \right) \cdot d^n \stackrel{n}{\geq} \left(a_0^n + \frac{5}{24} \frac{3!}{n!} \right) \cdot d^n,$$

as wanted. \square

We can finally prove Theorem 6.1.1, which we state again.

Theorem 6.1.1. *For any $n \geq 3$ and any $i = 0, \dots, n-1$, there exists $c_i^n > a_i^n$ and a family $\{Q_d^n\}_{d \in \mathbb{N}}$ of completely nondegenerate real Laurent polynomials in n variables such that $\Delta(Q_d^n) = S_d^n$, that the associated family of real projective hypersurfaces is asymptotically maximal and that*

$$b_i(V_{\mathbb{R}P^n}(Q_d^n)) \stackrel{n}{\geq} c_i^n \cdot d^n.$$

Proof. Let $n \geq 3$ and $i \in \{0, \dots, n-1\}$.

We mainly rely on the construction from Lemma 6.2.10 and the result of Lemma 6.2.1. However, as $D^2 a_{p-2}^{n-4} = 0$ for $p = 0, n-1$ (the construction from Lemma 6.2.10 cannot help

us get a large number of connected components), we also need Lemma 6.2.12; moreover, as we were not able to show in Lemma 6.2.1 that the finite differential $D^2 a_p^n$ is never 0 between $k = -1$ and $k = n$, we need another ad hoc trick.

We assume that $n \geq 8$; the cases $n \leq 7$ are treated in more details in Section 6.3.

If $i \in \{0, n-1\}$, we define Q_d^n as L_d^n from Lemma 6.2.12, and set $c_i^n := a_i^n + \frac{5}{24} \frac{3!}{n!}$ (remember that Poincaré duality applies) - this suffices.

Otherwise, consider $D^2 a_{i-2}^{n-4}$. If it is strictly positive, define Q_d^n as $H_d^{+,n}$ from Lemma 6.2.10 and $c_i^n := a_i^n + \frac{2}{n} \frac{5}{24} D^2 a_{i-2}^{n-4}$; if it strictly negative, define Q_d^n as $H_d^{-,n}$ from the same lemma and $c_i^n := a_i^n - \frac{2}{n} \frac{1}{24} D^2 a_{i-2}^{n-4}$. In both cases, we are done (using the statement of the lemma).

If we are unlucky, and i is the only index in $\{1, \dots, n-2\}$ such that $D^2 a_{i-2}^{n-4} = 0$, we know from Lemma 6.2.1 that $D^2 a_p^{n-5}$ is never 0 for $p \in \{-1, \dots, n-5\}$. Moreover, Formula 6.2.4 tells us that

$$D^2 a_{i-2}^{n-4} = \frac{n-i-1}{n-4} D^2 a_{i-3}^{n-5} + \frac{i}{n-4} D^2 a_{i-2}^{n-5}.$$

As at least one of the two terms is nonzero, both must be for $D^2 a_{i-2}^{n-4}$ to be 0. Observe also that $\frac{n-i-1}{n-4} \neq \frac{i}{n-4}$, as otherwise $i = \frac{n-1}{2}$, in which case $D^2 a_{i-2}^{n-4} = D^2 a_{\frac{(n-4)-1}{2}}^{n-4} \neq 0$ (the middle term is never 0, see Lemma 6.2.1). Hence $D^2 a_{i-3}^{n-5} + D^2 a_{i-2}^{n-5} \neq 0$.

Now apply the Cooking Theorem 5.1.1 to the following ingredients $\{P_d^k\}_{d \in \mathbb{N}}$: let P_d^k be equal to I_d^k from Theorem 6.2.5 for $k \in \{1, \dots, n-2\}$, and let P_d^{n-1} be equal to $H_d^{+,n-1}$ from Lemma 6.2.10 if $D^2 a_{i-3}^{n-5} + D^2 a_{i-2}^{n-5} > 0$ (respectively, equal to $H_d^{-,n-1}$ from Lemma 6.2.10 if $D^2 a_{i-3}^{n-5} + D^2 a_{i-2}^{n-5} < 0$). Following the notations introduced with Formula (6.2.7), we have $t_i^{n-1} = \frac{2}{n-1} \frac{5}{24} D^2 a_{i-2}^{n-5}$ and $t_{i-1}^{n-1} = \frac{2}{n-1} \frac{5}{24} D^2 a_{i-3}^{n-5}$ (respectively, $t_i^{n-1} = -\frac{2}{n-1} \frac{1}{24} D^2 a_{i-2}^{n-5}$ and $t_{i-1}^{n-1} = -\frac{2}{n-1} \frac{1}{24} D^2 a_{i-3}^{n-5}$), and $t_j^k = 0$ for all other $k < n-1$ (by definition of the polynomials P_d^k).

Hence application of the Cooking Theorem yields a family $\{Q_d^n\}_{d \in \mathbb{N}}$ such that

$$b_i(V_{\mathbb{R}P^n}(Q_d^n)) \geq \left(a_i^n + \frac{1}{n} \left(t_i^{n-1} + t_{i-1}^{n-1} + \sum_{k=1}^{n-2} \sum_{j=0}^{i-1} 2(t_j^k \cdot a_{i-1-j}^{n-1-k}) + t_j^k \cdot t_{i-1-j}^{n-1-k} \right) \right) \cdot d^n =$$

$$\left(a_i^n + \frac{1}{n} \frac{5}{24} \frac{2}{n-1} (D^2 a_{i-2}^{n-5} + D^2 a_{i-3}^{n-5}) \right) \cdot d^n$$

(respectively, $b_i(V_{\mathbb{R}P^n}(Q_d^n)) \geq \left(a_i^n - \frac{1}{n} \frac{1}{24} \frac{2}{n-1} (D^2 a_{i-2}^{n-5} + D^2 a_{i-3}^{n-5}) \right) \cdot d^n$).

Define $c_i^n := a_i^n + \frac{1}{n} \frac{5}{24} \frac{2}{n-1} (D^2 a_{i-2}^{n-5} + D^2 a_{i-3}^{n-5})$ (respectively, $c_i^n := a_i^n - \frac{1}{n} \frac{1}{24} \frac{2}{n-1} (D^2 a_{i-2}^{n-5} + D^2 a_{i-3}^{n-5})$). This suffices.

In each case above, the family of hypersurfaces associated to the family $\{Q_d^n\}_{d \in \mathbb{N}}$ is asymptotically maximal, as the family $\{Q_d^n\}_{d \in \mathbb{N}}$ always comes from an application of the Cooking Theorem to families of polynomials such that the associated families of hypersurfaces are asymptotically maximal.

□

Hence we found in all dimensions $n \geq 3$ and indices $i = 0, \dots, n-1$ Betti numbers that are asymptotically (in d) strictly greater than the standard case - however, the asymptotics (in n) of that surplus is not very good.

Indeed, the asymptotic behavior of the Eulerian numbers (and hence of the coefficients a_p^n) is known: it was shown by G. Polya in [Pol13] (see [Rza08] for a more easily accessible reference) that for any $x \in \mathbb{R}$, we have

$$a_{\lfloor \frac{n-1}{2} + x\sqrt{n} \rfloor}^n = \sqrt{\frac{6}{\pi(n+1)}} \exp(-6x^2) + \mathcal{O}\left(n^{-\frac{3}{2}}\right). \quad (6.2.9)$$

(what he considered was actually the volume of hypercube slices, which is equivalent, as seen above).

On the other hand, the surplus that we found in Lemma 6.2.10 in dimension $n \geq 3$ and index $1 \leq i \leq n-2$ relative to the standard case was of the form $C \frac{1}{n} D^2 a_{i-2}^{n-4}$, for some constant C . We have already mentioned in Remark 6.2.3 that for a fixed $s \in \mathbb{R}$, $D^2 a_{\lfloor \frac{n-1}{2} + s\sqrt{n} \rfloor}^n$ is $\mathcal{O}\left(n^{-\frac{3}{2}}\right)$. Hence, the ratio $\frac{c_i^n - a_i^n}{a_i^n}$, where c_i^n comes from Theorem 6.1.1, is at most $\mathcal{O}\left(n^{-2}\right)$. We achieve much better results in the next subsection.

6.2.4 The second construction

In this subsection, we recall the statements of Theorem 6.1.2 and Theorem 6.1.3 and prove them. They yield good "asymptotic asymptotic" results, in the sense that we find families of families of polynomials such that the associated Betti numbers are asymptotically of magnitude $c_i^n \cdot d^n$ (as the degree d goes to infinity), while the Betti numbers of the standard case are of magnitude $a_i^n \cdot d^n$, with $\frac{c_i^n}{a_i^n}$ converging (as the dimension n goes to infinity) to a strictly positive constant.

To do so, we apply recursively the Cooking Theorem 5.1.1 to the ingredients provided by Theorems 6.2.5 and 6.2.6. The construction itself is simple; the main difficulty lies in understanding the asymptotic behavior of the sequences recursively defined using Formula 5.1.2 that describe the asymptotic behavior of the Betti numbers, as we cannot expect most terms to be trivial, unlike in the proof of Theorem 6.1.1. We succeed by applying probabilistic methods.

Theorem 6.1.2. *Let $N \geq 1$. For $k = 1, \dots, N$, let $\{P_d^k\}_{d \in \mathbb{N}}$ be a family of completely nondegenerate real Laurent polynomials in k variables such that the Newton polytope $\Delta(P_d^k)$ of P_d^k is S_d^k . Suppose additionally that for $k = 1, \dots, N$ and $i = 0, \dots, k-1$,*

$$b_i(V_{\mathbb{R}\mathbb{P}^k}(P_d^k)) \stackrel{k}{=} x_i^k \cdot d^k$$

for some $x_i^k \in \mathbb{R}_{\geq 0}$ such that $\sum_{i=0}^{k-1} x_i^k = 1$ (in particular, the family of projective hypersurfaces associated to each family $\{P_d^k\}_{d \in \mathbb{N}}$ is asymptotically maximal). Set also x_i^k to be 0 for $i \notin \{0, \dots, k-1\}$.

Define

$$\sigma^2 := \frac{2}{(N+1)(N+2)} \left(\frac{1}{4} + \sum_{k=1}^N \sum_{i=0}^{k-1} x_i^k \left(i - \frac{k-1}{2} \right)^2 \right).$$

Then for every $n \geq N+1$ and any $i \in \mathbb{Z}$, there exist $x_i^n \in \mathbb{R}_{\geq 0}$ and a family $\{Q_d^n\}_{d \in \mathbb{N}}$ of completely nondegenerate real Laurent polynomials in n variables such that $\Delta(Q_d^n) = S_d^n$, that for $i \in \mathbb{Z}$

$$b_i(V_{\mathbb{R}\mathbb{P}^n}(Q_d^n)) \stackrel{n}{=} x_i^n \cdot d^n$$

and such that for any $m \in \mathbb{Z}$ we have

$$x_m^n = \frac{1}{\sigma\sqrt{2\pi}} \frac{1}{\sqrt{n}} \exp\left(-\frac{\left(\frac{n-1}{2} - m\right)^2}{2n\sigma^2}\right) + o\left(n^{-\frac{1}{2}}\right), \quad (6.2.10)$$

where the $o(1)$ error term is uniform in m . The family of projective hypersurfaces associated to each family $\{Q_d^n\}_{d \in \mathbb{N}}$ is also asymptotically maximal.

Remark 6.2.13. As the error term is uniform in m , Formula (6.2.10) is equivalent to

$$x_{\lfloor \frac{n-1}{2} + x\sqrt{n} \rfloor}^n = \frac{1}{\sqrt{2\pi}\sigma} \frac{1}{\sqrt{n}} \exp\left(\frac{-x^2}{2\sigma^2}\right) + o\left(n^{-\frac{1}{2}}\right),$$

for all $x \in \mathbb{R}$ (with the error term uniform in x).

Remark 6.2.14. Compare with the standard case of Formula (6.2.9). If we want to get comparatively large Betti numbers for i near the middle index $\frac{n-1}{2}$, we want the variance σ to be small. If we want large Betti numbers far from the center, we need it to be large.

As always, finding new constructions with interesting asymptotic Betti numbers in low dimensions would automatically yield improved (either particularly large or small) parameters σ^2 .

Proof. We define the families $\{Q_d^n\}_{d \in \mathbb{N}}$ recursively, starting from $n = N+1$.

Let $n > N$ and suppose that families of polynomials $\{Q_d^m\}_{d \in \mathbb{N}}$ and coefficients x_i^m have already been defined for all $N < m < n$ and all $i \in \mathbb{Z}$.

We apply the Cooking Theorem 5.1.1 to the ingredients $\{P_d^k\}_{d \in \mathbb{N}}$ (for $k = 1, \dots, N$) and $\{Q_d^k\}_{d \in \mathbb{N}}$ (for $k = N+1, \dots, n-1$). It yields a family $\{Q_d^n\}_{d \in \mathbb{N}}$ such that

$$b_i(V_{\mathbb{R}\mathbb{P}^n}(Q_d^n)) \stackrel{n}{\geq} \frac{1}{n} (x_i^{n-1} + x_{i-1}^{n-1} + \sum_{k=1}^{n-2} \sum_{j=0}^{i-1} x_j^k \cdot x_{i-1-j}^{n-1-k}) \cdot d^n \quad (6.2.11)$$

for all $i \in \mathbb{Z}$.

Define $x_i^n := \frac{1}{n}(x_i^{n-1} + x_{i-1}^{n-1} + \sum_{k=1}^{n-2} \sum_{j=0}^{i-1} x_j^k \cdot x_{i-1-j}^{n-1-k})$ for $i \in \mathbb{Z}$ (note that it is 0 for $i \notin \{0, \dots, n-1\}$). Lemma 6.2.4 tells us that the family of hypersurfaces associated to $\{Q_d^n\}_{d \in \mathbb{N}}$ is asymptotically maximal, that $\sum_{i \in \mathbb{Z}} x_i^n = 1$ and that the asymptotic inequality (6.2.11) is in fact an asymptotic equality.

Suppose now that $\{Q_d^n\}_{d \in \mathbb{N}}$ and x_i^n have been defined for all $n > N$ and $i \in \mathbb{Z}$. What is left to show is that the coefficients x_i^n satisfy Formula (6.2.10). This is, in fact, the hardest part, and a consequence of Proposition 6.2.16 at the end of this section. \square

The result below is a direct application of Theorem 6.1.2 to the two most extreme constructions known in dimension 3, *i.e.* those from Theorem 6.2.6.

Theorem 6.1.3. *For any $n \geq 3$ and any $i \in \mathbb{Z}$, there exist $c_i^n, d_i^n \in \mathbb{R}$ and families $\{F_d^{+,n}\}_{d \in \mathbb{N}}$ and $\{F_d^{-,n}\}_{d \in \mathbb{N}}$ of completely nondegenerate real Laurent polynomials in n variables such that the Newton polytope $\Delta(F_d^{\pm,n})$ is S_d^n and that for $i = 0, \dots, n-1$, we have*

$$b_i(V_{\mathbb{R}\mathbb{P}^n}(F_d^{+,n})) \stackrel{n}{=} c_i^n \cdot d^n$$

and

$$b_i(V_{\mathbb{R}\mathbb{P}^n}(F_d^{-,n})) \stackrel{n}{=} d_i^n \cdot d^n.$$

Moreover, for all $x \in \mathbb{R}$, we have

$$c_{\lfloor \frac{n-1}{2} + x\sqrt{n} \rfloor}^n = \frac{2}{\sqrt{\pi}} \frac{1}{\sqrt{n}} \exp(-4x^2) + o\left(n^{-\frac{1}{2}}\right)$$

and

$$d_{\lfloor \frac{n-1}{2} + x\sqrt{n} \rfloor}^n = \frac{\sqrt{20}}{\sqrt{3\pi}} \frac{1}{\sqrt{n}} \exp\left(\frac{-20x^2}{3}\right) + o\left(n^{-\frac{1}{2}}\right),$$

where the error terms $o\left(n^{-\frac{1}{2}}\right)$ are uniform in x . The family of projective hypersurfaces associated to each family $\{F_d^{\pm,n}\}_{d \in \mathbb{N}}$ is also asymptotically maximal.

Proof. It is a trivial application of Theorem 6.1.2 to $N = 3$ and the following families of polynomials: let $\{P_d^k\}_{d \in \mathbb{N}}$ be $\{I_d^k\}_{d \in \mathbb{N}}$ from Theorem 6.2.5 for $k = 1, 2$ and let $\{P_d^3\}_{d \in \mathbb{N}}$ be $\{B_d^{\pm}\}_{d \in \mathbb{N}}$ from Theorem 6.2.6 when defining $\{F_d^{\pm,n}\}_{d \in \mathbb{N}}$.

We can directly compute that the variance σ^2 is equal to

$$\frac{2}{(3+1)(3+2)} \left(\frac{1}{4} + 0 + 2 \frac{1}{2} \left(\frac{1}{2} \right)^2 + 2 \left(\frac{1}{6} + \frac{5}{24} \right) 1^2 \right) = \frac{1}{12} + \frac{1}{5} \frac{5}{24} = \frac{1}{8}$$

for $\{F_d^{+,n}\}_{d \in \mathbb{N}}$ and to

$$\frac{2}{(3+1)(3+2)} \left(\frac{1}{4} + 0 + 2 \frac{1}{2} \left(\frac{1}{2} \right)^2 + 2 \left(\frac{1}{6} - \frac{1}{24} \right) 1^2 \right) = \frac{1}{12} - \frac{1}{5} \frac{1}{24} = \frac{3}{40}$$

for $\{F_d^{-,n}\}_{d \in \mathbb{N}}$. This is enough to conclude. \square

Remark 6.2.15. As noted in Remark 6.2.9, we can easily get for any $a \in [-\frac{1}{24}, \frac{5}{24}]$ a family $\{P_d^3\}_{d \in \mathbb{N}}$ of completely nondegenerate real Laurent polynomials in 3 variables such that the Newton polytope $\Delta(P_d^3)$ is S_d^3 and that for $i = 0, 1, 2$, we have

$$b_i(V_{\mathbb{R}P^n}(F_d^{+,n})) \stackrel{n}{=} x_i^3 \cdot d^n$$

with $x_0^3 = x_2^3 = \frac{1}{6} + a$ and $x_1^3 = \frac{4}{6} - 2a$. The same reasoning as in Theorem 6.1.3 applied to $\{I_d^1\}_{d \in \mathbb{N}}$, $\{I_d^2\}_{d \in \mathbb{N}}$ and such a family $\{P_d^3\}_{d \in \mathbb{N}}$ yields a family $\{Q_d^n\}_{d \in \mathbb{N}}$ for any $n \geq 4$ such that

$$b_i(V_{\mathbb{R}P^n}(Q_d^n)) \stackrel{n}{=} x_i^n \cdot d^n$$

and that

$$x_{\lfloor \frac{n-1}{2} + x\sqrt{n} \rfloor}^n = \frac{1}{\sqrt{2\pi} \sqrt{\frac{1}{12} + \frac{a}{5}}} \frac{1}{\sqrt{n}} \exp\left(-\frac{x^2}{2(\frac{1}{12} + \frac{a}{5})}\right) + o\left(n^{-\frac{1}{2}}\right).$$

Observe also that

$$\frac{x_{\lfloor \frac{n-1}{2} + x\sqrt{n} \rfloor}^n}{a_{\lfloor \frac{n-1}{2} + x\sqrt{n} \rfloor}^n} = \frac{\sqrt{\frac{1}{12}}}{\sqrt{\frac{1}{12} + \frac{a}{5}}} \exp\left(-\frac{x^2}{2} \left(\frac{1}{\frac{1}{12} + \frac{a}{5}} - \frac{1}{\frac{1}{12}}\right)\right) + o(1)$$

is asymptotically strictly greater than 1 for $|x| < \sqrt{\frac{\ln(\frac{1}{12}) - \ln(\frac{1}{12} + \frac{a}{5})}{\frac{1}{\frac{1}{12} + \frac{a}{5}} - 12}}$ and $a < 0$ as well as for

$|x| > \sqrt{\frac{\ln(\frac{1}{12}) - \ln(\frac{1}{12} + \frac{a}{5})}{\frac{1}{\frac{1}{12} + \frac{a}{5}} - 12}}$ and $a > 0$. The only x for which we cannot get a strict asymptotic

inequality are $\pm \lim_{a \rightarrow 0} \sqrt{\frac{\ln(\frac{1}{12}) - \ln(\frac{1}{12} + \frac{a}{5})}{\frac{1}{\frac{1}{12} + \frac{a}{5}} - 12}} = \pm \frac{1}{12}$.

The rest of the section is devoted to the proof of the following proposition.

Proposition 6.2.16. Let $N \geq 1$. For $n = 1, \dots, N$ and $i \in \mathbb{Z}$, let $x_i^n \in \mathbb{R}_{\geq 0}$ be such that $x_i^n = x_{\frac{n-1}{2}-i}^n$, that $\sum_{i \in \mathbb{Z}} x_i^n = 1$ and that $x_i^n = 0$ for $i \notin \{0, \dots, n-1\}$.

Recursively define $x_i^n \in \mathbb{R}_{\geq 0}$ for all $n > N$ as

$$x_i^n := \frac{1}{n}(x_i^{n-1} + x_{i-1}^{n-1} + \sum_{k=1}^{n-2} \sum_{j=0}^{i-1} x_j^k \cdot x_{i-1-j}^{n-1-k})$$

for $i \in \mathbb{Z}$.

Define

$$\sigma^2 := \frac{2}{(N+1)(N+2)} \left(\frac{1}{4} + \sum_{k=1}^N \sum_{i=0}^{k-1} x_i^k \left(i - \frac{k-1}{2} \right)^2 \right).$$

Then

$$x_m^n = \frac{1}{\sigma\sqrt{2\pi}} \frac{1}{\sqrt{n}} \exp \left(-\frac{\left(\frac{n-1}{2} - m\right)^2}{2n\sigma^2} \right) + o\left(n^{-\frac{1}{2}}\right), \quad (6.2.12)$$

where the $o(1)$ error term is uniform in m .

Proof. The idea is to see the functions $x^n : i \mapsto x_i^n$ as discrete distributions, in order to apply probabilistic techniques.

Define $x_{-1}^0 = x_0^0 = \frac{1}{2}$ and $x_i^0 = 0$ for all $i \in \mathbb{Z} \setminus \{-1, 0\}$. This formal trick allows us to rewrite x_i^n as

$$x_i^n = \frac{1}{n} \sum_{k=0}^{n-1} \sum_{j \in \mathbb{Z}} x_j^k \cdot x_{i-1-j}^{n-1-k}$$

for all $i \in \mathbb{Z}$ and $n \geq N+1$. Each family of coefficients $\{x_i^n\}_{i \in \mathbb{Z}}$ (for $n \geq 0$) defines a discrete distribution on \mathbb{Z} ; the sum $\sum_{j \in \mathbb{Z}} x_j^k \cdot x_{i-1-j}^{n-1-k}$ is simply the probability density of the convolution of two such distributions in $i-1$. It can be directly checked that each distribution $\{x_i^n\}_{i \in \mathbb{Z}}$ is symmetric in $\frac{n-1}{2}$.

We recursively define distributions $\{\tilde{x}^n\}_{n \geq 1}$ over $\frac{1}{2}\mathbb{Z}$ thus: for $k = 1, \dots, N+1$, we set

$$\tilde{x}_i^k = x_{i+\frac{k-2}{2}}^{k-1}. \quad (6.2.13)$$

Note the shifts in both indices. Assume now that \tilde{x}^k has been defined for any $k \leq n$ (for some $n \geq N+1$). Let X_1, \dots, X_n be independent random variables such that the probability density function of X_k on \mathbb{R} is \tilde{x}^k . Define a random variable X_{n+1} as follows:

$$X_{n+1} = X_K + X_{n+1-K},$$

where K is a uniform random variable on the set $\{1, \dots, n\}$. Define \tilde{x}^{n+1} as the probability density function of X_{n+1} on $\frac{1}{2}\mathbb{Z}$.

Hence for any $i \in \frac{1}{2}\mathbb{Z}$, we have

$$\tilde{x}_i^{n+1} = \frac{1}{n} \sum_{k=1}^n \sum_{j \in \mathbb{Z}} \tilde{x}_j^k \cdot \tilde{x}_{i-j}^{n+1-k}.$$

It is then trivial to show by induction that Formula (6.2.13) holds for all $k \geq 1$. In particular, \tilde{x}^k only takes non-trivial values $\frac{1}{2} + \mathbb{Z}$ for odd k , and on \mathbb{Z} for even k .

Notice that the variance of the distribution \tilde{x}^k is the same as that of x^{k-1} , which is $\sum_{i \in \mathbb{Z}} x_i^{k-1} \left(i - \frac{k-2}{2} \right)^2$ (this is equal to $\frac{1}{4}$ for $k=1$). Now let $\{\tilde{X}_i^r \mid r \in \mathbb{N}, i = 1, \dots, N+1\}$ be a family of independent random variables such that \tilde{X}_i^r admits \tilde{x}_i as a probability density

function. For any $i = 1, \dots, N + 1$, recursively define the random variables α_i^n as follows:

$\alpha_i^k := 0$ for any $k \in \{1, \dots, N + 1\} \setminus \{i\}$ and $\alpha_i^i := 1$. For any $n \geq N + 1$, $\alpha_i^{n+1} := \tilde{\alpha}_i^K + \tilde{\alpha}_i^{n+1-K}$, where K is a uniform random variable on the set $\{1, \dots, n\}$ and $\{\tilde{\alpha}_i^k\}_{k=1, \dots, n}$ is a family of independent variables such that $\tilde{\alpha}_i^k$ follows the same distribution as α_i^k .

Intuitively, α_i^{n+1} can be understood as such: consider the set $\{1, \dots, n + 1\}$. If $n + 1 \leq N + 1$, you are done. Otherwise, randomly split it into two sets $\{1, \dots, K\}$ and $\{K + 1, \dots, n + 1\}$, and proceed similarly with each of these. Continue this procedure until you have obtained a partition of $\{1, \dots, n + 1\}$ into sets of cardinal less than or equal to $N + 1$; the random variable α_i^{n+1} counts the number of sets of cardinal i in that partition.

Let Z_{n+1} be a random variable of distribution \tilde{x}_{n+1} , for $n \geq N + 1$. Based on what we have seen of \tilde{x}_{n+1} , the variable Z_{n+1} can be chosen so that there are independent random variables $\tilde{X}_1, \dots, \tilde{X}_n$ (such that \tilde{X}_k is of distribution \tilde{x}_k) and a uniform random variable K on the set $\{1, \dots, n\}$ such that $Z_{n+1} = \tilde{X}_K + \tilde{X}_{n+1-K}$. Moreover, each random variable \tilde{X}_k can be chosen so that it satisfies the same condition (relative to the appropriate indices), as long as $k > N + 1$. Hence Z_{n+1} can be chosen (since we only concern ourselves with probability density functions in the statement of the lemma, and not particular random variables) so that by repeatedly decomposing it in that manner, it can be written as

$$Z_{n+1} = \sum_{i=1}^{N+1} \alpha_i^{n+1} \tilde{X}_i^r$$

if $n \geq N + 1$.

Using Lemma 6.2.17 below (notice that there is a shift $N \rightarrow N + 1$ due to the wording of the lemma's statement), we know that $\mathbb{E}\left[\frac{\alpha_i^n}{n}\right] = \frac{2}{(N+1)(N+2)}$ and $\text{Var}\left(\frac{\alpha_i^n}{n}\right) = \frac{C(N+1)}{n} \xrightarrow{n \rightarrow \infty} 0$ for $i = 1, \dots, N + 1$. Consequently, the sequence of random variables $\left\{\frac{\alpha_i^n}{n}\right\}_{n \in \mathbb{N}}$ converges in probability to $a(N) := \frac{2}{(N+1)(N+2)}$.

We now prove some variant of the Local Limit Theorem to get Formula (6.2.12). The main difficulty lies in the fact that the random variables $\alpha_1^n, \dots, \alpha_{N+1}^n$ are not independent.

We first compute the limit as $n \rightarrow \infty$ of the characteristic function of $\frac{Z_n}{\sqrt{n}}$.

We denote $\alpha^n := (\alpha_1^n, \dots, \alpha_{N+1}^n)$. The random variable α^n takes value in \mathbb{N}^{N+1} . We have

$$\begin{aligned} \mathbb{E}\left[\exp\left(it\frac{1}{\sqrt{n}}Z_n\right)\right] &= \sum_{k=(k_1, \dots, k_{N+1}) \in \mathbb{N}^{N+1}} \mathbb{P}(\alpha^n = k) \mathbb{E}\left[\exp\left(it\frac{1}{\sqrt{n}}Z_n\right) \mid \alpha^n = k\right] = \\ &= \sum_{k \in \mathbb{N}^{N+1}} \mathbb{P}(\alpha^n = k) \prod_{i=1}^{N+1} \mathbb{E}\left[\exp\left(it\frac{1}{\sqrt{n}}\sum_{r=1}^{k_i} \tilde{X}_i^r\right)\right] = \sum_{k \in \mathbb{N}^{N+1}} \mathbb{P}(\alpha^n = k) \prod_{i=1}^{N+1} \left(1 - \frac{t^2 \text{Var}(\tilde{X}_i)}{2n} + o\left(\frac{t^2}{n}\right)\right)^{k_i} \end{aligned}$$

by independence of the random variables \tilde{X}_i^r and Taylor expansion (where as above, \tilde{X}_i is any random variable of law \tilde{x}^i).

Moreover, for any $\epsilon > 0$, define $\mathbb{N}_{\epsilon, n}^{N+1} := \{(k_1, \dots, k_{N+1}) \in \mathbb{N}^{N+1} \mid |\frac{k_i}{n} - a(N)| <$

$\epsilon a(N)$ for $i = 1, \dots, N+1$. By hypothesis, for a given $\epsilon > 0$, we have $\lim_{n \rightarrow \infty} \mathbb{P}(\alpha^n \in \mathbb{N}_{\epsilon, n}^{N+1}) = 1$.

Let us show that for any $t \in \mathbb{R}$, the characteristic function $\mathbb{E} \left[\exp \left(i \frac{t}{\sqrt{n}} Z_n \right) \right]$ converges to $\exp \left(-\frac{t^2}{2} \sum_{i=1}^{N+1} a(N) \text{Var}(\tilde{X}_i) \right)$ as $n \rightarrow \infty$. Indeed, choose $\epsilon > 0$ and consider

$$\begin{aligned} \mathbb{E} \left[\exp \left(i \frac{t}{\sqrt{n}} Z_n \right) \right] &= \mathbb{P}(\alpha^n \notin \mathbb{N}_{\epsilon, n}^{N+1}) \mathbb{E} \left[\exp \left(i \frac{t}{\sqrt{n}} Z_n \right) \mid \alpha^n \notin \mathbb{N}_{\epsilon, n}^{N+1} \right] + \\ &\quad \mathbb{P}(\alpha^n \in \mathbb{N}_{\epsilon, n}^{N+1}) \mathbb{E} \left[\exp \left(i \frac{t}{\sqrt{n}} Z_n \right) \mid \alpha^n \in \mathbb{N}_{\epsilon, n}^{N+1} \right]. \end{aligned}$$

The first term converges to 0 as $n \rightarrow \infty$. Moreover,

$$\begin{aligned} \mathbb{P}(\alpha^n \in \mathbb{N}_{\epsilon, n}^{N+1}) \mathbb{E} \left[\exp \left(i \frac{t}{\sqrt{n}} Z_n \right) \mid \alpha^n \in \mathbb{N}_{\epsilon, n}^{N+1} \right] &= \sum_{k \in \mathbb{N}_{\epsilon, n}^{N+1}} \mathbb{P}(\alpha^n = k) \mathbb{E} \left[\exp \left(i \frac{t}{\sqrt{n}} Z_n \right) \mid \alpha^n = k \right] = \\ &\sum_{k \in \mathbb{N}_{\epsilon, n}^{N+1}} \mathbb{P}(\alpha^n = k) \prod_{i=1}^{N+1} \left(1 - \frac{t^2 \text{Var}(\tilde{X}_i)}{2n} + o \left(\frac{t^2}{n} \right) \right)^{k_i} = \\ &\sum_{k \in \mathbb{N}_{\epsilon, n}^{N+1}} \mathbb{P}(\alpha^n = k) \prod_{i=1}^{N+1} \left(1 - \frac{t^2 \text{Var}(\tilde{X}_i) a(N)}{2na(N)} + o \left(\frac{t^2}{n} \right) \right)^{na(N)}. \\ &\cdot \left(\left(1 - \frac{t^2 \text{Var}(\tilde{X}_i) a(N)}{2na(N)} + o \left(\frac{t^2}{n} \right) \right)^{\frac{k_i - na(N)}{na(N)}} \right)^{na(N)} = \\ &\prod_{i=1}^{N+1} \left(1 - \frac{t^2 \text{Var}(\tilde{X}_i) a(N)}{2na(N)} + o \left(\frac{t^2}{n} \right) \right)^{na(N)} \left[\mathbb{P}(\alpha^n \in \mathbb{N}_{\epsilon, n}^{N+1}) + \sum_{k \in \mathbb{N}_{\epsilon, n}^{N+1}} \mathbb{P}(\alpha^n = k) \cdot \right. \\ &\left. \cdot \left(\prod_{i=1}^{N+1} \left(\left(1 - \frac{t^2 \text{Var}(\tilde{X}_i) a(N)}{2na(N)} + o \left(\frac{t^2}{n} \right) \right)^{\frac{k_i - na(N)}{na(N)}} - 1 \right) \right) \right]. \end{aligned}$$

As $n \rightarrow \infty$, we have $\mathbb{P}(\alpha^n \in \mathbb{N}_{\epsilon, n}^{N+1}) \rightarrow 1$ and $\prod_{i=1}^{N+1} \left(1 - \frac{t^2 \text{Var}(\tilde{X}_i) a(N)}{2na(N)} + o \left(\frac{t^2}{n} \right) \right)^{na(N)} \rightarrow \exp \left(-\frac{t^2}{2} \sum_{i=1}^{N+1} \text{Var}(\tilde{X}_i) a(N) \right)$. Moreover, $\left| \frac{k_i - a(N)n}{a(N)n} \right| < \epsilon$ for any $i = 1, \dots, N+1$ and any $k \in \mathbb{N}_{\epsilon, n}^{N+1}$. Hence there exists a function $f : \mathbb{R}_{>0} \rightarrow \mathbb{R}_{>0}$ such that for n large enough,

$$\left| \prod_{i=1}^{N+1} \left(\left(1 - \frac{t^2 \text{Var}(\tilde{X}_i) a(N)}{2na(N)} + o \left(\frac{t^2}{n} \right) \right)^{\frac{k_i - na(N)}{na(N)}} - 1 \right) \right| < f(\epsilon)$$

for any $\epsilon > 0$ and $k \in \mathbb{N}_{\epsilon, n}^{N+1}$, and such that $\lim_{\epsilon \rightarrow 0} f(\epsilon) = 0$.

As $\epsilon > 0$ can be chosen arbitrarily small, this shows that $\lim_{n \rightarrow \infty} \mathbb{E}[\exp(i \frac{t}{\sqrt{n}} Z_n)] =$

$\exp(-\frac{t^2}{2} a(N) \sum_{i=1}^{N+1} \text{Var}(\tilde{X}_i))$. As in the statement of the proposition, let us write

$$\sigma^2 = a(N) \sum_{i=1}^{N+1} \text{Var}(\tilde{X}_i) = \frac{2}{(N+1)(N+2)} \left(\frac{1}{4} + \sum_{k=1}^N \sum_{i=0}^{k-1} x_i^k \left(i - \frac{k-1}{2} \right)^2 \right).$$

Note that using Lévy's continuity theorem, this already shows that the sequence of distributions $\{\tilde{x}^n\}_{n \in \mathbb{N}}$ converge in distribution to a normal distribution $\mathcal{N}(0, a(N) \sum_{i=1}^N \text{Var}(\tilde{X}_i))$. As we want a local result, some additional work is still needed.

The remainder of our proof is inspired by the presentation of the Discrete Local Limit Theorem on Terence Tao's blog ([Tao]).

By definition, for any $m \in \mathbb{Z}$, we have

$$x_m^n = \tilde{x}_{m - \frac{n-1}{2}}^{n+1} = \mathbb{P} \left(Z_{n+1} = m - \frac{n-1}{2} \right) = \mathbb{P} \left(Z_{n+1} + \frac{n-1}{2} = m \right).$$

As $Z_{n+1} + \frac{n-1}{2}$ only takes values in \mathbb{Z} and m is also an integer, we can write

$$1_{Z_{n+1} + \frac{n-1}{2} = m} = \frac{1}{2\pi} \int_{-\pi}^{\pi} \exp \left(it \left(Z_{n+1} + \frac{n-1}{2} \right) \right) \exp(-itm) dt,$$

which implies (using Fubini's theorem) that

$$\mathbb{P} \left(Z_{n+1} + \frac{n-1}{2} = m \right) = \frac{1}{2\pi} \int_{-\pi}^{\pi} \mathbb{E} [\exp(itZ_{n+1})] e^{it\frac{n-1}{2}} e^{-itm} dt$$

and then

$$\begin{aligned} \sqrt{n+1} \mathbb{P} \left(Z_{n+1} + \frac{n-1}{2} = m \right) &= \frac{1}{2\pi} \int_{-\sqrt{n+1}\pi}^{\sqrt{n+1}\pi} \mathbb{E} \left[\exp \left(i \frac{x}{\sqrt{n+1}} Z_{n+1} \right) \right] e^{i \frac{x}{\sqrt{n+1}} \frac{n-1}{2}} e^{-i \frac{x}{\sqrt{n+1}} m} dx \\ &= \frac{1}{2\pi} \int_{\mathbb{R}} 1_{|x| \leq \sqrt{n+1}\pi} \mathbb{E} \left[\exp \left(i \frac{x}{\sqrt{n+1}} Z_{n+1} \right) \right] e^{i \frac{x}{\sqrt{n+1}} \frac{n-1}{2}} e^{-i \frac{x}{\sqrt{n+1}} m} dx \end{aligned}$$

using a change of variables.

We want to show that this expression converges to

$$\frac{1}{2\pi} \int_{\mathbb{R}} e^{-\frac{x^2 \sigma^2}{2}} e^{i \frac{x}{\sqrt{n+1}} \frac{n-1}{2}} e^{-i \frac{x}{\sqrt{n+1}} m} dx = \frac{1}{\sigma \sqrt{2\pi}} \exp \left(-\frac{\left(\frac{n-1}{2} - m \right)^2}{2(n+1)\sigma^2} \right)$$

uniformly in m (i.e. that the difference between the two expressions is an $o(1)$ error term that can be upper-bounded uniformly in m).

We only need to show that

$$\frac{1}{2\pi} \int_{\mathbb{R}} \left| 1_{|x| \leq \sqrt{n+1}\pi} \mathbb{E} \left[\exp \left(i \frac{x}{\sqrt{n+1}} Z_{n+1} \right) \right] - e^{-\frac{x^2 \sigma^2}{2}} \right| dx$$

converges to 0.

As we have proved above that $1_{|x| \leq \sqrt{n+1}\pi} \mathbb{E} \left[\exp \left(i \frac{x}{\sqrt{n+1}} Z_{n+1} \right) \right]$ converges (for a given $x \in \mathbb{R}$) to $e^{-\frac{x^2 \sigma^2}{2}}$, we want to show that there exists an absolutely integrable function that dominates $\left| 1_{|x| \leq \sqrt{n+1}\pi} \mathbb{E} \left[\exp \left(i \frac{x}{\sqrt{n+1}} Z_{n+1} \right) \right] \right|$ so that we can conclude using the dominated convergence theorem (as $x \mapsto e^{-\frac{x^2 \sigma^2}{2}}$ is clearly absolutely integrable).

As above, we write

$$\mathbb{E} \left[\exp \left(i \frac{x}{\sqrt{n+1}} Z_{n+1} \right) \right] = \sum_{k \in \mathbb{N}^{N+1}} \mathbb{P}(\alpha^n = k) \prod_{i=1}^{N+1} \mathbb{E} \left[\exp \left(i \frac{x}{\sqrt{n+1}} \sum_{r=1}^{k_i} \tilde{X}_i^r \right) \right].$$

For $i = 1, \dots, N+1$, either $\text{Var}(\tilde{X}_i) = 0$ and the term $\mathbb{E} \left[\exp \left(i \frac{x}{\sqrt{n+1}} \sum_{r=1}^{k_i} \tilde{X}_i^r \right) \right]$ is always equal to 1, or $\text{Var}(\tilde{X}_i) \neq 0$ and we write it as $\left(1 - \frac{x^2 \text{Var}(\tilde{X}_i)}{2(n+1)} + o \left(\frac{x^2}{n+1} \right) \right)^{k_i}$.

There exist two constants $\delta > 0$ and $C_1 > 0$ such that

$$\left| 1 - \frac{x^2 \text{Var}(\tilde{X}_i)}{2(n+1)} + o \left(\frac{x^2}{n+1} \right) \right| < e^{-C_1 \frac{x^2}{n+1}} \leq 1$$

for all $|x| < \delta \sqrt{n+1}$ and all i such that $\text{Var}(\tilde{X}_i) \neq 0$. As $\text{Var}(\tilde{X}_1) = \frac{1}{4}$, there is at least one such i .

Define

$$\Omega_n := \{k \in \mathbb{N}^{N+1} | k_1 \geq \frac{a(N)}{2} n\}.$$

Using Chebyshev's inequality and the fact that $\mathbb{E}[\frac{\alpha_1^{n+1}}{n+1}] = a(N)$ and $\text{Var}(\frac{\alpha^{n+1}}{n+1}) = \frac{C(N+1)}{n+1}$, we see that $\mathbb{P}(\alpha^{n+1} \notin \Omega_{n+1}) \leq \frac{C_2}{n+1}$ for some constant $C_2 > 0$.

Hence

$$\begin{aligned} & \left| 1_{|x| \leq \delta \sqrt{n+1}} \mathbb{E} \left[\exp \left(i \frac{x}{\sqrt{n+1}} Z_{n+1} \right) \right] \right| \leq \\ & 1_{|x| \leq \delta \sqrt{n+1}} \mathbb{P}(\alpha^{n+1} \notin \Omega_{n+1}) + 1_{|x| \leq \delta \sqrt{n+1}} \sum_{k \in \Omega_{n+1}} \mathbb{P}(\alpha^{n+1} = k) \prod_{i=1}^{N+1} \left| \mathbb{E} \left[\exp \left(i \frac{x}{\sqrt{n+1}} \sum_{r=1}^{k_i} \tilde{X}_i^r \right) \right] \right| \leq \\ & 1_{|x| \leq \delta \sqrt{n+1}} \frac{C_2}{n+1} + \sum_{k \in \Omega_{n+1}} \mathbb{P}(\alpha^{n+1} = k) e^{-C_1 \frac{x^2}{n+1} k_1} \leq 1_{|x| \leq \delta \sqrt{n+1}} \frac{C_2}{n+1} + e^{-C_1 \frac{x^2}{2} a(N)} \leq \\ & C_2 \delta^2 \min \left(\frac{1}{x^2}, \frac{1}{\delta^2} \right) + e^{-C_1 \frac{x^2}{2} a(N)}, \end{aligned} \tag{6.2.14}$$

assuming (as we can) that $\delta < 1$.

Suppose now that we have $\left| \mathbb{E} \left[\exp \left(it \tilde{X}_1 \right) \right] \right| = 1$ for some $\delta \leq t \leq \pi$. It means that $\exp \left(it \tilde{X}_1 \right)$ is almost surely of constant argument, hence $t \tilde{X}_1$ almost surely takes values in $a + 2\pi\mathbb{Z}$ for some $a \in \mathbb{R}$. Thus \tilde{X}_1 takes values in $\frac{a}{t} + \frac{2\pi}{t}\mathbb{Z}$. But $\frac{2\pi}{t} \geq 2$, and by

definition $\mathbb{P}(\tilde{X}_1 = \frac{1}{2}) = \mathbb{P}(\tilde{X}_1 = -\frac{1}{2}) = \frac{1}{2}$ (remember that \tilde{X}_1 comes from the "artificial" distribution x^0 defined at the beginning of the proof). This is impossible. Hence we have $|\mathbb{E}[\exp(it\tilde{X}_1)]| < 1$ for any $\delta \leq t \leq \pi$, and by continuity and compacity there exists a constant $0 < C_3 < 1$ such that $|\mathbb{E}[\exp(it\tilde{X}_1)]| < C_3 < 1$ for any $\delta \leq t \leq \pi$.

Now we can write

$$\begin{aligned} & \left| 1_{\delta\sqrt{n+1} \leq |x| \leq \pi\sqrt{n+1}} \mathbb{E} \left[\exp \left(i \frac{x}{\sqrt{n+1}} Z_{n+1} \right) \right] \right| \leq \\ & 1_{\delta\sqrt{n+1} \leq |x| \leq \pi\sqrt{n+1}} \mathbb{P}(\alpha^{n+1} \notin \Omega_{n+1}) + \\ & 1_{\delta\sqrt{n+1} \leq |x| \leq \pi\sqrt{n+1}} \sum_{k \in \Omega_{n+1}} \mathbb{P}(\alpha^{n+1} = k) \prod_{i=1}^{N+1} \left| \mathbb{E} \left[\exp \left(i \frac{x}{\sqrt{n+1}} \sum_{r=1}^{k_i} \tilde{X}_i^r \right) \right] \right| \\ & \leq 1_{\delta\sqrt{n+1} \leq |x| \leq \pi\sqrt{n+1}} \frac{C_2}{n+1} + 1_{\delta\sqrt{n+1} \leq |x| \leq \pi\sqrt{n+1}} \sum_{k \in \Omega_{n+1}} \mathbb{P}(\alpha^{n+1} = k) C_3^{k_1} \leq \\ & 1_{|x| \leq \pi\sqrt{n+1}} \frac{C_2}{n+1} + 1_{|x| \leq \pi\sqrt{n+1}} C_3^{\frac{\alpha(N)}{2}(n+1)} \leq C_2 \pi^2 \min \left(\frac{1}{x^2}, 1 \right) + \left(C_3^{\frac{\alpha(N)}{2\pi^2}} \right)^{x^2}. \end{aligned}$$

This, together with Formula (6.2.14), allows us to conclude: we have shown that

$$x_m^n = \frac{1}{\sigma\sqrt{2\pi}} \frac{1}{\sqrt{n+1}} \exp \left(-\frac{\left(\frac{n-1}{2} - m\right)^2}{2(n+1)\sigma^2} \right) + o(n^{-\frac{1}{2}})$$

for some error term uniform in m . We can finally observe (by distinguishing the cases where $\left(\frac{n-1}{2} - m\right)^2 \leq n^{\frac{3}{2}}$ from the cases where $\left(\frac{n-1}{2} - m\right)^2 \geq n^{\frac{3}{2}}$) that

$$\frac{1}{\sigma\sqrt{2\pi}} \frac{1}{\sqrt{n+1}} \exp \left(-\frac{\left(\frac{n-1}{2} - m\right)^2}{2(n+1)\sigma^2} \right) = \frac{1}{\sigma\sqrt{2\pi}} \frac{1}{\sqrt{n}} \exp \left(-\frac{\left(\frac{n-1}{2} - m\right)^2}{2n\sigma^2} \right) + o(n^{-\frac{1}{2}})$$

with the error term once again uniform in m .

□

Lemma 6.2.17. *Let $N \geq 1$. For any $i = 1, \dots, N$, recursively define the random variables α_i^n as follows: $\alpha_i^k := 0$ for any $k \in \{1, \dots, N\} \setminus \{i\}$ and $\alpha_i^i := 1$. For any $n \geq N$, $\alpha_i^{n+1} := \tilde{\alpha}_i^K + \tilde{\alpha}_i^{n+1-K}$, where K is a uniform random variable on the set $\{1, \dots, n\}$ and $\{\tilde{\alpha}_i^k\}_{k=1, \dots, n}$ is a family of independent variables such that $\tilde{\alpha}_i^k$ follows the same distribution as α_i^k .*

Then for any $n \geq N + 1$, we have

$$\mathbb{E}[\alpha_i^n] = \frac{2n}{(N+1)N}$$

and

$$\text{Var}(\alpha_i^n) = C(N)n,$$

where $C(N)$ is some constant that only depends on N .

Proof. Let $i \in \{1, \dots, N\}$ and observe that if $n \geq N$, then

$$\mathbb{E}[\alpha_i^{n+1}] = \frac{1}{n} \left(\sum_{k=1}^n \mathbb{E}[\tilde{\alpha}_i^k] + \mathbb{E}[\tilde{\alpha}_i^{n+1-k}] \right) = \frac{2}{n} \sum_{k=1}^n \mathbb{E}[\alpha_i^k].$$

Hence

$$\sum_{k=1}^{n+1} \mathbb{E}[\alpha_i^k] = \sum_{k=1}^n \mathbb{E}[\alpha_i^k] + \mathbb{E}[\alpha_i^{n+1}] = \frac{n+2}{n} \sum_{k=1}^n \mathbb{E}[\alpha_i^k]$$

and necessarily

$$\sum_{k=1}^{n+1} \mathbb{E}[\alpha_i^k] = \frac{n+2}{n} \frac{n+1}{n-1} \cdots \frac{N+3}{N+1} \frac{N+2}{N} \sum_{k=1}^N \mathbb{E}[\alpha_i^k] = \frac{(n+2)(n+1)}{(N+1)N} \sum_{k=1}^N \mathbb{E}[\alpha_i^k].$$

Moreover, we get from the definition of the random variables α_i^n that $\sum_{k=1}^N \mathbb{E}[\alpha_i^k] = 1$: thus $\sum_{k=1}^{n+1} \mathbb{E}[\alpha_i^k] = \frac{(n+2)(n+1)}{(N+1)N}$, and finally

$$\mathbb{E}[\alpha_i^{n+1}] = \sum_{k=1}^{n+1} \mathbb{E}[\alpha_i^k] - \sum_{k=1}^n \mathbb{E}[\alpha_i^k] = \frac{(n+2)(n+1)}{(N+1)N} - \frac{(n+1)n}{(N+1)N} = \frac{2(n+1)}{(N+1)N}$$

for any $n \geq N$.

Let us now compute the variance of α_i^{n+1} . First observe that

$$\begin{aligned} \mathbb{E}[(\alpha_i^{n+1})^2] &= \frac{1}{n} \left(\sum_{k=1}^n \mathbb{E}[(\tilde{\alpha}_i^k + \tilde{\alpha}_i^{n+1-k})^2] \right) = \frac{2}{n} \left(\sum_{k=1}^n \mathbb{E}[(\tilde{\alpha}_i^k)^2] + \mathbb{E}[\tilde{\alpha}_i^k] \mathbb{E}[\tilde{\alpha}_i^{n+1-k}] \right) = \\ &= \frac{2}{n} \left(\sum_{k=1}^n \mathbb{E}[(\alpha_i^k)^2] + \sum_{k=1}^n \frac{4k(n+1-k)}{N^2(N+1)^2} \right) = \frac{2}{n} \left(\sum_{k=1}^n \mathbb{E}[(\alpha_i^k)^2] + \frac{2n(n+1)(n+2)}{3N^2(N+1)^2} \right) \end{aligned}$$

as the variables $\tilde{\alpha}_i^k$ are independent from each other.

Now define for any $n \geq 1$

$$g(n+1) := \sum_{k=1}^{n+1} \mathbb{E}[(\alpha_i^k)^2] - \frac{2(n+1)(n+2)(2n-3)}{3N^2(N+1)^2},$$

as is natural to do in such a situation.

Then

$$\begin{aligned} g(n+1) &= \sum_{k=1}^{n+1} \mathbb{E}[(\alpha_i^k)^2] - \frac{2(n+1)(n+2)(2n-3)}{3N^2(N+1)^2} = \\ &= \sum_{k=1}^n \mathbb{E}[(\alpha_i^k)^2] + \frac{2}{n} \left(\sum_{k=1}^n \mathbb{E}[(\alpha_i^k)^2] + \frac{2n(n+1)(n+2)}{3N^2(N+1)^2} \right) - \frac{2(n+1)(n+2)(2n-3)}{3N^2(N+1)^2} = \end{aligned}$$

$$\begin{aligned}
& \frac{n+2}{n} \sum_{k=1}^n \mathbb{E}[(\alpha_i^k)^2] + (2 - (2n-3)) \frac{2(n+1)(n+2)}{3N^2(N+1)^2} = \\
& \frac{n+2}{n} \sum_{k=1}^n \mathbb{E}[(\alpha_i^k)^2] - \frac{2(n+1)(n+2)(2n-5)}{3N^2(N+1)^2} = \\
& \frac{n+2}{n} \left(\sum_{k=1}^n \mathbb{E}[(\alpha_i^k)^2] - \frac{2n(n+1)(2n-5)}{3N^2(N+1)^2} \right) = \frac{n+2}{n} g(n)
\end{aligned}$$

for any $n \geq N$, hence as before,

$$g(n+1) = \frac{(n+2)(n+1)}{(N+1)N} g(N).$$

Thus

$$\begin{aligned}
\mathbb{E}[(\alpha_i^k)^2] &= g(n+1) - g(n) + \frac{2(n+1)(n+2)(2n-3)}{3N^2(N+1)^2} - \frac{2n(n+1)(2n-5)}{3N^2(N+1)^2} = \\
& \frac{2(n+1)}{(N+1)N} g(N) + \frac{2(n+1)}{3N^2(N+1)^2} ((n+2)(2n-3) - n(2n-5)) = \\
& \frac{2(n+1)}{(N+1)N} g(N) + \frac{4(n+1)(n-1)}{N^2(N+1)^2}.
\end{aligned}$$

From this, we see that for any $n \geq N$,

$$\begin{aligned}
\text{Var}(\alpha_i^{n+1}) &= \mathbb{E}[(\alpha_i^{n+1})^2] - (\mathbb{E}[\alpha_i^{n+1}])^2 = \frac{2(n+1)}{N(N+1)} g(N) + \frac{4(n+1)(n-1)}{N^2(N+1)^2} - \frac{4(n+1)^2}{N^2(N+1)^2} = \\
& \frac{2(n+1)}{N(N+1)} g(N) - \frac{8(n+1)}{N^2(N+1)^2} = (n+1)C(N)
\end{aligned}$$

for some finite constant $C(N) := \frac{2g(N)}{N(N+1)} - \frac{8}{N^2(N+1)^2}$ that only depends on N .

□

6.3 Some explicit computations

Given $n \geq 3$, we can try to apply the Cooking Theorem 5.1.1 to any combination of families of polynomials $\{P_d^k\}_{d \in \mathbb{N}}$ for $k = 1, \dots, n-1$; these various combinations result in families of polynomials $\{Q_d^n\}_{d \in \mathbb{N}}$ and associated hypersurfaces with a priori distinct asymptotic Betti numbers, which we can in turn use to define new polynomials and hypersurfaces in ambient dimension $n+1$. The total number of possibilities in dimension n grows extremely fast as n goes to infinity (as C^{2^n} for some $C > 1$), even with a low number of starting ingredients, *i.e.* families of polynomials that are already known. Given $n \geq 3$ and $i \in \{0, \dots, n-1\}$, it is not yet clear how to pick the combination which will result in the largest asymptotic value for the i -th Betti numbers $b_i(V_{\mathbb{R}P^n}(Q_d^n))$.

The author used a poorly coded C++ program to test out each combination achievable

i:	0	1	2	3	4	5	6
n:							
3	0.2083	0.0833	0.2083				
4	0.0520	0.0104	0.0104	0.0520			
5	0.0104	0.0833	0.0375	0.0833	0.0104		
6	0.0017	0.0677	0.0138	0.0138	0.0677	0.0017	
7	0.0002	0.0364	0.0238	0.0310	0.0238	0.0364	0.0002

Figure 6.2:

in ambient dimension $n = 4, 5, 6, 7$ using both constructions from Theorem 6.2.6 by Bruggallé and the family of constructions from Theorem 6.2.5 by Itenberg and Viro as building blocks. Any n greater than 7 exceeded the computational power of the author's arguably cheap computer.

Figure 6.2 shows, for $n = 3, \dots, 7$ and $i \in \{0, \dots, n-1\}$, the largest t_i^n (rounded down to the 4-th decimal) such that we were able to cook, using the Cooking Theorem 5.1.1, a family $\{Q_d^n\}_{d \in \mathbb{N}}$ of completely nondegenerate real Laurent polynomials in n variables such that $\Delta(Q_d^n) = S_d^n$, that the associated family of real projective hypersurfaces is asymptotically maximal (this is not an additional constraint, as all our ingredients are asymptotically maximal) and that

$$b_i(V_{\mathbb{R}\mathbb{P}^n}(Q_d^n)) \stackrel{n}{\geq} (a_i^n + t_i^n) \cdot d^n.$$

In particular, it is enough to complete the proof of Theorem 6.1.1 for $n \leq 7$.

In Figure 6.3, we indicate, for $5 \leq n \leq 99$ odd and $i \in \{0, \dots, n-1\}$, the values of $\frac{d_{\frac{n-1}{2}}^n - a_{\frac{n-1}{2}}^n}{a_{\frac{n-1}{2}}^n}$ (rounded down to the 5-th decimal), where $d_{\frac{n-1}{2}}^n$ comes from Theorem 6.1.3.

The ratio appears to converge relatively fast to $\lim_{n \rightarrow \infty} \frac{d_{\frac{n-1}{2}}^n - a_{\frac{n-1}{2}}^n}{a_{\frac{n-1}{2}}^n} = \frac{\sqrt{10}}{3} - 1 \cong 0.05409$.

6.4 Chapter conclusion

Concerning possible generalizations, the same method could certainly be applied to more general toric varieties, though not without any modifications, as it relies heavily on the geometry of the standard simplex. Given an n -polytope with integer vertices Δ , and should we want to define a family of polynomials $\{P_d^n\}_{d \in \mathbb{N}}$ such that $\Delta(P_d^n) = d \cdot \Delta$ and such that the induced family of hypersurfaces in the associated toric variety has interesting asymptotic Betti numbers, a solution could be to simply divide each $d \cdot \Delta$ into several "big" simplices (as well as some smaller polytopes to fill in the gaps), in which we apply the methods described here. Thinking in terms of cycles and axes, it should be relatively easy to find good asymptotic lower bounds on the Betti numbers.

5	0.06818	53	0.05552
7	0.06478	55	0.05547
9	0.06227	57	0.05542
11	0.06085	59	0.05538
13	0.05984	61	0.05533
15	0.05909	63	0.05529
17	0.05851	65	0.05526
19	0.05805	67	0.05522
21	0.05768	69	0.05519
23	0.05737	71	0.05516
25	0.05711	73	0.05513
27	0.05689	75	0.05510
29	0.05670	77	0.05508
31	0.05653	79	0.05505
33	0.05638	81	0.05503
35	0.05625	83	0.05501
37	0.05614	85	0.05498
39	0.05603	87	0.05496
41	0.05594	89	0.05494
43	0.05585	91	0.05493
45	0.05577	93	0.05491
47	0.05570	95	0.05489
49	0.05564	97	0.05487
51	0.05558	99	0.05486

Figure 6.3: For $n = 5, \dots, 99$ odd, the ratio $\frac{d_{\frac{n-1}{2}}^n - a_{\frac{n-1}{2}}^n}{a_{\frac{n-1}{2}}^n}$, where $d_{\frac{n-1}{2}}^n$ is as in Theorem 6.1.3.

Another interesting problem would be to find combinatorial analogs to Theorem 6.2.6, *i.e.* families $\{P_d^3\}_{d \in \mathbb{N}}$ of completely nondegenerate real Laurent polynomials in 3 variables obtained using the combinatorial Patchwork and such that the Newton polytope $\Delta(P_d^3)$ is S_d^3 and that for $i = 0, \dots, 2$, we have

$$b_i(V_{\mathbb{R}\mathbb{P}^n}(P_d^3)) \stackrel{n}{=} x_i^3 \cdot d^n$$

with $x_0^3 = x_2^3 = \frac{1}{6} + a$ and $x_1^3 = \frac{4}{6} - 2a$ for non-zero a . In particular, those families have to be asymptotically maximal (non-asymptotically maximal examples are relatively easy to find).

As the Cooking Theorem respects the combinatorial nature of the ingredients it uses, this would automatically yield combinatorial versions of Theorems 6.1.1 and 6.1.2.

Chapter 7

A tropical analog to Lefschetz's section theorem

7.1 Chapter introduction

This chapter is based on a joint work [ARS19] with Arthur Renaudineau ¹ and Kristin Shaw ². In this article, we prove a tropical analog to Lefschetz's section theorem, or more precisely to one of its best-known corollaries, relating the tropical homology of a non-singular tropical hypersurface in a non-singular tropical toric variety to the tropical homology of the ambient variety, assuming some technical conditions. We also directly prove that the tropical homology of non-singular tropical toric varieties is torsion-free, and use this, in conjunction with the Lefschetz-like theorem, to show that the tropical homology of non-singular tropical hypersurfaces in non-singular tropical toric varieties is also torsion-free (assuming, again, some technical conditions). As a bonus of sorts, this allows us to obtain some results similar to those of [IKMZ16] relating tropical homology and Hodge-Deligne numbers through purely combinatorial means, though only in the case of hypersurfaces.

In the present chapter, we restrict ourselves to two types of ambient non-singular tropical toric varieties: non-singular compact toric varieties whose dual fan is the same as that of the full-dimensional Newton polytope of the considered hypersurface, and the tropical algebraic torus \mathbb{R}^{n+1} . Our hypersurfaces are also of two types: either non-singular, in which case our theorems hold with tropical (co)homology with coefficients in \mathbb{Z} and \mathbb{R} , or singular, in which case we restrict ourselves to tropical (co)homology with real coefficients.

Again, the results can be found in their full generality in [ARS19]. Throughout the chapter, we mostly use definitions and notations from Chapter 3.

As advertised above, the main result of this chapter is the following tropical analog to

¹Univ. Lille - Laboratoire Paul Painlevé, Lille, France. arthur.renaudineau@univ-lille.fr

²Univ. of Oslo, Oslo, Norway. krishshaw@math.uio.no

Lefschetz's section theorem. Given a tropical toric variety or a tropical hypersurface Z , we denote as in Chapter 4 by $H_q(Z; \mathcal{F}_p^{Z, \mathbb{Z}})$ the (q, p) -th tropical homology group of Z with coefficients in \mathbb{Z} , and by $H_q^{BM}(Z; \mathcal{F}_p^{Z, \mathbb{Z}})$ the (q, p) -th tropical Borel-Moore homology group of Z with coefficients in \mathbb{Z} , and similarly for cohomology. We often simply write \mathcal{F}_p^Z and \mathcal{F}_Z^p instead of $\mathcal{F}_p^{Z, \mathbb{Z}}$ and $\mathcal{F}_{Z, \mathbb{Z}}^p$. To avoid confusion, we sometimes refer to $H_q(Z; \mathcal{F}_p^Z)$ as a *standard* tropical homology group.

As explained in Chapter 3, we call a full-dimensional polytope $\Delta \subset \mathbb{R}^{n+1}$ simple or non-singular if its normal fan is simplicial unimodular. Such a polytope naturally gives rise to a non-singular compact tropical toric variety Y_Δ via its normal fan Σ . Moreover, any tropical polynomial P in $n+1$ variables defines a tropical hypersurface X_0 in \mathbb{R}^{n+1} whose structure is dual to the subdivision of the Newton polytope $\Delta(P)$ of P induced by P itself (see the Duality Theorem 3.2.4). If the subdivision is primitive, the tropical hypersurface X_0 is non-singular. As in Chapter 3, we call the natural compactification in a non-singular tropical toric Y_Δ of a non-singular hypersurface $X_0 \subset \mathbb{R}^{n+1}$ defined by a tropical polynomial whose full-dimensional Newton polytope is Δ a non-singular hypersurface in Y_Δ .

Theorem 7.1.1. *Let X be an n -dimensional tropical hypersurface in Y with Newton polytope Δ , where Y is either \mathbb{R}^{n+1} or a tropical toric variety generated by the normal fan Σ of Δ , in which case we ask that Δ be full-dimensional and Σ be simplicial unimodular.*

Then the map induced by inclusion

$$i_* : H_q^{BM}(X; \mathcal{F}_p^{X, \mathbb{R}}) \rightarrow H_q^{BM}(Y; \mathcal{F}_p^{Y, \mathbb{R}})$$

is an isomorphism when $p+q < n$ and a surjection when $p+q = n$.

Moreover, if Δ is full-dimensional, then the map induced by inclusion

$$i_* : H_q(X; \mathcal{F}_p^{X, \mathbb{R}}) \rightarrow H_q(Y; \mathcal{F}_p^{Y, \mathbb{R}})$$

is an isomorphism when $p+q < n$ and a surjection when $p+q = n$.

Additionally, if X is non-singular in Y , the same two statements hold with coefficients in \mathbb{Z} instead of \mathbb{R} .

Though we restrict ourselves to slightly less general conditions than in the article [ARS19], the theorem covers the most common and reasonable cases. In Section 7.2.2, we present a few counter-examples to its conclusions in cases where its hypotheses are not satisfied.

The case where X is non-singular and its tropical homology groups with coefficients in \mathbb{R} are considered can be recovered as a consequence of the main theorem from Itenberg, Katzarkov, Mikhalkin and Zharkov's [IKMZ16]. However, the statements regarding the integer tropical homology of a non-singular tropical hypersurface X and the tropical homology with coefficients in \mathbb{R} of a singular tropical hypersurface X are new.

Though our theorem is analogous to a well-known corollary of Lefschetz's section theorem, the proofs have little in common. Ours rely on a careful examination of the cellular homology complexes using a cell decomposition of the ambient space induced by the hypersurface itself; we show that the tropical homology of the pair (Y, X) is in a certain sense "locally trivial" in degrees $p + q \leq n$. Notice that unlike the classical Lefschetz section theorem, ours does not require the ambient variety to be compact, making it closer to the generalizations that can be found in [Eyr04].

Somewhat disappointingly, our proof does not appear to be easily adaptable to the case where $X \subset Y$ is a tropical variety of codimension strictly greater than 1.

As immediate consequences of Theorem 7.1.1, we have the following corollaries.

Corollary 7.1.2. *Let Y be a $(n + 1)$ -dimensional non-singular compact tropical toric variety defined by a full-dimensional polytope Δ . Let X be a non-singular tropical hypersurface in Y , defined by a tropical polynomial whose Newton polytope is also Δ . Then the map induced by inclusion*

$$i_*: H_q(X; \mathcal{F}_p^X) \rightarrow H_q(Y; \mathcal{F}_p^Y)$$

is an isomorphism when $p + q < n$ and a surjection when $p + q = n$.

Note that as Y and X are compact, the standard and Borel-Moore tropical homology groups coincide.

We have a similar statement when choosing the tropical torus \mathbb{R}^{n+1} as an ambient variety, rather than a compact one.

Corollary 7.1.3. *Let X be a non-singular tropical hypersurface in \mathbb{R}^{n+1} , defined by a tropical polynomial P . Then the map induced by inclusion*

$$i_*: H_q^{BM}(X; \mathcal{F}_p^X) \rightarrow H_q^{BM}(\mathbb{R}^{n+1}; \mathcal{F}_p^{\mathbb{R}^{n+1}})$$

is an isomorphism when $p + q < n$ and a surjection when $p + q = n$.

If additionally the Newton polytope of P is full-dimensional, then the map

$$i_*: H_q(X; \mathcal{F}_p^X) \rightarrow H_q(\mathbb{R}^{n+1}; \mathcal{F}_p^{\mathbb{R}^{n+1}})$$

is an isomorphism when $p + q < n$ and a surjection when $p + q = n$.

It is easy to show that $H_q^{BM}(\mathbb{R}^{n+1}; \mathcal{F}_p^{\mathbb{R}^{n+1}})$ is isomorphic to $\bigwedge^p \mathbb{Z}^{n+1}$ if $q = n + 1$ and trivial otherwise, and that $H_q(\mathbb{R}^{n+1}; \mathcal{F}_p^{\mathbb{R}^{n+1}})$ is isomorphic to $\bigwedge^p \mathbb{Z}^{n+1}$ if $q = 0$ and trivial otherwise.

In the case of real coefficients and singular X , we also have the two corollaries below.

Corollary 7.1.4. *Let P be a tropical polynomial whose Newton polytope Δ is full-dimensional and non-singular. Let Y be the $(n + 1)$ -dimensional non-singular compact tropical toric*

variety to which Δ gives rise, and let X be the tropical hypersurface in Y to which P gives rise (note that we do not ask for X to be non-singular).

Then the map induced by inclusion

$$i_*: H_q^{BM}(X; \mathcal{F}_p^{X, \mathbb{R}}) \rightarrow H_q^{BM}(Y; \mathcal{F}_p^{Y, \mathbb{R}})$$

is an isomorphism when $p + q < n$ and a surjection when $p + q = n$.

Corollary 7.1.5. *Let X be a tropical hypersurface in \mathbb{R}^{n+1} , defined by a tropical polynomial P (note that we do not ask for X to be non-singular). Then the map induced by inclusion*

$$i_*: H_q^{BM}(X; \mathcal{F}_p^{X, \mathbb{R}}) \rightarrow H_q^{BM}(\mathbb{R}^{n+1}; \mathcal{F}_p^{\mathbb{R}^{n+1}, \mathbb{R}})$$

is an isomorphism when $p + q < n$ and a surjection when $p + q = n$.

If additionally the Newton polytope of P is full-dimensional, then the map

$$i_*: H_q(X; \mathcal{F}_p^{X, \mathbb{R}}) \rightarrow H_q(\mathbb{R}^{n+1}; \mathcal{F}_p^{\mathbb{R}^{n+1}, \mathbb{R}})$$

is an isomorphism when $p + q < n$ and a surjection when $p + q = n$.

The equivalent statements for rational coefficients are a consequence of the universal coefficient theorem, or can be directly obtained using the exact same proof.

Observe that we do not even ask that the subdivision of the Newton polytope of P induced by P be a triangulation.

Adiprasito and Björner also established tropical variants of the Lefschetz hyperplane section theorem in [AB14]. Their theorems relate the tropical homology with real coefficients (but say nothing of integral tropical homology groups) of a non-singular tropical variety X contained in a tropical toric variety to the tropical homology groups of the intersection of X with a so-called “chamber complex”, which is a codimension one polyhedral complex in a tropical toric variety whose complement consists of pointed polyhedra. Their proof relies on Morse theory, and does not seem to have much in common with ours.

We also give some description of the integral tropical homology of non-singular toric varieties, using tropical Poincaré duality (see [JRS17]).

Proposition 7.1.6. *Let Y be a $(n + 1)$ -dimensional non-singular compact tropical toric variety. Then the integral tropical homology groups of Y are torsion-free.*

Moreover, we have

$$\text{rank } H_q(Y; \mathcal{F}_p^Y) = h^{p,q}(\mathbb{C}Y)$$

where $\mathbb{C}Y$ is the corresponding non-singular compact complex toric variety (i.e. they are defined using the same simplicial unimodular complete fan). In particular, we have $H_q(Y; \mathcal{F}_p^Y) = 0$ unless $p = q$.

Using this result and Theorem 7.1.1, we get the following statement.

Theorem 7.1.7. *Let X be a non-singular n -dimensional tropical hypersurface in Y with Newton polytope Δ , where Y is either \mathbb{R}^{n+1} or a toric variety generated by the normal fan Σ of Δ , in which case we ask that Δ be full-dimensional and that Σ be simplicial unimodular.*

Then both the Borel-Moore and standard integral tropical homology groups of X are torsion-free.

Our main motivation for establishing torsion-freeness of the tropical homology groups of tropical hypersurfaces comes from the main result from [RS18], which we have already discussed in Chapter 4 (see Formula (4.5.4)) and which we quote again here: let X be a smooth real algebraic hypersurface in a $(n + 1)$ -dimensional non-singular toric variety obtained via primitive combinatorial patchworking, and let X^{trop} be an associated tropical hypersurface. Denote by $\mathbb{C}X$ (respectively, $\mathbb{R}X$) the complex (respectively, real) points of X . Then Renaudineau and Shaw proved that for any $i = 0, \dots, n$, we have

$$b_i(\mathbb{R}X) \leq \sum_{p=1}^n \dim_{\mathbb{Z}_2} H_q(X^{trop}; \mathcal{F}_p^{X^{trop}, \mathbb{Z}_2}).$$

Theorem 7.1.7 then allows us to see that if the ambient toric variety is either compact or the algebraic torus, then the integral tropical homology of X^{trop} is torsion-free, which implies that $\dim_{\mathbb{Z}_2} H_q(X^{trop}; \mathcal{F}_p^{X^{trop}, \mathbb{Z}_2}) = \text{rank } H_q(X^{trop}; \mathcal{F}_p^{X^{trop}})$. We can then conclude, either from [IKMZ16] or the results below, that $\text{rank } H_q(X^{trop}; \mathcal{F}_p^{X^{trop}}) = h^{q,p}(\mathbb{C}X)$ (where $h^{q,p}(\mathbb{C}X)$ is the (q, p) -th Hodge number of $\mathbb{C}X$) and that we have for any $i = 0, \dots, n$

$$b_i(\mathbb{R}X) \leq h^{i, n-i}(\mathbb{C}X) + 1 - \delta_{i, \frac{n}{2}},$$

where $\delta_{i, \frac{n}{2}}$ is 1 if $i = \frac{n}{2}$ and 0 otherwise.

As another consequence of the Lefschetz-like Theorem 7.1.1, we are able to express under the same assumptions (once again using tropical Poincaré duality) the rank of the integral tropical homology of non-singular tropical hypersurfaces in compact tropical toric varieties and in \mathbb{R}^{n+1} in terms of the Hodge-Deligne numbers of a related real algebraic hypersurface.

If $\mathbb{C}Y$ is a complex toric variety, a hypersurface $\mathbb{C}X \subset \mathbb{C}Y$ is *torically non-degenerate* if the intersection of $\mathbb{C}X$ with any proper torus orbit of $\mathbb{C}Y$ is non-singular and $\mathbb{C}X$ intersects each torus orbit of $\mathbb{C}Y$ transversally. If $\mathbb{C}Y$ is the complex toric variety associated to the Newton polytope of $\mathbb{C}X$, then the second condition follows from the first one (see for example [Kho77]).

Following V. Danilov and A. Khovanskii (see [DK86]), we denote Hodge-Deligne num-

bers of a complex variety $\mathbb{C}X$ by $h^{p,q}(H_c^k(\mathbb{C}X))$ and define the numbers

$$e_c^{p,q}(\mathbb{C}X) := \sum_k (-1)^k h^{p,q}(H_c^k(\mathbb{C}X)),$$

where $H_c^k(\mathbb{C}X)$ is the k -th cohomology group with compact support of $\mathbb{C}X$. We then define the polynomial

$$\chi_y(\mathbb{C}X) := \sum_{p,q} e_c^{p,q}(\mathbb{C}X) y^p.$$

Parallely, given a tropical hypersurface X , we consider the Euler characteristic $\chi(C_{\bullet}^{BM}(X; \mathcal{F}_p^X))$ of the tropical integral Borel-Moore cellular complex. Both $\chi_y(\mathbb{C}X)$ and $\chi(C_{\bullet}^{BM}(X; \mathcal{F}_p^X))$ have nice additivity properties, which allow us to get through purely combinatorial computations the following results.

Theorem 7.1.8. *Let X be a non-singular tropical hypersurface in a tropical toric variety Y , and let $\mathbb{C}X$ be a complex hypersurface torically non-degenerate in a complex toric variety $\mathbb{C}Y$ such that the tropical, respectively complex polynomials defining X and $\mathbb{C}X$ have the same full-dimensional Newton polytope Δ . Moreover, let Y and $\mathbb{C}Y$ be either \mathbb{R}^{n+1} and $(\mathbb{C}^*)^{n+1}$, or a tropical, respectively complex $(n+1)$ -dimensional non-singular toric varieties defined using the normal fan of Δ (in which case we ask that it be simplicial and unimodular).*

Then we have

$$\chi_y(\mathbb{C}X) = \sum_{p=0}^n (-1)^p \chi(C_{\bullet}^{BM}(X; \mathcal{F}_p^X)) y^p,$$

and thus

$$(-1)^p \chi(C_{\bullet}^{BM}(X; \mathcal{F}_p^X)) = \sum_q e_c^{p,q}(\mathbb{C}X).$$

Combining this with our Lefschetz-like theorems and some classical results concerning Hodge-Deligne numbers, we find the two following corollaries.

Corollary 7.1.9. *Let Y and $\mathbb{C}Y$ be tropical, respectively complex $(n+1)$ -dimensional non-singular compact toric varieties coming from the same non-singular full-dimensional integral polytope Δ .*

Let X be a non-singular tropical hypersurface in Y (in particular, defined by a tropical polynomial whose Newton polytope is also Δ). Let $\mathbb{C}X$ be a torically non-degenerate complex hypersurface in $\mathbb{C}Y$, defined by a Laurent polynomial whose Newton polytope is Δ as well.

Then for all p and q we have

$$h^{p,q}(\mathbb{C}X) = \text{rank } H_q(X; \mathcal{F}_p^X).$$

Corollary 7.1.10. *Let X be a non-singular tropical hypersurface in \mathbb{R}^{n+1} defined by a tropical polynomial whose Newton polytope is full-dimensional. If $\mathbb{C}X$ is a non-singular complex hypersurface in $(\mathbb{C}^*)^{n+1}$ with the same Newton polytope as X , then*

$$\operatorname{rank} H_q^{BM}(X; \mathcal{F}_p^X) = \begin{cases} \sum_{l=0}^q h^{p,l}(H_c^n(\mathbb{C}X)) & \text{if } p+q = n \\ h^{p,p}(H_c^{n+p}(\mathbb{C}X)) & \text{if } q = n \\ 0 & \text{otherwise.} \end{cases}$$

The Hodge-Deligne numbers appearing in the above corollary can be calculated using the algorithms in [DK86]. For example, we have under the hypotheses of Corollary 7.1.10 that $h^{p,p}(H_c^{n+p}(\mathbb{C}X)) = \binom{n+1}{p+1}$.

One can also get Corollary 7.1.9 as a consequence of the main theorem of [IKMZ16] (though a complete description of the integral tropical homology groups of X would nonetheless require some analog to Theorem 7.1.7 to show the lack of torsion).

All results in this chapter can be easily generalized to cases where the Newton polytope of the hypersurface X is not full-dimensional. For example, if the ambient variety Y is \mathbb{R}^{n+1} , the hypersurface X is of the form $\tilde{X} \times \mathbb{R}^k$ for some k and some $(n-k)$ -dimensional tropical hypersurface \tilde{X} whose Newton polytope is full-dimensional in \mathbb{R}^{n+1-k} . One can then apply the various theorems stated in this section to \tilde{X} , and use Künneth's formula for tropical homology (see [GS19]) to obtain information regarding the tropical homology of X . Likewise if the pair $X \subset Y$ is of the form $\tilde{X} \times \mathbb{R}^k \subset \tilde{Y} \times \mathbb{R}^k$, with \tilde{Y} being some non-singular tropical toric variety dual to the full-dimensional Newton polytope of \tilde{X} . More delicate generalizations can be found in [ARS19].

In Section 7.2, we explain some notations, prove a preliminary lemma, and show counterexamples to the conclusions of some of the main results when we drop certain hypotheses. In Section 7.3, we prove many lemmas, as well as the Lefschetz-like Theorem 7.1.1. In Section 7.4, we study the tropical homology of non-singular tropical toric varieties and the torsion-freeness of tropical hypersurfaces, and prove Proposition 7.1.6 as well as Theorem 7.1.7. Finally, in Section 7.5, we use concepts from V. Danilov's and A. Khovanskii's [DK86] to prove Theorem 7.1.8 and Corollaries 7.1.9 and 7.1.10.

7.2 Preliminaries

We start with some definitions and basic observations in Subsection 7.2.1, then present some interesting pathological cases in Subsection 7.2.2.

7.2.1 Definitions and observations

Throughout the text and unless otherwise specified, when considering a tropical hypersurface X contained in a tropical toric variety Y , we always use the polyhedral structure on

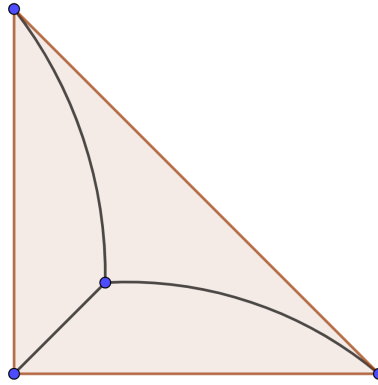

Figure 7.1: The tropical curve induced by the tropical polynomial " $x + y + xy$ " in \mathbb{TP}^2 .

X that comes from the subdivision of the associated Newton polytope (see Chapter 3) and the polyhedral structure on Y induced by that of X .

Let Y be a tropical toric variety and let $X \subset Y$ be a tropical hypersurface. We say that the pair (Y, X) is a *cellular pair* if the cellular structure induced by X on Y makes it a cell complex according to the definition that we gave in Subsection 3.3.2 (which comes from [Cur13] and differs slightly from the usual definition). Example 7.2.3 below shows that it needs not necessarily be the case. Requiring (Y, X) to be a cellular pair automatically implies that X (equipped with its natural polyhedral structure) is also a cell complex.

Given a tropical toric variety Y , we say that a polyhedral complex Z is *proper in Y* if for each cell σ of Z of sedentarity 0 and each cone ρ such that $\sigma \cap Y_\rho \neq \emptyset$, one has $\dim(\sigma \cap Y_\rho) = \dim(\sigma) - \dim(\rho)$.

If Y is a non-singular tropical toric variety and X a non-singular hypersurface in Y , then X is proper in Y (see the Duality Theorem 3.2.4). It need not be the case for tropical hypersurfaces in tropical toric varieties in general: consider for example a tropical curve induced by the tropical polynomial " $x + y + xy$ " in \mathbb{TP}^2 , as illustrated in Figure 7.1.

Let γ be a polyhedron of dimension s and $\text{sed}(\gamma) = 0$ in a tropical toric variety Y . For each cone ρ in the fan Σ defining Y , set $\gamma_\rho := \gamma \cap Y_\rho$ and define

$$\gamma^\circ := \bigsqcup_{\rho} \text{relint } \gamma_\rho,$$

where $\text{relint } \gamma_\rho$ is the relative interior of γ_ρ (in Y_ρ). If we assume that γ is proper in Y , a face σ of γ° of dimension q is necessarily of sedentarity order $\text{sed}(\sigma) = \dim \gamma - q$.

A tropical hypersurface X in an $n + 1$ dimensional tropical toric variety Y is *combinatorially ample* if for every face γ of dimension $n + 1$ of Y , considered with the polyhedral structure induced by X , the polyhedral complex γ° is homeomorphic as a stratified topological space to a product of copies of \mathbb{T} and \mathbb{R} .

If Y is a non-singular tropical toric variety and X a non-singular hypersurface in Y , then X is combinatorially ample in Y . It need not be the case for the closure in a non-singular toric variety Y of a non-singular hypersurface X_0 in \mathbb{R}^{n+1} , as is shown in Example 7.2.5.

The following lemma about the structure of the cosheaves in the case of a non-singular tropical hypersurface proves useful later on.

Lemma 7.2.1. *Let X be a non-singular tropical hypersurface in Y , where Y is either \mathbb{R}^{n+1} or the non-singular compact tropical toric variety generated by the normal fan of the Newton polytope Δ of X (in which case we ask that Δ be full-dimensional and that its normal fan be simplicial and unimodular).*

If τ is a face of X of dimension q whose relative interior is contained in a stratum Y_ρ of dimension m , then

$$\mathcal{F}_p^X(\tau) \cong \bigoplus_{l=0}^p \mathcal{F}_{p-l}^{H_{m-q-1}}(v) \otimes \bigwedge^l T_{\mathbb{Z}}(\tau),$$

where H_{m-q-1} is the standard tropical hyperplane of dimension $m - q - 1$ in \mathbb{R}^{m-q} and v denotes its vertex.

If τ is a codimension one face of σ in X and $\text{relint}(\tau)$ and $\text{relint}(\sigma)$ are contained in the distinct strata Y_ρ and Y_η , respectively, then the cosheaf map $i_{\sigma,\tau}: \mathcal{F}_p^X(\sigma) \rightarrow \mathcal{F}_p^X(\tau)$ together with the above isomorphisms commute with the map

$$\bigoplus_{l=0}^p \mathcal{F}_{p-l}^{H_{m-q-1}}(v) \otimes \bigwedge^l T_{\mathbb{Z}}(\sigma) \rightarrow \bigoplus_{l=0}^p \mathcal{F}_{p-l}^{H_{m-q-1}}(v) \otimes \bigwedge^l T_{\mathbb{Z}}(\tau), \quad (7.2.1)$$

which is induced by the map $\text{id} \otimes \pi_{\eta,\rho}$ on each factor of the direct sum, where $\pi_{\eta,\rho}: \bigwedge^l T_{\mathbb{Z}}(\sigma) \rightarrow \bigwedge^l T_{\mathbb{Z}}(\tau)$ is from Equation 3.3.1 in Chapter 3.

Proof. Recall that $T_{\mathbb{Z}}(\tau)$ denotes the integral points in the tangent space of the face τ . Now let L be a $m - q$ dimensional affine subspace of $\mathbb{R}^m \cong Y_\rho$ defined over \mathbb{Z} such that L intersects all faces of X_ρ that contain $\text{relint}(\tau)$ transversally and that together $T_{\mathbb{Z}}(L)$ and $T_{\mathbb{Z}}(\tau)$ generate the lattice $T_{\mathbb{Z}}(Y_\rho)$. By the above transversality assumption, the intersection $L' = L \cap X$ has a single vertex v' contained in τ .

For every l there is a map

$$i_l: \mathcal{F}_{p-l}^{L'}(v') \otimes \bigwedge^l T_{\mathbb{Z}}(\tau) \rightarrow \mathcal{F}_p^X(\tau),$$

given by taking the wedge product of the vectors in $\mathcal{F}_{p-l}^{L'}(v')$ and $\bigwedge^l T_{\mathbb{Z}}(\tau)$. Taking the

direct sum of the maps i_l for all $0 \leq l \leq p$ gives a map

$$\bigoplus_{l=0}^p \mathcal{F}_{p-l}^{L'}(v') \otimes \bigwedge^l T_{\mathbb{Z}}(\tau) \rightarrow \mathcal{F}_p^X(\tau). \quad (7.2.2)$$

If σ is a facet of $X \cap Y_\rho$ containing the face τ , then by our assumptions on L' , we have

$$T_{\mathbb{Z}}(\sigma) \cong T_{\mathbb{Z}}(\tau) \oplus T_{\mathbb{Z}}(L' \cap \sigma).$$

Therefore,

$$\mathcal{F}_p^X(\sigma) \cong \bigoplus_{l=0}^p \mathcal{F}_{p-l}^{L' \cap \sigma}(v') \otimes \bigwedge^l T_{\mathbb{Z}}(\tau).$$

Now since $\mathcal{F}_p^X(\tau)$ is generated by all $\mathcal{F}_p^X(\sigma)$ for σ a facet containing τ , the map in Equation 7.2.2 is an isomorphism.

By the assumption that X is non-singular in Y , every non-empty stratum $X_\rho = Y_\rho \cap X$ is a non-singular tropical hypersurface in \mathbb{R}^m , where $m = n + 1 - \dim \rho$. Therefore, the hypersurface X_ρ is defined by a tropical polynomial f_ρ and it is dual to a primitive regular subdivision of the Newton polytope of f_ρ which is induced by f_ρ . A face σ of X whose relative interior is contained in X_ρ is dual to a face of the dual subdivision of $\Delta(f_\rho)$, and since this dual subdivision is primitive, the face dual to σ is a simplex. Therefore, near the vertex v' the polyhedral complex L' is up to an integral affine transformation the same as a neighborhood of the vertex v of the tropical hyperplane H_{m-q-1} and we have $\mathcal{F}_{p-l}^{L'}(v') \cong \mathcal{F}_{p-l}^{H_{m-q-1}}(v)$. This proves the isomorphism stated in the lemma.

If τ is a face of σ , and τ and σ are contained in Y_η and Y_ρ respectively, for $\eta \neq \rho$, then we can write $T_{\mathbb{Z}}(Y_\rho) = T_{\mathbb{Z}}(L_\sigma) \oplus T_{\mathbb{Z}}(\sigma)$ and $T_{\mathbb{Z}}(Y_\eta) = T_{\mathbb{Z}}(L_\tau) \oplus T_{\mathbb{Z}}(\tau)$, where L_σ and L_τ are the linear spaces chosen in the argument above to intersect σ and τ , respectively. Since the polyhedral structure on X is proper in Y , the map $\pi_{\rho\eta}: T_{\mathbb{Z}}(Y_\rho) \rightarrow T_{\mathbb{Z}}(Y_\eta)$ restricts to an isomorphism between $T_{\mathbb{Z}}(L_\sigma)$ and $T_{\mathbb{Z}}(L_\tau)$. Therefore, it also restricts to an isomorphism between $\mathcal{F}_p^{L_\sigma \cap X}(v_\sigma)$ and $\mathcal{F}_p^{L_\tau \cap X}(v_\tau)$ for all p .

The claim about the commutativity of the above isomorphisms with the maps in Formula (7.2.1) and $i_{\sigma,\tau}: \mathcal{F}_p^X(\sigma) \rightarrow \mathcal{F}_p^X(\tau)$ follows, since $i_{\sigma,\tau}$ is induced by projecting along a direction $\pi_{\rho,\eta}$. \square

7.2.2 Counterexamples

In this subsection, we show how everything can go terribly wrong: a series of examples in which some of our hypotheses are not satisfied and the main theorems fail.

Example 7.2.2. Consider the complete rational fan Σ in \mathbb{R}^2 such that its only 1-dimensional cones are $\mathbb{R}_{\geq 0} \cdot (-2, 1)$, $\mathbb{R}_{\geq 0} \cdot (2, 1)$ and $\mathbb{R}_{\geq 0} \cdot (0, -1)$, and the associated toric variety Y . Consider also the tropical hypersurface $X \subset Y$ whose Newton polytope is the triangle of

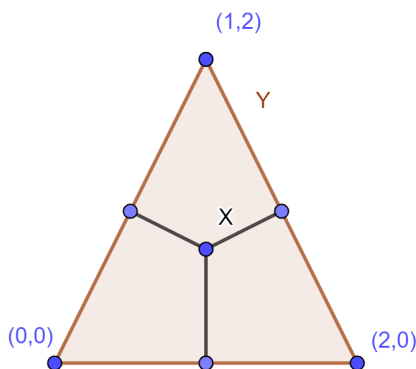
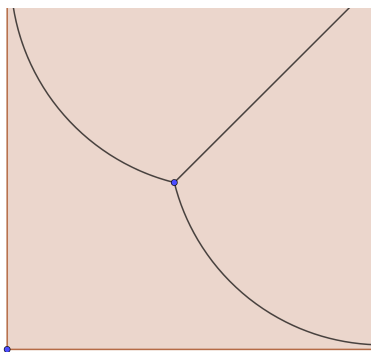
Figure 7.2: The pair (Y, X) from Example 7.2.2Figure 7.3: The tropical curve induced by the tropical polynomial " $0 + xy^2 + x^2y$ " in \mathbb{T}^2 .

vertices $(0,0)$, $(2,0)$ and $(1,2)$ (which we do not further triangulate). The pair (Y, X) is represented in Figure 7.2.

Both Y and X are singular, and it is easy to see that $H_0(X; \mathcal{F}_1^X) \cong \mathbb{Z}_2$ and that $H_1(Y; \mathcal{F}_1^Y) \cong \mathbb{Z} \oplus \mathbb{Z}_2 \oplus \mathbb{Z}_2$; compare with Theorem 7.1.7 and Proposition 7.1.6.

Example 7.2.3. There are examples of tropical hypersurfaces in tropical toric varieties which are not cellular pairs. For example, let $X \subset \mathbb{T}^2$ be the tropical curve in \mathbb{T}^2 with three rays in directions $(-2, 1)$, $(1, -2)$ and $(1, 1)$ (see Figure 7.3) to which the tropical polynomial " $0 + xy^2 + x^2y$ " gives rise. In this case, the pair (\mathbb{T}^2, X) is not a cellular pair, though X may be combinatorially ample in \mathbb{T}^2 .

Example 7.2.4. On a related note, consider the case when the Newton polytope of the polynomial that gives rise to X is an interval of lattice length equal to 1 in \mathbb{R}^{n+1} (for $n \geq 1$); in particular, and unlike what is required in the second part of Corollary 7.1.3, it is not full-dimensional.

Then the tropical hypersurface X is a (classical) \mathbb{Z} -affine subspace of $Y = \mathbb{R}^{n+1}$ of dimension n , and the one point compactification of \mathbb{R}^{n+1} (with the cell structure induced by X) is not a regular cell complex (as shown in Lemma 3.3.6). Upon further subdividing X and Y so that they form a cellular pair, or using singular tropical homology, we can compute the standard tropical homology groups to be:

$$H_q(X; \mathcal{F}_p^X) = \begin{cases} \bigwedge^p \mathbb{Z}^n & \text{if } q = 0, \\ 0 & \text{if } q \neq 0 \end{cases} \quad \text{and} \quad H_q(Y; \mathcal{F}_p^Y) = \begin{cases} \bigwedge^p \mathbb{Z}^{n+1} & \text{if } q = 0, \\ 0 & \text{if } q \neq 0. \end{cases}$$

Whereas the Borel-Moore homology groups are

$$H_q^{BM}(X; \mathcal{F}_p^X) = \begin{cases} \bigwedge^p \mathbb{Z}^n & \text{if } q = n, \\ 0 & \text{if } q \neq n \end{cases}$$

and

$$H_q^{BM}(Y; \mathcal{F}_p^Y) = \begin{cases} \bigwedge^p \mathbb{Z}^{n+1} & \text{if } q = n + 1, \\ 0 & \text{if } q \neq n + 1. \end{cases}$$

We see that the conclusions of Corollary 7.1.3 do not hold for the standard tropical homology groups; the fact that (\mathbb{R}^{n+1}, X) is not a cellular pair is what makes the proof fail. However, the conclusions regarding the Borel-Moore tropical homology groups do apply.

Example 7.2.5. Here is a counterexample to the conclusions of Corollary 7.1.2 when we drop the condition that Y is defined by the normal fan of the Newton polytope of the polynomial that gives rise to X . Consider the standard tropical hyperplane $X^o \subset \mathbb{R}^{n+1}$. The case $n = 2$ is depicted in the left of Figure 7.4. Let Σ be the fan for the $(n + 1)$ -dimensional projective space blown up in a toric fixed point, and let Y be the tropical toric variety defined by Σ . Let X denote the compactification of X^o in Y . Then it can be computed that $\text{rank } H_1(X, \mathcal{F}_1^X) = 1$ and $\text{rank } H_1(Y, \mathcal{F}_1^Y) = 2$, so the map $H_1(X, \mathcal{F}_1^X) \rightarrow H_1(Y, \mathcal{F}_1^Y)$ is not surjective (unlike in the conclusion of Corollary 7.1.2 for $n \geq 2$).

The connected component of $Y \setminus X$ containing the stratum of Y dual to the ray of Σ corresponding to the exceptional divisor of the blow up does not satisfy the condition to be combinatorially ample, which is where the proof fails.

The complex geometric version of the same scenario also does not satisfy the conclusions of the Lefschetz hyperplane section theorem (as the hypersurface of the toric variety is not ample).

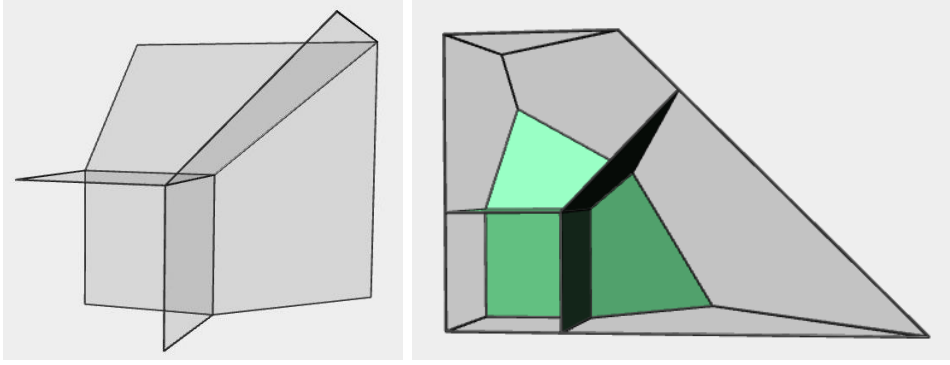

Figure 7.4: The standard tropical hyperplane in \mathbb{R}^3 on the left, its closure in the tropical toric variety described in Example 7.2.5 on the right.

7.3 Tropical Lefschetz hyperplane section theorems

This section is mainly dedicated to proving Theorem 7.1.1, but we first need some intermediate lemmas.

7.3.1 Preliminary results

A tropical hypersurface X in a tropical toric variety Y induces a polyhedral structure on Y . As above, and unless it is explicitly mentioned, we use this polyhedral structure on Y to compute its cellular tropical homology groups.

If Z is a polyhedral complex, $Z' \subset Z$ is a subpolyhedral complex and \mathcal{G} is a cosheaf on Z , then the restriction cosheaf $\mathcal{G}|_{Z'}$ is a cosheaf on Z' which assigns the \mathbb{Z} -module $\mathcal{G}(\sigma)$ for σ a face of Z' . The cosheaf $\mathcal{G}|_{Z'}$ can also be considered as a cosheaf on Z . In this case, it assigns $\mathcal{G}(\sigma)$ if σ is a face of Z' and 0 otherwise.

Since we consider the polyhedral structure on Y induced by X , the tropical hypersurface X is a subpolyhedral complex of Y and we have the cosheaves $\mathcal{F}_p^Y|_X$, which can be considered on X or Y as described above.

To prove our Lefschetz-like theorems, we consider two exact sequences of cosheaves. The first is the exact sequence of cosheaves on Y given by

$$0 \rightarrow \mathcal{F}_p^{Y,A}|_X \rightarrow \mathcal{F}_p^{Y,A} \rightarrow \mathcal{Q}_p^A \rightarrow 0 \quad (7.3.1)$$

for $A = \mathbb{Z}, \mathbb{R}$. The second one consists of cosheaves on X and is given by

$$0 \rightarrow \mathcal{F}_p^{X,A} \rightarrow \mathcal{F}_p^{Y,A}|_X \rightarrow \mathcal{N}_p^A \rightarrow 0 \quad (7.3.2)$$

for $A = \mathbb{Z}, \mathbb{R}$. We often simply write \mathcal{Q}_p and \mathcal{N}_p for $\mathcal{Q}_p^{\mathbb{Z}}$ and $\mathcal{N}_p^{\mathbb{Z}}$.

The injective maps on the left-hand side of both cosheaf sequences are both natural

inclusions on the stalks over faces. The cosheaves \mathcal{Q}_p^A and \mathcal{N}_p^A are defined as the cokernel cosheaves in both short exact sequences. The cosheaves $\mathcal{F}_p^{Y,A}|_X$, $\mathcal{F}_p^{Y,A}$, and $\mathcal{F}_p^{X,A}$ are all free A -modules.

The main idea of the proofs is that the cosheaves \mathcal{Q}_p^A and \mathcal{N}_p^A vanish locally in the right degrees (and under the right hypotheses), in a sense that is made clear in the remainder of this section.

Example 7.3.1. Consider the tropical line X in \mathbb{TP}^2 from Example 3.3.2 and Figure 3.5 in Chapter 3. Then the cosheaf \mathcal{Q}_p on \mathbb{TP}^2 assigns the trivial \mathbb{Z} -module to any face of \mathbb{TP}^2 which is also a face of X . For σ a face of \mathbb{TP}^2 which is not a face of X , then $\mathcal{Q}_p(\sigma) = \mathcal{F}_p^{\mathbb{TP}^2}(\sigma)$. The inclusion maps $\mathcal{Q}_p(\sigma) \rightarrow \mathcal{Q}_p(\tau)$ are either 0 or equal to $\iota_{\sigma,\tau}: \mathcal{F}_p^{\mathbb{TP}^2}(\sigma) \rightarrow \mathcal{F}_p^{\mathbb{TP}^2}(\tau)$.

For x the unique vertex of sedentarity 0 of X , the cosheaf \mathcal{N}_p assigns $\mathcal{N}_p(x) = 0$ for all $p < 2$. When $p = 2$, we have $\mathcal{N}_p(x) = \bigwedge^2 \mathbb{Z}^2$.

For an edge σ_i of X the \mathbb{Z} -module $\mathcal{N}_p(\sigma_i)$ is a free module of rank 1, and similarly for the three other vertices τ_i of X that have non-zero sedentarity.

We recall the definition of γ° for a (closed) face γ of X of dimension s and $\text{sed}(\gamma) = 0$. For each cone ρ in the fan Σ defining Y , set $\gamma_\rho := \gamma \cap Y_\rho$ and define

$$\gamma^\circ := \bigsqcup_{\rho} \text{relint } \gamma_\rho.$$

The set γ° is not a polyhedral complex since the strata are not closed polyhedra, however $\overline{\gamma^\circ}$ is a subpolyhedral complex of Y . The set γ° is a stratified subset of Y and it can be viewed as a poset with the order relations given by inclusions.

Lemma 7.3.2. *Let X be an n -dimensional tropical hypersurface in Y , where Y is either \mathbb{R}^{n+1} or a toric variety generated by the normal fan of the Newton polytope of X (which we then suppose to be full-dimensional).*

Then for every face γ of Y , considered with the polyhedral structure induced by X , the stratified set γ° has a unique minimal face by inclusion.

Proof. If $Y = \mathbb{R}^{n+1}$, we have $\gamma^\circ = \text{relint } \gamma$ and it is trivial.

Otherwise, this is a direct consequence of the second part of the Duality Theorem 3.2.4. The cell γ is dual to a certain cell λ of the subdivision of the Newton polytope Δ of X . By definition of γ° , its minimal face corresponds to the cone ρ of the fan defining Y , where ρ is such that it is normal to the minimal face $F(\rho)$ of Δ that contains λ (using the notations of the Duality Theorem 3.2.4). \square

If γ is a face of a polyhedral complex Z and \mathcal{G} is a cellular cosheaf of A -modules (for some commutative ring A) on Z , we can consider the cosheaf \mathcal{G} restricted to γ° even though γ° is not a polyhedral complex. Similarly to how we defined cellular cosheaves in

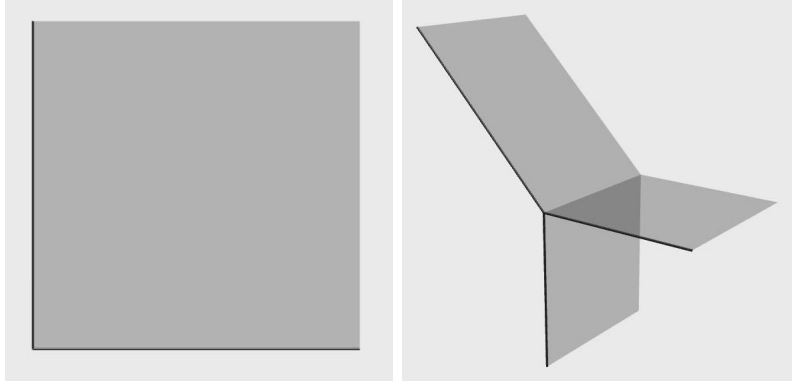

Figure 7.5: A depiction of the polyhedral complexes γ° for two faces γ from Example 7.3.3.

Section 3.3, the restriction $\mathcal{G}|_{\gamma^\circ}$ is a functor from γ° considered as a poset to the category of A -modules. The groups of Borel-Moore chains of \mathcal{G} restricted to γ° are

$$C_q^{BM}(\gamma^\circ; \mathcal{G}|_{\gamma^\circ}) := \bigoplus_{\dim \rho = q} \mathcal{G}(\gamma_\rho).$$

The chain groups form a complex with the boundary map

$$\partial: C_q^{BM}(\gamma^\circ; \mathcal{G}|_{\gamma^\circ}) \rightarrow C_{q-1}^{BM}(\gamma^\circ; \mathcal{G}|_{\gamma^\circ}) \quad (7.3.3)$$

given by the cosheaf maps combined with the orientation map inherited from Z . The homology groups of this complex are denoted $H_q^{BM}(\gamma^\circ; \mathcal{G}|_{\gamma^\circ})$. For simplicity, we denote by $\mathcal{F}_p^{\gamma^\circ}$ the cosheaves $\mathcal{F}_p^{\overline{\gamma^\circ}}|_{\gamma^\circ}$.

Example 7.3.3. Let X be a tropical hypersurface in a 3-dimensional tropical toric variety Y . We describe the polyhedral complexes γ° for some faces γ of X . If γ is a face of X which does not intersect any of the strata Y_ρ for $\rho \neq 0$, then γ° consists of a single cell, which is simply $\text{relint}(\gamma)$. Therefore, γ° is combinatorially isomorphic to \mathbb{R}^q , where q is the dimension of γ .

Suppose that γ is a 2-dimensional face of X and $\gamma \cap Y_\rho \neq \emptyset$ for a unique 1-dimensional stratum Y_ρ . There must be two 2-dimensional strata $Y_{\rho'}$ and $Y_{\rho''}$ of Y which contain Y_ρ , moreover γ has non-empty intersection with both $Y_{\rho'}$ and $Y_{\rho''}$. Therefore, γ° consists of four open cells and is combinatorially isomorphic to \mathbb{T}^2 , see the left-hand side of Figure 7.5. If γ is 2-dimensional and intersects only a single 2-dimensional stratum Y_ρ , then γ° consists of two open cells and is combinatorially isomorphic to $\mathbb{R} \times \mathbb{T}$.

Suppose γ is a 1-dimensional face of X of sedentarity 0 such that $\gamma \cap Y_\rho$ is non-empty for a unique stratum Y_ρ of codimension 1. Such a situation is depicted on the right-hand side of Figure 7.5. Then γ° consists of two open cells, the 1-dimensional cell $\gamma_0 = \gamma \cap \mathbb{R}^3$ and the point $\gamma_\rho := \gamma \cap Y_\rho$.

In the case of such a 1-dimensional face γ , we have $\mathcal{F}_p^Y|_{\gamma^\circ}(\gamma) \cong \bigwedge^p \mathbb{Z}^3$ and $\mathcal{F}_p^{\gamma^\circ}(\gamma) \cong \bigwedge^p \mathbb{Z}$ for all p .

Lemma 7.3.4. *Let X be an n -dimensional tropical hypersurface in Y with Newton polytope Δ , where Y is either \mathbb{R}^{n+1} or a toric variety generated by the normal fan Σ of Δ , in which case we ask that Δ be full-dimensional and Σ be simplicial unimodular.*

Consider the polyhedral structure on Y obtained by refinement by X . Let γ be a face of Y of sedentarity 0. Then for any p and all $r \neq \dim \gamma$,

$$H_r^{BM}(\gamma^\circ; \mathcal{F}_p^{\gamma^\circ, A}) = 0$$

for $A = \mathbb{Z}, \mathbb{R}$.

Remark 7.3.5. *If Y is the toric variety generated by Σ , the assumption that Σ should be simplicial unimodular means that Y is non-singular. However, X is not required to be non-singular (even though its Newton polytope is simple).*

Proof. Using the Duality Theorem 3.2.4 as in the proof of Lemma 7.3.2, we consider the cell λ dual to σ in the subdivision of Δ , and $F(\eta)$ the minimal face of Δ containing λ . The face $F(\eta)$ is dual to a cone η of Σ .

As Σ is required to be simplicial unimodular, we can assume, up to a change in coordinates (induced by some element of $SL(n, \mathbb{Z})$), that η is the cone $\mathbb{R}_+ e_1 + \dots + \mathbb{R}_+ e_{\dim \eta}$.

If we let q be the dimension of γ and k be the dimension of its minimal face γ_η , we then see (thanks to the Duality Theorem 3.2.4) that the stratification on γ° is isomorphic to the stratification of $\mathbb{R}^k \times \mathbb{T}^{q-k}$ (with strata corresponding to subcones of η).

Moreover, the Borel-Moore chain groups for γ° are

$$C_r^{BM}(\gamma^\circ; \mathcal{F}_p^{\gamma^\circ, A}) = \bigoplus_{\substack{\gamma_\rho \cap \gamma^\circ \neq \emptyset \\ \dim \gamma_\rho = r}} \bigwedge^p T_A(\gamma_\rho).$$

From this description, it follows that there is an isomorphism of the chain complexes for the tropical homology of γ° and the chain complexes for the cellular Borel-Moore tropical homology groups of $\mathbb{R}^k \times \mathbb{T}^{q-k}$. Therefore, there are isomorphisms of the corresponding homology groups.

By [JRS17], the space $\mathbb{R}^k \times \mathbb{T}^{q-k}$ satisfies Poincaré duality for tropical homology and the Borel-Moore tropical homology groups of $\mathbb{R}^{q-k} \times \mathbb{T}^k$ are zero, except in degree q . The statement of the lemma follows. \square

We need the following lemma regarding the cosheaves $\mathcal{F}_p^{\mathbb{R}}$.

Lemma 7.3.6. *Let P be a tropical polynomial in $n + 1$ variables, such that its Newton polytope Δ is $(n + 1)$ -dimensional and such that the subdivision it induces on Δ has a single*

$(n + 1)$ -dimensional cell (in other words, it coincides with the natural decomposition into faces of Δ as a polytope). Let $X \subset \mathbb{R}^{n+1}$ be the associated tropical hypersurface, and let v be its central vertex.

Then

$$\mathcal{F}_p^{X, \mathbb{R}}(v) = \bigwedge^p \mathbb{R}^{n+1}$$

for $0 \leq p \leq n$, and $\mathcal{F}_{n+1}^{X, \mathbb{R}}(v) = 0$.

Proof. The hypersurface X is a translate of the normal fan of Δ , minus its top-dimensional cones (that correspond to $\mathbb{R}^{n+1} \setminus X$).

We proceed by induction on n . The statement is trivial for $n = 0$; suppose now that we have proved it for all $k < n$.

If $p < n$, choose any $(p + 1)$ -dimensional face F of Δ , and consider the associated $n - p$ cell σ . The star in X of the relative interior of σ (i.e. $\text{star}_X(\sigma) = \{\text{relint}(\tau) \mid \sigma \subset \tau \subset X\} \subset \mathbb{R}^{n+1}$) is isomorphic to $\tilde{\sigma} \times \mathbb{R}^{n-p}$, where $\tilde{\sigma} \subset \mathbb{R}^{p+1}$ is the tropical hypersurface associated to the restriction of P to the face F (and \mathbb{R}^{n-p} corresponds to the orthogonal complement in \mathbb{R}^{n+1} of the vector space spanned by F). Let \tilde{v} be the central vertex of $\tilde{\sigma}$.

Similarly to Lemma 7.2.1, we have

$$\mathcal{F}_p^{X, \mathbb{R}}(\sigma) \cong \bigoplus_{l=0}^p \mathcal{F}_l^{\tilde{\sigma}, \mathbb{R}}(\tilde{v}) \otimes \bigwedge^{p-l} \mathbb{R}^{n-p}.$$

By induction, $\dim \mathcal{F}_l^{\tilde{\sigma}, \mathbb{R}}(\tilde{v}) = \binom{p+1}{l}$ for any $l \leq p$, which shows that $\dim \mathcal{F}_p^{X, \mathbb{R}}(\sigma) = \sum_{l=0}^p \binom{p+1}{l} \binom{n-p}{p-l} = \binom{n+1}{p} = \dim \bigwedge^p \mathbb{R}^{n+1}$. By definition, $\mathcal{F}_p^{X, \mathbb{R}}(\sigma) \subset \mathcal{F}_p^{X, \mathbb{R}}(v) \subset \bigwedge^p \mathbb{R}^{n+1}$, which allows us to conclude in the case $p < n$.

Now suppose that $p = n$. Consider a vertex o of Δ ; let $v_1, \dots, v_N \in \mathbb{R}^{n+1}$ be vectors spanning the rays of the 1-dimensional faces of Δ to which o belongs (one vector for each 1-dimensional face). The family $\{v_1, \dots, v_N\}$ is not necessarily free, but as Δ is full-dimensional, it spans \mathbb{R}^{n+1} . Let σ_i be the n -dimensional cell of X dual to the face parallel to v_i (and thus perpendicular to v_i).

By definition, we have $\sum_{i=1}^N \mathcal{F}_n^{\sigma_i, \mathbb{R}}(\sigma_i) \subset \mathcal{F}_n^{X, \mathbb{R}}(v)$ (as $v \in \sigma_i$ for $i = 1, \dots, N$). Moreover, $\mathcal{F}_n^{\sigma_i, \mathbb{R}}(\sigma_i) \cong \bigwedge^n \mathbb{L}(\sigma_i)$, where $\mathbb{L}(\sigma_i)$ is the vector space spanned by σ_i .

Suppose that $\sum_{i=1}^N \mathcal{F}_n^{\sigma_i, \mathbb{R}}(\sigma_i) \subsetneq \bigwedge^n \mathbb{R}^{n+1}$. Using the non-degenerate pairing $\bigwedge^n \mathbb{R}^{n+1} \times \bigwedge^1 \mathbb{R}^{n+1} \rightarrow \bigwedge^{n+1} \mathbb{R}^{n+1}$ induced by the exterior product, we see that this implies that there exists a non-zero vector v that belongs to each space $\mathbb{L}(\sigma_i)$; in particular, v would be perpendicular to each v_i , which yields a contradiction and allows us to conclude the case $p = n$.

Finally, the case $p > n$ is trivial, as $\mathcal{F}_p^{X, \mathbb{R}}(v)$ is by definition the sum of the p -th exterior products of vector spaces spanned by cells of dimension less than or equal to n , which is then necessarily 0. \square

Remark 7.3.7. *Without additional non-singularity hypotheses, we would not necessarily have $\mathcal{F}_p^{X,\mathbb{Z}}(v) = \bigwedge^p \mathbb{Z}^{n+1}$ for $0 \leq p \leq n$.*

Lemma 7.3.8. *Let X be an n -dimensional tropical hypersurface in Y with Newton polytope Δ , where Y is either \mathbb{R}^{n+1} or a toric variety generated by the normal fan Σ of Δ (in which case we ask that Δ be full-dimensional).*

For σ a face of X of dimension q and sedentarity $\text{sed}(\sigma)$, we have $\mathcal{N}_p^{\mathbb{R}}(\sigma) = 0$ if $p \leq n - q - \text{sed}(\sigma)$.

Moreover, if Y is non-singular and X is non-singular in Y , then for σ a face of X of dimension q and sedentarity $\text{sed}(\sigma)$, we have $\mathcal{N}_p^{\mathbb{Z}}(\sigma) = 0$ if $p \leq n - q - \text{sed}(\sigma)$.

Proof. Let $A = \mathbb{Z}, \mathbb{R}$. Given a face σ of dimension q of X , the \mathbb{Z} -module $\mathcal{F}_p^{X,A}(\sigma)$ is a submodule of $\mathcal{F}_p^{Y,A}(\sigma)$, and the map $\mathcal{F}_p^{X,A}(\sigma) \rightarrow \mathcal{F}_p^{Y,A}(\sigma)$ is simply the inclusion map.

Let Y_ρ be the minimal stratum of Y such that σ is contained in Y_ρ . Let $m = n + 1 - \text{sed}(\sigma)$ be the dimension of Y_ρ (as Y is generated by the normal fan of the Newton polytope of X , we have $m \geq 1$). By definition of the cosheaves $\mathcal{F}_p^{X,A}$ and $\mathcal{F}_p^{Y,A}$, we can restrict ourselves to Y_ρ , which we can identify with \mathbb{R}^m .

Consider first the cosheaf $\mathcal{N}_p^{\mathbb{R}}(\sigma) = \mathcal{F}_p^{Y,\mathbb{R}}(\sigma) / \mathcal{F}_p^{X,\mathbb{R}}(\sigma)$. As we are using coefficients in \mathbb{R} , we simply have to show that $\mathcal{F}_p^{Y,\mathbb{R}}(\sigma)$ and $\mathcal{F}_p^{X,\mathbb{R}}(\sigma)$ have the same dimension if $p \leq n - q - \text{sed}(\sigma)$.

By definition, we know that

$$\dim_{\mathbb{R}} \mathcal{F}_p^{Y,\mathbb{R}}(\sigma) = \binom{m}{p}.$$

We also know, using the Duality Theorem 3.2.4, that σ is dual to a certain cell λ of dimension $m - q$ of the associated subdivision of Δ . Via the identification $Y_\rho \cong \mathbb{R}^m$, and up to a change in coordinates (corresponding to an element of $SL(m, \mathbb{Z})$), the star of the relative interior of σ in X_ρ is then isomorphic to $\tilde{\sigma} \times \mathbb{R}^q$, for some polyhedral complex $\tilde{\sigma} \subset \mathbb{R}^{m-q}$ dual to some $(m - q)$ -dimensional Newton polytope in \mathbb{R}^{m-q} (corresponding to the closure of λ) with a single top-dimensional cell, as in Lemma 7.3.6.

Similarly to Lemma 7.2.1, we then have

$$\mathcal{F}_p^{X,\mathbb{R}}(\sigma) \cong \bigoplus_{l=0}^p \mathcal{F}_l^{\tilde{\sigma},\mathbb{R}}(v) \otimes \bigwedge^{p-l} \mathbb{R}^q,$$

where v is the central vertex of $\tilde{\sigma}$, and we know from Lemma 7.3.6 that

$$\dim_{\mathbb{R}} \mathcal{F}_l^{\tilde{\sigma},\mathbb{R}}(v) = \binom{m-q}{l}$$

if $l \leq m - q - 1 = (n + 1 - \text{sed}(\sigma)) - q - 1 = n - q - \text{sed}(\sigma)$ (and 0 otherwise). This implies that if $p \leq n - q - \text{sed}(\sigma)$, then $\dim \mathcal{F}_p^{X,\mathbb{R}}(\sigma) = \sum_{l=0}^p \binom{m-q}{l} \binom{q}{p-l} = \binom{m}{p}$, which allows us

to conclude.

Suppose now that Y is non-singular and X is non-singular in Y .

As X is non-singular, $X_\rho \subset Y_\rho \cong \mathbb{R}^m$ is dual to a primitive triangulation T of some polytope in \mathbb{R}^m (see the Duality Theorem 3.2.4). In particular, the cell σ is dual to some unimodular $(m - q)$ -simplex γ of T . Up to the action of some element of $SL(m, \mathbb{Z})$, corresponding to a change of variables, we can assume γ to be the standard $(m - q)$ -simplex in \mathbb{R}^m whose $m - q + 1$ vertices are $x_0 := (0, \dots, 0), x_1 := (1, 0, \dots, 0), \dots, x_{m-q} := (0, \dots, 0, 1, 0, \dots, 0)$.

By definition of the duality between the triangulation T and the cellular subdivision of X_ρ , the star of the relative interior of σ in X_ρ is then isomorphic to $H_{m-q-1} \times \mathbb{R}^q \subset \mathbb{R}^{m-q} \times \mathbb{R}^q = \mathbb{R}^m$, and we have

$$\mathcal{F}_p^{X, \mathbb{Z}}(\sigma) \cong \bigoplus_{l=0}^p \mathcal{F}_l^{H_{m-q-1}, \mathbb{Z}}(v) \otimes \bigwedge^{p-l} \mathbb{Z}^q \subset \bigoplus_{l=0}^p \bigwedge^l \mathbb{Z}^{m-q} \otimes \bigwedge^{p-l} \mathbb{Z}^q \cong \bigwedge^p \mathbb{Z}^m = \mathcal{F}_p^{Y, \mathbb{Z}}(\sigma),$$

as in the description from Lemma 7.2.1.

Using the canonical base $\{e_1, \dots, e_{m-q}, e_{m-q+1}, \dots, e_m\}$ of $\mathbb{Z}^{m-q} \times \mathbb{Z}^q \cong \mathbb{Z}^m$ and the associated base $\{e_{i_1} \wedge \dots \wedge e_{i_p}\}_{0 \leq i_1 < \dots < i_p \leq m}$ of $\bigwedge^p \mathbb{Z}^m$, we immediately see from that description and the definitions of the standard tropical hyperplane H_{m-q-1} and the cosheaves $\mathcal{F}_l^{H_{m-q-1}, \mathbb{Z}}$ (see Example 3.3.3) that $\mathcal{F}_p^{X, \mathbb{Z}}(\sigma)$ is the free sub- \mathbb{Z} -module of $\mathcal{F}_p^{Y, \mathbb{Z}}(\sigma) \cong \bigwedge^p \mathbb{Z}^m$ spanned by all the elements $e_{i_1} \wedge \dots \wedge e_{i_l} \wedge e_{i_{l+1}} \wedge \dots \wedge e_{i_p}$ such that $i_1 < \dots < i_p$, that $i_l \leq m - q$ and that $l \leq m - q - 1$ (for $l = 0, \dots, p$).

This implies that if $p \leq m - q - 1 = n - q - \text{sed}(\sigma)$, then $\mathcal{F}_p^{X, \mathbb{Z}}(\sigma) = \mathcal{F}_p^{Y, \mathbb{Z}}(\sigma)$ and the quotient $\mathcal{F}_p^{Y, \mathbb{Z}}(\sigma) / \mathcal{F}_p^{X, \mathbb{Z}}(\sigma) = \mathcal{N}_p^{\mathbb{Z}}(\sigma)$ is trivial. \square

Lemma 7.3.9. *Let X be an n -dimensional tropical hypersurface in Y with Newton polytope Δ , where Y is either \mathbb{R}^{n+1} or a toric variety generated by the normal fan Σ of Δ , in which case we ask that Δ be full-dimensional and Σ be simplicial unimodular.*

Let $A \in \{\mathbb{Z}, \mathbb{R}\}$. For a face γ of X of sedentarity 0, we have

$$H_q^{BM}(\gamma^\circ; \mathcal{F}_p^{X, A}|_{\gamma^\circ}) = 0$$

for all $q \neq \dim \gamma$.

Proof. Denote by γ_m the unique minimal face of γ° (see Lemma 7.3.2) and suppose it is contained in the stratum Y_{ρ_m} . Let Γ denote the star of γ_m in X_{ρ_m} .

Using the Duality Theorem 3.2.4, we know that there is a cell λ of the subdivision of Δ dual to X such that λ is contained in the relative interior of the face $F(\rho_m)$ of Δ , and such that γ_m is dual to λ .

Then as a polyhedral complex, the star $\Gamma \subset \mathbb{R}^{n+1-\text{sed}(\gamma_m)}$ is, up to $\text{GL}_{n+1-\text{sed}(\gamma_m)}(\mathbb{Z})$, equal to a basic open set of $\Gamma' \times \mathbb{R}^{\dim \gamma_m}$, where Γ' is the tropical hypersurface in $\mathbb{R}^{n+1-\text{sed}(\gamma_m)-\dim \gamma_m}$

dual to the closure of λ (and its face structure). For the notion of basic open set, see [JSS15, Definition 3.7].

Moreover, the star of any other face γ_ρ in γ° is, up to $\mathrm{GL}_{n+1}(\mathbb{Z})$, equal to a basic open set of $\Gamma' \times \mathbb{R}^{\dim \gamma_\rho}$.

Let v be the vertex of Γ' . Then as in Lemma 7.2.1, for any face γ_ρ in γ° , we have

$$\mathcal{F}_p^{X,A}(\gamma_\rho) \cong \bigoplus_{l=0}^p \mathcal{F}_{p-l}^{\Gamma',A}(v) \otimes \bigwedge^l A^{\dim \gamma_\rho}.$$

For each l from 0 to p , let $C_\bullet^{p,l}$ (the coefficients ring A is implicit) denote the chain complex whose terms are

$$C_q^{p,l} = \bigoplus_{\substack{\rho \mid \gamma_\rho \neq \emptyset \\ \mathrm{sed}(\gamma_\rho) = \dim \gamma - q}} \mathcal{F}_{p-l}^{\Gamma',A}(v) \otimes \bigwedge^l A^{\dim \gamma_\rho}.$$

We define the boundary maps of the complex on the direct summands. If $\gamma_{\rho'}$ is a face of γ_ρ , then the map on the direct summand is

$$\mathrm{id} \otimes \pi_{\rho,\rho'}: \mathcal{F}_{p-l}^{\Gamma',A}(v) \otimes \bigwedge^l A^{\dim \gamma_\rho} \rightarrow \mathcal{F}_{p-l}^{\Gamma',A}(v) \otimes \bigwedge^l A^{\dim \gamma_{\rho'}},$$

where $\pi_{\rho,\rho'}: \bigwedge^l A^{\dim \gamma_\rho} \rightarrow \bigwedge^l A^{\dim \gamma_{\rho'}}$ is induced by the projection map

$$\pi_{\rho,\rho'}: T_A(Y_\rho) \rightarrow T_A(Y_{\rho'})$$

from Formula (3.3.1). If $\gamma_{\rho'}$ is not a face of γ_ρ , then the map is 0.

As in Lemma 7.2.1, there are isomorphisms of chain complexes

$$C_\bullet^{BM}(\gamma^\circ; \mathcal{F}_p^{X,A}|_{\gamma^\circ}) \cong \bigoplus_{l=0}^p C_\bullet^{p,l}.$$

By distributivity of tensor products (and because of the definition of $C_\bullet^{BM}(\gamma^\circ; \mathcal{F}_l^{\gamma^\circ,A})$, see the proof of Lemma 7.3.4), we also have the isomorphisms

$$C_\bullet^{p,l} \cong \mathcal{F}_{p-l}^{\Gamma',A}(v) \otimes C_\bullet^{BM}(\gamma^\circ; \mathcal{F}_l^{\gamma^\circ,A}).$$

Moreover, the homology of the chain complex $C_\bullet^{BM}(\gamma^\circ; \mathcal{F}_l^{\gamma^\circ,A})$ vanishes except in degree $q = \dim \gamma$ by Lemma 7.3.4, so we also have $H_q^{BM}(\gamma^\circ; \mathcal{F}_l^{\gamma^\circ,A}) = 0$ for all $q \neq \dim \gamma$. Because the tensor product is right exact, we have $H_q(C_\bullet^{p,l}) = 0$ for $q \neq \dim \gamma$ and all l and p . It now follows that $H_q^{BM}(\gamma^\circ; \mathcal{F}_p^{X,A}|_{\gamma^\circ}) = 0$ for $q \neq \dim \gamma$. \square

Lemma 7.3.10. *Let X be an n -dimensional tropical hypersurface in Y with Newton poly-*

tope Δ , where Y is either \mathbb{R}^{n+1} or a toric variety generated by the normal fan Σ of Δ , in which case we ask that Δ be full-dimensional and Σ be simplicial unimodular.

Let $A \in \{\mathbb{Z}, \mathbb{R}\}$. For a face γ of X of sedentarity 0, we have

$$H_q^{BM}(\gamma^\circ; \mathcal{N}_p^A|_{\gamma^\circ}) = 0$$

for all $q \neq \dim \gamma$.

Proof. The chain groups $C_q^{BM}(\gamma^\circ; \mathcal{N}_p^A|_{\gamma^\circ})$ are all zero for $q > \dim \gamma$, therefore it suffices to prove the vanishing of the homology of the cosheaf $\mathcal{N}_p^A|_{\gamma^\circ}$ in degrees strictly less than $\dim \gamma$. To do this we return to the short exact sequence from Formula (7.3.2), but restricted to γ° , namely

$$0 \rightarrow \mathcal{F}_p^{X,A}|_{\gamma^\circ} \rightarrow \mathcal{F}_p^{Y,A}|_{\gamma^\circ} \rightarrow \mathcal{N}_p^A|_{\gamma^\circ} \rightarrow 0.$$

The idea is to show that the appropriate homology groups of the cosheaves $\mathcal{F}_p^{X,A}|_{\gamma^\circ}$ and $\mathcal{F}_p^{Y,A}|_{\gamma^\circ}$ vanish in order to conclude using a long exact sequence argument.

By Lemma 7.3.9, we have $H_q^{BM}(\gamma^\circ; \mathcal{F}_p^{X,A}|_{\gamma^\circ}) = 0$ for $q < \dim \gamma$.

Next we will show that $H_q^{BM}(\gamma^\circ; \mathcal{F}_p^{Y,A}|_{\gamma^\circ}) = 0$ for $q < \dim \gamma$. By Lemma 7.3.2, there is a unique maximal cone ρ_m in the fan of Y such that $Y_{\rho_m} \cap \gamma^\circ \neq \emptyset$. Let \tilde{Y} be the tropical toric variety of dimension $n+1$ defined by the fan consisting of the single cone ρ_m (and its faces). There is a correspondence between the strata of γ° and the strata of \tilde{Y} , where a q -dimensional stratum σ of γ° corresponds to a $(n+1-\dim \gamma+q)$ -dimensional stratum $\tilde{\sigma}$ of \tilde{Y} . Moreover, under this correspondence we have $\mathcal{F}_p^{Y,A}|_{\gamma^\circ}(\sigma) = \mathcal{F}_p^{\tilde{Y},A}(\tilde{\sigma})$. The cellular chain complex $C_{\bullet}^{BM}(\gamma^\circ; \mathcal{F}_p^{Y,A}|_{\gamma^\circ})$ is isomorphic to the chain complex $C_{\bullet+n+1-\dim \gamma}^{BM}(\tilde{Y}; \mathcal{F}_p^{\tilde{Y},A})$.

By Lemma 7.3.4, we have $H_q^{BM}(\tilde{Y}; \mathcal{F}_p^{\tilde{Y},A}) = 0$ for $q < n+1$ and therefore, it follows that $H_q^{BM}(\gamma^\circ; \mathcal{F}_p^{Y,A}|_{\gamma^\circ}) = 0$ for $q < \dim \gamma$.

Considering the long exact sequence in homology to which the sequence (7.3.2) restricted to γ° gives rise proves that $H_q^{BM}(\gamma^\circ; \mathcal{N}_p^A|_{\gamma^\circ}) = 0$ for all $q \neq \dim \gamma$. \square

7.3.2 The main proof

The major part of the proof of the Lefschetz-like Theorem 7.1.1 is split into Propositions 7.3.11 and 7.3.13 below; the theorem itself then follows easily.

Proposition 7.3.11. *Let X be an n -dimensional tropical hypersurface in Y with Newton polytope Δ , where Y is either \mathbb{R}^{n+1} or a toric variety generated by the normal fan Σ of Δ , in which case we ask that Δ be full-dimensional and Σ be simplicial unimodular.*

Let $A \in \{\mathbb{Z}, \mathbb{R}\}$. Then $H_q^{BM}(Y; \mathcal{Q}_p^A) = 0$ for all $q < n+1$, and therefore the map

$$H_q^{BM}(X; \mathcal{F}_p^{Y,A}|_X) \rightarrow H_q^{BM}(Y; \mathcal{F}_p^{Y,A})$$

is an isomorphism when $q < n$ and a surjection when $q = n$.

If in addition Δ is full-dimensional, then $H_q(Y; \mathcal{Q}_p^A) = 0$ for all $q < n+1$, and therefore the map

$$H_q(X; \mathcal{F}_p^{Y,A}|_X) \rightarrow H_q(Y; \mathcal{F}_p^{Y,A})$$

is an isomorphism when $q < n$ and a surjection when $q = n$.

Remark 7.3.12. Of course, if Δ is full-dimensional and Y comes from the normal fan of Δ , then Y and X are compact, both types of homology groups coincide, and the second part of the statement is an immediate consequence of the first. This remark also applies to the next proposition.

Proof. We consider the polyhedral structure on Y given by refinement by X . For any face σ of Y which is also a face of X , we have $\mathcal{Q}_p^A(\sigma) = 0$. Therefore, we have the following isomorphisms of cellular chain complexes (see Section 3.3):

$$C_{\bullet}^{BM}(Y; \mathcal{Q}_p^A) = \bigoplus_{\sigma \in Y \setminus X} \mathcal{F}_p^{Y,A}(\sigma)$$

and

$$C_{\bullet}(Y; \mathcal{Q}_p^A) = \bigoplus_{\substack{\sigma \in Y \setminus X \\ \sigma \text{ compact}}} \mathcal{F}_p^{Y,A}(\sigma).$$

The complement $Y \setminus X$ consists of connected components each of dimension $n+1$. Each such connected component is equal to γ^o , where γ is a $n+1$ dimensional face of Y with polyhedral structure induced by X . For γ a face of Y of dimension $n+1$, we have the equality of cosheaves $\mathcal{F}_p^{\gamma^o, A} \cong \mathcal{F}_p^{Y,A}|_{\gamma^o}$. Each face σ in $Y \setminus X$ is contained in γ^o for a unique $(n+1)$ -dimensional face γ of Y . Moreover, the boundary of the face σ contained in γ^o is also contained in γ^o . Therefore, the cellular chain complexes for \mathcal{Q}_p^A split and we have the following isomorphisms,

$$C_{\bullet}^{BM}(Y; \mathcal{Q}_p^A) = \bigoplus_{\dim \gamma = n+1} C_{\bullet}^{BM}(\gamma^o; \mathcal{F}_p^{\gamma^o, A})$$

and

$$C_{\bullet}(Y; \mathcal{Q}_p^A) = \bigoplus_{\substack{\dim \gamma = n+1 \\ \gamma \text{ compact}}} C_{\bullet}^{BM}(\gamma^o; \mathcal{F}_p^{\gamma^o, A}).$$

This produces the isomorphism

$$H_q^{BM}(Y; \mathcal{Q}_p^A) = \bigoplus_{\dim \gamma = n+1} H_q^{BM}(\gamma^o; \mathcal{F}_p^{\gamma^o, A}).$$

Moreover, if Δ is full-dimensional and $Y = \mathbb{R}^{n+1}$, the pair (Y, X) is a cellular pair, as proved in Lemma 3.3.6. Hence we know, as explained in Section 3.3, that we have the

following isomorphism as well:

$$H_q(Y; \mathcal{Q}_p^A) = \bigoplus_{\substack{\dim \gamma = n+1 \\ \gamma \text{ compact}}} H_q^{BM}(\gamma^o; \mathcal{F}_p^{\gamma^o, A}).$$

If Δ is full-dimensional and Y is generated by Σ , both complexes coincides and this is trivial, as noted in Remark 7.3.12.

It follows from Lemma 7.3.4 that $H_q^{BM}(\gamma^o; \mathcal{F}_p^{\gamma^o, A}) = 0$ if $q \neq n+1$, and we obtain that $H_q^{BM}(Y; \mathcal{Q}_p^A) = 0$ for all $q < n+1$ (and $H_q(Y; \mathcal{Q}_p^A) = 0$ for all $q < n+1$ if Δ is full-dimensional).

A direct comparison of the respective chain complexes gives isomorphisms $H_q^{BM}(Y; \mathcal{F}_p^{Y, A}|_X) \cong H_q^{BM}(X; \mathcal{F}_p^{Y, A}|_X)$ (and $H_q(Y; \mathcal{F}_p^{Y, A}|_X) \cong H_q(X; \mathcal{F}_p^{Y, A}|_X)$ if Δ is full-dimensional). Lastly, combining this with the long exact sequence in homology associated to the short exact sequence (7.3.1) and the vanishing of $H_q^{BM}(Y; \mathcal{Q}_p^A)$ (and $H_q(Y; \mathcal{Q}_p^A)$ if Δ is full-dimensional) for all $q < n+1$ allows us to finish. \square

Proposition 7.3.13. *Let X be an n -dimensional tropical hypersurface in Y with Newton polytope Δ , where Y is either \mathbb{R}^{n+1} or a toric variety generated by the normal fan Σ of Δ , in which case we ask that Δ be full-dimensional and Σ be simplicial unimodular.*

Then

$$H_q^{BM}(X; \mathcal{N}_p^{\mathbb{R}}) = 0$$

for all $p+q \leq n$, and therefore the map

$$H_q^{BM}(X; \mathcal{F}_p^{X, \mathbb{R}}) \rightarrow H_q^{BM}(X; \mathcal{F}_p^{Y, \mathbb{R}}|_X)$$

is an isomorphism when $p+q < n$ and a surjection when $p+q = n$.

Moreover, if Δ is full-dimensional, then $H_q(X; \mathcal{N}_p^{\mathbb{R}}) = 0$ for all $p+q \leq n$, and therefore the map

$$H_q(X; \mathcal{F}_p^{X, \mathbb{R}}) \rightarrow H_q(X; \mathcal{F}_p^{Y, \mathbb{R}}|_X)$$

is an isomorphism when $p+q < n$ and a surjection when $p+q = n$.

Additionally, if X is non-singular, the same two statements hold with coefficients in \mathbb{Z} instead of \mathbb{R} .

Proof. By Lemma 7.3.8, for a face σ of dimension q and sedentarity k , we have $\mathcal{N}_p^{\mathbb{R}}(\sigma) = 0$ if $k \leq n-q-p$, and $\mathcal{N}_p^{\mathbb{Z}}(\sigma) = 0$ if $k \leq n-q-p$ and X is non-singular. This is in fact the only point where the non-singularity of X is directly used when considering coefficients in \mathbb{Z} . For the remainder of the proof, A is implicitly meant to be either \mathbb{R} , or \mathbb{Z} with the assumption that X is non-singular.

Moreover, there are no faces of X of dimension q and which have order of sedentarity strictly greater than $n-q$ (as Y is either \mathbb{R}^{n+1} or generated by the normal fan of Δ , in

which case the Duality Theorem 3.2.4 applies). Therefore, the Borel-Moore cellular chain groups with coefficients in \mathcal{N}_p^A can be written as

$$C_q^{BM}(X; \mathcal{N}_p^A) := \bigoplus_{k=\max\{0, n-q-p+1\}}^{n-q} \bigoplus_{\substack{\dim \sigma=q \\ \text{sed}(\sigma)=k}} \mathcal{N}_p^A(\sigma).$$

Perform the change of variables $k + q = m$:

$$C_q^{BM}(X; \mathcal{N}_p^A) := \bigoplus_{m=\max\{q, n-p+1\}}^n \bigoplus_{\substack{\dim \sigma=q \\ \text{sed}(\sigma)=m-q}} \mathcal{N}_p^A(\sigma). \quad (7.3.4)$$

As in the proof of Proposition 7.3.11, if in addition Δ is full-dimensional, then (Y, X) is a cellular pair, the cellular chain complexes compute the standard homology of X and we also have the isomorphism

$$C_q(X; \mathcal{N}_p^A) := \bigoplus_{m=\max\{q, n-p+1\}}^n \bigoplus_{\substack{\dim \sigma=q \\ \text{sed}(\sigma)=m-q \\ \sigma \text{ compact}}} \mathcal{N}_p^A(\sigma). \quad (7.3.5)$$

We now filter the cellular chain complexes for \mathcal{N}_p^A using the order of sedentarity of faces. Set

$$C_{q,m}^{BM}(X; \mathcal{N}_p^A) := \bigoplus_{\substack{\dim \sigma=q \\ \text{sed}(\sigma) \leq m-q}} \mathcal{N}_p^A(\sigma) \quad \text{and} \quad C_{q,m}(X; \mathcal{N}_p^A) := \bigoplus_{\substack{\dim \sigma=q \\ \text{sed}(\sigma) \leq m-q \\ \sigma \text{ compact}}} \mathcal{N}_p^A(\sigma).$$

Notice that $C_{q,m}^\blacksquare(X; \mathcal{N}_p^A) \subset C_{q,m+1}^\blacksquare(X; \mathcal{N}_p^A)$, where the \blacksquare in the exponent denotes either Borel-Moore or standard homology (with it being implied that we only consider standard homology when Δ is full-dimensional).

As the Duality Theorem 3.2.4 applies, the boundary operator can only increase the order of sedentarity by at most 1. Therefore,

$$\partial C_{q,m}^\blacksquare(X; \mathcal{N}_p^A) \subset C_{q-1,m}^\blacksquare(X; \mathcal{N}_p^A),$$

and there is a filtration of the chain complex $C_\bullet^\blacksquare(X; \mathcal{N}_p^A)$ by successive chain complexes:

$$C_\bullet^\blacksquare(X; \mathcal{N}_p^A) = C_{\bullet,n}^\blacksquare(X; \mathcal{N}_p^A) \supset C_{\bullet,n-1}^\blacksquare(X; \mathcal{N}_p^A) \supset \cdots \supset C_{\bullet,\tilde{m}}^\blacksquare(X; \mathcal{N}_p^A) \supset 0,$$

where $\tilde{m} = \max\{q, n - p + 1\}$. The first and last terms of the filtration come from the bounds on the direct sum in Equations (7.3.4) and (7.3.5).

The spectral sequence associated to this filtration (see for example A. Fomenko and

D. Fuchs' textbook [FF16] for more details on such constructions) for the Borel-Moore complex has 0-th page consisting of the terms

$$E_{q,m}^0 \cong \bigoplus_{\substack{\dim \sigma = q \\ \text{sed}(\sigma) = m - q}} \mathcal{N}_p^A(\sigma). \tag{7.3.6}$$

The differentials $\partial_0: E_{q,m}^0 \rightarrow E_{q-1,m}^0$ are induced by the usual cellular differentials. The complex $E_{\bullet,m}^0$ is then

$$0 \rightarrow E_{m,m}^0 \rightarrow E_{m-1,m}^0 \rightarrow \cdots \rightarrow E_{1,m}^0 \rightarrow E_{0,m}^0 \rightarrow 0.$$

Notice that the differential ∂_0 decreases the dimension of the cells by one and also increases the sedentarity of the cells by one. A q -dimensional face of sedentarity $m - q$ is in the boundary of a unique face γ of X of dimension m and sedentarity 0 (see the Duality Theorem 3.2.4). Moreover, the differential ∂_0 is defined on the direct summands from Equation (7.3.6) and it restricts to a non-zero map $\mathcal{N}_p^A(\sigma) \rightarrow \mathcal{N}_p^A(\sigma')$ only if σ and σ' are contained in the same m -dimensional sedentarity 0 face γ of X . In this case, the map $\mathcal{N}_p^A(\sigma) \rightarrow \mathcal{N}_p^A(\sigma')$ is the same as the one defined in (7.3.3) for the complex $C_{\bullet}^{BM}(\gamma^\circ; \mathcal{N}_p^A|_{\gamma^\circ})$. Therefore, we have an isomorphism of complexes for every m :

$$E_{\bullet,m}^0 = \bigoplus_{\substack{\dim \gamma = m \\ \text{sed}(\gamma) = 0}} C_{\bullet}^{BM}(\gamma^\circ; \mathcal{N}_p^A|_{\gamma^\circ}).$$

By Lemma 7.3.10, for a face γ of dimension m and sedentarity 0, we have $H_q^{BM}(\gamma^\circ; \mathcal{N}_p^A|_{\gamma^\circ}) = 0$ for $q \neq m$, and the first page of the spectral sequence associated to the filtration under consideration satisfies $E_{q,m}^1 = 0$ if $q \neq m$. Moreover, for $m \leq n - p$, the entire complex $E_{\bullet,m}^0$ is 0 by definition of the filtration, so $E_{q,m}^1 = 0$ for all q when $m \leq n - p$.

Therefore, the spectral sequence $E_{\bullet,\bullet}^r$ satisfies $E_{q,m}^r = 0$ for any $r \geq 1$ and $q \leq n - p$. Since $E_{\bullet,\bullet}^r$ converges, we conclude that $H_q^{BM}(X; \mathcal{N}_p^A) = 0$ for $p + q \leq n$.

The reasoning is the same for $H_q(X; \mathcal{N}_p^A)$, under the assumption that Δ is full-dimensional: consider the spectral sequence associated to the filtration of the chain complex for the standard homology. The first page of this spectral sequence has terms like in Equation (7.3.6), except that the sum is taken over the faces σ which are compact.

In order to proceed with a similar argument to that used for Borel-Moore homology, we use the fact that if σ is compact (and thus appears in the sum), then the unique face γ of X of sedentarity 0 which contains σ is also compact (and hence also appears in the sum). This is true, as Y is either compact (in which case the statement is trivial), or equal to \mathbb{R}^{n+1} , in which case there are only cells of sedentarity 0 and σ is equal to γ (and the statement is once again trivial). The rest of the argument is then the same as in the case of the Borel-Moore homology, except that we only consider compact faces of X .

To complete the proof of the proposition, consider the long exact sequence in homology associated to the short exact sequence in (7.3.2). Applying the vanishing statements for $H_q^{BM}(X; \mathcal{N}_p^A)$ gives the isomorphisms $H_q^{BM}(X; \mathcal{F}_p^{X,A}) \cong H_q^{BM}(Y; \mathcal{F}_p^{Y,A})$ for all $p + q < n$. This completes the proof. \square

We can now prove the following Theorem, which contains the statements of the Lefschetz-type Corollaries 7.1.2, 7.1.3, 7.1.4 and 7.1.5 as sub-cases.

Theorem 7.1.1. *Let X be an n -dimensional tropical hypersurface in Y with Newton polytope Δ , where Y is either \mathbb{R}^{n+1} or a tropical toric variety generated by the normal fan Σ of Δ , in which case we ask that Δ be full-dimensional and Σ be simplicial unimodular.*

Then the map induced by inclusion

$$i_* : H_q^{BM}(X; \mathcal{F}_p^{X,\mathbb{R}}) \rightarrow H_q^{BM}(Y; \mathcal{F}_p^{Y,\mathbb{R}})$$

is an isomorphism when $p + q < n$ and a surjection when $p + q = n$.

Moreover, if Δ is full-dimensional, then the map induced by inclusion

$$i_* : H_q(X; \mathcal{F}_p^{X,\mathbb{R}}) \rightarrow H_q(Y; \mathcal{F}_p^{Y,\mathbb{R}})$$

is an isomorphism when $p + q < n$ and a surjection when $p + q = n$.

Additionally, if X is non-singular, the same two statements hold with coefficients in \mathbb{Z} instead of \mathbb{R} .

Proof. This is a direct consequence of Propositions 7.3.11 and 7.3.13. \square

7.4 Torsion-freeness

We start this section with the proof of Proposition 7.1.6, which we state again below.

We only consider tropical (co)homology with coefficients in \mathbb{Z} in this section; hence, we omit to specify the coefficients ring.

For a non-singular compact complex toric variety $\mathbb{C}Y$, we let $h^{p,q}(\mathbb{C}Y)$ denote its (p, q) -th Hodge number. Recall that $h^{p,q}(\mathbb{C}Y) = 0$ if $p \neq q$ and the numbers $h^{p,p}(\mathbb{C}Y)$ form the toric h -vector of the full-dimensional simple polytope Δ whose normal fan is the fan defining $\mathbb{C}Y$ (see [Ful93, Section 5.2]).

Proposition 7.1.6. *Let Y be a $(n + 1)$ -dimensional non-singular compact tropical toric variety. Then the integral tropical homology groups of Y are torsion-free.*

Moreover, we have

$$\text{rank } H_q(Y; \mathcal{F}_p^Y) = h^{p,q}(\mathbb{C}Y)$$

where $\mathbb{C}Y$ is the corresponding non-singular compact complex toric variety (i.e. they are defined using the same simplicial unimodular complete fan). In particular, we have $H_q(Y; \mathcal{F}_p^Y) = 0$ unless $p = q$.

Proof. As Y is compact, standard and Borel-Moore homology groups coincide. For the duration of this proof, and unlike in the previous sections, we switch to computing the cellular homology groups of Y using the polyhedral structure on Y which is dual to the polyhedral structure on the defining fan Σ (instead of the structure induced by some hypersurface X).

Let us first show that $H_q(Y; \mathcal{F}_p^Y) = 0$ for all $p > q$. Notice that every stratum \overline{Y}_σ is compact (those strata make up the cell structure on Y). With this cellular structure on Y , a face \overline{Y}_σ of dimension q has sedentarity order $n + 1 - q$. By definition, we have that $\mathcal{F}_p^Y(\overline{Y}_\sigma) = \bigwedge^p \mathcal{F}_1^Y(\overline{Y}_\sigma)$ where $\dim \mathcal{F}_1^Y(\overline{Y}_\sigma) = q$. Therefore, we have $\mathcal{F}_p^Y(\overline{Y}_\sigma) = 0$ if $p > q$. Hence the chain groups $C_q(Y; \mathcal{F}_p^Y)$ are equal to zero for any $q < p$, which implies that $H_q(Y; \mathcal{F}_p^Y) = 0$ for $q < p$.

As noted in Subsection 3.3.2, the tropical cohomology groups are the cohomology of the complex dual to the tropical cellular cosheaf complex (i.e. $C^q(X, \mathcal{F}_X^p) \cong \text{Hom}(C_q(X, \mathcal{F}_X^p), \mathbb{Z})$). Therefore, we can apply the universal coefficient theorem for cohomology (see [Hat02, Theorem 3.2]) to get the exact sequence

$$0 \rightarrow \text{Ext}(H_q(Y; \mathcal{F}_p^Y), \mathbb{Z}) \rightarrow H^{q+1}(Y; \mathcal{F}_p^Y) \rightarrow \text{Hom}(H_{q+1}(Y; \mathcal{F}_p^Y), \mathbb{Z}) \rightarrow 0. \quad (7.4.1)$$

When $q < p$, we have $H_q(Y; \mathcal{F}_p^Y) = 0$, hence

$$H^{q+1}(Y; \mathcal{F}_p^Y) \cong \text{Hom}(H_{q+1}(Y; \mathcal{F}_p^Y), \mathbb{Z}).$$

This means that $H^{\tilde{q}}(Y; \mathcal{F}_p^Y)$ is torsion-free for all $\tilde{q} \leq p$, and equal to 0 for all $\tilde{q} < p$.

The tropical toric variety Y is a tropical manifold, thus Poincaré duality for tropical homology with integral coefficients (see Theorem 3.3.7) states that

$$H^{\tilde{q}}(Y; \mathcal{F}_p^Y) \cong H_{n+1-\tilde{q}}(Y; \mathcal{F}_{n+1-p}^Y)$$

for all \tilde{q} and p . This shows that $H_{n+1-\tilde{q}}(Y; \mathcal{F}_{n+1-p}^Y)$ is torsion free if $\tilde{q} \leq p$ (which is equivalent to $n + 1 - \tilde{q} \geq n + 1 - p$) and is trivial if $\tilde{q} < p$ (which is equivalent to $n + 1 - \tilde{q} > n + 1 - p$).

We have shown that $H_q(Y; \mathcal{F}_p^Y)$ is torsion free for all p, q , and trivial if $p \neq q$.

We also have

$$\chi(C_\bullet(Y; \mathcal{F}_p^Y)) := \sum_{q=0}^{n+1} (-1)^q \text{rank } C_q(Y; \mathcal{F}_p^Y) = (-1)^p \text{rank } H_p(Y; \mathcal{F}_p^Y).$$

Let f_q denote the number of strata of Y of dimension q ; (f_0, \dots, f_{n+1}) is then the

f -vector of a polytope Δ whose normal fan Σ is the fan defining Y . For every p and q , we have $\text{rank } C_q(Y; \mathcal{F}_p^Y) = \binom{q}{p} f_q$. Therefore,

$$\chi(C_\bullet(Y; \mathcal{F}_p^Y)) := \sum_{q=0}^{n+1} (-1)^q \binom{q}{p} f_q = (-1)^p h_p,$$

where (h_0, \dots, h_{n+1}) is the h -vector of the simple polytope Δ . By [Ful93, Section 5.2], we have $h_p = \dim H^{2p}(\mathbb{C}Y) = h^{p,p}(\mathbb{C}Y)$, which completes the proof. \square

Remark 7.4.1. *We needed Y to be compact so that it is automatically a cell complex (in the sense defined in Section 3.3), in order to compute its homology using its strata as cells. In fact, it should be possible to show that any non-singular tropical toric variety Y whose generating fan is full-dimensional (without necessarily being complete) is a cell complex; the proof would then be the same, showing that the tropical homology of Y is torsion-free.*

We can now move on to the torsion-freeness of the tropical homology of hypersurfaces in toric varieties, and prove Theorem 7.1.7.

Proposition 7.1.7. *Let X be a non-singular n -dimensional tropical hypersurface in Y with Newton polytope Δ , where Y is either \mathbb{R}^{n+1} or a toric variety generated by the normal fan Σ of Δ , in which case we ask that Δ be full-dimensional and that Σ be simplicial unimodular.*

Then both the Borel-Moore and standard integral tropical homology groups of X are torsion free.

Proof. Suppose first that the Newton polytope Δ of X is full-dimensional. Then both the standard and Borel-Moore tropical homology of Y is torsion-free, as Y is either \mathbb{R}^{n+1} or compact (as the dual fan of Δ gives rise to Y), in which case Proposition 7.1.6 applies.

Under that assumption, X is a cell complex in the sense of Section 3.3, and we can use its cell structure to compute its standard tropical homology.

By applying the Lefschetz-like Theorem 7.1.1 and using the torsion-freeness of the tropical Borel-Moore homology of Y , we directly get that $H_q^{BM}(X; \mathcal{F}_p^X)$ is torsion-free for $p + q < n$.

As noted in Subsection 3.3.2, the tropical cohomology groups are the cohomology of the complex dual to the tropical cellular cosheaf complexes. By the universal coefficients theorem for cohomology (see [Hat02, Theorem 3.2]), we then have for every p and q the following short exact sequence:

$$0 \rightarrow \text{Ext}(H_{n-q-1}(X; \mathcal{F}_{n-p}^X), \mathbb{Z}) \rightarrow H^{n-q}(X; \mathcal{F}_X^{n-p}) \rightarrow \text{Hom}(H_{n-q}(X; \mathcal{F}_{n-p}^X), \mathbb{Z}) \rightarrow 0.$$

If $p + q \geq n$, then $2n - p - q - 1 < n$, and it follows from the Lefschetz-like Theorem 7.1.1 that

$$H_{n-q-1}(X; \mathcal{F}_{n-p}^X) \cong H_{n-q-1}(Y, \mathcal{F}_{n-p}^Y).$$

Since we know $H_{n-q-1}(Y; \mathcal{F}_{n-p}^Y)$ to be a free \mathbb{Z} -module, this means that $\text{Ext}(H_{n-q-1}(X; \mathcal{F}_{n-p}^X), \mathbb{Z})$ is trivial. We also know that the \mathbb{Z} -module $\text{Hom}(H_{n-q}(X; \mathcal{F}_{n-p}^X), \mathbb{Z})$ is free, as it consists of maps to a free module. Therefore, for all $p + q \geq n$ we have

$$H^{n-q}(X; \mathcal{F}_X^{n-p}) \cong \text{Hom}(H_{n-q}(X; \mathcal{F}_{n-p}^X), \mathbb{Z})$$

and $H^{n-q}(X; \mathcal{F}_X^{n-p})$ is torsion free. The tropical hypersurface X is a non-singular tropical manifold, so by Poincaré duality for tropical homology with integral coefficients (see Theorem 3.2.4), we have

$$H^{n-q}(X; \mathcal{F}_X^{n-p}) \cong H_q^{BM}(X; \mathcal{F}_p^X)$$

for all p, q . This, combined with the torsion freeness of $H^{n-q}(X; \mathcal{F}_X^{n-p})$ established above, proves that $H_q^{BM}(X; \mathcal{F}_p^X)$ is torsion free for all $p + q \geq n$, and thus for all p, q .

Using Poincaré duality again, we see then that the standard tropical cohomology groups of X are all torsion-free. By considering once more the same short exact sequence from the universal coefficients theorem as above, we can conclude that the standard tropical homology groups of X are all torsion-free, which is what had to be proved.

Suppose now that the Newton polytope Δ of X is not full-dimensional, but rather of dimension $n + 1 - k$. By our hypotheses, Y must then be equal to \mathbb{R}^{n+1} . Then X is isomorphic to $\tilde{X} \times \mathbb{R}^k$, where \tilde{X} is some non-singular $(n - k)$ -dimensional tropical hypersurface \tilde{X} in \mathbb{R}^{n+1-k} whose Newton polytope is full-dimensional in \mathbb{R}^{n+1-k} (this can be seen with the Duality Theorem 3.2.4). We know that the tropical homology of \tilde{X} is torsion-free from what is above; using Künneth's formula for tropical homology (see [GS19]), we can conclude that so is the tropical homology of X .

□

7.5 Computations with the χ_y genus

In this section, we prove Theorem 7.1.8 and Corollaries 7.1.9 and 7.1.10.

The k -compactly supported cohomology group $H_c^k(\mathbb{C}X)$ of a complex hypersurface $\mathbb{C}X \subset (\mathbb{C}^*)^{n+1}$ carries a mixed Hodge structure (see [DK86]).

The numbers $e_c^{p,q}(\mathbb{C}X)$ are defined to be

$$e_c^{p,q}(\mathbb{C}X) := \sum_k (-1)^k h^{p,q}(H_c^k(\mathbb{C}X)),$$

where $h^{p,q}(H_c^k(\mathbb{C}X))$ denotes the Hodge-Deligne numbers of $\mathbb{C}X$.

The numbers $e_c^{p,q}(\mathbb{C}X)$ are the coefficients of the E -polynomial of $\mathbb{C}X$,

$$E(\mathbb{C}X; u, v) := \sum_{p,q} e_c^{p,q}(\mathbb{C}X) u^p v^q.$$

This polynomial has nice additive properties; see Danilov and Khovanskii's [DK86] for more details and useful results. The χ_y genus of $\mathbb{C}X$ is defined to be

$$\chi_y(\mathbb{C}X) = E(\mathbb{C}X; y, 1) := \sum_{p,q} e_c^{p,q}(\mathbb{C}X) y^p.$$

We first prove the following lemma.

Lemma 7.5.1. *Let X be a non-singular tropical hypersurface in a tropical toric variety Y . Let σ be a face of X of dimension q whose relative interior is contained in a stratum Y_ρ of dimension m . Then the polynomial defined by*

$$\chi_\sigma(\lambda) := \sum_{p=0}^n (-1)^p \text{rank } \mathcal{F}_p^X(\sigma) \lambda^p.$$

is

$$\chi_\sigma(\lambda) = (1 - \lambda)^m - (1 - \lambda)^q (-\lambda)^{m-q}.$$

Proof. Using the isomorphism in Lemma 7.2.1, we know that

$$\mathcal{F}_p^X(\sigma) \cong \bigoplus_{l=0}^p \mathcal{F}_{p-l}^{H_{m-q-1}}(v) \otimes \bigwedge^l T_{\mathbb{Z}}(\sigma),$$

where v is the central vertex of the standard $(m - q - 1)$ -dimensional tropical hyperplane H_{m-q-1} .

We know that $\text{rank } \bigwedge^l T_{\mathbb{Z}}(\sigma)$ is equal to $\binom{q}{l}$, and that as noted in Example 3.3.3, the rank of $\mathcal{F}_{p-l}^{H_{m-q-1}}(v)$ is $\binom{m-q}{p-l}$ if $p - l < m - q$, and 0 otherwise.

This means that

$$\sum_{k=0}^n (-1)^k \text{rank } \mathcal{F}_k^{H_{m-q-1}}(v) \lambda^k = (1 - \lambda)^{m-q} - (-\lambda)^{m-q},$$

and similarly that

$$\sum_{p=0}^n (-1)^p \text{rank} \left(\bigwedge^k T_{\mathbb{Z}}(\sigma) \right) \lambda^k = (1 - \lambda)^q.$$

Hence we obtain by tensorization that

$$\chi_\sigma(\lambda) = \sum_{p=0}^n (-1)^p \text{rank } \mathcal{F}_p^X(\sigma) \lambda^p = \sum_{p=0}^n (-1)^p \left[\sum_{k=0}^p \text{rank} \left(\mathcal{F}_{p-k}^{H_{m-q-1}}(v) \right) \cdot \text{rank} \left(\bigwedge^k T_{\mathbb{Z}}(\sigma) \right) \right] \lambda^p =$$

$$(1 - \lambda)^q [(1 - \lambda)^{m-q} - (-\lambda)^{m-q}],$$

which allows us to conclude □

We can now prove Theorem 7.1.8, which we first state again.

Theorem 7.1.8. *Let X be a non-singular tropical hypersurface in a tropical toric variety Y , and let $\mathbb{C}X$ be a complex hypersurface torically non-degenerate in a complex toric variety $\mathbb{C}Y$ such that the tropical, respectively complex polynomials defining X and $\mathbb{C}X$ have the same full-dimensional Newton polytope Δ . Moreover, let Y and $\mathbb{C}Y$ be either \mathbb{R}^{n+1} and $(\mathbb{C}^*)^{n+1}$, or a tropical, respectively complex $(n + 1)$ -dimensional non-singular toric varieties defined using the normal fan of Δ (in which case we ask that it be simplicial and unimodular).*

Then we have

$$\chi_y(\mathbb{C}X) = \sum_{p=0}^n (-1)^p \chi(C_{\bullet}^{BM}(X; \mathcal{F}_p^X)) y^p,$$

and thus

$$(-1)^p \chi(C_{\bullet}^{BM}(X; \mathcal{F}_p^X)) = \sum_q e_c^{p,q}(\mathbb{C}X).$$

Proof. First, consider the case where Y , respectively $\mathbb{C}Y$, are not equal to \mathbb{R}^{n+1} , respectively $(\mathbb{C}^*)^{n+1}$.

The variety $\mathbb{C}X$ is stratified by its intersection with the open torus orbits of $\mathbb{C}Y$. Moreover, the numbers $e_c^{p,q}(\mathbb{C}X)$ are additive along strata by [DK86, Proposition 1.6]. So we have

$$\sum_q e_c^{p,q}(\mathbb{C}X) = \sum_{\rho} \sum_q e_c^{p,q}(\mathbb{C}X_{\rho})$$

for $\mathbb{C}X = \sqcup_{\rho} \mathbb{C}X_{\rho}$, where $\mathbb{C}X_{\rho} := \mathbb{C}X \cap \mathbb{C}Y_{\rho}$ and $\mathbb{C}Y_{\rho}$ is the open torus orbit corresponding to the cone ρ of the fan Σ defining Y and $\mathbb{C}Y$.

The tropical hypersurface X admits a stratification analogous to that of $\mathbb{C}X$, with $X_{\rho} = X \cap Y_{\rho}$ corresponding to $\mathbb{C}X_{\rho}$. The Euler characteristics of the chain complexes for cellular tropical Borel-Moore homology of X satisfy the same additivity property. Namely,

$$\chi(C_{\bullet}^{BM}(X; \mathcal{F}_p^X)) = \sum_{\rho} \chi(C_{\bullet}^{BM}(X_{\rho}; \mathcal{F}_p^{X_{\rho}})).$$

Moreover, for any face ρ of the fan Σ defining Y and $\mathbb{C}Y$ (if they are not the tropical, respectively algebraic torus), the fact that X and $\mathbb{C}X$ have the same Newton polytope implies that $\mathbb{C}X_{\rho}$ and X_{ρ} do as well; their Newton polytope is the face of the initial Newton polytope Δ that is dual to ρ , and $\mathbb{C}X_{\rho}$, X_{ρ} , $\mathbb{C}Y_{\rho} \cong (\mathbb{C}^*)^{n+1-\dim \rho}$ and $Y_{\rho} \cong \mathbb{R}^{n+1-\dim \rho}$ also satisfy the hypotheses of the theorem.

Therefore, it suffices to prove the statement for $Y = \mathbb{R}^{n+1}$ and $\mathbb{C}Y = (\mathbb{C}^*)^{n+1}$, and the case where Y and $\mathbb{C}Y$ are compact can then be recovered by summing over their strata.

We now assume that X is in \mathbb{R}^{n+1} and $\mathbb{C}X$ is in $(\mathbb{C}^*)^{n+1}$. In [KS16, Section 5.2], Katz and Stapledon give a formula for the χ_y genus of a torically non-degenerate hypersurface in the torus. Their formula utilizes convex subdivisions of polytopes to refine the formula in terms of Newton polytopes of Danilov and Khovanskii [DK86]. Note that they use the term "schön" to describe what we call "torically non-degenerate". Let Δ be the Newton polytope for $\mathbb{C}X$, and $\tilde{\Delta}$ a convex subdivision (as defined in Chapter 2) of the lattice polytope Δ (this subdivision needs not, in general, be a primitive triangulation). Then the formula is

$$\chi_y(\mathbb{C}X) = \sum_{\substack{F \in \tilde{\Delta} \\ F \not\subset \partial\Delta}} \chi_y(\mathbb{C}X_F) (-1)^{n+1-\dim F}, \quad (7.5.1)$$

where $\mathbb{C}X_F$ is the hypersurface in the torus $(\mathbb{C}^*)^{n+1}$ defined by the polynomial obtained by restricting the polynomial defining $\mathbb{C}X$ to the monomials corresponding to the lattice points in the face F of $\tilde{\Delta}$, and $\partial\Delta$ is the boundary of Δ in \mathbb{R}^{n+1} . Notice that our description of $\mathbb{C}X_F$ differs from the one in [KS16] up to the direct product with a torus (hence also the sign $(-1)^{n+1-\dim F}$).

In our case, $\tilde{\Delta}$ is the subdivision induced by the tropical polynomial which gives rise to X . In particular, it is a primitive triangulation of Δ . Then for each face F of $\tilde{\Delta}$, the variety $\mathbb{C}X_F$ is the complement of a hyperplane arrangement. By either [Sha93] or [DK86], we can see that its mixed Hodge structure is pure and that $\chi_y(\mathbb{C}X_F) = \sum_p (-1)^{n+p} \dim H_c^{n+p}(\mathbb{C}X_F) y^p$.

In fact, this hyperplane arrangement complement is $\mathcal{C}_{n-q} \times (\mathbb{C}^*)^q$, where $\dim F = n+1-q$ and \mathcal{C}_{n-q} is the complement of $n+2-q$ generic hyperplanes in $\mathbb{C}\mathbb{P}^{n-q}$. Using [Zha13], we see that we have $\dim H_c^{n+p}(\mathbb{C}X_F) = \dim H_{n-p}(\mathbb{C}X_F) = \text{rank } \mathcal{F}_{n-p}^X(\sigma_F)$, where σ_F is the q -dimensional face of the tropical hypersurface X dual to F .

Therefore, we get that

$$\begin{aligned} \chi_y(\mathbb{C}X_F) &= \sum_p (-1)^{n+p} \dim H_c^{n+p}(\mathbb{C}X_F) y^p = y^n \sum_p (-1)^{n-p} \text{rank } \mathcal{F}_{n-p}^X(\sigma_F) y^{p-n} = \\ &= y^n \sum_p (-1)^p \text{rank } \mathcal{F}_p^X(\sigma_F) (y^{-1})^p = y^n (1-y^{-1})^q [(1-y^{-1})^{n+1-q} - (-y^{-1})^{n+1-q}] = \\ &= y^{-1} (y-1)^q [(y-1)^{n+1-q} - (-1)^{n+1-q}], \end{aligned}$$

using Lemma 7.5.1. Hence $\chi_y(\mathbb{C}X_F)$ only depends on the dimension of F . We can express Equation (7.5.1) in terms of the f -vector of bounded faces of X . Namely,

$$\chi_y(\mathbb{C}X) = \sum_{q=0}^n (-1)^q y^{-1} (y-1)^q [(y-1)^{n+1-q} - (-1)^{n+1-q}] f_q^b, \quad (7.5.2)$$

where f_q^b denotes the number of bounded faces of X of dimension q , as a face F of the triangulation $\tilde{\Delta}$ is contained in the boundary $\partial\Delta$ if and only if the face σ_F of X dual to it

is unbounded (see the Duality Theorem 3.2.4).

On the other hand, we can compute the Euler characteristics of the Borel-Moore chain complexes

$$\chi(C_{\bullet}^{BM}(X; \mathcal{F}_p^X)) = \sum_{\tau \in X} (-1)^{\dim \tau} \operatorname{rank} \mathcal{F}_p^X(\tau). \quad (7.5.3)$$

The star of a face τ of X is a basic open subset and satisfies Poincaré duality from [JRS17]. Therefore, we have

$$\begin{aligned} \operatorname{rank} \mathcal{F}_p^X(\tau) &= \operatorname{rank} H_0(\operatorname{star}(\tau); \mathcal{F}_p^X) = \operatorname{rank} H_c^n(\operatorname{star}(\tau); \mathcal{F}_X^{n-p}) \\ &= \sum_{q=0}^n \sum_{\sigma \supset \tau, \dim \sigma = q} (-1)^{n-q} \operatorname{rank} \mathcal{F}_{n-p}^X(\sigma). \end{aligned}$$

since $\operatorname{rank} \mathcal{F}_X^{n-p}(\sigma) = \operatorname{rank} \mathcal{F}_{n-p}^X(\sigma)$ (the last equality comes from considering the Euler characteristics of the compactly supported cohomology of $\operatorname{star}(\tau)$, whose only non-trivial group is in degree n). Combining this with 7.5.3 and swapping the order of the sum, we obtain

$$\chi(C_{\bullet}^{BM}(X; \mathcal{F}_p^X)) = \sum_{\tau \in X} (-1)^{\dim \tau} \operatorname{rank} \mathcal{F}_p^X(\tau) = \sum_{\sigma \in X} (-1)^{n-\dim \sigma} \operatorname{rank} \mathcal{F}_{n-p}^X(\sigma) \sum_{\tau \subset \sigma} (-1)^{\dim \tau}.$$

If σ is a bounded face of X , then $\sum_{\tau \subset \sigma} (-1)^{\dim \tau} = 1$, as we are computing the classical Euler characteristic of a contractible space. If σ is an unbounded face of X , then $\sum_{\tau \subset \sigma} (-1)^{\dim \tau} = 0$, since the one-point compactification of σ is homomorphic to a closed ball (X is a cell complex because Δ is full-dimensional, as in Section 7.3), and $\sum_{\tau \subset \sigma} (-1)^{\dim \tau}$ is equal to the Euler characteristic of the one-point compactification minus 1.

Therefore, the sum in Equation (7.5.3) becomes

$$\chi(C_{\bullet}^{BM}(X; \mathcal{F}_p^X)) = \sum_{\substack{\tau \in X \\ \tau \text{ bounded}}} (-1)^{n-\dim \tau} \operatorname{rank} \mathcal{F}_{n-p}^X(\tau).$$

For a face τ of dimension q , we have as before

$$\begin{aligned} \sum_p (-1)^p \operatorname{rank} \mathcal{F}_{n-p}^X(\tau) y^p &= (-1)^n y^n \sum_p (-1)^{n-p} \operatorname{rank} \mathcal{F}_{n-p}^X(\tau) y^{n-p} = \\ &= (-1)^n y^n (1 - y^{-1})^q [(1 - y^{-1})^{n+1-q} - (-y^{-1})^{n+1-q}] = (-1)^n y^{-1} (y - 1)^q [(y - 1)^{n+1-q} - (-1)^{n+1-q}] \end{aligned}$$

using Lemma 7.5.1.

We can now compare this with Equation (7.5.2), and see that

$$\sum_p (-1)^p \chi(C_{\bullet}^{BM}(X; \mathcal{F}_p^X)) y^p = \sum_p \sum_{\substack{\tau \in X \\ \tau \text{ bounded}}} (-1)^{n-\dim \tau} (-1)^p \operatorname{rank} \mathcal{F}_{n-p}^X(\tau) y^p =$$

$$\begin{aligned}
& \sum_{\substack{\tau \in X \\ \tau \text{ bounded}}} (-1)^{n-\dim \tau} \left(\sum_p (-1)^p \operatorname{rank} \mathcal{F}_{n-p}^X(\tau) y^p \right) = \\
& \sum_{\substack{\tau \in X \\ \tau \text{ bounded}}} (-1)^{n-\dim \tau} \left((-1)^n y^{-1} (y-1)^{\dim \tau} [(y-1)^{n+1-\dim \tau} - (-1)^{n+1-\dim \tau}] \right) = \\
& \sum_{q=0}^n (-1)^q y^{-1} (y-1)^q [(y-1)^{n+1-q} - (-1)^{n+1-q}] f_q^b = \chi_y(\mathbb{C}X),
\end{aligned}$$

which concludes the proof. □

Remark 7.5.2. *It is easy to generalize the theorem to situations in which Y is not necessarily generated by the normal fan of the Newton polytope of X but where X and Y intersect "nicely" (and $\mathbb{C}X$ and $\mathbb{C}Y$ do as well), using the additivity of both the genus χ_y and the tropical Euler characteristics by summing over the strata of Y and $\mathbb{C}Y$.*

We can now prove Corollaries 7.1.9 and 7.1.10, which we also state again.

Corollary 7.1.9. *Let Y and $\mathbb{C}Y$ be tropical, respectively complex $(n+1)$ -dimensional non-singular compact toric varieties coming from the same non-singular full-dimensional integral polytope Δ .*

Let X be a non-singular tropical hypersurface in Y (in particular, defined by a tropical polynomial whose Newton polytope is also Δ). Let $\mathbb{C}X$ be a torically non-degenerate complex hypersurface in $\mathbb{C}Y$, defined by a Laurent polynomial whose Newton polytope is Δ as well.

Then for all p and q we have

$$h^{p,q}(\mathbb{C}X) = \operatorname{rank} H_q(X; \mathcal{F}_p^X).$$

Proof. We know (see [DK86] or [dCMM18]) that $h^{p,q}(H_c^k(\mathbb{C}Y)) = 0$ if $k \neq p+q$; hence, $e_c^{p,q}(\mathbb{C}Y) = (-1)^{p+q} h^{p,q}(\mathbb{C}Y)$, where $h^{p,q}(\mathbb{C}Y)$ denotes the usual (p,q) -th Hodge number of $\mathbb{C}Y$. The same is true of $\mathbb{C}X$.

By combining Proposition 7.1.6 with the Lefschetz hyperplane section theorems for tropical homology and the homology of complex hypersurfaces of toric varieties (as well as classical results regarding Hodge structures), we have

$$\operatorname{rank} H_q(X; \mathcal{F}_p^X) = \operatorname{rank} H_q(Y; \mathcal{F}_p^Y) = h^{p,q}(\mathbb{C}Y) = h^{p,q}(\mathbb{C}X)$$

for $p+q < n$. The above equations combined with the classical and tropical Poincaré duality theorems (see Theorem 3.2.4) for $X, Y, \mathbb{C}X$ and $\mathbb{C}Y$ (all are compact) establish the same equalities when $p+q > n$.

Therefore, it only remains to prove the statement when $q + p = n$. It follows from the tropical and complex versions of Lefschetz theorems and from Proposition 7.1.6 that for $p < \frac{n}{2}$, we have

$$\chi(C_{\bullet}^{BM}(X; \mathcal{F}_p^X)) = (-1)^p \text{rank } H_p(Y; \mathcal{F}_p^Y) + (-1)^{n-p} \text{rank } H_{n-p}(X; \mathcal{F}_p^X),$$

and

$$\sum_q e_c^{p,q}(\mathbb{C}X) = \dim H^{p,p}(\mathbb{C}Y) + (-1)^n \dim H^{p,n-p}(\mathbb{C}X).$$

For $p > \frac{n}{2}$, we have

$$\chi(C_{\bullet}^{BM}(X; \mathcal{F}_p^X)) = (-1)^p \text{rank } H_{p+1}(Y; \mathcal{F}_{p+1}^Y) + (-1)^{n-p} \text{rank } H_{n-p}(X; \mathcal{F}_p^X),$$

and

$$\sum_q e_c^{p,q}(\mathbb{C}X) = \dim H^{p+1,p+1}(\mathbb{C}Y) + (-1)^n \dim H^{p,n-p}(\mathbb{C}X).$$

For $p = \frac{n}{2}$, we get

$$\chi(C_{\bullet}^{BM}(X; \mathcal{F}_{\frac{n}{2}}^X)) = (-1)^{\frac{n}{2}} \text{rank } H_{\frac{n}{2}}(X; \mathcal{F}_{\frac{n}{2}}^X),$$

and

$$\sum_q e_c^{\frac{n}{2},q}(\mathbb{C}X) = \dim H^{\frac{n}{2},\frac{n}{2}}(\mathbb{C}X).$$

Again, using Proposition 7.1.6 on tropical toric varieties, we have

$$\text{rank } H_p(Y; \mathcal{F}_p^Y) = \dim H^{p,p}(\mathbb{C}Y).$$

The statement of the corollary then follows from Theorem 7.1.8. \square

Corollary 7.1.10. *Let X be a non-singular tropical hypersurface in \mathbb{R}^{n+1} defined by a tropical polynomial whose Newton polytope is full-dimensional. If $\mathbb{C}X$ is a non-singular complex hypersurface in $(\mathbb{C}^*)^{n+1}$ with the same Newton polytope as X , then*

$$\text{rank } H_q^{BM}(X; \mathcal{F}_p^X) = \begin{cases} \sum_{l=0}^q h^{p,l}(H_c^n(\mathbb{C}X)) & \text{if } p + q = n \\ h^{p,p}(H^{n+p}(\mathbb{C}X)) & \text{if } q = n \\ 0 & \text{otherwise.} \end{cases}$$

Proof. The proof follows the same lines as the proof of Corollary 7.1.10. We know from

[DK86] that

$$h^{p,q}(H_c^k((\mathbb{C}^*)^{n+1})) = \begin{cases} \binom{n+1}{p} & \text{if } p = q \text{ and } k = n+1+p \\ 0 & \text{otherwise.} \end{cases}$$

The Borel-Moore tropical homology groups of \mathbb{R}^{n+1} satisfy $H_q^{BM}(\mathbb{R}^{n+1}; \mathcal{F}_p^{\mathbb{R}^{n+1}}) = 0$ if $q \neq n+1$ and

$$\text{rank } H_{n+1}^{BM}(\mathbb{R}^{n+1}; \mathcal{F}_p^{\mathbb{R}^{n+1}}) = \binom{n+1}{p}.$$

The standard tropical homology groups of \mathbb{R}^{n+1} satisfy $H_q(\mathbb{R}^{n+1}; \mathcal{F}_p^{\mathbb{R}^{n+1}}) = 0$ if $q \neq 0$ and

$$\text{rank } H_0(\mathbb{R}^{n+1}; \mathcal{F}_p^{\mathbb{R}^{n+1}}) = \binom{n+1}{p}.$$

Combining the tropical Lefschetz-like Theorem 7.1.1 and Poincaré duality for the tropical homology of X , we deduce from this that when $p+q \neq n$,

$$\text{rank } H_q^{BM}(X; \mathcal{F}_p^X) = \begin{cases} \binom{n+1}{p+1} & \text{if } q = n, \\ 0 & \text{if } q \neq n. \end{cases}$$

The hypersurface $\mathbb{C}X$ is a non-singular affine variety, so the Andreotti-Frankel theorem and Poincaré duality imply $H_c^k(\mathbb{C}X) = 0$ if $k < n$. By the Lefschetz-type theorems for the Hodge-Deligne numbers on $H_c^n(\mathbb{C}X)$ (see [DK86, Section 3]), if $k > n$, one has

$$h^{p,q}(H_c^k(\mathbb{C}X)) = \begin{cases} \binom{n+1}{p+1} & \text{if } p = q \text{ and } k = n+p \\ 0 & \text{otherwise.} \end{cases}$$

Therefore

$$e_c^{p,q}(\mathbb{C}X) = \begin{cases} (-1)^n h^{p,q}(H_c^n(\mathbb{C}X)) & \text{if } p+q \leq n \text{ and } p \neq q \\ (-1)^n h^{p,q}(H_c^n(\mathbb{C}X)) + (-1)^{n+p} \binom{n+1}{p+1} & \text{if } p+q \leq n \text{ and } p = q \\ (-1)^{n+p} \binom{n+1}{p+1} & \text{if } p+q > n \text{ and } p = q \\ 0 & \text{otherwise.} \end{cases}$$

We can then conclude by applying Theorem 7.1.8. \square

Chapter 8

Homology of simplicial real algebraic hypersurfaces

8.1 Chapter introduction

Let P be a real Laurent polynomial in n variables. As in Chapter 2, if P has exactly $n + 1$ monomials with non-zero coefficients and if its Newton polytope $\Delta(P)$ is a non-degenerate n -dimensional simplex, we call P a simplicial real polynomial. We also call the associated hypersurface $V_{(\mathbb{C}^*)^n}(P)$ a *simplicial* real algebraic hypersurface.

Such hypersurfaces are natural building blocks from which more complicated objects can be constructed. For example, the combinatorial case of the Patchwork method (see Chapter 2) consists in gluing such hypersurfaces together. Hence, a greater understanding of their properties might help us find new bounds on the topology of patchworked varieties (see Chapter 9 for more details), in the same spirit as Formula 4.5.4, in addition to improving our understanding of simplicial real algebraic hypersurfaces themselves, which are among the most natural and simple examples of real algebraic varieties.

In this chapter, we study the homology of a class of objects closely associated to simplicial real algebraic hypersurfaces, their *coamoebas*; more specifically, we describe the action of the complex conjugation on the coamoebas. Assuming that a certain conjecture, based on an article by G. Kerr and I. Zharkov [KZ16], holds (which seems very likely), this allows us to describe the action of the complex conjugation on the homology of the simplicial real algebraic hypersurfaces themselves, and in particular to identify the conditions under which they are Galois maximal (see Chapters 1 and 4).

Let X be a simplicial real algebraic hypersurface. In this chapter, we denote the real (respectively, complex) points of X in $(\mathbb{R}^*)^n$ (respectively, $(\mathbb{C}^*)^n$) by $\mathbb{R}X$ (respectively, $\mathbb{C}X$). Unless otherwise specified, all real algebraic varieties considered are hypersurfaces in the complex torus. The complex conjugation c on the complex torus naturally acts on $\mathbb{C}X$. Our goal here is to better understand this action and the induced action c_* on

the homology $H_*(\mathbb{C}X)$ of $\mathbb{C}X$ with coefficients in \mathbb{Z}_2 (in this chapter, we always consider homology with coefficients in \mathbb{Z}_2).

In their article [KZ16] that was mentioned above, Kerr and Zharkov show in particular that the complex part $\mathbb{C}X$ of a simplicial real algebraic hypersurface is homeomorphic to the associated *phase tropical variety* $\mathcal{T}X$. Moreover, it is easy to see that the phase tropical variety $\mathcal{T}X$ retracts by deformation to the coamoeba \mathcal{C}_X of X . Hence we get a homotopy equivalence $\mathbb{C}X \rightarrow \mathcal{C}_X$. Private conversations with Zharkov have led us to believe that this homotopy equivalence satisfies the following condition:

Conjecture 8.1.1. *Let X be a simplicial real algebraic hypersurface. There is a homotopy equivalence $\phi : \mathbb{C}X \rightarrow \mathcal{C}_X$ such that the following diagram commutes for all $i \geq 0$:*

$$\begin{array}{ccc} H_i(\mathbb{C}X) & \xrightarrow{\phi_*} & H_i(\mathcal{C}_X) \\ \downarrow c_* & & \downarrow c_* \\ H_i(\mathbb{C}X) & \xrightarrow{\phi_*} & H_i(\mathcal{C}_X) \end{array}$$

where c_* is induced by the complex conjugation on either $\mathbb{C}X$ or \mathcal{C}_X .

This would immediately imply

$$\begin{aligned} \dim(\text{Im}(1 + c_* : H_i(\mathbb{C}X) \rightarrow H_i(\mathbb{C}X))) = \\ \dim(\text{Im}(1 + c_* : H_i(\mathcal{C}_X) \rightarrow H_i(\mathcal{C}_X))), \end{aligned}$$

where 1 is the identity.

Our main goal here is to prove the following result, though the details of the proof might be of interest in themselves when considering other related questions. Consider a simplicial real algebraic hypersurface X , the Newton polytope Δ of the simplicial real Laurent polynomial P that defines X , and pick a vertex O of Δ . The edges of Δ containing O define n integer vectors (choosing 0 as their initial point). Define $A \in M_{n \times n}(\mathbb{Z}_2)$ as the matrix whose rows are these n vectors modulo 2.

Theorem 8.1.2. *If $\mathbb{R}X$ intersects non-trivially each quadrant of $(\mathbb{R}^*)^n$, then*

$$\dim_{\mathbb{Z}_2}(H_*(\mathbb{R}X)) = \dim_{\mathbb{Z}_2} \left(\frac{\text{Ker}(1 + c_*)}{\text{Im}(1 + c_*)} \right),$$

where $1 + c_* : H_*(\mathcal{C}_X) \rightarrow H_*(\mathcal{C}_X)$.

Otherwise, we have

$$\dim_{\mathbb{Z}_2} \left(\frac{\text{Ker}(1 + c_*)}{\text{Im}(1 + c_*)} \right) - \dim_{\mathbb{Z}_2}(H_*(\mathbb{R}X)) = 2^{(2^n - \text{rank}_{\mathbb{Z}_2}(A))} - 1 - (n - \text{rank}_{\mathbb{Z}_2}(A)).$$

The condition on the intersection of $\mathbb{R}X$ with the quadrants of $(\mathbb{R}^*)^n$ is equivalent to a condition on the matrix A and the signs of the monomials of P , as proved in Lemma 8.5.1.

Remember that a real algebraic variety X is Galois maximal if

$$\dim_{\mathbb{Z}_2}(H_*(\mathbb{R}X)) = \dim_{\mathbb{Z}_2}\left(\frac{\text{Ker}(1 + c_*)}{\text{Im}(1 + c_*)}\right),$$

where $1 + c_* : H_*(\mathbb{C}X) \rightarrow H_*(\mathbb{C}X)$, as defined in Chapter 1.

If Conjecture 8.1.1 holds, then Theorem 8.1.2 immediately implies

Theorem 8.1.3. *If $\mathbb{R}X$ intersects non-trivially each quadrant of $(\mathbb{R}^*)^n$, then X is always Galois maximal.*

Otherwise, we have

$$\dim_{\mathbb{Z}_2}\left(\frac{\text{Ker}(1 + c_*)}{\text{Im}(1 + c_*)}\right) - \dim_{\mathbb{Z}_2}(H_*(\mathbb{R}X)) = 2(2^{n - \text{rank}_{\mathbb{Z}_2}(A)} - 1 - (n - \text{rank}_{\mathbb{Z}_2}(A))),$$

where $1 + c_* : H_*(\mathbb{C}X) \rightarrow H_*(\mathbb{C}X)$, and X is Galois maximal if and only if $n - \text{rank}_{\mathbb{Z}_2}(A) \in \{0, 1\}$.

The rest of this chapter is organized as follows. In Section 8.2, we go over some definitions and notations. In Section 8.3, the coamoeba \mathcal{C}_X associated to X is introduced and described in a way suited to computations. In Section 8.4, the action of the conjugation on the homology of \mathcal{C}_X is described. In particular, the rank of $1 + c_*$ is computed. Finally, Theorem 8.1.2 is proved in Section 8.5.

8.2 Definitions and notations

We denote the n -dimensional torus $(\mathbb{R}/2\pi\mathbb{Z})^n$ (seen as the product of n unit circles) by T^n , and use either additive or multiplicative notations, based on context, to describe its natural group law. In particular, we frequently apply matrices with integer coefficients to elements of T^n .

Given a vector of signs $(\varepsilon_1, \dots, \varepsilon_n) \in \{1, -1\}^n$, we define $\delta(\varepsilon) = (\delta_1, \dots, \delta_n) \in \mathbb{Z}_2^n$ by the relation $\varepsilon_i = (-1)^{\delta_i}$.

Given a finite set S , let $|S|$ denote the cardinality of S .

We define $\text{Arg} : (\mathbb{C}^*)^n \rightarrow T^n$, $(z_1, \dots, z_n) \mapsto (\arg(z_1), \dots, \arg(z_n))$.

Throughout this chapter, we use the following conventions: for any $z = (z_1, \dots, z_n) \in \mathbb{C}^n$, any matrix $G \in M_{n \times n}(\mathbb{Z})$ and any vector $v = (v_1, \dots, v_n) \in \mathbb{Z}^n$, we define $z^v := z_1^{v_1} z_2^{v_2} \dots z_n^{v_n} \in \mathbb{C}$ and $z^G := (z^{G^1}, \dots, z^{G^n}) \in \mathbb{C}^n$, where G^i is the i -th **line** of G . Choosing lines instead of columns has the advantage of allowing us to write $\text{Arg}(z^G) = G \cdot \text{Arg}(z)$, and the disadvantage that for another matrix $H \in M_{n \times n}(\mathbb{Z})$, we have $(z^G)^H = z^{H \cdot G}$.

Consider as above a simplicial polynomial $P(z) = \sum_{\alpha \in \Delta_P} c_\alpha z^\alpha$, for some coefficients $c_\alpha \in \mathbb{R}^*$, and the associated simplicial real algebraic hypersurface X_P . Up to multiplication by a non-trivial Laurent monomial (which doesn't change X_P), the polynomial P can be

chosen so that Δ_P has $0 \in \mathbb{Z}^n$ as one of its vertices. We assume this to be the case from now on. Moreover, let us denote the non-null vertices of Δ_P by $\alpha_P^1, \dots, \alpha_P^n \in \mathbb{Z}^n$, and define $A_P \in M_{n \times n}(\mathbb{Z})$ as the matrix whose i -th **line** is α_P^i for $i = 1, \dots, n$. If we also define $\alpha_P^0 := 0 \in \mathbb{Z}^n$, we can write indifferently $P(z) = \sum_{\alpha \in \Delta_P} c_\alpha z^\alpha = \sum_{i=0, \dots, n} c_{\alpha_P^i} z^{\alpha_P^i} = \sum_{i=1, \dots, n} c_{\alpha_P^i} z^{A_P^i} + c_0$.

For any $G \in M_{n \times n}(\mathbb{Z})$, we define the algebraic morphism

$$\begin{aligned} \Phi_G : (\mathbb{C}^*)^n &\rightarrow (\mathbb{C}^*)^n \\ z &\mapsto z^G. \end{aligned}$$

If G is invertible, then Φ_G is an algebraic isomorphism that sends $X_{\tilde{P}} = \{\tilde{P}(z) = \sum_{i=1, \dots, n} c_{\alpha_P^i} z^{(A_P \cdot G)^i} + c_0 = 0\}$ to $X_P = \{P(z) = \sum_{i=1, \dots, n} c_{\alpha_P^i} z^{A_P^i} + c_0 = 0\}$ and respects the real structure. This means that up to such isomorphisms, we can consider the matrix A_P defining the simplex Δ_P up to right-multiplication by invertible matrices with integer coefficients.

Remark 8.2.1. *The complex part $\mathbb{C}X_P \subset (\mathbb{C}^*)^n$ of a simplicial real algebraic hypersurface X_P is smooth.*

Let X_P be given as above by $P(z) = \sum_{i=1, \dots, n} c_i z^{\alpha_i} + c_0$, for some coefficients $c_i \in \mathbb{R}^*$ and a simplex Δ_P . Let A be the $n \times n$ matrix whose lines correspond to the vertices α_i of Δ_P and the monomials of P (for $i = 1, \dots, n$). We also introduce B , the cofactor matrix of A , and $P_L(z) = \sum_{i=1, \dots, n} c_i z_i + c_0$ (the L stands for "linear").

Then $P(z) = P_L \circ \Phi_A(z)$, thus $\Phi_A : (\mathbb{C}^*)^n \rightarrow (\mathbb{C}^*)^n$ maps $\mathbb{C}X_P$ to the hyperplane $\mathbb{C}X_{P_L} := \{P_L(z) = 0\}$. But $\Phi_A \circ \Phi_B = \Phi_{\det(A) \cdot Id} : (z_1, \dots, z_n) \mapsto (z_1^{\det(A)}, \dots, z_n^{\det(A)})$ is a local diffeomorphism, which implies that so is Φ_A by a dimensional argument. Hence the smoothness of $\mathbb{C}X_P$ can be deduced from the smoothness of $\mathbb{C}X_{P_L}$.

8.3 Coamoebas

As above and for the remainder of this chapter, let $P(z) = \sum_{i=1, \dots, n} \varepsilon_i c_i z^{\alpha_i} + c_0$, where $\varepsilon = (\varepsilon_1, \dots, \varepsilon_n) \in \{1, -1\}^n$ and $c_i \in \mathbb{R}_{>0}$ for all i , be a simplicial real polynomial (we can suppose without loss of generality that the constant term is positive). Let $X := X_P \subset (\mathbb{C}^*)^n$ be the associated simplicial real algebraic hypersurface, and let Δ_P be the Newton polytope of P , and A be the $n \times n$ matrix whose lines correspond to the vertices of Δ_P and the monomials of P , *i.e.* $A^i = \alpha^i$.

8.3.1 Definition and description of \mathcal{C}_X

The *coamoeba* $\mathcal{C}_X \subset T^n$ of X is the closure in T^n of the image $\text{Arg}(\mathbb{C}X)$. The conjugation c acts as $-\text{id}$ on T^n ; if we fix a representation of T^n as $[0, 2\pi]^n$ with its boundary quotiented

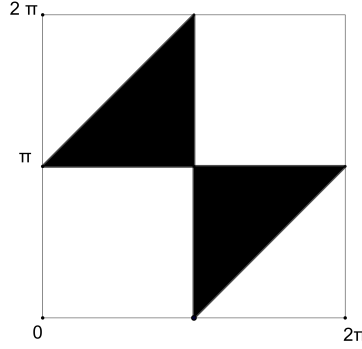

Figure 8.1: In black, the coamoeba $\mathcal{C}_{X_{P_L^+}}$. In white, the open zonotope Z

as needed, which we do from now on, c is the central symmetry.

We will use the convenient description of \mathcal{C}_X given by Kerr and Zharkov in [KZ16] in the linear case, *i.e.* when the coamoeba is given by an affine hyperplane, as an intermediate step to get to the general case. Let us introduce the simplicial polynomials $P_L^+(z) = \sum_{i=1, \dots, n} c_i z_i + c_0$ and $P_L(z) = \sum_{i=1, \dots, n} \varepsilon_i c_i z_i + c_0$, where the coefficients c_i and ε_i are the same as in P . Name $\mathcal{C}_{X_{P_L^+}}$ and $\mathcal{C}_{X_{P_L}}$ the associated coamoebas.

Consider $T := T^1 = \mathbb{R}/2\pi\mathbb{Z}$ and identify it with the unit circle via the map $E : [\theta] \mapsto \exp(i\theta)$. We say that $(\theta_1, \dots, \theta_n) \in T^n$ are in an *allowed configuration* if there is no open half-circle in T containing all the θ_i as well as the point $1 = E[0]$ (which corresponds to the constant term).

A *zonotope* is the Minkowski sum in \mathbb{R}^n of a finite collection of segments. Now consider such a zonotope \tilde{Z} ; if the quotient map $\mathbb{R}^n \rightarrow T^n = (\mathbb{R}/2\pi\mathbb{Z})^n$ restricted to the interior of \tilde{Z} is an embedding, we call in the rest of this chapter, by extension, the image Z of the interior of \tilde{Z} an (open) zonotope of T^n .

Lemma 8.3.1. *The points of $\mathcal{C}_{X_{P_L^+}}$ are exactly the n -tuples $(\theta_1, \dots, \theta_n) \in T^n$ in allowed configurations. There is an n -dimensional zonotope \tilde{Z} in \mathbb{R}^n , generated by $n+1$ segments, such that the quotient map $\mathbb{R}^n \rightarrow T^n = (\mathbb{R}/2\pi\mathbb{Z})^n$ restricted to the interior of \tilde{Z} is an embedding, and such that the open zonotope Z of T^n which is the image of the interior of \tilde{Z} is the complement of the points in allowed configurations (see Figure 8.1).*

The proof is almost trivial - see [KZ16] for related details. Note that Z is contractible in T^n , hence $(T^n, \mathcal{C}_{X_{P_L^+}})$ is of the same homotopy type as $(T^n, T^n \setminus \{\star\})$.

We now consider the slightly more general case of $\mathcal{C}_{X_{P_L}}$. Let $\delta = (\delta_1, \dots, \delta_n) := \delta(\varepsilon_1, \dots, \varepsilon_n) \in \mathbb{Z}_2^n$ be as in Section 8.2.

Lemma 8.3.2. *The coamoeba $\mathcal{C}_{X_{P_L}}$ is a translate of $\mathcal{C}_{X_{P_L^+}}$ by $\pi \cdot \delta \in T^n$, *i.e.* $\mathcal{C}_{X_{P_L}} = \mathcal{C}_{X_{P_L^+}} + \pi \cdot \delta \subset T^n$.*

The zonotope of forbidden configurations from Lemma 8.3.1 has simply been translated; the proof is once again almost trivial.

Let us now consider the general case of \mathcal{C}_X .

Lemma 8.3.3. *Using the same notations as above, the coamoeba \mathcal{C}_X is the preimage of the coamoeba $\mathcal{C}_{X_{P_L}}$ by the map $A \cdot : T^n \rightarrow T^n$, i.e. $\mathcal{C}_X = A^{-1}(\mathcal{C}_{X_{P_L}})$.*

Proof. First, let us show that $\text{Arg}(\mathbb{C}X) = A^{-1}(\text{Arg}(\mathbb{C}X_{P_L}))$.

Indeed, if $\theta = (\theta_1, \dots, \theta_n) \in \text{Arg}(\mathbb{C}X)$, by definition there exists $r = (r_1, \dots, r_n) \in (\mathbb{R}_{>0})^n$ such that $z := (r_1\theta_1, \dots, r_n\theta_n)$ belongs to $\mathbb{C}X$, i.e. $P(r_1\theta_1, \dots, r_n\theta_n) = \sum_{i=1, \dots, n} \varepsilon_i c_i r^{A^i} \theta^{A^i} + c_0 = P_L(r^{A^1} \theta^{A^1}, \dots, r^{A^n} \theta^{A^n}) = 0$. Hence $(r^{A^1} \theta^{A^1}, \dots, r^{A^n} \theta^{A^n}) \in \mathbb{C}X_{P_L}$ and $\theta^A = A \cdot \theta$ belongs to $\text{Arg}(\mathbb{C}X_{P_L})$.

Conversely, suppose that $A \cdot \theta \in \text{Arg}(\mathbb{C}X_{P_L})$. Then by definition there exists $s = (s_1, \dots, s_n) \in (\mathbb{R}_{>0})^n$ such that $P_L(s_1\theta^{A^1}, \dots, s_n\theta^{A^n}) = \sum_{i=1, \dots, n} \varepsilon_i c_i s_i \theta^{A^i} + c_0 = 0$. If there exists $r = (r_1, \dots, r_n) \in (\mathbb{R}_{>0})^n$ such that $r^A = s$, then $z := (r_1\theta_1, \dots, r_n\theta_n)$ is such that $P(z) = 0$ and we can conclude that $\theta \in \text{Arg}(\mathbb{C}X)$. Now consider the cofactor matrix B of A , and

$$\begin{aligned} (\mathbb{R}_{>0})^n &\xrightarrow{\Phi_B} (\mathbb{R}_{>0})^n \xrightarrow{\Phi_A} (\mathbb{R}_{>0})^n \\ r = (r_1, \dots, r_n) &\mapsto r^B \mapsto (r^B)^A = r^{\det(A)} = (r_1^{\det(A)}, \dots, r_n^{\det(A)}). \end{aligned}$$

This clearly shows that Φ_A is surjective from $(\mathbb{R}_{>0})^n$ onto itself; thence we have shown that $\text{Arg}(\mathbb{C}X) = A^{-1}(\text{Arg}(\mathbb{C}X_{P_L}))$.

As $A \cdot : T^n \rightarrow T^n$ is continuous, we immediately have that $\mathcal{C}_X = \overline{\text{Arg}(\mathbb{C}X)} \subset A^{-1}(\overline{\text{Arg}(\mathbb{C}X_{P_L})}) = A^{-1}(\mathcal{C}_{X_{P_L}})$. Following the same reasoning as in Remark 8.2.1, the map $A \cdot : T^n \rightarrow T^n$ is a local diffeomorphism, because $(AB) \cdot = (\det(A) \cdot \text{Id}) \cdot : T^n \rightarrow T^n$ is a local diffeomorphism, where B is the comatrix of A . Consider $\theta \in A^{-1}(\overline{\text{Arg}(\mathbb{C}X_{P_L})})$, an open neighborhood $U \subset T^n$ of θ such that $(A \cdot)|_U$ is an embedding, and some open neighborhood $V \subset T^n$ of θ . Then $A \cdot (U \cap V)$ is an open neighborhood of $A \cdot \theta \in \overline{\text{Arg}(\mathbb{C}X_{P_L})}$, hence there exists $\rho \in A \cdot (U \cap V) \cap \text{Arg}(\mathbb{C}X_{P_L})$. Then $((A \cdot)|_U)^{-1}(\rho) \in V \cap A^{-1}(\text{Arg}(\mathbb{C}X_{P_L})) = V \cap \text{Arg}(\mathbb{C}X)$, which shows that $\theta \in \overline{\text{Arg}(\mathbb{C}X)}$. \square

8.3.2 A more explicit description of \mathcal{C}_X

It is well-known (for example, using the theorem of structure of finitely generated abelian groups) that there exists two (non-uniquely defined) invertible matrices $G, H \in M_{n \times n}(\mathbb{Z})$ such that

$$G \cdot A \cdot H = D = \begin{bmatrix} d_1 & & 0 \\ & \ddots & \\ 0 & & d_n \end{bmatrix},$$

where $d_1|d_2|\dots|d_n \in \mathbb{Z}$ and $d_1d_2\dots d_k$ is the greatest common divisor of the non-trivial k -minors of A (for $k = 1, \dots, n$).

Consider $\delta^G = G \cdot \delta \in \mathbb{Z}_2^n$, where $\delta = \delta(\varepsilon_1, \dots, \varepsilon_n) \in \mathbb{Z}_2^n$ is as above.

We partition $\{1, \dots, n\}$ in the following way:

$$I^{0,0} := \{i \in \{1, \dots, n\} \mid \delta_i^G \equiv [0]_2, d_i \equiv [0]_2\},$$

$$I^{1,0} := \{i \in \{1, \dots, n\} \mid \delta_i^G \equiv [1]_2, d_i \equiv [0]_2\},$$

$$I^{0,1} := \{i \in \{1, \dots, n\} \mid \delta_i^G \equiv [0]_2, d_i \equiv [1]_2\},$$

$$I^{1,1} := \{i \in \{1, \dots, n\} \mid \delta_i^G \equiv [1]_2, d_i \equiv [1]_2\}.$$

For the remainder of this chapter, we fix two such matrices G and H . Moreover, as observed in Section 8.2, we can consider A up to right-multiplication by invertible matrices with integer coefficients: hence we can, and do, assume that H is the identity matrix. Hence from now on we have

$$A = G^{-1} \cdot D.$$

Then \mathcal{C}_X lends itself to the following description: define the set of indices $\Omega := \{0, \dots, d_1 - 1\} \times \dots \times \{0, \dots, d_n - 1\}$ and let $\widetilde{\delta}^G \in \{0, 1\}^n$ be the unique lifting of δ^G . Let also $G \cdot \widetilde{\mathcal{C}}_{X_{P_L}}$ be the preimage of $G \cdot \mathcal{C}_{X_{P_L}}$ by the quotient map $[0, 2\pi]^n \longrightarrow T^n$ (see the left part of Figure 8.2).

Cover $[0, 2\pi]^n$ with $d_1 \dots d_n$ hyperrectangular cells $C_\alpha := [\alpha_1 \frac{2\pi}{d_1}, (\alpha_1 + 1) \frac{2\pi}{d_1}] \times \dots \times [\alpha_n \frac{2\pi}{d_n}, (\alpha_n + 1) \frac{2\pi}{d_n}]$ for $\alpha = (\alpha_1, \dots, \alpha_n) \in \Omega$. Define $\widetilde{\mathcal{C}}_X \subset [0, 2\pi]^n$ as the set such that the pair $(C_\alpha, C_\alpha \cap \widetilde{\mathcal{C}}_X)$ is mapped to the pair $([0, 2\pi]^n, G \cdot \widetilde{\mathcal{C}}_{X_{P_L}})$ by $(z_1, \dots, z_n) \mapsto (d_1 z_1 - \alpha_1 2\pi, \dots, d_n z_n - \alpha_n 2\pi)$ (see the right part of Figure 8.2). Then

Proposition 8.3.4. *The pair (T^n, \mathcal{C}_X) is the image of $([0, 2\pi]^n, \widetilde{\mathcal{C}}_X)$ by the quotient map $[0, 2\pi]^n \longrightarrow T^n$.*

The coamoeba \mathcal{C}_X is the complement in T^n of $d_1 \dots d_n$ open zonotopes indexed by the set of indices Ω , such that the center of zonotope Z_α , for $\alpha = (\alpha_1, \dots, \alpha_n) \in \Omega$, is in $\pi \cdot (\widetilde{\delta}_1^G/d_1, \dots, \widetilde{\delta}_n^G/d_n) + 2\pi \cdot (\alpha_1/d_1, \dots, \alpha_n/d_n) \in T^n$. Those zonotopes are translate of each other.

Proof. From Lemma 8.3.3, we know that $\mathcal{C}_X = A^{-1}(\mathcal{C}_{X_{P_L}}) = D^{-1}(G \cdot \mathcal{C}_{X_{P_L}})$.

As explained in Lemmas 8.3.1 and 8.3.2, the coamoeba $\mathcal{C}_{X_{P_L}^+}$ is the complement in T^n of an open zonotope centered in 0, and $\mathcal{C}_{X_{P_L}}$ is the complement in T^n of the same zonotope translated and now centered in $(\delta_1\pi, \dots, \delta_n\pi) = \pi \cdot \delta \in T^n$.

The linear isomorphism G is then applied to it, so that $G \cdot \mathcal{C}_{X_{P_L}}$ is the complement in T^n of an open zonotope (geometrically the starting zonotope deformed by G) centered in $\pi \cdot \delta^G \in T^n$. The last step is to take the preimage by the covering map $D \cdot : T^n \longrightarrow T^n$.

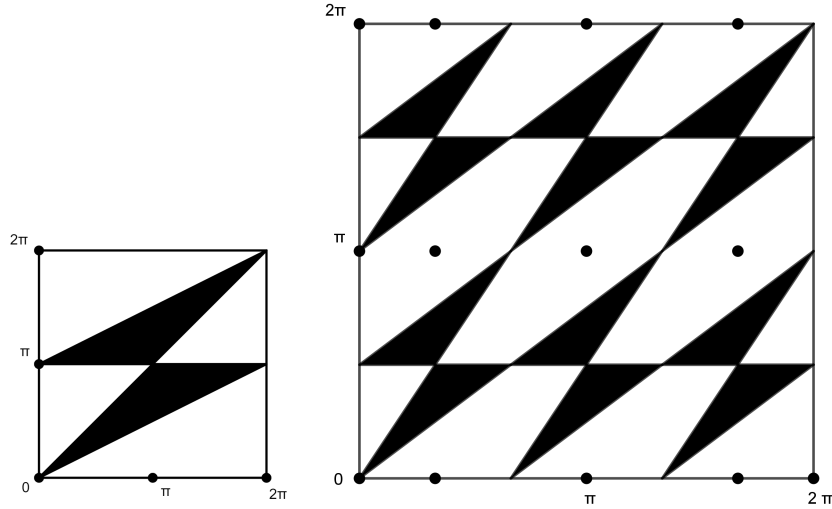

Figure 8.2: On the left, $G \cdot \widetilde{\mathcal{C}_{X_{P_L}}}$. On the right: the coamoeba \mathcal{C}_X in black and the zonotopes in white.

□

8.4 Homological computations

Let us now study the action of the conjugation c on \mathcal{C}_X , using the description from Proposition 8.3.4. As pointed out earlier, c simply acts as the central symmetry on T^n seen as an appropriate quotient of $[0, 2\pi]^n$. It maps \mathcal{C}_X to itself, and zonotopes to one another. Let us describe that action more precisely.

8.4.1 Action of the conjugation on the zonotopes

Let $\alpha = (\alpha_1, \dots, \alpha_n) \in \Omega = \{0, \dots, d_1 - 1\} \times \dots \times \{0, \dots, d_n - 1\}$. We define $c(\alpha) \in \Omega$ as the index such that $Z_{c(\alpha)} = c(Z_\alpha)$. Then:

If $i \in I^{0,0}$, then $c(\alpha)_i$ is the unique lifting to $\{0, \dots, d_i - 1\}$ of $[d_i - \alpha_i]_{d_i}$. In particular, notice that $c(\alpha)_i = \alpha_i$ if and only if $\alpha_i \in \{0, d_i/2\}$.

If $i \in I^{0,1}$, then $c(\alpha)_i$ is the unique lifting to $\{0, \dots, d_i - 1\}$ of $[d_i - \alpha_i]_{d_i}$. In particular, notice that $c(\alpha)_i = \alpha_i$ if and only if $\alpha_i = 0$.

If $i \in I^{1,0}$, then $c(\alpha)_i = (d_i - 1) - \alpha_i$. In particular, notice that $c(\alpha)_i$ is never equal to α_i .

If $i \in I^{1,1}$, then $c(\alpha)_i = (d_i - 1) - \alpha_i$. In particular, notice that $c(\alpha)_i = \alpha_i$ if and only if $\alpha_i = (d_i - 1)/2$.

Denote by $F := \{\alpha \in \Omega \mid c(\alpha) = \alpha\}$ the set of fixed points of c . If $|I^{1,0}| \neq 0$, then $F = \emptyset$. If $|I^{1,0}| = 0$, there are $2^{|I^{0,0}|}$ fixed points: the indices $\beta \in \Omega$ such that $\beta_i \in \{0, d_i/2\}$

if $i \in I^{0,0}$, $\beta_i = 0$ if $i \in I^{0,1}$ and $\beta_i = (d_i - 1)/2$ if $i \in I^{1,1}$.

8.4.2 Homology of \mathcal{C}_X

Denote by $\Gamma_1, \dots, \Gamma_n \in H_{n-1}(T^n)$ the n homology classes induced by the $(n-1)$ -dimensional tori $\{[\theta_i] = 0\} \subset T^n$. They form a basis of $H_{n-1}(T^n)$.

Using a Mayer-Vietoris long exact sequence, it is easy to see that

$$H_k(\mathcal{C}_X) \xrightarrow{in_*} H_k(T^n),$$

where in_* is induced by the inclusion, is an isomorphism for $k = 0, \dots, n-2$, and that $H_k(\mathcal{C}_X) = 0$ for $k \geq n$. As the conjugation acts trivially on the homology of T^n (with coefficients in \mathbb{Z}_2) and as it is compatible with the inclusion, this shows that

$$1 + c_* : H_k(\mathcal{C}_X) \longrightarrow H_k(\mathcal{C}_X)$$

is trivial for $k = 0, \dots, n-2$.

We also get a short exact sequence

$$0 \longrightarrow H_n(T^n) \longrightarrow H_{n-1}\left(\bigsqcup_{\alpha \in \Omega} \partial Z_\alpha\right) \longrightarrow H_{n-1}(\mathcal{C}_X) \longrightarrow H_{n-1}(T^n) \longrightarrow 0,$$

where ∂Z_α is the border of zonotope Z_α , which is homeomorphic to a $(n-1)$ -sphere. From it, we deduce the following lemma:

Lemma 8.4.1. *Given $B_1, \dots, B_n \in H_{n-1}(\mathcal{C}_X)$ such that $in_*(B_i) = \Gamma_i$ for all i , we have an isomorphism*

$$H_{n-1}(\mathcal{C}_X) \cong \left(\bigoplus_{i=1, \dots, n} \mathbb{Z}_2 \cdot B_i \right) \oplus \left(\frac{\bigoplus_{\alpha \in \Omega} \mathbb{Z}_2 \cdot [\partial Z_\alpha]}{\mathbb{Z}_2 \cdot \sum_{\alpha \in \Omega} [\partial Z_\alpha]} \right).$$

We already know that $c_*([\partial Z_\alpha]) = [\partial Z_{c(\alpha)}]$ (as we consider homology with coefficients in \mathbb{Z}_2 , we need not concern ourselves with orientation), where $c(\alpha)$ is as above - we only need to find suitable classes B_i and describe how c_* acts on them.

Let us define B_i , for $i \in \{1, \dots, n\}$. Consider the $(n-1)$ -dimensional torus $\{[\theta_i] = 0\} \subset T^n$, and the set I_i of intersections between $\{[\theta_i] = 0\}$ and the open zonotopes of the complement of \mathcal{C}_X in T^n . Notice that a given zonotope Z_α can intersect several times $\{[\theta_i] = 0\}$ - each of these intersections appears as a distinct element of I_i . Call $N_i(\alpha)$ the number of such intersections. We would like to define B_i as the class of $\{[\theta_i] = 0\}$, with a modification (since $\{[\theta_i] = 0\}$ is in general not included in \mathcal{C}_X).

For each intersection $\gamma \in I_i$, let $\alpha(\gamma) \subset \Omega$ be the index of the zonotope corresponding to γ . The intersection γ of $\{[\theta_i] = 0\}$ and $\overline{Z_{\alpha(\gamma)}}$ cuts $\partial Z_{\alpha(\gamma)}$ in two (topological) half-spheres of dimension $n-1$. Call S_γ^+ the half-sphere that lies in the direction e_i of $\{[\theta_i] = 0\}$, and S_γ^- the one lying in direction $-e_i$.

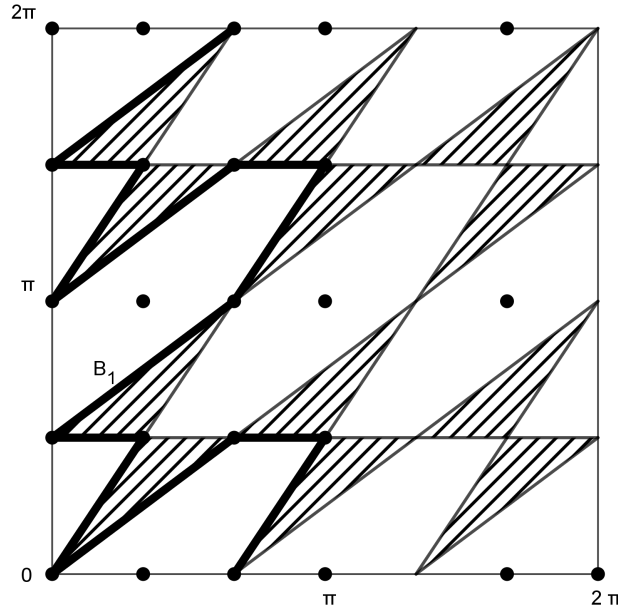

Figure 8.3: As a black broken line, the cycle \widetilde{B}_1 . In that example, I_1 is of cardinal 4.

We start our construction with $\{[\theta_i] = 0\}$. For each $\gamma \in I_i$, we remove the intersection $\{[\theta_i] = 0\} \cap Z_{\alpha(\gamma)}$, and we add S_γ^+ . Thus we obtain a $(n - 1)$ -cycle - name it \widetilde{B}_i and name its class B_i . Observe that parts of the border of a given zonotope Z_α can appear several times in \widetilde{B}_i : in other words, there can be several S_γ^+ that are subsets of the same $\overline{Z_\alpha}$ (with non-trivial intersections). Notice also that S_γ^+ can be homotopically contracted in T^n to the intersection $\{[\theta_i] = 0\} \cap \overline{Z_{\alpha(\gamma)}}$. Thus B_i is a lift of Γ_i , as required. This construction is illustrated in Figure 8.3.

8.4.3 Image of $1 + c_*$

We want to compute the image of $1 + c_* : H_{n-1}(\mathcal{C}_X) \rightarrow H_{n-1}(\mathcal{C}_X)$, and in particular its dimension. Using the description in Lemma 8.4.1, we see that

$$Im(1 + c_*) = \sum_{i=1, \dots, n} \mathbb{Z}_2 \cdot ((1 + c_*)(B_i)) + \sum_{\alpha \in \Omega} \mathbb{Z}_2 \cdot [\partial Z_\alpha + \partial Z_{c(\alpha)}] \tag{8.4.1}$$

Let us make some observations about the image of B_i under c_* . It is the class of the mirror image by central symmetry of \widetilde{B}_i . This means that it consists of $\{[\theta_i] = 0\}$, without the intersections $\{[\theta_i] = 0\} \cap Z_{\alpha(\gamma)}$ (for $\gamma \in I_i$), and with all the S_γ^- , i.e. the half-spheres lying in the direction $-e_i$. Thus $B_i + c_*(B_i) = \sum_{\gamma \in I_i} [\partial Z_{\alpha(\gamma)}]$ (since by definition $S_\gamma^+ + S_\gamma^- = \partial Z_\alpha$) - each ∂Z_α appears $N_i(\alpha)$ times.

It would be possible to compute $N_i(\alpha)$ exactly. However, we only want to compute the image of $1 + c_*$ - the following observations suffice for our purpose.

Since we are considering coefficients in \mathbb{Z}_2 , we only have to pay attention to the parity of $N_i(\alpha)$. Let us define $J_i := \{\alpha \in \Omega \mid N_i(\alpha) \equiv [1]_2\}$. The number of intersections $N_i(\alpha)$ depends only on the length of the zonotope Z_α in the direction e_i (which is the same for all α) and on the i -th coordinate of the center of Z_α , *i.e.* on α_i .

As we only have to consider the coordinate α_i and because of the symmetry of the situation, it is clear that if $\beta \in J_i$, then $c(\beta) \in J_i$. Consider the description (8.4.1) of $Im(1 + c_*)$; if $\beta \neq c(\beta)$, we have

$$\partial Z_\beta + \partial Z_{c(\beta)} \in \sum_{\alpha \in \Omega} \mathbb{Z}_2 \cdot [\partial Z_\alpha + \partial Z_{c(\alpha)}].$$

Thus for any $i \in \{1, \dots, n\}$ we get

$$\begin{aligned} \mathbb{Z}_2 \cdot ((1 + c_*)(B_i)) + \sum_{\alpha \in \Omega} \mathbb{Z}_2 \cdot [\partial Z_\alpha + \partial Z_{c(\alpha)}] &= \\ \mathbb{Z}_2 \cdot \sum_{\beta \in J_i} [\partial Z_\beta] + \sum_{\alpha \in \Omega} \mathbb{Z}_2 \cdot [\partial Z_\alpha + \partial Z_{c(\alpha)}] &= \\ \mathbb{Z}_2 \cdot \sum_{\beta \in J_i \cap F} [\partial Z_\beta] + \sum_{\alpha \in \Omega} \mathbb{Z}_2 \cdot [\partial Z_\alpha + \partial Z_{c(\alpha)}], \end{aligned}$$

where as above F is the set of fixed elements $\beta \in \Omega$.

We need to determine for all $i \in \{1, \dots, n\}$ the set $J_i \cap F$. Doing so will allow us to prove the following lemma.

Lemma 8.4.2. *If $|I^{1,0}| \neq 0$, the image of $1 + c_*$ is $\sum_{\alpha \in \Omega} \mathbb{Z}_2 \cdot [\partial Z_\alpha + \partial Z_{c(\alpha)}]$.*

If $|I^{1,0}| = 0$,

$$Im(1 + c_*) = \sum_{i \in I^{0,0}} \mathbb{Z}_2 \cdot ((1 + c_*)(B_i)) + \sum_{\alpha \in \Omega} \mathbb{Z}_2 \cdot [\partial Z_\alpha + \partial Z_{c(\alpha)}].$$

Proof. Indeed, as noted in Subsection 8.4.1, there are no fixed points if $|I^{1,0}| \neq 0$.

Let us now consider the case $|I^{1,0}| = 0$.

If $i \in I^{0,0}$, $\beta \in J_i$ for all β such that $\beta_i = 0$, and $\beta \notin J_i$ for all β such that $\beta_i = (d_i - 1)/2$. In particular, $J_i \cap F$ is the set of cardinality $2^{|I^{0,0}|-1}$ of all $\beta \in \Omega$ such that $\beta_i = 0$, $\beta_j \in \{0, d_j/2\}$ if $j \in I^{0,0} - \{i\}$, $\beta_j = 0$ if $j \in I^{0,1}$ and $\beta_j = (d_j - 1)/2$ if $j \in I^{1,1}$.

If $i \in I^{0,1}$, $\beta \in J_i$ for all β such that $\beta_i = 0$. In particular, $J_i \cap F = F$. Remember Lemma 8.4.1; we have $\sum_{\alpha \in \Omega} [\partial Z_\alpha] = 0$ in $H_{n-1}(\mathcal{C}_X)$. Then,

$$\sum_{\alpha \in F} [\partial Z_\alpha] = \sum_{\alpha \in F} [\partial Z_\alpha] + \sum_{\alpha \in \Omega} [\partial Z_\alpha] \subset \sum_{\alpha \in \Omega} [\partial Z_\alpha + \partial Z_{c(\alpha)}].$$

This implies that $\mathbb{Z}_2 \cdot ((1 + c_*)(B_i)) \subset \sum_{\alpha \in \Omega} \mathbb{Z}_2 \cdot [\partial Z_\alpha + \partial Z_{c(\alpha)}]$.

If $i \in I^{1,1}$, $\beta \notin J_i$ for all β such that $\beta_i = (d_i - 1)/2$. In particular, $J_i \cap F = \emptyset$.

Using description (8.4.1) , we can conclude. \square

8.4.4 Rank of $1 + c_*$

Let us compute the rank of $1 + c_*$. We get the following proposition.

Proposition 8.4.3. *If $|I^{1,0}| \neq 0$,*

$$\dim(\text{Im}(1 + c_*)) = \frac{d_1 \dots d_n}{2} - 1.$$

If $|I^{1,0}| = 0$,

$$\dim(\text{Im}(1 + c_*)) = |I^{0,0}| + \frac{d_1 \dots d_n - 2^{|I^{0,0}|}}{2}.$$

Proof. We will first compute the dimension of

$$\sum_{i=1, \dots, n} \mathbb{Z}_2 \cdot ((1 + c_*)(B_i)) + \sum_{\alpha \in \Omega} \mathbb{Z}_2 \cdot [\partial Z_\alpha + \partial Z_{c(\alpha)}]$$

in

$$\left(\bigoplus_{i=1, \dots, n} \mathbb{Z}_2 \cdot B_i \right) \oplus \left(\bigoplus_{\alpha \in \Omega} \mathbb{Z}_2 \cdot [\partial Z_\alpha] \right),$$

then quotient by $\mathbb{Z}_2 \cdot \sum_{\alpha \in \Omega} [\partial Z_\alpha]$ to get the dimension in $H_{n-1}(\mathcal{C}_X)$ (see Lemma 8.4.1).

Denote by $\tilde{\Omega} \subset \Omega$ a set defined as such: for each pair of elements $\{\alpha, c(\alpha)\}$, where $\alpha \in \Omega \setminus F$, choose exactly one element to be included in $\tilde{\Omega}$. Thus $\sum_{\alpha \in \Omega} \mathbb{Z}_2 \cdot [\partial Z_\alpha + \partial Z_{c(\alpha)}] = \sum_{\alpha \in \tilde{\Omega}} \mathbb{Z}_2 \cdot [\partial Z_\alpha + \partial Z_{c(\alpha)}]$. This sum is clearly a direct sum before quotienting.

If $|I^{1,0}| \neq 0$, then $\text{Im}(1 + c_*) = \sum_{\alpha \in \Omega} \mathbb{Z}_2 \cdot [\partial Z_\alpha + \partial Z_{c(\alpha)}] = \sum_{\alpha \in \tilde{\Omega}} \mathbb{Z}_2 \cdot [\partial Z_\alpha + \partial Z_{c(\alpha)}]$. When we quotient by $\mathbb{Z}_2 \cdot \sum_{\alpha \in \Omega} [\partial Z_\alpha]$, the dimension decreases by exactly one, as $\sum_{\alpha \in \Omega} [\partial Z_\alpha] \in \sum_{\alpha \in \tilde{\Omega}} \mathbb{Z}_2 \cdot [\partial Z_\alpha + \partial Z_{c(\alpha)}]$ (since there is no fixed point). Hence

$$\dim(\text{Im}(1 + c_*)) = |\tilde{\Omega}| - 1 = \frac{d_1 \dots d_n}{2} - 1.$$

If $|I^{1,0}| = 0$, we can see that

$$\sum_{i \in I^{0,0}} \mathbb{Z}_2 \cdot ((1 + c_*)(B_i)) + \sum_{\alpha \in \tilde{\Omega}} \mathbb{Z}_2 \cdot [\partial Z_\alpha + \partial Z_{c(\alpha)}]$$

is actually a free sum before quotienting. Indeed, suppose that for each $\alpha \in \tilde{\Omega}$ (respectively, $i \in I^{0,0}$) there is $\lambda_\alpha \in \mathbb{Z}_2$ (respectively, $\lambda_i \in \mathbb{Z}_2$), not all 0, such that

$$\sum_{i \in I^{0,0}} \lambda_i (1 + c_*(B_i)) + \sum_{\alpha \in \tilde{\Omega}} \lambda_\alpha [\partial Z_\alpha + \partial Z_{c(\alpha)}] = 0. \quad (8.4.2)$$

For $i \in I^{0,0}$, consider β defined by $\beta_i = 0$, $\beta_j = d_j/2$ if $j \in I^{0,0} - \{i\}$, $\beta_j = 0$ if $j \in I^{0,1}$ and $\beta_j = (d_j - 1)/2$ if $j \in I^{1,1}$. As explained in the description of $J_i \cap F$ in the proof

of Lemma 8.4.2, the class $[\partial Z_\beta]$ only appears in $((1 + c_*)(B_i))$ among all the terms of equation (8.4.2). Thus λ_i is necessarily 0. We can then conclude from the independence of the family $\{[\partial Z_\alpha + \partial Z_{c(\alpha)}]\}_{\alpha \in \tilde{\Omega}}$ before the quotient that all λ_α are 0, which proves our point.

Consider $\beta \in \Omega$ defined by $\beta_j = d_j/2$ if $j \in I^{0,0}$, $\beta_j = 0$ if $j \in I^{0,1}$ and $\beta_j = (d_j - 1)/2$ if $j \in I^{1,1}$. Since $[\partial Z_\beta]$ appears in $\sum_{\alpha \in \Omega} [\partial Z_\alpha]$ but not in $\sum_{i \in I^{0,0}} \mathbb{Z}_2 \cdot ((1 + c_*)(B_i)) + \sum_{\alpha \in \tilde{\Omega}} \mathbb{Z}_2 \cdot [\partial Z_\alpha + \partial Z_{c(\alpha)}]$ (once again going back to the proof of Lemma 8.4.2), we see that $\sum_{\alpha \in \Omega} [\partial Z_\alpha] \notin \sum_{i \in I^{0,0}} \mathbb{Z}_2 \cdot ((1 + c_*)(B_i)) + \sum_{\alpha \in \tilde{\Omega}} \mathbb{Z}_2 \cdot [\partial Z_\alpha + \partial Z_{c(\alpha)}]$. This means that the dimension of $\sum_{i \in I^{0,0}} \mathbb{Z}_2 \cdot ((1 + c_*)(B_i)) + \sum_{\alpha \in \tilde{\Omega}} \mathbb{Z}_2 \cdot [\partial Z_\alpha + \partial Z_{c(\alpha)}]$ does not decrease when we quotient. Thus

$$\dim(\text{Im}(1 + c_*)) = |I^{0,0}| + |\tilde{\Omega}| = |I^{0,0}| + \frac{|\Omega| - |F|}{2} = |I^{0,0}| + \frac{d_1 \dots d_n - 2^{|I^{0,0}|}}{2},$$

as stated. \square

8.5 Galois maximality

We are still using the notations of the previous sections.

To prove Theorem 8.1.2, we need to compare $\dim_{\mathbb{Z}_2} \left(\frac{\text{Ker}(1+c_*)}{\text{Im}(1+c_*)} \right)$ and $\dim_{\mathbb{Z}_2}(H_*(\mathbb{R}X))$. We consider $H_*(\mathbb{R}X)$ first, with the following lemma.

Lemma 8.5.1. *The real part $\mathbb{R}X \subset (\mathbb{R}^*)^n$ consists of 2^n contractible connected components if $\delta = \delta(\varepsilon) \in \mathbb{Z}_2^n$ is not in the image of $A : \mathbb{Z}_2^n \rightarrow \mathbb{Z}_2^n$, and of $2^n - 2^{n-\text{rank}(A)}$ contractible connected components if it is. Thus $H_*(\mathbb{R}X)$ is of \mathbb{Z}_2 -dimension 2^n if $\delta \notin \text{Im}(A)$ and of \mathbb{Z}_2 -dimension $2^n - 2^{n-\text{rank}(A)}$ if $\delta \in \text{Im}(A)$.*

Proof. Consider the 2^n quadrants of $(\mathbb{R}^*)^n$, and let $\gamma = (\gamma_1, \dots, \gamma_n) \in \{1, -1\}^n$ index the quadrant $Q_\gamma := \{(x_1, \dots, x_n) \in (\mathbb{R}^*)^n \mid x_1 \gamma_1 > 0, \dots, x_n \gamma_n > 0\}$. Consider as in Section 8.3 the real polynomial $P_L(z) = \sum_{i=1, \dots, n} \varepsilon_i c_i z^i + c_0$ associated to $P(z) = \sum_{i=1, \dots, n} \varepsilon_i c_i z^{A_i} + c_0$. Then the map

$$\begin{aligned} \Phi_{A^{-1}} : \quad Q_{(1, \dots, 1)} &\rightarrow Q_{(1, \dots, 1)} \\ z &\mapsto z^{A^{-1}}, \end{aligned}$$

where we extend the notation to include rational exponents, is a well defined homeomorphism that maps $\mathbb{R}X_{P_L} \cap Q_{(1, \dots, 1)}$ to $\mathbb{R}X \cap Q_{(1, \dots, 1)}$. In particular, $\mathbb{R}X \cap Q_{(1, \dots, 1)}$ is empty if $\varepsilon_i = 1$ for all $i \in \{1, \dots, n\}$, and is non-empty and contractible otherwise. Now observe that $\mathbb{R}X \cap Q_\gamma$ is isomorphic to $\mathbb{R}X_{P_\gamma} \cap Q_{(1, \dots, 1)}$, where $P_\gamma(z) := \sum_{i=1, \dots, n} \varepsilon_i \gamma^{A_i} c_i z^{A_i} + c_0$. Since $\delta(\varepsilon_1 \gamma^{A_1}, \dots, \varepsilon_n \gamma^{A_n}) = \delta(\varepsilon) + A \cdot \delta(\gamma)$, we see that $\mathbb{R}X \cap Q_\gamma$ is empty if $\delta(\varepsilon) = A \cdot \delta(\gamma)$, and non-empty and contractible otherwise. \square

The following lemma links the conditions of Theorem 8.1.2, Lemma 8.4.2 and Proposition 8.4.3.

Lemma 8.5.2. *The real part $\mathbb{R}X$ intersects non-trivially each quadrant of $(\mathbb{R}^*)^n$ if and only if $\delta \notin \text{Im}(A)$ if and only if $|I^{1,0}| \neq 0$.*

Proof. The first equivalence comes from Lemma 8.5.1. Then

$$\begin{aligned} \delta \in \text{Im}(A) &\iff \exists x \in \mathbb{Z}_2^n \text{ s.t. } A \cdot x = G^{-1} \cdot D \cdot x = \delta \iff \\ &\exists x \in \mathbb{Z}_2^n \text{ s.t. } D \cdot x = G \cdot \delta = \delta^G \iff \delta^G \in \text{Im}(D) \iff \\ &(\delta^G)_i = 0 \forall i \text{ s.t. } d_i = [0]_2 \iff |I^{1,0}| = 0. \end{aligned}$$

□

We are now ready to prove the main result.

Proof of Theorem 8.1.2. As mentioned at the beginning of Subsection 8.4.2, $1 + c_* : H_k(\mathcal{C}_X) \rightarrow H_k(\mathcal{C}_X)$ is trivial for $k \neq n - 1$. Moreover, we know that $H_k(\mathcal{C}_X)$ is isomorphic to $H_k(T^n)$ for $k \neq n - 1$, and that $\dim(H_{n-1}(\mathcal{C}_X)) = n + d_1 \dots d_n - 1$ (as is shown by Lemma 8.4.1).

Therefore, from Proposition 8.4.3 and Lemmas 8.5.1 and 8.5.2, we see that if $\mathbb{R}X$ intersects non-trivially each quadrant of $(\mathbb{R}^*)^n$,

$$\begin{aligned} \dim \left(\frac{\text{Ker}(1 + c_*)}{\text{Im}(1 + c_*)} \right) &= \dim(H_*(\mathcal{C}_X)) - 2 \dim(\text{Im}(1 + c_*)) = \\ 2^n - 1 + (d_1 \dots d_n - 1) - 2 \left(\frac{d_1 \dots d_n}{2} - 1 \right) &= 2^n = \dim(H_*(\mathbb{R}X)). \end{aligned}$$

Otherwise, we have by definition of the sets $I^{\pm 1, \pm 1}$ in Section 8.3 that $\text{rank}_{\mathbb{Z}_2}(\Delta_P) = \text{rank}_{\mathbb{Z}_2}(A) = |I^{0,1}| + |I^{1,1}| = n - |I^{0,0}|$ (since $|I^{1,0}| = 0$) and

$$\begin{aligned} \dim \left(\frac{\text{Ker}(1 + c_*)}{\text{Im}(1 + c_*)} \right) &= \dim(H_*(\mathcal{C}_X)) - 2 \dim(\text{Im}(1 + c_*)) = \\ 2^n - 1 + (d_1 \dots d_n - 1) - 2 \left(|I^{0,0}| + \frac{d_1 \dots d_n - 2|I^{0,0}|}{2} \right) &= \\ 2^n - 2 - 2(n - \text{rank}_{\mathbb{Z}_2}(A)) + 2^{n - \text{rank}_{\mathbb{Z}_2}(A)}, \end{aligned}$$

hence

$$\begin{aligned} \dim \left(\frac{\text{Ker}(1 + c_*)}{\text{Im}(1 + c_*)} \right) - \dim(H_*(\mathbb{R}X)) &= \\ 2^n - 2 - 2(n - \text{rank}_{\mathbb{Z}_2}(A)) + 2^{n - \text{rank}_{\mathbb{Z}_2}(A)} - (2^n - 2^{n - \text{rank}(A)}) &= \\ 2(2^{n - \text{rank}_{\mathbb{Z}_2}(A)} - 1 - (n - \text{rank}_{\mathbb{Z}_2}(A))). \end{aligned}$$

This ends the proof.

□

Chapter 9

Additional constraints on the topology of hypersurfaces obtained by combinatorial patchworking

9.1 Chapter introduction

This last chapter is a continuation of Chapter 4, and we retain the same assumptions and notations. Rather than completed results, we explain here what we think might be potential ways to make use of the constructions detailed in Chapter 4, in particular the bound from Formula (4.5.2), which we restate:

$$\dim_{\mathbb{Z}_2} H_q(\mathbb{R}X_t; A) \leq \sum_p \dim_{\mathbb{Z}_2} H_q(X; E_p^{\infty, K^a}). \quad (9.1.1)$$

As explained in the Introduction, there is a principle of sorts that suggests that the q -th Betti number of the real part of an n -dimensional real algebraic variety X should be expected to be bounded by the $(q, n - q)$ -th Hodge number of $\mathbb{C}X$ (possibly with some small correction). Viro's conjecture, which was mentioned in Chapter 4, exemplifies this principle.

Of course, this principle, in general, is wrong, and by a large margin, as shown in Chapter 6. However, it does hold under certain constraints, such as when X is a non-singular hypersurface in a suitable toric variety obtained by primitive combinatorial patchworking, in which case Formula (4.5.4) does state that $b_q(\mathbb{R}X) \leq h^{q, n-1-q}(\mathbb{C}X) + 1 - \delta_{i, \frac{n-1}{2}}$. It is natural, then, to try to relax slightly that condition.

We call a convex triangulation of an integer polytope Δ *maximal* if the only integer points contained in any simplex of the triangulation are its vertices. Note that this is not related to the definition of a maximal real algebraic variety.

In ambient dimension 3, Itenberg showed in [Ite97] that if X_t is a real projective

algebraic surface obtained via patchworking using a maximal triangulation, then

$$b_1(\mathbb{R}X_t) \leq h^{1,1}(\mathbb{C}X_t).$$

Moreover, the principle still holds for $b_0(\mathbb{R}X_t)$, up to a correction, as we have

$$b_0(\mathbb{R}X_t) \leq 1 + h^{0,2}(\mathbb{C}X_t) + N_8,$$

with N_8 being the number of 3-dimensional simplices Γ in the triangulation such that $V_{(\mathbb{R}^*)^3}(Q_\Gamma)$ has 8 connected components (where Q_Γ is one of the polynomials being patchworked and Γ is its Newton polytope).

A correction is indeed necessary, as the following example shows that the bound $b_0(\mathbb{R}X_t) \leq 1 + h^{0,n-1}(\mathbb{C}X_t)$ fails in all dimensions $n \geq 3$ for maximal triangulations.

Example 9.1.1. Consider the standard simplex $\Delta \subset \mathbb{R}^n$ of side length n in dimension n (for $n \geq 3$), and the point $P := (1, \dots, 1, 0) \in \Delta$. For each $\epsilon = (\epsilon_1, \dots, \epsilon_{n-1}) \in \{1, -1\}^{n-1}$, consider the $(n - 1)$ -dimensional simplex

$$\Delta_\epsilon := \text{Conv}(P, P + e_1\epsilon_1, \dots, P + e_{n-1}\epsilon_{n-1}),$$

where e_i is the i -th vector of the canonical basis of \mathbb{R}^n . Let T be a maximal triangulation of Δ containing the n -dimensional simplices $\tilde{\Delta}_\epsilon := \text{Conv}((0, \dots, 0, 2), \Delta_\epsilon)$ (for each $\epsilon \in \{1, -1\}^{n-1}$), and choose a sign distribution on $\Delta \cap \mathbb{Z}^n$ such that each vertex of each simplex $\tilde{\Delta}_\epsilon$ has sign $+$, except P , whose sign is $-$. This is illustrated in Figure 9.1. Let also $(0, 0, 3)$ have sign $-$. By applying combinatorial patchworking to this construction, we get a hypersurface Y in \mathbb{P}^n such that $\mathbb{R}Y$ has at least two connected components: one is a sphere "around P ", and one passes "in between $(0, 0, 2)$ and $(0, 0, 3)$ " (see Section 2.3); hence $b_0(\mathbb{R}Y) \geq 2$. On the other hand, one can see (with Formula (6.2.1)) that $h^{0,n-1}(\mathbb{C}Y) = 0$. Thus, $b_0(\mathbb{R}Y) > 1 + h^{0,n-1}(\mathbb{C}Y)$.

Example 9.1.1 shows that the bounds from the primitive case might not hold under looser conditions. Let us look once more at Diagram 4.5.3, which we display again:

$$\begin{array}{ccc} C_q(X; \mathbb{C}\mathcal{U}_p^{\mathbb{Z}_2}) & \xrightarrow{\sim LS} & H_q(X; \mathbb{C}\mathcal{U}_p^{\mathbb{Z}_2}) \xrightarrow[\Sigma_{p+q=l}]{LS} H_l(\mathbb{C}X_t; \mathbb{Z}_2) \\ & \downarrow \text{Ka} & \\ C_q(X; \frac{Ker(1+c_*)}{Im(1+c_*)}) & & \\ & \downarrow \text{Ka} & \\ C_q(X; E_p^{\infty, Ka}) & \xrightarrow{\sim HA} & H_q(X; E_p^{\infty, Ka}) \xrightarrow[\Sigma_p]{HA} H_q(\mathbb{R}X_t; \mathbb{Z}_2) \end{array} \tag{9.1.2}$$

We see that the two main obstacles to connecting the homology of $\mathbb{R}X_t$ to that of $\mathbb{C}X_t$ are understanding the passage from $H_q(X; \mathbb{C}\mathcal{U}_p^{\mathbb{Z}_2})$ to $H_*(\mathbb{C}X_t; \mathbb{Z}_2)$, *i.e.* the Leray-Serre

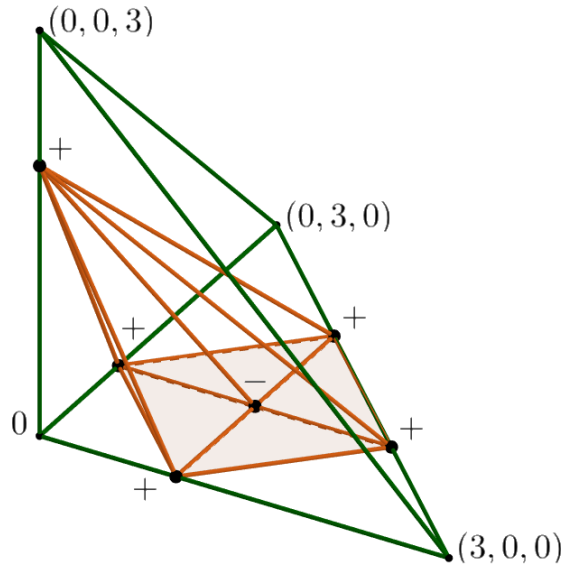

Figure 9.1: Construction from Example 9.1.1 in dimension $n = 3$.

spectral sequence of $\mathbb{C}X_t$, and relating $H_q(X; \mathbb{C}\mathcal{U}_p^{\mathbb{Z}_2})$ and $H_q(X; E_p^{\infty, K^a})$.

One could directly try to adapt classical degeneration results to our special type of Leray-Serre spectral sequence, or compare $H_q(X; \mathbb{C}\mathcal{U}_p^{\mathbb{Z}_2})$ and $H_q(X; E_p^{\infty, K^a})$, for example using generalized spectral sequences (see [Mat13]).

The primitive case also suggests the use of three types of tools: the first type would be Lefschetz-like theorems regarding the homology of various cosheaves (in particular $\mathbb{C}\mathcal{U}_p^{\mathbb{Z}_2}$ and E_p^{∞, K^a}) on X , in the same spirit as Section 7.3, though a similar proof might not work (as it is not clear which cosheaf to choose on the ambient space in order to make a comparison). Poincaré duality theorems for those cosheaves would also prove useful. The only statements that we have for now require the triangulation to be primitive, but it might be possible to adapt them. Finally, one can compare various Euler characteristics, such as that of the complex $C_\bullet(X; \mathbb{C}\mathcal{U}_p^{\mathbb{Z}_2})$, as in Section 7.5.

We look at surfaces in ambient dimension 3 in Section 9.2 for inspiration, and discuss what could be done in higher dimension in Section 9.3.

9.2 The case of surfaces

We consider, as Itenberg did in [Ite97], the case of a maximal triangulation T of the standard 3-dimensional simplex Δ of side length d .

Given a simplex Γ with integer vertices (not necessarily in ambient dimension 3), let O be any of its vertices, and consider the vectors corresponding to the edges of Γ containing O (and having O as their origin). Let A be the matrix with coefficients in \mathbb{Z}_2 whose lines

are those vectors modulo 2, and define the rank of the simplex as the rank of A .

Maximal triangulations have the special property, in ambient dimension 3, that each of their simplex Γ of dimension strictly less than 3 has rank equal to its dimension. This also means that simplices of dimension 3 are of rank at least 2. In particular, if Conjecture 8.1.1 does hold, then Theorem 8.1.3 immediately implies that each space O_σ is Galois maximal (in fact, this can also be proved directly).

We get that $E_p^{\infty, Ka}$ is isomorphic as a cosheaf to $\sigma \mapsto \frac{Ker(1+c_*:H_p(\mathbb{C}O_\sigma; \mathbb{Z}_2) \rightarrow H_p(\mathbb{C}O_\sigma; \mathbb{Z}_2))}{Im(1+c_*:H_p(\mathbb{C}O_\sigma; \mathbb{Z}_2) \rightarrow H_p(\mathbb{C}O_\sigma; \mathbb{Z}_2))}$ for any p , and that it is isomorphic as a cosheaf to $\mathbb{C}\mathcal{U}_p^{\mathbb{Z}_2}$ for $p = 0, 1$. Moreover, $E_2^{\infty, Ka}(\sigma) = \frac{Ker(1+c_*:H_2(\mathbb{C}O_\sigma; \mathbb{Z}_2) \rightarrow H_2(\mathbb{C}O_\sigma; \mathbb{Z}_2))}{Im(1+c_*:H_2(\mathbb{C}O_\sigma; \mathbb{Z}_2) \rightarrow H_2(\mathbb{C}O_\sigma; \mathbb{Z}_2))}$ is isomorphic as a group to $\mathbb{C}\mathcal{U}_2^{\mathbb{Z}_2}(\sigma)$ for σ in X of dimension 1 or 2.

Hence the trios of complexes

$$0 \longrightarrow C_2(X; E_2^{\infty, Ka}) \longrightarrow C_1(X; E_2^{\infty, Ka}) \longrightarrow C_0(X; E_2^{\infty, Ka}) \longrightarrow 0$$

$$0 \longrightarrow C_2(X; E_1^{\infty, Ka}) \longrightarrow C_1(X; E_1^{\infty, Ka}) \longrightarrow C_0(X; E_1^{\infty, Ka}) \longrightarrow 0$$

$$0 \longrightarrow C_2(X; E_0^{\infty, Ka}) \longrightarrow C_1(X; E_0^{\infty, Ka}) \longrightarrow C_0(X; E_0^{\infty, Ka}) \longrightarrow 0$$

and

$$0 \longrightarrow C_2(X; \mathbb{C}\mathcal{U}_2^{\mathbb{Z}_2}) \longrightarrow C_1(X; \mathbb{C}\mathcal{U}_2^{\mathbb{Z}_2}) \longrightarrow C_0(X; \mathbb{C}\mathcal{U}_2^{\mathbb{Z}_2}) \longrightarrow 0$$

$$0 \longrightarrow C_2(X; \mathbb{C}\mathcal{U}_1^{\mathbb{Z}_2}) \longrightarrow C_1(X; \mathbb{C}\mathcal{U}_1^{\mathbb{Z}_2}) \longrightarrow C_0(X; \mathbb{C}\mathcal{U}_1^{\mathbb{Z}_2}) \longrightarrow 0$$

$$0 \longrightarrow C_2(X; \mathbb{C}\mathcal{U}_0^{\mathbb{Z}_2}) \longrightarrow C_1(X; \mathbb{C}\mathcal{U}_0^{\mathbb{Z}_2}) \longrightarrow C_0(X; \mathbb{C}\mathcal{U}_0^{\mathbb{Z}_2}) \longrightarrow 0$$

are the same, except for the upper right entry, where $C_0(X; E_2^{\infty, Ka}) \cong C_0(X; \frac{Ker(1+c_*)}{Im(1+c_*)})$.

It can be directly shown that $H_0(X; \mathbb{C}\mathcal{U}_1^{\mathbb{Z}_2}) = 0$. Considering the direction of the morphisms of the Leray-Serre spectral sequence, and computing the Euler characteristic of the complex $C_\bullet(X; \mathbb{C}\mathcal{U}_2^{\mathbb{Z}_2})$, we find that the dimensions of the groups $H_q(X; \mathbb{C}\mathcal{U}_p^{\mathbb{Z}_2})$ (*i.e.* the homology of the second trio of complexes, displayed in the same order) are

1	0	$h^{0,2}(\mathbb{C}X_t) + (d^3 - N_S)$
a	$h^{1,1}(\mathbb{C}X_t) - (d^3 - N_S) + a$	0
$h^{2,0}(\mathbb{C}X_t)$	0	1

where N_S is the total number of 3-dimensional simplices in the triangulation T and $a := \dim_{\mathbb{Z}_2} H_2(X; \mathcal{CU}_1^{\mathbb{Z}_2})$. Note that as $h^{1,1}(\mathbb{C}X_t)$ is a polynomial in d whose dominant monomial is $\frac{2}{3}d^3$, and as $h^{1,1}(\mathbb{C}X_t) - (d^3 - N_S) + a \geq 0$, this means that if we can find a triangulation such that N_S is significantly smaller than $\frac{1}{3}d^3$ and d large enough (which does not seem particularly hard), the associated number a is nonzero and we have found an example of nondegeneracy of the Leray-Serre spectral sequence on the second page.

Similarly, the dimensions of the groups $H_q(X; E_p^{\infty, K^a})$ (*i.e.* the homology of the first trio of complexes, displayed in the same order) are

$$\begin{array}{ccc}
 1 & b & h^{0,2}(\mathbb{C}X_t) + (d^3 - N_S) + b - 2c \\
 \\
 a & h^{1,1}(\mathbb{C}X_t) - (d^3 - N_S) + a & 0 \\
 \\
 h^{2,0}(\mathbb{C}X_t) & 0 & 1
 \end{array}$$

where $b := \dim_{\mathbb{Z}_2} H_1(X; E_2^{\infty, K^a})$ and $c = \sum_{\dim \sigma=0} \dim_{\mathbb{Z}_2} (Im(1 + c_* : H_2(\mathbb{C}O_\sigma; \mathbb{Z}_2) \rightarrow H_2(\mathbb{C}O_\sigma; \mathbb{Z}_2)))$; this comes from the fact that we have replaced $C_0(X; \mathcal{CU}_2^{\mathbb{Z}_2})$ by its subquotient $C_0(X; E_2^{\infty, K^a}) = C_0(X; \frac{Ker(1+c_*)}{Im(1+c_*)})$. In particular, we have

$$b = \dim_{\mathbb{Z}_2} \left(Im(C_1(X; \mathcal{CU}_2^{\mathbb{Z}_2}) \rightarrow C_0(X; \mathcal{CU}_2^{\mathbb{Z}_2})) \cap C_0(X; Im(1 + c_*)) \right)$$

We can see (using the Galois maximality of the spaces O_σ) that $c = \frac{1}{2}(d^3 - 2N_S + N_7 + 2N_6)$, with N_7 (respectively, N_6) being the number of 3-dimensional simplices Γ in the triangulation such that $V_{(\mathbb{R}^*)^3}(Q_\Gamma)$ has 7 (respectively, 6) connected components (where Q_Γ is one of the polynomials being patchworked and Γ is its Newton polytope). Hence $d^3 - N_S - 2c = N_S - N_7 - 2N_6 = N_8 - N_6$ (as $N_S = N_6 + N_7 + N_8$).

Furthermore, we can use for each σ of dimension 0 arguments similar to those from Chapter 8 to show that $b \leq N_6$.

Hence, using Formula (9.1.1), we find that

$$\begin{aligned}
 b_0(\mathbb{R}X_t) &\leq \sum_p \dim_{\mathbb{Z}_2} H_q(X; E_p^{\infty, K^a}) = 1 + h^{0,2}(\mathbb{C}X_t) + (d^3 - N_S) + b - 2c \\
 &\leq 1 + h^{0,2}(\mathbb{C}X_t) + N_8.
 \end{aligned}$$

We have recovered the bound from [Ite97].

It also seems possible to show that under the same assumptions, $b \leq H_1(X; \mathcal{F}_2^{\mathbb{Z}_2})$ and $a = H_2(X; \mathcal{F}_1^{\mathbb{Z}_2})$, where $\mathcal{F}_p^{\mathbb{Z}_2}$ is the usual p -th pointy tropical homology cosheaf, which

would then yield

$$b_1(\mathbb{R}X_t) \leq h^{1,1}(\mathbb{C}X_t) - (d^3 - N_S) + H_1(X; \mathcal{F}_2^{\mathbb{Z}_2}) + H_2(X; \mathcal{F}_1^{\mathbb{Z}_2}).$$

Whether that bound is better or worse than the one from [Ite97] is not entirely clear.

9.3 Higher dimensions

It is not immediately clear how to generalize the case of a maximal triangulation in ambient dimension 3 to higher dimensions. Asking that the triangulation be maximal does not seem to give us any directly useful property.

Looking at what we actually made use of in dimension 3, we might want to consider *quasi-primitive* triangulations, *i.e.* triangulations such that every simplex, except possibly the top-dimensional ones, is of rank equal to its dimension.

As in dimension $n = 3$, we would have that $E_p^{\infty, Ka}$ is isomorphic as a cosheaf to $\sigma \mapsto \frac{Ker(1+c_*:H_p(\mathbb{C}O_\sigma; \mathbb{Z}_2) \rightarrow H_p(\mathbb{C}O_\sigma; \mathbb{Z}_2))}{Im(1+c_*:H_p(\mathbb{C}O_\sigma; \mathbb{Z}_2) \rightarrow H_p(\mathbb{C}O_\sigma; \mathbb{Z}_2))}$ for any p , and that it is isomorphic as a cosheaf to $\mathcal{C}U_p^{\mathbb{Z}_2}$ for $p < n - 1$. Moreover, $E_{n-1}^{\infty, Ka}(\sigma) = \frac{Ker(1+c_*:H_{n-1}(\mathbb{C}O_\sigma; \mathbb{Z}_2) \rightarrow H_{n-1}(\mathbb{C}O_\sigma; \mathbb{Z}_2))}{Im(1+c_*:H_{n-1}(\mathbb{C}O_\sigma; \mathbb{Z}_2) \rightarrow H_{n-1}(\mathbb{C}O_\sigma; \mathbb{Z}_2))}$ is isomorphic as a group to $\mathcal{C}U_{n-1}^{\mathbb{Z}_2}(\sigma)$ for σ in X of dimension strictly greater than 0.

Using Formula (9.1.1), we would then get

$$b_q(\mathbb{R}X_t) \leq \sum_p \dim_{\mathbb{Z}_2} H_q(X; \mathcal{C}U_p^{\mathbb{Z}_2})$$

for all $q < n - 2$, and

$$b_q(\mathbb{R}X_t) \leq \sum_p \dim_{\mathbb{Z}_2} H_q(X; \mathcal{C}U_p^{\mathbb{Z}_2}) + b$$

for $q \in \{n - 2, n - 1\}$ and some correction b (which can be bounded as in dimension 3). However, there is no immediately evident way to relate the terms $H_q(X; \mathcal{C}U_p^{\mathbb{Z}_2})$ on the second page of the Leray-Serre spectral sequence to the homology of $\mathbb{C}X_t$.

A more natural and less restrictive condition on the triangulation might be to ask that each space O_σ be Galois maximal; if Conjecture 8.1.1 holds, Theorem 8.1.3 gives us an exact criterion for Galois maximality - it was, in fact, the main motivation behind that result.

This makes the situation slightly more complicated, as we now have that $E_p^{\infty, Ka}$ is isomorphic as a cosheaf to $\sigma \mapsto \frac{Ker(1+c_*:H_p(\mathbb{C}O_\sigma; \mathbb{Z}_2) \rightarrow H_p(\mathbb{C}O_\sigma; \mathbb{Z}_2))}{Im(1+c_*:H_p(\mathbb{C}O_\sigma; \mathbb{Z}_2) \rightarrow H_p(\mathbb{C}O_\sigma; \mathbb{Z}_2))}$. Moreover, $E_q^{\infty, Ka}(\sigma) = \frac{Ker(1+c_*:H_q(\mathbb{C}O_\sigma; \mathbb{Z}_2) \rightarrow H_q(\mathbb{C}O_\sigma; \mathbb{Z}_2))}{Im(1+c_*:H_q(\mathbb{C}O_\sigma; \mathbb{Z}_2) \rightarrow H_q(\mathbb{C}O_\sigma; \mathbb{Z}_2))}$ is isomorphic as a group to $\mathcal{C}U_q^{\mathbb{Z}_2}(\sigma)$ for any σ in X and q such that $q < n - 1 - \dim(\sigma)$ (and in fact, for any σ in X and q such that $\dim(\sigma) = n$ as well). Hence, not only do we need to understand the homology of the cosheaves $\mathcal{C}U_p^{\mathbb{Z}_2}$, but also that of the cosheaves $\sigma \mapsto \frac{Ker(1+c_*:H_p(\mathbb{C}O_\sigma; \mathbb{Z}_2) \rightarrow H_p(\mathbb{C}O_\sigma; \mathbb{Z}_2))}{Im(1+c_*:H_p(\mathbb{C}O_\sigma; \mathbb{Z}_2) \rightarrow H_p(\mathbb{C}O_\sigma; \mathbb{Z}_2))}$ in order to make use of Formula (9.1.1).

Besides computing Euler characteristics and trying to prove Lefschetz- or Poincaré duality-inspired theorems regarding those cosheaves, as suggested in Section 9.1, one could also try comparing the round and pointy tropical cosheaves $\mathbb{C}\mathcal{U}_p^{\mathbb{Z}_2}$ and $\mathcal{F}_p^{\mathbb{Z}_2}$. They cannot be expected to be isomorphic when the triangulation is not primitive, but given a cell σ , they both seem to be related to the homology of the ambient space $(\mathbb{C}^*)^n$ of $\mathbb{C}O_\sigma$ - $\mathbb{C}\mathcal{U}_p^{\mathbb{Z}_2}(\sigma) = H_p(\mathbb{C}O_\sigma; \mathbb{Z}_2)$ via the classical Lefschetz section theorem, and $\mathcal{F}_p^{\mathbb{Z}_2}$ by definition (via some identification $H_p((\mathbb{C}^*)^n; \mathbb{Z}) \cong \bigwedge^p \mathbb{Z}^n$).

Bibliography

- [AB14] Karim Alexander Adiprasito and Anders Björner. Filtered geometric lattices and lefschetz section theorems over the tropical semiring. *arXiv preprint arXiv:1401.7301*, 2014.
- [Arn17] Charles Arnal. Patchwork combinatoire et topologie d’hypersurfaces algébriques réelles. Master’s Thesis, École Normale Supérieure, 2017.
- [ARS19] Charles Arnal, Arthur Renaudineau, and Kristin Shaw. Lefschetz section theorems for tropical hypersurfaces. *arXiv preprint arXiv:1907.06420*, 2019.
- [Ati81] Michael Atiyah. Convexity and commuting hamiltonians. *Bull. London Math. Soc.*, 14:1–15, 1981.
- [Bak18] Matthew Baker. Hodge theory in combinatorics. *Bulletin (New Series) of the American Mathematical Society*, 55(1), 2018.
- [BB07] Benoît Bertrand and Frédéric Bihan. Euler characteristic of real nondegenerate tropical complete intersections. *arXiv preprint arXiv:0710.1222v2*, 2007.
- [Ber06] Benoit Bertrand. Asymptotically maximal families of hypersurfaces in toric varieties. *J. Inst. Math. Jussieu*, 118:49–70, 2006.
- [Ber10] Benoit Bertrand. Euler characteristic of primitive T -hypersurfaces and maximal surfaces. *J. Inst. Math. Jussieu*, 9(1):1–27, 2010.
- [Bih02] Frédéric Bihan. Viro method for the construction of real complete intersections. *Advances in Mathematics*, 169(2):177–186, 2002.
- [Bih03] Frédéric Bihan. Asymptotic behaviour of Betti numbers of real algebraic surfaces. *Commentarii Mathematici Helvetici*, 78(2):227–244, 2003.
- [BIMS15] Erwan Brugallé, Ilia Itenberg, Grigory Mikhalkin, and Kristin Shaw. Brief introduction to tropical geometry. In *Proceedings of the Gökova Geometry-Topology Conference 2014*, pages 1–75. Gökova Geometry/Topology Conference (GGT), Gökova, 2015.

- [Bru06] Erwan Brugallé. Real plane algebraic curves with asymptotically maximal number of even ovals. *Duke Math. J.*, 131(3):575–587, 2006.
- [CK15] Yunhi Cho and Seonhwa Kim. Volume of hypercubes clipped by hyperplanes and combinatorial identities. *The electronic journal of linear algebra*, 36, 2015.
- [Cur13] Justin Curry. Sheaves, cosheaves and applications. <https://arxiv.org/abs/1303.3255>, 2013.
- [Cur14] Justin Michael Curry. *Sheaves, cosheaves and applications*. ProQuest LLC, Ann Arbor, MI, 2014. Thesis (Ph.D.)—University of Pennsylvania.
- [dCMM18] Mark Andrea de Cataldo, Luca Migliorini, and Mircea Mustață. Combinatorics and topology of proper toric maps. *Journal für die reine und angewandte Mathematik (Crelles Journal)*, 2018(744):133–163, 2018.
- [Deg92] A. Degtyarev. Stiefel orientations on a real algebraic variety. *Proc. of the Rennes Conf. on Real Alg. Geom.*, pages 205–220, 1992.
- [DIK00] Alexander Degtyarev, Ilia Itenberg, and Viatcheslav Kharlamov. *Real Enriques Surfaces*, volume 1746 of *Lecture Notes in Mathematics*. Springer, 2000.
- [DK86] V. I. Danilov and A. G. Khovanskiĭ. Newton polyhedra and an algorithm for calculating Hodge-Deligne numbers. *Izv. Akad. Nauk SSSR Ser. Mat.*, 50(5):925–945, 1986.
- [DK00] A. I. Degtyarev and V. M. Kharlamov. Topological properties of real algebraic varieties: Du cote de chez Rokhlin. *Uspekhi Mat. Nauk*, 55(4(334)):129–212, 2000.
- [Eyr04] Christophe Eyrat. Topology of quasi-projective varieties and lefschetz theory. *New Zealand Journal of Mathematics*, 33:63–81, 2004.
- [FF16] A. Fomenko and D. Fuchs. *Homotopical Topology*, volume 273 of *Graduate Texts in Mathematics*. Springer International Publishing, 2016.
- [Ful93] William Fulton. *Introduction to toric varieties*, volume 131 of *Annals of Mathematics Studies*. Princeton University Press, Princeton, NJ, 1993. The William H. Roever Lectures in Geometry.
- [GKZ94] I. Guelfand, M Kapranov, and A. Zelevinsky. *Discriminants, resultants and multidimensional determinants*. Birkhäuser, 1994.
- [GS19] Andreas Gross and Farbod Shokrieh. Sheaf-theoretic approach to tropical homology. *arxiv preprint: arXiv:1906.09245*, 2019.

- [Hat02] Allen Hatcher. *Algebraic topology*. Cambridge University Press, Cambridge, 2002.
- [IKMZ16] Ilia Itenberg, Ludmil Katzarkov, Grigory Mikhalkin, and Ilia Zharkov. Tropical homology. *arXiv preprint arXiv:1604.01838*, 2016.
- [IMS09] Ilia Itenberg, Grigory Mikhalkin, and Eugenio Shustin. *Tropical Algebraic Geometry*, volume 35 of *Oberwolfach Seminars*. Birkhauser Basel, 2009.
- [IS03] Ilia Itenberg and Eugenio Shustin. Critical points of real polynomials and topology of real algebraic T-surfaces. *Geometriae Dedicata*, 101(1):61–91, 2003.
- [Ite93] Ilia Itenberg. Contre-exemples à la conjecture de Ragsdale. *C. R. Acad. Sci. Paris Sér. I Math.*, 317(3):277–282, 1993.
- [Ite97] Ilia Itenberg. Topology of real algebraic T-surfaces. *Rev. Mat. Univ. Complut. Madrid*, 10(Special Issue, suppl.):131–152, 1997. Real algebraic and analytic geometry (Segovia, 1995).
- [Ite17] Ilia Itenberg. Tropical homology and betti numbers of real algebraic varieties. <http://users.math.yale.edu/~sp547/pdf/Itenberg-Simons2017.pdf>, 2017.
- [IV96] Ilia Itenberg and Oleg Viro. Patchworking algebraic curves disproves the Ragsdale conjecture. *Math. Intelligencer*, 18:19–28, 1996.
- [IV07] Ilia Itenberg and Oleg Viro. Asymptotically maximal real algebraic hypersurfaces of projective space. In *Proceedings of Gökova Geometry-Topology Conference 2006*, pages 91–105. Gökova Geometry/Topology Conference (GGT), Gökova, 2007.
- [JRS17] Philipp Jell, Johannes Rau, and Kristin Shaw. Lefschetz (1,1)-theorem in tropical geometry. To appear in *Épjournal de Géométrie Algébrique*, <https://arxiv.org/abs/1711.07900>, 2017.
- [JSS15] Philipp Jell, Jascha Smacka, and Kristin Shaw. Superforms, tropical cohomology and Poincaré duality. To appear in *Advances in Geometry*, <https://arxiv.org/abs/1512.07409>, 2015.
- [Kal92] IO Kalinin. Cohomological characteristics of real projective hypersurfaces. *St. Petersburg Mathematical Journal*, 3(2):313–332, 1992.
- [Kal05] IO Kalinin. Cohomology of real algebraic varieties. *Journal of Mathematical Sciences*, 131(1):5323–5344, 2005.
- [Kho77] A. G. Khovanskii. Newton polyhedra, and toroidal varieties. *Funkcional. Anal. i Priložen.*, 11(4):56–64, 96, 1977.

- [Kra84] Vyacheslav Krasnov. Harnack-Thom inequalities for mappings of real algebraic varieties. *Mathematics of the USSR-Izvestiya*, 22(2), 1984.
- [KS16] E. Katz and A. Stapledon. Tropical geometry, the motivic nearby fiber, and limit mixed Hodge numbers of hypersurfaces. *Res Math Sci*, 3, 2016.
- [KZ16] Gabriel Kerr and Ilia Zharkov. Phase tropical hypersurfaces. *arXiv preprint arXiv:1610.05290*, 2016.
- [Mat13] Benjamin Matschke. Successive spectral sequences. *arXiv preprint arXiv:1308.3187*, 2013.
- [Mez19] Istvan Mez. *Combinatorics and Number Theory of Counting Sequences*. Discrete Mathematics and Its Applications. CRC Press, 2019.
- [Mik04] Grigory Mikhalkin. Decomposition into pairs-of-pants for complex algebraic hypersurfaces. *Topology*, 43(5):1035–1065, 2004.
- [Mik06] Grigory Mikhalkin. Tropical geometry and its applications. *International Congress of Mathematicians*, 2:827–852, 2006.
- [MPP19] Stephen Melczer, Greta Panova, and Robin Pemantle. Counting partitions inside a rectangle. *arXiv preprint arXiv:1805.08375*, 2019.
- [MR] Grigory Mikhalkin and Johannes Rau. Tropical geometry. https://www.math.uni-tuebingen.de/user/jora/index_en.html.
- [MS15] Diane Maclagan and Bernd Sturmfels. *Introduction to tropical geometry*, volume 161 of *Graduate Studies in Mathematics*. American Mathematical Society, Providence, RI, 2015.
- [MZ14] Grigory Mikhalkin and Ilia Zharkov. Tropical eigenwave and intermediate Jacobians. In *Homological mirror symmetry and tropical geometry*, volume 15 of *Lect. Notes Unione Mat. Ital.*, pages 309–349. Springer, Cham, 2014.
- [OT92] Peter Orlik and Hiroaki Terao. *Arrangements of hyperplanes*, volume 300 of *Grundlehren der Mathematischen Wissenschaften [Fundamental Principles of Mathematical Sciences]*. Springer-Verlag, Berlin, 1992.
- [Pol13] G. Polya. Berechnung eines bestimmten integrals. *Math. Ann.*, 74:204–212, 1913.
- [Rag04] Virginia Ragsdale. *On the arrangement of the real branches of a plan algebraic curves*. ProQuest LLC, Ann Arbor, MI, 1904. Thesis (Ph.D.)—Bryn Mawr College.

- [Ren15] Arthur Renaudineau. *Constructions of real algebraic surfaces*. PhD thesis, IMJ-PRG - Institut de Mathématiques de Jussieu - Paris Rive Gauche, 2015.
- [RS18] Arthur Renaudineau and Kristin Shaw. Bounding the betti numbers of real hypersurfaces near the tropical limit. *arXiv preprint arXiv: arXiv:1805.02030*, 2018.
- [Rza08] Grzegorz Rządowski. Derivatives and Eulerian numbers. *The American Mathematical Monthly*, 115(5):458–460, 2008.
- [Sha93] Shapiro. The mixed hodge structure of the complement to an arbitrary arrangement of affine complex hyperplanes is pure. *Proc. Amer. Math. Soc.*, pages 93–32045, 1993.
- [Stu94] Bernd Sturmfels. Viro’s theorem for complete intersections. *Ann. Scuola Norm. Sup. Pisa*, 4(21):377–386, 1994.
- [SW14] Adrien Saumard and Jon A. Wellner. Log-concavity and strong log-concavity: A review. *Statist. Surv.*, 8:45–114, 2014.
- [Tao] Terence Tao. Blog entry 275a, notes 5: Variants of the central limit theorem. <https://terrytao.wordpress.com/2015/11/19/275a-notes-5-variants-of-the-central-limit-theorem/>.
- [Vir80] Oleg Viro. Curves of degree 7, curves of degree 8 and the Ragsdale conjecture. *Dokl. Akad. Nauk SSSR*, 254(6):1306–1310, 1980.
- [Vir06] Oleg Viro. Patchworking real algebraic varieties. *arXiv preprint arXiv:math/0611382*, 2006.
- [Voi07] Claire Voisin. *Hodge theory and complex algebraic geometry. II*, volume 77 of *Cambridge Studies in Advanced Mathematics*. Cambridge University Press, Cambridge, English edition, 2007.
- [Wil78] George Wilson. Hilbert’s sixteenth problem. *Topology*, 17(1):53–73, 1978.
- [XW11] Yan Xu and Ren-Hong Wang. Asymptotic properties of B-splines, Eulerian numbers and cube slicing. *Journal of Computational and Applied Mathematics*, 236(5):988–995, 2011.
- [Zha13] Ilia Zharkov. The Orlik-Solomon algebra and the Bergman fan of a matroid. *J. Gökova Geom. Topol. GGT*, 7:25–31, 2013.